

# Keysight X-Series Signal Analyzer

This manual provides documentation for the following

X-Series Analyzers:

PXA Signal Analyzer N9030A

MXA Signal Analyzer N9020A

EXA Signal Analyzer N9010A

CXA Signal Analyzer N9000A

N9076A & W9076A

1xEV-DO

Measurement

Application User's

and Programmer's

Reference

## Notices

© Keysight Technologies, Inc.  
2008-2014

No part of this manual may be reproduced in any form or by any means (including electronic storage and retrieval or translation into a foreign language) without prior agreement and written consent from Keysight Technologies, Inc. as governed by United States and international copyright laws.

### Manual Part Number

N9076-90003

### Edition

August 2014

Printed in USA

Keysight Technologies, Inc.  
1400 Fountaingrove Parkway  
Santa Rosa, CA 95403

### Warranty

The material contained in this document is provided “as is,” and is subject to being changed, without notice, in future editions. Further, to the maximum extent permitted by applicable law, Keysight disclaims all warranties, either express or implied, with regard to this manual and any information contained herein, including but not limited to the implied warranties of merchantability and fitness for a particular purpose. Keysight shall not be liable for errors or for incidental or consequential

damages in connection with the furnishing, use, or performance of this document or of any information contained herein. Should Keysight and the user have a separate written agreement with warranty terms covering the material in this document that conflict with these terms, the warranty terms in the separate agreement shall control.

### Technology Licenses

The hardware and/or software described in this document are furnished under a license and may be used or copied only in accordance with the terms of such license.

### Restricted Rights

#### Legend

If software is for use in the performance of a U.S. Government prime contract or subcontract, Software is delivered and licensed as “Commercial computer software” as defined in DFAR 252.227-7014 (June 1995), or as a “commercial item” as defined in FAR 2.101(a) or as “Restricted computer software” as defined in FAR 52.227-19 (June 1987) or any equivalent agency regulation or contract clause. Use, duplication or disclosure of Software is subject to Keysight Technologies’ standard commercial license terms, and non-DOD Departments and Agencies of the U.S. Government will receive no greater than Restricted Rights as defined in FAR 52.227-19(c)(1-2) (June 1987). U.S. Government users will

receive no greater than Limited Rights as defined in FAR 52.227-14 (June 1987) or DFAR 252.227-7015 (b)(2) (November 1995), as applicable in any technical data.

### Safety Notices

#### CAUTION

A CAUTION notice denotes a hazard. It calls attention to an operating procedure, practice, or the like that, if not correctly performed or adhered to, could result in damage to the product or loss of important data. Do not proceed beyond a CAUTION notice until the indicated conditions are fully understood and met.

#### WARNING

A WARNING notice denotes a hazard. It calls attention to an operating procedure, practice, or the like that, if not correctly performed or adhered to, could result in personal injury or death. Do not proceed beyond a WARNING notice until the indicated conditions are fully understood and met.

# Table of Contents

N9076A & W9076A 1xEV-DO Measurement Application User's and Programmer's Reference	i
Table of Contents	iii
<b>1 About the Analyzer</b>	<b>103</b>
Installing Application Software	104
Viewing a License Key	104
Obtaining and Installing a License Key	104
Updating Measurement Application Software	104
X-Series Options and Accessories	106
Front-Panel Features	107
Display Annotations	108
Rear-Panel Features	109
Window Control Keys	110
Multi-Window	110
Zoom	110
Next Window	111
Full Screen	112
Display Enable (Remote Command Only)	112
Mouse and Keyboard Control	114
Right-Click	114
PC Keyboard	116
Instrument Security & Memory Volatility	119
<b>2 About the 1xEV-DO Measurement Application</b>	<b>121</b>
What Does the 1xEV-DO Application Do?	122
<b>3 Programming the Analyzer</b>	<b>123</b>
What Programming Information is Available?	124
List of SCPI Commands	125
STATus Subsystem	173
Detailed Description	175
What Are Status Registers	176
What Are Status Register SCPI Commands	176
How to Use the Status Registers	177
Using a Status Register	178
Using the Service Request (SRQ) Method	179
Generating a Service Request	179
Status Register System	180
The Status Byte Register	181
Standard Event Status Register	183
Operation and Questionable Status Registers	185
Operation Status Register	185
Questionable Status Register	185

STATus Subsystem Command Descriptions	186
Operation Register	186
Operation Condition Query	186
Operation Enable	187
Operation Event Query	187
Operation Negative Transition	187
Operation Positive Transition	188
Preset the Status Byte	188
Questionable Register	189
Questionable Condition	189
Questionable Enable	189
Questionable Event Query	190
Questionable Negative Transition	190
Questionable Positive Transition	190
Questionable Calibration Register	191
Questionable Calibration Condition	191
Questionable Calibration Enable	191
Questionable Calibration Event Query	192
Questionable Calibration Negative Transition	192
Questionable Calibration Positive Transition	193
Questionable Calibration Skipped Register	193
Questionable Calibration Skipped Condition	193
Questionable Calibration Skipped Enable	194
Questionable Calibration Skipped Event Query	194
Questionable Calibration Skipped Negative Transition	195
Questionable Calibration Skipped Positive Transition	195
Questionable Calibration Extended Failure Register	195
Questionable Calibration Extended Failure Condition	196
Questionable Calibration Extended Failure Enable	196
Questionable Calibration Extended Failure Event Query	196
Questionable Calibration Extended Failure Negative Transition	197
Questionable Calibration Extended Failure Positive Transition	197
Questionable Calibration Extended Needed Register	198
Questionable Calibration Extended Needed Condition	198
Questionable Calibration Extended Needed Enable	198
Questionable Calibration Extended Needed Event Query	199
Questionable Calibration Extended Needed Negative Transition	199
Questionable Calibration Extended Needed Positive Transition	200
Questionable Frequency Register	200
Questionable Frequency Condition	200
Questionable Frequency Enable	201
Questionable Frequency Event Query	201
Questionable Frequency Negative Transition	201



Questionable Frequency Positive Transition	202
Questionable Integrity Register	202
Questionable Integrity Condition	202
Questionable Integrity Enable	203
Questionable Integrity Event Query	203
Questionable Integrity Negative Transition	204
Questionable Integrity Positive Transition	204
Questionable Integrity Signal Register	204
Questionable Integrity Signal Condition	205
Questionable Integrity Signal Enable	205
Questionable Integrity Signal Event Query	206
Questionable Integrity Signal Negative Transition	206
Questionable Integrity Signal Positive Transition	206
Questionable Integrity Uncalibrated Register	207
Questionable Integrity Uncalibrated Condition	207
Questionable Integrity Uncalibrated Enable	207
Questionable Integrity Uncalibrated Event Query	208
Questionable Integrity Uncalibrated Negative Transition	208
Questionable Integrity Uncalibrated Positive Transition	209
Questionable Power Register	209
Questionable Power Condition	209
Questionable Power Enable	210
Questionable Power Event Query	210
Questionable Power Negative Transition	211
Questionable Power Positive Transition	211
Questionable Temperature Register	211
Questionable Temperature Condition	212
Questionable Temperature Enable	212
Questionable Temperature Event Query	212
Questionable Temperature Negative Transition	213
Questionable Temperature Positive Transition	213
IEEE 488.2 Common Commands	215
All	215
Clear Status	217
Standard Event Status Enable	217
Standard Event Status Register Query	218
Identification Query	218
Operation Complete	219
Query Instrument Options	220
Recall Instrument State	220
*RST (Remote Command Only)	221
Save Instrument State	221
Service Request Enable	221

Status Byte Query	222
Trigger	222
Self Test Query	222
Wait-to-Continue	223
<b>4 Input/Output Functions</b>	<b>225</b>
Input/Output	226
Input/Output variables - Preset behavior	227
RF Input	228
Input Z Correction	228
RF Coupling	229
External Mixer	230
More Information	231
Ext Mix Setup	233
Mixer Presets	238
Mixer Bias	243
Cable IF Loss	243
I/Q	244
Baseband I/Q (Option BBA)	244
Baseband I/Q Remote Language Compatibility	246
I/Q Path	247
I+jQ	248
I Only	248
Q Only	248
I Setup	249
I Differential Input	249
I Input Z	250
I Skew	250
I Probe	251
Combined Differential/Input Z (Remote Command Only)	253
Q Setup	254
Q Same as I	254
Q Differential Input	254
Q Input Z	255
Q Skew	256
Q Probe	256
Reference Z	258
I/Q Cable Calibrate...	259
I/Q Probe Setup	260
Attenuation	260
Offset	261
Coupling	261
Calibrate	263
Clear Calibration	263

RF Calibrator	263
50 MHz	264
4.8 GHz	265
Off	265
External Gain	265
Ext Preamp	266
More Information	267
MS	267
BTS	268
I Ext Gain	269
Q Ext Gain	270
Restore Input/Output Defaults	270
Data Source	271
Inputs	271
Capture Buffer	272
Current Meas -> Capture Buffer	272
Corrections	273
Select Correction	273
Correction On/Off	274
Properties	274
Select Correction	275
Antenna Unit	275
Frequency Interpolation	277
Description	279
Comment	279
Edit	280
Navigate	281
Frequency	281
Amplitude	281
Insert Point Below	281
Delete Point	282
Scale X Axis	282
Delete Correction	282
Apply Corrections	282
Delete All Corrections	283
Remote Correction Data Set Commands	283
Set (Replace) Data (Remote Command Only)	283
Merge Correction Data (Remote Command Only)	284
Freq Ref In	284
Sense	286
Internal	287
External	287
Ext Ref Freq	287

External Reference Lock BW	288
External Ref Coupling	289
Output Config	290
Trig Out	291
Polarity	291
Off	292
Sweeping (HSWP)	292
Measuring	292
Main Trigger	292
Gate Trigger	293
Gate	293
Source Point Trigger	293
Odd/Even Trace Point	294
Analog Out	294
More Information	294
Auto	295
Off	295
Screen Video	295
Log Video (RF Envelope, Ref=Mixer Level)	296
Linear Video (RF Envelope, Ref=Ref Level)	297
Demod Audio	298
Digital Bus	298
Bus Out On/Off	299
I/Q Cal Out	299
1 kHz Square Wave	300
250 kHz Square Wave	300
Off	300
Aux IF Out	300
Off	301
Second IF	301
Arbitrary IF	302
Fast Log Video	302
I/Q Guided Calibration	303
I/Q Isolation Calibration	303
Next	303
Exit	303
I/Q Isolation Calibration Time (Remote Command Only)	304
I/Q Cable Calibrate...	304
I Port	305
I-bar Port	306
Q Port	307
Q-bar Port	308
I/Q Cable Calibration Time (Remote Command Only)	309

I/Q Probe Calibration	309
I Port	310
I-bar Port	311
Q Port	312
Q-bar Port	313
Show Adapter Screen	314
I/Q Probe Calibration Time (Remote Command Only)	315
Exit Confirmation	315
<b>5 Mode Functions</b>	<b>317</b>
Mode	318
More Information	319
Spectrum Analyzer	320
DVB-T/H with T2	321
cdma2000	321
Vector Signal Analyzer (VXA)	321
Analog Demod	322
Phase Noise	322
CMMB	322
Combined WLAN	323
TD-SCDMA with HSPA/8PSK	323
IQ Analyzer (Basic)	323
W-CDMA with HSPA+	324
GSM/EDGE/EDGE Evo	324
Noise Figure	324
WLAN	324
EMI Receiver	325
802.16 OFDM (Fixed WiMAX)	325
DTMB (CTTB)	325
1xEV-DO	326
802.16 OFDMA (WiMAX/WiBro)	326
89601 VSA	326
MSR	327
Bluetooth	328
LTE	328
SCPI Language Compatibility	328
Combined Fixed WiMAX	329
ISDB-T	329
Digital Cable TV	329
LTE TDD	329
Remote Language Compatibility	330
iDEN/WiDEN/MOTOTalk	330
Application Mode Number Selection (Remote Command Only)	330
Application Mode Catalog Query (Remote Command Only)	332

Application Identification (Remote Commands Only)	332
Current Application Model	333
Current Application Revision	333
Current Application Options	333
Application Identification Catalog (Remote Commands Only)	334
Application Catalog Number of Entries	334
Application Catalog Model Numbers	334
Application Catalog Revision	334
Application Catalog Options	335
Detailed List of Modes	335
1xEV-DO	335
802.16 OFDMA (WiMAX/WiBro)	336
802.16 OFDM (Fixed WiMAX)	336
89601 VSA	336
Analog Demod	337
Bluetooth	337
cdma2000	338
CMMB	338
Combined WLAN	338
Combined Fixed WiMAX	339
Digital Cable TV	339
DTMB (CTTB)	339
DVB-T/H with T2	340
EMI Receiver	340
GSM/EDGE/EDGE Evo	340
iDEN/WiDEN/MOTOTalk	341
IQ Analyzer (Basic)	341
ISDB-T	341
LTE	341
LTE TDD	342
MSR	342
Noise Figure	342
Phase Noise	343
Remote Language Compatibility	343
SCPI Language Compatibility	343
Spectrum Analyzer	344
TD-SCDMA with HSPA/8PSK	344
Vector Signal Analyzer (VXA)	344
W-CDMA with HSPA+	345
WLAN	345
Global Settings	346
Global Center Freq	346
Restore Defaults	347

Mode Setup	348
Radio	348
Device	348
Pre-defined Offset/Interval	348
Demod	349
Physical Layer Subtype	349
Noise Reduction	350
Noise Floor Extension	350
More Information	351
Restore Mode Defaults	352
<b>6 System Functions</b>	<b>353</b>
File	354
File Explorer	354
Page Setup	355
Print	356
Minimize	356
Exit	356
Maximize/Restore Down	357
Maximize	357
Restore Down	357
Print	358
System	359
Show	359
Errors	359
Previous Page	360
Next Page	361
History	361
Verbose SCPI On/Off	361
Refresh	362
Clear Error Queue	362
Input Overload Enable (Remote Command Only)	362
System	363
Show System contents (Remote Command Only)	364
Computer System description (Remote Command Only)	364
Hardware	364
LXI	365
Power On	365
Mode and Input/Output Defaults	366
User Preset	366
Last State	367
Power On Application	367
Configure Applications	368
Preloading Applications	369

Access to Configure Applications utility	369
Virtual memory usage	369
Select All	370
Deselect All	370
Move Up	370
Move Down	370
Select/Deselect	370
Save Changes and Exit	371
Exit Without Saving	371
Restore Power On Defaults	371
Configure Applications - Instrument boot-up	372
Configure Applications - Windows desktop	372
Configure Applications - Remote Commands	372
Configuration list (Remote Command Only)	373
Configuration Memory Available (Remote Command Only)	373
Configuration Memory Total (Remote Command Only)	373
Configuration Memory Used (Remote Command Only)	373
Configuration Application Memory (Remote Command Only)	374
Alignments	374
Auto Align	374
Normal	375
Partial	376
Off	376
All but RF	377
Alert	377
Execute Expired Alignments (Remote Command Only)	380
Align Now	381
All	381
All but RF	383
RF	384
External Mixer	385
Show Alignment Statistics	386
Restore Align Defaults	391
Backup or Restore Align Data...	391
Alignment Data Wizard	392
Perform Backup (Remote Command Only)	397
Perform Restore (Remote Command Only)	398
Advanced	398
Characterize Preselector	398
Characterize Reference Clock	399
Timebase DAC	402
Calibrated	403
User	403



I/O Config	404
GPIB	404
GPIB Address	404
GPIB Controller	405
SCPI LAN	406
SCPI Telnet	406
SCPI Socket	406
SICL Server	407
HiSLIP Server	408
SCPI Socket Control Port (Remote Command Only)	408
Reset Web Password	409
LXI	409
LAN Reset	409
Device Identification (Remote Command Only)	410
System IDN Response	410
Factory	410
User	411
Query USB Connection (Remote Command Only)	411
USB Connection Status (Remote Command Only)	411
USB Packet Count (Remote Command Only)	412
Restore Defaults	412
Restore Input/Output Defaults	413
Restore Power On Defaults	413
Restore Align Defaults	414
Restore Misc Defaults	414
Restore Mode Defaults (All Modes)	415
All	416
Control Panel...	417
Licensing...	418
Security	420
USB	420
Read-Write	420
Read only	421
Diagnostics	421
Show Hardware Statistics	421
SCPI for Show Hardware Statistics ( Remote Commands Only)	422
Internet Explorer...	424
System Remote Commands (Remote Commands Only)	424
System Powerdown (Remote Command Only)	424
List installed Options (Remote Command Only)	425
Lock the Front-panel keys (Remote Command Only)	425
List SCPI Commands (Remote Command Only)	425
SCPI Version Query (Remote Command Only)	426

Date (Remote Command Only)	426
Time (Remote Command Only)	426
<b>7 Trigger Functions</b>	<b>429</b>
Trigger	430
Trigger Source Presets	431
RF Trigger Source	434
I/Q Trigger Source	435
More Information	436
Free Run	437
Video (IF Envelope)	438
Trigger Level	438
Trig Slope	439
Trig Delay	440
Line	441
Trig Slope	442
Trig Delay	442
External 1	443
Trigger Level	443
Trig Slope	444
Trig Delay	445
External 2	445
Trigger Level	446
Trig Slope	446
Trig Delay	447
RF Burst	448
Absolute Trigger Level	448
Relative Trigger Level	449
Trigger Slope	450
Trig Delay	451
Periodic Timer (Frame Trigger)	452
Period	453
Offset	454
Reset Offset Display	455
Sync Source	455
Off	456
External 1	456
External 2	457
RF Burst	459
Trig Delay	461
Auto/Holdoff	462
Auto Trig	462
Trig Holdoff	463
<b>8 Channel Power Measurement</b>	<b>465</b>

AMPTD Y Scale	474
Ref Value	474
Attenuation	474
Dual Attenuator Configurations:	475
Single Attenuator Configuration:	476
(Mech) Atten	476
Attenuator Configurations and Auto/Man	478
Enable Elec Atten	478
More Information	479
Mechanical Attenuator Transition Rules	479
When the Electronic Attenuation is enabled from a disabled state:	479
Examples in the dual attenuator configuration:	479
When the Electronic Attenuation is disabled from an enabled state:	480
Using the Electronic Attenuator: Pros and Cons	480
Elec Atten	480
Adjust Atten for Min Clip	481
Pre-Adjust for Min Clip	481
Off	482
Elec Atten Only	482
Mech + Elec Atten	483
(Mech) Atten Step	483
Scale/Div	484
Presel Center	484
Proper Preselector Operation	485
Preselector Adjust	485
$\mu$ W Path Control	487
Standard Path	488
Low Noise Path Enable	488
More Information	489
$\mu$ W Preselector Bypass	490
Internal Preamp	491
Off	492
Low Band	493
Full Range	493
Ref Position	493
Auto Scaling	494
Auto Couple	495
More Information	495
Auto/Man Active Function keys	495
Auto/Man 1-of-N keys	495
BW	497
Res BW	497
Video BW	498

## Table of Contents

Filter Type	500
Cont (Continuous Measurement/Sweep)	501
File	503
FREQ Channel	504
Center Freq	504
Center Frequency Presets	505
RF Center Freq	507
Ext Mix Center Freq	508
I/Q Center Freq	509
CF Step	509
Input/Output	511
Marker	512
Select Marker	512
Marker Type	512
Properties	513
Select Marker	513
Relative To	513
All Markers Off	513
Marker X Axis Value (Remote Command Only)	514
Marker X Axis Position (Remote Command Only)	514
Marker Y Axis Value (Remote Command only)	515
Backward Compatibility SCPI Commands	515
Marker Function	517
Marker To	518
Meas	519
Remote Measurement Functions	519
Measurement Group of Commands	520
Current Measurement Query (Remote Command Only)	522
Limit Test Current Results (Remote Command Only)	522
Data Query (Remote Command Only)	522
Calculate/Compress Trace Data Query (Remote Command Only)	523
Calculate Peaks of Trace Data (Remote Command Only)	528
Format Data: Numeric Data (Remote Command Only)	529
Format Data: Byte Order (Remote Command Only)	530
Meas Setup	531
Avg/Hold Num	531
Avg Mode	532
Integ BW	533
PhNoise Opt	534
PhNoise Opt Auto	534
PhNoise Opt State	534
IF Gain	535
IF Gain Auto	536

IF Gain State	536
Limits	537
Power Limit	537
PSD Limit	538
Power Limit Fail (remote command only)	539
PSD Limit Fail (remote command only)	540
Meas Preset	540
PSD Unit	540
Mode	542
Mode Preset	543
How-To Preset	544
Preset Type (Remote Command Only)	545
Mode Setup	546
Peak Search	547
Print	548
Quick Save	549
Recall	551
State	551
More Information	553
From File...	553
Edit Register Names	555
Register 1 thru Register 16	555
Register 1 thru Register 16	556
Trace (+State)	557
To Trace	558
Register 1 thru Register 16	559
From File...	559
Data (Import)	561
Capture Buffer	562
Open...	562
Restart	563
More Information	563
Save	565
State	565
To File . . .	566
Edit Register Names	568
More Information	568
Register 1 thru Register 16	569
Register 1 thru Register 16	569
Data (Export)	570
Measurement Results	571
Capture Buffer	573
Save As . . .	574

Screen Image	574
Themes	575
3D Color	576
3D Monochrome	576
Flat Color	576
Flat Monochrome	577
Save As...	577
Mass Storage Catalog (Remote Command Only)	577
Mass Storage Change Directory (Remote Command Only)	578
Mass Storage Copy (Remote Command Only)	578
Mass Storage Device Copy (Remote Command Only)	578
Mass Storage Delete (Remote Command Only)	579
Mass Storage Data (Remote Command Only)	579
Mass Storage Make Directory (Remote Command Only)	579
Mass Storage Move (Remote Command Only)	580
Mass Storage Remove Directory (Remote Command Only)	580
Single (Single Measurement/Sweep)	581
More Information	581
Source	582
Span X Scale	583
Span	583
Full Span	584
Last Span	585
Sweep/Control	586
Sweep Time	586
Sweep Setup	587
Auto Sweep Time Rules	587
Pause	588
Gate	588
Gate On/Off	588
Gate View On/Off	589
Gate View Setup	592
Gate View Sweep Time	593
Gate View Start Time	593
Gate Delay	594
Gate Length	594
Gate Source	595
Line	596
External 1	596
External 2	598
RF Burst	600
Periodic Timer (Frame Trigger)	603
Control Edge/Level	614

Gate Holdoff	614
Gate Delay Compensation	616
More Information	617
Min Fast Position Query (Remote Command Only)	617
Gate Preset (Remote Command Only)	618
Gate Level (Remote Command Only)	618
Gate Polarity (Remote Command Only)	618
Points	619
System	621
Trace/Detector	622
Trace Type	622
Detector	622
Auto	623
Detector Selection	623
Trigger	625
Free Run	625
Video	625
Trigger Level	625
Trig Slope	625
Trig Delay	625
Line	625
Trig Slope	625
Trig Delay	625
External 1	625
Trigger Level	625
Trig Slope	625
Trig Delay	625
External 2	625
Trigger Level	626
Trig Slope	626
Trig Delay	626
RF Burst	626
Absolute Trigger	626
Relative Trigger	626
Trig Slope	626
Trig Delay	626
Periodic Timer	626
Period	626
Offset	626
Reset Offset Display	626
Sync Source	626
Off	626
External 1	627

External 2	627
RF Burst	627
Trig Delay	627
Auto/Holdoff	627
Auto Trig	627
Trig Holdoff	627
User Preset	628
User Preset	628
User Preset All Modes	629
Save User Preset	630
View/Display	631
View selection by name (MSR and LTE-Advanced FDD/TDD only)	633
Selects the results view. The following SCPI command allows you to select the desired measurement view by enumeration.	633
Selects the results view. The following SCPI command allows you to select the desired measurement view by enumeration.	634
View selection by name (DTMB (CTTB), DVB-T/H only)	634
View selection by name (ISDB-T, CMMB only)	635
Display	635
Annotation	635
Meas Bar On/Off	636
Screen	637
Active Function Values On/Off	637
Title	638
Change Title	638
Clear Title	639
Graticule	640
System Display Settings	640
Annotation Local Settings	640
Themes	641
Backlight	642
Backlight Intensity	642
Bar Graph	643
<b>9 ACP Measurement</b>	<b>645</b>
AMPTD Y Scale	657
Ref Value	657
Attenuation	657
Dual Attenuator Configurations:	658
Single Attenuator Configuration:	659
(Mech) Atten	659
Attenuator Configurations and Auto/Man	661
Enable Elec Atten	661
More Information	662



Mechanical Attenuator Transition Rules	662
When the Electronic Attenuation is enabled from a disabled state:	662
Examples in the dual attenuator configuration:	662
When the Electronic Attenuation is disabled from an enabled state:	663
Using the Electronic Attenuator: Pros and Cons	663
Elec Atten	663
Adjust Atten for Min Clip	664
Pre-Adjust for Min Clip	664
Off	665
Elec Atten Only	665
Mech + Elec Atten	666
(Mech) Atten Step	666
Scale/Div	667
Presel Center	667
Proper Preselector Operation	668
Preselector Adjust	668
$\mu$ W Path Control	670
Standard Path	671
Low Noise Path Enable	671
More Information	672
$\mu$ W Preselector Bypass	673
Internal Preamp	674
Off	675
Low Band	676
Full Range	676
Ref Position	676
Auto Scaling	677
Auto Couple	678
More Information	678
Auto/Man Active Function keys	678
Auto/Man 1-of-N keys	678
BW	680
Res BW	680
Video BW	681
RBW Control	683
Filter Type	683
Filter BW	684
Cont (Continuous Measurement/Sweep)	685
File	687
FREQ Channel	688
Center Freq	688
Center Frequency Presets	689
RF Center Freq	691

Ext Mix Center Freq	692
I/Q Center Freq	693
CF Step	693
Input/Output	695
Marker	696
Select Marker	696
Marker Type	696
Properties	697
Select Marker	697
Relative To	697
Marker Trace	698
Couple Markers	699
Marker All Off	699
Marker X Axis Value (Remote Command only)	699
Marker X Axis Position (Remote Command only)	700
Marker Y Axis Value (Remote Command only)	701
Backward Compatibility Remote Commands	701
Marker Function	702
Marker To	703
Meas	704
Remote Measurement Functions	704
Measurement Group of Commands	705
Current Measurement Query (Remote Command Only)	707
Limit Test Current Results (Remote Command Only)	707
Data Query (Remote Command Only)	707
Calculate/Compress Trace Data Query (Remote Command Only)	708
Calculate Peaks of Trace Data (Remote Command Only)	713
Format Data: Numeric Data (Remote Command Only)	714
Format Data: Byte Order (Remote Command Only)	715
Meas Setup	716
Average/Hold Number	716
Avg Mode	717
Carrier Setup (This menu is unavailable in MSR and LTE-Advanced FDD/TDD)	717
Carriers	717
Ref Carrier	718
Ref Car Freq	719
Power Ref	720
Total Power	720
PSD	721
Configure Carriers	722
Carrier	722
Carrier Pwr Present	723
Carrier Spacing	724

Measurement Noise Bandwidth	725
Offset/Limits	726
Select Offset	726
Offset Freq	727
Integ BW	729
Offset BW	730
Res BW	730
Video BW	732
RBW Control	733
Limits	735
Select Offset	735
Abs Limit	735
Rel Lim (Car)	737
Rel Limit (PSD)	739
Fail Mask	740
Offset Side	742
Offset Frequency Define	743
Carrier Result	743
Meas Method	744
Meas Type	746
PSD Ref	746
Limit Test	747
Noise Correction	747
Meas Preset	748
Offset RRC Weighting (Backward Compatibility SCPI)	749
Offset Filter Alpha (Backward Compatibility SCPI)	749
Method for Carrier (Backward Compatibility SCPI)	750
Mode	752
Mode Preset	753
How-To Preset	754
Preset Type (Remote Command Only)	755
Mode Setup	756
Peak Search	757
Next Peak	757
Next Pk Right	757
Next Pk Left	758
Marker Delta	758
Pk-Pk Search	758
Min Search	758
Print	760
Quick Save	761
Recall	763
State	763

## Table of Contents

More Information	765
From File...	765
Edit Register Names	767
Register 1 thru Register 16	767
Register 1 thru Register 16	768
Trace (+State)	769
To Trace	770
Register 1 thru Register 16	771
From File...	771
Data (Import)	773
Capture Buffer	774
Open...	774
Restart	775
More Information	775
Save	777
State	777
To File . . .	778
Edit Register Names	780
More Information	780
Register 1 thru Register 16	781
Register 1 thru Register 16	781
Data (Export)	782
Measurement Results	783
Capture Buffer	791
Save As . . .	791
Screen Image	792
Themes	793
3D Color	793
3D Monochrome	794
Flat Color	794
Flat Monochrome	794
Save As...	794
Mass Storage Catalog (Remote Command Only)	795
Mass Storage Change Directory (Remote Command Only)	795
Mass Storage Copy (Remote Command Only)	795
Mass Storage Device Copy (Remote Command Only)	796
Mass Storage Delete (Remote Command Only)	796
Mass Storage Data (Remote Command Only)	796
Mass Storage Make Directory (Remote Command Only)	797
Mass Storage Move (Remote Command Only)	797
Mass Storage Remove Directory (Remote Command Only)	797
Single (Single Measurement/Sweep)	799
More Information	799

Source	800
SPAN X Scale	801
Span	801
Full Span	802
Last Span	802
Sweep/Control	804
Sweep Time	804
Sweep Setup	805
Auto Sweep Time Rules	806
Pause	806
Gate	806
Gate On/Off	807
Gate View On/Off	808
Gate View Setup	811
Gate View Sweep Time	811
Gate View Start Time	812
Gate Delay	812
Gate Length	813
Gate Source	813
Line	814
External 1	815
External 2	817
RF Burst	818
Periodic Timer (Frame Trigger)	821
Control Edge/Level	832
Gate Holdoff	833
Gate Delay Compensation	834
More Information	835
Min Fast Position Query (Remote Command Only)	836
Gate Preset (Remote Command Only)	836
Gate Level (Remote Command Only)	836
Gate Polarity (Remote Command Only)	836
Points	837
System	839
Trace/Detector	840
Select Trace (Front-panel Only)	840
Trace Type	840
View/Blank	841
Detector	842
Auto	843
Detector Selection	843
Trigger	845
Free Run	845

## Table of Contents

Video	845
Trigger Level	845
Trig Slope	845
Trig Delay	845
Line	845
Trig Slope	845
Trig Delay	845
External 1	845
Trigger Level	845
Trig Slope	845
Trig Delay	845
External 2	845
Trigger Level	846
Trig Slope	846
Trig Delay	846
RF Burst	846
Absolute Trigger	846
Relative Trigger	846
Trig Slope	846
Trig Delay	846
Periodic Timer	846
Period	846
Offset	846
Reset Offset Display	846
Sync Source	846
Off	846
External 1	847
External 2	847
RF Burst	847
Trig Delay	847
Auto/Holdoff	847
Auto Trig	847
Trig Holdoff	847
User Preset	848
User Preset	848
User Preset All Modes	849
Save User Preset	850
View/Display	851
Spectrum Window	853
Results Window	853
Display	856
Annotation	856
Meas Bar On/Off	857

Screen	858
Active Function Values On/Off	858
Title	859
Change Title	859
Clear Title	860
Graticule	861
System Display Settings	861
Annotation Local Settings	861
Themes	862
Backlight	863
Backlight Intensity	863
Bar Graph	864
<b>10 Occupied Bandwidth Measurement</b>	<b>865</b>
AMPTD Y Scale (Amplitude/Y Scale)	868
Ref Value	868
Attenuation	868
Dual Attenuator Configurations:	869
Single Attenuator Configuration:	870
(Mech) Atten	870
Attenuator Configurations and Auto/Man	872
Enable Elec Atten	872
More Information	873
Mechanical Attenuator Transition Rules	873
When the Electronic Attenuation is enabled from a disabled state:	873
Examples in the dual attenuator configuration:	873
When the Electronic Attenuation is disabled from an enabled state:	874
Using the Electronic Attenuator: Pros and Cons	874
Elec Atten	874
Adjust Atten for Min Clip	875
Pre-Adjust for Min Clip	875
Off	876
Elec Atten Only	876
Mech + Elec Atten	877
(Mech) Atten Step	877
Scale/Div	878
Presel Center	878
Proper Preselector Operation	879
Preselector Adjust	879
$\mu$ W Path Control	881
Standard Path	882
Low Noise Path Enable	882
More Information	883
$\mu$ W Preselector Bypass	884

Internal Preamp	885
Off	886
Low Band	887
Full Range	887
Ref Position	887
Auto Scaling	888
Auto Couple	889
More Information	889
Auto/Man Active Function keys	889
Auto/Man 1-of-N keys	889
BW	891
Res BW	891
Video BW	892
Filter Type	893
Cont (Continuous Measurement/Sweep)	895
File	897
FREQ Channel	898
Center Freq	898
Center Frequency Presets	899
RF Center Freq	901
Ext Mix Center Freq	902
I/Q Center Freq	903
CF Step	903
Input/Output	905
Marker	906
Select Marker	906
Select Marker	906
Marker Type	906
Properties	907
Select Marker	907
Select Marker	907
Relative To	907
All Markers Off	908
Marker X Axis Value (Remote Command Only)	908
Marker X Axis Position (Remote Command Only)	909
Marker Y Axis Value (Remote Command Only)	909
Backward Compatibility SCPI Commands	910
Marker Function	911
Marker To	912
Meas	913
Remote Measurement Functions	913
Measurement Group of Commands	914
Current Measurement Query (Remote Command Only)	916



Limit Test Current Results (Remote Command Only)	916
Data Query (Remote Command Only)	916
Calculate/Compress Trace Data Query (Remote Command Only)	917
Calculate Peaks of Trace Data (Remote Command Only)	922
Format Data: Numeric Data (Remote Command Only)	923
Format Data: Byte Order (Remote Command Only)	924
Meas Setup	925
Avg/Hold Num	925
Avg Mode	926
Occ BW % Pwr	926
x dB	927
IF Gain	928
IF Gain Auto	928
IF Gain State	928
Limit (for all modes except MSR and LTE-Advanced FDD/TDD)	929
Meas Preset	930
Max Hold (Remote Command Only)	931
Mode	932
Mode Preset	933
How-To Preset	934
Preset Type (Remote Command Only)	935
Mode Setup	936
Peak Search	937
Print	938
Quick Save	939
Recall	941
State	941
More Information	943
From File...	943
Edit Register Names	945
Register 1 thru Register 16	945
Register 1 thru Register 16	946
Trace (+State)	947
To Trace	948
Register 1 thru Register 16	949
From File...	949
Data (Import)	951
Capture Buffer	952
Open...	952
Restart	953
More Information	953
Save	955
State	955

To File . . .	956
Edit Register Names	958
More Information	958
Register 1 thru Register 16	959
Register 1 thru Register 16	959
Data (Export)	960
Measurement Results	961
Meas Results File Definition	961
Meas Results File Example	962
Capture Buffer	963
Save As . . .	964
Screen Image	964
Themes	966
3D Color	966
3D Monochrome	966
Flat Color	966
Flat Monochrome	967
Save As...	967
Mass Storage Catalog (Remote Command Only)	967
Mass Storage Change Directory (Remote Command Only)	968
Mass Storage Copy (Remote Command Only)	968
Mass Storage Device Copy (Remote Command Only)	968
Mass Storage Delete (Remote Command Only)	969
Mass Storage Data (Remote Command Only)	969
Mass Storage Make Directory (Remote Command Only)	969
Mass Storage Move (Remote Command Only)	970
Mass Storage Remove Directory (Remote Command Only)	970
Single (Single Measurement/Sweep)	971
More Information	971
Source	972
Span X Scale	973
Span	973
Full Span	974
Last Span	974
Sweep/Control	976
Sweep Time	976
Sweep Setup	977
Auto Sweep Time Rules	977
Pause	978
Gate	978
Gate On/Off	978
Gate View On/Off	979
Gate View Setup	982

Gate View Sweep Time	983
Gate View Start Time	983
Gate Delay	984
Gate Length	984
Gate Source	985
Line	986
External 1	986
External 2	988
RF Burst	990
Periodic Timer (Frame Trigger)	993
Control Edge/Level	1004
Gate Holdoff	1004
Gate Delay Compensation	1006
More Information	1007
Min Fast Position Query (Remote Command Only)	1007
Gate Preset (Remote Command Only)	1008
Gate Level (Remote Command Only)	1008
Gate Polarity (Remote Command Only)	1008
Points	1009
System	1011
Trace/Detector	1012
Trace Type	1012
Detector	1012
Auto	1013
Detector Selection	1013
Trigger	1015
Free Run	1015
Video	1015
Trigger Level	1015
Trig Slope	1015
Trig Delay	1015
Line	1015
Trig Slope	1015
Trig Delay	1015
External 1	1015
Trigger Level	1015
Trig Slope	1015
Trig Delay	1015
External 2	1015
Trigger Level	1016
Trig Slope	1016
Trig Delay	1016
RF Burst	1016

Absolute Trigger	1016
Relative Trigger	1016
Trig Slope	1016
Trig Delay	1016
Periodic Timer	1016
Period	1016
Offset	1016
Reset Offset Display	1016
Sync Source	1016
Off	1016
External 1	1017
External 2	1017
RF Burst	1017
Trig Delay	1017
Auto/Holdoff	1017
Auto Trig	1017
Trig Holdoff	1017
User Preset	1018
User Preset	1018
User Preset All Modes	1019
Save User Preset	1020
View/Display	1021
Spectrum View	1021
Display	1026
Annotation	1026
Meas Bar On/Off	1028
Screen	1028
Active Function Values On/Off	1028
Title	1029
Change Title	1029
Clear Title	1030
Graticule	1031
System Display Settings	1031
Annotation Local Settings	1031
Themes	1032
Backlight	1033
Backlight Intensity	1033
<b>11 Power vs Time</b>	<b>1035</b>
Amplitude (AMPTD) Y Scale	1036
Ref Value (Burst view RF Envelope window)	1036
Attenuation	1036
Dual Attenuator Configurations:	1037
Single Attenuator Configuration:	1037

(Mech) Atten	1038
Attenuator Configurations and Auto/Man	1039
Enable Elec Atten	1040
More Information	1041
Mechanical Attenuator Transition Rules	1041
When the Electronic Attenuation is enabled from a disabled state:	1041
Examples in the dual attenuator configuration:	1041
When the Electronic Attenuation is disabled from an enabled state:	1041
Using the Electronic Attenuator: Pros and Cons	1042
Elec Atten	1042
Adjust Atten for Min Clip	1043
Pre-Adjust for Min Clip	1043
Off	1044
Elec Atten Only	1044
Mech + Elec Atten	1045
(Mech) Atten Step	1045
Scale/Div (Burst view RF Envelope window)	1045
Presel Center	1046
Proper Preselector Operation	1047
Preselector Adjust	1047
$\mu$ W Path Control	1048
Standard Path	1050
Low Noise Path Enable	1050
More Information	1051
$\mu$ W Preselector Bypass	1052
Internal Preamp	1053
Off	1054
Low Band	1055
Full Range	1055
Ref Position (Burst view RF Envelope window)	1055
Auto Scaling (Burst view RF Envelope window)	1056
Auto Couple	1057
More Information	1057
Auto/Man Active Function keys	1057
Auto/Man 1-of-N keys	1057
BW	1059
Info BW	1059
Filter Type	1059
Cont (Continuous Measurement/Sweep)	1061
File	1063
FREQ Channel	1064
Center Freq	1064
Center Frequency Presets	1065

RF Center Freq	1067
Ext Mix Center Freq	1068
I/Q Center Freq	1069
CF Step	1069
Input/Output	1071
Marker	1072
Select Marker	1072
Marker Type	1072
Properties	1072
Select Marker	1073
Relative To	1073
Marker Trace	1073
Couple Marker	1074
All Markers Off	1074
Marker Fctn	1075
Marker To	1076
Meas	1077
Remote Measurement Functions	1077
Measurement Group of Commands	1078
Current Measurement Query (Remote Command Only)	1080
Limit Test Current Results (Remote Command Only)	1080
Data Query (Remote Command Only)	1080
Calculate/Compress Trace Data Query (Remote Command Only)	1081
Calculate Peaks of Trace Data (Remote Command Only)	1086
Format Data: Numeric Data (Remote Command Only)	1087
Format Data: Byte Order (Remote Command Only)	1088
Meas Setup	1089
Avg/Hold Num	1089
Avg Mode	1089
Avg Type	1090
Slot Type	1091
Idle Slot Filtering	1091
Region/Limits	1092
Region	1092
Offset Start	1092
Offset Stop	1093
Interval	1093
Upper Mask	1094
Lower Mask	1094
Power Reference	1095
Time Reference	1095
Burst Search Threshold	1096
Meas Preset	1096

Advanced	1096
Burst Slope Threshold	1096
Burst Slope Detect Intvl	1097
Idle Slot Threshold	1097
Time Ref Offset	1098
IF Gain	1098
IF Gain Auto	1098
IF Gain State	1099
Mode	1100
Mode Preset	1101
How-To Preset	1102
Preset Type (Remote Command Only)	1103
Mode Setup	1104
Peak Search	1105
Print	1106
Quick Save	1107
Recall	1109
State	1109
More Information	1111
From File...	1111
Edit Register Names	1113
Register 1 thru Register 16	1113
Register 1 thru Register 16	1114
Trace (+State)	1115
To Trace	1116
Register 1 thru Register 16	1117
From File...	1117
Data (Import)	1119
Capture Buffer	1120
Open...	1120
Restart	1121
More Information	1121
Save	1123
State	1123
To File . . .	1124
Edit Register Names	1126
More Information	1126
Register 1 thru Register 16	1127
Register 1 thru Register 16	1127
Data (Export)	1128
Measurement Results	1129
Meas Results File Contents	1129
Marker Table	1129

Peak Table	1132
Spectrogram	1135
Capture Buffer	1139
Save As . . .	1140
Screen Image	1140
Themes	1142
3D Color	1142
3D Monochrome	1142
Flat Color	1142
Flat Monochrome	1143
Save As...	1143
Mass Storage Catalog (Remote Command Only)	1143
Mass Storage Change Directory (Remote Command Only)	1144
Mass Storage Copy (Remote Command Only)	1144
Mass Storage Device Copy (Remote Command Only)	1144
Mass Storage Delete (Remote Command Only)	1145
Mass Storage Data (Remote Command Only)	1145
Mass Storage Make Directory (Remote Command Only)	1145
Mass Storage Move (Remote Command Only)	1146
Mass Storage Remove Directory (Remote Command Only)	1146
Single (Single Measurement/Sweep)	1147
More Information	1147
Source	1148
SPAN X Scale	1149
Ref Value (Burst view RF Envelope window)	1149
Scale/Div (Burst view RF Envelope window)	1149
Ref Position (Burst view RF Envelope window)	1150
Auto Scaling (Burst view RF Envelope window)	1150
Sweep/Control	1151
Pause/Resume	1151
System	1152
Trace/Detector	1153
Max Hold Trace	1153
Min Hold Trace	1153
Trigger	1154
Free Run	1154
Video	1154
Trigger Level	1154
Trig Slope	1154
Trig Delay	1154
Line	1154
Trig Slope	1154
Trig Delay	1154



External 1	1154
Trigger Level	1154
Trig Slope	1154
Trig Delay	1154
External 2	1154
Trigger Level	1155
Trig Slope	1155
Trig Delay	1155
RF Burst	1155
Absolute Trigger	1155
Relative Trigger	1155
Trig Slope	1155
Trig Delay	1155
Periodic Timer	1155
Period	1155
Offset	1155
Offset Adjust (Remote Command Only)	1155
Reset Offset Display	1155
Sync Source	1155
Off	1156
External 1	1156
External 2	1156
RF Burst	1156
Trig Delay	1156
Auto/Holdoff	1156
Auto Trig	1156
Trig Holdoff	1156
Holdoff Type	1156
User Preset	1157
User Preset	1157
User Preset All Modes	1158
Save User Preset	1159
View/Display	1160
Display	1160
Annotation	1160
Meas Bar On/Off	1162
Screen	1162
Active Function Values On/Off	1162
Title	1163
Change Title	1163
Clear Title	1164
Graticule	1165
System Display Settings	1165

Annotation Local Settings	1165
Themes	1166
Backlight	1167
Backlight Intensity	1167
Burst View	1168
RF Envelope window	1168
Numeric Results window	1169
Rise & Fall View	1170
Rising RF Envelope Window	1170
Falling RF Envelope Window	1170
Numeric Results Window	1170
Region View	1170
Region RF Envelope Window	1171
Numeric Results Window	1171
Limit Mask State	1171
Burst Search Threshold Line	1171
<b>12 Spectrum Emission Mask Measurement</b>	<b>1173</b>
AMPTD Y Scale	1196
Ref Value	1196
Attenuation	1196
Dual Attenuator Configurations:	1197
Single Attenuator Configuration:	1198
(Mech) Atten	1198
Attenuator Configurations and Auto/Man	1200
Enable Elec Atten	1200
More Information	1201
Mechanical Attenuator Transition Rules	1201
When the Electronic Attenuation is enabled from a disabled state:	1201
Examples in the dual attenuator configuration:	1201
When the Electronic Attenuation is disabled from an enabled state:	1202
Using the Electronic Attenuator: Pros and Cons	1202
Elec Atten	1202
Adjust Atten for Min Clip	1203
Pre-Adjust for Min Clip	1203
Off	1204
Elec Atten Only	1204
Mech + Elec Atten	1205
(Mech) Atten Step	1205
Scale/Div	1206
Presel Center	1206
Proper Preselector Operation	1207
Preselector Adjust	1207
$\mu$ W Path Control	1209

Standard Path	1210
Low Noise Path Enable	1210
More Information	1211
$\mu$ W Preselector Bypass	1212
Internal Preamp	1213
Off	1214
Low Band	1215
Full Range	1215
Ref Position	1215
Auto Scaling	1216
Auto Couple	1217
More Information	1217
Auto/Man Active Function keys	1217
Auto/Man 1-of-N keys	1217
BW	1219
Filter Type	1219
Cont (Continuous Measurement/Sweep)	1220
File	1222
FREQ Channel	1223
Center Freq	1223
Center Frequency Presets	1224
RF Center Freq	1226
Ext Mix Center Freq	1227
I/Q Center Freq	1228
CF Step	1228
Input/Output	1230
Marker	1231
Select Marker	1231
Marker Type	1231
Couple Markers	1232
All Markers Off	1232
Marker X Axis Value (Remote Command Only)	1232
Marker X Axis Position (Remote Command Only)	1233
Marker Y Axis Value (Remote Command Only)	1234
Marker Function	1235
Marker To	1236
Meas	1237
Remote Measurement Functions	1237
Measurement Group of Commands	1238
Current Measurement Query (Remote Command Only)	1240
Limit Test Current Results (Remote Command Only)	1240
Data Query (Remote Command Only)	1240
Calculate/Compress Trace Data Query (Remote Command Only)	1241

## Table of Contents

Calculate Peaks of Trace Data (Remote Command Only)	1246
Format Data: Numeric Data (Remote Command Only)	1247
Format Data: Byte Order (Remote Command Only)	1248
Meas Setup	1249
Avg/Hold Num	1249
Meas Type	1249
Ref Channel	1250
Integ BW	1250
Span	1251
Sweep Time	1253
Res BW	1253
Video BW	1255
VBW/RBW	1256
Power Ref (for the modes except MSR and LTE-Advanced FDD/TDD)	1257
Total Power	1257
PSD	1258
Spectrum Peak	1259
Offset/Limits	1260
Select Offset	1260
Start Freq	1260
Stop Freq	1263
Sweep Time	1265
Offset Side	1266
Res BW	1267
Meas BW	1269
Video BW	1270
VBW/RBW	1271
Limits	1273
Select Offset	1273
Abs Start	1273
Abs Stop	1275
Rel Start	1278
Rel Stop	1280
Fail Mask	1282
Offset Freq Define	1284
Meas Preset	1286
Mode	1287
Mode Preset	1288
How-To Preset	1289
Preset Type (Remote Command Only)	1290
Mode Setup	1291
Peak Search	1292
Print	1293

Quick Save	1294
Recall	1296
State	1296
More Information	1298
From File...	1298
Edit Register Names	1300
Register 1 thru Register 16	1300
Register 1 thru Register 16	1301
Trace (+State)	1302
To Trace	1303
Register 1 thru Register 16	1304
From File...	1304
Data (Import)	1306
Capture Buffer	1307
Open...	1307
Restart	1308
More Information	1308
Save	1310
State	1310
To File . . .	1311
Edit Register Names	1313
More Information	1313
Register 1 thru Register 16	1314
Register 1 thru Register 16	1314
Data (Export)	1315
Measurement Results	1316
Meas Results File Contents	1316
Capture Buffer	1325
Save As . . .	1326
Screen Image	1326
Themes	1328
3D Color	1328
3D Monochrome	1328
Flat Color	1328
Flat Monochrome	1329
Save As...	1329
Mass Storage Catalog (Remote Command Only)	1329
Mass Storage Change Directory (Remote Command Only)	1330
Mass Storage Copy (Remote Command Only)	1330
Mass Storage Device Copy (Remote Command Only)	1330
Mass Storage Delete (Remote Command Only)	1331
Mass Storage Data (Remote Command Only)	1331
Mass Storage Make Directory (Remote Command Only)	1331

## Table of Contents

Mass Storage Move (Remote Command Only)	1332
Mass Storage Remove Directory (Remote Command Only)	1332
Single (Single Measurement/Sweep)	1333
More Information	1333
Source	1334
Span X Scale	1335
Ref Value	1335
Scale/Div	1335
Ref Position	1336
Auto Scaling	1336
Sweep/Control	1338
Pause	1338
Gate	1338
Gate On/Off	1338
Gate View On/Off	1339
Gate View Setup	1342
Gate View Sweep Time	1343
Gate View Start Time	1343
Gate Delay	1344
Gate Length	1344
Gate Source	1345
Line	1346
External 1	1346
External 2	1348
RF Burst	1350
Periodic Timer (Frame Trigger)	1353
Control Edge/Level	1364
Gate Holdoff	1364
Gate Delay Compensation	1366
More Information	1367
Min Fast Position Query (Remote Command Only)	1367
Gate Preset (Remote Command Only)	1368
Gate Level (Remote Command Only)	1368
Gate Polarity (Remote Command Only)	1368
System	1370
Trace/Detector	1371
Trace Type	1371
Chan Detector	1371
Chan Detector Auto	1372
Chan Detector Selection	1372
Offset Detector	1373
Offset Detector Auto	1373
Offset Detector Selection	1374

Trigger	1375
Free Run	1375
Video	1375
Trigger Level	1375
Trig Slope	1375
Trig Delay	1375
Line	1375
Trig Slope	1375
Trig Delay	1375
External 1	1375
Trigger Level	1375
Trig Slope	1375
Trig Delay	1375
External 2	1375
Trigger Level	1376
Trig Slope	1376
Trig Delay	1376
RF Burst	1376
Absolute Trigger	1376
Relative Trigger	1376
Trig Slope	1376
Trig Delay	1376
Periodic Timer	1376
Period	1376
Offset	1376
Reset Offset Display	1376
Sync Source	1376
Off	1376
External 1	1377
External 2	1377
RF Burst	1377
Trig Delay	1377
Auto/Holdoff	1377
Auto Trig	1377
Trig Holdoff	1377
User Preset	1378
User Preset	1378
User Preset All Modes	1379
Save User Preset	1380
View/Display	1381
View Selection by Name (Remote Command Only)	1381
Views Selection by Number (Remote Command only)	1382
Display	1382

## Table of Contents

Annotation	1383
Meas Bar On/Off	1384
Screen	1385
Active Function Values On/Off	1385
Title	1386
Change Title	1386
Clear Title	1387
Graticule	1388
System Display Settings	1388
Annotation Local Settings	1388
Themes	1389
Backlight	1390
Backlight Intensity	1390
Abs Pwr Freq	1391
Abs Peak Pwr & Freq (Total Pwr Ref)	1391
Trace Window	1393
Results Window	1393
Abs Peak Pwr & Freq (PSD Ref)	1393
Trace Window	1395
Results Window	1395
Abs Peak Pwr & Freq (Spectrum Pk Ref)	1395
Trace Window	1397
Results Window	1397
Rel Pwr Freq	1397
Rel Peak Pwr & Freq (Total Pwr Ref)	1397
Trace Window	1398
Results Window	1398
Rel Peak Pwr & Freq (PSD Ref)	1399
Trace Window	1399
Results Window	1400
Rel Peak Pwr & Freq (Spectrum Pk Ref)	1400
Trace Window	1401
Results Window	1401
Integrated Power	1402
Integrated Power (Total Pwr Ref)	1402
Trace Window	1404
Results Window	1404
Integrated Power (PSD Ref)	1405
Trace Window	1407
Results Window	1407
Integrated Power (Spectrum Pk Ref)	1408
Trace Window	1409
Results Window	1409



Limit Lines	1410
<b>13 Spurious Emissions Measurement</b>	<b>1411</b>
AMPTD Y Scale	1414
Ref Value	1414
Attenuation	1414
Dual Attenuator Configurations:	1415
Single Attenuator Configuration:	1416
(Mech) Atten	1416
Attenuator Configurations and Auto/Man	1418
Enable Elec Atten	1418
More Information	1419
Mechanical Attenuator Transition Rules	1419
When the Electronic Attenuation is enabled from a disabled state:	1419
Examples in the dual attenuator configuration:	1419
When the Electronic Attenuation is disabled from an enabled state:	1420
Using the Electronic Attenuator: Pros and Cons	1420
Elec Atten	1420
Adjust Atten for Min Clip	1421
Pre-Adjust for Min Clip	1421
Off	1422
Elec Atten Only	1422
Mech + Elec Atten	1423
(Mech) Atten Step	1423
Scale/Div	1424
Presel Center	1424
Proper Preselector Operation	1425
Preselector Adjust	1426
$\mu$ W Path Control	1427
Standard Path	1428
Low Noise Path Enable	1428
More Information	1429
$\mu$ W Preselector Bypass	1430
Internal Preamp	1431
Off	1432
Low Band	1433
Full Range	1433
Auto Scaling	1433
Auto Couple	1435
More Information	1435
Auto/Man Active Function keys	1435
Auto/Man 1-of-N keys	1435
BW	1437
Cont (Continuous Measurement/Sweep)	1438

## Table of Contents

File	1440
FREQ Channel	1441
Center Freq	1441
Center Frequency Presets	1442
RF Center Freq	1444
Ext Mix Center Freq	1445
I/Q Center Freq	1446
CF Step	1446
Input/Output	1448
Marker	1449
Select Marker	1449
Marker Type	1449
Properties	1450
Select Marker	1450
Relative To	1450
Couple Markers	1451
All Markers Off	1451
Marker X Axis Value (Remote Command only)	1452
Marker X Axis Position (Remote Command only)	1452
Marker Y Axis Value (Remote Command only)	1453
Marker Function	1454
Marker To	1455
Meas	1456
Remote Measurement Functions	1456
Measurement Group of Commands	1457
Current Measurement Query (Remote Command Only)	1459
Limit Test Current Results (Remote Command Only)	1459
Data Query (Remote Command Only)	1459
Calculate/Compress Trace Data Query (Remote Command Only)	1460
Calculate Peaks of Trace Data (Remote Command Only)	1465
Format Data: Numeric Data (Remote Command Only)	1466
Format Data: Byte Order (Remote Command Only)	1467
Meas Setup	1468
Avg/Hold Num	1468
Avg Mode	1468
Range Table	1469
Range	1469
Start Freq	1471
Stop Freq	1472
Res BW	1473
Video BW	1475
Filter Type	1476
Abs Start Limit	1477

Abs Stop Limit	1478
Peak Excursion	1480
Pk Threshold	1480
Attenuation	1481
Detector 1	1482
Detector 2	1483
Sweep Time	1484
Points	1484
IF Gain	1486
IF Gain Auto	1486
IF Gain State	1487
Meas Type	1487
Spur	1488
Spurious Report Mode	1489
Meas Preset	1489
Fast Spurious Meas (Remote Command only)	1490
Mode	1491
Mode Preset	1492
How-To Preset	1493
Preset Type (Remote Command Only)	1494
Mode Setup	1495
Peak Search	1496
Next Peak	1496
Next Pk Right	1496
Next Pk Left	1497
Marker Delta	1497
Pk-Pk Search	1497
Min Search	1497
Print	1499
Quick Save	1500
Recall	1502
State	1502
More Information	1504
From File...	1504
Edit Register Names	1506
Register 1 thru Register 16	1506
Register 1 thru Register 16	1507
Trace (+State)	1508
To Trace	1509
Register 1 thru Register 16	1510
From File...	1510
Data (Import)	1512
Capture Buffer	1513

Open...	1513
Restart	1514
More Information	1514
Save	1516
State	1516
To File . . .	1517
Edit Register Names	1519
More Information	1519
Register 1 thru Register 16	1520
Register 1 thru Register 16	1520
Data (Export)	1521
Measurement Results	1522
Meas Results File Definition	1522
Meas Results File Example	1524
Capture Buffer	1527
Save As . . .	1528
Screen Image	1528
Themes	1530
3D Color	1530
3D Monochrome	1530
Flat Color	1530
Flat Monochrome	1531
Save As...	1531
Mass Storage Catalog (Remote Command Only)	1531
Mass Storage Change Directory (Remote Command Only)	1532
Mass Storage Copy (Remote Command Only)	1532
Mass Storage Device Copy (Remote Command Only)	1532
Mass Storage Delete (Remote Command Only)	1533
Mass Storage Data (Remote Command Only)	1533
Mass Storage Make Directory (Remote Command Only)	1533
Mass Storage Move (Remote Command Only)	1534
Mass Storage Remove Directory (Remote Command Only)	1534
Single (Single Measurement/Sweep)	1535
More Information	1535
Source	1536
Span X Scale	1537
Sweep/Control	1538
Sweep Setup	1538
Auto Sweep Time Rules	1538
Sweep Type	1539
Pause	1539
Gate	1539
Gate On/Off	1540

Gate View On/Off	1541
Gate View Setup	1544
Gate View Sweep Time	1544
Gate View Start Time	1545
Gate Delay	1545
Gate Length	1546
Gate Source	1546
Line	1547
External 1	1548
External 2	1550
RF Burst	1551
Periodic Timer (Frame Trigger)	1554
Control Edge/Level	1565
Gate Holdoff	1566
Gate Delay Compensation	1567
More Information	1568
Min Fast Position Query (Remote Command Only)	1569
Gate Preset (Remote Command Only)	1569
Gate Level (Remote Command Only)	1569
Gate Polarity (Remote Command Only)	1569
Gate	1570
System	1571
Trace/Detector	1572
Trigger	1573
Free Run	1573
Video	1573
Trigger Level	1573
Trig Slope	1573
Trig Delay	1573
Line	1573
Trig Slope	1573
Trig Delay	1573
External 1	1573
Trigger Level	1573
Trig Slope	1573
Trig Delay	1573
External 2	1573
Trigger Level	1574
Trig Slope	1574
Trig Delay	1574
RF Burst	1574
Absolute Trigger	1574
Relative Trigger	1574

## Table of Contents

Trig Slope	1574
Trig Delay	1574
Periodic Timer	1574
Period	1574
Offset	1574
Reset Offset Display	1574
Sync Source	1574
Off	1574
External 1	1575
External 2	1575
RF Burst	1575
Trig Delay	1575
Auto/Holdoff	1575
Auto Trig	1575
Trig Holdoff	1575
User Preset	1576
User Preset	1576
User Preset All Modes	1577
Save User Preset	1578
View/Display	1579
Display	1579
Annotation	1579
Meas Bar On/Off	1580
Screen	1581
Active Function Values On/Off	1581
Title	1582
Change Title	1582
Clear Title	1583
Graticule	1584
System Display Settings	1584
Annotation Local Settings	1584
Themes	1585
Backlight	1586
Backlight Intensity	1586
View Selection	1587
Graph + Metrics	1587
Range Table	1588
All Ranges	1591
Range Table Selection (SCPI only command)	1592
<b>14 Power Stat CCDF Measurement</b>	<b>1595</b>
AMPTD Y Scale	1600
Attenuation	1600
Dual Attenuator Configurations:	1600

Single Attenuator Configuration:	1601
(Mech) Atten	1602
Attenuator Configurations and Auto/Man	1603
Enable Elec Atten	1603
More Information	1604
Mechanical Attenuator Transition Rules	1604
When the Electronic Attenuation is enabled from a disabled state:	1605
Examples in the dual attenuator configuration:	1605
When the Electronic Attenuation is disabled from an enabled state:	1605
Using the Electronic Attenuator: Pros and Cons	1605
Elec Atten	1606
Adjust Atten for Min Clip	1606
Pre-Adjust for Min Clip	1607
Off	1608
Elec Atten Only	1608
Mech + Elec Atten	1608
(Mech) Atten Step	1608
Presel Center	1609
Proper Preselector Operation	1610
Preselector Adjust	1610
$\mu$ W Path Control	1612
Standard Path	1613
Low Noise Path Enable	1613
More Information	1614
$\mu$ W Preselector Bypass	1615
Internal Preamp	1616
Off	1617
Low Band	1618
Full Range	1618
Range	1618
Range Auto/Man	1619
I Range	1620
1 V Peak	1621
0.5 V Peak	1621
0.25 V Peak	1621
0.125 V Peak	1621
Q Range Value	1622
Q Same as I	1623
1 V Peak	1623
0.5 V Peak	1623
0.25 V Peak	1624
0.125 V Peak	1624
I/Q Gain Ranges	1624

## Table of Contents

1 V Peak	1624
0.5 V Peak	1624
0.25 V Peak	1624
0.125 V Peak	1625
Presel Center	1625
Auto Couple	1626
More Information	1626
Auto/Man Active Function keys	1626
Auto/Man 1-of-N keys	1626
BW	1628
Info BW	1628
Cont (Continuous Measurement/Sweep)	1630
File	1632
FREQ Channel	1633
Center Freq	1633
Center Frequency Presets	1634
RF Center Freq	1636
Ext Mix Center Freq	1637
I/Q Center Freq	1638
CF Step	1638
Input/Output	1640
Marker	1641
Select Marker	1641
Marker Type	1641
Properties	1642
Select Marker	1642
Relative To	1642
Marker Trace	1643
Couple Markers	1643
All Markers Off	1643
Marker X Axis Value (Remote Command Only)	1644
Marker Y Axis Value (Remote Command Only)	1644
Marker Function	1646
Marker To	1647
Meas	1648
Remote Measurement Functions	1648
Measurement Group of Commands	1649
Current Measurement Query (Remote Command Only)	1651
Limit Test Current Results (Remote Command Only)	1651
Data Query (Remote Command Only)	1651
Calculate/Compress Trace Data Query (Remote Command Only)	1652
Calculate Peaks of Trace Data (Remote Command Only)	1657
Format Data: Numeric Data (Remote Command Only)	1658



Format Data: Byte Order (Remote Command Only)	1659
Meas Setup	1660
Counts	1660
Meas Cycles	1660
Meas Interval (1xEVDO Only)	1661
Meas Offset	1661
IF Gain	1662
IF Gain Auto	1662
IF Gain State	1663
Meas Preset	1664
Mode	1665
Mode Preset	1666
How-To Preset	1667
Preset Type (Remote Command Only)	1668
Mode Setup	1669
Peak Search	1670
Print	1671
Quick Save	1672
Recall	1674
State	1674
More Information	1676
From File...	1676
Edit Register Names	1678
Register 1 thru Register 16	1678
Register 1 thru Register 16	1679
Trace (+State)	1680
To Trace	1681
Register 1 thru Register 16	1682
From File...	1682
Data (Import)	1684
Capture Buffer	1685
Open...	1685
Restart	1686
More Information	1686
Save	1688
State	1688
To File . . .	1689
Edit Register Names	1691
More Information	1691
Register 1 thru Register 16	1692
Register 1 thru Register 16	1692
Data (Export)	1693
Measurement Results	1694

Meas Results File Definition	1694
Meas Results File Example	1696
Capture Buffer	1697
Save As . . .	1698
Screen Image	1698
Themes	1700
3D Color	1700
3D Monochrome	1700
Flat Color	1700
Flat Monochrome	1701
Save As...	1701
Mass Storage Catalog (Remote Command Only)	1701
Mass Storage Change Directory (Remote Command Only)	1702
Mass Storage Copy (Remote Command Only)	1702
Mass Storage Device Copy (Remote Command Only)	1702
Mass Storage Delete (Remote Command Only)	1703
Mass Storage Data (Remote Command Only)	1703
Mass Storage Make Directory (Remote Command Only)	1703
Mass Storage Move (Remote Command Only)	1704
Mass Storage Remove Directory (Remote Command Only)	1704
Single (Single Measurement/Sweep)	1705
More Information	1705
Source	1706
Span X Scale	1707
Scale/Div	1707
Sweep/Control	1708
Pause/Resume	1708
System	1709
Trace/Detector	1710
Store Ref Trace	1710
Ref Trace	1710
Gaussian Line	1711
Trigger	1712
Free Run	1712
Video	1712
Trigger Level	1712
Trig Slope	1712
Trig Delay	1712
Line	1712
Trig Slope	1712
Trig Delay	1712
External 1	1712
Trigger Level	1712

Trig Slope	1712
Trig Delay	1712
External 2	1712
Trigger Level	1713
Trig Slope	1713
Trig Delay	1713
RF Burst	1713
Absolute Trigger	1713
Relative Trigger	1713
Trig Slope	1713
Trig Delay	1713
Periodic Timer	1713
Period	1713
Offset	1713
Offset Adjust (Remote Command Only)	1713
Reset Offset Display	1713
Sync Source	1713
Off	1714
External 1	1714
External 2	1714
RF Burst	1714
Trig Delay	1714
Auto/Holdoff	1714
Auto Trig	1714
Trig Holdoff	1714
User Preset	1715
User Preset	1715
User Preset All Modes	1716
Save User Preset	1717
View/Display	1718
Metrics window	1720
Graph window	1721
Wave window (TD-SCDMA and LTE TDD only)	1721
Display	1722
Annotation	1722
Meas Bar On/Off	1723
Screen	1724
Active Function Values On/Off	1724
Title	1725
Change Title	1725
Clear Title	1726
Graticule	1727
System Display Settings	1727

Annotation Local Settings	1727
Themes	1728
Backlight	1729
Backlight Intensity	1729
<b>15 Common Functions</b>	<b>1731</b>
<b>15 Forward Link Code Domain Measurement</b>	<b>1731</b>
Amplitude (AMPTD) Y Scale	1740
Attenuation	1740
Dual Attenuator Configurations:	1740
Single Attenuator Configuration:	1741
(Mech) Atten	1742
Attenuator Configurations and Auto/Man	1743
Enable Elec Atten	1743
More Information	1744
Mechanical Attenuator Transition Rules	1744
When the Electronic Attenuation is enabled from a disabled state:	1745
Examples in the dual attenuator configuration:	1745
When the Electronic Attenuation is disabled from an enabled state:	1745
Using the Electronic Attenuator: Pros and Cons	1745
Elec Atten	1746
Adjust Atten for Min Clip	1746
Pre-Adjust for Min Clip	1747
Off	1748
Elec Atten Only	1748
Mech + Elec Atten	1748
(Mech) Atten Step	1748
Presel Center	1749
Proper Preselector Operation	1750
Preselector Adjust	1750
$\mu$ W Path Control	1752
Standard Path	1753
Low Noise Path Enable	1753
More Information	1754
$\mu$ W Preselector Bypass	1755
Internal Preamp	1756
Off	1757
Low Band	1758
Full Range	1758
Range	1758
Range Auto/Man	1759
I Range	1760
1 V Peak	1761

0.5 V Peak	1761
0.25 V Peak	1761
0.125 V Peak	1761
Q Range Value	1762
Q Same as I	1763
1 V Peak	1763
0.5 V Peak	1763
0.25 V Peak	1764
0.125 V Peak	1764
I/Q Gain Ranges	1764
1 V Peak	1764
0.5 V Peak	1764
0.25 V Peak	1764
0.125 V Peak	1765
Ref Value	1765
Y Ref Value (Power Bar Graph & Metrics View, Power Bar Graph window)	1765
Y Ref Value (CDP Graph & CDE Graph View, Power Bar Graph window)	1765
Y Ref Value (CDP Graph & CDE Graph View, CDE Graph window)	1766
Y Ref Value (Code Domain (Quad View) View, Power Bar Graph window)	1766
Y Ref Value (Code Domain (Quad View) View, RMS Code Power/Slot window)	1767
Y Ref Value (Code Domain (Quad View) View, Chip Power window)	1767
Y Ref Value (Demod Bits View, Power Bar Graph window)	1768
Y Ref Value (Demod Bits View, RMS Code Power/Slot window)	1768
Scale/Div	1769
Y Scale/Div (Power Bar Graph & Metrics View, Power Bar Graph Window)	1769
Y Scale/Div (CDP Graph & CDE Graph View, Power Bar Graph Window)	1770
Y Scale/Div (CDP Graph & CDE Graph View, CDE Graph Window)	1770
Y Scale/Div (Code Domain (Quad View) View, Power Bar Graph Window)	1771
Y Scale/Div (Code Domain (Quad View) View, RMS Code Power/Slot Window)	1771
Y Scale/Div (Code Domain (Quad View) View, Chip Power Window)	1772
Y Scale/Div (Demod Bits View, Power Bar Graph Window)	1772
Y Scale/Div (Demod Bits View, RMS Code Power/Slot Window)	1773
Y Ref Position	1773
Y Ref Position (Code Domain (Quad View) view, RMS Code Power/Slot window)	1773
Ref Position (Code Domain (Quad View) view, Chip Power window)	1774
Y Ref Position (Demod Bits view, RMS Code Power/Slot window)	1774
Auto Scaling	1775
Y Auto Scaling (Power Bar Graph & Metrics View, Power Bar Graph)	1775
Y Auto Scaling (CDP Graph & CDE Graph View, Power Bar Graph Window)	1775
Y Auto Scaling (CDP Graph & CDE Graph View, CDE Graph Window)	1776
Y Auto Scaling (Code Domain (Quad View) View, Power Bar Graph Window)	1776
Y Auto Scaling (Code Domain (Quad View) View, RMS Code Power/Slot)	1777

Window)	
Y Auto Scaling (Code Domain (Quad View) View, Chip Power Window)	1778
Y Auto Scaling (Demod Bits View, Power Bar Graph Window)	1778
Y Auto Scaling (Demod Bits View, RMS Code Power/Slot Window)	1779
Auto Couple	1780
More Information	1780
Auto/Man Active Function keys	1780
Auto/Man 1-of-N keys	1780
BW	1782
Cont (Continuous Measurement/Sweep)	1783
File	1785
FREQ Channel	1786
Center Freq	1786
Center Frequency Presets	1787
RF Center Freq	1789
Ext Mix Center Freq	1790
I/Q Center Freq	1791
CF Step	1791
Input/Output	1793
Marker	1794
Marker Type	1794
Properties	1795
Marker	1795
Relative TO	1795
Marker Trace	1796
Couple Marker	1796
All Markers Off	1797
Marker Symbol Value (Remote Command only)	1797
Marker X Axis Value (Remote Command only)	1798
Marker X Axis Position (Remote Command only)	1798
Marker Y Axis Value (Remote Command only)	1799
Backward Compatibility SCPI Commands	1799
Marker Fctn	1800
Marker To	1801
Mkr -> Despread	1801
Meas	1802
Remote Measurement Functions	1802
Measurement Group of Commands	1803
Current Measurement Query (Remote Command Only)	1805
Limit Test Current Results (Remote Command Only)	1805
Data Query (Remote Command Only)	1805
Calculate/Compress Trace Data Query (Remote Command Only)	1806
Calculate Peaks of Trace Data (Remote Command Only)	1811

Format Data: Numeric Data (Remote Command Only)	1812
Format Data: Byte Order (Remote Command Only)	1813
Meas Setup	1814
Meas Type	1814
Channel Type	1814
Walsh Code Number	1815
I/Q Branch	1816
Meas Interval	1816
Meas Offset	1817
PN Offset	1818
Sync Start Slot	1818
MAC Position	1819
Data Channel Attributes	1819
Data Mod Scheme	1820
Preamble Length	1820
Active Data Channel	1821
Capture Interval	1821
Demod Bits Tri-State	1822
Spectrum	1822
Meas Preset	1823
Advanced	1823
Active Set Threshold	1823
Filter Alpha	1824
Chip Rate	1825
IF Gain	1825
IF Gain Auto	1825
IF Gain State	1826
Packed Mode (SCPI command only)	1827
Mode	1829
Mode Preset	1830
How-To Preset	1831
Preset Type (Remote Command Only)	1832
Mode Setup	1833
Peak Search	1834
Next Peak	1834
Next Pk Right	1834
Next Pk Left	1835
Marker Delta	1835
Pk-Pk Search	1835
Min Search	1835
Print	1837
Quick Save	1838
Recall	1840

## Table of Contents

State	1840
More Information	1842
From File...	1842
Edit Register Names	1844
Register 1 thru Register 16	1844
Register 1 thru Register 16	1845
Trace (+State)	1846
To Trace	1847
Register 1 thru Register 16	1848
From File...	1848
Data (Import)	1850
Capture Buffer	1851
Open...	1851
Restart	1852
More Information	1852
Save	1854
State	1854
To File . . .	1855
Edit Register Names	1857
More Information	1857
Register 1 thru Register 16	1858
Register 1 thru Register 16	1858
Data (Export)	1859
Measurement Results	1860
Meas Results File Contents	1860
Marker Table	1860
Peak Table	1863
Spectrogram	1866
Capture Buffer	1870
Save As . . .	1871
Screen Image	1871
Themes	1873
3D Color	1873
3D Monochrome	1873
Flat Color	1873
Flat Monochrome	1874
Save As...	1874
Mass Storage Catalog (Remote Command Only)	1874
Mass Storage Change Directory (Remote Command Only)	1875
Mass Storage Copy (Remote Command Only)	1875
Mass Storage Device Copy (Remote Command Only)	1875
Mass Storage Delete (Remote Command Only)	1876
Mass Storage Data (Remote Command Only)	1876



Mass Storage Make Directory (Remote Command Only)	1876
Mass Storage Move (Remote Command Only)	1877
Mass Storage Remove Directory (Remote Command Only)	1877
Single (Single Measurement/Sweep)	1878
More Information	1878
Source	1879
SPAN X Scale	1880
X Ref Value	1880
X Ref Value (Code Domain (Quad View) View, RMS Code Power/Slot window)	1880
X Ref Value (Code Domain (Quad View) View, Chip Power window)	1881
X Ref Value (Demod Bits View, RMS Code Power/Slot window)	1881
X Scale/Div	1882
X Scale/Div (Code Domain (Quad View) View, RMS Code Power/Slot Window)	1882
X Scale/Div (Code Domain (Quad View) View, Chip Power Window)	1883
X Scale/Div (Demod Bits View, RMS Code Power/Slot Window)	1883
X Ref Position	1884
Ref Position (Code Domain (Quad View) view, RMS Code Power/Slot window)	1884
Ref Position (Code Domain (Quad View) view, Chip Power window)	1884
Ref Position (Demod Bits view, RMS Code Power/Slot window)	1885
Auto Scaling	1885
Auto Scaling (Code Domain (Quad View) View, RMS Code Power/Slot Window)	1886
Auto Scaling (Code Domain (Quad View) View Chip Power Window)	1886
Auto Scaling (Demod Bits View, RMS Code Power/Slot Window)	1887
Sweep/Control	1888
Pause/Resume	1888
System	1889
Trace/Detector	1890
Trigger	1891
Free Run	1891
Video	1891
Trigger Level	1891
Trig Slope	1891
Trig Delay	1891
Line	1891
Trig Slope	1891
Trig Delay	1891
External 1	1891
Trigger Level	1891
Trig Slope	1891
Trig Delay	1891
External 2	1891
Trigger Level	1892
Trig Slope	1892

## Table of Contents

Trig Delay	1892
RF Burst	1892
Absolute Trigger	1892
Relative Trigger	1892
Trig Slope	1892
Trig Delay	1892
Periodic Timer	1892
Period	1892
Offset	1892
Offset Adjust (Remote Command Only)	1892
Reset Offset Display	1892
Sync Source	1892
Off	1893
External 1	1893
External 2	1893
RF Burst	1893
Trig Delay	1893
Auto/Holdoff	1893
Auto Trig	1893
Trig Holdoff	1893
Holdoff Type	1893
User Preset	1894
User Preset	1894
User Preset All Modes	1895
Save User Preset	1896
View/Display	1897
View Selection by Name	1897
View Selection by number (Remote Command only)	1898
Display	1898
Annotation	1898
Meas Bar On/Off	1899
Screen	1900
Active Function Values On/Off	1900
Title	1901
Change Title	1901
Clear Title	1902
Graticule	1903
System Display Settings	1903
Annotation Local Settings	1903
Themes	1904
Backlight	1905
Backlight Intensity	1905
Power Graph & Metrics	1906

Power Bar Graph window	1907
Metrics window	1907
Code Order	1909
I/Q Combined Power Bar	1909
CDP Graph & CDE Graph	1911
Power Bar Graph window	1913
Code Domain Error Graph window	1913
Code Order	1914
I/Q Combined Power Bar	1914
Code Domain (Quad View)	1916
Power Bar Graph window	1917
I/Q Symbol Polar Vector window	1917
RMS Code Power/Slot window	1918
Chip Power window	1918
Code Order	1918
I/Q Combined Power Bar	1918
Demod Bits window	1920
Pilot Channel	1921
MAC Channel	1921
Data Channel	1922
Preamble Channel	1923
Power Bar Graph window	1924
RMS Code Power/Slot window	1924
Demod Bits window	1924
Code Order	1925
I/Q Combined Power Bar	1926
Multiplexed Data Demod Bits view	1927
Multiplexed Data Demod Bits window	1928
Prev Page	1928
Next Page	1929
Scroll Up	1929
Scroll Down	1929
First Page	1929
Last Page	1929
Demod Bit Format	1930
<b>16 Reverse Link Code Domain</b>	<b>1931</b>
Amplitude (AMPTD) Y Scale	1932
Y Ref Value (Power Bar Graph & Metrics View, Power Bar Graph window)	1932
Attenuation	1932
Dual Attenuator Configurations:	1933
Single Attenuator Configuration:	1933
(Mech) Atten	1934
Attenuator Configurations and Auto/Man	1935

Enable Elec Atten	1936
More Information	1937
Mechanical Attenuator Transition Rules	1937
When the Electronic Attenuation is enabled from a disabled state:	1937
Examples in the dual attenuator configuration:	1937
When the Electronic Attenuation is disabled from an enabled state:	1937
Using the Electronic Attenuator: Pros and Cons	1938
Elec Atten	1938
Adjust Atten for Min Clip	1939
Pre-Adjust for Min Clip	1939
Off	1940
Elec Atten Only	1940
Mech + Elec Atten	1941
(Mech) Atten Step	1941
Y Scale/Div (Power Bar Graph & Metrics View, Power Bar Graph Window)	1941
Presel Center	1942
Proper Preselector Operation	1943
Preselector Adjust	1943
$\mu$ W Path Control	1944
Standard Path	1946
Low Noise Path Enable	1946
More Information	1947
$\mu$ W Preselector Bypass	1948
Internal Preamp	1949
Off	1950
Low Band	1951
Full Range	1951
Range	1951
Range Auto/Man	1952
I Range	1953
1 V Peak	1954
0.5 V Peak	1954
0.25 V Peak	1954
0.125 V Peak	1954
Q Range Value	1955
Q Same as I	1956
1 V Peak	1956
0.5 V Peak	1956
0.25 V Peak	1957
0.125 V Peak	1957
I/Q Gain Ranges	1957
1 V Peak	1957
0.5 V Peak	1957

0.25 V Peak	1957
0.125 V Peak	1958
Auto Couple	1959
More Information	1959
Auto/Man Active Function keys	1959
Auto/Man 1-of-N keys	1959
BW	1961
Cont (Continuous Measurement/Sweep)	1962
File	1964
FREQ Channel	1965
Center Freq	1965
Center Frequency Presets	1966
RF Center Freq	1968
Ext Mix Center Freq	1969
I/Q Center Freq	1970
CF Step	1970
Input/Output	1972
Marker	1973
Marker Type	1973
Properties	1974
Marker	1974
Relative TO	1974
Marker Trace	1975
Couple Marker	1975
All Markers Off	1976
Marker Fctn	1977
Marker To	1978
Mkr -> Despread	1978
Meas	1979
Remote Measurement Functions	1979
Measurement Group of Commands	1980
Current Measurement Query (Remote Command Only)	1982
Limit Test Current Results (Remote Command Only)	1982
Data Query (Remote Command Only)	1982
Calculate/Compress Trace Data Query (Remote Command Only)	1983
Calculate Peaks of Trace Data (Remote Command Only)	1988
Format Data: Numeric Data (Remote Command Only)	1989
Format Data: Byte Order (Remote Command Only)	1990
Meas Setup	1991
Meas Type	1991
Walsh Code Length	1991
Walsh Code Number	1992
I/Q Branch	1992

## Table of Contents

Sync Type	1993
Meas Offset	1993
I Long Code Mask	1994
Q Long Code Mask	1995
Active Code Channel	1995
Predefined Active Chan	1996
Pilot/RRI Channel	1996
DRC Channel Definition [Common for Subtype 0/1 and Subtype 2/3]	1997
ACK Channel Definition [Subtype 0/1 only]	1997
Data Channel Definition [Subtype 0/1 only]	1998
Sync Start Slot	1998
Capture Interval	1999
Spectrum	1999
Meas Preset	2000
Advanced	2000
Symbol EVM Compensation	2001
Frequency Compensation	2001
Active Set Threshold	2001
Freq Error Tol Range (Frequency Error Tolerance Range)	2002
More Information about Frequency Error Tolerance Range	2002
Chip Rate	2003
Filter Alpha	2003
IF Gain	2004
IF Gain Auto	2004
IF Gain State	2004
Mode	2006
Mode Preset	2007
How-To Preset	2008
Preset Type (Remote Command Only)	2009
Mode Setup	2010
Peak Search	2011
Next Peak	2011
Next Pk Right	2011
Next Pk Left	2012
Marker Delta	2012
Pk-Pk Search	2012
Min Search	2013
Print	2014
Quick Save	2015
Recall	2017
State	2017
More Information	2019
From File...	2019

Edit Register Names	2021
Register 1 thru Register 16	2021
Register 1 thru Register 16	2022
Trace (+State)	2023
To Trace	2024
Register 1 thru Register 16	2025
From File...	2025
Data (Import)	2027
Capture Buffer	2028
Open...	2028
Restart	2029
More Information	2029
Save	2031
State	2031
To File . . .	2032
Edit Register Names	2034
More Information	2034
Register 1 thru Register 16	2035
Register 1 thru Register 16	2035
Data (Export)	2036
Measurement Results	2037
Meas Results File Contents	2037
Marker Table	2037
Peak Table	2040
Spectrogram	2043
Capture Buffer	2047
Save As . . .	2048
Screen Image	2048
Themes	2050
3D Color	2050
3D Monochrome	2050
Flat Color	2050
Flat Monochrome	2051
Save As...	2051
Mass Storage Catalog (Remote Command Only)	2051
Mass Storage Change Directory (Remote Command Only)	2052
Mass Storage Copy (Remote Command Only)	2052
Mass Storage Device Copy (Remote Command Only)	2052
Mass Storage Delete (Remote Command Only)	2053
Mass Storage Data (Remote Command Only)	2053
Mass Storage Make Directory (Remote Command Only)	2053
Mass Storage Move (Remote Command Only)	2054
Mass Storage Remove Directory (Remote Command Only)	2054

## Table of Contents

Single (Single Measurement/Sweep)	2055
More Information	2055
Source	2056
Span X Scale	2057
X Ref Value (I/Q Error (Quad View) view, Magnitude Error window)	2057
X Scale/Div (I/Q Error (Quad) View, Magnitude Error Window)	2057
X Ref Position (I/Q Error (Quad) view, Phase Error window)	2058
Auto Scaling (I/Q Error (Quad View) View, Phase Error window)	2058
Sweep/Control	2060
Pause/Resume	2060
System	2061
Trace/Detector	2062
Trigger	2063
Free Run	2063
Video	2063
Trigger Level	2063
Trig Slope	2063
Trig Delay	2063
Line	2063
Trig Slope	2063
Trig Delay	2063
External 1	2063
Trigger Level	2063
Trig Slope	2063
Trig Delay	2063
External 2	2063
Trigger Level	2064
Trig Slope	2064
Trig Delay	2064
RF Burst	2064
Absolute Trigger	2064
Relative Trigger	2064
Trig Slope	2064
Trig Delay	2064
Periodic Timer	2064
Period	2064
Offset	2064
Offset Adjust (Remote Command Only)	2064
Reset Offset Display	2064
Sync Source	2064
Off	2065
External 1	2065
External 2	2065



RF Burst	2065
Trig Delay	2065
Auto/Holdoff	2065
Auto Trig	2065
Trig Holdoff	2065
Holdoff Type	2065
User Preset	2066
User Preset	2066
User Preset All Modes	2067
Save User Preset	2068
View/Display	2069
View Selection by Name	2069
View Selection by number (Remote Command only)	2069
Display	2070
Annotation	2070
Meas Bar On/Off	2071
Screen	2072
Active Function Values On/Off	2072
Title	2073
Change Title	2073
Clear Title	2074
Graticule	2075
System Display Settings	2075
Annotation Local Settings	2075
Themes	2076
Backlight	2077
Backlight Intensity	2077
Power Graph & Metrics	2078
Power Bar Graph window	2079
Metrics window	2079
Code Order	2080
Consolidated Marker	2080
I/Q Combined Power Bar	2081
CDP Graph & CDE Graph	2082
Code Domain Power Bar Graph window	2083
Code Domain Error Bar Graph window	2083
Code Order	2084
Consolidated Marker	2084
I/Q Combined Power Bar	2085
I/Q Error (Quad View) - Symbol EVM	2085
Magnitude Error window	2086
Phase Error window	2086
Symbol EVM window	2086

Metrics window	2087
Code Domain (Quad View)	2087
Power Bar Graph window	2088
Symbol/Chip Power vs Time window	2088
I/Q Symbol Polar Vector window	2088
Metrics window	2089
Code Order	2089
Consolidated Marker	2090
I/Q Combined Power Bar	2090
Demod Bits	2091
Changes in demod bit window with “I/Q Branch” key	2096
Power Bar Graph window	2098
Symbol/Chip Power window	2098
Demod Bits window	2098
Code Order	2099
Consolidated Marker	2099
I/Q Combined Power Bar	2100
<b>17 Forward Link Modulation Accuracy</b>	<b>2101</b>
Amplitude (AMPTD) Y Scale	2102
Attenuation	2102
Dual Attenuator Configurations:	2102
Single Attenuator Configuration:	2103
(Mech) Atten	2104
Attenuator Configurations and Auto/Man	2105
Enable Elec Atten	2105
More Information	2106
Mechanical Attenuator Transition Rules	2106
When the Electronic Attenuation is enabled from a disabled state:	2107
Examples in the dual attenuator configuration:	2107
When the Electronic Attenuation is disabled from an enabled state:	2107
Using the Electronic Attenuator: Pros and Cons	2107
Elec Atten	2108
Adjust Atten for Min Clip	2108
Pre-Adjust for Min Clip	2109
Off	2110
Elec Atten Only	2110
Mech + Elec Atten	2110
(Mech) Atten Step	2110
Presel Center	2111
Presel Adjust	2111
μW Path Control	2111
Standard Path	2113
Low Noise Path Enable	2113

More Information	2114
$\mu$ W Preselector Bypass	2115
Internal Preamp	2116
Off	2117
Low Band	2118
Full Range	2118
Range	2118
Range Auto/Man	2119
I Range	2120
1 V Peak	2121
0.5 V Peak	2121
0.25 V Peak	2121
0.125 V Peak	2121
Q Range Value	2122
Q Same as I	2123
1 V Peak	2123
0.5 V Peak	2123
0.25 V Peak	2124
0.125 V Peak	2124
I/Q Gain Ranges	2124
1 V Peak	2124
0.5 V Peak	2124
0.25 V Peak	2124
0.125 V Peak	2125
Auto Couple	2126
More Information	2126
Auto/Man Active Function keys	2126
Auto/Man 1-of-N keys	2126
BW	2128
Cont (Continuous Measurement/Sweep)	2129
File	2131
FREQ Channel	2132
Center Freq	2132
Center Frequency Presets	2133
RF Center Freq	2135
Ext Mix Center Freq	2136
I/Q Center Freq	2137
CF Step	2137
Input/Output	2139
Marker	2140
Select Marker	2140
Marker Type	2140
Properties	2141

Select Marker	2141
Relative To	2141
Marker Trace	2141
Couple Marker	2142
All Markers Off	2142
Marker Fctn	2143
Marker To	2144
Meas	2145
Remote Measurement Functions	2145
Measurement Group of Commands	2146
Current Measurement Query (Remote Command Only)	2148
Limit Test Current Results (Remote Command Only)	2148
Data Query (Remote Command Only)	2148
Calculate/Compress Trace Data Query (Remote Command Only)	2149
Calculate Peaks of Trace Data (Remote Command Only)	2154
Format Data: Numeric Data (Remote Command Only)	2155
Format Data: Byte Order (Remote Command Only)	2156
Meas Setup	2157
Avg/Hold Num	2157
Avg Mode	2157
Meas Slot Type	2158
Capture Interval	2158
Meas Offset	2159
PN Offset	2159
Sync Start Slot	2160
Meas Type	2161
Data Channel Attributes	2161
Data Mod Scheme	2162
Preamble Length	2162
Active Data Channel	2163
MAC Position	2163
Limits	2164
Limit Preset	2164
Rho Pilot Limit	2165
Rho MAC Limit	2166
Rho Data Limit	2166
Frequency Error Limit	2166
Pilot Offset Limit	2167
Max MAC Inactive Power Limit	2167
Max Data Active Power Limit	2168
Min Data Active Power Limit	2168
Rho Overall Limit	2169
Rho Preamble Limit	2169

RMS EVM Limit	2170
Peak EVM Limit	2170
Timing Limit	2170
Phase Limit	2171
Spectrum	2171
Advanced	2172
EVM Result I/Q Offset	2172
Result Preamble	2172
Filter Alpha	2173
Chip Rate	2173
Rho Overall	2174
IF Gain	2174
IF Gain Auto	2174
IF Gain State	2175
Multi Channel Estimator	2176
Timing Estimation	2176
Active Set Threshold	2177
Idle Slot Threshold	2177
Meas Preset	2178
Mode	2179
Mode Preset	2180
How-To Preset	2181
Preset Type (Remote Command Only)	2182
Mode Setup	2183
Peak Search	2184
Next Peak	2184
Next Pk Right	2184
Next Pk Left	2185
Marker Delta	2185
Pk-Pk Search	2185
Min Search	2185
Print	2187
Quick Save	2188
Recall	2190
State	2190
More Information	2192
From File...	2192
Edit Register Names	2194
Register 1 thru Register 16	2194
Register 1 thru Register 16	2195
Trace (+State)	2196
To Trace	2197
Register 1 thru Register 16	2198

## Table of Contents

From File...	2198
Data (Import)	2200
Capture Buffer	2201
Open...	2201
Restart	2202
More Information	2202
Save	2204
State	2204
To File . . .	2205
Edit Register Names	2207
More Information	2207
Register 1 thru Register 16	2208
Register 1 thru Register 16	2208
Data (Export)	2209
Measurement Results	2210
Meas Results File Contents	2210
Marker Table	2210
Peak Table	2213
Spectrogram	2216
Capture Buffer	2220
Save As . . .	2221
Screen Image	2221
Themes	2223
3D Color	2223
3D Monochrome	2223
Flat Color	2223
Flat Monochrome	2224
Save As...	2224
Mass Storage Catalog (Remote Command Only)	2224
Mass Storage Change Directory (Remote Command Only)	2225
Mass Storage Copy (Remote Command Only)	2225
Mass Storage Device Copy (Remote Command Only)	2225
Mass Storage Delete (Remote Command Only)	2226
Mass Storage Data (Remote Command Only)	2226
Mass Storage Make Directory (Remote Command Only)	2226
Mass Storage Move (Remote Command Only)	2227
Mass Storage Remove Directory (Remote Command Only)	2227
Single (Single Measurement/Sweep)	2228
More Information	2228
Source	2229
SPAN X Scale	2230
Sweep/Control	2231
Pause/Resume	2231

System	2232
Trace/Detector	2233
Trigger	2234
Free Run	2234
Video	2234
Trigger Level	2234
Trig Slope	2234
Trig Delay	2234
Line	2234
Trig Slope	2234
Trig Delay	2234
External 1	2234
Trigger Level	2234
Trig Slope	2234
Trig Delay	2234
External 2	2234
Trigger Level	2235
Trig Slope	2235
Trig Delay	2235
RF Burst	2235
Absolute Trigger	2235
Relative Trigger	2235
Trig Slope	2235
Trig Delay	2235
Periodic Timer	2235
Period	2235
Offset	2235
Offset Adjust (Remote Command Only)	2235
Reset Offset Display	2235
Sync Source	2235
Off	2236
External 1	2236
External 2	2236
RF Burst	2236
Trig Delay	2236
Auto/Holdoff	2236
Auto Trig	2236
Trig Holdoff	2236
Holdoff Type	2236
User Preset	2237
User Preset	2237
User Preset All Modes	2238
Save User Preset	2239

View/Display	2240
View Selection	2240
View Selection by number (SCPI Remote Command only)	2241
Display	2242
Annotation	2242
Meas Bar On/Off	2243
Screen	2244
Active Function Values On/Off	2244
Title	2245
Change Title	2245
Clear Title	2246
Graticule	2247
System Display Settings	2247
Annotation Local Settings	2247
Themes	2248
Backlight	2249
Backlight Intensity	2249
Display Channel Type	2250
I/Q Measured Polar Graph	2250
I/Q Measured Polar Vector window	2251
Metrics window	2251
I/Q Polar Vector/Constellation	2255
Chip Offset	2255
I/Q Chips	2255
+45° Rotation	2256
Full Vector(Background)	2256
Interpolation	2257
Chip Descrambling	2257
Result Metrics (One-Slot)	2258
Channel Peak/Avg Metrics	2263
Summary Peak/Avg Metrics	2270
I/Q Error (Quad View)	2272
Magnitude Error window	2273
Phase Error window	2274
EVM Window	2274
Metrics Window	2274
I/Q Measured(Quad Veiw)	2276
IQ Waveform window	2277
Chip Power window	2277
Measured IQ Polar Graph Window	2277
Numeric Results Window	2278
I/Q Polar Vector/Constellation	2278
Chip Offset	2278



I/Q Chips	2279
+45° Rotation	2279
Full Vector(Background)	2280
Interpolation	2280
Chip Descrambling	2280
Code Domain Power	2281
Code Domain Power Graph window	2282
Metrics window	2282
Code Order	2283
I/Q Combined Power Bar	2283
<b>18 Reverse Link Modulation Accuracy</b>	<b>2285</b>
Amplitude (AMPTD) Y Scale	2286
Attenuation	2286
Dual Attenuator Configurations:	2286
Single Attenuator Configuration:	2287
(Mech) Atten	2288
Attenuator Configurations and Auto/Man	2289
Enable Elec Atten	2289
More Information	2290
Mechanical Attenuator Transition Rules	2290
When the Electronic Attenuation is enabled from a disabled state:	2291
Examples in the dual attenuator configuration:	2291
When the Electronic Attenuation is disabled from an enabled state:	2291
Using the Electronic Attenuator: Pros and Cons	2291
Elec Atten	2292
Adjust Atten for Min Clip	2292
Pre-Adjust for Min Clip	2293
Off	2294
Elec Atten Only	2294
Mech + Elec Atten	2294
(Mech) Atten Step	2294
IF Gain	2295
Presel Adjust	2295
μW Path Control	2295
Standard Path	2297
Low Noise Path Enable	2297
More Information	2298
μW Preselector Bypass	2299
Internal Preamp	2300
Off	2301
Low Band	2302
Full Range	2302
Range	2302

## Table of Contents

Range Auto/Man	2303
I Range	2304
1 V Peak	2305
0.5 V Peak	2305
0.25 V Peak	2305
0.125 V Peak	2305
Q Range Value	2306
Q Same as I	2307
1 V Peak	2307
0.5 V Peak	2307
0.25 V Peak	2308
0.125 V Peak	2308
I/Q Gain Ranges	2308
1 V Peak	2308
0.5 V Peak	2308
0.25 V Peak	2308
0.125 V Peak	2309
Auto Couple	2310
More Information	2310
Auto/Man Active Function keys	2310
Auto/Man 1-of-N keys	2310
BW	2312
Cont (Continuous Measurement/Sweep)	2313
File	2315
FREQ Channel	2316
Center Freq	2316
Center Frequency Presets	2317
RF Center Freq	2319
Ext Mix Center Freq	2320
I/Q Center Freq	2321
CF Step	2321
Input/Output	2323
Marker	2324
Select Marker	2324
Marker Type	2324
Properties	2325
Select Marker	2325
Relative TO	2325
Marker Trace	2326
Couple Marker	2326
All Markers Off	2327
Marker Fctn	2328
Marker To	2329

Meas	2330
Remote Measurement Functions	2330
Measurement Group of Commands	2331
Current Measurement Query (Remote Command Only)	2333
Limit Test Current Results (Remote Command Only)	2333
Data Query (Remote Command Only)	2333
Calculate/Compress Trace Data Query (Remote Command Only)	2334
Calculate Peaks of Trace Data (Remote Command Only)	2339
Format Data: Numeric Data (Remote Command Only)	2340
Format Data: Byte Order (Remote Command Only)	2341
Meas Setup	2342
Avg/Hold Number	2342
Avg Mode	2342
Avg Slots	2343
Peak/Avg Metrics	2344
RMS EVM (Composite) [Subtype 0/1]	2347
Peak EVM (Composite) [Subtype 0/1]	2348
Rho (Composite) [Subtype 0/1]	2348
Peak Code Domain Error [Subtype 0/1]	2349
Frequency Error [Subtype 0/1]	2349
Pilot Offset [Subtype 0/1]	2350
Inactive CDP [Subtype 0/1]	2350
RRI/Pilot Power Tolerance [Subtype 0/1]	2351
Active CDP Tolerance [Subtype 0/1]	2351
DRC Channel Gain [Subtype 0/1]	2352
ACK Channel Gain [Subtype 0/1]	2352
Data Channel Gain [Subtype 0/1]	2353
Meas Offset	2353
Sync Type	2354
I Long Code Mask	2354
Q Long Code Mask	2354
Active Code Chan	2355
Predefined Active Channel	2355
Pilot/RRI Channel [Common for Subtype 0/1 , Subtype 2 and Subtype3 (NFM)]	2356
DRC Channel Definition [Common for Subtype 0/1 , Subtype 2 and Subtype3(NFM)]	2357
ACK Channel Definition [Subtype 0/1 only]	2357
Data Channel Definition [Subtype 0/1 only]	2357
Sync Start Slot	2358
Capture Interval	2359
Spectrum	2359
Advanced	2359

## Table of Contents

EVM Result I/Q Offset	2359
Active Set Threshold	2360
Chip Rate	2361
Filter Alpha	2361
IF Gain	2362
IF Gain Auto	2362
IF Gain State	2362
Multi Channel Estimator	2363
Timing Estimation	2364
Freq Error Tolerance Range	2364
Meas Preset	2365
Mode	2366
Mode Preset	2367
How-To Preset	2368
Preset Type (Remote Command Only)	2369
Mode Setup	2370
Peak Search	2371
Next Peak	2371
Next Pk Right	2371
Next Pk Left	2372
Marker Delta	2372
Pk-Pk Search	2372
Min Search	2372
Print	2374
Quick Save	2375
Recall	2377
State	2377
More Information	2379
From File...	2379
Edit Register Names	2381
Register 1 thru Register 16	2381
Register 1 thru Register 16	2382
Trace (+State)	2383
To Trace	2384
Register 1 thru Register 16	2385
From File...	2385
Data (Import)	2387
Capture Buffer	2388
Open...	2388
Restart	2389
More Information	2389
Save	2391
State	2391

To File . . .	2392
Edit Register Names	2394
More Information	2394
Register 1 thru Register 16	2395
Register 1 thru Register 16	2395
Data (Export)	2396
Measurement Results	2397
Meas Results File Contents	2397
Marker Table	2397
Peak Table	2400
Spectrogram	2403
Capture Buffer	2407
Save As . . .	2408
Screen Image	2408
Themes	2410
3D Color	2410
3D Monochrome	2410
Flat Color	2410
Flat Monochrome	2411
Save As...	2411
Mass Storage Catalog (Remote Command Only)	2411
Mass Storage Change Directory (Remote Command Only)	2412
Mass Storage Copy (Remote Command Only)	2412
Mass Storage Device Copy (Remote Command Only)	2412
Mass Storage Delete (Remote Command Only)	2413
Mass Storage Data (Remote Command Only)	2413
Mass Storage Make Directory (Remote Command Only)	2413
Mass Storage Move (Remote Command Only)	2414
Mass Storage Remove Directory (Remote Command Only)	2414
Single (Single Measurement/Sweep)	2415
More Information	2415
Source	2416
SPAN X Scale	2417
Sweep/Control	2418
Pause/Resume	2418
System	2419
Trace/Detector	2420
Trigger	2421
Free Run	2421
Video	2421
Trigger Level	2421
Trig Slope	2421
Trig Delay	2421

## Table of Contents

Line	2421
Trig Slope	2421
Trig Delay	2421
External 1	2421
Trigger Level	2421
Trig Slope	2421
Trig Delay	2421
External 2	2421
Trigger Level	2422
Trig Slope	2422
Trig Delay	2422
RF Burst	2422
Absolute Trigger	2422
Relative Trigger	2422
Trig Slope	2422
Trig Delay	2422
Periodic Timer	2422
Period	2422
Offset	2422
Offset Adjust (Remote Command Only)	2422
Reset Offset Display	2422
Sync Source	2422
Off	2423
External 1	2423
External 2	2423
RF Burst	2423
Trig Delay	2423
Auto/Holdoff	2423
Auto Trig	2423
Trig Holdoff	2423
Holdoff Type	2423
User Preset	2424
User Preset	2424
User Preset All Modes	2425
Save User Preset	2426
View/Display	2427
View Selection (Remote Command only)	2427
View Selection by number (Remote Command only)	2428
Display	2428
Annotation	2428
Meas Bar On/Off	2429
Screen	2430
Active Function Values On/Off	2430

Title	2431
Change Title	2431
Clear Title	2432
Graticule	2433
System Display Settings	2433
Annotation Local Settings	2433
Themes	2434
Backlight	2435
Backlight Intensity	2435
I/Q Measured Polar Graph	2436
I/Q Measured Polar Vector window	2437
Metrics window	2437
I/Q Polar Vector/Constellation	2438
Chip Offset	2438
I/Q Chips	2439
+45° Rotation	2439
Full Vector(Background)	2440
Interpolation	2440
Peak/Avg Metrics	2441
I/Q Error (Quad View)	2444
Magnitude Error window	2445
Phase Error window	2445
EVM Window	2446
Metrics Window	2446
Code Domain Power	2447
Code Domain Power Graph window	2448
Metrics window	2448
Code Order	2449
Consolidated Marker	2450
I/Q Combined Power Bar	2450
<b>19 QPSK EVM Measurement</b>	<b>2453</b>
AMPTD Y Scale	2457
Attenuation	2457
Dual Attenuator Configurations:	2457
Single Attenuator Configuration:	2458
(Mech) Atten	2459
Attenuator Configurations and Auto/Man	2460
Enable Elec Atten	2460
More Information	2461
Mechanical Attenuator Transition Rules	2461
When the Electronic Attenuation is enabled from a disabled state:	2462
Examples in the dual attenuator configuration:	2462
When the Electronic Attenuation is disabled from an enabled state:	2462

Using the Electronic Attenuator: Pros and Cons	2462
Elec Atten	2463
Adjust Atten for Min Clip	2463
Pre-Adjust for Min Clip	2464
Off	2465
Elec Atten Only	2465
Mech + Elec Atten	2465
(Mech) Atten Step	2465
Presel Center	2466
Proper Preselector Operation	2467
Preselector Adjust	2467
$\mu$ W Path Control	2469
Standard Path	2470
Low Noise Path Enable	2470
More Information	2471
$\mu$ W Preselector Bypass	2472
Internal Preamp	2473
Off	2474
Low Band	2475
Full Range	2475
Range	2475
Range Auto/Man	2476
I Range	2477
1 V Peak	2478
0.5 V Peak	2478
0.25 V Peak	2478
0.125 V Peak	2478
Q Range Value	2479
Q Same as I	2480
1 V Peak	2480
0.5 V Peak	2480
0.25 V Peak	2481
0.125 V Peak	2481
I/Q Gain Ranges	2481
1 V Peak	2481
0.5 V Peak	2481
0.25 V Peak	2481
0.125 V Peak	2482
Presel Center	2482
Presel Adjust	2482
Auto Couple	2483
More Information	2483
Auto/Man Active Function keys	2483



Auto/Man 1-of-N keys	2483
BW	2485
Info BW	2485
Info BW Control	2485
Filter Type	2486
Cont (Continuous Measurement/Sweep)	2487
File	2489
FREQ Channel	2490
Center Freq	2490
Center Frequency Presets	2491
RF Center Freq	2493
Ext Mix Center Freq	2494
I/Q Center Freq	2495
CF Step	2495
Input/Output	2497
Marker	2498
Select Marker	2498
Marker Type	2498
Marker Properties	2499
Select Marker	2499
Relative To	2499
Marker Trace	2500
Couple Marker	2500
All Markers Off	2501
Marker X Axis Value (Remote Command only)	2501
Marker Chip Value (Remote Command only)	2502
Marker X Axis Position (Remote Command only)	2502
Marker Y Axis Value (Query Only)	2503
Marker Function	2504
Marker To	2505
Meas	2506
Remote Measurement Functions	2506
Measurement Group of Commands	2507
Current Measurement Query (Remote Command Only)	2509
Limit Test Current Results (Remote Command Only)	2509
Data Query (Remote Command Only)	2509
Calculate/Compress Trace Data Query (Remote Command Only)	2510
Calculate Peaks of Trace Data (Remote Command Only)	2515
Format Data: Numeric Data (Remote Command Only)	2516
Format Data: Byte Order (Remote Command Only)	2517
Meas Setup	2518
Avg/Hold Number	2518
Avg Mode	2518

## Table of Contents

Limits	2519
RMS EVM	2519
Freq Error	2520
Meas Offset & Interval	2520
Meas Offset	2520
Meas Interval	2521
Spectrum	2521
Meas Preset	2522
Advanced	2522
EVM Result I/Q Offset	2523
RRC Filter Control	2523
Filter Alpha	2523
Chip Rate	2524
IF Gain	2524
IF Gain Auto	2525
IF Gain State	2525
Mode	2527
Mode Preset	2528
How-To Preset	2529
Preset Type (Remote Command Only)	2530
Mode Setup	2531
Peak Search	2532
Next Peak	2532
Next Pk Right	2532
Next Pk Left	2533
Marker Delta	2533
Pk-Pk Search	2533
Min Search	2533
Print	2535
Quick Save	2536
Recall	2538
State	2538
More Information	2540
From File...	2540
Edit Register Names	2542
Register 1 thru Register 16	2542
Register 1 thru Register 16	2543
Trace (+State)	2544
To Trace	2545
Register 1 thru Register 16	2546
From File...	2546
Data (Import)	2548
Capture Buffer	2549

Open...	2549
Restart	2550
More Information	2550
Save	2552
State	2552
To File . . .	2553
Edit Register Names	2555
More Information	2555
Register 1 thru Register 16	2556
Register 1 thru Register 16	2556
Data (Export)	2557
Measurement Results	2558
Meas Results File Contents	2558
Marker Table	2558
Peak Table	2561
Spectrogram	2564
Capture Buffer	2568
Save As . . .	2569
Screen Image	2569
Themes	2571
3D Color	2571
3D Monochrome	2571
Flat Color	2571
Flat Monochrome	2572
Save As...	2572
Mass Storage Catalog (Remote Command Only)	2572
Mass Storage Change Directory (Remote Command Only)	2573
Mass Storage Copy (Remote Command Only)	2573
Mass Storage Device Copy (Remote Command Only)	2573
Mass Storage Delete (Remote Command Only)	2574
Mass Storage Data (Remote Command Only)	2574
Mass Storage Make Directory (Remote Command Only)	2574
Mass Storage Move (Remote Command Only)	2575
Mass Storage Remove Directory (Remote Command Only)	2575
Single (Single Measurement/Sweep)	2576
More Information	2576
Source	2577
SPAN X Scale	2578
Sweep/Control	2579
Pause	2579
System	2580
Trace/Detector	2581
Trigger	2582

## Table of Contents

Free Run	2582
Video	2582
Trigger Level	2582
Trig Slope	2582
Trig Delay	2582
Line	2582
Trig Slope	2582
Trig Delay	2582
External 1	2582
Trigger Level	2582
Trig Slope	2582
Trig Delay	2582
External 2	2582
Trigger Level	2583
Trig Slope	2583
Trig Delay	2583
RF Burst	2583
Absolute Trigger	2583
Relative Trigger	2583
Trig Slope	2583
Trig Delay	2583
Periodic Timer	2583
Period	2583
Offset	2583
Offset Adjust (Remote Command Only)	2583
Reset Offset Display	2583
Sync Source	2583
Off	2584
External 1	2584
External 2	2584
RF Burst	2584
Trig Delay	2584
Auto/Holdoff	2584
Auto Trig	2584
Trig Holdoff	2584
User Preset	2585
User Preset	2585
User Preset All Modes	2586
Save User Preset	2587
View/Display	2588
View Selection by name (Remote Command Only)	2588
View Selection by number (Remote Command only)	2588
Display	2589

Annotation	2589
Meas Bar On/Off	2590
Screen	2591
Active Function Values On/Off	2591
Title	2592
Change Title	2592
Clear Title	2593
Graticule	2594
System Display Settings	2594
Annotation Local Settings	2594
Themes	2595
Backlight	2596
Backlight Intensity	2596
I/Q Polar Vec/Constln	2597
Chip Offset	2597
I/Q Chips	2598
Interpolation	2598
+45° Rotation	2599
Full Vector	2599
I/Q Error View	2600
Mag Error vs. Symbol Window	2600
Phase Error vs. Symbol Window	2601
EVM vs. Symbol Window	2601
Numeric Results Window	2601
<b>20 Monitor Spectrum Measurement</b>	<b>2603</b>
AMPTD Y Scale	2606
Ref Value	2606
Attenuation	2606
Dual Attenuator Configurations:	2607
Single Attenuator Configuration:	2607
(Mech) Atten	2608
Attenuator Configurations and Auto/Man	2609
Enable Elec Atten	2610
More Information	2611
Mechanical Attenuator Transition Rules	2611
When the Electronic Attenuation is enabled from a disabled state:	2611
Examples in the dual attenuator configuration:	2611
When the Electronic Attenuation is disabled from an enabled state:	2611
Using the Electronic Attenuator: Pros and Cons	2612
Elec Atten	2612
Adjust Atten for Min Clip	2613
Pre-Adjust for Min Clip	2613
Off	2614

## Table of Contents

Elec Atten Only	2614
Mech + Elec Atten	2615
(Mech) Atten Step	2615
Scale/Div	2615
Presel Center	2616
Proper Preselector Operation	2617
Preselector Adjust	2617
$\mu$ W Path Control	2618
Standard Path	2620
Low Noise Path Enable	2620
More Information	2621
$\mu$ W Preselector Bypass	2622
Internal Preamp	2623
Off	2624
Low Band	2625
Full Range	2625
Ref Position	2625
Auto Scaling	2626
Auto Couple	2627
More Information	2627
Auto/Man Active Function keys	2627
Auto/Man 1-of-N keys	2627
BW	2629
Res BW	2629
Video BW	2630
VBW:3dB RBW	2632
Span:3dB RBW	2632
Cont (Continuous Measurement/Sweep)	2634
File	2636
FREQ Channel	2637
Center Freq	2637
Center Frequency Presets	2638
RF Center Freq	2640
Ext Mix Center Freq	2641
I/Q Center Freq	2642
CF Step	2642
Input/Output	2644
Marker	2645
Select Marker	2645
Marker Type	2645
Properties	2646
Select Marker	2646
Relative To	2646

Marker Trace	2646
Couple Markers	2647
All Markers Off	2647
Marker X Axis Value (Remote Command only)	2648
Marker X Axis Position (Remote Command only)	2648
Marker Y Axis Value (Remote Command only)	2649
Marker Function	2650
Select Marker	2650
Marker Function Type	2650
Band Adjust	2650
Band/Interval Span for Frequency Domain	2651
Band/Interval Left for Frequency Domain	2651
Band/Interval Right for Frequency Domain	2652
Marker To	2653
Meas	2654
Remote Measurement Functions	2654
Measurement Group of Commands	2655
Current Measurement Query (Remote Command Only)	2657
Limit Test Current Results (Remote Command Only)	2657
Data Query (Remote Command Only)	2657
Calculate/Compress Trace Data Query (Remote Command Only)	2658
Calculate Peaks of Trace Data (Remote Command Only)	2663
Format Data: Numeric Data (Remote Command Only)	2664
Format Data: Byte Order (Remote Command Only)	2665
Meas Setup	2666
Avg/Hold Num	2666
Avg Mode	2666
Meas Preset	2667
Mode	2668
Mode Preset	2669
How-To Preset	2670
Preset Type (Remote Command Only)	2671
Mode Setup	2672
Peak Search	2673
Print	2674
Quick Save	2675
Recall	2677
State	2677
More Information	2679
From File...	2679
Edit Register Names	2681
Register 1 thru Register 16	2681
Register 1 thru Register 16	2682

Trace (+State)	2683
To Trace	2684
Register 1 thru Register 16	2685
From File...	2685
Data (Import)	2687
Capture Buffer	2688
Open...	2688
Restart	2689
More Information	2689
Save	2691
State	2691
To File . . .	2692
Edit Register Names	2694
More Information	2694
Register 1 thru Register 16	2695
Register 1 thru Register 16	2695
Data (Export)	2696
Measurement Results	2697
Meas Results File Contents	2697
Marker Table	2697
Peak Table	2700
Spectrogram	2703
Capture Buffer	2707
Save As . . .	2708
Screen Image	2708
Themes	2710
3D Color	2710
3D Monochrome	2710
Flat Color	2710
Flat Monochrome	2711
Save As...	2711
Mass Storage Catalog (Remote Command Only)	2711
Mass Storage Change Directory (Remote Command Only)	2712
Mass Storage Copy (Remote Command Only)	2712
Mass Storage Device Copy (Remote Command Only)	2712
Mass Storage Delete (Remote Command Only)	2713
Mass Storage Data (Remote Command Only)	2713
Mass Storage Make Directory (Remote Command Only)	2713
Mass Storage Move (Remote Command Only)	2714
Mass Storage Remove Directory (Remote Command Only)	2714
Single (Single Measurement/Sweep)	2715
More Information	2715
Source	2716



Span X Scale	2717
Span	2717
IDEN Mode Span Preset for Monitor Spectrum	2718
Full Span	2718
Last Span	2718
Sweep/Control	2720
Sweep Time	2720
Pause	2720
Gate	2721
Gate On/Off	2721
Gate View On/Off	2722
Gate View Setup	2725
Gate View Sweep Time	2726
Gate View Start Time	2726
Gate Delay	2727
Gate Length	2727
Gate Source	2728
Line	2729
External 1	2729
External 2	2731
RF Burst	2733
Periodic Timer (Frame Trigger)	2736
Control Edge/Level	2747
Gate Holdoff	2747
Gate Delay Compensation	2749
More Information	2750
Min Fast Position Query (Remote Command Only)	2750
Gate Preset (Remote Command Only)	2751
Gate Level (Remote Command Only)	2751
Gate Polarity (Remote Command Only)	2751
Points	2752
System	2753
Trace/Detector	2754
Select Trace	2754
Trace Type	2754
Update	2755
Display	2755
Detector	2756
Auto	2757
Clear Trace	2757
Clear All Traces	2757
Trigger	2759
Free Run	2759

Video	2759
Trigger Level	2759
Trig Slope	2759
Trig Delay	2759
Line	2759
Trig Slope	2759
Trig Delay	2759
External 1	2759
Trigger Level	2759
Trig Slope	2759
Trig Delay	2759
External 2	2759
Trigger Level	2760
Trig Slope	2760
Trig Delay	2760
RF Burst	2760
Absolute Trigger	2760
Relative Trigger	2760
Trig Slope	2760
Trig Delay	2760
Periodic Timer	2760
Period	2760
Offset	2760
Reset Offset Display	2760
Sync Source	2760
Off	2760
External 1	2761
External 2	2761
RF Burst	2761
Trig Delay	2761
Auto/Holdoff	2761
Auto Trig	2761
Trig Holdoff	2761
User Preset	2762
User Preset	2762
User Preset All Modes	2763
Save User Preset	2764
View/Display	2765
View for all modes except MSR, 1xEV-DO, LTE-Advanced FDD/TDD	2765
1xEV-DO Mode View	2766
MSR and LTE-Advanced FDD/TDD Mode Views	2766
View Selection by Name (MSR and LTE-Advanced FDD/TDD mode only)	2767
View Selection by Number (MSR and LTE-Advanced FDD/TDD mode only)	2767

Display	2767
Annotation	2768
Meas Bar On/Off	2769
Screen	2769
Active Function Values On/Off	2769
Title	2770
Change Title	2770
Clear Title	2771
Graticule	2772
System Display Settings	2772
Annotation Local Settings	2772
Themes	2773
Backlight	2774
Backlight Intensity	2774
<b>21 Waveform Measurement</b>	<b>2777</b>
AMPTD Y Scale	2781
Ref Value (RF Envelope View)	2781
Attenuation	2781
Dual Attenuator Configurations:	2782
Single Attenuator Configuration:	2783
(Mech) Atten	2783
Attenuator Configurations and Auto/Man	2785
Enable Elec Atten	2785
More Information	2786
Mechanical Attenuator Transition Rules	2786
When the Electronic Attenuation is enabled from a disabled state:	2786
Examples in the dual attenuator configuration:	2786
When the Electronic Attenuation is disabled from an enabled state:	2787
Using the Electronic Attenuator: Pros and Cons	2787
Elec Atten	2787
Adjust Atten for Min Clip	2788
Pre-Adjust for Min Clip	2788
Off	2789
Elec Atten Only	2789
Mech + Elec Atten	2790
(Mech) Atten Step	2790
Scale/Div (RF Envelope View)	2791
Presel Center	2791
Proper Preselector Operation	2792
Preselector Adjust	2792
$\mu$ W Path Control	2794
Standard Path	2795
Low Noise Path Enable	2795

More Information	2796
$\mu$ W Preselector Bypass	2797
Internal Preamp	2798
Off	2799
Low Band	2800
Full Range	2800
Ref Position (RF Envelope View)	2800
Auto Scaling	2801
Range	2801
Range Auto/Man	2802
I Range	2803
1 V Peak	2804
0.5 V Peak	2804
0.25 V Peak	2804
0.125 V Peak	2804
Q Range Value	2805
Q Same as I	2806
1 V Peak	2806
0.5 V Peak	2806
0.25 V Peak	2807
0.125 V Peak	2807
I/Q Gain Ranges	2807
1 V Peak	2807
0.5 V Peak	2807
0.25 V Peak	2807
0.125 V Peak	2808
Ref Value	2808
Ref Value (RF Envelope View)	2808
Ref Value (I/Q Waveform View)	2809
Scale/Div	2809
Scale/Div (RF Envelope View)	2809
Scale/Div (I/Q Waveform View)	2810
Ref Position	2811
Ref Position (RF Envelope View)	2811
Ref Position (I/Q Waveform View)	2811
Auto Couple	2813
More Information	2813
Auto/Man Active Function keys	2813
Auto/Man 1-of-N keys	2813
BW	2815
Digital IF BW	2815
Filter Type	2816
Filter BW	2817

Filter Alpha	2818
Filter Type Bwcc	2818
Gaussian	2819
Gaussian filters	2819
Flattop	2823
Flattop Filters	2824
Channel Filter Bandwidth Bwcc (Remote Command Only)	2825
Cont (Continuous Measurement/Sweep)	2826
File	2828
FREQ Channel	2829
Center Freq	2829
Center Frequency Presets	2830
RF Center Freq	2832
Ext Mix Center Freq	2833
I/Q Center Freq	2834
CF Step	2834
Input/Output	2836
Marker	2837
Select Marker	2837
Marker Type	2837
Properties	2838
Select Marker	2838
Relative To	2838
Marker Trace	2839
Couple Markers	2839
All Markers Off	2840
Marker X Axis Value (Remote Command Only)	2840
Marker X Axis Position (Remote Command Only)	2841
Marker Y Axis Value (Remote Command Only)	2841
Backward Compatibility SCPI Commands	2842
Marker ->	2843
Marker Function	2844
Select Marker	2844
Marker Function Type	2844
Band Adjust	2845
Band/Interval Span for Time Domain	2845
Band/Interval Left for Time Domain	2846
Band/Interval Right for Time Domain	2846
Meas	2848
Remote Measurement Functions	2848
Measurement Group of Commands	2849
Current Measurement Query (Remote Command Only)	2851
Limit Test Current Results (Remote Command Only)	2851

## Table of Contents

Data Query (Remote Command Only)	2851
Calculate/Compress Trace Data Query (Remote Command Only)	2852
Calculate Peaks of Trace Data (Remote Command Only)	2857
Format Data: Numeric Data (Remote Command Only)	2858
Format Data: Byte Order (Remote Command Only)	2859
Meas Setup	2860
Average/Hold Num	2860
Avg Mode	2860
Avg Type	2861
Time Avg Num	2862
Meas Time	2862
Sample Rate	2863
PhNoise Opt	2863
Auto	2864
Best Close-in P Noise	2865
Best Wide-offset P Noise	2865
Fast Tuning	2866
Advanced	2866
ADC Dither	2866
ADC Dither Auto	2866
ADC Dither	2867
IF Gain	2868
IF Gain Auto	2868
IF Gain State	2868
IF Gain Offset	2869
Meas Preset	2870
HW Averaging	2870
Sample Period (Aperture) Setting (Remote Command Only)	2871
Mode	2872
Mode Preset	2873
How-To Preset	2874
Preset Type (Remote Command Only)	2875
Mode Setup	2876
Peak Search	2877
Next Peak	2877
Min Search	2877
Print	2879
Quick Save	2880
Recall	2882
State	2882
More Information	2884
From File...	2884
Edit Register Names	2886

Register 1 thru Register 16	2886
Register 1 thru Register 16	2887
Trace (+State)	2888
To Trace	2889
Register 1 thru Register 16	2890
From File...	2890
Data (Import)	2892
Capture Buffer	2893
Open...	2893
Restart	2894
More Information	2894
Save	2896
State	2896
To File . . .	2897
Edit Register Names	2899
More Information	2899
Register 1 thru Register 16	2900
Register 1 thru Register 16	2900
Data (Export)	2901
Measurement Results	2902
Meas Results File Contents	2902
Marker Table	2902
Peak Table	2905
Spectrogram	2908
Capture Buffer	2912
Save As . . .	2913
Screen Image	2913
Themes	2915
3D Color	2915
3D Monochrome	2915
Flat Color	2915
Flat Monochrome	2916
Save As...	2916
Mass Storage Catalog (Remote Command Only)	2916
Mass Storage Change Directory (Remote Command Only)	2917
Mass Storage Copy (Remote Command Only)	2917
Mass Storage Device Copy (Remote Command Only)	2917
Mass Storage Delete (Remote Command Only)	2918
Mass Storage Data (Remote Command Only)	2918
Mass Storage Make Directory (Remote Command Only)	2918
Mass Storage Move (Remote Command Only)	2919
Mass Storage Remove Directory (Remote Command Only)	2919
Single (Single Measurement/Sweep)	2920

## Table of Contents

More Information	2920
Source	2921
Span X Scale	2922
Ref Value	2922
Scale/Div	2922
Ref Position	2923
Auto Scaling	2923
Sweep/Control	2925
Pause/Resume	2925
Abort (Remote Command Only)	2925
System	2927
Trace/Detector	2928
Trigger	2929
Free Run	2929
Video	2929
Trigger Level	2929
Trig Slope	2929
Trig Delay	2929
Line	2929
Trig Slope	2929
Trig Delay	2929
External 1	2929
Trigger Level	2929
Trig Slope	2929
Trig Delay	2929
External 2	2929
Trigger Level	2930
Trig Slope	2930
Trig Delay	2930
RF Burst	2930
Absolute Trigger	2930
Relative Trigger	2930
Trig Slope	2930
Trig Delay	2930
Periodic Timer	2930
Period	2930
Offset	2930
Offset Adjust (Remote Command Only)	2930
Reset Offset Display	2930
Sync Source	2930
Off	2931
External 1	2931
External 2	2931



RF Burst	2931
Trig Delay	2931
Auto/Holdoff	2931
Auto Trig	2931
Trig Holdoff	2931
User Preset	2932
User Preset	2932
User Preset All Modes	2933
Save User Preset	2934
View/Display	2935
View Selection by name (Remote Command Only)	2935
View Selection by number (Remote Command Only)	2935
Display	2936
Annotation	2936
Meas Bar On/Off	2937
Screen	2938
Active Function Values On/Off	2938
Title	2939
Change Title	2939
Clear Title	2940
Graticule	2941
System Display Settings	2941
Annotation Local Settings	2941
Themes	2942
Backlight	2943
Backlight Intensity	2943
RF Envelope	2944
I/Q Waveform	2945



## 1 About the Analyzer

The X-Series signal analyzer measures and monitors complex RF and microwave signals. Analog baseband analysis is available on MXA. The analyzer integrates traditional spectrum measurements with advanced vector signal analysis to optimize speed, accuracy, and dynamic range. The analyzer has Windows 7<sup>®</sup> built in as an operating system, which expands its usability.

With a broad set of applications and demodulation capabilities, an intuitive user interface, outstanding connectivity and powerful one-button measurements, the analyzer is ideal for both R&D and manufacturing engineers working on cellular, emerging wireless communications, general purpose, aerospace and defense applications.

## Installing Application Software

If you want to install a measurement application after your initial hardware purchase, you need only to license it. All of the available applications are loaded in your analyzer at the time of purchase.

Thus, when you purchase a new application, you will receive an entitlement certificate that you can use to obtain a license key for that application. To activate the new measurement application, enter the license key that you obtain into the Signal Analyzer.

For the latest information on Keysight Signal Analyzer measurement applications and upgrade kits, visit the following internet URL.

[http://www.agilent.com/find/sa\\_upgrades](http://www.agilent.com/find/sa_upgrades)

### Viewing a License Key

Measurement applications that you purchased with your instrument have been installed and activated at the factory before shipment. The instrument requires a unique License Key for every measurement application purchased. The license key is a hexadecimal string that is specific to your measurement application, instrument model number and serial number. It enables you to install, or reactivate, that particular application.

Press **System, Show, System** to display the measurement applications that are currently licensed in your analyzer.

Go to the following location to view the license keys for the installed measurement applications:

C:\Program Files\Agilent\Licensing

You may want to keep a copy of your license key in a secure location. To do this, you can print out a copy of the display showing the license numbers. If you should lose your license key, call your nearest Keysight Technologies service or sales office for assistance.

### Obtaining and Installing a License Key

If you purchase an additional application that requires installation, you will receive an "Entitlement Certificate", which may be redeemed for a license key for one instrument. To obtain your license key, follow the instructions that accompany the certificate.

Installing a license key for the selected application can be done automatically using a USB memory device. To do this, you copy the license file to the USB memory device, at the root level. Follow the instructions that come with your software installation kit.

Installing a license key can also be done manually using the built-in license management application, which may be found via the instrument front panel keys at **System, Licensing. . .**, or on-disk at:

C:\Programming Files\Agilent\Licensing

You can also use these procedures to reinstall a license key that has been accidentally deleted, or lost due to a memory failure.

### Updating Measurement Application Software

All the software applications were loaded at the time of original instrument manufacture. It is a good idea to regularly update your software with the latest available version. This helps to ensure that you receive

any improvements and expanded functionality.

Because the software was loaded at the initial purchase, further additional measurement applications may now be available. If the application you are interested in licensing is not available, you will need to do a software update. (To display a list of installed applications, press **System, Show, System.**)

Check the appropriate page of the Keysight web site for the latest available software versions, according to the name of your instrument, as follows:

[http://www.agilent.com/find/pxa\\_software](http://www.agilent.com/find/pxa_software)

[http://www.agilent.com/find/mxa\\_software](http://www.agilent.com/find/mxa_software)

[http://www.agilent.com/find/exa\\_software](http://www.agilent.com/find/exa_software)

[http://www.agilent.com/find/cxa\\_software](http://www.agilent.com/find/cxa_software)

You can load the updated software package into the analyzer from a USB drive, or directly from the internet. An automatic loading program is included with the files.

## X-Series Options and Accessories

You can view an online list of available Options and Accessories for your instrument as follows:

1. Browse to one of the following URLs, according to the product name of your analyzer:

[www.agilent.com/find/cxa](http://www.agilent.com/find/cxa)

[www.agilent.com/find/exa](http://www.agilent.com/find/exa)

[www.agilent.com/find/mxa](http://www.agilent.com/find/mxa)

[www.agilent.com/find/pxa](http://www.agilent.com/find/pxa)

2. The home page for your instrument appears (in some cases, you may see an initial splash screen containing a button named View the Webpage, which you should click to display the home page).
3. Locate the Options tab, as highlighted in the example below, which shows the home page for the MXA.



4. Click the Options tab, to display a list of available options and accessories for your instrument.

## Front-Panel Features

The instrument's Front-panel features are fully detailed in the section "Front-Panel Features" (under the chapter "Front and Rear Panel Features") of the document:

### [Getting Started Guide](#)

If you are viewing this information as a Help file in the instrument, then you can click on the link above to open the PDF document.

## Display Annotations

Display Annotations are fully detailed under the chapter "Front and Rear Panel Features" of the document:

[Getting Started Guide](#)

If you are viewing this information as a Help file in the instrument, then you can click on the link above to open the PDF document.



## Rear-Panel Features

The instrument's Rear-panel features are fully detailed in the section "Rear-Panel Features" (under the chapter "Front and Rear Panel Features") of the document:

### [Getting Started Guide](#)

If you are viewing this information as a Help file in the instrument, then you can click on the link above to open the PDF document.

## Window Control Keys

The instrument provides three front-panel keys for controlling windows. They are Multi Window, Zoom, and Next Window. These are all “immediate action” keys.

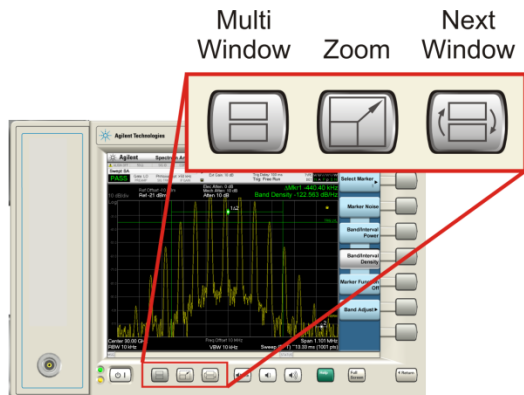

### Multi-Window



The Multi Window front-panel key will toggle you back and forth between the Normal View and the last Multi Window View (Zone Span, Trace Zoom or Spectrogram) that you were in, when using the Swept SA measurement of the Spectrum Analyzer Mode. It remembers which View you were in through a Preset. This “previous view” is set to Zone Span on a Restore Mode Defaults.

Key Path	Front-panel key
Initial S/W Revision	Prior to A.02.00

### Zoom

Zoom is a toggle function. Pressing this key once increases the size of the selected window. Pressing the key again returns the window to the original size.

When Zoom is on for a window, that window will get the entire primary display area. The zoomed window, since it is the selected window, is outlined in green.

Zoom is local to each Measurement. Each Measurement remembers its Zoom state. The Zoom state of each Measurement is part of the Mode’s state.

**NOTE**

Data acquisition and processing for the other windows continues while a window is zoomed, as does all SCPI communication with the other windows.

<b>Remote Command</b>	<code>:DISPlay:WINDow:FORMat:ZOOM</code>
-----------------------	------------------------------------------

<b>Remote Command</b>	:DISPlay:WINDow:FORMat:TILE
<b>Example</b>	:DISP:WIND:FORM:ZOOM sets zoomed :DISP:WIND:FORM:TILE sets un-zoomed
Preset	TILE
Initial S/W Revision	Prior to A.02.00

## Next Window

Selects the next window of the current view. When the Next Window key is pressed, the next window in the order of precedence becomes selected. If the selected window was zoomed, the next window will also be zoomed.

The window numbers are as follows. Note that these numbers also determine the order of precedence (that is, Next Window goes from 1 to 2, then 2 to 3, etc.):

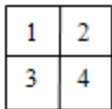

**Four window display**

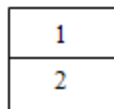

**Two window display**

## RTSA measurements:

Only two windows are available in the Spectrogram view under the Spectrum measurement and up to three windows are available in the Power vs. Time measurement, depending on the view set up.

<b>Remote Command</b>	:DISPlay:WINDow[:SElect] <number> :DISPlay:WINDow[:SElect]?
<b>Example</b>	:DISP:WIND 1
Preset	1
Min	1
Max	If <number> is greater than the number of windows, limit to <number of windows>
Initial S/W Revision	Prior to A.02.00

One and only one window is always selected. The selected window has the focus; this means that all window-specific key presses apply only to that window. You can tell which window is selected by the thick green border around it. If a window is not selected, its boundary is gray.

If a window in a multi-window display is zoomed it is still outlined in green. If there is only one window, the green outline is not used. This allows the user to distinguish between a zoomed window and a display with only one window.

The selected window is local to each Measurement. Each Measurement remembers which window is selected. The selected window for each Measurement is remembered in Mode state.

**NOTE**

When this key is pressed in Help Mode, it toggles focus between the table of contents window and the topic pane window.

## Full Screen

When Full Screen is pressed the measurement window expands horizontally over the entire instrument display. The screen graticule area expands to fill the available display area.

It turns off the display of the softkey labels, however the menus and active functions still work. (Though it would obviously be very hard to navigate without the key labels displayed.) Pressing Full Screen again while Full Screen is in effect cancels Full Screen.

Note that the banner and status lines are unaffected. You can get even more screen area for your data display by turning off the Meas Bar (in the Display menu) which also turns off the settings panel.

Full Screen is a Meas Global function. Therefore it is cancelled by the Preset key.

Key Path	Display
<b>Remote Command</b>	:DISPlay:FSCReen[:STATe] OFF ON 0 1 :DISPlay:FSCReen[:STATe]?
Preset	Unaffected by Preset but set to Off by Restore Misc Defaults or shutdown and restart
State Saved	Not saved in instrument state.
<b>Backwards Compatibility SCPI</b>	:DISPlay:MENU[:STATe] OFF ON 0 1 This emulates ESA full screen functionality, which is the same as the FSCReen command in PSA except that the sense of on/off is reversed (that is, OFF means the menus are OFF, so Fullscreen is ON) and the default is ON (meaning Fullscreen is OFF).
Backwards Compatibility Notes	In ESA/PSA, Full Screen was turned on with a softkey, so pressing any other key turned Full Screen off. In the X-Series, because a hardkey is provided to turn this function on and off, pressing any other key no longer turns off Full Screen
Initial S/W Revision	Prior to A.02.00

## Display Enable (Remote Command Only)

Turns the display on/off, including the display drive circuitry. The backlight stays lit so you can tell that the instrument is on. The display enable setting is mode global. The reasons for turning the display off are three:

- To increase speed as much as possible by freeing the instrument from having to update the display
- To reduce emissions from the display, drive circuitry
- For security purposes

If you have turned off the display:

- and you are in local operation, the display can be turned back on by pressing any key or by sending the SYSTem:DEFaults MISC command or the DISPlay:ENABle ON (neither \*RST nor SYSTem:PRESet enable the display.)
- and you are in remote operation, the display can be turned back on by pressing the Local or Esc keys or by sending the SYSTem:DEFaults MISC command or the DISPlay:ENABle ON (neither \*RST nor SYSTem:PRESet enable the display.)

and you are using either the SYSTem:KLOCK command or GPIB local lockout, then no front-panel key press will turn the display back on. You must turn it back on remotely.

<b>Remote Command</b>	:DISPlay:ENABle OFF ON 0 1 :DISPlay:ENABle?
<b>Example</b>	DISP:ENAB OFF
<b>Couplings</b>	DISP:ENAB OFF turns Backlight OFF and DISP:ENAB ON turns Backlight ON. However, settings of Backlight do not change the state of DISP:ENAB
<b>Preset</b>	On Set by SYST:DEF MISC, but Not affected by *RST or SYSTem:PRESet.
<b>State Saved</b>	Not saved in instrument state.
<b>Backwards Compatibility Notes</b>	SYST:PRES no longer turns on DISPlay:ENABle as it did in legacy analyzers
<b>Initial S/W Revision</b>	Prior to A.02.00

## Mouse and Keyboard Control

If you do not have access to the instrument front-panel, there are several ways that a mouse and PC Keyboard can give you access to functions normally accessed using the front-panel keys.

### Right-Click

If you plug in a mouse and right-click on the analyzer screen, a menu will appear as below:

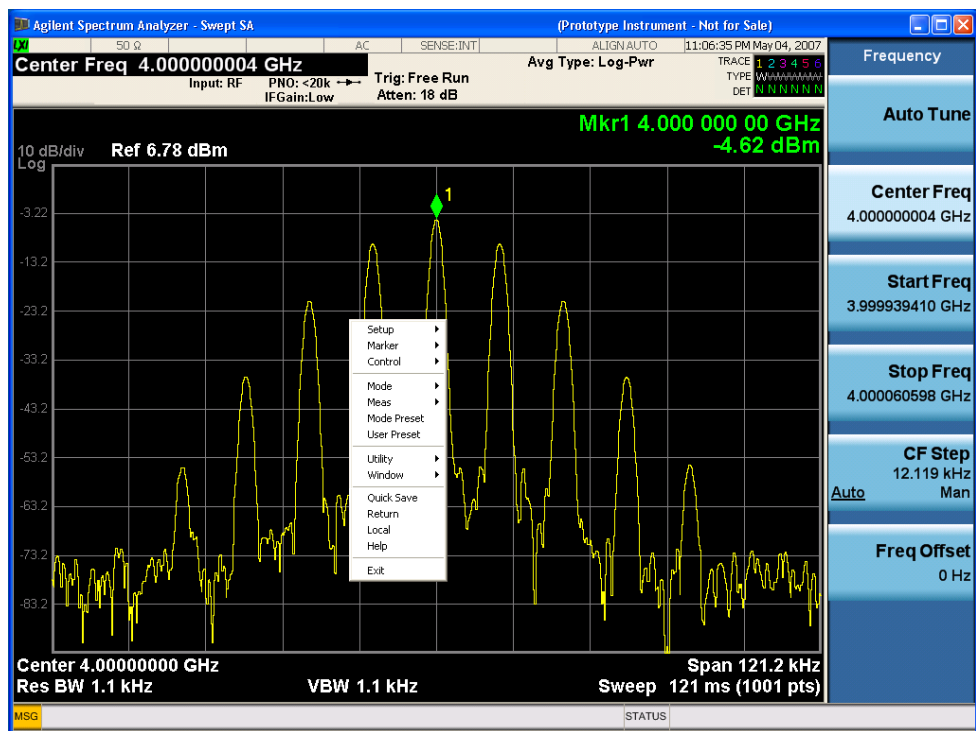

Placing the mouse on one of the rows marked with a right arrow symbol will cause that row to expand, as for example below where the mouse is hovered over the “Utility” row:

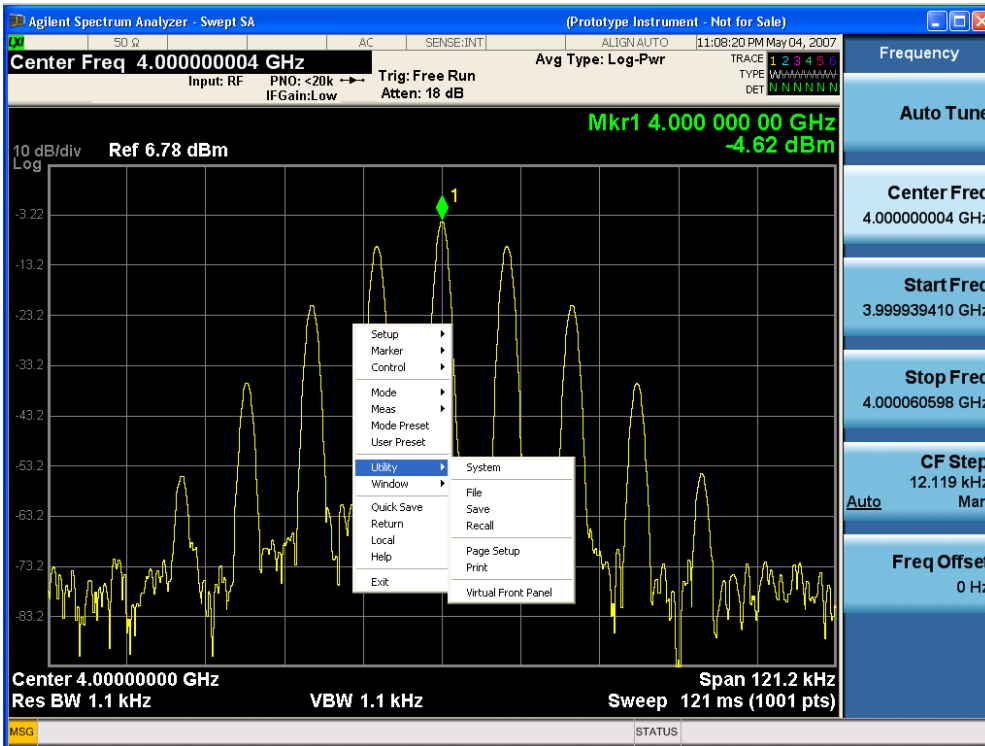

This method can be used to access any of the front-panel keys by using a mouse; as for example if you are accessing the instrument through Remote Desktop.

The array of keys thus available is shown below:

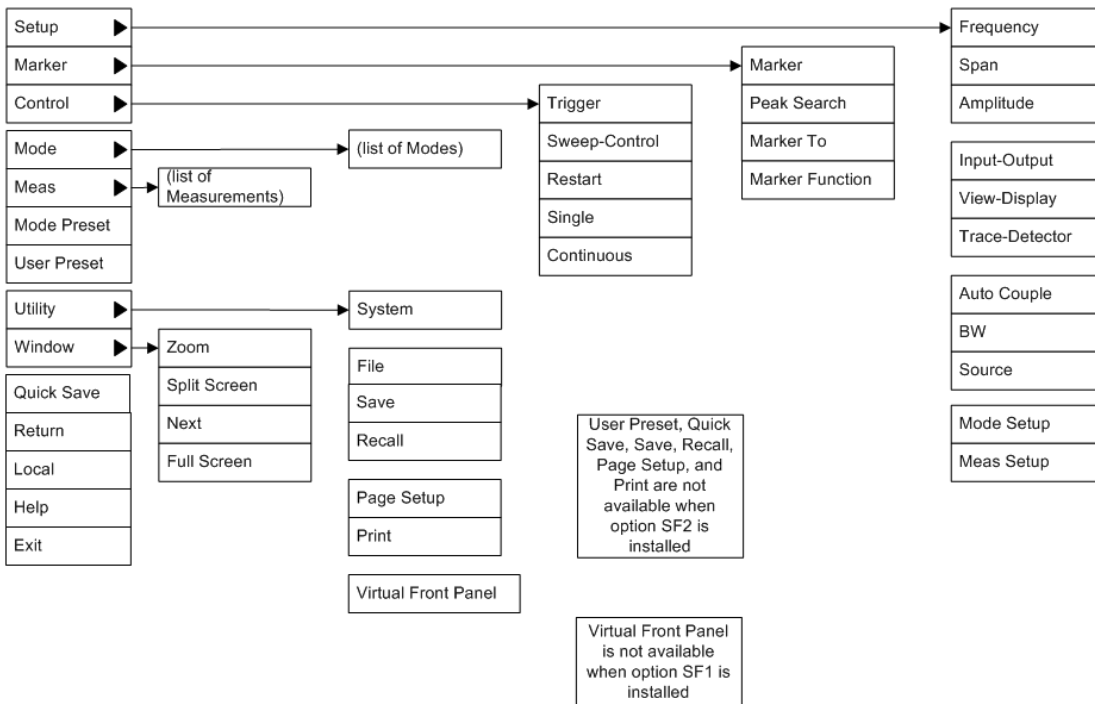

## PC Keyboard

If you have a PC keyboard plugged in (or via Remote Desktop), certain key codes on the PC keyboard map to front-panel keys on the GPSA front panel. These key codes are shown below:

Front-panel key	Key code
Frequency	CTRL+SHIFT+F
Span	CTRL+SHIFT+S
Amplitude	CTRL+SHIFT+A
Input/Output	CTRL+SHIFT+O
View/Display	CTRL+SHIFT+V
Trace/Detector	CTRL+ALT+T
Auto Couple	CTRL+SHIFT+C
Bandwidth	CTRL+ALT+B
Source	CTRL+ALT-U
Marker	CTRL+ALT+K
Peak Search	CTRL+ALT+P
Marker To	CTRL+ALT+N
Marker Function	CTRL+ALT+F
System	CTRL+SHIFT+Y
Quick Save	CTRL+Q
Save	CTRL+S
Recall	CTRL+R
Mode Preset	CTRL+M
User Preset	CTRL+U
Print	CTRL+P
File	CTRL+SHIFT+L
Mode	CTRL+SHIFT+M
Measure	CTRL+ALT+M
Mode Setup	CTRL+SHIFT+E
Meas Setup	CTRL+ALT+E
Trigger	CTRL+SHIFT+T
Sweep/Control	CTRL+SHIFT+W
Restart	CTRL+ALT+R
Single	CTRL+ALT+S
Cont	CTRL+ALT+C
Zoom	CTRL+SHIFT+Z
Next Window	CTRL+SHIFT+N
Split Screen	CTRL+L



Front-panel key	Key code
Full Screen	CTRL+SHIFT+B
Return	CTRL+SHIFT+R
Mute	Mute
Inc Audio	Volume Up
Dec Audio	Volume Down
Help	F1
Control	CTRL
Alt	ALT
Enter	Return
Cancel	Esc
Del	Delete
Backspace	Backspace
Select	Space
Up Arrow	Up
Down Arrow	Down
Left Arrow	Left
Right Arrow	Right
Menu key 1	CTRL+SHIFT+F1
Menu key 2	CTRL+SHIFT+F2
Menu key 3	CTRL+SHIFT+F3
Menu key 4	CTRL+SHIFT+F4
Menu key 5	CTRL+SHIFT+F5
Menu key 6	CTRL+SHIFT+F6
Menu key 7	CTRL+SHIFT+F7
Backspace	BACKSPACE
Enter	ENTER
Tab	Tab
1	1
2	2
3	3
4	4
5	5
6	6
7	7
8	8
9	9
0	0

1 About the Analyzer  
 Mouse and Keyboard Control

This is a pictorial view of the table:

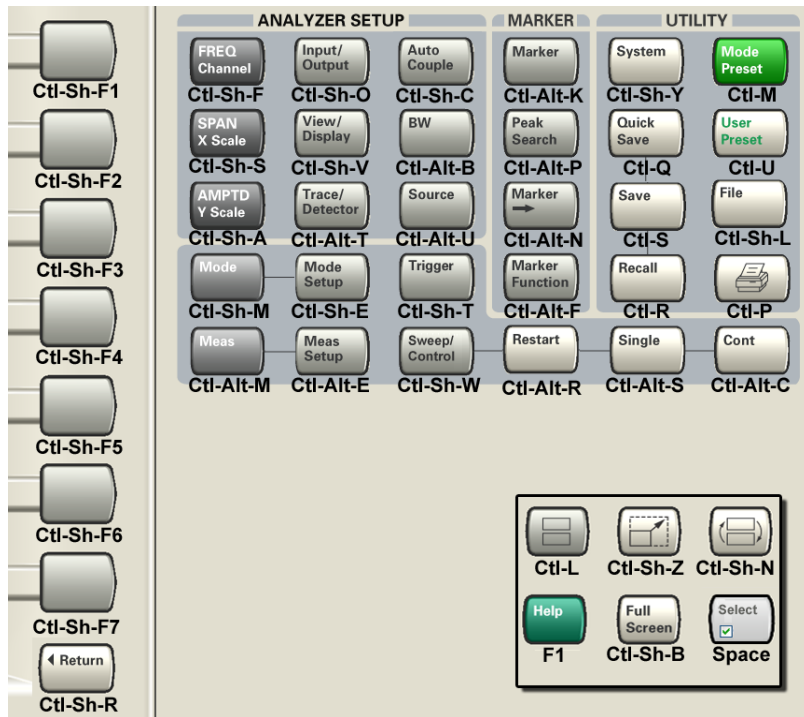

## Instrument Security & Memory Volatility

If you are using the instrument in a secure environment, you may need details of how to clear or sanitize its memory, in compliance with published security standards of the United States Department of Defense, or other similar authorities.

For X-Series analyzers, this information is contained in the document "Security Features and Document of Volatility". This document is not included in the Documentation CD, or the instrument's on-disk library, but it may be downloaded from Keysight's web site.

To obtain a copy of the document, click on or browse to the following URL:

<http://www.agilent.com/find/security>

To locate and download the document, select Model Number "N9020A", then click "Submit". Then, follow the on-screen instructions to download the file.



## 2 About the 1xEV-DO Measurement Application

This chapter provides overall information on 1xEV-DO communications systems, and describes 1xEV-DO measurements made by the analyzer.

## What Does the 1xEV-DO Application Do?

This analyzer can be used for testing a 1xEV-DO transmitter, manufactured according to the following standard document:

- 3GPP2 C.S0024-B cdma2000 High Rate Packet Data Air Interface Specification

These documents define complex, multi-part measurements used to create and maintain an interference-free environment. For example, the documents include standardized test methods for the measurement of power in a carrier, a spectrum emission mask, and other critical measurements.

The instrument automatically makes these measurements using the measurement methods and limits defined in the documents. The detailed results displayed by the measurements enable you to analyze 1xEV-DO system performance. You may alter the measurement parameters for specialized analysis. For infrastructure test, the analyzer will test transmitters of base stations in a non-interfering manner using a coupler or power splitter.

This analyzer makes the following measurements of 1xEV-DO signals:

- Channel Power
- Adjacent Channel Power (ACP or ACLR)
- Spectrum Emission Mask
- Spurious Emissions
- Occupied BW
- Power Stat CCDF
- Forward Link Code Domain
- Reverse Link Code Domain
- Forward Link Modulation Accuracy (Waveform Quality)
- Reverse Link Modulation Accuracy (Waveform Quality)
- Power vs Time
- QPSK EVM
- Monitor Spectrum
- IQ Waveform (Time Domain)

### 3 Programming the Analyzer

This section provides introductory information about the programming documentation included with your product.

- ["What Programming Information is Available?" on page 124](#)
- ["STATus Subsystem " on page 173](#)
- ["IEEE 488.2 Common Commands" on page 215](#)

## What Programming Information is Available?

The X-Series Documentation can be accessed through the Additional Documentation page in the instrument Help system and is included on the Documentation DVD shipped with the instrument. It can also be found online at: [http://www.agilent.com/find/mxa\\_manuals](http://www.agilent.com/find/mxa_manuals).

The following resources are available to help you create programs for automating your X-Series measurements:

Resource	Description
X-Series Programmer's Guide	Provides general SCPI programming information on the following topics: <ul style="list-style-type: none"><li>• Programming the X-Series Applications</li><li>• Programming fundamentals</li><li>• Programming examples</li></ul> Note that SCPI command descriptions for measurement applications are not in this book, but are in the User's and Programmer's Reference.
User's and Programmer's Reference manuals	Describes all front-panel keys and softkeys, including SCPI commands for a measurement application. Note that: <ul style="list-style-type: none"><li>• Each measurement application has its own User's and Programmer's Reference.</li><li>• The content in this manual is duplicated in the instrument's Help (the Help that you see for a key is identical to what you see in this manual).</li></ul>
Embedded Help in your instrument	Describes all front-panel keys and softkeys, including SCPI commands, for a measurement application. Note that the content that you see in Help when you press a key is identical to what you see in the User's and Programmer's Reference.
X-Series Getting Started Guide	Provides valuable sections related to programming including: <ul style="list-style-type: none"><li>• Licensing New Measurement Application Software - After Initial Purchase</li><li>• Configuring instrument LAN Hostname, IP Address, and Gateway Address</li><li>• Using the Windows Remote Desktop to connect to the instrument remotely</li><li>• Using the Embedded Web Server Telnet connection to communicate SCPI</li></ul> This printed document is shipped with the instrument.
Keysight Application Notes	Printable PDF versions of pertinent application notes.
Keysight VISA User's Guide	Describes the Keysight Virtual Instrument Software Architecture (VISA) library and shows how to use it to develop I/O applications and instrument drivers on Windows PCs.



## List of SCPI Commands

```

*CAL?
*CLS
*ESE <integer>
*ESE?
*ESR?
*IDN?
*OPC
*OPC?
*OPT?
*RCL <register#>
*RST
*SAV <register#>
*SRE <integer>
*SRE?
*STB?
*TRG
*TST?
*WAI
ABORT
CALCulate:ACPower:LIMit:STATe OFF | ON | 0 | 1
CALCulate:ACPower:LIMit:STATe?
CALCulate:ACPower:MARKer:AOff
CALCulate:ACPower:MARKer:COUple[:STATe] ON | OFF | 1 | 0
CALCulate:ACPower:MARKer:COUple[:STATe]?
CALCulate:ACPower:MARKer[1]|2|...|12:FUNCTion:RESult?
CALCulate:ACPower:MARKer[1]|2|...|12:MAXimum
CALCulate:ACPower:MARKer[1]|2|...|12:MAXimum:LEFT
CALCulate:ACPower:MARKer[1]|2|...|12:MAXimum:NEXT
CALCulate:ACPower:MARKer[1]|2|...|12:MAXimum:RIGHT
CALCulate:ACPower:MARKer[1]|2|...|12:MINimum
CALCulate:ACPower:MARKer[1]|2|...|12:MODE POSition | DELTA | OFF
CALCulate:ACPower:MARKer[1]|2|...|12:MODE?
CALCulate:ACPower:MARKer[1]|2|...|12:PTPeak
CALCulate:ACPower:MARKer[1]|2|...|12:REFerence <integer>
CALCulate:ACPower:MARKer[1]|2|...|12:REFerence?
CALCulate:ACPower:MARKer[1]|2|...|12:STATe OFF | ON | 0 | 1
CALCulate:ACPower:MARKer[1]|2|...|12:STATe?
CALCulate:ACPower:MARKer[1]|2|...|12:TRACe 1 | 2 | 3
CALCulate:ACPower:MARKer[1]|2|...|12:TRACe?
CALCulate:ACPower:MARKer[1]|2|...|12:X <freq>
CALCulate:ACPower:MARKer[1]|2|...|12:X?
CALCulate:ACPower:MARKer[1]|2|...|12:X:POSition <real>
CALCulate:ACPower:MARKer[1]|2|...|12:X:POSition?
CALCulate:ACPower:MARKer[1]|2|...|12:Y?
CALCulate:ACPower:OFFSet[:OUTer]:LIST:LIMit:NEGative[:UPPer]:DATA <real>,
...
CALCulate:ACPower:OFFSet[:OUTer]:LIST:LIMit:NEGative[:UPPer]:DATA?
CALCulate:ACPower:OFFSet[:OUTer]:LIST:LIMit:POSitive[:UPPer]:DATA <real>,
...
CALCulate:ACPower:OFFSet[:OUTer]:LIST:LIMit:POSitive[:UPPer]:DATA?

```

### 3 Programming the Analyzer

#### List of SCPI Commands

```
CALCulate:CDPower:ASET:THReshold
CALCulate:CDPower:AXIS
CALCulate:CDPower[:BTS]:ASET:THReshold <real>
CALCulate:CDPower[:BTS]:ASET:THReshold?
CALCulate:CDPower[:BTS]:ASET:THReshold:AUTO OFF | ON | 0 | 1
CALCulate:CDPower[:BTS]:ASET:THReshold:AUTO?
CALCulate:CDPower[:BTS]:AXIS IPH | QPH
CALCulate:CDPower[:BTS]:AXIS?
CALCulate:CDPower[:BTS]:CHANnel:TYPE PILOT | MAC | DATA | PREAMBLE
CALCulate:CDPower[:BTS]:CHANnel:TYPE?
CALCulate:CDPower[:BTS]:DBIT:FORMat BIN | HEX
CALCulate:CDPower[:BTS]:DBIT:FORMat?
CALCulate:CDPower[:BTS]:DBITS:TSTATE ON | OFF | 0 | 1
CALCulate:CDPower[:BTS]:DBITS:TSTATE?
CALCulate:CDPower[:BTS]:IQ:COMBined[:STATE] 0 | 1 | OFF | ON
CALCulate:CDPower[:BTS]:IQ:COMBined[:STATE]?
CALCulate:CDPower[:BTS]:MARKer:AOFF
CALCulate:CDPower[:BTS]:MARKer:COUPLE[:STATE] ON | OFF | 1 | 0
CALCulate:CDPower[:BTS]:MARKer:COUPLE[:STATE]?
CALCulate:CDPower[:BTS]:MARKer[1]|2|...12:MAXimum
CALCulate:CDPower[:BTS]:MARKer[1]|2|...12:MAXimum:LEFT
CALCulate:CDPower[:BTS]:MARKer[1]|2|...12:MAXimum:NEXT
CALCulate:CDPower[:BTS]:MARKer[1]|2|...12:MAXimum:RIGHT
CALCulate:CDPower[:BTS]:MARKer[1]|2|...12:MINimum
CALCulate:CDPower[:BTS]:MARKer[1]|2|...12:MODE POSITION | DELTA | OFF
CALCulate:CDPower[:BTS]:MARKer[1]|2|...12:MODE?
CALCulate:CDPower[:BTS]:MARKer[1]|2|...12:PTPeak
CALCulate:CDPower[:BTS]:MARKer[1]|2|...12:REFERENCE <integer>
CALCulate:CDPower[:BTS]:MARKer[1]|2|...12:REFERENCE?
CALCulate:CDPower[:BTS]:MARKer[1]|2|...12[:SET]:DESPread
CALCulate:CDPower[:BTS]:MARKer[1]|2|...12:STATE OFF | ON | 0 | 1
CALCulate:CDPower[:BTS]:MARKer[1]|2|...12:STATE?
CALCulate:CDPower[:BTS]:MARKer[1]|2|...12:SYMBOL <real>
CALCulate:CDPower[:BTS]:MARKer[1]|2|...12:SYMBOL?
CALCulate:CDPower[:BTS]:MARKer[1]|2|...12:TRACE CDPower | SPOWER | CPOWER
| CDError
CALCulate:CDPower[:BTS]:MARKer[1]|2|...12:TRACE?
CALCulate:CDPower[:BTS]:MARKer[1]|2|...12:X <real>
CALCulate:CDPower[:BTS]:MARKer[1]|2|...12:X?
CALCulate:CDPower[:BTS]:MARKer[1]|2|...12:X:POSITION <real>
CALCulate:CDPower[:BTS]:MARKer[1]|2|...12:X:POSITION?
CALCulate:CDPower[:BTS]:MARKer[1]|2|...12:Y?
CALCulate:CDPower[:BTS]:PACKed OFF | PKM1
CALCulate:CDPower[:BTS]:PACKed?
CALCulate:CDPower[:BTS]:SWEep:OFFSet <real>
CALCulate:CDPower[:BTS]:SWEep:OFFSet?
CALCulate:CDPower[:BTS]:SWEep:TIME <real>
CALCulate:CDPower[:BTS]:SWEep:TIME?
CALCulate:CDPower[:BTS]:TYPE RLOG | RLINear | ALOG | ALINear
CALCulate:CDPower[:BTS]:TYPE?
CALCulate:CDPower[:BTS]:TYPE:DATA QPSK | OPSK | QAM | QAM64 | AUTO
CALCulate:CDPower[:BTS]:TYPE:DATA?
CALCulate:CDPower[:BTS]:WCODE[:NUMBER] <integer>
```

```

CALCulate:CDPower[:BTS]:WCOde[:NUMBer]?
CALCulate:CDPower[:BTS]:WCOde:ORDer HADamard | BREVerse
CALCulate:CDPower[:BTS]:WCOde:ORDer?
CALCulate:CDPower:CHANnel:TYPE
CALCulate:CDPower:DBITs:TSTate
CALCulate:CDPower:IQ:COMBined[:STATe]
CALCulate:CDPower:MARKer:AOff
CALCulate:CDPower:MARKer:COUple[:STATe]
CALCulate:CDPower:MARKer[1]|2|...4:MAXimum
CALCulate:CDPower:MARKer[1]|2|...4:MAXimum:LEFT
CALCulate:CDPower:MARKer[1]|2|...4:MAXimum:NEXT
CALCulate:CDPower:MARKer[1]|2|...4:MAXimum:RIGHT
CALCulate:CDPower:MARKer[1]|2|...4:MINimum
CALCulate:CDPower:MARKer[1]|2|...4:MODE
CALCulate:CDPower:MARKer[1]|2|...4:PTPeak
CALCulate:CDPower:MARKer[1]|2|...4:REFerence
CALCulate:CDPower:MARKer[1]|2|...4[:SET]:DESread
CALCulate:CDPower:MARKer[1]|2|...4:STATe
CALCulate:CDPower:MARKer[1]|2|...4:TRACe
CALCulate:CDPower:MS:ASET:THReshold <real>
CALCulate:CDPower:MS:ASET:THReshold?
CALCulate:CDPower:MS:ASET:THReshold:AUTO OFF | ON | 0 | 1
CALCulate:CDPower:MS:ASET:THReshold:AUTO?
CALCulate:CDPower:MS:AXIS IPH | QPH | IQCombined
CALCulate:CDPower:MS:AXIS?
CALCulate:CDPower:MS:IQ:COMBined[:STATe] 0 | 1 | OFF | ON
CALCulate:CDPower:MS:IQ:COMBined[:STATe]?
CALCulate:CDPower:MS:MARKer:AOff
CALCulate:CDPower:MS:MARKer:COUple[:STATe] ON | OFF | 1 | 0
CALCulate:CDPower:MS:MARKer:COUple[:STATe]?
CALCulate:CDPower:MS:MARKer[1]|2|...12:MAXimum
CALCulate:CDPower:MS:MARKer[1]|2|...12:MAXimum:LEFT
CALCulate:CDPower:MS:MARKer[1]|2|...12:MAXimum:NEXT
CALCulate:CDPower:MS:MARKer[1]|2|...12:MAXimum:RIGHT
CALCulate:CDPower:MS:MARKer[1]|2|...12:MINimum
CALCulate:CDPower:MS:MARKer[1]|2|...12:MODE POSition | DELTa | OFF
CALCulate:CDPower:MS:MARKer[1]|2|...12:MODE?
CALCulate:CDPower:MS:MARKer[1]|2|...12:PTPeak
CALCulate:CDPower:MS:MARKer[1]|2|...12:REFerence <integer>
CALCulate:CDPower:MS:MARKer[1]|2|...12:REFerence?
CALCulate:CDPower:MS:MARKer[1]|2|...12[:SET]:DESread
CALCulate:CDPower:MS:MARKer[1]|2|...12:TRACe CDPower | CDError | SPOwer |
CPOwer | EVM | MERRor | PERRor | POLar
CALCulate:CDPower:MS:MARKer[1]|2|...12:TRACe?
CALCulate:CDPower:MS:SEVM:FCOMpen ON | OFF | 0 | 1
CALCulate:CDPower:MS:SEVM:FCOMpen?
CALCulate:CDPower:MS:SWEep:OFFSet <real>
CALCulate:CDPower:MS:SWEep:OFFSet?
CALCulate:CDPower:MS:TYPE RELative | ABSolute
CALCulate:CDPower:MS:TYPE?
CALCulate:CDPower:MS:WCOde:LENGth <integer>
CALCulate:CDPower:MS:WCOde:LENGth?
CALCulate:CDPower:MS:WCOde[:NUMBer] <integer>

```

```
CALCulate:CDPower:MS:WCODE[:NUMBER]?  
CALCulate:CDPower:PACKed  
CALCulate:CDPower:SWEep:OFFSet  
CALCulate:CDPower:SWEep:TIME  
CALCulate:CDPower:TYPE  
CALCulate:CDPower:TYPE:DATA  
CALCulate:CDPower:WCODE[:NUMBER]  
CALCulate:CDPower:WCODE:ORDER  
CALCulate:CHPower:LIMit:POWER <ampl>  
CALCulate:CHPower:LIMit:POWER?  
CALCulate:CHPower:LIMit:POWER:FAIL?  
CALCulate:CHPower:LIMit:POWER:STATE OFF | ON | 0 | 1  
CALCulate:CHPower:LIMit:POWER:STATE?  
CALCulate:CHPower:LIMit:PSDensity <real>  
CALCulate:CHPower:LIMit:PSDensity?  
CALCulate:CHPower:LIMit:PSDensity:STATE OFF | ON | 0 | 1  
CALCulate:CHPower:LIMit:PSDensity:STATE?  
CALCulate:CHPower:LIMit:PSD:FAIL?  
CALCulate:CHPower:MARKer:AOFF  
CALCulate:CHPower:MARKer[1]|2|...|12:MAXimum  
CALCulate:CHPower:MARKer[1]|2|...|12:MODE POSITION | DELTA | OFF  
CALCulate:CHPower:MARKer[1]|2|...|12:MODE?  
CALCulate:CHPower:MARKer[1]|2|...|12:REFERENCE <integer>  
CALCulate:CHPower:MARKer[1]|2|...|12:REFERENCE?  
CALCulate:CHPower:MARKer[1]|2|...|12:STATE OFF | ON | 0 | 1  
CALCulate:CHPower:MARKer[1]|2|...|12:STATE?  
CALCulate:CHPower:MARKer[1]|2|...|12:X <real>  
CALCulate:CHPower:MARKer[1]|2|...|12:X?  
CALCulate:CHPower:MARKer[1]|2|...|12:X:POSITION <real>  
CALCulate:CHPower:MARKer[1]|2|...|12:X:POSITION?  
CALCulate:CHPower:MARKer[1]|2|...|12:Y?  
CALCulate:CLIMits:FAIL?  
CALCulate:DATA<n>:COMPRESS? BLOCK | CFIT | MAXimum | MINimum | MEAN |  
DMEan | RMS | RMSCubed | SAMPLE | SDEviation | PPHase[, <soffset>[,  
<length>[, <roffset>[, <rlimit>]]]]  
CALCulate:DATA[n]?  
CALCulate:DATA[1]|2|...|6:PEAKs? <threshold>, <excursion>[, AMPLitude |  
FREQuency | TIME]  
CALCulate:DATA[1]|2|...|6:PEAKs? <threshold>, <excursion>[, AMPLitude |  
FREQuency | TIME[, ALL | GTDLine | LTDLine]]  
CALCulate:EVMQpsk:IQOffset:INCLude OFF | ON | 0 | 1  
CALCulate:EVMQpsk:IQOffset:INCLude?  
CALCulate:EVMQpsk:LIMit:FERRor <freq>  
CALCulate:EVMQpsk:LIMit:FERRor?  
CALCulate:EVMQpsk:LIMit:RMS <real>  
CALCulate:EVMQpsk:LIMit:RMS?  
CALCulate:EVMQpsk:MARKer:AOFF  
CALCulate:EVMQpsk:MARKer[1]|2|...|12:CHIP <real>  
CALCulate:EVMQpsk:MARKer[1]|2|...|12:CHIP?  
CALCulate:EVMQpsk:MARKer:COUple[:STATE] ON | OFF | 1 | 0  
CALCulate:EVMQpsk:MARKer:COUple[:STATE]?  
CALCulate:EVMQpsk:MARKer[1]|2|...|12:FUNCTion:RESult?
```

```

CALCulate:EVMQpsk:MARKer[1]|2|...12:MAXimum
CALCulate:EVMQpsk:MARKer[1]|2|...12:MAXimum:LEFT
CALCulate:EVMQpsk:MARKer[1]|2|...12:MAXimum:NEXT
CALCulate:EVMQpsk:MARKer[1]|2|...12:MAXimum:RIGHT
CALCulate:EVMQpsk:MARKer[1]|2|...12:MINimum
CALCulate:EVMQpsk:MARKer[1]|2|...12:MODE POSITION | DELTA | OFF
CALCulate:EVMQpsk:MARKer[1]|2|...12:MODE?
CALCulate:EVMQpsk:MARKer[1]|2|...12:PTPeak
CALCulate:EVMQpsk:MARKer[1]|2|...12:REference <integer>
CALCulate:EVMQpsk:MARKer[1]|2|...12:REference?
CALCulate:EVMQpsk:MARKer[1]|2|...12:TRACE POLar | EVM | PERRor | MERRor
CALCulate:EVMQpsk:MARKer[1]|2|...12:TRACE?
CALCulate:EVMQpsk:MARKer[1]|2|...12:X <real>
CALCulate:EVMQpsk:MARKer[1]|2|...12:X?
CALCulate:EVMQpsk:MARKer[1]|2|...12:X:POSITION <real>
CALCulate:EVMQpsk:MARKer[1]|2|...12:X:POSITION?
CALCulate:EVMQpsk:MARKer[1]|2|...12:Y?
CALCulate:MCPower:OFFSet:LIST:LIMit:NEGative[:UPPer]:DATA (PSAPowerSuite)
CALCulate:MCPower:OFFSet:LIST:LIMit:POSitive[:UPPer]:DATA (PSAPowerSuite)
CALCulate:MONitor:MARKer:AOff
CALCulate:MONitor:MARKer:COUple[:STATe] ON | OFF | 1 | 0
CALCulate:MONitor:MARKer:COUple[:STATe]?
CALCulate:MONitor:MARKer[1]|2|...|12:FUNCTion NOISe | BPOwer | BDENSity |
OFF
CALCulate:MONitor:MARKer[1]|2|...|12:FUNCTion?
CALCulate:MONitor:MARKer[1]|2|...|12:FUNCTion:BAND:LEFT <freq>
CALCulate:MONitor:MARKer[1]|2|...|12:FUNCTion:BAND:LEFT?
CALCulate:MONitor:MARKer[1]|2|...|12:FUNCTion:BAND:RIGHT <freq>
CALCulate:MONitor:MARKer[1]|2|...|12:FUNCTion:BAND:RIGHT?
CALCulate:MONitor:MARKer[1]|2|...|12:FUNCTion:BAND:SPAN <freq>
CALCulate:MONitor:MARKer[1]|2|...|12:FUNCTion:BAND:SPAN?
CALCulate:MONitor:MARKer[1]|2|...|12:FUNCTion:RESult?
CALCulate:MONitor:MARKer[1]|2|...|12:MAXimum
CALCulate:MONitor:MARKer[1]|2|...|12:MODE POSITION | DELTA | OFF
CALCulate:MONitor:MARKer[1]|2|...|12:MODE?
CALCulate:MONitor:MARKer[1]|2|...|12:REference <integer>
CALCulate:MONitor:MARKer[1]|2|...|12:REference?
CALCulate:MONitor:MARKer[1]|2|...|12:TRACE <integer>
CALCulate:MONitor:MARKer[1]|2|...|12:TRACE?
CALCulate:MONitor:MARKer[1]|2|...|12:X <freq>
CALCulate:MONitor:MARKer[1]|2|...|12:X?
CALCulate:MONitor:MARKer[1]|2|...|12:X:POSITION <real>
CALCulate:MONitor:MARKer[1]|2|...|12:X:POSITION?
CALCulate:MONitor:MARKer[1]|2|...|12:Y?
CALCulate:OBwidth:LIMit:FBLimit <freq>
CALCulate:OBwidth:LIMit:FBLimit?
CALCulate:OBwidth:LIMit[:TEST] ON | OFF | 1 | 0
CALCulate:OBwidth:LIMit[:TEST]?
CALCulate:OBwidth:MARKer:AOff
CALCulate:OBwidth:MARKer[1]|2|...|12:MAXimum
CALCulate:OBwidth:MARKer[1]|2|...|12:MODE POSITION | DELTA | OFF
CALCulate:OBwidth:MARKer[1]|2|...|12:MODE?
CALCulate:OBwidth:MARKer[1]|2|...|12:REference <integer>

```

```

CALCulate:OBWidth:MARKer[1]|2|...|12:REfERENCE?
CALCulate:OBWidth:MARKer[1]|2|...|12:STATE OFF | ON | 0 | 1
CALCulate:OBWidth:MARKer[1]|2|...|12:STATE?
CALCulate:OBWidth:MARKer[1]|2|...|12:X <freq>
CALCulate:OBWidth:MARKer[1]|2|...|12:X?
CALCulate:OBWidth:MARKer[1]|2|...|12:X:POSition <real>
CALCulate:OBWidth:MARKer[1]|2|...|12:X:POSition?
CALCulate:OBWidth:MARKer[1]|2|...|12:Y?
CALCulate:PStatistic:MARKer:AOff
CALCulate:PStatistic:MARKer[1]|2|...|12:FUNCTion:RESult?
CALCulate:PStatistic:MARKer[1]|2|...|12:MODE POSition | DELTA | OFF
CALCulate:PStatistic:MARKer[1]|2|...|12:MODE?
CALCulate:PStatistic:MARKer[1]|2|...|12:REfERENCE <integer>
CALCulate:PStatistic:MARKer[1]|2|...|12:REfERENCE?
CALCulate:PStatistic:MARKer[1]|2|...|12:TRACe MEASured | GAUSSian |
REfERENCE
CALCulate:PStatistic:MARKer[1]|2|...|12:TRACe?
CALCulate:PStatistic:MARKer[1]|2|...|12:X <rel_ampl>
CALCulate:PStatistic:MARKer[1]|2|...|12:X?
CALCulate:PStatistic:MARKer[1]|2|...|12:Y?
CALCulate:PStatistic:STORE:REfERENCE
CALCulate:PVTime:MARKer:AOff
CALCulate:PVTime:MARKer:COUple[:STATE] ON | OFF | 1 | 0
CALCulate:PVTime:MARKer:COUple[:STATE]?
CALCulate:PVTime:MARKer[1]|2|...12:MAXimum
CALCulate:PVTime:MARKer[1]|2|...12:MODE POSition | DELTA | OFF
CALCulate:PVTime:MARKer[1]|2|...12:MODE?
CALCulate:PVTime:MARKer[1]|2|...12:REfERENCE <integer>
CALCulate:PVTime:MARKer[1]|2|...12:REfERENCE?
CALCulate:PVTime:MARKer[1]|2|...12:TRACe RFENvelope | UMask | LMask |
MAXHold | MINHold
CALCulate:PVTime:MARKer[1]|2|...12:TRACe?
CALCulate:RHO:ASET:THreshold
CALCulate:RHO[:BTS]:ASET:THreshold <real>
CALCulate:RHO[:BTS]:ASET:THreshold?
CALCulate:RHO[:BTS]:ASET:THreshold:AUTO OFF | ON | 0 | 1
CALCulate:RHO[:BTS]:ASET:THreshold:AUTO?
CALCulate:RHO[:BTS]:CHANnel:TYPE:DATA QPSK | OPSK | QAM | QAM64 | AUTO
CALCulate:RHO[:BTS]:CHANnel:TYPE:DATA?
CALCulate:RHO[:BTS]:IQ:COMBined[:STATE] OFF | ON | 0 | 1
CALCulate:RHO[:BTS]:IQ:COMBined[:STATE]?
CALCulate:RHO[:BTS]:IQOffset:INCLude OFF | ON | 0 | 1
CALCulate:RHO[:BTS]:IQOffset:INCLude?
CALCulate:RHO[:BTS]:LIMit:DATA[:ACTive]:LOWer <real>
CALCulate:RHO[:BTS]:LIMit:DATA[:ACTive]:LOWer?
CALCulate:RHO[:BTS]:LIMit:DATA[:ACTive][:UPPer] <real>
CALCulate:RHO[:BTS]:LIMit:DATA[:ACTive][:UPPer]?
CALCulate:RHO[:BTS]:LIMit:FREQuency <real>
CALCulate:RHO[:BTS]:LIMit:FREQuency?
CALCulate:RHO[:BTS]:LIMit:MAC:INACTive[:UPPer] <real>
CALCulate:RHO[:BTS]:LIMit:MAC:INACTive[:UPPer]?
CALCulate:RHO[:BTS]:LIMit:PEAK <real>
CALCulate:RHO[:BTS]:LIMit:PEAK?

```

```

CALCulate:RHO[:BTS]:LIMit:PHASe <real>
CALCulate:RHO[:BTS]:LIMit:PHASe?
CALCulate:RHO[:BTS]:LIMit:POFFset <real>
CALCulate:RHO[:BTS]:LIMit:POFFset?
CALCulate:RHO[:BTS]:LIMit:PRESet
CALCulate:RHO[:BTS]:LIMit:PRESet?
CALCulate:RHO[:BTS]:LIMit:RHO:ALL <real>
CALCulate:RHO[:BTS]:LIMit:RHO:ALL?
CALCulate:RHO[:BTS]:LIMit:RHO:DATA <real>
CALCulate:RHO[:BTS]:LIMit:RHO:DATA?
CALCulate:RHO[:BTS]:LIMit:RHO:MAC <real>
CALCulate:RHO[:BTS]:LIMit:RHO:MAC?
CALCulate:RHO[:BTS]:LIMit:RHO:PILot <real>
CALCulate:RHO[:BTS]:LIMit:RHO:PILot?
CALCulate:RHO[:BTS]:LIMit:RHO:PREamble <real>
CALCulate:RHO[:BTS]:LIMit:RHO:PREamble?
CALCulate:RHO[:BTS]:LIMit:RMS <real>
CALCulate:RHO[:BTS]:LIMit:RMS?
CALCulate:RHO[:BTS]:LIMit:TIMing <second>
CALCulate:RHO[:BTS]:LIMit:TIMing?
CALCulate:RHO[:BTS]:MARKer:AOFF
CALCulate:RHO[:BTS]:MARKer:COUPle[:STATe] ON | OFF | 1 | 0
CALCulate:RHO[:BTS]:MARKer:COUPle[:STATe]?
CALCulate:RHO[:BTS]:MARKer[1]|2|...12:MAXimum
CALCulate:RHO[:BTS]:MARKer[1]|2|...12:MAXimum:LEFT
CALCulate:RHO[:BTS]:MARKer[1]|2|...12:MAXimum:NEXT
CALCulate:RHO[:BTS]:MARKer[1]|2|...12:MAXimum:RIGHT
CALCulate:RHO[:BTS]:MARKer[1]|2|...12:MINimum
CALCulate:RHO[:BTS]:MARKer[1]|2|...12:MODE POSition | DELTA | =OFF
CALCulate:RHO[:BTS]:MARKer[1]|2|...12:MODE?
CALCulate:RHO[:BTS]:MARKer[1]|2|...12:PTPeak
CALCulate:RHO[:BTS]:MARKer[1]|2|...12:REFerence <integer>
CALCulate:RHO[:BTS]:MARKer[1]|2|...12:REFerence?
CALCulate:RHO[:BTS]:MARKer[1]|2|...12:TRACe EVM | MERRor | PERRor | IQ |
CHIP | CDPower | POLar
CALCulate:RHO[:BTS]:MARKer[1]|2|...12:TRACe?
CALCulate:RHO[:BTS]:SWEep:OFFSet <integer>
CALCulate:RHO[:BTS]:SWEep:OFFSet?
CALCulate:RHO[:BTS]:WCODE:ORDER BREVerse | HADamard
CALCulate:RHO[:BTS]:WCODE:ORDER?
CALCulate:RHO:CHANnel:TYPE:DATA
CALCulate:RHO:IQ:COMBined[:STATe]
CALCulate:RHO:IQOFFset:INCLude
CALCulate:RHO:LIMit:DATA[:ACTive]:LOWer
CALCulate:RHO:LIMit:DATA[:ACTive][:UPPer]
CALCulate:RHO:LIMit:FREQuency
CALCulate:RHO:LIMit:MAC:INACTive[:UPPer]
CALCulate:RHO:LIMit:PEAK
CALCulate:RHO:LIMit:PHASe
CALCulate:RHO:LIMit:POFFset
CALCulate:RHO:LIMit:PRESet
CALCulate:RHO:LIMit:RHO:ALL
CALCulate:RHO:LIMit:RHO:DATA

```

### 3 Programming the Analyzer

#### List of SCPI Commands

```
CALCulate:RHO:LIMit:RHO:MAC
CALCulate:RHO:LIMit:RHO:PILOt
CALCulate:RHO:LIMit:RHO:PREAmble
CALCulate:RHO:LIMit:RMS
CALCulate:RHO:LIMit:TIMing
CALCulate:RHO:MARKer:AOFF
CALCulate:RHO:MS:ASET:THReshold <real>
CALCulate:RHO:MS:ASET:THReshold?
CALCulate:RHO:MS:ASET:THReshold:AUTO OFF | ON | 0 | 1
CALCulate:RHO:MS:ASET:THReshold:AUTO?
CALCulate:RHO:MS:IQ:COMBined[:STATE] 0 | 1 | OFF | ON
CALCulate:RHO:MS:IQ:COMBined[:STATE]?
CALCulate:RHO:MS:IQOffset:INCLude OFF | ON | 0 | 1
CALCulate:RHO:MS:IQOffset:INCLude?
CALCulate:RHO:MS:LIMit:ACDPower[:SUB0] <real>
CALCulate:RHO:MS:LIMit:ACDPower[:SUB0]?
CALCulate:RHO:MS:LIMit:ACK:GAIN[:SUB0] <real>
CALCulate:RHO:MS:LIMit:ACK:GAIN[:SUB0]?
CALCulate:RHO:MS:LIMit:CDError[:SUB0] <real>
CALCulate:RHO:MS:LIMit:CDError[:SUB0]?
CALCulate:RHO:MS:LIMit:DATA:GAIN[:SUB0] <real>
CALCulate:RHO:MS:LIMit:DATA:GAIN[:SUB0]?
CALCulate:RHO:MS:LIMit:DRC:GAIN[:SUB0] <real>
CALCulate:RHO:MS:LIMit:DRC:GAIN[:SUB0]?
CALCulate:RHO:MS:LIMit:FERRor[:SUB0] <real>
CALCulate:RHO:MS:LIMit:FERRor[:SUB0]?
CALCulate:RHO:MS:LIMit:ICDPower[:SUB0] <real>
CALCulate:RHO:MS:LIMit:ICDPower[:SUB0]?
CALCulate:RHO:MS:LIMit:PEAK[:SUB0] <real>
CALCulate:RHO:MS:LIMit:PEAK[:SUB0]?
CALCulate:RHO:MS:LIMit:POFFset[:SUB0] <real>
CALCulate:RHO:MS:LIMit:POFFset[:SUB0]?
CALCulate:RHO:MS:LIMit:RHO[:SUB0] <real>
CALCulate:RHO:MS:LIMit:RHO[:SUB0]?
CALCulate:RHO:MS:LIMit:RMS[:SUB0] <real>
CALCulate:RHO:MS:LIMit:RMS[:SUB0]?
CALCulate:RHO:MS:LIMit:RRI[:SUB0] <real>
CALCulate:RHO:MS:LIMit:RRI[:SUB0]?
CALCulate:RHO:MS:MARKer:AOFF
CALCulate:RHO:MS:MARKer:COUPlE[:STATE] ON | OFF | 1 | 0
CALCulate:RHO:MS:MARKer:COUPlE[:STATE]?
CALCulate:RHO:MS:MARKer[1]|2|...12:MAXimum
CALCulate:RHO:MS:MARKer[1]|2|...12:MAXimum:LEFT
CALCulate:RHO:MS:MARKer[1]|2|...12:MAXimum:NEXT
CALCulate:RHO:MS:MARKer[1]|2|...12:MAXimum:RIGHT
CALCulate:RHO:MS:MARKer[1]|2|...12:MINimum
CALCulate:RHO:MS:MARKer[1]|2|...12:MODE POSition | DELTa | OFF
CALCulate:RHO:MS:MARKer[1]|2|...12:MODE?
CALCulate:RHO:MS:MARKer[1]|2|...12:PTPeak
CALCulate:RHO:MS:MARKer[1]|2|...12:REFerence <integer>
CALCulate:RHO:MS:MARKer[1]|2|...12:REFerence?
CALCulate:RHO:MS:MARKer[1]|2|...12:TRACe EVM | MERRor | PERRor | CDPower |
POLar
```



```

CALCulate:RHO:MS:MARKer[1]|2|...|12:TRACe?
CALCulate:RHO:MS:SWEep:OFFSet <integer>
CALCulate:RHO:MS:SWEep:OFFSet?
CALCulate:RHO:MS:WCODe:ORDer HADamard | BREVerse
CALCulate:RHO:MS:WCODe:ORDer?
CALCulate:RHO:SWEep:OFFSet
CALCulate:RHO:WCODe:ORDer
CALCulate:SEMask:LLIne:STATe ON | OFF | 1 | 0
CALCulate:SEMask:LLIne:STATe?
CALCulate:SEMask:MARKer:AOff
CALCulate:SEMask:MARKer:COUple[:STATe] ON | OFF | 1 | 0
CALCulate:SEMask:MARKer:COUple[:STATe]?
CALCulate:SEMask:MARKer[1]|2|...|12:FUNCTion:RESult?
CALCulate:SEMask:MARKer[1]|2|...|12:MODE POSition | OFF
CALCulate:SEMask:MARKer[1]|2|...|12:MODE?
CALCulate:SEMask:MARKer[1]|2|...|12:X <freq>
CALCulate:SEMask:MARKer[1]|2|...|12:X?
CALCulate:SEMask:MARKer[1]|2|...|12:X:POSition <real>
CALCulate:SEMask:MARKer[1]|2|...|12:X:POSition?
CALCulate:SEMask:MARKer[1]|2|...|12:Y?
CALCulate:SPURious:MARKer:AOff
CALCulate:SPURious:MARKer:COUple[:STATe] ON | OFF | 1 | 0
CALCulate:SPURious:MARKer:COUple[:STATe]?
CALCulate:SPURious:MARKer[1]|2|...|12:MAXimum
CALCulate:SPURious:MARKer[1]|2|...|12:MAXimum:LEfT
CALCulate:SPURious:MARKer[1]|2|...|12:MAXimum:NEXt
CALCulate:SPURious:MARKer[1]|2|...|12:MAXimum:RIgHt
CALCulate:SPURious:MARKer[1]|2|...|12:MINimum
CALCulate:SPURious:MARKer[1]|2|...|12:MODE POSition | DELTa | OFF
CALCulate:SPURious:MARKer[1]|2|...|12:MODE?
CALCulate:SPURious:MARKer[1]|2|...|12:PTPeak
CALCulate:SPURious:MARKer[1]|2|...|12:REFerence <integer>
CALCulate:SPURious:MARKer[1]|2|...|12:REFerence?
CALCulate:SPURious:MARKer[1]|2|...|12:X <freq>
CALCulate:SPURious:MARKer[1]|2|...|12:X?
CALCulate:SPURious:MARKer[1]|2|...|12:X:POSition <integer>
CALCulate:SPURious:MARKer[1]|2|...|12:X:POSition?
CALCulate:SPURious:MARKer[1]|2|...|12:Y?
CALCulate:SPURious[:RANGE][:LIST]:LIMit:ABSolute[:UPPer]:DATA[:START]
<ampl>, ...
CALCulate:SPURious[:RANGE][:LIST]:LIMit:ABSolute[:UPPer]:DATA[:START]?
CALCulate:SPURious[:RANGE][:LIST]:LIMit:ABSolute[:UPPer]:DATA:STOP <ampl>,
...
CALCulate:SPURious[:RANGE][:LIST]:LIMit:ABSolute[:UPPer]:DATA:STOP?
CALCulate:SPURious[:RANGE][:LIST]:LIMit:ABSolute[:UPPer]:DATA:STOP:AUTO
OFF|ON|0|1, ...
CALCulate:SPURious[:RANGE][:LIST]:LIMit:ABSolute[:UPPer]:DATA:STOP:AUTO?
CALCulate:TCDPower:ASET:THReshold
CALCulate:TCDPower:AXIS
CALCulate:TCDPower:IQ:COMBined[:STATe]
CALCulate:TCDPower:MARKer:AOff
CALCulate:TCDPower:MARKer:COUple[:STATe]

```

### 3 Programming the Analyzer

#### List of SCPI Commands

```
CALCulate:TCDPower:MARKer[1]|2|...4:MAXimum
CALCulate:TCDPower:MARKer[1]|2|...4:MAXimum:LEFT
CALCulate:TCDPower:MARKer[1]|2|...4:MAXimum:NEXT
CALCulate:TCDPower:MARKer[1]|2|...4:MAXimum:RIGHT
CALCulate:TCDPower:MARKer[1]|2|...4:MINimum
CALCulate:TCDPower:MARKer[1]|2|...4:MODE
CALCulate:TCDPower:MARKer[1]|2|...4:PTPeak
CALCulate:TCDPower:MARKer[1]|2|...4:REFerence
CALCulate:TCDPower:MARKer[1]|2|...4[:SET]:DESPread
CALCulate:TCDPower:MARKer[1]|2|...4:TRACe
CALCulate:TCDPower:SEVM:FCOMpen
CALCulate:TCDPower:SWEep:OFFSet
CALCulate:TCDPower:TYPE
CALCulate:TCDPower:WCOde:LENGth
CALCulate:TCDPower:WCOde[:NUMBer]
CALCulate:TRHO:ASET:THReshold
CALCulate:TRHO:IQ:COMBined[:STATe]
CALCulate:TRHO:IQOFFset:INCLude
CALCulate:TRHO:LIMit:ACDPower[:SUB0]
CALCulate:TRHO:LIMit:ACK:GAIN[:SUB0]
CALCulate:TRHO:LIMit:CDErRor[:SUB0]
CALCulate:TRHO:LIMit:DATA:GAIN[:SUB0]
CALCulate:TRHO:LIMit:DRC:GAIN[:SUB0]
CALCulate:TRHO:LIMit:FERRor[:SUB0]
CALCulate:TRHO:LIMit:ICDPower[:SUB0]
CALCulate:TRHO:LIMit:PEAK[:SUB0]
CALCulate:TRHO:LIMit:POFFset[:SUB0]
CALCulate:TRHO:LIMit:RHO[:SUB0]
CALCulate:TRHO:LIMit:RMS[:SUB0]
CALCulate:TRHO:LIMit:RRI[:SUB0]
CALCulate:TRHO:MARKer:AOFF
CALCulate:TRHO:MARKer[1]|2|...4:MAXimum
CALCulate:TRHO:MARKer[1]|2|...4:MAXimum:LEFT
CALCulate:TRHO:MARKer[1]|2|...4:MAXimum:NEXT
CALCulate:TRHO:MARKer[1]|2|...4:MAXimum:RIGHT
CALCulate:TRHO:MARKer[1]|2|...4:MINimum
CALCulate:TRHO:MARKer[1]|2|...4:PTPeak
CALCulate:TRHO:MARKer[1]|2|...4:TRACe
CALCulate:TRHO:SWEep:OFFSet
CALCulate:TRHO:WCOde:ORDer
CALCulate:WAVeform:MARKer:AOFF
CALCulate:WAVeform:MARKer:COUPle[:STATe] ON | OFF | 1 | 0
CALCulate:WAVeform:MARKer:COUPle[:STATe]?
CALCulate:WAVeform:MARKer[1]|2|...|12:FUNCTion BPOWer | BDENsity | OFF
CALCulate:WAVeform:MARKer[1]|2|...|12:FUNCTion?
CALCulate:WAVeform:MARKer[1]|2|...|12:FUNCTion:BAND:LEFT <time>
CALCulate:WAVeform:MARKer[1]|2|...|12:FUNCTion:BAND:LEFT?
CALCulate:WAVeform:MARKer[1]|2|...|12:FUNCTion:BAND:RIGHT <time>
CALCulate:WAVeform:MARKer[1]|2|...|12:FUNCTion:BAND:RIGHT?
CALCulate:WAVeform:MARKer[1]|2|...|12:FUNCTion:BAND:SPAN <time>
CALCulate:WAVeform:MARKer[1]|2|...|12:FUNCTion:BAND:SPAN?
CALCulate:WAVeform:MARKer[1]|2|...|12:FUNCTion:RESUlt?
CALCulate:WAVeform:MARKer[1]|2|...|12:MAXimum
```

```

CALCulate:WAVEform:MARKer[1]|2|...|12:MAXimum:NEXT
CALCulate:WAVEform:MARKer[1]|2|...|12:MINimum
CALCulate:WAVEform:MARKer[1]|2|...|12:MODE POSition | DELTA | OFF
CALCulate:WAVEform:MARKer[1]|2|...|12:MODE?
CALCulate:WAVEform:MARKer[1]|2|...|12:REference <integer>
CALCulate:WAVEform:MARKer[1]|2|...|12:REference?
CALCulate:WAVEform:MARKer[1]|2|...|12:STATE OFF | ON | 0 | 1
CALCulate:WAVEform:MARKer[1]|2|...|12:STATE?
CALCulate:WAVEform:MARKer[1]|2|...|12:TRACe RFENvelope | I | Q | IQ
CALCulate:WAVEform:MARKer[1]|2|...|12:TRACe?
CALCulate:WAVEform:MARKer[1]|2|...|12:X <time>
CALCulate:WAVEform:MARKer[1]|2|...|12:X?
CALCulate:WAVEform:MARKer[1]|2|...|12:X:POSition <real>
CALCulate:WAVEform:MARKer[1]|2|...|12:X:POSition?
CALCulate:WAVEform:MARKer[1]|2|...|4:X:SPAN
CALCulate:WAVEform:MARKer[1]|2|...|12:Y?
CALibration[:ALL]
CALibration[:ALL]?
CALibration:AUTO ALERT
CALibration:AUTO ON | PARTial | OFF
CALibration:AUTO?
CALibration:AUTO:ALERT TEMperature | DAY | WEEK | NONE
CALibration:AUTO:ALERT?
CALibration:AUTO:MODE ALL | NRF
CALibration:AUTO:MODE?
CALibration:AUTO:TIME:OFF?
CALibration:DATA:BACKup <filename>
CALibration:DATA:DEFault
CALibration:DATA:REStore <filename>
CALibration:EMIXer
CALibration:EMIXer?
CALibration:EXPIred?
CALibration:FREQuency:REFeRence:COARse <integer>
CALibration:FREQuency:REFeRence:COARse
CALibration:FREQuency:REFeRence:COARse?
CALibration:FREQuency:REFeRence:FINE <integer>
CALibration:FREQuency:REFeRence:FINE?
CALibration:FREQuency:REFeRence:MODE CALibrated | USER
CALibration:FREQuency:REFeRence:MODE?
CALibration:IQ:FLATness:I
CALibration:IQ:FLATness:IBAR
CALibration:IQ:FLATness:I | IBAR | Q | QBAR:TIME?
CALibration:IQ:FLATness:Q
CALibration:IQ:FLATness:QBAR
CALibration:IQ:ISOLation
CALibration:IQ:ISOLation:TIME?
CALibration:IQ:PROBe:I
CALibration:IQ:PROBe:IBar
CALibration:IQ:PROBe:I | IBAR | Q | QBAR:TIME?
CALibration:IQ:PROBe:I | Q:CLEar
CALibration:IQ:PROBe:Q
CALibration:IQ:PROBe:QBar
CALibration:NRF

```

### 3 Programming the Analyzer

#### List of SCPI Commands

```
CALibration:NRF?
CALibration:REFErence:CLOCK?
CALibration:REFErence:CLOCK:END?
CALibration:REFErence:CLOCK:INITialize?
CALibration:RF
CALibration:RF?
CALibration:RFPSelector:SCHeduler:TIME:NEXT?
CALibration:SOURce:STATe OFF | ON | 0 | 1
CALibration:SOURce:STATe?
CALibration:TEMPerature:CURRent?
CALibration:TEMPerature:LALL?
CALibration:TEMPerature:LPReselector?
CALibration:TEMPerature:LRF?
CALibration:TEMPerature:RFPSelector:LCONducted?
CALibration:TEMPerature:RFPSelector:LRADiated?
CALibration:TIME:LALL?
CALibration:TIME:LPReselector?
CALibration:TIME:LRF?
CALibration:TIME:REFErence:CLOCK?
CALibration:TIME:RFPSelector:LCONducted?
CALibration:TIME:RFPSelector:LRADiated?
CALibration:YTF
CALibration:YTF?
CONF FSC
CONFigure?
CONFigure:ACP
CONFigure:ACP:NDEFault
CONFigure:ACPower
CONFigure:CDPower
CONFigure:CDPower
CONFigure:CDPower[:BTS]
CONFigure:CDPower[:BTS]:NDEFault
CONFigure:CHPower
CONFigure:CHPower
CONFigure:CHPower:NDEFault
CONFigure:EVMQpsk
CONFigure:EVMQpsk
CONFigure:EVMQpsk:NDEFault
CONFigure:MONitor
CONFigure:MONitor
CONFigure:MONitor:NDEFault
CONFigure:OBWidth
CONFigure:OBWidth
CONFigure:OBWidth:NDEFault
CONFigure:PStatistic
CONFigure:PStatistic
CONFigure:PStatistic:NDEFault
CONFigure:PVTime
CONFigure:RHO[:BTS]
CONFigure:RHO:MS
CONFigure:SEMask
CONFigure:SEMask
CONFigure:SEMask:NDEFault
```

```

CONFigure:SPURious
CONFigure:SPURious
CONFigure:SPURious:NDEFault
CONFigure:TRHO
CONFigure:WAVEform
CONFigure:WAVEform
CONFigure:WAVEform:NDEFault
COUple ALL | NONE
DISPlay:<measurement>:ANNOtation:TITLe:DATA <string>
DISPlay:<measurement>:ANNOtation:TITLe:DATA?
DISPlay:ACPoweR:VIEW:NSElect <integer>
DISPlay:ACPoweR:VIEW:NSElect?
DISPlay:ACPoweR:VIEW[:SElect] PRESult | CINformation
DISPlay:ACPoweR:VIEW[:SElect]?
DISPlay:ACPoweR:VIEW[1]:WINDow[1]:BGRaph OFF | ON | 0 | 1
DISPlay:ACPoweR:VIEW[1]:WINDow[1]:BGRaph?
DISPlay:ACPoweR:VIEW[1]:WINDow[1]:TRACe:Y[:SCALe]:COUple 0 | 1 | OFF | ON
DISPlay:ACPoweR:VIEW[1]:WINDow[1]:TRACe:Y[:SCALe]:COUple?
DISPlay:ACPoweR:VIEW[1]:WINDow[1]:TRACe:Y[:SCALe]:PDIVision <rel_amp>
DISPlay:ACPoweR:VIEW[1]:WINDow[1]:TRACe:Y[:SCALe]:PDIVision?
DISPlay:ACPoweR:VIEW[1]:WINDow[1]:TRACe:Y[:SCALe]:RLEVel <real>
DISPlay:ACPoweR:VIEW[1]:WINDow[1]:TRACe:Y[:SCALe]:RLEVel?
DISPlay:ACPoweR:VIEW[1]:WINDow[1]:TRACe:Y[:SCALe]:RPOStion TOP | CENTer |
BOTTom
DISPlay:ACPoweR:VIEW[1]:WINDow[1]:TRACe:Y[:SCALe]:RPOStion?
DISPlay:ACTivefunc[:STATe] ON | OFF | 1 | 0
DISPlay:ACTivefunc[:STATe]?
DISPlay:ANNOtation:MBAR[:STATe] OFF | ON | 0 | 1
DISPlay:ANNOtation:MBAR[:STATe]?
DISPlay:ANNOtation:SCREen[:STATe] OFF | ON | 0 | 1
DISPlay:ANNOtation:SCREen[:STATe]?
DISPlay:BACKlight ON | OFF
DISPlay:BACKlight?
DISPlay:BACKlight:INTensity <integer>
DISPlay:BACKlight:INTensity?
DISPlay:CDPoweR[:BTS]:VIEW:NSElect <integer>
DISPlay:CDPoweR[:BTS]:VIEW:NSElect?
DISPlay:CDPoweR[:BTS]:VIEW[:SElect] PGRaph | CDPError | CDQView | DBITs |
MDDBits
DISPlay:CDPoweR[:BTS]:VIEW[:SElect]?
DISPlay:CDPoweR[:BTS]:VIEW4:WINDow2:TRACe:X[:SCALe]:COUple 0 | 1 | OFF |
ON
DISPlay:CDPoweR[:BTS]:VIEW3:WINDow4:TRACe:X[:SCALe]:COUple 0 | 1 | OFF |
ON
DISPlay:CDPoweR[:BTS]:VIEW3:WINDow2:TRACe:X[:SCALe]:COUple 0 | 1 | OFF |
ON
DISPlay:CDPoweR[:BTS]:VIEW4:WINDow2:TRACe:X[:SCALe]:COUple?
DISPlay:CDPoweR[:BTS]:VIEW3:WINDow4:TRACe:X[:SCALe]:COUple?
DISPlay:CDPoweR[:BTS]:VIEW3:WINDow2:TRACe:X[:SCALe]:COUple?
DISPlay:CDPoweR[:BTS]:VIEW3:WINDow4:TRACe:X[:SCALe]:PDIVision <real>
DISPlay:CDPoweR[:BTS]:VIEW3:WINDow2:TRACe:X[:SCALe]:PDIVision <real>
DISPlay:CDPoweR[:BTS]:VIEW4:WINDow2:TRACe:X[:SCALe]:PDIVision <real>

```

### 3 Programming the Analyzer

#### List of SCPI Commands

```
DISPlay:CDPower[:BTS]:VIEW3:WINDow2:TRACe:X[:SCALe]:PDIVision?
DISPlay:CDPower[:BTS]:VIEW3:WINDow4:TRACe:X[:SCALe]:PDIVision?
DISPlay:CDPower[:BTS]:VIEW4:WINDow2:TRACe:X[:SCALe]:PDIVision?
DISPlay:CDPower[:BTS]:VIEW3:WINDow2:TRACe:X[:SCALe]:RLEVel <real>
DISPlay:CDPower[:BTS]:VIEW4:WINDow2:TRACe:X[:SCALe]:RLEVel <real>
DISPlay:CDPower[:BTS]:VIEW3:WINDow4:TRACe:X[:SCALe]:RLEVel <real>
DISPlay:CDPower[:BTS]:VIEW4:WINDow2:TRACe:X[:SCALe]:RLEVel?
DISPlay:CDPower[:BTS]:VIEW3:WINDow2:TRACe:X[:SCALe]:RLEVel?
DISPlay:CDPower[:BTS]:VIEW3:WINDow4:TRACe:X[:SCALe]:RLEVel?
DISPlay:CDPower[:BTS]:VIEW4:WINDow2:TRACe:X[:SCALe]:RPOsition LEFT |
CENTer | RIGHT
DISPlay:CDPower[:BTS]:VIEW3:WINDow4:TRACe:X[:SCALe]:RPOsition LEFT |
CENTer | RIGHT
DISPlay:CDPower[:BTS]:VIEW3:WINDow2:TRACe:X[:SCALe]:RPOsition LEFT |
CENTer | RIGHT
DISPlay:CDPower[:BTS]:VIEW4:WINDow2:TRACe:X[:SCALe]:RPOsition?
DISPlay:CDPower[:BTS]:VIEW3:WINDow2:TRACe:X[:SCALe]:RPOsition?
DISPlay:CDPower[:BTS]:VIEW3:WINDow4:TRACe:X[:SCALe]:RPOsition?
DISPlay:CDPower[:BTS]:VIEW4:WINDow2:TRACe:Y[:SCALe]:COUPle 0 | 1 | OFF |
ON
DISPlay:CDPower[:BTS]:VIEW2:WINDow2:TRACe:Y[:SCALe]:COUPle 0 | 1 | OFF |
ON
DISPlay:CDPower[:BTS]:VIEW4:WINDow[1]:TRACe:Y[:SCALe]:COUPle 0 | 1 | OFF |
ON
DISPlay:CDPower[:BTS]:VIEW3:WINDow2:TRACe:Y[:SCALe]:COUPle 0 | 1 | OFF |
ON
DISPlay:CDPower[:BTS]:VIEW3:WINDow[1]:TRACe:Y[:SCALe]:COUPle 0 | 1 | OFF |
ON
DISPlay:CDPower[:BTS]:VIEW3:WINDow4:TRACe:Y[:SCALe]:COUPle 0 | 1 | OFF |
ON
DISPlay:CDPower[:BTS]:VIEW[1]:WINDow[1]:TRACe:Y[:SCALe]:COUPle 0 | 1 | OFF
| ON
DISPlay:CDPower[:BTS]:VIEW2:WINDow[1]:TRACe:Y[:SCALe]:COUPle 0 | 1 | OFF |
ON
DISPlay:CDPower[:BTS]:VIEW3:WINDow4:TRACe:Y[:SCALe]:COUPle?
DISPlay:CDPower[:BTS]:VIEW3:WINDow[1]:TRACe:Y[:SCALe]:COUPle?
DISPlay:CDPower[:BTS]:VIEW3:WINDow2:TRACe:Y[:SCALe]:COUPle?
DISPlay:CDPower[:BTS]:VIEW[1]:WINDow[1]:TRACe:Y[:SCALe]:COUPle?
DISPlay:CDPower[:BTS]:VIEW2:WINDow2:TRACe:Y[:SCALe]:COUPle?
DISPlay:CDPower[:BTS]:VIEW2:WINDow[1]:TRACe:Y[:SCALe]:COUPle?
DISPlay:CDPower[:BTS]:VIEW4:WINDow2:TRACe:Y[:SCALe]:COUPle?
DISPlay:CDPower[:BTS]:VIEW4:WINDow[1]:TRACe:Y[:SCALe]:COUPle?
DISPlay:CDPower[:BTS]:VIEW4:WINDow2:TRACe:Y[:SCALe]:PDIVision <real>
DISPlay:CDPower[:BTS]:VIEW3:WINDow2:TRACe:Y[:SCALe]:PDIVision <real>
DISPlay:CDPower[:BTS]:VIEW3:WINDow[1]:TRACe:Y[:SCALe]:PDIVision <real>
DISPlay:CDPower[:BTS]:VIEW4:WINDow[1]:TRACe:Y[:SCALe]:PDIVision <real>
DISPlay:CDPower[:BTS]:VIEW[1]:WINDow[1]:TRACe:Y[:SCALe]:PDIVision <real>
DISPlay:CDPower[:BTS]:VIEW3:WINDow4:TRACe:Y[:SCALe]:PDIVision <real>
DISPlay:CDPower[:BTS]:VIEW2:WINDow2:TRACe:Y[:SCALe]:PDIVision <real>
DISPlay:CDPower[:BTS]:VIEW2:WINDow[1]:TRACe:Y[:SCALe]:PDIVision <real>
DISPlay:CDPower[:BTS]:VIEW[1]:WINDow[1]:TRACe:Y[:SCALe]:PDIVision?
DISPlay:CDPower[:BTS]:VIEW2:WINDow2:TRACe:Y[:SCALe]:PDIVision?
```

```

DISPlay:CDPower[:BTS]:VIEW2:WINDow[1]:TRACe:Y[:SCALe]:PDIVision?
DISPlay:CDPower[:BTS]:VIEW3:WINDow[1]:TRACe:Y[:SCALe]:PDIVision?
DISPlay:CDPower[:BTS]:VIEW3:WINDow2:TRACe:Y[:SCALe]:PDIVision?
DISPlay:CDPower[:BTS]:VIEW4:WINDow[1]:TRACe:Y[:SCALe]:PDIVision?
DISPlay:CDPower[:BTS]:VIEW4:WINDow2:TRACe:Y[:SCALe]:PDIVision?
DISPlay:CDPower[:BTS]:VIEW3:WINDow4:TRACe:Y[:SCALe]:PDIVision?
DISPlay:CDPower[:BTS]:VIEW[1]:WINDow[1]:TRACe:Y[:SCALe]:RLEVel <real>
DISPlay:CDPower[:BTS]:VIEW3:WINDow[1]:TRACe:Y[:SCALe]:RLEVel <real>
DISPlay:CDPower[:BTS]:VIEW2:WINDow[1]:TRACe:Y[:SCALe]:RLEVel <real>
DISPlay:CDPower[:BTS]:VIEW2:WINDow2:TRACe:Y[:SCALe]:RLEVel <real>
DISPlay:CDPower[:BTS]:VIEW4:WINDow[1]:TRACe:Y[:SCALe]:RLEVel <real>
DISPlay:CDPower[:BTS]:VIEW4:WINDow2:TRACe:Y[:SCALe]:RLEVel <real>
DISPlay:CDPower[:BTS]:VIEW3:WINDow2:TRACe:Y[:SCALe]:RLEVel <real>
DISPlay:CDPower[:BTS]:VIEW3:WINDow4:TRACe:Y[:SCALe]:RLEVel <real>
DISPlay:CDPower[:BTS]:VIEW4:WINDow[1]:TRACe:Y[:SCALe]:RLEVel?
DISPlay:CDPower[:BTS]:VIEW2:WINDow[1]:TRACe:Y[:SCALe]:RLEVel?
DISPlay:CDPower[:BTS]:VIEW4:WINDow2:TRACe:Y[:SCALe]:RLEVel?
DISPlay:CDPower[:BTS]:VIEW[1]:WINDow[1]:TRACe:Y[:SCALe]:RLEVel?
DISPlay:CDPower[:BTS]:VIEW3:WINDow4:TRACe:Y[:SCALe]:RLEVel?
DISPlay:CDPower[:BTS]:VIEW2:WINDow2:TRACe:Y[:SCALe]:RLEVel?
DISPlay:CDPower[:BTS]:VIEW3:WINDow2:TRACe:Y[:SCALe]:RLEVel?
DISPlay:CDPower[:BTS]:VIEW3:WINDow[1]:TRACe:Y[:SCALe]:RLEVel?
DISPlay:CDPower[:BTS]:VIEW4:WINDow2:TRACe:Y[:SCALe]:RPOSition TOP | CENTER
| BOTTOm
DISPlay:CDPower[:BTS]:VIEW3:WINDow2:TRACe:Y[:SCALe]:RPOSition TOP | CENTER
| BOTTOm
DISPlay:CDPower[:BTS]:VIEW3:WINDow4:TRACe:Y[:SCALe]:RPOSition TOP | CENTER
| BOTTOm
DISPlay:CDPower[:BTS]:VIEW3:WINDow4:TRACe:Y[:SCALe]:RPOSition?
DISPlay:CDPower[:BTS]:VIEW3:WINDow2:TRACe:Y[:SCALe]:RPOSition?
DISPlay:CDPower[:BTS]:VIEW4:WINDow2:TRACe:Y[:SCALe]:RPOSition?
DISPlay:CDPower:MS:MARKer:CONSolidated ON | OFF | 1 | 0
DISPlay:CDPower:MS:MARKer:CONSolidated?
DISPlay:CDPower:MS:VIEW:NSElect <integer>
DISPlay:CDPower:MS:VIEW:NSElect?
DISPlay:CDPower:MS:VIEW[:SElect] PGRaph | CDPError | SEVM | QUAD | DBITs
DISPlay:CDPower:MS:VIEW[:SElect]?
DISPlay:CDPower:MS:VIEW3:WINDow2:TRACe:X[:SCALe]:COUple 0 | 1 | OFF | ON
DISPlay:CDPower:MS:VIEW3:WINDow2:TRACe:X[:SCALe]:COUple?
DISPlay:CDPower:MS:VIEW3:WINDow[1]:TRACe:X[:SCALe]:PDIVision <real>
DISPlay:CDPower:MS:VIEW3:WINDow[1]:TRACe:X[:SCALe]:PDIVision?
DISPlay:CDPower:MS:VIEW3:WINDow[1]:TRACe:X[:SCALe]:RLEVel <real>
DISPlay:CDPower:MS:VIEW3:WINDow[1]:TRACe:X[:SCALe]:RLEVel?
DISPlay:CDPower:MS:VIEW3:WINDow2:TRACe:X[:SCALe]:RPOSition LEFT | CENTER |
RIGHT
DISPlay:CDPower:MS:VIEW3:WINDow2:TRACe:X[:SCALe]:RPOSition?
DISPlay:CDPower:MS:VIEW[1]:WINDow[1]:TRACe:Y[:SCALe]:PDIVision <real>
DISPlay:CDPower:MS:VIEW[1]:WINDow[1]:TRACe:Y[:SCALe]:PDIVision?
DISPlay:CDPower:MS:VIEW[1]:WINDow[1]:TRACe:Y[:SCALe]:RLEVel <real>
DISPlay:CDPower:MS:VIEW[1]:WINDow[1]:TRACe:Y[:SCALe]:RLEVel?
DISPlay:CDPower:VIEW:NSElect
DISPlay:CDPower:VIEW[:SElect]

```

### 3 Programming the Analyzer

#### List of SCPI Commands

```
DISPlay:CDPower:VIEW4:WINDow2:TRACe:X[:SCALE]:COUPlE
DISPlay:CDPower:VIEW3:WINDow4:TRACe:X[:SCALE]:COUPlE
DISPlay:CDPower:VIEW3:WINDow2:TRACe:X[:SCALE]:COUPlE
DISPlay:CDPower:VIEW3:WINDow2:TRACe:X[:SCALE]:PDIVision
DISPlay:CDPower:VIEW4:WINDow2:TRACe:X[:SCALE]:PDIVision
DISPlay:CDPower:VIEW3:WINDow4:TRACe:X[:SCALE]:PDIVision
DISPlay:CDPower:VIEW3:WINDow4:TRACe:X[:SCALE]:RLEVel
DISPlay:CDPower:VIEW3:WINDow2:TRACe:X[:SCALE]:RLEVel
DISPlay:CDPower:VIEW4:WINDow2:TRACe:X[:SCALE]:RLEVel
DISPlay:CDPower:VIEW4:WINDow2:TRACe:X[:SCALE]:RPOSition
DISPlay:CDPower:VIEW3:WINDow2:TRACe:X[:SCALE]:RPOSition
DISPlay:CDPower:VIEW3:WINDow4:TRACe:X[:SCALE]:RPOSition
DISPlay:CDPower:VIEW3:WINDow2:TRACe:Y[:SCALE]:COUPlE
DISPlay:CDPower:VIEW4:WINDow1:TRACe:Y[:SCALE]:COUPlE
DISPlay:CDPower:VIEW3:WINDow4:TRACe:Y[:SCALE]:COUPlE
DISPlay:CDPower:VIEW2:WINDow[1]:TRACe:Y[:SCALE]:COUPlE
DISPlay:CDPower:VIEW4:WINDow2:TRACe:Y[:SCALE]:COUPlE
DISPlay:CDPower:VIEW2:WINDow2:TRACe:Y[:SCALE]:COUPlE
DISPlay:CDPower:VIEW[1]:WINDow[1]:TRACe:Y[:SCALE]:PDIVision
DISPlay:CDPower:VIEW3:WINDow[1]:TRACe:Y[:SCALE]:PDIVision
DISPlay:CDPower:VIEW4:WINDow2:TRACe:Y[:SCALE]:PDIVision
DISPlay:CDPower:VIEW4:WINDow[1]:TRACe:Y[:SCALE]:PDIVision
DISPlay:CDPower:VIEW3:WINDow2:TRACe:Y[:SCALE]:PDIVision
DISPlay:CDPower:VIEW3:WINDow4:TRACe:Y[:SCALE]:PDIVision
DISPlay:CDPower:VIEW2:WINDow2:TRACe:Y[:SCALE]:PDIVision
DISPlay:CDPower:VIEW2:WINDow[1]:TRACe:Y[:SCALE]:PDIVision
DISPlay:CDPower:VIEW2:WINDow[1]:TRACe:Y[:SCALE]:RLEVel
DISPlay:CDPower:VIEW3:WINDow2:TRACe:Y[:SCALE]:RLEVel
DISPlay:CDPower:VIEW2:WINDow2:TRACe:Y[:SCALE]:RLEVel
DISPlay:CDPower:VIEW4:WINDow[1]:TRACe:Y[:SCALE]:RLEVel
DISPlay:CDPower:VIEW3:WINDow4:TRACe:Y[:SCALE]:RLEVel
DISPlay:CDPower:VIEW3:WINDow[1]:TRACe:Y[:SCALE]:RLEVel
DISPlay:CDPower:VIEW[1]:WINDow[1]:TRACe:Y[:SCALE]:RLEVel
DISPlay:CDPower:VIEW4:WINDow2:TRACe:Y[:SCALE]:RLEVel
DISPlay:CDPower:VIEW3:WINDow4:TRACe:Y[:SCALE]:RPOSition
DISPlay:CDPower:VIEW3:WINDow2:TRACe:Y[:SCALE]:RPOSition
DISPlay:CDPower:VIEW4:WINDow2:TRACe:Y[:SCALE]:RPOSition
DISPlay:CHPower:VIEW:NSElect <integer>
DISPlay:CHPower:VIEW:NSElect?
DISPlay:CHPower:VIEW[:SElect] RFSpectrum | SHOulder
DISPlay:CHPower:VIEW[:SElect] RFSpectrum | SHOulder | MASK
DISPlay:CHPower:VIEW[:SElect] PRESult | CINformation
DISPlay:CHPower:VIEW[:SElect]?
DISPlay:CHPower:VIEW[:SElect]?
DISPlay:CHPower:VIEW[:SElect]?
DISPlay:CHPower:VIEW[1]:WINDow[1]:BGRaph ON | OFF | 1 | 0
DISPlay:CHPower:VIEW[1]:WINDow[1]:BGRaph?
DISPlay:CHPower:VIEW[1]:WINDow[1]:TRACe:Y[:SCALE]:COUPlE 0 | 1 | OFF | ON
DISPlay:CHPower:VIEW[1]:WINDow[1]:TRACe:Y[:SCALE]:COUPlE?
DISPlay:CHPower:VIEW[1]:WINDow[1]:TRACe:Y[:SCALE]:PDIVision <rel_ampl>
DISPlay:CHPower:VIEW[1]:WINDow[1]:TRACe:Y[:SCALE]:PDIVision?
DISPlay:CHPower:VIEW[1]:WINDow[1]:TRACe:Y[:SCALE]:RLEVel <real>
DISPlay:CHPower:VIEW[1]:WINDow[1]:TRACe:Y[:SCALE]:RLEVel?
```



```

DISPlay:CHPower:VIEW[1]:WINDow[1]:TRACe:Y[:SCALe]:RPOSition TOP | CENTER |
BOTTOm
DISPlay:CHPower:VIEW[1]:WINDow[1]:TRACe:Y[:SCALe]:RPOSition?
DISPlay:ENABLE OFF | ON | 0 | 1
DISPlay:ENABLE?
DISPlay:EVMQpsk:VIEW:NSElect <integer>
DISPlay:EVMQpsk:VIEW:NSElect?
DISPlay:EVMQpsk:VIEW[:SElect] POLar | ERRor
DISPlay:EVMQpsk:VIEW[:SElect]?
DISPlay:EVMQpsk:VIEW[1]:WINDow2:TRACe:COFFset <integer>
DISPlay:EVMQpsk:VIEW[1]:WINDow2:TRACe:COFFset?
DISPlay:EVMQpsk:VIEW[1]:WINDow2:TRACe:FVEctor[:STATe] OFF | ON | 0 | 1
DISPlay:EVMQpsk:VIEW[1]:WINDow2:TRACe:FVEctor[:STATe]?
DISPlay:EVMQpsk:VIEW[1]:WINDow2:TRACe:INTPolation[:STATe] OFF | ON | 0 | 1
DISPlay:EVMQpsk:VIEW[1]:WINDow2:TRACe:INTPolation[:STATe]?
DISPlay:EVMQpsk:VIEW[1]:WINDow2:TRACe:IQCHips <integer>
DISPlay:EVMQpsk:VIEW[1]:WINDow2:TRACe:IQCHips?
DISPlay:EVMQpsk:VIEW[1]:WINDow2:TRACe:POLar VC | VECTor | CONSTln
DISPlay:EVMQpsk:VIEW[1]:WINDow2:TRACe:POLar?
DISPlay:EVMQpsk:VIEW[1]:WINDow2:TRACe:ROTQpi[:STATe] OFF | ON | 0 | 1
DISPlay:EVMQpsk:VIEW[1]:WINDow2:TRACe:ROTQpi[:STATe]?
DISPlay:FSCreen[:STATe] OFF | ON | 0 | 1
DISPlay:FSCreen[:STATe]?
DISPlay:MENU[:STATe] OFF | ON | 0 | 1
DISPlay:MONitor:VIEW:NSElect <integer>
DISPlay:MONitor:VIEW:NSElect?
DISPlay:MONitor:VIEW[:SElect] RTRace | CINFormation
DISPlay:MONitor:VIEW[:SElect]?
DISPlay:MONitor:VIEW:WINDow:TRACe[1]|2|3:CLEar
DISPlay:MONitor:VIEW:WINDow:TRACe:CLEar:ALL
DISPlay:MONitor:VIEW:WINDow:TRACe[1]|2|3:TYPE
DISPlay:MONitor:VIEW[1]:WINDow[1]:TRACe:Y[:SCALe]:COUPle 0 | 1 | OFF | ON
DISPlay:MONitor:VIEW[1]:WINDow[1]:TRACe:Y[:SCALe]:COUPle?
DISPlay:MONitor:VIEW[1]:WINDow[1]:TRACe:Y[:SCALe]:PDIVision <rel_ampl>
DISPlay:MONitor:VIEW[1]:WINDow[1]:TRACe:Y[:SCALe]:PDIVision?
DISPlay:MONitor:VIEW[1]:WINDow[1]:TRACe:Y[:SCALe]:RLEVEL <real>
DISPlay:MONitor:VIEW[1]:WINDow[1]:TRACe:Y[:SCALe]:RLEVEL?
DISPlay:MONitor:VIEW[1]:WINDow[1]:TRACe:Y[:SCALe]:RPOSition TOP | CENTER |
BOTTOm
DISPlay:MONitor:VIEW[1]:WINDow[1]:TRACe:Y[:SCALe]:RPOSition?
DISPlay:OBWidth:VIEW[1]:WINDow[1]:TRACe:Y[:SCALe]:COUPle 0 | 1 | OFF | ON
DISPlay:OBWidth:VIEW[1]:WINDow[1]:TRACe:Y[:SCALe]:COUPle?
DISPlay:OBWidth:VIEW[1]:WINDow[1]:TRACe:Y[:SCALe]:PDIVision <rel_ampl>
DISPlay:OBWidth:VIEW[1]:WINDow[1]:TRACe:Y[:SCALe]:PDIVision?
DISPlay:OBWidth:VIEW[1]:WINDow[1]:TRACe:Y[:SCALe]:RLEVEL <real>
DISPlay:OBWidth:VIEW[1]:WINDow[1]:TRACe:Y[:SCALe]:RLEVEL?
DISPlay:OBWidth:VIEW[1]:WINDow[1]:TRACe:Y[:SCALe]:RPOSition TOP | CENTER |
BOTTOm
DISPlay:OBWidth:VIEW[1]:WINDow[1]:TRACe:Y[:SCALe]:RPOSition?
DISPlay:PStatistic:GAUSSian[:STATe] OFF | ON | 0 | 1
DISPlay:PStatistic:GAUSSian[:STATe]?
DISPlay:PStatistic:RTRace[:STATe] OFF | ON | 0 | 1

```

```

DISPlay:PStAtiStic:RTRace[:StAtE]?
DISPlay:PStAtiStic:VIEW[1]:WINDow2:TRACe:X[:SCALe]:PDIVision <rel_amp>
DISPlay:PStAtiStic:VIEW[1]:WINDow2:TRACe:X[:SCALe]:PDIVision?
DISPlay:PStAtiStic:XSCale
DISPlay:PVTime:BURSt:STHReshold ON | OFF | 1 | 0
DISPlay:PVTime:BURSt:STHReshold?
DISPlay:PVTime:LIMit:MASK ON | OFF | 1 | 0
DISPlay:PVTime:LIMit:MASK?
DISPlay:PVTime:VIEW ALL | BOTH | A | B | C | D | E
DISPlay:PVTime:VIEW?
DISPlay:PVTime:VIEW:WINDow:TRACe:MAXHold[:StAtE] ON | OFF | 1 | 0
DISPlay:PVTime:VIEW:WINDow:TRACe:MAXHold[:StAtE]?
DISPlay:PVTime:VIEW:WINDow:TRACe:MINHold[:StAtE] ON | OFF | 1 | 0
DISPlay:PVTime:VIEW:WINDow:TRACe:MINHold[:StAtE]?
DISPlay:PVTime:VIEW[1]:WINDow[1]:TRACe:X[:SCALe]:COUPle 0 | 1 | OFF | ON
DISPlay:PVTime:VIEW[1]:WINDow[1]:TRACe:X[:SCALe]:COUPle?
DISPlay:PVTime:VIEW[1]:WINDow[1]:TRACe:X[:SCALe]:PDIVision <time>
DISPlay:PVTime:VIEW[1]:WINDow[1]:TRACe:X[:SCALe]:PDIVision?
DISPlay:PVTime:VIEW[1]:WINDow[1]:TRACe:X[:SCALe]:RLEVel <time>
DISPlay:PVTime:VIEW[1]:WINDow[1]:TRACe:X[:SCALe]:RLEVel?
DISPlay:PVTime:VIEW[1]:WINDow[1]:TRACe:X[:SCALe]:RPOStion LEFT | CENTER |
RIGHT
DISPlay:PVTime:VIEW[1]:WINDow[1]:TRACe:X[:SCALe]:RPOStion?
DISPlay:PVTime:VIEW[1]:WINDow[1]:TRACe:Y[:SCALe]:COUPle 0 | 1 | OFF | ON
DISPlay:PVTime:VIEW[1]:WINDow[1]:TRACe:Y[:SCALe]:COUPle?
DISPlay:PVTime:VIEW[1]:WINDow[1]:TRACe:Y[:SCALe]:PDIVision <rel_amp>
DISPlay:PVTime:VIEW[1]:WINDow[1]:TRACe:Y[:SCALe]:PDIVision?
DISPlay:PVTime:VIEW[1]:WINDow[1]:TRACe:Y[:SCALe]:RLEVel <real>
DISPlay:PVTime:VIEW[1]:WINDow[1]:TRACe:Y[:SCALe]:RLEVel?
DISPlay:PVTime:VIEW[1]:WINDow[1]:TRACe:Y[:SCALe]:RPOStion TOP | CENTER |
BOTTom
DISPlay:PVTime:VIEW[1]:WINDow[1]:TRACe:Y[:SCALe]:RPOStion?
DISPlay:RHO[:BTS]:CDEScramble[:StAtE] 0 | 1 | OFF | ON
DISPlay:RHO[:BTS]:CDEScramble[:StAtE]?
DISPlay:RHO[:BTS]:CHANnel:TYPE PILOt | MAC | DATA | PREAmble | ALL1 | ALL2
DISPlay:RHO[:BTS]:CHANnel:TYPE?
DISPlay:RHO[:BTS]:FVEctor[:StAtE] 0 | 1 | OFF | ON
DISPlay:RHO[:BTS]:FVEctor[:StAtE]?
DISPlay:RHO[:BTS]:INTErpolate OFF | ON | 0 | 1
DISPlay:RHO[:BTS]:INTErpolate?
DISPlay:RHO[:BTS]:IQCHips <integer>
DISPlay:RHO[:BTS]:IQCHips?
DISPlay:RHO[:BTS]:IQPType VCONStln | VECTOR | CONSTln
DISPlay:RHO[:BTS]:IQPType?
DISPlay:RHO[:BTS]:OFFSet <integer>
DISPlay:RHO[:BTS]:OFFSet?
DISPlay:RHO[:BTS]:ROTQpi[:StAtE] 0 | 1 | OFF | ON
DISPlay:RHO[:BTS]:ROTQpi[:StAtE]?
DISPlay:RHO[:BTS]:VIEW:NSElect <integer>
DISPlay:RHO[:BTS]:VIEW:NSElect?
DISPlay:RHO[:BTS]:VIEW[:SElect] POLar | TABLE | ERRor | QUAD | CDPower |
CPATable | SPATable

```

```

DISPlay:RHO[:BTS]:VIEW[:SElect]?
DISPlay:RHO:CHANnel:TYPE
DISPlay:RHO:MS:FVEctor[:STATE] 0 | 1 | OFF | ON
DISPlay:RHO:MS:FVEctor[:STATE]?
DISPlay:RHO:MS:INTErpolate OFF | ON | 0 | 1
DISPlay:RHO:MS:INTErpolate?
DISPlay:RHO:MS:IQCHips <integer>
DISPlay:RHO:MS:IQCHips?
DISPlay:RHO:MS:IQPTYPE VCONStln | VECTor | CONSTln
DISPlay:RHO:MS:IQPTYPE?
DISPlay:RHO:MS:MARKer:CONSolidated ON | OFF | 1 | 0
DISPlay:RHO:MS:MARKer:CONSolidated?
DISPlay:RHO:MS:OFFSet <integer>
DISPlay:RHO:MS:OFFSet?
DISPlay:RHO:MS:ROTPi[:STATE] 0 | 1 | OFF | ON
DISPlay:RHO:MS:ROTPi[:STATE]?
DISPlay:RHO:MS:VIEW:NSElect <integer>
DISPlay:RHO:MS:VIEW:NSElect?
DISPlay:RHO:MS:VIEW[:SElect] POLar | ERRor | TABLE | CDPower
DISPlay:RHO:MS:VIEW[:SElect]?
DISPlay:RHO:VIEW:NSElect
DISPlay:RHO:VIEW[:SElect]
DISPlay:SEMAsk:VIEW:NSElect <integer>
DISPlay:SEMAsk:VIEW:NSElect?
DISPlay:SEMAsk:VIEW[:SElect] APFReq | RPFReq | IPOWer | CINformation
DISPlay:SEMAsk:VIEW[:SElect]?
DISPlay:SEMAsk:VIEW[1]:WINDow[1]:TRACe:X[:SCALE]:COUple 0 | 1 | OFF | ON
DISPlay:SEMAsk:VIEW[1]:WINDow[1]:TRACe:X[:SCALE]:COUple?
DISPlay:SEMAsk:VIEW[1]:WINDow[1]:TRACe:X[:SCALE]:PDIVision <freq>
DISPlay:SEMAsk:VIEW[1]:WINDow[1]:TRACe:X[:SCALE]:PDIVision ?
DISPlay:SEMAsk:VIEW[1]:WINDow[1]:TRACe:X[:SCALE]:RLEVel <freq>
DISPlay:SEMAsk:VIEW[1]:WINDow[1]:TRACe:X[:SCALE]:RLEVel?
DISPlay:SEMAsk:VIEW[1]:WINDow[1]:TRACe:X[:SCALE]:RPOSITION LEFT | CENTER |
RIGHT
DISPlay:SEMAsk:VIEW[1]:WINDow[1]:TRACe:X[:SCALE]:RPOSITION?
DISPlay:SEMAsk:VIEW[1]:WINDow[1]:TRACe:Y[:SCALE]:COUple 0 | 1 | ON | OFF
DISPlay:SEMAsk:VIEW[1]:WINDow[1]:TRACe:Y[:SCALE]:COUple?
DISPlay:SEMAsk:VIEW[1]:WINDow[1]:TRACe:Y[:SCALE]:PDIVision <rel_ampl>
DISPlay:SEMAsk:VIEW[1]:WINDow[1]:TRACe:Y[:SCALE]:PDIVision?
DISPlay:SEMAsk:VIEW[1]:WINDow[1]:TRACe:Y[:SCALE]:RLEVel <real>
DISPlay:SEMAsk:VIEW[1]:WINDow[1]:TRACe:Y[:SCALE]:RLEVel?
DISPlay:SEMAsk:VIEW[1]:WINDow[1]:TRACe:Y[:SCALE]:RPOSITION TOP | CENTER |
BOTTom
DISPlay:SEMAsk:VIEW[1]:WINDow[1]:TRACe:Y[:SCALE]:RPOSITION?
DISPlay:SPURious:VIEW:RANGE[:SElect] <integer>
DISPlay:SPURious:VIEW:RANGE[:SElect]?
DISPlay:SPURious:VIEW:RANGE:TABLE <integer>
DISPlay:SPURious:VIEW:RANGE:TABLE?
DISPlay:SPURious:VIEW[:SElect] RESult | RANGE | ALL
DISPlay:SPURious:VIEW[:SElect]?
DISPlay:SPURious:VIEW[1]:WINDow[1]:TRACe:Y[:SCALE]:COUple 0 | 1 | OFF | ON
DISPlay:SPURious:VIEW[1]:WINDow[1]:TRACe:Y[:SCALE]:COUple?
DISPlay:SPURious:VIEW[1]:WINDow[1]:TRACe:Y[:SCALE]:PDIVision <rel_ampl>

```

### 3 Programming the Analyzer

#### List of SCPI Commands

```
DISPlay:SPURious:VIEW[1]:WINDow[1]:TRACe:Y[:SCALe]:PDIVision?
DISPlay:SPURious:VIEW[1]:WINDow[1]:TRACe:Y[:SCALe]:RLEVel <real>
DISPlay:SPURious:VIEW[1]:WINDow[1]:TRACe:Y[:SCALe]:RLEVel?
DISPlay:TCDPower:MARKer:CONSolidated
DISPlay:TCDPower:VIEW:NSElect
DISPlay:TCDPower:VIEW[:SElect]
DISPlay:TCDPower:VIEW3:WINDow2:TRACe:X[:SCALe]:COUple
DISPlay:TCDPower:VIEW3:WINDow[1]:TRACe:X[:SCALe]:PDIVision
DISPlay:TCDPower:VIEW3:WINDow[1]:TRACe:X[:SCALe]:RLEVel
DISPlay:TCDPower:VIEW3:WINDow2:TRACe:X[:SCALe]:RPOStion
DISPlay:TCDPower:VIEW[1]:WINDow[1]:TRACe:Y[:SCALe]:PDIVision
DISPlay:TCDPower:VIEW[1]:WINDow[1]:TRACe:Y[:SCALe]:RLEVel
DISPlay:TRHO:MARKer:CONSolidated
DISPlay:TRHO:VIEW:NSElect
DISPlay:TRHO:VIEW[:SElect]
DISPlay:WAVEform:VIEW:NSElect <integer>
DISPlay:WAVEform:VIEW:NSElect?
DISPlay:WAVEform:VIEW[:SElect] RFENvelope | IQ
DISPlay:WAVEform:VIEW[:SElect]?
DISPlay:WAVEform:VIEW[1]|2:WINDow[1]:TRACe:X[:SCALe]:COUple 0 | 1 | OFF |
ON
DISPlay:WAVEform:VIEW[1]|2:WINDow[1]:TRACe:X[:SCALe]:COUple?
DISPlay:WAVEform:VIEW[1]|2:WINDow[1]:TRACe:X[:SCALe]:PDIVision <time>
DISPlay:WAVEform:VIEW[1]|2:WINDow[1]:TRACe:X[:SCALe]:PDIVision?
DISPlay:WAVEform:VIEW[1]|2:WINDow[1]:TRACe:X[:SCALe]:RLEVel <time>
DISPlay:WAVEform:VIEW[1]|2:WINDow[1]:TRACe:X[:SCALe]:RLEVel?
DISPlay:WAVEform:VIEW[1]|2:WINDow[1]:TRACe:X[:SCALe]:RPOStion LEFT |
CENTer | RIGHT
DISPlay:WAVEform:VIEW[1]|2:WINDow[1]:TRACe:X[:SCALe]:RPOStion?
DISPlay:WAVEform:VIEW[1]|2:WINDow[1]:TRACe:Y[:SCALe]:COUple 0 | 1 | OFF |
ON
DISPlay:WAVEform:VIEW[1]|2:WINDow[1]:TRACe:Y[:SCALe]:COUple?
DISPlay:WAVEform:VIEW[1]:WINDow[1]:TRACe:Y[:SCALe]:PDIVision <rel_ampl>
DISPlay:WAVEform:VIEW2:WINDow[1]:TRACe:Y[:SCALe]:PDIVision <voltage>
DISPlay:WAVEform:VIEW2:WINDow[1]:TRACe:Y[:SCALe]:PDIVision?
DISPlay:WAVEform:VIEW[1]:WINDow[1]:TRACe:Y[:SCALe]:PDIVision?
DISPlay:WAVEform:VIEW[1]:WINDow[1]:TRACe:Y[:SCALe]:RLEVel <ampl>
DISPlay:WAVEform:VIEW2:WINDow[1]:TRACe:Y[:SCALe]:RLEVel <voltage>
DISPlay:WAVEform:VIEW2:WINDow[1]:TRACe:Y[:SCALe]:RLEVel?
DISPlay:WAVEform:VIEW[1]:WINDow[1]:TRACe:Y[:SCALe]:RLEVel?
DISPlay:WAVEform:VIEW2:WINDow[1]:TRACe:Y[:SCALe]:RPOStion TOP | CENTer |
BOTTom
DISPlay:WAVEform:VIEW[1]:WINDow[1]:TRACe:Y[:SCALe]:RPOStion TOP | CENTer
| BOTTom
DISPlay:WAVEform:VIEW[1]:WINDow[1]:TRACe:Y[:SCALe]:RPOStion?
DISPlay:WAVEform:VIEW2:WINDow[1]:TRACe:Y[:SCALe]:RPOStion?
DISPlay:WINDow[1]:ANNOtation[:ALL] OFF | ON | 0 | 1
DISPlay:WINDow[1]:ANNOtation[:ALL]?
DISPlay:WINDow:FORMat:TILE
DISPlay:WINDow:FORMat:ZOOM
DISPlay:WINDow[:SElect] <number>
DISPlay:WINDow[:SElect]?
```

```

DISPlay:WINDow[1]:TRACe:GRATicule:GRID[:STATe] OFF | ON | 0 | 1
DISPlay:WINDow[1]:TRACe:GRATicule:GRID[:STATe]?
FETCh:ACP[n]?
FETCh:CDPower[:BTS][n]?
FETCh:CHPower:CHPower?
FETCh:CHPower:DENSity?
FETCh:CHPower[n]?
FETCh:EVMQpsk[n]?
FETCh:MONitor[n]?
FETCh:OBwidth:FERRor?
FETCh:OBwidth[n]?
FETCh:OBwidth:OBwidth?
FETCh:OBwidth:XDB?
FETCh:PStatistic[n]?
FETCh:SEMask[n]?
FETCh:SPURious[n]?
FETCh:WAVEform[n]?
FORMat:BORDER NORMAl | SWAPped
FORMat:BORDER?
FORMat[:TRACe][:DATA] ASCii | INTeger, 32 | REAL, 32 | REAL, 64
FORMat[:TRACe][:DATA]?
GLOBal:DEFault
GLOBal:FREQUency:CENTer[:STATe] 1 | 0 | ON | OFF
GLOBal:FREQUency:CENTer[:STATe]?
HCOPY:ABORT
HCOPY[:IMMediate]
INITiate:ACP
INITiate:CDPower[:BTS]
INITiate:CHPower
INITiate:CONTinuous OFF | ON | 0 | 1
INITiate:CONTinuous?
INITiate[:IMMediate]
INITiate:MONitor
INITiate:OBwidth
INITiate:PAUSE
INITiate:PStatistic
INITiate:REStart
INITiate:RESume
INITiate:SEMask
INITiate:SPURious
INITiate:WAVEform
INPut:COUPLing AC | DC
INPut:COUPLing?
INPut:COUPLing:I|Q DC | LFR1 | LFR2
INPut:COUPLing:I|Q?
INPut:IMPedance:IQ U50 | B50 | U1M | B1M
INPut:IMPedance:IQ?
INPut:IMPedance:REFerence <integer>
INPut:IMPedance:REFerence?
INPut[1]:IQ:BALanced[:STATe] OFF | ON | 0 | 1
INPut[1]:IQ:BALanced[:STATe]?
INPut:IQ[:I]:DIFFerential OFF | ON | 0 | 1
INPut:IQ[:I]:DIFFerential?

```

### 3 Programming the Analyzer

#### List of SCPI Commands

```
INPut[1]:IQ[:I]:IMPedance LOW | HIGH
INPut[1]:IQ[:I]:IMPedance?
INPut:IQ:MIRROred OFF | ON | 0 | 1
INPut:IQ:MIRROred?
INPut:IQ:Q:DIFFerential OFF | ON | 0 | 1
INPut:IQ:Q:DIFFerential?
INPut[1]:IQ:Q:IMPedance LOW | HIGH
INPut[1]:IQ:Q:IMPedance?
INPut[1]:IQ:TYPE IQ | I | Q
INPut[1]:IQ:TYPE?
INPut:MIXer EXTernal | INTernal
INPut:MIXer?
INPut:OFFSet:I|Q <voltage>
INPut:OFFSet:I|Q?
INSTRument:CATalog?
INSTRument:COUple:DEFault
INSTRument:COUple:FREQuency:CENTer ALL | NONE
INSTRument:COUple:FREQuency:CENTer?
INSTRument:NSElect <integer>
INSTRument:NSElect?
INSTRument[:SElect] 'SA' | 'PNOISE' | 'EDGE' | 'GSM' | 'BASIC'
INSTRument[:SElect] RECeiver
INSTRument[:SElect] SANalyzer
INSTRument[:SElect] SA | RTSA | SEQAN | EMI | BASIC | WCDMA | EDGE GSM |
WIMAXOFDMA | VSA | PNOISE | NFIGure | ADEMOD | BTooth | TDSCDMA | CDMA2K |
CDMA1XEV | LTE | LTETDD | LTEAFDD | LTEATDD | MSR | DVB | DTMB | DCATV |
ISDBT | CMMB | WLAN | CWLAN | CWIMAXOFDM | WIMAXFIXED | IDEN | RLC |
SCPILC | VSA89601
INSTRument[:SElect] GSM
INSTRument[:SElect]?
INST:SEL EMI
INST:SEL SCPILC
LXI:IDENtify[:STATE] OFF | ON | 0 | 1
LXI:IDENtify[:STATE]?
MEASure:ACP[n]?
MEASure:CDPower[:BTS][n]?
MEASure:CHPower:CHPower?
MEASure:CHPower:DENSity?
MEASure:CHPower[n]?
MEASure:EVMQpsk[n]?
MEASure:MONitor[n]?
MEASure:OBWidth:FERRor?
MEASure:OBWidth[n]?
MEASure:OBWidth:OBWidth?
MEASure:OBWidth:XDB?
MEASure:PStatistic[n]?
MEASure:SEMask[n]?
MEASure:SPURious[n]?
MEASure:WAVEform[n]?
MMEMory:CATalog? [<directory_name>]
MMEMory:CDIRectory [<directory_name>]
MMEMory:CDIRectory?
```

```

MMEMory:COpy <string>, <string>[, <string>, <string>]
MMEMory:COpy:DEvice <source_string>, <dest_string>
MMEMory:DATA <file_name>, <data>
MMEMory:DATA? <file_name>
MMEMory:DELeTe <file_name>[, <directory_name>]
MMEMory:LOAD:STATe <filename>
MMEMory:LOAD:STATe 1, <filename>
MMEMory:LOAD:TRACe TRACE1 | TRACE2 | TRACE3 | TRACE4 | TRACE5 | TRACE6,
<filename>
MMEMory:LOAD:TRACe:REGister TRACE1 | TRACE2 | TRACE3 | TRACE4 | TRACE5 |
TRACE6, <integer>
MMEMory:MDIRectory <directory_name>
MMEMory:MOVE <string>, <string>[, <string>, <string>]
MMEMory:RDIRectory <directory_name>
MMEMory:REGister:STATe:LABel <regnumber>, "label"
MMEMory:REGister:STATe:LABel? <regnumber>
MMEMory:STORE:RESults <string>
MMEMory:STORE:RESults <string>
MMEMory:STORE:RESults <string>
MMEMory:STORE:RESults <string>
MMEMory:STORE:RESults <string>
MMEMory:STORE:RESults <string>
MMEMory:STORE:RESults:MTABLE|PTABLE|SPECTrogram <filename>
MMEMory:STORE:SCReen <filename>
MMEMory:STORE:SCReen:THEME TDColor | TDMonochrome | FColor | FMOnochrome
MMEMory:STORE:SCReen:THEME?
MMEMory:STORE:STATe 1, <filename>
MMEMory:STORE:STATe <filename>
OUTPut:ANALog OFF | SVIDeo | LOGVideo | LINVideo | DAUDio
OUTPut:ANALog?
OUTPut:ANALog:AUTO OFF | ON | 0 | 1
OUTPut:ANALog:AUTO?
OUTPut:AUX SIF | AIF | LOGVideo | OFF
OUTPut:AUX?
OUTPut:AUX:AIF <value>
OUTPut:AUX:AIF?
OUTPut:DBUS[1][:STATe] ON | OFF | 1 | 0
OUTPut:DBUS[1][:STATe]?
OUTPut:IQ:OUTPut IQ1 | IQ250 | OFF
OUTPut:IQ:OUTPut?
READ:ACP[n]?
READ:CDPower[:BTS][n]?
READ:CHPower:CHPower?
READ:CHPower:DENSity
READ:CHPower[n]?
READ:EVMQpsk[n]?
READ:MONitor[n]?
READ:OBWidth:FERRor?
READ:OBWidth[n]?
READ:OBWidth:OBWidth?
READ:OBWidth:XDB?
READ:PStatistic[n]?
READ:SEMask[n]?

```

```

READ:SPURious[n]?
READ:WAVEform[n]?
[:SENSe]:<measurement>:TRIGger:SOURce
[:SENSe]:<measurement>:TRIGger:SOURce IF
[:SENSe]:ACPower:AVERAge:COUNT <integer>
[:SENSe]:ACPower:AVERAge:COUNT?
[:SENSe]:ACPower:AVERAge[:STATe] OFF | ON | 0 | 1
[:SENSe]:ACPower:AVERAge[:STATe]?
[:SENSe]:ACPower:AVERAge:TCONtrol EXPonential | REPeat
[:SENSe]:ACPower:AVERAge:TCONtrol?
[:SENSe]:ACPower:BANDwidth:INTEgration
[:SENSe]:ACPower:BANDwidth[:RESolution] <freq>
[:SENSe]:ACPower:BANDwidth[:RESolution]?
[:SENSe]:ACPower:BANDwidth[:RESolution]:AUTO ON | OFF | 1 | 0
[:SENSe]:ACPower:BANDwidth[:RESolution]:AUTO?
[:SENSe]:ACPower:BANDwidth:SHAPE GAUSSian | FLATtop
[:SENSe]:ACPower:BANDwidth:SHAPE?
[:SENSe]:ACPower:BANDwidth:TYPE DB3 | DB6
[:SENSe]:ACPower:BANDwidth:TYPE?
[:SENSe]:ACPower:BANDwidth:VIDeo <freq>
[:SENSe]:ACPower:BANDwidth:VIDeo?
[:SENSe]:ACPower:BANDwidth:VIDeo:AUTO OFF | ON | 0 | 1
[:SENSe]:ACPower:BANDwidth:VIDeo:AUTO?
[:SENSe]:ACPower:BWIDth:INTEgration
[:SENSe]:ACPower:BWIDth[:RESolution]
[:SENSe]:ACPower:BWIDth:SHAPE
[:SENSe]:ACPower:BWIDth:TYPE
[:SENSe]:ACPower:BWIDth:VIDeo
[:SENSe]:ACPower:CARRier[1]|2:AUTO[:STATe] OFF | ON | 0 | 1
[:SENSe]:ACPower:CARRier[1]|2:AUTO[:STATe]?
[:SENSe]:ACPower:CARRier[1]|2:COUNT <integer>
[:SENSe]:ACPower:CARRier[1]|2:COUNT?
[:SENSe]:ACPower:CARRier[1]|2:CPSD <real>
[:SENSe]:ACPower:CARRier[1]|2:CPSD?
[:SENSe]:ACPower:CARRier[1]|2:LIST:BANDwidth[:INTEgration] <freq>, ...
[:SENSe]:ACPower:CARRier[1]|2:LIST:BANDwidth[:INTEgration]?
[:SENSe]:ACPower:CARRier[1]|2:LIST:BWIDth[:INTEgration]
[:SENSe]:ACPower:CARRier[1]|2:LIST:METHOD IBW | RRC, ...
[:SENSe]:ACPower:CARRier[1]|2:LIST:METHOD?
[:SENSe]:ACPower:CARRier[1]|2:LIST:PPResent YES|NO, ...
[:SENSe]:ACPower:CARRier[1]|2:LIST:PPResent?
[:SENSe]:ACPower:CARRier[1]|2:LIST:WIDTh <freq>, ...
[:SENSe]:ACPower:CARRier[1]|2:LIST:WIDTh?
[:SENSe]:ACPower:CARRier[1]|2[:POWER] <real>
[:SENSe]:ACPower:CARRier[1]|2[:POWER]?
[:SENSe]:ACPower:CARRier[1]|2:RCARrier <integer>
[:SENSe]:ACPower:CARRier[1]|2:RCARrier?
[:SENSe]:ACPower:CARRier[1]|2:RCARrier:AUTO OFF | ON | 0 | 1
[:SENSe]:ACPower:CARRier[1]|2:RCARrier:AUTO?
[:SENSe]:ACPower:CARRier[1]|2:RCFRequency <freq>
[:SENSe]:ACPower:CARRier[1]|2:RCFRequency?
[:SENSe]:ACPower:CARRier[1]|2:RCFRequency:AUTO OFF | ON | 0 | 1
[:SENSe]:ACPower:CARRier[1]|2:RCFRequency:AUTO?

```



```

[:SENSE]:ACPower:CORRection:NOISe[:AUTO] OFF | ON | 0 | 1
[:SENSE]:ACPower:CORRection:NOISe[:AUTO]?
[:SENSE]:ACPower:DETEctor:AUTO ON | OFF | 1 | 0
[:SENSE]:ACPower:DETEctor:AUTO?
[:SENSE]:ACPower:DETEctor[:FUNction] AVERAge | NEGAtive | NORMAl |
POSitive | SAMPlE
[:SENSE]:ACPower:DETEctor[:FUNction]?
[:SENSE]:ACPower:FILTer[:RRC]:ALPHa <real>
[:SENSE]:ACPower:FILTer[:RRC]:ALPHa?
[:SENSE]:ACPower:FILTer[:RRC][:STATe] OFF | ON | 0 | 1
[:SENSE]:ACPower:FILTer[:RRC][:STATe]?
[:SENSE]:ACPower:FREQuency:SPAN <freq>
[:SENSE]:ACPower:FREQuency:SPAN?
[:SENSE]:ACPower:FREQuency:SPAN:FULL
[:SENSE]:ACPower:FREQuency:SPAN:PREVIOUS
[:SENSE]:ACPower:FREQuency:SYNThesis:AUTO[:STATe] OFF | ON | 0 | 1
[:SENSE]:ACPower:FREQuency:SYNThesis:AUTO[:STATe]?
[:SENSE]:ACPower:FREQuency:SYNThesis[:STATe] 1 | 2 | 3
[:SENSE]:ACPower:FREQuency:SYNThesis[:STATe]?
[:SENSE]:ACPower:LIMit[:STATe]
[:SENSE]:ACPower:METHod IBW | IBWRange | FAST | RBW
[:SENSE]:ACPower:METHod?
[:SENSE]:ACPower:OFFSet[1]|2:LIST:BWIDth[:INTEgration]
[:SENSE]:ACPower:OFFSet[1]|2:LIST:BWIDth:RESolution
[:SENSE]:ACPower:OFFSet[1]|2:LIST:BWIDth:SHAPE
[:SENSE]:ACPower:OFFSet[1]|2:LIST:BWIDth:TYPE
[:SENSE]:ACPower:OFFSet[1]|2:LIST:BWIDth:VIDEo
[:SENSE]:ACPower:OFFSet[1]|2[:OUTer]:LIST:ABSolute <real>, ...
[:SENSE]:ACPower:OFFSet[1]|2[:OUTer]:LIST:ABSolute?
[:SENSE]:ACPower:OFFSet[1]|2[:OUTer]:LIST:BANDwidth[:INTEgration] <freq>,
...
[:SENSE]:ACPower:OFFSet[1]|2[:OUTer]:LIST:BANDwidth[:INTEgration]?
[:SENSE]:ACPower:OFFSet[1]|2[:OUTer]:LIST:BANDwidth:RESolution <freq>, ...
[:SENSE]:ACPower:OFFSet[1]|2[:OUTer]:LIST:BANDwidth:RESolution?
[:SENSE]:ACPower:OFFSet[1]|2[:OUTer]:LIST:BANDwidth:RESolution:AUTO
ON|OFF|1|0, ...
[:SENSE]:ACPower:OFFSet[1]|2[:OUTer]:LIST:BANDwidth:RESolution:AUTO?
[:SENSE]:ACPower:OFFSet[1]|2[:OUTer]:LIST:BANDwidth:SHAPE
GAUSSian|FLATtop, ...
[:SENSE]:ACPower:OFFSet[1]|2[:OUTer]:LIST:BANDwidth:SHAPE?
[:SENSE]:ACPower:OFFSet[1]|2[:OUTer]:LIST:BANDwidth:TYPE DB3|DB6, ...
[:SENSE]:ACPower:OFFSet[1]|2[:OUTer]:LIST:BANDwidth:TYPE?
[:SENSE]:ACPower:OFFSet[1]|2[:OUTer]:LIST:BANDwidth:VIDEo <freq>, ...
[:SENSE]:ACPower:OFFSet[1]|2[:OUTer]:LIST:BANDwidth:VIDEo?
[:SENSE]:ACPower:OFFSet[1]|2[:OUTer]:LIST:BANDwidth:VIDEo:AUTO OFF|ON|0|1,
...
[:SENSE]:ACPower:OFFSet[1]|2[:OUTer]:LIST:BANDwidth:VIDEo:AUTO?
[:SENSE]:ACPower:OFFSet[1]|2[:OUTer]:LIST[:FREQuency] <freq>, ...
[:SENSE]:ACPower:OFFSet[1]|2[:OUTer]:LIST[:FREQuency]?
[:SENSE]:ACPower:OFFSet[1]|2[:OUTer]:LIST:RCARrier <real>, ...
[:SENSE]:ACPower:OFFSet[1]|2[:OUTer]:LIST:RCARrier?
[:SENSE]:ACPower:OFFSet[1]|2[:OUTer]:LIST:RPSDensity <rel_ampl>, ...

```

### 3 Programming the Analyzer

#### List of SCPI Commands

```
[ :SENSe]:ACPower:OFFSet[1]|2[:OUTer]:LIST:RPSDensity?
[:SENSe]:ACPower:OFFSet[1]|2[:OUTer]:LIST:SIDE NEGative|BOTH|POSitive, ...
[:SENSe]:ACPower:OFFSet[1]|2[:OUTer]:LIST:SIDE?
[:SENSe]:ACPower:OFFSet[1]|2[:OUTer]:LIST:STATE OFF|ON|0|1, ...
[:SENSe]:ACPower:OFFSet[1]|2[:OUTer]:LIST:STATE?
[:SENSe]:ACPower:OFFSet[1]|2[:OUTer]:LIST:TEST ABSolute|AND|OR|RELative,
...
[:SENSe]:ACPower:OFFSet[1]|2[:OUTer]:LIST:TEST?
[:SENSe]:ACPower:OFFSet[1]|2[:OUTer]:TYPE CTOCenter | CTOEdge | ETOCenter
| ETOEdge
[:SENSe]:ACPower:OFFSet[1]|2[:OUTer]:TYPE?
[:SENSe]:ACPower:SWEep:POINTs <integer>
[:SENSe]:ACPower:SWEep:POINTs?
[:SENSe]:ACPower:SWEep:TIME <time>
[:SENSe]:ACPower:SWEep:TIME?
[:SENSe]:ACPower:SWEep:TIME:AUTO OFF | ON | 0 | 1
[:SENSe]:ACPower:SWEep:TIME:AUTO?
[:SENSe]:ACPower:SWEep:TIME:AUTO:RULEs NORMAL | ACCuracy
[:SENSe]:ACPower:SWEep:TIME:AUTO:RULEs?
[:SENSe]:ACPower:TYPE TPRef | PSDRef
[:SENSe]:ACPower:TYPE?
[:SENSe]:ACPR:AVERAge:COUNT
[:SENSe]:ACPR:AVERAge:TCONTROL
[:SENSe]:ACPR:FILTer[:RRC]:ALPHA
[:SENSe]:ACPR:FILTer[:RRC][:STATE]
[:SENSe]:ACPR:OFFSet[1]|2:LIST:ABSolute (PSAW-CDMA, PSAcma2000)
[:SENSe]:ACPR:OFFSet[1]|2:LIST:BANDwidth
[:SENSe]:ACPR:OFFSet[1]|2:LIST:BWIDth
[:SENSe]:ACPR:SWEep:DETEctor[:FUNCTION]
[:SENSe]:ACPR:SWEep:TYPE
[:SENSe]:ACPR:TRIGger:SOURce
[:SENSe]:ACP:SWEep:BANDwidth|BWIDth[:RESolution] (PSAW-CDMA, PSAcma2000)
[:SENSe]:CDPower:ACODE
[:SENSe]:CDPower:ALPHA
[:SENSe]:CDPower[:BTS]:ACODE AUTO | PREDefined
[:SENSe]:CDPower[:BTS]:ACODE?
[:SENSe]:CDPower[:BTS]:ALPHA <real>
[:SENSe]:CDPower[:BTS]:ALPHA?
[:SENSe]:CDPower[:BTS]:CAPture:TIME <integer>
[:SENSe]:CDPower[:BTS]:CAPture:TIME?
[:SENSe]:CDPower[:BTS]:CRATE <freq>
[:SENSe]:CDPower[:BTS]:CRATE?
[:SENSe]:CDPower[:BTS]:IF:GAIN:AUTO[:STATE] OFF | ON | 0 | 1
[:SENSe]:CDPower[:BTS]:IF:GAIN:AUTO[:STATE]?
[:SENSe]:CDPower[:BTS]:IF:GAIN[:STATE] OFF | ON | 0 | 1
[:SENSe]:CDPower[:BTS]:IF:GAIN[:STATE]?
[:SENSe]:CDPower[:BTS]:MACPosition SH1 | SH2 | FULL
[:SENSe]:CDPower[:BTS]:MACPosition?
[:SENSe]:CDPower[:BTS]:PNOFFset <integer>
[:SENSe]:CDPower[:BTS]:PNOFFset?
[:SENSe]:CDPower[:BTS]:PREAmble:LENGth <integer>
[:SENSe]:CDPower[:BTS]:PREAmble:LENGth?
[:SENSe]:CDPower[:BTS]:PREAmble:LENGth:AUTO OFF | ON | 0 | 1
```

```

[:SENSe]:CDPower[:BTS]:PREamble:LENGth:AUTO?
[:SENSe]:CDPower[:BTS]:SPECTrum NORMAL | INVert
[:SENSe]:CDPower[:BTS]:SPECTrum?
[:SENSe]:CDPower[:BTS]:SSLot:NUMBER <integer>
[:SENSe]:CDPower[:BTS]:SSLot:NUMBER?
[:SENSe]:CDPower[:BTS]:SSLot[:STATE] OFF | ON | 0 | 1
[:SENSe]:CDPower[:BTS]:SSLot[:STATE]?
[:SENSe]:CDPower:CAPTure:TIME
[:SENSe]:CDPower:CRATe
[:SENSe]:CDPower:IF:GAIN:AUTO[:STATE]
[:SENSe]:CDPower:IF:GAIN[:STATE]
[:SENSe]:CDPower:MS:ACODE AUTO | COMBination | PREDeFined
[:SENSe]:CDPower:MS:ACODE?
[:SENSe]:CDPower:MS:ACODE:ACK OFF | ON | 0 | 1
[:SENSe]:CDPower:MS:ACODE:ACK?
[:SENSe]:CDPower:MS:ACODE:DATA OFF | ON | 0 | 1
[:SENSe]:CDPower:MS:ACODE:DATA?
[:SENSe]:CDPower:MS:ACODE:DRC OFF | ON | 0 | 1
[:SENSe]:CDPower:MS:ACODE:DRC?
[:SENSe]:CDPower:MS:ACODE:PILot OFF | ON | 0 | 1
[:SENSe]:CDPower:MS:ACODE:PILot?
[:SENSe]:CDPower:MS:ALPHa <real>
[:SENSe]:CDPower:MS:ALPHa?
[:SENSe]:CDPower:MS:CAPTure:TIME <integer>
[:SENSe]:CDPower:MS:CAPTure:TIME?
[:SENSe]:CDPower:MS:CRATE <freq>
[:SENSe]:CDPower:MS:CRATE?
[:SENSe]:CDPower:MS:FERRor:TRANGe NARRow | NORMAl | WIDE
[:SENSe]:CDPower:MS:FERRor:TRANGe?
[:SENSe]:CDPower:MS:IF:GAIN:AUTO[:STATE] OFF | ON | | 1
[:SENSe]:CDPower:MS:IF:GAIN:AUTO[:STATE]?
[:SENSe]:CDPower:MS:IF:GAIN[:STATE] OFF | ON | 0 | 1
[:SENSe]:CDPower:MS:IF:GAIN[:STATE]?
[:SENSe]:CDPower:MS:SPECTrum NORMAl | INVert
[:SENSe]:CDPower:MS:SPECTrum?
[:SENSe]:CDPower:MS:SSLot:NUMBER <integer>
[:SENSe]:CDPower:MS:SSLot:NUMBER?
[:SENSe]:CDPower:MS:SSLot[:STATE] OFF | ON | 0 | 1
[:SENSe]:CDPower:MS:SSLot[:STATE] OFF | ON | 0 | 1
[:SENSe]:CDPower:MS:SSLot[:STATE]?
[:SENSe]:CDPower:MS:SSLot[:STATE]?
[:SENSe]:CDPower:MS:SYNC PILot | APILot
[:SENSe]:CDPower:MS:SYNC?
[:SENSe]:CDPower:MS:SYNC:ILCMask <integer>
[:SENSe]:CDPower:MS:SYNC:ILCMask?
[:SENSe]:CDPower:MS:SYNC:QLCMask <integer>
[:SENSe]:CDPower:MS:SYNC:QLCMask?
[:SENSe]:CDPower:PNOffset
[:SENSe]:CDPower:SPECTrum
[:SENSe]:CDPower:SSLot:NUMBER
[:SENSe]:CHPower:AVERage:COUNT <integer>
[:SENSe]:CHPower:AVERage:COUNT?
[:SENSe]:CHPower:AVERage[:STATE] ON | OFF | 1 | 0

```

### 3 Programming the Analyzer

#### List of SCPI Commands

```
[ :SENSe]:CHPower:AVERAge[:STATe]?
[ :SENSe]:CHPower:AVERAge:TCONtrol EXPonential | REPeat
[ :SENSe]:CHPower:AVERAge:TCONtrol?
[ :SENSe]:CHPower:BANDwidth:INTegration <bandwidth>
[ :SENSe]:CHPower:BANDwidth:INTegration?
[ :SENSe]:CHPower:BANDwidth[:RESolution] <bandwidth>
[ :SENSe]:CHPower:BANDwidth[:RESolution]?
[ :SENSe]:CHPower:BANDwidth[:RESolution]:AUTO ON | OFF | 1 | 0
[ :SENSe]:CHPower:BANDwidth[:RESolution]:AUTO?
[ :SENSe]:CHPower:BANDwidth:SHAPE GAUSSian | FLATtop
[ :SENSe]:CHPower:BANDwidth:SHAPE?
[ :SENSe]:CHPower:BANDwidth:VIDeo <bandwidth>
[ :SENSe]:CHPower:BANDwidth:VIDeo?
[ :SENSe]:CHPower:BANDwidth:VIDeo:AUTO ON | OFF | 1 | 0
[ :SENSe]:CHPower:BANDwidth:VIDeo:AUTO?
[ :SENSe]:CHPower:BWIDth[:RESolution]
[ :SENSe]:CHPower:BWIDth:SHAPE
[ :SENSe]:CHPower:DETEctor:AUTO ON | OFF | 1 | 0
[ :SENSe]:CHPower:DETEctor:AUTO?
[ :SENSe]:CHPower:DETEctor[:FUNction] NORMal | AVERAge | POSitive | SAMPlE
| NEGative
[ :SENSe]:CHPower:DETEctor[:FUNction]?
[ :SENSe]:CHPower:FREQUency:SPAN <freq>
[ :SENSe]:CHPower:FREQUency:SPAN?
[ :SENSe]:CHPower:FREQUency:SPAN:FULL
[ :SENSe]:CHPower:FREQUency:SPAN:PREVious
[ :SENSe]:CHPower:FREQUency:SYNThesis:AUTO[:STATe] OFF | ON | 0 | 1
[ :SENSe]:CHPower:FREQUency:SYNThesis:AUTO[:STATe]?
[ :SENSe]:CHPower:FREQUency:SYNThesis[:STATe] 1 | 2 | 3
[ :SENSe]:CHPower:FREQUency:SYNThesis[:STATe]?
[ :SENSe]:CHPower:IF:GAIN:AUTO[:STATe] ON | OFF | 1 | 0
[ :SENSe]:CHPower:IF:GAIN:AUTO[:STATe]?
[ :SENSe]:CHPower:IF:GAIN[:STATe] ON | OFF | 1 | 0
[ :SENSe]:CHPower:IF:GAIN[:STATe]?
[ :SENSe]:CHPower:SWEep:POINts <integer>
[ :SENSe]:CHPower:SWEep:POINts?
[ :SENSe]:CHPower:SWEep:TIME <time>
[ :SENSe]:CHPower:SWEep:TIME?
[ :SENSe]:CHPower:SWEep:TIME:AUTO OFF | ON | 0 | 1
[ :SENSe]:CHPower:SWEep:TIME:AUTO?
[ :SENSe]:CHPower:SWEep:TIME:AUTO:RULEs NORMal | ACCuracy
[ :SENSe]:CHPower:SWEep:TIME:AUTO:RULEs?
[ :SENSe]:CORRection:BTS[:RF]:GAIN <rel_ampl>
[ :SENSe]:CORRection:BTS[:RF]:GAIN?
[ :SENSe]:CORRection:BTS[:RF]:LOSS <rel_ampl>
[ :SENSe]:CORRection:BTS[:RF]:LOSS?
[ :SENSe]:CORRection:CSET:ALL:DELeTe
[ :SENSe]:CORRection:CSET:ALL[:STATe] ON | OFF | 1 | 0
[ :SENSe]:CORRection:CSET:ALL[:STATe]?
[ :SENSe]:CORRection:CSET[1]:ANTenna[:UNIT] GAUSS | PTESla | UVM | UAM | UA
| NOConversion
[ :SENSe]:CORRection:CSET[1]:ANTenna[:UNIT]?
[ :SENSe]:CORRection:CSET[1]|2|...|8:COMMENT "text"
```

```

[:SENSE]:CORREction:CSET[1]|2|...|8:COMMeNt?
[:SENSE]:CORREction:CSET[1]|2|...|8:DATA <freq>, <ampl>, ...
[:SENSE]:CORREction:CSET[1]|2|...|8:DATA?
[:SENSE]:CORREction:CSET[1]|2|...|8:DATA:MERGe <freq>, <ampl>, ...
[:SENSE]:CORREction:CSET[1]|2|...|6:DELeTe
[:SENSE]:CORREction:CSET[1]|2|...|8:DESCription "text"
[:SENSE]:CORREction:CSET[1]|2|...|8:DESCription?
[:SENSE]:CORREction:CSET[1]|2|...|8[:STATE] ON | OFF | 1 | 0
[:SENSE]:CORREction:CSET[1]|2|...|8[:STATE]?
[:SENSE]:CORREction:CSET[1]|2|...|8:X:SPACing LINear | LOGarithmic
[:SENSE]:CORREction:CSET[1]|2|...|8:X:SPACing?
[:SENSE]:CORREction:IMPedance[:INPut][:MAGNitude] 50 | 75
[:SENSE]:CORREction:IMPedance[:INPut][:MAGNitude]?
[:SENSE]:CORREction:IQ:I:GAIN <rel_ampl>
[:SENSE]:CORREction:IQ:I:GAIN?
[:SENSE]:CORREction:IQ:I|Q:ATTenuation <rel_ampl>
[:SENSE]:CORREction:IQ:I|Q:ATTenuation?
[:SENSE]:CORREction:IQ:I|Q:ATTenuation:RATio <real>
[:SENSE]:CORREction:IQ:I|Q:ATTenuation:RATio?
[:SENSE]:CORREction:IQ[:I]:SKEW <seconds>
[:SENSE]:CORREction:IQ[:I]:SKEW?
[:SENSE]:CORREction:IQ:Q:GAIN <rel_ampl>
[:SENSE]:CORREction:IQ:Q:GAIN?
[:SENSE]:CORREction:IQ:Q:SKEW <seconds>
[:SENSE]:CORREction:IQ:Q:SKEW?
[:SENSE]:CORREction:MS[:RF]:GAIN <rel_ampl>
[:SENSE]:CORREction:MS[:RF]:GAIN?
[:SENSE]:CORREction:MS[:RF]:LOSS <rel_ampl>
[:SENSE]:CORREction:MS[:RF]:LOSS?
[:SENSE]:CORREction:NOISe:FLOor ON | OFF | 1 | 0
[:SENSE]:CORREction:NOISe:FLOor?
[:SENSE]:CORREction:OFFSet[:MAGNitude]
[:SENSE]:CORREction:SA[:RF]:GAIN <rel_ampl>
[:SENSE]:CORREction:SA[:RF]:GAIN?
[:SENSE]:EBwidth:AVERage:COUNT
[:SENSE]:EBwidth:FREQuency:SPAN
[:SENSE]:EBwidth:MAXHold
[:SENSE]:EBwidth:XDB
[:SENSE]:EVMQpsk:ALPHa
[:SENSE]:EVMQpsk:AVERage:COUNT <integer>
[:SENSE]:EVMQpsk:AVERage:COUNT?
[:SENSE]:EVMQpsk:AVERage[:STATE] OFF | ON | 0 | 1
[:SENSE]:EVMQpsk:AVERage[:STATE]?
[:SENSE]:EVMQpsk:AVERage:TCONtrol EXPOntial | REPeat
[:SENSE]:EVMQpsk:AVERage:TCONtrol?
[:SENSE]:EVMQpsk:BANDwidth[:RESolution] <freq>
[:SENSE]:EVMQpsk:BANDwidth[:RESolution]?
[:SENSE]:EVMQpsk:BANDwidth:SHAPE GAUSSian | FLATtop
[:SENSE]:EVMQpsk:BANDwidth:SHAPE?
[:SENSE]:EVMQpsk:BWIDth[:RESolution]
[:SENSE]:EVMQpsk:BWIDth:SHAPE
[:SENSE]:EVMQpsk:CRATe <freq>
[:SENSE]:EVMQpsk:CRATe?

```

### 3 Programming the Analyzer

#### List of SCPI Commands

```
[ :SENSe]:EVMQpsk:FILTer:ALPHa <real>
[ :SENSe]:EVMQpsk:FILTer:ALPHa?
[ :SENSe]:EVMQpsk:FILTer[:RRC][:STATe] OFF | ON | 0 | 1
[ :SENSe]:EVMQpsk:FILTer[:RRC][:STATe]?
[ :SENSe]:EVMQpsk:IF:GAIN:AUTO[:STATe] ON | OFF | 1 | 0
[ :SENSe]:EVMQpsk:IF:GAIN:AUTO[:STATe]?
[ :SENSe]:EVMQpsk:IF:GAIN[:STATe] ON | OFF | 1 | 0
[ :SENSe]:EVMQpsk:IF:GAIN[:STATe]?
[ :SENSe]:EVMQpsk:MEAS:LENGth <integer>
[ :SENSe]:EVMQpsk:MEAS:LENGth?
[ :SENSe]:EVMQpsk:MEAS:OFFSet <integer>
[ :SENSe]:EVMQpsk:MEAS:OFFSet?
[ :SENSe]:EVMQpsk:SPECTrum NORMAl | INVert
[ :SENSe]:EVMQpsk:SPECTrum?
[ :SENSe]:FEED AREFERENCE
[ :SENSe]:FEED IQ | IONLy | QONLy
[ :SENSe]:FEED RF | AIQ | EMIXer
[ :SENSe]:FEED?
[ :SENSe]:FEED?
[ :SENSe]:FEED:AREFERENCE REF50 | REF4800 | OFF
[ :SENSe]:FEED:AREFERENCE?
[ :SENSe]:FEED:DATA INPut | STORed
[ :SENSe]:FEED:DATA?
[ :SENSe]:FEED:DATA:STORe
[ :SENSe]:FEED:IQ:TYPE IQ | IONLy | QONLy
[ :SENSe]:FEED:IQ:TYPE?
[ :SENSe]:FEED:SOURce INPut | STORed
[ :SENSe]:FEED:SOURce?
[ :SENSe]:FEED:SOURce:STORe
[ :SENSe]:FREQuency:CENTer <freq>
[ :SENSe]:FREQuency:CENTer?
[ :SENSe]:FREQuency:CENTer:STEP:AUTO OFF | ON | 0 | 1
[ :SENSe]:FREQuency:CENTer:STEP:AUTO?
[ :SENSe]:FREQuency:CENTer:STEP[:INCRement] <freq>
[ :SENSe]:FREQuency:CENTer:STEP[:INCRement]?
[ :SENSe]:FREQuency:EMIXer:CENTer <freq>
[ :SENSe]:FREQuency:EMIXer:CENTer?
[ :SENSe]:FREQuency:IQ:CENTer <freq>
[ :SENSe]:FREQuency:IQ:CENTer?
[ :SENSe]:FREQuency:RF:CENTer <freq>
[ :SENSe]:FREQuency:RF:CENTer?
[ :SENSe]:MCPower:AVERAge:COUNT (PSAPowerSuite, PSAW-CDMA, PSACdma2000)
[ :SENSe]:MCPower:CARRier[1]|2:LIST:BANDwidth[:INTEgration] (PSAPowerSuite)
[ :SENSe]:MCPower:CARRier[1]|2:LIST:BWIDth[:INTEgration] (PSAPowerSuite)
[ :SENSe]:MCPower:CARRier[1]|2:LIST:PPResent (PSAPowerSuite)
[ :SENSe]:MCPower:CARRier[1]|2:LIST:WIDTh (PSAPowerSuite)
[ :SENSe]:MCPower:CARRier[1]|2[:POWER]
[ :SENSe]:MCPower:FILTer[:RRC]:ALPHa
[ :SENSe]:MCPower:FILTer[:RRC][:STATe]
[ :SENSe]:MCPower:LIMit[:STATe]
[ :SENSe]:MCPower:METHod (PSAPowerSuite)
[ :SENSe]:MCPower:OFFSet[1]|2:LIST:ABSolute (PSAW-CDMA)
[ :SENSe]:MCPower:OFFSet[1]|2:LIST:BANDwidth[:INTEgration] (PSAPowerSuite)
```

```

[:SENSE]:MCPower:OFFSet[1]|2:LIST:BWIDth[:INTEgration] (PSAPowerSuite)
[:SENSE]:MCPower:OFFSet[1]|2:LIST[:FREQuency] (PSAPowerSuite)
[:SENSE]:MCPower:OFFSet[1]|2:LIST:RCARrier (PSAWCDMA)
[:SENSE]:MCPower:OFFSet[1]|2:LIST:TEST
[:SENSE]:MCPower:RCARrier[1]|2 (PSAPowerSuite)
[:SENSE]:MIXer:BAND A | Q | U | V | W | NA | ND | NE | NF | NG | NJ | NK |
NQ | NU | NV | NW | NY | NEXT | DD | DF | DG | DJ | DK | DQ | DV | DW | DY
| DEXT | MA | ME | MU | MCOAX | USB
[:SENSE]:MIXer:BAND?
[:SENSE]:MIXer:BIAS <real>
[:SENSE]:MIXer:BIAS?
[:SENSE]:MIXer:BIAS:STATE OFF | ON | 0 | 1
[:SENSE]:MIXer:BIAS:STATE?
[:SENSE]:MIXer:CIFLoss <rel_ampl>
[:SENSE]:MIXer:CIFLoss?
[:SENSE]:MONitor:AVERage:COUNT <integer>
[:SENSE]:MONitor:AVERage:COUNT?
[:SENSE]:MONitor:AVERage[:STATE] OFF | ON | 0 | 1
[:SENSE]:MONitor:AVERage[:STATE]?
[:SENSE]:MONitor:AVERage:TCONtrol EXPONential | REPEAT
[:SENSE]:MONitor:AVERage:TCONtrol?
[:SENSE]:MONitor:BANDwidth[:RESolution] <freq>
[:SENSE]:MONitor:BANDwidth[:RESolution]?
[:SENSE]:MONitor:BANDwidth[:RESolution]:AUTO OFF | ON | 0 | 1
[:SENSE]:MONitor:BANDwidth[:RESolution]:AUTO?
[:SENSE]:MONitor:BANDwidth:VIDeo <bandwidth>
[:SENSE]:MONitor:BANDwidth:VIDeo?
[:SENSE]:MONitor:BANDwidth:VIDeo:AUTO ON | OFF | 1 | 0
[:SENSE]:MONitor:BANDwidth:VIDeo:AUTO?
[:SENSE]:MONitor:BANDwidth:VIDeo:RATio <real>
[:SENSE]:MONitor:BANDwidth:VIDeo:RATio?
[:SENSE]:MONitor:BANDwidth:VIDeo:RATio:AUTO OFF | ON | 0 | 1
[:SENSE]:MONitor:BANDwidth:VIDeo:RATio:AUTO?
[:SENSE]:MONitor:BWIDth[:RESolution]
[:SENSE]:MONitor:BWIDth:VIDeo
[:SENSE]:MONitor:BWIDth:VIDeo:RATio
[:SENSE]:MONitor:DETEctor:AUTO ON | OFF | 1 | 0
[:SENSE]:MONitor:DETEctor:AUTO?
[:SENSE]:MONitor:DETEctor[:FUNction]
[:SENSE]:MONitor:DETEctor:TRACe AVERage | NEGative | NORMal | POSitive |
SAMPLE
[:SENSE]:MONitor:DETEctor:TRACe?
[:SENSE]:MONitor:FREQuency:SPAN <freq>
[:SENSE]:MONitor:FREQuency:SPAN?
[:SENSE]:MONitor:FREQuency:SPAN:BANDwidth[:RESolution]:RATio <integer>
[:SENSE]:MONitor:FREQuency:SPAN:BANDwidth[:RESolution]:RATio?
[:SENSE]:MONitor:FREQuency:SPAN:BANDwidth[:RESolution]:RATio:AUTO OFF | ON
| 0 | 1
[:SENSE]:MONitor:FREQuency:SPAN:BANDwidth[:RESolution]:RATio:AUTO?
[:SENSE]:MONitor:FREQuency:SPAN:BWIDth[:RESolution]:RATio
[:SENSE]:MONitor:FREQuency:SPAN:FULL
[:SENSE]:MONitor:FREQuency:SPAN:PREVIOUS

```

```

[:SENSe]:MONitor:SWEep:POINTs <integer>
[:SENSe]:MONitor:SWEep:POINTs?
[:SENSe]:MONitor:SWEep:TIME <time>
[:SENSe]:MONitor:SWEep:TIME?
[:SENSe]:MONitor:SWEep:TIME:AUTO OFF | ON | 0 | 1
[:SENSe]:MONitor:SWEep:TIME:AUTO?
[:SENSe]:OBwidth:AVERage:COUNT <integer>
[:SENSe]:OBwidth:AVERage:COUNT?
[:SENSe]:OBwidth:AVERage[:STATE] ON | OFF | 1 | 0
[:SENSe]:OBwidth:AVERage[:STATE]?
[:SENSe]:OBwidth:AVERage:TCONtrol EXPonential | REPeat
[:SENSe]:OBwidth:AVERage:TCONtrol?
[:SENSe]:OBwidth:BANDwidth[:RESolution] <bandwidth>
[:SENSe]:OBwidth:BANDwidth[:RESolution]?
[:SENSe]:OBwidth:BANDwidth[:RESolution]:AUTO ON | OFF | 1 | 0
[:SENSe]:OBwidth:BANDwidth[:RESolution]:AUTO?
[:SENSe]:OBwidth:BANDwidth:SHAPE GAUSSian | FLATtop
[:SENSe]:OBwidth:BANDwidth:SHAPE?
[:SENSe]:OBwidth:BANDwidth:VIDeo <bandwidth>
[:SENSe]:OBwidth:BANDwidth:VIDeo?
[:SENSe]:OBwidth:BANDwidth:VIDeo:AUTO ON | OFF | 1 | 0
[:SENSe]:OBwidth:BANDwidth:VIDeo:AUTO?
[:SENSe]:OBwidth:BWIDth[:RESolution]
[:SENSe]:OBwidth:BWIDth:SHAPE
[:SENSe]:OBwidth:BWIDth:VIDeo
[:SENSe]:OBwidth:DETEctor:AUTO ON | OFF | 1 | 0
[:SENSe]:OBwidth:DETEctor:AUTO?
[:SENSe]:OBwidth:DETEctor[:FUNcTION] NORMAl | AVERage | POSitive | SAMPlE
| NEGative
[:SENSe]:OBwidth:DETEctor[:FUNcTION]?
[:SENSe]:OBwidth:FREQuency:SPAN <freq>
[:SENSe]:OBwidth:FREQuency:SPAN?
[:SENSe]:OBwidth:FREQuency:SPAN:AUTO ON | OFF | 0 | 1
[:SENSe]:OBwidth:FREQuency:SPAN:AUTO?
[:SENSe]:OBwidth:FREQuency:SPAN:FULL
[:SENSe]:OBwidth:FREQuency:SPAN:PREVious
[:SENSe]:OBwidth:IF:GAIN:AUTO[:STATE] ON | OFF | 1 | 0
[:SENSe]:OBwidth:IF:GAIN:AUTO[:STATE]?
[:SENSe]:OBwidth:IF:GAIN[:STATE] ON | OFF | 1 | 0
[:SENSe]:OBwidth:IF:GAIN[:STATE]?
[:SENSe]:OBwidth:MAXHold ON | OFF | 1 | 0
[:SENSe]:OBwidth:MAXHold?
[:SENSe]:OBwidth:PERCent <real>
[:SENSe]:OBwidth:PERCent?
[:SENSe]:OBwidth:SWEep:POINTs <integer>
[:SENSe]:OBwidth:SWEep:POINTs?
[:SENSe]:OBwidth:SWEep:TIME <time>
[:SENSe]:OBwidth:SWEep:TIME?
[:SENSe]:OBwidth:SWEep:TIME:AUTO OFF | ON | 0 | 1
[:SENSe]:OBwidth:SWEep:TIME:AUTO?
[:SENSe]:OBwidth:SWEep:TIME:AUTO:RULEs NORMAl | ACCuracy
[:SENSe]:OBwidth:SWEep:TIME:AUTO:RULEs?
[:SENSe]:OBwidth:XDB <rel_ampl>

```



```

[:SENSe]:OBWidth:XDB?
[:SENSe]:POWer:IQ[:I]:RANGe[:UPPer] <ampl>
[:SENSe]:POWer:IQ[:I]:RANGe[:UPPer]?
[:SENSe]:POWer:IQ:Q:RANGe[:UPPer] <ampl>
[:SENSe]:POWer:IQ:Q:RANGe[:UPPer]?
[:SENSe]:POWer:IQ:RANGe:AUTO OFF | ON | 0 | 1
[:SENSe]:POWer:IQ:RANGe:AUTO?
[:SENSe]:POWer[:RF]:ATTenuation <rel_ampl>
[:SENSe]:POWer[:RF]:ATTenuation?
[:SENSe]:POWer[:RF]:ATTenuation:AUTO OFF | ON | 0 | 1
[:SENSe]:POWer[:RF]:ATTenuation:AUTO?
[:SENSe]:POWer[:RF]:ATTenuation:STEP[:INCRement] 10 dB | 2 dB
[:SENSe]:POWer[:RF]:ATTenuation:STEP[:INCRement]?
[:SENSe]:POWer[:RF]:EATTenuation <rel_ampl>
[:SENSe]:POWer[:RF]:EATTenuation?
[:SENSe]:POWer[:RF]:EATTenuation:STATE OFF | ON | 0 | 1
[:SENSe]:POWer[:RF]:EATTenuation:STATE?
[:SENSe]:POWer[:RF]:GAIN:BAND LOW | FULL
[:SENSe]:POWer[:RF]:GAIN:BAND?
[:SENSe]:POWer[:RF]:GAIN[:STATE] OFF | ON | 0 | 1
[:SENSe]:POWer[:RF]:GAIN[:STATE]?
[:SENSe]:POWer[:RF]:MMW:PADJust
[:SENSe]:POWer[:RF]:MW:PADJust
[:SENSe]:POWer[:RF]:MW:PATH STD | LNPath | MPBypass | FULL
[:SENSe]:POWer[:RF]:MW:PATH?
[:SENSe]:POWer[:RF]:MW:PRESelector[:STATE] ON | OFF | 0 | 1
[:SENSe]:POWer[:RF]:MW:PRESelector[:STATE]?
[:SENSe]:POWer[:RF]:PADJust <freq>
[:SENSe]:POWer[:RF]:PADJust?
[:SENSe]:POWer[:RF]:PADJust:PRESelector MWAVe | MMWave | EXTERNAL
[:SENSe]:POWer[:RF]:PADJust:PRESelector?
[:SENSe]:POWer[:RF]:PCENTER
[:SENSe]:POWer[:RF]:RANGe:AUTO ON | OFF | 1 | 0
[:SENSe]:POWer[:RF]:RANGe:AUTO?
[:SENSe]:POWer[:RF]:RANGe:OPTimize IMMEDIATE
[:SENSe]:POWer[:RF]:RANGe:OPTimize:ATTenuation OFF | ELECTRICAL | COMBINED
[:SENSe]:POWer[:RF]:RANGe:OPTimize:ATTenuation?
[:SENSe]:PStatistic:BANDwidth <freq>
[:SENSe]:PStatistic:BANDwidth?
[:SENSe]:PStatistic:BWIDth
[:SENSe]:PStatistic:COUNTs <integer>
[:SENSe]:PStatistic:COUNTs?
[:SENSe]:PStatistic:GAUSSian[:STATE]
[:SENSe]:PStatistic:IF:GAIN:AUTO[:STATE] ON | OFF | 1 | 0
[:SENSe]:PStatistic:IF:GAIN:AUTO[:STATE]?
[:SENSe]:PStatistic:IF:GAIN[:STATE] ON | OFF | 1 | 0
[:SENSe]:PStatistic:IF:GAIN[:STATE]?
[:SENSe]:PStatistic:MEAS:OFFSet <time>
[:SENSe]:PStatistic:MEAS:OFFSet?
[:SENSe]:PStatistic:RTRace[:STATE]
[:SENSe]:PStatistic:SRTRace
[:SENSe]:PStatistic:SWEep:CYCLes <integer>
[:SENSe]:PStatistic:SWEep:CYCLes?

```

### 3 Programming the Analyzer

#### List of SCPI Commands

```
[ :SENSe]:PStatIstIc:SWEEp:TIME <time>
[ :SENSe]:PStatIstIc:SWEEp:TIME?
[ :SENSe]:PVTime:AVERAge:COUNT <integer>
[ :SENSe]:PVTime:AVERAge:COUNT?
[ :SENSe]:PVTime:AVERAge[:STATE] OFF | ON | 0 | 1
[ :SENSe]:PVTime:AVERAge[:STATE]?
[ :SENSe]:PVTime:AVERAge:TCONTRol EXPonentIal | REPEat
[ :SENSe]:PVTime:AVERAge:TCONTRol?
[ :SENSe]:PVTime:AVERAge:TYPE LOG | MAX | MIN | RMS | SCALAr
[ :SENSe]:PVTime:AVERAge:TYPE?
[ :SENSe]:PVTime:BANDwidth|BWIDth[:RESolution]:TYPE
[ :SENSe]:PVTime:BANDwidth[:RESolution] <freq>
[ :SENSe]:PVTime:BANDwidth[:RESolution]?
[ :SENSe]:PVTime:BANDwidth:TYPE GAUSSian | FLATtop
[ :SENSe]:PVTime:BANDwidth:TYPE?
[ :SENSe]:PVTime:BURSt:SLOPe <real>
[ :SENSe]:PVTime:BURSt:SLOPe?
[ :SENSe]:PVTime:BURSt:SLOPe:DETEction:TIME <real>
[ :SENSe]:PVTime:BURSt:SLOPe:DETEction:TIME?
[ :SENSe]:PVTime:BURSt:STHReshold <rel_ampl>
[ :SENSe]:PVTime:BURSt:STHReshold?
[ :SENSe]:PVTime:BWIDth[:RESolution]
[ :SENSe]:PVTime:IF:GAIN:AUTO OFF | ON | 0 | 1
[ :SENSe]:PVTime:IF:GAIN:AUTO?
[ :SENSe]:PVTime:IF:GAIN[:STATE] LOW | HIGH
[ :SENSe]:PVTime:IF:GAIN[:STATE]?
[ :SENSe]:PVTime:ISLot:FILTEring 0 | 1 | OFF | ON
[ :SENSe]:PVTime:ISLot:FILTEring?
[ :SENSe]:PVTime:ISLot:THReshold <rel_ampl>
[ :SENSe]:PVTime:ISLot:THReshold?
[ :SENSe]:PVTime:MASK:LIST:LOWer:RELative <rel_ampl>, ...
[ :SENSe]:PVTime:MASK:LIST:LOWer:RELative?
[ :SENSe]:PVTime:MASK:LIST:SWEEp:TIME <time>, ...
[ :SENSe]:PVTime:MASK:LIST:SWEEp:TIME?
[ :SENSe]:PVTime:MASK:LIST:TIME:STARt <time>, ...
[ :SENSe]:PVTime:MASK:LIST:TIME:STARt?
[ :SENSe]:PVTime:MASK:LIST:TIME:STOP <time>, ...
[ :SENSe]:PVTime:MASK:LIST:TIME:STOP?
[ :SENSe]:PVTime:MASK:LIST:UPPer:RELative <rel_ampl>, ...
[ :SENSe]:PVTime:MASK:LIST:UPPer:RELative?
[ :SENSe]:PVTime:MASK:PREFErence A | B | C | D | E
[ :SENSe]:PVTime:MASK:PREFErence?
[ :SENSe]:PVTime:MASK:REFerence[:OFFSet]:TIME <time>
[ :SENSe]:PVTime:MASK:REFerence[:OFFSet]:TIME?
[ :SENSe]:PVTime:MASK:TREFErence RISE | CENTER | TRIGger
[ :SENSe]:PVTime:MASK:TREFErence?
[ :SENSe]:PVTime:SLOT[:TYPE] IDLE | ACTIve
[ :SENSe]:PVTime:SLOT[:TYPE]?
[ :SENSe]:RADIo:DEVIce
[ :SENSe]:RADIo:PLSubtype SUB0 | SUB2 | SUB3
[ :SENSe]:RADIo:PLSubtype?
[ :SENSe]:RADIo:STANdard:DEVIce BTS | MS
[ :SENSe]:RADIo:STANdard:DEVIce?
```

```

[:SENSe]:RHO:ACODE
[:SENSe]:RHO:ALL[:STATe]
[:SENSe]:RHO:ALPHa
[:SENSe]:RHO:AVERAge:COUNT
[:SENSe]:RHO:AVERAge:TCONtrol
[:SENSe]:RHO[:BTS]:ACODE AUTO | PREDeFined
[:SENSe]:RHO[:BTS]:ACODE?
[:SENSe]:RHO[:BTS]:ALL[:STATe] OFF | ON | 0 | 1
[:SENSe]:RHO[:BTS]:ALL[:STATe]?
[:SENSe]:RHO[:BTS]:ALPHa <real>
[:SENSe]:RHO[:BTS]:ALPHa?
[:SENSe]:RHO[:BTS]:AVERAge:COUNT <integer>
[:SENSe]:RHO[:BTS]:AVERAge:COUNT?
[:SENSe]:RHO[:BTS]:AVERAge[:STATe] OFF | ON | 0 | 1
[:SENSe]:RHO[:BTS]:AVERAge[:STATe]?
[:SENSe]:RHO[:BTS]:AVERAge:TCONtrol EXPonential | REPeat
[:SENSe]:RHO[:BTS]:AVERAge:TCONtrol?
[:SENSe]:RHO[:BTS]:CAPTure:TIME <integer>
[:SENSe]:RHO[:BTS]:CAPTure:TIME?
[:SENSe]:RHO[:BTS]:CRATE <freq>
[:SENSe]:RHO[:BTS]:CRATE?
[:SENSe]:RHO[:BTS]:IF:GAIN:AUTO[:STATe] OFF | ON | 0 | 1
[:SENSe]:RHO[:BTS]:IF:GAIN:AUTO[:STATe]?
[:SENSe]:RHO[:BTS]:IF:GAIN[:STATe] OFF | ON | 0 | 1
[:SENSe]:RHO[:BTS]:IF:GAIN[:STATe]?
[:SENSe]:RHO[:BTS]:ISLot:THReshold <real>
[:SENSe]:RHO[:BTS]:ISLot:THReshold?
[:SENSe]:RHO[:BTS]:MACPosition HS1 | HS2 | FULL
[:SENSe]:RHO[:BTS]:MACPosition?
[:SENSe]:RHO[:BTS]:MCEStimator OFF | ON | 0 | 1
[:SENSe]:RHO[:BTS]:MCEStimator?
[:SENSe]:RHO[:BTS]:MCEStimator:TIMing CHANnel | GLOBal
[:SENSe]:RHO[:BTS]:MCEStimator:TIMing?
[:SENSe]:RHO[:BTS]:PNOffset <integer>
[:SENSe]:RHO[:BTS]:PNOffset?
[:SENSe]:RHO[:BTS]:POWER:TYPE RLOG | RLINear | ALOG | ALINear
[:SENSe]:RHO[:BTS]:POWER:TYPE?
[:SENSe]:RHO[:BTS]:PREAmble:LENGth <integer>
[:SENSe]:RHO[:BTS]:PREAmble:LENGth?
[:SENSe]:RHO[:BTS]:PREAmble:LENGth:AUTO OFF | ON | 0 | 1
[:SENSe]:RHO[:BTS]:PREAmble:LENGth:AUTO?
[:SENSe]:RHO[:BTS]:PREAmble:STATe OFF | ON | 0 | 1
[:SENSe]:RHO[:BTS]:PREAmble:STATe?
[:SENSe]:RHO[:BTS]:SLOT:TYPE ACTive | IDLE
[:SENSe]:RHO[:BTS]:SLOT:TYPE?
[:SENSe]:RHO[:BTS]:SPECTrum NORMal | INVert
[:SENSe]:RHO[:BTS]:SPECTrum?
[:SENSe]:RHO[:BTS]:SSLot:NUMBer <integer>
[:SENSe]:RHO[:BTS]:SSLot:NUMBer?
[:SENSe]:RHO[:BTS]:SSLot[:STATe] OFF | ON | 0 | 1
[:SENSe]:RHO[:BTS]:SSLot[:STATe]?
[:SENSe]:RHO:CAPTure:TIME
[:SENSe]:RHO:CRATE

```

### 3 Programming the Analyzer

#### List of SCPI Commands

```
[ :SENSe ]:RHO:IF:GAIN:AUTO[:STATe]
[ :SENSe ]:RHO:IF:GAIN[:STATe]
[ :SENSe ]:RHO:ISLot:THReshold
[ :SENSe ]:RHO:MCEStimator
[ :SENSe ]:RHO:MCEStimator:TIMing
[ :SENSe ]:RHO:MS:ACODE AUTO | COMBination | PREDeFined
[ :SENSe ]:RHO:MS:ACODE?
[ :SENSe ]:RHO:MS:ACODE:ACK OFF | ON | 0 | 1
[ :SENSe ]:RHO:MS:ACODE:ACK?
[ :SENSe ]:RHO:MS:ACODE:DATA OFF | ON | 0 | 1
[ :SENSe ]:RHO:MS:ACODE:DATA?
[ :SENSe ]:RHO:MS:ACODE:DRC OFF | ON | 0 | 1
[ :SENSe ]:RHO:MS:ACODE:DRC?
[ :SENSe ]:RHO:MS:ACODE:PILOt OFF | ON | 0 | 1
[ :SENSe ]:RHO:MS:ACODE:PILOt?
[ :SENSe ]:RHO:MS:ALPHa <real>
[ :SENSe ]:RHO:MS:ALPHa?
[ :SENSe ]:RHO:MS:AVERAge:COUNT <integer>
[ :SENSe ]:RHO:MS:AVERAge:COUNT?
[ :SENSe ]:RHO:MS:AVERAge:SLOT HS1 | HS2 | FS
[ :SENSe ]:RHO:MS:AVERAge:SLOT?
[ :SENSe ]:RHO:MS:AVERAge[:STATe] OFF | ON | 0 | 1
[ :SENSe ]:RHO:MS:AVERAge[:STATe]?
[ :SENSe ]:RHO:MS:AVERAge:TCONTRol EXPOntial | REPEat
[ :SENSe ]:RHO:MS:AVERAge:TCONTRol?
[ :SENSe ]:RHO:MS:CRATE <freq>
[ :SENSe ]:RHO:MS:CRATE?
[ :SENSe ]:RHO:MS:FERRor:TRANge NARRow | NORMAl | WIDE
[ :SENSe ]:RHO:MS:FERRor:TRANge?
[ :SENSe ]:RHO:MS:IF:GAIN:AUTO[:STATe] OFF | ON | 0 | 1
[ :SENSe ]:RHO:MS:IF:GAIN:AUTO[:STATe]?
[ :SENSe ]:RHO:MS:IF:GAIN[:STATe] OFF | ON | 0 | 1
[ :SENSe ]:RHO:MS:IF:GAIN[:STATe]?
[ :SENSe ]:RHO:MS:MCEStimator OFF | ON | 0 | 1
[ :SENSe ]:RHO:MS:MCEStimator?
[ :SENSe ]:RHO:MS:MCEStimator:TIMing CHANnel | GLOBal
[ :SENSe ]:RHO:MS:MCEStimator:TIMing?
[ :SENSe ]:RHO:MS:SPECTrum NORMAl | INVert
[ :SENSe ]:RHO:MS:SPECTrum?
[ :SENSe ]:RHO:MS:SSLot:NUMBer <integer>
[ :SENSe ]:RHO:MS:SSLot:NUMBer?
[ :SENSe ]:RHO:MS:SSLot[:STATe] OFF | ON | 0 | 1
[ :SENSe ]:RHO:MS:SSLot[:STATe]?
[ :SENSe ]:RHO:MS:SYNC PILOt | APILOt
[ :SENSe ]:RHO:MS:SYNC?
[ :SENSe ]:RHO:MS:SYNC:ILCMask <long_integer>
[ :SENSe ]:RHO:MS:SYNC:ILCMask?
[ :SENSe ]:RHO:MS:SYNC:QLCMask <long_integer>
[ :SENSe ]:RHO:MS:SYNC:QLCMask?
[ :SENSe ]:RHO:PNOFFset
[ :SENSe ]:RHO:POWER:TYPE
[ :SENSe ]:RHO:PREAmble:LENGth
[ :SENSe ]:RHO:PREAmble:STATE
```

```

[:SENSe]:RHO:SLOT:TYPE
[:SENSe]:RHO:SPECTrum
[:SENSe]:RHO:SSlot:NUMBER
[:SENSe]:ROSCillator:BANDwidth WIDE | NARRow
[:SENSe]:ROSCillator:BANDwidth?
[:SENSe]:ROSCillator:COUPLing NORMAl | NACQuisition
[:SENSe]:ROSCillator:COUPLing?
[:SENSe]:ROSCillator:EXTErnal:FREQuency <freq>
[:SENSe]:ROSCillator:EXTErnal:FREQuency?
[:SENSe]:ROSCillator:SOURce INTernal | EXTErnal
[:SENSe]:ROSCillator:SOURce?
[:SENSe]:ROSCillator:SOURce:TYPE INTernal | EXTErnal | SENSE | PULSe
[:SENSe]:ROSCillator:SOURce:TYPE?
[:SENSe]:SEMAsk:AVERAge:COUNT <integer>
[:SENSe]:SEMAsk:AVERAge:COUNT?
[:SENSe]:SEMAsk:AVERAge[:STATE] ON | OFF | 1 | 0
[:SENSe]:SEMAsk:AVERAge[:STATE]?
[:SENSe]:SEMAsk:BANDwidth[1]|2:INTEgration <bandwidth>
[:SENSe]:SEMAsk:BANDwidth[1]|2:INTEgration?
[:SENSe]:SEMAsk:BANDwidth[1]|2[:RESolution] <bandwidth>
[:SENSe]:SEMAsk:BANDwidth[1]|2[:RESolution]?
[:SENSe]:SEMAsk:BANDwidth[1]|2[:RESolution]:AUTO OFF | ON | 1 | 0
[:SENSe]:SEMAsk:BANDwidth[1]|2[:RESolution]:AUTO?
[:SENSe]:SEMAsk:BANDwidth:SHAPE ASENse | GAUSSian | FLATtop
[:SENSe]:SEMAsk:BANDwidth:SHAPE?
[:SENSe]:SEMAsk:BANDwidth[1]|2:VIDeo <bandwidth>
[:SENSe]:SEMAsk:BANDwidth[1]|2:VIDeo?
[:SENSe]:SEMAsk:BANDwidth[1]|2:VIDeo:AUTO OFF | ON | 1 | 0
[:SENSe]:SEMAsk:BANDwidth[1]|2:VIDeo:AUTO?
[:SENSe]:SEMAsk:BANDwidth[1]|2:VIDeo:RATio
[:SENSe]:SEMAsk:BANDwidth[1]|2:VIDeo:RATio <real>
[:SENSe]:SEMAsk:BANDwidth[1]|2:VIDeo:RATio:AUTO OFF | ON | 1 | 0
[:SENSe]:SEMAsk:BANDwidth[1]|2:VIDeo:RATio:AUTO?
[:SENSe]:SEMAsk:BWIDth[1]|2[:RESolution]
[:SENSe]:SEMAsk:BWIDth[1]|2:VIDeo
[:SENSe]:SEMAsk:BWIDth[1]|2:VIDeo:RATio
[:SENSe]:SEMAsk:CARRier:AUTO[:STATE] OFF | ON | 1 | 0
[:SENSe]:SEMAsk:CARRier:AUTO[:STATE]?
[:SENSe]:SEMAsk:CARRier:CPSD <real>
[:SENSe]:SEMAsk:CARRier:CPSD?
[:SENSe]:SEMAsk:CARRier:PEAK[:POWER] <real>
[:SENSe]:SEMAsk:CARRier:PEAK[:POWER]?
[:SENSe]:SEMAsk:CARRier[:POWER] <real>
[:SENSe]:SEMAsk:CARRier[:POWER]?
[:SENSe]:SEMAsk:DETEctor:CARRier:AUTO ON | OFF | 1 | 0
[:SENSe]:SEMAsk:DETEctor:CARRier:AUTO?
[:SENSe]:SEMAsk:DETEctor:CARRier[:FUNCTion] AVERAge | NEGAtive | NORMAl |
Positive | SAMPLe
[:SENSe]:SEMAsk:DETEctor:CARRier[:FUNCTion]?
[:SENSe]:SEMAsk:DETEctor:OFFSet:AUTO ON | OFF | 1 | 0
[:SENSe]:SEMAsk:DETEctor:OFFSet:AUTO?
[:SENSe]:SEMAsk:DETEctor:OFFSet[:FUNCTion] AVERAge | NEGAtive | NORMAl |
Positive | SAMPLe

```

### 3 Programming the Analyzer

#### List of SCPI Commands

```

[:SENSe]:SEMask:DETEctor:OFFSet[:FUNction]?
[:SENSe]:SEMask:FREQuency[1]|2:SPAN <freq>
[:SENSe]:SEMask:FREQuency[1]|2:SPAN?
[:SENSe]:SEMask:OFFSet[1]|2:LIST:BWIDth:IMULti
[:SENSe]:SEMask:OFFSet[1]|2:LIST:BWIDth[:RESolution]
[:SENSe]:SEMask:OFFSet[1]|2:LIST:BWIDth:VIDeo
[:SENSe]:SEMask:OFFSet[1]|2:LIST:SWEep[:TIME]
[:SENSe]:SEMask:OFFSet[1]|2[:OUTer]:LIST:BANDwidth:IMULti <integer>, ...
[:SENSe]:SEMask:OFFSet[1]|2[:OUTer]:LIST:BANDwidth:IMULti?
[:SENSe]:SEMask:OFFSet[1]|2[:OUTer]:LIST:BANDwidth[:RESolution]
<bandwidth>, ...
[:SENSe]:SEMask:OFFSet[1]|2[:OUTer]:LIST:BANDwidth[:RESolution]?
[:SENSe]:SEMask:OFFSet[1]|2[:OUTer]:LIST:BANDwidth[:RESolution]:AUTO OFF |
ON | 1 | 0, ...
[:SENSe]:SEMask:OFFSet[1]|2[:OUTer]:LIST:BANDwidth[:RESolution]:AUTO?
[:SENSe]:SEMask:OFFSet[1]|2[:OUTer]:LIST:BANDwidth:VIDeo <freq>, ...
[:SENSe]:SEMask:OFFSet[1]|2[:OUTer]:LIST:BANDwidth:VIDeo?
[:SENSe]:SEMask:OFFSet[1]|2[:OUTer]:LIST:BANDwidth:VIDeo:AUTO OFF | ON | 0
| 1, ...
[:SENSe]:SEMask:OFFSet[1]|2[:OUTer]:LIST:BANDwidth:VIDeo:AUTO?
[:SENSe]:SEMask:OFFSet[1]|2[:OUTer]:LIST:BANDwidth:VIDeo:RATio <real>, ...
[:SENSe]:SEMask:OFFSet[1]|2[:OUTer]:LIST:BANDwidth:VIDeo:RATio?
[:SENSe]:SEMask:OFFSet[1]|2[:OUTer]:LIST:BANDwidth:VIDeo:RATio:AUTO OFF |
ON | 0 | 1, ...
[:SENSe]:SEMask:OFFSet[1]|2[:OUTer]:LIST:BANDwidth:VIDeo:RATio:AUTO?
[:SENSe]:SEMask:OFFSet[1]|2[:OUTer]:LIST:FREQuency:START <freq>, ...
[:SENSe]:SEMask:OFFSet[1]|2[:OUTer]:LIST:FREQuency:START?
[:SENSe]:SEMask:OFFSet[1]|2[:OUTer]:LIST:FREQuency:STOP <freq>, ...
[:SENSe]:SEMask:OFFSet[1]|2[:OUTer]:LIST:FREQuency:STOP?
[:SENSe]:SEMask:OFFSet[1]|2[:OUTer]:LIST:SIDE BOTH | NEGative | POSitive,
...
[:SENSe]:SEMask:OFFSet[1]|2[:OUTer]:LIST:SIDE?
[:SENSe]:SEMask:OFFSet[1]|2[:OUTer]:LIST:START:ABSolute <real>, ...
[:SENSe]:SEMask:OFFSet[1]|2[:OUTer]:LIST:START:ABSolute?
[:SENSe]:SEMask:OFFSet[1]|2[:OUTer]:LIST:START:RCARrier <rel_ampl>, ...
[:SENSe]:SEMask:OFFSet[1]|2[:OUTer]:LIST:START:RCARrier?
[:SENSe]:SEMask:OFFSet[1]|2[:OUTer]:LIST:STATe ON | OFF | 1 | 0, ...
[:SENSe]:SEMask:OFFSet[1]|2[:OUTer]:LIST:STATe?
[:SENSe]:SEMask:OFFSet[1]|2[:OUTer]:LIST:STOP:ABSolute <real>, ...
[:SENSe]:SEMask:OFFSet[1]|2[:OUTer]:LIST:STOP:ABSolute?
[:SENSe]:SEMask:OFFSet[1]|2[:OUTer]:LIST:STOP:ABSolute:COUPLE ON | OFF | 1
| 0, ...
[:SENSe]:SEMask:OFFSet[1]|2[:OUTer]:LIST:STOP:ABSolute:COUPLE?
[:SENSe]:SEMask:OFFSet[1]|2[:OUTer]:LIST:STOP:RCARrier <rel_ampl>, ...
[:SENSe]:SEMask:OFFSet[1]|2[:OUTer]:LIST:STOP:RCARrier?
[:SENSe]:SEMask:OFFSet[1]|2[:OUTer]:LIST:STOP:RCARrier:COUPLE ON | OFF | 1
| 0, ...
[:SENSe]:SEMask:OFFSet[1]|2[:OUTer]:LIST:STOP:RCARrier:COUPLE?
[:SENSe]:SEMask:OFFSet[1]|2[:OUTer]:LIST:SWEep:TIME <time>, ...
[:SENSe]:SEMask:OFFSet[1]|2[:OUTer]:LIST:SWEep:TIME?
[:SENSe]:SEMask:OFFSet[1]|2[:OUTer]:LIST:SWEep:TIME:AUTO ON | OFF | 1 | 0,
...

```

```

[:SENSE]:SEMask:OFFSet[1]|2[:OUTER]:LIST:SWEep:TIME:AUTO?
[:SENSE]:SEMask:OFFSet[1]|2[:OUTER]:LIST:TEST ABSolute | AND | OR |
RELative, ...
[:SENSE]:SEMask:OFFSet[1]|2[:OUTER]:LIST:TEST?
[:SENSE]:SEMask:OFFSet[1]|2:TYPE CTOCenter | CTOEdge | ETOCenter | ETOEdge
[:SENSE]:SEMask:OFFSet[1]|2:TYPE?
[:SENSE]:SEMask:SWEep[1]|2:TIME <time>
[:SENSE]:SEMask:SWEep[1]|2:TIME?
[:SENSE]:SEMask:SWEep[1]|2:TIME:AUTO OFF | 0 | ON | 1
[:SENSE]:SEMask:SWEep[1]|2:TIME:AUTO?
[:SENSE]:SEMask:TYPE PSDRef | TPreF | SPRef
[:SENSE]:SEMask:TYPE?
[:SENSE]:SPURious:AVERAge:COUNT <integer>
[:SENSE]:SPURious:AVERAge:COUNT?
[:SENSE]:SPURious:AVERAge[:STATE] ON | OFF | 1 | 0
[:SENSE]:SPURious:AVERAge[:STATE]?
[:SENSE]:SPURious:AVERAge:TCONtrol EXPonential | REPeat
[:SENSE]:SPURious:AVERAge:TCONtrol?
[:SENSE]:SPURious:FSMeas ON | OFF | 1 | 0
[:SENSE]:SPURious:FSMeas?
[:SENSE]:SPURious:IF:GAIN:AUTO[:STATE] OFF|ON|0|1, ...
[:SENSE]:SPURious:IF:GAIN:AUTO[:STATE]?
[:SENSE]:SPURious:IF:GAIN[:STATE] OFF|ON|0|1, ...
[:SENSE]:SPURious:IF:GAIN[:STATE]?
[:SENSE]:SPURious:POWer[:RF]:RANGE:AUTO
[:SENSE]:SPURious[:RANGE]:ALL:SWEep:TYPE:AUTO OFF | ON | 0 | 1
[:SENSE]:SPURious[:RANGE]:ALL:SWEep:TYPE:AUTO?
[:SENSE]:SPURious[:RANGE][:LIST]:ATTenuation <rel_ampl>, ...
[:SENSE]:SPURious[:RANGE][:LIST]:ATTenuation?
[:SENSE]:SPURious[:RANGE][:LIST]:ATTenuation:AUTO OFF|ON|0|1, ...
[:SENSE]:SPURious[:RANGE][:LIST]:ATTenuation:AUTO?
[:SENSE]:SPURious[:RANGE][:LIST]:BANDwidth[:RESolution] <freq>, ...
[:SENSE]:SPURious[:RANGE][:LIST]:BANDwidth[:RESolution]?
[:SENSE]:SPURious[:RANGE][:LIST]:BANDwidth[:RESolution]:AUTO OFF|ON|0|1,
...
[:SENSE]:SPURious[:RANGE][:LIST]:BANDwidth[:RESolution]:AUTO?
[:SENSE]:SPURious[:RANGE][:LIST]:BANDwidth:SHAPE GAUSSian|FLATtop, ...
[:SENSE]:SPURious[:RANGE][:LIST]:BANDwidth:SHAPE?
[:SENSE]:SPURious[:RANGE][:LIST]:BANDwidth:VIDeo <freq>, ...
[:SENSE]:SPURious[:RANGE][:LIST]:BANDwidth:VIDeo?
[:SENSE]:SPURious[:RANGE][:LIST]:BANDwidth:VIDeo:AUTO OFF|ON|0|1, ...
[:SENSE]:SPURious[:RANGE][:LIST]:BANDwidth:VIDeo:AUTO?
[:SENSE]:SPURious[:RANGE][:LIST]:BWIDth[:RESolution]
[:SENSE]:SPURious[:RANGE][:LIST]:BWIDth:SHAPE
[:SENSE]:SPURious[:RANGE][:LIST]:BWIDth:VIDeo
[:SENSE]:SPURious[:RANGE][:LIST]:DETector2[:FUNction]
OFF|AVERAge|NEGative|NORMal|POSitive|SAMPle|RMS, ...
[:SENSE]:SPURious[:RANGE][:LIST]:DETector[1][:FUNction]
AVERAge|NEGative|NORMal|POSitive|SAMPle|RMS, ...
[:SENSE]:SPURious[:RANGE][:LIST]:DETector2[:FUNction]?
[:SENSE]:SPURious[:RANGE][:LIST]:DETector[1][:FUNction]?
[:SENSE]:SPURious[:RANGE][:LIST]:FREQuency:START <freq>, ...

```

### 3 Programming the Analyzer

#### List of SCPI Commands

```
[ :SENSe]:SPURious[:RANGe][:LIST]:FREQuency:START?
[:SENSe]:SPURious[:RANGe][:LIST]:FREQuency:STOP <freq>, ...
[:SENSe]:SPURious[:RANGe][:LIST]:FREQuency:STOP?
[:SENSe]:SPURious[:RANGe][:LIST]:PEAK:EXCursion <rel_ampl>, ...
[:SENSe]:SPURious[:RANGe][:LIST]:PEAK:EXCursion?
[:SENSe]:SPURious[:RANGe][:LIST]:PEAK:THReshold <real>, ...
[:SENSe]:SPURious[:RANGe][:LIST]:PEAK:THReshold?
[:SENSe]:SPURious[:RANGe][:LIST]:STATE ON|OFF|1|0, ...
[:SENSe]:SPURious[:RANGe][:LIST]:STATE?
[:SENSe]:SPURious[:RANGe][:LIST]:SWEep:POINTs <integer>
[:SENSe]:SPURious[:RANGe][:LIST]:SWEep:POINTs?
[:SENSe]:SPURious[:RANGe][:LIST]:SWEep:POINTs:AUTO OFF|ON|0|1, ...
[:SENSe]:SPURious[:RANGe][:LIST]:SWEep:POINTs:AUTO?
[:SENSe]:SPURious[:RANGe][:LIST]:SWEep:TIME <time>, ...
[:SENSe]:SPURious[:RANGe][:LIST]:SWEep:TIME?
[:SENSe]:SPURious[:RANGe][:LIST]:SWEep:TIME:AUTO OFF|ON|0|1, ...
[:SENSe]:SPURious[:RANGe][:LIST]:SWEep:TIME:AUTO?
[:SENSe]:SPURious:REPT:MODE ALL | LIMTest | MMARgin
[:SENSe]:SPURious:REPT:MODE?
[:SENSe]:SPURious:SPUR <integer>
[:SENSe]:SPURious:SPUR?
[:SENSe]:SPURious:SWEep:TIME:AUTO:RULEs NORMal | ACCuracy
[:SENSe]:SPURious:SWEep:TIME:AUTO:RULEs?
[:SENSe]:SPURious:TYPE EXAMine | FULL
[:SENSe]:SPURious:TYPE?
[:SENSe]:SType ?
[:SENSe]:SType IS1 | IS2 | HS1 | HS2 | PIL1 | PIL2 | MAC1 | MAC2 | MAC3 |
MAC4 | FS
[:SENSe]:SWEep:EGATE:CONTRol EDGE | LEVel
[:SENSe]:SWEep:EGATE:CONTRol?
[:SENSe]:SWEep:EGATE:DELay <time>
[:SENSe]:SWEep:EGATE:DELay?
[:SENSe]:SWEep:EGATE:DELay:COMPensation:TYPE OFF | SETTled | GDELay
[:SENSe]:SWEep:EGATE:DELay:COMPensation:TYPE?
[:SENSe]:SWEep:EGATE:EXTernal[1]|2:LEVel <voltage>
[:SENSe]:SWEep:EGATE:EXTernal[1]|2:LEVel?
[:SENSe]:SWEep:EGATE:HOLDoff <time>
[:SENSe]:SWEep:EGATE:HOLDoff?
[:SENSe]:SWEep:EGATE:HOLDoff:AUTO OFF | ON | 0 | 1
[:SENSe]:SWEep:EGATE:HOLDoff:AUTO?
[:SENSe]:SWEep:EGATE:LENGth <time>
[:SENSe]:SWEep:EGATE:LENGth?
[:SENSe]:SWEep:EGATE:MINFast?
[:SENSe]:SWEep:EGATE:POLarity NEGative | POSitive
[:SENSe]:SWEep:EGATE:POLarity?
[:SENSe]:SWEep:EGATE:SOURce EXTernal1 | EXTernal2 | LINE | FRAME | RFBurst
[:SENSe]:SWEep:EGATE:SOURce?
[:SENSe]:SWEep:EGATE[:STATE] OFF | ON | 0 | 1
[:SENSe]:SWEep:EGATE[:STATE]?
[:SENSe]:SWEep:EGATE:TIME <time>
[:SENSe]:SWEep:EGATE:TIME?
[:SENSe]:SWEep:EGATE:VIEW ON | OFF | 1 | 0
[:SENSe]:SWEep:EGATE:VIEW?
```



```

[:SENSe]:SWEep:EGATe:VIEW:START <time>
[:SENSe]:SWEep:EGATe:VIEW:START?
[:SENSe]:SWEep:TIME:GATE:LEVel HIGH | LOW
[:SENSe]:SWEep:TIME:GATE:LEVel?
[:SENSe]:TCDPower:ACODE
[:SENSe]:TCDPower:ACODE:ACK
[:SENSe]:TCDPower:ACODE:DATA
[:SENSe]:TCDPower:ACODE:DRC
[:SENSe]:TCDPower:ACODE:PILot
[:SENSe]:TCDPower:CAPTure:TIME
[:SENSe]:TCDPower:CRATE
[:SENSe]:TCDPower:FERRor:TRANge
[:SENSe]:TCDPower:IF:GAIN:AUTO[:STATe]
[:SENSe]:TCDPower:IF:GAIN[:STATe]
[:SENSe]:TCDPower:SPECTrum
[:SENSe]:TCDPower:SSLot:NUMBER
[:SENSe]:TCDPower:SYNC
[:SENSe]:TCDPower:SYNC:ILCMask
[:SENSe]:TCDPower:SYNC:QLCMask
[:SENSe]:TRHO:ACODE
[:SENSe]:TRHO:ACODE:ACK
[:SENSe]:TRHO:ACODE:DATA
[:SENSe]:TRHO:ACODE:DRC
[:SENSe]:TRHO:ACODE:PILot
[:SENSe]:TRHO:ALPHa
[:SENSe]:TRHO:AVERAge:COUNT
[:SENSe]:TRHO:AVERAge:SLOT
[:SENSe]:TRHO:AVERAge:TCONtrol
[:SENSe]:TRHO:CRATE
[:SENSe]:TRHO:FERRor:TRANge
[:SENSe]:TRHO:IF:GAIN:AUTO[:STATe]
[:SENSe]:TRHO:IF:GAIN[:STATe]
[:SENSe]:TRHO:MCEStimator
[:SENSe]:TRHO:MCEStimator:TIMing
[:SENSe]:TRHO:SPECTrum
[:SENSe]:TRHO:SSLot:NUMBER
[:SENSe]:TRHO:SYNC:ILCMask
[:SENSe]:TRHO:SYNC:QLCMask
[:SENSe]:VOLTage:IQ[:I]:RANGE[:UPPer] <voltage>
[:SENSe]:VOLTage:IQ[:I]:RANGE[:UPPer]?
[:SENSe]:VOLTage:IQ:Q:RANGE[:UPPer] <voltage>
[:SENSe]:VOLTage:IQ:Q:RANGE[:UPPer]?
[:SENSe]:VOLTage:IQ:RANGE:AUTO OFF | ON | 0 | 1
[:SENSe]:VOLTage:IQ:RANGE:AUTO?
[:SENSe]:VOLTage|POWER:IQ:MIRRored OFF | ON | 0 | 1
[:SENSe]:VOLTage|POWER:IQ:MIRRored?
[:SENSe]:WAVEform:ADC:DITHer:AUTO[:STATe] OFF | ON | 0 | 1
[:SENSe]:WAVEform:ADC:DITHer:AUTO[:STATe]?
[:SENSe]:WAVEform:ADC:DITHer[:STATe] OFF | ON | 0 | 1
[:SENSe]:WAVEform:ADC:DITHer[:STATe]?
[:SENSe]:WAVEform:APERture?
[:SENSe]:WAVEform:AVERAge:COUNT <integer>
[:SENSe]:WAVEform:AVERAge:COUNT?

```

### 3 Programming the Analyzer

#### List of SCPI Commands

```
[ :SENSe]:WAVeform:AVERAge[:STATe] OFF | ON | 0 | 1
[ :SENSe]:WAVeform:AVERAge[:STATe]?
[ :SENSe]:WAVeform:AVERAge:TACount <integer>
[ :SENSe]:WAVeform:AVERAge:TACount?
[ :SENSe]:WAVeform:AVERAge:TCONTRol EXPonential | REPeat
[ :SENSe]:WAVeform:AVERAge:TCONTRol?
[ :SENSe]:WAVeform:AVERAge:TYPE LOG | MAXimum | MINimum | RMS | SCALar
[ :SENSe]:WAVeform:AVERAge:TYPE?
[ :SENSe]:WAVeform:BANDwidth|BWIDth[:RESolution]:TYPE
[ :SENSe]:WAVeform:BANDwidth[:RESolution]
[ :SENSe]:WAVeform:BANDwidth:SHAPE
[ :SENSe]:WAVeform:BWIDth[:RESolution]
[ :SENSe]:WAVeform:BWIDth:SHAPE
[ :SENSe]:WAVeform:DIF:BANDwidth <freq>
[ :SENSe]:WAVeform:DIF:BANDwidth?
[ :SENSe]:WAVeform:DIF:FILTer:ALPHa <real>
[ :SENSe]:WAVeform:DIF:FILTer:ALPHa?
[ :SENSe]:WAVeform:DIF:FILTer:BANDwidth <freq>
[ :SENSe]:WAVeform:DIF:FILTer:BANDwidth?
[ :SENSe]:WAVeform:DIF:FILTer:BANDwidth:AUTO ON | OFF | 1 | 0
[ :SENSe]:WAVeform:DIF:FILTer:BANDwidth:AUTO?
[ :SENSe]:WAVeform:DIF:FILTer:TYPE GAUSSian | FLATtop
[ :SENSe]:WAVeform:DIF:FILTer:TYPE GAUSSian | FLATtop | SNYQuist |
RSNYquist | RCOSine | RRCosine
[ :SENSe]:WAVeform:DIF:FILTer:TYPE?
[ :SENSe]:WAVeform:DIF:FILTer:TYPE?
[ :SENSe]:WAVeform:FREQuency:SYNThesis:AUTO[:STATe] OFF | ON | 0 | 1
[ :SENSe]:WAVeform:FREQuency:SYNThesis:AUTO[:STATe]?
[ :SENSe]:WAVeform:FREQuency:SYNThesis[:STATe] 1 | 2 | 3
[ :SENSe]:WAVeform:FREQuency:SYNThesis[:STATe]?
[ :SENSe]:WAVeform:IF:GAIN:AUTO[:STATe] ON | OFF | 1 | 0
[ :SENSe]:WAVeform:IF:GAIN:AUTO[:STATe]?
[ :SENSe]:WAVeform:IF:GAIN:OFFSet <rel_ampl>
[ :SENSe]:WAVeform:IF:GAIN:OFFSet?
[ :SENSe]:WAVeform:IF:GAIN[:STATe] AUTOrange | LOW | HIGH
[ :SENSe]:WAVeform:IF:GAIN[:STATe]?
[ :SENSe]:WAVeform:PDITHer
[ :SENSe]:WAVeform:SRATe <freq>
[ :SENSe]:WAVeform:SRATe?
[ :SENSe]:WAVeform:SWEep:TIME <time>
[ :SENSe]:WAVeform:SWEep:TIME?
[ :SENSe]:WAVeform:WBIF:ADC:DITHer
[ :SENSe]:WAVeform:WBIF:FILTer:ALPHa
[ :SENSe]:WAVeform:WBIF:FILTer:BANDwidth <real>
[ :SENSe]:WAVeform:WBIF:FILTer:BANDwidth?
[ :SENSe]:WAVeform:WBIF:FILTer[:TYPE] GAUSSian | NONE | NYQuist | RNYQuist
| RCOSine | RRCosine
[ :SENSe]:WAVeform:WBIF:FILTer[:TYPE]?
STATus:OPERation:CONDition?
STATus:OPERation:ENABle <integer>
STATus:OPERation:ENABle?
STATus:OPERation[:EVENT]?
STATus:OPERation:NTRansition <integer>
```

```
STATUS:OPERation:NTRansition?
STATUS:OPERation:PTRansition <integer>
STATUS:OPERation:PTRansition?
STATUS:PRESet
STATUS:QUEStionable:CALibration:CONDition?
STATUS:QUEStionable:CALibration:ENABle <integer>
STATUS:QUEStionable:CALibration:ENABle?
STATUS:QUEStionable:CALibration[:EVENT]?
STATUS:QUEStionable:CALibration:EXTended:FAILure:CONDition?
STATUS:QUEStionable:CALibration:EXTended:FAILure:ENABle <integer>
STATUS:QUEStionable:CALibration:EXTended:FAILure:ENABle?
STATUS:QUEStionable:CALibration:EXTended:FAILure[:EVENT]?
STATUS:QUEStionable:CALibration:EXTended:FAILure:NTRansition <integer>
STATUS:QUEStionable:CALibration:EXTended:FAILure:NTRansition?
STATUS:QUEStionable:CALibration:EXTended:FAILure:PTRansition <integer>
STATUS:QUEStionable:CALibration:EXTended:FAILure:PTRansition?
STATUS:QUEStionable:CALibration:EXTended:NEEDed:CONDition?
STATUS:QUEStionable:CALibration:EXTended:NEEDed:ENABle <integer>
STATUS:QUEStionable:CALibration:EXTended:NEEDed:ENABle?
STATUS:QUEStionable:CALibration:EXTended:NEEDed[:EVENT]?
STATUS:QUEStionable:CALibration:EXTended:NEEDed:NTRansition <integer>
STATUS:QUEStionable:CALibration:EXTended:NEEDed:NTRansition?
STATUS:QUEStionable:CALibration:EXTended:NEEDed:PTRansition <integer>
STATUS:QUEStionable:CALibration:EXTended:NEEDed:PTRansition?
STATUS:QUEStionable:CALibration:NTRansition <integer>
STATUS:QUEStionable:CALibration:NTRansition?
STATUS:QUEStionable:CALibration:PTRansition <integer>
STATUS:QUEStionable:CALibration:PTRansition?
STATUS:QUEStionable:CALibration:SKIPped:CONDition?
STATUS:QUEStionable:CALibration:SKIPped:ENABle <integer>
STATUS:QUEStionable:CALibration:SKIPped:ENABle?
STATUS:QUEStionable:CALibration:SKIPped[:EVENT]?
STATUS:QUEStionable:CALibration:SKIPped:NTRansition <integer>
STATUS:QUEStionable:CALibration:SKIPped:NTRansition?
STATUS:QUEStionable:CALibration:SKIPped:PTRansition <integer>
STATUS:QUEStionable:CALibration:SKIPped:PTRansition?
STATUS:QUEStionable:CONDition?
STATUS:QUEStionable:ENABle <integer>
STATUS:QUEStionable:ENABle?
STATUS:QUEStionable[:EVENT]?
STATUS:QUEStionable:FREQuency:CONDition?
STATUS:QUEStionable:FREQuency:ENABle <integer>
STATUS:QUEStionable:FREQuency:ENABle?
STATUS:QUEStionable:FREQuency[:EVENT]?
STATUS:QUEStionable:FREQuency:NTRansition <integer>
STATUS:QUEStionable:FREQuency:NTRansition?
STATUS:QUEStionable:FREQuency:PTRansition <integer>
STATUS:QUEStionable:FREQuency:PTRansition?
STATUS:QUEStionable:INTEgrity:CONDition?
STATUS:QUEStionable:INTEgrity:ENABle <integer>
STATUS:QUEStionable:INTEgrity:ENABle?
STATUS:QUEStionable:INTEgrity[:EVENT]?
STATUS:QUEStionable:INTEgrity:NTRansition <integer>
```

```
STATUS:QUESTIONABLE:INTEGRITY:NTRANSITION?
STATUS:QUESTIONABLE:INTEGRITY:PTRANSITION <integer>
STATUS:QUESTIONABLE:INTEGRITY:PTRANSITION?
STATUS:QUESTIONABLE:INTEGRITY:SIGNAL:CONDITION?
STATUS:QUESTIONABLE:INTEGRITY:SIGNAL:ENABLE <integer>
STATUS:QUESTIONABLE:INTEGRITY:SIGNAL:ENABLE?
STATUS:QUESTIONABLE:INTEGRITY:SIGNAL[:EVENT]?
STATUS:QUESTIONABLE:INTEGRITY:SIGNAL:NTRANSITION <integer>
STATUS:QUESTIONABLE:INTEGRITY:SIGNAL:NTRANSITION?
STATUS:QUESTIONABLE:INTEGRITY:SIGNAL:PTRANSITION <integer>
STATUS:QUESTIONABLE:INTEGRITY:SIGNAL:PTRANSITION?
STATUS:QUESTIONABLE:INTEGRITY:UNCALIBRATED:CONDITION?
STATUS:QUESTIONABLE:INTEGRITY:UNCALIBRATED:ENABLE
STATUS:QUESTIONABLE:INTEGRITY:UNCALIBRATED:ENABLE?
STATUS:QUESTIONABLE:INTEGRITY:UNCALIBRATED[:EVENT]?
STATUS:QUESTIONABLE:INTEGRITY:UNCALIBRATED:NTRANSITION <integer>
STATUS:QUESTIONABLE:INTEGRITY:UNCALIBRATED:NTRANSITION?
STATUS:QUESTIONABLE:INTEGRITY:UNCALIBRATED:PTRANSITION <integer>
STATUS:QUESTIONABLE:INTEGRITY:UNCALIBRATED:PTRANSITION?
STATUS:QUESTIONABLE:NTRANSITION <integer>
STATUS:QUESTIONABLE:NTRANSITION?
STATUS:QUESTIONABLE:POWER:CONDITION?
STATUS:QUESTIONABLE:POWER:ENABLE <integer>
STATUS:QUESTIONABLE:POWER:ENABLE?
STATUS:QUESTIONABLE:POWER[:EVENT]?
STATUS:QUESTIONABLE:POWER:NTRANSITION <integer>
STATUS:QUESTIONABLE:POWER:NTRANSITION?
STATUS:QUESTIONABLE:POWER:PTRANSITION <integer>
STATUS:QUESTIONABLE:POWER:PTRANSITION?
STATUS:QUESTIONABLE:PTRANSITION <integer>
STATUS:QUESTIONABLE:PTRANSITION?
STATUS:QUESTIONABLE:TEMPERATURE:CONDITION?
STATUS:QUESTIONABLE:TEMPERATURE:ENABLE <integer>
STATUS:QUESTIONABLE:TEMPERATURE:ENABLE?
STATUS:QUESTIONABLE:TEMPERATURE[:EVENT]?
STATUS:QUESTIONABLE:TEMPERATURE:NTRANSITION <integer>
STATUS:QUESTIONABLE:TEMPERATURE:NTRANSITION?
STATUS:QUESTIONABLE:TEMPERATURE:PTRANSITION <integer>
STATUS:QUESTIONABLE:TEMPERATURE:PTRANSITION?
SYSTEM:APPLICATION:CATALOG[:NAME]?
SYSTEM:APPLICATION:CATALOG[:NAME]:COUNT?
SYSTEM:APPLICATION:CATALOG:OPTION? <model>
SYSTEM:APPLICATION:CATALOG:REVISION? <model>
SYSTEM:APPLICATION[:CURRENT][:NAME]?
SYSTEM:APPLICATION[:CURRENT]:OPTION?
SYSTEM:APPLICATION[:CURRENT]:REVISION?
SYSTEM:COMMUNICATE:GPIB[1][:SELF]:ADDRESS <integer>
SYSTEM:COMMUNICATE:GPIB[1][:SELF]:ADDRESS?
SYSTEM:COMMUNICATE:GPIB[1][:SELF]:CONTROLLER[:ENABLE] ON | OFF | 0 | 1
SYSTEM:COMMUNICATE:GPIB[1][:SELF]:CONTROLLER[:ENABLE]?
SYSTEM:COMMUNICATE:LAN:SCPI:HISLIP:ENABLE OFF | ON | 0 | 1
SYSTEM:COMMUNICATE:LAN:SCPI:HISLIP:ENABLE?
SYSTEM:COMMUNICATE:LAN:SCPI:SICL:ENABLE OFF | ON | 0 | 1
```

```

SYSTEM:COMMunicate:LAN:SCPI:SICL:ENABle?
SYSTEM:COMMunicate:LAN:SCPI:SOCKeT:CONTRol?
SYSTEM:COMMunicate:LAN:SCPI:SOCKeT:ENABle OFF | ON | 0 | 1
SYSTEM:COMMunicate:LAN:SCPI:SOCKeT:ENABle?
SYSTEM:COMMunicate:LAN:SCPI:TELNet:ENABle OFF | ON | 0 | 1
SYSTEM:COMMunicate:LAN:SCPI:TELNet:ENABle?
SYSTEM:COMMunicate:USB:CONNection?
SYSTEM:COMMunicate:USB:PACKets?
SYSTEM:COMMunicate:USB:STATus?
SYSTEM:CONFigure[:SYSTem]?
SYSTEM:CSYSTem?
SYSTEM:DATE "<year>, <month>, <day>"
SYSTEM:DATE?
SYSTEM:DEFault [ALL] | ALIGn | INPut | MISC | MODes | PON
SYSTEM:ERRor[:NEXT]?
SYSTEM:ERRor:OVERload[:STATe] 0 | 1 | OFF | ON
SYSTEM:ERRor:VERBoSe OFF | ON | 0 | 1
SYSTEM:ERRor:VERBoSe?
SYSTEM:HELP:HEADers?
SYSTEM:HID?
SYSTEM:IDN <string>
SYSTEM:IDN?
SYSTEM:KLOCK OFF | ON | 0 | 1
SYSTEM:KLOCK?
SYSTEM:LKEY <"OptionInfo">, <"LicenseInfo">
SYSTEM:LKEY? <"OptionInfo">
SYSTEM:LKEY:DELeTe <"OptionInfo">, <"LicenseInfo">
SYSTEM:LKEY:LIST?
SYSTEM:MRELay:COUNT?
SYSTEM:OPTions?
SYSTEM:PDOWN [NORMal | FORCe]
SYSTEM:PON:APPLication:LLIST <stringofINSTrument:SElectnames>
SYSTEM:PON:APPLication:LLIST?
SYSTEM:PON:APPLication:VMEMory[:AVAILable]?
SYSTEM:PON:APPLication:VMEMory:TOTAL?
SYSTEM:PON:APPLication:VMEMory:USED?
SYSTEM:PON:APPLication:VMEMory:USED:NAME? <INSTrument:SElectname>
SYSTEM:PON:ETIME?
SYSTEM:PON:MODE SA | BASIC | ADEMOD | NFIGURE | PNOISE | CDMA2K | TDSCDMA
| VSA | VSA89601 | WCDMA | WIMAXOFDMA
SYSTEM:PON:MODE?
SYSTEM:PON:TIME?
SYSTEM:PON:TYPE MODE | USER | LAST
SYSTEM:PON:TYPE PRESet
SYSTEM:PON:TYPE?
SYSTEM:PRESet
SYSTEM:PRESet:TYPE FACTory | MODE | USER
SYSTEM:PRESet:TYPE?
SYSTEM:PRESet:USER
SYSTEM:PRESet:USER:ALL
SYSTEM:PRESet:USER:SAVE
SYSTEM:PRINT:THEME TDColor | TDMonochrome | FCOLOR | FMONochrome
SYSTEM:PRINT:THEME?

```

### 3 Programming the Analyzer

#### List of SCPI Commands

```
SYSTem:PUP:PROCEss
SYSTem:SECurity:USB:WPRotect[:ENABLE] ON | OFF | 0 | 1
SYSTem:SECurity:USB:WPRotect[:ENABLE]?
SYSTem:SHOW OFF | ERRor | SYSTem | HARDware | LXI | HWStAtistics |
ALIGnment | SOFTware | CAPplication
SYSTem:SHOW?
SYSTem:TEMPerature:HEXTreme?
SYSTem:TEMPerature:LEXTreme?
SYSTem:TIME "<hour>, <minute>, <second>"
SYSTem:TIME?
SYSTem:VERSion?
TRACe[1]|2|3:ACPoweR:DISPlay[:STATE] ON | OFF | 0 | 1
TRACe[1]|2|3:ACPoweR:DISPlay[:STATE]?
TRACe[1]|2|3:ACPoweR:TYPE WRITE | AVERAge | MAXHold | MINHold
TRACe[1]|2|3:ACPoweR:TYPE?
TRACe[1]|2|3:ACPoweR:UPDate[:STATE] ON | OFF | 0 | 1
TRACe[1]|2|3:ACPoweR:UPDate[:STATE]?
TRACe:CHPower:TYPE WRITE | AVERAge | MAXHold | MINHold
TRACe:CHPower:TYPE?
TRACe:MONitor:CLear [TRACE1] | TRACE2 | TRACE3
TRACe:MONitor:CLear:ALL
TRACe[1]|2|3:MONitor:DISPlay[:STATE] ON | OFF | 0 | 1
TRACe[1]|2|3:MONitor:DISPlay[:STATE]?
TRACe[1]|2|3:MONitor:TYPE WRITE | AVERAge | MAXHold | MINHold
TRACe[1]|2|3:MONitor:TYPE?
TRACe[1]|2|3:MONitor:UPDate[:STATE] ON | OFF | 0 | 1
TRACe[1]|2|3:MONitor:UPDate[:STATE]?
TRACe:OBWidth:TYPE WRITE | AVERAge | MAXHold | MINHold
TRACe:OBWidth:TYPE?
TRACe:SEMAsk:TYPE WRITE | AVERAge | MAXHold | MINHold
TRACe:SEMAsk:TYPE?
TRIGger:<measurement>[:SEQUence]:IQ:SOURce EXTErnal1 | EXTErnal2 |
IMMEdiate | IQMag | IDEMod | QDEMod | IINPut | QINPut | AIQMag
TRIGger:<measurement>[:SEQUence]:IQ:SOURce?
TRIGger:<measurement>[:SEQUence]:RF:SOURce EXTErnal1 | EXTErnal2 |
IMMEdiate | LINE | FRAME | RFBurst | VIDEo | IF | ALARm | LAN | TV
TRIGger:<measurement>[:SEQUence]:RF:SOURce?
TRIGger:<measurement>[:SEQUence]:SOURce EXTErnal1 | EXTErnal2 | IMMEdiate
| LINE | FRAME | RFBurst | VIDEo | IF | ALARm | LAN | IQMag | IDEMod |
QDEMod | IINPut | QINPut | AIQMag | TV
TRIGger:<measurement>[:SEQUence]:SOURce?
TRIGger[:SEQUence]:ATRigger <time>
TRIGger[:SEQUence]:ATRigger?
TRIGger[:SEQUence]:ATRigger:STATE OFF | ON | 0 | 1
TRIGger[:SEQUence]:ATRigger:STATE?
TRIGger[:SEQUence]:DELay <time>
TRIGger[:SEQUence]:DELay?
TRIGger[:SEQUence]:DELay:STATE OFF | ON | 0 | 1
TRIGger[:SEQUence]:DELay:STATE?
TRIGger[:SEQUence]:EXTErnal1:DELay <time>
TRIGger[:SEQUence]:EXTErnal2:DELay <time>
TRIGger[:SEQUence]:EXTErnal:DELay
```

```

TRIGger[:SEQuence]:EXTErnal1:DELay?
TRIGger[:SEQuence]:EXTErnal2:DELay?
TRIGger[:SEQuence]:EXTErnal2:DELay:STATE OFF | ON | 0 | 1
TRIGger[:SEQuence]:EXTErnal1:DELay:STATE OFF | ON | 0 | 1
TRIGger[:SEQuence]:EXTErnal1:DELay:STATE?
TRIGger[:SEQuence]:EXTErnal2:DELay:STATE?
TRIGger[:SEQuence]:EXTErnal1:LEVel <level>
TRIGger[:SEQuence]:EXTErnal:LEVel
TRIGger[:SEQuence]:EXTErnal2:LEVel
TRIGger[:SEQuence]:EXTErnal1:LEVel?
TRIGger[:SEQuence]:EXTErnal2:LEVel?
TRIGger[:SEQuence]:EXTErnal:SLOPe
TRIGger[:SEQuence]:EXTErnal1:SLOPe POSitive | NEGative
TRIGger[:SEQuence]:EXTErnal2:SLOPe POSitive | NEGative
TRIGger[:SEQuence]:EXTErnal1:SLOPe?
TRIGger[:SEQuence]:EXTErnal2:SLOPe?
TRIGger[:SEQuence]:FRAME:ADJust <time>
TRIGger[:SEQuence]:FRAME:DELay <time>
TRIGger[:SEQuence]:FRAME:DELay?
TRIGger[:SEQuence]:FRAME:DELay:STATE OFF | ON | 0 | 1
TRIGger[:SEQuence]:FRAME:DELay:STATE?
TRIGger[:SEQuence]:FRAME:EXTErnal2:LEVel
TRIGger[:SEQuence]:FRAME:EXTErnal1:LEVel
TRIGger[:SEQuence]:FRAME:EXTErnal1:SLOPe
TRIGger[:SEQuence]:FRAME:EXTErnal2:SLOPe
TRIGger[:SEQuence]:FRAME:OFFSet <time>
TRIGger[:SEQuence]:FRAME:OFFSet?
TRIGger[:SEQuence]:FRAME:OFFSet:DISPlay:RESet
TRIGger[:SEQuence]:FRAME:PERiod <time>
TRIGger[:SEQuence]:FRAME:PERiod?
TRIGger[:SEQuence]:FRAME:RFBurst:LEVel:ABSolute
TRIGger[:SEQuence]:FRAME:RFBurst:SLOPe
TRIGger[:SEQuence]:FRAME:SYNC EXTErnal
TRIGger[:SEQuence]:FRAME:SYNC EXTErnal1 | EXTErnal2 | RFBurst | OFF
TRIGger[:SEQuence]:FRAME:SYNC?
TRIGger[:SEQuence]:FRAME:SYNC:HOLDOff <time>
TRIGger[:SEQuence]:FRAME:SYNC:HOLDOff?
TRIGger[:SEQuence]:FRAME:SYNC:HOLDOff:STATE OFF | ON | 0 | 1
TRIGger[:SEQuence]:FRAME:SYNC:HOLDOff:STATE?
TRIGger[:SEQuence]:HOLDOff <time>
TRIGger[:SEQuence]:HOLDOff?
TRIGger[:SEQuence]:HOLDOff:STATE OFF | ON | 0 | 1
TRIGger[:SEQuence]:HOLDOff:STATE?
TRIGger[:SEQuence]:IF:LEVel
TRIGger[:SEQuence]:IF:LEVel?
TRIGger[:SEQuence]:IF:SLOPe NEGative | POSitive
TRIGger[:SEQuence]:IF:SLOPe?
TRIGger[:SEQuence]:LINE:DELay <time>
TRIGger[:SEQuence]:LINE:DELay?
TRIGger[:SEQuence]:LINE:DELay:STATE OFF | ON | 0 | 1
TRIGger[:SEQuence]:LINE:DELay:STATE?
TRIGger[:SEQuence]:LINE:SLOPe POSitive | NEGative
TRIGger[:SEQuence]:LINE:SLOPe?

```

### 3 Programming the Analyzer

#### List of SCPI Commands

```
TRIGger[:SEquence]:OFFSet <time>
TRIGger[:SEquence]:OFFSet?
TRIGger[:SEquence]:OFFSet:STATE OFF | ON | 0 | 1
TRIGger[:SEquence]:OFFSet:STATE?
TRIGger[:SEquence]:RFBurst:DElay <time>
TRIGger[:SEquence]:RFBurst:DElay?
TRIGger[:SEquence]:RFBurst:DElay:STATE OFF | ON | 0 | 1
TRIGger[:SEquence]:RFBurst:DElay:STATE?
TRIGger[:SEquence]:RFBurst:LEvel
TRIGger[:SEquence]:RFBurst:LEvel:ABSolute <ampl>
TRIGger[:SEquence]:RFBurst:LEvel:ABSolute?
TRIGger[:SEquence]:RFBurst:LEvel:RELative <rel_ampl>
TRIGger[:SEquence]:RFBurst:LEvel:RELative?
TRIGger[:SEquence]:RFBurst:LEvel:TYPE ABSolute | RELative
TRIGger[:SEquence]:RFBurst:LEvel:TYPE?
TRIGger[:SEquence]:RFBurst:SLOPe POSitive | NEGative
TRIGger[:SEquence]:RFBurst:SLOPe?
TRIGger[:SEquence]:SLOPe POSitive | NEGative
TRIGger[:SEquence]:SLOPe?
TRIGger[:SEquence]:SOURCe EXTernal
TRIGger[:SEquence]:VIDeo:DElay <time>
TRIGger[:SEquence]:VIDeo:DElay?
TRIGger[:SEquence]:VIDeo:DElay:STATE OFF | ON | 0 | 1
TRIGger[:SEquence]:VIDeo:DElay:STATE?
TRIGger[:SEquence]:VIDeo:LEvel <ampl>
TRIGger[:SEquence]:VIDeo:LEvel?
TRIGger[:SEquence]:VIDeo:SLOPe POSitive | NEGative
TRIGger[:SEquence]:VIDeo:SLOPe?
TRIGger|TRIGger1|TRIGger2[:SEquence]:OUTPut HSWP | MEASuring | MAIN | GATE
| GTRigger | OEVEN | SPOINT | SSweep | SSETtled | S1Marker | S2Marker |
S3Marker | S4Marker | OFF
TRIGger|TRIGger1|TRIGger2[:SEquence]:OUTPut?
TRIGger|TRIGger1|TRIGger2[:SEquence]:OUTPut:POLarity POSitive | NEGative
TRIGger|TRIGger1|TRIGger2[:SEquence]:OUTPut:POLarity?
UNIT:ACPower:POWER:PSD DBMHZ | DBMMHZ
UNIT:ACPower:POWER:PSD?
UNIT:CHPower:POWER:PSD DBMHZ | DBMMHZ
UNIT:CHPower:POWER:PSD?
```



## STATus Subsystem

The following diagram provides a graphical overview of the entire X-Series Status Register System.

For readability, the diagram is split into two sections:

- ["X-Series Status Register System \(1\)" on page 174](#)
- ["X-Series Status Register System \(2\)" on page 175](#)

X-Series Status Register System (1)

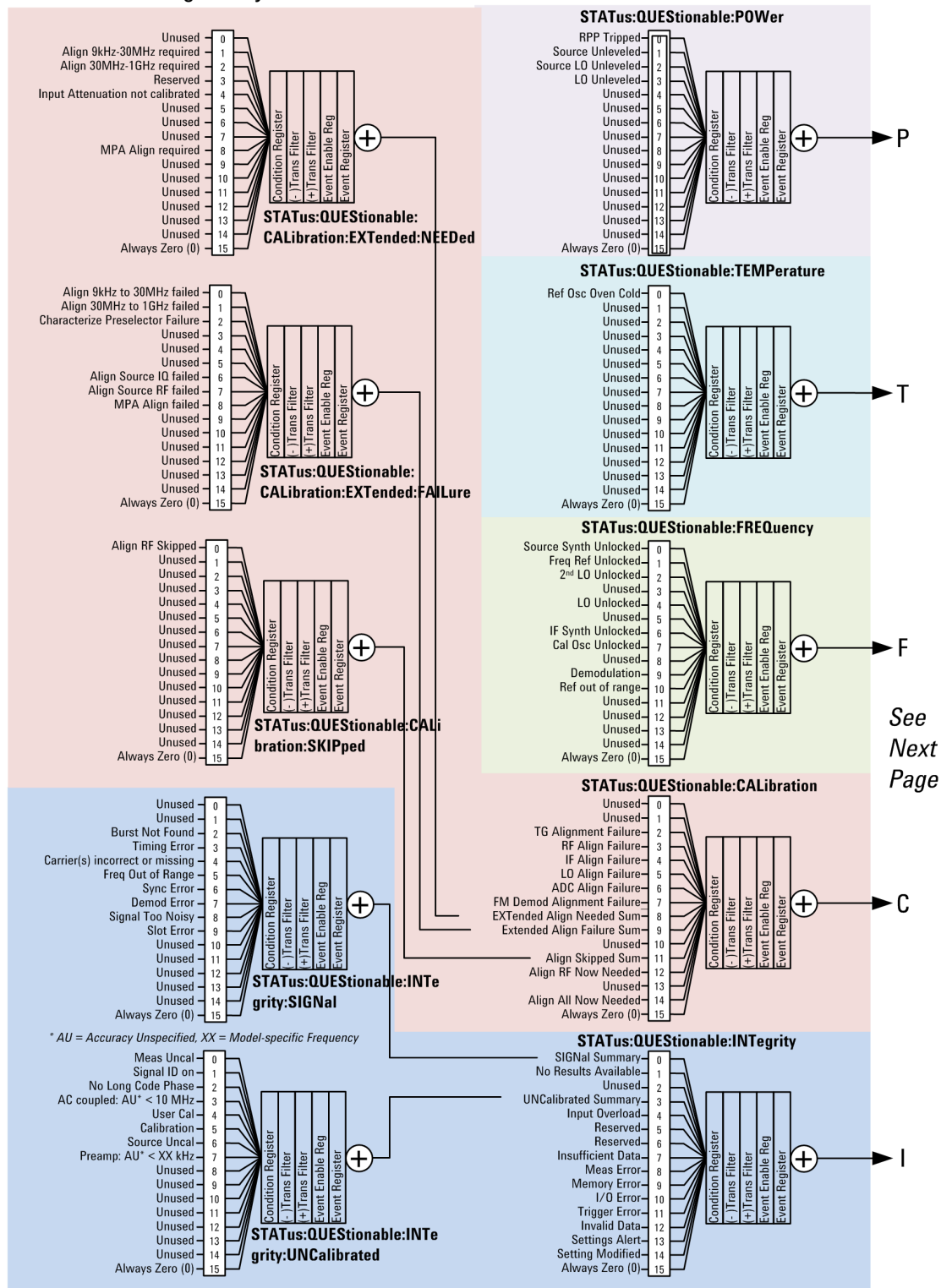

## X-Series Status Register System (2)

See  
Previous  
Page

P  
T  
F  
  
C  
I

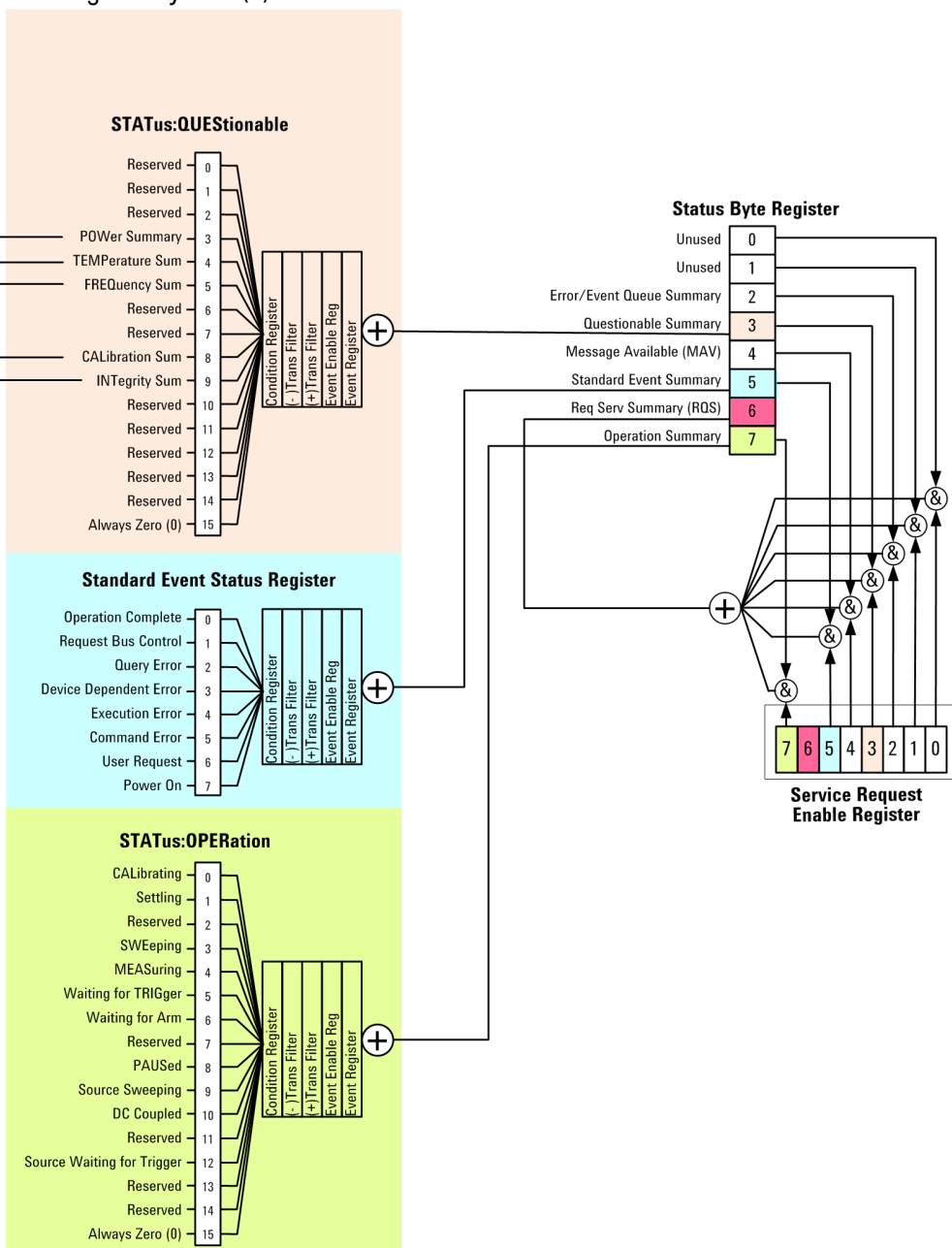

## Detailed Description

The STATus subsystem remote commands set and query the status hardware registers. This system of registers monitors various events and conditions in the instrument. Software written to control the instrument may need to monitor some of these events and conditions.

### NOTE

All status register commands are sequential. Most commands can be started immediately and will overlap with any existing commands that are already running. This is not true of status commands. All the commands in the spectrum analyzer are assumed to be overlapped unless a command description specifically says that it is sequential.

## What Are Status Registers

The status system contains multiple registers that are arranged in a hierarchical order. The lower-level status registers propagate their data to the higher-level registers in the data structures by means of summary bits. The status byte register is at the top of the hierarchy and contains general status information for the instrument's events and conditions. All other individual registers are used to determine the specific events or conditions. For a diagram of the registers and their interconnections, see above.

The operation and questionable status registers are sets of registers that monitor the overall instrument condition. They are accessed with the STATus:OPERation and STATus:QUEStionable commands in the STATus command subsystem. Each register set is made up of five registers:

- Condition Register—It reports the real-time state of the signals monitored by this register set. There is no latching or buffering for a condition register.
- Positive Transition Register—This filter register controls which signals will set a bit in the event register when the signal makes a low to high transition (when the condition bit changes from 0 to 1).
- Negative Transition Register—This filter register controls which signals will set a bit in the event register when the signal makes a high to low transition (when the condition bit changes from 1 to 0).
- Event Register—It latches any signal state changes, in the way specified by the filter registers. Bits in the event register are never cleared by signal state changes. Event registers are cleared when read. They are also cleared by \*CLS and by presetting the instrument.
- Event Enable Register—It controls which of the bits, being set in the event register, will be summarized as a single output for the register set. Summary bits are then used by the next higher register.

The STATus:QUEStionable registers report abnormal operating conditions. The status register hierarchy is:

1. The summary outputs from the six STATus:QUEStionable:<keyword> detail registers are inputs to the STATus:QUEStionable register.
2. The summary output from the STATus:QUEStionable register is an input to the Status Byte Register. See the overall system in Figure at the beginning of this section.

The STATus:OPERation register set has no summarized inputs. The inputs to the STATus:OPERation:CONDition register indicate the real time state of the instrument. The STATus:OPERation:EVENT register summary output is an input to the Status Byte Register.

## What Are Status Register SCPI Commands

Most monitoring of the instrument conditions is done at the highest level using the IEEE common commands indicated below. Complete command descriptions are available in the IEEE commands section at the beginning of the language reference. Individual status registers can be set and queried using the commands in the STATus subsystem of the language reference.

- \*CLS (clear status) clears the status byte by emptying the error queue and clearing all the event registers.
- \*ESE, \*ESE? (event status enable) sets and queries the bits in the enable register part of the standard event status register.
- \*ESR? (event status register) queries and clears the event register part of the standard event status register.

- \*OPC, \*OPC? (operation complete) sets the standard event status register to monitor the completion of all commands. The query stops any new commands from being processed until the current processing is complete, then returns a '1'.
- \*PSC, \*PSC? (power-on state clear) sets the power-on state so that it clears the service request enable register and the event status enable register at power on.
- \*SRE, \*SRE? (service request enable) sets and queries the value of the service request enable register.
- \*STB? (status byte) queries the value of the status byte register without erasing its contents.

## How to Use the Status Registers

A program often needs to be able to detect and manage error conditions or changes in instrument status. There are two methods you can use to programmatically access the information in status registers:

- The polling method
- The service request (SRQ) method

In the polling method, the instrument has a passive role. It only tells the controller that conditions have changed when the controller asks the right question. In the SRQ method, the instrument takes a more active role. It tells the controller when there has been a condition change without the controller asking. Either method allows you to monitor one or more conditions.

The polling method works well if you do not need to know about changes the moment they occur. The SRQ method should be used if you must know immediately when a condition changes. To detect a change using the polling method, the program must repeatedly read the registers.

Use the SRQ method when:

- you need time-critical notification of changes
- you are monitoring more than one device which supports SRQs
- you need to have the controller do something else while waiting
- you can't afford the performance penalty inherent to polling

Use polling when:

- your programming language/development environment does not support SRQ interrupts
- you want to write a simple, single-purpose program and don't want the added complexity of setting up an SRQ handler
- To monitor a condition:
  - a. Determine which register contains the bit that reports the condition.
  - b. Send the unique SCPI query that reads that register.
  - c. Examine the bit to see if the condition has changed.

You can monitor conditions in different ways.

- Check the current instrument hardware and firmware status.

Do this by querying the condition registers which continuously monitor status. These registers represent the current state of the instrument. Bits in a condition register are updated in real time. When the condition monitored by a particular bit becomes true, the bit is set to 1. When the condition becomes false, the bit is reset to 0.

- Monitor a particular condition (bit).

You can enable a particular bit(s), using the event enable register. The instrument will then monitor that particular condition(s). If the bit becomes true (0 to 1 transition) in the event register, it will stay set until the event register is cleared. Querying the event register allows you to detect that this condition occurred even if the condition no longer exists. The event register can only be cleared by querying it or sending the \*CLS command.

- Monitor a particular type of change in a condition (bit).
  - The transition registers are preset to register if the condition goes from 0 to 1 (false to true, or a positive transition).
  - This can be changed so the selected condition is detected if the bit goes from 1 to 0 (true to false, or a negative transition).
  - It can also be set for both types of transitions occurring.
  - Or it can be set for neither transition. If both transition registers are set to 0 for a particular bit position, that bit will not be set in the event register for either type of change.

### Using a Status Register

Each bit in a register is represented by a numerical value based on its location. See figure below. This number is sent with the command to enable a particular bit. If you want to enable more than one bit, you would send the sum of all the bits that you want to monitor.

Figure: Status Register Bit Values

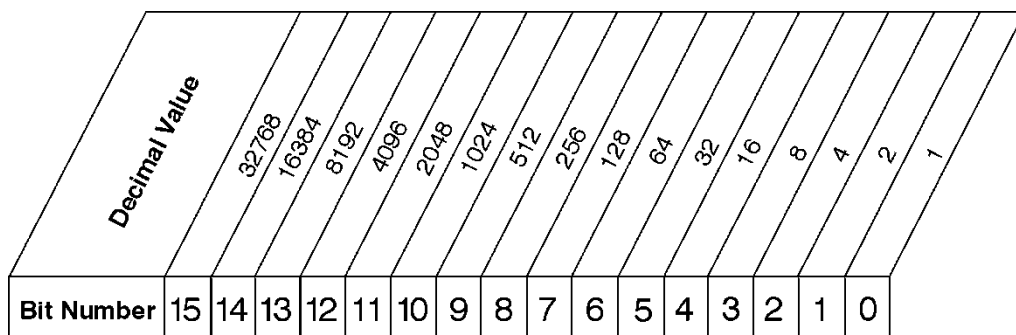

STATus:OPERation:ENABLE < num >  
 STATus:OPERation:ENABLE?

### Standard Operation Event Enable Register

ck730a

Bit 15 is not used to report status.

Example 1:

1. To enable bit 0 and bit 6 of standard event status register, you would send the command \*ESE 65 because 1 + 64 = 65.

2. The results of a query are evaluated in a similar way. If the \*STB? command returns a decimal value of 140, (140 = 128 + 8 + 4) then bit 7 is true, bit 3 is true and bit 2 is true.

Example 2:

1. Suppose you want to know if an Auto-trigger Timeout occurs, but you only cared about that specific condition. So you would want to know what was happening with bit 10 in the Status Questionable Integrity register, and not about any other bits.
2. It's usually a good idea to start by clearing all the status registers with \*CLS.
3. Sending the STAT:QUES:INT:ENAB 1024 command lets you monitor only bit 10 events, instead of the default monitoring all the bits in the register. The register default is for positive transition events (0 to 1 transition). That is, when an auto-trigger timeout occurs. If instead, you wanted to know when the Auto-trigger timeout condition is cleared, then you would set the STAT:QUES:INT:PTR 0 and the STAT:QUES:INT:NTR 32767.
4. So now the only output from the Status Questionable Integrity register will come from a bit 10 positive transition. That output goes to the Integrity Sum bit 9 of the Status Questionable register.
5. You can do a similar thing with this register to only look at bit 9 using, STAT:QUES:ENAB 512.
6. The Status Questionable register output goes to the "Status Questionable Summary" bit 3 of the Status Byte Register. The output from this register can be enabled using the \*SRE 8 command.
7. Finally, you would use the serial polling functionality available for the particular bus/software that you are using to monitor the Status Byte Register. (You could also use \*STB? to poll the Status Byte Register.)

### Using the Service Request (SRQ) Method

Your language, bus, and programming environment must be able to support SRQ interrupts. (For example, BASIC used with VXI-11.3 (GPIB over LAN). When you monitor a condition with the SRQ method, you must:

1. Determine which bit monitors the condition.
2. Determine how that bit reports to the request service (RQS) bit of the status byte.
3. Send SCPI commands to enable the bit that monitors the condition and to enable the summary bits that report the condition to the RQS bit.
4. Enable the controller to respond to service requests.

When the condition changes, the instrument sets its RQS bit. The controller is informed of the change as soon as it occurs. As a result, the time the controller would otherwise have used to monitor the condition can be used to perform other tasks. Your program determines how the controller responds to the SRQ.

### Generating a Service Request

To use the SRQ method, you must understand how service requests are generated. Bit 6 of the status byte register is the request service (RQS) bit. The \*SRE command is used to configure the RQS bit to report changes in instrument status. When such a change occurs, the RQS bit is set. It is cleared when the status byte register is queried using \*SRE? (with a serial poll.) It can be queried without erasing the contents with \*STB?.

When a register set causes a summary bit in the status byte to change from 0 to 1, the instrument can initiate the service request (SRQ) process. However, the process is only initiated if both of the following conditions are true:

- The corresponding bit of the service request enable register is also set to 1.
- The instrument does not have a service request pending. (A service request is considered to be pending between the time the instrument's SRQ process is initiated and the time the controller reads the status byte register.)

The SRQ process sets the SRQ true. It also sets the status byte's request service (RQS) bit to 1. Both actions are necessary to inform the controller that the instrument requires service. Setting the SRQ line only informs the controller that some device on the bus requires service. Setting the RQS bit allows the controller to determine which instrument requires service.

If your program enables the controller to detect and respond to service requests, it should instruct the controller to perform a serial poll when the SRQ is set true. Each device on the bus returns the contents of its status byte register in response to this poll. The device whose RQS bit is set to 1 is the device that requested service.

When you read the instrument's status byte register with a serial poll, the RQS bit is reset to 0. Other bits in the register are not affected.

If the status register is configured to SRQ on end-of-measurement and the measurement is in continuous mode, then restarting a measurement (INIT command) can cause the measuring bit to pulse low. This causes an SRQ when you have not actually reached the "end-of-measurement" condition. To avoid this:

1. Set INITiate:CONTinuous off.
2. Set/enable the status registers.
3. Restart the measurement (send INIT).

## Status Register System

The hardware status registers are combined to form the instrument status system. Specific status bits are assigned to monitor various aspects of the instrument operation and status. See the diagram of the status system above for information about the bit assignments and status register interconnections.



### The Status Byte Register

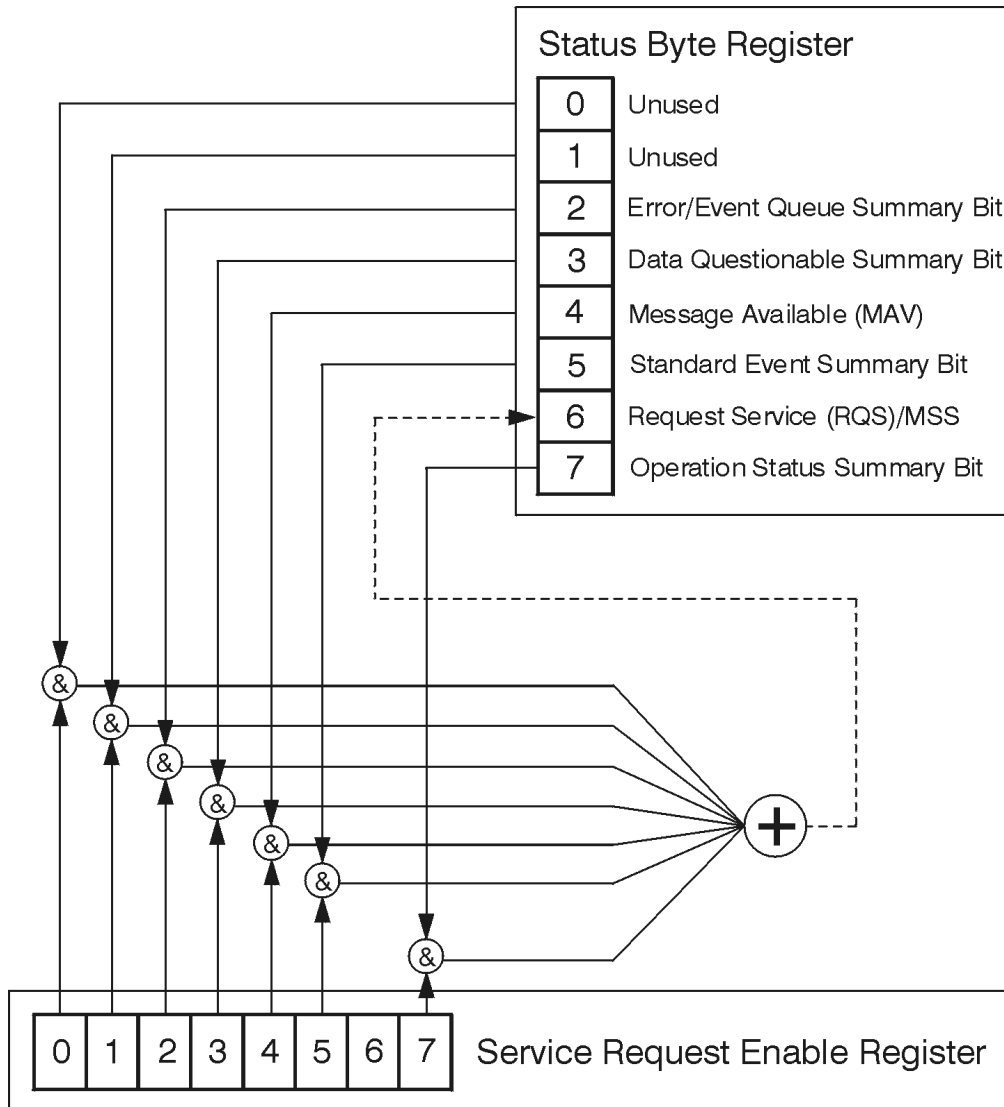

ck776a

The RQS bit is read and reset by a serial poll. The same bit position (MSS) is read, non-destructively by the \*STB? command. If you serial poll bit 6 it is read as RQS, but if you send \*STB it reads bit 6 as MSS. For more information refer to IEEE 488.2 standards, section 11.

	<b>Description</b>	Standard Operation Status Summary Bit	Request Service (RQS) Summary Bit	Standard Event Status Summary Bit	Message Available (MAV)	Data Questionable Status Summary Bit	Error/Event Queue Summary Bit	Unused	Unused
<b>Bit Number</b>	7	6	5	4	3	2	1	0	

\*STB?

**Status Byte Register**

ck725a

Bit	Description
0, 1	These bits are always set to 0.
2	A 1 in this bit position indicates that the SCPI error queue is not empty which means that it contains at least one error message.
3	A 1 in this bit position indicates that the data questionable summary bit has been set. The data questionable event register can then be read to determine the specific condition that caused this bit to be set.
4	A 1 in this bit position indicates that the instrument has data ready in the output queue. There are no lower status groups that provide input to this bit.
5	A 1 in this bit position indicates that the standard event summary bit has been set. The standard event status register can then be read to determine the specific event that caused this bit to be set.
6	A 1 in this bit position indicates that the instrument has at least one reason to report a status change. This bit is also called the master summary status bit (MSS).
7	A 1 in this bit position indicates that the standard operation summary bit has been set. The standard operation event register can then be read to determine the specific condition that caused this bit to be set.

To query the status byte register, send the command \*STB?. The response will be the decimal sum of the bits which are set to 1. For example, if bit number 7 and bit number 3 are set to 1, the decimal sum of the 2 bits is 128 plus 8. So the decimal value 136 is returned. The \*STB command does not clear the status register.

In addition to the status byte register, the status byte group also contains the service request enable register. This register lets you choose which bits in the status byte register will trigger a service request.

Send the \*SRE <integer> command where <integer> is the sum of the decimal values of the bits you want to enable plus the decimal value of bit 6. For example, assume that you want to enable bit 7 so that whenever the standard operation status register summary bit is set to 1 it will trigger a service request. Send the command \*SRE 192 (because 192 = 128 + 64). You must always add 64 (the numeric value of RQS

bit 6) to your numeric sum when you enable any bits for a service request. The command \*SRE? returns the decimal value of the sum of the bits previously enabled with the \*SRE <integer> command.

The service request enable register presets to zeros (0).

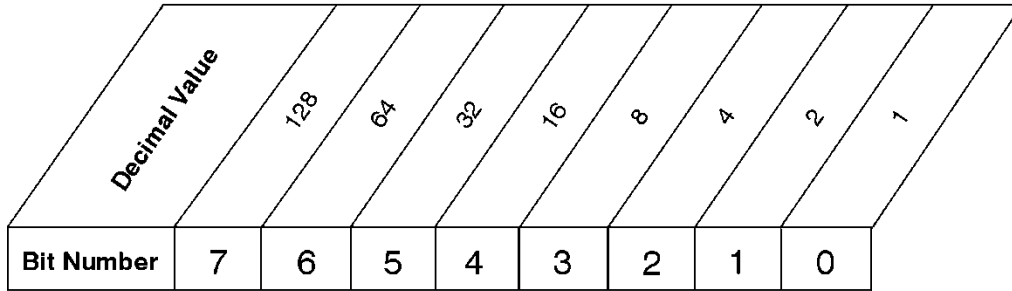

\*SRE <num>  
 \*SRE?

**Service Request Enable Register**

ck726a

**Standard Event Status Register**

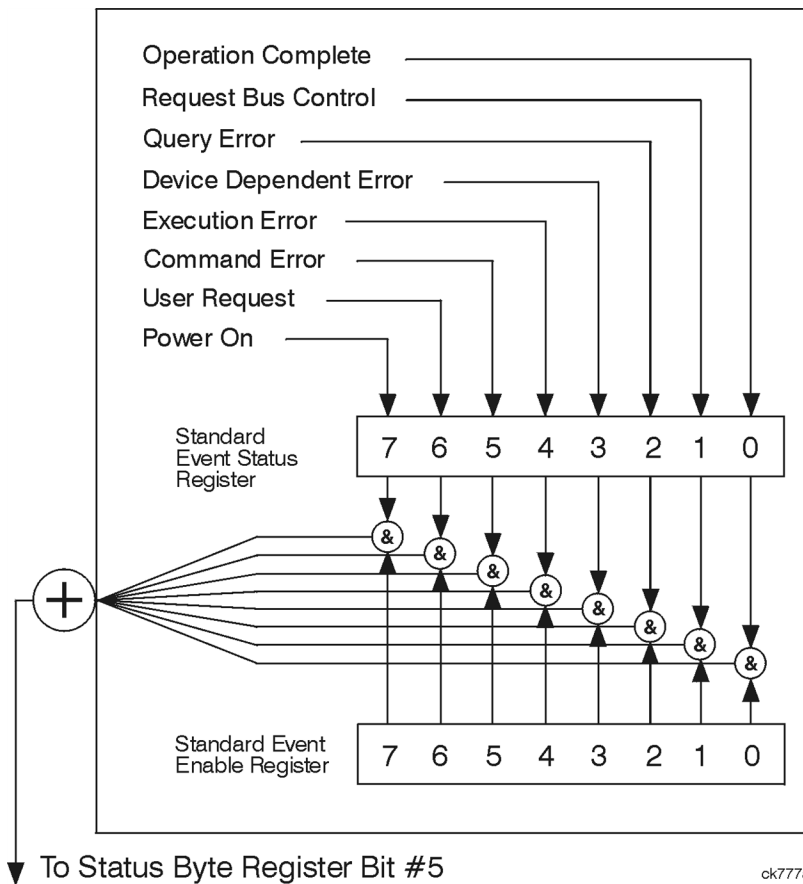

The standard event status register contains the following bits:

<b>Bit Number</b>	<b>7</b>	<b>6</b>	<b>5</b>	<b>4</b>	<b>3</b>	<b>2</b>	<b>1</b>	<b>0</b>	

\*ESR?

**Standard Event Status Register**

ck727a

Bit	Description
0	A 1 in this bit position indicates that all pending operations were completed following execution of the *OPC command.
1	This bit is for GPIB handshaking to request control. Currently it is set to 0 because there are no implementations where the spectrum analyzer controls another instrument.
2	A 1 in this bit position indicates that a query error has occurred. Query errors have SCPI error numbers from -499 to -400.
3	A 1 in this bit position indicates that a device dependent error has occurred. Device dependent errors have SCPI error numbers from -399 to -300 and 1 to 32767.
4	A 1 in this bit position indicates that an execution error has occurred. Execution errors have SCPI error numbers from -299 to -200.
5	A 1 in this bit position indicates that a command error has occurred. Command errors have SCPI error numbers from -199 to -100.
6	A 1 in this bit position indicates that the LOCAL key has been pressed. This is true even if the instrument is in local lockout mode.
7	A 1 in this bit position indicates that the instrument has been turned off and then on.

The standard event status register is used to determine the specific event that set bit 5 in the status byte register. To query the standard event status register, send the command \*ESR?. The response will be the decimal sum of the bits which are enabled (set to 1). For example, if bit number 7 and bit number 3 are enabled, the decimal sum of the 2 bits is 128 plus 8. So the decimal value 136 is returned.

In addition to the standard event status register, the standard event status group also contains a standard event status enable register. This register lets you choose which bits in the standard event status register will set the summary bit (bit 5 of the status byte register) to 1. Send the \*ESE <integer> command where <integer> is the sum of the decimal values of the bits you want to enable. For example, to enable bit 7 and bit 6 so that whenever either of those bits is set to 1, the standard event status summary bit of the status

byte register will be set to 1, send the command \*ESE 192 (128 + 64). The command \*ESE? returns the decimal value of the sum of the bits previously enabled with the \*ESE <integer> command.

The standard event status enable register presets to zeros (0).

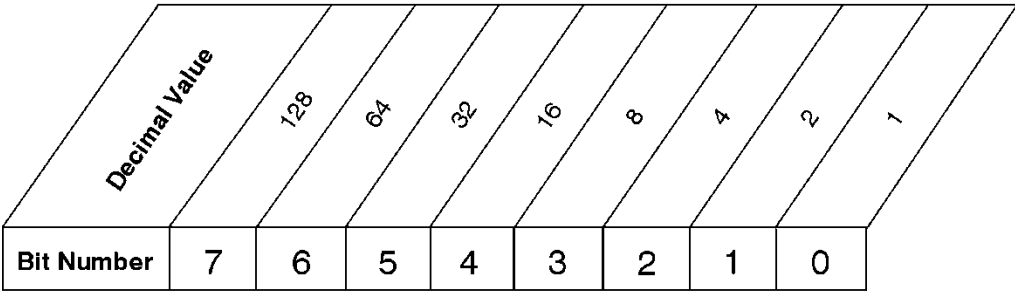

\*ESE <num>  
 \*ESE?

**Standard Event Status Enable Register**

ck728a

**Operation and Questionable Status Registers**

The operation and questionable status registers are registers that monitor the overall instrument condition. They are accessed with the STATUS:OPERation and STATUS:QUESTionable commands in the STATUS command subsystem. See the figure at the beginning of this chapter.

**Operation Status Register**

The operation status register monitors the current instrument measurement state. It checks to see if the instrument is calibrating, sweeping, or waiting for a trigger. For more information see the \*OPC? command located in the IEEE Common Commands section.

Bit	Condition	Operation
0	Calibrating	The instrument is busy executing its Align Now process
3	Sweeping	The instrument is busy taking a sweep.
4	Measuring	The instrument is busy making a measurement. Measurements often require multiple sweeps. They are initiated by keys under the MEASURE key or with the MEASure group of commands.  The bit is valid for most X-Series Modes.
5	Waiting for trigger	The instrument is waiting for the trigger conditions to be met, then it will trigger a sweep or measurement.

**Questionable Status Register**

The questionable status register monitors the instrument's condition to see if anything questionable has happened to it. It is looking for anything that might cause an error or a bad measurement like a hardware problem, an out of calibration situation, or a unusual signal. All the bits are summary bits from lower-level event registers.

Bit	Condition	Operation
-----	-----------	-----------

3	Power summary	The instrument hardware has detected a power unlevelled condition.
4	Temperature summary	The instrument is still warming up.
5	Frequency summary	The instrument hardware has detected an unlocked condition or a problem with the external frequency reference.
8	Calibration summary	The instrument has detected a hardware problem while doing the automatic internal alignment process.
9	Integrity summary	The instrument has detected a questionable measurement condition such as: bad timing, bad signal/data, timeout problem, signal overload, or "meas uncal".

### STATus Subsystem Command Descriptions

The STATus subsystem controls the SCPI-defined instrument status reporting structures. Each status register has a set of five commands used for querying or masking that particular register.

Numeric values for bit patterns can be entered using decimal or hexadecimal representations. (i.e. 0 to 32767 is equivalent to #H0 to #H7FFF. It is also equal to all ones, 11111111111111) See the SCPI Basics information about using bit patterns for variable parameters.

#### Operation Register

"Operation Condition Query" on page 186

"Operation Enable" on page 187

"Operation Event Query" on page 187

"Operation Negative Transition" on page 187

"Operation Positive Transition" on page 188

#### Operation Condition Query

This query returns the decimal value of the sum of the bits in the Status Operation Condition register.

**NOTE** The data in this register is continuously updated and reflects the current conditions.

Mode	All
<b>Remote Command</b>	:STATus:OPERation:CONDition?
<b>Example</b>	STAT:OPER:COND?
Preset	0
Status Bits/OPC dependencies	Sequential command
Initial S/W Revision	Prior to A.02.00

## Operation Enable

This command determines which bits in the Operation Event register, will set the Operation Status Summary bit (bit 7) in the Status Byte Register. The variable <integer> is the sum of the decimal values of the bits you want to enable.

**NOTE**

The preset condition is to have all bits in this enable register set to 0. To have any Operation Events reported to the Status Byte Register, one or more bits need to be set to 1.

Mode	All
<b>Remote Command</b>	:STATus:OPERation:ENABle <integer> :STATus:OPERation:ENABle?
<b>Example</b>	STAT:OPER:ENAB 1 Sets the register so that Align Now operation will be reported to the Status Byte Register.
Preset	0
Min	0
Max	32767
Status Bits/OPC dependencies	Sequential command
Initial S/W Revision	Prior to A.02.00

## Operation Event Query

This query returns the decimal value of the sum of the bits in the Operation Event register.

**NOTE**

The register requires that the associated PTR or NTR filters be set before a condition register bit can set a bit in the event register. The data in this register is latched until it is queried. Once queried, the register is cleared.

Mode	All
<b>Remote Command</b>	:STATus:OPERation[:EVENT]?
<b>Example</b>	STAT:OPER?
Preset	0
Status Bits/OPC dependencies	Sequential command
Initial S/W Revision	Prior to A.02.00

## Operation Negative Transition

This command determines which bits in the Operation Condition register will set the corresponding bit in the Operation Event register when the condition register bit has a negative transition (1 to 0). The variable <integer> is the sum of the decimal values of the bits that you want to enable.

Mode	All
<b>Remote Command</b>	:STATus:OPERation:NTRansition <integer> :STATus:OPERation:NTRansition?
<b>Example</b>	STAT:OPER:NTR 1 Align Now operation complete will be reported to the Status Byte Register.
Preset	0
Min	0
Max	32767
Status Bits/OPC dependencies	Sequential command
Initial S/W Revision	Prior to A.02.00

### Operation Positive Transition

This command determines which bits in the Operation Condition register will set the corresponding bit in the Operation Event register when the condition register bit has a positive transition (0 to 1). The variable <integer> is the sum of the decimal values of the bits that you want to enable.

Mode	All
<b>Remote Command</b>	:STATus:OPERation:PTRansition <integer> :STATus:OPERation:PTRansition?
<b>Example</b>	STAT:OPER:PTR 1 Align Now operation beginning will be reported to the Status Byte Register.
Preset	32767
Min	0
Max	32767
Status Bits/OPC dependencies	Sequential command
Initial S/W Revision	Prior to A.02.00

### Preset the Status Byte

Sets bits in most of the enable and transition registers to their default state. It presets all the Transition Filters, Enable Registers, and the Error/Event Queue Enable. It has no effect on Event Registers, Error/Event QUEUE, IEEE 488.2 ESE, and SRE Registers as described in IEEE Standard 488.2–1992, IEEE Standard Codes, Formats, Protocols, and Common Commands for Use with ANSI/IEEE Std 488.1–1987. New York, NY, 1992.

<b>Remote Command</b>	:STATus:PRESet
<b>Example</b>	STAT:PRES
Initial S/W Revision	Prior to A.02.00



## Questionable Register

"Questionable Condition " on page 189

"Questionable Enable " on page 189

"Questionable Event Query " on page 190

"Questionable Negative Transition " on page 190

"Questionable Positive Transition" on page 190

## Questionable Condition

This query returns the decimal value of the sum of the bits in the Questionable Condition register.

### NOTE

The data in this register is continuously updated and reflects the current conditions.

Mode	All
<b>Remote Command</b>	:STATus:QUEStionable:CONDition?
<b>Example</b>	STAT:QUES:COND?
Preset	0
Status Bits/OPC dependencies	Sequential command
Initial S/W Revision	Prior to A.02.00

## Questionable Enable

This command determines which bits in the Questionable Event register will set the Questionable Status Summary bit (bit3) in the Status Byte Register. The variable <integer> is the sum of the decimal values of the bits you want to enable.

### NOTE

The preset condition is all bits in this enable register set to 0. To have any Questionable Events reported to the Status Byte Register, one or more bits need to be set to 1. The Status Byte Event Register should be queried after each measurement to check the Questionable Status Summary (bit 3). If it is equal to 1, a condition during the test may have made the test results invalid. If it is equal to 0, this indicates that no hardware problem or measurement problem was detected by the analyzer.

Mode	All
<b>Remote Command</b>	:STATus:QUEStionable:ENABle <integer> :STATus:QUEStionable:ENABle?
<b>Example</b>	STAT:OPER:PTR 1 Align Now operation beginning will be reported to the Status Byte Register.
Preset	0
Min	0
Max	32767
Status Bits/OPC dependencies	Sequential command
Initial S/W Revision	Prior to A.02.00

### Questionable Event Query

This query returns the decimal value of the sum of the bits in the Questionable Event register.

**NOTE** The register requires that the associated PTR or NTR filters be set before a condition register bit can set a bit in the event register. The data in this register is latched until it is queried. Once queried, the register is cleared.

Mode	All
Remote Command	:STATus:QUEStionable[:EVENT]?
Example	STAT:QUES?
Preset	0
Status Bits/OPC dependencies	Sequential command
Initial S/W Revision	Prior to A.02.00

### Questionable Negative Transition

This command determines which bits in the Questionable Condition register will set the corresponding bit in the Questionable Event register when the condition register bit has a negative transition (1 to 0). The variable <integer> is the sum of the decimal values of the bits that you want to enable.

Mode	All
Remote Command	:STATus:QUEStionable:NTRansition <integer> :STATus:QUEStionable:NTRansition?
Example	STAT:QUES:NTR 16 Temperature summary 'questionable cleared' will be reported to the Status Byte Register.
Preset	0
Min	0
Max	32767
Status Bits/OPC dependencies	Sequential command
Initial S/W Revision	Prior to A.02.00

### Questionable Positive Transition

This command determines which bits in the Questionable Condition register will set the corresponding bit in the Questionable Event register when the condition register bit has a positive transition (0 to 1). The variable <integer> is the sum of the decimal values of the bits that you want to enable.

Mode	All
------	-----

<b>Remote Command</b>	:STATus:QUESTionable:PTRansition <integer> :STATus:QUESTionable:PTRansition?
<b>Example</b>	STAT:QUES:PTR 16 Temperature summary 'questionable asserted' will be reported to the Status Byte Register.
Preset	32767
Min	0
Max	32767
Status Bits/OPC dependencies	Sequential command
Initial S/W Revision	Prior to A.02.00

## Questionable Calibration Register

"Questionable Calibration Condition " on page 191

"Questionable Calibration Enable " on page 191

"Questionable Calibration Event Query " on page 192

"Questionable Calibration Negative Transition " on page 192

"Questionable Calibration Positive Transition " on page 193

## Questionable Calibration Condition

This query returns the decimal value of the sum of the bits in the Questionable Calibration Condition register.

**NOTE**

The data in this register is continuously updated and reflects the current conditions.

Mode	All
<b>Remote Command</b>	:STATus:QUESTionable:CALibration:CONDition?
<b>Example</b>	STAT:QUES:CAL:COND?
Preset	0
Status Bits/OPC dependencies	Sequential command
Initial S/W Revision	Prior to A.02.00

## Questionable Calibration Enable

This command determines which bits in the Questionable Calibration Condition Register will set bits in the Questionable Calibration Event register, which also sets the Calibration Summary bit (bit 8) in the Questionable Register. The variable <integer> is the sum of the decimal values of the bits you want to enable.

Mode	All
<b>Remote Command</b>	:STATus:QUESTionable:CALibration:ENABLE <integer> :STATus:QUESTionable:CALibration:ENABLE?
<b>Example</b>	STAT:QUES:CAL:ENAB 16384 Can be used to query if an alignment is needed, if you have turned off the automatic alignment process.
Min	0
Max	32767
Status Bits/OPC dependencies	Sequential command
Initial S/W Revision	Prior to A.02.00

### Questionable Calibration Event Query

This query returns the decimal value of the sum of the bits in the Questionable Calibration Event register.

**NOTE**

The register requires that the associated PTR or NTR filters be set before a condition register bit can set a bit in the event register. The data in this register is latched until it is queried. Once queried, the register is cleared.

Mode	All
<b>Remote Command</b>	:STATus:QUESTionable:CALibration[:EVENT]?
<b>Example</b>	STAT:QUES:CAL?
Preset	0
Status Bits/OPC dependencies	Sequential command
Initial S/W Revision	Prior to A.02.00

### Questionable Calibration Negative Transition

This command determines which bits in the Questionable Calibration Condition register will set the corresponding bit in the Questionable Calibration Event register when the condition register bit has a negative transition (1 to 0). The variable <integer> is the sum of the decimal values of the bits that you want to enable.

Mode	All
<b>Remote Command</b>	:STATus:QUESTionable:CALibration:NTRansition <integer> :STATus:QUESTionable:CALibration:NTRansition?
<b>Example</b>	STAT:QUES:CAL:NTR 16384 Alignment is not required.
Preset	0
Min	0

Max	32767
Status Bits/OPC dependencies	Sequential command
Initial S/W Revision	Prior to A.02.00

### Questionable Calibration Positive Transition

This command determines which bits in the Questionable Calibration Condition register will set the corresponding bit in the Questionable Calibration Event register when the condition register bit has a positive transition (0 to 1). The variable <integer> is the sum of the decimal values of the bits that you want to enable.

Mode	All
<b>Remote Command</b>	:STATus:QUESTionable:CALibration:PTRansition <integer> :STATus:QUESTionable:CALibration:PTRansition?
<b>Example</b>	STAT:QUES:CAL:PTR 16384 Alignment is required.
Preset	32767
Min	0
Max	32767
Status Bits/OPC dependencies	Sequential command
Initial S/W Revision	Prior to A.02.00

### Questionable Calibration Skipped Register

"Questionable Calibration Skipped Condition " on page 193

"Questionable Calibration Skipped Enable " on page 194

"Questionable Calibration Skipped Event Query " on page 194

"Questionable Calibration Skipped Negative Transition " on page 195

"Questionable Calibration Skipped Positive Transition " on page 195

### Questionable Calibration Skipped Condition

This query returns the decimal value of the sum of the bits in the Questionable Calibration Skipped Condition register.

**NOTE**

The data in this register is continuously updated and reflects the current conditions.

Mode	All
<b>Remote Command</b>	:STATus:QUESTionable:CALibration:SKIpped:CONDition?

<b>Example</b>	STAT:QUES:CAL:SKIP:COND?
Preset	0
Status Bits/OPC dependencies	Sequential command
Initial S/W Revision	Prior to A.02.00

### Questionable Calibration Skipped Enable

This command determines which bits in the Questionable Calibration Skipped Condition Register will set bits in the Questionable Calibration Skipped Event register, which also sets bit 11 of the Questionable Calibration Register. The variable <integer> is the sum of the decimal values of the bits you want to enable.

Mode	All
<b>Remote Command</b>	:STATus:QUESTionable:CALibration:SKIpped:ENABle <integer> :STATus:QUESTionable:CALibration:SKIpped:ENABle?
<b>Example</b>	STAT:QUES:CAL:SKIP:ENAB 1 Can be used to query if an EMI alignment skipped condition is detected
Preset	32767
Min	0
Max	32767
Status Bits/OPC dependencies	Sequential command
Initial S/W Revision	Prior to A.02.00

### Questionable Calibration Skipped Event Query

This query returns the decimal value of the sum of the bits in the Questionable Calibration Event register.

**NOTE**

The register requires that the associated PTR or NTR filters be set before a condition register bit can set a bit in the event register. The data in this register is latched until it is queried. Once queried, the register is cleared.

Mode	All
<b>Remote Command</b>	:STATus:QUESTionable:CALibration:SKIpped[:EVENT]?
<b>Example</b>	STAT:QUES:CAL:SKIP?
Preset	0
Status Bits/OPC dependencies	Sequential command
Initial S/W Revision	Prior to A.02.00

### Questionable Calibration Skipped Negative Transition

This command determines which bits in the Questionable Calibration Skipped Condition register will set the corresponding bit in the Questionable Calibration Skipped Event register when the condition register bit has a negative transition (1 to 0). The variable <integer> is the sum of the decimal values of the bits that you want to enable.

Mode	All
<b>Remote Command</b>	:STATus:QUEStionable:CALibration:SKIPped:NTRansition <integer> :STATus:QUEStionable:CALibration:SKIPped:NTRansition?
<b>Example</b>	STAT:QUES:CAL:SKIP:NTR 1 Align RF skipped is not required.
Preset	0
Min	0
Max	32767
Status Bits/OPC dependencies	Sequential command
Initial S/W Revision	Prior to A.02.00

### Questionable Calibration Skipped Positive Transition

This command determines which bits in the Questionable Calibration Skipped Condition register will set the corresponding bit in the Questionable Calibration Skipped Event register when the condition register bit has a positive transition (0 to 1). The variable <integer> is the sum of the decimal values of the bits that you want to enable.

Mode	All
<b>Remote Command</b>	:STATus:QUEStionable:CALibration:SKIPped:PTRansition <integer> :STATus:QUEStionable:CALibration:SKIPped:PTRansition?
<b>Example</b>	STAT:QUES:CAL:SKIP:PTR 1 Align RF skipped is required.
Preset	32767
Min	0
Max	32767
Status Bits/OPC dependencies	Sequential command
Initial S/W Revision	Prior to A.02.00

### Questionable Calibration Extended Failure Register

"Questionable Calibration Extended Failure Condition " on page 196

"Questionable Calibration Extended Failure Enable " on page 196

"Questionable Calibration Extended Failure Event Query " on page 196

"Questionable Calibration Extended Failure Negative Transition " on page 197

"Questionable Calibration Extended Failure Positive Transition " on page 197

### Questionable Calibration Extended Failure Condition

This query returns the decimal value of the sum of the bits in the Questionable Calibration Extended Failure Condition register.

**NOTE** The data in this register is continuously updated and reflects the current conditions.

Mode	All
<b>Remote Command</b>	:STATus:QUESTionable:CALibration:EXTended:FAILure:CONDition?
<b>Example</b>	STAT:QUES:CAL:EXT:FAIL:COND?
Preset	0
Status Bits/OPC dependencies	Sequential command
Initial S/W Revision	Prior to A.02.00

### Questionable Calibration Extended Failure Enable

This command determines which bits in the Questionable Calibration Extended Failure Condition Register will set bits in the Questionable Calibration Extended Failure Event register, which also sets bit 9 of the Questionable Calibration Register. The variable <integer> is the sum of the decimal values of the bits you want to enable.

Mode	All
<b>Remote Command</b>	:STATus:QUESTionable:CALibration:EXTended:FAILure:ENABle <integer> :STATus:QUESTionable:CALibration:EXTended:FAILure:ENABle?
<b>Example</b>	STAT:QUES:CAL:EXT:FAIL:ENAB 1 Can be used to query if an EMI conducted alignment is needed.
Preset	32767
Min	0
Max	32767
Status Bits/OPC dependencies	Sequential command
Initial S/W Revision	Prior to A.02.00

### Questionable Calibration Extended Failure Event Query

This query returns the decimal value of the sum of the bits in the Questionable Calibration Extended Failure Event register.

**NOTE** The register requires that the associated PTR or NTR filters be set before a condition register bit can set a bit in the event register. The data in this register is latched until it is queried. Once queried, the register is cleared.



Mode	All
<b>Remote Command</b>	:STATus:QUESTionable:CALibration:EXTended:FAILure[:EVENT]?
<b>Example</b>	STAT:QUES:CAL:EXT:FAIL?
Preset	0
Status Bits/OPC dependencies	Sequential command
Initial S/W Revision	Prior to A.02.00

### Questionable Calibration Extended Failure Negative Transition

This command determines which bits in the Questionable Calibration Extended Failure Condition register will set the corresponding bit in the Questionable Calibration Extended Failure Event register when the condition register bit has a negative transition (1 to 0). The variable <integer> is the sum of the decimal values of the bits that you want to enable.

Mode	All
<b>Remote Command</b>	:STATus:QUESTionable:CALibration:EXTended:FAILure:NTRansition <integer> :STATus:QUESTionable:CALibration:EXTended:FAILure:NTRansition?
<b>Example</b>	STAT:QUES:CAL:EXT:FAIL:NTR 1 EMI conducted align failure is not required.
Preset	0
Min	0
Max	32767
Status Bits/OPC dependencies	Sequential command
Initial S/W Revision	Prior to A.02.00

### Questionable Calibration Extended Failure Positive Transition

This command determines which bits in the Questionable Calibration Extended Failure Condition register will set the corresponding bit in the Questionable Calibration Extended Failure Event register when the condition register bit has a positive transition (0 to 1). The variable <integer> is the sum of the decimal values of the bits that you want to enable.

Mode	All
<b>Remote Command</b>	:STATus:QUESTionable:CALibration:EXTended:FAILure:PTRansition <integer> :STATus:QUESTionable:CALibration:EXTended:FAILure:PTRansition?
<b>Example</b>	STAT:QUES:CAL:EXT:FAIL:PTR 1 EMI conducted align failure is required.
Preset	32767
Min	0
Max	32767

Status Bits/OPC dependencies	Sequential command
Initial S/W Revision	Prior to A.02.00

### Questionable Calibration Extended Needed Register

- "Questionable Calibration Extended Needed Condition " on page 198
- "Questionable Calibration Extended Needed Enable " on page 198
- "Questionable Calibration Extended Needed Event Query " on page 199
- "Questionable Calibration Extended Needed Negative Transition " on page 199
- "Questionable Calibration Extended Needed Positive Transition " on page 200

### Questionable Calibration Extended Needed Condition

This query returns the decimal value of the sum of the bits in the Questionable Calibration Extended Needed Condition register.

**NOTE** The data in this register is continuously updated and reflects the current conditions.

Mode	All
Remote Command	:STATus:QUESTionable:CALibration:EXTended:NEEDed:CONDition?
Example	STAT:QUES:CAL:EXT:NEED:COND?
Preset	0
Status Bits/OPC dependencies	Sequential command
Initial S/W Revision	Prior to A.02.00

### Questionable Calibration Extended Needed Enable

This command determines which bits in the Questionable Calibration Extended Needed Condition Register will set bits in the Questionable Calibration Extended Needed Event register, which also sets bit 14 of the Questionable Calibration Register. The variable <integer> is the sum of the decimal values of the bits you want to enable.

Mode	All
Remote Command	:STATus:QUESTionable:CALibration:EXTended:NEEDed:ENABle <integer> :STATus:QUESTionable:CALibration:EXTended:NEEDed:ENABle?
Example	STAT:QUES:CAL:EXT:NEED:ENAB 2 Can be used to query if an EMI conducted alignment is needed.
Preset	32767
Min	0

Max	32767
Status Bits/OPC dependencies	Sequential command
Initial S/W Revision	Prior to A.02.00

### Questionable Calibration Extended Needed Event Query

This query returns the decimal value of the sum of the bits in the Questionable Calibration Extended Needed Event register.

**NOTE** The register requires that the associated PTR or NTR filters be set before a condition register bit can set a bit in the event register. The data in this register is latched until it is queried. Once queried, the register is cleared.

Mode	All
<b>Remote Command</b>	:STATus:QUESTionable:CALibration:EXTended:NEEDED[:EVENT]?
<b>Example</b>	STAT:QUES:CAL:EXT:NEED?
Preset	0
Status Bits/OPC dependencies	Sequential command
Initial S/W Revision	Prior to A.02.00

### Questionable Calibration Extended Needed Negative Transition

This command determines which bits in the Questionable Calibration Extended Needed Condition register will set the corresponding bit in the Questionable Calibration Extended Needed Event register when the condition register bit has a negative transition (1 to 0). The variable <integer> is the sum of the decimal values of the bits that you want to enable.

Mode	All
<b>Remote Command</b>	:STATus:QUESTionable:CALibration:EXTended:NEEDED:NTRansition <integer> :STATus:QUESTionable:CALibration:EXTended:NEEDED:NTRansition?
<b>Example</b>	STAT:QUES:CAL:EXT:NEED:NTR 2 Align EMI conducted is not required.
Preset	0
Min	0
Max	32767
Status Bits/OPC dependencies	Sequential command
Initial S/W Revision	Prior to A.02.00

### Questionable Calibration Extended Needed Positive Transition

This command determines which bits in the Questionable Calibration Extended Needed Condition register will set the corresponding bit in the Questionable Calibration Extended Needed Event register when the condition register bit has a positive transition (0 to 1). The variable <integer> is the sum of the decimal values of the bits that you want to enable.

Mode	All
<b>Remote Command</b>	:STATus:QUESTionable:CALibration:EXTended:NEEDed:PTRansition <integer> :STATus:QUESTionable:CALibration:EXTended:NEEDed:PTRansition?
<b>Example</b>	STAT:QUES:CAL:EXT:NEED:PTR 2 Align EMI conducted is required.
Preset	32767
Min	0
Max	32767
Status Bits/OPC dependencies	Sequential command
Initial S/W Revision	Prior to A.02.00

### Questionable Frequency Register

"Questionable Frequency Condition " on page 200

"Questionable Frequency Enable " on page 201

"Questionable Frequency Event Query " on page 201

"Questionable Frequency Negative Transition " on page 201

"Questionable Frequency Positive Transition " on page 202

### Questionable Frequency Condition

This query returns the decimal value of the sum of the bits in the Questionable Frequency Condition register.

**NOTE**

The data in this register is continuously updated and reflects the current conditions.

Mode	All
<b>Remote Command</b>	:STATus:QUESTionable:FREQuency:CONDition?
<b>Example</b>	STAT:QUES:FREQ:COND?
Preset	0
Status Bits/OPC dependencies	Sequential command
Initial S/W Revision	Prior to A.02.00

### Questionable Frequency Enable

This command determines which bits in the Questionable Frequency Condition Register will set bits in the Questionable Frequency Event register, which also sets the Frequency Summary bit (bit 5) in the Questionable Register. The variable <integer> is the sum of the decimal values of the bits you want to enable.

Mode	All
<b>Remote Command</b>	:STATus:QUEStionable:FREQuency:ENABle <integer> :STATus:QUEStionable:FREQuency:ENABle?
<b>Example</b>	STAT:QUES:FREQ:ENAB 2 Frequency Reference Unlocked will be reported to the Frequency Summary of the Status Questionable register.
Preset	32767
Min	0
Max	32767
Status Bits/OPC dependencies	Sequential command
Initial S/W Revision	Prior to A.02.00

### Questionable Frequency Event Query

This query returns the decimal value of the sum of the bits in the Questionable Frequency Event register.

**NOTE** The register requires that the associated PTR or NTR filters be set before a condition register bit can set a bit in the event register. The data in this register is latched until it is queried. Once queried, the register is cleared.

Mode	All
<b>Remote Command</b>	:STATus:QUEStionable:FREQuency[:EVENT]?
<b>Example</b>	STAT:QUES:FREQ?
Preset	0
Status Bits/OPC dependencies	Sequential command
Initial S/W Revision	Prior to A.02.00

### Questionable Frequency Negative Transition

This command determines which bits in the Questionable Frequency Condition register will set the corresponding bit in the Questionable Frequency Event register when the condition register bit has a negative transition (1 to 0). The variable <integer> is the sum of the decimal values of the bits that you want to enable.

Mode	All
------	-----

<b>Remote Command</b>	:STATus:QUESTionable:FREQuency:NTRansition <integer> :STATus:QUESTionable:FREQuency:NTRansition?
<b>Example</b>	STAT:QUES:FREQ:NTR 2 Frequency Reference 'regained lock' will be reported to the Frequency Summary of the Status Questionable register.
Preset	0
Min	0
Max	32767
Status Bits/OPC dependencies	Sequential command
Initial S/W Revision	Prior to A.02.00

### Questionable Frequency Positive Transition

This command determines which bits in the Questionable Frequency Condition register will set the corresponding bit in the Questionable Frequency Event register when the condition register bit has a positive transition (0 to 1). The variable <integer> is the sum of the decimal values of the bits that you want to enable.

Mode	All
<b>Remote Command</b>	:STATus:QUESTionable:FREQuency:PTRansition <integer> :STATus:QUESTionable:FREQuency:PTRansition?
<b>Example</b>	STAT:QUES:FREQ:PTR 2 Frequency Reference 'became unlocked' will be reported to the Frequency Summary of the Status Questionable register.
Preset	32767
Min	0
Max	32767
Status Bits/OPC dependencies	Sequential command
Initial S/W Revision	Prior to A.02.00

### Questionable Integrity Register

"Questionable Integrity Condition " on page 202

"Questionable Integrity Enable " on page 203

"Questionable Integrity Event Query " on page 203

"Questionable Integrity Negative Transition " on page 204

"Questionable Integrity Positive Transition " on page 204

### Questionable Integrity Condition

This query returns the decimal value of the sum of the bits in the Questionable Integrity Condition register.

**NOTE**

The data in this register is continuously updated and reflects the current conditions.

Mode	All
<b>Remote Command</b>	:STATus:QUESTionable:INTEgrity:CONDition?
<b>Example</b>	STAT:QUES:INT:COND?
Preset	0
Status Bits/OPC dependencies	Sequential command
Initial S/W Revision	Prior to A.02.00

### Questionable Integrity Enable

This command determines which bits in the Questionable Integrity Condition Register will set bits in the Questionable Integrity Event register, which also sets the Integrity Summary bit (bit 9) in the Questionable Register. The variable <integer> is the sum of the decimal values of the bits you want to enable.

Mode	All
<b>Remote Command</b>	:STATus:QUESTionable:INTEgrity:ENABle <integer> :STATus:QUESTionable:INTEgrity:ENABle?
<b>Example</b>	STAT:QUES:INT:ENAB 8 Measurement Uncalibrated Summary will be reported to the Integrity Summary of the Status Questionable register.
Preset	32767
Min	0
Max	32767
Status Bits/OPC dependencies	Sequential command
Initial S/W Revision	Prior to A.02.00

### Questionable Integrity Event Query

This query returns the decimal value of the sum of the bits in the Questionable Integrity Event register.

**NOTE**

The register requires that the associated PTR or NTR filters be set before a condition register bit can set a bit in the event register. The data in this register is latched until it is queried. Once queried, the register is cleared.

Mode	All
<b>Remote Command</b>	:STATus:QUESTionable:INTEgrity[:EVENT]?
<b>Example</b>	STAT:QUES:INT?
Preset	0
Status Bits/OPC dependencies	Sequential command
Initial S/W Revision	Prior to A.02.00

### Questionable Integrity Negative Transition

This command determines which bits in the Questionable Integrity Condition register will set the corresponding bit in the Questionable Integrity Event register when the condition register bit has a negative transition (1 to 0)

The variable <integer> is the sum of the decimal values of the bits that you want to enable.

<b>Mode</b>	All
<b>Remote Command</b>	:STATus:QUEStionable:INTEgrity:NTRansition <integer> :STATus:QUEStionable:INTEgrity:NTRansition?
<b>Example</b>	STAT:QUES:INT:NTR 8 Measurement 'regained calibration' Summary will be reported to the Integrity Summary of the Status Questionable register.
Preset	0
Min	0
Max	32767
Status Bits/OPC dependencies	Sequential command
Initial S/W Revision	Prior to A.02.00

### Questionable Integrity Positive Transition

This command determines which bits in the Questionable Integrity Condition register will set the corresponding bit in the Questionable Integrity Event register when the condition register bit has a positive transition (0 to 1). The variable <integer> is the sum of the decimal values of the bits that you want to enable.

<b>Mode</b>	All
<b>Remote Command</b>	:STATus:QUEStionable:INTEgrity:PTRansition <integer> :STATus:QUEStionable:INTEgrity:PTRansition?
<b>Example</b>	STAT:QUES:INT:PTR 8 Measurement 'became uncalibrated' Summary will be reported to the Integrity Summary of the Status Questionable register.
Preset	32767
Min	0
Max	32767
Status Bits/OPC dependencies	Sequential command
Initial S/W Revision	Prior to A.02.00

### Questionable Integrity Signal Register

"Questionable Integrity Signal Condition" on page 205



"Questionable Integrity Signal Enable" on page 205

"Questionable Integrity Signal Event Query" on page 206

"Questionable Integrity Signal Negative Transition" on page 206

"Questionable Integrity Signal Positive Transition" on page 206

### Questionable Integrity Signal Condition

This query returns the decimal value of the sum of the bits in the Questionable Integrity Signal Condition register.

<b>NOTE</b>	The data in this register is continuously updated and reflects the current conditions.
<b>Mode</b>	All
<b>Remote Command</b>	:STATus:QUEStionable:INTEgrity:SIGNal:CONDition?
<b>Example</b>	STAT:QUES:INT:SIGN:COND?
<b>Preset</b>	0
<b>Status Bits/OPC dependencies</b>	Sequential command
<b>Initial S/W Revision</b>	Prior to A.02.00

### Questionable Integrity Signal Enable

This command determines which bits in the Questionable Integrity Signal Condition Register will set bits in the Questionable Integrity Signal Event register, which also sets the Integrity Summary bit (bit 9) in the Questionable Register. The variable <integer> is the sum of the decimal values of the bits you want to enable.

<b>Mode</b>	All
<b>Remote Command</b>	:STATus:QUEStionable:INTEgrity:SIGNal:ENABle <integer> :STATus:QUEStionable:INTEgrity:SIGNal:ENABle?
<b>Example</b>	STAT:QUES:INT:SIGN:ENAB 4 Burst Not Found will be reported to the Integrity Summary of the Status Questionable register.
<b>Preset</b>	32767
<b>Min</b>	0
<b>Max</b>	32767
<b>Status Bits/OPC dependencies</b>	Sequential command
<b>Initial S/W Revision</b>	Prior to A.02.00

### Questionable Integrity Signal Event Query

This query returns the decimal value of the sum of the bits in the Questionable Integrity Signal Event register.

**NOTE** The register requires that the associated PTR or NTR filters be set before a condition register bit can set a bit in the event register. The data in this register is latched until it is queried. Once queried, the register is cleared.

Mode	All
<b>Remote Command</b>	:STATus:QUESTionable:INTEgrity:SIGNal[:EVENT]?
<b>Example</b>	STAT:QUES:INT:SIGN?
Preset	0
Status Bits/OPC dependencies	Sequential command
Initial S/W Revision	Prior to A.02.00

### Questionable Integrity Signal Negative Transition

This command determines which bits in the Questionable Integrity Signal Condition register will set the corresponding bit in the Questionable Integrity Signal Event register when the condition register bit has a negative transition (1 to 0). The variable <integer> is the sum of the decimal values of the bits that you want to enable.

Mode	All
<b>Remote Command</b>	:STATus:QUESTionable:INTEgrity:SIGNal:NTRansition <integer> :STATus:QUESTionable:INTEgrity:SIGNal:NTRansition?
<b>Example</b>	STAT:QUES:INT:SIGN:NTR 4 Burst found will be reported to the Integrity Summary of the Status Questionable register.
Preset	0
Min	0
Max	32767
Status Bits/OPC dependencies	Sequential command
Initial S/W Revision	Prior to A.02.00

### Questionable Integrity Signal Positive Transition

This command determines which bits in the Questionable Integrity Signal Condition register will set the corresponding bit in the Questionable Integrity Signal Event register when the condition register bit has a positive transition (0 to 1). The variable <integer> is the sum of the decimal values of the bits that you want to enable.

Mode	All
<b>Remote Command</b>	:STATus:QUEStionable:INTEgrity:SIGNal:PTRansition <integer> :STATus:QUEStionable:INTEgrity:SIGNal:PTRansition?
<b>Example</b>	STAT:QUES:INT:SIGN:PTR 4 Burst not found will be reported to the Integrity Summary of the Status Questionable register.
Preset	32767
Min	0
Max	32767
Status Bits/OPC dependencies	Sequential command
Initial S/W Revision	Prior to A.02.00

### Questionable Integrity Uncalibrated Register

"Questionable Integrity Uncalibrated Condition " on page 207

"Questionable Integrity Uncalibrated Enable " on page 207

"Questionable Integrity Uncalibrated Event Query " on page 208

"Questionable Integrity Uncalibrated Negative Transition " on page 208

"Questionable Integrity Uncalibrated Positive Transition " on page 209

### Questionable Integrity Uncalibrated Condition

This query returns the decimal value of the sum of the bits in the Questionable Integrity Uncalibrated Condition register.

#### NOTE

The data in this register is continuously updated and reflects the current conditions.

Mode	All
<b>Remote Command</b>	:STATus:QUEStionable:INTEgrity:UNCalibrated:CONDition?
<b>Example</b>	STAT:QUES:INT:UNC:COND?
Preset	0
Status Bits/OPC dependencies	Sequential command
Initial S/W Revision	Prior to A.02.00

### Questionable Integrity Uncalibrated Enable

This command determines which bits in the Questionable Integrity Uncalibrated Condition Register will set bits in the Questionable Integrity Uncalibrated Event register, which also sets the Data Uncalibrated Summary bit (bit 3) in the Questionable Integrity Register. The variable <integer> is the sum of the decimal values of the bits you want to enable.

Mode	All
Remote Command	:STATus:QUEStionable:INTEgrity:UNCalibrated:ENABle :STATus:QUEStionable:INTEgrity:UNCalibrated:ENABle?
Example	STAT:QUES:INT:UNC:ENAB 1 Oversweep (Meas Uncal) will be reported to the Integrity Summary of the Status Questionable register.
Preset	32767
Min	0
Max	32767
Status Bits/OPC dependencies	Sequential command
Initial S/W Revision	Prior to A.02.00

### Questionable Integrity Uncalibrated Event Query

This query returns the decimal value of the sum of the bits in the Questionable Integrity Uncalibrated Event register.

**NOTE**

The register requires that the associated PTR or NTR filters be set before a condition register bit can set a bit in the event register. The data in this register is latched until it is queried. Once queried, the register is cleared.

Mode	All
Remote Command	:STATus:QUEStionable:INTEgrity:UNCalibrated[:EVENT]?
Example	STAT:QUES:INT:UNC?
Preset	0
Status Bits/OPC dependencies	Sequential command
Initial S/W Revision	Prior to A.02.00

### Questionable Integrity Uncalibrated Negative Transition

This command determines which bits in the Questionable Integrity Uncalibrated Condition register will set the corresponding bit in the Questionable Integrity Uncalibrated Event register when the condition register bit has a negative transition (1 to 0). The variable <integer> is the sum of the decimal values of the bits that you want to enable.

Mode	All
Remote Command	:STATus:QUEStionable:INTEgrity:UNCalibrated:NTRansition <integer> :STATus:QUEStionable:INTEgrity:UNCalibrated:NTRansition?
Example	STAT:QUES:INT:UNC:NTR 1 Oversweep cleared will be reported to the Integrity Summary of the Status Questionable register.

Preset	0
Min	0
Max	32767
Status Bits/OPC dependencies	Sequential command
Initial S/W Revision	Prior to A.02.00

### Questionable Integrity Uncalibrated Positive Transition

This command determines which bits in the Questionable Integrity Uncalibrated Condition register will set the corresponding bit in the Questionable Integrity Uncalibrated Event register when the condition register bit has a positive transition (0 to 1). The variable <integer> is the sum of the decimal values of the bits that you want to enable.

Mode	All
<b>Remote Command</b>	:STATus:QUEStionable:INTEgrity:UNCalibrated:PTRansition <integer> :STATus:QUEStionable:INTEgrity:UNCalibrated:PTRansition?
<b>Example</b>	STAT:QUES:INT:UNC:PTR 1 Oversweep (Meas Uncal) occurred will be reported to the Integrity Summary of the Status Questionable register.
Preset	32767
Min	0
Max	32767
Status Bits/OPC dependencies	Sequential command
Initial S/W Revision	Prior to A.02.00

### Questionable Power Register

"Questionable Power Condition " on page 209

"Questionable Power Enable " on page 210

"Questionable Power Event Query " on page 210

"Questionable Power Negative Transition " on page 211

"Questionable Power Positive Transition " on page 211

### Questionable Power Condition

This query returns the decimal value of the sum of the bits in the Questionable Power Condition register.

#### NOTE

The data in this register is continuously updated and reflects the current conditions.

Mode	All
<b>Remote Command</b>	:STATus:QUEStionable:POWer:CONDition?
<b>Example</b>	STAT:QUES:POW:COND?
Preset	0
Status Bits/OPC dependencies	Sequential command
Initial S/W Revision	Prior to A.02.00

### Questionable Power Enable

This command determines which bits in the Questionable Power Condition Register will set bits in the Questionable Power Event register, which also sets the Power Summary bit (bit 3) in the Questionable Register. The variable <integer> is the sum of the decimal values of the bits you want to enable.

Mode	All
<b>Remote Command</b>	:STATus:QUEStionable:POWer:ENABle <integer> :STATus:QUEStionable:POWer:ENABle?
<b>Example</b>	STAT:QUES:POW:ENAB 32 50 MHz Input Pwr too High for Cal will be reported to the Power Summary of the Status Questionable register.
Preset	32767
Min	0
Max	32767
Status Bits/OPC dependencies	Sequential command
Initial S/W Revision	Prior to A.02.00

### Questionable Power Event Query

This query returns the decimal value of the sum of the bits in the Questionable Power Event register.

**NOTE**

The register requires that the associated PTR or NTR filters be set before a condition register bit can set a bit in the event register. The data in this register is latched until it is queried. Once queried, the register is cleared.

Mode	All
<b>Remote Command</b>	:STATus:QUEStionable:POWer[:EVENT]?
<b>Example</b>	STAT:QUES:POW?
Preset	0
Status Bits/OPC dependencies	Sequential command
Initial S/W Revision	Prior to A.02.00

### Questionable Power Negative Transition

This command determines which bits in the Questionable Power Condition register will set the corresponding bit in the Questionable Power Event register when the condition register bit has a negative transition (1 to 0). The variable <integer> is the sum of the decimal values of the bits that you want to enable.

Mode	All
<b>Remote Command</b>	:STATus:QUESTionable:POWer:NTRansition <integer> :STATus:QUESTionable:POWer:NTRansition?
<b>Example</b>	STAT:QUES:POW:NTR 32 50 MHz Input Power became OK for Cal will be reported to the Power Summary of the Status Questionable register.
Preset	0
Min	0
Max	32767
Status Bits/OPC dependencies	Sequential command
Initial S/W Revision	Prior to A.02.00

### Questionable Power Positive Transition

This command determines which bits in the Questionable Power Condition register will set the corresponding bit in the Questionable Power Event register when the condition register bit has a positive transition (0 to 1). The variable <integer> is the sum of the decimal values of the bits that you want to enable.

Mode	All
<b>Remote Command</b>	:STATus:QUESTionable:POWer:PTRansition <integer> :STATus:QUESTionable:POWer:PTRansition?>
<b>Example</b>	STAT:QUES:POW:PTR 32 50 MHz Input Power became too high for Cal will be reported to the Power Summary of the Status Questionable register.
Preset	32767
Min	0
Max	32767
Status Bits/OPC dependencies	Sequential command
Initial S/W Revision	Prior to A.02.00

### Questionable Temperature Register

"Questionable Temperature Condition" on page 212

"Questionable Temperature Enable" on page 212

"Questionable Temperature Event Query" on page 212

"Questionable Temperature Negative Transition" on page 213

"Questionable Temperature Positive Transition" on page 213

### Questionable Temperature Condition

This query returns the decimal value of the sum of the bits in the Questionable Temperature Condition register.

**NOTE**

The data in this register is continuously updated and reflects the current conditions.

Mode	All
<b>Remote Command</b>	:STATus:QUESTionable:TEMPerature:CONDition?
<b>Example</b>	STAT:QUES:TEMP:COND?
Preset	0
Status Bits/OPC dependencies	Sequential command
Initial S/W Revision	Prior to A.02.00

### Questionable Temperature Enable

This command determines which bits in the Questionable Temperature Condition Register will set bits in the Questionable Temperature Event register, which also sets the Temperature Summary bit (bit 4) in the Questionable Register. The variable <integer> is the sum of the decimal values of the bits you want to enable.

Mode	All
<b>Remote Command</b>	:STATus:QUESTionable:TEMPerature:ENABle <integer> :STATus:QUESTionable:TEMPerature:ENABle?
<b>Example</b>	STAT:QUES:TEMP:ENAB 1 Reference Oscillator Oven Cold will be reported to the Temperature Summary of the Status Questionable register.
Preset	32767
Min	0
Max	32767
Status Bits/OPC dependencies	Sequential command
Initial S/W Revision	Prior to A.02.00

### Questionable Temperature Event Query

This query returns the decimal value of the sum of the bits in the Questionable Temperature Event register.



**NOTE**

The register requires that the associated PTR or NTR filters be set before a condition register bit can set a bit in the event register. The data in this register is latched until it is queried. Once queried, the register is cleared

Mode	All
<b>Remote Command</b>	:STATus:QUEStionable:TEMPerature[:EVENT]?
<b>Example</b>	STAT:QUES:TEMP?
Preset	0
Status Bits/OPC dependencies	Sequential command
Initial S/W Revision	Prior to A.02.00

### Questionable Temperature Negative Transition

This command determines which bits in the Questionable Temperature Condition register will set the corresponding bit in the Questionable Temperature Event register when the condition register bit has a negative transition (1 to 0). The variable <integer> is the sum of the decimal values of the bits that you want to enable.

Mode	All
<b>Remote Command</b>	:STATus:QUEStionable:TEMPerature:NTRansition <integer> :STATus:QUEStionable:TEMPerature:NTRansition?
<b>Example</b>	STAT:QUES:TEMP:NTR 1 Reference Oscillator Oven not cold will be reported to the Temperature Summary of the Status Questionable register.
Preset	0
Min	0
Max	32767
Status Bits/OPC dependencies	Sequential command
Initial S/W Revision	Prior to A.02.00

### Questionable Temperature Positive Transition

This command determines which bits in the Questionable Temperature Condition register will set the corresponding bit in the Questionable Temperature Event register when the condition register bit has a positive transition (0 to 1). The variable <integer> is the sum of the decimal values of the bits that you want to enable.

Mode	All
<b>Remote Command</b>	:STATus:QUEStionable:TEMPerature:PTRansition <integer> :STATus:QUEStionable:TEMPerature:PTRansition?
<b>Example</b>	STAT:QUES:TEMP:PTR 1 Reference Oscillator Oven became cold will be reported to the

---

	Temperature Summary of the Status Questionable register.
Preset	32767
Min	0
Max	32767
Status Bits/OPC dependencies	Sequential command
Initial S/W Revision	Prior to A.02.00

---

## IEEE 488.2 Common Commands

The instrument supports the following subset of IEEE 488.2 Common Commands, as defined in Chapter 10 of [IEEE Standard 488.2–1992](#). As indicated in the detailed descriptions, some of these commands correspond directly to instrument front-panel key functionality, while others are available only as remote commands.

Command	Description
*CAL?	Align Now "All " on page 381
*CLS	"Clear Status " on page 217
*ESE	"Standard Event Status Enable " on page 217
*ESE?	
*ESR?	"Standard Event Status Register Query " on page 218
*IDN?	"Identification Query " on page 218
*OPC	"Operation Complete " on page 219
*OPC?	
*OPT?	"Query Instrument Options " on page 220
*RCL	"Recall Instrument State " on page 220
*RST	"*RST (Remote Command Only)" on page 221
*SAV	"Save Instrument State " on page 221
*SRE	"Service Request Enable " on page 221
*SRE?	
*STB?	"Status Byte Query " on page 222
*TRG	"Trigger " on page 222
*TST?	"Self Test Query " on page 222
*WAI	"Wait-to-Continue " on page 223

### All

(In MXE the key label is "All (plus RF Presel 20 Hz – 3.6 GHz)")Immediately executes an alignment of all subsystems In MXE, the Align Now All is followed by additionally aligning the RF Preselector section, so in MXE, the key label contains the parenthetical note "(plus RF Presel 20 Hz – 3.6 GHz)". The instrument stops any measurement currently underway, performs the alignment, then restarts the measurement from the beginning (similar to pressing the Restart key).

If an interfering user signal is present at the RF Input, the alignment is performed on all subsystems except the RF. After completion, the Error Condition message "Align skipped: 50 MHz interference" or "Align skipped: 4.8 GHz interference" is generated. In addition the Error Condition message "Align Now, RF required" is generated, and bits 11 and 12 are set in the Status Questionable Calibration register.

The query form of the remote commands (:CALibration[:ALL]? or \*CAL?) invokes the alignment of all subsystems and returns a success or failure value. An interfering user signal is not grounds for failure; if the

alignment was able to succeed on all portions but unable to align the RF because of an interfering signal, the resultant will be the success value.

Successful completion of Align Now, All will clear the “Align Now, All required” Error Condition, and clear bit 14 in the Status Questionable Calibration register. It will also begin the elapsed time counter for Last Align Now, All Time, and capture the Last Align Now, All Temperature.

In the MXE, successful completion will also clear the “Align 20 Hz to 30 MHz required” Error Condition, the “Align 30 MHz to 3.6 GHz required” Error Condition, and the “Align 20 Hz to 3.6 GHz required” Error Condition, and clear bits 1 and bit 2 and clear the bit 1 in the Status Questionable Calibration Extended Needed register.

If the Align RF subsystem succeeded in aligning (no interfering signal present), the elapsed time counter begins for Last Align Now, RF Time, and the temperature is captured for the Last Align Now, RF Temperature. In addition the Error Conditions “Align skipped: 50 MHz interference” and “Align skipped: 4.8 GHz interference” are cleared, the Error Condition “Align Now, RF required” is cleared, and bits 11 and 12 are cleared in the Status Questionable Calibration register

Align Now, All can be interrupted by pressing the Cancel (ESC) front-panel key or remotely with Device Clear followed by the :ABORt SCPI command. When this occurs the Error Condition message “Align Now, All required” is generated, and bit 14 is set in the Status Questionable Condition register. This is because new alignment data may be employed for an individual subsystem, but not a cohesive set of data for all subsystems.

In many cases, you might find it more convenient to change alignments to Normal, instead of executing Align Now, All. When the Auto Align process transitions to Normal, the analyzer will immediately start to update only the alignments that have expired, thus efficiently restoring the alignment process.

<b>Key Path</b>	System, Alignments, Align Now
<b>Mode</b>	All
<b>Remote Command</b>	:CALibration[:ALL] :CALibration[:ALL]?
<b>Example</b>	:CAL
<b>Notes</b>	:CALibration[:ALL]? returns 0 if successful :CALibration[:ALL]? returns 1 if failed :CALibration[:ALL]? is the same as *CAL? While Align Now, All is performing the alignment, bit 0 in the Status Operation register is set. Completion, or termination, will clear bit 0 in the Status Operation register. This command is sequential; it must complete before further SCPI commands are processed. Interrupting the alignment from remote is accomplished by invoking Device Clear followed by the :ABORt command. Successful completion will clear bit 14 in the Status Questionable Calibration register. An interfering user signal is not grounds for failure of Align Now, All. However, bits 11 and 12 are set in the Status Questionable Calibration register to indicate Align Now, RF is required. An interfering user supplied signal will result in the instrument requiring an Align Now, RF with the interfering signal removed.
<b>Couplings</b>	Initializes the time for the Last Align Now, All Time. Records the temperature for the Last Align Now, All Temperature.

	If Align RF component succeeded, initializes the time for the Last Align Now, RF Time. If Align RF component succeeded, records the temperature for the Last Align Now, RF Temperature.
Status Bits/OPC dependencies	Bits 11, 12, or 14 may be set in the Status Questionable Calibration register.
Initial S/W Revision	Prior to A.02.00

Mode	All
<b>Remote Command</b>	*CAL?
<b>Example</b>	*CAL?
Notes	*CAL? returns 0 if successful *CAL? returns 1 if failed :CALibration[:ALL]? is the same as *CAL? See additional remarks described with :CALibration[:ALL]? Everything about :CALibration[:ALL]? is synonymous with *CAL? including all conditions, status register bits, and couplings
Initial S/W Revision	Prior to A.02.00

## Clear Status

Clears the status byte register. It does this by emptying the error queue and clearing all bits in all of the event registers. The status byte register summarizes the states of the other registers. It is also responsible for generating service requests.

Key Path	No equivalent key. Related key System, Show Errors, Clear Error Queue
<b>Remote Command</b>	*CLS
<b>Example</b>	*CLS Clears the error queue and the Status Byte Register.
Notes	For related commands, see the SYSTem:ERRor[:NEXT]? command. See also the STATus:PRESet command and all commands in the STATus subsystem.
Status Bits/OPC dependencies	Resets all bits in all event registers to 0, which resets all the status byte register bits to 0 also.
Backwards Compatibility Notes	In general the status bits used in the X-Series status system will be backwards compatible with ESA and PSA. However, note that all conditions will generate events that go into the event log, and some will also generate status bits.
Initial S/W Revision	Prior to A.02.00

## Standard Event Status Enable

Selects the desired bits from the standard event status enable register. This register monitors I/O errors and synchronization conditions such as operation complete, request control, query error, device

dependent error, status execution error, command error, and power on. The selected bits are OR'd to become a summary bit (bit 5) in the byte register which can be queried.

The query returns the state of the standard event status enable register.

Key Path	No equivalent key. Related key System, Show Errors, Clear Error Queue
Remote Command	*ESE <integer> *ESE?
Example	*ESE 36 Enables the Standard Event Status Register to monitor query and command errors (bits 2 and 5). *ESE? Returns a 36 indicating that the query and command status bits are enabled.
Notes	For related commands, see the STATus subsystem and SYSTem:ERRor[:NEXT]? commands.
Preset	255
State Saved	Not saved in state.
Min	0
Max	255
Status Bits/OPC dependencies	Event Enable Register of the Standard Event Status Register.
Initial S/W Revision	Prior to A.02.00

### Standard Event Status Register Query

Queries and clears the standard event status event register. (This is a destructive read.) The value returned is a hexadecimal number that reflects the current state (0/1) of all the bits in the register.

Remote Command	*ESR?
Example	*ESR? Returns a 1 if there is either a query or command error, otherwise it returns a zero.
Notes	For related commands, see the STATus subsystem commands.
Preset	0
Min	0
Max	255
Status Bits/OPC dependencies	Standard Event Status Register (bits 0 - 7).
Initial S/W Revision	Prior to A.02.00

### Identification Query

Returns a string of instrument identification information. The string will contain the model number, serial number, and firmware revision.

The response is organized into four fields separated by commas. The field definitions are as follows:

- Manufacturer

- Model
- Serial number
- Firmware version

Key Path	No equivalent key. See related key System, Show System.
Remote Command	*IDN?
Example	*IDN? Returns instrument identification information, such as: Keysight Technologies, N9020A, US01020004, A.01.02
Initial S/W Revision	Prior to A.02.00

## Operation Complete

The \*OPC command sets bit 0 in the standard event status register (SER) to “1” when pending operations have finished, that is when all overlapped commands are complete. It does not hold off subsequent operations. You can determine when the overlapped commands have completed either by polling the OPC bit in SER, or by setting up the status system such that a service request (SRQ) is asserted when the OPC bit is set.

The \*OPC? query returns a “1” after all the current overlapped commands are complete. So it holds off subsequent commands until the “1” is returned, then the program continues. This query can be used to synchronize events of other instruments on the external bus.

Remote Command	*OPC *OPC?
Example	INIT:CONT 0 Selects single sweeping. INIT:IMM Initiates a sweep. *OPC? Holds off any further commands until the sweep is complete.
Status Bits/OPC dependencies	Not global to all remote ports or front panel. *OPC only considers operation that was initiated on the same port as the *OPC command was issued from. *OPC is an overlapped command, but *OPC? is sequential.
Backwards Compatibility Notes	<ol style="list-style-type: none"> <li>1. The ESA/PSA/VSA products do not meet all the requirements for the *OPC command specified by IEEE 488.2. This is corrected for X-Series. This will sometimes cause behavior that is not backward compatible, but it will work as customers expect.</li> <li>2. Commands such as, *OPC/*OPC?/*WAI/*RST used to be global. They considered front panel operation in conjunction with the GPIB functionality. Now they are evaluated on a per channel basis. That is, the various rear panel remote ports and the front panel i/o are all considered separately. Only the functionality initiated on the port where the *OPC was sent, is considered for its operation.</li> <li>3. *OPC used to hold off until the operation bits were cleared. Now it holds off until all overlapping commands are completed. Also, earlier instruments did not wait for completion of all processes, only the ones identified here (in the STATus:OPERation register): Calibrating: monitored by PSA, ESA, VSA (E4406A) Sweeping: monitored by PSA, ESA, VSA (E4406A) Waiting for Trigger: monitored by PSA, ESA, VSA (E4406A)</li> </ol>

	Measuring: monitored by PSA and ESA (but not in all Modes). Paused: monitored by VSA (E4406A). Printing: monitored by VSA (E4406A). Mass memory busy: monitored by VSA (E4406A).
Initial S/W Revision	Prior to A.02.00

## Query Instrument Options

Returns a string of all the installed instrument options. It is a comma separated list with quotes, such as: "503,P03,PFR".

To be IEEE compliant, this command should return an arbitrary ascii variable that would not begin and end with quotes. But the quotes are needed to be backward compatible with previous SA products and software. So, the actual implementation will use arbitrary ascii. But quotes will be sent as the first and last ascii characters that are sent with the comma-separated option list.

<b>Remote Command</b>	*OPT?
Initial S/W Revision	Prior to A.02.00

## Recall Instrument State

This command recalls the instrument state from the specified instrument memory register.

- If the state being loaded has a newer firmware revision than the revision of the instrument, no state is recalled and an error is reported
- If the state being loaded has an equal firmware revision than the revision of the instrument, the state will be loaded.
- If the state being loaded has an older firmware revision than the revision of the instrument, the instrument will only load the parts of the state that apply to the older revision.

<b>Remote Command</b>	*RCL <register #>
<b>Example</b>	*RCL 7 Recalls the instrument state that is currently stored in register 7.
Notes	Registers 0 through 6 are accessible from the front panel in menu keys for Recall Registers.
Min	0
Max	127
Status Bits/OPC dependencies	The command is sequential.
Initial S/W Revision	Prior to A.02.00



## \*RST (Remote Command Only)

\*RST is equivalent to :SYST:PRES::INIT:CONT OFF, which is a Mode Preset in the Single measurement state. This remote command is preferred over Mode Preset remote command - :SYST:PRES, as optimal remote programming occurs with the instrument in the single measurement state.

<b>Remote Command</b>	*RST
<b>Example</b>	*RST
<b>Notes</b>	Sequential Clears all pending OPC bits and the Status Byte is set to 0.
<b>Couplings</b>	A *RST will cause the currently running measurement to be aborted and cause the default measurement to be active. *RST gets the mode to a consistent state with all of the default couplings set.
<b>Backwards Compatibility Notes</b>	In legacy analyzers *RST did not set the analyzer to Single, but in the X-Series it does, for compliance with the IEEE 488.2 specification. In the X-Series, *RST does not do a *CLS (clear the status bits and the error queue). In legacy analyzers, *RST used to do the equivalent of SYSTem:PRESet, *CLS and INITiate:CONTinuous OFF. But to be 488.2 compliant, *RST in the X-Series does not do a *CLS.
<b>Initial S/W Revision</b>	Prior to A.02.00

## Save Instrument State

This command saves the current instrument state and mode to the specified instrument memory register.

<b>Remote Command</b>	*SAV <register #>
<b>Example</b>	*SAV 9 Saves the instrument state in register 9.
<b>Notes</b>	Registers 0 through 6 are accessible from the front panel in menu keys for Save Registers.
<b>Min</b>	0
<b>Max</b>	127
<b>Status Bits/OPC dependencies</b>	The command is sequential.
<b>Initial S/W Revision</b>	Prior to A.02.00

## Service Request Enable

This command enables the desired bits of the service request enable register.

The query returns the value of the register, indicating which bits are currently enabled.

<b>Remote Command</b>	*SRE <integer> *SRE?
<b>Example</b>	*SRE 22 Enables bits 1, 2, and 4 in the service request enable register.

Notes	For related commands, see the STATus subsystem and SYSTem:ERRor[:NEXT]? commands.
Preset	0
Min	0
Max	255
Status Bits/OPC dependencies	Service Request Enable Register (all bits, 0 – 7).
Initial S/W Revision	Prior to A.02.00

## Status Byte Query

Returns the value of the status byte register without erasing its contents.

<b>Remote Command</b>	*STB?
<b>Example</b>	*STB? Returns a decimal value for the bits in the status byte register. For example, if a 16 is returned, it indicates that bit 5 is set and one of the conditions monitored in the standard event status register is set.
Notes	See related command *CLS.
Status Bits/OPC dependencies	Status Byte Register (all bits, 0 – 7).
Initial S/W Revision	Prior to A.02.00

## Trigger

This command triggers the instrument. Use the :TRIGger[:SEQuence]:SOURce command to select the trigger source.

Key Path	No equivalent key. See related keys Single and Restart.
<b>Remote Command</b>	*TRG
<b>Example</b>	*TRG Triggers the instrument to take a sweep or start a measurement, depending on the current instrument settings.
Notes	See related command :INITiate:IMMediate.
Initial S/W Revision	Prior to A.02.00

## Self Test Query

This query performs the internal self-test routines and returns a number indicating the success of the testing. A zero is returned if the test is successful, 1 if it fails.

<b>Remote Command</b>	*TST?
<b>Example</b>	*TST? Runs the self-test routines and returns 0=passed, 1=some part failed.
Initial S/W Revision	Prior to A.02.00

## Wait-to-Continue

This command causes the instrument to wait until all overlapped commands are completed before executing any additional commands. There is no query form for the command.

<b>Remote Command</b>	*WAI
<b>Example</b>	INIT:CONT OFF; INIT;*WAI Sets the instrument to single sweep. Starts a sweep and waits for its completion.
<b>Status Bits/OPC dependencies</b>	Not global to all remote ports or front panel. *OPC only considers operation that was initiated on the same port as the *OPC command was issued from.
<b>Initial S/W Revision</b>	Prior to A.02.00



## 4 Input/Output Functions

## Input/Output

The Input/Output features are common across multiple Modes and Measurements. These common features are described in this section. See the Measurement description for information on features that are unique.

The Input/Output key accesses the keys that control the Input/Output parameters of the instrument. In general, these are functions associated with external connections to the analyzer, either to the inputs or the outputs. Since these connections tend to be fairly stable within a given setup, in general, the input/output settings do not change when you Preset the analyzer.

Other functions related to the input/output connections, but which tend to change on a measurement by measurement basis, can be found under the Trigger and AMPTD Y Scale keys. In addition, some of the digital I/O bus configurations can be found under the System key.

**NOTE**

The functions in the Input/Output menu are "global" (common) to all Modes (applications). But individual Input/Output functions only appear in a Mode if they apply to that Mode. Functions that apply to a Mode but not to all measurements in the Mode may be grayed-out in some measurements.

["Input/Output variables - Preset behavior" on page 227](#)

The Input Port selection is the first menu under the Input/Output key:

Key Path	Front-panel key
<b>Remote Command</b>	<code>[ :SENSe ] :FEED RF   AIQ   EMIXer</code> <code>[ :SENSe ] :FEED?</code>
<b>Example</b>	<code>:FEED RF</code> <code>:FEED?</code>
<b>Couplings</b>	The <code>[ :SENSe ] :FEED RF</code> command turns the calibrator OFF
<b>Preset</b>	This setting is unaffected by a Preset or power cycle. It survives a Mode Preset and mode changes. It is set to RF on a "Restore Input/Output Defaults" or "Restore System Defaults->All"
<b>State Saved</b>	Saved in instrument state
<b>Backwards Compatibility SCPI</b>	<code>[ :SENSe ] :FEED AREFERENCE</code> In the PSA the calibrator was one of the inputs and selected using the AREF parameter to the same <code>:FEED</code> command that switched the inputs. In the X-Series it is controlled in a separate menu and overrides the input selection. For code compatibility the <code>[ :SENSe ] :FEED AREFERENCE</code> command is provided, and is aliased to <code>[ :SENSe ] :FEED :AREF REF50</code> , which causes the input to be switched to the 50 MHz calibrator. The <code>[ :SENSe ] :FEED RF</code> command switches the input back to the RF port and turns the calibrator OFF, thus providing full compatibility with the PSA calibrator function. Note that after sending this, the query <code>[ :SENSe ] :FEED?</code> will NOT return "AREF" but instead the currently selected input.
<b>Backwards Compatibility SCPI</b>	<code>[ :SENSe ] :FEED IQ   IONLy   QONLy</code> <code>[ :SENSe ] :FEED?</code> The parameters <code>IQ   IONLy   QONLy</code> are supported for backwards compatibility with the E44406A. <code>[ :SENSe ] :FEED IQ</code> aliases to <code>[ :SENSe ] :FEED :IQ :TYPE IQ</code> <code>[ :SENSe ] :FEED IONLy</code> aliases to <code>[ :SENSe ] :FEED :IQ :TYPE IONLy</code>

	<p>[;SENSe]:FEED QONLY aliases to [;SENSe]:FEED:IQ:TYPE QONLY</p> <p>The query [;SENSe]:FEED? will always returns AIQ whatever the type of legacy parameters IQ   IONLY   QONLY has been used.</p>
Backwards Compatibility Notes	<p>Most of the settings in the X-Series Input/Output system, including External Gain, Amplitude Corrections settings and data, etc., are shared by all modes and are not changed by a mode switch. Furthermore, most variables in the Input/Output system key are not affected by Mode Preset. Both of these behaviors represent a departure from legacy behavior.</p> <p>In the X-Series. Input/Output settings are reset by using the "Restore Input/Output Defaults" function. They can also be reset to their default values through the System-&gt;Restore System Defaults-&gt; In/Out Config key or through the System -&gt;Restore System Defaults -&gt; All key (and corresponding SCPI).</p> <p>While this matches most use cases better, it does create some code compatibility issues. For example, Amplitude Corrections are no longer turned off by a Mode Preset, but instead by using the "Restore Input/Output Defaults" key/SCPI.</p> <p>Although Input/Output settings are not part of each Mode's State, they are saved in the Save State files, so that all of the instrument settings can be recalled with Recall State, as in legacy instruments.</p>
Initial S/W Revision	Prior to A.02.00
<b>Remote Command</b>	<p>:INPut:MIXer EXTernal INTernal</p> <p>:INPut:MIXer?</p>
<b>Example</b>	<p>INP:MIX INT</p> <p>INP:MIX?</p>
Notes	<p>In legacy analyzers you choose between the Internal mixer or an External Mixer. In the X-Series, the External Mixer is one of the choices for the Input and is selected using the FEED command (:SENSe:FEED EXTMIxer).</p> <p>For compatibility, the INPut:MIXer EXTernal INTernal legacy command is mapped as follows:</p> <ol style="list-style-type: none"> <li>1. When INPut:MIXer EXTernal is received, SENSe:FEED EMIXer is executed.</li> <li>2. When INPut:MIXer INTernal is received, SENSe:FEED RF is executed.</li> <li>3. When INPut:MIXer? is received, the response will be INT if any input other than the external mixer is selected and EXT if the external mixer is selected</li> </ol>
Preset	INT
Backwards Compatibility Notes	<p>PSA supports the following SCPI Command :</p> <p>:INPut:MIXer:TYPE PRESelected UNPReselect</p> <p>:INPut:MIXer:TYPE?</p> <p>PXA does not support the :INPut:MIXer:TYPE command.</p>
Initial S/W Revision	A.08.01

## Input/Output variables - Preset behavior

Virtually all the input/output settings are NOT a part of mode preset. They can be set to their default value

by one of the three ways:

- by using the Restore Input/Output Defaults key on the first page of the input/output menu,
- by using the System->Restore System Defaults->Input/Output Settings or,
- by using the System -> Restore System Defaults->All. Also, they survive a Preset and a Power cycle.

A very few of the Input/Output settings do respond to a Mode Preset; for example, if the Calibrator is on it turns off on a Preset, and if DC coupling is in effect it switches to AC on a Preset. These exceptions are made in the interest of reliability and usability, which overrides the need for absolute consistency. Exceptions are noted in the SCPI table for the excepted functions.

## RF Input

Selects the front-panel RF input port to be the analyzer signal input. If RF is already selected, pressing this key accesses the RF input setup functions.

<b>Key Path</b>	<b>Input/Output</b>
<b>Example</b>	[:SENSe]:FEED RF
<b>Couplings</b>	The act of connecting the U7227A USB Preamplifier to one of the analyzer's USB ports will cause the Input to automatically switch to the RF Input. If the RF Calibrator is on, it is turned off. Subsequently disconnecting the USB Preamp from USB does not change the Input selection nor restore the previous selection.
<b>Readback</b>	The RF input port, RF coupling, and current input impedance settings appear on this key as: "XX, YY, ZZ" where XX is RF, RF2, RFIO1, RFIO2, depending on what input is selected (only appears on analyzers with multiple RF inputs) YY is AC or DC ZZ is 50Ω or 75Ω
<b>Initial S/W Revision</b>	Prior to A.02.00
<b>Modified at S/W Revision</b>	A.14.00

## Input Z Correction

Sets the input impedance for unit conversions. This affects the results when the y-axis unit is voltage or current units (dBmV, dBμV, dBμA, V, A), but not when it is power units (dBm, W). The impedance you select is for computational purposes only, since the actual impedance is set by internal hardware to 50 ohms. Setting the computational input impedance to 75 ohms is useful when using a 75 ohm to 50 ohm adapter to measure a 75 ohm device on an analyzer with a 50 ohm input impedance.

There are a variety ways to make 50 to 75 ohm transitions, such as impedance transformers or minimum loss pads. The choice of the solution that is best for your measurement situation requires balancing the amount of loss that you can tolerate with the amount of measurement frequency range that you need. If you are using one of these pads/adaptors with the Input Z Corr function, you might also want to use the Ext Gain key. This function is used to set a correction value to compensate for the gain (loss) through your pad. This correction factor is applied to the displayed measurement values.



Key Path	Input/Output, RF Input
Remote Command	[ :SENSe ] :CORRection:IMPedance [ :INPut ] [ :MAGNitude ] 50   75 [ :SENSe ] :CORRection:IMPedance [ :INPut ] [ :MAGNitude ] ?
Example	CORR:IMP 75 sets the input impedance correction to 75 ohms. CORR:IMP?
Couplings	In the N9000A option C75, when RF Input 2 is selected, the Input Z Correction will automatically change to 75 ohms. You may then change it to whatever is desired. When the main RF Input is selected, the Input Z Correction will automatically change to 50 ohms. You may then change it to whatever is desired.
Preset	This is unaffected by a Preset but is set to 50 ohms on a "Restore Input/Output Defaults" or "Restore System Defaults->All" Some instruments/options may have 75 ohms available.
State Saved	Saved in instrument state
Readback	50 $\Omega$ or 75 $\Omega$ . Current setting reads back to the RF key.
Initial S/W Revision	Prior to A.02.00

## RF Coupling

Specifies alternating current (AC) or direct current (DC) coupling at the analyzer RF input port. Selecting AC coupling switches in a blocking capacitor that blocks any DC voltage present at the analyzer input. This decreases the input frequency range of the analyzer, but prevents damage to the input circuitry of the analyzer if there is a DC voltage present at the RF input.

In AC coupling mode, you can view signals below the corner frequency of the DC block, but below a certain frequency the amplitude accuracy is not specified. The frequency below which specifications do not apply is:

X-Series Model	Lowest Freq for meeting specs when AC coupled	Lowest Freq for meeting specs when DC coupled
N9000A-503/507	100 kHz	n/a
N9000A-C75 Input 2	1 MHz	n/a
N9000A-513/526	10 MHz	9 kHz
N9010A	10 MHz	9 kHz
N9020A	10 MHz	20 Hz
N9030A	10 MHz	3 Hz

Some amplitude specifications apply only when coupling is set to DC. Refer to the appropriate amplitude specifications and characteristics for your analyzer.

When operating in DC coupled mode, ensure protection of the analyzer input circuitry by limiting the DC part of the input level to within 200 mV of 0 Vdc. In AC or DC coupling, limit the input RF power to +30 dBm (1 Watt).

<b>Key Path</b>	Input/Output, RF Input
<b>Remote Command</b>	:INPut:COUPling AC DC :INPut:COUPling?
<b>Example</b>	INP:COUP DC
<b>Dependencies</b>	This key does not appear in models that are always AC coupled. When the SCPI command to set DC coupling is sent to these models, it results in the error "Illegal parameter value; This model is always AC coupled" In these models, the SCPI query INP:COUP? always returns AC.  This key does not appear in models that are always DC coupled. When the SCPI command to set AC coupling is sent to these models, it results in the error "Illegal parameter value; This instrument is always DC coupled" In these models, the SCPI query INP:COUP? always returns DC.
<b>Preset</b>	AC on models that support AC coupling On models that are always DC coupled, such as millimeter wave models (frequency ranges 30 GHz and above), the preset is DC.
<b>State Saved</b>	Saved in instrument state.
<b>Initial S/W Revision</b>	Prior to A.02.00
<b>Modified at S/W Revision</b>	A.03.00

## External Mixer

This key allows you to choose an External Mixer through which to apply signal input to the analyzer. When chosen, the LO/IF port becomes the input to the analyzer.

External Mixing requires option EXM. The External Mixer key will not appear unless option EXM is installed. The presence of the LO/IF connector alone does not indicate that you have Option EXM licensed. To verify that option EXM is installed, press System, Show, System.

When External Mixer is selected, the Center Freq key controls the setting of the Center Freq in external mixing, which is separate from the settings of Center Freq for the RF Input or BBIQ. Each input retains its unique settings for Center Freq. A unique SCPI command is provided solely for the external mixing Center Freq (see the Center Freq key description), which only affects the External Mixer CF, although sending the generic Center Freq command while External Mixer is selected also controls the External Mixer CF.

See ["More Information" on page 231](#)

<b>Key Path</b>	Input/Output
<b>Example</b>	:FEED EMIX
<b>Notes</b>	Not all measurements support the use of the External Mixer input. When External Mixer is selected in a measurement that does not support it, the "No result; Meas invalid with Ext Mixing" error condition occurs.
<b>Dependencies</b>	Unless option EXM is present, the External Mixer key is blanked, and all SCPI commands associated with menus accessed by this key return an error

	Manual FFT mode is available with external mixing, but not with Signal ID.
Preset	All settings under this key are returned to their default state when Restore Input/Output Defaults is pressed.
State Saved	All settings under this key, and all Frequency settings, are remembered when you go out of External Mixer, so that when External Mixer is chosen again, all the external mixer functions will retain their previous settings, with the exception of Signal ID which is set to OFF (Signal ID is also set to Off unless External Mixer is the selected Input).
Readback Text	The readback text on this key shows the currently selected mixer, in square brackets.
Backwards Compatibility Notes	Unlike PSA, all external mixer settings including Center Frequency are retained when you go in and out of External Mixing. Also, Preset does not take you out of External Mixing (Restore Input/Output Defaults does).
Initial S/W Revision	A.08.01

### More Information

X-series analyzers have a combined LO Out/IF In connection, whereas earlier analyzers used separate ports for the LO Out and the IF in. Internal diplexers in the analyzer and the mixer simplify the connection for the user – only a single SMA cable is required.

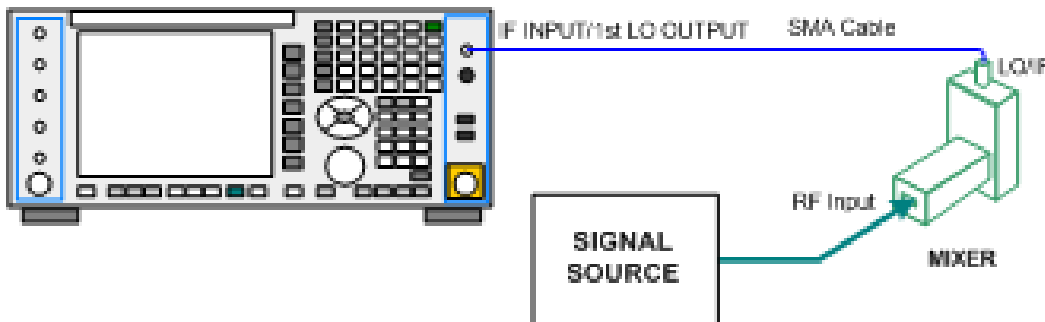

Legacy HP/Agilent and some third party mixers have separate LO In and IF out connections. This requires you to use an external diplexer to connect these mixers. A diplexer can easily be purchased for this purpose (for example, Diplexer Model # DPL.26 or # DPL.313B from OML Inc., Morgan Hill CA)

The connection diagram for such a legacy mixer is:

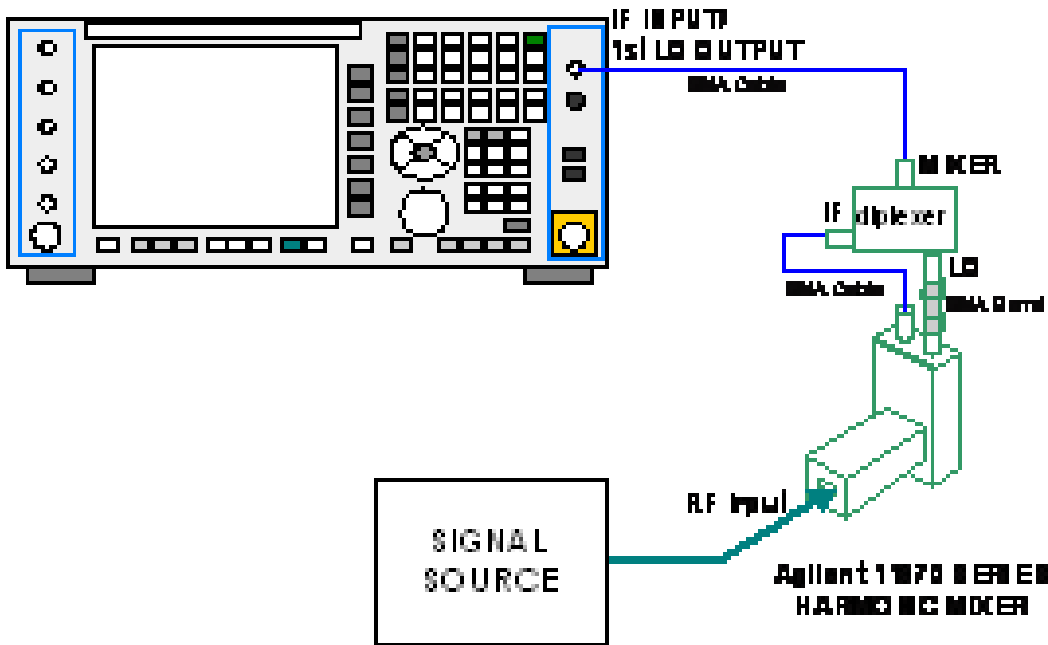

In addition, External Mixing in the X-Series supports the new Agilent M1970 series of Harmonic Mixers, which provide a USB connection for download of calibration data and additional control.

The connection diagram for one of the Agilent USB mixers is:

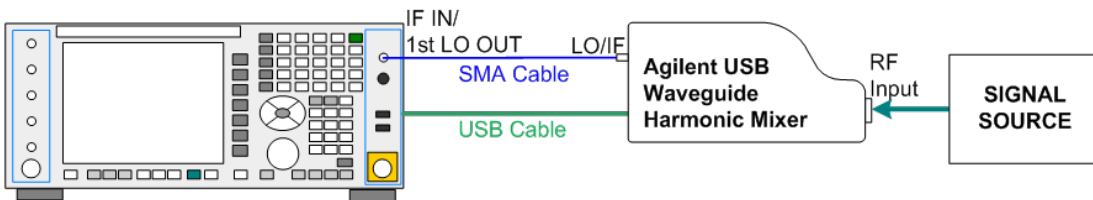

External Mixing is only supported in certain Modes and Measurements in the X-Series, as shown in the table below:

Mode	Measurements	Sig ID (Image Suppress only)
Spectrum Analyzer	Swept SA	Y*
	TOI	Y
	Harmonics	N
	Spurious Emissions	Y
	Channel Power	Y
	Occupied BW	Y
	ACP	Y
	Spectrum Emissions Mask	Y
	CCDF	N

	Burst Power	N
	List Sweep	N
Phase Noise	Monitor Spectrum	Y
	Log Plot	Y
	Spot Frequency	N
	Waveform	N
I/Q Analyzer	Complex Spectrum	N
	Waveform	N
Vector Signal Analyzer	Vector Analysis	N
	Analog Demod	N
	Digital Demod	N

\* the Swept SA measurement also supports Image Shift

## Ext Mix Setup

This menu lets you select the mixer type, and lets you configure your mixer (if necessary). While in this menu, and any of its submenus, the External Mixer Setup screen appears, showing you the current settings for the selected mixer. These settings may be dependent on which IF path is currently in use, whether a + or – harmonic is currently selected, etc.

To apply any amplitude correction factors needed to correct mixer flatness, you enter values into one of the Correction tables (under Input/Output, Corrections). The correction conversion loss values can be extracted from data supplied with the mixer or from manual measurements you make to determine the conversion loss. Note that the correction applied by the Correction tables is global to the analyzer; therefore you should make sure to turn off the External Mixer corrections when you are not using the External Mixer input.

### NOTE

The Agilent USB Mixers automatically give their flatness data to the analyzer, and the correction is applied internally. No correction needs to be entered by the user, and the correction does not appear in the user-accessible Corrections tables. The user is free to enter additional corrections into the Correction tables under Input/Output, Corrections.

Key Path	Input/Output, External Mixer
State Saved	All settings in the Mixer Setup are part of the Input/Output system, and hence are saved whenever State is saved.
Readback Text	The readback line on this key shows the currently selected mixer, in square brackets.
Initial S/W Revision	A.08.01
Modified at S/W Revision	A.08.50

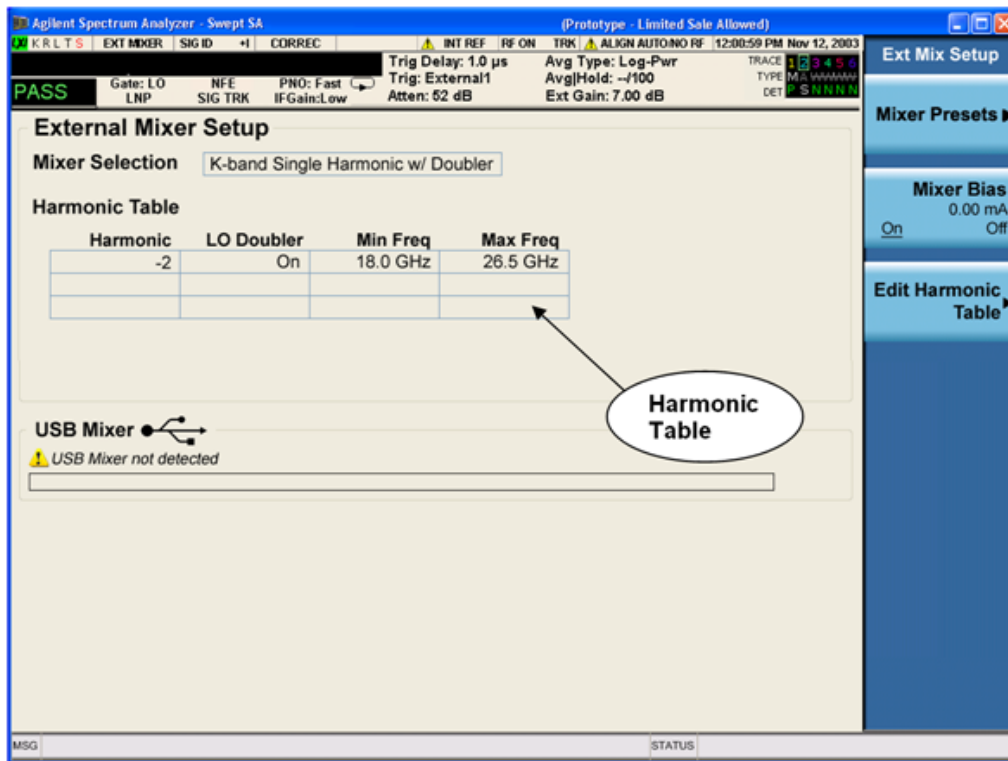

The External Mixer Setup screen looks like this

The current Mixer selection (the current or most recently connected USB Mixer, or the most recent Mixer Preset, or “Custom” if the user has modified the setup) reads out at the top of this screen.

The Harmonic Table currently being used reads out below the Mixer Selection. It shows each range being used for the current mixer. Note that a band may be made up of up to 3 ranges. Each range represents a choice of mixer harmonic and doubler state. When you select a Mixer Preset, it sets the analyzer Start and Stop frequency to the values shown in the Harmonic Table; Start Freq is set to the Min Freq for the bottom range, and Stop Freq is set to the Max Freq for the top range. In many cases you can exceed these nominal values; the absolute maximum and minimum frequency for each preset are shown in the tables that accompany the key descriptions for the Mixer Presets.

**NOTE** If the current measurement has a limited Span available to it, and cannot achieve the Span shown in the table (Span=Stop Freq – Start Freq), the analyzer uses the maximum Span the measurement allows, and sets the Center Freq to the midpoint of the Start and Stop Freq values in the Harmonic Table.

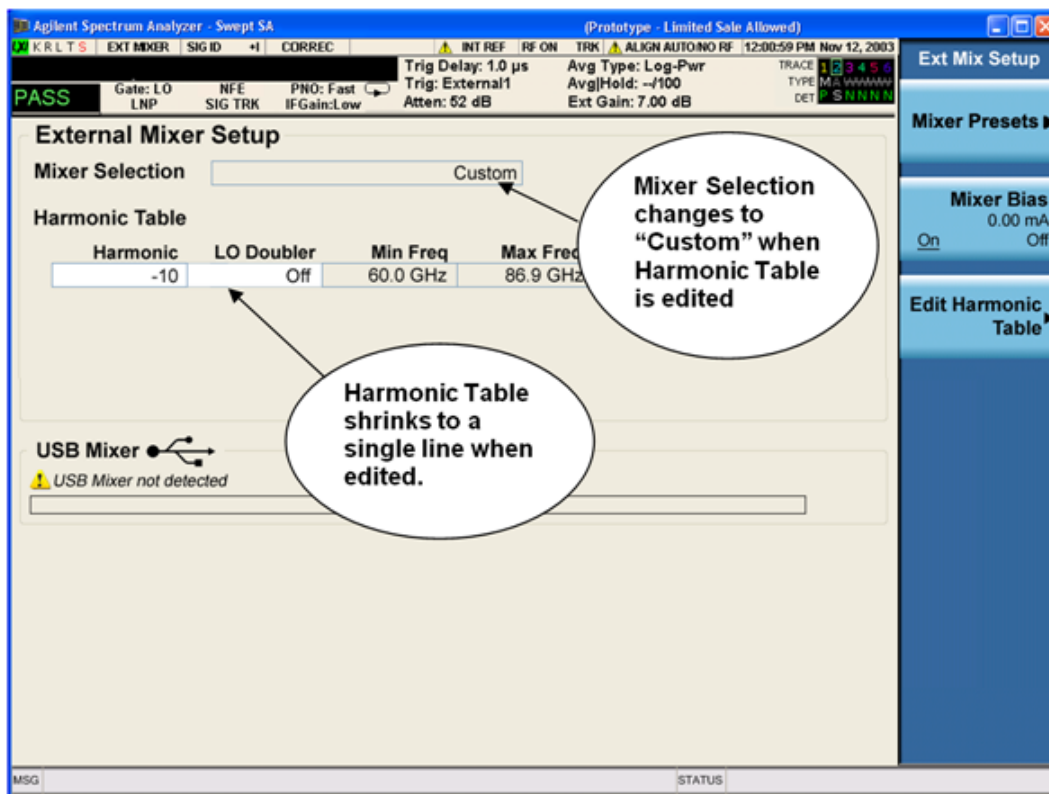

You may customize the Harmonic Table, but when you do this the analyzer goes into “single harmonic” mode. You may enter the harmonic number and whether to use the doubler or not, but now range switching is not supported, so you can only have one harmonic.

When you edit the Harmonic Table, the Mixer Selection changes to “Custom.” To change it back you must go back into the Mixer Presets menu and select a Preset.

When you edit the Harmonic Table, the nominal Min Freq and Max Freq that are available will usually be different than the Preset you were using; and the absolute frequency limits will change as well. This may result in a change to your Start and/or Stop Freq, if the current values fall outside the new range, requiring you to retune your Center Freq to get your signal back in the center.

The analyzer supports the Agilent M1970 Series Harmonic Mixers with USB connection. While in External Mixing, if one of these mixers is plugged in to a USB port, it is automatically detected and displayed in the “USB Mixer” area of the setup screen, including its model number and serial number.

The analyzer assumes that if you plug a mixer into the USB, that is the mixer you want to use. Therefore:

1. If a USB mixer is connected to the USB port, the Mixer Presets menu is grayed out, as none of the presets make sense with a USB Mixer connected. Note that once the analyzer has acquired the USB Mixer, the mixer selection will remain if it is subsequently unplugged from the USB, allowing you to plug it back in with no change to your settings. However, once you unplug it, the Mixer Presets key will stop being grayed out, allowing you to preset to a different mixer.
2. When Restore Input/Output Defaults is performed, if an Agilent USB Mixer is plugged into the analyzer’s USB port, the Mixer Selection remains unchanged.

3. When recalling an instrument state, if an Agilent USB Mixer is plugged into the analyzer's USB port, and the Mixer Selection in the recalled state is for a USB Mixer that does not match the mixer currently plugged in, you will have to unplug your mixer and then plug it back in to get the analyzer to recognize your mixer.

As long as the selection in Ext Mixer Setup shows one of the USB mixers, both the Mixer Bias and Edit Harmonic Table keys will be grayed out.

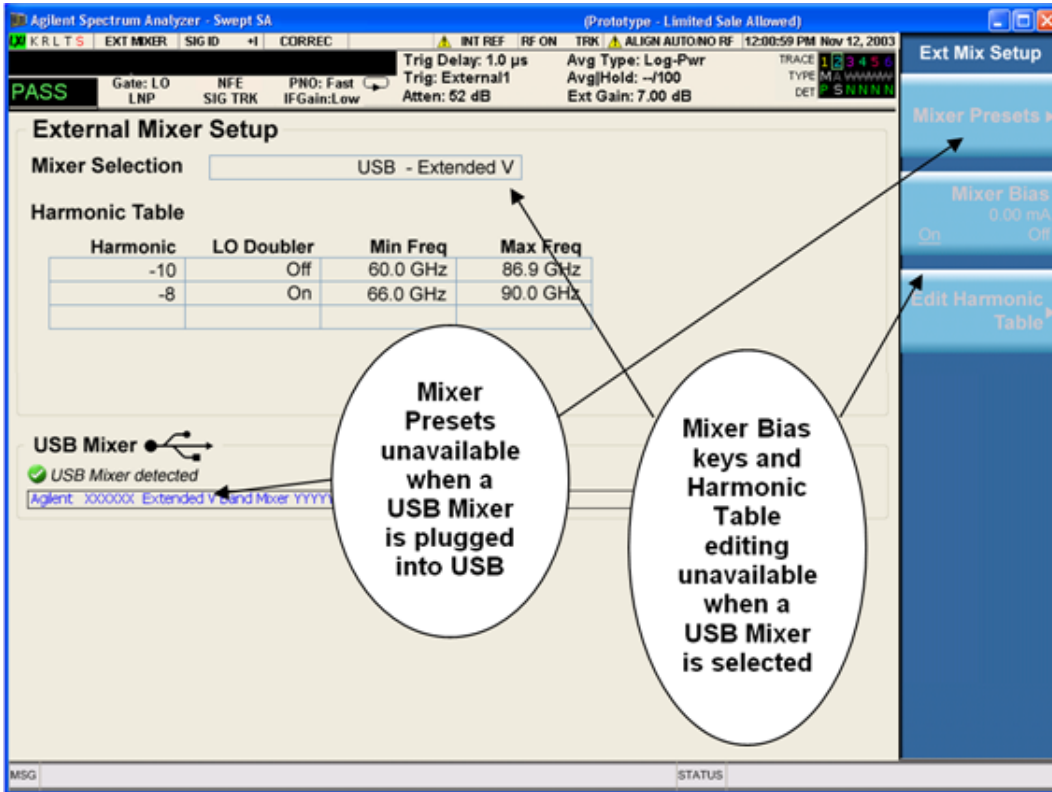



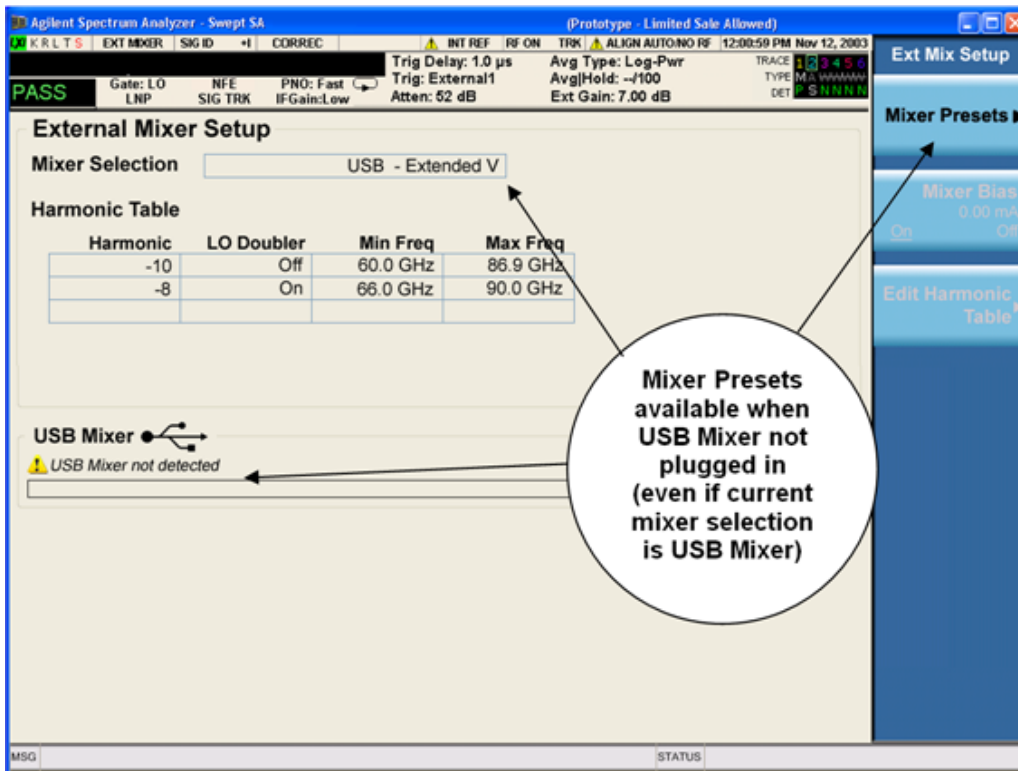

Only one USB Mixer is supported at a time. To switch to a different USB Mixer, disconnect the one that is no longer being used prior to connecting a new one.

The Mixer Selection displayed and softkey readback for the Agilent M1970 series mixers is:

Mixer Model	Mixer Selection display on Setup Screen	Readback on softkeys
Agilent M1970E: Option 001: 60 to 90 GHz Waveguide Harmonic Mixer	USB - M1970E E-Band	USB Mixer E-Band
Agilent M1970V Option 001: 50 to 75 GHz Waveguide Harmonic Mixer	USB - M1970V-001 V-Band	USB Mixer V-Band
Agilent M1970V Option 002: 50 to 80 GHz Waveguide Harmonic Mixer	USB - M1970V-002 Extended V-Band	USB Mixer Extended V
Agilent M1970W: 75 to 110 GHz Waveguide Harmonic Mixer	USB - M1970W W-Band	USB Mixer W-Band

The Agilent USB mixer essentially acts as a “remote front end” and is fully calibrated over the specified frequency range, without requiring any user interaction. This is particularly useful at high mm-wave frequencies, where cable loss is typically quite large, and it is desirable to bring the front end right up to the device under test, rather than bringing the mm-wave signal to the analyzer using a lossy and uncalibrated cable or waveguide connection.

Connecting the mixer to the USB port on the analyzer switches you to External Mixing, aborts the current measurement, and initiates an alignment of the mixer. A popup message, “USB Mixer connected” appears on the display. When a USB mixer and the LO/IF cable are connected the alignment is performed. When the alignment begins, an “Aligning” popup replaces the previous message on the display. When the alignment completes, the current measurement restarts.

### Mixer Presets

This menu lets you preset the mixer setup for the particular type of mixer that you are using.

These presets are divided into four groups:

- one for Agilent legacy mixers,
- three for general purpose mixers:
  - o presets that use a single harmonic and no doubling
  - o presets that use a single harmonic but double the LO
  - o presets that use multiple harmonics

Note that the IF/LO port provides a 3.8–14 GHz LO in two bands: 3.8–8.7 (LO fundamental), and 8.6–14 GHz (doubled LO).

In most cases, once you have executed the preset, you will not need to adjust any further settings.

Key Path	Input/Output, External Mixer, Ext Mix Setup
<b>Remote Command</b>	[:SENSe]:MIXer:BAND A   Q   U   V   W   NA   ND   NE   NF   NG   NJ   NK   NQ   NU   NV   NW   NY   NEXT   DD   DF   DG   DJ   DK   DQ   DV   DW   DY   DEXT   MA   ME   MU   MCOAX   USB  [:SENSe]:MIXer:BAND?
<b>Example</b>	:MIX:BAND A :MIX:BAND?
<b>Notes</b>	A Q U V W select Agilent 11970 mixer presets NA ND NE NF NG NJ NK NQ NU NV NW NY NEXT select single harmonic, non-doubled LO presets DD DF DG DJ DK DQ DV DW DY DEXT select single harmonic, doubled LO presets MA ME MU MCOAX select multiple harmonic presets All of these presets are detailed in their respective key descriptions The query form of this command returns the most recent preset, UNLESS the harmonic table has been edited after the preset was executed. If the harmonic table has been edited it returns CUSTOM The command USB will refresh the USB mixer connection and automatically detect the mixer band. The query form of this command returns the following if an Agilent USB Mixer is plugged into the analyzer’s USB port: USB E Agilent E-Band USB Mixer USB V Agilent V-Band USB Mixer USB VEXT Agilent Extended V-Band USB Mixer USB W Agilent W-Band USB Mixer Note that the parameters CUSTOM, USBV, USBVEXT, and USBW are query responses only, and cannot be sent TO the analyzer.

	<p>The following cross-reference matches the mixer band designators used by Agilent to the EIA waveguide designations:</p> <p>EIAAgilentFreq Range</p> <p>WR-28 A26.5 – 40 GHz</p> <p>WR-22 Q33 – 50 GHz</p> <p>WR-19 U40 – 60 GHz</p> <p>WR-15 V50 – 75 GHz</p> <p>WR-12 E60 – 90 GHz</p> <p>WR-10 W75 – 110 GHz</p> <p>WR-8 F90 – 140 GHz</p> <p>WR-6 D110 – 170 GHz</p> <p>WR-5 G140 – 220 GHz</p> <p>WR-3 J220 – 325 GHz</p>
Preset	<p>When Restore Input/Output Defaults is performed, an “A” mixer preset is also issued (11970A band), unless an Agilent USB Mixer is plugged into the analyzer’s USB port, in which case the Mixer Selection remains unchanged.</p> <p>When using Agilent USB Mixers, if a Restore All Defaults (SCPI command SYSTem:DEFault) has been performed, either remove and reinsert the USB cable or press the Refresh USB Mixer Connection softkey.</p>
Backwards Compatibility Notes	<p>The [:SENSe]:MIXer:BAND command was used in PSA and ESA to select the mixer band. In the X-Series, only the legacy parameters A, Q, U, V, and W are honored, and they preset the analyzer to match the corresponding Agilent 11970 legacy mixer. Parameters D, E, F, G, J, K, Y, which were accepted in ESA and PSA, return an error if sent. If you are using a mixer in one of these bands, you should study the tables of presets and choose the appropriate preset to match your application. Also the USER parameter is no longer accepted, as the control model for mixer customization is very different in the X-Series.</p>
Initial S/W Revision	A.08.01
Modified at S/W Revision	A.14.00

### Agilent 11970

This menu allows you to preset for one of the models in the HP/Agilent 11970 series.

Because the X-Series has an LO range of 3.8 – 14 GHz, and older analyzers had an LO range of 3.0 – 6.8 GHz, the harmonic numbers used in the X-Series may differ from those used on older analyzers for the same mixers. Additionally, some of the 11970 mixers cannot be operated over their full range with the X-Series without switching harmonics. Consequently, you will find that some of the bands (A-Band, for example) are broken into two ranges for use with the X-Series.

See ["More Information" on page 240](#)

Key Path	Input/Output, External Mixer, Ext Mix Setup, Mixer Presets
Example	MIX:BAND A
Initial S/W Revision	A.08.01

## More Information

Below are the 11970A presets. The 11970U and the 11970W use a single harmonic. The other three switch harmonics mid-band. Both harmonic ranges are shown in the table. None of these mixers use LO doubling.

The 11970 K-band mixer and the 11974 preselected mixer series are not supported.

Preset	Readout in setup screen	Readback on softkeys	Range	Harm #	RF start	RF stop	RF center
A-band	Agilent 11970A	Agilent 11970A	1	-6	26.5	30.45	28.475
			2	-8	30.35	40	35.175
Q-band	Agilent 11970Q	Agilent 11970Q	1	-8	33	40.8	36.9
			2	-10	39.8	50	44.9
U-band	Agilent 11970U	Agilent 11970U	..	-10	40	60	50
V-band	Agilent 11970V	Agilent 11970V	1	-12	50	66	58
			2	-14	53	75	64
W-band	Agilent 11970W	Agilent 11970W	..	-18	75	110	92.5

### Single Harmonic

These presets choose a setup that uses a single harmonic and no doubling for the LO.

Key Path	Input/Output, External Mixer, Ext Mix Setup, Mixer Presets
Example	MIX:BAND NA
Initial S/W Revision	A.08.01

These are the presets for single harmonic operation with no doubler:

Mixer	Readout in setup screen	Readback on softkeys	Harm #	RF start	RF stop	RF center
K-band	K-band Single Harmonic, no doubler	Sngl harm LOx1 K-band	-4	18	26.5	22.25
A-band	A-band Single Harmonic, no doubler	Sngl harm LOx1 A-band	-6	26.5	40	33.25
D-band	D-band Single Harmonic, no doubler	Sngl harm LOx1 D-band	-20	110	170	140
E-band	E-band Single Harmonic, no doubler	Sngl harm LOx1 E-band	-12	60	90	75
F-band	F-band Single Harmonic, no doubler	Sngl harm LOx1	-18	90	140	115

Mixer	Readout in setup screen	Readback on softkeys	Harm #	RF start	RF stop	RF center
		F-band				
Q-band	Q-band Single Harmonic, no doubler	Sngl harm LOx1 Q-band	-6	33	50	41.5
U-band	U-band Single Harmonic, no doubler	Sngl harm LOx1 U-band	-8	40	60	50
V-band	V-band Single Harmonic, no doubler	Sngl harm LOx1 V-band	-10	50	75	62.5
W-band	W-band Single Harmonic, no doubler	Sngl harm LOx1 W-band	-14	75	110	92.5
G-band	G-band Single Harmonic, no doubler	Sngl harm LOx1 G-band	-26	140	220	180
Y-band	Y-band Single Harmonic, no doubler	Sngl harm LOx1 Y-band	-30	170	260	215
J-band	J-band Single Harmonic, no doubler	Sngl harm LOx1 J-band	-38	220	325	272.5
Extended	Extended Single Harmonic, no doubler	Sngl harm LOx1 Extended	-40	155	345	250

### Single Harmonic w/doubler

These presets choose a setup that uses a single harmonic and doubling for the LO.

Key Path	Input/Output, External Mixer, Ext Mix Setup, Mixer Presets
<b>Example</b>	MIX:BAND DW
Initial S/W Revision	A.08.01

These are the presets for single harmonic operation with LO doubling:

Mixer	Readout in setup screen	Readback on softkeys	Harm #	RF start	RF stop	RF center
D-band	D-band Single Harmonic w/doubler	Sngl harm LOx2 K-band	-14	110	170	140
F-band	F-band Single Harmonic w/doubler	Sngl harm LOx2 A-band	-10	90	140	115
G-band	G-band Single Harmonic w/doubler	Sngl harm LOx2 A-band	-16	140	220	180
J-band	J-band Single	Sngl harm LOx2	-24	220	325	272.5

Mixer	Readout in setup screen	Readback on softkeys	Harm #	RF start	RF stop	RF center
	Harmonic w/doubler	A-band				
K-band	K-band Single Harmonic w/doubler	Sngl harm LOx2 A-band	-2	18	26.5	22.25
Q-band	Q-band Single Harmonic w/doubler	Sngl harm LOx2 A-band	-4	33	50	41.5
V-band	V-band Single Harmonic w/doubler	Sngl harm LOx2 A-band	-6	50	75	62.5
W-band	W-band Single Harmonic w/doubler	Sngl harm LOx2 A-band	-8	75	110	92.5
Y-band	Y-band Single Harmonic w/doubler	Sngl harm LOx2 A-band	-20	170	260	215
Extended	Extended Single Harmonic w/doubler	Sngl harm LOx2 A-band	-28	245	390	317.5

### Multiple Harmonics

These presets choose a setup that uses multiple harmonics and may or may not use doubling for the LO.

Key Path	Input/Output, External Mixer, Ext Mix Setup, Mixer Presets
<b>Example</b>	MIX:BAND MA
Initial S/W Revision	A.08.01

These are the presets for multiple harmonic operation:

Mixer	Readout in setup screen	Readback on softkeys	Range	Harm #	Dblr?	RF start	RF stop	RF Center
A-band	A-band Multiple Harmonic	Multi harm A-band	1	-4	N	26.5	34.1	30.3
			2	-4	Y	33.1	40	36.55
E-band	E-band Multiple Harmonic	Multi harm E-band	1	-6	Y	60	83	71.5
			2	-8	Y	65	90	77.5
U-band	U-band Multiple Harmonic	Multi harm U-band	1	-6	N	40	51.5	45.75
			2	-6	Y	49.5	60	54.75
Coaxial	Coaxial Multiple Harmonic	Multi harm Coaxial	1	-4	N	26.5	34	30.25
			2	-4	Y	32.5	55	43.75
			3	-6	Y	50	70	60

## Mixer Bias

Adjusts an internal bias source for use with external mixers. The bias signal is present on the center conductor of the IF input connector on the front panel. The shunt current range is from –10 mA to 10 mA and it can be set whether Mixer Bias state is On or Off, but it will only be applied if it is On.

The bias remains as set if the user switches to another input (e.g., the RF Input).

<b>Key Path</b>	Input/Output, External Mixer, Ext Mix Setup
<b>Remote Command</b>	[:SENSe]:MIXer:BIAS <real> [:SENSe]:MIXer:BIAS? [:SENSe]:MIXer:BIAS:STATe OFF ON 0 1 [:SENSe]:MIXer:BIAS:STATe?
<b>Example</b>	:MIX:BIAS 0 :MIX:BIAS? MIX:BIAS:STAT 0 MIX:BIAS:STAT?
<b>Preset</b>	This is unaffected by Preset but is set to OFF and 0 on a "Restore Input/Output Defaults"
<b>State Saved</b>	Saved in instrument state
<b>Min</b>	-10 mA
<b>Max</b>	10 mA
<b>Initial S/W Revision</b>	A.08.01

## Cable IF Loss

The loss at the IF in the IF/LO cable can be compensated for with this function, by entering the loss in dB for your cable.

The cable loss will depend on the IF frequency. The IF frequency varies depending on which IF path your measurement is using. For best accuracy, characterize your cable's loss for the IF frequency or frequencies you will be using.

IF Frequencies:

10 MHz path: 322.5 MHz

25 MHz path: 322.5 MHz

40 MHz path: 250 MHz

140 MHz path: 300 MHz

<b>Key Path</b>	Input/Output, External Mixer
<b>Key Path</b>	Input/Output, External Mixer, Calibrate Mixer
<b>Remote Command</b>	[:SENSe]:MIXer:CIFLoss <rel_amp1> [:SENSe]:MIXer:CIFLoss?

<b>Example</b>	:MIX:CIFL 0.23 DB :MIX:CIFL?
Preset	0.26 dB
State Saved	Saved in instrument state
Min	-100
Max	100
Initial S/W Revision	A.08.01

## I/Q

This feature is not available unless the "[Baseband I/Q \(Option BBA\)](#)" on page 244 is installed.

Selects the front-panel I/Q input ports to be the analyzer signal input. If I/Q is already selected, pressing this key accesses the I/Q setup menu.

<b>Key Path</b>	Input/Output
<b>Mode</b>	BASIC, CDMA2K, EDGE GSM, TDSCDMA, VSA89601, WIMAX OFDMA, LTE, LTE TDD, LTE FDD, LTE ATDD, DCATV, DTMB (CTTB), DVB-T/H with T2, CMMB, ISDBT, WCDMA, VXA, CDMA1XEV
<b>Example</b>	FEED AIQ
<b>Notes</b>	Not all measurements support the use of the I/Q signal input. When I/Q is selected in a measurement that does not support it, the "No Result; Meas invalid with I/Q inputs" error condition message appears. This is error 135
<b>Initial S/W Revision</b>	Prior to A.02.00

## Baseband I/Q (Option BBA)

The Baseband I/Q functionality is a hardware option. It is option BBA. If the option is not installed, none of the I/Q functionality is enabled.

The Baseband I/Q has four input ports and one output port. The input ports are I, I-bar, Q, and Q-bar. The I and I-bar together compose the I channel and the Q and Q-bar together compose the Q channel. Each channel has two modes of operation, Single-Ended (also called "unbalanced") and Differential Input (also called "balanced"). When in Single-Ended operation, only the main port (I or Q) is used and the complementary port (I-bar or Q-bar) is ignored. When in Differential Input mode, both main and complementary ports are used.

The input settings (range, attenuation, skew, impedance, external gain) apply to the channels, not the individual ports.

The system supports a variety of 1 M $\Omega$  input passive probes as well as the Agilent 113x Series active differential probes using the Infinimax probe interface.

The Agilent 113x Series active probes can be used for both single ended and differential measurements. In either case a single connection is made for each channel (on either the I or Q input). The input is



automatically configured to 50  $\Omega$  single ended and the probe power is supplied through the Infinimax interface. The probe can be configured for a variety of input coupling and low frequency rejection modes. In addition, a wide range of offset voltages and probe attenuation accessories are supported at the probe interface. The active probe has the advantage that it does not significantly load the circuit under test, even with unity gain probing.

With passive 1 M $\Omega$  probes, the probe will introduce a capacitive load on the circuit, unless higher attenuation is used at the probe interface. Higher attenuation reduces the signal level and degrades the signal-to-noise-ratio of the measurement. Passive probes are available with a variety of attenuation values for a moderate cost. Most Agilent passive probes can be automatically identified by the system, setting the input impedance setting required as well as the nominal attenuation. For single ended measurements a single probe is used for each channel. Other passive probes can be used, with the attenuation and impedance settings configured manually.

For full differential measurements, the system supports probes on each of the four inputs. The attenuation of the probes should be the same for good common mode rejection and channel match.

Both active and passive probes in single ended and differential configurations can be calibrated. This calibration uses the Cal Out BNC connection and a probe connection accessory. The calibration achieves excellent absolute gain flatness in a probed measurement. It matches both the gain and frequency response of the I and Q channels as well as any delay skew, resulting in high accuracy in derived measurements such as Error Vector Magnitude (EVM).

When a probe is connected a status message will be displayed. The message will indicate if calibration data is available or not. Calibration data is saved for each type of probe (including "none") for each port and will be reapplied whenever that type of probe is re-connected to the same port. For probes with EEPROM identification, the calibration data will be stored based on the unique probe identifier and will reapply data for that particular probe if it is available. The data will not follow a probe from one port to another. For probes without EEPROM identification, the instrument cannot distinguish between different probes of the same type and it will use the data from the last calibration for that probe type on that port.

When in differential mode, both the main and complementary probes are expected to be of the same type.

In some situations, the I and Q channels should be configured identically. In other situations it is convenient to control them independently. Some menus have a "Q Same as I" setting that will cause the Q channel configuration to mirror the I channel configuration, avoiding the overhead of double data entry when the channels should be the same.

The output port is for calibrating the I/Q input ports, although it can also be manually controlled.

There are two types of calibrations available: cable calibration and probe calibration. The cable calibration will guide the user through connecting each input port in turn. All ports must be calibrated together. The probe calibration is done for a specific channel (I or Q). If in Single-Ended mode, only the main port is calibrated. When in Differential Input mode, the user is guided through calibrating both main and complementary ports.

The front panel I/Q port LEDs indicate the current state of that port. On (green) indicates it is active, and off (dark) indicates it is not in use. For example, the Cal Out port LED is on if and only if there is signal coming out of that port.

The input is a context and some parameters have separate values for each context. The SCPI for these parameters has an optional "[:RF|IQ]" node. If the specific context is omitted, the command acts on the current input context's value. Here are the parameters that are input context sensitive:

- Center Frequency
- Trigger Source

It is important to distinguish between the I and Q input ports and the displayed I and Q data values. The I and Q input ports feed into a digital receiver that does digital tuning and filtering. The I and Q data seen by the user (either on the display or through SCPI) corresponds to the real ("I") and the imaginary ("Q") output from the digital receiver. When the input path is I+jQ or I Only and the center frequency is 0 Hz the I input ends up in as the real output from the receiver and appears as "I" data. Likewise, when the input path is I+jQ and the center frequency is 0 Hz, the Q input ends up as the imaginary output from the receiver and appears as "Q" data. However, when the input path is Q Only, the Q input is sent to the receiver as Q+j0, so the receiver output has the Q input coming out on the real output, and so in Q Only, the signal from the Q input port appears as the "I" data. Another situation where the I and Q data do not necessarily correspond directly to the I and Q inputs is when the center frequency is non-zero. The digital processing involved in the tuning is a complex operation. This will result in I Only data appearing as both "I" and "Q" data, the same as that signal would appear if seen through the RF input port.

### Baseband I/Q Remote Language Compatibility

For the Agilent E4406A VSA Series Transmitter Tester, Option B7C provided baseband I/Q inputs. Code compatibility has been provided to allow many of the commands for option B7C to function properly with the X-Series. The X-Series has hardware differences and additional capabilities (e.g., E4406A does not have independent settings of I & Q nor does it provide for probe calibrations) which make 100% compatibility impossible.

1. The following commands are supported:

:CALibration:IQ:FLATness

:INPut:IMPedance:IQ U50|B50|U1M|B1M

:INPut:IMPedance:REFerence <integer>

2. The [:SENSe]:FEED RF|IQ|IONLy|QONLy|AREFerence|IFALign command supports all parameters except IFALign. The FEED? query will return only RF|AIQ|AREF.

3. The following commands are not supported:

:CALibration:GIQ

:CALibration:IQ:CMR

:INPut:IQ:ALIGn OFF|ON|0|1

The Rohde & Schwarz FSQ-B71 also provides baseband I/Q inputs. A certain amount of code compatibility is provided in the X-Series, however hardware differences make this a somewhat limited set.

Supported:

The "<1|2>" is supported as "[1]".

INPut<1|2>:IQ:BALanced[:STATe] ON | OFF

INPut<1|2>:IQ:TYPE I | Q | IQ

INPut<1|2>:IQ:IMPedance LOW | HIGH

Not Supported:

INPut<1|2>:SElect AIQ | RF

TRACe<1|2>:IQ:DATA:FORMat COMPatible | IQBLock | IQPair>

TRACe<1|2>:IQ:DATA:MEMory? <offset samples>,<# of samples>

TRACe<1|2>:IQ:DATA?

TRACe<1|2>:IQ:SET <filter type>,<rbw>,<sample rate>,<trigger source>,<trigger slope>,<pretrigger samples>,<# of samples>

TRACe<1|2>:IQ:SRATe 10.0kHz to 81.6MHz

TRACe<1|2>:IQ[:STATe] ON|OFF

The Rohde & Schwarz FMU has the following SCPI, which is not supported (these commands start/abort the probe calibration procedure, which is manually interactive from the front panel):

CALibration:ABORT

CALibration:PROBe[:START]

## I/Q Path

Selects which I/Q input channels are active. The LED next to each I/Q input port will be on when that port is active.

The analysis bandwidth for each channel is the same as that of the instrument. For example, the base N9020A has a bandwidth of 10 MHz. With I/Q input the I and Q channels would each have an analysis bandwidth of 10 MHz, giving 20 MHz of bandwidth when the I/Q Path is I+jQ. With option B25, the available bandwidth becomes 25 MHz, giving 25 MHz each to I and Q and 50 MHz to I+jQ.

I/Q voltage to power conversion processing is dependent on the I/Q Path selected.

- With I+jQ input we know that the input signal may not be symmetrical about 0 Hz, because it has a complex component. Therefore, above 0 Hz only the positive frequency information is displayed, and below 0 Hz only the negative frequency information is displayed.
- With all other Input Path selections, the input signal has no complex component and therefore is always symmetrical about 0 Hz. In this case, by convention, the power conversion shows the combined voltage for both the positive and negative frequencies. The information displayed below 0 Hz is the mirror of the information displayed above 0 Hz. This results in a power reading 6.02 dB higher (for both) than would be seen with only the positive frequency voltage. Note also that, in this case the real signal may have complex modulation embedded in it, but that must be recovered by further signal processing.

Key Path	Input/Output, I/Q
<b>Remote Command</b>	[ :SENSe ] :FEED:IQ:TYPE IQ IONLy QONLy [ :SENSe ] :FEED:IQ:TYPE?
<b>Example</b>	Set the input to be both the I and Q channels, combined as I + j * Q. FEED:IQ:TYPE IQ
<b>Preset</b>	IQ
<b>State Saved</b>	Yes This is unaffected by a Preset but is set to the default value on a "Restore Input/Output Defaults" or

	"Restore System Defaults->All"
Range	I+jQ   I Only   Q Only
Readback Text	I+jQ   I Only   Q Only
Initial S/W Revision	Prior to A.02.00

<b>Remote Command</b>	:INPut [1] :IQ:TYPE IQ   I   Q :INPut [1] :IQ:TYPE?
Notes	For R&S FSQ-B71 compatibility
Preset	IQ
Initial S/W Revision	Prior to A.02.00

### I+jQ

Sets the signal input to be both the I and Q channels. The I and Q channel data will be combined as  $I + j * Q$ .

Key Path	Input/Output, I/Q, I/Q Path
<b>Example</b>	Set the input to be both the I and Q channels, combined as $I + j * Q$ . FEED:IQ:TYPE IQ
Initial S/W Revision	Prior to A.02.00

### I Only

Sets the signal input to be only the I channel. The Q channel will be ignored. The data collected is still complex. When the center frequency is 0 the imaginary part will always be zero, but for any other center frequency both the real and imaginary parts will be significant.

Key Path	Input/Output, I/Q, I/Q Path
<b>Example</b>	Set the input to be only the I channel. FEED:IQ:TYPE IONL
Initial S/W Revision	Prior to A.02.00

### Q Only

Sets the signal input to be only the Q channel. The I channel will be ignored. The Q channel will be sent to the digital receiver block as  $Q+j0$ . The receiver's output is still complex. When the center frequency is 0 the imaginary part will always be zero, but for any other center frequency both the real and imaginary parts will be significant. Note that since the receiver's real output is displayed as the "I" data, when the center frequency is 0, the Q Only input appears as the "I" data.

Key Path	Input/Output, I/Q, I/Q Path
<b>Example</b>	Set the input to be only the Q channel. FEED:IQ:TYPE QONL
Initial S/W Revision	Prior to A.02.00

## I Setup

Access the channel setup parameters for the I channel.

Key Path	Input/Output, I/Q
Initial S/W Revision	Prior to A.02.00

## I Differential Input

Selects differential input on or off for the I channel. For differential input (also called balanced input), the analyzer uses both main and complementary ports. When differential input is off (also called single-ended or unbalanced input), the analyzer uses only the main port.

Key Path	Input/Output, I/Q, I Setup
<b>Remote Command</b>	:INPut:IQ[:I]:DIFFerential OFF ON 0 1 :INPut:IQ[:I]:DIFFerential?
<b>Example</b>	Put the I channel in Differential Input mode INP:IQ:DIFF ON
Notes	When I Differential Input = On, the analyzer will check for attenuation mismatches between the I and I-bar ports. If the difference in attenuation values exceeds 0.5 dB a Settings Alert error condition, error 159 will be set. When I Differential Input = On, and IQ Path is I+jQ, the Q Differential input must also be On. Similarly, when I Differential Input = Off, and IQ Path is I+jQ, the Q Differential input must also be Off. If the states of the two inputs do not match, an error condition message is generated, 159;Settings Alert;I/Q mismatch:Differential.
Couplings	Some active probes include built-in differential capability. When one of these probes is sensed, this key is disabled. Since the differential capability is handled in the probe, the Analyzer will use only the main port and the key will show that the Analyzer's Differential Input mode is Off (indicating that the complementary port is not in use). When Q Same as I is On, the value set for I will also be copied to Q.
Preset	Off
State Saved	Yes This is unaffected by a Preset but is set to the default value on a "Restore Input/Output Defaults" or "Restore System Defaults->All"
Range	Off   On
Initial S/W Revision	Prior to A.02.00

<b>Remote Command</b>	:INPut [1] :IQ:BAALanced[:STATe] OFF ON 0 1 :INPut [1] :IQ:BAALanced[:STATe] ?
Notes	For R&S FSQ-B71 compatibility, with no independent settings for the I and Q channels. Therefore, it is tied only to the I channel and does not provide an equivalent for the Q channel. For proper operation of the backwards compatibility command Q Same as I should be set to On.
Preset	OFF
Initial S/W Revision	Prior to A.02.00

### I Input Z

Selects the input impedance for the I channel. The impedance applies to both the I and I-bar ports.

The input impedance controls the hardware signal path impedance match. It is not used for converting voltage to power. The voltage to power conversion always uses the Reference Z parameter. The Reference Z parameter applies to both I and Q channels.

<b>Key Path</b>	Input/Output, I/Q, I Setup
<b>Remote Command</b>	:INPut [1] :IQ[:I] :IMPedance LOW HIGH :INPut [1] :IQ[:I] :IMPedance?
<b>Example</b>	Set the I channel input impedance to 1 M $\Omega$ INP:IQ:IMP HIGH
Notes	LOW = 50 $\Omega$ , HIGH = 1 M $\Omega$ When IQ Path is I+jQ, the I Input Z setting must be the same as the Q Input Z setting. If the settings of the two inputs do not match, an error condition message is generated, 159;Settings Alert;I/Q mismatch:Input Z.
Couplings	Input impedance is a built-in characteristic of a probe. Therefore, whenever a probe is sensed, this key is disabled and the value is set to match the probe. When no probe is sensed on Q and Q Same as I is On, the value set for I will also be copied to Q.
Preset	LOW
State Saved	Yes This is unaffected by a Preset but is set to the default value on a "Restore Input/Output Defaults" or "Restore System Defaults->All"
Range	50 $\Omega$   1 M $\Omega$
Initial S/W Revision	Prior to A.02.00

### I Skew

Sets the skew factor for the I channel. The skew will shift the channel's data in time. Use this to compensate for differences in the electrical lengths of the input paths due to cabling.

<b>Key Path</b>	Input/Output, I/Q, I Setup
<b>Remote Command</b>	[:SENSe]:CORRection:IQ[:I]:SKEW <seconds>

	<code>[ :SENSe ] :CORRection:IQ[:I]:SKEW?</code>
<b>Example</b>	Delay the data for the I channel by 10 ns. <code>CORR:IQ:SKEW 10 ns</code>
Preset	0
State Saved	Yes This is unaffected by Preset but is set to the default value on a "Restore Input/Output Defaults" or "Restore System Defaults->All"
Range	0 s to 100 ns
Min	0 s
Max	+100 ns
Initial S/W Revision	Prior to A.02.00

### I Probe

Access the probe setup parameters for the I channel. See ["I/Q Probe Setup" on page 260](#).

Key Path	Input/Output, I/Q, I Setup
State Saved	No
Readback Text	[<I port probe id>] This is reporting the type of probe sensed on the I port. There is no parameter for overriding what is sensed.
Initial S/W Revision	Prior to A.02.00

### Attenuation

The attenuation is part of the calibration data stored with the probe type and is initially the value that was returned by the last calibration. You can modify this value and any changes will be stored with the calibration data and will survive power cycles and presets. When a probe calibration is performed the attenuation value will be overwritten by the calibration.

Key Path	Input/Output, I/Q, I Setup   Q Setup, I Probe   Q Probe
<b>Remote Command</b>	<code>[ :SENSe ] :CORRection:IQ:I Q:ATTenuation:RATio &lt;real&gt;</code> <code>[ :SENSe ] :CORRection:IQ:I Q:ATTenuation:RATio?</code>
<b>Example</b>	Set the attenuation for the current I probe to 100.00:1. <code>CORR:IQ:I:ATT:RAT 100</code>
Notes	Each probe type has its own attenuation setting. As probes are changed the attenuation value will reflect the new probe's setting. Changing the attenuation affects only the current probe type's setting and leaves all others unchanged. When the IQ Path is I+jQ, the Q probe attenuation setting must match the I Probe attenuation setting within 1 dB. If this is not the case, an error condition message is generated, 159;Settings Alert;I/Q mismatch:Attenuation.

Preset	Each probe type has its own default. The default for the "Unknown" probe type is 1:1.
State Saved	Saved with probe calibration data. It survives a power cycle and is not affected by a Preset or Restore.
Range	0.001 to 10000
Min	0.001
Max	10000
Initial S/W Revision	Prior to A.02.00

This is an alternate form of the SCPI that allows input as a power instead of a ratio.

<b>Remote Command</b>	<code>[[:SENSE]:CORRection:IQ:I Q:ATTenuation &lt;rel_ampl&gt;</code> <code>[[:SENSE]:CORRection:IQ:I Q:ATTenuation?</code>
<b>Example</b>	Set the attenuation for the current I probe type to 100.00:1. CORR:IQ:I:ATT 20 dB
Range	-60 dB to +80 dB
Min	-60 dB
Max	+80 dB
Initial S/W Revision	Prior to A.02.00

### Calibrate

Invokes the guided probe calibration. The guided probe calibration is context sensitive and depends on the channel (I or Q) and the Differential Input state. The calibration is only performed on the selected channel. When Differential Input is on, both the probe attached to the main port and the probe attached to the complementary port are calibrated. When Differential Input is off, only the probe attached to the main port is calibrated. See "[I/Q Guided Calibration](#)" on page 303.

Key Path	Input/Output, I/Q, I Setup   Q Setup, I Probe   Q Probe, Coupling
Readback Text	The last calibration date, or if no calibration exists, "(empty)". Last: <cal date> <cal time> Example: Last: 8/22/2007 1:02:49 PM
Initial S/W Revision	Prior to A.02.00

### Clear Calibration

Clears the calibration data for the current port and probe. It does not clear the data for other probe types or other ports. If the sensed probe has EEPROM identification, only the data for that specific probe is



cleared. After this command has completed, the probe calibration state will be the same as if no probe calibration had ever been performed for the specified channel and probe. The probe attenuation will be the default value for that probe type and the Cable Calibration frequency response corrections will be used. This command is dependent on the Differential Input state. When Differential Input is on, both the data for the probe attached to the main port and the data for the probe attached to the complementary port are cleared. When Differential Input is off, only data for the probe attached to the main port is cleared.

<b>Key Path</b>	Input/Output, I/Q, I Setup   Q Setup, I Probe   Q Probe
<b>Remote Command</b>	:CALibration:IQ:PROBe:I Q:CLEar
<b>Example</b>	Clear the calibration data for the I channel and the current probe (with EEPROM identification) or probe type (without EEPROM identification). :CAL:IQ:PROBe:I:CLE
<b>Initial S/W Revision</b>	Prior to A.02.00

### Combined Differential/Input Z (Remote Command Only)

This is Remote Command only (no front panel) and is for backwards compatibility only. It combines the Differential Input and Input Z selections into a single SCPI command.

<b>Remote Command</b>	:INPut:IMPedance:IQ U50 B50 U1M B1M :INPut:IMPedance:IQ?
<b>Example</b>	:INPut:IMPedance:IQ U50 This is equivalent to the following two SCPI commands: :INP:IQ:DIFF OFF :INP:IQ:IMP 50
<b>Notes</b>	Provided for E4406A code compatibility. The enum values translate as follows: U50: Differential Input = Off, Input Z = 50Ω B50: Differential Input = On, Input Z = 50Ω U1M: Differential Input = Off, Input Z = 1 MΩ B1M: Differential Input = On, Input Z = 1 MΩ This command is for backwards compatibility. It combines the Input Z (50Ω or 1 MΩ) parameter with the Differential Input (Off = "Unbalanced", On = "Balanced") parameter into a single enumeration. This backwards compatibility SCPI command was for an instrument without independent settings for the I and Q channels. Therefore, it is tied only to the I channel and does not provide an equivalent for the Q channel. For proper operation of the backwards compatibility command Q Same as I should be set to On. Also, note the subtle difference between this SCPI command and the backwards compatibility command for Input Z. The Input Z SCPI has "IQ" before "IMP" while this command has that order reversed.
<b>Couplings</b>	This command does not have an independent parameter, but instead is tied to the Differential Input and Input Z parameters. The coupling for those parameters apply to this command too.
<b>Preset</b>	U50
<b>Initial S/W Revision</b>	Prior to A.02.00

## Q Setup

Access the channel setup parameters for the Q channel.

Key Path	Input/Output, I/Q
Readback Text	When Q Same as I is On the readback is "Q Same as I".
Initial S/W Revision	Prior to A.02.00

## Q Same as I

Many, but not all, usages require the I and Q channels have an identical setup. To simplify channel setup, the Q Same as I will cause the Q channel parameters to be mirrored from the I channel. That way you only need to set up one channel (the I channel). The I channel values are copied to the Q channel, so at the time Q Same as I is turned off the I and Q channel setups will be identical. This does not apply to Probe settings or to parameters that are determined by the probe.

Key Path	Input/Output, I/Q, Q Setup
Remote Command	:INPut:IQ:MIRRored OFF ON 0 1 :INPut:IQ:MIRRored?
Example	Turn off the mirroring of parameters from I to Q. INP:IQ:MIRR OFF
Couplings	Only displayed for the Q channel. When Yes, the I channel values for some parameters are mirrored (copied) to the Q channel. However, when a parameter is determined by the type of probe and a probe is sensed, the probe setting is always used and the I channel setting is ignored. The following parameters are mirrored: Differential Input (when not determined by probe) Input Z (when not determined by probe)
Preset	This is unaffected by a Preset but is set to the default value (Q Same as I set to "On") on a "Restore Input/Output Defaults" or "Restore System Defaults->All"
State Saved	Saved in instrument state
Range	On   Off
Readback Text	"Q Same as I" when On, otherwise none.
Initial S/W Revision	Prior to A.02.00

## Q Differential Input

Selects differential input on or off for the Q channel. For differential input (also called balanced input), the analyzer uses both the Q and Q-bar ports. When differential input is off (also called single-ended or unbalanced input), the analyzer uses only the Q port.

Key Path	Input/Output, I/Q, Q Setup
----------	----------------------------

<b>Remote Command</b>	:INPut:IQ:Q:DIFFerential OFF ON 0 1 :INPut:IQ:Q:DIFFerential?
<b>Example</b>	Put the Q channel in Differential Input mode INP:IQ:Q:DIFF ON
<b>Notes</b>	When Differential Input = On, the analyzer will check for attenuation mismatches between the Q and Q-bar ports. If the difference in attenuation values exceeds 0.5 dB a Settings Alert error condition, error 159 will be set. When Q Differential Input = On, and IQ Path is I+jQ, the I Differential input must also be On. Similarly, when Q Differential Input = Off, and IQ Path is I+jQ, the I Differential input must also be Off. If the states of the two inputs do not match, an error condition message is generated, 159;Settings Alert;I/Q mismatch:Differential.
<b>Couplings</b>	Some active probes include built-in differential capability. When one of these probes is sensed, this key is disabled. Since the differential capability is handled in the probe, the Analyzer will use only the main port and the key will show that the Analyzer's Differential Input mode is Off (indicating that the complementary port not in use). When a differential probe is not sensed and Q Same as I is On, the value set for I will be copied to Q. This key is disabled when Q Same as I is On.
<b>Preset</b>	Off
<b>State Saved</b>	Yes This is unaffected by a Preset but is set to the default value on a "Restore Input/Output Defaults" or "Restore System Defaults->All"
<b>Range</b>	Off   On
<b>Initial S/W Revision</b>	Prior to A.02.00

## Q Input Z

Selects the input impedance for the Q channel. The impedance applies to both the Q and Q-bar ports.

The input impedance controls the hardware signal path impedance match. It is not used for converting voltage to power. The voltage to power conversion always uses the Reference Z parameter. The Reference Z parameter applies to both I and Q channels.

<b>Key Path</b>	Input/Output, I/Q, Q Setup
<b>Remote Command</b>	:INPut [1] :IQ:Q:IMPedance LOW HIGH :INPut [1] :IQ:Q:IMPedance?
<b>Example</b>	Set the Q channel input impedance to 1 M $\Omega$ INP:IQ:Q:IMP HIGH
<b>Notes</b>	LOW = 50 $\Omega$ , HIGH = 1 M $\Omega$ When IQ Path is I+jQ, the I Input Z setting must be the same as the Q Input Z setting. If the settings of the two inputs do not match, an error condition message is generated, 159;Settings Alert;I/Q mismatch:Input Z.
<b>Couplings</b>	Input impedance is a built-in characteristic of a probe. Therefore, whenever a probe is sensed, this key is disabled and the value is set to match the probe.

	When no probe is sensed and Q Same as I is On, the value set for I will also be copied to Q. This key is disabled when Q Same as I is On.
Preset	LOW
State Saved	Yes This is unaffected by Preset but is set to the default value on a "Restore Input/Output Defaults" or "Restore System Defaults->All"
Range	50 $\Omega$   1 M $\Omega$
Initial S/W Revision	Prior to A.02.00

### Q Skew

Sets the skew factor for the Q channel. The skew will shift the channel's data in time. Use this to compensate for differences in the electrical lengths of the input paths due to cabling and probes.

Key Path	Input/Output, I/Q, Q Setup
<b>Remote Command</b>	<code>[ :SENSe]:CORRection:IQ:Q:SKEW &lt;seconds&gt;</code> <code>[ :SENSe]:CORRection:IQ:Q:SKEW?</code>
<b>Example</b>	Delay the data for the Q channel by 10 ns. <code>CORR:IQ:Q:SKEW 10 ns</code>
Preset	0
State Saved	Yes This is unaffected by a Preset but is set to the default value on a "Restore Input/Output Defaults" or "Restore System Defaults->All"
Range	0 s to 100 ns
Min	0 s
Max	+100 ns
Initial S/W Revision	Prior to A.02.00

### Q Probe

Accesses the probe setup parameters for the Q channel. See "[I/Q Probe Setup](#)" on page 260.

Key Path	Input/Output, I/Q, Q Setup
State Saved	No
Readback Text	[<Q port probe id>] This is reporting the type of probe sensed on the Q port. There is no parameter for overriding what is sensed.
Initial S/W Revision	Prior to A.02.00

## Attenuation

The attenuation is part of the calibration data stored with the probe type and is initially the value that was returned by the last calibration. You can modify this value and any changes will be stored with the calibration data and will survive power cycles and presets. When a probe calibration is performed the attenuation value will be overwritten by the calibration.

<b>Key Path</b>	Input/Output, I/Q, I Setup   Q Setup, I Probe   Q Probe
<b>Remote Command</b>	[ :SENSe ] :CORRection:IQ:I Q:ATTenuation:RATio <real> [ :SENSe ] :CORRection:IQ:I Q:ATTenuation:RATio?
<b>Example</b>	Set the attenuation for the current I probe to 100.00:1. CORR:IQ:I:ATT:RAT 100
<b>Notes</b>	Each probe type has its own attenuation setting. As probes are changed the attenuation value will reflect the new probe's setting. Changing the attenuation affects only the current probe type's setting and leaves all others unchanged.  When the IQ Path is I+jQ, the Q probe attenuation setting must match the I Probe attenuation setting within 1 dB. If this is not the case, an error condition message is generated, 159;Settings Alert;I/Q mismatch:Attenuation.
<b>Preset</b>	Each probe type has its own default. The default for the "Unknown" probe type is 1:1.
<b>State Saved</b>	Saved with probe calibration data. It survives a power cycle and is not affected by a Preset or Restore.
<b>Range</b>	0.001 to 10000
<b>Min</b>	0.001
<b>Max</b>	10000
<b>Initial S/W Revision</b>	Prior to A.02.00

This is an alternate form of the SCPI that allows input as a power instead of a ratio.

<b>Remote Command</b>	[ :SENSe ] :CORRection:IQ:I Q:ATTenuation <rel_ampl> [ :SENSe ] :CORRection:IQ:I Q:ATTenuation?
<b>Example</b>	Set the attenuation for the current I probe type to 100.00:1. CORR:IQ:I:ATT 20 dB
<b>Range</b>	-60 dB to +80 dB
<b>Min</b>	-60 dB
<b>Max</b>	+80 dB
<b>Initial S/W Revision</b>	Prior to A.02.00

## Calibrate

Invokes the guided probe calibration. The guided probe calibration is context sensitive and depends on the channel (I or Q) and the Differential Input state. The calibration is only performed on the selected channel. When Differential Input is on, both the probe attached to the main port and the probe attached to the

complementary port are calibrated. When Differential Input is off, only the probe attached to the main port is calibrated. See "[I/Q Guided Calibration](#)" on page 303.

Key Path	Input/Output, I/Q, I Setup   Q Setup, I Probe   Q Probe, Coupling
Readback Text	The last calibration date, or if no calibration exists, "(empty)". Last: <cal date> <cal time> Example: Last: 8/22/2007 1:02:49 PM
Initial S/W Revision	Prior to A.02.00

### Clear Calibration

Clears the calibration data for the current port and probe. It does not clear the data for other probe types or other ports. If the sensed probe has EEPROM identification, only the data for that specific probe is cleared. After this command has completed, the probe calibration state will be the same as if no probe calibration had ever been performed for the specified channel and probe. The probe attenuation will be the default value for that probe type and the Cable Calibration frequency response corrections will be used. This command is dependent on the Differential Input state. When Differential Input is on, both the data for the probe attached to the main port and the data for the probe attached to the complementary port are cleared. When Differential Input is off, only data for the probe attached to the main port is cleared.

Key Path	Input/Output, I/Q, I Setup   Q Setup, I Probe   Q Probe
Remote Command	:CALibration:IQ:PROBe:I Q:CLEar
Example	Clear the calibration data for the I channel and the current probe (with EEPROM identification) or probe type (without EEPROM identification). :CAL:IQ:PROBe:I:CLE
Initial S/W Revision	Prior to A.02.00

### Reference Z

Sets the value of the impedance to be used in converting voltage to power for the I and Q channels. This does not change the hardware's path impedance (see "[I Input Z](#)" on page 250).

Key Path	Input/Output, I/Q
Remote Command	:INPut:IMPedance:REFerence <integer> :INPut:IMPedance:REFerence?
Example	Set the I/Q reference impedance to 50 Ω INP:IMP:REF 50
Preset	50 Ω
State Saved	Yes

	This is unaffected by a Preset but is set to the default value on a "Restore Input/Output Defaults" or "Restore System Defaults->All"
Range	1 $\Omega$ to 1 M $\Omega$
Min	1 $\Omega$
Max	1 M $\Omega$
Initial S/W Revision	Prior to A.02.00

### I/Q Cable Calibrate...

The I/Q cable calibration creates correction data for each of the front panel I/Q ports. This calibration data is used whenever no probe specific calibration data is available. It is important that all ports are calibrated using the same short BNC cable so that the data is comparable from port to port.

The guided calibration (front panel only) will show connection diagrams and guide you through the isolation calibration and calibrating each port. The calibration data for each port is stored separately, so as soon as a port is calibrated that data is saved and will be used. If you press "Exit" to exit the calibration process, the data for the ports already completed will still be used. It is recommended that a calibration be completed once started, or if exited, that it be properly done before the next use of the I/Q ports. The "Next" button will perform the calibration for the current port and then proceed to the next step in the calibration procedure. The "Back" button will return to the prior port in the procedure. Both keys and dialog buttons are supplied for ease of use. The dialog buttons are for mouse use and the softkeys for front panel use.

The calibration can also be done via SCPI, but no connection diagrams will be shown. You will have to make the correct connections before issuing each port calibration command. Again, it is recommended that all ports be calibrated at the same time.

The instrument state remains as it was prior to entering the calibration procedure except while a port is actually being calibrated. Once a port is calibrated it returns to the prior state. A port calibration is in process only from the time the "Next" button is pressed until the next screen is shown. For SCPI, this corresponds to the time from issuing the CAL:IQ:FLAT:I|B|Q|QB command until the operation is complete.

For example, if the prior instrument state is Cal Out = Off, Input = I+jQ, and Differential = Off, then up until the time the "Next" button is pressed the I Input and Q Input LEDs are on and the Cal Out, I-bar Input and Q-bar Input LEDs are off. Once the "Next" button is pressed for the I port calibration, only the Cal Out and I Input LEDs will be on and the others will be off. When the screen progresses to the next step ("Next" button again enabled), the prior state is restored and only the I Input and Q Input LEDs are on (Cal Out is off again).

The last calibration date and time for each port will be displayed. Any calibrations that are more than a day older than the most recent calibration will be displayed with the color amber.

Key Path	Input/Output, I/Q
Initial S/W Revision	Prior to A.02.00

## I/Q Probe Setup

The set of I/Q probe setup parameters will change based on the type of probe that is sensed. All probe types have the Attenuation parameter, and all probe types can be calibrated. The remaining parameters are only available for some probe types and will not be shown when not available. The probe type is determined by and reported for only for the I and Q ports, never the I-bar or Q-bar ports. The menu title will be "<ch>: <probe id>", where "<ch>" is either "I" or "Q" and "<probe id>" is the type of probe. For example, for the I Probe setup with an Agilent 1130A probe connected to the I port, the title will be "I: 1130A".

Probe calibration data is stored for each probe type for each channel. When no probe is sensed, the probe type "Unknown" is used, and this is also treated like a probe type with its own calibration data. When a probe is changed, the calibration data for that probe type for that port is restored. An advisory message will be displayed showing the new probe type and the calibration status. The calibration data is stored permanently (survives a power cycle) and is not affected by a Preset or any of the Restore commands. When the probe has EEPROM identification (most newer Agilent probes have this), the calibration data is stored by probe serial number and port, so if you have two probes of the same type, the correct calibration data will be used for each. For probes that do not have EEPROM identification, the calibration data is stored by probe type and port and the instrument cannot distinguish between different probes of the same type. In all cases (with or without EEPROM identification), the calibration data is port specific, so it will not follow a specific probe from port to port if the probe is moved.

The "Unknown" probe type is used whenever no probe is sensed. When no calibration data exists for "Unknown" the latest cable calibration data is used (see ["I/Q Guided Calibration" on page 303](#)).

### Attenuation

The attenuation is part of the calibration data stored with the probe type and is initially the value that was returned by the last calibration. You can modify this value and any changes will be stored with the calibration data and will survive power cycles and presets. When a probe calibration is performed the attenuation value will be overwritten by the calibration.

<b>Key Path</b>	Input/Output, I/Q, I Setup   Q Setup, I Probe   Q Probe
<b>Remote Command</b>	[ :SENSe ] :CORRection:IQ:I Q:ATTenuation:RATio <real> [ :SENSe ] :CORRection:IQ:I Q:ATTenuation:RATio?
<b>Example</b>	Set the attenuation for the current I probe to 100.00:1. CORR:IQ:I:ATT:RAT 100
<b>Notes</b>	Each probe type has its own attenuation setting. As probes are changed the attenuation value will reflect the new probe's setting. Changing the attenuation affects only the current probe type's setting and leaves all others unchanged.  When the IQ Path is I+jQ, the Q probe attenuation setting must match the I Probe attenuation setting within 1 dB. If this is not the case, an error condition message is generated, 159;Settings Alert;I/Q mismatch:Attenuation.
<b>Preset</b>	Each probe type has its own default. The default for the "Unknown" probe type is 1:1.
<b>State Saved</b>	Saved with probe calibration data. It survives a power cycle and is not affected by a Preset or Restore.
<b>Range</b>	0.001 to 10000
<b>Min</b>	0.001
<b>Max</b>	10000
<b>Initial S/W Revision</b>	Prior to A.02.00



This is an alternate form of the SCPI that allows input as a power instead of a ratio.

<b>Remote Command</b>	<code>[ :SENSE ] :CORREction:IQ:I Q:ATTenuation &lt;rel_ampl&gt;</code> <code>[ :SENSE ] :CORREction:IQ:I Q:ATTenuation?</code>
<b>Example</b>	Set the attenuation for the current I probe type to 100.00:1. <code>CORR:IQ:I:ATT 20 dB</code>
Range	-60 dB to +80 dB
Min	-60 dB
Max	+80 dB
Initial S/W Revision	Prior to A.02.00

### Offset

Some active probes have DC offset capability. When one of these probes is connected this control will be visible. The signal is adjusted for the DC offset before entering the analyzer's port. This allows for removal of a DC offset before reaching the analyzer's input port voltage limits. For example, a signal that varies 1 V peak-to-peak with a DC offset equal to the analyzer's max input voltage would exceed the input limits of the analyzer for half its cycle. Removing the DC offset allows the analyzer to correctly process the entire signal.

<b>Key Path</b>	Input/Output, I/Q, I Setup   Q Setup, I Probe   Q Probe
<b>Remote Command</b>	<code>:INPut:OFFSet:I Q &lt;voltage&gt;</code> <code>:INPut:OFFSet:I Q?</code>
<b>Example</b>	Remove a DC offset of -0.5 V from the I channel input. <code>INP:OFFS:I -0.5</code>
Notes	Only some probe types support Offset. For those that do, each probe type has its own Offset setting. As probes are changed the Offset value will reflect the new probe's setting. Changing the Offset affects only the current probe type's setting and leaves all others unchanged.
Preset	0 V
State Saved	Saved with probe calibration data. It survives power cycle and is not affected by Preset or Restore.
Range	-18 V to +18 V
Min	-18 V
Max	+18 V
Initial S/W Revision	Prior to A.02.00

### Coupling

Some probe types allow coupling to reject low frequencies. This will filter out the DC component of a signal that is composed of a DC bias plus some AC signal. This control is visible only for probe types that have this capability.

Key Path	Input/Output, I/Q, I Setup   Q Setup, I Probe   Q Probe
Remote Command	:INPut:COUPling:I Q DC LFR1 LFR2 :INPut:COUPling:I Q?
Example	Set the probe to low frequency rejection below 1.7 Hz. INP:COUP:I LFR1
Notes	Only some probe types support Coupling. For those that do, each probe type has its own Coupling setting. As probes are changed the Coupling value will reflect the new probe's setting. Changing the Coupling affects only the current probe type's setting and leaves all others unchanged.
Preset	DC
State Saved	Saved with probe calibration data. It survives a power cycle and is not affected by a Preset or Restore.
Range	DC   AC 1.7 Hz LFR1   AC 0.14 Hz LFR2
Readback Text	DC   LFR1   LFR2
Initial S/W Revision	Prior to A.02.00

#### DC

Turns off low frequency rejection, allowing signals down to DC.

Key Path	Input/Output, I/Q, I Setup   Q Setup, I Probe   Q Probe, Coupling
Example	Turn off low frequency rejection on the I channel INP:COUP:I DC
Initial S/W Revision	Prior to A.02.00

#### LFR1

Turns on low frequency rejection, rejecting signal component lower than 1.7 Hz.

Key Path	Input/Output, I/Q, I Setup   Q Setup, I Probe   Q Probe, Coupling
Example	Turn on low frequency rejection on the I channel for frequencies lower than 1.7 Hz INP:COUP:I LFR1
Initial S/W Revision	Prior to A.02.00

#### LFR2

Turns on low frequency rejection, rejecting signal component lower than 0.14 Hz.

Key Path	Input/Output, I/Q, I Setup   Q Setup, I Probe   Q Probe, Coupling
Example	Turn on low frequency rejection on the I channel for frequencies lower than 0.14 Hz INP:COUP:I LFR2
Initial S/W Revision	Prior to A.02.00

## Calibrate

Invokes the guided probe calibration. The guided probe calibration is context sensitive and depends on the channel (I or Q) and the Differential Input state. The calibration is only performed on the selected channel. When Differential Input is on, both the probe attached to the main port and the probe attached to the complementary port are calibrated. When Differential Input is off, only the probe attached to the main port is calibrated. See "[I/Q Guided Calibration](#)" on page 303.

Key Path	Input/Output, I/Q, I Setup   Q Setup, I Probe   Q Probe, Coupling
Readback Text	The last calibration date, or if no calibration exists, "(empty)". Last: <cal date> <cal time> Example: Last: 8/22/2007 1:02:49 PM
Initial S/W Revision	Prior to A.02.00

## Clear Calibration

Clears the calibration data for the current port and probe. It does not clear the data for other probe types or other ports. If the sensed probe has EEPROM identification, only the data for that specific probe is cleared. After this command has completed, the probe calibration state will be the same as if no probe calibration had ever been performed for the specified channel and probe. The probe attenuation will be the default value for that probe type and the Cable Calibration frequency response corrections will be used. This command is dependent on the Differential Input state. When Differential Input is on, both the data for the probe attached to the main port and the data for the probe attached to the complementary port are cleared. When Differential Input is off, only data for the probe attached to the main port is cleared.

Key Path	Input/Output, I/Q, I Setup   Q Setup, I Probe   Q Probe
Remote Command	:CALibration:IQ:PROBe:I Q:CLEar
Example	Clear the calibration data for the I channel and the current probe (with EEPROM identification) or probe type (without EEPROM identification). :CAL:IQ:PROBe:I:CLE
Initial S/W Revision	Prior to A.02.00

## RF Calibrator

Lets you choose a calibrator signal to look at or turns the calibrator "off".

Key Path	Input/Output
Remote Command	[ :SENSe ] :FEED:AREFERENCE REF50   REF4800   OFF [ :SENSe ] :FEED:AREFERENCE?

<b>Example</b>	FEED:AREF REF50 selects the 50 MHz amplitude reference as the signal input. FEED:AREF REF4800 selects the 4.8 GHz amplitude reference as the signal input FEED:AREF OFF turns the calibrator "off" (switches back to the selected input – RF or I/Q)
Dependencies	Selecting an input (RF or I/Q) turns the Calibrator OFF. This is true whether the input is selected by the keys or with the [:SENSe]:FEED command.  The 4.8 GHz internal reference is only available in some models and frequency range options. If the 4.8 GHz reference is not present, the 4.8 GHz softkey will be blanked, and if the REF4800 parameter is sent, the analyzer will generate an error.
Couplings	When one of the calibrator signals is selected, the analyzer routes that signal (an internal amplitude reference) to the analyzer, and changes the main input selection to RF so the calibrator signal can be seen. When you turn the calibrator off it does not switch back to the previously selected input.
Preset	OFF
State Saved	Saved in instrument state
Readback	Off, 50 MHz, 4.8 GHz
Initial S/W Revision	Prior to A.02.00

<b>Remote Command</b>	:CALibration:SOURce:STATe OFF ON 0 1  :CALibration:SOURce:STATe?
Notes	For ESA backwards compatibility.  In the ESA the calibrator was a separate output which you connected to the input and switched on with this command.  In the X-Series, the ON parameter is aliased to the [:SENSe]:FEED:AREF REF50 command and the OFF parameter is aliased to [:SENSe]:FEED:AREF OFF.  When CALibration:SOURce:STATe? is received, 1 will be returned if any of the references is selected and 0 if the Calibrator is "Off"
Preset	OFF
Initial S/W Revision	Prior to A.02.00

## 50 MHz

Selects the 50 MHz internal reference as the input signal.

Key Path	Input/Output, RF Calibrator
<b>Example</b>	:FEED:AREF REF50
Readback	50 MHz
Initial S/W Revision	Prior to A.02.00

## 4.8 GHz

Selects the 4.8 GHz internal reference as the input signal.

Key Path	Input/Output, RF Calibrator
<b>Example</b>	:FEED:AREF REF4800
Dependencies	The 4.8 GHz internal reference is only available in some models and frequency range options. If the 4.8 GHz reference is not present, the 4.8 GHz softkey will be blanked, and if the REF4800 parameter is sent, the analyzer will generate an error.
Readback	4.8 GHz
Initial S/W Revision	Prior to A.02.00
Modified at S/W Revision	A.03.00

## Off

Switches the input back to the selected input (RF or I/Q)

Key Path	Input/Output, RF Calibrator
<b>Example</b>	:FEED:AREF OFF
Readback	Off
Initial S/W Revision	Prior to A.02.00

## External Gain

Compensates for gain or loss in the measurement system outside the spectrum analyzer. The External Gain is subtracted from the amplitude readout (or the loss is added to the amplitude readout). So, the displayed signal level represents the signal level at the output of the device-under-test, which can be the input of an external device that provides gain or loss.

Entering an External Gain value does not affect the Reference Level, therefore the trace position on screen changes, as do all of the values represented by the trace data. Thus, the values of exported trace data, queried trace data, marker amplitudes, trace data used in calculations such as N dB points, trace math, peak threshold, etc., are all affected by External Gain. Changing the External Gain, even on a trace that is not updating, will immediately change all of the above, without new data needing to be taken.

### NOTE

Changing the External Gain causes the analyzer to immediately stop the current sweep and prepare to begin a new sweep. The data will not change until the trace data updates because the offset is applied to the data as it is taken. If a trace is exported with a nonzero External Gain, the exported data will contain the trace data with the offset applied.

In the Spectrum Analyzer mode, a Preamp is the common external device providing gain or loss. In a measurement application mode like GSM or W-CDMA, the gain or loss could be from a BTS (Base Transceiver Station) or an MS (Mobile Station). So in the Spectrum Analyzer mode MS and BTS would be

grayed out and the only choice would be Ext Preamp. Similarly in some of the digital communications applications, Ext Preamp will be grayed out and you would have a choice of MS or BTS.

<b>Key Path</b>	Input/Output
<b>Couplings</b>	The Ext Preamp, MS, and BS keys may be grayed out depending on which measurement is currently selected. If any of the grayed out keys are pressed, or the equivalent SCPI command is sent, an advisory message is generated.
<b>Readback</b>	1-of-N selection   [variable]
<b>Initial S/W Revision</b>	Prior to A.02.00

## Ext Preamp

This function is similar to the reference level offset function. Both affect the displayed signal level. Ref Lvl Offset is a mathematical offset only, no analyzer configuration is affected. Ext Preamp gain is used when determining the auto-coupled value of the Attenuator. The External Gain value and the Maximum Mixer Level settings are both part of the automatic setting equation for the RF attenuation setting. (10 dB of Attenuation is added for every 10 dB of External Gain.)

Note that the Ref Lvl Offset and Maximum Mixer Level are described in the Amplitude section. They are reset by the instrument Preset. The External Preamp Gain is reset by the "Restore Input/Output Defaults" or "Restore System Defaults->All functions. . The External Gain is subtracted from the amplitude readout so that the displayed signal level represents the signal level at the output of the device-under-test, which is the input of the external device that is providing gain or loss.

"More Information" on page 267

<b>Key Path</b>	Input/Output, External Gain
<b>Remote Command</b>	<code>[[:SENSE]:CORRection:SA[:RF]:GAIN &lt;rel_ampl&gt;</code> <code>[[:SENSE]:CORRection:SA[:RF]:GAIN?</code>
<b>Example</b>	CORR:SA:GAIN 10 sets the Ext Gain value to 10 dB CORR:SA:GAIN -10 sets the Ext Gain value to -10 dB (that is, an attenuation of 10 dB)
<b>Notes</b>	Does not auto return.
<b>Dependencies</b>	The reference level limits are determined in part by the External Gain/Atten, Max Mixer Level, and RF Atten. This key is grayed out in Modes that do not support External Gain
<b>Preset</b>	This is unaffected by Preset but is set to 0 dB on a "Restore Input/Output Defaults" or "Restore System Defaults->All"
<b>State Saved</b>	Saved in instrument state
<b>Min</b>	-120 dB
<b>Max</b>	120 dB
<b>Readback</b>	Preamp Gain, <Ext Gain value> dB
<b>Backwards Compatibility SCPI</b>	<code>[[:SENSE]:CORRection:OFFSet[:MAGNitude]</code> The legacy "Ext Preamp Gain" key is now called "Ext Gain" and the sub-menu has choices of Ext

	Preamp   MS   BTS for backwards compatibility.
Initial S/W Revision	Prior to A.02.00
Modified at S/W Revision	A.14.00

## More Information

The U7227A USB Preamplifier is an accessory for the X-Series Signal Analyzer that provides gain externally, and whose gain settings are automatically loaded into the analyzer over USB whenever it is connected to one of the analyzer's USB ports.

While the USB Preamplifier is plugged into one of the analyzer's USB ports, the analyzer will consider it to be in the signal path of the RF Input and will apply the calibration data from the USB Preamp to measurements taken at the RF Input (on 2 input boxes, it will be considered to be in the signal path of RF Input 1; it is not supported for RF Input 2).

The USB Preamplifier contains its own cal data. This includes a noise trace suitable for use with NFE, for those models which support NFE. The act of connecting the Preamp to USB will cause the cal data to be downloaded from the preamp. When this happens an informational message is provided saying "Cal data loaded from USB Preamp". The analyzer will then automatically apply the calibration factors loaded from the Preamp in any measurement that supports the USB Preamp.

The External Preamp Gain setting may still be used, even though it is not required for the USB Preamp (since the USB Preamp supplies its own gain data to the analyzer which is applied automatically). Connecting the USB Preamp does not change the External Preamp Gain setting, however unless you have another gain or attenuation element in the signal path, the appropriate setting for External Preamp Gain is 0 dB.

Overload detection and reporting will apply when the USB preamplifier is connected to USB. The USB Preamplifier has its own overload detector which reports overloads to the instrument over USB. This generates an error condition, "Input Overload;USB Preamp."

If, while the USB Preamp is connected to USB, a measurement is selected that does not support the USB preamplifier, the "No result; Meas invalid with Preamp" error condition is generated.

## MS

Sets an external gain/attenuation value for MS (Mobile Station) tests.

Key Path	Input/Output, External Gain
Remote Command	<code>[ :SENSe ] :CORRection:MS[:RF]:GAIN &lt;rel_amp&gt;</code> <code>[ :SENSe ] :CORRection:MS[:RF]:GAIN?</code>
Example	<code>CORR:MS:GAIN 10</code> sets the Ext Gain value to 10 dB <code>CORR:MS:GAIN -10</code> sets the Ext Gain value to -10 dB (that is, a loss of 10 dB.)
Notes	Does not auto return.
Dependencies	The reference level limits are determined in part by the External Gain, Max Mixer Level, RF Atten This key is grayed out in modes that do not support MS.
Preset	This is unaffected by a Preset but is set to 0 dB on a "Restore Input/Output Defaults" or "Restore

	System Defaults->All"
State Saved	Saved in instrument state.
Min	-100 dB
Max	100 dB
Readback	MS, <Ext Gain value> dB
Initial S/W Revision	Prior to A.02.00

<b>Remote Command</b>	<code>[ :SENSe ] :CORRection:MS[:RF]:LOSS &lt;rel_ampl&gt;</code> <code>[ :SENSe ] :CORRection:MS[:RF]:LOSS?</code>
<b>Example</b>	<code>CORR:MS:LOSS 10</code> sets the Ext Gain value to -10 dB, and subsequently querying <code>:LOSS</code> will give 10 dB <code>CORR:MS:LOSS -10</code> sets the Ext Gain value to 10 dB, and subsequently querying <code>:LOSS</code> will give -10 dB
<b>Notes</b>	A positive value of <rel_ampl> in the above command means a loss and a negative value indicates a gain. Anytime <code>:LOSS</code> is set it sets <code>:GAIN</code> to the negative value of the parameter sent. Anytime <code>:LOSS</code> is queried it gives the negative of <code>:GAIN</code>
<b>Preset</b>	This is unaffected by a Preset but is set to 0 dB on a "Restore Input/Output Defaults" or "Restore System Defaults->All"
<b>Min</b>	100 dB
<b>Max</b>	-100 dB
<b>Initial S/W Revision</b>	Prior to A.02.00

## BTS

Sets an external attenuation value for BTS (Base Transceiver Station) tests.

<b>Key Path</b>	Input/Output, External Gain
<b>Remote Command</b>	<code>[ :SENSe ] :CORRection:BTS[:RF]:GAIN &lt;rel_ampl&gt;</code> <code>[ :SENSe ] :CORRection:BTS[:RF]:GAIN?</code>
<b>Example</b>	<code>CORR:BTS:GAIN 10</code> sets the Ext Gain value to 10 dB <code>CORR:BTS:GAIN -10</code> sets the Ext Gain value to -10 dB (that is, a loss of 10 dB.)
<b>Notes</b>	Does not auto return.
<b>Dependencies</b>	The reference level limits are determined in part by the External Gain, Max Mixer Level, RF Atten This key is grayed out in modes that do not support BTS.
<b>Preset</b>	This is unaffected by a Preset but is set to 0 dB on a "Restore Input/Output Defaults" or "Restore System Defaults->All"



State Saved	Saved in instrument state.
Min	-100 dB
Max	100 dB
Readback	BTS, <Ext Gain value> dB
Initial S/W Revision	Prior to A.02.00
<hr/>	
<b>Remote Command</b>	<code>[ :SENSe ] :CORRection:BTS[:RF]:LOSS &lt;rel_ampl&gt;</code> <code>[ :SENSe ] :CORRection:BTS[:RF]:LOSS?</code>
<b>Example</b>	<code>CORR:BTS:LOSS 10</code> sets the Ext Gain value to -10 dB, and subsequently querying <code>:LOSS</code> will give 10 dB <code>CORR:BTS:LOSS -10</code> sets the Ext Gain value to 10 dB, and subsequently querying <code>:LOSS</code> will give -10 dB
Notes	A positive value of <rel_ampl> in the above command means a loss and a negative value indicates a gain. Anytime <code>:LOSS</code> is set it sets <code>:GAIN</code> to the negative value of the parameter sent. Anytime <code>:LOSS</code> is queried it gives the negative of <code>:GAIN</code>
Preset	This is unaffected by a Preset but is set to 0 dB on a "Restore Input/Output Defaults" or "Restore System Defaults->All"
Min	100 dB
Max	-100 dB
Initial S/W Revision	Prior to A.02.00

## I Ext Gain

This function affects the I channel input. However, when Q Gain in I+jQ is set to Same as I Gain, this value is applied to both I and Q channel inputs.

Key Path	Input/Output, External Gain
<b>Remote Command</b>	<code>[ :SENSe ] :CORRection:IQ:I:GAIN &lt;rel_ampl&gt;</code> <code>[ :SENSe ] :CORRection:IQ:I:GAIN?</code>
<b>Example</b>	Set the I Ext Gain to 10 dB <code>CORR:IQ:I:GAIN 10</code> Set the I Ext Gain to -10 dB (that is, a loss of 10 dB.) <code>CORR:IQ:I:GAIN -10</code>
Dependencies	Not available unless option BBA is installed
Preset	0 dB This is unaffected by a Preset but is set to 0 dB on a "Restore Input/Output Defaults" or "Restore System Defaults->All"

State Saved	Saved in instrument state.
Min	-100 dB
Max	100 dB
Readback Text	I Gain, <I Ext Gain> dB
Initial S/W Revision	Prior to A.02.00

## Q Ext Gain

This function affects the Q channel input.

Key Path	Input/Output, External Gain
Remote Command	[ :SENSe ] :CORRection:IQ:Q:GAIN <rel_ampl> [ :SENSe ] :CORRection:IQ:Q:GAIN?
Example	Set the Q Ext Gain to 10 dB CORR:IQ:Q:GAIN 10 Set the Q Ext Gain to -10 dB (that is, a loss of 10 dB.) CORR:IQ:Q:GAIN -10
Dependencies	Not available unless option BBA is installed.
Preset	0 dB This is unaffected by a Preset but is set to 0 dB on a "Restore Input/Output Defaults" or "Restore System Defaults->All"
State Saved	Saved in instrument state
Min	-100 dB
Max	100 dB
Readback Text	Q Gain, <I Ext Gain> dB
Initial S/W Revision	Prior to A.02.00

## Restore Input/Output Defaults

This selection causes the group of settings and data associated with the Input/Output key to be a reset to their default values. In addition, when a Source is installed, licensed and selected, Restore Input/Output defaults will initiate a Source Preset.

This level of Restore System Defaults does not affect any other system settings or mode settings and does not cause a mode switch. All the features described in this section are reset using this key, including Input Corrections and Data (described in the Corrections section).

Key Path	Input/Output
Example	:SYST:DEF INP presets all the Input/Output variables to their factory default values.

Notes	Refer to the Utility Functions for information about Restore System Defaults and the complete description of the :SYSTem:DEFault INPut: command.
Initial S/W Revision	Prior to A.02.00

## Data Source

Gives you the choice of either using a hardware input signal as the input or raw data stored in a data storage buffer from an earlier acquisition. You can also share raw data across certain measurements that support this feature. The measurements must be capable of storing raw data. There are three choices under this menu. You can select "Inputs" which is the same as selecting one of the inputs from the input port, for example RF, AREF, I/Q, or IFALign. Selecting "Capture Buffer" allows you to use data that has been stored earlier in the same measurement or from a previous measurement using the "Current Meas -> Capture Buffer" feature. Selecting "Recorded Data" allows you to playback long data capture records stored in the record buffer.

Key Path	Input/Output
<b>Remote Command</b>	[ :SENSe ] :FEED:DATA INPut STORed [ :SENSe ] :FEED:DATA?
<b>Example</b>	FEED:DATA STOR FEED:DATA?
Notes	INPutS = Inputs STORed = Capture Buffer
Dependencies	Not all inputs are available in all modes. Unavailable keys are grayed out.
Preset	This is unaffected by Preset but is set to INPut on a "Restore Input/Output Defaults" or "Restore System Defaults->All"
State Saved	Saved in instrument state
Readback	Variable
<b>Backwards Compatibility SCPI</b>	[ :SENSe ] :FEED:SOURce INPut STORed [ :SENSe ] :FEED:SOURce?
Initial S/W Revision	Prior to A.02.00

## Inputs

Sets the measurement to use the input selections (RF, AREF, I/Q)

Key Path	Input/Output, Data Source
<b>Example</b>	FEED:DATA INP causes the measurement to look at the input selection

Notes	Does not auto return.
Readback	Inputs
Initial S/W Revision	Prior to A.02.00

## Capture Buffer

Some WCDMA and demod measurements support this feature. This allows sharing of the raw data across certain measurements. If you want to make another measurement on the same signal, you would store that raw data using the "Current Meas -> Capture Buffer" key. Then the data is available for the next measurement to use. You must have raw data stored in the instrument memory before the Capture Buffer choice is available for use.

Key Path	Input/Output, Data Source
<b>Example</b>	FEED:DATA STOR causes stored measurement data to be used with a different measurement that supports this.
Notes	Does not auto return. This key is grayed out when you switch to a measurement that does not support this feature.
Dependencies	If you switch to a measurement that does not support this feature, then the instrument switches to use "Inputs" and grays out this key. If the grayed out key is pressed, it generates a message.
Readback	Stored Data
Initial S/W Revision	Prior to A.02.00

## Current Meas -> Capture Buffer

Pressing this key stores the raw data of one measurement in the internal memory of the instrument where it can then be used by a different measurement by pressing "Stored Data". When raw data is stored, then the data source selection switch automatically changes to "Stored Data". Stored raw data cannot be directly accessed by a user. There is no save/recall function to save the raw data in an external media. However if you want to get the stored raw data, you must first perform a measurement using the stored raw data. Now you can access the used raw data, which is the same as stored raw data, using the FETch or READ commands.

Key Path	Input/Output, Data Source
<b>Remote Command</b>	[ :SENSe ] :FEED:DATA:STORe
<b>Example</b>	FEED:DATA:STOR stores recorded data
Notes	This is command only, there is no query
Dependencies	Grayed out in the SA measurement.
<b>Backwards Compatibility SCPI</b>	[ :SENSe ] :FEED:SOURce:STORe
Initial S/W Revision	Prior to A.02.00

## Corrections

This key accesses the Amplitude Corrections menu.

Amplitude Corrections arrays can be entered, sent over SCPI, or loaded from a file. They allow you to correct the response of the analyzer for various use cases. The X-series supports four separate Corrections arrays, each of which can contain up to 2000 points. They can be turned on and off individually and any or all can be on at the same time.

Trace data is in absolute units and corrections data is in relative units, but we want to be able to display trace data at the same time as corrections data. Therefore we establish a reference line to be used while building or editing a Corrections table. The reference line is halfway up the display and represents 0 dB of correction. It is labeled "0 dB CORREC". It is drawn in blue.

Corrections data is always in dB. Whatever dB value appears in the correction table represents the correction applied to that trace at that frequency. So if a table entry shows 30 dB that means we ADD 30 dB to each trace to correct it before displaying it.

In zero span, where the frequency is always the center frequency of the analyzer, we apply the (interpolated) correction for the center frequency to all points in the trace. In the event where there are two correction amplitudes at the center frequency, we apply the first one in the table.

Note that the corrections are applied as the data is taken; therefore, a trace in View (Update Off) will not be affected by changes made to the corrections table after the trace is put in View.

Key Path	Input/Output, Corrections
Mode	SA, I/Q Analyzer, Phase Noise, VXA, RTSA, EMI Receiver, DVB-T/H, DTMB, DVB-T/H, DTMB, W-CDMA, LTE & LTE-Adv FDD, LTE & LTE-Adv TDD, Sequence Analyzer, BTooth
Dependencies	This key will only appear if you have the proper option installed in your instrument. Amplitude correction may not be available in all modes; if a mode does not support amplitude correction, the Corrections key should be blanked while in that mode. If an application supports corrections but the current measurement does not, then the key should be grayed out in that measurement
Preset	Corrections arrays are reset (deleted) by Restore Input/Output Defaults. They survive shutdown and restarting of the analyzer application, which means they will survive a power cycle.
Initial S/W Revision	A.02.00
Modified at S/W Revision	x.14.50

## Select Correction

Specifies the selected correction. The term "selected correction" is used throughout this document to specify which correction will be affected by the functions.

Key Path	Input/Output, Corrections
Mode	SA, I/Q Analyzer, Phase Noise, VXA, RTSA, EMI Receiver, DVB-T/H, DTMB, DVB-T/H, DTMB, W-CDMA, LTE & LTE-Adv FDD, LTE & LTE-Adv TDD, Sequence Analyzer, BTooth

Notes	The selected correction is remembered even when not in the correction menu.
Preset	Set to Correction 1 by Restore Input/Output Defaults
Readback	Correction 1 Correction 2 Correction 3 Correction 4 Correction 5 Correction 6 Correction 7 Correction 8
Initial S/W Revision	A.02.00
Modified at S/W Revision	x.14.50

## Correction On/Off

Turning the Selected Correction from the OFF state to the ON state allows the values in it to be applied to the data. This state transition also automatically turns on "Apply Corrections" (sets it to ON), otherwise the correction would not take effect.

A new sweep is initiated if an amplitude correction is switched on or off. Note that changing, sending or loading corrections data does NOT directly initiate a sweep, however in general these operations will turn corrections on, which DOES initiate a sweep.

Key Path	Input/Output, Corrections
Remote Command	<code>[[:SENSe]:CORRection:CSET[1] 2 ... 8[:STATe] ON OFF 1 0</code> <code>[[:SENSe]:CORRection:CSET[1] 2 ... 8[:STATe]?</code>
Example	SENS:CORR:CSET1 ON
Dependencies	Changing this from the OFF state to the ON state automatically turns on "Apply Corrections". Only the first correction array (Correction 1) supports antenna units. When this array is turned on, and it contains an Antenna Unit other than "None", the Y Axis Unit of the analyzer is forced to that Antenna Unit. All other Y Axis Unit choices are grayed out. Note that this means that a correction file with an Antenna Unit can only be loaded into the Corrections 1 register. Consequently only for Correction 1 does the dropdown in the Recall dialog include.ant, and if an attempt is made to load a correction file into any other Correction register which DOES contain an antenna unit, a Mass Storage error is generated. This command will generate an "Option not available" error unless you have the proper option installed in your instrument.
Preset	Not affected by a Preset. Set to OFF by Restore Input/Output Defaults
State Saved	Saved in instrument state.
Backwards Compatibility Notes	Unlike legacy analyzers, Preset does not turn Corrections off (Restore Input/Output Defaults does).
Initial S/W Revision	A.02.00
Modified at S/W Revision	A.14.00

## Properties

Accesses a menu that lets you set the properties of the selected correction.

Key Path	Input/Output, Corrections
Initial S/W Revision	A.02.00

### Select Correction

Specifies the selected correction. The term "selected correction" is used throughout this document to specify which correction will be affected by the functions.

Key Path	Input/Output, Corrections
Mode	SA, I/Q Analyzer, Phase Noise, VXA, RTSA, EMI Receiver, DVB-T/H, DTMB, DVB-T/H, DTMB, W-CDMA, LTE & LTE-Adv FDD, LTE & LTE-Adv TDD, Sequence Analyzer, BTooth
Notes	The selected correction is remembered even when not in the correction menu.
Preset	Set to Correction 1 by Restore Input/Output Defaults
Readback	Correction 1 Correction 2 Correction 3 Correction 4 Correction 5 Correction 6 Correction 7 Correction 8
Initial S/W Revision	A.02.00
Modified at S/W Revision	x.14.50

### Antenna Unit

For devices (like antennas) that make measurements of field strength or flux density, the correction array should contain within its values the appropriate conversion factors such that, when the data on the analyzer is presented in dB $\mu$ V, the display is calibrated in the appropriate units. The "Antenna Unit" used for the conversion is contained within the corrections array database. It may be specified or loaded in from an external file or SCPI.

When an array with an Antenna Unit other than "None" is turned on, the Y Axis Unit of the analyzer is forced to that unit. When this array is turned on, and it contains an Antenna Unit other than "None", the Y Axis Unit of the analyzer is forced to that Antenna Unit., and all other Y Axis Unit choices are grayed out.

Antenna Unit does not appear in all Modes that support Corrections. Only the modes listed in the Mode row of the table below support Antenna Units.

Key Path	Input/Output, Corrections, Properties
Mode	SA, I/Q Analyzer, Phase Noise, VXA, RTSA, EMI Receiver, DVB-T/H, DTMB, DVB-T/H, DTMB, W-CDMA, LTE & LTE-Adv FDD, LTE & LTE-Adv TDD, Sequence Analyzer, BTooth
Remote Command	<code>[ :SENSe ] :CORRection:CSET[1]:ANTenna[:UNIT] GAUSs   PTESla   UVM   UAM   UA   NOConversion</code> <code>[ :SENSe ] :CORRection:CSET[1]:ANTenna[:UNIT] ?</code>
Example	CORR:CSET:ANT GAUS
Dependencies	Only the first correction array (Correction 1) supports antenna units. Note that this means that a correction file with an Antenna Unit can only be loaded into the Corrections 1 register. Consequently only for Correction 1 does the dropdown in the Recall dialog

	include.ant, and if an attempt is made to load a correction file into any other Correction register which DOES contain an antenna unit, a Mass Storage error is generated.
Preset	Unaffected by Preset. Set to NOC by Restore Input/Output Defaults
State Saved	Saved in instrument state
Initial S/W Revision	A.02.00
Modified at S/W Revision	x.14.50

#### None

Selects no antenna unit for this Correction set. Thus no Y Axis unit will be forced.

Key Path	Input/Output, Corrections, Properties, Antenna Unit
<b>Example</b>	:CORR:CSET:ANT NOC
Readback	"None"
Initial S/W Revision	A.02.00

#### dB $\mu$ V/m

Sets the antenna unit to dB $\mu$ V/m. If this correction is turned on, and Apply Corrections is on, the Y Axis Unit will then be forced to dB $\mu$ V/m and all other Y Axis Unit selections will be grayed out.

Key Path	Input/Output, Corrections, Properties, Antenna Unit
<b>Example</b>	:CORR:CSET:ANT UVM
Readback	"dB $\mu$ V/m"
Initial S/W Revision	A.02.00

#### dB $\mu$ A/m

Sets the antenna unit to dB $\mu$ A/m. If this correction is turned on, and Apply Corrections is on, the Y Axis Unit will then be forced to dB $\mu$ A/m and all other Y Axis Unit selections will be grayed out.

Key Path	Input/Output, Corrections, Properties, Antenna Unit
<b>Example</b>	:CORR:CSET:ANT UVA
Readback	" dB $\mu$ A/m"
Initial S/W Revision	A.02.00

#### dBpT

Sets the antenna unit to dBpT. If this correction is turned on, and Apply Corrections is on, the Y Axis Unit will then be forced to dBpT and all other Y Axis Unit selections will be grayed out.



Key Path	Input/Output, Corrections, Properties, Antenna Unit
<b>Example</b>	:CORR:CSET:ANT PTES
Readback	"dBpT"
Initial S/W Revision	A.02.00

### dBG

Sets the antenna unit to dBG. If this correction is turned on, and Apply Corrections is on, the Y Axis Unit will then be forced to dBG and all other Y Axis Unit selections will be grayed out.

Key Path	Input/Output, Corrections, Properties, Antenna Unit
<b>Example</b>	:CORR:CSET:ANT GAUS
Readback	" dBG"
Initial S/W Revision	A.02.00

### dB $\mu$ A

Sets the antenna unit to dB $\mu$ A. If this correction is turned on, and Apply Corrections is on, the Y Axis Unit will then be forced to dB $\mu$ A and all other Y Axis Unit selections will be grayed out.

Key Path	Input/Output, Corrections, Properties, Antenna Unit
<b>Example</b>	:CORR:CSET:ANT UA
Readback	" dB $\mu$ A"
Initial S/W Revision	A.11.00

### Frequency Interpolation

This setting controls how the correction values per-bucket are calculated. We interpolate between frequencies in either the logarithmic or linear scale.

This setting is handled and stored individually per correction set.

See ["Interpolation" on page 278](#)

Key Path	Input/Output, Corrections, Properties
<b>Remote Command</b>	[[:SENSe]:CORRection:CSET[1] 2 ... 8:X:SPACing LINear   LOGarithmic [:SENSe]:CORRection:CSET[1] 2 ... 8:X:SPACing?
<b>Example</b>	CORR:CSET:X:SPAC LIN
Preset	Unaffected by a Preset. Set to Linear by Restore Input/Output Defaults.
State Saved	Saved in instrument state.
Initial S/W Revision	A.02.00
Modified at S/W Revision	A.14.00

### Interpolation

For each bucket processed by the application, all of the correction factors at the frequency of interest (center frequency of each bucket) are summed and added to the amplitude. All trace operations and post processing treat this post-summation value as the true signal to use.

To effect this correction, the goal, for any particular start and stop frequency, is to build a correction trace, whose number of points matches the current Sweep Points setting of the instrument, which will be used to apply corrections on a bucket by bucket basis to the data traces.

For amplitudes that lie between two user specified frequency points, we interpolate to determine the amplitude value. You may select either linear or logarithmic interpolation between the frequencies.

If we interpolate on a log scale, we assume that the line between the two points is a straight line on the log scale. For example, let's say the two points are (2,4) and (20,1). A straight line between them on a log scale looks like:

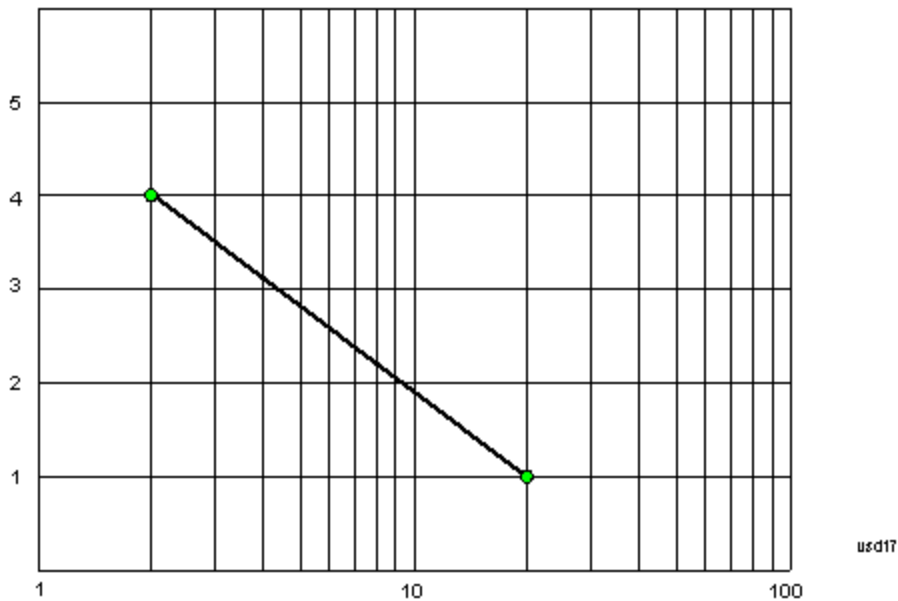

On a linear scale (like that of the spectrum analyzer), this translates to:

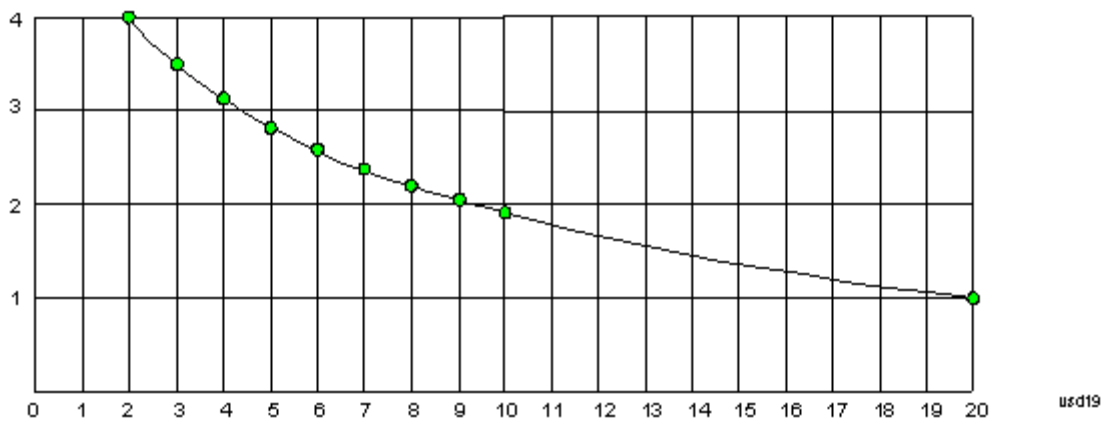

If we interpolate on a linear scale, we assume that the two points are connected by a straight line on the linear scale, as below:

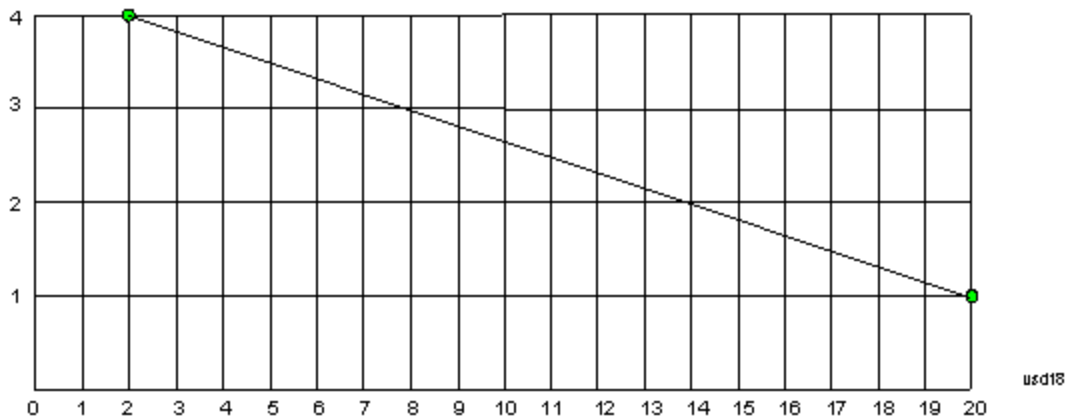

The correction to be used for each bucket is taken from the interpolated correction curve at the center of the bucket.

### Description

Sets an ASCII description field which will be stored in an exported file. Can be displayed in the active function area by selecting as the active function, if desired to appear in a screen capture.

Key Path	Input/Output, Corrections, Properties
Remote Command	<code>[[:SENSe]:CORRection:CSET[1] 2 ... 8:DESCription "text"</code> <code>[[:SENSe]:CORRection:CSET[1] 2 ... 8:DESCription?</code>
Example	<code>:CORR:CSET1:DESC "11941A Antenna correction"</code>
Notes	45 chars max; may not fit on display if max chars used
Preset	Unaffected by a Preset. Set to empty by Restore Input/Output Defaults
State Saved	Saved in instrument state.
Initial S/W Revision	A.02.00
Modified at S/W Revision	A.14.00

### Comment

Sets an ASCII comment field which will be stored in an exported file. Can be displayed in the active function area by selecting as the active function, if desired to appear in a screen capture.

Key Path	Input/Output, Corrections, Properties
Remote Command	<code>[[:SENSe]:CORRection:CSET[1] 2 ... 8:COMMeNt "text"</code> <code>[[:SENSe]:CORRection:CSET[1] 2 ... 8:COMMeNt?</code>
Example	<code>:CORR:CSET1:COMM "this is a comment"</code>
Notes	60 chars max; may not fit on display if max chars used
Preset	Unaffected by Preset. Set to empty by Restore Input/Output Defaults

State Saved	Saved in instrument state
Initial S/W Revision	A.02.00
Modified at S/W Revision	A.14.00

## Edit

Invokes the integrated editing facility for this correction set.

When entering the menu, the editor window turns on, the selected correction is turned On, Apply Corrections is set to On, the amplitude scale is set to Log, and the Amplitude Correction (“Ampcor”) trace is displayed. The actual, interpolated correction trace is shown in green for the selected correction. Note that since the actual interpolated correction is shown, the correction trace may have some curvature to it. This trace represents only the correction currently being edited, rather than the total, accumulated amplitude correction for all amplitude corrections which are currently on, although the total, accumulated correction for all corrections which are turned on is still applied to the data traces.

Because corrections data is always in dB, but the Y-axis of the analyzer is in absolute units, it is necessary to establish a reference line for display of the Corrections data. The reference line is halfway up the display and represents 0 dB of correction. It is labeled “0 dB CORREC”. It is drawn in blue.

Corrections data is always in dB. Whatever dB value appears in the correction table represents the correction to be applied to that trace at that frequency. So if a table entry shows 30 dB that means we ADD 30 dB to each trace to correct it before displaying it. By definition all points are connected. If a gap is desired for corrections data, enter 0 dB.

Note that a well-designed Corrections array should start at 0 dB and end at 0 dB. This is because whatever the high end point is will be extended to the top frequency of the instrument, and whatever the low end point is will be extended down to 0 Hz. So for a Corrections array to have no effect outside its range, you should start and end the array at 0 dB.

### NOTE

The table editor will only operate properly if the analyzer is sweeping, because its updates are tied to the sweep system. Thus, you should not try to use the editor in single sweep, and it will be sluggish during compute-intensive operations like narrow-span FFT sweeps.

When exiting the edit menu (by using the Return key or by pressing an instrument front-panel key), the editor window turns off and the Ampcor trace is no longer displayed; however, Apply Corrections remains On, any correction that was on while in the editor remains on, and the amplitude scale returns to its previous setting.

Corrections arrays are not affected by a Preset, because they are in the Input/Output system. They also survive shutdown and restarting of the analyzer application, which means they will survive a power cycle.

When editing a correction, the editor remembers which correction and which element in the correction array you were editing, and returns you to that correction and that element when you return to the editor after leaving it.

Key Path	Input/Output, Corrections
Initial S/W Revision	A.02.00

## Navigate

Lets you move through the table to edit the desired point.

Key Path	Input/Output, Corrections, Edit
Notes	There is no value readback on the key
Min	1
Max	2000
Initial S/W Revision	A.02.00

## Frequency

Lets you edit the frequency of the current row.

Key Path	Input/Output, Corrections, Edit
Notes	There is no value readback on the key.
Min	0
Max	1 THz
Initial S/W Revision	A.02.00

## Amplitude

Lets you edit the Amplitude of the current row.

Key Path	Input/Output, Corrections, Edit
Notes	There is no value readback on the key.
Min	-1000 dB
Max	1000 dB
Initial S/W Revision	A.02.00

## Insert Point Below

Inserts a point below the current point. The new point is a copy of the current point and becomes the current point. The new point is not yet entered into the underlying table, and the data in the row is displayed in light gray.

Key Path	Input/Output, Corrections, Edit
Initial S/W Revision	A.02.00

### Delete Point

Deletes the currently-selected point, whether or not that point is being edited, and selects the Navigate functionality. The point following the currently-selected point (or the point preceding if there is none) will be selected.

Key Path	Input/Output, Corrections, Edit
Initial S/W Revision	A.02.00

### Scale X Axis

Matches the X Axis to the selected Correction, as well as possible. Sets the Start and Stop Frequency to contain the minimum and maximum Frequency of the selected Correction. The range between Start Frequency and Stop Frequency is 12.5% above the range between the minimum and maximum Frequency, so that span exceeds this range by one graticule division on either side. If in zero-span, or there is no data in the Ampcor table, or the frequency range represented by the table is zero, no action is taken. Standard clipping rules apply if the value in the table is outside the allowable range for the X axis.

Key Path	Input/Output, Corrections, Edit
Dependencies	If either the first or last point in the array is outside the frequency range of the current input, an error message is generated: “-221. Settings conflict; Start or Stop Freq out of range for current input settings”
Initial S/W Revision	A.02.00

### Delete Correction

Deletes the correction values for this set. When this key is pressed a prompt is placed on the screen that says “Please press Enter or OK key to delete correction. Press ESC or Cancel to close this dialog.” The deletion is only performed if you press OK or Enter.

Key Path	Input/Output, Corrections
Remote Command	[ :SENSe ] :CORRection:CSET [ 1 ]   2   . . .   6 :DELete
Example	CORR:CSET:DEL CORR:CSET1:DEL CORR:CSET4:DEL
Notes	Pressing this key when no corrections are present is accepted without error.
Initial S/W Revision	A.02.00

### Apply Corrections

Applies amplitude corrections, which are marked as ON to the measured data. If this is set to OFF, then no amplitude correction sets will be used, regardless of their individual on/off settings. If set to ON, the corrections that are marked as ON (see ["Correction On/Off" on page 274](#)) are used.

Key Path	Input/Output, Corrections
Remote Command	[ :SENSe ] :CORRection:CSET:ALL [ :STATe ] ON   OFF   1   0 [ :SENSe ] :CORRection:CSET:ALL [ :STATe ] ?
Example	SENS:CORR:CSET:ALL OFF This command makes sure that no amplitude corrections are applied, regardless of their individual on/off settings.
Preset	Not affected by Preset. Set to OFF by Restore Input/Output Defaults
State Saved	Saved in instrument state.
Initial S/W Revision	A.02.00

## Delete All Corrections

Erases all correction values for all 4 Amplitude Correction sets.

When this key is pressed a prompt is placed on the screen that says “Please press Enter or OK key to delete all corrections. Press ESC or Cancel to close this dialog.” The deletion is only performed if you press OK or Enter.

Key Path	Input/Output, Corrections
Remote Command	[ :SENSe ] :CORRection:CSET:ALL:DELeTe
Example	CORR:CSET:ALL:DEL
Initial S/W Revision	A.02.00

## Remote Correction Data Set Commands

This section describes the remote (SCPI) commands used to put values into correction sets. See the correction / table editor section of the Input/Output section for the information on front panel entry of correction data.

["Set \(Replace\) Data \(Remote Command Only\)" on page 283](#)

["Merge Correction Data \(Remote Command Only\)" on page 284](#)

### Set (Replace) Data (Remote Command Only)

The command takes an ASCII series of alternating frequency and amplitude points, each value separated by commas.

The values sent in the command will totally replace all existing correction points in the specified set.

An Ampcor array can contain 2000 points maximum.

Remote Command	[ :SENSe ] :CORRection:CSET [ 1 ]   2   ...   8 :DATA <freq>, <ampl>, . . . [ :SENSe ] :CORRection:CSET [ 1 ]   2   ...   8 :DATA ?
Example	CORR:CSET1:DATA 10000000, -1.0, 20000000, 1.0

	This defines two correction points at (10 MHz, -1.0 dB) and (20 MHz, 1.0 dB) for correction set 1.
Preset	Empty after Restore Input/Output Defaults. Survives a shutdown or restart of analyzer application (including a power cycle).
State Saved	Saved in instrument state.
Min	Freq: 0 Hz Amptd: -1000 dBm
Max	Freq: 1 THz Amptd: +1000 dBm
Initial S/W Revision	A.02.00
Modified at S/W Revision	A.14.00

### Merge Correction Data (Remote Command Only)

The command takes an ASCII series of alternating frequency and amplitude points, each value separated by commas. The difference between this command and Set Data is that this merges new correction points into an existing set.

Any new point with the same frequency as an existing correction point will replace the existing point's amplitude with that of the new point.

An Ampcor array can contain 2000 total points, maximum.

<b>Remote Command</b>	<code>[[:SENSE]:CORRection:CSET[1] 2 ... 8:DATA:MERGe &lt;freq&gt;, &lt;ampl&gt;, ...</code>
<b>Example</b>	<code>CORR:CSET1:DATA:MERGE 15000000, -5.0, 25000000, 5.0</code> This adds two correction points at (15 MHz, -5.0 dB) and (25 MHz, 5.0 dB) to whatever values already exist in correction set 1.
Preset	Empty after Restore Input/Output Defaults. Survives shutdown/restart of analyzer application (including power cycle)
Min	Freq: 0 Hz Amptd: -1000 dBm
Max	Freq: 1 THz Amptd: +1000 dBm
Initial S/W Revision	A.02.00
Modified at S/W Revision	A.14.00

### Freq Ref In

Specifies the frequency reference as being the internal reference at the rear panel input labeled EXT REF IN, a 1 pulse per second signal at the EXT REF IN input,, external reference or sensing the presence of a signal at the EXT REF IN input.

When the frequency reference is set to internal, the internal 10 MHz reference is used even if an external reference is connected.



When the frequency reference is set to external, the instrument will use the external reference. However, if there is no external signal present, or it is not within the proper amplitude range, a condition error message is generated. When the external signal becomes valid, the error is cleared.

When the frequency reference is set to Pulse, the instrument expects a 1 pulse per second signal at the EXT REF IN input. The instrument uses this signal to adjust the frequency of the internal reference.

If Sense is selected, the instrument checks whether a signal is present at the external reference connector. If it senses a signal within 5 ppm of the External Ref Freq (as set on the External Ref Freq softkey), it will automatically switch to the external reference. If it senses a 1 pulse per second signal, it enters Pulse mode, wherein the signal is used to adjust the internal reference. When no signal is present, it automatically switches to the internal reference. No message is generated as the reference switches between pulse, external and internal. The monitoring of the external reference occurs approximately on 1 millisecond intervals, and never occurs in the middle of a measurement acquisition, only at the end of the measurement (end of the request).

If for any reason the instrument's frequency reference is not able to obtain lock, Status bit 1 in the Questionable Frequency register will be true and a condition error message is generated. When lock is regained, Status bit 1 in the Questionable Frequency register will be cleared and the condition error will be cleared.

If an external frequency reference is being used, you must enter the frequency of the external reference if it is not exactly 10 MHz. The External Ref Freq key is provided for this purpose.

Key Path	Input/Output
<b>Remote Command</b>	<code>[ :SENSe ] :ROSCillator :SOURCE :TYPE INTernal   EXTernal   SENSe   PULSe</code> <code>[ :SENSe ] :ROSCillator :SOURCE :TYPE ?</code>
Dependencies	The PULSe parameter, and support of the 1 pps signal at the EXT REF IN input, are not available in firmware prior to A.13.00. They are also not available in some model numbers. If not available, the Pulse key will be blank, and sending the PULSe parameter via SCPI will generate an error:
Preset	This is unaffected by a Preset but is set to SENSe on a "Restore Input/Output Defaults" or "Restore System Defaults->All".
State Saved	Saved in instrument state.
Status Bits/OPC dependencies	STATus:QUESTionable:FREQUency bit 1 set if unlocked.
Backwards Compatibility Notes	Freq Ref In was not saved in state in the legacy instruments. It is a part of state in the X-Series.
Initial S/W Revision	Prior to A.02.00
Modified at S/W Revision	A.14.00

<b>Remote Command</b>	<code>[ :SENSe ] :ROSCillator :SOURCE ?</code>
Notes	The query <code>[SENSe]:ROSCillator:SOURCE?</code> returns the current switch setting. This means: <ol style="list-style-type: none"> <li>1. If it was set to SENSe but there is no external reference nor 1 pps signal so the instrument is actually using the internal reference, then this query returns INTernal and not SENSe.</li> <li>2. If it was set to SENSe and there is an external reference present, the query returns EXTernal and not SENSe.</li> </ol>

3. If it was set to SENSE and there is a 1 pps signal present, the query returns PULSe and not SENSE.
4. If it was set to EXTERNAL, then the query returns "EXTERNAL"
5. If it was set to INTERNAL, then the query returns "INTERNAL".
6. If it was set to PULSe, then the query returns "PULSe"

Preset	SENSe
Backwards Compatibility Notes	The query [:SENSe]:ROSCillator:SOURce? was a query-only command in ESA which always returned whichever reference the instrument was using. The instrument automatically switched to the ext ref if it was present.  In PSA (which had no sensing) the command [:SENSe]:ROSCillator:SOURce set the reference (INT or EXT), so again its query returned the actual routing.  Thus the query form of this command is 100% backwards compatible with both instruments.
Initial S/W Revision	Prior to A.02.00

<b>Remote Command</b>	[:SENSe]:ROSCillator:SOURce INTernal EXTernal
Notes	For PSA compatibility the command form is provided and is directly mapped to [:SENSe]:ROSCillator:SOURce:TYPE
Initial S/W Revision	Prior to A.02.00

## Sense

If Sense is selected, the instrument checks whether a signal is present at the external reference connector. If it senses a signal within 5 ppm of the External Ref Freq (as set on the External Ref Freq softkey), it will use this signal as an External Reference. If it senses a 1 pulse per second signal, it will use this signal to adjust the internal reference by adjusting the User setting of the Timebase DAC. When no signal is present, it automatically switches to the internal reference.

Key Path	Input/Output, Freq Ref In
<b>Example</b>	:ROSC:SOUR:TYPE SENS
Couplings	If set to SENSE and the analyzer senses a 1 pulse per second signal, it sets the System, Alignments, Timebase DAC setting to "User". This setting survives Preset and Power Cycle but is set to "Calibrated" on a System, Restore Defaults, Align or a System, Restore Defaults, All
Readback	Sense
Initial S/W Revision	Prior to A.02.00
Modified at S/W Revision	A.14.00

## Internal

The internal reference is used. A 1 pps signal at the EXT REF IN port, or a signal there between 1 and 50 MHz, will cause a warning triangle to appear in the settings panel next to the word "INTERNAL", but will otherwise be ignored.

Key Path	Input/Output, Freq Ref In
<b>Example</b>	:ROSC:SOUR:TYPE INT
Readback	Internal
Initial S/W Revision	Prior to A.02.00
Modified at S/W Revision	A.14.00

## External

The external reference is used.

Key Path	Input/Output, Freq Ref In
<b>Example</b>	:ROSC:SOUR:TYPE EXT
Readback	External
Initial S/W Revision	Prior to A.02.00

## Ext Ref Freq

This key tells the analyzer the frequency of the external reference. When the external reference is in use (either because the reference has been switched to External or because the Reference has been switched to Sense and there is a valid external reference present) this information is used by the analyzer to determine the internal settings needed to lock to that particular external reference signal.

For the instrument to stay locked, the value entered must be within 5 ppm of the actual external reference frequency. So it is important to get it close, or you risk an unlock condition.

Note that this value only affects the instrument's ability to lock. It does not affect any calculations or measurement results. See "Freq Offset" in the Frequency section for information on how to offset frequency values.

Key Path	Input/Output, Freq Ref In
<b>Remote Command</b>	[ :SENSe ] :ROSCillator:EXTernal:FREQuency <freq> [ :SENSe ] :ROSCillator:EXTernal:FREQuency?
<b>Example</b>	ROSC:EXT:FREQ 20 MHz sets the external reference frequency to 20 MHz, but does not select the external reference. ROSC:SOUR:TYPE EXT selects the external reference.
Dependencies	Still available with Internal or Pulse selected, to allow setup for when External is in use. However, the setting has no effect if the Internal Reference is in use (Freq Ref In set to Internal, Pulse, or SENSE:INT or SENSE:PULSE).

Preset	This is unaffected by a Preset but is set to 10 MHz on a "Restore Input/Output Defaults" or "Restore System Defaults->All"
Min	CXA: 10 MHz EXA: 10 MHz MXA: 1 MHz PXA: 1 MHz N8973B, N8974B, N8975B, or N8976B: 10 MHz
Max	CXA: 10 MHz EXA: 10 MHz EXA with option R13: 20 MHz MXA: 50 MHz PXA: 50 MHz N8973B, N8974B, N8975B, or N8976B: 10 MHz
Default Unit	Hz
Initial S/W Revision	Prior to A.02.00
Modified at S/W Revision	A.14.00

## External Reference Lock BW

This control lets you adjust the External Reference phase lock bandwidth. This control is available in some models of the X-Series.

The PXA variable reference loop bandwidth allows an external reference to be used and have the analyzer close-in phase noise improved to match that of the reference. This could result in an improvement of tens of decibels. The choice of "Wide" or "Narrow" affects the phase noise at low offset frequencies, especially 4 to 400 Hz offset. When using an external reference with superior phase noise, we recommend setting the external reference phase-locked-loop bandwidth to wide (60 Hz), to take advantage of that superior performance. When using an external reference with inferior phase noise performance, we recommend setting that bandwidth to narrow (15 Hz). In these relationships, inferior and superior phase noise are with respect to  $-134$  dBc/Hz at 30 Hz offset from a 10 MHz reference. Because most reference sources have phase noise behavior that falls off at a rate of 30 dB/decade, this is usually equivalent to  $-120$  dBc/Hz at 10 Hz offset.

Key Path	Input/Output, Freq Ref In
Scope	Mode Global
Remote Command	<code>[[:SENSe]:ROSCillator:BANDwidth WIDE NARROW</code> <code>[[:SENSe]:ROSCillator:BANDwidth?</code>
Example	ROSC:BAND WIDE

Dependencies	Still available with Internal or Pulse selected, to allow setup for when External is in use. However, the setting has no effect if the Internal Reference is in use (Freq Ref In set to Internal, Pulse, or SENSE:INT or SENSE:PULSE).  This key only appears in analyzers equipped with the required hardware.
Preset	This is unaffected by a Preset but is set to Narrow on a "Restore Input/Output Defaults" or "Restore System Defaults -> All"
State Saved	Saved in Input/Output state.
Initial S/W Revision	A.04.00
Modified at S/W Revision	A.14.00

## External Ref Coupling

Only appears with option ERC installed and licensed.

This function lets you couple the sweep system of the analyzer to the state of the External Reference. If Normal is selected, data acquisition proceeds regardless of the state of the External Reference. When you select Ext Ref Out Of Range Stops Acquisition, the data acquisition (sweep or measurement) stops when either the "521, External ref out of range" or the "503, Frequency Reference unlocked" error message is asserted. Note that this will only take place if the Freq Ref In selection is External.

With the acquisition stopped, the data display will stop updating (even if this occurs in the middle of a sweep or measurement) and no data will be returned to a READ? or MEASure? query; that is, these queries will not complete because the analyzer will not respond to them. Furthermore, no response will be generated to a \*WAI? or \*OPC? query.

Proper SCPI sequences are shown below, which will always fail to return if the acquisition stops during the requested sweep or measurement. Note that, for predictable operation of this function, it is best to operate the analyzer in single measurement mode (INIT:CONT OFF), because if operating in continuous mode, the analyzer may respond to the above queries even after the acquisition stops, with data left over from the previous acquisition.

```
:INIT:CONT OFF
:INIT:IMM;*OPC?
--
:INIT:CONT OFF
:INIT:IMM;*WAI?
--
:INIT:CONT OFF
:READ?
--
:INIT:CONT OFF
```

:MEASure?

When the acquisition ceases, in addition to the error condition(s) described above, a popup error message will be generated informing you that the acquisition has ceased due to an invalid external reference. This message will stay on the screen while the acquisition is suspended.

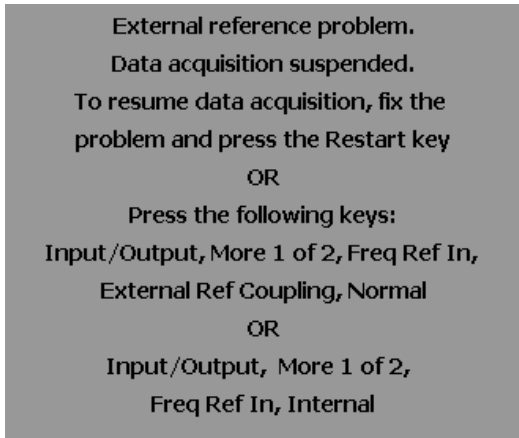

If you press the Restart key this message will be taken off the screen and a new acquisition will be attempted. If the External Reference problem persists the message will re-appear. You can also remove the message by changing back to the Normal setting of Sweep/Ext Ref Coupling, or by pressing Freq Ref In, Internal, or Freq Ref In, Sense, or Restore Input/Output Defaults.

The setting of External Ref Coupling is persistent across power-cycling and is not reset with a Preset. It is reset to the default state (Normal) when Restore Input/Output Defaults is invoked, which will also restart normal data acquisition.

The detection of invalid external reference is under interrupt processing. If the external reference becomes invalid then returns to valid in too short a time, no error condition will be detected or reported and therefore the acquisition will not be stopped.

Key Path	Input/Output, Freq Ref In
Mode	All
Remote Command	[[:SENSE]:ROSCillator:COUpling NORMal NACquisition [:SENSE]:ROSCillator:COUpling?
Preset	This setting is persistent: it survives power-cycling or a Preset and is reset with Restore Input/Output defaults.
State Saved	Not saved in instrument state
Readback	Normal Stop Acq
Initial S/W Revision	A.02.00

## Output Config

Accesses keys that configure various output settings, like the frequency reference output, trigger output and analog output.

Key Path	Input/Output
Backwards Compatibility Notes	In ESA there was not a user interface to enable the Video Output (Analog Output), Trigger Output, or Gate Output. In the X-Series each of these physical connectors requires configuration, thus the user interface has been added for X-Series, along with the potential for an output you think is always on to be switched off.
Initial S/W Revision	Prior to A.02.00

## Trig Out

Select the type of output signal that will be output from the Trig 1 Out, or Trig 2 Out connectors.

Key Path	Input/Output, Output Config
<b>Remote Command</b>	:TRIGger TRIGger1 TRIGger2[:SEquence]:OUTPut HSWP   MEASuring   MAIN   GATE   GTRigger   OEVEN   SPOint   SSWeep   SSEtled   S1Marker   S2Marker   S3Marker   S4Marker   OFF  :TRIGger TRIGger1 TRIGger2[:SEquence]:OUTPut?
<b>Example</b>	TRIG:OUTP HSWP TRIG2:OUTP GATE
Dependencies	The second Trigger output (Trig 2 Out) does not appear in all models; in models that do not support it, the Trig 2 Out key is blanked, and sending the SCPI command for this output generates an error, "Hardware missing; Not available for this model number" In models that do not support the Trigger 2 output, this error is returned if trying to set Trig 2 Out and a query of Trig 2 Out returns OFF.
Preset	Trigger 1: Sweeping (HSWP) Trigger 2: Gate This is unaffected by a Preset but is preset to the above values on a "Restore Input/Output Defaults" or "Restore System Defaults->All"
State Saved	Saved in instrument state
Initial S/W Revision	Prior to A.02.00

## Polarity

Sets the output to the Trig 1 Out, or Trig 2 Out, connector to trigger on either the positive or negative polarity.

Key Path	Input/Output, Output Config, Trig 1/2 Output
<b>Remote Command</b>	:TRIGger TRIGger1 TRIGger2[:SEquence]:OUTPut:POLarity POSitive   NEGative  :TRIGger TRIGger1 TRIGger2[:SEquence]:OUTPut:POLarity?
<b>Example</b>	TRIG1:OUTP:POL POS
Preset	This is unaffected by a Preset but is set to POSitive on a "Restore Input/Output Defaults" or "Restore System Defaults->All"

---

State Saved	Saved in instrument state
Initial S/W Revision	Prior to A.02.00

---

### Off

Selects no signal to be output to the Trig 1 Out, or Trig 2 Out, connector.

---

Key Path	Input/Output, Output Config, Trig 1/2 Output
<b>Example</b>	TRIG1:OUTP OFF
Readback	Off
Initial S/W Revision	Prior to A.02.00

---

### Sweeping (HSWP)

Selects the Sweeping Trigger signal to be output to the Trig 1 Out, or Trig 2 Out, connector when a measurement is made. This signal has historically been known as "HSWP" (High = Sweeping), and is 5 V TTL level with 50 ohm output impedance.

---

Key Path	Input/Output, Output Config, Trig 1/2 Output
<b>Example</b>	TRIG1:OUTP HSWP
Readback	Sweeping
Initial S/W Revision	Prior to A.02.00

---

### Measuring

Selects the Measuring trigger signal to be output to the Trig 1 Out, or Trig 2 Out, connector. This signal is true while the Measuring status bit is true.

---

Key Path	Input/Output, Output Config, Trig 1/2 Output
<b>Example</b>	TRIG1:OUTP MEAS
Readback	Measuring
Initial S/W Revision	Prior to A.02.00

---

### Main Trigger

Selects the current instrument trigger signal to be output to the Trig 1 Out, or Trig 2 Out, connector.

---

Key Path	Input/Output, Output Config, Trig 1/2 Output
----------	----------------------------------------------

---



<b>Example</b>	TRIG1:OUTP MAIN
Readback	Main Trigger
Initial S/W Revision	Prior to A.02.00

### Gate Trigger

Selects the gate trigger signal to be output to the Trig 1 Out, or Trig 2 Out, connector. This is the source of the gate timing, not the actual gate signal.

Key Path	Input/Output, Output Config, Trig 1/2 Output
<b>Example</b>	TRIG1:OUTP GTR
Readback	Gate Trigger
Initial S/W Revision	Prior to A.02.00

### Gate

Selects the gate signal to be output to the Trig 1 Out, or Trig 2 Out, connector. The gate signal has been delayed and its length determined by delay and length settings. When the polarity is positive, a high on the Trig 1 Out, or Trig 2 Out, represents the time the gate is configured to pass the signal.

Key Path	Input/Output, Output Config, Trig 1/2 Output
<b>Example</b>	TRIG1:OUTP GATE
Readback	Gate
Initial S/W Revision	Prior to A.02.00

### Source Point Trigger

Selects the gate signal to be output to the Trig 1 Out, or Trig 2 Out, connector for use as the Point Trigger when operating an external source in Tracking mode. When Ext Trigger 1 is selected as the Point Trigger under Source, the Source Point Trigger under Trig1 Out automatically gets selected. Similarly, when Ext Trigger 2 is selected as the Point Trigger under Source, the Source Point Trigger key under Trig 2 Out automatically gets selected

Key Path	Input/Output, Output Config, Trig 1/2 Output
<b>Example</b>	TRIG1:OUTP SPO
Readback	Source Point
Initial S/W Revision	Prior to A.02.00

### Odd/Even Trace Point

Selects either the odd or even trace points as the signal to be output to the Trig 1 Out, or Trig 2 Out, connector when performing swept spectrum analysis. When the polarity is positive, this output goes high during the time the analyzer is sweeping past the first point (Point 0) and every other following trace point. The opposite is true if the polarity is negative.

Key Path	Input/Output, Output Config, Trig 1/2 Output
<b>Example</b>	TRIG1:OUTP OEV
Readback	Odd/Even
Initial S/W Revision	Prior to A.02.00

### Analog Out

This menu lets you control which signal is fed to the “Analog Out” connector on the analyzer rear panel.

See ["More Information" on page 294](#)

Key Path	Input/Output, Output Config
<b>Remote Command</b>	:OUTPut:ANALog OFF SVIDeo LOGVIdeo LINVIdeo DAUDio :OUTPut:ANALog?
Example	OUTP:ANAL SVIDeo ! causes the analog output type to be Screen Video
Preset	This is unaffected by Preset but is set to DAUDio on a "Restore Input/Output Defaults" or "Restore System Defaults->All
Preset	OFF
State Saved	Saved in Input/Output State
Readback line	1-of-N selection [variable]
Backwards Compatibility Notes	Prior to A.04.00, OFF was the default functionality except when in the Analog Demod application or with Tune and Listen, in which case it was DAUDio, and there was no selection menu. So for backwards compatibility with earlier X-Series firmware versions, Auto (:OUTP:ANAL:AUTO ON) will duplicate the prior behavior.  The DNWB and SANalyzer parameters, which were legal in PSA but perform no function in the X-Series, are accepted without error.
Initial S/W Revision	A.04.00

### More Information

The table below gives the range for each output.

Analog Out	Nominal Range exc. (10% overrange)	Scale Factor	Notes
Off	0 V		

<b>Analog Out</b>	<b>Nominal Range exc. (10% overrange)</b>	<b>Scale Factor</b>	<b>Notes</b>
Screen Video	0 – 1 V open circuit	10%/division	8566 compatible
Log Video	0 – 1 V terminated	1/(192.66 dB/V)	dB referenced to mixer level, 1V out for –10 dBm at the mixer.
Linear Video	0 – 1 V terminated	100%/V	Linear referenced to Ref Level, 1 V out for RF envelope at the Ref Level.
Demod Audio	(varies with analyzer setting)		

### Auto

Selects the Auto state for the Analog Output menu. In this state, the Analog Output will automatically be set to the most sensible setting for the current mode or measurement.

If you make a selection manually from the Analog Out menu, this selection will remain in force until you change it (or re-select Auto), even if you go to a mode or measurement for which the selected output does not apply.

<b>Key Path</b>	Input/Output, Output Config, Analog Out
<b>Remote Command</b>	OUTPut:ANALog:AUTO OFF ON 0 1 OUTPut:ANALog:AUTO?
<b>Example</b>	OUTP:ANAL:AUTO ON
<b>Preset</b>	ON
<b>State Saved</b>	Saved in Input/Output State
<b>Initial S/W Revision</b>	A.04.00

### Off

Turns off the analog output.

<b>Key Path</b>	Input/Output, Output Config, Analog Out
<b>Example</b>	OUTP:ANAL OFF ! causes the analog output to be off
<b>Readback Text</b>	Off
<b>Initial S/W Revision</b>	A.04.00

### Screen Video

Selects the analog output to be the screen video signal. In this mode, the pre-detector data is output to the Analog Out connector. The output looks very much like the trace displayed on the analyzer's screen,

and depends on the Log/Lin display Scale, Reference Level, and dB per division, but is not influenced by the selected detector or any digital flatness corrections or trace post-processing (like Trace Averaging).

Note that this mode is similar to the Analog Output of the HP 8566 family and the Video Out (opt 124) capability of the Agilent PSA analyzer (E444x), although there are differences in the behavior.

Key Path	Input/Output, Output Config, Analog Out
Example	OUTP:ANAL SVID
Dependencies	<p>Because the Screen Video output uses one of the two IF processing channels, only one detector is available while Screen Video is selected. All active traces will change to use the same detector as the selected trace when Screen Video is activated.</p> <p>Screen Video output is not available while any EMI Detector is selected (Quasi Peak, RMS Average or EMI Average), because these detectors use both IF processing channels. Consequently, if the user chooses an EMI Detector, there will be no Screen Video output.</p> <p>The output holds at its last value during an alignment and during a marker count. After a sweep:</p> <ul style="list-style-type: none"> <li>• If a new sweep is to follow (as in Continuous sweep mode), the output holds at its last value during the retrace before the next sweep starts. If the analyzer is in zero-span, there is no retrace, as the analyzer remains tuned to the Center Frequency and does not sweep. Therefore, in zero-span, the output simply remains live between display updates.</li> <li>• If no new sweep is to follow (as in Single sweep mode), the output remains live, and continues to show the pre-detector data</li> </ul> <p>This function depends on optional capability; the key will be blanked and the command will generate an "Option not available" error unless you have Option YAV or YAS licensed in your instrument.</p>
Couplings	Screen Video output changes while in FFT Sweeps, so for measurements that use exclusively FFT Sweeps, or if the user manually chooses FFT Sweeps, the Screen Video output will look different than it does in swept mode.
Readback Text	Screen Video
Backwards Compatibility Notes	See " <b>Backwards Compatibility:</b> " on page 296, below.
Initial S/W Revision	A.04.00

#### Backwards Compatibility:

The Screen Video function is intended to be very similar to the 8566 Video Output and the PSA Option 124. However, unlike the PSA, it is not always on; it must be switched on by the Screen Video key. Also, unlike the PSA, there are certain dependencies (detailed above) – for example, the Quasi Peak Detector is unavailable when Screen Video is on.

Furthermore, the PSA Option 124 hardware was unipolar and its large range was padded to be exactly right for use as a Screen Video output. In the X-Series, the hardware is bipolar and has a wider range to accommodate the other output choices. Therefore, the outputs won't match up exactly and users may have to modify their setup when applying the X-Series in a PSA application.

#### Log Video (RF Envelope, Ref=Mixer Level)

Selects the analog output to be the log of the video signal. In this mode, the pre-detector data is output to the Analog Out connector with a Log scaling. The output is referenced to the current level at the mixer, does not depend on display settings like Reference Level or dB per division, and it is not influenced by the

selected detector or any digital flatness corrections or trace post-processing (like Trace Averaging), but does change with input attenuation.

The output is designed so that full scale (1 V) corresponds to  $-10$  dBm at the mixer. The full range (0–1 V) covers 192.66 dB ; thus, 0 V corresponds to  $-202.66$  dBm at the mixer.

Key Path	Input/Output, Output Config, Analog Out
Example	OUTP:ANAL LOGV
Dependencies	<p>Because the Log Video output uses one of the two IF processing channels, only one detector is available while Screen Video is selected. All active traces will change to use the same detector as the selected trace when Log Video is activated.</p> <p>Log Video output is not available while any EMI Detector is selected (Quasi Peak, RMS Average or EMI Average), because these detectors use both IF processing channels. Consequently, if the user chooses an EMI Detector, there will be no Log Video output.</p> <p>The output holds at its last value during an alignment, during a marker count, and during retrace (after a sweep and before the next sweep starts).</p> <p>This function depends on optional capability. The key will be blanked and the command will generate an “Option not available” error unless you have Option YAV licensed in your instrument.</p>
Couplings	Log Video output changes while in FFT Sweeps, so for measurements that use exclusively FFT Sweeps, or if the user manually chooses FFT Sweeps, the Log Video output will look different than it does in swept mode.
Readback Text	Log Video
Initial S/W Revision	A.04.00

### Linear Video (RF Envelope, Ref=Ref Level)

Selects the analog output to be the envelope signal on a linear (voltage) scale. In this mode, the pre-detector data is output to the Analog Out connector with a Linear scaling. The output is based on the current Reference Level, and is not influenced by the selected detector or any digital flatness corrections or trace post-processing (like Trace Averaging).

The scaling is set so that 1 V output occurs with an instantaneous video level equal to the reference level, and 0 V occurs at the bottom of the graticule. This scaling gives you the ability to control the gain without having another setup control for the key. But it requires you to control the look of the display (the reference level) in order to control the analog output.

This mode is ideal for looking at Amplitude Modulated signals, as the linear envelope effectively demodulates the signal.

Key Path	Input/Output, Output Config, Analog Out
Example	OUTP:ANAL LINV
Dependencies	<p>Because the Linear Video output uses one of the two IF processing channels, only one detector is available while Linear Video is selected. All active traces will change to use the same detector as the selected trace when Log Video is activated.</p> <p>Linear Video output is not available while any EMI Detector is selected (Quasi Peak, RMS Average or EMI Average), because these detectors use both IF processing channels. Consequently, if the user chooses an EMI Detector, there will be no Linear Video output.</p>

	<p>The output holds at its last value during an alignment and during a marker count and during retrace (after a sweep and before the next sweep starts).</p> <p>This function depends on optional capability; the key will be blanked and the command will generate an “Option not available” error unless you have Option YAV licensed in your instrument.</p>
Couplings	Linear Video output changes while in FFT Sweeps, so for measurements that use exclusively FFT Sweeps, or if the user manually chooses FFT Sweeps, the Linear Video output will look different than it does in swept mode.
Readback Text	Linear Video
Initial S/W Revision	A.04.00

### Demod Audio

Selects the analog output to be the demodulation of the video signal.

When Demod Audio is selected, the demodulated audio signal appears at this output whenever the Analog Demod application is demodulating a signal or when Analog Demod Tune and Listen is operating in the Swept SA measurement.

When Analog Out is in the Auto state, this output is auto-selected when in the Analog Demod mode or when Analog Demod Tune and Listen is operating in the Swept SA measurement.

If any other Analog Output is manually selected when in the Analog Demod mode or when Analog Demod Tune and Listen is operating in the Swept SA measurement, a condition warning message appears.

Key Path	Input/Output, Output Config, Analog Out
Example	OUTP:ANAL DAUD
Dependencies	<p>This key only appears if the Analog Demod application (N9063A), the N6141A or W6141A application, or Option EMC is installed and licensed, otherwise the key will be blanked and the command will generate an “Option not available” error.</p> <p>The output holds at its last value during an alignment and during a marker count. It is not held between sweeps, in order for Tune and Listen to work properly.</p> <p>When Demod Audio is the selected Analog Output:</p> <ul style="list-style-type: none"> <li>• all active traces are forced to use the same detector.</li> <li>• CISPR detectors (QPD, EMI Avg, RMS Avg) are unavailable</li> </ul>
Readback Text	Demod Audio
Initial S/W Revision	Prior to A.02.00 (this was the default functionality, and there was no selection)
Modified at S/W Revision	A.04.00

### Digital Bus

This menu allows you to configure the LVDS connector located on the rear panel of the instrument. It is a unidirectional link of real time data at a 90 MSa/s rate. The ADC is sampling a 22.5 MHz IF.

The data that appears on this port is raw, uncorrected ADC samples, unless you have option RTL. With option RTL, you get fully corrected I/Q data.

This connector will only be active when the Narrowband IF Path is currently in use.

Key Path	Input/Output, Output Config
Initial S/W Revision	A.04.00

### Bus Out On/Off

When Bus Out is on, all acquisitions are streamed to the output port including acquisitions for internal purposes such as Alignment. The internal processing and routing of acquisitions continues as usual and is unaffected by the state of Bus Out.

When Bus Out is off, no signal appears on the LVDS port.

Key Path	Input/Output, Output Config, Digital Bus
Scope	Mode Global
<b>Remote Command</b>	:OUTPut:DBUS[1][:STATe] ON OFF 1 0 :OUTPut:DBUS[1][:STATe]?
<b>Example</b>	OUTP:DBUS ON
Preset	This is unaffected by a Preset but is set to Off on a "Restore Input/Output Defaults" or "Restore System Defaults -> All"
State Saved	Saved in Input/Output State
Initial S/W Revision	Prior to A.02.00
Modified at S/W Revision	A.04.00

### I/Q Cal Out

The Baseband I/Q "Cal Out" port can be turned on with either a 1 kHz or a 250 kHz square wave. This can be turned on independent of the input selection. A Preset will reset this to Off.

Key Path	Input/Output, Output Config
<b>Remote Command</b>	:OUTPut:IQ:OUTPut IQ1 IQ250 OFF :OUTPut:IQ:OUTPut?
<b>Example</b>	OUTP:IQ:OUTP IQ1
Couplings	An I/Q Cable Calibration or an I/Q Probe Calibration will change the state of the Cal Out port as needed by the calibration routine. When the calibration is finished the I/Q Cal Out is restored to the pre-calibration state.
Preset	Off
State Saved	Saved in instrument state
Range	1 kHz Square Wave 250 kHz Square Wave Off
Readback Text	1 kHz 250 kHz Off
Initial S/W Revision	Prior to A.02.00

### 1 kHz Square Wave

Turns on the 1 kHz square wave signal at the Cal Out port. This choice is only available with option BBA.

Key Path	Input/Output, Output Config, I/Q Cal Out
Readback	I/Q 1kHz
Initial S/W Revision	Prior to A.02.00

### 250 kHz Square Wave

Turns on the 250 kHz square wave signal at the Cal Out port. This choice is only available with option BBA.

Key Path	Input/Output, Output Config, I/Q Cal Out
Readback	I/Q 250kHz
Initial S/W Revision	Prior to A.02.00

### Off

Turns off the signal at the Cal Out port. This choice is only available with option BBA.

Key Path	Input/Output, Output Config, I/Q Cal Out
Readback	Off
Initial S/W Revision	Prior to A.02.00

### Aux IF Out

This menu controls the signals that appear on the SMA output on the rear panel labeled "AUX IF OUT"

The Aux IF Out functionality is only valid for RF and External Mixer inputs. When using the External Mixing path, the Aux IF Out levels (for all three Options CR3, CRP, and ALV) will be uncalibrated because the factory default Aux IF level was set to accommodate the expected IF levels for the RF path.

Key Path	Input/Output, Output Config
<b>Remote Command</b>	:OUTPut:AUX SIF AIF LOGVideo OFF :OUTPut:AUX?
Dependencies	The softkey does not appear in models that do not support the Aux IF Out.
Preset	This is unaffected by a Preset but is set to OFF on a "Restore Input/Output Defaults" or "Restore System Defaults->All"
State Saved	Saved in Input/Output state
Readback line	1-of-N selection [variable]



Backwards Compatibility Notes	In the PSA, the IF output has functionality equivalent to the "Second IF" function in the X-Series' Aux IF Out menu. In the X-Series, it is necessary to switch the Aux IF Out to "Second IF" to get this functionality, whereas in PSA it is always on, since there are no other choices. Hence a command to switch this function to "Second IF" will have to be added by customers migrating from PSA who use the IF Output in PSA.
Initial S/W Revision	A.04.00

## Off

In this mode nothing comes out of the "AUX IF OUT" connector on the rear panel. The connector appears as an open-circuit (that is, it is not terminated in any way).

Key Path	Input/Output, Output Config, Aux IF Out
<b>Example</b>	OUTP:AUX OFF causes the aux output type to be off
Readback Text	Off
Initial S/W Revision	A.04.00

## Second IF

In this mode the 2nd IF output is routed to the rear panel connector. The annotation on the key shows the current 2nd IF frequency in use in the analyzer.

The frequency of the 2nd IF depends on the current IF signal path as shown in the table below:

IF Path Selected	Frequency of "Second IF" Output
10 MHz	322.5 MHz
25 MHz	322.5 MHz
40 MHz	250 MHz
140 MHz	300 MHz

The signal quality, such as signal to noise ratio and phase noise, are excellent in this mode.

Key Path	Input/Output, Output Config, Aux IF Out
<b>Example</b>	OUTP:AUX SIF causes the aux output type to be Second IF
Dependencies	Does not appear unless Option CR3 is installed.
Readback Text	Second IF
Initial S/W Revision	A.04.00

### Arbitrary IF

In this mode the 2nd IF output is mixed with a local oscillator and mixer to produce an arbitrary IF output between 10 MHz and 75 MHz with 500 kHz resolution. The phase noise in this mode will not be as good as in Second IF mode.

The IF output frequency is adjustable, through an active function which appears on the Arbitrary IF selection key, from 10 MHz to 75 MHz with 500 kHz resolution.

The bandwidth of this IF output varies with band and center frequency, but is about 40 MHz at the -3 dB width. When the output is centered at lower frequencies in its range, signal frequencies at the bottom of the bandwidth will “fold”. For example, with a 40 MHz bandwidth (20 MHz half-bandwidth), and a 15 MHz IF center, a signal -20 MHz relative to the spectrum analyzer center frequency will have a relative response of about -3 dB with a frequency 20 MHz below the 15 MHz IF center. This -5 MHz frequency will fold to become a +5 MHz signal at the IF output. Therefore, lower IF output frequencies are only useful with known band-limited signals.

Key Path	Input/Output, Output Config, Aux IF Out
<b>Example</b>	OUTP:AUX AIF causes the aux output type to be the Arbitrary IF
Dependencies	Does not appear unless Option CRP is installed.
Readback Text	Arbitrary IF
Initial S/W Revision	A.04.00

Key Path	Input/Output, Output Config, Aux IF Out
Scope	Mode Global
<b>Remote Command</b>	:OUTPut:AUX:AIF <value> :OUTPut:AUX:AIF?
<b>Example</b>	:OUTP:AUX:AIF 50 MHZ
Preset	This is unaffected by a Preset but is set to 70 MHz on a "Restore Input/Output Defaults" or "Restore System Defaults->All"
State Saved	Saved in Input/Output State
Min	10 MHz
Max	75 MHz
Default Unit	Hz
Initial S/W Revision	A.04.00

### Fast Log Video

In this mode the 2nd IF output is passed through a log amp and the log envelope of the IF signal is sent to the rear panel. The open circuit output level varies by about 25 mV per dB, with a top-of-screen signal producing about 1.6 Volts. The output impedance is nominally 50 ohms.

This mode is intended to meet the same needs as Option E4440A-H7L Fast Rise Time Video Output on the Agilent E4440A PSA Series, allowing you to characterize pulses with fast rise times using standard measurement suites on modern digital scopes.

Key Path	Input/Output, Output Config, Aux IF Out
<b>Example</b>	OUTP:AUX LOGVideo causes the aux output type to be Fast Log Video
Dependencies	Does not appear unless Option ALV is installed. The output is off during an alignment but not during a marker count, and is not blanked during retrace (after a sweep and before the next sweep starts).
Readback Text	Fast Log Video
Initial S/W Revision	A.04.00

## I/Q Guided Calibration

Calibrating the Baseband I/Q ports requires several steps and manual connections. The Guided Calibration will interactively step you through the required steps, displaying diagrams to help with the connections. The steps will vary depending on the setup.

In the Guided Calibration windows, the date and time of the last calibration are displayed. If any of the items listed are displayed in yellow, this indicates that the calibration for that item is inconsistent with the latest calibration, and you should complete the entire calibration process before you exit the calibration.

## I/Q Isolation Calibration

The I/Q Isolation Calibration must be run before calibrating any port with either the I/Q Cable Calibration or I/Q Probe Calibration. This calibration is performed with nothing connected to any of the front panel I/Q ports. This is the first step in both the I/Q Cable Calibration and the I/Q Probe Calibration.

### Next

Perform the I/Q Isolation calibration.

Key Path	Input/Output, I/Q, I/Q Cable Calibration
<b>Remote Command</b>	:CALibration:IQ:ISOLation
<b>Example</b>	CAL:IQ:ISOL
Notes	All front panel I/Q ports must not be connected to anything.
Notes	All cables and probes should be disconnected from the I/Q ports before issuing the SCPI command.
State Saved	No.
Initial S/W Revision	Prior to A.02.00

### Exit

Exits the calibration procedure. All ports calibrated before pressing Exit will use the newly acquired calibration data.

Key Path	Input/Output, I/Q, I/Q Cable Calibration
Notes	Using the Exit button will not restore the calibration data to the state prior to entering the guided calibration. Once a port is calibrated the data is stored immediately and the only way to change it is to redo the calibration step.  When the calibration may be left in an inconsistent state, a confirmation dialog will be displayed (see <a href="#">"Exit Confirmation" on page 315</a> ).
Initial S/W Revision	Prior to A.02.00

### I/Q Isolation Calibration Time (Remote Command Only)

Returns the last date and time that the I/Q Isolation Calibration was performed. This is a remote query command only.

Remote Command	:CALibration:IQ:ISOLation:TIME?
Example	:CAL:IQ:ISOL:TIME?
Notes	This returns 6 integer values: year, month, day, hour, minute, second. When no calibration has been performed, all values will be 0.
Initial S/W Revision	A.02.00

### I/Q Cable Calibrate...

The I/Q cable calibration creates correction data for each of the front panel I/Q ports. This calibration data is used whenever no probe specific calibration data is available. It is important that all ports are calibrated using the same short BNC cable so that the data is comparable from port to port.

The guided calibration (front panel only) will show connection diagrams and guide you through the isolation calibration and calibrating each port. The calibration data for each port is stored separately, so as soon as a port is calibrated that data is saved and will be used. If you press "Exit" to exit the calibration process, the data for the ports already completed will still be used. It is recommended that a calibration be completed once started, or if exited, that it be properly done before the next use of the I/Q ports. The "Next" button will perform the calibration for the current port and then proceed to the next step in the calibration procedure. The "Back" button will return to the prior port in the procedure. Both keys and dialog buttons are supplied for ease of use. The dialog buttons are for mouse use and the softkeys for front panel use.

The calibration can also be done via SCPI, but no connection diagrams will be shown. You will have to make the correct connections before issuing each port calibration command. Again, it is recommended that all ports be calibrated at the same time.

The instrument state remains as it was prior to entering the calibration procedure except while a port is actually being calibrated. Once a port is calibrated it returns to the prior state. A port calibration is in process only from the time the "Next" button is pressed until the next screen is shown. For SCPI, this corresponds to the time from issuing the CAL:IQ:FLAT:|I|B|Q|QB command until the operation is complete.

For example, if the prior instrument state is Cal Out = Off, Input = I+jQ, and Differential = Off, then up until the time the "Next" button is pressed the I Input and Q Input LEDs are on and the Cal Out, I-bar Input and Q-bar Input LEDs are off. Once the "Next" button is pressed for the I port calibration, only the Cal Out and I

Input LEDs will be on and the others will be off. When the screen progresses to the next step ("Next" button again enabled), the prior state is restored and only the I Input and Q Input LEDs are on (Cal Out is off again).

The last calibration date and time for each port will be displayed. Any calibrations that are more than a day older than the most recent calibration will be displayed with the color amber.

Key Path	Input/Output, I/Q
Initial S/W Revision	Prior to A.02.00

## I Port

The I port calibration is performed with the front panel's I port connected via a short BNC cable to the Cal Out port. The guided calibration will show a diagram of the required connections.

### Back

Return to the prior step in the calibration procedure.

Key Path	Input/Output, I/Q, Q Setup, Q Probe, Calibrate
Initial S/W Revision	Prior to A.02.00

### Next

Perform the I port calibration.

Key Path	Input/Output, I/Q, I/Q Cable Calibrate...
<b>Remote Command</b>	:CALibration:IQ:FLATness:I
<b>Example</b>	CAL:IQ:FLAT:I
Notes	The recommended procedure is to use the same BNC cable to calibrate all I/Q ports. All I/Q ports should be calibrated sequentially during the procedure. The calibration data is saved as soon as the port is calibrated and will survive power cycles. It is not reset by any preset or restore data commands.
Notes	The I port must be connected to the Cal Out port before issuing the SCPI command.
State Saved	No.
Initial S/W Revision	Prior to A.02.00

### Exit

Exit the calibration procedure. All ports calibrated before pressing Exit will use the newly acquired calibration data.

Key Path	Input/Output, I/Q, I/Q Cable Calibrate...
Notes	Using the Exit button will not restore the calibration data to the state prior to entering the guided calibration. Once a port is calibrated the data is stored immediately and the only way to change it is

to redo the calibration step.

When the calibration may be left in an inconsistent state, a confirmation dialog will be displayed (see "Exit Confirmation" on page 315 ).

Initial S/W Revision	Prior to A.02.00
----------------------	------------------

### I-bar Port

The I-bar port calibration is performed with the front panel's I-bar port connected via a short BNC cable to the Cal Out port. The guided calibration will show a diagram of the required connections.

#### Back

Return to the prior step in the calibration procedure.

Key Path	Input/Output, I/Q, I/Q Cable Calibration
Notes	Using the Back button will not restore the calibration data to a prior state. Once a port is calibrated the data is stored immediately and the only way to change it is to redo the calibration step. The Back button allows the user to go back to a prior step to redo that calibration step.
Initial S/W Revision	Prior to A.02.00

#### Next

Perform the I-bar port calibration.

Key Path	Input/Output, I/Q, I/Q Cable Calibrate...
<b>Remote Command</b>	:CALibration:IQ:FLATness:IBAR
<b>Example</b>	CAL:IQ:FLAT:IBAR
Notes	The recommended procedure is to use the same BNC cable to calibrate all I/Q ports. All I/Q ports should be calibrated sequentially during the procedure.  The calibration data is saved as soon as the port is calibrated and will survive power cycles. It is not reset by any preset or restore data commands.
Notes	The I-bar port must be connected to the Cal Out port before issuing the SCPI command.
State Saved	No
Initial S/W Revision	Prior to A.02.00

#### Exit

Exit the calibration procedure. All ports calibrated before pressing Exit will use the newly acquired calibration data.

Key Path	Input/Output, I/Q, I/Q Cable Calibrate...
Notes	Using the Exit button will not restore the calibration data to the state prior to entering the guided calibration. Once a port is calibrated the data is stored immediately and the only way to change it is

---

to redo the calibration step.

When the calibration may be left in an inconsistent state, a confirmation dialog will be displayed (see "[Exit Confirmation](#)" on page 315 ).

---

Initial S/W Revision	Prior to A.02.00
----------------------	------------------

---

## Q Port

The Q port calibration is performed with the front panel's Q port connected via a short BNC cable to the Cal Out port. The guided calibration will show a diagram of the required connections.

### Back

Return to the prior step in the calibration procedure.

---

Key Path	Input/Output, I/Q, I/Q Cable Calibrate...
Notes	Using the Back button will not restore the calibration data to a prior state. Once a port is calibrated the data is stored immediately and the only way to change it is to redo the calibration step. The Back button allows the user to go back to a prior step to redo that calibration step.
Initial S/W Revision	Prior to A.02.00

---

### Next

Perform the Q port calibration.

---

Key Path	Input/Output, I/Q, I/Q Cable Calibrate...
<b>Remote Command</b>	:CALibration:IQ:FLATness:Q
<b>Example</b>	CAL:IQ:FLAT:Q
Notes	The recommended procedure is to use the same BNC cable to calibrate all I/Q ports. All I/Q ports should be calibrated sequentially during the procedure.  The calibration data is saved as soon as the port is calibrated and will survive power cycles. It is not reset by any preset or restore data commands.
Notes	The Q port must be connected to the Cal Out port before issuing the SCPI command.
State Saved	No
Initial S/W Revision	Prior to A.02.00

---

### Exit

Exit the calibration procedure. All ports calibrated before pressing Exit will use the newly acquired calibration data.

---

Key Path	Input/Output, I/Q, I/Q Cable Calibrate...
Notes	Using the Exit button will not restore the calibration data to the state prior to entering the guided calibration. Once a port is calibrated the data is stored immediately and the only way to change it is

---

to redo the calibration step.

When the calibration may be left in an inconsistent state, a confirmation dialog will be displayed (see "Exit Confirmation" on page 315 ).

Initial S/W Revision	Prior to A.02.00
----------------------	------------------

### Q-bar Port

The Q-bar port calibration is performed with the front panel's Q-bar port connected via a short BNC cable to the Cal Out port. The guided calibration will show a diagram of the required connections.

#### Back

Return to the prior step in the calibration procedure.

Key Path	Input/Output, I/Q, I/Q Cable Calibrate...
Notes	Using the Back button will not restore the calibration data to a prior state. Once a port is calibrated the data is stored immediately and the only way to change it is to redo the calibration step. The Back button allows the user to go back to a prior step to redo that calibration step.
Initial S/W Revision	Prior to A.02.00

#### Next

Perform the Q-bar port calibration.

Key Path	Input/Output, I/Q, I/Q Cable Calibrate...
<b>Remote Command</b>	:CALibration:IQ:FLATness:QBAR
<b>Example</b>	CAL:IQ:FLAT:QBAR
Notes	The recommended procedure is to use the same BNC cable to calibrate all I/Q ports. All I/Q ports should be calibrated sequentially during the procedure.  The calibration data is saved as soon as the port is calibrated and will survive power cycles. It is not reset by any preset or restore data commands.
Notes	The Q-bar port must be connected to the Cal Out port before issuing the SCPI command.
State Saved	No
Initial S/W Revision	Prior to A.02.00

#### Exit

Exit the calibration procedure. All ports calibrated before pressing Exit will use the newly acquired calibration data.

Key Path	Input/Output, I/Q, I/Q Cable Calibrate...
Notes	Using the Exit button will not restore the calibration data to the state prior to entering the guided calibration. Once a port is calibrated the data is stored immediately and the only way to change it is



---

to redo the calibration step.

When the calibration may be left in an inconsistent state, a confirmation dialog will be displayed (see **"Exit Confirmation" on page 315**).

---

Initial S/W Revision      Prior to A.02.00

---

### I/Q Cable Calibration Time (Remote Command Only)

Returns the last date and time that the I/Q Cable Calibration was performed for a specific port. This is a remote query command only.

---

**Remote Command**      :CALibration:IQ:FLATness:I|IBAR|Q|QBAR:TIME?

---

**Example**                :CAL:IQ:FLAT:I:TIME?

---

**Notes**                    This returns 6 integer values: year, month, day, hour, minute, second. When no calibration has been performed, all values will be 0.

---

Initial S/W Revision      A.02.00

---

### I/Q Probe Calibration

The I/Q probe calibration creates correction data for one of the front panel I/Q channels. When the probe has EEPROM identification, the data is unique to that specific probe. When the probe does not have EEPROM identification, the data will be used for all probes of the same type. The data is also unique to the channel, so calibration data for the I channel will not be used for the Q channel and vice versa.

The guided calibration (front panel only) will show connection diagrams and guide the user through the I/Q Isolation Calibration and through calibrating each port. The calibration data for each port is stored separately, so as soon as a port is calibrated that data is saved and will be used. If a user presses "Exit" to exit the calibration process, the data for the port already completed will still be used. It is recommended that a calibration be completed once started, or if exited, that it be properly done before the next use of the probe. The "Next" button will perform the calibration for the current port and then proceed to the next step in the calibration procedure. The "Back" button will return to the prior port in the procedure. Both softkeys and dialog buttons are supplied for ease of use. The dialog buttons are for mouse use and the softkeys for front panel use.

The calibration can also be done via SCPI, but no connection diagrams will be shown. The user will have to make the correct connections before issuing each port calibration command. Again, it is recommended that all ports be calibrated at the same time.

For Active probes or when Differential is Off, only the main port is calibrated, otherwise both the main and complementary ports are calibrated.

The instrument state remains as it was prior to entering the calibration procedure except while a port is actually being calibrated. Once a port is calibrated it returns to the prior state. A port calibration is in process only from the time the "Next" button is pressed until the next screen is shown. For SCPI, this corresponds to the time from issuing the CAL:IQ:PROB:I|B|Q|QB command until the operation is complete.

For example, if the prior instrument state is Cal Out = Off, Input = I+jQ, and Differential = Off, then up until the time the "Next" button is pressed the I Input and Q Input LEDs are on and the Cal Out, I-bar Input and

Q-bar Input LEDs are off. Once the "Next" button is pressed for the I port calibration, only the Cal Out and I Input LEDs will be on and the others will be off. When the screen progresses to the next step ("Next" button again enabled), the prior state is restored and only the I Input and Q Input LEDs are on (Cal Out is off again).

The last calibration date and time for each relevant port will be displayed. For passive probes with Differential On, any calibration that is more than a day older than the most recent calibration will be displayed with the color amber.

### I Port

The I port calibration is performed with the probe body attached to the front panel's I port and the probe tip connected via an adapter to the Cal Out port. The guided calibration will show a diagram of the required connections.

#### Show Adapter

Show a connection diagram and instructions for the probe and adapter. See ["Show Adapter Screen" on page 314](#).

Key Path	Input/Output, I/Q, I Setup, I Probe, Calibrate
Notes	Either a passive or an active probe adapter diagram will be shown, depending on the type of probe attached.
Initial S/W Revision	Prior to A.02.00

### Back

Return to the prior step in the calibration procedure.

Key Path	Input/Output, I/Q, Q Setup, Q Probe, Calibrate
Initial S/W Revision	Prior to A.02.00

### Next

Perform the I port calibration.

Key Path	Input/Output, I/Q, I Setup, I Probe, Calibrate
<b>Remote Command</b>	:CALibration:IQ:PROBE:I
<b>Example</b>	CAL:IQ:PROB:I
Notes	The I port must be connected to the Cal Out port before issuing the SCPI command. The calibration data is saved as soon as the port is calibrated and will survive power cycles. It is not reset by any preset or restore data commands.
State Saved	No
Initial S/W Revision	Prior to A.02.00

## Exit

Exit the calibration procedure. All ports calibrated before pressing Exit will use the newly acquired calibration data.

Key Path	Input/Output, I/Q, I Setup, I Probe, Calibrate
Notes	Using the Exit button will not restore the calibration data to the state prior to entering the guided calibration. Once a port is calibrated the data is stored immediately and the only way to change it is to redo the calibration step. When the calibration may be left in an inconsistent state, a confirmation dialog will be displayed (see <a href="#">"Exit Confirmation" on page 315</a> ).
Initial S/W Revision	Prior to A.02.00

## I-bar Port

The I-bar port calibration is performed with the probe body attached to the front panel's I-bar port and the probe tip connected via an adapter to the Cal Out port. The I-bar probe calibration is only available for passive probes with Differential On. The guided calibration will show a diagram of the required connections.

### Show Adapter

Show a connection diagram and instructions for the probe and adapter. See ["Show Adapter Screen" on page 314](#).

Key Path	Input/Output, I/Q, I Setup, I Probe, Calibrate
Notes	Either a passive or an active probe adapter diagram will be shown, depending on the type of probe attached.
Initial S/W Revision	Prior to A.02.00

## Back

Return to the prior step in the calibration procedure.

Key Path	Input/Output, I/Q, I Setup, I Probe, Calibrate
Notes	Using the Back button will not restore the calibration data to a prior state. Once a port is calibrated the data is stored immediately and the only way to change it is to redo the calibration step. The Back button allows the user to go back to a prior step to redo that calibration step.
Initial S/W Revision	Prior to A.02.00

## Next

Perform the I-bar port calibration.

Key Path	Input/Output, I/Q, I Setup, I Probe, Calibrate
----------	------------------------------------------------

<b>Remote Command</b>	:CALibration:IQ:PROBe:IBar
<b>Example</b>	CAL:IQ:PROB:IB
<b>Notes</b>	The I-bar port must be connected to the Cal Out port before issuing the SCPI command. The calibration data is saved as soon as the port is calibrated and will survive power cycles. It is not reset by any preset or restore data commands.
<b>State Saved</b>	No
<b>Initial S/W Revision</b>	Prior to A.02.00

### Exit

Exit the calibration procedure. All ports calibrated before pressing Exit will use the newly acquired calibration data.

<b>Key Path</b>	Input/Output, I/Q, I Setup, I Probe, Calibrate
<b>Notes</b>	Using the Exit button will not restore the calibration data to the state prior to entering the guided calibration. Once a port is calibrated the data is stored immediately and the only way to change it is to redo the calibration step. When the calibration may be left in an inconsistent state, a confirmation dialog will be displayed (see <a href="#">"Exit Confirmation" on page 315</a> ).
<b>Initial S/W Revision</b>	Prior to A.02.00

### Q Port

The Q port calibration is performed with the probe body attached to the front panel's Q port and the probe tip connected via an adapter to the Cal Out port. The guided calibration will show a diagram of the required connections.

#### Show Adapter

Show a connection diagram and instructions for the probe and adapter. See ["Show Adapter Screen" on page 314](#).

<b>Key Path</b>	Input/Output, I/Q, Q Setup, Q Probe, Calibrate
<b>Notes</b>	Either a passive or an active probe adapter diagram will be shown, depending on the type of probe attached.
<b>Initial S/W Revision</b>	Prior to A.02.00

### Back

Return to the prior step in the calibration procedure.

<b>Key Path</b>	Input/Output, I/Q, Q Setup, Q Probe, Calibrate
<b>Initial S/W Revision</b>	Prior to A.02.00

**Next**

Perform the Q port calibration.

<b>Key Path</b>	Input/Output, I/Q, Q Setup, Q Probe, Calibrate
<b>Remote Command</b>	:CALibration:IQ:PROBe:Q
<b>Example</b>	CAL:IQ:PROB:Q
<b>Notes</b>	The Q port must be connected to the Cal Out port before issuing the SCPI command. The calibration data is saved as soon as the port is calibrated and will survive power cycles. It is not reset by any preset or restore data commands.
<b>State Saved</b>	No
<b>Initial S/W Revision</b>	Prior to A.02.00

**Exit**

Exit the calibration procedure. All ports calibrated before pressing Exit will use the newly acquired calibration data.

<b>Key Path</b>	Input/Output, I/Q, Q Setup, Q Probe, Calibrate
<b>Notes</b>	Using the Exit button will not restore the calibration data to the state prior to entering the guided calibration. Once a port is calibrated the data is stored immediately and the only way to change it is to redo the calibration step. When the calibration may be left in an inconsistent state, a confirmation dialog will be displayed (see <a href="#">"Exit Confirmation" on page 315</a> ).
<b>Initial S/W Revision</b>	Prior to A.02.00

**Q-bar Port**

The Q-bar port calibration is performed with the probe body attached to the front panel's Q-bar port and the probe tip connected via an adapter to the Cal Out port. The Q-bar probe calibration is only available for passive probes with Differential On. The guided calibration will show a diagram of the required connections.

**Show Adapter**

Show a connection diagram and instructions for the probe and adapter. See ["Show Adapter Screen" on page 314](#).

<b>Key Path</b>	Input/Output, I/Q, Q Setup, Q Probe, Calibrate
<b>Notes</b>	Either a passive or an active probe adapter diagram will be shown, depending on the type of probe attached.
<b>Initial S/W Revision</b>	Prior to A.02.00

### Back

Return to the prior step in the calibration procedure.

Key Path	Input/Output, I/Q, Q Setup, Q Probe, Calibrate
Notes	Using the Back button will not restore the calibration data to a prior state. Once a port is calibrated the data is stored immediately and the only way to change it is to redo the calibration step. The Back button allows the user to go back to a prior step to redo that calibration step.
Initial S/W Revision	Prior to A.02.00

### Next

Perform the Q-bar port calibration.

Key Path	Input/Output, I/Q, Q Setup, Q Probe, Calibrate
Remote Command	:CALibration:IQ:PROBE:QBar
Example	CAL:IQ:PROB:QB
Notes	The Q-bar port must be connected to the Cal Out port before issuing the SCPI command. The calibration data is saved as soon as the port is calibrated and will survive power cycles. It is not reset by any preset or restore data commands.
State Saved	No
Initial S/W Revision	Prior to A.02.00

### Exit

Exit the calibration procedure. All ports calibrated before pressing Exit will use the newly acquired calibration data.

Key Path	Input/Output, I/Q, Q Setup, Q Probe, Calibrate
Notes	Using the Exit button will not restore the calibration data to the state prior to entering the guided calibration. Once a port is calibrated the data is stored immediately and the only way to change it is to redo the calibration step. When the calibration may be left in an inconsistent state, a confirmation dialog will be displayed (see <a href="#">"Exit Confirmation" on page 315</a> ).
Initial S/W Revision	Prior to A.02.00

### Show Adapter Screen

When one of the Probe Calibration Show Adapter buttons is pressed, a diagram of the probe with its adapter will be shown. Depending on the type of probe attached, either the Passive Probe Adapter or the Active Probe Adapter diagram will be shown.

### I/Q Probe Calibration Time (Remote Command Only)

Return the last date and time that the I/Q Probe Calibration was performed for a specific port. This is a remote query command only.

<b>Remote Command</b>	:CALibration:IQ:PROBe:I IBAR Q QBAR:TIME?
<b>Example</b>	:CAL:IQ:PROB:I:TIME?
<b>Notes</b>	This returns 6 integer values: year, month, day, hour, minute, second. When no calibration has been performed, all values will be 0. The value is specific to both the port and probe, so the value will change as probes are connected or disconnected.
<b>Initial S/W Revision</b>	A.02.00

### Exit Confirmation

When Exit is pressed during one of the calibration routines, the calibration may be in an inconsistent state with some of the ports having newly measured calibration data and others with old data. If this is the case, a dialog box will appear to confirm that the user really wants to exit. A "Yes" answer will exit the calibration procedure, leaving potentially inconsistent calibration data in place. A "No" answer will return to the calibration procedure.





## 5 Mode Functions

## Mode

The Mode key allows you to select the available measurement applications or “Modes”. Modes are a collection of measurement capabilities packaged together to provide an instrument personality that is specific to your measurement needs. Each application software product is ordered separately by Model Number and must be licensed to be available. Once an instrument mode is selected, only the commands that are valid for that mode can be executed.

**NOTE**

Key operation can be different between modes. The information displayed in Help is about the current mode.

To access Help for a different Mode you must first exit Help (by pressing the Cancel (Esc) key). Then select the desired mode and re-access Help.

For more information on Modes, preloading Modes, and memory requirements for Modes,

see ["More Information" on page 319](#)

Key Path	Front-panel key
<b>Remote Command</b>	:INSTrument[:SElect] SA   RTSA   SEQAN   EMI   BASIC   WCDMA   EDGE GSM   WIMAXOFDMA   VSA   PNOISE   NFIGure   ADEMOD   BTooth   TDSCDMA   CDMA2K   CDMA1XEV   LTE   LTETDD   LTEAFDD   LTEATDD   MSR   DVB   DTMB   DCATV   ISDBT   CMMB   WLAN   CWLAN   CWIMAXOFDM   WIMAXFIXED   IDEN   RLC   SCPI LC   VSA89601  :INSTrument[:SElect]?
<b>Example</b>	:INST SA
<b>Notes</b>	The available parameters are dependent upon installed and licensed applications resident in the instrument. Parameters given here are an example, specific parameters are in the individual Application.  A list of the valid mode choices is returned with the INST:CAT? Query.
<b>Preset</b>	This is unaffected by a Preset but is set on a “Restore System Defaults->All” to: For N9038A: EMI For N8973B, N8974B, N8975B, or N8976B: NFIG For all other models: SA
<b>State Saved</b>	Saved in instrument state
<b>Backwards Compatibility SCPI</b>	:INSTrument[:SElect] GSM provided for backwards compatibility. Mapped to EDGE GSM.
<b>Backwards Compatibility SCPI</b>	:INSTrument[:SElect] SANalyzer provided for ESU compatibility. When this command is received, the analyzer aliases it to the following: INST:SEL SCPI LC  This results in the analyzer being placed in SCPI Language Compatibility Mode, in order to emulate

	the ESU Spectrum Analyzer Mode.
<b>Backwards Compatibility SCPI</b>	:INSTrument[:SElect] RECeiver provided for ESU compatibility. When this command is received, the analyzer aliases it to the following: :INST:SEL EMI :CONF FSC This results in the analyzer being placed in the EMI Receiver Mode, running the Frequency Scan measurement, in order to emulate the ESU Receiver Mode.
Initial S/W Revision	Prior to A.02.00
Modified at S/W Revision	A.13.00

<b>Example</b>	:INST 'SA'
Notes	The query is not a quoted string. It is an enumeration as indicated in the Instrument Select table above. The command must be sequential: i.e. continued parsing of commands cannot proceed until the instrument select is complete and the resultant SCPI trees are available.
<b>Backwards Compatibility SCPI</b>	:INSTrument[:SElect] 'SA'   'PNOISE'   'EDGE'   'GSM'   'BASIC'
Initial S/W Revision	Prior to A.02.00

## More Information

The Mode name appears on the banner after the word “Agilent” followed by the Measurement Title. For example, for the Spectrum Analyzer mode with the Swept SA measurement running:



It is possible to specify the order in which the Modes appear in the Mode menu, using the Configure Applications utility (System, Power On, Configure Applications). It is also possible, using the same utility, to specify a subset of the available applications to load into memory at startup time, which can significantly decrease the startup time of the analyzer. During runtime, if an application that is not loaded into memory is selected (by either pressing that applications Mode key or sending that applications :INST:SEL command over SCPI), there will be a pause while the Application is loaded. During this pause a message box that says “Loading application, please wait...” is displayed.

Each application (Mode) that runs in the X-Series signal analyzers consumes virtual memory. The various applications consume varying amounts of virtual memory, and as more applications run, the memory consumption increases. Once an application is run, some of its memory remains allocated even when it is not running, and is not released until the analyzer program (xSA.exe) is shut down.

Agilent characterizes each Mode and assigns a memory usage quantity based on a conservative estimate. There is a limited amount of virtual memory available to applications (note that this is virtual memory and is independent of how much physical RAM is in the instrument). The instrument keeps track of how much

memory is being used by all loaded applications – which includes those that preloaded at startup, and all of those that have been run since startup.

When you request a Mode that is not currently loaded, the instrument looks up the memory estimate for that Mode, and adds it to the residual total for all currently loaded Modes. If there is not enough virtual memory to load the Mode, a dialog box and menu will appear that gives you four options:

1. Close and restart the analyzer program without changing your configured preloads. This may free up enough memory to load the requested Mode, depending on your configured preloads
2. Clear out all preloads and close and restart the analyzer program with only the requested application preloaded, and with that application running. This choice is guaranteed to allow you to run the requested application; but you will lose your previously configured preloads. In addition, there may be little or no room for other applications, depending on the size of the requested application.
3. Bring up the Configure Applications utility in order to reconfigure the preloaded apps to make room for the applications you want to run (this will then require restarting the analyzer program with your new configuration). This is the recommended choice because it gives you full flexibility to select exactly what you want.
4. Exit the dialog box without doing anything, which means you will be unable to load the application you requested.

In each case except 4, this will cause the analyzer software to close, and you will lose all unsaved traces and results.

If you attempt to load a mode via SCPI that will exceed memory capacity, the Mode does not load and an error message is returned:

```
-225,"Out of memory;Insufficient resources to load Mode (mode name)"
```

where “mode name” is the SCPI parameter for the Mode in question, for example, SA for Spectrum Analyzer Mode.

## Spectrum Analyzer

Selects the Spectrum Analyzer mode for general purpose measurements. There are several measurements available in this mode. General spectrum analysis measurements, in swept and zero span, can be done using the first key in the Meas menu, labeled Swept SA. Other measurements in the Meas Menu are designed to perform specialized measurement tasks, including power and demod measurements.

If you are using the Help feature, this mode must be currently active to access its detailed information. If it is not active, exit the Help feature (Esc key), select the mode, and re-access Help.

Key Path	Mode
<b>Example</b>	INST:SEL SA INST:NSEL 1
Initial S/W Revision	Prior to A.02.00

## DVB-T/H with T2

Selects the DVB-T/H mode for measurements of digital video signals using this format. There are several power and demod measurements available in this mode.

If you are using the Help feature, this mode must be currently active to access its detailed information. If it is not active, exit the Help feature (Esc key), select the mode, and re-access Help.

Key Path	Mode
<b>Example</b>	INST:SEL DVB INST:NSEL 235
Initial S/W Revision	A.02.00
Modified at S/W Revision	A.07.00

## cdma2000

Selects the cdma2000 mode for general purpose measurements of signals following this standard. There are several measurements available in this mode.

If you are using the Help feature, this mode must be currently active to access its detailed information. If it is not active, exit the Help feature (Esc key), select the mode, and re-access Help.

Key Path	Mode
<b>Example</b>	INST:SEL CDMA2K INST:NSEL 10
Initial S/W Revision	Prior to A.02.00

## Vector Signal Analyzer (VXA)

The N9064A (formerly 89601X) VXA Vector signal and WLAN modulation analysis application provides solutions for basic vector signal analysis, analog demodulation, and digital demodulation. The digital demodulation portion of N9064A allows you to perform measurements on standard-based formats such as cellular, wireless networking and digital video as well as general purpose flexible modulation analysis for wide range of digital formats, FSK to 1024QAM, with easy-to-use measurements and display tools such as constellation and eye diagram, EVM traces and up to four simultaneous displays. Analog baseband analysis is available using the MXA and PXA with option BBA. Option 3FP WLAN has been discontinued.

N9064A honors existing 89601X licenses with all features and functionalities found on X-Series software versions prior to A.06.00. Specifically:

N9064A-1 is equivalent to 89601X-205

N9064A-2 is equivalent to 89601X-AYA

If you are using the Help feature, this mode must be currently active to access its detailed information. If it is not active, exit the Help feature (Esc key), select the mode, and re-access Help.

Key Path	Mode
<b>Example</b>	INST:SEL VSA INST:NSEL 100
Initial S/W Revision	Prior to A.02.00

## Analog Demod

Selects the Analog Demod mode for making measurements of AM, FM and phase modulated signals.

If you are using the Help feature, this mode must be currently active to access its detailed information. If it is not active, exit the Help feature (Esc key), select the mode, and re-access Help.

Key Path	Mode
<b>Example</b>	INST:SEL ADEMOM INST:NSEL 234
Initial S/W Revision	Prior to A.02.00

## Phase Noise

The Phase Noise mode provides pre-configured measurements for making general purpose measurements of device phase noise.

If you are using the Help feature, this mode must be currently active to access its detailed information. If it is not active, exit the Help feature (Esc key), select the mode, and re-access Help.

Key Path	Mode
<b>Example</b>	INST:SEL PNOISE or INST:NSEL 14
Initial S/W Revision	Prior to A.02.00

## CMMB

Selects the CMMB mode for measurements of digital video signals using this format. There are several power and demod measurements available in this mode.

If you are using the Help feature, this mode must be currently active to access its detailed information. If it is not active, exit the Help feature (Esc key), select the mode, and re-access Help.

Key Path	Mode
<b>Example</b>	INST:SEL CMMB INST:NSEL 240
Initial S/W Revision	A.03.00

## Combined WLAN

Selects the CWLAN mode for general purpose measurements of signals following this standard. There are several measurements available in this mode.

If you are using the Help feature, this mode must be currently active to access its detailed information. If it is not active, exit the Help feature (Esc key), select the mode, and re-access Help.

Key Path	Mode
<b>Example</b>	INST:SEL CWLAN INST:NSEL 19
Initial S/W Revision	A.02.00

## TD-SCDMA with HSPA/8PSK

Selects the TD-SCDMA mode for general purpose measurements of signals following this standard. There are several measurements available in this mode.

If you are using the Help feature, this mode must be currently active to access its detailed information. If it is not active, exit the Help feature (Esc key), select the mode, and re-access Help.

Key Path	Mode
<b>Example</b>	INST:SEL TDSCDMA INST:NSEL 211
Initial S/W Revision	Prior to A.02.00

## IQ Analyzer (Basic)

The IQ Analyzer Mode makes general purpose frequency domain and time domain measurements. These measurements often use alternate hardware signal paths when compared with a similar measurement in the Signal Analysis Mode using the Swept SA measurement. These frequency domain and time domain measurements can be used to output I/Q data results when measuring complex modulated digital signals.

If you are using the Help feature, this mode must be currently active to access its detailed information. If it is not active, exit the Help feature (Esc key), select the mode, and re-access Help.

Key Path	Mode
<b>Example</b>	INST:SEL BASIC INST:NSEL 8
Initial S/W Revision	Prior to A.02.00

### W-CDMA with HSPA+

Selects the W-CDMA with HSPA+ mode for general purpose measurements of signals following this standard. There are several measurements available in this mode.

If you are using the Help feature, this mode must be currently active to access its detailed information. If it is not active, exit the Help feature (Esc key), select the mode, and re-access Help.

Key Path	Mode
<b>Example</b>	INST:SEL WCDMA INST:NSEL 9
Initial S/W Revision	Prior to A.02.00

### GSM/EDGE/EDGE Evo

Selects the GSM with EDGE mode for general purpose measurements of signals following this standard. There are several measurements available in this mode.

If you are using the Help feature, this mode must be currently active to access its detailed information. If it is not active, exit the Help feature (Esc key), select the mode, and re-access Help.

Key Path	Mode
<b>Example</b>	INST:SEL EDGE GSM INST:NSEL 13
Initial S/W Revision	Prior to A.02.00
Modified at S/W Revision	A.02.00

### Noise Figure

The Noise Figure mode provides pre-configured measurements for making general purpose measurements of device noise figure.

If you are using the Help feature, this mode must be currently active to access its detailed information. If it is not active, exit the Help feature (Esc key), select the mode, and re-access Help.

Key Path	Mode
<b>Example</b>	INST:SEL NFIGURE INST:NSEL 219
Initial S/W Revision	Prior to A.02.00

### WLAN

Selects the WLAN mode for general purpose measurements of signals following this standard. There are several measurements available in this mode.



If you are using the Help feature, this mode must be currently active to access its detailed information. If it is not active, exit the Help feature (Esc key), select the mode, and re-access Help.

Key Path	Mode
<b>Example</b>	INST:SEL WLAN INST:NSEL 217
Initial S/W Revision	A.09.491

## EMI Receiver

The EMI Receiver Mode makes EMC measurements. Several measurements are provided to aid the user in characterizing EMC performance of their systems, including looking at signals with CISPR-16 compliant detectors, performing scans for interfering signals, and determining and charting interfering signals over time.

If you are using the Help feature, this mode must be currently active to access its detailed information. If it is not active, exit the Help feature (Esc key), select the mode, and re-access Help.

Key Path	Mode
<b>Example</b>	INST:SEL EMI INST:NSEL 141
Initial S/W Revision	A.07.01

## 802.16 OFDM (Fixed WiMAX)

Selects the 802.16 OFDM (Fixed WiMAX) mode. This mode allows modulation quality measurements of signals that comply with IEEE 802.16a-2003 and IEEE 802.16-2004 standards, with flexibility to measure nonstandard OFDM formats. Along with the typical digital demodulation measurement results, several additional 802.16 OFDM unique trace data formats and numeric error data results provide enhanced data analysis.

If you are using the Help feature, this mode must be currently active to access its detailed information. If it is not active, exit the Help feature (Esc key), select the mode, and re-access Help.

Key Path	Mode
<b>Example</b>	INST:SEL WIMAXFIXED INST:NSEL 104
Initial S/W Revision	A.02.00

## DTMB (CTTB)

Selects the DTMB (CTTB) mode for measurements of digital video signals using this format. There are several power and demod measurements available in this mode.

If you are using the Help feature, this mode must be currently active to access its detailed information. If it is not active, exit the Help feature (Esc key), select the mode, and re-access Help.

Key Path	Mode
<b>Example</b>	INST:SEL DTMB INST:NSEL 236
Initial S/W Revision	A.02.00

## 1xEV-DO

Selects the 1xEV-DO mode for general purpose measurements of signals following this standard. There are several measurements available in this mode.

If you are using the Help feature, this mode must be currently active to access its detailed information. If it is not active, exit the Help feature (Esc key), select the mode, and re-access Help.

Key Path	Mode
<b>Example</b>	INST:SEL CDMA1XEV INST:NSEL 15
Initial S/W Revision	Prior to A.02.00

## 802.16 OFDMA (WiMAX/WiBro)

Selects the OFDMA mode for general purpose measurements of WiMAX signals. There are several measurements available in this mode.

If you are using the Help feature, this mode must be currently active to access its detailed information. If it is not active, exit the Help feature (Esc key), select the mode, and re-access Help.

Key Path	Mode
<b>Example</b>	INST:SEL WIMAXOFDMA INST:NSEL 75
Initial S/W Revision	Prior to A.02.00

## 89601 VSA

Selecting the 89601 VSA mode will start the 89600 VSA software. The 89600 VSA software is powerful, PC-based software, offering the industry's most sophisticated general purpose and standards specific signal evaluation and troubleshooting tools for R&D engineers. Even for proprietary and non-standard signals in SATCOM or MILCOM applications, you can make signal quality measurements with customized IQ constellation. Reach deeper into signals, gather more data on signal problems, and gain greater insight.

- Over 35 general-purpose analog and digital demodulators ranging from 2FSK to 4096QAM

- Flexible and custom IQ and OFDM signal analysis for single carrier
- Standards specific modulation analysis including:
  - Cellular: GSM/EDGE, cdma2000, W-CDMA, TD-SCDMA, LTE(FDD/TDD),
  - LTE-Advanced and more
  - Wireless networking: 802.11a/b/g, 802.11n, 802.ac, 802.16 WiMAX (fixed/mobile), WiSUN (MR-FSK PHY)
  - RFID
  - Digital satellite video and other satellite signals, radar, LMDS
  - Up to 400K bin FFT, for the highest resolution spectrum analysis
  - A full suite of time domain analysis tools, including signal capture and playback, time gating, and CCDF measurements
  - 20 simultaneous trace displays and the industry's most complete set of marker functions
  - Easy-to-use Microsoft ® Windows ® graphical user interface

For more information see the Agilent 89600 Series VSA web site at [www.agilent.com/find/89600vsa](http://www.agilent.com/find/89600vsa)

To learn more about how to use the 89600 VSA running in the X-Series, after the 89600 VSA software is running, open the 89600 VSA Help and open the "About Agilent X-Series Signal Analyzer with 89600 VSA Software" help topic.

Key Path	Mode
<b>Example</b>	INST:SEL VSA89601 INST:NSEL 101
Initial S/W Revision	Prior to A.02.00

## MSR

Selects the MSR mode. The MSR mode makes several measurements for Cellular Communication devices that can be configured with multiple radio formats simultaneously following the 3GPP standard of Multi-Standard Radio, including GSM/EDGE, WCDMA/HSPA+ and LTE.

If you are using the Help feature, this mode must be currently active to access its detailed information. If it is not active, exit the Help feature (Esc key), select the mode, and re-access Help.

Key Path	Mode
<b>Example</b>	INST:SEL MSR INST:NSEL 106
Initial S/W Revision	A.09.491

## Bluetooth

Selects the Bluetooth mode for Bluetooth specific measurements. There are several measurements available in this mode.

If you are using the Help feature, this mode must be currently active to access its detailed information. If it is not active, exit the Help feature (Esc key), select the mode, and re-access Help.

Key Path	Mode
<b>Example</b>	INST:SEL BT INST:NSEL 228
Initial S/W Revision	A.06.01

## LTE

Selects the LTE mode for general purpose measurements of signals following the LTE FDD standard. There are several measurements available in this mode.

If you are using the Help feature, this mode must be currently active to access its detailed information. If it is not active, exit the Help feature (Esc key), select the mode, and re-access Help.

Key Path	Mode
<b>Example</b>	INST:SEL LTE INST:NSEL 102
Initial S/W Revision	Prior to A.02.00

## SCPI Language Compatibility

The SCPI Language Compatibility mode provides remote language compatibility for SCPI-based instruments, such as the Rohde and Schwartz FSP and related series of spectrum analyzers.

**NOTE** After changing into or out of this mode, allow a 1 second delay before sending any subsequent commands.

If you are using the Help feature, this mode must be currently active to access its detailed information. If it is not active, exit the Help feature (Esc key), select the mode, and re-access Help.

Key Path	Mode
<b>Example</b>	INST:SEL SCPI LC Or INST:NSEL 270
Initial S/W Revision	A.06.00

## Combined Fixed WiMAX

Selects the Combined Fixed WiMAX mode for general purpose measurements of signals following this standard. There are several measurements available in this mode.

If you are using the Help feature, this mode must be currently active to access its detailed information. If it is not active, exit the Help feature (Esc key), select the mode, and re-access Help.

Key Path	Mode
<b>Example</b>	INST:SEL CWIMAXOFDM INST:NSEL 81
Initial S/W Revision	A.02.00

## ISDB-T

Selects the ISDB-T mode for measurements of digital video signals using this format. There are several power and demod measurements available in this mode.

If you are using the Help feature, this mode must be currently active to access its detailed information. If it is not active, exit the Help feature (Esc key), select the mode, and re-access Help.

Key Path	Mode
<b>Example</b>	INST:SEL ISDBT INST:NSEL 239
Initial S/W Revision	A.03.00

## Digital Cable TV

Selects the Digital Cable TV mode for measurements of digital cable television systems. There are several power and demod measurements available in this mode.

If you are using the Help feature, this mode must be currently active to access its detailed information. If it is not active, exit the Help feature (Esc key), select the mode, and re-access Help.

Key Path	Mode
<b>Example</b>	INST:SEL DCATV INST:NSEL 238
Initial S/W Revision	A.07.00

## LTE TDD

Selects the LTE TDD mode for general purpose measurements of signals following the LTE TDD standard. There are several measurements available in this mode.

If you are using the Help feature, this mode must be currently active to access its detailed information. If it is not active, exit the Help feature (Esc key), select the mode, and re-access Help.

Key Path	Mode
<b>Example</b>	INST:SEL LTETDD INST:NSEL 105
Initial S/W Revision	A.03.00

### Remote Language Compatibility

The Remote Language Compatibility (RLC) mode provides remote command backwards compatibility for the 8560 series of spectrum analyzers, known as legacy spectrum analyzers.

**NOTE** After changing into or out of this mode, allow a 1 second delay before sending any subsequent commands.

If you are using the Help feature, this mode must be currently active to access its detailed information. If it is not active, exit the Help feature (Esc key), select the mode, and re-access Help.

Key Path	Mode
<b>Example</b>	INST:SEL RLC Or INST:NSEL 266
Initial S/W Revision	Prior to A.02.00

### iDEN/WiDEN/MOTOTalk

Selects the iDEN/WiDEN/MOTOTalk mode for general purpose measurements of iDEN and iDEN-related signals. There are several measurements available in this mode.

If you are using the Help feature, this mode must be currently active to access its detailed information. If it is not active, exit the Help feature (Esc key), select the mode, and re-access Help.

Key Path	Mode
<b>Example</b>	INST:SEL IDEN INST:NSEL 103
Initial S/W Revision	A.02.00

### Application Mode Number Selection (Remote Command Only)

Select the measurement mode by its mode number. The actual available choices depend upon which applications are installed in your instrument. The modes appear in this table in the same order they appear in the Mode menu (if the order is not changed by the Configure Applications utility found in the System, Power On menu). See "[Detailed List of Modes](#)" on page 335 for Mode details.

The Mode Number is the parameter for use with the :INSTrument:NSElect command. The Mode Parameter is the parameter for use with the :INSTrument[:SElect] command.

Mode	Mode Number	Mode Parameter
Spectrum Analyzer	1	SA
Real Time Spectrum Analyzer	107	RTSA
Sequence Analyzer	400	SEQAN
EMI Receiver	141	EMI
I/Q Analyzer (Basic)	8	BASIC
WCDMA with HSPA+	9	WCDMA
GSM/EDGE/EDGE Evo	13	EDGE GSM
802.16 OFDMA (WiMAX/WiBro)	75	WIMAX OFDMA
Vector Signal Analyzer (VXA)	100	VSA
Phase Noise	14	PNOISE
Noise Figure	219	NFIGure
Analog Demod	234	ADEM0D
Bluetooth	228	BT00th
TD-SCDMA with HSPA/8PSK	211	TDSCDMA
cdma2000	10	CDMA2K
1xEV-DO	15	CDMA1XEV
LTE	102	LTE
LTE TDD	105	LTETDD
LTE-Advanced FDD	107	LTEAFDD
LTE-Advanced TDD	108	LTEATDD
MSR	106	MSR
DVB-T/H with T2	235	DVB
DTMB (CTTB)	236	DTMB
Digital Cable TV	238	DCATV
ISDB-T	239	ISDBT
CMMB	240	CMMB
WLAN	217	WLAN
Combined WLAN	19	CWLAN
Combined Fixed WiMAX	81	CWIMAX OFDM
802.16 OFDM (Fixed WiMAX)	104	WIMAX FIXED
iDEN/WiDEN/MotoTalk	103	IDEN
Remote Language Compatibility	266	RLC
SCPI Language Compatibility	270	SCPILC
89601 VSA	101	VSA89601

<b>Remote Command</b>	:INSTrument:NSElect <integer> :INSTrument:NSElect?
<b>Example</b>	:INST:NSEL 1
<b>Notes</b>	SA mode is 1 The command must be sequential: i.e. continued parsing of commands cannot proceed until the instrument select is complete and the resultant SCPI trees are available.
<b>Preset</b>	Not affected by Preset. Set to default mode (1 for SA mode) following Restore System Defaults.
<b>State Saved</b>	Saved in instrument state
<b>Initial S/W Revision</b>	Prior to A.02.00

### Application Mode Catalog Query (Remote Command Only)

Returns a string containing a comma separated list of names of all the installed and licensed measurement modes (applications). These names can only be used with the :INSTrument[:SElect] command.

<b>Remote Command</b>	:INSTrument:CATalog?
<b>Example</b>	:INST:CAT?
<b>Notes</b>	Query returns a quoted string of the installed and licensed modes separated with a comma. Example: "SA,PNOISE,WCDMA"
<b>Backwards Compatibility Notes</b>	VSA (E4406A) :INSTrument:CATalog? returned a list of installed INSTrument:SELECT items as a comma separated list of string values: "BASIC", "GSM", "EDGE GSM", "CDMA", "NADC", "PDC", "WCDMA", "CDMA2K", "CDMA1XEV", "IDEN", "WIDEN", "WLAN", "SERVICE" X-Series uses the ESA/PSA compatible query of a string contain comma separated values: "SA,PNOISE,NFIGURE,BASIC,CDMA,CDMA2K,WCDMA,CDMA1XEV,EDGE GSM,GSM,NADC,PDC,TDSCDMA,DMODULATION,WLAN"
<b>Initial S/W Revision</b>	Prior to A.02.00

### Application Identification (Remote Commands Only)

Each entry in the Mode Menu will have a Model Number and associated information: Version, and Options. This information is displayed in the Show System screen. The corresponding SCPI remote commands are defined here.

"Current Application Model " on page 333

"Current Application Revision" on page 333



"Current Application Options" on page 333

## Current Application Model

Returns a string that is the Model Number of the currently selected application (mode).

<b>Remote Command</b>	:SYSTem:APPLication[:CURRent] [:NAME] ?
<b>Example</b>	:SYST:APPL?
<b>Notes</b>	Query returns a quoted string that is the Model Number of the currently selected application (Mode). Example: "N9060A" String length is 6 characters.
<b>Preset</b>	Not affected by Preset
<b>State Saved</b>	Not saved in state, the value will be the selected application when a Save is done.
<b>Initial S/W Revision</b>	Prior to A.02.00

## Current Application Revision

Returns a string that is the Revision of the currently selected application (mode).

<b>Remote Command</b>	:SYSTem:APPLication[:CURRent]:REVision?
<b>Example</b>	:SYST:APPL:REV?
<b>Notes</b>	Query returns a quoted string that is the Revision of the currently selected application (Mode). Example: "1.0.0.0" String length is a maximum of 23 characters. (each numeral can be an integer + 3 decimal points)
<b>Preset</b>	Not affected by a Preset
<b>State Saved</b>	Not saved in state, the value will be the selected application when a Save is done.
<b>Initial S/W Revision</b>	Prior to A.02.00

## Current Application Options

Returns a string that is the Options list of the currently selected application (Mode).

<b>Remote Command</b>	:SYSTem:APPLication[:CURRent]:OPTion?
<b>Example</b>	:SYST:APPL:OPT?
<b>Notes</b>	Query returns a quoted string that is the Option list of the currently selected application (Mode). The format is the name as the *OPT? or SYSTem:OPTion command: a comma separated list of option identifiers. Example: "1FP,2FP" String length is a maximum of 255 characters.

Preset	Not affected by a Preset
State Saved	Not saved in state per se, the value will be the selected application when a Save is invoked.
Initial S/W Revision	Prior to A.02.00

### Application Identification Catalog (Remote Commands Only)

A catalog of the installed and licensed applications (Modes) can be queried for their identification.

"Application Catalog Number of Entries" on page 334

"Application Catalog Model Numbers" on page 334

"Application Catalog Revision" on page 334

"Application Catalog Options" on page 335

### Application Catalog Number of Entries

Returns the number of installed and licensed applications (Modes).

<b>Remote Command</b>	:SYSTem:APPLication:CATalog[:NAME]:COUNT?
<b>Example</b>	:SYST:APPL:CAT:COUN?
Preset	Not affected by Preset
State Saved	Not saved in instrument state.
Initial S/W Revision	Prior to A.02.00

### Application Catalog Model Numbers

Returns a list of Model Numbers for the installed and licensed applications (Modes).

<b>Remote Command</b>	:SYSTem:APPLication:CATalog[:NAME]?
<b>Example</b>	:SYST:APPL:CAT?
Notes	Returned value is a quoted string of a comma separated list of Model Numbers. Example, if SAMS and Phase Noise are installed and licensed: "N9060A,N9068A" String length is COUNT * 7 - 1. (7 = Model Number length + 1 for comma. -1 = no comma for the 1st entry.)
Preset	Not affected by a Preset
State Saved	Not saved in instrument state.
Initial S/W Revision	Prior to A.02.00

### Application Catalog Revision

Returns the Revision of the provided Model Number.

<b>Remote Command</b>	:SYSTem:APPLication:CATalog:REVision? <model>
<b>Example</b>	:SYST:APPL:CAT:REV? 'N9060A'
<b>Notes</b>	Returned value is a quoted string of revision for the provided Model Number. The revision will be a null-string ("") if the provided Model Number is not installed and licensed. Example, if SAMS is installed and licensed: "1.0.0.0"
<b>Preset</b>	Not affected by a Preset.
<b>State Saved</b>	Not saved in instrument state.
<b>Initial S/W Revision</b>	Prior to A.02.00

### Application Catalog Options

Returns a list of Options for the provided Model Number

<b>Remote Command</b>	:SYSTem:APPLication:CATalog:OPTion? <model>
<b>Example</b>	:SYST:APPL:CAT:OPT? 'N9060A'
<b>Notes</b>	Returned value is a quoted string of a comma separated list of Options, in the same format as *OPT? or :SYSTem:OPTion?. If the provided Model Number is not installed and licensed a null-string ("") will be returned. Example, if SAMS is installed and licensed: "2FP" String length is a maximum of 255 characters.
<b>Preset</b>	Not affected by a Preset
<b>State Saved</b>	Not saved in instrument state.
<b>Initial S/W Revision</b>	Prior to A.02.00

### Detailed List of Modes

This section contains an alphabetical list of Modes available in the X-Series, along with a brief description of each Mode.

Note that with the exception of the 89601 VSA, only licensed applications appear in the Mode menu. The 89601 will always appear, because it's licensing is handled differently.

#### 1xEV-DO

Selects the 1xEV-DO mode for general purpose measurements of signals following this standard. There are several measurements available in this mode.

If you are using the Help feature, this mode must be currently active to access its detailed information. If it is not active, exit the Help feature (Esc key), select the mode, and re-access Help.

Key Path	Mode
----------	------

---

<b>Example</b>	INST:SEL CDMA1XEV INST:NSEL 15
Initial S/W Revision	Prior to A.02.00

---

### 802.16 OFDMA (WiMAX/WiBro)

Selects the OFDMA mode for general purpose measurements of WiMAX signals. There are several measurements available in this mode.

If you are using the Help feature, this mode must be currently active to access its detailed information. If it is not active, exit the Help feature (Esc key), select the mode, and re-access Help.

---

<b>Key Path</b>	<b>Mode</b>
<b>Example</b>	INST:SEL WIMAXOFDMA INST:NSEL 75
Initial S/W Revision	Prior to A.02.00

---

### 802.16 OFDM (Fixed WiMAX)

Selects the 802.16 OFDM (Fixed WiMAX) mode. This mode allows modulation quality measurements of signals that comply with IEEE 802.16a–2003 and IEEE 802.16–2004 standards, with flexibility to measure nonstandard OFDM formats. Along with the typical digital demodulation measurement results, several additional 802.16 OFDM unique trace data formats and numeric error data results provide enhanced data analysis.

If you are using the Help feature, this mode must be currently active to access its detailed information. If it is not active, exit the Help feature (Esc key), select the mode, and re-access Help.

---

<b>Key Path</b>	<b>Mode</b>
<b>Example</b>	INST:SEL WIMAXFIXED INST:NSEL 104
Initial S/W Revision	A.02.00

---

### 89601 VSA

Selecting the 89601 VSA mode will start the 89600 VSA software. The 89600 VSA software is powerful, PC-based software, offering the industry's most sophisticated general purpose and standards specific signal evaluation and troubleshooting tools for R&D engineers. Even for proprietary and non-standard signals in SATCOM or MILCOM applications, you can make signal quality measurements with customized IQ constellation. Reach deeper into signals, gather more data on signal problems, and gain greater insight.

- Over 35 general-purpose analog and digital demodulators ranging from 2FSK to 4096QAM
- Flexible and custom IQ and OFDM signal analysis for single carrier

- Standards specific modulation analysis including:
  - Cellular: GSM/EDGE, cdma2000, W-CDMA, TD-SCDMA, LTE(FDD/TDD),
  - LTE-Advanced and more
  - Wireless networking: 802.11a/b/g, 802.11n, 802.ac, 802.16 WiMAX (fixed/mobile), WiSUN (MR-FSK PHY)
  - RFID
  - Digital satellite video and other satellite signals, radar, LMDS
  - Up to 400K bin FFT, for the highest resolution spectrum analysis
  - A full suite of time domain analysis tools, including signal capture and playback, time gating, and CCDF measurements
  - 20 simultaneous trace displays and the industry's most complete set of marker functions
  - Easy-to-use Microsoft ® Windows ® graphical user interface

For more information see the Agilent 89600 Series VSA web site at [www.agilent.com/find/89600vsa](http://www.agilent.com/find/89600vsa)

To learn more about how to use the 89600 VSA running in the X-Series, after the 89600 VSA software is running, open the 89600 VSA Help and open the "About Agilent X-Series Signal Analyzer with 89600 VSA Software" help topic.

Key Path	Mode
<b>Example</b>	INST:SEL VSA89601 INST:NSEL 101
Initial S/W Revision	Prior to A.02.00

## Analog Demod

Selects the Analog Demod mode for making measurements of AM, FM and phase modulated signals.

If you are using the Help feature, this mode must be currently active to access its detailed information. If it is not active, exit the Help feature (Esc key), select the mode, and re-access Help.

Key Path	Mode
<b>Example</b>	INST:SEL ADEMODO INST:NSEL 234
Initial S/W Revision	Prior to A.02.00

## Bluetooth

Selects the Bluetooth mode for Bluetooth specific measurements. There are several measurements available in this mode.

If you are using the Help feature, this mode must be currently active to access its detailed information. If it is not active, exit the Help feature (Esc key), select the mode, and re-access Help.

Key Path	Mode
<b>Example</b>	INST:SEL BT INST:NSEL 228
Initial S/W Revision	A.06.01

### cdma2000

Selects the cdma2000 mode for general purpose measurements of signals following this standard. There are several measurements available in this mode.

If you are using the Help feature, this mode must be currently active to access its detailed information. If it is not active, exit the Help feature (Esc key), select the mode, and re-access Help.

Key Path	Mode
<b>Example</b>	INST:SEL CDMA2K INST:NSEL 10
Initial S/W Revision	Prior to A.02.00

### CMMB

Selects the CMMB mode for measurements of digital video signals using this format. There are several power and demod measurements available in this mode.

If you are using the Help feature, this mode must be currently active to access its detailed information. If it is not active, exit the Help feature (Esc key), select the mode, and re-access Help.

Key Path	Mode
<b>Example</b>	INST:SEL CMMB INST:NSEL 240
Initial S/W Revision	A.03.00

### Combined WLAN

Selects the CWLAN mode for general purpose measurements of signals following this standard. There are several measurements available in this mode.

If you are using the Help feature, this mode must be currently active to access its detailed information. If it is not active, exit the Help feature (Esc key), select the mode, and re-access Help.

Key Path	Mode
<b>Example</b>	INST:SEL CWLAN

	INST:NSEL 19
Initial S/W Revision	A.02.00

### Combined Fixed WiMAX

Selects the Combined Fixed WiMAX mode for general purpose measurements of signals following this standard. There are several measurements available in this mode.

If you are using the Help feature, this mode must be currently active to access its detailed information. If it is not active, exit the Help feature (Esc key), select the mode, and re-access Help.

Key Path	Mode
<b>Example</b>	INST:SEL CWIMAXOFDM INST:NSEL 81
Initial S/W Revision	A.02.00

### Digital Cable TV

Selects the Digital Cable TV mode for measurements of digital cable television systems. There are several power and demod measurements available in this mode.

If you are using the Help feature, this mode must be currently active to access its detailed information. If it is not active, exit the Help feature (Esc key), select the mode, and re-access Help.

Key Path	Mode
<b>Example</b>	INST:SEL DCATV INST:NSEL 238
Initial S/W Revision	A.07.00

### DTMB (CTTB)

Selects the DTMB (CTTB) mode for measurements of digital video signals using this format. There are several power and demod measurements available in this mode.

If you are using the Help feature, this mode must be currently active to access its detailed information. If it is not active, exit the Help feature (Esc key), select the mode, and re-access Help.

Key Path	Mode
<b>Example</b>	INST:SEL DTMB INST:NSEL 236
Initial S/W Revision	A.02.00

## DVB-T/H with T2

Selects the DVB-T/H mode for measurements of digital video signals using this format. There are several power and demod measurements available in this mode.

If you are using the Help feature, this mode must be currently active to access its detailed information. If it is not active, exit the Help feature (Esc key), select the mode, and re-access Help.

Key Path	Mode
<b>Example</b>	INST:SEL DVB INST:NSEL 235
Initial S/W Revision	A.02.00
Modified at S/W Revision	A.07.00

## EMI Receiver

The EMI Receiver Mode makes EMC measurements. Several measurements are provided to aid the user in characterizing EMC performance of their systems, including looking at signals with CISPR-16 compliant detectors, performing scans for interfering signals, and determining and charting interfering signals over time.

If you are using the Help feature, this mode must be currently active to access its detailed information. If it is not active, exit the Help feature (Esc key), select the mode, and re-access Help.

Key Path	Mode
<b>Example</b>	INST:SEL EMI INST:NSEL 141
Initial S/W Revision	A.07.01

## GSM/EDGE/EDGE Evo

Selects the GSM with EDGE mode for general purpose measurements of signals following this standard. There are several measurements available in this mode.

If you are using the Help feature, this mode must be currently active to access its detailed information. If it is not active, exit the Help feature (Esc key), select the mode, and re-access Help.

Key Path	Mode
<b>Example</b>	INST:SEL EDGE GSM INST:NSEL 13
Initial S/W Revision	Prior to A.02.00
Modified at S/W Revision	A.02.00



## iDEN/WiDEN/MOTOTalk

Selects the iDEN/WiDEN/MOTOTalk mode for general purpose measurements of iDEN and iDEN-related signals. There are several measurements available in this mode.

If you are using the Help feature, this mode must be currently active to access its detailed information. If it is not active, exit the Help feature (Esc key), select the mode, and re-access Help.

Key Path	Mode
<b>Example</b>	INST:SEL IDEN INST:NSEL 103
Initial S/W Revision	A.02.00

## IQ Analyzer (Basic)

The IQ Analyzer Mode makes general purpose frequency domain and time domain measurements. These measurements often use alternate hardware signal paths when compared with a similar measurement in the Signal Analysis Mode using the Swept SA measurement. These frequency domain and time domain measurements can be used to output I/Q data results when measuring complex modulated digital signals.

If you are using the Help feature, this mode must be currently active to access its detailed information. If it is not active, exit the Help feature (Esc key), select the mode, and re-access Help.

Key Path	Mode
<b>Example</b>	INST:SEL BASIC INST:NSEL 8
Initial S/W Revision	Prior to A.02.00

## ISDB-T

Selects the ISDB-T mode for measurements of digital video signals using this format. There are several power and demod measurements available in this mode.

If you are using the Help feature, this mode must be currently active to access its detailed information. If it is not active, exit the Help feature (Esc key), select the mode, and re-access Help.

Key Path	Mode
<b>Example</b>	INST:SEL ISDBT INST:NSEL 239
Initial S/W Revision	A.03.00

## LTE

Selects the LTE mode for general purpose measurements of signals following the LTE FDD standard. There are several measurements available in this mode.

If you are using the Help feature, this mode must be currently active to access its detailed information. If it is not active, exit the Help feature (Esc key), select the mode, and re-access Help.

Key Path	Mode
<b>Example</b>	INST:SEL LTE INST:NSEL 102
Initial S/W Revision	Prior to A.02.00

### LTE TDD

Selects the LTE TDD mode for general purpose measurements of signals following the LTE TDD standard. There are several measurements available in this mode.

If you are using the Help feature, this mode must be currently active to access its detailed information. If it is not active, exit the Help feature (Esc key), select the mode, and re-access Help.

Key Path	Mode
<b>Example</b>	INST:SEL LTETDD INST:NSEL 105
Initial S/W Revision	A.03.00

### MSR

Selects the MSR mode. The MSR mode makes several measurements for Cellular Communication devices that can be configured with multiple radio formats simultaneously following the 3GPP standard of Multi-Standard Radio, including GSM/EDGE, WCDMA/HSPA+ and LTE.

If you are using the Help feature, this mode must be currently active to access its detailed information. If it is not active, exit the Help feature (Esc key), select the mode, and re-access Help.

Key Path	Mode
<b>Example</b>	INST:SEL MSR INST:NSEL 106
Initial S/W Revision	A.09.491

### Noise Figure

The Noise Figure mode provides pre-configured measurements for making general purpose measurements of device noise figure.

If you are using the Help feature, this mode must be currently active to access its detailed information. If it is not active, exit the Help feature (Esc key), select the mode, and re-access Help.

Key Path	Mode
----------	------

<b>Example</b>	INST:SEL NFIGURE INST:NSEL 219
Initial S/W Revision	Prior to A.02.00

### Phase Noise

The Phase Noise mode provides pre-configured measurements for making general purpose measurements of device phase noise.

If you are using the Help feature, this mode must be currently active to access its detailed information. If it is not active, exit the Help feature (Esc key), select the mode, and re-access Help.

<b>Key Path</b>	<b>Mode</b>
<b>Example</b>	INST:SEL PNOISE or INST:NSEL 14
Initial S/W Revision	Prior to A.02.00

### Remote Language Compatibility

The Remote Language Compatibility (RLC) mode provides remote command backwards compatibility for the 8560 series of spectrum analyzers, known as legacy spectrum analyzers.

**NOTE** After changing into or out of this mode, allow a 1 second delay before sending any subsequent commands.

If you are using the Help feature, this mode must be currently active to access its detailed information. If it is not active, exit the Help feature (Esc key), select the mode, and re-access Help.

<b>Key Path</b>	<b>Mode</b>
<b>Example</b>	INST:SEL RLC Or INST:NSEL 266
Initial S/W Revision	Prior to A.02.00

### SCPI Language Compatibility

The SCPI Language Compatibility mode provides remote language compatibility for SCPI-based instruments, such as the Rohde and Schwartz FSP and related series of spectrum analyzers.

**NOTE** After changing into or out of this mode, allow a 1 second delay before sending any subsequent commands.

If you are using the Help feature, this mode must be currently active to access its detailed information. If it is not active, exit the Help feature (Esc key), select the mode, and re-access Help.

<b>Key Path</b>	<b>Mode</b>
<b>Example</b>	INST:SEL SCPI LC Or INST:NSEL 270
<b>Initial S/W Revision</b>	A.06.00

### Spectrum Analyzer

Selects the Spectrum Analyzer mode for general purpose measurements. There are several measurements available in this mode. General spectrum analysis measurements, in swept and zero span, can be done using the first key in the Meas menu, labeled Swept SA. Other measurements in the Meas Menu are designed to perform specialized measurement tasks, including power and demod measurements.

If you are using the Help feature, this mode must be currently active to access its detailed information. If it is not active, exit the Help feature (Esc key), select the mode, and re-access Help.

<b>Key Path</b>	<b>Mode</b>
<b>Example</b>	INST:SEL SA INST:NSEL 1
<b>Initial S/W Revision</b>	Prior to A.02.00

### TD-SCDMA with HSPA/8PSK

Selects the TD-SCDMA mode for general purpose measurements of signals following this standard. There are several measurements available in this mode.

If you are using the Help feature, this mode must be currently active to access its detailed information. If it is not active, exit the Help feature (Esc key), select the mode, and re-access Help.

<b>Key Path</b>	<b>Mode</b>
<b>Example</b>	INST:SEL TDSCDMA INST:NSEL 211
<b>Initial S/W Revision</b>	Prior to A.02.00

### Vector Signal Analyzer (VXA)

The N9064A (formerly 89601X) VXA Vector signal and WLAN modulation analysis application provides solutions for basic vector signal analysis, analog demodulation, and digital demodulation. The digital demodulation portion of N9064A allows you to perform measurements on standard-based formats such as cellular, wireless networking and digital video as well as general purpose flexible modulation analysis for wide range of digital formats, FSK to 1024QAM, with easy-to-use measurements and display tools such as

constellation and eye diagram, EVM traces and up to four simultaneous displays. Analog baseband analysis is available using the MXA and PXA with option BBA. Option 3FP WLAN has been discontinued.

N9064A honors existing 89601X licenses with all features and functionalities found on X-Series software versions prior to A.06.00. Specifically:

N9064A-1 is equivalent to 89601X-205

N9064A-2 is equivalent to 89601X-AYA

If you are using the Help feature, this mode must be currently active to access its detailed information. If it is not active, exit the Help feature (Esc key), select the mode, and re-access Help.

Key Path	Mode
<b>Example</b>	INST:SEL VSA INST:NSEL 100
Initial S/W Revision	Prior to A.02.00

### W-CDMA with HSPA+

Selects the W-CDMA with HSPA+ mode for general purpose measurements of signals following this standard. There are several measurements available in this mode.

If you are using the Help feature, this mode must be currently active to access its detailed information. If it is not active, exit the Help feature (Esc key), select the mode, and re-access Help.

Key Path	Mode
<b>Example</b>	INST:SEL WCDMA INST:NSEL 9
Initial S/W Revision	Prior to A.02.00

### WLAN

Selects the WLAN mode for general purpose measurements of signals following this standard. There are several measurements available in this mode.

If you are using the Help feature, this mode must be currently active to access its detailed information. If it is not active, exit the Help feature (Esc key), select the mode, and re-access Help.

Key Path	Mode
<b>Example</b>	INST:SEL WLAN INST:NSEL 217
Initial S/W Revision	A.09.491

## Global Settings

Opens a menu that allows you to switch certain Meas Global parameters to a Mode Global state. These switches apply to all Modes that support global settings. No matter what Mode you are in when you set the “Global Center Frequency” switch to on, it applies to all Modes that support Global Settings.

<b>Key Path</b>	<b>Mode Setup</b>
Initial S/W Revision	Prior to A.02.00

## Global Center Freq

The software maintains a Mode Global value called “Global Center Freq”.

When the Global Center Freq key is switched to On in any mode, the current mode’s center frequency is copied into the Global Center Frequency, and from then on all modes that support global settings use the Global Center Frequency. So you can switch between any of these modes and the Center Freq will remain unchanged.

Adjusting the Center Freq of any mode which supports Global Settings, while Global Center Freq is On, will modify the Global Center Frequency.

When Global Center Freq is turned Off, the Center Freq of the current mode is unchanged, but now the Center Freq of each mode is once again independent.

When Mode Preset is pressed while Global Center Freq is On, the Global Center Freq is preset to the preset Center Freq of the current mode.

This function is reset to Off when the Restore Defaults key is pressed in the Global Settings menu, or when System, Restore Defaults, All Modes is pressed.

<b>Key Path</b>	<b>Mode Setup, Global Settings</b>
<b>Scope</b>	<b>Mode Global</b>
<b>Remote Command</b>	:INSTRument:COUPle:FREQuency:CENTer ALL NONE :INSTRument:COUPle:FREQuency:CENTer?
<b>Example</b>	INST:COUP:FREQ:CENT ALL INST:COUP:FREQ:CENT?
<b>Preset</b>	Set to Off on Global Settings, Restore Defaults and System, Restore Defaults, All Modes
<b>Range</b>	On Off
<b>Initial S/W Revision</b>	Prior to A.02.00

<b>Remote Command</b>	:GLOBal:FREQuency:CENTer[:STATe] 1 0 ON OFF :GLOBal:FREQuency:CENTer[:STATe]?
<b>Preset</b>	Off
<b>Initial S/W Revision</b>	Prior to A.02.00

## Restore Defaults

This key resets all of the functions in the Global Settings menu to Off. This also occurs when System, Restore Defaults, All Modes is pressed.

Key Path	Mode Setup, Global Settings
<b>Remote Command</b>	:INSTRument:COUPle:DEFault
<b>Example</b>	INST:COUP:DEF
<b>Backwards Compatibility SCPI</b>	:GLOBal:DEFault
Initial S/W Revision	Prior to A.02.00

## Mode Setup

This key accesses a menu to allow you to select mode parameters. These settings will be in effect for all measurements in the current mode.

Key Path	Front Panel
Initial S/W Revision	Prior to A.02.00

### Radio

This key accesses a menu to allow you to select the device.

Key Path	Mode Setup
Initial S/W Revision	Prior to A.02.00

### Device

Allows you to specify the device to be used.

Key Path	Mode Setup, Radio
Mode	1xEVDO
<b>Remote Command</b>	[ :SENSe ] :RADio:STANdard:DEVIce BTS MS [ :SENSe ] :RADio:STANdard:DEVIce?
<b>Example</b>	:RAD:STAN:DEV BTS :RAD:STAN:DEV?
Notes	In the 1xEV-DO mode, Radio device BTS is called Forward Link and MS is called Reverse Link
Preset	BTS
State Saved	Saved in instrument state.
Range	BTS   MS
<b>Backwards Compatibility SCPI</b>	[ :SENSe ] :RADio:DEVIce
Initial S/W Revision	Prior to A.02.00

### Pre-defined Offset/Interval

Accesses a menu that enables you to select one of the following slot types:

Idle slot #1 – The active burst in first half idle slot.

Idle slot #2 – The active burst in second half idle slot.

Half slot #1 – The first half slot.



Half slot #2 – The second half slot

Pilot #1 – The first pilot slot.

Pilot #2 – The second pilot slot.

MAC #1 – The first MAC slot.

MAC #2 – The second MAC slot.

MAC #3 – The third MAC slot.

MAC #4 – The fourth MAC slot.

Full slot – The whole slot.

By couple, user can indirectly set the delay and length of Gate.

Key Path	Mode Setup, Radio
Mode	1xEVDO
Remote Command	[ :SENSe ] :STYPe IS1   IS2   HS1   HS2   PIL1   PIL2   MAC1   MAC2   MAC3   MAC4   FS  [ :SENSe ] :STYPe ?
Example	:STYPe HS1 :TYPE?
Preset	IS1
State Saved	Saved in instrument state.
Range	IdleSlot 1   IdleSlot 2   HalfSlot 1   HalfSlot 2   Pilot1   Pilot2   MAC1   MAC2   MAC3   MAC4   FullSlot
Initial S/W Revision	Prior to A.02.00

## Demod

This key accesses a menu to allow you to select the pre-defined offset/interval.

Key Path	Mode Setup
Initial S/W Revision	Prior to A.02.00

## Physical Layer Subtype

Allows you to select the subtype used in measurement.

Key Path	Mode Setup, Demod
Mode	1xEVDO
Remote Command	[ :SENSe ] :RADio:PLSubtype SUB0   SUB2   SUB3 [ :SENSe ] :RADio:PLSubtype?
Example	:RADio:PLSubtype SUB0

	:RADio:PLSubtype?
Notes	For reverse link, Subtype3 only supports No Feedback Mux mode. In the 1xEV-DO mode, sub0/1 type indicates the revision 0 of protocol, sub2 indicates revision A, and sub3 indicates revision B.
Couplings	For the measurements Mod Accuracy and Code Domain measurements, the "Predefined Active Chan" menu under the Meas Setup menu is not the same depending on the Physical Layer Subtype selected here.
Preset	SUB0
State Saved	Saved in instrument state.
Range	Subtype 0/1   Subtype 2   Subtype 3
Initial S/W Revision	Prior to A.02.00

## Noise Reduction

Noise Reduction accesses a menu for configuring the noise compensation of the instrument. This menu only appears in models that support Noise Reduction.

Key Path	Mode Setup
Initial S/W Revision	A.04.00

## Noise Floor Extension

Turns on the Noise Floor Extension function. When this function is On, the expected noise power of the analyzer (derived from a factory calibration) is subtracted from the trace data. This will usually reduce the apparent noise level by about 10 dB in low band, and 8 dB in high band (>~3.6 GHz).

Noise Floor Extension works with any RBW, VBW, detector, any setting of Average Type, any amount of trace averaging, and any signal type. It is ineffective when the trace is not smoothed (smoothing processes include narrow VBWs, trace averaging, and long sweep times with the detector set to Average or Peak). It works best with extreme amounts of smoothing, and with the average detector, with the Average Type set to Power.

### NOTE

Noise Floor Extensions has no effect unless the RF Input is selected, therefore it does nothing when External Mixing is selected.

In those cases where the cancellation is ineffective, it nonetheless has no undesirable side-effects. There is no significant speed impact to having Noise Floor Extension on.

The best accuracy is achieved when substantial smoothing occurs in each point before trace averaging. Thus, when using the average detector, results are better with long sweep times and fewer trace averages. When using the sample detector, the VBW filter should be set narrow with less trace averaging, instead of a wide VBW filter with more trace averaging.

See "[More Information](#)" on page 351

Key Path	Mode Setup, Noise Reduction
Scope	Meas Global
Remote Command	[ :SENSe]:CORRection:NOISe:FLOor ON OFF 1 0 [ :SENSe]:CORRection:NOISe:FLOor?
Example	CORR:NOIS:FLO ON
Dependencies	This key only appears in instruments with the NFE or NF2 license installed. In all others, the key does not appear, however the SCPI command will be accepted without error (but will have no effect).
Couplings	When NFE is enabled in any mode manually, a prompt will be displayed reminding you to perform the Characterize Noise Floor operation if it is needed. If NFE is enabled through SCPI and a Characterize Noise Floor operation is needed, an error will be entered in the system error queue.
Preset	Unaffected by Mode Preset. Turned off by Restore Mode Defaults.
State Saved	No
Initial S/W Revision	A.04.00

## More Information

The analyzer is characterized in the factory (or during a field calibration) with a model of the noise, referred to the input mixer, versus frequency in each band and path combination. Bands are 0 (low band) and 1 through 4 (high band) in a 26.5 GHz instrument, for example. Paths include normal paths, preamp paths, the electronic attenuator, etc.

In most band/path combinations, the noise can be well characterized based on just two parameters and the analyzer frequency response before compensation for frequency-dependent losses.

After the noise density at the input mixer is estimated, the effects of the input attenuator, RBW, detector, etc. are computed to get the estimated input-port-referred noise level.

In the simplest case, the measured power (signal plus analyzer noise) in each display point (bucket) is compensated by subtracting the estimated noise power, leaving just the signal power. This is the operation when the detector is Average and the Average Type is set to Power.

In other cases, operation is often not quite as good but still highly effective. With peak detection, the noise floor is estimated based on the RBW and the duration of the bucket using the same equations used in the noise marker function. The voltage of the noise is subtracted from the voltage of the observed signal-plus-noise measurement to compute the estimated signal voltage. The peak detector is one example of processing that varies with detector to give good estimates of the signal level without the analyzer noise.

For best operation, the average detector and the power scale are recommended, as already stated. Peak detection for pulsed-RF can still give excellent effectiveness. FFT analysis does not work well, and does not do NFE well, with pulsed-RF signals, so this combination is not recommended. Negative peak detection is not very useful, either. Sample detection works well, but is never better than the average detector because it doesn't smooth as well. The Normal detector is a combination of peak and negative peak behaviors, and works about as well as these.

For best operation, extreme smoothing is desirable, as already stated. Using narrow VBWs works well, but using very long bucket durations and the average detector works best. Reducing the number of trace points will make the buckets longer.

For best operation, the power scale (Average Type = Power) is optimum. When making CW measurements in the presence of noise without NFE, averaging on the decibel scale has the advantage of reducing the effect of noise. When using NFE, the NFE does an even better job than using the log scale ever could. Using NFE with the log scale is not synergistic, though; NFE with the power scale works a little better than NFE with log averaging type.

The results from NFE with internal preamp can often be lower than the theoretical noise in a signal source at room temperature, a noise density of  $-174$  dBm/Hz. This is expected and useful behavior, because NFE is designed to report the amount of input signal that is in excess of the thermal noise, not the amount that includes the thermal noise. This can be a useful behavior because thermal noise often interferes with what you want to measure, instead of being part of what you want to measure. Note that NFE is not adequately accurate to always be able to read below kTB.

On instruments with the NF2 license installed, the calibrated Noise Floor used by Noise Floor Extensions should be refreshed periodically. Agilent recommends that the Characterize Noise Floor operation be performed after the first 500 hours of operation, and once every calendar year. The key to perform this is located in the System, Alignments, Advanced menu. If you have not done this yourself at the recommended interval, then when you turn on Noise Floor Extensions, the analyzer will prompt you to do so with a dialog that says:

“This action will take several minutes to perform. Please disconnect all cables from the RF input and press Enter to proceed. Press ESC to cancel, or Postpone to postpone for a week.”

If you Cancel, you will be prompted again the next time you turn NFE on. If you postpone, you will be prompted again after a week passes and you then turn NFE on.

### Restore Mode Defaults

Restore Mode Defaults resets the state for the currently active mode by resetting the mode persistent settings to their factory default values, clearing mode data and by performing a Mode Preset

Please refer to ["Restore Mode Defaults \(All Modes\)" on page 415](#) for details.

Key Path	Mode Setup
Initial S/W Revision	Prior to A.02.00

## 6 System Functions

## File

Opens a menu that enables you to access various standard and custom Windows functions. Press any other front-panel key to exit

Key Path	Front-panel key
Initial S/W Revision	Prior to A.02.00

## File Explorer

Opens the standard Windows File Explorer. The File Explorer opens in the My Documents directory for the current user.

The File Explorer is a separate Windows application, so to return to the analyzer once you are in the File Explorer, you may either:

Exit the File Explorer by clicking on the red X in the upper right corner, with a mouse

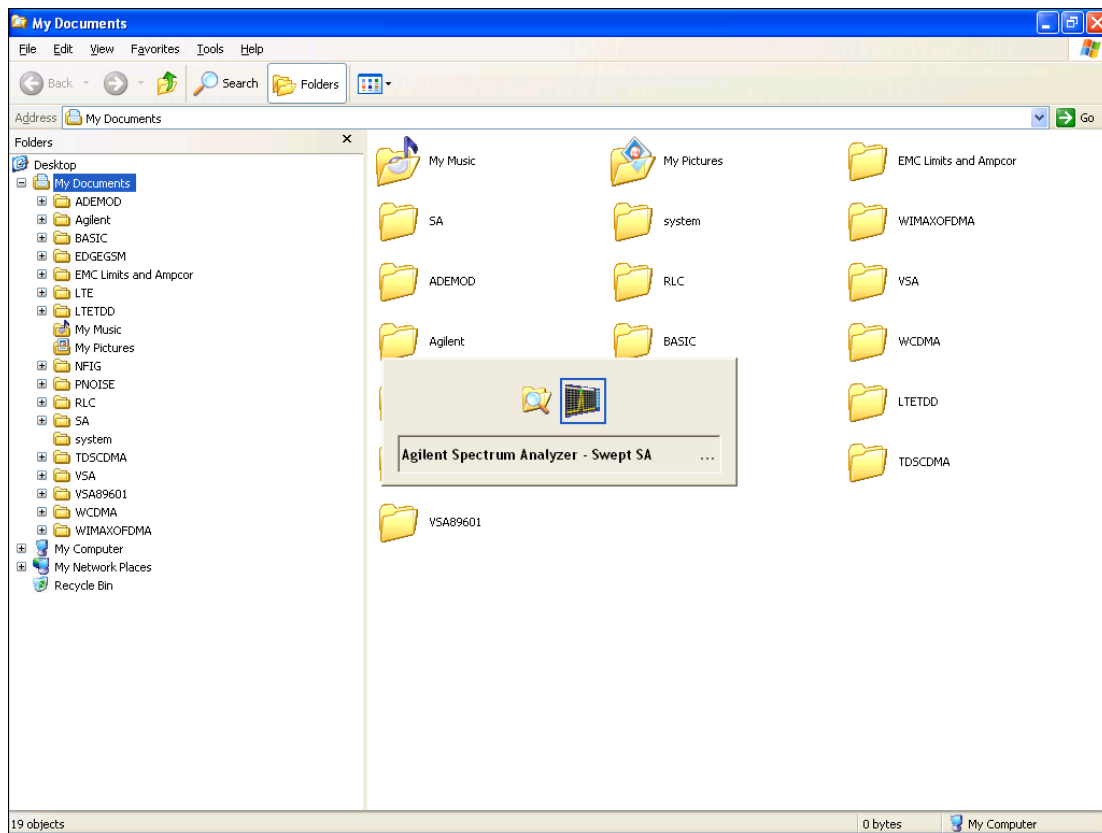

Or use Alt-Tab: press and hold the Alt key and press and release the Tab key until the Analyzer logo is showing in the window in the center of the screen, as shown above, then release the Alt key.

The ability to access File Explorer is not available if Option SF1 is installed.

Key Path	File
Initial S/W Revision	Prior to A.02.00

## Page Setup

The Page Setup key brings up a Windows Page Setup dialog that allows you to control aspects of the pages sent to the printer when the PRINT hardkey is pressed.

Key Path	File
Initial S/W Revision	Prior to A.02.00

Paper size, the printer paper source, the page orientation and the margins are all settable. Just like any standard Windows dialog, you may navigate the dialog using the front-panel keys, or a mouse. There are no SCPI commands for controlling these parameters.

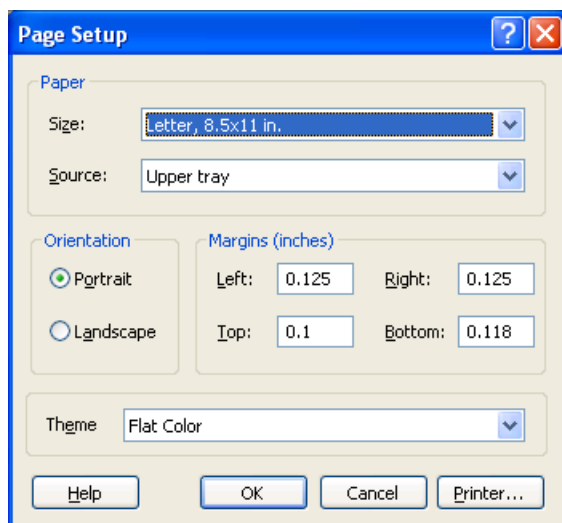

Also contained in this dialog is a drop-down control that lets you select the Theme to use when printing. For more on Themes, see information under View/Display, Display, System Display Settings, Theme. The Theme control has a corresponding SCPI command.

Parameter Name	Print Themes
Parameter Type	Enum
Mode	All
<b>Remote Command</b>	:SYSTem:PRINt:THEME TDCoLor TDMonochrome FCOLor FMONochrome :SYSTem:PRINt:THEME?
<b>Example</b>	:SYST:PRIN:THEM FCOL
Setup	:SYSTem:DEFault MISC
Preset	FCOL; not part of Preset, but is reset by Restore Misc Defaults or Restore System Defaults All and

	survives subsequent running of the modes.
State Saved	No
Initial S/W Revision	Prior to A.02.00

## Print

This front-panel key is equivalent to performing a File, Print, OK. It immediately performs the currently configured Print to the Default printer.

The :HCOpy command is equivalent to pressing the PRINT key. The HCOpy:ABORt command can be used to abort a print which is already in progress. Sending HCOpy:ABORt will cause the analyzer to stop sending data to the printer, although the printer may continue or even complete the print, depending on how much data was sent to the printer before the user sent the ABORt command.

Key Path	Front-panel key
Remote Command	:HCOpy[:IMMediate]
Initial S/W Revision	Prior to A.02.00

Key Path	SCPI command only
Remote Command	:HCOpy:ABORt
Initial S/W Revision	Prior to A.02.00

## Minimize

The Minimize key causes the analyzer display to disappear down into the task bar, allowing you to see the Windows Desktop. You can use Alt-Tab (press and hold the Alt  key and press and release the Tab key) to restore the analyzer display.

Key Path	File
Mode	All
Notes	No equivalent remote command for this key.
State Saved	No
Initial S/W Revision	A.05.01

## Exit

This key, when pressed, will exit the Instrument Application. A dialog box is used to confirm that you intended to exit the application:



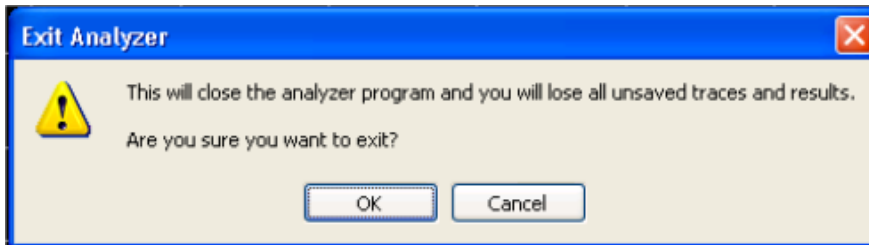

Key Path	File
Mode	All
Notes	The Instrument Application will close. No further SCPI commands can be sent. Use with caution!
Initial S/W Revision	Prior to A.02.00

## Maximize/Restore Down

These keys allow the Instrument Application to be maximized and then restored to its prior state. Only one of the two keys is visible at a time. When not already maximized the Maximize Application key is visible, and when maximized, the Restore Down Application key is visible and replaces the Maximize Application key.

### Maximize

This key allows you to Maximize the Instrument Application, which causes the analyzer display to fill the screen. Once the application is maximized, this key is replaced by the Restore Down key.

Key Path	File
Mode	All
Notes	No equivalent remote command for this key.
State Saved	No
Initial S/W Revision	A.05.01

### Restore Down

This key allows you to Restore Down the Instrument Application and reverses the action taken by Maximize. This key is only visible when the application has been maximized, and after the Restore Down action has been completed this key is replaced by the Maximize key.

Key Path	File
Mode	All
Notes	No equivalent remote command for this key.
State Saved	No
Initial S/W Revision	A.05.01

## Print

This front-panel key is equivalent to performing a File, Print, OK. It immediately performs the currently configured Print to the Default printer.

The :HCOPY command is equivalent to pressing the PRINT key. The HCOpy:ABORt command can be used to abort a print which is already in progress. Sending HCOpy:ABORt will cause the analyzer to stop sending data to the printer, although the printer may continue or even complete the print, depending on how much data was sent to the printer before the user sent the ABORt command.

---

Key Path	Front-panel key
<b>Remote Command</b>	:HCOPY[:IMMEDIATE]
Initial S/W Revision	Prior to A.02.00

---

---

Key Path	SCPI command only
<b>Remote Command</b>	:HCOpy:ABORt
Initial S/W Revision	Prior to A.02.00

---

## System

Opens a menu of keys that access various configuration menus and dialogs.

Key Path	Front-panel key
Notes	No remote command for this key specifically.
Initial S/W Revision	Prior to A.02.00

## Show

Accesses a menu of choices that enable you to select the information window you want to view.

Key Path	System
Mode	All
Remote Command	:SYSTem:SHOW OFF   ERRor   SYSTem   HARDware   LXI   HWSTatistics   ALIGNment   SOFTware   CAPPllication :SYSTem:SHOW?
Example	:SYST:SHOW SYST
Notes	This command displays (or exits) the various System information screens.
Preset	OFF
State Saved	No
Range	OFF ERRor SYSTem HARDware LXI HWSTatistics ALIGNment SOFTware CAPPllication
Initial S/W Revision	Prior to A.02.00

## Errors

There are two modes for the Errors selection, History and Status.

The list of errors displayed in the Errors screen does not automatically refresh. You must press the Refresh key or leave the screen and return to it to refresh it.

History brings up a screen displaying the event log in chronological order, with the newest event at the top. The history queue can hold up to 100 messages (if a message has a repeat count greater than 1 it only counts once against this number of 100). Note that this count bears no relation to the size of the SCPI queue. If the queue extends onto a second page, a scroll bar appears to allow scrolling with a mouse. Time is displayed to the second.

Status brings up a screen summarizing the status conditions currently in effect. Note that the time is displayed to the second.

The fields on the Errors display are:

Type (unlabeled) - Displays the icon identifying the event or condition as an error or warning.

ID - Displays the error number.

Message - Displays the message text.

Repeat (RPT) - This field shows the number of consecutive instances of the event, uninterrupted by other events. If an event occurs 5 times with no other intervening event, the value of repeat will be 5.

If the value of Repeat is 1 the field does not display. If the value of Repeat is >1, the time and date shown are those of the most recent occurrence. If the value of repeat reaches 999,999 it stops there.

Time - Shows the most recent time (including the date) at which the event occurred.

Key Path	System, Show
Mode	All
Remote Command	:SYSTem:ERRor[:NEXT]?
Example	:SYST:ERR?
Notes	The return string has the format: “<Error Number>,<Error>” Where <Error Number> and <Error> are those shown on the Show Errors screen
Backwards Compatibility Notes	In some legacy analyzers, the Repeat field shows the number of times the message has repeated since the last time the error queue was cleared. In the X-Series, the Repeat field shows the number of times the error has repeated since the last intervening error. So the count may very well be different than in the past even for identical signal conditions  Unlike previous analyzers, in the X-Series all errors are reported through the Message or Status lines and are logged to the event queue. They never appear as text in the graticule area (as they sometimes do in previous analyzers) and they are never displayed in the settings panel at the top of the screen (as they sometimes do, by changing color, in previous analyzers).  As a consequence of the above, the user can only see one status condition (the most recently generated) without looking at the queue. In the past, at least in the Spectrum Analyzer, multiple status conditions might display on the right side of the graticule.  In general, there is no backwards compatibility specified or guaranteed between the error numbers in the X-Series and those of earlier products. Error, event, and status processing code in customers' software will probably need to be rewritten to work with X-Series.  In the legacy analyzers, some conditions report as errors and others simply turn on status bits. Conditions that report as errors often report over and over as long as the condition exists. In the X-series, all conditions report as start and stop events. Consequently, software that repeatedly queries for a condition error until it stops reporting will have to be rewritten for the X-series.
Initial S/W Revision	Prior to A.02.00

### Previous Page

See ["Next Page" on page 361](#).

Key Path	System, Show, Errors
Initial S/W Revision	Prior to A.02.00

## Next Page

Next Page and Previous Page menu keys move you between pages of the log, if it fills more than one page. These keys are grayed out in some cases:

- If on the last page of the log, the Next Page key is grayed-out
- If on the first page of the log, the Previous Page key is grayed-out.
- If there is only one page, both keys are grayed out.

Key Path	System, Show, Errors
Initial S/W Revision	Prior to A.02.00

## History

The History and Status keys select the Errors view. The Status key has a second line that shows a number in [square brackets]. This is the number of currently open status items.

Key Path	System, Show, Errors
Initial S/W Revision	Prior to A.02.00

## Verbose SCPI On/Off

When you turn Verbose SCPI on, additional information is returned when you send the :SYSTem:ERRor? query. The additional information consists of the characters that stimulated the error. This can aid you in debugging your test programs by indicating where in the parsing of a SCPI command the instrument encountered an invalid command or query.

Specifically, with Verbose SCPI on, the SYSTem:ERRor? query is expanded to show the SCPI data received, with the indicator <Err> at the point in the stream that the error occurred.

Verbose SCPI has no effect on the Show Errors screen or front panel Message Line; it only changes the response to the :SYST:ERR? query.

See the example below, where the invalid command "SENS:BOGUS" is sent:

Normal response to :SYST:ERR (using the Telnet window):

```
SCPI> SENS:BOGUS
```

```
SCPI> SYST:ERR?
```

```
-113,"Undefined header"
```

Now after turning on Verbose SCPI:

```
SCPI> SYST:BOGUS
```

```
SCPI> SYST:ERR?
```

```
-113,"Undefined header;SYST:BOGUS<Err>"
```

Key Path	System, Show, Errors
Mode	All
<b>Remote Command</b>	:SYSTem:ERRor:VERBoSe OFF ON 0 1 :SYSTem:ERRor:VERBoSe?
<b>Example</b>	:SYST:ERR:VERB ON
Preset	This is unaffected by Preset but is set to OFF on a "Restore System Defaults->Misc"
State Saved	No
Range	On   Off
Initial S/W Revision	Prior to A.02.00

### Refresh

When pressed, refreshes the Show Errors display.

Key Path	System, Show, Errors
Initial S/W Revision	Prior to A.02.00

### Clear Error Queue

This clears all errors in all error queues.

Note the following:

- Clear Error Queue does not affect the current status conditions.
- Mode Preset does not clear the error queue.
- Restore System Defaults will clear all error queues.
- \*CLS only clears the queue if it is sent remotely and \*RST does not affect any error queue.
- Switching modes does not affect any error queues.

Key Path	System, Show, Errors
Initial S/W Revision	Prior to A.02.00

### Input Overload Enable (Remote Command Only)

Input Overload errors are reported using the Input Overload status bit (bit 12 in the Measurement Integrity status register). Input Overloads (for example, ADC Overload errors) can come and go with great frequency, generating many error events (for example, for signals just on the verge of overload), and so are not put into the SCPI error queue by default. Normally the status bit is the only way for detecting these errors remotely.

It is possible to enable Input Overload reporting to the SCPI queue, by issuing the :SYSTEM:ERROR:OVERload ON command. To return to the default state, issue the :SYSTEM:ERROR:OVERload OFF command. In either case, Input Overloads always set the status bit.

**NOTE**

For versions of firmware before A.10.01, the Input Overload was only a Warning and so was never available in the SCPI queue, although it did set the status bit. For A.10.01 and later, the Input Overload is an error and can be enabled to the SCPI queue using this command.

Key Path	SCPI only
Remote Command	:SYSTEM:ERROR:OVERload[:STATE] 0 1 OFF ON
Example	:SYST:ERR:OVER 1 Enable overload errors
Preset	Set to OFF by Restore Misc Defaults (no Overload errors go to SCPI)
State Saved	Saved in instrument state.
Initial S/W Revision	A.10.01

## System

The System screen is formatted into three groupings: product descriptive information, options tied to the hardware, and software products:

```

<Product Name> <Product Description>
Product Number: N9020A
Serial Number: US46220924
Firmware Revision: A.01.01
Computer Name: <hostname>
Host ID: N9020A,US44220924

N9020A-503      Frequency Range to 3.6 GHz
N9020A-PFR     Precision Frequency Reference
N9020A-P03     Preamp 3.6 GHz

N9060A-2FP     Spectrum Analysis Measurement Suite  1.0.0.0
N9073A-1FP     WCDMA                                1.0.0.0
N9073A-2FP     WCDMA with HSDPA                      1.0.0.0

```

The Previous Page is grayed-out if the first page of information is presently displayed. The Next Page menu key is grayed-out if the last page of information is presently displayed.

Key Path	System, Show
Mode	All
Example	SYST:SHOW SYST

---

Backwards Compatibility Notes	The hardware statistics that are displayed in the PSA Show System screen have been moved to a dedicated Show Hardware Statistics screen in the Service Menu.
Initial S/W Revision	Prior to A.02.00

---

### Show System contents (Remote Command Only)

A remote command is available to obtain the contents of the Show System screen (the entire contents, not just the currently displayed page).

---

<b>Remote Command</b>	:SYSTem:CONFigure [:SYSTem] ?
<b>Example</b>	:SYST:CONF?
Notes	The output is an IEEE Block format of the Show System contents. Each line is separated with a new-line character.
Initial S/W Revision	Prior to A.02.00

---

### Computer System description (Remote Command Only)

A remote command is available to obtain the Computer System description. The Computer System is the operating system and patch level as reported by operating system.

---

<b>Remote Command</b>	:SYSTem:CSYSem?
<b>Example</b>	:SYST:CSYS?
Notes	The return value is the Computer System name and service pack level.
Initial S/W Revision	Prior to A.12.00

---

### Hardware

The show hardware screen is used to view details of the installed hardware. This information can be used to determine versions of hardware assemblies and field programmable devices, in the advent of future upgrades or potential repair needs.

The screen is formatted into two groupings: product descriptive information and hardware information. The hardware information is listed in a table format:



**Hardware Information**

MXA Signal Analyzer  
 Product Number: N9020A  
 Serial Number: US46220107  
 Firmware Revision: A.01.14

Assembly Name	Part #	Serial #	Mat Rev	Rev	OF Rev	Hw Id	Misc
Analog IF	E441060104	78060200131	003	0	C	15	
YIG Tuned Filter	50877305	11061500550	005	0	A	11	
Digital IF	E441060105	78060100559	003	0	F	14	
Front End Controller	E441060101	78060100147	004	2	A	8	
Low Band Switch	E441060170	78060800346	005	1	A	10	
LO Synthesizer	E441060102	78060100226	003	3	G	2	
Reference	E441060108	78060300420	004	1	C	16	
Front End	E441060154	13062800820	010	2	B	9	

The Previous Page is grayed-out if the first page of information is presently displayed. The Next Page menu key is grayed-out if the last page is information is presently displayed.

<b>Key Path</b>	System, Show
<b>Mode</b>	All
<b>Example</b>	SYST:SHOW HARD
<b>Initial S/W Revision</b>	Prior to A.02.00

**LXI**

This key shows you the product number, serial number, firmware revision, computer name, IP address, Host ID, LXI Class, LXI Version, MAC Address, and the Auto-MDIX Capability.

<b>Key Path</b>	System, Show
<b>Initial S/W Revision</b>	Prior to A.02.00

**Power On**

Enables you to select how the instrument should power on. The options are: Mode and Input/Output Defaults, User Preset and Last State.

Key Path	System
Mode	All
<b>Remote Command</b>	:SYSTem:PON:TYPE MODE USER LAST :SYSTem:PON:TYPE?
<b>Example</b>	:SYST:PON:TYPE MODE
Preset	This is unaffected by a Preset but is set to Mode on a “Restore System Defaults->All”
State Saved	No
<b>Backwards Compatibility SCPI</b>	:SYSTem:PON:TYPE PRESet the “PRESet” parameter is supported for backward compatibility only and behaves the same as MODE.
Backwards Compatibility Notes	The Preset Type key in legacy analyzers has been removed, and the Power On toggle key has been replaced by this 1-of-N key in the System menu.
Initial S/W Revision	Prior to A.02.00

## Mode and Input/Output Defaults

When the analyzer is powered on in Mode and Input/Output Defaults, it performs a Restore Mode Defaults to all modes in the instrument and also performs a Restore Input/Output Defaults.

Persistent parameters (such as Amplitude Correction tables or Limit tables) are not affected at power on, even though they are normally cleared by Restore Input/Output Defaults and/or Restore Mode Defaults.

Key Path	System, Power On
Mode	All
<b>Example</b>	SYST:PON:TYPE MODE
Readback Text	Defaults
Initial S/W Revision	Prior to A.02.00

## User Preset

Sets Power On to User Preset. When the analyzer is powered on in User Preset, it will User Preset each mode and switch to the power-on mode. Power On User Preset will not affect any settings beyond what a normal User Preset affects.

**NOTE**

An instrument could never power up for the first time in User Preset.

Key Path	System, Power On
Mode	All
<b>Example</b>	SYST:PON:TYPE USER
Readback Text	User Preset

Backwards Compatibility Notes	Power On User Preset will cause the instrument to power up in the power-on mode, not the last mode the instrument was in prior to shut down. Also, Power On User Preset will User Preset all modes. This does not exactly match legacy behavior.
Initial S/W Revision	Prior to A.02.00

## Last State

Sets Power On to **Last**. When the analyzer is powered on, it will put all modes in the last state they were in prior to when the analyzer was put into Power Standby and it will wake up in the mode it was last in prior to powering off the instrument. The saving of the active mode prior to shutdown happens behind the scenes when a controlled shutdown is requested by using the front panel power Standby key or by using the remote command SYSTem:PDOWn. The non-active modes are saved as they are deactivated and recalled by Power On Last State.

### NOTE

An instrument can never power up for the first time in Last.

If line power to the analyzer is interrupted, for example by pulling the line cord plug or by switching off power to a test rack, Power On Last State may not work properly. For proper operation, Power On Last State depends on you shutting down the instrument using the Standby key or the SYSTem:PDOWn SCPI command. This will ensure the last state of each mode is saved and can be recalled during a power up.

Key Path	System, Power On
Mode	All
<b>Example</b>	SYST:PON:TYPE LAST
Notes	Power on Last State only works if you have done a controlled shutdown prior to powering on in Last. If a controlled shutdown is not done when in Power On Last State, the instrument will power up in the last active mode, but it may not power up in the active mode's last state. If an invalid mode state is detected, a Mode Preset will occur. To control the shutdown under remote control use the :SYSTem:PDOWn command.
Readback Text	Last State
Backwards Compatibility Notes	It is no longer possible to power-up the analyzer in the last mode the analyzer was running with that mode in the preset state. (ESA/PSA SYST:PRESET:TYPE MODE with SYST:PON:PRESET) You can power-on the analyzer in the last mode the instrument was running in its last state (SYST:PON:TYPE LAST), or you can specify the mode to power-up in its preset state (SYST:PON:MODE <mode>).
Initial S/W Revision	Prior to A.02.00

## Power On Application

Accesses a menu that lists the available Modes and lets you select which Mode is to be the power-on application.

This application is used for Power On Type “Mode and Input/Output Defaults” and Restore System Defaults All.

Key Path	System, Power On
Mode	All
<b>Remote Command</b>	:SYSTem:PON:MODE SA   BASIC   ADEMOM   NFIGURE   PNOISE   CDMA2K   TDSCDMA   VSA   VSA89601   WCDMA   WIMAXOFDMA  :SYSTem:PON:MODE?
<b>Example</b>	SYST:PON:MODE SA
Notes	The list of possible modes (and remote parameters) to choose from is dependent on which modes are installed in the instrument.
Preset	This is unaffected by a Preset but is set on a "Restore System Defaults->All" to: For N9038A: EMI For N8973B, N8974B, N8975B, or N8976B: NFIG For all other models: SA
State Saved	No
Initial S/W Revision	Prior to A.02.00

## Configure Applications

The Configure Applications utility can be used to:

- select applications for preload
- determine how many applications can fit in memory at one time
- specify the order of the Modes in the Mode menu.

This utility consists of a window with instructions, a set of "Select Application" checkboxes, a "fuel bar" style memory gauge, and keys that help you set up your configuration.

For more information, see the following topics:

["Preloading Applications" on page 369](#)

["Access to Configure Applications utility" on page 369](#)

["Virtual memory usage" on page 369](#)

Key Path	System, Power On
<b>Example</b>	:SYST:SHOW CAPP Displays the Config Applications screen
Initial S/W Revision	A.02.00

## Preloading Applications

During runtime, if a Mode that is not preloaded is selected using the Mode menu or sending SCPI commands, there will be a pause while the Application is loaded. During this pause a message that says “Loading application, please wait ...” is displayed. Once loaded, the application stays loaded, so the next time you select it during a session, there is no delay.

Preloading enables you to “preload” at startup, to eliminate the runtime delay. Preloading an application will cause it to be loaded into the analyzer’s memory when the analyzer program starts up. If you do this, the delay will increase the time it takes to start up the analyzer program, but this may be preferable to having to wait the first time you select an application. Note that, once an application is loaded into memory, it cannot be unloaded without exiting and restarting the analyzer program.

Note that there are more applications available for the X-Series than can fit into Windows Virtual Memory. By allowing you to choose which licensed applications to load at startup, the Configure Applications utility allows you to make optimal use of your memory.

### Access to Configure Applications utility

A version of the utility runs the first time you power up the analyzer after purchasing it from Agilent. The utility automatically configures preloads so that as many licensed applications as possible are preloaded while keeping the total estimated virtual memory usage below the limit. This auto-configuration only takes place at the very first run, and after analyzer software upgrades.

You may, at any time, manually call up the Configure Applications utility by pressing System, Power On, Configure Applications, to find a configuration that works best for you, and then restart the analyzer program.

The utility may also be called if, during operation of the analyzer, you attempt to load more applications than can fit in memory at once.

### Virtual memory usage

There are more applications available for the X-Series than can fit into memory at any one time, so the Configure Applications utility includes a memory tracker that serves two purposes:

1. It will not let you preload more applications than will fit into memory at once.
2. You can determine how many of your favorite applications can reside in memory at one time.

The utility provides a graphical representation of the amount of memory (note that the memory in question here is Virtual memory and is a limitation imposed by the operating system, not by the amount of physical memory you have in your analyzer). You select applications to preload by checking the boxes on the left. Checked applications preload at startup. The colored fuel bar indicates the total memory required when all the checked applications are loaded (either preloaded or selected during runtime).

Here is what the fuel bar colors mean:

RED: the applications you have selected cannot all fit into the analyzer’s memory. You must deselect applications until the fuel bar turns yellow.

YELLOW: the applications you have selected can all fit into the analyzer’s memory, but there is less than 10% of the memory left, probably not enough to load any other applications, either via preload or by selecting a Mode while the analyzer is running..

GREEN: The indicator is green when <90% of the memory limit is consumed. This means the applications you have selected can all fit into the analyzer's memory with room to spare. You will likely be able to load one or more other applications without running out of memory.

### Select All

Marks all applications in the selection list. This allows you to enable all applications licensed on the instrument for pre-loading, or is a convenience for selecting all applications in one operation and then letting you deselect individual applications.

---

Key Path	System, Power On, Configure Applications
Initial S/W Revision	A.02.00

---

### Deselect All

Clears the marks from all applications in the selection list, except the Power On application. The Power On application cannot be eliminated from the pre-load list.

---

Key Path	System, Power On, Configure Applications
Initial S/W Revision	A.02.00

---

### Move Up

The application list is the order that applications appear in the Mode Menu. This key enables you to shift the selected application up in the list, thus moving the selected application earlier in the Mode Menu.

---

Key Path	System, Power On, Configure Applications
Initial S/W Revision	A.02.00

---

### Move Down

The application list is the order that applications appear in the Mode Menu. This key enables you to shift the selected application down in the list, thus moving the selected application later in the Mode Menu.

---

Key Path	System, Power On, Configure Applications
Initial S/W Revision	A.02.00

---

### Select/Deselect

Toggles the currently highlighted application in the list.

---

Key Path	System, Power On, Configure Applications
Initial S/W Revision	A.02.00

---

## Save Changes and Exit

Applies the configuration of the applications list. The marked applications will be pre-loaded in memory the next time the instrument application is started, and the order of the applications in the list will be the order of the applications in the Mode Menu.

After saving your changes, the analyzer asks you if you would like it to restart so that your changes can take effect (see dialog box, below). If you choose not to restart, the changes will not take effect until the next time you shut down and restart the analyzer.

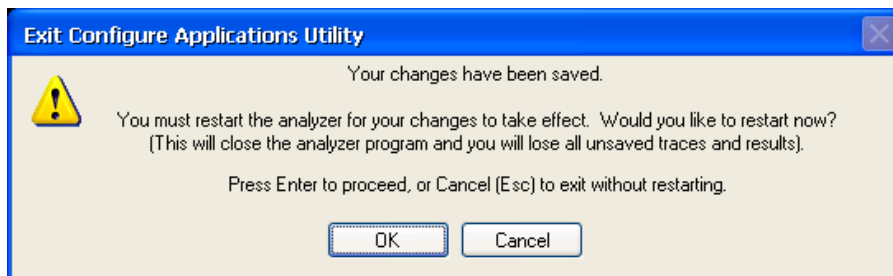

<b>Key Path</b>	System, Power On, Configure Applications
<b>Remote Command</b>	:SYSTem:PUP:PROcess
<b>Example</b>	:SYST:PUP:PROC This is the SCPI command for restarting the analyzer. You must Wait after this command for the instrument application to restart
<b>Notes</b>	The softkey will be grayed-out when the virtual memory of the selected applications exceeds 100% of the limit.
<b>Notes</b>	You cannot use *WAI or *OPC? to synchronize operation after a restart. This command stops and restarts the instrument application, thus the SCPI operation is terminated and restarted. A remote program must use fixed wait time to resume sending commands to the instrument. The wait time will be dependent upon which applications are pre-loaded.
<b>Initial S/W Revision</b>	A.02.00
<b>Modified at S/W Revision</b>	A.04.00

## Exit Without Saving

Pressing this key will exit the Configure Applications utility without saving your changes.

<b>Key Path</b>	System, Power On, Configure Applications
<b>Initial S/W Revision</b>	A.02.00
<b>Modified at S/W Revision</b>	A.04.00

## Restore Power On Defaults

This selection causes the Power On Type and Power On Application settings to be a reset to their default values. This level of Restore System Defaults does not affect any other system settings, mode settings and

does not cause a mode switch. The Power On key, under the Restore System Defaults menu, causes the same action.

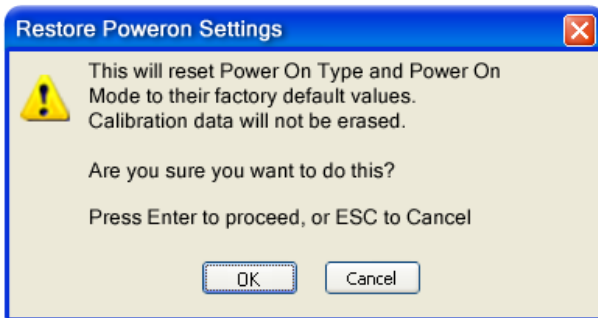

If you press any key other than OK or Enter, it is construed as a Cancel, because the only path that will actually cause the reset to be executed is through OK or Enter.

Key Path	System, Power On
Example	:SYST:DEF PON
Initial S/W Revision	Prior to A.02.00

### Configure Applications - Instrument boot-up

At start-up of the analyzer program a dialog box similar to the one under the System, Power On, Configure Applications key will be displayed allowing you to choose which licensed applications are to be loaded. This dialog will only be displayed if the memory required to pre-load all of the licensed applications exceeds the Virtual Memory available.

### Configure Applications - Windows desktop

The Configure Applications Utility may be run from the Windows Desktop. The utility is launched by double-

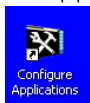

clicking the icon on the desktop, which brings-up a dialog box similar to the one under the System, Power On, Configure Applications key, allowing you to choose which licensed applications are to be loaded when the analyzer program starts up. This dialog box has mouse buttons on it that do the job the softkeys normally do in the System, Power On, Configure Applications menu.

### Configure Applications - Remote Commands

The following topics provide details on using remote commands to configure the list of applications you want to load into the instrument memory or query the Virtual Memory utilization for your applications.

- "Configuration list (Remote Command Only)" on page 373
- "Configuration Memory Available (Remote Command Only)" on page 373
- "Configuration Memory Total (Remote Command Only)" on page 373
- "Configuration Memory Used (Remote Command Only)" on page 373



- "Configuration Application Memory (Remote Command Only)" on page 374

### Configuration list (Remote Command Only)

This remote command is used to set or query the list of applications to be loaded in-memory.

<b>Remote Command</b>	:SYSTem:PON:APPLication:LLISt <string of INSTRument:SElect names> :SYSTem:PON:APPLication:LLISt?
<b>Example</b>	:SYST:PON:APPL:LLIS "SA,BASIC,WCDMA"
<b>Notes</b>	<string of INSTRument:SElect names> are from the enums of the :INSTRument:SElect command. The order of the <INSTRument:SElect names> is the order that the applications are loaded into memory, and the order that they appear in the Mode Menu. Error message -225 "Out of Memory" is reported when more applications are listed than can reside in Virtual Memory. When this occurs, the existing applications load list is unchanged.
<b>Preset</b>	Not affected by Preset
<b>State Saved</b>	Not saved in instrument state
<b>Initial S/W Revision</b>	A.02.00

### Configuration Memory Available (Remote Command Only)

This remote command is used to query the amount of Virtual Memory remaining.

<b>Remote Command</b>	:SYSTem:PON:APPLication:VMEMory[:AVAIlable]?
<b>Example</b>	:SYST:PON:APPL:VMEM?
<b>Preset</b>	Not affected by Preset
<b>Initial S/W Revision</b>	A.02.00

### Configuration Memory Total (Remote Command Only)

This remote command is used to query the limit of Virtual Memory allowed for applications.

<b>Remote Command</b>	:SYSTem:PON:APPLication:VMEMory:TOTal?
<b>Example</b>	:SYST:PON:APPL:VMEM:TOT?
<b>Preset</b>	Not affected by Preset
<b>Initial S/W Revision</b>	A.02.00

### Configuration Memory Used (Remote Command Only)

This remote command is a query of the amount of Virtual Memory used by all measurement applications.

<b>Remote Command</b>	:SYSTem:PON:APPLication:VMEMory:USED?
<b>Example</b>	:SYST:PON:APPL:VMEM:USED?

Preset	Not affected by Preset
Initial S/W Revision	A.02.00

### Configuration Application Memory (Remote Command Only)

This remote command is used to query the amount of Virtual Memory a particular application consumes.

<b>Remote Command</b>	:SYSTem:PON:APPLication:VMEMory:USED:NAME? <INSTRument:SElect name>
<b>Example</b>	:SYST:PON:APPL:VMEM:USED:NAME? CDMA2K
Notes	<INSTRument:SElect name> is from the enums of the :INSTRument:SElect command Value returned will be 0 (zero) if the name provided is invalid.
Preset	Not affected by Preset
Initial S/W Revision	Prior to A.02.00

### Alignments

The Alignments Menu controls and displays the automatic alignment of the instrument, and provides the ability to restore the default alignment values.

The current setting of the alignment system is displayed in the system Settings Panel along the top of the display, including a warning icon for conditions that may cause specifications to be impacted.



Key Path	System
Initial S/W Revision	Prior to A.02.00

### Auto Align

Configures the method for which the automatic background alignment is run.

Automatic background alignments are run periodically between measurement acquisitions. The instrument's software determines when alignments are to be performed to maintain warranted operation. The recommended setting for Auto Align is Normal.

An Auto Align execution cannot be aborted with the Cancel (ESC) key. To interrupt an Auto Align execution, select Auto Align Off.

Key Path	System, Alignments
Mode	All
<b>Remote Command</b>	:CALibration:AUTO ON PARTial OFF :CALibration:AUTO?
<b>Example</b>	:CAL:AUTO ON

Notes	While Auto Align is executing, bit 0 of Status Operation register is set.
Couplings	Auto Align is set to Off if Restore Align Data is invoked.
Preset	This is unaffected by Preset but is set to ON upon a “Restore System Defaults->Align”.
State Saved	No
Status Bits/OPC dependencies	When Auto Align is executing, bit 0 in the Status Operational register is set.
<b>Backwards Compatibility SCPI</b>	:CALibration:AUTO ALERT Parameter ALERT is for backward compatibility only and is mapped to PARTIAL
Backwards Compatibility Notes	<ol style="list-style-type: none"> <li>1. ESA SCPI for Auto Align is :CALibration:AUTO &lt;Boolean&gt;. The command for X-Series is an enumeration. Thus the parameters of “0” and “1” are not possible in X-Series.</li> <li>2. Similarly, the ESA SCPI for :CALibration:AUTO? returned the Boolean value 1 or 0, in X-Series it is an Enumeration (string). Thus, queries by customer applications into numeric variables will result in an error</li> <li>3. In PSA Auto Align OFF was not completely off, it is equivalent to PARTIAL in X-Series. In X-Series, OFF will be fully OFF. This means users of PSA SCPI who choose OFF may see degraded performance and should migrate their software to use PARTIAL.</li> </ol>
Initial S/W Revision	Prior to A.02.00

## Normal

Auto Align, Normal turns on the automatic alignment of all measurement systems. The Auto Align, Normal selection maintains the instrument in warranted operation across varying temperature and over time.

If the condition “Align Now, All required” is set, transition to Auto Align, Normal will perform the required alignments and clear the “Align Now, All required” condition and then continue with further alignments as required to maintain the instrument adequately aligned for warranted operation.

When Auto Align, Normal is selected the Auto Align Off time is set to zero.

When Auto Align, Normal is selected the Settings Panel indicates ALIGN AUTO.

Key Path	System, Alignments, Auto Align
Mode	All
<b>Example</b>	:CAL:AUTO ON
Notes	<p>Alignment processing as a result of the transition to Normal will be executed sequentially. Thus, *OPC? or *WAI following CAL:AUTO ON will return when the alignment processing is complete.</p> <p>The presence of an external signal may interfere with the RF portion of the alignment. If so, the Error Condition message “Align skipped: 50 MHz interference” or “Align skipped: 4.8 GHz interference” is reported, and bit 11 is set in the Status Questionable Calibration register. After the interfering signal is removed, subsequent alignment of the RF will clear the condition, and clear bit 11 in the Status Questionable Calibration register.</p>
Readback Text	Normal
Status Bits/OPC dependencies	An interfering user signal may prevent automatic alignment of the RF subsystem. If this occurs, the Error Condition message “Align skipped: 50 MHz interference” or “Align skipped: 4.8 GHz

interference” is reported, the Status Questionable Calibration bit 11 is set, and the alignment proceeds. When a subsequent alignment of the RF subsystem succeeds, either by the next cycle of automatic alignment or from an Align Now, RF, the Error Condition and Status Questionable Calibration bit 11 are cleared.

Initial S/W Revision	Prior to A.02.00
----------------------	------------------

### Partial

Auto Align, Partial disables the full automatic alignment and the maintenance of warranted operation for the benefit of improved measurement throughput. Accuracy is retained for the Resolution Bandwidth filters and the IF Passband, which is critical to FFT accuracy, demodulation, and many measurement applications. With Auto Align set to Partial, you are now responsible for maintaining warranted operation by updating the alignments when they expire. The Auto Align, Alert mechanism will notify you when alignments have expired. One solution to expired alignments is to perform the Align All, Now operation. Another is to return the Auto Align selection to Normal.

Auto Align, Partial is recommended for measurements where the throughput is so important that a few percent of improvement is more valued than an increase in the accuracy errors of a few tenths of a decibel. One good application of Auto Align, Partial would be an automated environment where the alignments can be called during overhead time when the device-under-test is exchanged.

When Auto Align, Partial is selected the elapsed time counter begins for Auto Align Off time.

When Auto Align, Partial is selected the Settings Panel indicates ALIGN PARTIAL with a warning icon. The warning icon is to inform the operator that they are responsible for maintaining the warranted operation of the instrument

Key Path	System, Alignments, Auto Align
Mode	All
<b>Example</b>	:CAL:AUTO PART
Notes	Auto Align Partial begins the elapsed time counter for Auto Align Off time.
Readback Text	Partial
Initial S/W Revision	Prior to A.02.00

### Off

Auto Align, Off disables automatic alignment and the maintenance of warranted operation, for the benefit of maximum measurement throughput. With Auto Align set to Off, you are now responsible for maintaining warranted operation by updating the alignments when they expire. The Auto Align, Alert mechanism will notify you when alignments have expired. One solution to expired alignments is to perform the Align All, Now operation. Another is to return the Auto Align selection to Normal.

The Auto Align, Off setting is rarely the best choice, because Partial gives almost the same improvement in throughput while maintaining the warranted performance for a much longer time. The choice is intended for unusual circumstances such as the measurement of radar pulses where you might like the revisit time to be as consistent as possible.

When Auto Align, Off is selected the Auto Align Off time is initialized and the elapsed time counter begins.

When Auto Align, Off is selected the Settings Panel indicates ALIGN OFF with a warning icon. The warning icon is to inform the operator that they are responsible for maintaining the warranted operation of the instrument:

Key Path	System, Alignments, Auto Align
Mode	All
<b>Example</b>	:CAL:AUTO OFF
Notes	Auto Align Off begins the elapsed time counter for Auto Align Off time.
Couplings	Auto Align is set to Off if Restore Align Data is invoked.
Readback Text	Off
Initial S/W Revision	Prior to A.02.00

### All but RF

Auto Align, All but RF, configures automatic alignment to include or exclude the RF subsystem. (Eliminating the automatic alignment of the RF subsystem prevents the input impedance from changing. The normal input impedance of 50 ohms can change to an open circuit when alignments are being used. Some devices under test do not behave acceptably under such circumstances, for example by showing instability.) When Auto Align, All but RF ON is selected, the operator is responsible for performing an Align Now, RF when RF-related alignments expire. The Auto Align, Alert mechanism will notify the operator to perform an Align Now, All when the combination of time and temperature variation is exceeded.

When Auto Align, All but RF ON is selected the Settings Panel indicates ALIGN AUTO/NO RF with a warning icon (warning icon is intended to inform the operator they are responsible for the maintaining the RF alignment of the instrument):

Key Path	System, Alignments, Auto Align
Mode	All
<b>Remote Command</b>	:CALibration:AUTO:MODE ALL NRF :CALibration:AUTO:MODE?
<b>Example</b>	:CAL:AUTO:MODE NRF
Preset	This is unaffected by Preset but is set to ALL on a "Restore System Defaults->Align".
State Saved	No
Readback Text	RF or NRF
Initial S/W Revision	Prior to A.02.00

### Alert

The instrument will signal an Alert when conditions exist such that you will need to perform a full alignment (for example, Align Now, All). The Alert can be configured in one of four settings; Time & Temperature, 24 hours, 7 days, or None. A confirmation is required when a selection other than Time & Temperature is chosen. This prevents accidental deactivation of alerts.

With Auto Align set to Normal, the configuration of Alert is not relevant because the instrument's software maintains the instrument in warranted operation.

Key Path	System, Alignments, Auto Align
Mode	All
Remote Command	:CALibration:AUTO:ALERt TTEMperature DAY WEEK NONE :CALibration:AUTO:ALERt?
Example	:CAL:AUTO:ALER TTEM
Notes	The alert that alignment is needed is the setting of bit 14 in the Status Questionable Calibration register.
Preset	This is unaffected by Preset but is set to TTEMperature on a "Restore System Defaults->Align".
State Saved	No
Status Bits/OPC dependencies	The alert is the Error Condition message "Align Now, All required" and bit 14 is set in the Status Questionable Calibration register.
Initial S/W Revision	Prior to A.02.00

### Time & Temperature

With Auto Align Alert set to Time & Temperature the instrument will signal an alert when alignments expire due to the combination of the passage of time and changes in temperature. The alert is the Error Condition message "Align Now, All required". If this choice for Alert is selected, the absence of an alert means that the analyzer alignment is sufficiently up-to-date to maintain warranted accuracy.

Key Path	System, Alignments, Auto Align, Alert
Mode	All
Example	:CAL:AUTO:ALER TTEM
Readback Text	Time & Temp
Status Bits/OPC dependencies	Bit 14 is set in the Status Questionable Calibration register.
Initial S/W Revision	Prior to A.02.00

### 24 hours

With Auto Align Alert set to 24 Hours the instrument will signal an alert after a time span of 24 hours since the last successful full alignment (for example, Align Now, All or completion of a full Auto Align). You may choose this selection in an environment where the temperature is stable on a daily basis at a small risk of accuracy errors in excess of the warranted specifications. The alert is the Error Condition message "Align Now, All required".

For front-panel operation, confirmation is required to transition into this setting of Alert. The confirmation dialog is:

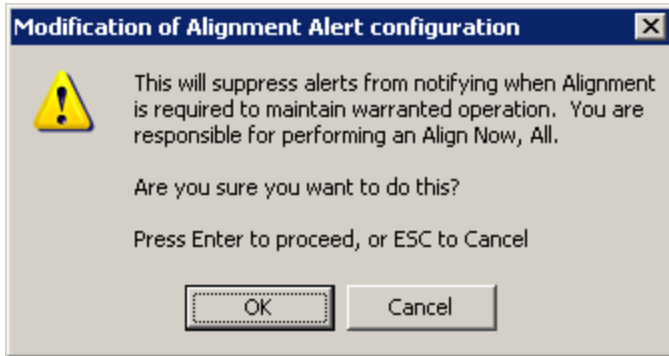

No confirmation is required when Alert is configured through a remote command.

Key Path	System, Alignments, Auto Align, Alert
Mode	All
<b>Example</b>	:CAL:AUTO:ALER DAY
Readback Text	24 hours
Status Bits/OPC dependencies	Bit 14 is set in the Status Questionable Calibration register.
Initial S/W Revision	Prior to A.02.00

### 7 days

With Auto Align Alert is set to 7 days the instrument will signal an alert after a time span of 168 hours since the last successful full alignment (for example, Align Now, All or completion of a full Auto Align). You may choose this selection in an environment where the temperature is stable on a weekly basis, at a modest risk of accuracy degradations in excess of warranted performance. The alert is the Error Condition message “Align Now, All required”.

For front panel operation, confirmation is required for the customer to transition into this setting of Alert. The confirmation dialog is:

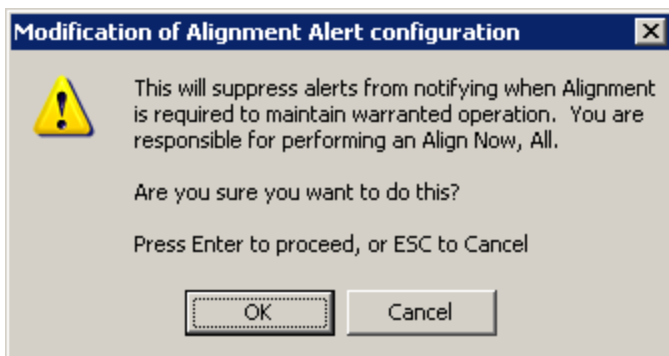

No confirmation is required when Alert is configured through a remote command.

Key Path	System, Alignments, Auto Align, Alert
Mode	All
<b>Example</b>	:CAL:AUTO:ALER WEEK
Readback Text	7 days
Status Bits/OPC dependencies	Bit 14 is set in the Status Questionable Calibration register.
Initial S/W Revision	Prior to A.02.00

**None**

With Auto Align Alert set to None the instrument will not signal an alert. This is provided for rare occasions where you are making a long measurement which cannot tolerate Auto Align interruptions, and must have the ability to capture a screen image at the end of the measurement without an alert posted to the display. Agilent does not recommends using this selection in any other circumstances, because of the risk of accuracy performance drifting well beyond expected levels without the operator being informed.

For front panel operation, confirmation is required to transition into this setting of Alert. The confirmation dialog is:

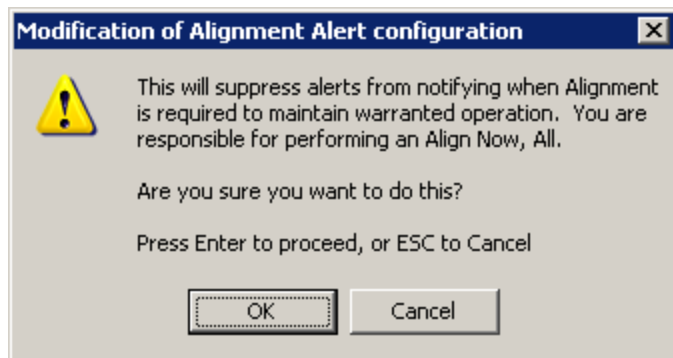

No confirmation is required when Alert is configured through a remote command.

Key Path	System, Alignments, Auto Align, Alert
Mode	All
<b>Example</b>	:CAL:AUTO:ALER NONE
Initial S/W Revision	Prior to A.02.00

**Execute Expired Alignments (Remote Command Only)**

Alignments can be expired in the situation where Auto Align is in the state of Partial or Off. This feature runs the alignments that have expired. This is different than performing an Align All, Now operation. Align All, Now performs an alignment of all subsystems regardless of whether they are needed or not, with Execute Expired Alignments, only the individual subsystems that have become due are aligned.



Mode	All
Remote Command	:CALibration:EXPIred?
Example	:CAL:EXP?
Notes	:CALibration:EXPIred? returns 0 if successful :CALibration:EXPIred? returns 1 if failed
Initial S/W Revision	Prior to A.02.00

## Align Now

Accesses alignment processes that are immediate action operations. They perform complete operations and run until they are complete.

Key Path	System, Alignments
Initial S/W Revision	Prior to A.02.00

## All

(In MXE the key label is “All (plus RF Presel 20 Hz – 3.6 GHz)”)Immediately executes an alignment of all subsystems In MXE, the Align Now All is followed by additionally aligning the RF Preselector section, so in MXE, the key label contains the parenthetical note “(plus RF Presel 20 Hz – 3.6 GHz)”. The instrument stops any measurement currently underway, performs the alignment, then restarts the measurement from the beginning (similar to pressing the Restart key).

If an interfering user signal is present at the RF Input, the alignment is performed on all subsystems except the RF. After completion, the Error Condition message “Align skipped: 50 MHz interference” or “Align skipped: 4.8 GHz interference” is generated. In addition the Error Condition message “Align Now, RF required” is generated, and bits 11 and 12 are set in the Status Questionable Calibration register.

The query form of the remote commands (:CALibration[:ALL]? or \*CAL?) invokes the alignment of all subsystems and returns a success or failure value. An interfering user signal is not grounds for failure; if the alignment was able to succeed on all portions but unable to align the RF because of an interfering signal, the resultant will be the success value.

Successful completion of Align Now, All will clear the “Align Now, All required” Error Condition, and clear bit 14 in the Status Questionable Calibration register. It will also begin the elapsed time counter for Last Align Now, All Time, and capture the Last Align Now, All Temperature.

In the MXE, successful completion will also clear the “Align 20 Hz to 30 MHz required” Error Condition, the “Align 30 MHz to 3.6 GHz required” Error Condition, and the “Align 20 Hz to 3.6 GHz required” Error Condition, and clear bits 1 and bit 2 and clear the bit 1 in the Status Questionable Calibration Extended Needed register.

If the Align RF subsystem succeeded in aligning (no interfering signal present), the elapsed time counter begins for Last Align Now, RF Time, and the temperature is captured for the Last Align Now, RF Temperature. In addition the Error Conditions “Align skipped: 50 MHz interference” and “Align skipped: 4.8

GHz interference” are cleared, the Error Condition “Align Now, RF required” is cleared, and bits 11 and 12 are cleared in the Status Questionable Calibration register

Align Now, All can be interrupted by pressing the Cancel (ESC) front-panel key or remotely with Device Clear followed by the :ABORt SCPI command. When this occurs the Error Condition message “Align Now, All required” is generated, and bit 14 is set in the Status Questionable Condition register. This is because new alignment data may be employed for an individual subsystem, but not a cohesive set of data for all subsystems.

In many cases, you might find it more convenient to change alignments to Normal, instead of executing Align Now, All. When the Auto Align process transitions to Normal, the analyzer will immediately start to update only the alignments that have expired, thus efficiently restoring the alignment process.

<b>Key Path</b>	System, Alignments, Align Now
<b>Mode</b>	All
<b>Remote Command</b>	:CALibration[:ALL] :CALibration[:ALL]?
<b>Example</b>	:CAL
<b>Notes</b>	:CALibration[:ALL]? returns 0 if successful :CALibration[:ALL]? returns 1 if failed :CALibration[:ALL]? is the same as *CAL? While Align Now, All is performing the alignment, bit 0 in the Status Operation register is set. Completion, or termination, will clear bit 0 in the Status Operation register. This command is sequential; it must complete before further SCPI commands are processed. Interrupting the alignment from remote is accomplished by invoking Device Clear followed by the :ABORt command. Successful completion will clear bit 14 in the Status Questionable Calibration register. An interfering user signal is not grounds for failure of Align Now, All. However, bits 11 and 12 are set in the Status Questionable Calibration register to indicate Align Now, RF is required. An interfering user supplied signal will result in the instrument requiring an Align Now, RF with the interfering signal removed.
<b>Couplings</b>	Initializes the time for the Last Align Now, All Time. Records the temperature for the Last Align Now, All Temperature. If Align RF component succeeded, initializes the time for the Last Align Now, RF Time. If Align RF component succeeded, records the temperature for the Last Align Now, RF Temperature.
<b>Status Bits/OPC dependencies</b>	Bits 11, 12, or 14 may be set in the Status Questionable Calibration register.
<b>Initial S/W Revision</b>	Prior to A.02.00

<b>Mode</b>	All
<b>Remote Command</b>	*CAL?
<b>Example</b>	*CAL?
<b>Notes</b>	*CAL? returns 0 if successful

	<p>*CAL? returns 1 if failed</p> <p>:CALibration[:ALL]? is the same as *CAL?</p> <p>See additional remarks described with :CALibration[:ALL]?</p> <p>Everything about :CALibration[:ALL]? is synonymous with *CAL? including all conditions, status register bits, and couplings</p>
Initial S/W Revision	Prior to A.02.00

## All but RF

(In MXE the key label is “All but RF (not including RF Presel)”)

Immediately executes an alignment of all subsystems except the RF subsystem . The instrument will stop any measurement currently underway, perform the alignment, and then restart the measurement from the beginning (similar to pressing the Restart key). This can be used to align portions of the instrument that are not impacted by an interfering user input signal.

This operation might be chosen instead of All if you do not want the device under test to experience a large change in input impedance, such as a temporary open circuit at the analyzer input.

The query form of the remote commands (:CALibration:NRF?) will invoke the alignment and return a success or failure value.

Successful completion of Align Now, All but RF will clear the “Align Now, All required” Error Condition, and clear bit 14 in the Status Questionable Calibration register. If “Align Now, All required” was in effect prior to executing the All but RF, the Error Condition message “Align Now, RF required” is generated and bit 12 in the Status Questionable Calibration register is set. It will also begin the elapsed time counter for Last Align Now, All Time, and capture the Last Align Now, All Temperature.

Align Now, All but RF can be interrupted by pressing the Cancel (ESC) front-panel key or remotely with Device Clear followed by the :ABORt SCPI command. When this occurs the Error Condition message “Align Now, All required” is generated, and bit 14 is set in the Status Questionable Condition register. This is because new alignment data may be used for an individual subsystem, but not a full new set of data for all subsystems.

In models with the RF Preselector, such as the N9038A, the “All but RF” alignment will execute an alignment of all subsystems except the RF subsystem of the Spectrum Analyzer, as well as the system gain of the RF Preselector.

Key Path	System, Alignments, Align Now
Mode	All
Remote Command	:CALibration:NRF :CALibration:NRF?
Example	:CAL:NRF
Notes	:CALibration:NRF? returns 0 if successful :CALibration:NRF? returns 1 if failed While Align Now, All but RF is performing the alignment, bit 0 in the Status Operation register is set. Completion, or termination, will clear bit 0 in the Status Operation register.

	<p>This command is sequential; it must complete before further SCPI commands are processed. Interrupting the alignment from remote is accomplished by invoking Device Clear followed by the :ABORt command.</p> <p>Successful completion will clear bit 14 in the Status Questionable Calibration register and set bit 12 if invoked with “Align Now, All required”.</p>
Couplings	<p>Initializes the time for the Last Align Now, All Time.</p> <p>Records the temperature for the Last Align Now, All Temperature.</p>
Status Bits/OPC dependencies	Bits 12 or 14 may be set in the Status Questionable Calibration register.
Initial S/W Revision	Prior to A.02.00

## RF

(In MXE the key label is “RF Only”)

Immediately executes an alignment of the RF subsystem . The instrument stops any measurement currently underway, performs the alignment, then restarts the measurement from the beginning (similar to pressing the Restart key).

This operation might be desirable if the alignments had been set to not include RF alignments, or if previous RF alignments could not complete because of interference which has since been removed.

If an interfering user signal is present at the RF Input, the alignment will terminate and generate the Error Condition message “Align skipped: 50 MHz interference” or “Align skipped: 4.8 GHz interference”, and Error Condition “Align Now, RF required”. In addition, bits 11 and 12 will be set in the Status Questionable Calibration register.

The query form of the remote commands (:CALibration:RF?) will invoke the alignment of the RF subsystem and return a success or failure value. An interfering user signal is grounds for failure.

Successful completion of Align Now, RF will begin the elapsed time counter for Last Align Now, RF Time, and capture the Last Align Now, RF Temperature.

Align Now, RF can be interrupted by pressing the Cancel (ESC) front-panel key or remotely with Device Clear followed by the :ABORt SCPI command. When this occurs, the Error Condition message “Align Now, RF required” is generated, and bit 12 is set in the Status Questionable Condition register. None of the new alignment data is used.

In models with the RF Preselector, such as the N9038A, the RF alignment will execute an alignment of the RF subsystem of the Spectrum Analyzer, as well as the RF subsystem on RF Preselector path.

Key Path	System, Alignments, Align Now
Mode	All
Remote Command	:CALibration:RF :CALibration:RF?
Example	:CAL:RF
Notes	:CALibration:RF? returns 0 if successful

	<p>:CALibration:RF? returns 1 if failed (including interfering user signal)</p> <p>While Align Now, RF is performing the alignment, bit 0 in the Status Operation register is set. Completion, or termination, will clear bit 0 in the Status Operation register.</p> <p>This command is sequential; it must complete before further SCPI commands are processed. Interrupting the alignment from remote is accomplished by invoking Device Clear followed by the :ABORt command.</p> <p>Successful completion clears the Error Conditions “Align skipped: 50 MHz interference” and “Align skipped: 4800 MHz interference” and the Error Conditions “Align RF failed” and “Align Now, RF required”, and clears bits 3, 11, and 12 in the Status Questionable Calibration register.</p> <p>A failure encountered during alignment will generate the Error Condition message “Align RF failed” and set bit 3 in the Status Questionable Calibration register.</p> <p>An interfering user signal will result in bits 11 and 12 to be set in the Status Questionable Calibration register to indicate Align Now, RF is required.</p> <p>An interfering user supplied signal will result in the instrument requiring an Align Now, RF with the interfering signal removed.</p>
Couplings	<p>Initializes the time for the Last Align Now, RF Time.</p> <p>Records the temperature for the Last Align Now, RF Temperature.</p>
Status Bits/OPC dependencies	Bits 11, 12, or 14 may be set in the Status Questionable Calibration register.
Initial S/W Revision	Prior to A.02.00

## External Mixer

Immediately executes an alignment of the External Mixer that is plugged into the USB port. The instrument stops any measurement currently underway, performs the alignment, then restarts the measurement from the beginning (similar to pressing the Restart key). As this alignment calibrates the LO power to the mixer, this is considered an LO alignment; and failure is classified as an LO alignment failure.

The query form of the remote commands (:CALibration:EMIXer?) will invoke the alignment of the External Mixer and return a success or failure value.

Key Path	System, Alignments, Align Now
Mode	All
Remote Command	<p>:CALibration:EMIXer</p> <p>:CALibration:EMIXer?</p>
Example	:CAL:EMIX
Notes	<p>:CAL:EMIX? returns 0 if successful</p> <p>:CAL:EMIX? returns 1 if failed</p> <p>While Align Now, Ext Mix is performing the alignment, bit 0 in the Status Operation register is set. Completion, or termination, will clear bit 0 in the Status Operation register.</p> <p>This command is sequential; it must complete before further SCPI commands are processed. Interrupting the alignment from remote is accomplished by invoking Device Clear followed by the :ABORt command.</p>

	A failure encountered during alignment will generate the Error Condition message “Align LO failed” and set bit 5 in the Status Questionable Calibration register. Successful completion will clear the “Align LO failed” message and bit 5 in the Status Questionable Calibration register.
Dependencies	This key does not appear unless option EXM is present and is grayed-out unless a USB mixer is plugged in to the USB.
Status Bits/OPC dependencies	Bit3 may be set in the Status Questionable Calibration Extended Failure register.
Initial S/W Revision	A.08.00

### Show Alignment Statistics

Shows alignment information you can use to ensure that the instrument is operating in a specific manner. The Show Alignment Statistics screen is where you can view time and temperature information.

Values which are displayed are only updated when the Show Alignment Statistics screen is invoked, they are not updated while the Show Alignment Statistics screen is being displayed. The remote commands that access this information obtain current values.

An example of the Show Alignment Statistics screen would be similar to:

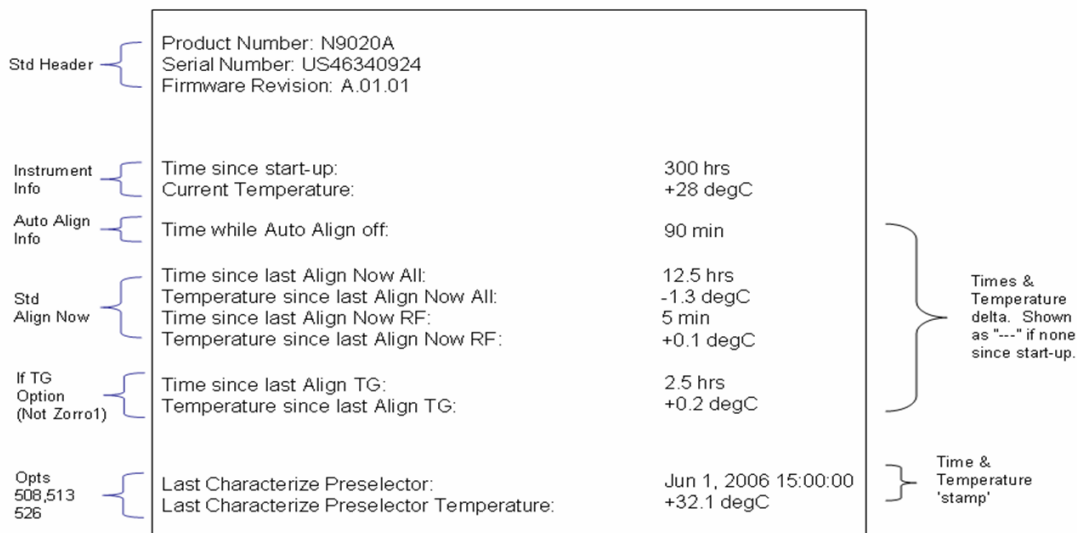

A successful Align Now, RF will set the Last Align RF temperature to the current temperature, and reset the Last Align RF time. A successful Align Now, All or Align Now, All but RF will set the Last Align Now All temperature to the current temperature, and reset the Last Align Now All time. A successful Align Now, All will also reset the Last Align RF items if the RF portion of the Align Now succeeded.

Key Path	System, Alignments
Mode	All

Notes	The values displayed on the screen are only updated upon entry to the screen and not updated while the screen is being displayed.
Initial S/W Revision	Prior to A.02.00

Key Path	Visual annotation in the Show Alignment Statistics screen
Mode	All
<b>Remote Command</b>	:SYSTem:PON:TIME?
<b>Example</b>	:SYST:PON:TIME?
Notes	Value is the time since the most recent start-up in seconds.
State Saved	No
Initial S/W Revision	Prior to A.02.00

Key Path	Visual annotation in the Show Alignment Statistics screen
Mode	All
<b>Remote Command</b>	:CALibration:TEMPerature:CURRent?
<b>Example</b>	:CAL:TEMP:CURR?
Notes	Value is in degrees Centigrade. Value is invalid if using default alignment data (Align Now, All required)
State Saved	No
Initial S/W Revision	Prior to A.02.00

Key Path	Visual annotation in the Show Alignment Statistics screen
Mode	All
<b>Remote Command</b>	:CALibration:TIME:LALL?
<b>Example</b>	:CAL:TIME:LALL?
Notes	Value is the elapsed time, in seconds, since the last successful Align Now, All or Align Now, All but RF was executed.
State Saved	No
Initial S/W Revision	Prior to A.02.00

Key Path	Visual annotation in the Show Alignment Statistics screen
Mode	All
<b>Remote Command</b>	:CALibration:TEMPerature:LALL?
<b>Example</b>	:CAL:TEMP:LALL?

Notes	Value is in degrees Centigrade at which the last successful Align Now, All or Align Now, All but RF was executed.
State Saved	No
Initial S/W Revision	Prior to A.02.00

Key Path	Visual annotation in the Show Alignment Statistics screen
Mode	All
<b>Remote Command</b>	:CALibration:TIME:LRF?
<b>Example</b>	:CAL:TIME:LRF?
Notes	Value is the elapsed time, in seconds, since the last successful Align Now, RF was executed, either individually or as a component of Align Now, All.
State Saved	No
Initial S/W Revision	Prior to A.02.00

Key Path	Visual annotation in the Show Alignment Statistics screen
Mode	All
<b>Remote Command</b>	:CALibration:TEMPerature:LRF?
<b>Example</b>	:CAL:TEMP:LRF?
Notes	Value is in degrees Centigrade at which the last successful Align Now, RF was executed, either individually or as a component of Align Now, All.
State Saved	No
Initial S/W Revision	Prior to A.02.00

Key Path	Visual annotation in the Show Alignment Statistics screen
Mode	All
<b>Remote Command</b>	:CALibration:TIME:LPreselector?
<b>Example</b>	:CAL:TIME:LPR?
Notes	Value is the date and time the last successful Characterize Preselector was executed. The date is separated from the time by a space character. Returns "" if no Characterize Preselector has ever been performed on the instrument.
Dependencies	In models that do not include preselectors, this command is not enabled and any attempt to set or query will yield an error.
State Saved	No
Initial S/W Revision	Prior to A.02.00



Key Path	Visual annotation in the Show Alignment Statistics screen
Mode	All
<b>Remote Command</b>	:CALibration:TEMPerature:LPReselector?
<b>Example</b>	:CAL:TEMP:LPR?
Notes	Value is in degrees Centigrade at which the last successful Characterize Preselector was executed.
Dependencies	In models that do not include preselectors, this command is not enabled and any attempt to set or query will yield an error.
State Saved	No
Initial S/W Revision	Prior to A.02.00

Key Path	Visual annotation in the Show Alignment Statistics screen
Mode	All
<b>Remote Command</b>	:CALibration:AUTO:TIME:OFF?
<b>Example</b>	:CAL:AUTO:TIME:OFF?
Notes	Value is the elapsed time, in seconds, since Auto Align has been set to Off or Off with Alert. The value is 0 if Auto Align is ALL or NORF.
State Saved	No
Initial S/W Revision	Prior to A.02.00

Key Path	Visual annotation in the Show Alignment Statistics screen
Mode	All
<b>Remote Command</b>	:CALibration:TIME:RFPSselector:LCONducted?
<b>Example</b>	:CAL:TIME:RFPS:LCON?
Notes	Values are the date and time the last successful Align Now, 20 Hz – 30 MHz was executed. The date is separated from the time by a semi-colon character.
State Saved	No

Key Path	Visual annotation in the Show Alignment Statistics screen
Mode	All
<b>Remote Command</b>	:CALibration:TEMPerature:RFPSselector:LCONducted?
<b>Example</b>	:CAL:TEMP:RFPS:LCON?
Notes	Value is in degrees Centigrade at which the last successful Align Now, 20 Hz – 30 MHz was executed.
State Saved	No

Key Path	Visual annotation in the Show Alignment Statistics screen
Mode	All
Remote Command	:CALibration:TIME:RFPSector:LRADiated?
Example	:CAL:TIME:RFPS:LRAD?
Notes	Value is the date and time the last successful Align Now, 30 MHz – 3.6 GHz was executed. The date is separated from the time by a semi-colon character.
State Saved	No

Key Path	Visual annotation in the Show Alignment Statistics screen
Mode	All
Remote Command	:CALibration:TEMPerature:RFPSector:LRADiated?
Example	:CAL:TEMP:RFPS:LRAD?
Notes	Value is in degrees Centigrade at which the last successful Align Now, 30 MHz – 3.6 GHz was executed.
State Saved	No

Key Path	Visual annotation in the Show Alignment Statistics screen
Mode	All
Remote Command	:CALibration:RFPSector:SCHeduler:TIME:NEXT? This query returns data using the following format “YYYY/MM/DD; HH:MM:SS”
Example	:CAL:RFPS:SCH:TIME:NEXT?
Notes	The next run time will be updated based on the start date/time and recurrence set by the users. “date” is representation of the date the task will run in the form of “YYYY/MM/DD” where: <ul style="list-style-type: none"> <li>–YYYY is the four digit representation of year. (for example, 2009)</li> <li>–MM is the two digit representation of month. (for example, 01 to 12)</li> <li>–DD is the two digit representation of the day. (for example, 01 to 28, 29, 30 or 31 depending on the month and year)</li> </ul> “time” is a representation of the time of day the task will run in the form of “HH:MM:SS” where: <ul style="list-style-type: none"> <li>–HH is the two digit representation of the hour in 24 hour format</li> <li>–MM is the two digit representation of minute</li> <li>–SS is the two digit representation of seconds</li> </ul> For model N9038A only.
State Saved	No

## Restore Align Defaults

Initializes the alignment user interface settings, not alignment data, to the factory default values. Align Now, All must be executed if the value of the Timebase DAC results in a change.

For front panel operation, you are prompted to confirm action before setting the alignment parameters to factory defaults:

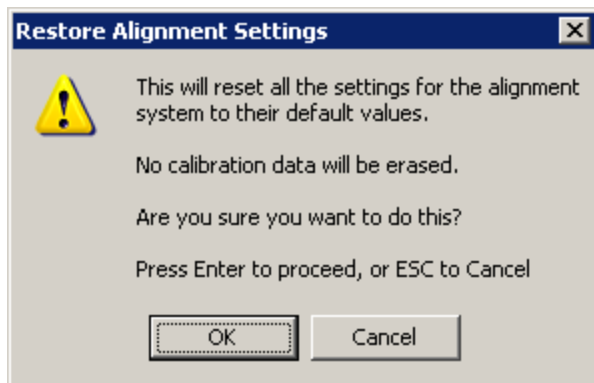

The parameters affected are:

Parameter	Setting
Timebase DAC	Calibrated
Timebase DAC setting	Calibrated value
Auto Align State	Normal (if the instrument is not operating with default alignment data, Off otherwise)
Auto Align All but RF	Off
Auto Align Alert	Time & Temperature

Key Path	System, Alignments
Mode	All
<b>Example</b>	:SYST:DEF ALIG
Notes	Alignment processing that results as the transition to Auto Alignment Normal will be executed sequentially; thus *OPC? or *WAI will wait until the alignment processing is complete.
Initial S/W Revision	Prior to A.02.00

## Backup or Restore Align Data...

Opens the utility for backing-up or restoring the alignment data.

Alignment data for the instrument resides on the hard drive in a database. Agilent uses high quality hard drives; however it is highly recommended the alignment data be backed-up to storage outside of the instrument. Additionally, for customers who use multiple CPU Assemblies or multiple disk drives, the

alignment that pertains to the instrument must be transferred to the resident hard drive after a CPU or hard drive is replaced. This utility facilitates backing-up and restoring the alignment data.

**NOTE**

This utility allows the operator to navigate to any location of the Windows file system. It is intended that the operator use a USB memory device or Mapped Network Drive to back up the alignment data to storage outside of the instrument.

---

Key Path	System, Alignments
Initial S/W Revision	A.02.00

---



---

Key Path	System, Alignments
Mode	All
<b>Remote Command</b>	:CALibration:DATA:DEfault
<b>Example</b>	:CAL:DATA:DEF
Couplings	Sets Auto Align to Off. Sets bit 14 in the Status Questionable Calibration register. The Error Condition message "Align Now, All required" is generated.
Initial S/W Revision	Prior to A.02.00

---

### Alignment Data Wizard

The Backup or Restore Alignment Data wizard guides you through the operation of backing-up or restoring the alignment data.

The following dialogue boxes operates without a mouse or external keyboard when you use the default file names.

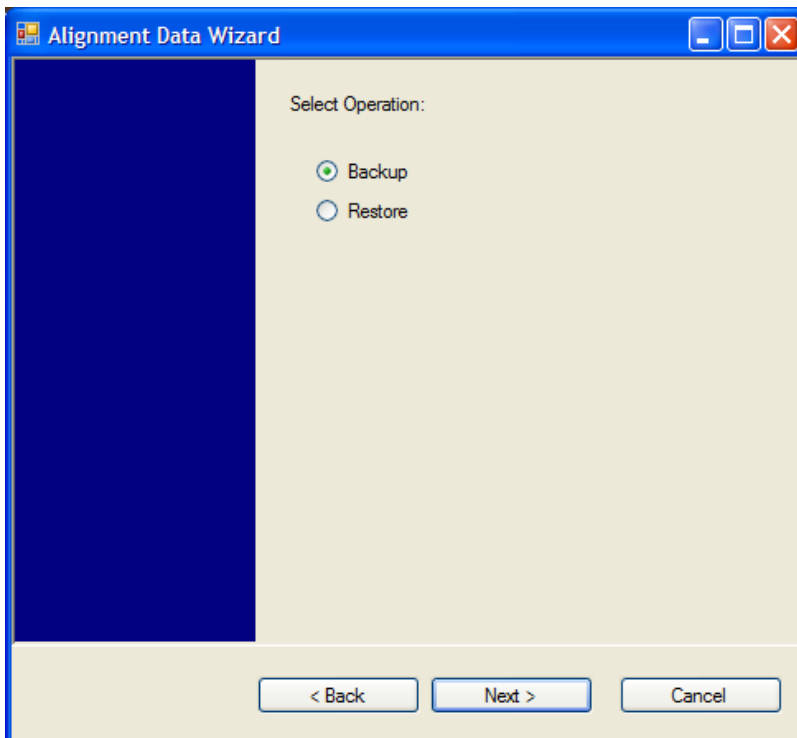
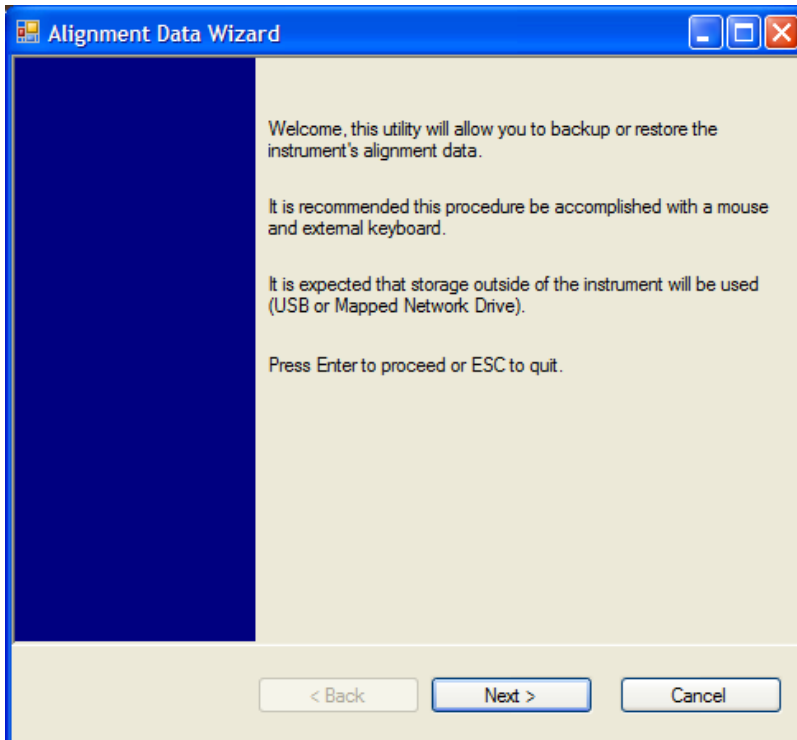

The backup screen indicates the approximate amount of space required to contain the backup file.

The default file name will be AlignDataBackup\_<model number>\_<serial number>\_<date in YYYYMMDDHHMMSS>.bak.

The default backup location will be first drive identified as an external drive (USB or LAN) if such is available; if not, the internal D: partition will be selected.

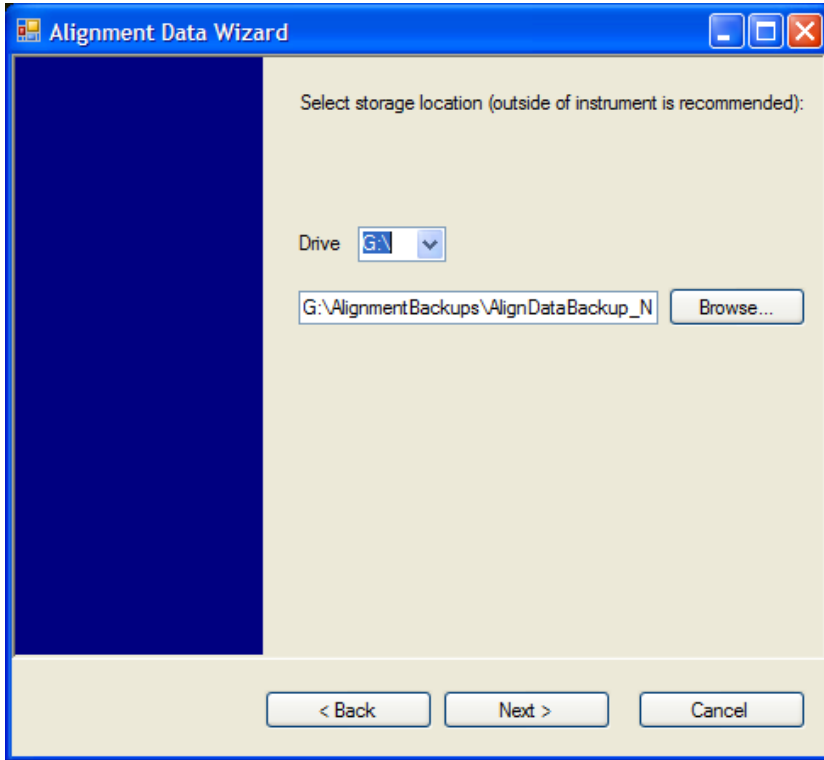

Changing the drive letter will also modify the path displayed in the box below. When this step is first loaded, the drive drop-down menu is populated with connected drives, which provide the user with write access. If there are many unreachable network drives connected to the instrument, this step can take a few seconds. If a USB drive is present, it will be selected by default. The path defaults to the AlignmentBackups folder, and a filename is automatically created in the form of AlignDataBackup\_<model>\_<serial number>\_<date><time>. When the "Next >" button is pressed, you will be prompted to create a new folder if the chosen path does not yet exist.

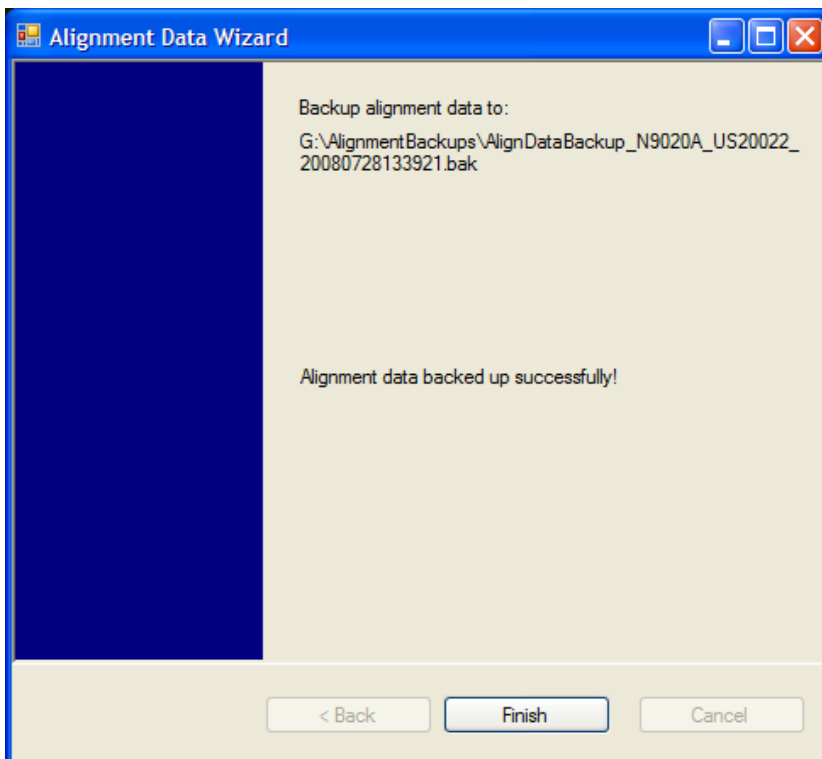
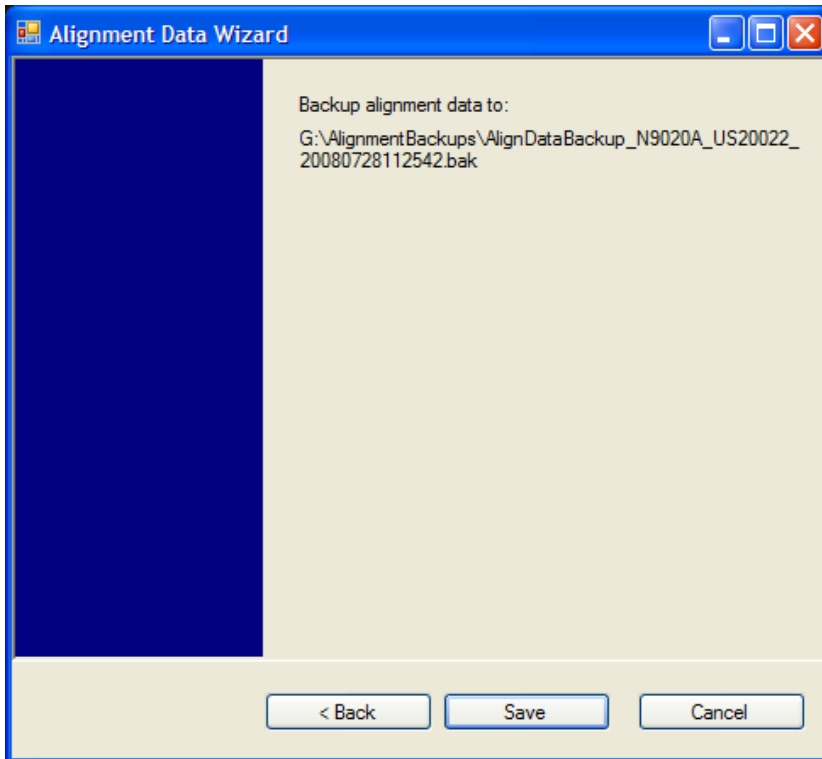

The restore operation checks the validity of the restore file using the database's built-in file validation. If the restore file is corrupt, the existing alignment data will remain in use.

If the serial number information in the backup file being restored is different from that of the instrument, the following message appears (the serial number shown are examples):

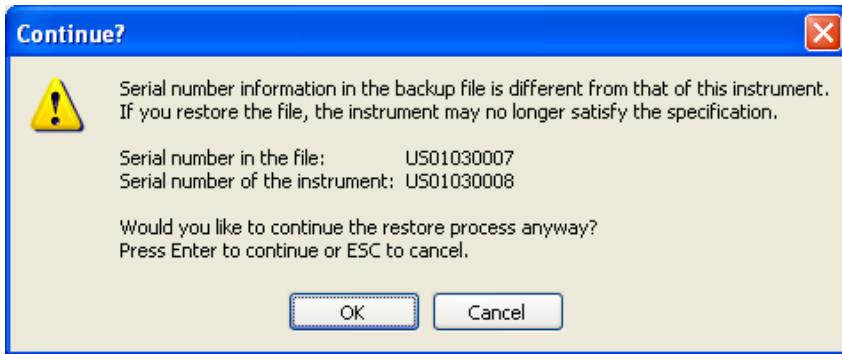

The default restore location will be first drive identified as an external drive (USB or LAN) if such is available; if not, the internal D: partition will be selected. The default restore file will be the most recent file that matches the default backup file name format: AlignDataBackup\_<model number>\_<serial number>\_<date>.bak

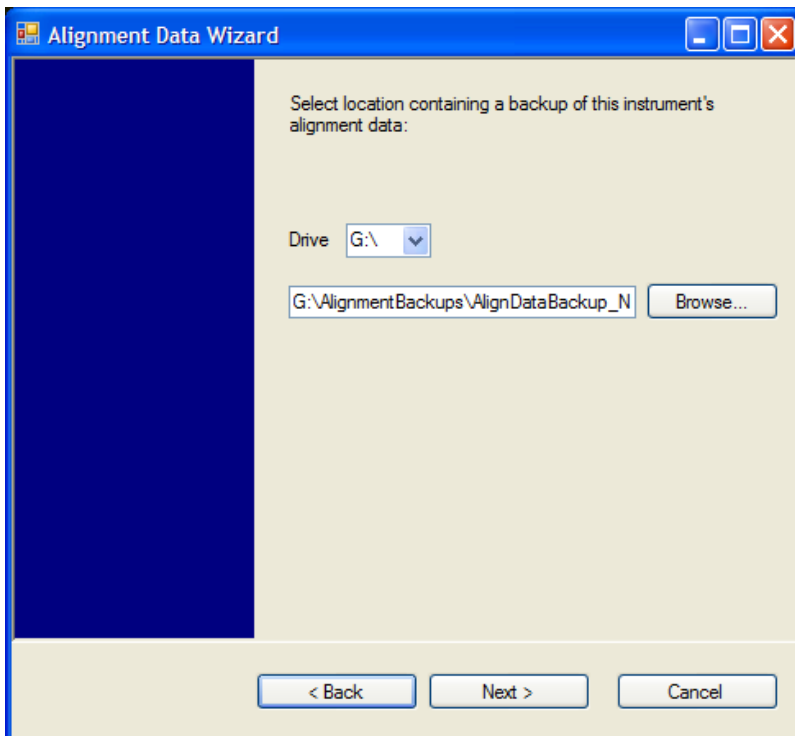

Changing the drive letter also modifies the path displayed in the box below. When this step is first loaded, the drive drop-down menu is populated with connected drives, which provide you with read access. The path defaults to the AlignBackups folder. The most recent \*.bak file in the folder will also be selected by default.



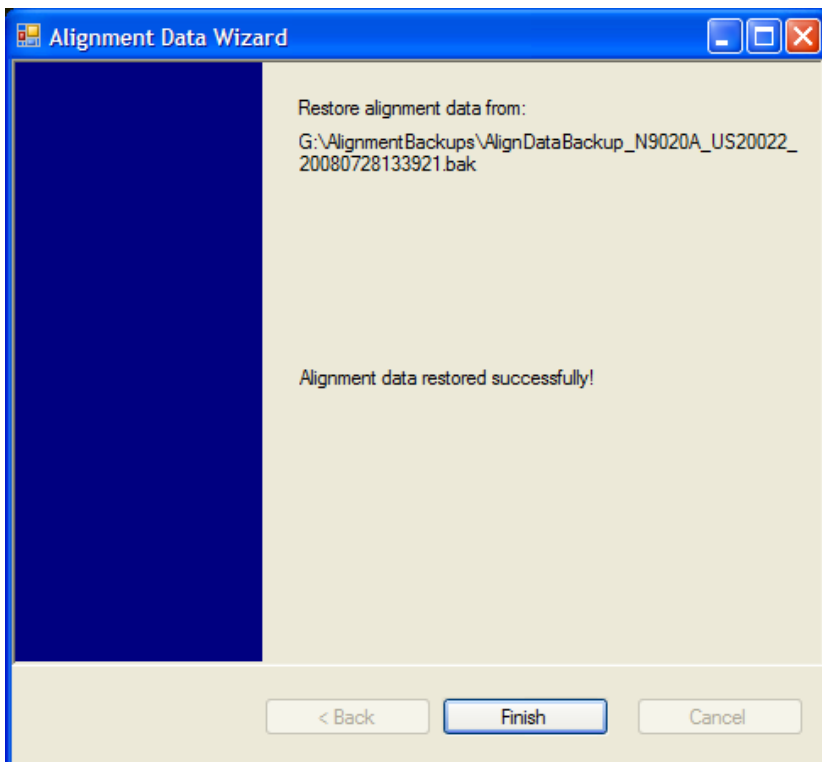
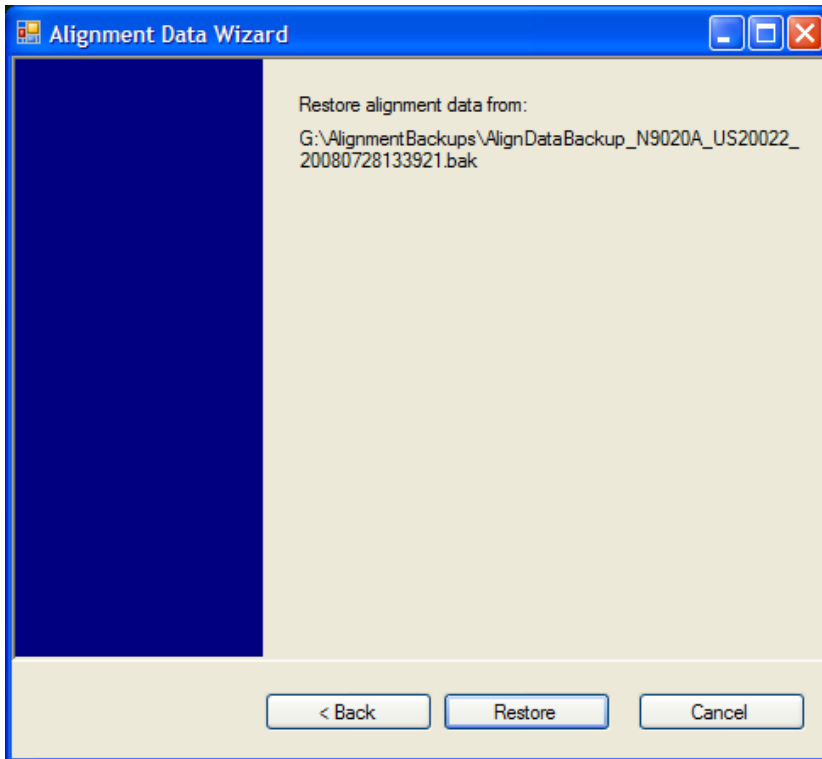

### Perform Backup (Remote Command Only)

Invokes an alignment data backup operation to the provided Folder.

**NOTE**

It is recommended that the Folder provided is outside of the instrument (USB or Mapped Network Drive).

<b>Remote Command</b>	:CALibration:DATA:BACKup <filename>
<b>Example</b>	:CAL:DATA:BACK "F:\AlignDataBackup_N9020A_US00000001_2008140100.bak"
<b>Initial S/W Revision</b>	A.02.00

### Perform Restore (Remote Command Only)

Invokes an alignment data restore operation from the provided filename.

<b>Remote Command</b>	:CALibration:DATA:REStore <filename>
<b>Example</b>	:CAL:DATA:REST "F:\AlignDataBackup_N9020A_US00000001_2008140100.bak "
<b>Initial S/W Revision</b>	A.02.00

### Advanced

Accesses alignment processes that are immediate action operations that perform operations that run until complete. Advanced alignments are performed on an irregular basis, or require additional operator interaction

<b>Key Path</b>	System, Alignments
<b>Initial S/W Revision</b>	Prior to A.02.00

### Characterize Preselector

The Preselector tuning curve drifts over temperature and time. Recognize that the Amplitude, Presel Center function adjusts the preselector for accurate amplitude measurements at an individual frequency. Characterize Preselector improves the amplitude accuracy by ensuring the Preselector is approximately centered at all frequencies without the use of the Amplitude, Presel Center function. Characterize Preselector can be useful in situations where absolute amplitude accuracy is not of utmost importance, and the throughput savings or convenience of not performing a Presel Center is desired. Presel Center is required prior to any measurement for best (and warranted) amplitude accuracy.

Agilent recommends that the Characterize Preselector operation be performed yearly as part of any calibration, but performing this operation every three months can be worthwhile.

Characterize Preselector immediately executes a characterization of the Preselector, which is a YIG-tuned filter (YTF). The instrument stops any measurement currently underway, performs the characterization, then restarts the measurement from the beginning (similar to pressing the Restart key).

The query form of the remote commands (:CALibration:YTF?) will invoke the alignment of the YTF subsystem and return a success or failure value.

A failure encountered during alignment will generate the Error Condition message "Characterize Preselector failure" and set bit 3 in the STATus:QUESTionable:CALibration:EXTended:FAILure status register. Successful completion of Characterize Preselector will clear this Condition. It will also begin the

elapsed time counter for Last Characterize Preselector Time, and capture the Last Characterize Preselector Temperature.

The last Characterize Preselector Time and Temperature survives across the power cycle as this operation is performed infrequently.

**NOTE**

The Characterize Preselector function can be interrupted by pressing the Cancel (ESC) front-panel key or remotely with Device Clear followed by the :ABORt SCPI command. None of the new characterization data is then used. However, since the old characterization data is purged at the beginning of the characterization, you now have an uncharacterized preselector. You should re-execute this function and allow it to finish before making any further preselected measurements.

Key Path	System, Alignments, Advanced
Mode	All
Remote Command	:CALibration:YTF :CALibration:YTF?
Example	:CAL:YTF
Notes	:CALibration:YTF? returns 0 if successful :CALibration:YTF? returns 1 if failed (including interfering user signal) While Advanced, Characterize Preselector is performing the alignment, bit 0 in the Status Operation register is set. Completion, or termination, will clear bit 0 in the Status Operation register. This command is sequential; it must complete before further SCPI commands are processed. Interrupting the alignment from remote is accomplished by invoking Device Clear followed by the :ABORt command. Successful completion will clear bit 9 in the Status Questionable Calibration register. A failure encountered during alignment will generate the Error Condition message "Characterize Preselector failed" and set bit 9 in the Status Questionable Calibration register. For Options that support frequencies > 3.6 GHz only.
Dependencies	This key does not appear in models that do not contain preselectors. In these models the SCPI command is accepted without error but no action is taken.
Couplings	Initializes the time for the Last Characterize Preselector Time. Records the temperature for the Last Characterize Preselector Temperature.
Initial S/W Revision	Prior to A.02.00

### Characterize Reference Clock

Characterizing the reference clock is calibrating the Reference Input Phase with the External Reference Output. This feature is only available when either option DP2 or B40 is present. It requires connecting the 10 MHz OUT to the EXT REF IN port with a BNC cable before running the characterization.

See ["Front panel guided calibration sequence" on page 401](#)

Key Path	System, Alignments, Advanced
Mode	All

<b>Remote Command</b>	:CALibration:REference:CLOCK?
<b>Example</b>	:CAL:REF:CLOC:INIT? //connect cable :CAL:REF:CLOC? //disconnect cable :CAL:REF:CLOC:END?
<b>Notes</b>	:CALibration:REference:CLOCK? returns 0 if successful :CALibration:REference:CLOCK? returns 1 if failed
<b>Dependencies</b>	Option DP2 or B40
<b>Couplings</b>	Initializes the time for the Last Characterize Reference Clock Time. Records the temperature for the Last Characterize Reference Clock Temperature. Expected to be run after :CAL:REF:CLOC:INIT, and before :CAL:REF:CLOC:END.
<b>Initial S/W Revision</b>	A.13.00

<b>Parameter Name</b>	Characterize Reference Clock Initialization
<b>Mode</b>	All
<b>Remote Command</b>	:CALibration:REference:CLOCK:INITialize?
<b>Example</b>	:CAL:REF:CLOC:INIT?
<b>Notes</b>	:CALibration:REference:CLOCK:INIT? returns 0 if successful :CALibration:REference:CLOCK:INIT? returns 1 if failed
<b>Dependencies</b>	Option DP2 or B40
<b>Couplings</b>	Expected to be run before sending the :CAL:REF:CLOC? command. This will stop the current measurement when it has completed (does not abort the current data acquisition), and it will prepare the instrument for the expected cabling.
<b>Force Restart</b>	Yes
<b>Initial S/W Revision</b>	A.12.00

<b>Parameter Name</b>	Characterize Reference Clock End
<b>Mode</b>	All
<b>Remote Command</b>	:CALibration:REference:CLOCK:END?
<b>Example</b>	:CAL:REF:CLOC:END?
<b>Notes</b>	:CALibration:REference:CLOCK:END? returns 0 if successful :CALibration:REference:CLOCK:END? returns 1 if failed
<b>Dependencies</b>	Option DP2 or B40
<b>Couplings</b>	Expected to be run after sending the :CAL:REF:CLOC? command, and after removing the cable used in that Characterize Reference Clock step. This will resume any queued measurements, and it concludes the reference clock characterization.
<b>Force Restart</b>	Yes
<b>Initial S/W Revision</b>	A.12.00

Parameter Name	Last Characterize Reference Clock
Key Path	Visual annotation in the Show Alignment Statistics screen
Parameter Type	String
Mode	All
<b>Remote Command</b>	:CALibration:TIME:REfERENCE:CLOCK?
<b>Example</b>	:CAL:TIME:REfERENCE:CLOCK?
Notes	Value is the date and time the last successful Characterize Reference Clock was executed. The date is separated from the time by a space character. Returns "" if Characterize Reference Clock has never been performed on the instrument.
Dependencies	Option DP2 or B40
State Saved	No
Initial S/W Revision	A.12.00

#### Front panel guided calibration sequence

When selecting "Characterize Reference Clock" through the front panel, the following form will be shown.

Step 1 of the guided calibration sequence:

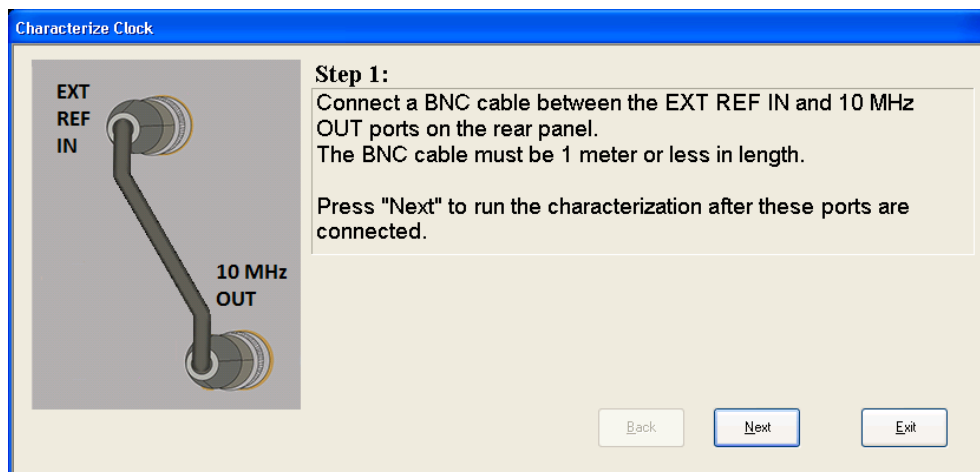

Step 2 of the guided calibration sequence:

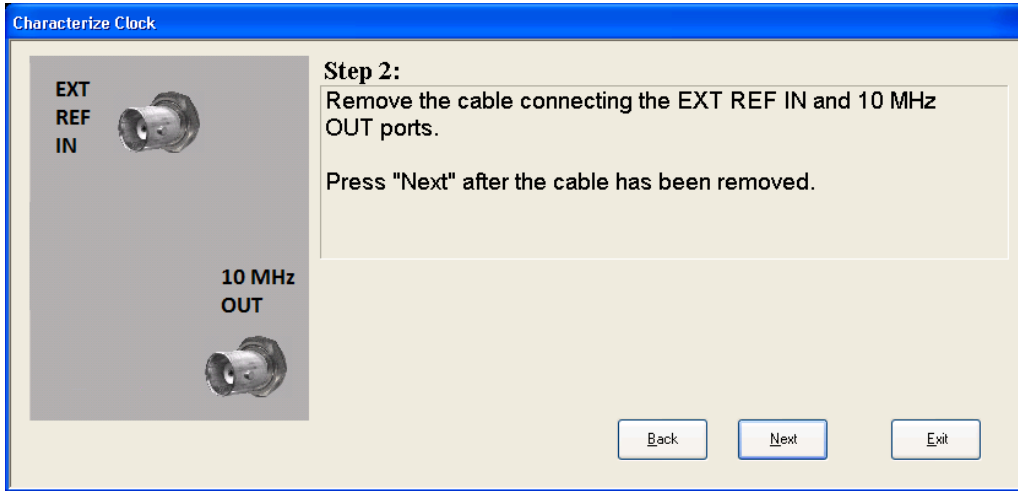

Step 3 of the guided calibration sequence:

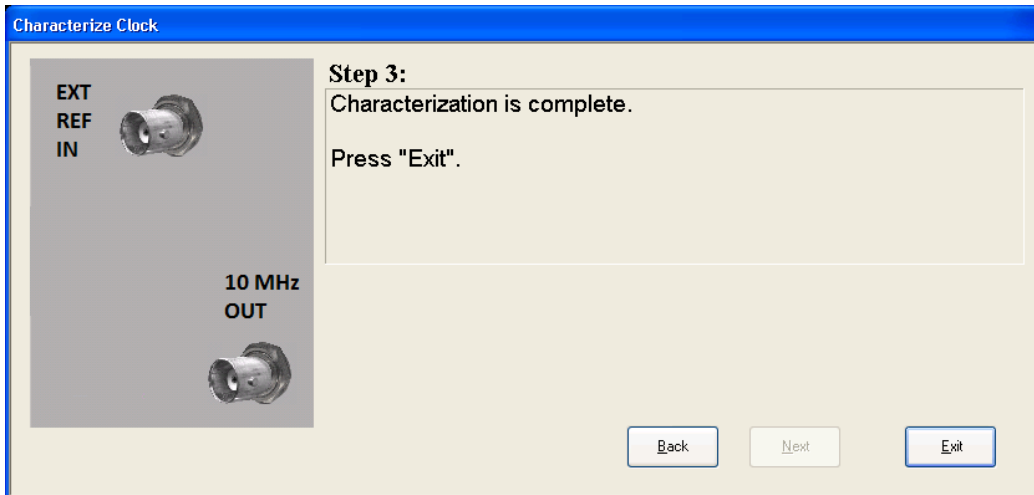

## Timebase DAC

Allows control of the internal 10 MHz reference oscillator timebase. This may be used to adjust for minor frequency alignment between the signal and the internal frequency reference. This adjustment has no effect if the instrument is operating with an External Frequency Reference.

If the value of the Timebase DAC changes (by switching to Calibrated from User with User set to a different value, or in User with a new value entered) an alignment may be necessary. The alignment system will take appropriate action; which will either invoke an alignment or cause an Alert.

Key Path	System, Alignments
Mode	All
Remote Command	:CALibration:FREquency:REFerence:MODE CALibrated USER :CALibration:FREquency:REFerence:MODE?
Example	:CAL:FREQ:REF:MODE CAL
Notes	If the value of the timebase is changed the alignment system automatically performs an alignment or

	alerts that an alignment is due. If the value of the timebase is changed the alignment system automatically performs an alignment or alerts that an alignment is due.
Preset	This is unaffected by Preset but is set to CALibrated on a “Restore System Defaults->Align”.
State Saved	No
Initial S/W Revision	Prior to A.02.00

### Calibrated

Sets the Timebase DAC to the value established during factory or field calibration. The value displayed on the menu key is the calibrated value.

Key Path	System, Alignments, Timebase DAC
Mode	All
<b>Example</b>	:CAL:FREQ:REF:MODE CAL
Readback Text	[xxx] < where xxx is the calibrated value
Initial S/W Revision	Prior to A.02.00

### User

Allows setting the Timebase DAC to a value other than the value established during the factory or field calibration. The value displayed on the menu key is the calibrated value.

Key Path	System, Alignments, Timebase DAC
Mode	All
<b>Example</b>	:CAL:FREQ:REF:MODE USER
Readback Text	xxx < where xxx is the Timebase DAC setting
Initial S/W Revision	Prior to A.02.00

Key Path	System, Alignments, Timebase DAC
Mode	All
<b>Remote Command</b>	:CALibration:FREQuency:REFerence:FINE <integer> :CALibration:FREQuency:REFerence:FINE?
<b>Example</b>	:CAL:FREQ:REF:FINE 8191
Notes	If the value of the timebase is changed the alignment system automatically performs an alignment or alerts that an alignment is due.
Couplings	Setting :CAL:FREQ:REF:FINE sets :CAL:FREQ:REF:MODE USER
Preset	This is unaffected by Preset but is set to the factory setting on a “Restore System Defaults->Align”.

State Saved	No
Min	0
Max	16383
<b>Backwards Compatibility SCPI</b>	:CALibration:FREQuency:REFeRence:COARse ESA hardware contained two DAC controls for the Timebase. In X-Series the command :CALibration:FREQuency:REFeRence:FINE is the method for adjusting the timebase. The :COARse command is provided as an alias to :FINE.
Initial S/W Revision	Prior to A.02.00

<b>Remote Command</b>	:CALibration:FREQuency:REFeRence:COARse <integer> :CALibration:FREQuency:REFeRence:COARse?
<b>Example</b>	:CAL:FREQ:REF:COAR 8191
Notes	This is an alias for CAL:FREQ:REF:FINE any change to COARse is reflected in FINE and vice-versa. See CAL:FREQ:REF:FINE for description of functionality.
Couplings	Setting :CAL:FREQ:REF:COAR sets :CAL:FREQ:REF:MODE USER
Initial S/W Revision	Prior to A.02.00

## I/O Config

Activates a menu for identifying and changing the I/O configuration for remote control.

Key Path	System
Initial S/W Revision	Prior to A.02.00

## GPIB

Activates a menu for configuring the GPIB I/O port.

Key Path	System, I/O Config
Initial S/W Revision	A.02.00

## GPIB Address

Select the GPIB remote address.

Key Path	System, I/O Config, GPIB
Mode	All
<b>Remote Command</b>	:SYSTem:COMMunicate:GPIB[1][:SELF]:ADDRESS <integer> :SYSTem:COMMunicate:GPIB[1][:SELF]:ADDRESS?



<b>Example</b>	:SYST:COMM:GPIB:ADDR 17
Notes	Changing the Address on the GPIB port requires all further communication to use the new address.
Preset	This is unaffected by Preset but is set to 18 on a “Restore System Defaults->Misc”
State Saved	No
Range	0 to 30
Min	0
Max	30
Initial S/W Revision	Prior to A.02.00

## GPIB Controller

Sets the GPIB port into controller or device mode. In the normal state, GPIB controller is disabled, which allows the analyzer to be controlled by a remote computer. When GPIB Controller is enabled, the instrument can run software applications that use the instrument's computer as a GPIB controller; controlling devices connected to the instrument's GPIB port.

### NOTE

When GPIB Controller is enabled, the analyzer application itself cannot be controlled over GPIB. In this case it can easily be controlled via LAN or USB. The GPIB port cannot be a controller and device at the same time. Only one controller can be active on the GPIB bus at any given time. If the analyzer is the controller, an external PC cannot be a controller.

To control the instrument from the software that is performing GPIB controller operation, you can use an internal TCP/IP connection to the analyzer application. Use the address TCPIP0:localhost:inst0:INSTR to send SCPI commands to the analyzer application.

Key Path	System, I/O Config, GPIB
Mode	All
Scope	Mode Global
<b>Remote Command</b>	:SYSTem:COMMunicate:GPIB[1] [:SELF]:CONTroller[:ENABle] ON   OFF   0   1 :SYSTem:COMMunicate:GPIB[1] [:SELF]:CONTroller[:ENABle] ?
<b>Example</b>	:SYST:COMM:GPIB:CONT ON Will set GPIB port to Controller
Notes	When the instrument becomes the Controller bit 0 in the Standard Event Status Register is set (and when the instrument relinquishes Controller capability bit 0 is cleared in the Standard Event Status Register).
Preset	This is unaffected by Preset but is set to OFF on a “Restore System Defaults->Misc”
State Saved	No
Range	Disabled Enabled
Initial S/W Revision	A.02.00

## Disabled

Disables the GPIB Controller capability, this is the default (or normal) setting.

Key Path	System, I/O Config, GPIB, GPIB Controller	
<b>Example</b>	:SYST:COMM:GPIB:CONT OFF	Will set GPIB port to Device
Initial S/W Revision	A.02.00	

#### Enabled

Enables the GPIB Controller capability.

Key Path	System, I/O Config, GPIB, GPIB Controller	
<b>Example</b>	:SYST:COMM:GPIB:CONT ON	Will set GPIB port to Controller
Initial S/W Revision	A.02.00	

### SCPI LAN

Activates a menu for identifying and changing the SCPI over a LAN configuration. There are a number of different ways to send SCPI remote commands to the instrument over LAN. It can be a problem to have multiple users simultaneously accessing the instrument over the LAN. These keys limit that somewhat by disabling the telnet, socket, and/or SICL capability.

Key Path	System, I/O Config
Initial S/W Revision	Prior to A.02.00

### SCPI Telnet

Turns the SCPI LAN telnet capability On or Off allowing you to limit SCPI access over LAN through telnet.

Key Path	System, I/O Config, SCPI LAN
Mode	All
<b>Remote Command</b>	:SYSTem:COMMunicate:LAN:SCPI:TELNet:ENABle OFF ON 0 1 :SYSTem:COMMunicate:LAN:SCPI:TELNet:ENABle?
<b>Example</b>	:SYST:COMM:LAN:SCPI:TELN:ENAB OFF
Preset	This is unaffected by Preset but is set to ON with a "Restore System Defaults->Misc"
State Saved	No
Range	On   Off
Initial S/W Revision	Prior to A.02.00

### SCPI Socket

Turns the capability of establishing Socket LAN sessions On or Off. This allows you to limit SCPI access over LAN through socket sessions.

Key Path	System, I/O Config, SCPI LAN
Mode	All
<b>Remote Command</b>	:SYSTem:COMMunicate:LAN:SCPI:SOCKet:ENABle OFF ON 0 1 :SYSTem:COMMunicate:LAN:SCPI:SOCKet:ENABle?
<b>Example</b>	:SYST:COMM:LAN:SCPI:SOCK:ENAB OFF
Preset	This is unaffected by a Preset but is set to ON with a “Restore System Defaults->Misc”
State Saved	No
Range	On   Off
Initial S/W Revision	Prior to A.02.00

### SICL Server

Turns the SICL server capability On or Off, enabling you to limit SCPI access over LAN through the SICL server. (SICL IEEE 488.2 protocol.)

Parameter	Description	Setting
Maximum Connections	The maximum number of connections that can be accessed simultaneously	5
Instrument Name	The name (same as the remote SICL address) of your analyzer	inst0
Instrument Logical Unit	The unique integer assigned to your analyzer when using SICL LAN	8
Emulated GPIB Name	The name (same as the remote SICL address) of the device used when communicating with your analyzer	gpib7
Emulated GPIB Logical Unit	The unique integer assigned to your device when it is being controlled using SICL LAN	8
Emulated GPIB Address	The emulated GPIB address assigned to your transmitter tester when it is a SICL server (the same as your GPIB address)	18

Key Path	System, I/O Config, SCPI LAN
Mode	All
<b>Remote Command</b>	:SYSTem:COMMunicate:LAN:SCPI:SICL:ENABle OFF ON 0 1 :SYSTem:COMMunicate:LAN:SCPI:SICL:ENABle?
<b>Example</b>	:SYST:COMM:LAN:SCPI:SICL:ENAB OFF
Preset	This is unaffected by Preset, but is set to ON with a “Restore System Defaults->Misc”
State Saved	No
Range	On   Off
Initial S/W Revision	Prior to A.02.00

### HiSLIP Server

Turns the HiSLIP server capability On or Off, enabling you to limit SCPI access over LAN through the HiSLIP server.

HiSLIP stands for High Speed LAN Instrument Protocol and is part of the IVI-6.1 specification.

Here is an example of a VISA connection string used to connect to the HiSLIP Server on an X-Series Spectrum Analyzer:

```
TCPIP0::a-n9030a-93016::hislip0::INSTR
```

In the example above, hislip0 is the HiSLIP device name that VISA users must include in their HiSLIP VISA Address strings. Your HiSLIP device name may be different depending on your VISA settings.

Key Path	System, I/O Config, SCPI LAN
Mode	All
Remote Command	:SYSTem:COMMunicate:LAN:SCPI:HISLip:ENABle OFF ON 0 1 :SYSTem:COMMunicate:LAN:SCPI:HISLip:ENABle?
Example	:SYST:COMM:LAN:SCPI:HISL:ENAB OFF
Preset	This is unaffected by Preset, but is set to ON with a “Restore System Defaults->Misc”
State Saved	No
Range	On   Off
Initial S/W Revision	A.11.00

### SCPI Socket Control Port (Remote Command Only)

Returns the TCP/IP port number of the control socket associated with the SCPI socket session. This query enables you to obtain the unique port number to open when a device clear is to be sent to the instrument. Every time a connection is made to the SCPI socket, the instrument creates a peer control socket. The port number for this socket is random. The user must use this command to obtain the port number of the control socket. To force a device clear on this socket, open the port and send the string “DCL” to the instrument.

If this SCPI command is sent to a non SCPI Socket interface, then 0 is returned.

Mode	All
Remote Command	:SYSTem:COMMunicate:LAN:SCPI:SOCKet:CONTRol?
Example	:SYST:COMM:LAN:SCPI:SOCK:CONT?
Preset	This is unaffected by Preset or “Restore System Defaults->Misc”.
State Saved	No
Range	0 to 65534
Min	0
Max	65534
Initial S/W Revision	Prior to A.02.00

## Reset Web Password

The embedded web server contains certain capability which are password protected; modifying the LAN configuration of the instrument, and access to web pages that can change the settings of the instrument. The default password from the factory is 'agilent' (without the quotes). The control provided here is the means to set the web password as the user desires, or to reset the password to the factory default.

Selecting Reset web password brings up a control for resetting the password as the user desires, or to the factory default. A keyboard is required to change the password from the factory default of 'agilent' or to set a new password that contains alphabetic characters. The control is:

If this control is entered without an external keyboard or mouse connected, you can cancel the control by pressing the Cancel (ESC) front-panel key.

Key Path	System, I/O Config
Mode	All
Initial S/W Revision	Prior to A.02.00

## LXI

Opens a menu that allows you to access the various LXI configuration properties.

Key Path	System, I/O Config
Initial S/W Revision	Prior to A.02.00

## LAN Reset

Resets the LAN connection.

Key Path	System, I/O Config, LXI
Initial S/W Revision	Prior to A.02.00

### Device Identification (Remote Command Only)

Enabling the LXI device identification will place the LXI Status Indicator to the 'Identify' state. Disabling the LXI device identification will place the LXI Status Indicator to the 'No Fault' state. The LXI Status indicator is in the upper left region of the instrument's graphical user interface ()

Mode	All
Remote Command	:LXI:IDENtify[:STATe] OFF ON 0 1 :LXI:IDENtify[:STATe]?
Example	:LXI:IDEN ON
Preset	Not part of Preset, but reset to OFF on Restore System Defaults All
State Saved	No
Range	On   Off
Initial S/W Revision	A.12.50

### System IDN Response

This key allows you to specify a response to the \*IDN? query, or to return the analyzer to the Factory response if you have changed it.

To choose the factory-set response, press the Factory key.

To specify your own response, press the User key, and enter your desired response.

Key Path	System, I/O Config
Mode	All
Remote Command	:SYSTem:IDN <string> :SYSTem:IDN?
Notes	<ul style="list-style-type: none"> <li>• This affects the response given in all Modes of the Analyzer, unless the current Mode has also specified a custom response, in which case the current Mode's custom IDN response takes precedence over the System's, but only while that Mode is the current Mode..</li> <li>• It survives shutdown and restart of the software and therefore survives a power cycle</li> <li>• Null string as parameter restores the Factory setting</li> </ul>
Preset	This is unaffected by Preset but is set to the original factory setting on a "Restore System Defaults->Misc"
State Saved	No
Initial S/W Revision	A.06.00

### Factory

This key selects the factory setting, for example:

"Agilent Technologies,N9020A,MY00012345,A.05.01"

where the fields are manufacturer, model number, serial number, firmware revision.

Key Path	System, I/O Config, IDN Response
<b>Example</b>	:SYST:IDN "" null string, restores the factory setting
Initial S/W Revision	A.06.0

## User

This key allows you to specify your own response to the \*IDN? query. You may enter your desired response with the Alpha Editor or a plugin PC keyboard.

When you press this key, the active function becomes the current User string with the cursor at the end. This makes it easy to edit the existing string.

If you enter a null string (for example, by clearing the User String while editing and then pressing Done) the analyzer automatically reverts to the Factory setting.

Key Path	System, I/O Config, IDN Response
<b>Example</b>	:SYST:IDN "XYZ Corp, Model 12, 012345, A.01.01" user specified response
Initial S/W Revision	A.06.00

## Query USB Connection (Remote Command Only)

Enables you to determine the speed of the USB connection.

Mode	All
<b>Remote Command</b>	:SYSTem:COMMunicate:USB:CONNection?
<b>Example</b>	:SYST:COMM:USB:CONN?
Notes	NONE – Indicates no USB connection has been made. LSPeed – Indicates a USB low speed connection (1.5 Mbps).  This is reserved for future use, the T+M488 protocol is not supported on low speed connections. HSPeed – Indicates that a USB high speed connection (480 Mbps) has been negotiated. FSPeed – Indicates that a USB full speed connection (12 Mbps) has been negotiated.
State Saved	No
Range	NONE LSPeed HSPeed FSPeed
Initial S/W Revision	Prior to A.02.00

## USB Connection Status (Remote Command Only)

Enables you to determine the current status of the USB connection.

Mode	All
<b>Remote Command</b>	:SYSTem:COMMunicate:USB:STATus?
<b>Example</b>	:SYST:COMM:USB:STAT?
Notes	<p>SUSPended – Indicates that the USB bus is currently in its suspended state. The bus is in the suspended state when:</p> <ul style="list-style-type: none"> <li>• The bus is not connected to any controller</li> <li>• The controller is currently powered off</li> <li>• The controller has explicitly placed the USB device into the suspended state.</li> </ul> <p>When in the suspended state, no USB activity, including start of frame packets are received.</p> <p>ACTive – Indicates that the USB device is in the active state. When the device is in the active state, it is receiving periodic start of frames but it isn't necessarily receiving or transmitting data.</p>
State Saved	No
Range	SUSPended ACTive
Initial S/W Revision	Prior to A.02.00

### USB Packet Count (Remote Command Only)

Enables you to determine the number of packets received and transmitted on the USB bus.

Mode	All
<b>Remote Command</b>	:SYSTem:COMMunicate:USB:PACKets?
<b>Example</b>	:SYST:COMM:USB:PACK?
Notes	<p>Two integers are returned. The first is the number of packets received since application invocation, the second is the number of packets transmitted since application invocation. If no packets have been received or transmitted the response is 0,0.</p> <p>The packet count is initialized to 0,0 when the instrument application is started.</p>
State Saved	No
Initial S/W Revision	Prior to A.02.00

### Restore Defaults

Provides incremental initialization of the system setting groups along with supporting a comprehensive reset of the entire instrument back to a factory default state. The menu selections are the groups of system settings and when one is selected, that particular group of system settings is reset back to their default values.

Key Path	System
Mode	All
<b>Remote Command</b>	:SYSTem:DEFault [ALL]   ALIGn   INPut   MISC   MODes   PON
<b>Example</b>	SYST:DEF



State Saved	No
Initial S/W Revision	Prior to A.02.00

## Restore Input/Output Defaults

Causes the group of settings and data associated with Input/Output front-panel key to be a reset to their default values. This level of Restore System Defaults does not affect any other system settings, mode settings and does not cause a mode switch. .

Confirmation is required to restore the Input/Output setting. The confirmation dialog is:

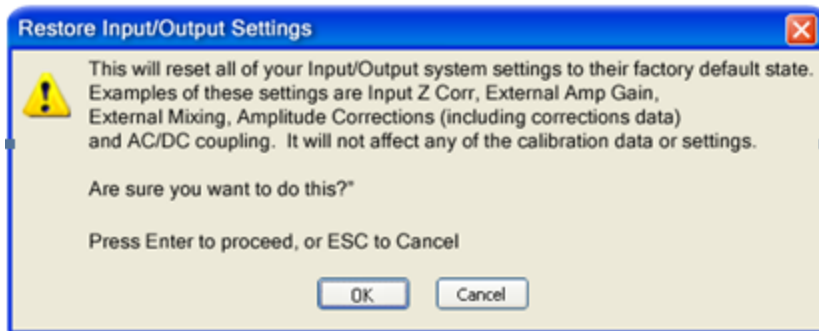

Key Path	System, Restore System Defaults
<b>Example</b>	:SYST:DEF INP
Initial S/W Revision	Prior to A.02.00

## Restore Power On Defaults

This selection causes the Power On settings to be a reset to their default value. This level of Restore System Defaults does not affect any other system settings, mode settings and does not cause a mode switch. The Power On settings and their default values are Power On Type reset to Mode and Input/Output Defaults and Power On Application reset to whatever the factory set as its default value.

Confirmation is required to restore the factory default values. The confirmation dialog is:

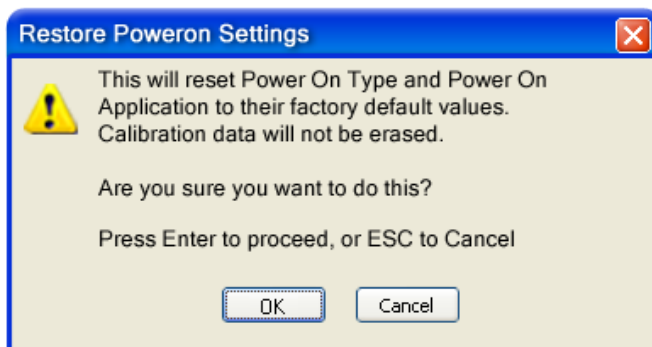

Key Path	System, Restore System Defaults
<b>Example</b>	:SYST:DEF PON
Initial S/W Revision	Prior to A.02.00

### Restore Align Defaults

This selection causes the Alignment system settings to be a reset to their default values. This does not affect any Alignment data stored in the system. This level of Restore System Defaults does not affect any other system settings, mode settings and does not cause a mode switch.

After performing this function, it may impact the auto-alignment time of the instrument until a new alignment baseline has been established.

Confirmation is required to restore the factory default values. The confirmation dialog is:

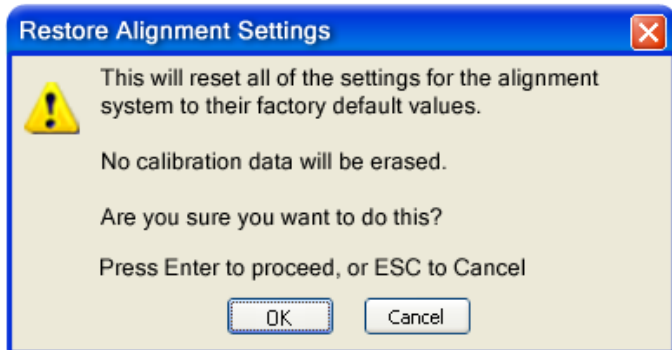

Key Path	System, Restore System Defaults
<b>Example</b>	:SYST:DEF ALIG
Initial S/W Revision	Prior to A.02.00

### Restore Misc Defaults

This selection causes miscellaneous system settings to be reset to their default values. With this reset, you lose the GPIB address and it is reset to 18, so this should be used with caution. This level of Restore System Defaults does not affect any other system settings, mode settings and does not cause a mode switch. This miscellaneous group contains the rest of the settings that have not been part of the other Restore System Defaults groups. The following table is a complete list of settings associated with this group:

Miscellaneous Setting	Default Value
Verbose SCPI	Off
The SYST:PRES:TYPE	MODE
Auto File Name Number	000

Miscellaneous Setting	Default Value
Save Type	State
State Save To	Register 1
Screen Save To	SCREEN000.png
DISP:ENABLE	ON
Full Screen	Off
SCPI Telnet	ON
SCPI Socket	ON
SICL Server	ON
Softkey Language	English
System Annotation	ON
Display Theme	TDColor
System IDN Response	Factory result of *IDN?
Display Intensity	100
Display Backlight	ON
GPIB Address	18

Confirmation is required to restore the factory default values. The confirmation dialog is:

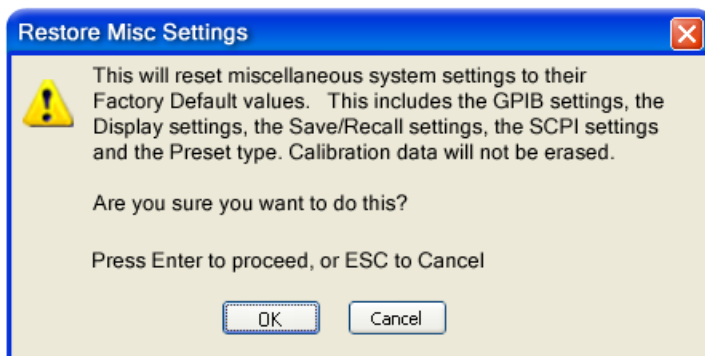

Key Path	System, Restore System Defaults
<b>Example</b>	:SYST:DEF MISC
Initial S/W Revision	Prior to A.02.00

### Restore Mode Defaults (All Modes)

This selection resets all of the modes in the instrument back to their default state just as a Restore Mode Defaults does and it switches the instrument to the power-on mode and causes the default measurement

for the power-on mode to be active. This level of Restore System Defaults does not affect any system settings, but it does affect the state of all modes and does cause a mode switch unless the instrument was already in the power-on mode.

Confirmation is required to restore the factory default values. The confirmation dialog is:

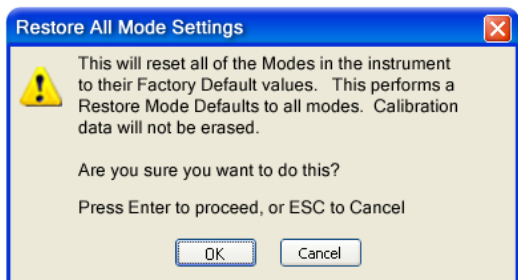

Key Path	System, Restore System Defaults
Example	:SYST:DEF MOD
Couplings	An All Mode will cause the currently running measurement to be aborted, mode switch to the power-on mode and activate the default measurement for the power-on mode.. It gets the mode to a consistent state with all of the default couplings set.
Initial S/W Revision	Prior to A.02.00

## All

This performs a comprehensive reset of ALL analyzer settings to their factory default values. It resets all of the system setting groups, causes a Restore Mode Defaults for all modes in the instrument, and switches back to the power-on mode. It does not affect the User Preset file or any user saved files.

Confirmation is required to restore the factory default values. The confirmation dialog is:

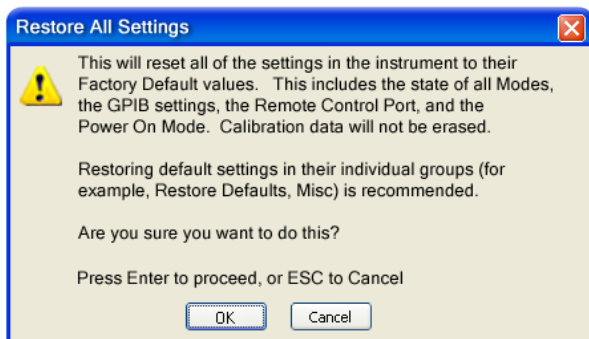

### NOTE

If you are using an Agilent USB External Mixer, then you will need to perform a Refresh USB Mixer Connection after Restoring All Defaults.

Key Path	System, Restore System Defaults
Example	:SYST:DEF ALL
Notes	If using Agilent USB External Mixer, perform a Refresh USB Mixer Connection (SCPI command

	:MIX:BAND USB) following a Restore All Defaults.
Couplings	An All will cause the currently running measurement to be aborted and get all modes to a consistent state, so it is unnecessary to couple any settings.
Initial S/W Revision	Prior to A.02.00
Modified at S/W Revision	A.14.00

## Control Panel...

Opens the Windows Control Panel. The Control Panel is used to configure certain elements of Windows that are not configured through the hardkey/softkey System menus.

**NOTE** This feature is not available if option SF1 is installed.

The Control Panel is a separate Windows application, so to return to the analyzer once you are in the Control Panel, you may either:

Exit the Control Panel by clicking on the red X in the upper right hand corner, with a mouse

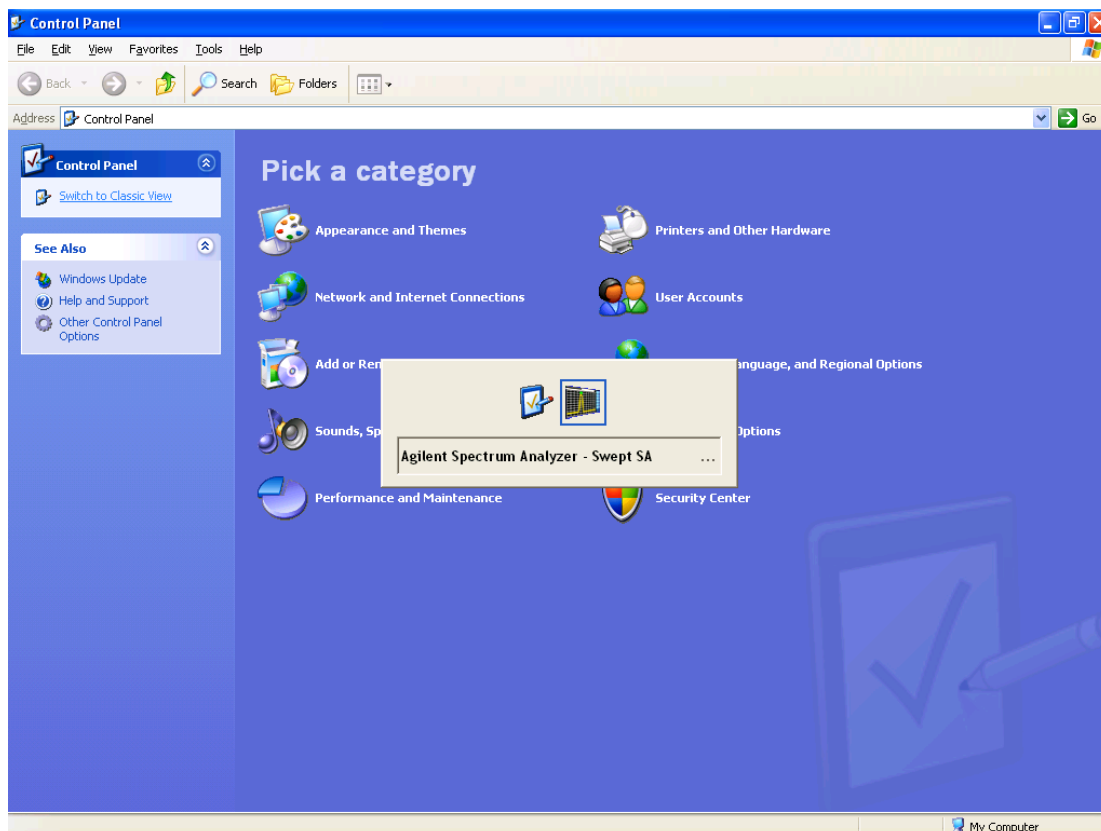

Or use Alt-Tab: press and hold the Alt key and press and release the Tab key until the Analyzer logo is showing in the window in the center of the screen, as above, then release the Alt key.

Key Path	System
Notes	No remote command for this key.
Initial S/W Revision	Prior to A.02.00

### Licensing...

Opens the license explorer.

**NOTE** This feature is not available if option SF1 is installed.

For Help on this key, select Help in the menu bar at the top of the license explorer window.

Key Path	System
Notes	No equivalent remote command for this key.
Backwards Compatibility Notes	In ESA the SCPI command for displaying the Show Licenses screen is: :SYSTem:CONFigure:LKEY:STATe OFF ON 0 1:SYSTem:CONFigure:LKEY:STATe? There are no equivalent SCPI commands in the X-Series for displaying the License Explorer.
Initial S/W Revision	Prior to A.02.00

<b>Remote Command</b>	:SYSTem:LKEY <"OptionInfo">, <"LicenseInfo">
<b>Example</b>	SYST:LKEY "N9073A-1FP", "027253AD27F83CDA5673A9BA5F427FDA5E4F25AEB1017638211AC9F60D9C639FE539735909C551DE0A91"
Notes	The <"OptionInfo"> contains the feature and the version. You must specify the feature but can omit the version. If you omit the version, the system regards it as the latest one, since the system knows which version is supported for each feature.  The <"LicenseInfo"> contains the signature, the expiration date, and serial number for transport if transportable. You must specify the signature, but you can omit the other information. If you omit the expiration date, the system regards it as permanent. If you omit the serial number, the system regards it as non-transportable. As a result, this supports reverse compatibility.
Initial S/W Revision	Prior to A.02.00

<b>Remote Command</b>	:SYSTem:LKEY:DELeTe <"OptionInfo">, <"LicenseInfo">
<b>Example</b>	SYST:LKEY:DEL 'N9073A-1FP', "027253AD27F83CDA5673A9BA5F427FDA5E4F25AEB1017638211AC9F60D9C639FE539735909C551DE0A91"
Notes	The <"OptionInfo"> contains the feature and the version. You must specify the feature but can omit the version. If

---

you omit the version, the system regards it as the latest one, if more than one version is installed.

The <"LicenseInfo"> contains the signature, the expiration date, and whether or not be transportable. You must specify the signature, but you can omit the other information. If you omit the expiration date, the system regards it as permanent. If you omit the transportability, the system regards it as non-transportable. As a result, this supports reverse compatibility.

---

Initial S/W Revision      Prior to A.02.00

---



---

**Remote Command**      :SYSTem:LKEY:LIST?

---

Notes

Return Value:

An <arbitrary block data> of all the installed instrument licenses.

The format of each license is as follows.

<Feature>,<Version>,<Signature>,<Expiration Date>,<Serial Number for Transport>

Return Value Example:

#3136

N9073A-1FP,1.000,B043920A51CA

N9060A-2FP,1.000,4D1D1164BE64

N9020A-508,1.000,389BC042F920

N9073A-1F1,1.000,5D71E9BA814C,13-aug-2005

<arbitrary block data> is:

#NMMM<data>

Where:

N is the number of digits that describes the number of MMM characters. For example if the data was 55 bytes, N would be 2.

MMM would be the ASCII representation of the number of bytes. In the previous example, N would be 55.

<data> ASCII contents of the data

---

Initial S/W Revision      Prior to A.02.00

---



---

**Remote Command**      :SYSTem:LKEY? <"OptionInfo">

---

**Example**                SYST:LKEY? "N9073A-1FP"

---

Notes

The <"OptionInfo"> contains the feature and the version. You must specify the feature but can omit the version. If you omit the version, the system regards it as the latest one.

Return Value:

<"LicenseInfo"> if the license is valid, null otherwise.

<"LicenseInfo"> contains the signature, the expiration date, and serial number if transportable.

Return Value Example:

"B043920A51CA"

---

Initial S/W Revision      Prior to A.02.00

---

<b>Remote Command</b>	:SYSTem:HID?
Notes	Return value is the host ID as a string
Initial S/W Revision	Prior to A.02.00

## Security

Accesses capabilities for operating the instrument in a security controlled environment.

Key Path	System
Initial S/W Revision	A.04.00

## USB

The Windows operating system can be configured to disable write access to the USB ports for users who are in a secure environment where transferring data from the instrument is prohibited. This user interface is a convenient way for the customer to disable write access to USB.

Key Path	System, Security
Mode	All
Scope	Mode Global
<b>Remote Command</b>	:SYSTem:SECurity:USB:WPRotect[:ENABLE] ON OFF 0 1 :SYSTem:SECurity:USB:WPRotect[:ENABLE]?
<b>Example</b>	:SYST:SEC:USB:WPR ON Will set USB ports to Read-only
Notes	When the USB ports are in Read-only mode then no data can be stored to USB, including the internal USB memory used for a back-up location for the calibration data.
Dependencies	This key is grayed-out unless the current user has administrator privileges.
Preset	This is unaffected by Preset or any Restore System Defaults. An Agilent Recovery will set the USB to write protect OFF
State Saved	No
Range	Read-Write Read only
Initial S/W Revision	A.04.00

## Read-Write

Selection for allowing full read-write access to the USB ports.

Key Path	System, Security, USB
<b>Example</b>	:SYST:SEC:USB:WPR OFF Will set USB ports to Read-Write
Initial S/W Revision	A.04.00



## Read only

Selection for disabling write access to the USB ports.

Key Path	System, Security, USB	
<b>Example</b>	:SYST:SEC:USB:WPR ON	Will set USB ports to Read only
Initial S/W Revision	A.04.00	

## Diagnostics

The Diagnostics key in the System menu gives you access to basic diagnostic capabilities of the instrument.

Key Path	System
Initial S/W Revision	Prior to A.02.00

## Show Hardware Statistics

Provides a display of various hardware statistics. The statistics include the following:

- Mechanical relay cycles
- High and Low temperature extremes
- Elapsed time that the instrument has been powered-on (odometer)

The display should appear listing the statistics, product number, serial number, and firmware revision.

**Hardware Statistical Information**  
 Agilent MXA Signal Analyzer  
 Product Number: N9020A  
 Serial Number: US00061145  
 Instrument S/W Revision: A.12.00  
 Revision Date: 7/11/2012 12:11:10 PM

Component Name	Value	
MechAtten #1 Count Total	457304	
Calibrator Switch Cycles	105953	
AC/DC Switch Cycles	114240	
2 dB #1 Mechanical Atten Cycles	112655	
2 dB #2 Mechanical Atten Cycles	124456	
MechAtten #2 Count Total	472265	
6 dB Mechanical Atten Cycles	115302	
10 dB Mechanical Atten Cycles	93602	
20 dB Mechanical Atten Cycles	144781	
30 dB Mechanical Atten Cycles	118580	
Low Noise Path Switch	45668	Only shown if LNP installed
Preselector Bypass Cycles	31133	Only shown if MPB installed
High temperature operating extreme	45.75	
Low temperature operating extreme	-23.9375	
Elapsed Time (On-Time)(hours)	134164	

The CXA models in which the AC/DC Switch field is called Fixed Atten and that omit the mechanical attenuation fields are the N9000A–503/507 models.

Modular HWs only have time and temperature information in Show Hardware Statistics.

The data will be updated only when the Show Hardware Statistics menu key is pressed, it will not be updated while the screen is displayed.

The tabular data should be directly printable.

Key Path	System, Diagnostics
Mode	All
Notes	The values displayed on the screen are only updated upon entry to the screen and not updated while the screen is being displayed.
Initial S/W Revision	Prior to A.02.00

### SCPI for Show Hardware Statistics ( Remote Commands Only)

Each of the hardware statistic items can be queried via SCPI.

- "Query the Mechanical Relay Cycle Count" on page 423
- "Query the Operating Temperature Extremes" on page 423
- "Query the Elapsed Time since 1st power on" on page 423

### Query the Mechanical Relay Cycle Count

Return the count of mechanical relay cycles. For N9038A model, there are additional 2 Mechanical Relays which are <N9038A Input2>, <N9038A Bypass>.

<b>Remote Command</b>	:SYSTem:MRELay:COUNT?
<b>Example</b>	:SYST:MREL:COUN?
<b>Notes</b>	<p>Query Only</p> <p>The return value is a comma separated list of the individual counts for each mechanical relay. The position of the relays in the list is:</p> <p>“&lt;Cal Signal&gt;,&lt;AC/DC&gt;,&lt;2dB #1 Atten&gt;,&lt;2dB #2 Atten&gt;,&lt;6dB Atten&gt;,&lt;10dB Atten&gt;,&lt;20dB Atten&gt;,&lt;30dB Atten&gt;,&lt;Fixed Atten&gt;,&lt;Low Noise Path Switch&gt;,&lt;Presel Bypass&gt;,&lt;N9038A Input2&gt;,&lt;N9038A Bypass&gt;”</p> <p>Items in the list not pertaining to your particular hardware configuration will return as -999 for those items.</p>
<b>Initial S/W Revision</b>	Prior to A.02.00
<b>Modified at S/W Revision</b>	A.08.00

### Query the Operating Temperature Extremes

Returns the low operating temperature extreme value. The value survives a power-cycle and is the temperature extreme encountered since the value was reset by the factory or service center.

<b>Mode</b>	All
<b>Remote Command</b>	:SYSTem:TEMPerature:LEXTreme?
<b>Example</b>	:SYST:TEMP:LEXT?
<b>Notes</b>	Value is in degrees Celsius at which the lowest operating temperature has been recorded since 1st power-up.
<b>State Saved</b>	No
<b>Initial S/W Revision</b>	Prior to A.02.00

<b>Mode</b>	All
<b>Remote Command</b>	:SYSTem:TEMPerature:HEXTreme?
<b>Example</b>	:SYST:TEMP:HEXT?
<b>Notes</b>	Value is in degrees Celsius at which the highest operating temperature has been recorded since 1st power-up.
<b>State Saved</b>	No
<b>Initial S/W Revision</b>	Prior to A.02.00

### Query the Elapsed Time since 1<sup>st</sup> power on

Returns the elapsed on-time in minutes since 1st power-on.

<b>Remote Command</b>	:SYSTem:PON:ETIMe?
<b>Example</b>	:SYST:PON:ETIM?
<b>Notes</b>	Query Only
<b>Initial S/W Revision</b>	Prior to A.02.00

## Internet Explorer...

This key launches Microsoft Internet Explorer. A mouse and external keyboard are highly desired for using Internet Explorer. When Internet Explorer is running, close Internet Explorer to return focus to the Instrument Application (or use Alt-Tab).

**NOTE** This feature is not available if option SF1 is installed.

<b>Key Path</b>	System
<b>Mode</b>	All
<b>Notes</b>	No equivalent remote command for this key.
<b>Initial S/W Revision</b>	A.05.01

## System Remote Commands (Remote Commands Only)

The commands in this section have no front-panel key equivalent.

["System Powerdown \(Remote Command Only\)" on page 424](#)

["List installed Options \(Remote Command Only\)" on page 425](#)

["Lock the Front-panel keys \(Remote Command Only\)" on page 425](#)

["List SCPI Commands \(Remote Command Only\)" on page 425](#)

["SCPI Version Query \(Remote Command Only\)" on page 426](#)

["Date \(Remote Command Only\)" on page 426](#)

["Time \(Remote Command Only\)" on page 426](#)

<b>Initial S/W Revision</b>	Prior to A.02.00
-----------------------------	------------------

## System Powerdown (Remote Command Only)

<b>Remote Command</b>	SYSTem:PDOWn [NORMal   FORCe]
<b>Notes</b>	Shuts down the instrument in the normal way (NORMal) or forced way (FORCe). In case there is another application with modified data pending for saving, the application prompt the user. The system waits until the user responds in the normal mode. It will go off after 20 seconds of wait in the force mode and all data will be lost.

## List installed Options (Remote Command Only)

Lists the installed options that pertain to the instrument (signal analyzer).

Mode	All
<b>Remote Command</b>	:SYSTem:OPTions?
<b>Example</b>	:SYST:OPT?
Notes	The return string is a comma separated list of the installed options. For example: "503,P03,PFR" :SYSTem:OPTions? and *OPT? are the same.
State Saved	No
Initial S/W Revision	Prior to A.02.00

## Lock the Front-panel keys (Remote Command Only)

Disables the instrument keyboard to prevent local input when the instrument is controlled remotely. Annunciation showing a "K" for 'Klock' (keyboard lock) alerts the local user that the keyboard is locked. Klock is similar to the GPIB Local Lockout function; namely that no front-panel keys are active with the exception of the Power Standby key. (The instrument is allowed to be turned-off if Klock is ON.) The Klock command is used in remote control situations where Local Lockout cannot be used.

Although primary intent of Klock is to lock-out the front panel, it will lock-out externally connected keyboards through USB. Klock has no effect on externally connected pointing devices (mice).

The front panel 'Local' key (Cancel/Esc) has no effect if Klock is ON.

Mode	All
<b>Remote Command</b>	:SYSTem:KLOCK OFF ON 0 1 :SYSTem:KLOCK?
<b>Example</b>	:SYST:KLOC ON
Notes	Keyboard lock remains in effect until turned-off or the instrument is power-cycled
Preset	Initialized to OFF at startup, unaffected by Preset
State Saved	No
Initial S/W Revision	Prior to A.02.00

## List SCPI Commands (Remote Command Only)

Outputs a list of the valid SCPI commands for the currently selected Mode.

<b>Remote Command</b>	:SYSTem:HELP:HEADers?
<b>Example</b>	:SYST:HELP:HEAD?
Notes	The output is an IEEE Block format with each command separated with the New-Line character (hex

	0x0A)
Initial S/W Revision	Prior to A.02.00

### SCPI Version Query (Remote Command Only)

Returns the SCPI version number with which the instrument complies. The SCPI industry standard changes regularly. This command indicates the version used when the instrument SCPI commands were defined.

<b>Remote Command</b>	:SYSTem:VERSion?
<b>Example</b>	:SYST:VERS?
Initial S/W Revision	Prior to A.02.00

### Date (Remote Command Only)

The recommended access to the Date, Time, and Time zone of the instrument is through the Windows native control (Control Panel or accessing the Task Bar). You may also access this information remotely, as shown in this command and Time (below).

Sets or queries the date in the instrument.

Mode	All
<b>Remote Command</b>	:SYSTem:DATE "<year>,<month>,<day>" :SYSTem:DATE?
<b>Example</b>	:SYST:DATE "2006,05,26"
Notes	<year> is the four digit representation of year. (for example, 2006) <month> is the two digit representation of year. (for example. 01 to 12) <day> is the two digit representation of day. (for example, 01 to 28, 29, 30, or 31) depending on the month and year Unless the current account has Power User or Administrator privileges, an error will be generated by this command and no action will be taken.
Initial S/W Revision	Prior to A.02.00

### Time (Remote Command Only)

Sets or queries the time in the instrument.

Mode	All
<b>Remote Command</b>	:SYSTem:TIME "<hour>,<minute>,<second>" :SYSTem:TIME?
<b>Example</b>	:SYST:TIME "13,05,26"

---

Notes	<hour> is the two digit representation of the hour in 24 hour format <minute> is the two digit representation of minute <second> is the two digit representation of second Unless the current account has Power User or Administrator privileges, an error will be generated by this command and no action will be taken.
Initial S/W Revision	Prior to A.02.00

---





## 7 Trigger Functions

## Trigger

Accesses a menu of keys to control the selection of the trigger source and the setup of each of the trigger sources. The analyzer is designed to allow triggering from a number of different sources, for example, Free Run, Video, External, RF Burst, and so forth.

The TRIG:SOURCe command (below) will specify the trigger source for the currently selected input (RF or I/Q). If you change inputs, the new input remembers the trigger source it was last programmed to for the current measurement, and uses that trigger source. You can directly set the trigger source for each input using the TRIGger:RF:SOURce and TRIGger:IQ:SOURce commands (later in this section). When in External Mixing, the analyzer uses the RF trigger source.

Note the inclusion of the <measurement> parameter in the command below. Because each measurement remembers its own Trigger Source, the command must be qualified with the measurement name. Note that for the Swept SA measurement this is not the case; for backwards compatibility, no <measurement> parameter is used when setting the Trigger Source for the Swept SA measurement.

See ["Trigger Source Presets" on page 431](#)

See ["RF Trigger Source" on page 434](#)

See ["I/Q Trigger Source" on page 435](#)

See ["More Information" on page 436](#)

Key Path	Front-panel key
<b>Remote Command</b>	<pre>:TRIGger:&lt;measurement&gt;[:SEquence]:SOURce EXTernal1   EXTernal2   IMMediate   LINE   FRAMe   RFBurst   VIDeo   IF   ALARm   LAN   IQMag   IDEMod   QDEMod   IINPut   QINPut   AIQMag   TV  :TRIGger:&lt;measurement&gt;[:SEquence]:SOURce?</pre> <p>where &lt;measurement&gt; is the measurement for which you wish to set the Source (blank for the Swept SA measurement)</p>
<b>Example</b>	<pre>TRIG:ACP:SOUR EXT1</pre> <p>Selects the external 1 trigger input for the ACP measurement and the selected input</p> <pre>TRIG:SOUR VID</pre> <p>Selects video triggering for the Swept SA (SANalyzer) measurement in the Spectrum Analyzer mode. For SAN, do not use the &lt;measurement&gt; keyword. Only send this form in the Spectrum Analyzer mode or you will get an Undefined Header error</p>
<b>Notes</b>	<p>Not all measurements have all the trigger sources available to them. Check the trigger source documentation for your specific measurement to see what sources are available.</p> <p>Not all trigger sources are available for each input. See the <a href="#">"RF Trigger Source" on page 434</a> and <a href="#">"I/Q Trigger Source" on page 435</a> commands for detailed information on which trigger sources are available for each input.</p> <p>Other trigger-related commands are found in the INITiate and ABORt SCPI command subsystems.</p> <p>*OPC should be used after requesting data. This will hold off any subsequent changes to the selected trigger source, until after the sweep is completed and the data is returned.</p> <p>Available ranges and presets can vary from mode to mode.</p>
<b>Dependencies</b>	<p>In some models, there is no second External input. In these models, the External 2 key is blanked and</p>

	the EXternal2 parameter will generate a "Hardware missing; Not available for this model number" message.
Preset	See table below
Status Bits/OPC dependencies	The Status Operation Register bit 5 "Waiting for Trigger" is set at the same time as the Sweeping or Measuring bit is set. It is cleared when the trigger actually occurs (that is, after the trigger event occurs and all the applicable trigger criteria have been met). A corresponding pop-up message ("Waiting for trigger") is generated if no trigger signal appears after approximately 2 sec. This message goes away when a trigger signal appears.
<b>Backwards Compatibility SCPI</b>	:TRIGger[:SEquence]:SOURCe EXTernal For backward compatibility, the parameter EXTernal is mapped to EXTernal1
<b>Backwards Compatibility SCPI</b>	[:SENSe]:<measurement>:TRIGger:SOURce This backwards compatibility alias command is provided for ESA/PSA compatibility This backwards compatibility command does not apply to the Swept SA measurement, for that just use :TRIGger:SOURCe This backwards compatibility command does not apply to the monitor spectrum, log plot and spot frequency measurements
<b>Backwards Compatibility SCPI</b>	[:SENSe]:<measurement>:TRIGger:SOURce IF In earlier instruments, the parameter IF was used by apps for the video trigger, so using the IF parameter selects VIDeo triggering. Sending IF in the command causes VID to be returned to a query.
<b>Backwards Compatibility SCPI</b>	[:SENSe]:ACPR:TRIGger:SOURce This backwards Compatibility SCPI command is provided to support the same functionality as [:SENSe]:ACPr:TRIGger:SOURce (PSA W-CDMA, PSA cdma2000 and PSA 1xEVDO) due to the fact that the ACPr node conflicts with the ACPower node.
Initial S/W Revision	Prior to A.02.00
Modified at S/W Revision	A.03.00

## Trigger Source Presets

Here are the Trigger Source Presets for the various measurements:

Meas	Mode	Preset for RF	Preset for IQ	Notes
Swept SA	SA	IMM	IQ not supported	
CHP	SA, WCDMA, C2K, WIMAX OFDMA, 1xEVDO, DVB-T/H, DTMB, LTE, LTETDD, CMMB, ISDB-T, Digital Cable TV, MSR	IMM	IQ not supported	
OBW	SA, WCDMA, C2K, WIMAX OFDMA,	1xEVDO: EXT1 others: IMM	IQ not supported	For 1xEVDO mode, the trigger source is coupled with the gate state, as well as the gate

	TD-SCDMA, 1xEVDO, LTE, LTETDD, CMMB, ISDB-T, MSR			source. When the trigger source changes to RFBurst, External1 or External2, the gate state is set to on, and the gate source is set identically with the trigger source. When the trigger source changes to IMMEDIATE, VIDEO, LINE, FRAME or IF, the gate state is set to off.
CCDF	SA, WCDMA, C2K, WIMAX OFDMA, TD-SCDMA, 1xEV-DO, DVB-T/H, DTMB, LTE, LTETDD, CMMB, ISDB-T, Digital Cable TV, MSR	WIMAX OFDMA: RFBurst LTETDD: BTS: External 1 MS: Periodic Timer TD-SCDMA and 1xEV-DO: BTS: External 1 MS: RFBurst SA, WCDMA, C2K, LTE, CMMB, ISDB-T, DVB-T/H, DTMB, Digital Cable TV, MSR: IMMEDIATE	TD-SCDMA and 1xEV-DO: BTS: External 1 MS: IQMag LTETDD: BTS: External 1 MS: Periodic Timer Others: IMM	For TD-SCDMA: Trigger source is coupled with radio device. When radio device changes to BTS, trigger source will be changed to EXTERNAL1. When radio device changes to MS, trigger source will be set as RFBurst for RF or IQ Mag for BBIQ. When TriggerSource is RFBurst or IQ Mag, Measure Interval is grayed out.
ACP	SA, WCDMA, C2K, WIMAX OFDMA, TD-SCDMA, 1xEVDO, DVB-T/H, DTMB, LTE, LTETDD, CMMB, ISDB-T, Digital Cable TV, MSR	IMM	IQ not supported	
Tx Power	SA, GSM, TD-SCDMA	SA, GSM: RFBurst TD-SCDMA: EXTERNAL	IMM	TD-SCDMA doesn't support the Line and Periodic Timer parameters. When the mode is TD-SCDMA, if the Radio Device is switched to BTS, the value will be changed to External 1 and if the Radio device is switched to MS, the value will be changed to RFBurst
SPUR	SA, WCDMA, C2K, WIMAX OFDMA, TD-SCDMA, 1xEV-DO, DVB-T/H, LTE, LTETDD, MSR	IMM	IQ not supported	
SEM	SA, WCDMA, C2K, WIMAX OFDMA, TD-SCDMA, 1xEVDO, DVB-	1xEVDO(BTS): EXTERNAL1 All others: IMMEDIATE	IQ not supported	

	T/H, DTMB, LTE, LTETDD, CMMB, ISDB-T, Digital Cable TV, MSR			
CDP	WCDMA	IMM	IMM	
RHO	WCDMA	IMM	IMM	
PCON	WCDMA	IMM	IMM	
QPSK	WCDMA, C2K, 1xEVDO	All except CDMA1xEVDO: IMMediate CDMA1xEVDO: EXT1	IMM	
MON	All except SA and BASIC	IMM	IQ not supported	
WAV		LTETDD: BTS: External 1 MS: Periodic Timer GSM/EDGE: RFBurst All others: IMMediate	LTETDD: BTS: External 1 MS: Periodic Timer GSM/EDGE: IQMag All others: IMMMediate	
PVT	WIMAXOFDMA	RFB	IMM	
EVM	WIMAXOFDMA, DVB-T/H, DTMB, LTE, LTETDD, CMMB, ISDB-T, Digital Cable TV	All but CMMB: IMM CMMB: Periodic Timer	All but CMMB: IMM CMMB: External 1	LTE, LTETDD supports Free Run, Video and External 1 only.
SPEC	BASIC	IMM	IMM	
LOG Plot	PN	IMM	IQ not supported	
Spot Freq	PN	IMM	IQ not supported	
GMSK PVT	EDGE/GSM	RFB	IMM	
GMSK PFER	EDGE/GSM	RFB	IQMag	
GMSK ORFS	EDGE/GSM	RF Burst	IQ not supported	
EDGE PVT	EDGE/GSM	RFB	IMM	

EDGE EVM	EDGE/GSM	RFB	IQMag
EDGE ORFS	EDGE/GSM	Periodic Timer	IQ not supported
Combined WCDMA	WCDMA	IMM	IQ not supported
Combined GSM	EDGE/GSM	RFB	IQ not supported
List Power Step	WCDMA, EDGE/GSM	IMM	IQ not supported
Transmit On/Off Power	LTETDD	LTETDD: BTS: External 1 MS: Periodic Timer	LTETDD: BTS: External 1 MS: Periodic Timer
Transmit Analysis	BLUETOOTH	RFB	IQ not supported
Adjacent Channel Power	BLUETOOTH	IMM	IQ not supported
LE In-band Emissions	BLUETOOTH	IMM	IQ not supported
EDR In-band Spurious Emissions	BLUETOOTH	Periodic Timer	IQ not supported
Conformance EVM	LTE, LTETDD, MSR	IMM	IMM

## RF Trigger Source

The RF Trigger Source command selects the trigger to be used for the specified measurement when RF is the selected input. The RF trigger source can be queried and changed even while another input is selected, but it is inactive until RF becomes the selected input.

Note the inclusion of the <measurement> parameter in the command below. Because each measurement remembers its own Trigger Source, the command must be qualified with the measurement name. Note that for the Swept SA measurement this is not the case; for backwards compatibility, no <measurement> parameter is used when setting the Trigger Source for the Swept SA measurement.

<b>Remote Command</b>	<code>:TRIGger:&lt;measurement&gt;[:SEquence]:RF:SOURce EXTernal1   EXTernal2   IMMEDIATE   LINE   FRAME   RFBurst   VIDEO   IF   ALARm   LAN   TV</code> <code>:TRIGger:&lt;measurement&gt;[:SEquence]:RF:SOURce?</code>
-----------------------	------------------------------------------------------------------------------------------------------------------------------------------------------------------------------------------------------------------------------

<b>Example</b>	<code>TRIG:ACP:RF:SOUR EXT1</code> Selects the external 1 trigger input for the ACP measurement and the RF input
----------------	---------------------------------------------------------------------------------------------------------------------

	<p><b>TRIG:RF:SOUR VID</b></p> <p>Selects video triggering for the SANalyzer measurement and the RF input. For SAN, do not use the &lt;measurement&gt; keyword.</p>
Notes	<p>Not all measurements have all the trigger sources available to them. Check the trigger source documentation for your specific measurement to see what sources are available.</p> <p>Not all trigger sources are available for each input. For the RF Trigger Source, the following trigger sources are available:</p> <ul style="list-style-type: none"> <li>–IMMediate - free run triggering</li> <li>–VIDeo - triggers on the video signal level</li> <li>–LINE - triggers on the power line signal</li> <li>–EXTernal1 (or EXTernal) - triggers on an externally connected trigger source marked “Trigger 1 In” on the rear panel</li> <li>–EXTernal2 - triggers on an externally connected trigger source marked “Trigger 2 In” on the front panel. In some models, there is no second External input. In these models, the External 2 key is blanked and the EXTernal2 parameter will generate a “Hardware missing; Not available for this model number” message</li> <li>–RFBurst - triggers on the bursted frame</li> <li>–FRAMe - triggers on the periodic timer</li> <li>–IF (video) - same as video, for backwards compatibility only</li> </ul> <p>*OPC should be used after requesting data. This will hold off any subsequent changes to the selected trigger source, until after the sweep is completed and the data is returned.</p> <p>Available ranges, and presets can vary from mode to mode.</p>
Status Bits/OPC dependencies	<p>The Status Operation Register bit 5 "Waiting for Trigger" is set at the same time as the Sweeping or Measuring bit is set. It is cleared when the trigger actually occurs (that is, after the trigger event occurs and all the applicable trigger criteria have been met). A corresponding pop-up message ("Waiting for trigger") is generated if no trigger signal appears after approximately 2 sec. This message goes away when a trigger signal appears.</p>
Initial S/W Revision	Prior to A.02.00

## I/Q Trigger Source

This command selects the trigger to be used for the specified measurement when I/Q (which requires option BBA) is the selected input. The I/Q trigger source can be queried and changed even while another input is selected, but it is inactive until I/Q becomes the selected input.

<b>Remote Command</b>	<pre>:TRIGger:&lt;measurement&gt;[:SEquence]:IQ:SOURce EXTernal1   EXTernal2   IMMediate   IQMag   IDEMod   QDEMod   IINPut   QINPut   AIQMag  :TRIGger:&lt;measurement&gt;[:SEquence]:IQ:SOURce?</pre>
<b>Example</b>	<p><b>TRIG:WAVeform:SOUR IQM</b></p> <p>Selects I/Q magnitude triggering for the IQ Waveform measurement and the I/Q input</p>
Notes	<p>Not all measurements have all the trigger sources available to them. Check the trigger source documentation for your specific measurement to see what sources are available.</p> <p>Not all trigger sources are available for each input. For the I/Q Trigger Source, the following trigger sources are available:</p>

---

	<ul style="list-style-type: none"> <li>–IMMediate - free run triggering</li> <li>–EXternal1 (or EXternal) - triggers on an externally connected trigger source on the rear panel</li> <li>–EXternal2 - triggers on an externally connected trigger source on the front panel</li> <li>–IQMag - triggers on the magnitude of the I/Q signal</li> <li>–IDEMod - triggers on the I/Q signal's demodulated I voltage</li> <li>–QDEMod - triggers on the I/Q signal's demodulated Q voltage</li> <li>–IINPut - triggers on the I channel's ADC voltage</li> <li>–QINPut - triggers on the Q channel's ADC voltage</li> <li>–AIQMag - triggers on the magnitude of the auxiliary receiver channel I/Q signal</li> </ul> <p>*OPC should be used after requesting data. This will hold off any subsequent changes to the selected trigger source, until after the sweep is completed and the data is returned.</p> <p>Available ranges, and from mode to mode presets can vary</p>
Status Bits/OPC dependencies	The Status Operation Register bit 5 "Waiting for Trigger" is set at the same time as the Sweeping or Measuring bit is set. It is cleared when the trigger actually occurs (that is, after the trigger event occurs and all the applicable trigger criteria have been met). A corresponding pop-up message ("Waiting for trigger") is generated if no trigger signal appears after approximately 2 sec. This message goes away when a trigger signal appears.
Initial S/W Revision	Prior to A.02.00

---

## More Information

The trigger menus let you select the trigger source and trigger settings for a sweep or measurement. In triggered operation (basically, any trigger source other than Free Run), the analyzer will begin a sweep or measurement only with the selected trigger conditions are met, generally when your trigger source signal meets the specified trigger level and polarity requirements. (In FFT measurements, the trigger controls when the data acquisition begins for FFT conversion.)

For each of the trigger sources, you may define a set of operational parameters or settings which will be applied when that source is selected as the current trigger source. Examples of these settings are Trigger Level, Trigger Delay, and Trigger Slope. You may apply different settings for each source; so, for example, you could have a Trigger Level of 1v for External 1 trigger and –10 dBm for Video trigger.

Once you have established the settings for a given trigger source, they generally will remain unchanged for that trigger source as you go from measurement to measurement within a Mode (although the settings do change as you go from Mode to Mode). Furthermore, the trigger settings within a Mode are the same for the **Trigger** menu, the **Gate Source** menu, and the **Sync Source** menu that is part of the **Periodic Timer Trigger Setup** menu. That is, if **Ext1** trigger level is set to 1v in the **Trigger** menu, it will appear as 1v in both the **Gate Source** and the **Sync Source** menus. For these reasons the trigger settings commands are not qualified with the measurement name, the way the trigger source commands are.

The settings setup menu can be accessed by pressing the key for the current trigger source a second time. For example, one press of Video selects the Video trigger as the source. The Video key becomes highlighted and the hollow arrow on the key turns black. Now a second press of the key takes you into the Video Trigger Setup menu.

Trigger Setup Parameters:



The following examples show trigger setup parameters using an external trigger source.

Example 1 illustrates the trigger conditions with negative slope and no trigger occurs during trigger Holdoff time.

Example 2 illustrates the trigger conditions with positive slope, trigger delay, and auto trigger time.

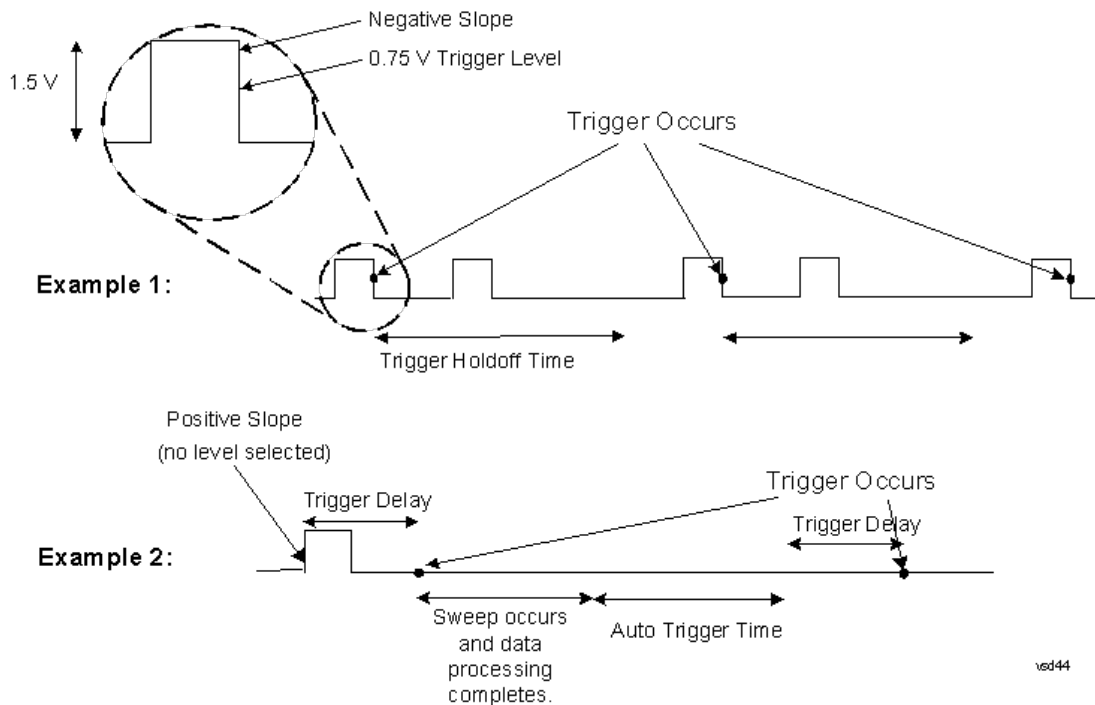

## Free Run

Pressing this key, when it is not selected, selects free-run triggering. Free run triggering occurs immediately after the sweep/measurement is initiated.

Key Path	Trigger
<b>Example</b>	TRIG:SOUR IMM Swept SA measurement TRIG:<meas>:SOUR IMM Measurements other than Swept SA
State Saved	Saved in instrument state
Status Bits/OPC dependencies	The Status Operation Register bit 5 "Waiting for Trigger" is set at the same time as the Sweeping or Measuring bit is set. It is cleared when the trigger actually occurs (that is, after the trigger event occurs and all the applicable trigger criteria have been met). A corresponding pop-up message ("Waiting for trigger") is generated if no trigger signal appears after approximately 2 sec. This message goes away when a trigger signal appears.
Initial S/W Revision	Prior to A.02.00

## Video (IF Envelope)

Pressing this key, when it is not selected, selects the video signal as the trigger. The Video trigger condition is met when the video signal (the filtered and detected version of the input signal, including both RBW and VBW filtering) crosses the video trigger level.

**NOTE** When the detector selected for all active traces is the average detector, the video signal for triggering does not include any VBW filtering.

The video trigger level is shown as a labeled line on the display. The line is displayed as long as video is the selected trigger source.

Pressing this key, when it is already selected, accesses the video trigger setup functions.

Key Path	Trigger
<b>Example</b>	TRIG:SOUR VID Swept SA measurement TRIG:<meas>:SOUR VID Measurements other than Swept SA
Notes	Log Plot and Spot Frequency measurements do not support Video Trigger
Dependencies	Video trigger is allowed in average detector mode.
State Saved	Saved in instrument state
Status Bits/OPC dependencies	The Status Operation Register bit 5 "Waiting for Trigger" is set at the same time as the Sweeping or Measuring bit is set. It is cleared when the trigger actually occurs (that is, after the trigger event occurs and all the applicable trigger criteria have been met). A corresponding pop-up message ("Waiting for trigger") is generated if no trigger signal appears after approximately 2 sec. This message goes away when a trigger signal appears.
Backwards Compatibility Notes	In the past, the Average detector was not available when Video triggering was on, and consequently, functions that set the detector to average (such as Marker Noise or Band/Intvl Power) were not available when the video trigger was on. Similarly, Video triggering was not available when the detector was Average. In the X-Series, these restrictions are removed.
Initial S/W Revision	Prior to A.02.00

## Trigger Level

Sets a level for the video signal trigger. When the video signal crosses this level, with the chosen slope, the trigger occurs. This level is displayed with a horizontal line only if **Video** is the selected trigger source.

Key Path	Trigger, Video
<b>Remote Command</b>	:TRIGger[:SEquence]:VIDeo:LEVel <ampl> :TRIGger[:SEquence]:VIDeo:LEVel?
<b>Example</b>	TRIG:VID:LEV -40 dBm
Notes	When sweep type = FFT, the video trigger uses the amplitude envelope in a bandwidth wider than the FFT width as a trigger source. This might often be useful, but does not have the same relationship between the displayed trace and the trigger level as in swept triggering. Amplitude Corrections are not taken into account by the Video Trig Level. For example, if you have

given yourself effective gain with an amplitude correction factor, the Video Trigger will not fire until you have dropped the trigger line that far below the displayed signal level, rather than simply dropping it down to the displayed signal level.

Note that other corrections, specifically External Gain and Ref Level Offset, modify the actual trace data as it is taken and therefore ARE taken into account by Trig Level.

Couplings	This same level is used for the Video trigger source in the Trigger menu and for the Video selection in the Gate Source menu.
Preset	Set the Video Trigger Level -25 dBm on Preset. When the Video Trigger Level becomes the active function, if the value is off screen, set it to either the top or bottom of screen, depending on which direction off screen it was.
State Saved	Saved in instrument state
Min	-170 dBm
Max	+30 dBm
Default Unit	Depends on the current selected Y axis unit
<b>Backwards Compatibility SCPI</b>	:TRIGger[:SEquence]:IF:LEVel :TRIGger[:SEquence]:IF:LEVel?
Backwards Compatibility Notes	This alias is provided for backward compatibility with VSA/PSA comms apps.
Initial S/W Revision	Prior to A.02.00

## Trig Slope

Controls the trigger polarity. It is set positive to trigger on a rising edge and negative to trigger on a falling edge.

Key Path	Trigger, Video
<b>Remote Command</b>	:TRIGger[:SEquence]:VIDeo:SLOPe POSitive NEGative :TRIGger[:SEquence]:VIDeo:SLOPe?
<b>Example</b>	TRIG:VID:SLOP NEG
Preset	POSitive
State Saved	Saved in instrument state
<b>Backwards Compatibility SCPI</b>	:TRIGger[:SEquence]:IF:SLOPe NEGative POSitive :TRIGger[:SEquence]:IF:SLOPe? For backward compatibility with VSA/PSA comms apps
Backwards Compatibility Notes	The legacy :TRIGger[:SEquence]:SLOPe command affects the slopes for the VID, LINE, EXT1, EXT2, and RFB triggers.
Initial S/W Revision	Prior to A.02.00

<b>Remote Command</b>	:TRIGger[:SEquence]:SLOPe POSitive NEGative :TRIGger[:SEquence]:SLOPe?
<b>Example</b>	TRIG:SLOP NEG
<b>Preset</b>	POSitive
<b>State Saved</b>	Saved in instrument state
<b>Backwards Compatibility Notes</b>	In ESA/PSA, the Trigger Slope was global to all triggers. In the X-Series, the slope can be set individually for each Trigger Source. For backward compatibility, the global SLOPe command updates all instances of trigger slope (VID, LINE, EXT1, EXT2, TV, RFB). The query returns the trigger slope setting of the currently selected trigger source.
<b>Initial S/W Revision</b>	Prior to A.02.00

## Trig Delay

Controls a time delay during that the analyzer will wait to begin a sweep after meeting the trigger criteria. You can use negative delay to pre-trigger the instrument in the time domain or FFT, but not in swept spans.

<b>Key Path</b>	Trigger, Video
<b>Remote Command</b>	:TRIGger[:SEquence]:VIDeo:DELaY <time> :TRIGger[:SEquence]:VIDeo:DELaY? :TRIGger[:SEquence]:VIDeo:DELaY:STATe OFF ON 0 1 :TRIGger[:SEquence]:VIDeo:DELaY:STATe?
<b>Example</b>	TRIG:VID:DEL:STAT ON TRIG:VID:DEL 100 ms
<b>Notes</b>	Video trigger delay may be set to negative values, in time domain, FFT and even swept. It makes intuitive sense in time domain and works well in FFT mode where the bandwidth of the filter before the video trigger is about 1.25 span. In swept spans, negative settings of Trig Delay are treated as a zero setting within the internal hardware and the advisory message "Neg. Trig Delay unavailable in Swept Mode, zero delay used." is generated when such a delay is set.
<b>Preset</b>	Off, 1 us
<b>State Saved</b>	Saved in instrument state
<b>Min</b>	-150 ms
<b>Max</b>	+500 ms
<b>Default Unit</b>	s
<b>Backwards Compatibility Notes</b>	! For backward compatibility with VSA/PSA comms apps :TRIGger[:SEquence]:IF:DELaY :TRIGger[:SEquence]:DELaY The legacy :TRIGger[:SEquence]:DELaY command affects the delay for the VID, LINE, EXT1, EXT2, and RFB triggers.
<b>Initial S/W Revision</b>	Prior to A.02.00

<b>Remote Command</b>	:TRIGger[:SEquence]:DELay <time> :TRIGger[:SEquence]:DELay? :TRIGger[:SEquence]:DELay:STATE OFF ON 0 1 :TRIGger[:SEquence]:DELay:STATE?
<b>Example</b>	TRIG:DEL 1 ms
<b>Preset</b>	1 us
<b>State Saved</b>	Saved in instrument state
<b>Backwards Compatibility Notes</b>	In ESA/PSA, the Trigger Delay was global to all triggers. In the X-Series, the delay can be set individually for each Trigger Source. For backward compatibility, the global DELay command updates all instances of trigger slope (VID, LINE, EXT1, EXT2) except TV and RFBurst. The query returns the trigger delay setting of the currently selected trigger source.
<b>Initial S/W Revision</b>	Prior to A.02.00

<b>Remote Command</b>	:TRIGger[:SEquence]:OFFSet <time> :TRIGger[:SEquence]:OFFSet? :TRIGger[:SEquence]:OFFSet:STATE OFF ON 0 1 :TRIGger[:SEquence]:OFFSet:STATE?
<b>Example</b>	TRIG:OFFS ON TRIG:OFFS -100 ms
<b>Notes</b>	These are ESA commands for trigger offset that allowed you to use a positive or negative delay when in zero span and in a Res BW $\geq$ 1 kHz. For ESA compatibility, X-series analyzers keep track of this offset and adds it to the Trigger Delay for VIDEo, LINE, EXTernal1 or EXTernal2 whenever the value is sent to the hardware, if in Zero Span and RBW $\geq$ 1 kHz.
<b>Preset</b>	Off, 0 s
<b>State Saved</b>	Saved in instrument state
<b>Min</b>	-11 s
<b>Max</b>	+11 s
<b>Initial S/W Revision</b>	Prior to A.02.00

## Line

Pressing this key, when it is not selected, selects the line signal as the trigger. A new sweep/measurement will start synchronized with the next cycle of the line voltage. Pressing this key, when it is already selected, access the line trigger setup menu.

<b>Key Path</b>	Trigger
<b>Example</b>	TRIG:SOUR LINE Swept SA measurement TRIG:<meas>:SOUR LINE Measurements other than Swept SA
<b>Dependencies</b>	Line trigger is not available when operating from a "dc power source", for example, when the

	instrument is powered from batteries.
State Saved	Saved in instrument state
Status Bits/OPC dependencies	The Status Operation Register bit 5 "Waiting for Trigger" is set at the same time as the Sweeping or Measuring bit is set. It is cleared when the trigger actually occurs (that is, after the trigger event occurs and all the applicable trigger criteria have been met). A corresponding pop-up message ("Waiting for trigger") is generated if no trigger signal appears after approximately 2 sec. This message goes away when a trigger signal appears.
Initial S/W Revision	Prior to A.02.00

### Trig Slope

Controls the trigger polarity. It is set positive to trigger on a rising edge and negative to trigger on a falling edge.

Key Path	Trigger, Line
Remote Command	:TRIGger[:SEquence]:LINE:SLOPe POSitive NEGative :TRIGger[:SEquence]:LINE:SLOPe?
Example	TRIG:LINE:SLOP NEG
Preset	POSitive
State Saved	Saved in instrument state
Backwards Compatibility Notes	The legacy :TRIGger[:SEquence]:SLOPe command affects the slopes for the VID, LINE, EXT1, EXT2, and RFB triggers.
Initial S/W Revision	Prior to A.02.00

### Trig Delay

Controls a time delay during which the analyzer will wait to begin a sweep after meeting the trigger criteria. You can use negative delay to pre-trigger the instrument in time domain or FFT, but not in swept spans.

Key Path	Trigger, Line
Remote Command	:TRIGger[:SEquence]:LINE:DELay <time> :TRIGger[:SEquence]:LINE:DELay? :TRIGger[:SEquence]:LINE:DELay:STATe OFF ON 0 1 :TRIGger[:SEquence]:LINE:DELay:STATe?
Example	TRIG:LINE:DEL:STAT ON TRIG:LINE:DEL 100 ms
Notes	Video trigger delay may be set to negative values, in time domain, FFT and even swept. It makes intuitive sense in time domain and works well in FFT mode where the bandwidth of the filter before the video trigger is about 1.25 span. In swept spans, negative settings of Trig Delay are treated as a

	zero setting within the internal hardware and the advisory message "Neg. Trig Delay unavailable in Swept Mode, zero delay used." is generated when such a delay is set.
Preset	Off, 1.000 us
State Saved	Saved in instrument state
Min	-150 ms
Max	500 ms
Default Unit	S
Backwards Compatibility Notes	The legacy :TRIGger[:SEQuence]:DELay command affects the delay for the VID, LINE, EXT1, EXT2, and RFB triggers. The legacy :TRIGger[:SEQuence]:OFFSet command is supported for the VIDeo, LINE, EXT1, and EXT2 triggers.
Initial S/W Revision	Prior to A.02.00

## External 1

Pressing this key, when it is not selected, selects an external input signal as the trigger. A new sweep/measurement will start when the external trigger condition is met using the external 1 input connector on the rear panel.

Pressing this key, when it is already selected, accesses the external 1 trigger setup menu.

Key Path	Trigger
<b>Example</b>	TRIG:SOUR EXT1 Swept SA measurement TRIG:<meas>:SOUR EXT1 Measurements other than Swept SA
Dependencies	Grayed out if in use by Point Trigger in the Source Setup menu. Forced to Free Run if already selected and Point Trigger is set to External 1.
State Saved	Saved in instrument state
Status Bits/OPC dependencies	The Status Operation Register bit 5 "Waiting for Trigger" is set at the same time as the Sweeping or Measuring bit is set. It is cleared when the trigger actually occurs (that is, after the trigger event occurs and all the applicable trigger criteria have been met). A corresponding pop-up message ("Waiting for trigger") is generated if no trigger signal appears after approximately 2 sec. This message goes away when a trigger signal appears.
Initial S/W Revision	Prior to A.02.00

## Trigger Level

Sets the value where the external 1 trigger input will trigger a new sweep/measurement.

Key Path	Trigger, External 1
<b>Remote Command</b>	:TRIGger[:SEQuence]:EXTernal1:LEVel <level>

	:TRIGger[:SEquence]:EXTernal1:LEVel?
<b>Example</b>	TRIG:EXT1:LEV 0.4 V
Couplings	This same level is used for the Ext1 trigger source in the Trigger menu, for the Ext1 selection in the Periodic Timer sync source (in the Trigger menu and in the Gate Source menu), and also for the Ext1 selection in the Gate Source menu.
Preset	1.2 V
State Saved	Saved in instrument state
Min	-5 V
Max	5 V
Default Unit	V
<b>Backwards Compatibility SCPI</b>	:TRIGger[:SEquence]:EXTernal:LEVel
<b>Backwards Compatibility SCPI</b>	For backward compatibility, the parameter EXTernal is mapped to EXTernal1
<b>Backwards Compatibility SCPI</b>	:TRIGger[:SEquence]:FRAMe:EXTernal1:LEVel
Initial S/W Revision	Prior to A.02.00

## Trig Slope

Controls the trigger polarity. It is set positive to trigger on a rising edge and negative to trigger on a falling edge.

Key Path	Trigger, External 1
<b>Remote Command</b>	:TRIGger[:SEquence]:EXTernal1:SLOPe POSitive NEGative :TRIGger[:SEquence]:EXTernal1:SLOPe?
<b>Example</b>	TRIG:EXT1:SLOP NEG
Couplings	This same slope is used in the Ext1 selection for the trigger source in the Trigger menu and for the period timer sync source (in the Trigger menu and in the Gate Source menu).
Preset	POSitive
State Saved	Saved in instrument state
<b>Backwards Compatibility SCPI</b>	:TRIGger[:SEquence]:EXTernal:SLOPe
<b>Backwards Compatibility SCPI</b>	For backward compatibility, the parameter EXTernal is mapped to EXTernal1
<b>Backwards Compatibility SCPI</b>	:TRIGger[:SEquence]:FRAMe:EXTernal1:SLOPe
Backwards Compatibility Notes	The legacy :TRIGger[:SEquence]:SLOPe command affects the slopes for the VID, LINE, EXT1, EXT2, and RFB triggers.
Initial S/W Revision	Prior to A.02.00



## Trig Delay

Controls a time delay during which the analyzer will wait to begin a sweep after meeting the trigger criteria. You can use negative delay to pre-trigger the instrument in time domain or FFT, but not in swept spans.

Key Path	Trigger, External 1
Remote Command	:TRIGger[:SEquence]:EXTernal1:DElay <time> :TRIGger[:SEquence]:EXTernal1:DElay? :TRIGger[:SEquence]:EXTernal1:DElay:STATe OFF ON 0 1 :TRIGger[:SEquence]:EXTernal1:DElay:STATe?
Example	TRIG:EXT1:DEL:STAT ON TRIG:EXT1:DEL 100 ms
Notes	Video trigger delay may be set to negative values, in time domain, FFT and even swept. It makes intuitive sense in time domain and works well in FFT mode where the bandwidth of the filter before the video trigger is about 1.25 span. In swept spans, negative settings of Trig Delay are treated as a zero setting within the internal hardware and the advisory message "Neg. Trig Delay unavailable in Swept Mode, zero delay used." is generated when such a delay is set.
Preset	Off, 1.000 us
State Saved	Saved in instrument state
Min	-150 ms
Max	+500 ms
Default Unit	s
Backwards Compatibility SCPI	:TRIGger[:SEquence]:EXTernal:DElay For backward compatibility, the parameter EXTernal is mapped to EXTernal1
Backwards Compatibility Notes	The legacy :TRIGger[:SEquence]:DElay command affects the delay for the VID, LINE, EXT1, EXT2, and RFB triggers. The legacy :TRIGger[:SEquence]:OFFSet command is supported for the VIDeO, LINE, EXT1, and EXT2 triggers.
Initial S/W Revision	Prior to A.02.00

## External 2

Pressing this key, when it is not selected, selects an external input signal as the trigger. A new sweep/measurement will start when the external trigger condition is met using the external 2 input connector. The external trigger 2 input connector is on the rear panel.

Pressing this key, when it is already selected, accesses the external 2 trigger setup menu.

Key Path	Trigger
Example	TRIG:SOUR EXT2 Swept SA measurement TRIG:<meas>:SOUR EXT2 Measurements other than Swept SA
Dependencies	In some models, there is no second External input. In these models, the External 2 key is blanked and

	<p>the EXTERNAL2 parameter will generate a "Hardware missing; Not available for this model number" message.</p> <p>Grayed out if in use by Point Trigger in the Source Setup menu.</p> <p>Forced to Free Run if already selected and Point Trigger is set to External 2.</p>
State Saved	Saved in instrument state
Status Bits/OPC dependencies	The Status Operation Register bit 5 "Waiting for Trigger" is set at the same time as the Sweeping or Measuring bit is set. It is cleared when the trigger actually occurs (that is, after the trigger event occurs and all the applicable trigger criteria have been met). A corresponding pop-up message ("Waiting for trigger") is generated if no trigger signal appears after approximately 2 sec. This message goes away when a trigger signal appears.
Initial S/W Revision	Prior to A.02.00
Modified at S/W Revision	A.03.00

### Trigger Level

Sets the value where the external 2 trigger input will trigger a new sweep/measurement.

Key Path	Trigger, External 2
Remote Command	:TRIGger[:SEquence]:EXTERNAL2:LEVEL :TRIGger[:SEquence]:EXTERNAL2:LEVEL?
Example	TRIG:EXT2:LEV 1.1 V
Couplings	This same level is used for the Ext2 trigger source in the Trigger menu, for the Ext2 selection in the Periodic Timer sync source (in the Trigger menu and in the Gate Source menu), and also for the Ext2 selection in the Gate Source menu.
Preset	1.2 V
State Saved	Saved in instrument state
Min	-5 V
Max	5 V
Default Unit	V
Backwards Compatibility SCPI	:TRIGger[:SEquence]:FRAME:EXTERNAL2:LEVEL
Initial S/W Revision	Prior to A.02.00

### Trig Slope

Controls the trigger polarity. It is set positive to trigger on a rising edge and negative to trigger on a falling edge.

Key Path	Trigger, External 2
Remote Command	:TRIGger[:SEquence]:EXTERNAL2:SLOPe POSitive NEGative

	:TRIGger[:SEquence]:EXTernal2:SLOPe?
<b>Example</b>	TRIG:EXT2:SLOP NEG
Couplings	This same slope is used in the Ext2 selection for the trigger source in the Trigger menu and for the period timer sync source (in the Trigger menu and in the Gate Source menu).
Preset	POSitive
State Saved	Saved in instrument state
<b>Backwards Compatibility SCPI</b>	:TRIGger[:SEquence]:FRAMe:EXTernal2:SLOPe
Backwards Compatibility Notes	The legacy :TRIGger[:SEquence]:SLOPe command affects the slopes for the VID, LINE, EXT1, EXT2, and RFB triggers.
Initial S/W Revision	Prior to A.02.00

## Trig Delay

Controls a time delay during which the analyzer will wait to begin a sweep after meeting the trigger criteria. You can use negative delay to pre-trigger the instrument in time domain or FFT, but not in swept spans.

Key Path	Trigger, External 2
<b>Remote Command</b>	:TRIGger[:SEquence]:EXTernal2:DELAy <time> :TRIGger[:SEquence]:EXTernal2:DELAy? :TRIGger[:SEquence]:EXTernal2:DELAy:STATe OFF ON 0 1 :TRIGger[:SEquence]:EXTernal2:DELAy:STATe?
<b>Example</b>	TRIG:EXT2:DEL:STAT ON TRIG:EXT2:DEL 100 ms
Notes	Video trigger delay may be set to negative values, in time domain, FFT and even swept. It makes intuitive sense in time domain and works well in FFT mode where the bandwidth of the filter before the video trigger is about 1.25 span. In swept spans, negative settings of Trig Delay are treated as a zero setting within the internal hardware and the advisory message "Neg. Trig Delay unavailable in Swept Mode, zero delay used." is generated when such a delay is set.
Preset	Off, 1.000 us
State Saved	Saved in instrument state
Min	-150 ms
Max	500 ms
Default Unit	s
Backwards Compatibility Notes	The legacy :TRIGger[:SEquence]:DELAy command affects the delay for the VID, LINE, EXT1, EXT2, and RFB triggers. The legacy :TRIGger[:SEquence]:OFFSet command is supported for the VIDeO, LINE, EXT1, and EXT2 triggers.
Initial S/W Revision	Prior to A.02.00

## RF Burst

Pressing this key, when it is not selected, selects the RF Burst as the trigger. A new sweep/measurement will start when an RF burst envelope signal is identified from the signal at the RF Input connector. Pressing this key, when it is already selected, accesses the RF Burst trigger setup menu.

In some models, a variety of burst trigger circuitry is available, resulting in various available burst trigger bandwidths. The analyzer automatically chooses the appropriate trigger path based on the hardware configuration and other settings of the analyzer.

Key Path	Trigger
<b>Example</b>	TRIG:SOUR RFB Swept SA measurement TRIG:<meas>:SOUR RFB Measurements other than Swept SA
State Saved	Saved in instrument state
Status Bits/OPC dependencies	The Status Operation Register bit 5 "Waiting for Trigger" is set at the same time as the Sweeping or Measuring bit is set. It is cleared when the trigger actually occurs (that is, after the trigger event occurs and all the applicable trigger criteria have been met). A corresponding pop-up message ("Waiting for trigger") is generated if no trigger signal appears after approximately 2 sec. This message goes away when a trigger signal appears.
Backwards Compatibility Notes	The legacy command: :TRIGger[:SEQuence]:RFBurst:FSElectivity[:STATe] OFF ON 0 1 is not supported in the X-Series, as the hardware to do Frequency Selective burst triggers does not exist in X-Series.
Initial S/W Revision	Prior to A.02.00
Modified at S/W Revision	A.04.00

## Absolute Trigger Level

Sets the absolute trigger level for the RF burst envelope.

When using the External Mixing path, the Absolute Trigger Level is uncalibrated because the factory default was set to accommodate the expected IF levels for the RF path.

Key Path	Trigger, RF Burst
Scope	Meas Global
<b>Remote Command</b>	:TRIGger[:SEQuence]:RFBurst:LEVel:ABSolute <ampl> :TRIGger[:SEQuence]:RFBurst:LEVel:ABSolute?
<b>Example</b>	TRIG:RFB:LEV:ABS 10 dBm sets the trigger level of the RF burst envelope signal to the absolute level of 10 dBm
Notes	Sending this command does not switch the setting from relative to absolute; to switch it you need to send the :TRIGger[:SEQuence]:RFBurst:LEVel:TYPE command, below. Amplitude Corrections are not taken into account by the Absolute Trigger Level. For example, if you have given yourself effective gain with an amplitude correction factor, the Absolute Trigger will not fire until you have set the trigger level that far below the displayed signal level, rather than simply to

	the displayed signal level. This is only true for Amplitude Corrections, not External Gain or Ref Level Offset functions. If mode is Bluetooth, the default value is -50 dBm.
Couplings	This same level is used for the RF Burst trigger source in the Trigger menu, for the RF Burst selection in the Periodic Timer sync source (in the Trigger menu and in the Gate Source menu), and also for the RF Burst selection in the Gate Source menu
Preset	-20 dBm
State Saved	Saved in instrument state
Min	-200 dBm
Max	100 dBm
Default Unit	depends on the current selected Y-Axis unit
<b>Backwards Compatibility SCPI</b>	:TRIGger[:SEquence]:FRAMe:RFBurst:LEVel:ABSolute
Initial S/W Revision	Prior to A.02.00
Modified at S/W Revision	A.04.00
<hr/>	
Key Path	Trigger, RF Burst
<b>Remote Command</b>	:TRIGger[:SEquence]:RFBurst:LEVel:TYPE ABSolute RELative :TRIGger[:SEquence]:RFBurst:LEVel:TYPE?
<b>Example</b>	TRIG:RFB:LEV:TYPE REL sets the trigger level type of the RF burst trigger to Relative.
Preset	ABSolute
State Saved	Saved in instrument state
Initial S/W Revision	Prior to A.02.00
Modified at S/W Revision	A.04.00

## Relative Trigger Level

Sets the relative trigger level for the RF burst envelope.

In some models, the relative burst trigger function is implemented in hardware. In other models, without the advanced triggering hardware required, the relative burst trigger function is implemented in software in some measurements, and is unavailable in other measurements.

When implemented in software, the relative RF Burst trigger function is implemented as follows:

1. The measurement starts with the absolute RF Burst trigger setting. If it cannot get a trigger with that level, auto trigger fires and the acquisition starts anyway. After the acquisition, the measurement searches for the peak in the acquired waveform and saves it.

2. Now, in the next cycle of the measurement, the measurement determines a new absolute RF Burst level based on the peak value from the first measurement and the Relative RF Burst Trigger Level (always 0 or negative dB) set by the user. The following formula is used:
  3. absolute RF Burst level = peak level of the previous acquisition + relative RF Burst level
  4. If the new absolute RF Burst level differs from the previous by more than 0.5 dB, the new level is sent to the hardware; otherwise it is not updated (to avoid slowing down the acquisition)
- Steps 2 and 3 repeat for subsequent measurements.

Key Path	Trigger, RF Burst
Scope	Meas Global
Remote Command	:TRIGger[:SEquence]:RFBurst:LEVel:RELative <rel_ampl> :TRIGger[:SEquence]:RFBurst:LEVel:RELative?
Example	TRIG:RFB:LEV:REL -10 dB sets the trigger level of the RF burst envelope signal to the relative level of -10 dB
Notes	Sending this command does not switch the setting from absolute to relative; to switch it you need to send the :TRIGger[:SEquence]:RFBurst:LEVel:TYPE command, above. The relative trigger level is not available in some measurements. In those measurements the RELative parameter, and the :TRIGger[:SEquence]:RFBurst:LEVel:TYPE command (above), will generate an error if sent.
Dependencies	This key is grayed out and Absolute Trigger Level selected if the required hardware is not present in your analyzer and the current measurement does not support Relative triggering.
Preset	-6 dB GSM: -25 dB
State Saved	Saved in instrument state
Min	-45 dB
Max	0 dB
Default Unit	dB or dBc
Backwards Compatibility SCPI	:TRIGger[:SEquence]:RFBurst:LEVel This legacy command is aliased to :TRIGger[:SEquence]:RFBurst:LEVel:RELative because the PSA had ONLY relative burst triggering
Initial S/W Revision	Prior to A.02.00
Modified at S/W Revision	A.04.00

## Trigger Slope

It is set positive to trigger on a rising edge and negative to trigger on a falling edge.

Key Path	Trigger, RF Burst
Remote Command	:TRIGger[:SEquence]:RFBurst:SLOPe POSitive NEGative :TRIGger[:SEquence]:RFBurst:SLOPe?

<b>Example</b>	TRIG:RFB:SLOP NEG
Couplings	This same slope is used in the RF Burst selection for the trigger source in the Trigger menu and for the period timer sync source (in the Trigger menu and in the Gate Source menu).
Preset	POSitive
State Saved	Saved in instrument state
<b>Backwards Compatibility SCPI</b>	:TRIGger[:SEQuence]:FRAMe:RFBurst:SLOPe
Backwards Compatibility Notes	The legacy :TRIGger[:SEQuence]:SLOPe command affects the slopes for the VID, LINE, EXT1, EXT2, and RFB triggers.
Initial S/W Revision	Prior to A.02.00

## Trig Delay

Controls a time delay during which the analyzer will wait to begin a sweep after meeting the trigger criteria. You can use negative delay to pre-trigger the instrument in time domain or FFT, but not in swept spans.

Key Path	Trigger, RF Burst
<b>Remote Command</b>	:TRIGger[:SEQuence]:RFBurst:DELay <time> :TRIGger[:SEQuence]:RFBurst:DELay? :TRIGger[:SEQuence]:RFBurst:DELay:STATe OFF ON 0 1 :TRIGger[:SEQuence]:RFBurst:DELay:STATe?
<b>Example</b>	TRIG:RFB:DEL:STAT ON TRIG:RFB:DEL 100 ms
Notes	Video trigger delay may be set to negative values, in time domain, FFT and even swept. It makes intuitive sense in time domain and works well in FFT mode where the bandwidth of the filter before the video trigger is about 1.25 span. In swept spans, negative settings of Trig Delay are treated as a zero setting within the internal hardware and the advisory message "Neg. Trig Delay unavailable in Swept Mode, zero delay used." is generated when such a delay is set.
Preset	Off, 1.000 us
State Saved	Saved in instrument state
Min	-150 ms
Max	500 ms
Default Unit	s
Backwards Compatibility Notes	The legacy :TRIGger[:SEQuence]:DELay command affects the delay for the VID, LINE, EXT1, EXT2, and RFB triggers.
Initial S/W Revision	Prior to A.02.00

## Periodic Timer (Frame Trigger)

Pressing this key, when it is not selected, selects the internal periodic timer signal as the trigger. Triggering occurrences are set by the **Period** parameter, which is modified by the **Sync Source** and **Offset**. Pressing this key, when it is already selected, accesses the periodic timer trigger setup functions.

If you do not have a sync source selected (it is Off), then the internal timer will not be synchronized with any external timing events.

Key Path	Trigger
<b>Example</b>	TRIG:SOUR FRAM Swept SA measurement TRIG:< meas>:SOUR FRAM Measurements other than Swept SA
State Saved	Saved in instrument state
Readback	[Sync: <value of Sync Source>], for example, [Sync: External 1]
Status Bits/OPC dependencies	The Status Operation Register bit 5 "Waiting for Trigger" is set at the same time as the Sweeping or Measuring bit is set. It is cleared when the trigger actually occurs (that is, after the trigger event occurs and all the applicable trigger criteria have been met). A corresponding pop-up message ("Waiting for trigger") is generated if no trigger signal appears after approximately 2 sec. This message goes away when a trigger signal appears.
Initial S/W Revision	Prior to A.02.00

Periodic Timer Triggering:

This feature selects the internal periodic timer signal as the trigger. Trigger occurrences are set by the **Periodic Timer** parameter, which is modified by the **Sync Source** and **Offset**.

The figure below shows the action of the periodic timer trigger. Before reviewing the figure, we'll explain some uses for the periodic trigger.

A common application is measuring periodic burst RF signals for which a trigger signal is not easily available. For example, we might be measuring a TDMA radio which bursts every 20 ms. Let's assume that the 20 ms period is very consistent. Let's also assume that we do not have an external trigger source available that is synchronized with the period, and that the signal-to-noise ratio of the signal is not high enough to provide a clean RF burst trigger at all of the analysis frequencies. For example, we might want to measure spurious transmissions at an offset from the carrier that is larger than the bandwidth of the RF burst trigger. In this application, we can set the Periodic Timer to a 20.00 ms period and adjust the offset from that timer to position our trigger just where we want it. If we find that the 20.00 ms is not exactly right, we can adjust the period slightly to minimize the drift between the period timer and the signal to be measured.

A second way to use this feature would be to use **Sync Source** temporarily, instead of **Offset**. In this case, we might tune to the signal in a narrow span and use the RF Burst trigger to synchronize the periodic timer. Then we would turn the sync source off so that it would not miss-trigger. Miss-triggering can occur when we are tuned so far away from the RF burst trigger that it is no longer reliable.

A third example would be to synchronize to a signal that has a reference time element of much longer period than the period of interest. In some CDMA applications, it is useful to look at signals with a short periodicity, by synchronizing that periodicity to the "even-second clock" edge that happens every two



seconds. Thus, we could connect the even-second clock trigger to Ext1 and use then Ext1 as the sync source for the periodic timer.

The figure below illustrates this third example. The top trace represents the even-second clock. It causes the periodic timer to synchronize with the leading edge shown. The analyzer trigger occurs at a time delayed by the accumulated offset from the period trigger event. The periodic timer continues to run, and triggers continue to occur, with a periodicity determined by the analyzer time base. The timer output (labeled "late event") will drift away from its ideal time due to imperfect matching between the time base of the signal being measured and the time base of the analyzer, and also because of imperfect setting of the period parameter. But the synchronization is restored on the next even-second clock event. ("Accumulated offset" is described in the in the **Offset** function section.)

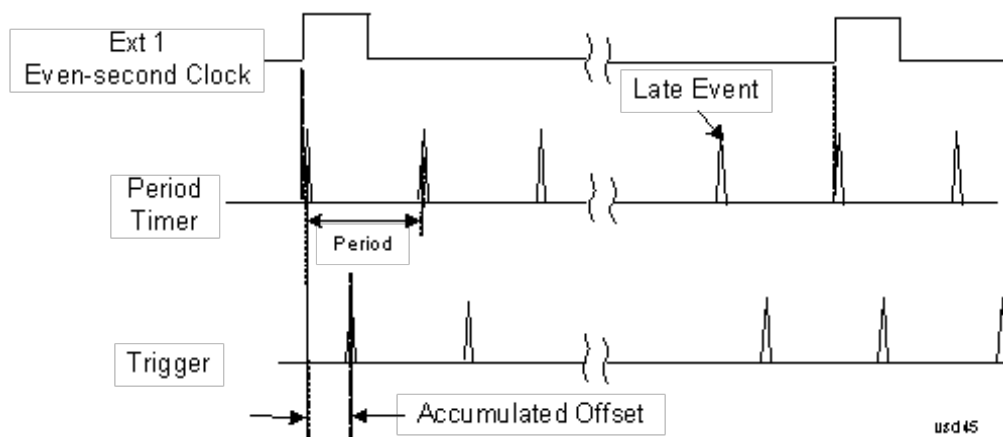

## Period

Sets the period of the internal periodic timer clock. For digital communications signals, this is usually set to the frame period of your current input signal. In the case that sync source is not set to OFF, and the external sync source rate is changed for some reason, the periodic timer is synchronized at the every external synchronization pulse by resetting the internal state of the timer circuit.

Key Path	Trigger, Periodic Timer
Remote Command	:TRIGger[:SEquence]:FRAMe:PERiod <time> :TRIGger[:SEquence]:FRAMe:PERiod?
Example	TRIG:FRAM:PER 100 ms
Dependencies	The invalid data indicator turns on when the period is changed, until the next sweep/measurement completes.
Couplings	The same period is used in the Gate Source selection of the period timer.
Preset	20 ms GSM: 4.615383
State Saved	Saved in instrument state
Min	100.000 ns
Max	559.0000 ms
Default Unit	S
Initial S/W Revision	Prior to A.02.00

## Offset

Adjusts the accumulated offset between the periodic timer events and the trigger event. Adjusting the accumulated offset is different than setting an offset, and requires explanation.

The periodic timer is usually not synchronized with any external events, so the timing of its output events has no absolute meaning. Since the timing relative to external events (RF signals) is important, you need to be able to adjust (offset) it. However, you have no direct way to see when the periodic timer events occur. All that you can see is the trigger timing. When you want to adjust the trigger timing, you will be changing the internal offset between the periodic timer events and the trigger event. Because the absolute value of that internal offset is unknown, we will just call that the accumulated offset. Whenever the Offset parameter is changed, you are changing that accumulated offset. You can reset the displayed offset using Reset Offset Display. Changing the display does not change the value of the accumulated offset, and you can still make additional changes to accumulated offset.

To avoid ambiguity, we define that an increase in the "offset" parameter, either from the knob or the SCPI adjust command, serves to delay the timing of the trigger event.

<b>Key Path</b>	Trigger, Periodic Timer
<b>Remote Command</b>	:TRIGger[:SEquence]:FRAMe:OFFSet <time> :TRIGger[:SEquence]:FRAMe:OFFSet?
<b>Example</b>	TRIG:FRAM:OFFS 1.2 ms
<b>Notes</b>	<p>The front panel interface (for example, the knob), and this command, adjust the accumulated offset, which is shown on the active function display. However, the actual amount sent to the hardware each time the offset is updated is the delta value, that is, the current accumulated offset value minus the previous accumulated offset value. Note that the accumulated offset value is essentially arbitrary; it represents the accumulated offset from the last time the offset was zeroed (with the Reset Offset Display key).</p> <p>Note that this command does not change the period of the trigger waveform. Note also that Offset is used only when the sync source is set to OFF, otherwise delay is used, see section "<a href="#">Trig Delay</a>" on <a href="#">page 461</a>.</p> <p>An increase in the "offset" parameter, either from the knob or the SCPI adjust command, serves to delay the timing of the trigger event.</p>
<b>Notes</b>	<p>When the SCPI command is sent the value shown on the key (and the Active Function, if this happens to be the active function) is updated with the new value. However, the actual amount sent to the hardware is the delta value, that is, the current accumulated offset value minus the previous accumulated offset value.</p> <p>The SCPI query simply returns the value currently showing on the key.</p>
<b>Dependencies</b>	The invalid data indicator turns on when the offset is changed, until the next sweep/measurement completes.
<b>Couplings</b>	The same offset is used in the Gate Source selection of the period timer.
<b>Preset</b>	0 s
<b>State Saved</b>	Saved in instrument state
<b>Min</b>	-10.000 s
<b>Max</b>	10.000 s

Default Unit	S
Initial S/W Revision	Prior to A.02.00

## Reset Offset Display

Resets the value of the periodic trigger offset display setting to 0.0 seconds. The current displayed trigger location may include an offset value defined with the Offset key. Pressing this key redefines the currently displayed trigger location as the new trigger point that is 0.0 s offset. The Offset key can then be used to add offset relative to this new timing.

Key Path	Trigger, Periodic Timer
<b>Remote Command</b>	:TRIGger[:SEquence]:FRAMe:OFFSet:DISPlay:RESet
<b>Example</b>	TRIG:FRAM:OFFS:DISP:RES
Initial S/W Revision	Prior to A.02.00

## Sync Source

Selects a signal source for you to synchronize your periodic timer trigger to, otherwise you are triggering at some arbitrary location in the frame. Synchronization reduces the precision requirements on the setting of the period.

For convenience you may adjust the level and slope of the selected sync source in a conditional branch setup menu accessed from the Sync Source menu. Note that these settings match those in the **Trigger** and **Gate Source** menus; that is, each trigger source has only one value of level and slope, regardless of which menu it is accessed from.

Key Path	Trigger, Periodic Timer
<b>Remote Command</b>	:TRIGger[:SEquence]:FRAMe:SYNC EXTernal1   EXTernal2   RFBurst   OFF :TRIGger[:SEquence]:FRAMe:SYNC?
<b>Example</b>	TRIG:FRAM:SYNC EXT2
Dependencies	In some models, there is no second External input. In these models, the External 2 key is blanked and the EXTernal2 parameter will generate a "Hardware missing; Not available for this model number" message.
Preset	Off GSM/EDGE, MSR,LTE,LTETDD: RFBurst
State Saved	Saved in instrument state
Readback	The current setting is read back to this key and it is also Readback to the previous Periodic Timer trigger key.
<b>Backwards Compatibility SCPI</b>	:TRIGger[:SEquence]:FRAMe:SYNC EXTernal For backward compatibility, the parameter EXTernal is mapped to EXTernal1
Initial S/W Revision	Prior to A.02.00
Modified at S/W Revision	A.03.00, A.14.00

## Off

Turns off the sync source for your periodic trigger. With the sync source off, the timing will drift unless the signal source frequency is locked to the analyzer frequency reference.

Key Path	Trigger, Periodic Timer, Sync Source
<b>Example</b>	TRIG:FRAM:SYNC OFF
Readback	Off
Initial S/W Revision	Prior to A.02.00

## External 1

Pressing this key, when it is not selected, selects an external input signal as the trigger. A new sweep/measurement will start when the external trigger condition is met using the external 1 input connector on the rear panel.

Pressing this key, when it is already selected, accesses the external 1 trigger setup menu.

Key Path	Trigger
<b>Example</b>	TRIG:SOUR EXT1          Swept SA measurement TRIG:<meas>:SOUR EXT1   Measurements other than Swept SA
Dependencies	Grayed out if in use by Point Trigger in the Source Setup menu. Forced to Free Run if already selected and Point Trigger is set to External 1.
State Saved	Saved in instrument state
Status Bits/OPC dependencies	The Status Operation Register bit 5 "Waiting for Trigger" is set at the same time as the Sweeping or Measuring bit is set. It is cleared when the trigger actually occurs (that is, after the trigger event occurs and all the applicable trigger criteria have been met). A corresponding pop-up message ("Waiting for trigger") is generated if no trigger signal appears after approximately 2 sec. This message goes away when a trigger signal appears.
Initial S/W Revision	Prior to A.02.00

## Trigger Level

Sets the value where the external 1 trigger input will trigger a new sweep/measurement.

Key Path	Trigger, External 1
<b>Remote Command</b>	:TRIGger[:SEquence]:EXTernal1:LEVel <level> :TRIGger[:SEquence]:EXTernal1:LEVel?
<b>Example</b>	TRIG:EXT1:LEV 0.4 V
Couplings	This same level is used for the Ext1 trigger source in the Trigger menu, for the Ext1 selection in the Periodic Timer sync source (in the Trigger menu and in the Gate Source menu), and also for the Ext1

	selection in the Gate Source menu.
Preset	1.2 V
State Saved	Saved in instrument state
Min	-5 V
Max	5 V
Default Unit	V
<b>Backwards Compatibility SCPI</b>	:TRIGger[:SEquence]:EXTernal:LEVel
	For backward compatibility, the parameter EXTernal is mapped to EXTernal1
<b>Backwards Compatibility SCPI</b>	:TRIGger[:SEquence]:FRAMe:EXTernal1:LEVel
Initial S/W Revision	Prior to A.02.00

### Trig Slope

Controls the trigger polarity. It is set positive to trigger on a rising edge and negative to trigger on a falling edge.

Key Path	Trigger, External 1
<b>Remote Command</b>	:TRIGger[:SEquence]:EXTernal1:SLOPe POSitive NEGative :TRIGger[:SEquence]:EXTernal1:SLOPe?
<b>Example</b>	TRIG:EXT1:SLOP NEG
Couplings	This same slope is used in the Ext1 selection for the trigger source in the Trigger menu and for the period timer sync source (in the Trigger menu and in the Gate Source menu).
Preset	POSitive
State Saved	Saved in instrument state
<b>Backwards Compatibility SCPI</b>	:TRIGger[:SEquence]:EXTernal:SLOPe
	For backward compatibility, the parameter EXTernal is mapped to EXTernal1
<b>Backwards Compatibility SCPI</b>	:TRIGger[:SEquence]:FRAMe:EXTernal1:SLOPe
Backwards Compatibility Notes	The legacy :TRIGger[:SEquence]:SLOPe command affects the slopes for the VID, LINE, EXT1, EXT2, and RFB triggers.
Initial S/W Revision	Prior to A.02.00

### External 2

Pressing this key, when it is not selected, selects an external input signal as the trigger. A new sweep/measurement will start when the external trigger condition is met using the external 2 input connector. The external trigger 2 input connector is on the rear panel.

Pressing this key, when it is already selected, accesses the external 2 trigger setup menu.

Key Path	Trigger
<b>Example</b>	TRIG:SOUR EXT2 Swept SA measurement TRIG:<meas>:SOUR EXT2 Measurements other than Swept SA
Dependencies	In some models, there is no second External input. In these models, the External 2 key is blanked and the EXTERNAL2 parameter will generate a "Hardware missing; Not available for this model number" message. Grayed out if in use by Point Trigger in the Source Setup menu. Forced to Free Run if already selected and Point Trigger is set to External 2.
State Saved	Saved in instrument state
Status Bits/OPC dependencies	The Status Operation Register bit 5 "Waiting for Trigger" is set at the same time as the Sweeping or Measuring bit is set. It is cleared when the trigger actually occurs (that is, after the trigger event occurs and all the applicable trigger criteria have been met). A corresponding pop-up message ("Waiting for trigger") is generated if no trigger signal appears after approximately 2 sec. This message goes away when a trigger signal appears.
Initial S/W Revision	Prior to A.02.00
Modified at S/W Revision	A.03.00

### Trigger Level

Sets the value where the external 2 trigger input will trigger a new sweep/measurement.

Key Path	Trigger, External 2
<b>Remote Command</b>	:TRIGger[:SEquence]:EXTernal2:LEVel :TRIGger[:SEquence]:EXTernal2:LEVel?
<b>Example</b>	TRIG:EXT2:LEV 1.1 V
Couplings	This same level is used for the Ext2 trigger source in the Trigger menu, for the Ext2 selection in the Periodic Timer sync source (in the Trigger menu and in the Gate Source menu), and also for the Ext2 selection in the Gate Source menu.
Preset	1.2 V
State Saved	Saved in instrument state
Min	-5 V
Max	5 V
Default Unit	V
<b>Backwards Compatibility SCPI</b>	:TRIGger[:SEquence]:FRAMe:EXTernal2:LEVel
Initial S/W Revision	Prior to A.02.00

## Trig Slope

Controls the trigger polarity. It is set positive to trigger on a rising edge and negative to trigger on a falling edge.

Key Path	Trigger, External 2
<b>Remote Command</b>	:TRIGger[:SEquence]:EXTernal2:SLOPe POSitive NEGative :TRIGger[:SEquence]:EXTernal2:SLOPe?
<b>Example</b>	TRIG:EXT2:SLOP NEG
Couplings	This same slope is used in the Ext2 selection for the trigger source in the Trigger menu and for the period timer sync source (in the Trigger menu and in the Gate Source menu).
Preset	POSitive
State Saved	Saved in instrument state
<b>Backwards Compatibility SCPI</b>	:TRIGger[:SEquence]:FRAMe:EXTernal2:SLOPe
Backwards Compatibility Notes	The legacy :TRIGger[:SEquence]:SLOPe command affects the slopes for the VID, LINE, EXT1, EXT2, and RFB triggers.
Initial S/W Revision	Prior to A.02.00

## RF Burst

Pressing this key, when it is not selected, selects the RF Burst as the trigger. A new sweep/measurement will start when an RF burst envelope signal is identified from the signal at the RF Input connector. Pressing this key, when it is already selected, accesses the RF Burst trigger setup menu.

In some models, a variety of burst trigger circuitry is available, resulting in various available burst trigger bandwidths. The analyzer automatically chooses the appropriate trigger path based on the hardware configuration and other settings of the analyzer.

Key Path	Trigger
<b>Example</b>	TRIG:SOUR RFB Swept SA measurement TRIG:<meas>:SOUR RFB Measurements other than Swept SA
State Saved	Saved in instrument state
Status Bits/OPC dependencies	The Status Operation Register bit 5 "Waiting for Trigger" is set at the same time as the Sweeping or Measuring bit is set. It is cleared when the trigger actually occurs (that is, after the trigger event occurs and all the applicable trigger criteria have been met). A corresponding pop-up message ("Waiting for trigger") is generated if no trigger signal appears after approximately 2 sec. This message goes away when a trigger signal appears.
Backwards Compatibility Notes	The legacy command: :TRIGger[:SEquence]:RFBurst:FSElectivity[:STATe] OFF ON 0 1 is not supported in the X-Series, as the hardware to do Frequency Selective burst triggers does not exist in X-Series.
Initial S/W Revision	Prior to A.02.00
Modified at S/W Revision	A.04.00

### Absolute Trigger Level

Sets the absolute trigger level for the RF burst envelope.

When using the External Mixing path, the Absolute Trigger Level is uncalibrated because the factory default was set to accommodate the expected IF levels for the RF path.

Key Path	Trigger, RF Burst
Scope	Meas Global
<b>Remote Command</b>	:TRIGger[:SEquence]:RFBurst:LEVel:ABSolute <ampl> :TRIGger[:SEquence]:RFBurst:LEVel:ABSolute?
<b>Example</b>	TRIG:RFB:LEV:ABS 10 dBm sets the trigger level of the RF burst envelope signal to the absolute level of 10 dBm
Notes	Sending this command does not switch the setting from relative to absolute; to switch it you need to send the :TRIGger[:SEquence]:RFBurst:LEVel:TYPE command, below.  Amplitude Corrections are not taken into account by the Absolute Trigger Level. For example, if you have given yourself effective gain with an amplitude correction factor, the Absolute Trigger will not fire until you have set the trigger level that far below the displayed signal level, rather than simply to the displayed signal level. This is only true for Amplitude Corrections, not External Gain or Ref Level Offset functions.  If mode is Bluetooth, the default value is -50 dBm.
Couplings	This same level is used for the RF Burst trigger source in the Trigger menu, for the RF Burst selection in the Periodic Timer sync source (in the Trigger menu and in the Gate Source menu), and also for the RF Burst selection in the Gate Source menu
Preset	-20 dBm
State Saved	Saved in instrument state
Min	-200 dBm
Max	100 dBm
Default Unit	depends on the current selected Y-Axis unit
<b>Backwards Compatibility SCPI</b>	:TRIGger[:SEquence]:FRAMe:RFBurst:LEVel:ABSolute
Initial S/W Revision	Prior to A.02.00
Modified at S/W Revision	A.04.00

Key Path	Trigger, RF Burst
<b>Remote Command</b>	:TRIGger[:SEquence]:RFBurst:LEVel:TYPE ABSolute RELative :TRIGger[:SEquence]:RFBurst:LEVel:TYPE?
<b>Example</b>	TRIG:RFB:LEV:TYPE REL sets the trigger level type of the RF burst trigger to Relative.
Preset	ABSolute



State Saved	Saved in instrument state
Initial S/W Revision	Prior to A.02.00
Modified at S/W Revision	A.04.00

### Trigger Slope

It is set positive to trigger on a rising edge and negative to trigger on a falling edge.

Key Path	Trigger, RF Burst
<b>Remote Command</b>	:TRIGger[:SEquence]:RFBurst:SLOPe POSitive NEGative :TRIGger[:SEquence]:RFBurst:SLOPe?
<b>Example</b>	TRIG:RFB:SLOP NEG
Couplings	This same slope is used in the RF Burst selection for the trigger source in the Trigger menu and for the period timer sync source (in the Trigger menu and in the Gate Source menu).
Preset	POSitive
State Saved	Saved in instrument state
<b>Backwards Compatibility SCPI</b>	:TRIGger[:SEquence]:FRAME:RFBurst:SLOPe
Backwards Compatibility Notes	The legacy :TRIGger[:SEquence]:SLOPe command affects the slopes for the VID, LINE, EXT1, EXT2, and RFB triggers.
Initial S/W Revision	Prior to A.02.00

### Trig Delay

This setting delays the measurement timing relative to the Periodic Timer.

Key Path	Trigger, Periodic Timer
<b>Remote Command</b>	:TRIGger[:SEquence]:FRAME:DELAy <time> :TRIGger[:SEquence]:FRAME:DELAy? :TRIGger[:SEquence]:FRAME:DELAy:STATE OFF ON 0 1 :TRIGger[:SEquence]:FRAME:DELAy:STATE?
Notes	Note that delay is used when the sync source is not set to OFF. If the sync source is set to OFF, offset is used.
Preset	Off, 1.000 us
State Saved	Saved in instrument state
Min	-150 ms
Max	+500 ms
Default Unit	s
Initial S/W Revision	Prior to A.02.00

## Auto/Holdoff

Opens up a menu that lets you adjust Auto Trigger and Trigger Holdoff parameters

Key Path	Trigger
Readback line	<p>Displays a summary of the Auto Trig and Holdoff settings, in square brackets</p> <p>First line: Auto Off or Auto On</p> <p>Second Line: "Hldf" followed by:</p> <ul style="list-style-type: none"> <li>• If Holdoff is Off, readback Off</li> <li>• If Holdoff On and Type = Normal, readback value</li> <li>• If Holdoff On and Type = Above, readback value followed by AL</li> <li>• If Holdoff On and Type = Below, readback value followed by BL</li> <li>• If Holdoff Type selection is not supported by the current measurement, Holdoff Type is always Normal</li> </ul>
Initial S/W Revision	A.02.00

## Auto Trig

Sets the time that the analyzer will wait for the trigger conditions to be met. If they are not met after that much time, then the analyzer is triggered anyway.

Key Path	Trigger, Auto/Holdoff
<b>Remote Command</b>	<pre>:TRIGger[:SEquence]:ATRigger &lt;time&gt; :TRIGger[:SEquence]:ATRigger? :TRIGger[:SEquence]:ATRigger:STATe OFF ON 0 1 :TRIGger[:SEquence]:ATRigger:STATe?</pre>
<b>Example</b>	<pre>TRIG:ATR:STAT ON TRIG:ATR 100 ms</pre>
Notes	The "time that the analyzer will wait" starts when the analyzer is ready for a trigger, which may be hundreds of ms after the data acquisition for a sweep is done. The "time" ends when the trigger condition is satisfied, not when the delay ends.
Preset	Off, 100 ms
State Saved	Saved in instrument state
Min	1 ms
Max	100 s
Default Unit	s
Initial S/W Revision	Prior to A.02.00

## Trig Holdoff

Sets the holdoff time between triggers. When the trigger condition is satisfied, the trigger occurs, the delay begins, and the holdoff time begins. New trigger conditions will be ignored until the holdoff time expires. For a free-running trigger, the holdoff value is the minimum time between triggers.

Key Path	Trigger, Auto/Holdoff
Remote Command	:TRIGger[:SEquence]:HOLDoFF <time> :TRIGger[:SEquence]:HOLDoFF? :TRIGger[:SEquence]:HOLDoFF:STATe OFF ON 0 1 :TRIGger[:SEquence]:HOLDoFF:STATe?
Example	TRIG:HOLD:STAT ON TRIG:HOLD 100 ms
Dependencies	Unavailable if the selected Input is BBIQ. If this is the case, the key is grayed out if it is pressed the informational message "Feature not supported for this Input" is displayed. If the SCPI command is sent, the error "Settings conflict; Feature not supported for this Input" is generated.
Preset	Off, 100 ms
State Saved	Saved in instrument state
Min	0 s
Max	0.5 s
Default Unit	s
Initial S/W Revision	Prior to A.02.00



## 8 Channel Power Measurement

The Channel Power measurement is used to find the total power present in a specified bandwidth. The power spectral density (the power in the signal normalized to 1 Hz) is also reported (In WLAN mode or WLAN radio standard in SA mode, the peak power spectral density for 1 MHz is reported). For measurement results and views, see ["View/Display" on page 631](#).

This topic contains the following sections:

["Measurement Commands for Channel Power" on page 466](#)

["Remote CommandResults for Channel Power Measurement" on page 467](#)

## Measurement Commands for Channel Power

These commands are used to measure the total rms power in a specified integration bandwidth.

Use :INSTrument:SElect to set the mode.

```
:CONFigure:CHPower
:CONFigure:CHPower:NDEFault
:INITiate:CHPower
:FETCh:CHPower[n]?
:MEASure:CHPower[n]?
:READ:CHPower[n]?
:FETCh:CHPower:CHPower?
:MEASure:CHPower:CHPower?
:READ:CHPower:CHPower?
:FETCh:CHPower:DENSity?
:MEASure:CHPower:DENSity?
:READ:CHPower:DENSity
```

For more measurement related commands, see the SENSE subsystem, and the section "[Remote Measurement Functions](#)" on page 2848.

## Remote CommandResults for Channel Power Measurement

For DVB-T/H and DTMB (CTTB) mode, see ["DVB-T/H and DTMB \(CTTB\) Mode Remote Command Results" on page 468](#).

For ISDB-T and CMMB mode, see ["ISDB-T and CMMB mode Remote Command Results" on page 470](#).

For MSR, see ["Remote Command Results for WLAN Channel Power Measurement" on page 473](#)

For LTE-Advanced FDD/TDD, see ["LTE-Advanced FDD/TDD Mode Remote Command Results " on page 472](#)

For WLAN, see ["MSR Mode Remote Command Results" on page 471](#)

Command	Return Value
FETCh:CHPower[n]?	Refer to the table below.
MEASure:CHPower[n]?	
READ:CHPower[n]?	
FETCh:CHPower:CHPower?	Returns the Channel Power (dBm) (BW compatibility functionality)
MEASure:CHPower:CHPower?	
READ:CHPower:CHPower?	
FETCh:CHPower:DENSity?	Returns the Power Spectral Density (dBm/Hz) (BW compatibility functionality)
MEASure:CHPower:DENSity?	
READ:CHPower:DENSity?	

n	Results Returned
n=1 (or not specified)	Returns scalar results: <ol style="list-style-type: none"> <li>1. Channel Power is a floating point number representing the total channel power in the specified integration bandwidth.</li> <li>2. PSD (Power Spectral Density) is the power in the specified unit bandwidth. The unit bandwidth is selected by the PSD Unit parameter in either dBm/Hz or dBm/MHz.</li> </ol>
2	Returns floating point numbers that are the captured trace data of the power (in dBm/resolution BW) of the signal. The frequency span of the captured trace data is specified by the Span key.

## DVB-T/H and DTMB (CTTB) Mode Remote Command Results

The following commands are available only for DVB-T/H and DTMB (CTTB) mode.

Condition	n	Results Returned
	n=1 (or not specified)	Returns scalar results: 1. Channel Power is a floating point number representing the total channel power in the specified integration bandwidth. 2. PSD (Power Spectral Density) is the power in the specified unit bandwidth. The unit bandwidth is selected by the PSD Unit parameter in either dBm/Hz or dBm/MHz.
	2	Returns floating point numbers that are the captured trace data of the power (in dBm/resolution BW) of the signal. The frequency span of the captured trace data is specified by the Span key.
Mode = DVB-T/H or Mode = DTMB (CTTB)	3	Returns 7 comma-separated scalar results, in the following order. 1. The shoulder attenuation result (dB) 2. Lower shoulder attenuation result (dB) 3. Upper shoulder attenuation result (dB) 4. Lower Offset - MAX shoulder point power (dBm) 5. Lower Offset - MAX shoulder point frequency (MHz) 6. Upper Offset - MAX shoulder point power (dBm) 7. Upper Offset - MAX shoulder point frequency (MHz) If the results are not available, -999.0 is returned. For example, if current view is RF spectrum or spectrum mask, -999.0 is returned.
Mode = DVB-T/H or Mode = DTMB (CTTB)	4	Returns floating point numbers that are the captured trace data of the power (in dBm/resolution BW) of the signal in the left graph of the shoulder attenuation view. If the results are not available, -999.0 is returned. For example, if current view is RF spectrum or spectrum mask, -999.0 is returned.
Mode = DVB-T/H or Mode = DTMB (CTTB)	5	Returns floating point numbers that are the captured trace data of the power (in dBm/resolution BW) of the signal in the right graph of the shoulder attenuation view. If the results are not available, -999.0 is returned. For example, if current view is RF spectrum or spectrum mask, -999.0 is returned.
Mode = DVB-T/H or Mode = DTMB (CTTB)	6	Returns floating point numbers that are the captured trace data of the power (in dBm/resolution BW) of the mask in the spectrum mask view. If the results are not available, -999.0 is returned. For example, if current view is RF spectrum or shoulder attenuation, -999.0 is returned.
Mode = DVB-T/H or Mode = DTMB (CTTB)	7	Returns the failed point information in the following order: 1. the 1st failed point frequency (MHz) 2. the 1st failed point absolute power (dBm) 3. the 1st failed point relative power (dB) 4. the 2nd failed point frequency (MHz) 5. the 2nd failed point absolute power (dBm)



---

6. the 2nd failed point relative power (dB)

...

$3*N-2$ . the ( $3*N-2$ )th failed point frequency (MHz)

$3*N-1$ . the ( $3*N-1$ )th failed point absolute power (dBm)

$3*N$ . the ( $3*N$ )th failed point relative power (dB)

If the number of failed points is less than 20, it will show all of them (frequency, power and relative power),  $N < 20$ ;

If the number of failed points is great than 20, the first ten failed points and the last ten failed points will be show,  $N=20$ .

If the results are not available, -999.0 is returned.

For example, if current view is RF spectrum or shoulder attenuation, -999.0 is returned.

---

## ISDB-T and CMMB mode Remote Command Results

The following commands are available only for ISDB-T and CMMB mode.

Condition	n	Results Returned
	n=1 (or not specified)	Returns scalar results: 1. Channel Power is a floating point number representing the total channel power in the specified integration bandwidth. 2. PSD (Power Spectral Density) is the power in the specified unit bandwidth. The unit bandwidth is selected by the PSD Unit parameter in either dBm/Hz or dBm/MHz.
	2	Returns floating point numbers that are the captured trace data of the power (in dBm/resolution BW) of the signal. The frequency span of the captured trace data is specified by the Span key.
Mode = ISDB-T or Mode = CMMB	3	Returns 7 comma-separated scalar results, in the following order. 1. The shoulder attenuation result (dB) 2. Lower shoulder attenuation result (dB) 3. Upper shoulder attenuation result (dB) 4. Lower Offset - MAX shoulder point power (dBm) 5. Lower Offset - MAX shoulder point frequency (MHz) 6. Upper Offset - MAX shoulder point power (dBm) 7. Upper Offset - MAX shoulder point frequency (MHz) If the results are not available, -999.0 is returned. For example, if current view is RF spectrum or spectrum mask, -999.0 is returned.
Mode = ISDB-T or Mode = CMMB	4	Returns floating point numbers that are the captured trace data of the power (in dBm/resolution BW) of the signal in the left window of the shoulder attenuation view. If the results are not available, -999.0 is returned. For example, if current view is RF spectrum or spectrum mask, -999.0 is returned.
Mode = ISDB-T or Mode = CMMB	5	Returns floating point numbers that are the captured trace data of the power (in dBm/resolution BW) of the signal in the right window of the shoulder attenuation view. If the results are not available, -999.0 is returned. For example, if current view is RF spectrum or spectrum mask, -999.0 is returned.

## MSR Mode Remote Command Results

The following commands are available only for MSR mode.

Condition	n	Results Returned
	n=1 (or not specified)	Returns scalar results: 1. Channel Power is a floating point number representing the total channel power in the specified integration bandwidth. 2. PSD (Power Spectral Density) is the power in the specified unit bandwidth. The unit bandwidth is selected by the PSD Unit parameter in either dBm/Hz or dBm/MHz.
	2	Returns floating point numbers that are the captured trace data of the power (in dBm/resolution BW) of the signal. The frequency span of the captured trace data is specified by the Span key.
Mode = MSR	3	Returns [Carriers] comma-separated scalar results, in the following order. 1. Total Power of Carrier 1 (dBm) 2. Total Power of Carrier 2 (dBm) ... [Carriers]. Total Power of Carrier [Carriers] (dBm) If the result is not available, NaN (9.91E+37) is returned. Number of returned values might be changed in future releases.
Mode = MSR	4	Returns comma-separated scalar results, in the following order. 1. Total Power of LTE FDD carriers (dBm) 2. Total Power of W-CDMA carriers (dBm) 3. Total Power of GSM/EDGE carriers (dBm) 4. Total Power of cdma2000 carriers (dBm) 5. Total Power of 1xEV-DO carriers (dBm) ... The number of results is incremented by one when a new format is supported. If the result is not available, NaN (9.91E+37) is returned. Number of returned values will be changed in future releases if the number of supported radio format is increased.

## LTE-Advanced FDD/TDD Mode Remote Command Results

The following commands are available only for LTE-Advanced FDD/TDD mode.

Condition	n	Results Returned
	n=1 (or not specified)	Returns scalar results: 1. Channel Power is a floating point number representing the total channel power in the specified integration bandwidth. 2. PSD (Power Spectral Density) is the power in the specified unit bandwidth. The unit bandwidth is selected by the PSD Unit parameter in either dBm/Hz or dBm/MHz.
	2	Returns floating point numbers that are the captured trace data of the power (in dBm/resolution BW) of the signal. The frequency span of the captured trace data is specified by the Span key.
Mode = LTEATDD/ LTEAFDD	3	Returns comma-separated scalar results, in the following order. 1. Total Power of Component Carrier 0 (dBm) 2. Total Power of Component Carrier 1 (dBm) 3. Total Power of Component Carrier 2 (dBm) 4. Total Power of Component Carrier 3 (dBm) 5. Total Power of Component Carrier 4 (dBm) If the result is not available, NaN (9.91E+37) is returned.
Mode = LTEATDD/ LTEAFDD	4	Returns comma-separated scalar results, in the following order. The unit bandwidth is selected by the PSD Unit parameter in either dBm/Hz or dBm/MHz. 1. Total Power Spectral Density of Component Carrier 0 (PSD Unit) 2. Total Power Spectral Density of Component Carrier 1 (PSD Unit) 3. Total Power Spectral Density of Component Carrier 2 (PSD Unit) 4. Total Power Spectral Density of Component Carrier 3 (PSD Unit) 5. Total Power Spectral Density of Component Carrier 4 (PSD Unit) If the result is not available, NaN (9.91E+37) is returned.

## Remote Command Results for WLAN Channel Power Measurement

n	Results Returned
n=1 (or not specified)	<p>Returns scalar results:</p> <p>When the radio standard is NOT WLAN 802.11ac 80 + 80 MHz:</p> <ol style="list-style-type: none"> <li>1. Channel Power is a floating point number representing the total channel power in the specified integration bandwidth.</li> <li>2. PSD (Power Spectral Density) is the power in the specified unit bandwidth. The unit bandwidth is selected by the PSD Unit parameter in either dBm/Hz or dBm/MHz.</li> </ol> <p>When the radio standard is WLAN 802.11ac 80 + 80 MHz:</p> <ol style="list-style-type: none"> <li>1. Channel Power of the carrier of which the center frequency is indicated by Freq Segment 1 is a floating point number representing the total channel power of the first segment in the specified integration bandwidth.</li> <li>2. PSD (Power Spectral Density) of the carrier of which the center frequency is indicated by Freq Segment 1 is the power in the specified unit bandwidth of the first segment. The unit bandwidth is selected by the PSD Unit parameter in either dBm/Hz or dBm/MHz.</li> <li>3. Channel Power of the carrier of which the center frequency is indicated by Freq Segment 2 is a floating point number representing the total channel power of the second segment in the specified integration bandwidth.</li> <li>4. PSD (Power Spectral Density) of the carrier of which the center frequency is indicated by Freq Segment 2 is the power in the specified unit bandwidth of the second segment. The unit bandwidth is selected by the PSD Unit parameter in either dBm/Hz or dBm/MHz.</li> </ol>
2	Returns floating point numbers that are the captured trace data of the power (in dBm/resolution BW) of the signal. The frequency span of the captured trace data is specified by the Span key.
Key Path	Meas
Mode	SA, WCDMA, C2K, WIMAX OFDMA, 1xEVDO, DVB-T/H, DTMB (CTTB), ISDB-T, CMMB, LTE, LTETDD, Digital Cable TV, WLAN, MSR, LTEAFDD, LTEATDD
Initial S/W Revision	Prior to A.02.00
Modified at S/W Revision	A.03.00

## AMPTD Y Scale

Accesses a menu of functions that enable you to set the vertical scale parameters. The parameter values are measurement independent, except all Attenuation values and the Internal Preamp selection, which are the same across all measurements.

Key Path	Front-panel key
Initial S/W Revision	Prior to A.02.00

### Ref Value

Sets the value for the absolute power reference. However, since the Auto Scaling is defaulted to On, this value is automatically determined by the measurement result. When you set a value manually, Auto Scaling automatically changes to Off.

Key Path	AMPTD Y Scale
Mode	SA, WCDMA, C2K, WIMAX OFDMA, 1xEVDO, DVB-T/H, DTMB (CTTB), ISDB-T, CMMB, LTE, LTETDD, Digital Cable TV, WLAN, MSR, LTEAFDD, LTEATDD
Remote Command	:DISPlay:CHPower:VIEW[1]:WINDow[1]:TRACe:Y[:SCALe]:RLEVel <real> :DISPlay:CHPower:VIEW[1]:WINDow[1]:TRACe:Y[:SCALe]:RLEVel?
Example	DISP:CHP:VIEW:WIND:TRAC:Y:RLEV 10 dBm DISP:CHP:VIEW:WIND:TRAC:Y:RLEV?
Notes	You must be in the Spectrum Analysis mode, W-CDMA mode, cdma2000 mode, DVB-T/H mode, DTMB (CTTB) mode, ISDB-T mode, CMMB mode, Digital Cable TV mode, LTD mode, LTE TDD mode, WLAN mode, 1xEVDO mode, MSR, LTE-Advanced FDD/TDD mode or WIMAX OFDMA mode to use this command. Use :INSTrument:SElect to set the mode.
Couplings	When the Auto Scaling is On, this value is automatically determined by the measurement result. When you set a value manually, Auto Scaling automatically changes to Off.
Preset	10.00 dBm
State Saved	Saved in instrument state.
Min	-250.00 dBm
Max	250.00 dBm
Initial S/W Revision	Prior to A.02.00
Modified at S/W Revision	A.02.00, A.03.00

### Attenuation

This menu controls the attenuator functions and interactions between the attenuation system components.

There are two attenuator configurations in the X-Series. One is a dual attenuator configuration consisting of a mechanical attenuator and an optional electronic attenuator. The other configuration uses a single

attenuator with combined mechanical and electronic sections that controls all the attenuation functions. Different models in the X-Series come with different configurations.

See ["Dual Attenuator Configurations:" on page 475](#)

See ["Single Attenuator Configuration:" on page 476](#)

Most Attenuation settings are the same for all measurements – they do not change as you change measurements. Settings like these are called “Meas Global” and are unaffected by Meas Preset.

Key Path	AMPTD Y Scale
Scope	Meas Global
Dependencies	In measurements that support the I/Q inputs, this key is unavailable when I/Q is the selected input, and is replaced by the Range key in that case.
Readback Line	Contains a summary in [ ] brackets of the current total attenuation. See the descriptions of the , " <a href="#">(Mech) Atten</a> " on page 2783, and " <a href="#">Enable Elec Atten</a> " on page 2785 keys for more detail on the contributors to the total attenuation.  Note that when "Pre-Adjust for Min Clip" is on, this value can change at the start of every measurement.
Initial S/W Revision	Prior to A.02.00
Modified at S/W Revision	A.03.00

## Dual Attenuator Configurations:

Configuration 1: Mechanical attenuator + optional electronic attenuator

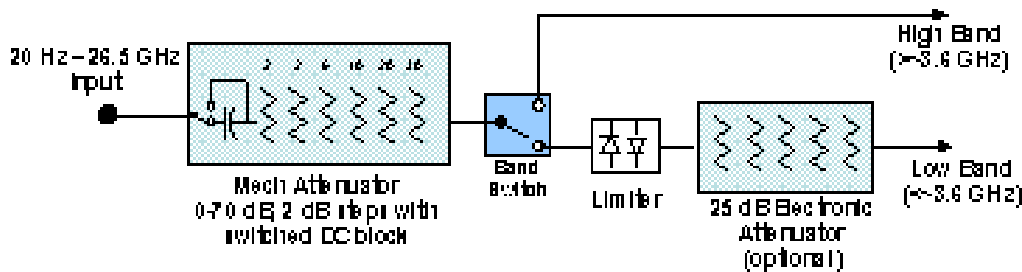

Configuration 2: Mechanical attenuator, no optional electronic attenuator

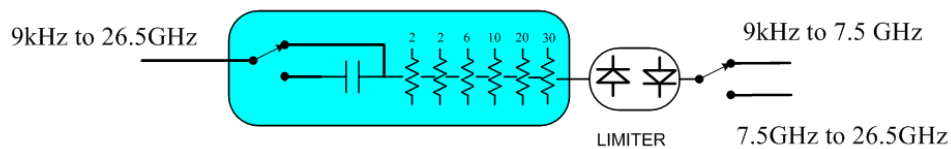

(note that Configuration 2 is not strictly speaking a dual-section attenuator, since there is no electronic section available. However, it behaves exactly like Configuration 1 without the Electronic Attenuator option EA3, therefore for the sake of this document it is grouped into the “Dual Attenuator” configuration)

### Single Attenuator Configuration:

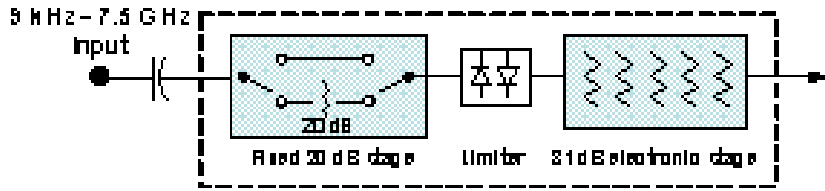

You can tell which attenuator configuration you have by pressing the Attenuation key, which (in most Modes) opens the Attenuation menu. If the first key in the Attenuation menu says Mech Atten you have the dual attenuator configuration. If the first key says Atten you have the single attenuator configuration.

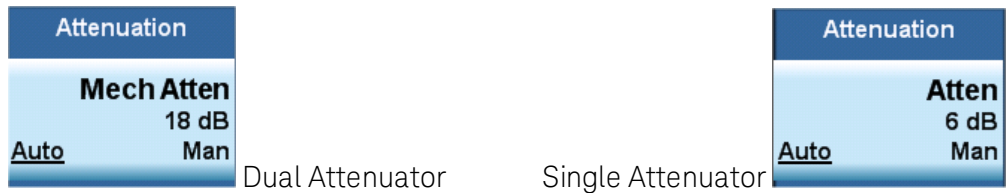

In the single attenuator configuration, you control the attenuation with a single control, as the fixed stage has only two states. In the dual attenuator configuration, both stages have significant range so you are given separate control of the mechanical and electronic attenuator stages.

When you have the dual attenuator configuration, you may still have only a single attenuator, because unless option EA3 (the Electronic Attenuator option) is available, and you purchase it, you will have only the mechanical attenuator.

### (Mech) Atten

This key is labeled Mech Atten in dual attenuator models and Atten in single attenuator models. In the dual attenuator configuration, this key only affects the mechanical attenuator.

This key lets you modify the attenuation applied to the RF input signal path. This value is normally auto coupled to the Ref Level, the Internal Preamp Gain, any External Gain that is entered, and the Max Mixer Level, as described in the table below.

See ["Attenuator Configurations and Auto/Man" on page 478](#)

Key Path	AMPTD Y Scale, Attenuation
<b>Remote Command</b>	<pre>[ :SENSE ] : POWer [ :RF ] : ATTenuation &lt;rel_ampl&gt; [ :SENSE ] : POWer [ :RF ] : ATTenuation? [ :SENSE ] : POWer [ :RF ] : ATTenuation : AUTO OFF   ON   0   1 [ :SENSE ] : POWer [ :RF ] : ATTenuation : AUTO?</pre>
<b>Example</b>	<p>POW:ATT 20</p> <p>Dual attenuator configuration: sets the mechanical attenuator to 20 dB</p> <p>Single attenuator mode: sets the main attenuation to 20 dB (see below for definition of “main” attenuation).</p> <p>If the attenuator was in Auto, it sets it to Manual.</p>
<b>Dependencies</b>	Some measurements do not support the Auto setting of (Mech) Atten. In these measurements, the



Auto/Man selection is not available, and the Auto/Man line on the key disappears.

In dual attenuator configurations, when the electronic attenuator is enabled, the mechanical attenuator has no auto setting and the Auto/Man line on the key disappears. The state of Auto/Man is remembered and restored when the electronic attenuator is once again disabled. This is described in more detail in the ["Enable Elec Atten" on page 2785](#) key description.

See ["Attenuator Configurations and Auto/Man" on page 478](#) for more information on the Auto/Man functionality of Attenuation.

Couplings

When (Mech) Atten is in Auto, it uses the following algorithm to determine a value:  
 If the USB Preamp is connected to USB, use 0 dB.  
 Otherwise,  $Atten = ReferenceLevel + PreAmpGain + ExternalGain - RefLevelOffset - MaxMixerLevel + IF\ Gain$ .  
 Limit this value to be between 6 dB and the Max value. No value below 6 dB can ever be chosen by Auto.  
 The resulting value is rounded up to the largest value possible given the attenuation step setting. That is, 50.01 dB would change to 60 dB (for a 10 dB attenuation step).  
 The "IF Gain" term in the equation above is either 0 dB or +10 dB, depending on the settings of FFT IF Gain, Swept IF Gain, max Ref Level and the Auto/Man setting of Mech Atten.  
 In External Mixing and BBIQ, where the Attenuator is not in the signal path, the Attenuator setting changes as described above when (Mech) Atten is in Auto, but no changes are made to the actual attenuator hardware setting until the input is changed back to the RF Input.

Preset The preset for Mech Attenuation is "Auto."  
 The Auto value of attenuation is:  
 CXA, EXA, MXA and PXA: 10 dB

State Saved Saved in instrument state

Min 0 dB  
 The attenuation set by this key cannot be decreased below 6 dB with the knob or step keys. To get to a value below 6 dB it has to be directly entered from the keypad or via SCPI. This protects from adjusting the attenuation to a dangerously small value which can put the instrument at risk of damage to input circuitry. However, if the current mechanical attenuation is below 6 dB it can be increased with the knob and step keys, but not decreased.

Max CXA N9000A-503/507: 50 dB  
 CXA N9000A-513/526: 70dB  
 EXA: 60 dB  
 MXA and PXA: 70 dB  
 In the single attenuator configuration, the total of ATT and EATT cannot exceed 50 dB, so if the EATT is set to 24 dB first, the main attenuation cannot be greater than 26 dB and will be reduced accordingly; if the main attenuator is set to 40 dB first, EATT cannot be greater than 10 dB.

Initial S/W Revision Prior to A.02.00

Modified at S/W Revision A.03.00

## Attenuator Configurations and Auto/Man

As described in the Attenuation key description, there are two distinct attenuator configurations available in the X-Series, the single attenuator and dual attenuator configurations. In dual attenuator configurations, we have the mechanical attenuation and the electronic attenuation, and the current total attenuation is the sum of the electronic + mechanical attenuation. In single attenuator configurations, we refer to the attenuation set using the (Mech) Atten key (or POW:ATT SCPI) as the “main” attenuation; and the attenuation that is set by the SCPI command POW:EATT as the “soft” attenuation (the POW:EATT command is honored even in the single attenuator configuration, for compatibility purposes). Then the current total attenuation is the sum of the main + soft attenuation. See the Elec Atten key description for more on “soft” attenuation.

In the dual attenuator configuration, when the electronic attenuator is enabled, there is no Auto/Man functionality for the mechanical attenuator, and the third line of the key label (the Auto/Man line) disappears:

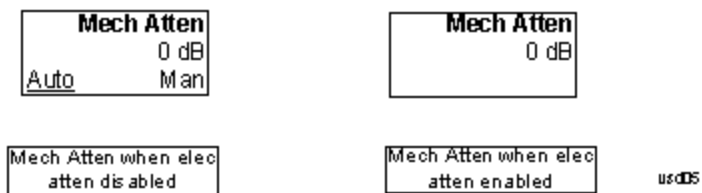

## Enable Elec Atten

Enables the Electronic Attenuator.

The electronic attenuator offers finer steps than the mechanical attenuator, has no acoustical noise, is faster, and is less subject to wear. These advantages primarily aid in remote operation and are negligible for front panel use. See ["Using the Electronic Attenuator: Pros and Cons" on page 480](#) for a detailed discussion of the pros and cons of using the electronic attenuator.

For the single attenuator configuration, for SCPI backwards compatibility, the “soft” attenuation feature replaces the dual attenuator configuration’s electronic attenuator. All the same couplings and limitations apply. See ["Attenuator Configurations and Auto/Man" on page 2785](#)

See ["More Information" on page 479](#)

<b>Key Path</b>	AMPTD Y Scale, Attenuation
<b>Remote Command</b>	[ :SENSE ] :POWER [ :RF ] :EATTenuation:STATE OFF ON 0 1 [ :SENSe ] :POWER [ :RF ] :EATTenuation:STATe?
<b>Example</b>	POW:EATT:STAT ON
<b>Dependencies</b>	This key only appears in Dual Attenuator models with an Electronic Attenuator installed. It does not appear in models with the Single Attenuator configuration, as in the single attenuator configuration there is no “electronic attenuator” there is only a single integrated attenuator (which has both a mechanical and electronic stage). However, in the single attenuator configuration, EATT SCPI commands are accepted for compatibility with other X-series instruments and set a “soft” attenuation as described in <a href="#">"Attenuator Configurations and Auto/Man" on page 2785</a> . The electronic attenuator (and the “soft” attenuation function provided in single attenuator configurations) is unavailable above 3.6 GHz. Therefore, if the Stop Frequency of the analyzer is > 3.6 GHz then the Enable Elec Atten key will be OFF and grayed out.

---

If the Internal Preamp is on, meaning it is set to Low Band or Full, the electronic attenuator (and the “soft” attenuation function provided in single attenuator configurations) is unavailable. In this case the Enable Elec Atten key will be OFF and grayed out.

If either of the above is true, if the SCPI command is sent, an error indicating that the electronic attenuator is unavailable will be sent.

If the electronic/soft Attenuator is enabled, then the Stop Freq of the analyzer is limited to 3.6 GHz and the Internal Preamp is unavailable.

The SCPI-only “soft” electronic attenuation for the single-attenuator configuration is not available in all measurements; in particular, it is not available in the Swept SA measurement.

Couplings	Enabling and disabling the Electronic Attenuator affects the setting of the Mechanical Attenuator (in dual attenuator configurations). This is described in more detail below this table.
Preset	OFF for Swept SA measurement; ON for all other measurements that support the electronic attenuator
State Saved	Saved in instrument state
Initial S/W Revision	Prior to A.02.00
Modified at S/W Revision	A.03.00

## More Information

### Mechanical Attenuator Transition Rules

When the Electronic Attenuator is enabled, the Mechanical Attenuator transitions to a state that has no Auto function. Below are the rules for transitioning the Mechanical Attenuator. NOTE that the information below ONLY applies to the dual attenuator configurations, and ONLY when the Electronic Attenuator is installed:

#### When the Electronic Attenuation is enabled from a disabled state:

- The Mechanical Attenuator is initialized to 10 dB (this is its optimal performance setting). You can then set it as desired with SCPI, numeric keypad, step keys, or knob, and it behaves as it normally would in manual mode
- The Auto/Man state of (Mech) Atten is saved
- The Auto/Man line on the (Mech) Atten key disappears and the auto rules are disabled
- The Electronic Attenuator is set to 10 dB less than the previous value of the Mechanical Attenuator, within the limitation that it must stay within the range of 0 to 24 dB of attenuation.

#### Examples in the dual attenuator configuration:

- Mech Atten at 20 dB. Elec Atten enabled, Mech Atten set to 10 dB, and Elec Atten set to 10 dB. New total attenuation equals the value before Elec Atten enabled.
- Mech Atten at 0 dB. Elec Atten enabled, Mech Atten set to 10 dB, and Elec Atten set to 0 dB. New total attenuation does not equal the value before Elec Atten enabled.
- Mech Atten at 40 dB. Elec Atten enabled, Mech Atten set to 10 dB, and Elec Atten set to 24 dB. New total attenuation does not equal the value before Elec Atten enabled.

**When the Electronic Attenuation is disabled from an enabled state:**

- The Elec Atten key is grayed out
- The Auto/Man state of (Mech) Atten is restored
- If now in Auto, (Mech) Atten recouples
- If now in Man, (Mech) Atten is set to the value of total attenuation that existed before the Elec Atten was disabled. The resulting value is rounded up to the smallest value possible given the (Mech) Atten Step setting - (That is, 57 dB changes to 58 dB when (Mech) Atten Step is 2 dB.)

**Using the Electronic Attenuator: Pros and Cons**

The electronic attenuator offers finer steps than the mechanical attenuator, has no acoustical noise, is faster, and is less subject to wear.

The “finer steps” advantage of the electronic attenuator is beneficial in optimizing the alignment of the analyzer dynamic range to the signal power in the front panel as well as remote use. Thus, you can achieve improved relative signal measurement accuracy. Compared to a mechanical attenuator with 2 dB steps, the 1 dB resolution of the electronic attenuator only gives better resolution when the odd-decibel steps are used. Those odd-decibel steps are less accurately calibrated than the even-decibel steps, so one tradeoff for this superior relative accuracy is reduced absolute amplitude accuracy.

Another disadvantage of the electronic attenuator is that the spectrum analyzer loses its “Auto” setting, making operation less convenient.

Also, the relationship between the dynamic range specifications (TOI, SHI, compression and noise) and instrument performance are less well-known with the electrical attenuator. With the mechanical attenuator, TOI, SHI and compression threshold levels increase dB-for-dB with increasing attenuation, and the noise floor does as well. With the electronic attenuator, there is an excess attenuation of about 1 to 3 dB between 0 and 3.6 GHz, making the effective TOI, SHI, and so forth, less well known. Excess attenuation is the actual attenuation relative to stated attenuation. Excess attenuation is accounted for in the analyzer calibration

**Elec Atten**

Controls the Electronic Attenuator in dual attenuator configurations. This key does not appear in single attenuator configurations, as the control of both the mechanical and electronic stages of the single attenuator is integrated into the single Atten key.

<b>Key Path</b>	AMPTD Y Scale, Attenuation
<b>Remote Command</b>	[ :SENSe ] :POWer [ :RF ] :EATTenuation <rel_amp1> [ :SENSe ] :POWer [ :RF ] :EATTenuation?
<b>Notes</b>	Electronic Attenuation’s specification is defined only when Mechanical Attenuation is 6 dB.
<b>Dependencies</b>	This key only appears in Dual Attenuator models with an Electronic Attenuator installed. It does not appear in models with the Single Attenuator configuration, as in the single attenuator configuration there is no “electronic attenuator” there is only a single integrated attenuator (which has both a mechanical and electronic stage). However, in the single attenuator configuration, EATT SCPI commands are accepted for compatibility with other X-series instruments and set a “soft” attenuation as described in <a href="#">"Attenuator Configurations and Auto/Man" on page 2785</a> . The “soft” attenuation is treated as an addition to the “main” attenuation value set by the Atten softkey or the

	POW:ATT SCPI command and affects the total attenuation displayed on the Attenuation key and the Meas Bar. When Enable Elec Atten is off or grayed out, the Elec Atten key is grayed out.
Preset	0 dB
State Saved	Saved in instrument state
Min	0 dB
Max	Dual attenuator configuration: 24 dB Single attenuator configuration: the total of ATT and EATT cannot exceed 50 dB, so if the EATT is set to 24 dB first, the main attenuation cannot be greater than 26 dB and will be reduced accordingly; if the main attenuator is set to 40 dB first, EATT cannot be greater than 10 dB
Initial S/W Revision	Prior to A.02.00
Modified at S/W Revision	A.03.00

### Adjust Atten for Min Clip

Sets the combination of mechanical and electronic attenuation and gain based on the current measured signal level so that clipping will be at a minimum.

This is an "immediate action" function, that is, it executes once, when the key is pressed.

This key is grayed out in measurements that do not support this functionality. The spectrum analyzer measurement, Swept SA, does not support this functionality.

Key Path	AMPTD Y Scale, Attenuation
Remote Command	<code>[ :SENSe ] :POWer [ :RF ] :RANGe:OPTimize IMMEDIATE</code>
Initial S/W Revision	Prior to A.02.00
Modified at S/W Revision	A.03.00

### Pre-Adjust for Min Clip

If this function is on, it does the adjustment described under "[Adjust Atten for Min Clip](#)" on page 2788 each time a measurement restarts. Therefore, in Continuous measurement mode, it only executes before the first measurement.

In dual attenuator models, you can set Elec+Mech Atten, in which case both attenuators participate in the autoranging, or Elec Atten Only, in which case the mechanical attenuator does not participate in the autoranging. This latter case results in less wear on the mechanical attenuator and is usually faster.

This key is grayed out in measurements that do not support this functionality. The spectrum analyzer measurement, Swept SA, does not support this functionality.

Key Path	AMPTD Y Scale, Attenuation
Remote Command	<code>[ :SENSe ] :POWer [ :RF ] :RANGe:OPTimize:ATTenuation OFF   ELECTRICAL   COMBINED</code>

	<code>[ :SENSe ] :POWer [ :RF ] :RANGe:OPTimize:ATTenuation?</code>
Notes	The SCPI parameter ELECtrical sets this function to On in single attenuator models. The SCPI parameter COMBined is mapped to ELECtrical in single attenuator models; if you send COMBined, it sets the function to On and returns ELEC to a query.
Dependencies	This key only appears in Dual Attenuator models with an Electronic Attenuator installed. In instruments with Dual Attenuator model, when Enable Elec Atten is off or grayed out, the Pre-Adjust for Min Clip key is grayed out.
Preset	OFF for Swept SA measurement; ON for all other measurements that support Pre-Adjust for Min Clip
State Saved	Saved in instrument state
Range	Dual attenuator models: Off   Elec Atten Only   Mech + Elec Atten Single attenuator models: Off   On
Initial S/W Revision	Prior to A.02.00
Modified at S/W Revision	A.03.00

<b>Remote Command</b>	<code>[ :SENSe ] :POWer [ :RF ] :RANGe:AUTO ON OFF 1 0</code> <code>[ :SENSe ] :POWer [ :RF ] :RANGe:AUTO?</code>
Notes	ON aliases to "Elec Atten Only" (:POW:RANG:OPT:ATT ELEC) OFF aliases to "Off" (:POW:RANG:OPT:ATT OFF) The query :POW:RANG:AUTO? returns true if :POW:RANG:OPT:ATT is not "Off"
Initial S/W Revision	Prior to A.02.00

## Off

Turns Pre-Adjust for Min Clip off. This is the default setting.

This key is grayed out in measurements that do not support this functionality. The spectrum analyzer measurement, Swept SA, does not support this functionality.

Key Path	AMPTD Y Scale, Attenuation, Pre-Adjust for Min Clip
Example	:POW:RANGe:OPT:ATT OFF
Initial S/W Revision	Prior to A.02.00

## Elec Atten Only

Selects only the electric attenuator to participate in auto ranging. This offers less wear on the mechanical attenuator and is usually faster.

This key is grayed out in measurements that do not support this functionality. The spectrum analyzer measurement, Swept SA, does not support this functionality.

Key Path	AMPTD Y Scale, Attenuation, Pre-Adjust for Min Clip
Example	:POW:RANGe:OPT:ATT ELEC
Initial S/W Revision	Prior to A.02.00

### Mech + Elec Atten

In dual attenuator models, this selects both attenuators participate in the autoranging.

This key is grayed out in measurements that do not support this functionality. The spectrum analyzer measurement, Swept SA, does not support this functionality.

Key Path	AMPTD Y Scale, Attenuation, Pre-Adjust for Min Clip
Example	:POW:RANGe:OPT:ATT COMB
Initial S/W Revision	Prior to A.02.00

### (Mech) Atten Step

This controls the step size used when making adjustments to the input attenuation.

This key is labeled Mech Atten Step in dual attenuator models and Atten Step in single attenuator models. In the dual attenuator configuration, this key only affects the step size of the mechanical attenuator.

Key Path	AMPTD Y Scale, Attenuation
<b>Remote Command</b>	[ :SENSe ] :POWer [ :RF ] :ATTenuation :STEP [ :INCRement ] 10 dB   2 dB [ :SENSe ] :POWer [ :RF ] :ATTenuation :STEP [ :INCRement ] ?
<b>Example</b>	POW:ATT:STEP 2
Notes	Note this feature works like a 1-N choice from the front panel, but it takes a specific value (in dB) when used remotely. The only valid values are 2 and 10.
Dependencies	Blanked in CXA and EXA if option FSA (2 dB steps) is not present. If blanked, attempts to set it via SCPI will yield an error.
Couplings	When the attenuation step size changes, the current mechanical attenuation value is adjusted (if necessary) to be quantized to the new step size. That is, if step is set to 10 dB, mech atten is increased if necessary so it is a multiple of 10 dB
Preset	PXA and MXA: 2 dB EXA and CXA: 10 dB (2 dB with option FSA)
State Saved	Saved in instrument state
Initial S/W Revision	Prior to A.02.00
Modified at S/W Revision	A.03.00

## Scale/Div

Sets the units per division of the vertical scale in the logarithmic display. However, since the Auto Scaling is defaulted to On, this value is automatically determined by the measurement result. When you set a value manually, Auto Scaling automatically changes to Off.

<b>Key Path</b>	AMPTD Y Scale
<b>Mode</b>	SA, WCDMA, C2K, WIMAX OFDMA, 1xEVDO, DVB-T/H, DTMB (CTTB), ISDB-T, CMMB, LTE, LTETDD, Digital Cable TV, WLAN, MSR, LTEAFDD, LTEATDD
<b>Remote Command</b>	:DISPlay:CHPower:VIEW[1]:WINDow[1]:TRACe:Y[:SCALe]:PDIVision <rel_amp1> :DISPlay:CHPower:VIEW[1]:WINDow[1]:TRACe:Y[:SCALe]:PDIVision?
<b>Example</b>	DISP:CHP:VIEW:WIND:TRAC:Y:PDIV 2 DISP:CHP:VIEW:WIND:TRAC:Y:PDIV?
<b>Notes</b>	You must be in the Spectrum Analysis mode, W-CDMA mode, cdma2000 mode, DVB-T/H mode, DTMB (CTTB) mode, ISDB-T mode, CMMB mode, Digital Cable TV mode, LTE mode, LTE TDD mode, WLAN mode, 1xEVDO mode, MSR, LTE-Advanced FDD/TDD mode or WIMAX OFDMA mode to use this command. Use :INSTrument:SElect to set the mode.
<b>Couplings</b>	When the Auto Scaling is On, this value is automatically determined by the measurement result. When you set a value manually, Auto Scaling automatically changes to Off.
<b>Preset</b>	10.00 dB
<b>State Saved</b>	Saved in instrument state.
<b>Min</b>	0.10 dB
<b>Max</b>	20.00 dB
<b>Initial S/W Revision</b>	Prior to A.02.00
<b>Modified at S/W Revision</b>	A.02.00, A.03.00

## Presel Center

When this key is pressed, the centering of the preselector filter is adjusted to optimize the amplitude accuracy at the frequency of the selected marker. If the selected marker is not on when Presel Center is pressed, the analyzer will turn on the selected marker, perform a peak search, and then perform centering on the marker's center frequency. If the selected marker is already on and between the start and stop frequencies of the analyzer, the analyzer performs the preselector calibration on that marker's frequency. If the selected marker is already on, but outside the frequency range between Start Freq and Stop Freq, the analyzer will first perform a peak search, and then perform centering on the marker's center frequency.

The value displayed on the Presel Adjust key will change to reflect the new preselector tuning (see Presel Adjust).

A number of considerations should be observed to ensure proper operation. See ["Proper Preselector Operation" on page 485](#).

<b>Key Path</b>	AMPTD Y Scale
<b>Remote Command</b>	[:SENSE]:POWer[:RF]:PCENTER



<b>Example</b>	POW:PCEN
Notes	Note that the rules outlined above under the key description apply for the remote command as well as the key. The result of the command is dependent on marker position, and so forth. Any message shown by the key press is also shown in response to the remote command.
Dependencies	<ul style="list-style-type: none"> <li>• Grayed out if the microwave preselector is off. )</li> <li>• If the selected marker's frequency is below Band 1, advisory message 0.5001 is generated and no action is taken.</li> <li>• Grayed out if entirely in Band 0.</li> <li>• Blank in models that do not include a preselector, such as option 503. If the SCPI is sent in these instruments, it is accepted without error, and the query always returns 0.</li> <li>• Grayed out in the Spectrogram View.</li> </ul>
Couplings	<p>The active marker position determines where the centering will be attempted.</p> <p>If the analyzer is in a measurement such as averaging when centering is initiated, the act of centering the preselector will restart averaging but the first average trace will not be taken until the centering is completed.</p>
Status Bits/OPC dependencies	<p>When centering the preselector, *OPC will not return true until the process is complete and a subsequent measurement has completed, nor will results be returned to a READ or MEASure command.</p> <p>The Measuring bit should remain set while this command is operating and should not go false until the subsequent sweep/measurement has completed.</p>
Initial S/W Revision	Prior to A.02.00
Modified at S/W Revision	A.03.00

## Proper Preselector Operation

A number of considerations should be observed to ensure proper operation:

1. If the selected marker is off, the analyzer will turn on a marker, perform a peak search, and adjust the preselector using the selected marker's frequency. It uses the "highest peak" peak search method unqualified by threshold or excursion, so that there is no chance of a 'no peak found' error. It continues with that peak, even if it is the peak of just noise. Therefore, for this operation to work properly, there should be a signal on screen in a preselected range for the peak search to find.
2. If the selected marker is already on, the analyzer will attempt the centering at that marker's frequency. There is no preselector for signals below about 3.6 GHz, therefore if the marker is on a signal below 3.6 GHz, no centering will be attempted and an advisory message generated
3. In some models, the preselector can be bypassed. If it is bypassed, no centering will be attempted in that range and a message will be generated.

## Preselector Adjust

Allows you to manually adjust the preselector filter frequency to optimize its response to the signal of interest. This function is only available when "[Presel Center](#)" on page 2791 is available.

For general purpose signal analysis, using Presel Center is recommended. Centering the filter minimizes the impact of long-term preselector drift. Presel Adjust can be used instead to manually optimize the preselector. One application of manual optimization would be to peak the preselector response, which both optimizes the signal-to-noise ratio and minimizes amplitude variations due to small (short-term) preselector drifting.

<b>Key Path</b>	AMPTD Y Scale
<b>Scope</b>	Meas Global
<b>Remote Command</b>	<code>[ :SENSe ] :POWer [ :RF ] :PADJust &lt;freq&gt;</code> <code>[ :SENSe ] :POWer [ :RF ] :PADJust?</code>
<b>Example</b>	POW:PADJ 100KHz POW:PADJ?
<b>Notes</b>	The value on the key reads out to 0.1 MHz resolution.
<b>Dependencies</b>	<ul style="list-style-type: none"> <li>• Grayed out if microwave preselector is off. )</li> <li>• Grayed out if entirely in Band 0.</li> <li>• Blank in models that do not include a preselector, such as option 503. If the SCPI is sent in these instruments, it is accepted without error, and the query always returns 0.</li> <li>• Grayed out in the Spectrogram View.</li> </ul>
<b>Preset</b>	0 MHz
<b>State Saved</b>	The Presel Adjust value set by Presel Center, or by manually adjusting Presel Adjust, is not saved in instrument state, and does not survive a Preset or power cycle.
<b>Min</b>	-500 MHz
<b>Max</b>	500 MHz
<b>Default Unit</b>	Hz
<b>Backwards Compatibility SCPI</b>	<code>[ :SENSe ] :POWer [ :RF ] :MW :PADJust</code> <code>[ :SENSe ] :POWer [ :RF ] :MMW :PADJust</code> PSA had multiple preselectors, but the X-Series has only one. These commands simply alias to <code>[ :SENSe ] :POWer [ :RF ] :PADJust</code>
<b>Initial S/W Revision</b>	Prior to A.02.00
<b>Modified at S/W Revision</b>	A.03.00

<b>Remote Command</b>	<code>[ :SENSe ] :POWer [ :RF ] :PADJust :PRESelector MWAVE   MMWave   EXTERNAL</code> <code>[ :SENSe ] :POWer [ :RF ] :PADJust :PRESelector?</code>
<b>Notes</b>	PSA had multiple preselectors, and you could select which preselector to adjust. Since the X-Series has only one mm/uW preselector, the preselector selection softkey is no longer available. However, to provide backward compatibility, we accept the legacy remote commands. The command form has no effect, the query always returns MWAVE
<b>Initial S/W Revision</b>	Prior to A.02.00

## μW Path Control

The μW Path Control functions include the μW Preselector Bypass (Option MPB) and Low Noise Path (Option LNP) controls in the High Band path circuits.

When the μW Preselector is bypassed, the user has better flatness, but will be subject to spurs from out of band interfering signals. When the Low Noise Path is enabled, the analyzer automatically switches around certain circuitry in the high frequency bands which can contribute to noise, when it is appropriate based on other analyzer settings.

For most applications, the preset state is Standard Path, which gives the best remote-control throughput, minimizes acoustic noise from switching and minimizes the risk of wear out in the hardware switches. For applications that utilize the wideband IF paths, the preset state is the μW Preselector Bypass path, if option MPB is present. This is because, when using a wideband IF such as the 140 MHz IF, the μW Preselector's bandwidth can be narrower than the available IF bandwidth, causing degraded amplitude flatness and phase linearity, so it is desirable to bypass the preselector in the default case.

Users may choose Low Noise Path Enable. It gives a lower noise floor, especially in the 21–26.5 GHz region, though without improving many measures of dynamic range, and without giving the best possible noise floor. The preamp, if purchased and used, gives better noise floor than does the Low Noise Path, however its compression threshold and third-order intercept are much poorer than that of the non-preamp Low Noise Path. There are some applications, typically for signals around –30 dBm, for which the third-order dynamic range of the standard path is good enough, but the noise floor is not low enough even with 0 dB input attenuation. When the third-order dynamic range of the preamp path is too little and the noise floor of the standard path is too high, the Low Noise Path can provide the best dynamic range.

<b>Key Path</b>	AMPTD Y Scale
<b>Mode</b>	SA, BASIC, PNOISE, VSA , LTE, LTETDD
<b>Scope</b>	Meas Global
<b>Remote Command</b>	[ :SENSe ] :POWer [ :RF ] :MW:PATH STD LNPath MPBypass FULL [ :SENSe ] :POWer [ :RF ] :MW:PATH?
<b>Example</b>	:POW:MW:PATH LNP Enables the Low Noise path
<b>Notes</b>	If a Presel Center is performed, the analyzer will momentarily switch to the Standard Path, regardless of the setting of μW Path Control  The DC Block will always be switched in when the low noise path is switched in, to protect succeeding circuitry from DC. Note that this does not mean “when the low noise path is enabled” but when, based on the Low Noise Path rules, the path is actually switched in. This can happen when the selection is Low Noise Path Enable . In the case where the DC Block is switched in the analyzer is now AC coupled. However, if the user has selected DC coupling, the UI will still behave as though it were DC coupled, including all annunciation, warnings, status bits, and responses to SCPI queries. This is because, based on other settings, the analyzer could switch out the low noise path at any time and hence go back to being DC coupled.  Alignment switching ignores the settings in this menu, and restores them when finished.
<b>Dependencies</b>	Unavailable in BBIQ and External Mixing
<b>Preset</b>	All modes other than IQ Analyzer mode and VXA: STD IQ Analyzer, VXA and WLAN mode:

	MPB option present and licensed: MPB MPB option not present and licensed: STD
State Saved	Save in instrument state
Readback	Value selected in the submenu
Initial S/W Revision	A.04.00
Modified at S/W Revision	A.10.00

## Standard Path

This path gives the best remote-control throughput, minimizes acoustic noise from switching and minimizes the risk of wear in the hardware switches, particularly in remote test scenarios where both low band and high band setups will follow in rapid succession.

In this path, the bypass of the low band/high band switch and microwave preamp is never activated, which can cause some noise degradation but preserves the life of the bypass switch.

Key Path	AMPTD Y Scale, $\mu$ W Path Control
Example	:POW:MW:PATH STD
Readback Text	Standard Path
Initial S/W Revision	A.04.00

## Low Noise Path Enable

You may choose Low Noise Path Enable, which gives a lower noise floor under some circumstances, particularly when operating in the 21–26.5 GHz region. With the Low Noise Path enabled, the low band/high band switch and microwave preamp are bypassed whenever all of the following are true:

- The analyzer is not in the Low Band, meaning:
- the start frequency is above 3.5 GHz and
- the stop frequency is above 3.6 GHz.
- the internal preamp is not installed or (if installed) is set to Off or Low Band

Note that this means that, when any part of a sweep is done in Low Band, the Low Noise Path is not used, whether or not the Low Noise Path Enable is selected in the user interface. Also, if the preamp is turned on, the Low Noise Path is not used, whether or not the Low Noise Path Enable is selected in the user interface. The only time the Low Noise Path is used is when Low Noise Path Enable is selected, the sweep is completely in High Band (> 3.6 GHz) and no preamp is in use.

See "[More Information](#)" on page 489

Key Path	AMPTD Y Scale, $\mu$ W Path Control
Measurement	Swept SA

<b>Example</b>	:POW:MW:PATH LNP
<b>Notes</b>	<p>For measurements that use IQ acquisition, the low noise path is used when the Center Frequency is in High Band (&gt; 3.6 GHz) and no preamp is in use.</p> <p>In other words, the rules above are modified to use only the center frequency to qualify which path to switch in.</p> <p>This is not the case for FFT's in the Swept SA measurement; they use the same rules as swept measurements.</p>
<b>Dependencies</b>	<p>Key is blanked if current mode does not support it.</p> <p>Key is grayed out if mode supports it but current measurement does not support it.</p> <p>Unless Option LNP is present and licensed, key is blank and if SCPI command sent, error -241, "Hardware missing; Option not installed" is generated.</p>
<b>Readback Text</b>	Low Noise Path Enable
<b>Initial S/W Revision</b>	A.04.00

### More Information

The user should understand that the Low Noise Path, while giving improved DANL, has the disadvantage of decreased TOI performance and decreased gain compression performance relative to the standard path.

The user should also understand that the bypass switch is a mechanical switch and has finite life, so if the Low Noise Path is enabled, it is possible to cause frequent cycling of this switch by frequently changing analyzer settings such that the above conditions hold true only some of the time. A user making tests of this nature should consider opting for the Standard Path, which will never throw the bypass switch, at the expense of some degraded noise performance.

The low noise path is useful for situations where the signal level is so low that the analyzer performance is dominated by noise even with 0 dB attenuation, but still high enough that the preamp option would have excessive third-order intermodulation or compression. The preamp, if purchased and used, gives better noise floor than does the "Low Noise Path." However, its compression threshold and third-order intercept are much poorer than that of the non-preamp path. There are some applications, typically for signals around -30 dBm, for which the third-order dynamic range of the standard path is good enough, but the noise floor is not low enough even with 0 dB input attenuation. When the third-order dynamic range of the preamp path is too little and the noise floor of the standard path is too high, the Low Noise Path can provide the best dynamic range

The graph below illustrates the concept. It shows, in red, the performance of an analyzer at different attenuation settings, both with the preamp on and off, in a measurement that is affected by both analyzer noise and analyzer TOI. The green shows the best available dynamic range, offset by 0.5 dB for clarity. The blue shows how the best available dynamic range improves for moderate signal levels with the low noise path switched in. In this illustration, the preamp improves the noise floor by 15 dB while degrading the third-order intercept by 30 dB, and the low noise path reduces loss by 8 dB. The attenuator step size is 2 dB.

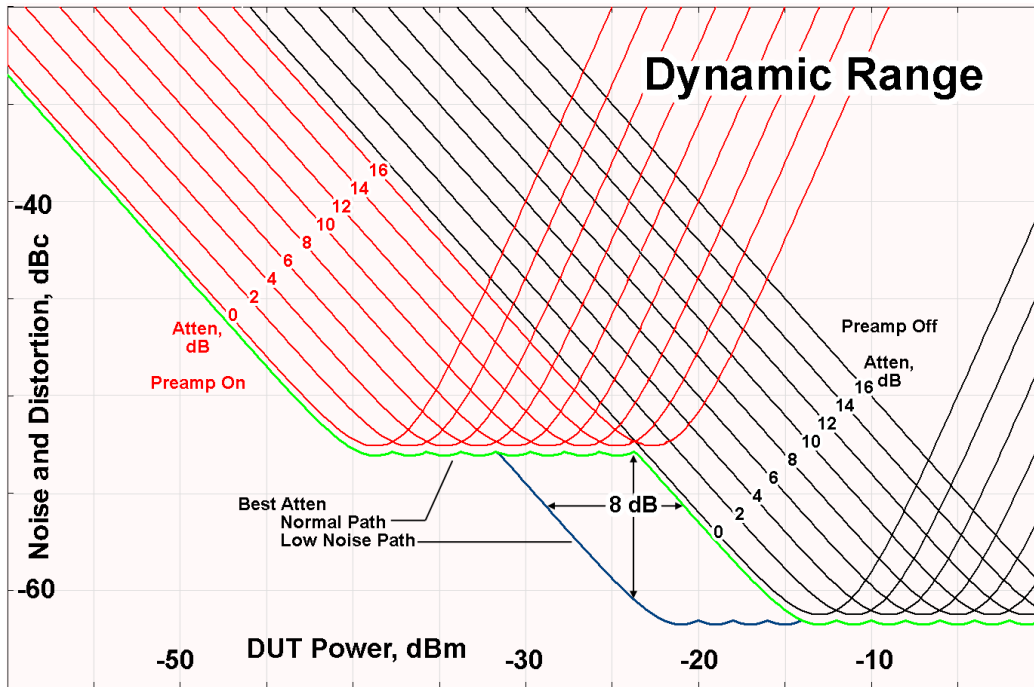

There are other times where selecting the low noise path improves performance, too. Compression-limited measurements such as finding the nulls in a pulsed-RF spectrum can profit from the low noise path in a way similar to the TOI-limited measurement illustrated. Accuracy can be improved when the low noise path allows the optimum attenuation to increase from a small amount like 0, 2 or 4 dB to a larger amount, giving better return loss at the analyzer input. Harmonic measurements, such as second and third harmonic levels, are much improved using the low noise path because of the superiority of that path for harmonic (though not intermodulation) distortion performance.

### μW Preselector Bypass

This key toggles the preselector bypass switch for band 1 and higher. When the microwave preselector is on, the signal path is preselected. When the microwave preselector is off, the signal path is not preselected. The preselected path is the normal path for the analyzer.

The preselector is a tunable bandpass filter which prevents signals away from the frequency of interest from combining in the mixer to generate in-band spurious signals (images). The consequences of using a preselector filter are its limited bandwidth, the amplitude and phase ripple in its passband, and any amplitude and phase instability due to center frequency drift.

Option MPB or pre-selector bypass provides an unpreselected input mixer path for certain X-Series signal analyzers with frequency ranges above 3.6 GHz. This signal path allows a wider bandwidth and less amplitude variability, which is an advantage when doing modulation analysis and broadband signal analysis. The disadvantage is that, without the preselector, image signals will be displayed. Another disadvantage of bypassing the preselector is increased LO emission levels at the front panel input port.

Image responses are separated from the real signal by twice the 1st IF. For IF Paths of 10 MHz and 25 MHz, the 1st IF is 322.5 MHz, so the image response and the real signal will be separated by 645 MHz. The 1st IF will be different for other IF Path settings. When viewing a real signal and its corresponding image response in internal mixing, the image response will be to the left of the real signal.

Also, the image response and the real signal typically have the same amplitude and exhibit the same shape factor.

However, if Option FS1, Fast Sweep Capability, is enabled, the image response in the Swept SA measurement will appear lower in amplitude and have a much wider shape factor compared to the real signal.

Key Path	AMPTD Y Scale, $\mu$ W Path Control
<b>Example</b>	:POW:MW:PATH MPB
Dependencies	Key is blanked if current mode does not support it. Key is grayed out if mode supports it but current measurement does not support it. Key is blank unless Option MPB is present and licensed. If SCPI command sent when MPB not present, error -241, "Hardware missing; Option not installed" is generated.
Readback Text	$\mu$ W Preselector Bypass
Initial S/W Revision	A.04.00

<b>Remote Command</b>	[ :SENSe ] :POWer [ :RF ] :MW:PRESelector [ :STATe ] ON OFF 0 1 [ :SENSe ] :POWer [ :RF ] :MW:PRESelector [ :STATe ] ?
<b>Example</b>	:POW:MW:PRES OFF Bypasses the microwave preselector
Notes	The ON parameter sets the STD path (:POW:MW:PATH STD) The OFF parameter sets path MPB (:POW:MW:PATH MPB)
Preset	ON

## Internal Preamp

Accesses a menu of keys that control the internal preamps. Turning on the preamp gives a better noise figure, but a poorer TOI to noise floor dynamic range. You can optimize this setting for your particular measurement.

The instrument takes the preamp gain into account as it sweeps. If you sweep outside of the range of the preamp the instrument will also account for that. The displayed result will always reflect the correct gain.

For some measurements, when the preamp is on and any part of the displayed frequency range is below the lowest frequency for which the preamp has specifications, a warning condition message appears in the status line. For example, for a preamp with a 9 kHz lowest specified frequency: "Preamp: Accy unspec'd below 9 kHz".

Key Path	AMPTD Y Scale
Scope	Meas Global
<b>Remote Command</b>	[ :SENSe ] :POWer [ :RF ] :GAIN [ :STATe ] OFF ON 0 1 [ :SENSe ] :POWer [ :RF ] :GAIN [ :STATe ] ?
Dependencies	Preamp is not available on all hardware platforms. If the preamp is not present or is unlicensed, the

---

	key is not shown. The preamp is not available when the electronic/soft attenuator is enabled.
--	--------------------------------------------------------------------------------------------------

---

Couplings	The act of connecting the U7227A USB Preamplifier to one of the analyzer's USB ports will cause the Internal Preamp to be switched on. When this happens an informational message will be generated: "Internal Preamp turned on for optimal operation with USB Preamp." Note that if the Internal Preamp was already on, there will be no change to the setting, but if it was Off it will be switched On, to Full Range.  Note that this same action occurs when the SA mode is selected while the USB Preamp is connected to one of the analyzer's USB ports, if it is the first time that the SA mode has run since powerup, or if the last time the SA mode was running the USB Preamp was NOT connected. Subsequently disconnecting the USB Preamp from USB does not change the Internal Preamp setting nor restore the previous setting.
Preset	OFF
State Saved	Saved in instrument state
Initial S/W Revision	Prior to A.02.00
Modified at S/W Revision	A.14.00

---

Key Path	AMPTD Y Scale, Internal Preamp
Scope	Meas Global
<b>Remote Command</b>	[ :SENSe ] :POWer [ :RF ] :GAIN:BAND LOW FULL [ :SENSe ] :POWer [ :RF ] :GAIN:BAND?
Dependencies	Preamp is not available on all hardware platforms. If the preamp is not present or is unlicensed, the key is not shown.  If a POW:GAIN:BAND FULL command is sent when a low band preamp is available, the preamp band parameter is to LOW instead of FULL, and an "Option not installed" message is generated.
Preset	LOW
State Saved	Saved in instrument state
Initial S/W Revision	Prior to A.02.00

---

## Off

Turns the internal preamp off

Key Path	AMPTD Y Scale, Internal Preamp
<b>Example</b>	:POW:GAIN OFF
Readback	Off
Initial S/W Revision	Prior to A.02.00

---



## Low Band

Sets the internal preamp to use only the low band.

The frequency range of the installed (optional) low-band preamp is displayed in square brackets on the Low Band key label.

Key Path	AMPTD Y Scale, Internal Preamp
<b>Example</b>	:POW:GAIN ON :POW:GAIN:BAND LOW
Readback	Low Band
Initial S/W Revision	Prior to A.02.00

## Full Range

Sets the internal preamp to use its full range. The low band (0–3.6 GHz or 0–3GHz, depending on the model) is supplied by the low band preamp and the frequencies above low band are supplied by the high band preamp.

The frequency range of the installed (optional) preamp is displayed in square brackets on the Full Range key label. If the high band option is not installed the Full Range key does not appear.

Key Path	AMPTD Y Scale, Internal Preamp
<b>Example</b>	:POW:GAIN ON :POW:GAIN:BAND FULL
Readback	Full Range
Initial S/W Revision	Prior to A.02.00

## Ref Position

Positions the reference level at the top, center, or bottom of the Y Scale display. Changing the reference position does not change the reference level value.

Key Path	AMPTD Y Scale
Mode	SA, WCDMA, C2K, WIMAX OFDMA, 1xEVDO, DVB-T/H, DTMB (CTTB), ISDB-T, CMMB, LTE, LTETDD, Digital Cable TV, WLAN, MSR, LTEAFDD, LTEATDD
<b>Remote Command</b>	:DISPlay:CHPower:VIEW[1]:WINDow[1]:TRACe:Y[:SCALE]:RPOSition TOP   CENTER   BOTTom :DISPlay:CHPower:VIEW[1]:WINDow[1]:TRACe:Y[:SCALE]:RPOSition?
<b>Example</b>	DISP:CHP:VIEW:WIND:TRAC:Y:RPOS CENT DISP:CHP:VIEW:WIND:TRAC:Y:RPOS?
Notes	You must be in the Spectrum Analysis mode, W-CDMA mode, cdma2000 mode, DVB-T/H mode, DTMB (CTTB) mode, ISDB-T mode, CMMB mode, Digital Cable TV mode, LTE mode, LTE TDD mode, WLAN mode, 1xEVDO mode, MSR, LTE-Advanced FDD/TDD mode or WIMAX OFDMA mode to use

	this command. Use :INSTrument:SElect to set the mode.
Preset	TOP
State Saved	Saved in instrument state.
Range	Top Ctr Bot
Initial S/W Revision	Prior to A.02.00
Modified at S/W Revision	A.02.00, A.03.00

## Auto Scaling

Toggles the Auto Scaling function between On and Off.

Key Path	AMPTD Y Scale
Mode	SA, WCDMA, C2K, WIMAX OFDMA, 1xEVDO, DVB-T/H, DTMB (CTTB), ISDB-T, CMMB, LTE, LTETDD, Digital Cable TV, WLAN, MSR, LTEAFDD, LTEATDD
Remote Command	:DISPlay:CHPower:VIEW[1]:WINDow[1]:TRACe:Y[:SCALE]:COUPle 0   1   OFF   ON  :DISPlay:CHPower:VIEW[1]:WINDow[1]:TRACe:Y[:SCALE]:COUPle?
Example	DISP:CHP:VIEW:WIND:TRAC:Y:COUP OFF DISP:CHP:VIEW:WIND:TRAC:Y:COUP?
Couplings	When Auto Scaling is On, and the Restart front-panel key is pressed, this function automatically sets the scale per division to 10 dB and determines the reference values based on the measurement results.  When you set a value to either Scale/Div or Ref Value manually, Auto Scaling automatically changes to Off.
Preset	1
State Saved	Saved in instrument state.
Range	On Off
Initial S/W Revision	Prior to A.02.00
Modified at S/W Revision	A.02.00, A.03.00

## Auto Couple

The Auto Couple feature provides a quick and convenient way to automatically couple multiple instrument settings. This helps ensure accurate measurements and optimum dynamic range. When the Auto Couple feature is activated, either from the front panel or remotely, all parameters of the current measurement that have an Auto/Manual mode are set to Auto mode and all measurement settings dependent on (or coupled to) the Auto/Man parameters are automatically adjusted for optimal performance.

However, the Auto Couple key actions are confined to the current measurement only. It does not affect other measurements in the mode, and it does not affect markers, marker functions, or trace or display attributes.

See "[More Information](#)" on page 495

Key Path	Front-panel key
Remote Command	:COUPle ALL NONE
Example	:COUP ALL
Notes	:COUPle ALL puts all Auto/Man parameters in Auto mode (equivalent to pressing the Auto Couple key). :COUPLE NONE puts all Auto/Man parameters in manual mode. It decouples all the coupled instrument parameters and is not recommended for making measurements.
Initial S/W Revision	Prior to A.02.00

### More Information

There are two types of functions that have Auto/Manual modes.

#### Auto/Man Active Function keys

An Auto/Man toggle key controls the binary state associated with an instrument parameter by toggling between Auto (where the parameter is automatically coupled to the other parameters it is dependent upon) and Man (where the parameter is controlled independent of the other parameters), as well as making the parameter the active function. The current mode is indicated on the softkey with either Auto or Man underlined as illustrated below.



#### Auto/Man 1-of-N keys

An Auto/Man 1-of-N key allows you to manually pick from a list of parameter values, or place the function in Auto, in which case the value is automatically selected (and indicated) as shown below. If in Auto, Auto is underlined on the calling key. If in manual operation, manual is indicated on the calling key. But the calling key does not actually toggle the function, it simply opens the menu.

8 Channel Power Measurement  
Auto Couple

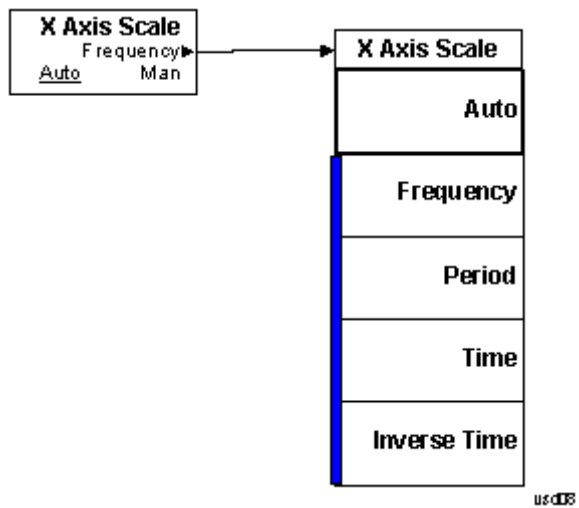

## BW

Accesses a menu of functions that enable you to specify and control the video and resolution bandwidths. You can also select the type of filter for the measurement and set the filter bandwidth.

Key Path	Front-panel key
Initial S/W Revision	Prior to A.02.00

## Res BW

Sets the value of the resolution bandwidth (RBW). If an unavailable bandwidth is entered with the numeric keypad, the closest available bandwidth is selected.

LTE-Advanced FDD/TDD Auto RBW:

Bandwidth	RBW (KHz)
1.4MHz	20
3MHz	43
5MHz	68
10MHz	150
15MHz	220
20MHz	270

the resolution bandwidth is predefined based on the corresponding bandwidth of the single LTE carrier, which is listed above. When ResBW mode is Auto, the narrowest RBW over the active carriers is selected for Multi-carriers.

Key Path	BW
Mode	SA, WCDMA, C2K, WIMAX OFDMA, 1xEVDO, DVB-T/H, DTMB (CTTB), ISDB-T, CMMB, LTE, LTE-TDD, Digital Cable TV, WLAN, MSR, LTEAFDD, LTEATDD
<b>Remote Command</b>	<pre>[ :SENSe ] :CHPower :BANDwidth [ :RESolution ] &lt;bandwidth&gt; [ :SENSe ] :CHPower :BANDwidth [ :RESolution ] ? [ :SENSe ] :CHPower :BANDwidth [ :RESolution ] :AUTO ON   OFF   1   0 [ :SENSe ] :CHPower :BANDwidth [ :RESolution ] :AUTO ?</pre>
<b>Example</b>	<pre>CHP:BAND 5 MHz CHP:BAND? CHP:BAND:AUTO ON CHP:BAND:AUTO?</pre>
Notes	You must be in the Spectrum Analysis mode, W-CDMA mode, cdma2000 mode, DVB-T/H mode, DTMB (CTTB) mode, ISDB-T mode, CMMB mode, Digital Cable TV mode, LTE mode, LTE TDD mode, WLAN mode, 1xEVDO mode, MSR, LTE-Advanced FDD/TDD mode or WIMAX OFDMA mode to use this command. Use :INSTRument:SElect to set the mode.

Couplings	<p>Sweep time is coupled to the RBW. As the RBW changes, the sweep time (if set to Auto) is changed to maintain amplitude calibration.</p> <p>Video bandwidth (VBW) is coupled to the RBW. As the resolution bandwidth changes, the video bandwidth (if set to Auto) changes to maintain the ratio of VBW/RBW (10:1).</p> <p>When the Res BW is set to Auto, the resolution bandwidth is auto-coupled to the span. The ratio of Span/RBW is approximately 106:1 when auto coupled. When Res BW is set to Man, and the bandwidths are entered manually, these bandwidths are used regardless of other analyzer settings.</p>
Preset	<p>SA: Auto</p> <p>WCDMA: 240 kHz</p> <p>C2K: 24 kHz</p> <p>WIMAX OFDMA: 100kHz</p> <p>1xEVDO: 30kHz</p> <p>DVB-T/H: 3.9kHz</p> <p>DTMB (CTTB): 3.9kHz</p> <p>ISDB-T: 30kHz</p> <p>CMMB: 3.9kHz</p> <p>LTE: Auto</p> <p>LTETDD: Auto</p> <p>Digital Cable TV: 3.9kHz</p> <p>WLAN: 100 kHz</p> <p>MSR: 100kHz</p> <p>LTEAFDD/LTEATDD: Auto</p> <p>WCDMA, C2K, 1xEVDO , WIMAX OFDMA, DVB-T/H, DTMB (CTTB), ISDB-T, CMMB, Digital Cable TV, WLAN, MSR, LTEAFDD, LTEATDD: OFF</p> <p>SA, LTE, LTETDD: ON</p>
State Saved	Saved in instrument state.
Min	1 Hz
Max	8 MHz
<b>Backwards Compatibility SCPI</b>	<code>[ :SENSe ] :CHPower:BWIDth [ :RESolution ]</code>
Initial S/W Revision	Prior to A.02.00
Modified at S/W Revision	A.02.00, A.03.00

## Video BW

Changes the analyzer post-detection filter (VBW).

Key Path	BW
Mode	SA, WCDMA, C2K, WIMAX OFDMA, 1xEVDO, DVB-T/H, DTMB (CTTB), ISDB-T, CMMB, LTE, LTETDD, Digital Cable TV, WLAN, MSR, LTEAFDD, LTEATDD
Remote Command	<code>[ :SENSe ] :CHPower:BWIDth:VIDeo &lt;bandwidth&gt;</code>

	<pre>[ :SENSe ] :CHPower :BANDwidth :VIDeo?</pre> <pre>[ :SENSe ] :CHPower :BANDwidth :VIDeo :AUTO ON   OFF   1   0</pre> <pre>[ :SENSe ] :CHPower :BANDwidth :VIDeo :AUTO?</pre>
<b>Example</b>	<pre>CHP:BAND:VID 2.4 MHz</pre> <pre>CHP:BAND:VID?</pre> <pre>CHP:BAND:VID:AUTO OFF</pre> <pre>CHP:BAND:VID:AUTO?</pre>
Notes	<p>You must be in the Spectrum Analysis mode, W-CDMA mode, cdma2000 mode, DVB-T/H mode, DTMB (CTTB) mode, ISDB-T mode, CMMB mode, Digital Cable TV mode, LTE mode, LTE TDD mode, WLAN mode, 1xEVDO mode, MSR,LTE-Advanced FDD/TDD mode or WIMAX OFDMA mode to use this command. Use :INSTrument:SElect to set the mode.</p>
Dependencies	See Couplings
Couplings	<p>Video bandwidth (VBW) is coupled to the RBW. As the resolution bandwidth changes, the video bandwidth (if set to Auto) changes to maintain the ratio set by VBW/RBW.</p> <p>Sweep Time is coupled to the Video Bandwidth (VBW). As the VBW is changed, the sweep time (when set to Auto) is changed to maintain amplitude calibration. This occurs because of common hardware between the two circuits, even though the Video BW filter is not actually “in-circuit” when the detector is set to Average. Because the purpose of the average detector and the VBW filter are the same, either can be used to reduce the variance of the result.</p> <p>Although the VBW filter is not “in-circuit” when using the average detector, the Video BW key can have an effect on (Auto) sweep time, and is not disabled. In this case, reducing the VBW setting increases the sweep time, which increases the averaging time, producing a lower-variance trace.</p> <p>When using the average detector with either Sweep Time set to Man, or in zero span, the VBW setting has no effect and is disabled (grayed out).</p> <p>When the video bandwidth is AUTO coupled, the video bandwidth value is set to: Resolution Bandwidth * Video Bandwidth to Resolution Bandwidth Ratio</p>
Preset	<pre>SA: Auto</pre> <pre>WCDMA: 2.4MHz</pre> <pre>C2K: 240 kHz</pre> <pre>WIMAX OFDMA: Auto</pre> <pre>1xEVDO: 300 kHz</pre> <pre>DVB-T/H: 39kHz</pre> <pre>DTMB (CTTB): 39kHz</pre> <pre>ISDB-T: 300kHz</pre> <pre>CMMB: 39kHz</pre> <pre>LTE, MSR: Auto</pre> <pre>LTETDD: Auto</pre> <pre>LTEAFDD,LTEATDD:Auto</pre> <pre>Digital Cable TV: 39kHz</pre> <pre>WLAN: Auto</pre> <pre>ON</pre>

State Saved	Saved in instrument state.
Min	1 Hz
Max	50 MHz
Initial S/W Revision	Prior to A.02.00
Modified at S/W Revision	A.02.00, A.03.00

## Filter Type

Selects the type of bandwidth filter that is used. The choices are Gaussian or Flat top.

Key Path	BW
Mode	SA, WCDMA, C2K, WIMAX OFDMA, 1xEVDO, DVB-T/H, DTMB (CTTB), ISDB-T, CMMB, LTE, LTE-TDD, Digital Cable TV, WLAN, MSR, LTEAFDD, LTEATDD
<b>Remote Command</b>	[ :SENSe ] :CHPower :BANDwidth :SHAPE GAUSSian FLATtop [ :SENSe ] :CHPower :BANDwidth :SHAPE?
<b>Example</b>	CHP:BAND:SHAP GAUS CHP:BAND:SHAP?
Preset	GAUSSian
State Saved	Saved in instrument state.
Range	Gaussian Flattop
<b>Backwards Compatibility SCPI</b>	[ :SENSe ] :CHPower :BWIDth :SHAPE
Initial S/W Revision	Prior to A.02.00
Modified at S/W Revision	A.02.00, A.03.00



## Cont (Continuous Measurement/Sweep)

Sets the analyzer for Continuous measurement operation. The single/continuous state is Meas Global so the setting will affect all measurements. If you are Paused, pressing Cont does a Resume.

Key Path	Front-panel key
Remote Command	:INITiate:CONTinuous OFF ON 0 1 :INITiate:CONTinuous?
Example	:INIT:CONT 0 puts analyzer in Single measurement operation. :INIT:CONT 1 puts analyzer in Continuous measurement operation
Preset	ON (Note that SYST:PRESet sets INIT:CONT to ON but *RST sets INIT:CONT to OFF)
State Saved	Saved in instrument state
Backwards Compatibility Notes	For Spectrum Analysis mode in ESA and PSA, there is no Cont hardkey, instead there is a Sweep Single/Cont key. In these analyzers, switching the Sweep Single/Cont key from Single to Cont restarts averages (displayed average count reset to 1), but does not restart Max Hold and Min Hold. The X-Series has Single and Cont keys in place of the SweepSingleCont key. In the X-Series, if in single measurement, the Cont key (and INIT:CONT ON ) switches to continuous measurement, but never restarts a measurement and never resets a sweep.
Initial S/W Revision	Prior to A.02.00

In Swept SA Measurement (Spectrum Analysis Mode):

The analyzer takes repetitive sweeps, averages, measurements, etc., when in Continuous mode. When the average count reaches the Average/Hold Number the count stops incrementing, but the analyzer keeps sweeping. See the Trace/Detector section for the averaging formula used both before and after the Average/Hold Number is reached. The trigger condition must be met prior to each sweep. The type of trace processing for multiple sweeps, is set under the Trace/Detector key, with choices of Trace Average, Max Hold, or Min Hold.

In Other Measurements/Modes:

With Avg/Hold Num (in the Meas Setup menu) set to Off or set to On with a value of 1, a sweep is taken after the trigger condition is met; and the analyzer continues to take new sweeps after the current sweep has completed and the trigger condition is again met. However, with Avg/Hold Num set to On with a value >1, multiple sweeps (data acquisitions) are taken for the measurement. The trigger condition must be met prior to each sweep. The sweep is not stopped when the average count k equals the number N set for Avg/Hold Num is reached, but the number k stops incrementing. A measurement average usually applies to all traces, marker results, and numeric results. But sometimes it only applies to the numeric results.

If the analyzer is in Single measurement, pressing the Cont key does not change k and does not cause the sweep to be reset; the only action is to put the analyzer into Continuous measurement operation.

If it is already in continuous sweep:

the INIT:CONT 1 command has no effect

## 8 Channel Power Measurement Cont (Continuous Measurement/Sweep)

the INIT:CONT 0 command will place the analyzer in Single Sweep but will have no effect on the current sequence until  $k = N$ , at which point the current sequence will stop and the instrument will go to the idle state.

File

See "File" on page 354

## FREQ Channel

Accesses a menu of keys that allow you to control the Frequency and Channel parameters of the instrument.

Some features in the Frequency menu are the same for all measurements – they do not change as you change measurements. Settings like these are called “Meas Global” and are unaffected by Meas Preset. For example, the Center Freq setting is the same for all measurements - it does not change as you change measurements.

<b>Key Path</b>	<b>Front-panel key</b>
<b>Initial S/W Revision</b>	<b>Prior to A.02.00</b>

### Center Freq

Sets the frequency that corresponds to the horizontal center of the graticule (when frequency Scale Type is set to linear). While adjusting the Center Frequency the Span is held constant, which means that both Start Frequency and Stop Frequency will change.

Pressing Center Freq also sets the frequency entry mode to Center/Span. In Center/Span mode, the center frequency and span values are displayed below the graticule, and the default active function in the Frequency menu is Center Freq.

The center frequency setting is the same for all measurements within a mode, that is, it is Meas Global. Some modes are also able to share a Mode Global center frequency value. If this is the case, the Mode will have a Global Settings key in its Mode Setup menu.

The Center Freq function sets (and queries) the Center Frequency for the currently selected input. If your analyzer has multiple inputs, and you select another input, the Center Freq changes to the value for that input. SCPI commands are available to directly set the Center Freq for a specific input.

Center Freq is remembered as you go from input to input. Thus you can set a Center Freq of 10 GHz with the RF Input selected, change to BBIQ and set a Center Freq of 20 MHz, then switch to External Mixing and set a Center Freq of 60 GHz, and when you go back to the RF Input the Center Freq will go back to 10 GHz; back to BBIQ and it is 20 MHz; back to External Mixing and it is 60 GHz.

See ["RF Center Freq" on page 507](#)

See [Ext Mix Center Freq](#)

See ["I/Q Center Freq" on page 509](#)

See ["Center Frequency Presets" on page 505](#)

<b>Key Path</b>	<b>FREQ Channel</b>
<b>Scope</b>	<b>Meas Global</b>
<b>Remote Command</b>	<code>[ :SENSe ] :FREQuency:CENTer &lt;freq&gt;</code> <code>[ :SENSe ] :FREQuency:CENTer?</code>

<b>Example</b>	FREQ:CENT 50 MHz FREQ:CENT UP changes the center frequency to 150 MHz if you use FREQ:CENT:STEP 100 MHz to set the center frequency step size to 100 MHz FREQ:CENT?
<b>Notes</b>	This command sets either the RF or I/Q Center Frequency depending on the selected input. For RF input it is equivalent to FREQ:RF:CENT For I/Q input it is equivalent to FREQ:IQ:CENT Preset and Max values are dependent on Hardware Options (5xx) If no terminator (e.g. MHz) is sent the terminator Hz is used. If a terminator with unit other than Frequency is used, an invalid suffix error message is generated.
<b>Dependencies</b>	The Center Frequency can be limited by Start or Stop Freq limits, if the Span is so large that Start or Stop reach their limit.
<b>Couplings</b>	When operating in “swept span”, any value of the Center Frequency or Span that is within the frequency range of the analyzer is allowed when the value is being set through the front panel numeric key pad or the SCPI command. The other parameter is forced to a different value if needed, to keep the Start and the Stop Frequencies within the analyzer’s frequency range
<b>Preset</b>	Depends on instrument maximum frequency, mode, measurement, and selected input. See <a href="#">"Center Frequency Presets" on page 505</a> and <a href="#">"RF Center Freq" on page 507</a> and <a href="#">Ext Mix Center Freq</a> and <a href="#">"I/Q Center Freq" on page 509</a> .
<b>State Saved</b>	Saved in instrument state
<b>Min</b>	Depends on instrument maximum frequency, mode, measurement, and selected input.. See <a href="#">"Center Frequency Presets" on page 505</a> and <a href="#">"RF Center Freq" on page 507</a> and <a href="#">"I/Q Center Freq" on page 509</a> .
<b>Max</b>	Depends on instrument maximum frequency, mode, measurement, and selected input.. See <a href="#">"Center Frequency Presets" on page 505</a> and <a href="#">"RF Center Freq" on page 507</a> and <a href="#">"I/Q Center Freq" on page 509</a> .
<b>Default Unit</b>	Hz
<b>Status Bits/OPC</b>	Non-overlapped
<b>Dependencies</b>	
<b>Initial S/W Revision</b>	Prior to A.02.00

## Center Frequency Presets

The following table provides the Center Frequency Presets for the Spectrum Analyzer mode, and the Max Freq, for the various frequency options:

Freq Option	CF after Mode Preset	Stop Freq after Mode Preset	Max Freq (can't tune)

8 Channel Power Measurement  
 FREQ Channel

			above)
503 (all but N9000A)	1.805 GHz	3.6 GHz	3.7 GHz
503 (N9000A)	1.505 GHz	3.0 GHz	3.08 GHz
507 (all but N9000A)	3.505 GHz	7.0 GHz	7.1 GHz
507 (N9000A)	3.755 GHz	7.5 GHz	7.58 GHz
508 (all but N9038A)	1.805 GHz	3.6 GHz	8.5 GHz
508 (N9038A)	4.205 GHz	8.4 GHz	8.5 GHz
513	6.805 GHz	13.6 GHz	13.8 GHz
526 (all but N9000A and N9038A)	13.255 GHz	26.5 GHz	27.0 GHz
526 (N9000A)	13.255 GHz	26.5 GHz	26.55 GHz
526 (N9038A)	1.805 GHz	3.6 GHz	27.0 GHz
532	16.005 GHz	32.0 GHz	32.5 GHz
543	21.505 GHz	43.0 GHz	TBD
544	22.005 GHz	44.0 GHz	44.5 GHz
550	25.005 GHz	50.0 GHz	51 GHz

Input 2:

Model	CF after Mode Preset	Stop Freq after Mode Preset	Max Freq (can't tune above)
N9000A opt C75	0.7505GHz	1.5 GHz	1.58 GHz
N9038A	505 MHz	1 GHz	1.000025 GHz

Tracking Generator Frequency Limits (N9000A only):

Tracking Generator Option	Min Freq (clips to this freq when turn TG on and	If above this Freq, Stop Freq clipped to this Freq when	Max Freq (can't tune above) while TG

	can't tune below while TG on)	TG turned on	on
T03	9 kHz	3.0 GHz	3.08 GHz
T06	9 kHz	6.0 GHz	6.05 GHz

The following table shows the Center Frequency Presets for modes other than Spectrum Analyzer:

Mode	CF Preset for RF
WCDMA	1 GHz
WIMAXOFDMA,	1 GHz
BASIC	1 GHz
ADEMOD	1 GHz
VSA	1 GHz
TDSCDMA	1 GHz
PNOISE	1 GHz
LTE	1 GHz
LTETDD	1 GHz
MSR	1 GHz
GSM	935.2 MHz
NFIGURE	1.505 GHz

## RF Center Freq

SCPI command for specifying the RF Center Frequency. This command will set the Center Frequency to be used when the RF input is selected, even if the RF input is not the input that is selected at the time the command is sent. Note that the Center Freq function in the Frequency menu on the front panel always applies to the currently selected input.

Scope	Meas Global
<b>Remote Command</b>	<code>[ :SENSe ] :FREQuency:RF:CENTer &lt;freq&gt;</code> <code>[ :SENSe ] :FREQuency:RF:CENTer?</code>
<b>Example</b>	FREQ:RF:CENT 30 MHz
Notes	This command is the same in all modes, but the parameter is Measurement Global. So the value is independent in each mode and common across all the measurements in the mode.
Dependencies	If the electronic/soft attenuator is enabled, any attempt to set Center Frequency such that the Stop Frequency would be >3.6 GHz fails and results in an advisory message. If the equivalent SCPI command is sent, this same message is generated as part of a “-221, Settings conflict” warning. If Source Mode is set to Tracking, and the Max or Min Center Freq is therefore limited by the limits of the source, a warning message is generated, “Data out of range;clipped to source max/min” if these limits are exceeded. Note that for an external source, these limits can be affected by the settings of

	Source Numerator, Source Denominator and Power Sweep.
Preset	See table above
State Saved	Saved in instrument state.
Min	-79.999995 MHz, unless Source Mode is set to Tracking, in which case it is limited by the minimum frequency of the Source
Max	See table above. Basically instrument maximum frequency - 5 Hz. Note that, if the Source Mode is set to Tracking, the effective instrument maximum frequency may be limited by the source maximum frequency.  If the knob or step keys are being used, also depends on the value of the other three interdependent parameters Span, Start Frequency and Stop Frequency
Initial S/W Revision	Prior to A.02.00
Modified at S/W Revision	A.03.00

### Ext Mix Center Freq

SCPI command for specifying the External Mixer Center Frequency. This command will set the Center Frequency to be used when the External Mixer is selected, even if the External Mixer input is not the input which is selected at the time the command is sent. Note that the Center Freq function in the Frequency menu on the front panel always applies to the currently selected input.

Scope	Meas Global
Remote Command	<code>[ :SENSe ] :FREQuency:EMIXer:CENTer &lt;freq&gt;</code> <code>[ :SENSe ] :FREQuency:EMIXer:CENTer?</code>
Example	<code>:FREQ:EMIX:CENT 60 GHz</code> <code>:FREQ:EMIX:CENT?</code>
Notes	This command is the same in all modes, but the parameter is Measurement Global. So the value is independent in each mode and common across all the measurements in the mode.
Couplings	When returning to External Mixing after having been switched to one of the other inputs (e.g., RF), you will come back into the settings that you had when you left External Mixing. So you will come back to the band you were in with the Center Frequency that you had. However, Span is not an input-dependent parameter, therefore you will bring the span over from the other input. Therefore, the analyzer comes back with the span from the previous input, limited as necessary by the current mixer setup.
Preset	When a Mode Preset is performed while in External Mixing, the Start frequency of the current Mode is set to the nominal Min Freq of the lowest harmonic range in the Harmonic Table for the current mixer setup. Similarly, the Stop frequency of the current Mode is set to the nominal Max Freq of the highest harmonic range in the Harmonic Table. The Center Freq thus presets to the point arithmetically equidistant from these two frequencies.  If the current measurement has a limited Span available to it, and cannot achieve the Span shown in the table (Span=Stop Freq - Start Freq), the analyzer uses the maximum Span the measurement allows, and still sets the Center Freq to the midpoint of the Start and Stop Freq values in the Harmonic Table.



	When Restore Input/Output Defaults is performed, the mixer presets to the 11970A, whose Start and Stop frequencies are 26.5 and 40 GHz respectively. The center of these two frequencies is 33.25 GHz. Therefore, after a Restore Input/Output Defaults, if you go into External Mixing and do a Mode Preset while in the Spectrum Analyzer Mode, the resulting Center Freq is 33.25 GHz.
State Saved	Saved in instrument state.
Min	The minimum frequency in the currently selected mixer band + 5 Hz
Max	The maximum frequency in the currently selected mixer band – 5 Hz If the knob or step keys are being used, also depends on the value of the other three interdependent parameters Span, Start Frequency and Stop Frequency
Initial S/W Revision	A.08.01

## I/Q Center Freq

SCPI command for specifying the I/Q Center Frequency. This command will set the Center Frequency to be used when the I/Q input is selected, even if the I/Q input is not the input which is selected at the time the command is sent. Note that the Center Freq function in the Frequency menu on the front panel always applies to the currently selected input.

Scope	Meas Global
<b>Remote Command</b>	<code>[ :SENSe ] :FREQuency:IQ:CENTer &lt;freq&gt;</code> <code>[ :SENSe ] :FREQuency:IQ:CENTer?</code>
<b>Example</b>	FREQ:IQ:CENT: 30 MHz
Notes	This command is the same in all modes, but the parameter is Measurement Global. So the value is independent in each mode and common across all the measurements in the mode.
Preset	0 Hz
State Saved	Saved in instrument state.
Min	-40.049995 MHz
Max	40.049995 MHz
Initial S/W Revision	Prior to A.02.00

## CF Step

Changes the step size for the center frequency and start and stop frequency functions. Once a step size has been selected and the center frequency function is active, the step keys (and the UP|DOWN parameters for Center Frequency from remote commands) change the center frequency by the step-size value. The step size function is useful for finding harmonics and sidebands beyond the current frequency span of the analyzer.

Note that the start and stop frequencies also step by the CF Step value.

Key Path	FREQ Channel
Remote Command	[:SENSe]:FREQuency:CENTer:STEP[:INCRement] <freq> [:SENSe]:FREQuency:CENTer:STEP[:INCRement]? [:SENSe]:FREQuency:CENTer:STEP:AUTO OFF ON 0 1 [:SENSe]:FREQuency:CENTer:STEP:AUTO?
Example	FREQ:CENT:STEP:AUTO ON FREQ:CENT:STEP 500 MHz FREQ:CENT UP increases the current center frequency value by 500 MHz FREQ:CENT:STEP? FREQ:CENT:STEP:AUTO?
Notes	Preset and Max values are depending on Hardware Options (503, 507, 508, 513, 526)
Notes	Preset and Max values are dependent on Hardware Options (5xx)
Dependencies	Freq Offset is not available in External Mixing. In this case the Freq Offset key is grayed out and shows a value of zero. It will once again be available, and show the previously set value, when you return to the RF Input.
Dependencies	Span, RBW, Center frequency If the electronic/soft attenuator is enabled, any attempt to change the value of the center frequency >3.6 GHz by pressing the Up-arrow key, fails and results in an advisory message. If the equivalent SCPI command is sent, this same message is generated as part of a “-221, Settings conflict” warning.
Couplings	When auto-coupled in a non-zero span, the center frequency step size is set to 10% of the span. When auto-coupled in zero span, the center frequency step size is set to the equivalent -3 dB RBW value.
Preset	Auto ADEM0D: 1 MHz ON
State Saved	Saved in instrument state
Min	– (the maximum frequency of the instrument). That is, 27 GHz max freq instrument has a CF step range of +/- 27 GHz. Note that this is the maximum frequency given the current settings of the instrument, so in External Mixing, for example, it is the maximum frequency of the current mixer band.
Max	The maximum frequency of the instrument. That is, 27 GHz max freq instrument has a CF step range of +/- 27 GHz. Note that this is the maximum frequency given the current settings of the instrument, so in External Mixing, for example, it is the maximum frequency of the current mixer band.
Default Unit	Hz
Status Bits/OPC dependencies	non-overlapped
Initial S/W Revision	Prior to A.02.00
Modified at S/W Revision	A.03.00

## Input/Output

See ["Input/Output" on page 226](#)

## Marker

Accesses a menu that enables you to select, set up and control the markers for the current measurement.

Key Path	Front-panel key
Initial S/W Revision	Prior to A.02.00

### Select Marker

Displays 12 markers available for selection.

Key Path	Marker
Initial S/W Revision	Prior to A.02.00

### Marker Type

Sets the marker control mode to Normal, Delta, Fixed or Off. All interactions and dependencies detailed under the key description are enforced when the remote command is sent. If the selected marker is Off, pressing Marker sets it to Normal and places it at the center of the screen on the trace determined by the Marker Trace rules. At the same time, Marker X Axis Value appears on the Active Function area.

The default active function is the active function for the currently selected marker control mode. If the current control mode is Off, there is no active function and the active function is turned off.

Key Path	Marker
Mode	SA, WCDMA, C2K, WIMAX OFDMA, 1xEVDO, DVB-T/H, DTMB (CTTB), ISDB-T, CMMB, LTE, LTETDD, Digital Cable TV, WLAN, MSR, LTEAFDD, LTEATDD
Remote Command	:CALCulate:CHPower:MARKer[1] 2 ... 12:MODE POSITION   DELTa   OFF :CALCulate:CHPower:MARKer[1] 2 ... 12:MODE?
Example	CALC:CHP:MARK3:MODE POS CALC:CHP:MARK3:MODE?
Notes	If the selected marker is Off, pressing Marker sets it to Normal and places it at the center of the screen on the trace determined by the Marker Trace rules. At the same time, Marker X Axis Value appears on the Active Function area.  Default Active Function: the active function for the selected marker's current control mode. If the current control mode is Off, there is no active function and the active function is turned off.  Active Function Display: the marker X axis value entered in the active function area displays the marker value to its full entered precision.
Preset	OFF
State Saved	Saved in instrument state.
Range	Normal Delta Off
Initial S/W Revision	Prior to A.02.00
Modified at S/W Revision	A.02.00, A.03.00

## Properties

Accesses the marker properties menu.

Key Path	Marker
Initial S/W Revision	Prior to A.02.00

## Select Marker

Displays 12 markers available for selection.

Key Path	Marker
Initial S/W Revision	Prior to A.02.00

## Relative To

Sets the reference marker to which the selected marker is relative.

Key Path	Marker, Properties
Mode	SA, WCDMA, C2K, WIMAX OFDMA, 1xEVDO, DVB-T/H, DTMB (CTTB), ISDB-T, CMMB, LTE, LTETDD, Digital Cable TV, WLAN, MSR, LTEAFDD, LTEATDD
<b>Remote Command</b>	:CALCulate:CHPower:MARKer[1] 2 ... 12:REFerence <integer> :CALCulate:CHPower:MARKer[1] 2 ... 12:REFerence?
<b>Example</b>	CALC:CHP:MARK:REF 5 CALC:CHP:MARK:REF?
Notes	A marker cannot be relative to itself so that choice is grayed out, and if sent from SCPI generates error -221: "Settings conflict; marker cannot be relative to itself." When queried, a single value is returned (the specified marker numbers relative marker). You must be in the Spectrum Analysis or WCDMA mode to use this command. Use :INSTrument:SElect to set the mode.
Preset	2 3 4 5 6 7 8 9 10 11 12 1
State Saved	Saved in instrument state.
Min	1
Max	12
Initial S/W Revision	Prior to A.02.00
Modified at S/W Revision	A.02.00, A.03.00

## All Markers Off

Turns off all markers.

<b>Key Path</b>	Marker
<b>Mode</b>	SA, WCDMA, C2K, WIMAX OFDMA, 1xEVDO, DVB-T/H, DTMB (CTTB), ISDB-T, CMMB, LTE, LTETDD, Digital Cable TV, WLAN, MSR, LTEAFDD, LTEATDD
<b>Remote Command</b>	:CALCulate:CHPower:MARKer:AOff
<b>Example</b>	CALC:CHP:MARK:AOff
<b>Initial S/W Revision</b>	Prior to A.02.00
<b>Modified at S/W Revision</b>	A.02.00, A.03.00

### Marker X Axis Value (Remote Command Only)

Sets the marker X Axis value in the current marker X Axis Scale unit. It has no effect if the control mode is Off, but is the SCPI equivalent of entering an X value if the control mode is Normal, Delta, or Fixed.

<b>Mode</b>	SA, WCDMA, CDMA2K, WIMAXOFDMA, CDMA1XEV, DVB, DTMB, ISDBT, CMMB, LTE, LTETDD, DCATV, WLAN, MSR, LTEAFDD, LTEATDD
<b>Remote Command</b>	:CALCulate:CHPower:MARKer[1] 2 ... 12:X <real> :CALCulate:CHPower:MARKer[1] 2 ... 12:X?
<b>Example</b>	CALC:CHP:MARK3:X 0 CALC:CHP:MARK3:X?
<b>Notes</b>	The query returns the marker's absolute X Axis value if the control mode is Normal, or the offset from the marker's reference marker if the control mode is Delta. The query is returned in the fundamental units for the current marker X Axis scale: Hz for Frequency.
<b>Preset</b>	After a preset, all markers are turned OFF, so Marker X Axis Value query returns a not a number (NAN).
<b>State Saved</b>	Saved in instrument state.
<b>Min</b>	-9.9E+37
<b>Max</b>	9.9E+37
<b>Initial S/W Revision</b>	Prior to A.02.00
<b>Modified at S/W Revision</b>	A.02.00, A.03.00

### Marker X Axis Position (Remote Command Only)

Sets the marker X Axis Scale position in trace points. This setting has no effect if the control mode is Off, but is the SCPI equivalent of entering a value if the control mode is Normal or Delta . The entered value is immediately translated into the current X Axis Scale units for setting the value of the marker.

<b>Mode</b>	SA, WCDMA, CDMA2K, WIMAXOFDMA, CDMA1XEV, DVB, DTMB, ISDBT, CMMB, LTE, LTETDD, DCATV, WLAN, MSR, LTEAFDD, LTEATDD
<b>Remote Command</b>	:CALCulate:CHPower:MARKer[1] 2 ... 12:X:POStion <real> :CALCulate:CHPower:MARKer[1] 2 ... 12:X:POStion?
<b>Example</b>	CALC:CHP:MARK10:X:POS 0

	CALC:CHP:MARK10:X:POS?
Notes	The query returns the marker's absolute X Axis value in trace points if the control mode is Normal, or the offset from the marker's reference marker in trace points if the control mode is Delta.
Preset	After a preset, all markers are turned OFF, so Marker X Axis Value query returns a not a number (NAN).
State Saved	Saved in instrument state.
Min	-9.9E+37
Max	9.9E+37
Initial S/W Revision	Prior to A.02.00
Modified at S/W Revision	A.02.00, A.03.00

### Marker Y Axis Value (Remote Command only)

Returns the marker Y Axis value in the current marker Y Axis unit.

Mode	SA, WCDMA, CDMA2K, WIMAXOFDMA, CDMA1XEV, DVB, DTMB, ISDBT, CMMB, LTE, LTETDD, DCATV, WLAN, MSR, LTEAFDD, LTEATDD
<b>Remote Command</b>	:CALCulate:CHPower:MARKer [1]   2   ...   12 : Y ?
<b>Example</b>	CALC:CHP:MARK11:Y?
Preset	Result dependent on Markers setup and signal source.
State Saved	Saved in instrument state.
Initial S/W Revision	Prior to A.02.00
Modified at S/W Revision	A.02.00, A.03.00

### Backward Compatibility SCPI Commands

Sets or queries the state of a marker. Setting a marker which is OFF to state ON or 1 puts it in Normal mode and places it at the center of the screen.

Mode	SA, WCDMA, CDMA2K, WIMAXOFDMA, CDMA1XEV, DVB, DTMB, ISDBT, CMMB, LTE, LTETDD, DCATV, WLAN, MSR, LTEAFDD, LTEATDD
<b>Remote Command</b>	:CALCulate:CHPower:MARKer [1]   2   ...   12 : STATe OFF   ON   0   1 :CALCulate:CHPower:MARKer [1]   2   ...   12 : STATe ?
<b>Example</b>	CALC:CHP:MARK3:STAT ON CALC:CHP:MARK3:STAT?
Preset	OFF
State Saved	Saved in instrument state.
Range	On Off
Initial S/W Revision	Prior to A.02.00
Modified at S/W Revision	A.02.00, A.03.00





## Marker Function

There are no 'Marker Functions' supported in Channel Power, so this front-panel key displays a blank menu when pressed.

---

Key Path	Front-panel key
Initial S/W Revision	Prior to A.02.00

---

## Marker To

There is no 'Marker To' functionality supported in Channel Power measurement, so this front-panel key displays a blank key menu when pressed.

---

Key Path	Front-panel key
Initial S/W Revision	Prior to A.02.00

---

## Meas

The information in this section is common to all measurements. For key and remote command information for a specific measurement, refer to the section that describes the measurement of interest.

Measurements available under the Meas key are specific to the current Mode.

When viewing Help for measurements, note the following:

**NOTE**

Operation for some keys differs between measurements. The information displayed in Help pertains to the current measurement. To see how a key operates in a different measurement, exit Help (press the Cancel Esc key), select the measurement, then reenter Help (press the Help key) and press that key.

---

Key Path	Front-panel key
Initial S/W Revision	Prior to A.02.00

---

### Remote Measurement Functions

This section contains the following topics:

"Measurement Group of Commands" on page 2849

"Current Measurement Query (Remote Command Only)" on page 2851

"Limit Test Current Results (Remote Command Only)" on page 2851

"Data Query (Remote Command Only)" on page 2851

"Calculate/Compress Trace Data Query (Remote Command Only)" on page 2852

"Calculate Peaks of Trace Data (Remote Command Only)" on page 2857

Hardware-Accelerated Fast Power Measurement (Remote Command Only)

"Format Data: Numeric Data (Remote Command Only)" on page 2858

"Format Data: Byte Order (Remote Command Only)" on page 2859

---

Initial S/W Revision	Prior to A.02.00
----------------------	------------------

---

## Measurement Group of Commands

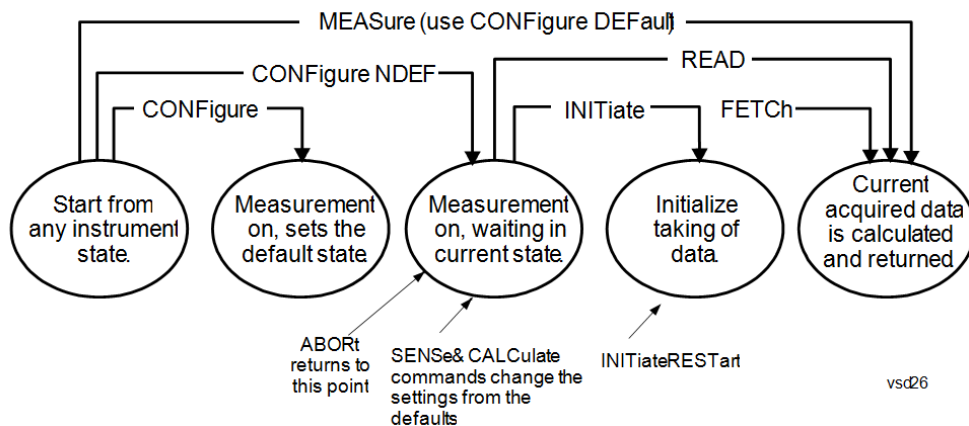

---

### Measure Commands:

:MEASure:<measurement>[n]?

This is a fast single-command way to make a measurement using the factory default instrument settings. These are the settings and units that conform to the Mode Setup settings (e.g. radio standard) that you have currently selected.

- Stops the current measurement (if any) and sets up the instrument for the specified measurement using the factory defaults
- Initiates the data acquisition for the measurement
- Blocks other SCPI communication, waiting until the measurement is complete before returning results.
- If the function does averaging, it is turned on and the number of averages is set to 10.
- After the data is valid it returns the scalar results, or the trace data, for the specified measurement. The type of data returned may be defined by an [n] value that is sent with the command.
- The scalar measurement results will be returned if the optional [n] value is not included, or is set to 1. If the [n] value is set to a value other than 1, the selected trace data results will be returned. See each command for details of what types of scalar results or trace data results are available.
- ASCII is the default format for the data output. (Older versions of Spectrum Analysis and Phase Noise mode measurements only use ASCII.) The binary data formats should be used for handling large blocks of data since they are smaller and faster than the ASCII format. Refer to the FORMat:DATA command for more information.

If you need to change some of the measurement parameters from the factory default settings you can set up the measurement with the CONFIGure command. Use the commands in the SENSE:<measurement> and CALCulate:<measurement> subsystems to change the settings. Then you can use the READ? command to initiate the measurement and query the results.

If you need to repeatedly make a given measurement with settings other than the factory defaults, you can use the commands in the SENSE:<measurement> and CALCulate:<measurement> subsystems to set up the measurement. Then use the READ? command to initiate the measurement and query results.

Measurement settings persist if you initiate a different measurement and then return to a previous one. Use READ:<measurement>? if you want to use those persistent settings. If you want to go back to the default settings, use MEASure:<measurement>?.

---

### Configure Commands:

:CONFIGure:<measurement>

This command stops the current measurement (if any) and sets up the instrument for the specified measurement using

---

---

the factory default instrument settings. It does not initiate the taking of measurement data unless INIT:CONTinuous is ON. If you change any measurement settings after using the CONFigure command, the READ command can be used to initiate a measurement without changing the settings back to their defaults.

In the Swept SA measurement in Spectrum Analyzer mode the CONFigure command also turns the averaging function on and sets the number of averages to 10 for all measurements.

:CONFigure: <measurement>: NDEFault stops the current measurement and changes to the specified measurement. It does not change the settings to the defaults. It does not initiate the taking of measurement data unless INIT:CONTinuous is ON.

The CONFigure? query returns the current measurement name.

The CONFigure:CATalog? query returns a quoted string of all licensed measurement names in the current mode. For example, "SAN, CHP, OBW, ACP, PST, TXP, SPUR, SEM, LIST".

---

#### Fetch Commands:

---

:FETCh:<measurement>[n]?

This command puts selected data from the most recent measurement into the output buffer. Use FETCh if you have already made a good measurement and you want to return several types of data (different [n] values, for example, both scalars and trace data) from a single measurement. FETCh saves you the time of re-making the measurement. You can only FETCh results from the measurement that is currently active, it will not change to a different measurement. An error message is reported if a measurement other than the current one is specified.

If you need to get new measurement data, use the READ command, which is equivalent to an INITiate followed by a FETCh.

The scalar measurement results will be returned if the optional [n] value is not included, or is set to 1. If the [n] value is set to a value other than 1, the selected trace data results will be returned. See each command for details of what types of scalar results or trace data results are available. The binary data formats should be used for handling large blocks of data since they are smaller and transfer faster than the ASCII format. (FORMat:DATA)

FETCh may be used to return results other than those specified with the original READ or MEASure command that you sent.

---

#### INITiate Commands:

---

:INITiate:<measurement>

This command is not available for measurements in all the instrument modes:

- Initiates a trigger cycle for the specified measurement, but does not output any data. You must then use the FETCh<meas> command to return data. If a measurement other than the current one is specified, the instrument will switch to that measurement and then initiate it.
  - For example, suppose you have previously initiated the ACP measurement, but now you are running the channel power measurement. If you send INIT:ACP? it will change from channel power to ACP and will initiate an ACP measurement.
  - Does not change any of the measurement settings. For example, if you have previously started the ACP measurement and you send INIT:ACP? it will initiate a new ACP measurement using the same instrument settings as the last time ACP was run.
  - If your selected measurement is currently active (in the idle state) it triggers the measurement, assuming the trigger conditions are met. Then it completes one trigger cycle. Depending upon the measurement and the number of averages, there may be multiple data acquisitions, with multiple trigger events, for one full trigger cycle. It also holds off additional commands on GPIB until the acquisition is complete.
- 

#### READ Commands:

---

:READ:<measurement>[n]?

- Does not preset the measurement to the factory default settings. For example, if you have previously initiated the ACP
-

---

measurement and you send READ:ACP? it will initiate a new measurement using the same instrument settings.

- Initiates the measurement and puts valid data into the output buffer. If a measurement other than the current one is specified, the instrument will switch to that measurement before it initiates the measurement and returns results.
  - For example, suppose you have previously initiated the ACP measurement, but now you are running the channel power measurement. Then you send READ:ACP? It will change from channel power back to ACP and, using the previous ACP settings, will initiate the measurement and return results.
  - Blocks other SCPI communication, waiting until the measurement is complete before returning the results
  - If the optional [n] value is not included, or is set to 1, the scalar measurement results will be returned. If the [n] value is set to a value other than 1, the selected trace data results will be returned. See each command for details of what types of scalar results or trace data results are available. The binary data formats should be used when handling large blocks of data since they are smaller and faster than the ASCII format. (FORMat:DATA)
- 

---

Initial S/W Revision	Prior to A.02.00
----------------------	------------------

---

### Current Measurement Query (Remote Command Only)

This command returns the name of the measurement that is currently running.

---

<b>Remote Command</b>	:CONFigure?
-----------------------	-------------

<b>Example</b>	CONF?
----------------	-------

Initial S/W Revision	Prior to A.02.00
----------------------	------------------

---

### Limit Test Current Results (Remote Command Only)

Queries the status of the current measurement limit testing. It returns a 0 if the measured results pass when compared with the current limits. It returns a 1 if the measured results fail any limit tests.

---

<b>Remote Command</b>	:CALCulate:CLIMits:FAIL?
-----------------------	--------------------------

<b>Example</b>	CALC:CLIM:FAIL? queries the current measurement to see if it fails the defined limits. Returns a 0 or 1: 0 it passes, 1 it fails.
----------------	--------------------------------------------------------------------------------------------------------------------------------------

Initial S/W Revision	Prior to A.02.00
----------------------	------------------

---

### Data Query (Remote Command Only)

Returns the designated measurement data for the currently selected measurement and subopcode.

n = any valid subopcode for the current measurement. See the measurement command results table for your current measurement, for information about what data is returned for the subopcodes.

This command uses the data setting specified by the FORMat:BORDER and FORMat:DATA commands and can return real or ASCII data. (See the format command descriptions under Input/Output in the Analyzer Setup section.)

<b>Remote Command</b>	:CALCulate:DATA[n]?
<b>Notes</b>	The return trace depends on the measurement. In CALCulate:<meas>:DATA[n], n is any valid subopcode for the current measurement. It returns the same data as the FETCH:<measurement>? query where <measurement> is the current measurement.
<b>Initial S/W Revision</b>	Prior to A.02.00

## Calculate/Compress Trace Data Query (Remote Command Only)

Returns compressed data for the currently selected measurement and sub-opcode [n].

n = any valid sub-opcode for that measurement. See the MEASure:<measurement>? command description of your specific measurement for information on the data that can be returned.

The data is returned in the current Y Axis Unit of the analyzer. The command is used with a sub-opcode <n> (default=1) to specify the trace. With trace queries, it is best if the analyzer is not sweeping during the query. Therefore, it is generally advisable to be in Single Sweep, or Update=Off.

This command is used to compress or decimate a long trace to extract and return only the desired data. A typical example would be to acquire N frames of GSM data and return the mean power of the first burst in each frame. The command can also be used to identify the best curve fit for the data.

<b>Remote Command</b>	:CALCulate:DATA<n>:COMPRESS? BLOCK   CFIT   MAXimum   MINimum   MEAN   DMEan   RMS   RMSCubed   SAMPLE   SDEVIation   PPHase [,<soffset> [,<length>[,<roffset>[,<rlimit>]]]]
<b>Example</b>	To query the mean power of a set of GSM bursts: Supply a signal that is a set of GSM bursts. Select the IQ Waveform measurement (in IQ Analyzer Mode). Set the sweep time to acquire at least one burst. Set the triggers such that acquisition happens at a known position relative to a burst. Then query the mean burst levels using, CALC:DATA2:COMP? MEAN, 24e-6, 526e-6 (These parameter values correspond to GSM signals, where 526e-6 is the length of the burst in the slot and you just want 1 burst.)
<b>Notes</b>	The command supports 5 parameters. Note that the last 4 (<soffset>, <length>, <roffset>, <rlimit>) are optional. But these optional parameters must be entered in the specified order. For example, if you want to specify <length>, then you must also specify <soffset>. See details below for a definition of each of these parameters.  This command uses the data in the format specified by FORMat:DATA, returning either binary or ASCII data.
<b>Initial S/W Revision</b>	Prior to A.02.00

- BLOCK or block data - returns all the data points from the region of the trace data that you specify. For example, it could be used to return the data points of an input signal over several timeslots, excluding the portions of the trace data that you do not want. (This is x,y pairs for trace data and I,Q pairs for complex data.)

- CFIT or curve fit - applies curve fitting routines to the data. <soffset> and <length> are required to define the data that you want. <roffset> is an optional parameter for the desired order of the curve equation. The query will return the following values: the x-offset (in seconds) and the curve coefficients ((order + 1) values).

MIN, MAX, MEAN, DME, RMS, RMSC, SAMP, SDEV and PPH return one data value for each specified region (or <length>) of trace data, for as many regions as possible until you run out of trace data (using <roffset> to specify regions). Or they return the number of regions you specify (using <rlimit>) ignoring any data beyond that.

- MINimum - returns the minimum data point (y value) for the specified region(s) of trace data. For I/Q trace data, the minimum magnitude of the I/Q pairs is returned.
- MAXimum - returns the maximum data point (y value) for the specified region(s) of trace data. For I/Q trace data, the maximum magnitude of the I/Q pairs is returned.
- MEAN - returns a single value that is the arithmetic mean of the data point values (in dB/ dBm) for the specified region(s) of trace data. For I/Q trace data, the mean of the magnitudes of the I/Q pairs is returned. See the following equations.

**NOTE** If the original trace data is in dB, this function returns the arithmetic mean of those log values, not log of the mean power which is a more useful value. The mean of the log is the better measurement technique when measuring CW signals in the presence of noise. The mean of the power, expressed in dB, is useful in power measurements such as Channel Power. To achieve the mean of the power, use the RMS option.

Equation 1

Mean Value of Data Points for Specified Region(s)

$$\text{MEAN} = \frac{1}{n} \sum_{X_i \in \text{region}(s)} X_i$$

where  $X_i$  is a data point value, and  $n$  is the number of data points in the specified region(s).

Equation 2

Mean Value of I/Q Data Pairs for Specified Region(s)

$$\text{MEAN} = \frac{1}{n} \sum_{X_i \in \text{region}(s)} |X_i|$$

where  $|X_i|$  is the magnitude of an I/Q pair, and  $n$  is the number of I/Q pairs in the specified region(s).

- DMEan - returns a single value that is the mean power (in dB/ dBm) of the data point values for the specified region(s) of trace data. See the following equation:

Equation 3

DMEan Value of Data Points for Specified Region(s)



$$\text{DME} = 10 \times \log_{10} \left( \frac{1}{n} \sum_{X_i \in \text{region}(s)} 10^{\frac{X_i}{10}} \right)$$

- RMS - returns a single value that is the average power on a root-mean-squared voltage scale (arithmetic rms) of the data point values for the specified region(s) of trace data. See the following equation.

**NOTE** For I/Q trace data, the rms of the magnitudes of the I/Q pairs is returned. See the following equation. This function is very useful for I/Q trace data. However, if the original trace data is in dB, this function returns the rms of the log values which is not usually needed.

Equation 4

RMS Value of Data Points for Specified Region(s)

$$\text{RMS} = \sqrt{\frac{1}{n} \sum_{X_i \in \text{region}(s)} X_i^2}$$

where  $X_i$  is a data point value, and  $n$  is the number of data points in the specified region(s).

Equation 5

RMS Value of I/Q Data Pairs for Specified Region(s)

$$\text{RMS} = \sqrt{\frac{1}{n} \sum_{X_i \in \text{region}(s)} X_i X_i^*}$$

where  $X_i$  is the complex value representation of an I/Q pair,  $X_i^*$  its conjugate complex number, and  $n$  is the number of I/Q pairs in the specified region(s).

Once you have the rms value for a region of trace data (linear or I/Q), you may want to calculate the mean power. You must convert this rms value (peak volts) to power in dBm:

$$10 \times \log[10 \times (\text{rms value})^2]$$

- SAMPLe - returns the first data value (x,y pair) for the specified region(s) of trace data. For I/Q trace data, the first I/Q pair is returned.
- SDEVIation - returns a single value that is the arithmetic standard deviation for the data point values for the specified region(s) of trace data. See the following equation.
- For I/Q trace data, the standard deviation of the magnitudes of the I/Q pairs is returned. See the following equation.

Equation 6

Standard Deviation of Data Point Values for Specified Region(s)

$$\text{SDEV} = \sqrt{\frac{1}{n} \sum_{X_i \in \text{region}(s)} (X_i - \bar{X})^2}$$

where  $X_i$  is a data point value,  $\bar{X}$  is the arithmetic mean of the data point values for the specified region (s), and  $n$  is the number of data points in the specified region(s).

$$\text{SDEV} = \sqrt{\frac{1}{n} \sum_{X_i \in \text{region}(s)} (|X_i| - \bar{X})^2}$$

where  $|X_i|$  is the magnitude of an I/Q pair,  $\bar{X}$  is the mean of the magnitudes for the specified region(s), and  $n$  is the number of data points in the specified region(s).

- PPHase - returns the x,y pairs of both rms power (dBm) and arithmetic mean phase (radian) for every specified region and frequency offset (Hz). The number of pairs is defined by the specified number of regions. This parameter can be used for I/Q vector ( $n=0$ ) in Waveform (time domain) measurement and all parameters are specified by data point in PPHase.

The rms power of the specified region may be expressed as:

$$\text{Power} = 10 \times \log [10 \times (\text{RMS I/Q value})] + 10.$$

The RMS I/Q value (peak volts) is:

$$\sqrt{\frac{1}{n} \sum_{X_i \in \text{region}} X_i X_i^*}$$

where  $X_i$  is the complex value representation of an I/Q pair,  $X_i^*$  its conjugate complex number, and  $n$  is the number of I/Q pairs in the specified region.

The arithmetic mean phase of the specified region may be expressed as:

$$\frac{1}{n} \sum_{Y_i \in \text{region}} Y_i$$

where  $Y_i$  is the unwrapped phase of I/Q pair with applying frequency correction and  $n$  is the number of I/Q pairs in the specified region.

The frequency correction is made by the frequency offset calculated by the arithmetic mean of every specified region's frequency offset. Each frequency offset is calculated by the least square method against the unwrapped phase of I/Q pair.

Sample Trace Data - Constant Envelope

(See below for explanation of variables.)

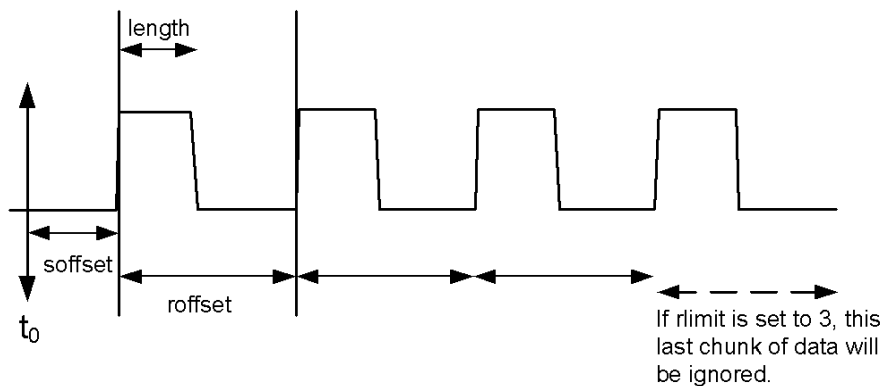

### Sample Trace Data - Not Constant Envelope

(See below for explanation of variables.)

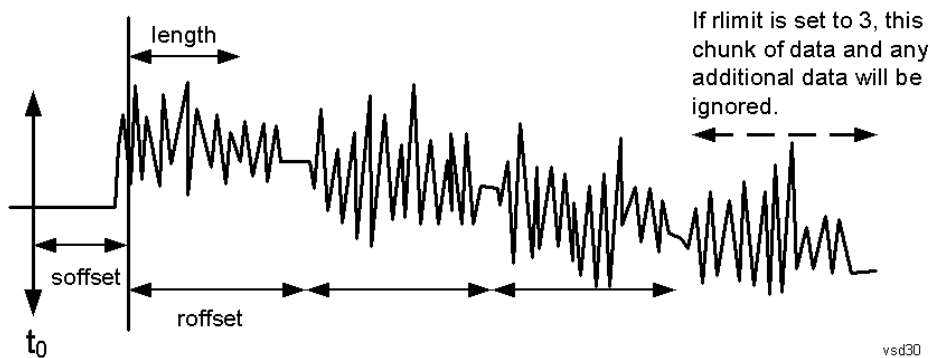

<soffset> - start offset is an optional real number. (It is in seconds for time-domain traces, and is a dimensionless index 0 to Npoints - 1, for frequency-domain traces). It specifies the amount of data at the beginning of the trace that will be ignored before the decimation process starts. It is the time or frequency change from the start of the trace to the point where you want to start using the data. The default value is zero.

<length> - is an optional real number. (It is in seconds for time-domain traces, and is a dimensionless index 0 to Npoints - 1, for frequency-domain traces). It defines how much data will be compressed into one value. This parameter has a default value equal to the current trace length.

<roffset> - repeat offset is an optional real number. (It is in seconds for time-domain traces, and is a dimensionless index 0 to Npoints - 1, for frequency-domain traces). It defines the beginning of the next field of trace elements to be compressed. This is relative to the beginning of the previous field. This parameter has a default value equal to the <length> variable. Note that this parameter is used for a completely different purpose when curve fitting (see CFIT above).

<rlimit> - repeat limit is an optional integer. It specifies the number of data items that you want returned. It will ignore any additional items beyond that number. You can use the Start offset and the Repeat limit to pick out exactly what part of the data you want to use. The default value is all the data.

## Calculate Peaks of Trace Data (Remote Command Only)

Returns a list of all the peaks for the currently selected measurement and sub-opcode [n]. The peaks must meet the requirements of the peak threshold and excursion values.

n = any valid sub-opcode for the current measurement. See the MEASure:<measurement> command description of your specific measurement for information on the data that can be returned.

The command can only be used with specific sub-opcodes with measurement results that are trace data. Both real and complex traces can be searched, but complex traces are converted to magnitude in dBm. In many measurements the sub-opcode n=0, is the raw trace data which cannot be searched for peaks. And Sub-opcode n=1, is often calculated results values which also cannot be searched for peaks.

This command uses the data setting specified by the FORMat:BORDER and FORMat:DATA commands and can return real or ASCII data. If the format is set to INT,32, it returns REAL,32 data.

The command has four types of parameters:

- Threshold (in dBm)
- Excursion (in dB)
- Sorting order (amplitude, frequency, time)
- Optional in some measurements: Display line use (all, > display line, < display line)

---

<b>Remote Command</b>	<p>For Swept SA measurement:</p> <pre>:CALCulate:DATA[1] 2 ... 6:PEAKs? &lt;threshold&gt;,&lt;excursion&gt;[,AMPLitude   FREQuency   TIME[,ALL   GTDLLine   LTDLine]]</pre> <p>For most other measurements:</p> <pre>:CALCulate:DATA[1] 2 ... 6:PEAKs? &lt;threshold&gt;,&lt;excursion&gt;[,AMPLitude   FREQuency   TIME]</pre>
-----------------------	---------------------------------------------------------------------------------------------------------------------------------------------------------------------------------------------------------------------------------------------------------------------------------------------------------------------------------

---

<b>Example</b>	<p>Example for Swept SA measurement in Spectrum Analyzer Mode:</p> <p>CALC:DATA4:PEAK? -40, 10, FREQ, GTDL This will identify the peaks of trace 4 that are above -40 dBm, with excursions of at least 10 dB. The peaks are returned in order of increasing frequency, starting with the lowest frequency. Only the peaks that are above the display line are returned.</p> <p>Query Results 1:</p> <p>With FORMat:DATA REAL, 32 selected, it returns a list of floating-point numbers. The first value in the list is the number of peak points that are in the following list. A peak point consists of two values: a peak amplitude followed by its corresponding frequency (or time).</p> <p>If no peaks are found the peak list will consist of only the number of peaks, (0).</p>
----------------	-----------------------------------------------------------------------------------------------------------------------------------------------------------------------------------------------------------------------------------------------------------------------------------------------------------------------------------------------------------------------------------------------------------------------------------------------------------------------------------------------------------------------------------------------------------------------------------------------------------------------------------------------------------------------------------------------------------------------------------------------------------------------------------------

---

<b>Notes</b>	<p>&lt;n&gt; - is the trace that will be used</p> <p>&lt;threshold&gt; - is the level below which trace data peaks are ignored. Note that the threshold value is required and is always used as a peak criterion. To effectively disable the threshold criterion for this command, provide a substantially low threshold value such as -200 dBm. Also note that the threshold value used in this command is independent of and has no effect on the threshold value stored under the Peak Criteria menu.</p> <p>&lt;excursion&gt; - is the minimum amplitude variation (rise and fall) required for a signal to be identified as peak. Note that the excursion value is required and is always used as a peak criterion. To effectively disable the excursion criterion for this command, provide the minimum value of 0.0 dB. Also note that the excursion value used in this command is independent of and has no effect on the</p>
--------------	---------------------------------------------------------------------------------------------------------------------------------------------------------------------------------------------------------------------------------------------------------------------------------------------------------------------------------------------------------------------------------------------------------------------------------------------------------------------------------------------------------------------------------------------------------------------------------------------------------------------------------------------------------------------------------------------------------------------------------------------------------------------------------------------------------------------------------------------------------------------------------------------------------------------------------------

---

excursion value stored under the Peak Criteria menu.

Values must be provided for threshold and excursion. The sorting and display line parameters are optional (defaults are AMPLitude and ALL).

Note that there is always a Y-axis value for the display line, regardless of whether the display line state is on or off. It is the current Y-axis value of the display line which is used by this command to determine whether a peak should be reported

Sorting order:

AMPLitude - lists the peaks in order of descending amplitude, with the highest peak first (default if optional parameter not sent)

FREQUency - lists the peaks in order of occurrence, left to right across the x-axis.

TIME - lists the peaks in order of occurrence, left to right across the x-axis.

Peaks vs. Display Line:

ALL - lists all of the peaks found (default if optional parameter not sent).

GTDLine (greater than display line) - lists all of the peaks found above the display line.

LTDLine (less than display line) - lists all of the peaks found below the display line.

Initial S/W Revision      Prior to A.02.00

### Format Data: Numeric Data (Remote Command Only)

This command specifies the format of the trace data input and output. It specifies the formats used for trace data during data transfer across any remote port. It affects only the data format for setting and querying trace data for the :TRACe[:DATA], TRACe[:DATA]?, :CALCulate:DATA[n]? and FETCh:SANalyzer [n]? commands and queries.

**Remote Command**      :FORMat[:TRACe] [:DATA] ASCii|INTeger,32|REAL,32 |REAL,64  
:FORMat[:TRACe] [:DATA] ?

**Notes**      The query response is:  
ASCii: ASC,8  
REAL,32: REAL,32  
REAL,64: REAL,64  
INTeger,32: INT,32

When the numeric data format is REAL or ASCii, data is output in the current Y Axis unit. When the data format is INTeger, data is output in units of m dBm (.001 dBm).

The INT,32 format returns binary 32-bit integer values in internal units (m dBm), in a definite length block.

**Dependencies**      Sending a data format spec with an invalid number (for example, INT,48) generates no error. The analyzer simply uses the default (8 for ASCii, 32 for INTeger, 32 for REAL).

Sending data to the analyzer which does not conform to the current FORMat specified, results in an error. Sending ASCII data when a definite block is expected generates message -161 "Invalid Block Data" and sending a definite block when ASCII data is expected generates message -121 "Invalid Character in Number".

**Preset**      ASCii

**Backwards Compatibility Notes**      Note that the INT,32 format is only applicable to the command, TRACe:DATA. This preserves backwards compatibility for the Swept SA measurement. For all other commands/queries which honor FORMat:DATA, if INT,32 is sent the analyzer will behave as though it were set to REAL,32.

Initial S/W Revision      Prior to A.02.00

The specs for each output type follow:

AScii - Amplitude values are in ASCII, in the current Y Axis Unit, one ASCII character per digit, values separated by commas, each value in the form:

SX.YYYYYEsZZ

Where:

S = sign (+ or -)

X = one digit to left of decimal point

Y = 5 digits to right of decimal point

E = E, exponent header

s = sign of exponent (+ or -)

ZZ = two digit exponent

REAL,32 - Binary 32-bit real values in the current Y Axis Unit, in a definite length block.

REAL,64 - Binary 64-bit real values in the current Y Axis Unit, in a definite length block.

### Format Data: Byte Order (Remote Command Only)

This command selects the binary data byte order for data transfer and other queries. It controls whether binary data is transferred in normal or swapped mode. This command affects only the byte order for setting and querying trace data for the :TRACe[:DATA], TRACe[:DATA]? , :CALCulate:DATA[n]? and FETCh:SANalyzer[n]? commands and queries.

By definition any command that says it uses FORMat:DATA uses any format supported by FORMat:DATA.

The NORMal order is a byte sequence that begins with the most significant byte (MSB) first, and ends with the least significant byte (LSB) last in the sequence: 1|2|3|4. SWAPped order is when the byte sequence begins with the LSB first, and ends with the MSB last in the sequence: 4|3|2|1.

---

<b>Remote Command</b>	:FORMat:BORDER NORMal   SWAPped :FORMat:BORDER?
<b>Preset</b>	NORMal
<b>Initial S/W Revision</b>	Prior to A.02.00

---

## Meas Setup

Displays the setup menu for the currently selected measurement. The parameters included in this menu are as follows.

- Averaging
- IF Gain
- Channel Power Span
- Integrated Bandwidth
- Filter Bandwidth
- Root Raised Cosine (RRC) Filter

Key Path	Front-panel key
Initial S/W Revision	Prior to A.02.00

## Avg/Hold Num

Specifies the number of measurement averages used to calculate the measurement result. The average is displayed at the end of each sweep. After the specified number of average counts, the averaging mode (terminal control) setting determines the averaging action.

Key Path	Meas Setup
Mode	SA, WCDMA, C2K, WIMAX OFDMA, 1xEVDO, DVB-T/H, DTMB (CTTB), ISDB-T, CMMB, LTE, LTETDD, Digital Cable TV, WLAN, MSR, LTEAFDD, LTEATDD
<b>Remote Command</b>	[:SENSe]:CHPower:AVERage:COUNT <integer> [:SENSe]:CHPower:AVERage:COUNT? [:SENSe]:CHPower:AVERage[:STATe] ON OFF 1 0 [:SENSe]:CHPower:AVERage[:STATe]?
<b>Example</b>	CHP:AVER:COUN 15 CHP:AVER:COUN? CHP:AVER ON CHP:AVER?
Notes	You must be in the Spectrum Analysis mode, W-CDMA mode, cdma2000 mode, DVB-T/H mode, DTMB (CTTB) mode, ISDB-T mode, CMMB mode, Digital Cable TV mode, LTE mode, LTE TDD mode 1xEVDO mode or WIMAX OFDMA mode to use this command. Use :INSTRument:SElect to set the mode.
Preset	SA: 10 WCDMA: 200 WIMAX OFDMA, LTE, LTETDD, MSR: 200 CDMA2K: 20 1xEVDO: 20

	DVB-T/H: 20 DTMB (CTTB): 20 ISDB-T: 10 CMMB: 10 Digital Cable TV: 10 WLAN: 10 LTEAFDD, LTEATDD:200 ON
State Saved	Saved in instrument state.
Min	1
Max	10000
Initial S/W Revision	Prior to A.02.00
Modified at S/W Revision	A.02.00, A.03.00

## Avg Mode

Allows you to select the type of termination control used for the averaging function. This determines the averaging action after the specified number of data acquisitions (average count) is reached.

When set to Exponential (Exp) the measurement averaging continues using the specified number of averages to compute each exponentially-weighted averaged value. The average is displayed at the end of each sweep.

When set to Repeat, the measurement resets the average counter each time the specified number of averages is reached.

Key Path	Meas Setup
Mode	SA, WCDMA, C2K, WIMAX OFDMA, 1xEVDO, DVB-T/H, DTMB (CTTB), ISDB-T, CMMB, LTE, LTEATDD, Digital Cable TV, WLAN, MSR, LTEAFDD, LTEATDD
Remote Command	[ :SENSe ] :CHPower:AVERage:TCONtrol EXPonential REPeat [ :SENSe ] :CHPower:AVERage:TCONtrol?
Example	CHP:AVER:TCON EXP CHP:AVER:TCON?
Notes	You must be in the Spectrum Analysis mode, W-CDMA mode, cdma2000 mode, DVB-T/H mode, DTMB (CTTB) mode, ISDB-T mode, CMMB mode, Digital Cable TV mode, LTE mode, LTE TDD mode, WLAN mode, 1xEVDO mode or WIMAX OFDMA mode to use this command. Use :INSTrument:SElect to set the mode.
Preset	EXP
State Saved	Saved in instrument state.
Range	Exp Repeat
Initial S/W Revision	Prior to A.02.00
Modified at S/W Revision	A.02.00, A.03.00



## Integ BW

Specifies the range of integration used in calculating the power in the channel. The integration bandwidth (IBW) is displayed on the trace as two markers connected by an arrow.

<b>Key Path</b>	<b>Meas Setup</b>
<b>Mode</b>	SA, WCDMA, C2K, WIMAX OFDMA, 1xEVDO, DVB-T/H, DTMB (CTTB), ISDB-T, CMMB, LTE, LTETDD, Digital Cable TV, WLAN
<b>Remote Command</b>	[ :SENSe ] :CHPower:BANDwidth:INTEgration <bandwidth> [ :SENSe ] :CHPower:BANDwidth:INTEgration?
<b>Example</b>	CHP:BAND:INT 10MHz CHP:BAND:INT?
<b>Notes</b>	You must be in the Spectrum Analysis mode, W-CDMA mode, cdma2000 mode, DVB-T/H mode, DTMB (CTTB) mode, ISDB-T mode, CMMB mode, Digital Cable TV mode, LTE mode, LTE TDD mode, WLAN mode, 1xEVDO mode or WIMAX OFDMA mode to use this command. Use :INSTrument:SElect to set the mode.
<b>Dependencies</b>	For MSR/LTE-Advanced FDD/TDD mode, this key is blank.
<b>Couplings</b>	The minimum value of the span is coupled with the integration bandwidth.
<b>Preset</b>	SA: 2 MHz WCDMA: 5 MHz C2K: 1.23 MHz WIMAX OFDMA: 10 MHz 1xEVDO: 1.23 MHz DVB-T/H: 7.61MHz DTMB (CTTB): 8MHz ISDB-T: 5.6MHz CMMB: 8MHz LTE: 5 MHz LTETDD: 5 MHz Digital Cable TV: 8MHz WLAN: if Radio Std is 802.11a/g(OFDM/DSSS-OFDM): 20 MHz if Radio Std is 802.11b: 25 MHz if Radio Std is 802.11n(20MHz): 20 MHz if Radio Std is 802.11n(40MHz): 40 MHz if Radio Std is 802.11ac (20 MHz): 20 MHz if Radio Std is 802.11ac (40 MHz): 40 MHz if Radio Std is 802.11ac (80 MHz): 80 MHz if Radio Std is 802.11ac (160 MHz): 160 MHz if Radio Std is 802.11ac (80 MHz + 80 MHz): 80 MHz

State Saved	Saved in instrument state.
Min	100 Hz
Max	Hardware Maximum Span
Initial S/W Revision	Prior to A.02.00
Modified at S/W Revision	A.02.00, A.03.00

### PhNoise Opt

Selects the LO (local oscillator) phase noise behavior for various operating conditions. Refer to PhNoise Opt

in the Swept SA measurement for details.

Key Path	Meas Setup
Initial S/W Revision	A.04.20

### PhNoise Opt Auto

Selects the LO (local oscillator) phase noise behavior to optimize dynamic range and speed for various instrument operating conditions. Refer to PhNoise Opt Auto State in the Swept SA measurement for details.

Key Path	Meas Setup
<b>Remote Command</b>	<code>[[:SENSe]:CHPower:FREQuency:SYNTHeSis:AUTO[:STATe] OFF ON 0 1</code> <code>[[:SENSe]:CHPower:FREQuency:SYNTHeSis:AUTO[:STATe]?</code>
<b>Example</b>	CHP:FREQ:SYNT:AUTO 1 CHP:FREQ:SYNT:AUTO?
Preset	OFF
State Saved	Saved in instrument state.
Range	Auto Man
Readback Text	“Auto” is underlined when Auto is selected, otherwise Man is underlined.
Initial S/W Revision	A.04.20

### PhNoise Opt State

Selects the LO (local oscillator) phase noise behavior for various operating conditions. Refer to PhNoise Opt in the Swept SA measurement for details.

Key Path	Meas Setup
----------	------------

<b>Remote Command</b>	<code>[ :SENSe ] :CHPower:FREQuency:SYNThesis[:STATe] 1 2 3</code> <code>[ :SENSe ] :CHPower:FREQuency:SYNThesis[:STATe] ?</code>
<b>Example</b>	CHP:FREQ:SYNT 1 CHP:FREQ:SYNT?
<b>Notes</b>	Parameter key: 1. optimizes phase noise for close-in from the carrier. 2. optimizes phase noise for wide-offset from the carrier. 3. optimizes LO for tuning speed.
<b>Couplings</b>	Best Close-in $\Phi$ Noise The frequency below which the phase noise is optimized is model dependent: PXA with option EP1: [offset <140 kHz] Models with option EP2: [offset <70 kHz] CXA with option EP4: [offset <90 kHz] CXA without option EP4: n/a All other models: [offset <20 kHz] Best Wide-offset $\Phi$ Noise The frequency below which the phase noise is optimized is model dependent: PXA with option EP1: [offset >160 kHz] Models with option EP2: [offset >100 kHz] CXA with option EP4: [offset >130 kHz] CXA without option EP4: n/a All other models: [offset >30 kHz] Fast Tuning The Fast Tuning details are model dependent: CXA without option EP4: n/a PXA with option EP1: [single loop] Models with option EP2: [medium loop bandwidth] All other models: [same as Close-in]
<b>Preset</b>	3
<b>State Saved</b>	Saved in instrument state.
<b>Range</b>	Best Close-in $\Phi$ Noise [offset < 140 kHz]   Best Wide-offset $\Phi$ Noise [offset > 160 kHz]   Fast Tuning [same as Close-in] [ ] is model dependent. See Couplings for details.
<b>Initial S/W Revision</b>	A.04.20

## IF Gain

Sets the IF Gain function to Auto, Low Gain or High Gain. These settings affect sensitivity and IF overloads.

<b>Key Path</b>	Meas Setup
-----------------	------------

Dependencies	The IF Gain keys (FFT IF Gain and Swept IF Gain) have no effect when the U7227A USB Preamplifier is connected. This is not annotated or reflected on any softkey; there are no keys grayed out nor any SCPI locked out. The analyzer simply behaves as though both FFT IF Gain and Swept IF Gain are set to Low regardless of the setting on the keys.
Initial S/W Revision	Prior to A.02.00

## IF Gain Auto

Activates the auto rules for IF Gain. When Auto is active, the IF Gain is set to High Gain under any of the following conditions:

- The input attenuator is set to 0 dB
- The preamp is turned On and the frequency range is under 3.6 GHz

For other settings, Auto sets the IF Gain to Low Gain.

Key Path	Meas Setup, IF Gain
Remote Command	[ :SENSe ] :CHPower:IF:GAIN:AUTO [ :STATe ] ON OFF 1 0 [ :SENSe ] :CHPower:IF:GAIN:AUTO [ :STATe ] ?
Example	CHP:IF:GAIN:AUTO ON CHP:IF:GAIN:AUTO?
Couplings	When the auto attenuation exists (for example, with an electrical attenuator), IF Gain State differs depending on the condition. Auto sets IF Gain to High Gain under any of the following conditions: The input attenuator is set to 0 dB, or the preamp is turned on and the frequency range is under 3.6 GHz. For other conditions, Auto sets IF Gain to Low Gain.
Preset	OFF
State Saved	Saved in instrument state.
Range	Off On
Initial S/W Revision	Prior to A.02.00

## IF Gain State

Selects the range of the IF Gain.

Key Path	Meas Setup, IF Gain
Remote Command	[ :SENSe ] :CHPower:IF:GAIN [ :STATe ] ON OFF 1 0 [ :SENSe ] :CHPower:IF:GAIN [ :STATe ] ?
Example	CHP:IF:GAIN ONCHP:IF:GAIN?
Notes	ON = high gain OFF = low gain

Couplings	When the auto attenuation exists (for example, with an electrical attenuator), IF Gain State differs depending on the condition. Auto sets IF Gain to High Gain under any of the following conditions: The input attenuator is set to 0 dB, or the preamp is turned on and the frequency range is under 3.6 GHz. For other conditions, Auto sets IF Gain to Low Gain.
Preset	OFF
State Saved	Saved in instrument state.
Range	Low Gain High Gain
Initial S/W Revision	Prior to A.02.00

## Limits

Accesses the Limits menu that allows you to set up the test limit for channel power or power spectral density.

When DVB-T/H mode or DTMB (CTTB) mode is selected or DVB-T radio standard is selected in SA mode, this functionality is disabled and input signal will be compared against pre-defined spectrum mask, instead. See 1.3.2 Limit Line Mask for DVB-T for more details.

In DVB-T/H, DTMB (CTTB), ISDB-T, CMMB mode, this key is blank. If DVB-T is selected as current Radio Std in SA Mode, this key is grayed out.

In MSR, LTE-Advanced FDD/TDD mode, this feature is not supported and the key is blank because the power of each carrier may be different.

Key Path	Meas Setup
Initial S/W Revision	A.10.00

## Power Limit

If Power Limit is on, Power Limit is used as threshold which can judge whether the real measured channel power can be passed or not. If real measured channel power exceeds Power Limit, channel power test fails, otherwise, it passes. If Power Limit is off, channel power test is always passed.

Key Path	Meas Setup, Limits
Mode	SA, WCDMA, C2K, WIMAX OFDMA, 1xEVDO, LTE, LTETDD, Digital Cable TV, WLAN
Remote Command	:CALCulate:CHPower:LIMit:POWer <ampl> :CALCulate:CHPower:LIMit:POWer? :CALCulate:CHPower:LIMit:POWer:STATe OFF ON 0 1 :CALCulate:CHPower:LIMit:POWer:STATe?
Example	CALC:CHP:LIM:POW 16.00 CALC:CHP:LIM:POW? CALC:CHP:LIM:POW:STAT ON

	CALC:CHP:LIM:POW:STAT?
Notes	<p>This parameter and PSD Limit can determine Pass/Fail criteria.</p> <p>If (( power limit = On) and (PSD limit= Off) )            Pass if (power test passes)            Fail if (power test fails)</p> <p>If (( power limit = On) and (PSD limit= On) )            Pass if ( both power test and PSD test pass)            Fail if ( either of power test or PSD test fails)</p> <p>If (( power limit = Off) and (PSD limit= On) )            Pass if (PSD test passes)            Fail if (PSD test fails)</p> <p>If (( power limit = Off) and (PSD limit= Off) )            Always Pass</p> <p>For MSR mode, this key is blank.            For LTE-Advanced FDD/TDD mode, this key is blank.            For WLAN 802.11 ac (80 MHz + 80 MHz), the power test and the PSD test are performed to both carriers. Which means the power (or PSD) readouts of both carriers should be compared with the power (or PSD) limit individually, and the test passes only when both values are lower than the limit.</p>
Preset	<p>16.00</p> <p>SA, WCDMA, C2K, WIMAX OFDMA, 1xEVDO, DVB-T/H, DTMB (CTTB), LTE, LTETDD, Digital Cable TV: OFF            WLAN: ON</p>
State Saved	Saved in instrument state.
Min	-200.0
Max	200.0
Initial S/W Revision	A.10.00

## PSD Limit

If PSD (power spectral density) Limit is ON, PSD Limit is used as threshold which can judge whether the real measured PSD can be passed or not. If real measured PSD exceeds PSD Limit, PSD test fails, otherwise, it passes. If PSD is off, PSD test is always passed.

Key Path	Meas Setup, Limits
Mode	SA, WCDMA, C2K, WIMAX OFDMA, 1xEVDO, LTE, LTETDD, Digital Cable TV, WLAN
Remote Command	<pre>:CALCulate:CHPower:LIMit:PSDdensity &lt;real&gt; :CALCulate:CHPower:LIMit:PSDdensity? :CALCulate:CHPower:LIMit:PSDdensity:STATe OFF ON 0 1 :CALCulate:CHPower:LIMit:PSDdensity:STATe?</pre>
Example	CALC:CHP:LIM:PSD 4.00

	CALC:CHP:LIM:PSD? CALC:CHP:LIM:POW:STAT ON CALC:CHP:LIM:POW:STAT?
Notes	This parameter and Power Limit can determine Pass/Fail criteria. If (( power limit = On) and (PSD limit= Off) ) Pass if (power test passes) Fail if (power test fails) If (( power limit = On) and (PSD limit= On) ) Pass if ( both power test and PSD test pass) Fail if ( either of power test or PSD test fails) If (( power limit = Off) and (PSD limit= On) ) Pass if (PSD test passes) Fail if (PSD test fails) If (( power limit = Off) and (PSD limit= Off) ) Always Pass For MSR mode, this key is blank. For LTE-Advanced FDD/TDD mode, this key is blank. For WLAN 802.11ac (80 MHz + 80 MHz), the power test and the PSD test are performed to both carriers. Which means the PSD (or power) readouts of both carriers should be compared with the PSD (or power) limit individually, and the test passes only when both values are lower than the limit.
Couplings	The value is automatically converted when PSD Unit is changed.
Preset	4.00 SA, WCDMA, C2K, WIMAX OFDMA, 1Xevdo, LTE, LTETDD, Digital Cable TV: OFF WLAN: ON
State Saved	Saved in instrument state.
Min	-200.0
Max	200.0
Initial S/W Revision	A.10.00

### Power Limit Fail (remote command only)

The command is query only and used to query if power test passes or fails. When DVB-T/H mode or DTMB (CTTB) mode is selected or DVB-T radio standard is selected in SA mode, this query SCPI command does not make any sense.

<b>Remote Command</b>	:CALCulate:CHPower:LIMit:POWer:FAIL?
<b>Example</b>	CALC:CHP:LIM:POW:FAIL?
Notes	This command is query only. When Power Limit is off, the returned value is always 0 (pass).

	When Power Limit is on, the returned value is 0(pass) while power test passes and 1(fail) while power test fails. In MSR, LTE-Advanced FDD/TDD mode, this feature is not supported.
Initial S/W Revision	A.10.00

### PSD Limit Fail (remote command only)

The command is query only and used to query if PSD test passes or fails. When DVB-T/H mode or DTMB (CTTB) mode is selected or DVB-T radio standard is selected in SA mode, this query SCPI command does not make any sense.

<b>Remote Command</b>	:CALCulate:CHPower:LIMit:PSD:FAIL?
<b>Example</b>	CALC:CHP:LIM:PSD:FAIL?
<b>Notes</b>	This command is query only. When PSD Limit is off, the returned value is always 0 (pass). When PSD Limit is on, the returned value is 0(pass) while PSD test passes and 1(fail) while PSD test fails.
Initial S/W Revision	A.10.00

### Meas Preset

Restores all the measurement parameters to their default values.

<b>Key Path</b>	Meas Setup
<b>Mode</b>	SA, WCDMA, C2K, WIMAX OFDMA, 1xEVDO, DVB-T/H, DTMB (CTTB), ISDB-T, CMMB, LTE, LTETDD, Digital Cable TV, WLAN, MSR, LTEAFDD, LTEATDD
<b>Remote Command</b>	:CONFigure:CHPower
<b>Example</b>	CONF:CHP
Initial S/W Revision	Prior to A.02.00
Modified at S/W Revision	A.02.00, A.03.00

### PSD Unit

Sets the unit bandwidth for Power Spectral Density. The available units are dBm/Hz and dBm/MHz.

<b>Key Path</b>	Meas Setup
<b>Mode</b>	SA, WCDMA, WIMAX OFDMA, 1xEVDO, DVB-T/H, DTMB (CTTB), LTE, LTETDD, Digital Cable TV, WLAN, MSR, LTEAFDD, LTEATDD
<b>Remote Command</b>	:UNIT:CHPower:POWer:PSD DBMHZ   DBMMHZ :UNIT:CHPower:POWer:PSD?



<b>Example</b>	UNIT:CHP:POW:PSD DBMMHZ UNIT:CHP:POW:PSD?
Couplings	When the PSD unit is changed, the PSD result of the “MEAS READ FETCH:CHP1?” is also changed by the PSD unit basis (in either dBm/Hz or dBm/MHz).
Preset	DBMHZ WLAN: DBMMHZ
State Saved	Saved in instrument state.
Range	dBm/Hz dBm/MHz
Initial S/W Revision	Prior to A.02.00
Modified at S/W Revision	A.02.00, A.03.00

8 Channel Power Measurement  
Mode

Mode

See "[Mode](#)" on page 318

## Mode Preset

Returns the active mode to a known state.

Mode Preset does the following for the currently active mode:

- Aborts the currently running measurement.
- Brings up the default menu for the mode, with no active function.
- Sets measurement Global settings to their preset values for the active mode only.
- Activates the default measurement.
- Brings up the default menu for the mode.
- Clears the input and output buffers.
- Sets Status Byte to 0.

Mode Preset does not:

- Cause a mode switch
- Affect mode persistent settings
- Affect system settings

See "[How-To Preset](#)" on page 544 for more information.

Key Path	Front-panel key
<b>Remote Command</b>	:SYSTem:PRESet
<b>Example</b>	:SYST:PRES
Notes	*RST is preferred over :SYST:PRES for remote operation. *RST does a Mode Preset, as done by the :SYST:PRES command, and it sets the measurement mode to Single measurement rather than Continuous for optimal remote control throughput. Clears all pending OPC bits. The Status Byte is set to 0.
Couplings	A Mode Preset aborts the currently running measurement, activates the default measurement, and gets the mode to a consistent state with all of the default couplings set.
Backwards Compatibility Notes	In the X-Series, the legacy "Factory Preset" has been replaced with Mode Preset, which only presets the currently active mode, not the entire instrument. In the X-Series, the way to preset the entire instrument is by using System, Restore System Defaults All, which behaves essentially the same way as restore System Defaults does on ESA and PSA. There is also no "Preset Type" as there is on the PSA. There is a green Mode Preset front-panel key that does a Mode Preset and a white-with-green-letters User Preset front-panel key that does a User Preset. The old PRESet:TYPE command is ignored (without generating an error), and SYST:PRES without a parameter does a Mode Preset, which should cover most backward code compatibility issues. The settings and correction data under the Input/Output front-panel key (examples: Input Z Corr, Ext Amp Gain, etc.) are no longer part of any Mode, so they will not be preset by a Mode Preset. They are preset using Restore Input/Output Defaults, Restore System Defaults All. Note that because User Preset does a Recall State, and all of these settings are saved in State, they ARE recalled when using

	User Preset.
Initial S/W Revision	Prior to A.02.00

## How-To Preset

The table below shows all possible presets, their corresponding SCPI commands and front-panel access (key paths). Instrument settings depend on the current measurement context. Some settings are local to the current measurement, some are global (common) across all the measurements in the current mode, and some are global to all the available modes. In a similar way, restoring the settings to their preset state can be done within the different contexts.

Auto Couple - is a measurement local key. It sets all Auto/Man parameter couplings in the measurement to Auto. Any Auto/Man selection that is local to other measurements in the mode will not be affected.

Meas Preset - is a measurement local key. Meas Preset resets all the variables local to the current measurement except the persistent ones.

Mode Preset - resets all the current mode's measurement local and measurement global variables except the persistent ones.

Restore Mode Defaults - resets ALL the Mode variables (and all the Meas global and Meas local variables), including the persistent ones.

Type Of Preset	SCPI Command	Front Panel Access
Auto Couple	:COUPle ALL	Auto Couple front-panel key
Meas Preset	:CONFigure:<Measurement>	Meas Setup Menu
Mode Preset	:SYSTem:PRESet	Mode Preset (green key)
Restore Mode Defaults	:INSTrument:DEFault	Mode Setup Menu
Restore All Mode Defaults	:SYSTem:DEFault MODes	System Menu; Restore System Default Menu
*RST	*RST	not possible (Mode Preset with Single)
Restore Input/Output Defaults	:SYSTem:DEFault INPUt	System Menu; Restore System Default Menu
Restore Power On Defaults	:SYSTem:DEFault PON	System Menu; Restore System Default Menu
Restore Alignment Defaults	:SYSTem:DEFault ALIGN	System Menu; Restore System Default Menu
Restore Miscellaneous Defaults	:SYSTem:DEFault MISC	System Menu; Restore System Default Menu
Restore All System Defaults	:SYSTem:DEFault [ALL] :SYSTem:PRESet:PERsistent	System Menu; Restore System Default Menu
User Preset	:SYSTem:PRESet:USER	User Preset Menu
User Preset All Modes	:SYSTem:PRESet:USER:ALL	User Preset Menu

Power On Mode Preset	:SYSTem:PON:TYPE MODE	System Menu
Power On User Preset	:SYSTem:PON:TYPE USER	System Menu
Power On Last State	:SYSTem:PON:TYPE LAST	System Menu

### Preset Type (Remote Command Only)

As stated in the Backward Compatibility section, to be compatible with ESA/PSA the PRESet:TYPE command will be implemented as a no-op.

Mode	All
<b>Remote Command</b>	:SYSTem:PRESet:TYPE FACTory MODE USER :SYSTem:PRESet:TYPE?
<b>Example</b>	:SYST:PRESet:TYPE FACT
Notes	This command is supported for backward compatibility only. It is a no-op which does not change the behavior of any preset operation.
Preset	This is unaffected by Preset but is set to Mode on a “Restore System Defaults->All”
State Saved	No
Initial S/W Revision	Prior to A.02.00

## Mode Setup

See "[Mode Setup](#)" on page 348

## Peak Search

Places the selected marker on the trace point with the maximum y-axis value. Pressing Peak Search with the selected marker Off causes the selected marker to be set to Normal, then a peak search is immediately performed.

Key Path	Front panel key
Mode	SA, WCDMA, C2K, WIMAX OFDMA, 1xEVDO, DVB-T/H, DTMB (CTTB), ISDB-T, CMMB, LTE, LTETDD, Digital Cable TV, WLAN, MSR, LTEAFDD, LTEATDD
<b>Remote Command</b>	:CALCulate:CHPower:MARKer[1] 2 ... 12:MAXimum
<b>Example</b>	CALC:CHP:MARK2:MAX
Initial S/W Revision	Prior to A.02.00
Modified at S/W Revision	A.02.00, A.03.00

8 Channel Power Measurement  
Print

Print

See ["Print" on page 358](#)



## Quick Save

The Quick Save front-panel key repeats the most recent save that was performed from the Save menu, with the following exceptions:

- Register saves are not remembered as Saves for the purpose of the Quick Save function
- If the current measurement does not support the last non-register save that was performed, an informational message is generated, “File type not supported for this measurement”

Quick Save repeats the last type of qualified save (that is, a save qualified by the above criteria) in the last save directory by creating a unique filename using the Auto File Naming algorithm described below.

If Quick Save is pressed after startup and before any qualified Save has been performed, the Quick Save function performs a Screen Image save using the current settings for Screen Image saves (current theme, current directory), which then becomes the “last save” for the purpose of subsequent Quick Saves.

The Auto File Naming feature automatically generates a file name for use when saving a file. The filename consists of a prefix and suffix separated by a dot, as is standard for the Windows® file system. A default prefix exists for each of the available file types:

Type	Default Prefix	Menu
State	State_	(Save/Recall)
Trace + State	State_	(Save/Recall)
Screen	Screen_	(Save/Recall)
Amplitude Corrections	Ampcor_	(Import/Export)
Traces	Trace_	(Import/Export)
Limit Lines	LLine_	(Import/Export)
Measurement Result	MeasR_	(Import/Export)
Capture Buffer	CapBuf_	(Import/Export)

A four digit number is appended to the prefix to create a unique file name. The numbering sequence starts at 0000 within each Mode for each file type and updates incrementally to 9999, then wraps to 0000 again. It remembers where it was through a Mode Preset and when leaving and returning to the Mode. It is reset by Restore Misc Defaults and Restore System Defaults and subsequent running of the instrument application. So, for example, the first auto file name generated for State files is State\_0000.state. The next is State\_0001, and so forth.

One of the key features of Auto File Name is that we guarantee that the Auto File Name will never conflict with an existing file. The algorithm looks for the next available number. If it gets to 9999, then it looks for holes. If it find no holes, that is no more numbers are available, it gives an error.

For example, if when we get to State\_0010.state there is already a State\_0010.state file in the current directory, it advances the counter to State\_0011.state to ensure that no conflict will exist (and then it verifies that State\_0011.state also does not exist in the current directory and advances again if it does, and so forth).

If you enter a file name for a given file type, then the prefix becomes the filename you entered instead of the default prefix, followed by an underscore. The last four letters (the suffix) are the 4-digit number.

For example, if you save a measurement results file as “fred.csv”, then the next auto file name chosen for a measurement results save will be fred\_0000.csv.

**NOTE**

Although 0000 is used in the example above, the number that is used is actually the current number in the Meas Results sequence, that is, the number that would have been used if you had not entered your own file name.

---

**NOTE**

If the filename you entered ends with \_dddd, where d=any number, making it look just like an auto file name, then the next auto file name picks up where you left off with the suffix being dddd + 1.

---

Key Path	Front-panel key
Notes	No remote command for this key specifically.
Initial S/W Revision	Prior to A.02.00

## Recall

The Recall menu lets you choose what you want to recall, and where you want to recall it from. Among the types of files you can recall are **States and Traces**. In addition, an Import (Data) option lets you recall a number of data types stored in CSV files (as used by Excel and other spreadsheet programs).

The default paths for Recall are data type dependent and are the same as for the Save key.

Key Path	Front-panel key
Notes	<p>No remote command for this key specifically, but the :MMEM:LOAD command is available for specific file types. An example is :MMEM:LOAD:STATe &lt;filename&gt;.</p> <p>If you try to recall a State file for a mode that is not licensed or not available in the instrument, an error message will occur and the state will not change.</p>
Backwards Compatibility Notes	<p>In legacy analyzers, it was possible to load a state without affecting the trace data, limit lines or correction data. Similarly (since User Preset is actually loading a state), it was possible to do a User Preset without affecting the trace data, limit lines or correction data.</p> <p>In the X-Series, “state” always includes all of this data; so whenever state is loaded, all of the traces, limit lines and corrections are affected. Although this differs from previous behavior, it is desirable behavior, and should not cause adverse issues for users.</p>
Backwards Compatibility Notes	<p>Recall for the X-Series supports backward compatibility in the sense that you can recall a state file from any X-Series model number and any version of X-Series software. This is only possible if part of the recalling process goes through a limiting step after recalling the mode settings, at least for settings that may vary with version number, model number, option and license differences. If you try to recall a state file onto an instrument with less capability than what was available on the instrument during the save, the recall will ignore the state it doesn't support and it will limit the recalled setting to what it allows.</p> <p>Example: if the saved state includes preamp ON, but the recalling instrument does not have a preamp; the preamp is limited to OFF. Conversely, if you save a state without a preamp, the preamp is OFF in the state file. When this saved file is recalled on an instrument with a licensed preamp, the preamp is changed to OFF. Another example is if the saved state has center frequency set to 20 GHz, but the instrument recalling the saved state is a different model and only supports 13.5 GHz. In this case, the center frequency is limited along with any other frequency based settings. Since the center frequency can't be preserved in this case, the recall limiting tries to at least preserve span to keep the measurement setup as intact as possible.</p> <p>It may be appropriate to issue a warning if the state is limited on the recall; warnings do not go out to SCPI so this would only affect the manual user.</p> <p>Note that there is no state file compatibility outside of the X-Series. For example, you cannot recall a state file from ESA or PSA.</p>
Initial S/W Revision	Prior to A.02.00

## State

The Recall State menu lets you choose a register or file from which to recall the state.

The content of a state file includes all of the settings and data required to return the analyzer as closely as possible to the Mode it was in, with the exact settings that were in place, when the save occurred. The Mode settings in each state file include the settings that are affected by Mode Preset, as well as the

additional settings affected by Restore Mode Defaults; all of the Mode's settings. In addition, all of the settings of the Input/Output system are included, even though they are outside of the Mode's state, because they are needed to restore the complete setup. Persistent System settings (for example, GPIB address) are not affected by either a Mode Preset or Restore Mode Defaults, nor are they included in a saved State file.

Since each state file is only for one Mode, the settings for other Modes are unaffected when it is loaded. Recall State will cause a mode switch if the state being recalled is not from the current active mode.

After the recall completes, the message "File <filename> recalled" or "Recalled State Register <register number>" is displayed.

For rapid recalls, the State menu lists 16 registers that you can choose from to recall. Pressing a Register key initiates the recall. You can also select a file from which to recall.

The default path for all State Files is:

My Documents\<<mode name>\state

where <mode name> is the parameter used to select the mode with the INST:SEL command (for example, SA for the Spectrum Analyzer).

See "[More Information](#)" on page 553.

<b>Key Path</b>	Recall
<b>Mode</b>	All
<b>Remote Command</b>	:MMEMory:LOAD:STATe <filename>
<b>Example</b>	:MMEM:LOAD:STAT "myState.state" This recalls the file myState.state on the default path
<b>Example</b>	MMEM:LOAD:STAT "MyStateFile.state" This loads the state file data (on the default file directory path) into the instrument state.
<b>Notes</b>	<p>When you pick a file to recall, the analyzer first verifies that the file is recallable in the current instrument by checking the software version and model number of the instrument. If everything matches, a full recall proceeds by aborting the currently running measurement, clearing any pending operations, and then loading the State from the saved state file. You can open state files from any mode, so recalling a State file switches to the mode that was active when the save occurred. After switching to the mode of the saved state file, mode settings and data (if any for the mode) are loaded with values from the saved file. The saved measurement of the mode becomes the newly active measurement and the data relevant to the measurement (if there is any) is recalled.</p> <p>If there is a mismatch between file version or model number or instrument version or model number, the recall function tries to recall as much as possible and returns a warning message. It may limit settings that differ based on model number, licensing or version number.</p> <p>After recalling the state, the Recall State function does the following:</p> <ul style="list-style-type: none"> <li>• Makes the saved measurement for the mode the active measurement.</li> <li>• Clears the input and output buffers.</li> <li>• Status Byte is set to 0.</li> <li>• Executes a *CLS</li> </ul> <p>If the file specified is empty an error is generated. If the specified file does not exist, another error is generated. If there is a mismatch between the file and the proper file type, an error is generated. If</p>

	there is a mismatch between file version or model number or instrument version or model number, a warning is displayed. Then it returns to the State menu and File Open dialog goes away. After the Recall, the analyzer exits the Recall menu and returns to the previous menu.
<b>Backwards Compatibility SCPI</b>	:MMEMory:LOAD:STATe 1,<filename> For backwards compatibility, the above syntax is supported. The "1" is simply ignored.
Initial S/W Revision	Prior to A.02.00

## More Information

In measurements that support saving Traces, for example, Swept SA, the Trace data is saved along with the State in the State file. When recalling the State, the Trace data is recalled as well. Traces are recalled exactly as they were stored, including the writing mode and update and display modes. If a Trace was updating and visible when the State was saved, it will come back updating and visible, and its data will be rewritten right away. When you use State to save and recall traces, any trace whose data must be preserved should be placed in View or Blank mode before saving.

The following table describes the Trace Save and Recall possibilities:

You want to recall state and one trace's data, leaving other traces unaffected.	Save Trace+State from 1 trace. Make sure that no other traces are updating (they should all be in View or Blank mode) when the save is performed.	On Recall, specify the trace you want to load the one trace's data into. This trace will load in View. All other traces' data will be unaffected, although their trace mode will be as it was when the state save was performed.
You want to recall all traces	Save Trace+State from ALL traces.	On Recall, all traces will come back in View (or Blank if they were in Blank or Background when saved)
You want all traces to load exactly as they were when saved.	Save State	On recall, all traces' mode and data will be exactly as they were when saved. Any traces that were updating will have their data immediately overwritten.

## From File...

When you press "From File", the analyzer brings up a Windows dialog and a menu entitled "File Open." This menu allows you to navigate to the various fields in the Windows dialog without using a keyboard or mouse. The Tab and Arrow keys can also be used for dialog navigation.

## 8 Channel Power Measurement Recall

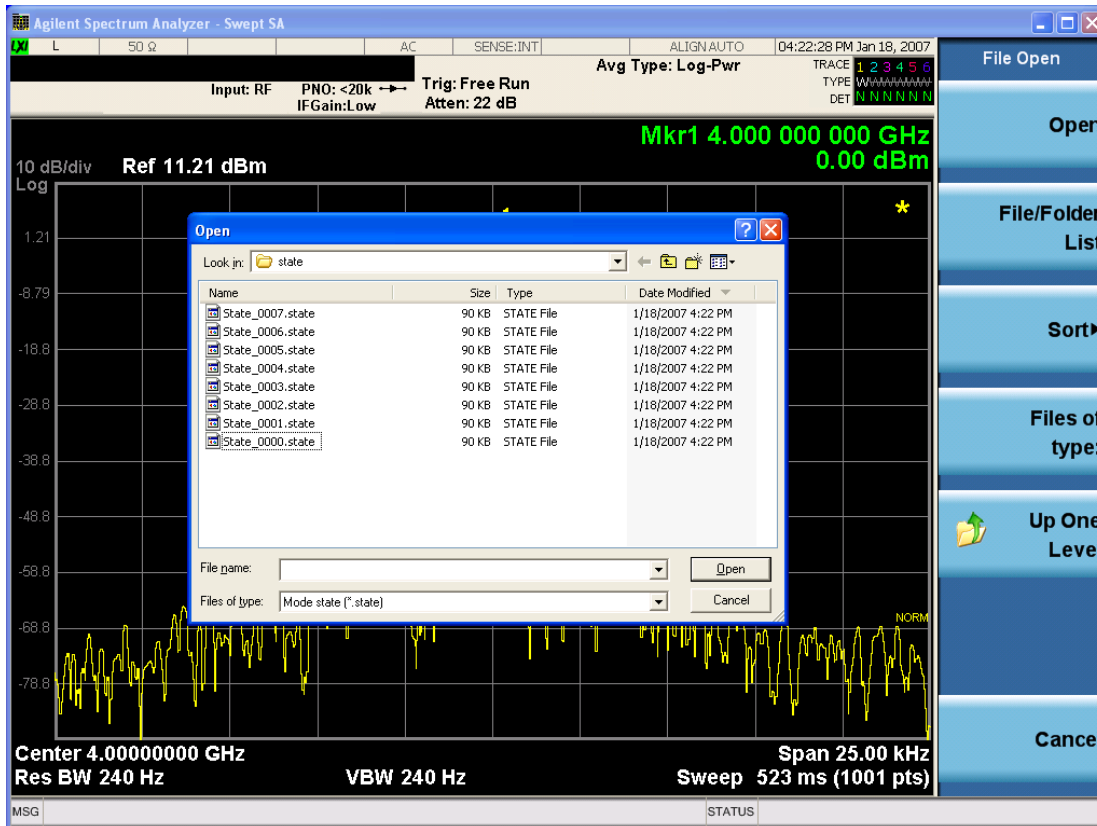

Listed below are the functions of the various fields in the dialog, and the corresponding softkeys:

### Open

Performs the recall of the specified file. While the recall is being performed, the floppy icon appears briefly in the Meas bar.

### File/Folder List

Enables you to navigate to the center of the dialog that contains the list of files and folders. Once here you can get information about the file and use the tab keys to navigate to the other fields in the dialog, such as Look In.

### Look In

The Look In field shows the path from which the file will be recalled and allows you to change the path using the up and down arrow keys to navigate to other paths; the Enter key to open a directory; and the Backspace key to go back one directory. The **Look In field** first uses the last path from the Save As dialog **Save In:** path for that same file type. There is no softkey for directly navigating to the Look In field, but you can use the left tab to get here from the File/Folder List.

User specified paths are remembered when you leave and return to a Mode and are reset back to the default using Restore Mode Defaults.

### Sort

Accesses a menu that enables you to sort the files within the File Open dialog. Only one sorting type can be selected at a time and the sorting happens immediately. The sorting types are By Date, By Name, By extension, and By Size.

#### Files of Type

This field shows the file suffix for the type of file you have selected to recall. For example, if you navigated here while recalling State, "Mode state (\*.state)" is in the field. If you navigated here while recalling Trace, ""Mode state (\*.trace)" is in the field. If you navigated here while importing a trace data file, "Trace Data (\*.csv)" is in the field. For some file types, there is more than one choice in the dropdown menu, which you can select by using the up and down arrow keys and Enter.

#### Up One Level

This key corresponds to the icon of a folder with the up arrow that is in the tool bar of the dialog. When pressed, it causes the file and folder list to navigate up one level in the directory structure. The Backspace key does the same thing.

#### Cancel

This key corresponds to the Cancel selection in the dialog. It causes the current **Open** request to be cancelled. The ESC key does the same thing.

Key Path	Recall, State
Notes	Brings up the Open dialog for recalling a State Save Type
Initial S/W Revision	Prior to A.02.00

## Edit Register Names

You may enter a custom name on any of the Register keys, to help you remember what you are using that state to save. To do this, press the Edit Register Names key, choose the register whose name you wish to edit, and then enter the desired label using the Alpha Editor or an external PC keyboard.

The maximum number of characters that can be added is 30. In most cases, 30 characters will fit on two lines of the key.

For more information and the SCPI command, see Edit Register Names under the Save, State function.

Key Path	Recall, State
Mode	All
Dependencies	N9060A-7FP or N9060B-2FP license required to edit the register names. When the feature is not licensed, sending the SCPI command generates an error, -221, "Settings conflict;Option not available"
Initial S/W Revision	A.11.00

## Register 1 thru Register 16

Selecting any one of these register keys causes the State of the mode from the specified Register to be recalled. Each of the register keys annotates whether it is empty or at what date and time it was last

modified. In addition, you can use the Edit Register Names key under Save, State to enter custom names for each register.

Registers are shared by all modes, so recalling from any one of the registers will cause a mode switch to the mode that was active when the save to the Register occurred.

Although these 16 registers are the only registers available from the front panel, there are 128 state registers available in the instrument. Registers 17–128 are only available from the SCPI interface, using the \*RCL command.

After the recall completes, the message "Register <register number> recalled" appears in the message bar. If you are in the Spectrum Analyzer Mode, and you are recalling a register that was saved in the Spectrum Analyzer Mode, then after the recall, you will still be in the Recall Register menu. If the Recall causes you to switch modes, then after the Recall, you will be in the Frequency menu.

If a requested register is empty an error is generated.

<b>Key Path</b>	Recall, State
<b>Example</b>	*RCL 1
<b>Range</b>	1–16 from front panel, 1–128 from SCPI
<b>Readback</b>	Date and time with seconds resolution are displayed on the key OR A custom name of up to 30 characters entered using the Save, State, Edit Register Names key OR “(empty)” if no prior save operation has been performed to this register.
<b>Initial S/W Revision</b>	Prior to A.02.00
<b>Modified at S/W Revision</b>	Prior to A.11.00

## Register 1 thru Register 16

Selecting any one of these register keys causes the State of the mode from the specified Register to be recalled. Each of the register keys annotates whether it is empty or at what date and time it was last modified. In addition, you can use the Edit Register Names key under Save, State to enter custom names for each register.

Registers are shared by all modes, so recalling from any one of the registers will cause a mode switch to the mode that was active when the save to the Register occurred.

Although these 16 registers are the only registers available from the front panel, there are 128 state registers available in the instrument. Registers 17–128 are only available from the SCPI interface, using the \*RCL command.

After the recall completes, the message "Register <register number> recalled" appears in the message bar. If you are in the Spectrum Analyzer Mode, and you are recalling a register that was saved in the Spectrum Analyzer Mode, then after the recall, you will still be in the Recall Register menu. If the Recall causes you to switch modes, then after the Recall, you will be in the Frequency menu.

If a requested register is empty an error is generated.



Key Path	Recall, State
<b>Example</b>	*RCL 1
Range	1-16 from front panel, 1-128 from SCPI
Readback	Date and time with seconds resolution are displayed on the key OR A custom name of up to 30 characters entered using the Save, State,Edit Register Names key OR “(empty)” if no prior save operation has been performed to this register.
Initial S/W Revision	Prior to A.02.00
Modified at S/W Revision	Prior to A.11.00

### Trace (+State)

The Recall Trace (+State) menu lets you choose a register or file from which to recall the Trace+State state file.

A saved state contains all of the settings and data required to return the analyzer as closely as possible to the exact setup it had when the save occurred. This includes the Input/Output settings, even though they are outside of the Mode’s state, because they are needed to restore the complete setup. A Trace+State file also includes trace data from one trace or all traces, which will load in View mode when the Trace+State file is recalled. Recall Trace (+State) will also cause a mode switch if the state being recalled is not for the current active mode.

After the recall completes, the message "File <filename> recalled" or “Recalled Trace Register <register number>” is displayed.

For rapid recalls, the Trace (+State) menu lists 5 registers to choose from to recall. Pressing a Register key initiates the recall. You can also select a file from which to recall.

The default path for all State Files including .trace files is:

My Documents\<mode name>\state

where <mode name> is the parameter used to select the mode with the INST:SEL command (for example, SA for the Spectrum Analyzer).

Key Path	Recall
Mode	SA
<b>Remote Command</b>	:MMEMory:LOAD:TRACe TRACE1   TRACE2   TRACE3   TRACE4   TRACE5   TRACE6,<filename>  :MMEMory:LOAD:TRACe:REGister TRACE1   TRACE2   TRACE3   TRACE4   TRACE5   TRACE6,<integer>
<b>Example</b>	MMEM:LOAD:TRAC TRACE2, "MyTraceFile.trace" This loads the trace file data (on the default file directory path) into the specified trace; if it is a "single trace" save file, that trace is loaded to trace 2, and is set to be not updating. :MMEM:LOAD:TRAC:REG TRACE1,2

	restores the trace data in register 2 to Trace 1
Notes	<p>When you perform the recall, the recalling Trace function must first verify the file is recallable in this instrument by checking instrument software version and model number, since it includes State. If everything matches, a full recall proceeds by aborting the currently running measurement, and loading the state from the saved state file to as close as possible to the context in which the save occurred. You can open .trace files from any mode that supports them, so recalling a Trace file switches to the mode that was active when the save occurred. After switching to the mode of the saved state file, mode settings and data (if any for the mode) are loaded with values from the saved file and the saved measurement of the mode becomes the newly active measurement, and the data relevant to the measurement (if there is any) is recalled.</p> <p>Once the state is loaded, the trace data must be loaded. The internal flags are consulted to see which trace to load and the "To Trace" setting to see where to load it. Trace data is always loaded with the specified trace set to View, so that the data is visible and not updating(so as not to erase the recalled data). If the file is an "all trace" file, all traces are loaded with the saved data(to the original trace the data was saved from) and set to View. Traces whose data is not loaded are restored to the update state that existed when they were saved.</p> <p>After the Recall the analyzer exits the Recall menu and returns to the previous menu.</p> <p>Some modes and measurements do not have available all 6 traces. Phase Noise mode command, for example, is: <code>MMEMory:LOAD:TRACe TRACE1 TRACE2 TRACE3,&lt;filename&gt;</code></p> <p>Some modes and measurements have more than 6 traces available. The Realtime SA mode command, for example, is: <code>MMEMory:STORe:TRACe TRACE1   TRACE2   TRACE3   TRACE4   TRACE5   TRACE6   TRACE7   TRACE8   TRACE9   TRACE10   TRACE11   TRACE12   ALL,&lt;filename&gt;</code></p>
Initial S/W Revision	Prior to A.02.00

## To Trace

These menu selections let you choose the Trace where the recalled saved trace will go. Not all modes have the full 6 traces available. The default is the currently selected trace, selected in this menu or in the Trace/Detector, Export Data, Import Data, or Save Trace menus, except if you have chosen All, then it remains chosen until you specifically change it to a single trace.

If the .trace file is an "all trace" file, "To Trace" is ignored and the traces each go back to the trace from which they were saved.

Once selected, the key returns back to the Recall Trace menu and the selected Trace number is annotated on the key. Now you have selected exactly where the trace needs to be recalled.To trigger a recall of the selected Trace, you must select the Open key in the Recall Trace menu.

When you select a trace, it makes that trace the current trace, so it displays on top of all of the other traces.

Key Path	Save, Data, Trace
Mode	SA
Initial S/W Revision	Prior to A.02.00

## Register 1 thru Register 16

Selecting any one of these register keys causes the State of the mode from the specified Register to be recalled. Each of the register keys annotates whether it is empty or at what date and time it was last modified. In addition, you can use the Edit Register Names key under Save, State to enter custom names for each register.

Registers are shared by all modes, so recalling from any one of the registers will cause a mode switch to the mode that was active when the save to the Register occurred.

Although these 16 registers are the only registers available from the front panel, there are 128 state registers available in the instrument. Registers 17–128 are only available from the SCPI interface, using the \*RCL command.

After the recall completes, the message "Register <register number> recalled" appears in the message bar. If you are in the Spectrum Analyzer Mode, and you are recalling a register that was saved in the Spectrum Analyzer Mode, then after the recall, you will still be in the Recall Register menu. If the Recall causes you to switch modes, then after the Recall, you will be in the Frequency menu.

If a requested register is empty an error is generated.

Key Path	Recall, State
<b>Example</b>	*RCL 1
Range	1–16 from front panel, 1–128 from SCPI
Readback	Date and time with seconds resolution are displayed on the key OR A custom name of up to 30 characters entered using the Save, State, Edit Register Names key OR “(empty)” if no prior save operation has been performed to this register.
Initial S/W Revision	Prior to A.02.00
Modified at S/W Revision	Prior to A.11.00

## From File...

When you press “From File”, the analyzer brings up a Windows dialog and a menu entitled “File Open.” This menu allows you to navigate to the various fields in the Windows dialog without using a keyboard or mouse. The Tab and Arrow keys can also be used for dialog navigation.

## 8 Channel Power Measurement Recall

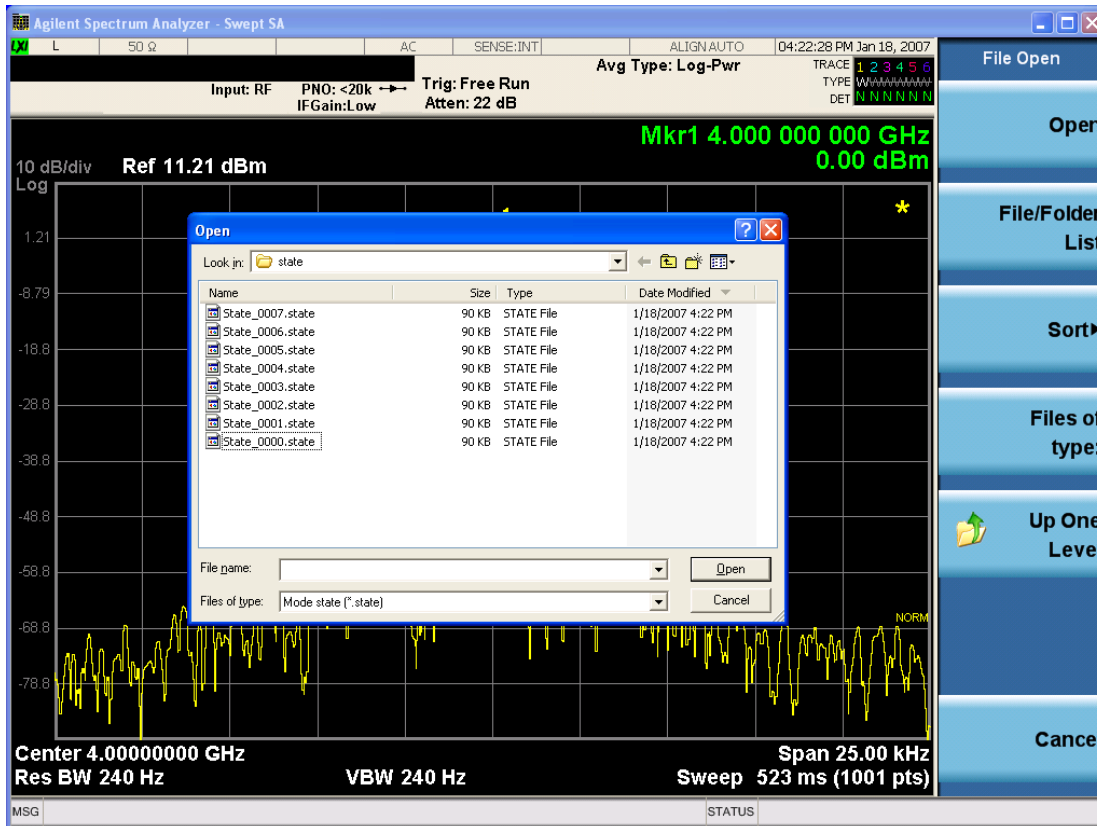

Listed below are the functions of the various fields in the dialog, and the corresponding softkeys:

### Open

Performs the recall of the specified file. While the recall is being performed, the floppy icon appears briefly in the Meas bar.

### File/Folder List

Enables you to navigate to the center of the dialog that contains the list of files and folders. Once here you can get information about the file and use the tab keys to navigate to the other fields in the dialog, such as Look In.

### Look In

The Look In field shows the path from which the file will be recalled and allows you to change the path using the up and down arrow keys to navigate to other paths; the Enter key to open a directory; and the Backspace key to go back one directory. The **Look In field** first uses the last path from the Save As dialog **Save In:** path for that same file type. There is no softkey for directly navigating to the Look In field, but you can use the left tab to get here from the File/Folder List.

User specified paths are remembered when you leave and return to a Mode and are reset back to the default using Restore Mode Defaults.

### Sort

Accesses a menu that enables you to sort the files within the File Open dialog. Only one sorting type can be selected at a time and the sorting happens immediately. The sorting types are By Date, By Name, By extension, and By Size.

#### Files of Type

This field shows the file suffix for the type of file you have selected to recall. For example, if you navigated here while recalling State, "Mode state (\*.state)" is in the field. If you navigated here while recalling Trace, ""Mode state (\*.trace)" is in the field. If you navigated here while importing a trace data file, "Trace Data (\*.csv)" is in the field. For some file types, there is more than one choice in the dropdown menu, which you can select by using the up and down arrow keys and Enter.

#### Up One Level

This key corresponds to the icon of a folder with the up arrow that is in the tool bar of the dialog. When pressed, it causes the file and folder list to navigate up one level in the directory structure. The Backspace key does the same thing.

#### Cancel

This key corresponds to the Cancel selection in the dialog. It causes the current **Open** request to be cancelled. The ESC key does the same thing.

Key Path	Recall, State
Notes	Brings up the Open dialog for recalling a State Save Type
Initial S/W Revision	Prior to A.02.00

## Data (Import)

Importing a data file loads data that was previously saved from the current measurement or from other measurements and/or modes that produce compatible data files. The Import Menu only contains Data Types that are supported by the current measurement.

Since the commonly exported data files are in .csv format, the data can be edited by the user prior to importing. This allows you to export a data file, manipulate the data in Excel (the most common PC Application for manipulating .csv files) and then import it.

Importing Data loads measurement data from the specified file into the specified or default destination, depending on the data type selected. Selecting an Import Data menu key will not actually cause the importing to occur, since the analyzer still needs to know from where to get the data. Pressing the Open key in this menu brings up the Open dialog and Open menu that provides you with the options from where to recall the data. Once a filename has been selected or entered in the Open menu, the recall occurs as soon as the Open button is pressed.

Key Path	Recall
Mode	All
Notes	The menu is built from whatever data types are available for the mode. Some keys will be missing completely, so the key locations in the sub-menu will vary.  No SCPI command directly controls the Data Type that this key controls. The Data Type is included in the MMEM:LOAD commands.

Dependencies	If a file type is not used by a certain measurement, it is grayed out for that measurement. The key for a file type will not show at all if there are no measurements in the Mode that support it.
Preset	Is not affected by Preset or shutdown, but is reset during Restore Mode Defaults
Readback	The data type that is currently selected
Initial S/W Revision	Prior to A.02.00

## Capture Buffer

The captured data is raw data which is not processed.

Key Path	Recall, Data
Mode	<b>CDMA1XEV</b>
Example	MMEM:LOAD:CAPT "MyCaptureData.bin" This loads the file of capture data (on the default file directory path) into the instrument.
Dependencies	In case the capture buffer data is not available from the selected measurement, the key will be grayed out.
Initial S/W Revision	A.11.00

## Open...

When you press "Open", the analyzer brings up a Windows dialog and a menu entitled "**File Open.**" This menu allows you to navigate to the various fields in the Windows dialog without using a keyboard or mouse. The Tab and Arrow keys can also be used for dialog navigation.

See "[From File...](#)" on page 2890 in Recall, State, for a full description of this dialog and menu.

Key Path	Recall, Data
Notes	The key location is mode-dependent and will vary. Brings up Open dialog for recalling a <mode specific> Save Type
Initial S/W Revision	Prior to A.02.00

## Restart

The Restart function restarts the current sweep, or measurement, or set of averaged/held sweeps or measurements. If you are Paused, pressing Restart does a Resume.

The Restart function is accessed in several ways:

- Pressing the Restart key
- Sending the remote command INIT:IMMEDIATE
- Sending the remote command INIT:RESTART

See "[More Information](#)" on page 563

Key Path	Front-panel key
Remote Command	:INITiate[:IMMEDIATE] :INITiate:RESTART
Example	:INIT:IMM :INIT:REST
Notes	:INITiate:RESTART and :INITiate:IMMEDIATE perform exactly the same function.
Couplings	Resets average/hold count k. For the first sweep overwrites all active (update=on) traces with new current data. For application modes, it resets other parameters as required by the measurement.
Status Bits/OPC dependencies	This is an Overlapped command. The STATUS:OPERation register bits 0 through 8 are cleared. The STATUS:QUESTIONable register bit 9 (INTEgrity sum) is cleared. The SWEEPING bit is set. The MEASURING bit is set.
Backwards Compatibility Notes	For Spectrum Analysis mode in ESA and PSA, the Restart hardkey and the INITiate:RESTART command restart trace averages (displayed average count reset to 1) for a trace in Clear Write, but did not restart Max Hold and Min Hold. In the X-Series, the Restart hardkey and the INITiate:RESTART command restart not only Trace Average, but MaxHold and MinHold traces as well. For wireless comms modes in ESA and PSA, the Restart hardkey and the INITiate:RESTART command restart every measurement, which includes all traces and numeric results. There is no change to this operation.
Initial S/W Revision	Prior to A.02.00

### More Information

The **Restart** function first aborts the current sweep/measurement as quickly as possible. It then resets the sweep and trigger systems, sets up the measurement and initiates a new data measurement sequence with a new data acquisition (sweep) taken once the trigger condition is met.

If the analyzer is in the process of aligning when **Restart** is executed, the alignment finishes before the restart function is performed.

Even when set for Single operation, multiple sweeps may be taken when Restart is pressed (for example, when averaging/holding is on). Thus when we say that **Restart** "restarts a measurement," we may mean:

- It restarts the current sweep
- It restarts the current measurement
- It restarts the current set of sweeps if any trace is in Trace Average, Max Hold or Min Hold
- It restarts the current set of measurements if Averaging, or Max Hold, or Min Hold is on for the measurement
- depending on the current settings.

With **Average/Hold Number** (in **Meas Setup** menu) set to 1, or Averaging off, or no trace in Trace Average or Hold, a single sweep is equivalent to a single measurement. A single sweep is taken after the trigger condition is met; and the analyzer stops sweeping once that sweep has completed. However, with **Average/Hold Number** >1 and at least one trace set to **Trace Average, Max Hold, or Min Hold (SA Measurement)** or **Averaging on (most other measurements)**, multiple sweeps/data acquisitions are taken for a single measurement. The trigger condition must be met prior to each sweep. The sweep is stopped when the average count  $k$  equals the number  $N$  set for **Average/Hold Number**. A measurement average usually applies to all traces, marker results, and numeric results; but sometimes it only applies to the numeric results.

Once the full set of sweeps has been taken, the analyzer will go to idle state. To take one more sweep without resetting the average count, increment the average count by 1, by pressing the step up key while **Average/Hold Number** is the active function, or sending the remote command `CALC:AVER:TCON UP`.



## Save

The Save menu lets you choose what you want to save and where you want to save it. Among the types of files you can save are **States**, **Traces**, and **Screen Images**. In addition, an Export (Data) option lets you save a number of data types as CSV files for easy import into Excel and other spreadsheet programs.

Key Path	Front-panel key
Mode	All
Notes	No remote command for this key specifically, but the :MMEM:STORe command is available for specific file types. An example is :MMEM:STOR:STATe <filename>.
Initial S/W Revision	Prior to A.02.00

## State

The Save State menu lets you choose a register or file for saving the state.

The content of a state file includes all of the settings and data required to return the analyzer as closely as possible to the Mode it was in, with the exact settings which were in place, when the save occurred. The Mode settings in each state file include the settings that are affected by Mode Preset, as well as the additional settings affected by Restore Mode Defaults; all of the Mode's settings. In addition, all of the settings of the Input/Output system are included, even though they are outside of the Mode's state, because they are needed to restore the complete setup. Persistent System settings (for example, Verbose SCPI) are not affected by either Mode Preset or Restore Mode Defaults, nor are they included in a saved State file.

After the save completes, the message "File <filename> saved" or "State Register <register number> saved" is displayed.

For rapid saving, the State menu lists 16 registers to save to. Pressing a Register key initiates the save. You can also select a file to save to.

The default path for all State Files is:

My Documents\<>mode name>\state

where <mode name> is the parameter used to select the mode with the INST:SEL command (for example, SA for the Spectrum Analyzer).

Key Path	Save
Mode	All
Remote Command	:MMEMory:STORe:STATe <filename>
Example	MMEM:STOR:STATe "MyStateFile.state" This stores the current instrument state data in the file MyStateFile.state in the default directory.
Notes	Both single and double quotes are supported for any filename parameter over remote. After saving to a register, that register's menu key is updated with the date the time, unless a custom label has been entered for that key. After saving to a register, you remain in the Save State menu, so that you can see the Register key

update. After saving to a file, the analyzer automatically returns to the previous menu and any Save As dialog goes away.

**Backwards Compatibility SCPI** :MMEMory:STORe:STATe 1,<filename>

For backwards compatibility, the above syntax is supported. The "1" is simply ignored. The command is sequential.

Initial S/W Revision Prior to A.02.00

### To File . . .

When you press “To File”, the analyzer brings up a Windows dialog and a menu entitled “Save As.” This menu allows you to navigate to the various fields in the Windows dialog without using a keyboard or mouse. The Tab and Arrow keys can also be used for dialog navigation.

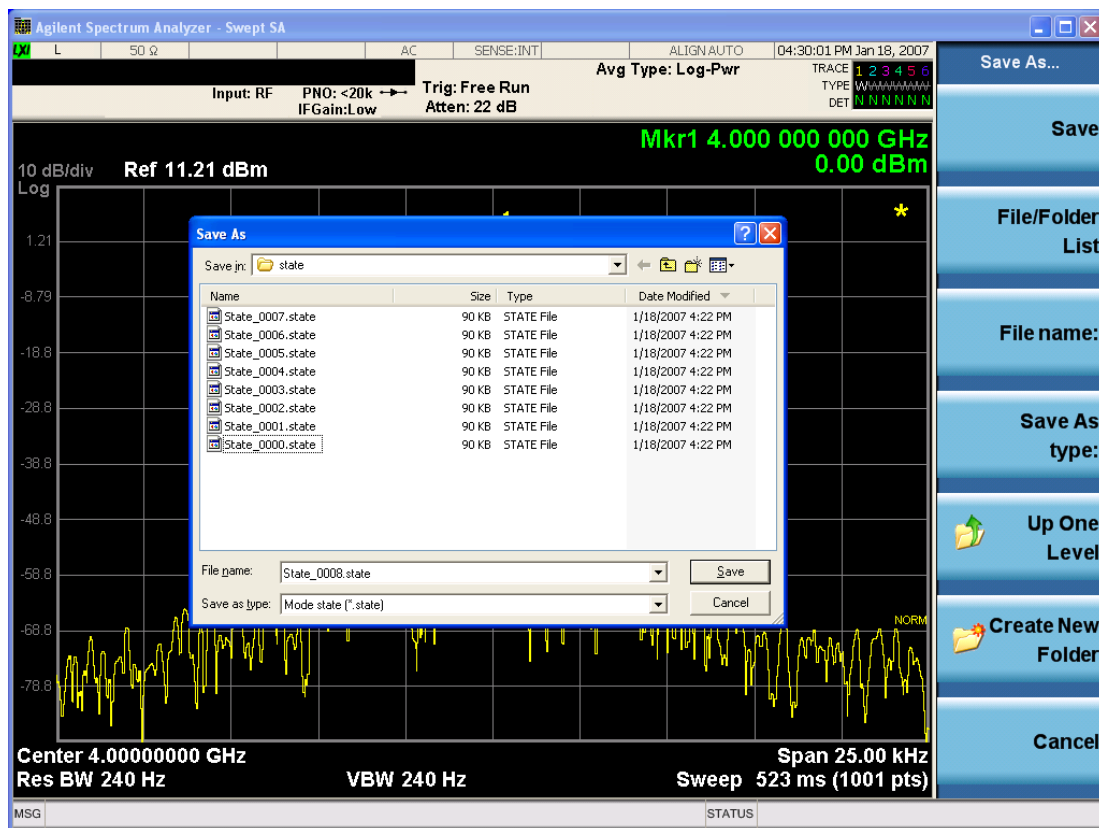

The Listed below

are the functions of the various fields in the dialog, and the corresponding softkeys:

#### Save

Performs the save to the specified file of the selected type. If the file already exists, a dialog will appear that allows you to replace the existing file by selecting OK, or you can Cancel the request. If you select OK, the file will be overwritten. Using the C: drive is strongly discouraged, since it runs the risk of being overwritten during an instrument software upgrade.

While the save is being performed, the floppy icon appears briefly in the Meas bar.

## File/Folder List

Enables you to navigate to the center of the dialog that contains the list of files and folders. Once here you can get information about the file and use the tab keys to navigate to the other fields in the dialog, such as Save In.

## Save In

The Save In field shows the path to which the file will be saved and allows you to change the path using the up and down arrow keys to navigate to other paths; the Enter key to open a directory; and the Backspace key to go back one directory. The **Save In field** defaults to the default path for this type of file and remembers the last path you used to save this type of file. There is no softkey for directly navigating to the Save In field but you can use left tab to get here from the File/Folder List.

User specified paths are remembered when you leave and return to a Mode and are reset back to the default using Restore Mode Defaults.

## File Name

The File Name field is initially loaded with an automatically generated filename specific to the appropriate Save Type. The automatically generated filename is guaranteed not to conflict with any filename currently in the directory. You may replace or modify this filename using the File Name key. See the ["Quick Save " on page 2880](#) documentation for more on the automatic file naming algorithm.

When you press the File Name key the analyzer displays the Alpha Editor. Use the knob to choose the letter to add and the front-panel Enter key to add the letter to the file name. The BK character moves you back and the FW character moves you forward in the filename. The Select key on the front panel generates a space character. When you are done entering the filename press the Done softkey. This returns back to the **File Open** dialog and menu, but does not cause the save to occur.

## Save As Type

This field shows the file suffix for the type of file you have selected to save. For example, if you navigated here while saving State, "Mode state (\*.state)" is in the field. If you navigated here from saving Trace, ""Mode state (\*.trace)" is in the field. If you navigated here while exporting a trace data file, "Trace Data (\*.csv)" is in the field. For some file types, there is more than one choice in the dropdown, which you can select by using the up and down arrow keys and Enter.

## Up One Level

This key corresponds to the icon of a folder with the up arrow that is in the tool bar of the dialog. When pressed, it causes the file and folder list to navigate up one level in the directory structure. The Backspace key does the same thing.

## Create New Folder

This key corresponds to the icon of a folder with the "\*" that is in the tool bar of the dialog. When pressed, a new folder is created in the current directory with the name **New Folder** and you can enter a new folder name using the Alpha Editor.

## Cancel

This key corresponds to the Cancel selection in the dialog. It causes the current **Save As** request to be cancelled. The ESC key does the same thing.

Key Path	Save, State
Mode	All
Notes	Brings up Save As dialog for saving a State Save Type
Initial S/W Revision	Prior to A.02.00

## Edit Register Names

You may enter a custom name on any of the Register keys, to help you remember what you are using that state to save. To do this, press the Edit Register Names key, choose the register whose name you wish to edit, and then enter the desired label using the Alpha Editor or an external PC keyboard.

The maximum number of characters that can be added is 30. In most cases, 30 characters will fit on two lines of the key.

See ["More Information" on page 568](#)

Key Path	Save, State
Mode	All
<b>Remote Command</b>	:MMEMory:REGister:STATe:LABel <reg number>,"label" :MMEMory:REGister:STATe:LABel? <reg number>
<b>Example</b>	:MMEM:REG:STAT:LAB 1,"my label"
Notes	<reg number> is an integer from 1 to 16. If the SCPI specifies an invalid register number an error message is generated, -222,"Data out of range;Invalid register label number" "label" is a string from 0 to 30 characters in length. If a label exceeds 30 characters, an error message is generated, -150,"String data error;Label clipped to 30 characters" "label" of length 0 erases the custom label and restores the default (time and date) label. E.g.: :MMEM:REG:STAT:LAB 1,""
Dependencies	N9060A-7FP or N9060B-2FP license required to edit the register names. When the feature is not licensed, sending this command generates an error, -221,"Settings conflict;Option not available"
Preset	The names are unaffected by Preset or power cycle but are set to the default label (time and date) on a "Restore System Defaults->Misc"
Initial S/W Revision	A.11.00

## More Information

When you edit one of the register names, the time and date field will be replaced by the custom name.

If you delete all the characters in the custom name, it restores the default (time and date).

The register names are stored within the state files, but they are not part of the instrument state; that is, once you have edited a register name, loading a new state will not change that register name. Another consequence of this is that the names will be persistent through a power cycle. Also, if a named state file is transferred to another analyzer, it will bring its custom name along with it.

If you try to edit the name of an empty register, the analyzer will first save the state to have a file to put the name in. If you load a named state file into an analyzer with older firmware it will ignore the metadata.

The \*SAV and \*RCL commands will not be affected by the custom register names, nor will the MMEM commands.

### Register 1 thru Register 16

Selecting any one of these register menu keys causes the State of the currently active mode to be saved to the specified Register. The registers are provided for rapid saving and recalling, since you do not need to specify a filename or navigate to a file. Each of the register menu keys annotates whether it is empty or at what date and time it was last modified. In addition, you can use the Edit Register Names key to enter custom names for each register.

Although these 16 registers are the only registers available from the front panel, there are 128 state registers available in the instrument. Registers 17–128 are only available from the SCPI interface, using the \*SAV command.

There is one set of 128 state registers in the instrument, not one set for each Mode. When a state is saved, the Mode it was saved from is saved with it; then when it is recalled, the instrument switches to that Mode.

After the save completes, the corresponding register menu key annotation is updated with the date and time and the message "Register <register number> saved" is displayed.

Key Path	Save, State
Mode	All
<b>Example</b>	*SAV 1
Range	1–16 from front panel, 1–128 from SCPI
Readback	Date and time with seconds resolution are displayed on the key OR A custom name of up to 30 characters entered using the Edit Register Names key OR “(empty)” if no prior save operation has been performed to this register.
Initial S/W Revision	Prior to A.02.00
Modified at S/W Revision	A.11.00

### Register 1 thru Register 16

Selecting any one of these register menu keys causes the State of the currently active mode to be saved to the specified Register. The registers are provided for rapid saving and recalling, since you do not need to specify a filename or navigate to a file. Each of the register menu keys annotates whether it is empty or at what date and time it was last modified. In addition, you can use the Edit Register Names key to enter custom names for each register.

Although these 16 registers are the only registers available from the front panel, there are 128 state registers available in the instrument. Registers 17–128 are only available from the SCPI interface, using the \*SAV command.

There is one set of 128 state registers in the instrument, not one set for each Mode. When a state is saved, the Mode it was saved from is saved with it; then when it is recalled, the instrument switches to that Mode.

After the save completes, the corresponding register menu key annotation is updated with the date and time and the message "Register <register number> saved" is displayed.

Key Path	Save, State
Mode	All
Example	*SAV 1
Range	1-16 from front panel, 1-128 from SCPI
Readback	Date and time with seconds resolution are displayed on the key OR A custom name of up to 30 characters entered using the Edit Register Names key OR “(empty)” if no prior save operation has been performed to this register.
Initial S/W Revision	Prior to A.02.00
Modified at S/W Revision	A.11.00

## Data (Export)

Exporting a data file stores data from the current measurement to mass storage files. The Export Menu only contains data types that are supported by the current measurement.

Since the commonly exported data files are in .csv format, the data can be edited by you prior to importing. This allows you to export a data file, manipulate the data in Excel (the most common PC Application for manipulating .csv files) and then import it.

Selecting an Export Data menu key will not actually cause the exporting to occur, since the analyzer still needs to know where you wish to save the data. Pressing the Save As key in this menu brings up the Save As dialog and Save As menu that allows you to specify the destination file and directory. Once a filename has been selected or entered in the Open menu, the export will occur as soon as the Save key is pressed.

Key Path	Save
Mode	All
Notes	The menu is built from whatever data types are available for the mode. So the key locations in the sub menu will vary.  No SCPI command directly controls the Data Type that this key controls. The Data Type is included in the MMEM:STOR commands.
Dependencies	If a file type is not used by a certain measurement, that type is grayed out for that measurement. The key for a file type will not show at all if there are no measurements in the Mode that support it.
Preset	Is not affected by a Preset or shutdown, but is reset during Restore Mode Defaults
Readback	The data type that is currently selected
Initial S/W Revision	Prior to A.02.00

## Measurement Results

Pressing this key selects Meas Results as the data type to be exported.

The Meas Results file contains information which describes the current state of the analyzer. It is detailed in Meas Result File Contents below.

Key Path	Save, Data
Remote Command	:MMEMory:STORe:RESults <string>
Example	:MMEM:STOR:RES "MeasR_0000.csv"
Notes	<p>If the save is initiated via SCPI and the file already exists, the file will be overwritten.</p> <p>The SCPI command exports Channel Power measurement results to the file specified as the parameter in the current path. The default path is My Documents\&lt;current mode&gt;\data\CHP\results.</p> <p>Using the C: drive is strongly discouraged, since it runs the risk of being overwritten during an instrument software upgrade.</p> <p>The SCPI parameter is a quoted string, which specifies the filename. Both single and double quotes are supported for any filename parameter over SCPI.</p>
Dependencies	The current active measurement must be the Channel Power measurement to use this command.
Status Bits/OPC dependencies	Sequential – waits for the previous measurement to complete.
Initial S/W Revision	Prior to A.02.00

### Meas Results File Contents

A Meas Results File contains measurement results with the following information.

- File ID string, which is "MeasResult"
- Measurement ID following Mode ID, which is "SA:CHP" for example.
- Firmware rev and model number
- Option string
- Auto Sweep Time Rules
- Average Mode
- Average Number
- Average State
- Center Frequency
- Detector
- Electrical Atten
- Electrical Atten State
- IFGain

- IFGainAuto
- Impedance
- Integ BW
- Internal Preamp
- Internal Preamp Band
- Mechanical Atten
- MechanicalAttenStepEnum
- PSD Unit
- Resolution Band Width
- Resolution Bandwidth Shape
- RRC Filter Alpha
- RRC Filter BW
- RRC Filter State
- Span
- Sweep Points
- Sweep Time
- Sweep Time Auto
- TriggerSource
- Video Bandwidth
- Y Axis Unit

The file contains these data followed by MeasResult1 and MeasResult2 that flag the start of the measurement results. Each line of Measurement Results consists of two comma separated values, MeasResult1 value and MeasResult2 value. MeasResult1 contains the same results as MEAS/READ/FETCH:CHPower1; MeasResult2, MEAS/READ/FETCH:CHPower2.

Exported file is .csv file. The Meas Results file, when imported into Excel, will show the following data:

MeasResult	
SA:CHP	
A.10.53	N9030A
526 ALV ATP B1X B1Y B25 B40 BBA CR3 CRP DCF DDA DP2 DRD EA3 EDP EMC EP1 ERC ESC ESP EXM FSA LFE LNP MAT MPB NFE NUL P26 PFR PNC RTL RTS S40 SB1 SEC SM1 TVT YAS YAV	1
Auto Sweep Time Rules	Normal
Average Mode	Exponential



Average Number	10
Average State	TRUE
Center Frequency	13255000000
Detector	Average
IFGain	FALSE
IFGainAuto	FALSE
Impedance	50
Integ BW	2000000
Internal Preamp	FALSE
Internal Preamp Band	Low
PSD Unit	DbmHz
Resolution Band Width	27000
Resolution Bandwidth Shape	Gaussian
RRC Filter Alpha	0.22
RRC Filter BW	3840000
RRC Filter State	FALSE
Span	3000000
Sweep Points	1001
Sweep Time	0.004933333
Sweep Time Auto	TRUE
TriggerSource	Free
Video Bandwidth	270000
Y Axis Unit	DecibelMilliwatt
MeasResult1	MeasResult2
-76.8141133132837	-95.29174
-139.824413269924	-94.99601
	-94.95281
	-95.17146

## Capture Buffer

Capture Buffer functionality is not available for all measurements. The captured data is raw data which is not processed.

Key Path	Save, Data
Mode	CDMA1XEV
Example	M MEM:STOR:CAPT "MyCaptureData.bin" This stores the capture data in the file MyCaptureData.bin in the default directory.

Dependencies	In case the capture buffer data is not available from the selected measurement, the key will be grayed out.
Initial S/W Revision	A.11.00

## Save As . . .

When you press "Save As", the analyzer brings up a Windows dialog and a menu entitled "**Save As.**" This menu allows you to navigate to the various fields in the Windows dialog without using a keyboard or mouse. The Tab and Arrow keys can also be used for dialog navigation.

See "[To File . . .](#)" on page 2897 in Save, State for a full description of this dialog and menu.

The default path for saving files is:

For all of the Trace Data Files:

My Documents\<<mode name>\data\traces

For all of the Limit Data Files:

My Documents\<<mode name>\data\limits

For all of the Measurement Results Data Files:

My Documents\<<mode name>\data\<<measurement name>\results

For all of the Capture Buffer Data Files:

My Documents\<<mode name>\data\captureBuffer

Key Path	Save, Data
Mode	All
Notes	The key location is mode-dependent and will vary. Brings up the Save As dialog for saving a <mode specific> Save Type. The save is performed immediately and does not wait until the measurement is complete.
Initial S/W Revision	Prior to A.02.00

## Screen Image

Pressing Screen Image accesses a menu of functions that enable you to specify a format and location for the saved screen image. It brings up a menu that allows you to specify the color scheme of the Screen Image (Themes) or navigate to the Save As dialog to perform the actual save.

Screen Image files contain an exact representation of the analyzer display. They cannot be loaded back onto the analyzer, but they can be loaded into your PC for use in many popular applications.

The image to be saved is actually captured when the Save front panel key is pressed, and kept in temporary storage to be used if you ask for a Screen Image save. When the Screen Image key is pressed, a "thumbnail" of the captured image is displayed, as shown below:

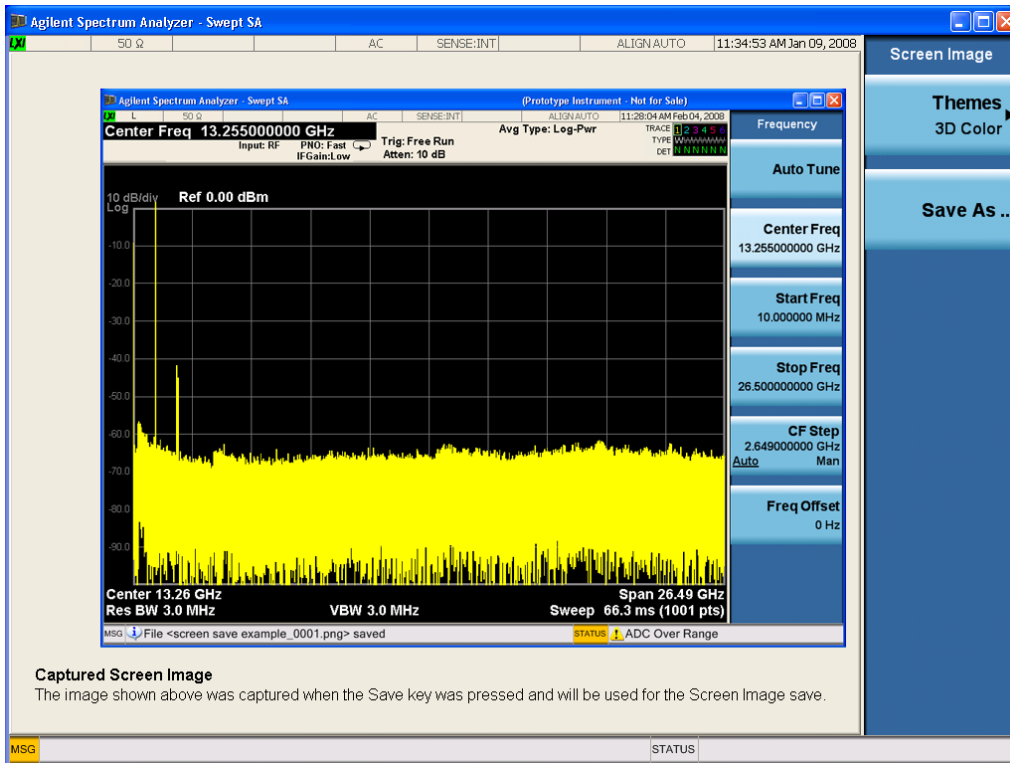

When you continue on into the Save As menu and complete the Screen Image save, the image depicted in the thumbnail is the one that gets saved, showing the menus that were on the screen before going into the Save menus. The save is performed immediately and does not wait until the measurement is complete.

After you have completed the save, the Quick Save front-panel key lets you quickly repeat the last save performed, using an auto-named file, with the current screen data.

**NOTE**

For versions previous to A.01.55, if you initiate a screen image save by navigating through the Save menus, the image that is saved will contain the Save menu softkeys, not the menus and the active function that were on the screen when you first pressed the Save front panel key.

Key Path	Save
Mode	All
Remote Command	:MMEMory:STORe:SCREen <filename>
Example	:MMEM:STOR:SCR "myScreen.png" This stores the current screen image in the file MyScreenFile.png in the default directory.
Initial S/W Revision	Prior to A.02.00

**Themes**

Accesses a menu of functions that enable you to choose the theme to be used when saving the screen image.

The **Themes** option is the same as the **Themes** option under the **Display** and **Page Setup** dialogs. It allows you to choose between themes to be used when saving the screen image.

<b>Key Path</b>	Save, Screen Image
<b>Remote Command</b>	:MMEMory:STORe:SCReen:THEMe TDColor   TDMonochrome   FCOLor   FMONochrome  :MMEMory:STORe:SCReen:THEMe?
<b>Example</b>	:MMEM:STOR:SCR:THEM TDM
<b>Preset</b>	3D Color; Is not part of Preset, but is reset by Restore Misc Defaults or Restore System Defaults All and survives subsequent running of the modes.
<b>Readback</b>	3D Color   3D Mono   Flat Color   Flat Mono
<b>Backwards Compatibility Notes</b>	In ESA and PSA we offer the choice of "Reverse Bitmap" or "Reverse Metafile" when saving screen images. This is much like the "Flat Color" theme available in X-Series. Also, if you selected Reverse Bitmap AND a black & white screen image, that would be much like "Flat Monochrome". In other words, each of the X-Series themes has a similar screen image type in ESA/PSA. But they are not identical.
<b>Initial S/W Revision</b>	Prior to A.02.00

### 3D Color

Selects a standard color theme with each object filled, shaded and colored as designed.

<b>Key Path</b>	Save, Screen Image, Themes
<b>Example</b>	MMEM:STOR:SCR:THEM TDC
<b>Readback</b>	3D Color
<b>Initial S/W Revision</b>	Prior to A.02.00

### 3D Monochrome

Selects a format that is like 3D color but shades of gray are used instead of colors.

<b>Key Path</b>	Save, Screen Image, Themes
<b>Example</b>	MMEM:STOR:SCR:THEM TDM
<b>Readback</b>	3D Mono
<b>Initial S/W Revision</b>	Prior to A.02.00

### Flat Color

Selects a format that is best when the screen is to be printed on an ink printer.

<b>Key Path</b>	Save, Screen Image, Themes
-----------------	----------------------------

<b>Example</b>	MMEM:STOR:SCR:THEM FCOL
Readback	Flat Color
Initial S/W Revision	Prior to A.02.00

### Flat Monochrome

Selects a format that is like Flat Color. But only black is used (no colors, not even gray), and no fill.

Key Path	Save, Screen Image, Themes
<b>Example</b>	MMEM:STOR:SCR:THEM FMON
Readback	Flat Mono
Initial S/W Revision	Prior to A.02.00

### Save As...

When you press "Save As", the analyzer brings up a Windows dialog and a menu entitled "**Save As.**" This menu allows you to navigate to the various fields in the Windows dialog without using a keyboard or mouse. The Tab and Arrow keys can also be used for dialog navigation.

See "[To File . . .](#)" on page 2897 in Save, State for a full description of this dialog and menu.

The default path for Screen Images is

My Documents\`<mode name>`\screen.

where `<mode name>` is the parameter used to select the mode with the INST:SEL command (for example, SA for the Spectrum Analyzer).

Key Path	Save, Screen Image
Notes	Brings up Save As dialog for saving a Screen Image Save Type
Initial S/W Revision	Prior to A.02.00

### Mass Storage Catalog (Remote Command Only)

Key path	SCPI Only
<b>Remote Command</b>	:MMEMory:CATalog? [ <code>&lt;directory_name&gt;</code> ]
Notes	<p>The string must be a valid logical path.</p> <p>Queries disk usage information (drive capacity, free space available) and obtains a list of files and directories in a specified directory in the following format:</p> <p><code>&lt;numeric_value&gt;,&lt;numeric_value&gt;,{&lt;file_entry&gt;}</code></p> <p>It returns two numeric parameters and as many strings as there are files and directories. The first parameter indicates the total amount of storage currently used in bytes. The second parameter</p>

---

	<p>indicates the total amount of storage available, also in bytes. The &lt;file_entry&gt; is a string. Each &lt;file_entry&gt; indicates the name, type, and size of one file in the directory list: &lt;file_name&gt;,&lt;file_type&gt;,&lt;file_size&gt;</p> <p>As the windows file system has an extension that indicates file type, &lt;file_type&gt; is always empty. &lt;file_size&gt; provides the size of the file in bytes. For directories, &lt;file_entry&gt; is surrounded by square brackets and both &lt;file_type&gt; and &lt;file_size&gt; are empty</p>
Initial S/W Revision	Prior to A.02.00

---

### Mass Storage Change Directory (Remote Command Only)

---

Key path	SCPI Only
<b>Remote Command</b>	<pre>:MMEMory:CDIRectory [&lt;directory_name&gt;] :MMEMory:CDIRectory?</pre>
Notes	<p>The string must be a valid logical path.</p> <p>Changes the default directory for a mass memory file system. The &lt;directory_name&gt; parameter is a string. If no parameter is specified, the directory is set to the *RST value.</p> <p>At *RST, this value is set to the default user data storage area, that is defined as System.Environment.SpecialFolder.Personal.</p> <p>Query returns full path of the default directory.</p>
Initial S/W Revision	Prior to A.02.00

---

### Mass Storage Copy (Remote Command Only)

---

Key path	SCPI Only
<b>Remote Command</b>	<pre>:MMEMory:COPY &lt;string&gt;,&lt;string&gt;[,&lt;string&gt;,&lt;string&gt;]</pre>
Notes	<p>The string must be a valid logical path.</p> <p>Copies an existing file to a new file or an existing directory to a new directory.</p> <p>Two forms of parameters are allowed. The first form has two parameters. In this form, the first parameter specifies the source, and the second parameter specifies the destination.</p> <p>The second form has four parameters. In this form, the first and third parameters specify the source. The second and fourth parameters specify the directories. The first pair of parameters specifies the source. The second pair specifies the destination. An error is generated if the source doesn't exist or the destination file already exists.</p> <p>This command will generate an "access denied" error if the destination is a restricted folder (e.g., C:\Windows) and the current user does not have Power User or Administrator privileges.</p>

---

### Mass Storage Device Copy (Remote Command Only)

This command transfers data to/from a file and a peripheral device.

Key path	SCPI Only
<b>Remote Command</b>	:MMEMory:COpy:DEvice <source_string>,<dest_string>
Notes	<p>The strings must be a valid logical path or a valid device keyword. If the dest_string is a device keyword, the data is copied from the source file to the device. If the source_string is a device keyword, the data is copied to the source file from the device.</p> <p>Valid device keywords are:            SNS (smart noise source)</p> <p>An error is generated if the file or device is not found.</p>

### Mass Storage Delete (Remote Command Only)

Key path	SCPI Only
<b>Remote Command</b>	:MMEMory:DElete <file_name>[,<directory_name>]
Notes	<p>The string must be a valid logical path.</p> <p>Removes a file from the specified directory. The &lt;file_name&gt; parameter specifies the file name to be removed. This command will generate an “access denied” error if the file is in a restricted folder (e.g., C:\Windows) and the current user does not have Power User or Administrator privileges.</p>
Initial S/W Revision	Prior to A.02.00

### Mass Storage Data (Remote Command Only)

Creates a file containing the specified data OR queries the data from an existing file.

Key path	SCPI Only
<b>Remote Command</b>	:MMEMory:DATA <file_name>, <data> :MMEMory:DATA? <file_name>
Notes	<p>The string must be a valid logical path.</p> <p>The command form is MMEMory:DATA &lt;file_name&gt;,&lt;data&gt;. It loads &lt;data&gt; into the file &lt;file_name&gt;. &lt;data&gt; is in 488.2 block format. &lt;file_name&gt; is string data.</p> <p>The query form is MMEMory:DATA? &lt;file_name&gt; with the response being the associated &lt;data&gt; in block format.</p>
Initial S/W Revision	Prior to A.02.00

### Mass Storage Make Directory (Remote Command Only)

Key path	SCPI Only
<b>Remote Command</b>	:MMEMory:MDIRectory <directory_name>
Notes	<p>The string must be a valid logical path.</p> <p>Creates a new directory. The &lt;directory_name&gt; parameter specifies the name to be created.</p>

---

	This command will generate an “access denied” error if the new directory would be in a restricted folder (e.g., C:\Windows) and the current user does not have Power User or Administrator privileges.
Initial S/W Revision	Prior to A.02.00

---

### Mass Storage Move (Remote Command Only)

---

Key path	SCPI Only
<b>Remote Command</b>	:MMEMory:MOVE <string>,<string>[,<string>,<string>]
Notes	<p>The string must be a valid logical path.</p> <p>Moves an existing file to a new file or an existing directory to a new directory.</p> <p>Two forms of parameters are allowed. The first form has two parameters. In this form, the first parameter specifies the source, and the second parameter specifies the destination.</p> <p>The second form has four parameters. In this form, the first and third parameters specify the source. The second and fourth parameters specify the directories. The first pair of parameters specifies the source. The second pair specifies the destination. An error is generated if the source doesn't exist or the destination file already exists.</p> <p>This command will generate an “access denied” error if the destination is a restricted folder (e.g., C:\Windows) and the current user does not have Power User or Administrator privileges.</p>
Initial S/W Revision	Prior to A.02.00

---

### Mass Storage Remove Directory (Remote Command Only)

---

Key path	SCPI Only
<b>Remote Command</b>	:MMEMory:RDIRECTory <directory_name>
Notes	<p>The string must be a valid logical path.</p> <p>Removes a directory. The &lt;directory_name&gt; parameter specifies the directory name to be removed. All files and directories under the specified directory shall also be removed.</p> <p>This command will generate an “access denied” error if the folder is a restricted folder (e.g., C:\Windows) or is in a restricted folder and the current user does not have Power User or Administrator privileges.</p>
Initial S/W Revision	Prior to A.02.00

---



## Single (Single Measurement/Sweep)

Sets the analyzer for Single measurement operation. The single/continuous state is Meas Global, so the setting will affect all the measurements. If you are Paused, pressing Single does a Resume.

See "[More Information](#)" on page 581

Key Path	Front-panel key
Example	:INIT:CONT OFF
Notes	See Cont key description.
Backwards Compatibility Notes	<p>For Spectrum Analysis mode in ESA and PSA, the Single hardkey and the INITiate:IMM switched from continuous measurement to single measurement and restarted sweeps and averages (displayed average count reset to 1), but did not restart Max Hold and Min Hold. In the X-Series, the Single hardkey and the INITiate:IMM command initiate a sweep/ measurement/ average sequence/hold sequence including MaxHold and MinHold.</p> <p>For Spectrum Analysis mode in ESA and PSA, the Single hardkey restarted the sweep regardless of whether or not you were in an active sweep or sweep sequence. In the X-Series, Restart does this but Single only restarts the sweep or sweep sequence if you are in the idle state.</p> <p>INIT[:IMM] in ESA &amp; PSA Spectrum Analysis Mode does an implied ABORT. In some other PSA Modes, INIT[:IMM] is ignored if not in the idle state. . The X-Series follows the ESA/PSA SA Mode model, which may cause some Modes to have compatibility problems.</p>
Initial S/W Revision	Prior to A.02.00

### More Information

See "[Restart](#)" on page 2894 for details on the INIT:IMMEDIATE (Restart) function.

If you are already in single sweep, the INIT:CONT OFF command has no effect.

If you are already in Single Sweep, then pressing the Single key in the middle of a sweep does not restart the sweep or sequence. Similarly, pressing the Single key does not restart the sweep or sequence if the sweep is not in the idle state (for example, if you are taking a very slow sweep, or the analyzer is waiting for a trigger). Instead, it results in a message. "Already in Single, press Restart to initiate a new sweep or sequence". Even though pressing the Single key in the middle of a sweep does not restart the sweep, sending INIT:IMMEDIATE does reset it.

To take one more sweep without resetting the average count, increment the average count by 1, by pressing the step up key while **Average/Hold Number** is the active function, or sending the remote command CALC:AVER:TCON UP.

## Source

There is no Source control functionality for this measurement. When this key is pressed, the screen either displays a blank menu, or the previously-selected menu remains unchanged.

---

Key Path	Front-panel key
----------	-----------------

---

## Span X Scale

Accesses a menu of functions that enable you set the horizontal scale parameters.

Key Path	Front-panel key
Initial S/W Revision	Prior to A.02.00

### Span

Changes the frequency range symmetrically about the center frequency.

The default (and minimum) Span is calculated using the number of carriers and the carrier width where;

$$\text{Span} = (\text{Upper Carrier Freq} + (\text{max offset IBW} * (1 + \alpha)) / 2) - (\text{Lower Carrier Freq} - (\text{max offset IBW} * (1 + \alpha)) / 2)$$

The span is increased by a factor of 1 + Filter Alpha if the RRC Filter is on.

Key Path	Span X Scale
Mode	SA, WCDMA, C2K, WIMAX OFDMA, 1xEVDO, DVB-T/H, DTMB (CTTB), ISDB-T, CMMB, LTE, LTETDD, Digital Cable TV, WLAN
Remote Command	[ :SENSe ] :CHPower:FREQuency:SPAN <freq> [ :SENSe ] :CHPower:FREQuency:SPAN?
Example	CHP:FREQ:SPAN 10 MHz CHP:FREQ:SPAN?
Notes	You must be in the Spectrum Analysis mode, W-CDMA mode, cdma2000 mode, DVB-T/H mode, DTMB (CTTB) mode, ISDB-T mode, CMMB mode, Digital Cable TV mode, LTE mode, LTE TDD mode, WLAN mode, 1xEVDO mode or WIMAX OFDMA mode to use this command. Use :INSTrument:SElect to set the mode.
Dependencies	For MSR mode, this key is blank. For LTE-Advanced FDD/TDD mode, this key is blank. For WLAN 802.11ac (80 MHz + 80 MHz), the key is not enabled and its value is coupled with the spacing between the center frequencies of the two carriers. Span =  Center Frequency 1 - Center Frequency 2  + Integ BW + 40 MHz Margin. When the calculated span is over 1 GHz, it's still coupled to its maximum value, which is 1 GHz.
Couplings	When Res BW is set to Auto, the resolution bandwidth is auto-coupled to span. The ratio of span /RBW is approximately 106:1. When the Res BW is set to Man, bandwidths are entered by the user, and these bandwidths are used regardless of other analyzer settings. Since Span is coupled to Integ BW in the factory default condition, if you change the integration bandwidth setting, the span setting changes by a proportional amount until a limit value is reached. However, the span can be individually set. The minimum value of the span is coupled with the integration bandwidth.
Preset	SA: 3 MHz WCDMA: 7.5 MHz

	<p>C2K: 1.845 MHz  WIMAX OFDMA: 20 MHz  1xEVDO: 2.0MHz  DVB-T/H: 10MHz  DTMB (CTTB): 10MHz  ISDB-T: 10MHz  CMMB: 10MHz  LTE: 7.5 MHz  LTETDD: 7.5 MHz  Digital Cable TV: 10MHz  WLAN:  if Radio Std is 802.11a/g(OFDM/DSSS-OFDM): 30 MHz  if Radio Std is 802.11b: 37.5MHz  if Radio Std is 802.11n(20MHz): 30 MHz  if Radio Std is 802.11n(40MHz): 60 MHz  if Radio Std is 802.11ac (20 MHz): 30 MHz  if Radio Std is 802.11ac (40 MHz): 60 MHz  if Radio Std is 802.11ac (80 MHz): 120 MHz  if Radio Std is 802.11ac (160 MHz): 240 MHz  if Radio Std is 802.11ac (80 MHz + 80 MHz): 360 MHz</p>
State Saved	Saved in instrument state.
Min	100 Hz
Max	Hardware Maximum Span
Initial S/W Revision	Prior to A.02.00
Modified at S/W Revision	A.02.00, A.03.00

## Full Span

Changes the span to show the full frequency range of the spectrum analyzer.

Key Path	Span X Scale
Mode	SA, WCDMA, C2K, WIMAX OFDMA, 1xEVDO, DVB-T/H, DTMB (CTTB), ISDB-T, CMMB, LTE, LTETDD, Digital Cable TV, WLAN
Remote Command	[ :SENSe] :CHPower:FREQuency:SPAN:FULL
Example	CHP:FREQ:SPAN:FULL
Notes	You must be in the Spectrum Analysis mode, W-CDMA mode, cdma2000 mode, DVB-T/H mode, DTMB (CTTB) mode, ISDB-T mode, CMMB mode, Digital Cable TV mode, LTE mode, LTE TDD mode, WLAN mode, 1xEVDO mode or WIMAX OFDMA mode to use this command. Use :INSTrument:SElect to set the mode.

Dependencies	For MSR mode, this key is blank. For LTE-Advanced FDD/TDD mode, this key is blank.
Couplings	Selecting full span changes the measurement span value.
Initial S/W Revision	Prior to A.02.00
Modified at S/W Revision	A.02.00, A.03.00

## Last Span

Changes the span to the previous span setting. If no previous span value exists, then the span remains unchanged.

Key Path	Span X Scale
Mode	SA, WCDMA, C2K, WIMAX OFDMA, 1xEVDO, DVB-T/H, DTMB (CTTB), ISDB-T, CMMB, LTE, LTETDD, Digital Cable TV, WLAN
<b>Remote Command</b>	[ :SENSe ] :CHPower:FREQuency:SPAN:PREvious
<b>Example</b>	CHP:FREQ:SPAN:PREV
Notes	You must be in the Spectrum Analysis mode, W-CDMA mode, cdma2000 mode, DVB-T/H mode, DTMB (CTTB) mode, ISDB-T mode, CMMB mode, Digital Cable TV mode, LTE mode, LTE TDD mode, WLAN mode, 1xEVDO mode or WIMAX OFDMA mode to use this command. Use :INSTrument:SElect to set the mode.
Dependencies	For MSR mode, this key is blank. For LTE-Advanced FDD/TDD mode, this key is blank.
Couplings	Selecting last span changes the measurement span value.
Initial S/W Revision	Prior to A.02.00
Modified at S/W Revision	A.02.00, A.03.00

## Sweep/Control

Accesses a menu of functions that enable you to set up and control the sweep time and source for the current measurement. See "[Sweep/Control](#)" on page 2925 for more information.

Key Path	Front-panel key
Initial S/W Revision	Prior to A.02.00

### Sweep Time

Selects the length of time that the spectrum analyzer sweeps the displayed frequency span. Additional overhead time, which impacts the sweep rate, is not calculated as part of the sweep time. In fact:

$$\text{sweep rate} = \text{span} / \text{sweep time}$$

$$\text{update rate} = 1 / (\text{sweep time} + \text{overhead})$$

$$\text{sweep cycle time} = \text{sweep time} + \text{overhead}$$

Sweep time is coupled to RBW and VBW, and is impacted by the number of sweep points, so changing those parameters may change the sweep time.

Key Path	Sweep/Control
Mode	SA, WCDMA, C2K, WIMAX OFDMA, 1xEVDO, DVB-T/H, DTMB (CTTB), ISDB-T, CMMB, LTE, LTETDD, Digital Cable TV, WLAN, MSR, LTEAFDD, LTEATDD
Remote Command	<pre>[ :SENSe ] :CHPower:SWEep:TIME &lt;time&gt; [ :SENSe ] :CHPower:SWEep:TIME? [ :SENSe ] :CHPower:SWEep:TIME:AUTO OFF ON 0 1 [ :SENSe ] :CHPower:SWEep:TIME:AUTO?</pre>
Example	<pre>CHP:SWE:TIME 25ms CHP:SWE:TIME? CHP:SWE:TIME:AUTO OFF CHP:SWE:TIME:AUTO?</pre>
Preset	<pre>SA, WIMAX OFDMA: Automatically Calculated WCDMA: 1.0 ms CDMA2K: 9.4ms 1xEVDO: 2.66ms DVB-T/H: Automatically Calculated DTMB (CTTB): Automatically Calculated ISDB-T: Automatically Calculated CMMB: Automatically Calculated LTE, MSR: Automatically Calculated LTETDD: Automatically Calculated Digital Cable TV: Automatically Calculated</pre>

	WLAN: Automatically Calculated LTEAFDD,LTEATDD:Automatically Calculated
State Saved	Saved in instrument state.
Min	1 ms
Max	4000 s
Initial S/W Revision	Prior to A.02.00
Modified at S/W Revision	A.02.00, A.03.00

## Sweep Setup

Accesses a menu that enables you to set the sweep state for the current measurement.

Key Path	Sweep/Control
Initial S/W Revision	Prior to A.02.00

## Auto Sweep Time Rules

Switches the analyzer between normal and accuracy sweep states.

Setting Auto Sweep Time to Accy results in slower sweep times, usually about three times as long, but yields better amplitude accuracy for CW signals. The instrument amplitude accuracy specifications only apply when Auto Sweep Time is set to Accy.

Additional amplitude errors which occur when Auto Sweep Time is set to Norm are usually well under 0.1 dB, though this is not guaranteed. Because of the faster sweep times and still low errors, Norm is the preferred setting of Auto Sweep Time. Auto Sweep Time is set to Norm on a Preset or Auto Couple. This means that in the Preset or Auto Coupled state, instrument amplitude accuracy specifications do not apply.

Key Path	Sweep/Control, Sweep Setup
Mode	SA, WCDMA, C2K, WIMAX OFDMA, 1xEVDO, DVB-T/H, DTMB (CTTB), ISDB-T, CMMB, LTE, LTE-TDD, Digital Cable TV, WLAN, MSR, LTEAFDD, LTEATDD
Remote Command	[ :SENSe ] :CHPower:SWEep:TIME:AUTO:RULEs NORMal ACCuracy [ :SENSe ] :CHPower:SWEep:TIME:AUTO:RULEs?
Example	CHP:SWE:TIME:AUTO:RUL NORM CHP:SWE:TIME:AUTO:RUL?
Notes	In Zero Span, this key is irrelevant and inaccessible (because the whole Sweep Setup menu is grayed out in Zero Span), however its settings can be changed remotely with no error indication. Set to Norm when Auto Couple is pressed or sent remotely

Preset	NORMal
State Saved	Saved in instrument state.
Range	Norm Accy
Initial S/W Revision	Prior to A.02.00
Modified at S/W Revision	A.02.00, A.03.00

## Pause

Pauses a measurement after the current data acquisition is complete. When Paused, the label on the key changes to Resume. Pressing the Resume key resumes the measurement at the point it was at when paused. See ["Pause/Resume" on page 2925](#) for more details.

Key Path	Sweep/Control
Initial S/W Revision	Prior to A.02.00

## Gate

Accesses a menu that enables you to control the gating function. The Gate functionality is used to view signals best viewed by qualifying them with other events.

Gate setup parameters are the same for all measurements – they do not change as you change measurements. Settings like these are called “Meas Global” and are unaffected by Meas Preset.

Note that Sweep Time autocoupling rules and annotation are changed by Gate being on.

Key Path	Sweep/Control
Scope	Meas Global
Readback	The state and method of Gate, as [Off, LO] or [On, Video]. Note that for measurements that only support gated LO, the method is nonetheless read back, but always as LO.
Initial S/W Revision	Prior to A.02.00

## Gate On/Off

Turns the gate function on and off.

When the Gate Function is on, the selected Gate Method is used along with the gate settings and the signal at the gate source to control the sweep and video system with the gate signal. Not all measurements allow every type of Gate Methods.

When Gate is on, the annunciation in the measurement bar reflects that it is on and what method is used, as seen in the following "Gate: LO" annunciator graphic.



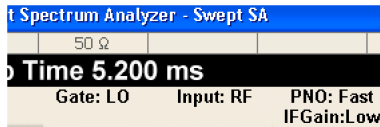

Key Path	Sweep/Control, Gate
Remote Command	[ :SENSe ] :SWEep:EGATe [ :STATe ] OFF ON 0 1 [ :SENSe ] :SWEep:EGATe [ :STATe ] ?
Example	SWE:EGAT ON SWE:EGAT?
Dependencies	<p>The function is unavailable (grayed out) and Off when:</p> <ul style="list-style-type: none"> <li>• Gate Method is LO or Video and FFT Sweep Type is manually selected.</li> <li>• Gate Method is FFT and Swept Sweep Type is manually selected.</li> <li>• Marker Count is ON.</li> </ul> <p>The following are unavailable whenever Gate is on:</p> <ul style="list-style-type: none"> <li>• FFT under Sweep Type when Method=LO or Video or Swept under Sweep Type when Method=FFT</li> <li>• Marker Count</li> </ul> <p>While Gate is on, the Auto Rules for Sweep Type are modified so that the choice agrees with the Gate Method: i.e., FFT for Method = FFT and Swept for Method = LO or Video.</p> <p>The Gate softkey and all SCPI under the [:SENSe]:SWEep:EGATe SCPI node are grayed out when Source Mode is Tracking with an external source. This is because the Gate circuitry is used to sync the external source. If the Tracking Source is turned on, the Gate is turned off.</p> <p>When in the ACP measurement:</p> <ul style="list-style-type: none"> <li>• When Meas Method is RBW or FAST, this function is unavailable and the key is grayed out.</li> <li>• Whenever Gate is on, Meas Method, RBW or FAST is unavailable and keys for those are grayed out.</li> <li>• When Gate is on, Offset Res BW and Offset Video BW are ignored (if you set these values) and the measurement works as if all Offset Res BW and all Offset Video BW are coupled with the Res BW and the Video BW under the BW menu. When Gate is on, the Offset BW key in the Offset/Limit menu is grayed out.</li> </ul>
Preset	Off LTETDD: On
State Saved	Saved in instrument state
Range	On Off
Backwards Compatibility SCPI	[ :SENSe ] :SWEep:TIME:GATE[:STATe] ESA compatibility
Backwards Compatibility Notes	In ESA, Trig Delay (On) and Gate (On) could not be active at the same time.. This dependency does not exist in PSA or in the X-Series.
Initial S/W Revision	Prior to A.02.00

## Gate View On/Off

Turning on Gate View in the Swept SA measurement provides a single-window gate view display..

Turning on Gate View in other measurements shows the split-screen Gate View. In these measurements, when the Gate View is on, the regular view of the current measurement traces and results are reduced vertically to about 70% of the regular height. The Zero Span window, showing the positions of the Gate, is shown between the Measurement Bar and the reduced measurement window. By reducing the height of the measurement window, some of the annotation on the Data Display may not fit and is not shown.

<b>Key Path</b>	Sweep/Control, Gate
<b>Remote Command</b>	[ :SENSe ] :SWEep:EGATe:VIEW ON OFF 1 0 [ :SENSe ] :SWEep:EGATe:VIEW?
<b>Example</b>	SWE:EGAT:VIEW ON turns on the gate view.
<b>Dependencies</b>	In the Swept SA measurement: In Gate View, the regular Sweep Time key is grayed out . When pressed, the grayed out key puts up the informational message "Use Gate View Sweep Time in the Gate menu." In the other measurements: When you turn Gate View on, the lower window takes on the current state of the instrument. Upon leaving Gate View, the instrument takes on the state of the lower window. When you turn Gate View on, the upper window Sweep Time is set to the gate view sweep time.
<b>Couplings</b>	These couplings apply to the Swept SA measurement: <ul style="list-style-type: none"> <li>• When Gate View is turned on, the instrument is set to Zero Span.</li> <li>• Gate View automatically turns off whenever a Span other than Zero is selected.</li> <li>• Gate View automatically turns off if you press the Last Span key while in Gate View, and the instrument returns to the Span it was in before entering Gate View (even if that is Zero Span).</li> <li>• When Gate View is turned on, the sweep time used is the gate view sweep time. This is set according to the rules in section "<a href="#">Gate View Setup</a>" on page 2725</li> <li>• When Gate View is turned off, Sweep Time is set to the normal Swept SA measurement sweep time.</li> <li>• If Gate View is on and Gate is off, then turning on Gate turns off Gate View.</li> </ul>
<b>Preset</b>	OFF
<b>State Saved</b>	Saved in instrument state
<b>Range</b>	On Off
<b>Initial S/W Revision</b>	Prior to A.02.00

A sample of the Gate View screen in the Swept SA measurement is shown in the following graphic :

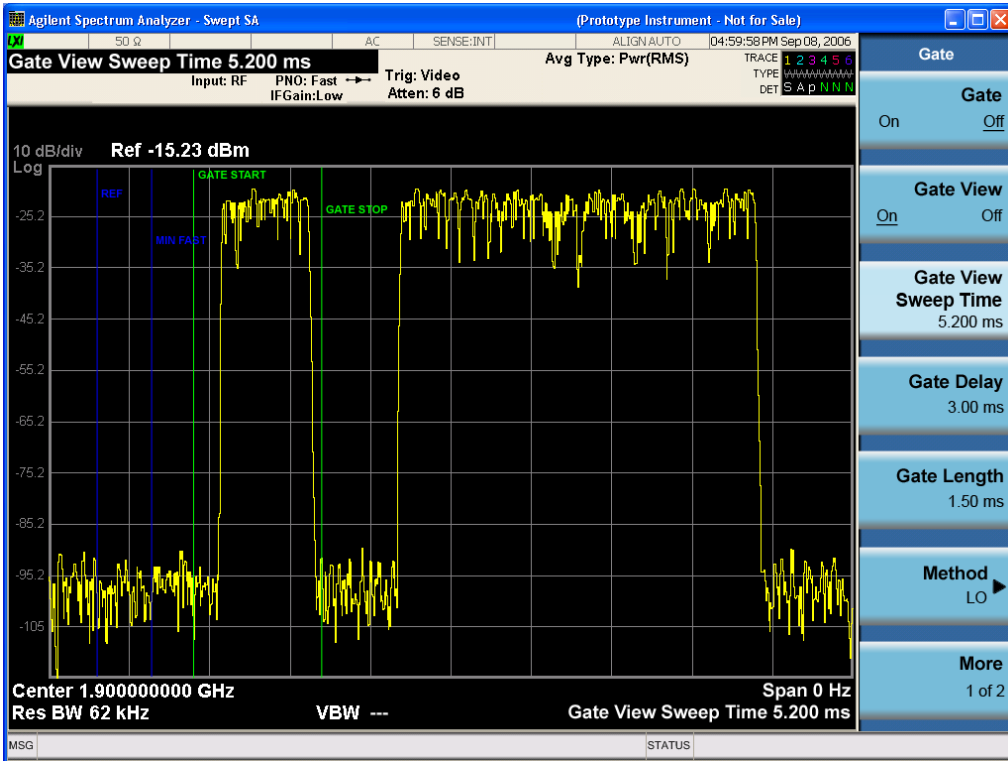

A sample of the Gate View screen in other measurements is shown in the following graphic. This example is for the ACP measurement:

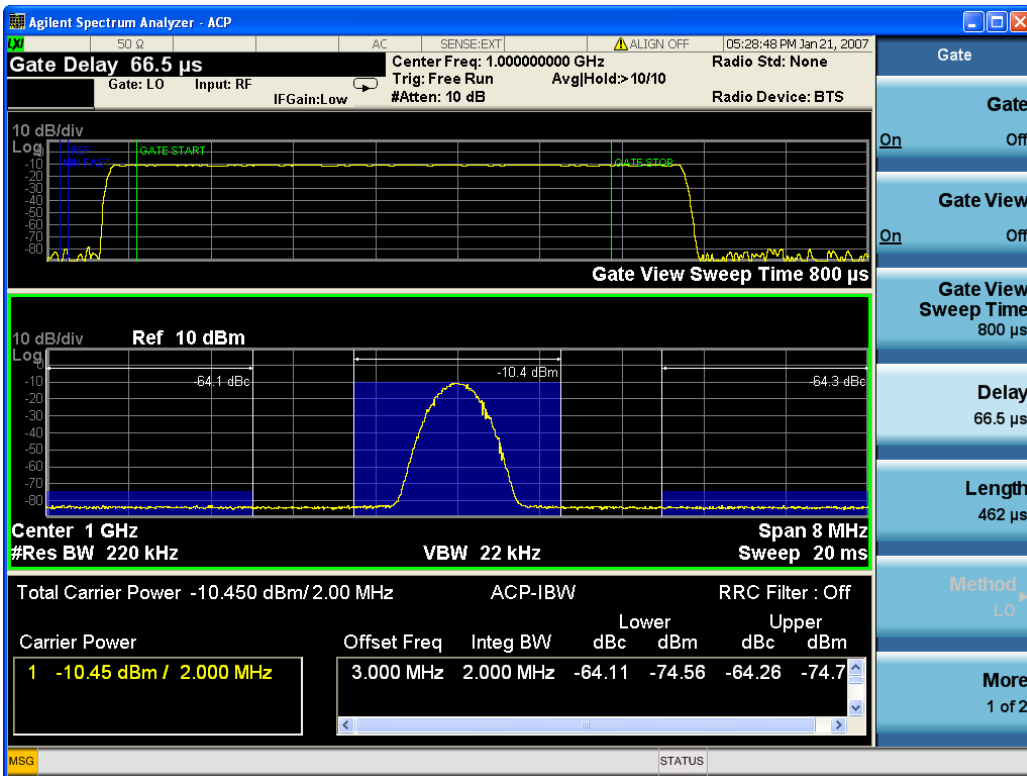

Turning Gate View off returns the analyzer to the Normal measurement view.

In the Swept SA, the normal measurement view is the single-window Swept SA view. When returning to this view, the Swept SA measurement returns to the Span it was in before entering **Gate View** (even if that is Zero Span).

The **Gate View** window is triggered from the Gate Source, with zero trigger delay. Also, when updating the **Gate View** window, the Gate itself must not operate. So it is internally shut off while the gate view window is being updated. For the Swept SA measurement, this means that the Gate is internally shut off whenever the gate view window is displayed. The measurement bar and softkeys continue to show the Trigger source for the main sweep window and give no indication that the Gate is shut off or that the Gate View window is triggered from the Gate Source.

When in **Gate View**, vertical lines are displayed in the Gate View window as follows:

- Green lines are displayed at the gate edges as follows: in Edge Gate, a line is shown for Delay and one for the end of the Gate period, defined by Length. In Level Gate a line is shown only for Delay. You can adjust the position of the green lines by adjusting the gate length and the gate delay. These lines update in the Gate View window as the active function changes, even if the window is not being updated. In Gated LO and Gated Video, these lines are positioned relative to the delay reference line (not relative to 0 time). In Gated FFT, their location is relative to the left edge of the screen.
- A blue line is displayed showing the delay reference, that is, the reference point for the Gate Delay within the Zero Span window. The blue line represents where (in time) the effective location of the gate start would be if the gate were programmed to zero delay.
- 
- The second blue line is labeled "MIN FAST" as shown in the figure above because it represents the minimum Gate Delay for fast Gated LO operation. This line is only displayed in Gated LO. You cannot scroll (knob) or decrement (down key) the Gate Delay to less than that represented by the position of this line, it can only be set below this position manually, although once there it can be moved freely with the knob while below the line.
- A yellow line in the Gated Video case only, is displayed at Blength, where Blength is the display point (bucket) length for the swept trace, which is given by the sweep time for that trace divided by number of Points - 1. So it is referenced to 0 time, not to the delay reference. This line is labeled NEXT PT (it is not shown in the figure above because the figure above is for Gated LO).
- The yellow line represents the edge of a display point (bucket). Normally in Gated Video, the bucket length must be selected so that it exceeds the off time of the burst. There is another way to use the analyzer in Gated Video measurements, and that is to set the bucket width much shorter than the off time of the burst. Then use the Max Hold trace function to fill in "missing" buckets more slowly. This allows you to see some of the patterns of the Gated Video results earlier, though seeing a completely filled-in spectrum later.

## Gate View Setup

Accesses a menu that enables you to setup parameters relevant to the Gate View

Key Path	Sweep/Control, Gate
Scope	Meas Global
Initial S/W Revision	A.10.00

## Gate View Sweep Time

Controls the sweep time in the Gate View window. To provide an optimal view of the gate signal, the analyzer initializes Gate View Sweep Time based on the current settings of Gate Delay and Gate Length.

Key Path	Sweep/Control, Gate, Gate View Setup
Remote Command	[ :SENSe ] :SWEep:EGATe:TIME <time> [ :SENSe ] :SWEep:EGATe:TIME?
Example	SWE:EGAT:TIME 500 ms
Dependencies	Gate View Sweep Time is initialized: <ul style="list-style-type: none"> <li>• On Preset (after initializing delay and length).</li> <li>• Every time the Gate Method is set/changed.</li> </ul> <p>Additionally, in the Swept SA measurement, whenever you do a Preset, or leave Gate View, the analyzer remembers the Gate Delay and Gate Length settings. Then, when returning to Gate View, if the current Gate Delay and/or Gate Length do not match the remembered values Gate View Sweep Time is re-initialized.</p> <ol style="list-style-type: none"> <li>1. Compute the location of the "gate stop" line, which you know is at time <math>t = t_{min} + \text{GateDelay} + \text{GateLength}</math>.</li> </ol>
Preset	519.3 $\mu$ s WiMAX OFDMA: 5 ms GSM/EDGE: 1 ms
State Saved	Saved in instrument state
Max	6000 s
Initial S/W Revision	Prior to A.02.00

## Gate View Start Time

Controls the time at the left edge of the Gate View.

Key Path	Sweep/Control, Gate, Gate View Setup
Remote Command	[ :SENSe ] :SWEep:EGATe:VIEW:STARt <time> [ :SENSe ] :SWEep:EGATe:VIEW:STARt?
Example	SWE:EGAT:VIEW:STAR 10ms
Notes	Units of time are required or no units; otherwise an invalid suffix error message will be generated. See error -131.
Preset	0 ms
State Saved	Saved in instrument state
Min	0
Max	500 ms
Initial S/W Revision	A.10.00

## Gate Delay

Controls the length of time from the time the gate condition goes True until the gate is turned on.

Key Path	Sweep/Control, Gate
Remote Command	[ :SENSe ] :SWEep:EGATe:DELay <time> [ :SENSe ] :SWEep:EGATe:DELay?
Example	SWE:EGAT:DELay 500ms SWE:EGAT:DELay?
Notes	Units of time are required or no units; otherwise an invalid suffix error message will be generated.
Preset	57.7 us WiMAX OFDMA: 71 us GSM/EDGE: 600 us WLAN: 500 us
State Saved	Saved in instrument state
Min	0.0 us
Max	100 s
Backwards Compatibility SCPI	[ :SENSe ] :SWEep:TIME:GATE:DELay ESA compatibility
Initial S/W Revision	Prior to A.02.00

## Gate Length

Controls the length of time that the gate is on after it opens.

Key Path	Sweep/Control, Gate
Remote Command	[ :SENSe ] :SWEep:EGATe:LENGth <time> [ :SENSe ] :SWEep:EGATe:LENGth?
Example	SWE:EGAT:LENG 1 SWE:EGAT:LENG?
Notes	Units of time are required or no units; otherwise an invalid suffix error message will be generated.
Dependencies	<p>Grayed out when Gate Method is set to FFT in which case the label changes to that shown below.</p>  <p>The key is also grayed out if Gate Control = Level.</p>
Preset	461.6 us

	WiMAX OFDMA: 50 us GSM/EDGE: 200 us WLAN: 1.54 ms
State Saved	Saved in instrument state
Min	100 ns
Max	5 s
<b>Backwards Compatibility SCPI</b>	[:SENSe]:SWEep:TIME:GATE:LENGth ESA compatibility
Initial S/W Revision	Prior to A.02.00

## Gate Source

The menus under the Gate Source key are the same as those under the Trigger key, with the exception that neither Free Run nor Video are available as Gate Source selections. However, a different SCPI command is used to select the Gate Source (see table below) because you may independently set the Gate Source and the Trigger Source.

Any changes to the settings in the setup menus under each Gate Source selection key (for example: Trigger Level, Trigger Delay, etc.) also affect the corresponding settings under the Trigger menu keys. The SCPI commands used for these are the same for Trigger and Gate, since there is only one setting which affects both Gate and Trigger. Example: to set the Trigger Level for External 1 you use the command :TRIG:EXT1:LEV regardless of whether you are using External 1 as a Trigger Source or a Gate Source.

Key Path	Sweep/Control, Gate
<b>Remote Command</b>	[:SENSe]:SWEep:EGATe:SOURce EXTernal1   EXTernal2   LINE   FRAME   RFBurst  [:SENSe]:SWEep:EGATe:SOURce?
Dependencies	In some models, there is no second External input. In these models, the External 2 key is blanked and the EXTernal2 parameter will generate a "Hardware missing; Not available for this model number" error.
Preset	EXTernal 1 GSM/EDGE, MSR: FRAME LTETDD: EXTernal 1When Direction is Downlink, FRAME when Direction is Uplink.
Backwards Compatibility Notes	In ESA, there is a single Gate input port. In PSA, the Gate Source may be taken from one of two specified input ports. In the X-Series, any Trigger Source can be a Gate Source.
Initial S/W Revision	Prior to A.02.00
Modified at S/W Revision	A.03.00, A.14.00

## Line

Pressing this key, when it is not selected, selects the line signal as the trigger. A new sweep/measurement will start synchronized with the next cycle of the line voltage. Pressing this key, when it is already selected, access the line trigger setup menu.

Key Path	Trigger
<b>Example</b>	TRIG:SOUR LINE Swept SA measurement TRIG:<meas>:SOUR LINE Measurements other than Swept SA
Dependencies	Line trigger is not available when operating from a "dc power source", for example, when the instrument is powered from batteries.
State Saved	Saved in instrument state
Status Bits/OPC dependencies	The Status Operation Register bit 5 "Waiting for Trigger" is set at the same time as the Sweeping or Measuring bit is set. It is cleared when the trigger actually occurs (that is, after the trigger event occurs and all the applicable trigger criteria have been met). A corresponding pop-up message ("Waiting for trigger") is generated if no trigger signal appears after approximately 2 sec. This message goes away when a trigger signal appears.
Initial S/W Revision	Prior to A.02.00

## Trig Slope

Controls the trigger polarity. It is set positive to trigger on a rising edge and negative to trigger on a falling edge.

Key Path	Trigger, Line
<b>Remote Command</b>	:TRIGger[:SEquence]:LINE:SLOPe POSitive NEGative :TRIGger[:SEquence]:LINE:SLOPe?
<b>Example</b>	TRIG:LINE:SLOP NEG
Preset	POSitive
State Saved	Saved in instrument state
Backwards Compatibility Notes	The legacy :TRIGger[:SEquence]:SLOPe command affects the slopes for the VID, LINE, EXT1, EXT2, and RFB triggers.
Initial S/W Revision	Prior to A.02.00

## External 1

Pressing this key, when it is not selected, selects an external input signal as the trigger. A new sweep/measurement will start when the external trigger condition is met using the external 1 input connector on the rear panel.

Pressing this key, when it is already selected, accesses the external 1 trigger setup menu.



Key Path	Trigger
<b>Example</b>	TRIG:SOUR EXT1 Swept SA measurement TRIG:<meas>:SOUR EXT1 Measurements other than Swept SA
Dependencies	Grayed out if in use by Point Trigger in the Source Setup menu. Forced to Free Run if already selected and Point Trigger is set to External 1.
State Saved	Saved in instrument state
Status Bits/OPC dependencies	The Status Operation Register bit 5 "Waiting for Trigger" is set at the same time as the Sweeping or Measuring bit is set. It is cleared when the trigger actually occurs (that is, after the trigger event occurs and all the applicable trigger criteria have been met). A corresponding pop-up message ("Waiting for trigger") is generated if no trigger signal appears after approximately 2 sec. This message goes away when a trigger signal appears.
Initial S/W Revision	Prior to A.02.00

### Trigger Level

Sets the value where the external 1 trigger input will trigger a new sweep/measurement.

Key Path	Trigger, External 1
<b>Remote Command</b>	:TRIGger[:SEquence]:EXTernal1:LEVel <level> :TRIGger[:SEquence]:EXTernal1:LEVel?
<b>Example</b>	TRIG:EXT1:LEV 0.4 V
Couplings	This same level is used for the Ext1 trigger source in the Trigger menu, for the Ext1 selection in the Periodic Timer sync source (in the Trigger menu and in the Gate Source menu), and also for the Ext1 selection in the Gate Source menu.
Preset	1.2 V
State Saved	Saved in instrument state
Min	-5 V
Max	5 V
Default Unit	V
<b>Backwards Compatibility SCPI</b>	:TRIGger[:SEquence]:EXTernal:LEVel For backward compatibility, the parameter EXTernal is mapped to EXTernal1
<b>Backwards Compatibility SCPI</b>	:TRIGger[:SEquence]:FRAME:EXTernal1:LEVel
Initial S/W Revision	Prior to A.02.00

### Trig Slope

Controls the trigger polarity. It is set positive to trigger on a rising edge and negative to trigger on a falling edge.

Key Path	Trigger, External 1
Remote Command	:TRIGger[:SEquence]:EXTErnal1:SLOPe POSitive NEGative :TRIGger[:SEquence]:EXTErnal1:SLOPe?
Example	TRIG:EXT1:SLOP NEG
Couplings	This same slope is used in the Ext1 selection for the trigger source in the Trigger menu and for the period timer sync source (in the Trigger menu and in the Gate Source menu).
Preset	POSitive
State Saved	Saved in instrument state
Backwards Compatibility SCPI	:TRIGger[:SEquence]:EXTErnal:SLOPe For backward compatibility, the parameter EXTErnal is mapped to EXTErnal1
Backwards Compatibility SCPI	:TRIGger[:SEquence]:FRAMe:EXTErnal1:SLOPe
Backwards Compatibility Notes	The legacy :TRIGger[:SEquence]:SLOPe command affects the slopes for the VID, LINE, EXT1, EXT2, and RFB triggers.
Initial S/W Revision	Prior to A.02.00

## External 2

Pressing this key, when it is not selected, selects an external input signal as the trigger. A new sweep/measurement will start when the external trigger condition is met using the external 2 input connector. The external trigger 2 input connector is on the rear panel.

Pressing this key, when it is already selected, accesses the external 2 trigger setup menu.

Key Path	Trigger
Example	TRIG:SOUR EXT2 Swept SA measurement TRIG:<meas>:SOUR EXT2 Measurements other than Swept SA
Dependencies	In some models, there is no second External input. In these models, the External 2 key is blanked and the EXTErnal2 parameter will generate a "Hardware missing; Not available for this model number" message.  Grayed out if in use by Point Trigger in the Source Setup menu. Forced to Free Run if already selected and Point Trigger is set to External 2.
State Saved	Saved in instrument state
Status Bits/OPC dependencies	The Status Operation Register bit 5 "Waiting for Trigger" is set at the same time as the Sweeping or Measuring bit is set. It is cleared when the trigger actually occurs (that is, after the trigger event occurs and all the applicable trigger criteria have been met). A corresponding pop-up message ("Waiting for trigger") is generated if no trigger signal appears after approximately 2 sec. This message goes away when a trigger signal appears.
Initial S/W Revision	Prior to A.02.00
Modified at S/W Revision	A.03.00

## Trigger Level

Sets the value where the external 2 trigger input will trigger a new sweep/measurement.

Key Path	Trigger, External 2
<b>Remote Command</b>	:TRIGger[:SEquence]:EXTernal2:LEVel :TRIGger[:SEquence]:EXTernal2:LEVel?
<b>Example</b>	TRIG:EXT2:LEV 1.1 V
Couplings	This same level is used for the Ext2 trigger source in the Trigger menu, for the Ext2 selection in the Periodic Timer sync source (in the Trigger menu and in the Gate Source menu), and also for the Ext2 selection in the Gate Source menu.
Preset	1.2 V
State Saved	Saved in instrument state
Min	-5 V
Max	5 V
Default Unit	V
<b>Backwards Compatibility SCPI</b>	:TRIGger[:SEquence]:FRAMe:EXTernal2:LEVel
Initial S/W Revision	Prior to A.02.00

## Trig Slope

Controls the trigger polarity. It is set positive to trigger on a rising edge and negative to trigger on a falling edge.

Key Path	Trigger, External 2
<b>Remote Command</b>	:TRIGger[:SEquence]:EXTernal2:SLOPe POSitive NEGative :TRIGger[:SEquence]:EXTernal2:SLOPe?
<b>Example</b>	TRIG:EXT2:SLOP NEG
Couplings	This same slope is used in the Ext2 selection for the trigger source in the Trigger menu and for the period timer sync source (in the Trigger menu and in the Gate Source menu).
Preset	POSitive
State Saved	Saved in instrument state
<b>Backwards Compatibility SCPI</b>	:TRIGger[:SEquence]:FRAMe:EXTernal2:SLOPe
Backwards Compatibility Notes	The legacy :TRIGger[:SEquence]:SLOPe command affects the slopes for the VID, LINE, EXT1, EXT2, and RFB triggers.
Initial S/W Revision	Prior to A.02.00

## RF Burst

Pressing this key, when it is not selected, selects the RF Burst as the trigger. A new sweep/measurement will start when an RF burst envelope signal is identified from the signal at the RF Input connector. Pressing this key, when it is already selected, accesses the RF Burst trigger setup menu.

In some models, a variety of burst trigger circuitry is available, resulting in various available burst trigger bandwidths. The analyzer automatically chooses the appropriate trigger path based on the hardware configuration and other settings of the analyzer.

Key Path	Trigger
<b>Example</b>	TRIG:SOUR RFB Swept SA measurement TRIG:< meas>:SOUR RFB Measurements other than Swept SA
State Saved	Saved in instrument state
Status Bits/OPC dependencies	The Status Operation Register bit 5 "Waiting for Trigger" is set at the same time as the Sweeping or Measuring bit is set. It is cleared when the trigger actually occurs (that is, after the trigger event occurs and all the applicable trigger criteria have been met). A corresponding pop-up message ("Waiting for trigger") is generated if no trigger signal appears after approximately 2 sec. This message goes away when a trigger signal appears.
Backwards Compatibility Notes	The legacy command: :TRIGger[:SEQuence]:RFBurst:FSElectivity[:STATe] OFF ON 0 1 is not supported in the X-Series, as the hardware to do Frequency Selective burst triggers does not exist in X-Series.
Initial S/W Revision	Prior to A.02.00
Modified at S/W Revision	A.04.00

## Absolute Trigger Level

Sets the absolute trigger level for the RF burst envelope.

When using the External Mixing path, the Absolute Trigger Level is uncalibrated because the factory default was set to accommodate the expected IF levels for the RF path.

Key Path	Trigger, RF Burst
Scope	Meas Global
<b>Remote Command</b>	:TRIGger[:SEQuence]:RFBurst:LEVel:ABSolute <ampl> :TRIGger[:SEQuence]:RFBurst:LEVel:ABSolute?
<b>Example</b>	TRIG:RFB:LEV:ABS 10 dBm sets the trigger level of the RF burst envelope signal to the absolute level of 10 dBm
Notes	Sending this command does not switch the setting from relative to absolute; to switch it you need to send the :TRIGger[:SEQuence]:RFBurst:LEVel:TYPE command, below. Amplitude Corrections are not taken into account by the Absolute Trigger Level. For example, if you have given yourself effective gain with an amplitude correction factor, the Absolute Trigger will not fire until you have set the trigger level that far below the displayed signal level, rather than simply to

	the displayed signal level. This is only true for Amplitude Corrections, not External Gain or Ref Level Offset functions. If mode is Bluetooth, the default value is -50 dBm.
Couplings	This same level is used for the RF Burst trigger source in the Trigger menu, for the RF Burst selection in the Periodic Timer sync source (in the Trigger menu and in the Gate Source menu), and also for the RF Burst selection in the Gate Source menu
Preset	-20 dBm
State Saved	Saved in instrument state
Min	-200 dBm
Max	100 dBm
Default Unit	depends on the current selected Y-Axis unit
<b>Backwards Compatibility SCPI</b>	:TRIGger[:SEquence]:FRAMe:RFBurst:LEVel:ABSolute
Initial S/W Revision	Prior to A.02.00
Modified at S/W Revision	A.04.00

Key Path	Trigger, RF Burst
<b>Remote Command</b>	:TRIGger[:SEquence]:RFBurst:LEVel:TYPE ABSolute RELative :TRIGger[:SEquence]:RFBurst:LEVel:TYPE?
<b>Example</b>	TRIG:RFB:LEV:TYPE REL sets the trigger level type of the RF burst trigger to Relative.
Preset	ABSolute
State Saved	Saved in instrument state
Initial S/W Revision	Prior to A.02.00
Modified at S/W Revision	A.04.00

### Relative Trigger Level

Sets the relative trigger level for the RF burst envelope.

In some models, the relative burst trigger function is implemented in hardware. In other models, without the advanced triggering hardware required, the relative burst trigger function is implemented in software in some measurements, and is unavailable in other measurements.

When implemented in software, the relative RF Burst trigger function is implemented as follows:

1. The measurement starts with the absolute RF Burst trigger setting. If it cannot get a trigger with that level, auto trigger fires and the acquisition starts anyway. After the acquisition, the measurement searches for the peak in the acquired waveform and saves it.

2. Now, in the next cycle of the measurement, the measurement determines a new absolute RF Burst level based on the peak value from the first measurement and the Relative RF Burst Trigger Level (always 0 or negative dB) set by the user. The following formula is used:
  3. absolute RF Burst level = peak level of the previous acquisition + relative RF Burst level
  4. If the new absolute RF Burst level differs from the previous by more than 0.5 dB, the new level is sent to the hardware; otherwise it is not updated (to avoid slowing down the acquisition)
- Steps 2 and 3 repeat for subsequent measurements.

Key Path	Trigger, RF Burst
Scope	Meas Global
<b>Remote Command</b>	:TRIGger[:SEquence]:RFBurst:LEVel:RELative <rel_ampl> :TRIGger[:SEquence]:RFBurst:LEVel:RELative?
<b>Example</b>	TRIG:RFB:LEV:REL -10 dB sets the trigger level of the RF burst envelope signal to the relative level of -10 dB
Notes	Sending this command does not switch the setting from absolute to relative; to switch it you need to send the :TRIGger[:SEquence]:RFBurst:LEVel:TYPE command, above. The relative trigger level is not available in some measurements. In those measurements the RELative parameter, and the :TRIGger[:SEquence]:RFBurst:LEVel:TYPE command (above), will generate an error if sent.
Dependencies	This key is grayed out and Absolute Trigger Level selected if the required hardware is not present in your analyzer and the current measurement does not support Relative triggering.
Preset	-6 dB GSM: -25 dB
State Saved	Saved in instrument state
Min	-45 dB
Max	0 dB
Default Unit	dB or dBc
<b>Backwards Compatibility SCPI</b>	:TRIGger[:SEquence]:RFBurst:LEVel This legacy command is aliased to :TRIGger[:SEquence]:RFBurst:LEVel:RELative because the PSA had ONLY relative burst triggering
Initial S/W Revision	Prior to A.02.00
Modified at S/W Revision	A.04.00

### Trigger Slope

It is set positive to trigger on a rising edge and negative to trigger on a falling edge.

Key Path	Trigger, RF Burst
<b>Remote Command</b>	:TRIGger[:SEquence]:RFBurst:SLOPe POSitive NEGative :TRIGger[:SEquence]:RFBurst:SLOPe?

<b>Example</b>	TRIG:RFB:SLOP NEG
Couplings	This same slope is used in the RF Burst selection for the trigger source in the Trigger menu and for the period timer sync source (in the Trigger menu and in the Gate Source menu).
Preset	POSitive
State Saved	Saved in instrument state
<b>Backwards Compatibility SCPI</b>	:TRIGger[:SEQuence]:FRAMe:RFBurst:SLOPe
Backwards Compatibility Notes	The legacy :TRIGger[:SEQuence]:SLOPe command affects the slopes for the VID, LINE, EXT1, EXT2, and RFB triggers.
Initial S/W Revision	Prior to A.02.00

### Periodic Timer (Frame Trigger)

Pressing this key, when it is not selected, selects the internal periodic timer signal as the trigger. Triggering occurrences are set by the **Period** parameter, which is modified by the **Sync Source** and **Offset**. Pressing this key, when it is already selected, accesses the periodic timer trigger setup functions.

If you do not have a sync source selected (it is Off), then the internal timer will not be synchronized with any external timing events.

Key Path	Trigger
<b>Example</b>	TRIG:SOUR FRAM                      Swept SA measurement TRIG:<meas>:SOUR FRAM      Measurements other than Swept SA
State Saved	Saved in instrument state
Readback	[Sync: <value of Sync Source>], for example, [Sync: External 1]
Status Bits/OPC dependencies	The Status Operation Register bit 5 "Waiting for Trigger" is set at the same time as the Sweeping or Measuring bit is set. It is cleared when the trigger actually occurs (that is, after the trigger event occurs and all the applicable trigger criteria have been met). A corresponding pop-up message ("Waiting for trigger") is generated if no trigger signal appears after approximately 2 sec. This message goes away when a trigger signal appears.
Initial S/W Revision	Prior to A.02.00

### Periodic Timer Triggering:

This feature selects the internal periodic timer signal as the trigger. Trigger occurrences are set by the **Periodic Timer** parameter, which is modified by the **Sync Source** and **Offset**.

The figure below shows the action of the periodic timer trigger. Before reviewing the figure, we'll explain some uses for the periodic trigger.

A common application is measuring periodic burst RF signals for which a trigger signal is not easily available. For example, we might be measuring a TDMA radio which bursts every 20 ms. Let's assume that the 20 ms period is very consistent. Let's also assume that we do not have an external trigger source

available that is synchronized with the period, and that the signal-to-noise ratio of the signal is not high enough to provide a clean RF burst trigger at all of the analysis frequencies. For example, we might want to measure spurious transmissions at an offset from the carrier that is larger than the bandwidth of the RF burst trigger. In this application, we can set the Periodic Timer to a 20.00 ms period and adjust the offset from that timer to position our trigger just where we want it. If we find that the 20.00 ms is not exactly right, we can adjust the period slightly to minimize the drift between the period timer and the signal to be measured.

A second way to use this feature would be to use **Sync Source** temporarily, instead of **Offset**. In this case, we might tune to the signal in a narrow span and use the RF Burst trigger to synchronize the periodic timer. Then we would turn the sync source off so that it would not miss-trigger. Miss-triggering can occur when we are tuned so far away from the RF burst trigger that it is no longer reliable.

A third example would be to synchronize to a signal that has a reference time element of much longer period than the period of interest. In some CDMA applications, it is useful to look at signals with a short periodicity, by synchronizing that periodicity to the "even-second clock" edge that happens every two seconds. Thus, we could connect the even-second clock trigger to Ext1 and use then Ext1 as the sync source for the periodic timer.

The figure below illustrates this third example. The top trace represents the even-second clock. It causes the periodic timer to synchronize with the leading edge shown. The analyzer trigger occurs at a time delayed by the accumulated offset from the period trigger event. The periodic timer continues to run, and triggers continue to occur, with a periodicity determined by the analyzer time base. The timer output (labeled "late event") will drift away from its ideal time due to imperfect matching between the time base of the signal being measured and the time base of the analyzer, and also because of imperfect setting of the period parameter. But the synchronization is restored on the next even-second clock event. ("Accumulated offset" is described in the in the **Offset** function section.)

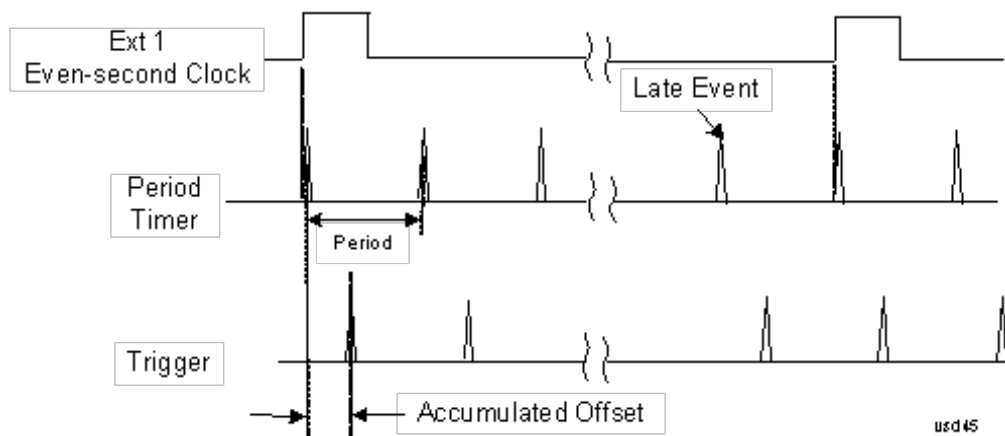

### Period

Sets the period of the internal periodic timer clock. For digital communications signals, this is usually set to the frame period of your current input signal. In the case that sync source is not set to OFF, and the external sync source rate is changed for some reason, the periodic timer is synchronized at the every external synchronization pulse by resetting the internal state of the timer circuit.

<b>Key Path</b>	Trigger, Periodic Timer
<b>Remote Command</b>	:TRIGger[:SEquence]:FRAME:PERiod <time>



	:TRIGger[:SEquence]:FRAMe:PERiod?
<b>Example</b>	TRIG:FRAM:PER 100 ms
Dependencies	The invalid data indicator turns on when the period is changed, until the next sweep/measurement completes.
Couplings	The same period is used in the Gate Source selection of the period timer.
Preset	20 ms GSM: 4.615383
State Saved	Saved in instrument state
Min	100.000 ns
Max	559.0000 ms
Default Unit	S
Initial S/W Revision	Prior to A.02.00

### Offset

Adjusts the accumulated offset between the periodic timer events and the trigger event. Adjusting the accumulated offset is different than setting an offset, and requires explanation.

The periodic timer is usually not synchronized with any external events, so the timing of its output events has no absolute meaning. Since the timing relative to external events (RF signals) is important, you need to be able to adjust (offset) it. However, you have no direct way to see when the periodic timer events occur. All that you can see is the trigger timing. When you want to adjust the trigger timing, you will be changing the internal offset between the periodic timer events and the trigger event. Because the absolute value of that internal offset is unknown, we will just call that the accumulated offset. Whenever the Offset parameter is changed, you are changing that accumulated offset. You can reset the displayed offset using Reset Offset Display. Changing the display does not change the value of the accumulated offset, and you can still make additional changes to accumulated offset.

To avoid ambiguity, we define that an increase in the "offset" parameter, either from the knob or the SCPI adjust command, serves to delay the timing of the trigger event.

Key Path	Trigger, Periodic Timer
<b>Remote Command</b>	:TRIGger[:SEquence]:FRAMe:OFFSet <time> :TRIGger[:SEquence]:FRAMe:OFFSet?
<b>Example</b>	TRIG:FRAM:OFFS 1.2 ms
Notes	The front panel interface (for example, the knob), and this command, adjust the accumulated offset, which is shown on the active function display. However, the actual amount sent to the hardware each time the offset is updated is the delta value, that is, the current accumulated offset value minus the previous accumulated offset value. Note that the accumulated offset value is essentially arbitrary; it represents the accumulated offset from the last time the offset was zeroed (with the Reset Offset Display key).  Note that this command does not change the period of the trigger waveform. Note also that Offset is used only when the sync source is set to OFF, otherwise delay is used, see section " <a href="#">Trig Delay</a> " on <a href="#">page 461</a> .

	An increase in the "offset" parameter, either from the knob or the SCPI adjust command, serves to delay the timing of the trigger event.
Notes	When the SCPI command is sent the value shown on the key (and the Active Function, if this happens to be the active function) is updated with the new value. However, the actual amount sent to the hardware is the delta value, that is, the current accumulated offset value minus the previous accumulated offset value.  The SCPI query simply returns the value currently showing on the key.
Dependencies	The invalid data indicator turns on when the offset is changed, until the next sweep/measurement completes.
Couplings	The same offset is used in the Gate Source selection of the period timer.
Preset	0 s
State Saved	Saved in instrument state
Min	-10.000 s
Max	10.000 s
Default Unit	S
Initial S/W Revision	Prior to A.02.00

#### Offset Adjust (Remote Command Only)

This remote command does not work at all like the related front panel keys. This command lets you advance the phase of the frame trigger by the amount you specify.

It does not change the period of the trigger waveform. If the command is sent multiple times, it advances the phase of the frame trigger an additional amount each time it is sent. Negative numbers are permitted.

<b>Remote Command</b>	:TRIGger[:SEquence]:FRAMe:ADJust <time>
<b>Example</b>	TRIG:FRAM:ADJ 1.2 ms
Notes	Note also that Offset is used only when the sync source is set to OFF, otherwise delay is used, see section " <a href="#">Trig Delay</a> " on page 461  An increase in the "offset" parameter, either from the knob or the SCPI adjust command, serves to delay the timing of the trigger event.
Notes	The front panel interface (for example, the knob) and the :TRIG:FRAM:OFFS command adjust the accumulated offset, which is shown on the active function display. However, the actual amount sent to the hardware is the delta value, that is, the current offset value minus the previous offset value.  When the SCPI command is sent the value shown on the key (and the Active Function, if this happens to be the active function) is updated by increasing it (or decreasing it if the value sent is negative) by the amount specified in the SCPI command.  This is a "command only" SCPI command, with no query.
Dependencies	The invalid data indicator turns on when the offset is changed, until the next sweep/measurement completes.
Couplings	The same offset is used in the Gate Source selection of the period timer.
Preset	0 s

State Saved	Saved in instrument state
Min	-10.000 s
Max	10.000 s
Default Unit	S
Initial S/W Revision	Prior to A.02.00

### Reset Offset Display

Resets the value of the periodic trigger offset display setting to 0.0 seconds. The current displayed trigger location may include an offset value defined with the Offset key. Pressing this key redefines the currently displayed trigger location as the new trigger point that is 0.0 s offset. The Offset key can then be used to add offset relative to this new timing.

Key Path	Trigger, Periodic Timer
<b>Remote Command</b>	:TRIGger[:SEquence]:FRAMe:OFFSet:DISPlay:RESet
<b>Example</b>	TRIG:FRAM:OFFS:DISP:RES
Initial S/W Revision	Prior to A.02.00

### Sync Source

Selects a signal source for you to synchronize your periodic timer trigger to, otherwise you are triggering at some arbitrary location in the frame. Synchronization reduces the precision requirements on the setting of the period.

For convenience you may adjust the level and slope of the selected sync source in a conditional branch setup menu accessed from the Sync Source menu. Note that these settings match those in the **Trigger** and **Gate Source** menus; that is, each trigger source has only one value of level and slope, regardless of which menu it is accessed from.

Key Path	Trigger, Periodic Timer
<b>Remote Command</b>	:TRIGger[:SEquence]:FRAMe:SYNC EXTernal1   EXTernal2   RFBurst   OFF :TRIGger[:SEquence]:FRAMe:SYNC?
<b>Example</b>	TRIG:FRAM:SYNC EXT2
Dependencies	In some models, there is no second External input. In these models, the External 2 key is blanked and the EXTernal2 parameter will generate a "Hardware missing; Not available for this model number" message.
Preset	Off GSM/EDGE, MSR,LTE,LTETDD: RFBurst
State Saved	Saved in instrument state
Readback	The current setting is read back to this key and it is also Readback to the previous Periodic Timer trigger key.

<b>Backwards Compatibility SCPI</b>	:TRIGger[:SEquence]:FRAMe:SYNC EXTernal
Initial S/W Revision	Prior to A.02.00
Modified at S/W Revision	A.03.00, A.14.00

### Off

Turns off the sync source for your periodic trigger. With the sync source off, the timing will drift unless the signal source frequency is locked to the analyzer frequency reference.

<b>Key Path</b>	Trigger, Periodic Timer, Sync Source
<b>Example</b>	TRIG:FRAM:SYNC OFF
Readback	Off
Initial S/W Revision	Prior to A.02.00

### External 1

Pressing this key, when it is not selected, selects an external input signal as the trigger. A new sweep/measurement will start when the external trigger condition is met using the external 1 input connector on the rear panel.

Pressing this key, when it is already selected, accesses the external 1 trigger setup menu.

<b>Key Path</b>	Trigger
<b>Example</b>	TRIG:SOUR EXT1 Swept SA measurement TRIG:<meas>:SOUR EXT1 Measurements other than Swept SA
<b>Dependencies</b>	Grayed out if in use by Point Trigger in the Source Setup menu. Forced to Free Run if already selected and Point Trigger is set to External 1.
<b>State Saved</b>	Saved in instrument state
<b>Status Bits/OPC dependencies</b>	The Status Operation Register bit 5 "Waiting for Trigger" is set at the same time as the Sweeping or Measuring bit is set. It is cleared when the trigger actually occurs (that is, after the trigger event occurs and all the applicable trigger criteria have been met). A corresponding pop-up message ("Waiting for trigger") is generated if no trigger signal appears after approximately 2 sec. This message goes away when a trigger signal appears.
Initial S/W Revision	Prior to A.02.00

### Trigger Level

Sets the value where the external 1 trigger input will trigger a new sweep/measurement.

Key Path	Trigger, External 1
<b>Remote Command</b>	:TRIGger[:SEquence]:EXTernal1:LEVel <level> :TRIGger[:SEquence]:EXTernal1:LEVel?
<b>Example</b>	TRIG:EXT1:LEV 0.4 V
Couplings	This same level is used for the Ext1 trigger source in the Trigger menu, for the Ext1 selection in the Periodic Timer sync source (in the Trigger menu and in the Gate Source menu), and also for the Ext1 selection in the Gate Source menu.
Preset	1.2 V
State Saved	Saved in instrument state
Min	-5 V
Max	5 V
Default Unit	V
<b>Backwards Compatibility SCPI</b>	:TRIGger[:SEquence]:EXTernal:LEVel For backward compatibility, the parameter EXTernal is mapped to EXTernal1
<b>Backwards Compatibility SCPI</b>	:TRIGger[:SEquence]:FRAMe:EXTernal1:LEVel
Initial S/W Revision	Prior to A.02.00

### Trig Slope

Controls the trigger polarity. It is set positive to trigger on a rising edge and negative to trigger on a falling edge.

Key Path	Trigger, External 1
<b>Remote Command</b>	:TRIGger[:SEquence]:EXTernal1:SLOPe POSitive NEGative :TRIGger[:SEquence]:EXTernal1:SLOPe?
<b>Example</b>	TRIG:EXT1:SLOP NEG
Couplings	This same slope is used in the Ext1 selection for the trigger source in the Trigger menu and for the period timer sync source (in the Trigger menu and in the Gate Source menu).
Preset	POSitive
State Saved	Saved in instrument state
<b>Backwards Compatibility SCPI</b>	:TRIGger[:SEquence]:EXTernal:SLOPe For backward compatibility, the parameter EXTernal is mapped to EXTernal1
<b>Backwards Compatibility SCPI</b>	:TRIGger[:SEquence]:FRAMe:EXTernal1:SLOPe
Backwards Compatibility Notes	The legacy :TRIGger[:SEquence]:SLOPe command affects the slopes for the VID, LINE, EXT1, EXT2, and RFB triggers.
Initial S/W Revision	Prior to A.02.00

## External 2

Pressing this key, when it is not selected, selects an external input signal as the trigger. A new sweep/measurement will start when the external trigger condition is met using the external 2 input connector. The external trigger 2 input connector is on the rear panel.

Pressing this key, when it is already selected, accesses the external 2 trigger setup menu.

Key Path	Trigger
<b>Example</b>	TRIG:SOUR EXT2 Swept SA measurement TRIG:<meas>:SOUR EXT2 Measurements other than Swept SA
Dependencies	In some models, there is no second External input. In these models, the External 2 key is blanked and the EXTERNAL2 parameter will generate a "Hardware missing; Not available for this model number" message. Grayed out if in use by Point Trigger in the Source Setup menu. Forced to Free Run if already selected and Point Trigger is set to External 2.
State Saved	Saved in instrument state
Status Bits/OPC dependencies	The Status Operation Register bit 5 "Waiting for Trigger" is set at the same time as the Sweeping or Measuring bit is set. It is cleared when the trigger actually occurs (that is, after the trigger event occurs and all the applicable trigger criteria have been met). A corresponding pop-up message ("Waiting for trigger") is generated if no trigger signal appears after approximately 2 sec. This message goes away when a trigger signal appears.
Initial S/W Revision	Prior to A.02.00
Modified at S/W Revision	A.03.00

## Trigger Level

Sets the value where the external 2 trigger input will trigger a new sweep/measurement.

Key Path	Trigger, External 2
<b>Remote Command</b>	:TRIGger[:SEquence]:EXTernal2:LEVel :TRIGger[:SEquence]:EXTernal2:LEVel?
<b>Example</b>	TRIG:EXT2:LEV 1.1 V
Couplings	This same level is used for the Ext2 trigger source in the Trigger menu, for the Ext2 selection in the Periodic Timer sync source (in the Trigger menu and in the Gate Source menu), and also for the Ext2 selection in the Gate Source menu.
Preset	1.2 V
State Saved	Saved in instrument state
Min	-5 V
Max	5 V
Default Unit	V
<b>Backwards Compatibility SCPI</b>	:TRIGger[:SEquence]:FRAME:EXTernal2:LEVel
Initial S/W Revision	Prior to A.02.00

## Trig Slope

Controls the trigger polarity. It is set positive to trigger on a rising edge and negative to trigger on a falling edge.

Key Path	Trigger, External 2
<b>Remote Command</b>	:TRIGger[:SEquence]:EXTernal2:SLOPe POSitive NEGative :TRIGger[:SEquence]:EXTernal2:SLOPe?
<b>Example</b>	TRIG:EXT2:SLOP NEG
Couplings	This same slope is used in the Ext2 selection for the trigger source in the Trigger menu and for the period timer sync source (in the Trigger menu and in the Gate Source menu).
Preset	POSitive
State Saved	Saved in instrument state
<b>Backwards Compatibility SCPI</b>	:TRIGger[:SEquence]:FRAMe:EXTernal2:SLOPe
Backwards Compatibility Notes	The legacy :TRIGger[:SEquence]:SLOPe command affects the slopes for the VID, LINE, EXT1, EXT2, and RFB triggers.
Initial S/W Revision	Prior to A.02.00

## RF Burst

Pressing this key, when it is not selected, selects the RF Burst as the trigger. A new sweep/measurement will start when an RF burst envelope signal is identified from the signal at the RF Input connector. Pressing this key, when it is already selected, accesses the RF Burst trigger setup menu.

In some models, a variety of burst trigger circuitry is available, resulting in various available burst trigger bandwidths. The analyzer automatically chooses the appropriate trigger path based on the hardware configuration and other settings of the analyzer.

Key Path	Trigger
<b>Example</b>	TRIG:SOUR RFB      Swept SA measurement TRIG:<meas>:SOUR RFB    Measurements other than Swept SA
State Saved	Saved in instrument state
Status Bits/OPC dependencies	The Status Operation Register bit 5 "Waiting for Trigger" is set at the same time as the Sweeping or Measuring bit is set. It is cleared when the trigger actually occurs (that is, after the trigger event occurs and all the applicable trigger criteria have been met). A corresponding pop-up message ("Waiting for trigger") is generated if no trigger signal appears after approximately 2 sec. This message goes away when a trigger signal appears.
Backwards Compatibility Notes	The legacy command: :TRIGger[:SEquence]:RFBurst:FSElectivity[:STATe] OFF ON 0 1 is not supported in the X-Series, as the hardware to do Frequency Selective burst triggers does not exist in X-Series.

Initial S/W Revision	Prior to A.02.00
Modified at S/W Revision	A.04.00

### Absolute Trigger Level

Sets the absolute trigger level for the RF burst envelope.

When using the External Mixing path, the Absolute Trigger Level is uncalibrated because the factory default was set to accommodate the expected IF levels for the RF path.

Key Path	Trigger, RF Burst
Scope	Meas Global
<b>Remote Command</b>	:TRIGger[:SEquence]:RFBurst:LEVel:ABSolute <ampl> :TRIGger[:SEquence]:RFBurst:LEVel:ABSolute?
<b>Example</b>	TRIG:RFB:LEV:ABS 10 dBm sets the trigger level of the RF burst envelope signal to the absolute level of 10 dBm
Notes	Sending this command does not switch the setting from relative to absolute; to switch it you need to send the :TRIGger[:SEquence]:RFBurst:LEVel:TYPE command, below.  Amplitude Corrections are not taken into account by the Absolute Trigger Level. For example, if you have given yourself effective gain with an amplitude correction factor, the Absolute Trigger will not fire until you have set the trigger level that far below the displayed signal level, rather than simply to the displayed signal level. This is only true for Amplitude Corrections, not External Gain or Ref Level Offset functions.  If mode is Bluetooth, the default value is -50 dBm.
Couplings	This same level is used for the RF Burst trigger source in the Trigger menu, for the RF Burst selection in the Periodic Timer sync source (in the Trigger menu and in the Gate Source menu), and also for the RF Burst selection in the Gate Source menu
Preset	-20 dBm
State Saved	Saved in instrument state
Min	-200 dBm
Max	100 dBm
Default Unit	depends on the current selected Y-Axis unit
<b>Backwards Compatibility SCPI</b>	:TRIGger[:SEquence]:FRAME:RFBurst:LEVel:ABSolute
Initial S/W Revision	Prior to A.02.00
Modified at S/W Revision	A.04.00

Key Path	Trigger, RF Burst
<b>Remote Command</b>	:TRIGger[:SEquence]:RFBurst:LEVel:TYPE ABSolute RELative :TRIGger[:SEquence]:RFBurst:LEVel:TYPE?



<b>Example</b>	TRIG:RFB:LEV:TYPE REL sets the trigger level type of the RF burst trigger to Relative.
Preset	ABSolute
State Saved	Saved in instrument state
Initial S/W Revision	Prior to A.02.00
Modified at S/W Revision	A.04.00

### Trigger Slope

It is set positive to trigger on a rising edge and negative to trigger on a falling edge.

Key Path	Trigger, RF Burst
<b>Remote Command</b>	:TRIGger[:SEQuence]:RFBurst:SLOPe POSitive NEGative :TRIGger[:SEQuence]:RFBurst:SLOPe?
<b>Example</b>	TRIG:RFB:SLOP NEG
Couplings	This same slope is used in the RF Burst selection for the trigger source in the Trigger menu and for the period timer sync source (in the Trigger menu and in the Gate Source menu).
Preset	POSitive
State Saved	Saved in instrument state
<b>Backwards Compatibility SCPI</b>	:TRIGger[:SEQuence]:FRAME:RFBurst:SLOPe
Backwards Compatibility Notes	The legacy :TRIGger[:SEQuence]:SLOPe command affects the slopes for the VID, LINE, EXT1, EXT2, and RFB triggers.
Initial S/W Revision	Prior to A.02.00

### Sync Holdoff

Sync Holdoff specifies the duration that the sync source signal must be kept false before the transition to true to be recognized as the sync timing. The periodic timer phase is aligned when the sync source signal becomes true, after the Holdoff time is satisfied.

A holdoff of 2 ms will work with most WiMAX signals, but there may be cases where the burst off duration is less than 1 ms and this value will need to be changed.

Key Path	Trigger, Periodic Timer
<b>Remote Command</b>	:TRIGger[:SEQuence]:FRAME:SYNC:HOLDoff <time> :TRIGger[:SEQuence]:FRAME:SYNC:HOLDoff? :TRIGger[:SEQuence]:FRAME:SYNC:HOLDoff:STATe OFF ON 0 1 :TRIGger[:SEQuence]:FRAME:SYNC:HOLDoff:STATe?
Preset	On, 1.000 ms

State Saved	Saved in instrument state
Min	0 ms
Max	+500 ms
Default Unit	s
Initial S/W Revision	Prior to A.02.00

## Control Edge/Level

Sets the method of controlling the gating function from the gating signal.

### Edge

In Edge triggering, the gate opens (after the Delay) on the selected edge (for example, positive) of the gate signal and closes on the alternate edge (for example, negative).

### Level

In Level triggering, the gate opens (after the Delay) when the gate signal has achieved a certain level and stays open as long as that level is maintained.

Key Path	Sweep/Control, Gate
Remote Command	[ :SENSe] :SWEep:EGATe:CONTRol EDGE LEVeL [ :SENSe] :SWEep:EGATe:CONTRol?
Example	SWE:EGAT:CONT EDGE
Dependencies	If the Gate Method is FFT the Control key is grayed out and Edge is selected. If the Gate Source is TV, Frame or Line, the Control key is grayed out and Edge is selected.
Preset	EDGE
State Saved	Saved in instrument state
Backwards Compatibility SCPI	[:SENSe]:SWEep:TIME:GATE:TYPE ESA Compatibility
Initial S/W Revision	Prior to A.02.00

## Gate Holdoff

Lets you increase or decrease the wait time after a gate event ends before the analyzer will respond to the next gate signal.

After any Gate event finishes, the analyzer must wait for the sweep system to settle before it can respond to another Gate signal. The analyzer calculates a "wait time," taking into account a number of factors, including RBW and Phase Noise Optimization settings. The goal is to achieve the same accuracy when gated as in ungated operation. The figure below illustrates this concept:

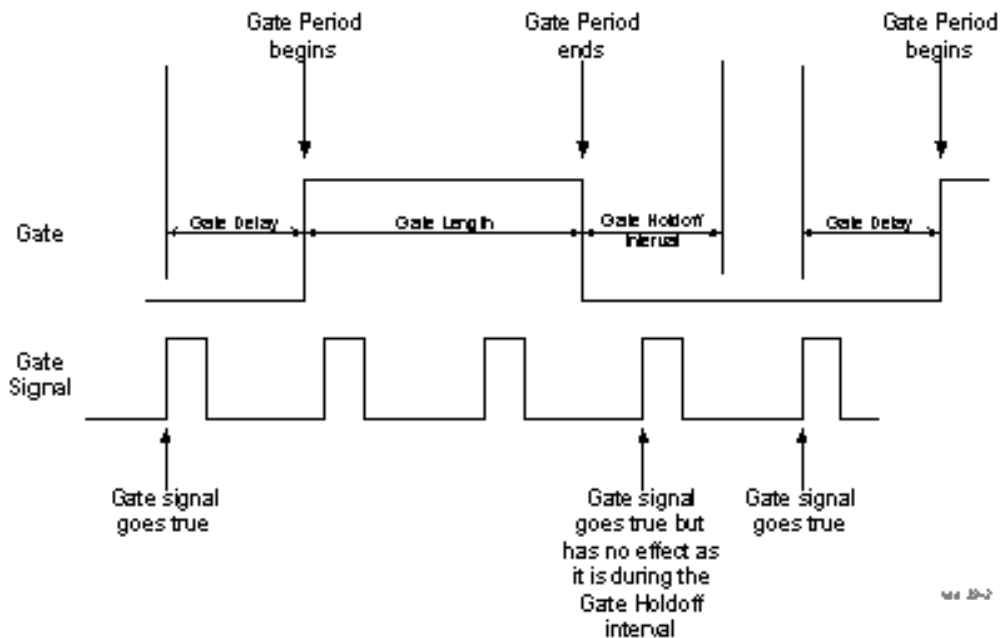

When Gate Holdoff is in Auto, the wait time calculated by the analyzer is used. When Gate Time is in Manual, the user may adjust the wait time, usually decreasing it in order to achieve greater speed, but at the risk of decreasing accuracy.

When the Method key is set to Video or FFT, the Gate Holdoff function has no effect.

In measurements that do not support Auto, the value shown when Auto is selected is “---” and the manually set holdoff is returned to a query.

Key Path	Sweep/Control, Gate
<b>Remote Command</b>	<pre>[ :SENSe ] :SWEep:EGATe:HOLDoff &lt;time&gt; [ :SENSe ] :SWEep:EGATe:HOLDoff? [ :SENSe ] :SWEep:EGATe:HOLDoff:AUTO OFF ON 0 1 [ :SENSe ] :SWEep:EGATe:HOLDoff:AUTO?</pre>
<b>Example</b>	<pre>SWE:EGAT:HOLD 0.0002 SWE:EGAT:HOLD? SWE:EGAT:HOLD:AUTO ON SWE:EGAT:HOLD:AUTO?</pre>
<b>Couplings</b>	<p>When Gate Holdoff is Auto, the Gate Holdoff key shows the value calculated by the analyzer for the wait time.</p> <p>Pressing the Gate Holdoff key while it is in Auto and not selected, causes the key to become selected and allows the user to adjust the value. If the value is adjusted, the setting changes to Man.</p> <p>Pressing the Gate Holdoff key, while it is in Auto and selected, does not change the value of Gate Holdoff, but causes the setting to change to Man. Now the user can adjust the value.</p> <p>Pressing the key while it is in Man and selected, cause the value to change back to Auto.</p> <p>Pressing the key while it is in Man and not selected, causes the key to become selected and allows the user to adjust the value.</p>

	When Method is set to Video or FFT, the Gate Holdoff function has no effect.
Preset	Auto Auto/On
State Saved	Saved in instrument state
Min	1 µsec
Max	1 sec
Initial S/W Revision	Prior to A.02.00

## Gate Delay Compensation

This function allows you to select an RBW-dependent value by which to adjust the gate delay, to compensate for changes in the delay caused by RBW effects.

You can select between uncompensated operation and two types of compensation, Delay Until RBW Settled and Compensate for RBW Group Delay.

See "[More Information](#)" on page 617

Key Path	Sweep/Control, Gate
Scope	Meas Global
Remote Command	[ :SENSe ] :SWEep:EGATe:DELay:COMPensation:TYPE OFF   SETTled   GDELay [ :SENSe ] :SWEep:EGATe:DELay:COMPensation:TYPE?
Example	SWE:EGAT:DEL:COMP:TYPE SETT SWE:EGAT:DEL:COMP:TYPE?
Notes	Although this function is Meas Global, there are some measurements that do not support this function. In those measurements the operation will be Uncompensated. Going into one of those measurements will not change the Meas Global selection; it will simply display the grayed-out menu key with "Uncompensated" showing as the selection. This is a non-forceful grayout, so the SCPI command is still accepted.  If Gate Delay Compensation is not supported at all within a particular mode, the key is not displayed, and if the SCPI command is sent while in a measurement within that mode, an "Undefined Header" message is generated.  Measurements that do not support this function include: Swept SA
Preset	TD-SCDMA mode: Compensate for RBW Group Delay All other modes: Delay Until RBW Settled
State Saved	Saved in instrument state
Range	Uncompensated Delay Until RBW Settled Compensate for RBW Group Delay
Readback text	Uncompensated Settled Group Delay
Initial S/W Revision	Prior to A.02.00
Modified at S/W Revision	A.11.0

## More Information

Selecting Uncompensated means that the actual gate delay is as you sets it.

Selecting Delay Until RBW Settled causes the gate delay to be increased above the user setting by an amount equal to  $3.06/\text{RBW}$ . This compensated delay causes the GATE START and GATE STOP lines on the display to move by the compensation amount, and the actual hardware gate delay to be increased by the same amount. All the other gate lines (for example, MIN FAST) are unaffected. If the RBW subsequently changes, the compensation is readjusted for the new RBW. The value shown on the Gate Delay key does NOT change.

Delay Until RBW Settled allows excellent measurements of gated signals, by allowing the IF to settle following any transient that affects the burst. Excellent measurements also require that the analysis region not extend into the region affected by the falling edge of the burst. Thus, excellent measurements can only be made over a width that declines with narrowing RBWs, which is achieved by decreasing the gate length below the user setting by an amount equal to  $2.53/\text{RBW}$ . Therefore, for general purpose compensation, you will still want to change the gate length with changes in RBW even if the gate delay is compensated. The compensated Gate Length is limited by the analyzer so that it will never go below 10% of the value shown on the Gate Length key, as otherwise the sweep times could get very long. Anytime the Gate Length and RBW values combine in such a way that this limiting takes place, a warning is displayed. For measurements which contain multiple sweeps with different RBW like SEM and SPUR, the smallest RBW is used for this limiting.

Selecting Compensate for RBW Group Delay causes the gate delay to be increased above the user setting by an amount equal to  $1.81/\text{RBW}$ . This compensated delay causes the GATE START, GATE STOP lines on the display to move by the compensation amount, and the actual hardware gate delay to be increased by the same amount. All the other gate lines (for example, MIN FAST) are unaffected. If the RBW subsequently changes, the compensation is readjusted for the new RBW. The value shown on the Gate Delay key does NOT change. Compensate for RBW Group Delay also includes gate length compensation; the gate length itself is adjusted as necessary to attempt to compensate for delay effects imposed by the RBW.

Compensate for RBW Group Delay is similar to Delay Until RBW Settled, but compensates for the group delay of the RBW filter, rather than the filter settling time. As the RBW gets narrow, this can allow the settling tail of the RBW to affect the beginning part of the gated measurement, and allow the beginning of the RBW settling transient to affect the end of the gated measurement. These two effects are symmetric because the RBW response is symmetric. Because the gate length is not automatically compensated, some users might find this compensation to be more intuitive than compensation for RBW settling.

## Min Fast Position Query (Remote Command Only)

This command queries the position of the MIN FAST line, relative to the delay reference (REF) line. See section "[Gate View On/Off](#)" on page 2722. If this query is sent while not in gate view, the MinFast calculation is performed based on the current values of the appropriate parameters and the result is returned. Knowing this value lets you set an optimal gate delay value for the current measurement setup.

<b>Remote Command</b>	[ :SENSe ] :SWEep:EGATe:MINFast?
<b>Example</b>	SWE:EGAT:MIN?
<b>Initial S/W Revision</b>	Prior to A.02.00

### Gate Preset (Remote Command Only)

Presets the time-gated spectrum analysis capability.

This command sets gate parameter values to the ESA preset values, as follows:

Gate trigger type = edge

Gate polarity = positive

Gate delay = 1 us

Gate length = 1 us

<b>Remote Command</b>	<code>[:SENSe]:SWEep:TIME:GATE:PRESet</code> ESA Compatibility
Initial S/W Revision	Prior to A.02.00

### Gate Level (Remote Command Only)

Sets the gate input transition point level for the external TRIGGER inputs on the front and rear panel. This is a legacy command for PSA compatibility. It is simply an alias to the equivalent trigger level command.

<b>Remote Command</b>	<code>[:SENSe]:SWEep:EGATE:EXTErnal[1] 2:LEVel &lt;voltage&gt;</code> <code>[:SENSe]:SWEep:EGATE:EXTErnal[1] 2:LEVel?</code>
Notes	This command is simply an alias to <code>:TRIGger[:SEQuence]:EXTErnal[1] 2:LEVel</code> For details refer
Initial S/W Revision	Prior to A.02.00

### Gate Polarity (Remote Command Only)

Sets the polarity for the gate signal. This setup is now done using the gate trigger's slope setting.

When Positive (Pos) is selected, a positive-going edge (Edge) or a high voltage (Level) will satisfy the gate condition, after the delay set with the Gate Delay key. When Negative (Neg) is selected, a negative-going edge (Edge) or a low voltage (Level) will satisfy the gate condition after the delay.

<b>Remote Command</b>	<code>[:SENSe]:SWEep:EGATE:POLarity</code> NEGative POSitive <code>[:SENSe]:SWEep:EGATE:POLarity?</code>
<b>Example</b>	<code>SWE:EGAT:POL</code> NEG <code>SWE:EGAT:POL?</code>
Preset	POSitive
State Saved	Saved in instrument state
<b>Backwards Compatibility SCPI</b>	<code>[:SENSe]:SWEep:TIME:GATE:POLarity</code> ESA compatibility
Initial S/W Revision	Prior to A.02.00

<b>Remote Command</b>	[ :SENSe ] :SWEep:TIME:GATE:LEVel HIGH LOW [ :SENSe ] :SWEep:TIME:GATE:LEVel? ESA compatibility
Preset	HIGH
Initial S/W Revision	Prior to A.02.00

## Points

Sets the number of points per sweep. The resolution of setting the sweep time depends on the number of points selected. If Preset is selected, the number of points per sweep defaults to 1001. The current value of points is displayed parenthetically, next to the sweep time in the lower-right corner of the display.

Changing the number of points has several effects on the analyzer. Since markers are read at the point location, the marker reading may change. All trace data is cleared.

Key Path	Sweep/Control
Mode	SA, WCDMA, C2K, WIMAX OFDMA, 1xEVDO, DVB-T/H, DTMB (CTTB), ISDB-T, CMMB, LTE, LTE-TDD, Digital Cable TV, WLAN, MSR, LTEAFDD, LTEATDD
<b>Remote Command</b>	[ :SENSe ] :CHPower:SWEep:POINts <integer> [ :SENSe ] :CHPower:SWEep:POINts?
<b>Example</b>	CHP:SWE:POIN 501 CHP:SWE:POIN?
Notes	Whenever the number of sweep points changes: All trace data is erased Any traces with Update Off also go to Display Off (like going from View to Blank in the older analyzers) Sweep time is re-quantized Any limit lines that are on are updated If averaging/hold is on, averaging/hold starts over
Couplings	Whenever the number of sweep points changes, the sweep time is re-quantized.
Preset	DVB-T/H: 2001 DTMB (CTTB): 2001 Other: 1001 ISDB-T: 2001 CMMB: 2001 1xEVDO: 512 Digital Cable TV: 2001
State Saved	Saved in instrument state.
Min	101

8 Channel Power Measurement  
Sweep/Control

Max	20001
Initial S/W Revision	Prior to A.02.00
Modified at S/W Revision	A.02.00, A.03.00



## System

See "System" on page 359

## Trace/Detector

Accesses a menu of functions that enable you to control the detectors for the current measurement.

Key Path	Front-panel key
Initial S/W Revision	Prior to A.02.00

### Trace Type

Allows you to select the type of trace you want to use for the current measurement. The first page of this menu contains a 1-of-N selection of the trace type (Clear Write, Average, Max Hold, Min Hold) for the selected trace.

Key Path	Trace/Detector
Mode	SA, WCDMA, C2K, WIMAX OFDMA, 1xEVDO, DVB-T/H, DTMB (CTTB), ISDB-T, CMMB, LTE, LTETDD, Digital Cable TV, WLAN, MSR, LTEAFDD, LTEATDD
Remote Command	:TRACe:CHPower:TYPE WRITe AVERAge MAXHold MINHold :TRACe:CHPower:TYPE?
Example	TRAC:CHP:TYPE WRIT TRAC:CHP:TYPE?
Notes	WRITe = Clear Write AVERAge = Average MAXHold = Maximum Hold MINHold = Minimum Hold
Couplings	When Detector setting is "Auto" (:SENSe]:CHPower:DETEctor:AUTO?), Detector (:SENSe]:CHPower:DETEctor[:FUNCTION]?) switches aligning with the switch of this parameter: "NORMal" with WRITe (Clear Write), "AVERAge" with AVERAge, "POSitive (peak)" with MAXHold, and "NEGative (peak)" with MINHold.
Preset	AVERAge
State Saved	Saved in instrument state.
Range	ClearWrite Average MaxHold MinHold
Initial S/W Revision	Prior to A.02.00
Modified at S/W Revision	A.02.00, A.03.00

### Detector

Accesses a menu of functions that enable you to control the detectors for the current measurement. The following choices are available:

- Auto– the detector selected depends on marker functions, trace functions, average type, and the trace averaging function.

- Normal—the detector determines the peak of the CW-like signals, and it yields alternating maximums and minimums of noise-like signals. This is also referred to as Rosenfell detection.
- Average—the detector determines the average of the signal within the sweep points. The averaging method depends upon the Average Type selection (voltage, power or log scales).
- Peak—the detector determines the maximum of the signal within the sweep points.
- Sample—the detector indicates the instantaneous level of the signal at the center of the sweep points represented by each display point.
- Negative Peak—the detector determines the minimum of the signal within the sweep points.

Key Path	Detector
Initial S/W Revision	Prior to A.02.00

## Auto

Sets the detector for the currently selected trace to Auto.

Key Path	Trace/Detector
Mode	SA, WCDMA, C2K, WIMAX OFDMA, 1xEVDO, DVB-T/H, DTMB (CTTB), ISDB-T, CMMB, LTE, LTE-TDD, Digital Cable TV, WLAN, MSR, LTEAFDD, LTEATDD
<b>Remote Command</b>	<code>[[:SENSe]:CHPower:DETECTOR:AUTO ON OFF 1 0</code> <code>[[:SENSe]:CHPower:DETECTOR:AUTO?</code>
<b>Example</b>	CHP:DET:AUTO ON CHP:DET:AUTO?
Couplings	When Detector setting is “Auto” ( <code>[[:SENSe]:CHPower:DETECTOR:AUTO?</code> ), Detector ( <code>[[:SENSe]:CHPower:DETECTOR[:FUNCTION]?</code> ) switches aligning with the switch of this parameter: “NORMal” with Clear Write, “AVERage” with AVERage, “POSitive (peak)” with MAXHold, and “NEGative (peak)” with MINHold.
Preset	Others: ON DVB-T/H, DTMB (CTTB), ISDB-T, CMMB, Digital Cable TV: OFF
State Saved	Saved in instrument state.
Initial S/W Revision	Prior to A.02.00
Modified at S/W Revision	A.02.00, A.03.00

## Detector Selection

Selects a detector to be used by the analyzer for the current measurement.

Key Path	Trace/Detector
Mode	SA, WCDMA, C2K, WIMAX OFDMA, 1xEVDO, DVB-T/H, DTMB (CTTB), ISDB-T, CMMB, LTE, LTE-TDD, Digital Cable TV, WLAN, MSR, LTEAFDD, LTEATDD

<b>Remote Command</b>	<code>[[:SENSe]:CHPower:DETEctor[:FUNction] NORMal   AVERage   POSitive   SAMPlE   NEGative [:SENSe]:CHPower:DETEctor[:FUNction]?</code>
<b>Example</b>	CHP:DET NORM CHP:DET?
<b>Notes</b>	<p>When you manually select a detector (instead of selecting Auto), that detector is used regardless of other analyzer settings.</p> <p>The Normal detector determines the peak of CW-like signals, and it yields alternating maximums and minimums of noise-like signals. This method of detection is also referred to as Rosenfell detection.</p> <p>The Average detector determines the average of the signal within the sweep points. The averaging method is Power Average (RMS).</p> <p>The Peak detector determines the maximum of the signal within the sweep points.</p> <p>The Sample detector indicates the instantaneous level of the signal at the center of the sweep points represented by each display point.</p> <p>The Negative Peak detector determines the minimum of the signal within the sweep points.</p>
<b>Couplings</b>	When Detector setting is "Auto" ( <code>[[:SENSe]:CHPower:DETEctor:AUTO?</code> ), Detector ( <code>[[:SENSe]:CHPower:DETEctor[:FUNction]?</code> ) switches aligning with the switch of this parameter: "NORMal" with Clear Write, "AVERage" with AVERage, "POSitive (peak)" with MAXHold, and "NEGative (peak)" with MINHold.
<b>Preset</b>	AVERage
<b>State Saved</b>	Saved in instrument state.
<b>Range</b>	Normal Average Peak Sample Negative Peak
<b>Initial S/W Revision</b>	Prior to A.02.00
<b>Modified at S/W Revision</b>	A.02.00, A.03.00

## Trigger

See ["Trigger" on page 430](#)

### Free Run

See ["Free Run " on page 437](#)

### Video

See ["Video \(IF Envelope\) " on page 438](#)

### Trigger Level

See ["Trigger Level " on page 438](#)

### Trig Slope

See ["Trig Slope " on page 439](#)

### Trig Delay

See ["Trig Delay " on page 440](#)

### Line

See ["Line " on page 2729](#)

### Trig Slope

See ["Trig Slope " on page 2729](#)

### Trig Delay

See ["Trig Delay " on page 442](#)

### External 1

See ["External 1 " on page 2741](#)

### Trigger Level

See ["Trigger Level " on page 2741](#)

### Trig Slope

See ["Trig Slope " on page 2742](#)

### Trig Delay

See ["Trig Delay " on page 445](#)

### External 2

See ["External 2 " on page 2743](#)

### **Trigger Level**

See "[Trigger Level](#) " on page 2743

### **Trig Slope**

See "[Trig Slope](#) " on page 2744

### **Trig Delay**

See "[Trig Delay](#) " on page 447

### **RF Burst**

See "[RF Burst](#) " on page 2744

### **Absolute Trigger**

See "[Absolute Trigger Level](#)" on page 2745

### **Relative Trigger**

See "[Relative Trigger Level](#)" on page 2734

### **Trig Slope**

See "[Trigger Slope](#) " on page 2746

### **Trig Delay**

See "[Trig Delay](#) " on page 451

### **Periodic Timer**

See "[Periodic Timer \(Frame Trigger\)](#) " on page 2736

### **Period**

See "[Period](#) " on page 2737

### **Offset**

See "[Offset](#) " on page 2738

### **Reset Offset Display**

See "[Reset Offset Display](#) " on page 2740

### **Sync Source**

See "[Sync Source](#) " on page 2740

### **Off**

See "[Off](#) " on page 2741

## External 1

See "External 1 " on page 2741

### Trigger Level

See "Trigger Level " on page 2741

### Trig Slope

See "Trig Slope " on page 2742

## External 2

See "External 2 " on page 2743

### Trigger Level

See "Trigger Level " on page 2743

### Trig Slope

See "Trig Slope " on page 2744

## RF Burst

See "RF Burst " on page 2744

## Absolute Trigger

See "Absolute Trigger Level" on page 2745

### Trig Slope

See "Trigger Slope " on page 2746

## Trig Delay

See "Trig Delay" on page 461

## Auto/Holdoff

See "Auto/Holdoff " on page 462

## Auto Trig

See "Auto Trig " on page 462

## Trig Holdoff

See "Trig Holdoff " on page 463

## User Preset

Accesses a menu that gives you the following three choices:

- User Preset – recalls a state previously saved using the Save User Preset function.
- User Preset All Modes – presets all of the modes in the analyzer
- Save User Preset– saves the current state for the current mode

Key Path	Front-panel key
Backwards Compatibility Notes	<p>User Preset is actually loading a state, and in legacy analyzers, it was possible to load a state without affecting the trace data, limit lines or correction data. Similarly it was possible to do a User Preset without affecting the trace data, limit lines or correction data.</p> <p>In the X-Series, “state” always includes all of this data; so whenever state is loaded, or User Preset is executed, all of the traces, limit lines and corrections are affected. Although this differs from previous behavior, it is desirable behavior, and should not cause adverse issues for users.</p> <p>On ESA and PSA, User Preset affected the entire instrument’s state. In the X-Series, User Preset only recalls the state for the active mode. There is a User Preset file for each mode. User Preset can never cause a mode switch as it can in legacy analyzers. If you want to recall all modes to their user preset file state, you will need to do a User Preset after mode switching into each mode.</p> <p>User Preset recalls mode state which can now include data like traces; whereas on ESA and PSA, User Preset did not affect data.</p>
Initial S/W Revision	Prior to A.02.00

## User Preset

User Preset sets the state of the currently active mode back to the state that was previously saved for this mode using the Save User Preset menu key or the SCPI command, SYST:PRES:USER:SAV. It not only recalls the Mode Preset settings, but it also recalls all of the mode persistent settings, and the Input/Output system setting that existed at the time Save User Preset was executed.

If a Save User Preset has not been done at any time, User Preset recalls the default user preset file for the currently active mode. The default user preset files are created if, at power-on, a mode detects there is no user preset file. There will never be a scenario when there is no user preset file to restore. For each mode, the default user preset state is the same state that would be saved if a Save User Preset is performed in each mode right after doing a Restore Mode Default and after a Restore Input/Output Defaults.

The User Preset function does the following:

- Aborts the currently running measurement.
- Sets the mode State to the values defined by Save User Preset.
- Makes the saved measurement for the currently running mode the active measurement.
- Brings up the saved menu for the power-on mode.
- Clears the input and output buffers.
- Sets the Status Byte to 0.



Key Path	User Preset
<b>Remote Command</b>	:SYSTem:PRESet:USER
<b>Example</b>	:SYST:PRES:USER:SAVE:SYST:PRES:USER
Notes	:SYST:PRES:USER:SAVE is used to save the current state as the user preset state. Clears all pending OPC bits. The Status Byte is set to 0. Pressing the User Preset front-panel key while already in the User Preset menu will cause the User Preset to get executed
Couplings	A user preset will cause the currently running measurement to be aborted and cause the saved measurement to be active. Recalling a User Preset file has the same issues that recalling a Save State file has. Some settings may need to be limited and therefore re-coupled, since the capabilities of the mode may have changes when the User Preset file was last saved.
Initial S/W Revision	Prior to A.02.00

## User Preset All Modes

Recalls all of the User Preset files for each mode, switches to the power-on mode, and activates the saved measurement from the power-on mode User Preset file.

### NOTE

When the instrument is secured, all of the user preset files are converted back to their default user preset files.

The User Preset function does the following:

- Aborts the currently running measurement.
- Switches the Mode to the power-on mode.
- Restores the User Preset files for each mode.
- Makes the saved measurement for the power-on mode the active measurement.
- Brings up the saved menu for the power-on mode.
- Clears the input and output buffers.
- Sets the Status Byte to 0.

Key Path	User Preset
<b>Remote Command</b>	:SYSTem:PRESet:USER:ALL
<b>Example</b>	:SYST:PRES:USER:SAVE:SYST:PRES:USER:ALL
Notes	Clears all pending OPC bits. The Status Byte is set to 0. :SYST:PRES:USER:SAVE is used to save the current state as the user preset state.
Couplings	A user preset will cause the currently running measurement to be aborted, cause a mode switch to the power-on mode, and cause the saved measurement to be active in the power-on mode. Recalling a User Preset file has the same issues that recalling a Save State file has. Some settings may need to be limited and therefore re-coupled, since the capabilities of the mode may have changes when the User Preset file was last saved.
Initial S/W Revision	Prior to A.02.00

## Save User Preset

Saves the currently active mode and its State. You can recall this User Preset file by pressing the User Preset menu key or sending the SYST:PRES:USER remote command. This same state is also saved by the Save State function.

Key Path	User Preset
Remote Command	:SYSTem:PRESet:USER:SAVE
Example	:SYST:PRES:USER:SAVE
Notes	:SYST:PRES:SAVE creates the same file as if the user requested a *SAV or a MMEM:STOR:STAT, except User Preset Save does not allow the user to specify the filename or the location of the file.
Initial S/W Revision	Prior to A.02.00

## View/Display

Accesses a menu of functions that enable you to control the instrument display as well as turn the bar graph On and Off.

If current mode is NOT DVB-T/H, DTMB (CTTB), ISDB-T, MSR, LTE-Advanced FDD/TDD or CMMB mode, the front panel views only contain one view: Spectrum View. The results of the measurement can be displayed as a single spectrum trace view or displayed with a Bar Graph trace on the spectrum trace.

### Spectrum View with Bar Graph off

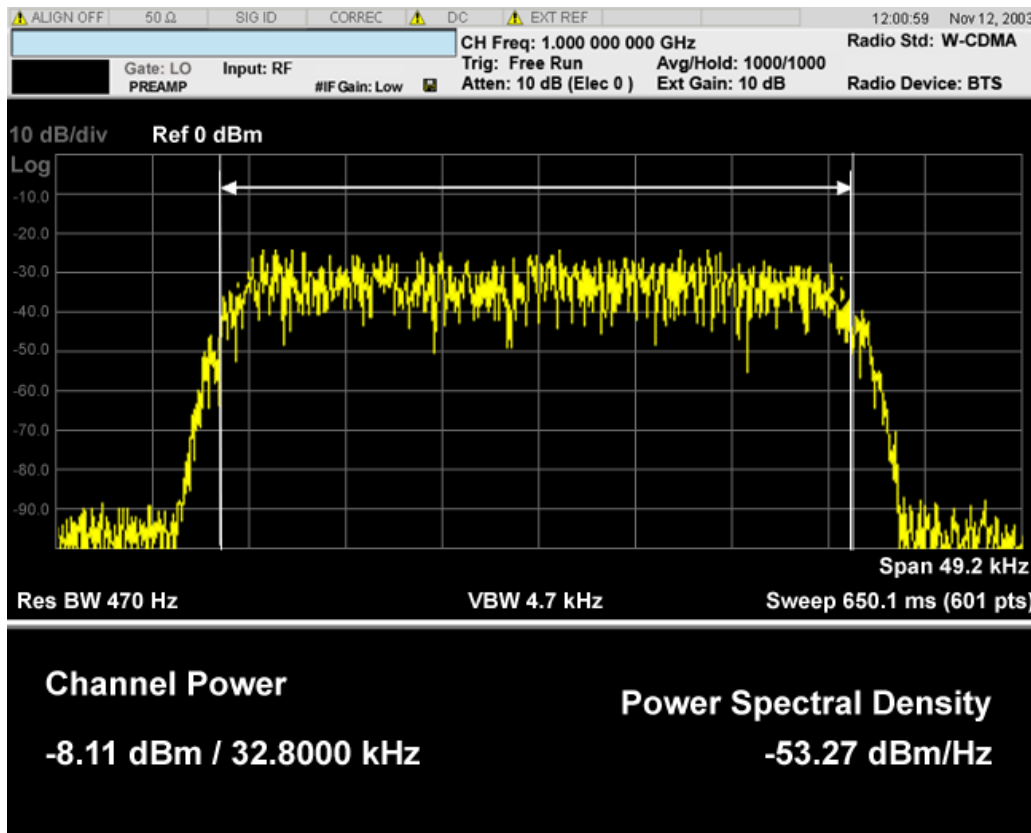

### Spectrum View with Bar Graph on

This View is the same as the 'Spectrum' view, but has a blue bar between the markers that indicates the measured output power level. The bar graph is activated when the "Bar Graph" Soft Key is set to ON under the View/Display menu. The actual measured output power level is displayed on the display at the bottom of the bar.

8 Channel Power Measurement  
View/Display

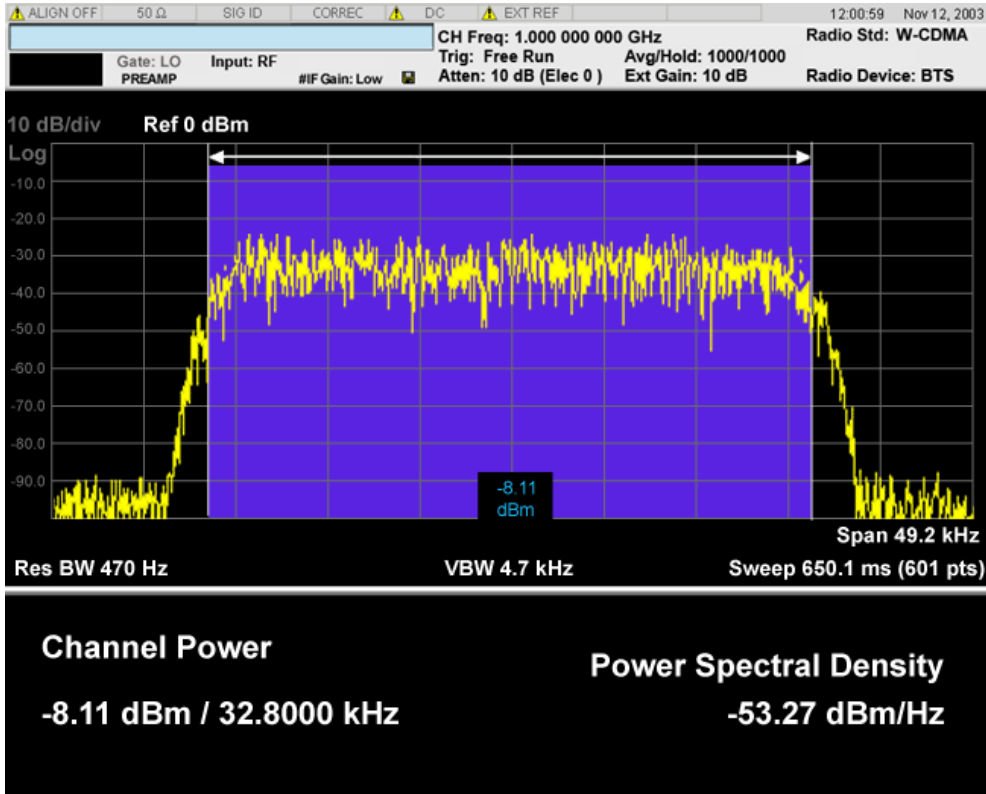

If current mode is MSR and LTE-Advanced FDD/TDD, there are two views, Power Results and Carrier Info. Power Results view is almost the same as the common CHP view.

If the current mode is WLAN and the format is WLAN 802.11ac 80+80 MHz, the spectrum view is changed a little so that the results of both carrier segments can be displayed.

Spectrum View with Bar Graph off for WLAN 802.11ac (80 + 80 MHz):

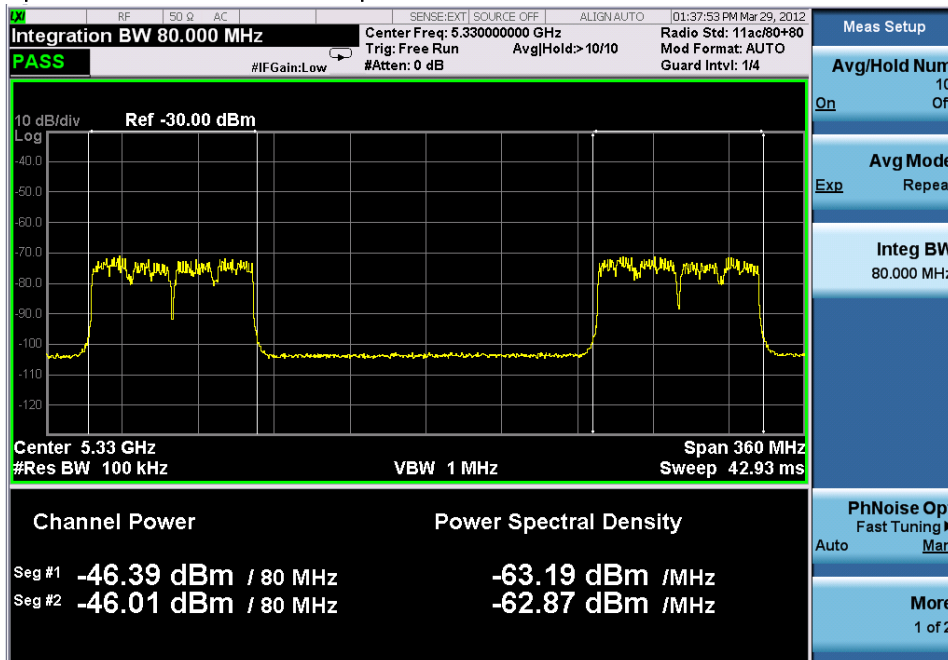

Spectrum View with Bar Graph on for WLAN 802.11ac (80 + 80 MHz):

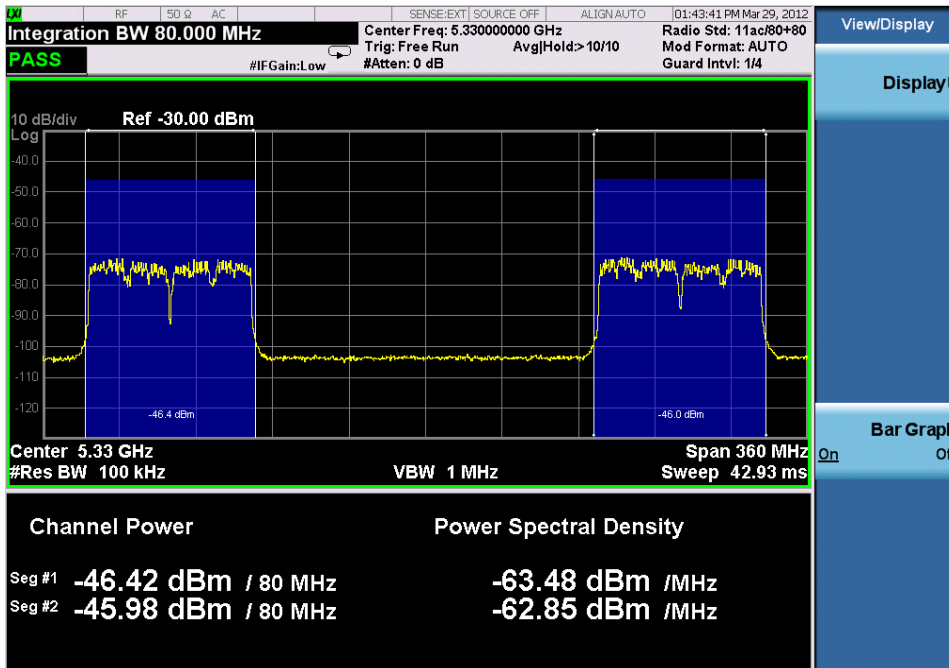

### Power Results:

The spectrum trace and power bars are displayed in the upper window. Total carrier power, total PSD and total format carrier power are displayed in the lower window. Total format carrier power is total power of carriers of the same Radio Format. If there is no carrier of the corresponding format, it is not displayed. Thus items in the total format power table changes depending on the carrier configuration. Since the metrics window of MSR and LTE-Advanced FDD/TDD is a bit denser than the common CHP, vertical positions of total power and power spectral density goes up a little bit.

### Carrier Info:

The lower window of Power Results view is replaced by the carrier info table in this view. Carrier center frequency can be displayed in either offset or absolute frequency depending on Carrier Freq. The table can be scrolled by Carrier Result on Meas Setup menu or by Select Carrier on Config Carriers menu. The highlighted row changes as either Carrier Result or Select Carrier is changed. The highlighted row and these keys are not coupled.

### View selection by name (MSR and LTE-Advanced FDD/TDD only)

Selects the results view. The following SCPI command allows you to select the desired measurement view by enumeration.

Key Path	No equivalent front-panel key
Mode	MSR, LTEAFDD, LTEATDD
Remote Command	:DISPlay:CHPower:VIEW[:SElect] PRESult CINformation :DISPlay:CHPower:VIEW[:SElect]?
Example	:DISP:CHP:VIEW PRES :DISP:CHP:VIEW?

Preset	PRESult
State Saved	Saved in instrument state
Range	Power Results Carrier Info
Initial S/W Revision	A.10.00

Selects the results view. The following SCPI command allows you to select the desired measurement view by enumeration.

Key Path	No equivalent front-panel key
Mode	MSR, LTEAFDD, LTEATDD
<b>Remote Command</b>	:DISPlay:CHPower:VIEW:NSElect <integer> :DISPlay:CHPower:VIEW:NSElect?
<b>Example</b>	DISP:CHP:VIEW:NSEL 1 DISP:CHP:VIEW:NSEL?
Preset	1
State Saved	Saved in instrument state
Min	1
Max	2
Initial S/W Revision	A.10.00

### View selection by name (DTMB (CTTB), DVB-T/H only)

Selects the results view. The following SCPI command allows you to select the desired measurement view by enumeration.

Key Path	No equivalent front-panel key
Mode	DVB-T/H, DTMB (CTTB)
<b>Remote Command</b>	:DISPlay:CHPower:VIEW[:SElect] RFSpectrum SHOULder MASK :DISPlay:CHPower:VIEW[:SElect]?
<b>Example</b>	DISP:CHP:VIEW RFSP DISP:CHP:VIEW?
Preset	RFSpectrum
State Saved	Saved in instrument state.
Range	RF Spectrum   Shoulder Attenuation   Spectrum Mask
Initial S/W Revision	A.02.00

## View selection by name (ISDB-T, CMMB only)

Selects the results view. The following SCPI command allows you to select the desired measurement view by enumeration.

Key Path	No equivalent front-panel key
Mode	ISDB-T, CMMB
<b>Remote Command</b>	:DISPlay:CHPower:VIEW[:SElect] RFSpectrum SHOUlder :DISPlay:CHPower:VIEW[:SElect]?
<b>Example</b>	DISP:CHP:VIEW RFSP DISP:CHP:VIEW?
Preset	RFSpectrum
State Saved	Saved in instrument state.
Range	RF Spectrum   Shoulder Attenuation
Initial S/W Revision	A.03.00

Key Path	Front-panel key
Initial S/W Revision	Prior to A.02.00

## Display

The Display menu is common to most measurements, and is used for configuring items on the display. Some Display menu settings apply to all the measurements in a mode, and some only to the current measurement. Those under the System Display Settings key apply to all measurements in all modes.

Key Path	Display
Key Path	View/Display
Initial S/W Revision	Prior to A.02.00

## Annotation

Turns on and off various parts of the display annotation. The annotation is divided up into four categories:

1. Meas Bar: This is the measurement bar at the top of the screen. It does not include the settings panel or the Active Function. Turning off the Meas Bar turns off the settings panel and the Active Function. When the Meas Bar is off, the graticule area expands to fill the area formerly occupied by the Meas Bar.
2. Screen Annotation: this is the annotation and annunciation around the graticule, including any annotation on lines (such as the display line, the threshold line, etc.) This does NOT include the marker number or the N dB result. When off, the graticule expands to fill the entire graticule area.
3. Trace annotation: these are the labels on the traces, showing their detector (or their math mode).

8 Channel Power Measurement  
View/Display

4. Active Function annotation: this is the active function display in the meas bar, and all of the active function values displayed on softkeys.

See the figure below. Each type of annotation can be turned on and off individually.

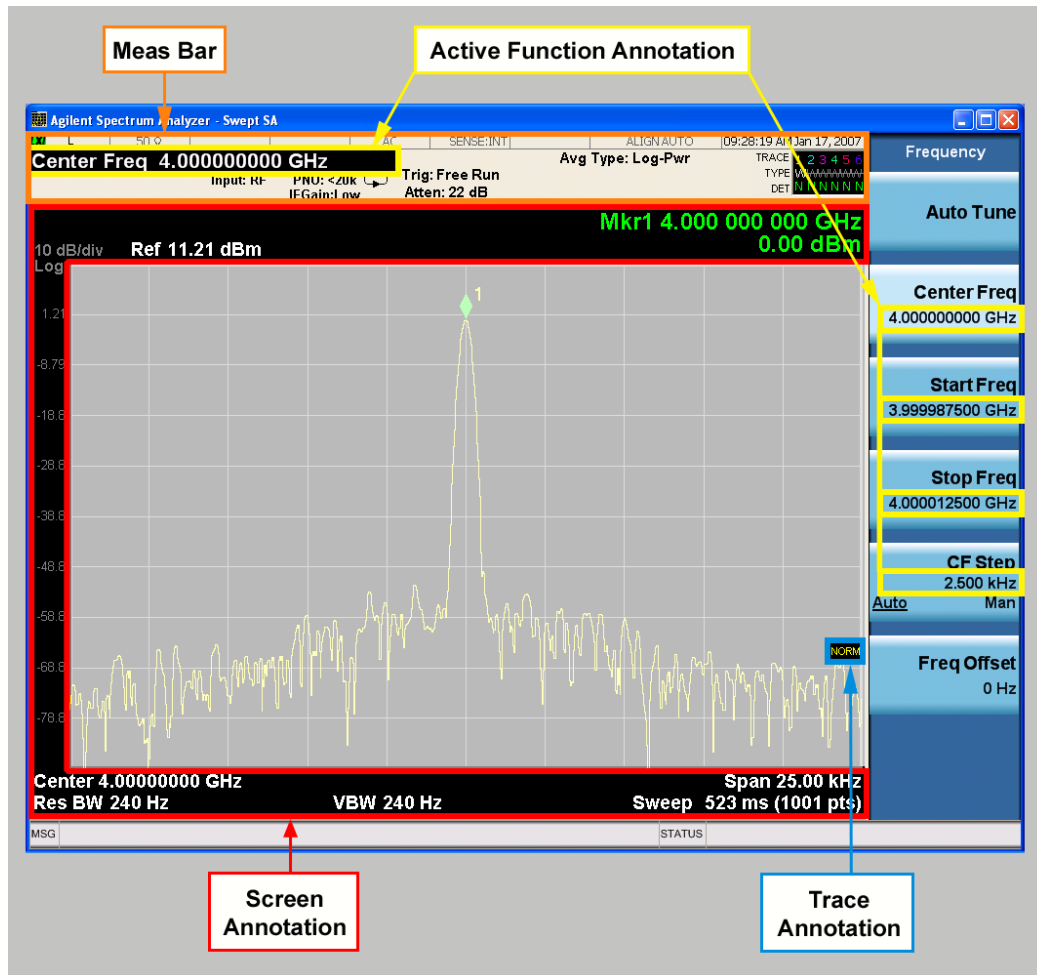

Key Path	View/Display, Display
Initial S/W Revision	Prior to A.02.00

Meas Bar On/Off

This function turns the Measurement Bar on and off, including the settings panel. When off, the graticule area expands to fill the area formerly occupied by the Measurement Bar.

Key Path	View/Display, Display, Annotation
Remote Command	:DISPlay:ANNotation:MBAR[:STATe] OFF ON 0 1 :DISPlay:ANNotation:MBAR[:STATe]?
Example	DISP:ANN:MBAR OFF



Dependencies	Grayed out and forced to OFF when System Display Settings, Annotation is set to Off.
Preset	On This should remain Off through a Preset when System DisplaySettings, Annotation is set to Off.
State Saved	Saved in instrument state.
Initial S/W Revision	Prior to A.02.00

## Screen

This controls the display of the annunciation and annotation around the graticule, including any annotation on lines (such as the display line, the threshold line, etc.) and the y-axis annotation. This does NOT include marker annotation (or the N dB result). When off, the graticule expands to fill the entire graticule area, leaving only the 1.5% gap above the graticule as described in the Trace/Detector chapter.

Key Path	View/Display, Display, Annotation
<b>Remote Command</b>	:DISPlay:ANNotation:SCReen[:STATe] OFF ON 0 1 :DISPlay:ANNotation:SCReen[:STATe]?
<b>Example</b>	DISP:ANN:SCR OFF
Dependencies	Grayed-out and forced to OFF when System Display Settings, Annotation is set to Off.
Preset	On This should remain Off through a Preset when System DisplaySettings, Annotation is set to Off
State Saved	Saved in instrument state.
Initial S/W Revision	Prior to A.02.00

## Active Function Values On/Off

Turns on and off the active function display in the Meas Bar, and all of the active function values displayed on the softkeys.

Note that all of the softkeys that have active functions have these numeric values blanked when this function is on. This is a security feature..

8 Channel Power Measurement  
View/Display

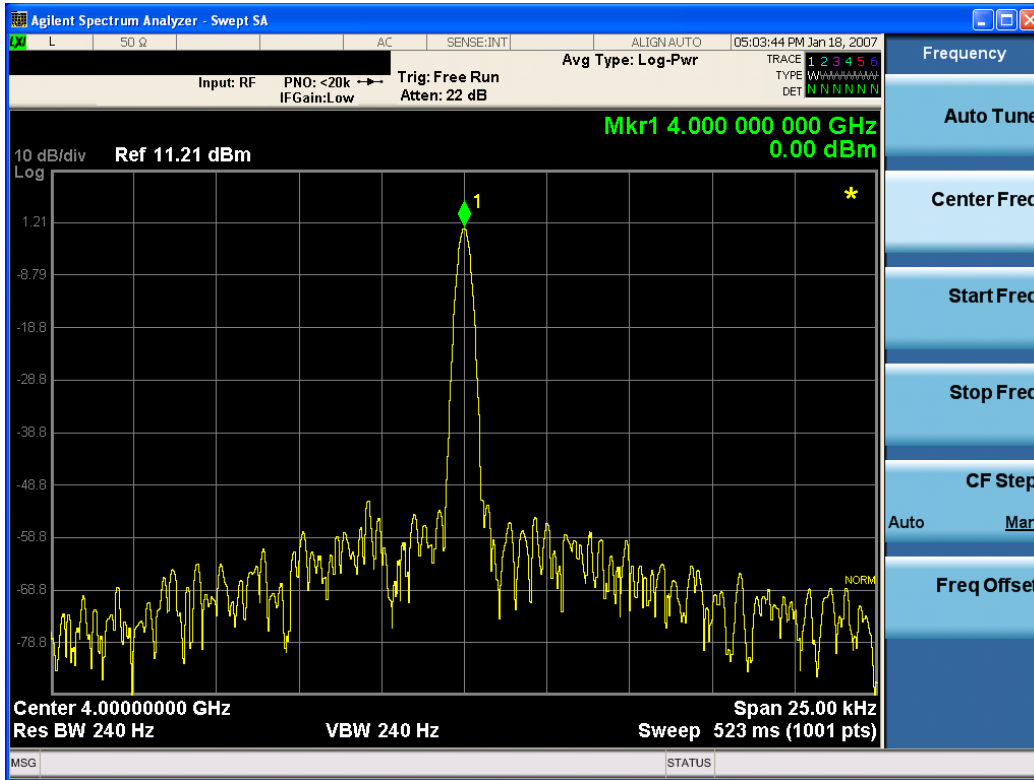

Key Path	View/Display, Display, Annotation
Remote Command	:DISPlay:ACTivefunc[:STATE] ON OFF 1 0 :DISPlay:ACTivefunc[:STATE]?
Example	DISP:ACT OFF
Dependencies	Grayed out and forced to OFF when System Display Settings, Annotation is set to Off.
Preset	On This should remain Off through a Preset when System DisplaySettings, Annotation is set to Off
State Saved	Saved in instrument state.
Initial S/W Revision	Prior to A.02.00

Title

Displays menu keys that enable you to change or clear a title on your display.

Key Path	View/Display, Display
Initial S/W Revision	Prior to A.02.00

Change Title

Writes a title into the "measurement name" field in the banner, for example, "Swept SA".

Press Change Title to enter a new title through the alpha editor. Press Enter or Return to complete the entry. Press ESC to cancel the entry and preserve your existing title.

The display title will replace the measurement name. It remains for this measurement until you press Change Title again, or you recall a state, or a Preset is performed. A title can also be cleared by pressing Title, Clear Title.

**NOTE**

Notice the inclusion of the <measurement> parameter in the command below. Because each measurement remembers the Display Title, the command must be qualified with the measurement name. For the Swept SA measurement this is not the case; no <measurement> parameter is used when changing the Display Title for the Swept SA measurement.

Key Path	View/Display, Display, Title
Mode	All
<b>Remote Command</b>	:DISPlay:<measurement>:ANNotation:TITLe:DATA <string> :DISPlay:<measurement>:ANNotation:TITLe:DATA?
<b>Example</b>	DISP:ANN:TITL:DATA "This Is My Title" This example is for the Swept SA measurement in the Spectrum Analyzer mode. The SANalyzer <measurement> name is not used. DISP:ACP:ANN:TITL:DATA "This Is My Title" This example is for Measurements other than Swept SA. Both set the title to: This Is My Title
Notes	Pressing this key cancels any active function. When a title is edited the previous title remains intact (it is not cleared) and the cursor goes at the end so that characters can be added or BKSP can be used to go back over previous characters.
Preset	No title (measurement name instead)
State Saved	Saved in instrument state.
Initial S/W Revision	Prior to A.02.00

### Clear Title

Clears a title from the front-panel display. Once cleared, the title cannot be retrieved. After the title is cleared, the current Measurement Name replaces it in the title bar.

Key Path	View/Display, Display, Title
<b>Example</b>	The following commands clear the title and restore the measurement's original title: DISP:ANN:TITL:DATA "" This example is for the Swept SA measurement in the Spectrum Analyzer mode. The SANalyzer <measurement> name is not used. DISP:ACP:ANN:TITL:DATA "" This example is for ACP; in measurements other than Swept SA the measurement name is required.
Notes	Uses the :DISPlay:<measurement>:ANNotation:TITLe:DATA <string> command with an empty string (in the Swept SA, the <measurement> is omitted).
Preset	Performed on Preset.
Initial S/W Revision	Prior to A.02.00

## Graticule

Pressing Graticule turns the display graticule On or Off. It also turns the graticule y-axis annotation on and off.

Key Path	View/Display, Display
Remote Command	:DISPlay:WINDow[1]:TRACe:GRATicule:GRID[:STATe] OFF ON 0 1 :DISPlay:WINDow[1]:TRACe:GRATicule:GRID[:STATe]?
Example	DISP:WIND:TRAC:GRAT:GRID OFF
Notes	The graticule is the set of horizontal and vertical lines that make up the grid/divisions for the x-axis and y-axis.
Preset	On
State Saved	Saved in instrument state
Initial S/W Revision	Prior to A.02.00

## System Display Settings

These settings are "Mode Global" – they affect all modes and measurements and are reset only by Restore Misc Defaults or Restore System Defaults under System.

Key Path	View/Display, Display
Initial S/W Revision	Prior to A.02.00

## Annotation Local Settings

This is a Mode Global override of the meas local annotation settings. When it is All Off, it forces ScreenAnnotation, Meas Bar, Trace, and Active Function Values settings to be OFF for all measurements in all modes. This provides the security based "annotation off" function of previous analyzers; hence it uses the legacy SCPI command.

When it is All Off, the Screen, Meas Bar, Trace, and Active Function Values keys under the Display, Annotation menu are grayed out and forced to Off. When Local Settings is selected, you are able to set the local annotation settings on a measurement by measurement basis.

Key Path	View/Display, Display, System Display Settings
Remote Command	:DISPlay:WINDow[1]:ANNotation[:ALL] OFF ON 0 1 :DISPlay:WINDow[1]:ANNotation[:ALL]?
Example	:DISP:WIND:ANN OFF
Preset	On (Set by Restore Misc Defaults)
State Saved	Not saved in instrument state.
Backwards Compatibility Notes	The WINDow parameter and optional subopcode is included for backwards compatibility but ignored – all windows are equally affected.
Initial S/W Revision	Prior to A.02.00

## Themes

Accesses a menu of functions that enable you to choose the theme to be used when saving the screen image.

The **Themes** option is the same as the **Themes** option under the **Display** and **Page Setup** dialogs. It allows you to choose between themes to be used when saving the screen image.

<b>Key Path</b>	Save, Screen Image
<b>Remote Command</b>	:MMEMory:STORe:SCReem:THEMe TDColor   TDMonochrome   FCOLOR   FMONochrome  :MMEMory:STORe:SCReem:THEMe?
<b>Example</b>	:MMEM:STOR:SCR:THEM TDM
<b>Preset</b>	3D Color; Is not part of Preset, but is reset by Restore Misc Defaults or Restore System Defaults All and survives subsequent running of the modes.
<b>Readback</b>	3D Color   3D Mono   Flat Color   Flat Mono
<b>Backwards Compatibility Notes</b>	In ESA and PSA we offer the choice of "Reverse Bitmap" or "Reverse Metafile" when saving screen images. This is much like the "Flat Color" theme available in X-Series. Also, if you selected Reverse Bitmap AND a black & white screen image, that would be much like "Flat Monochrome". In other words, each of the X-Series themes has a similar screen image type in ESA/PSA. But they are not identical.
<b>Initial S/W Revision</b>	Prior to A.02.00

### 3D Color

Selects a standard color theme with each object filled, shaded and colored as designed.

<b>Key Path</b>	Save, Screen Image, Themes
<b>Example</b>	MMEM:STOR:SCR:THEM TDC
<b>Readback</b>	3D Color
<b>Initial S/W Revision</b>	Prior to A.02.00

### 3D Monochrome

Selects a format that is like 3D color but shades of gray are used instead of colors.

<b>Key Path</b>	Save, Screen Image, Themes
<b>Example</b>	MMEM:STOR:SCR:THEM TDM
<b>Readback</b>	3D Mono
<b>Initial S/W Revision</b>	Prior to A.02.00

### Flat Color

Selects a format that is best when the screen is to be printed on an ink printer.

Key Path	Save, Screen Image, Themes
<b>Example</b>	MMEM:STOR:SCR:THEM FCOL
Readback	Flat Color
Initial S/W Revision	Prior to A.02.00

### Flat Monochrome

Selects a format that is like Flat Color. But only black is used (no colors, not even gray), and no fill.

Key Path	Save, Screen Image, Themes
<b>Example</b>	MMEM:STOR:SCR:THEM FMON
Readback	Flat Mono
Initial S/W Revision	Prior to A.02.00

### Backlight

Accesses the display backlight on/off keys. This setting may interact with settings under the Windows "Power" menu.

When the backlight is off, pressing ESC, TAB, SPACE, ENTER, UP, DOWN, LEFT, RIGHT, DEL, BKSP, CTRL, or ALT turns the backlight on without affecting the application. Pressing any other key will turn backlight on and could potentially perform the action as well.

Key Path	View/Display, Display, System Display Settings
<b>Remote Command</b>	:DISPlay:BACKlight ON OFF :DISPlay:BACKlight?
Preset	ON (Set by Restore Misc Defaults)
Initial S/W Revision	Prior to A.02.00

### Backlight Intensity

An active function used to set the backlight intensity. It goes from 0 to 100 where 100 is full on and 0 is off. This value is independent of the values set under the Backlight on/off key.

Key Path	View/Display, Display, System Display Settings
<b>Remote Command</b>	:DISPlay:BACKlight:INTensity <integer> :DISPlay:BACKlight:INTensity?
<b>Example</b>	DISP:BACK:INT 50

Preset	100 (Set by Restore Misc Defaults)
Min	0
Max	100
Initial S/W Revision	Prior to A.02.00

## Bar Graph

Turns the Bar Graph On and Off.

Key Path	DVB-T/H, DTMB (CTTB), ISDB-T, CMMB: View/Display, RF SpectrumOthers: View/Display
Mode	SA, WCDMA, C2K, WIMAX OFDMA, 1xEVDO, DVB-T/H, DTMB (CTTB), ISDB-T, CMMB, LTE, LTETDD, Digital Cable TV, WLAN, MSR, LTEAFDD, LTEATDD
<b>Remote Command</b>	:DISPlay:CHPower:VIEW[1]:WINDow[1]:BGRaph ON OFF 1 0 :DISPlay:CHPower:VIEW[1]:WINDow[1]:BGRaph?
<b>Example</b>	DISP:CHP:VIEW:WIND:BGR ON DISP:CHP:VIEW:WIND:BGR?
Notes	You must be in the Spectrum Analysis mode, W-CDMA mode, cdma2000 mode, DVB-T/H mode, DTMB (CTTB) mode, ISDB-T mode, CMMB mode, Digital Cable TV mode, LTE mode, LTE TDD mode, WLAN mode, 1xEVDO mode, MSR, LTE-Advanced FDD/TDD mode or WIMAX OFDMA mode to use this command. Use :INSTrument:SElect to set the mode.
Preset	OFF
State Saved	Saved in instrument state.
Range	On Off
Initial S/W Revision	Prior to A.02.00
Modified at S/W Revision	A.02.00, A.03.00





## 9 ACP Measurement

ACP is a measurement of the amount of interference, or power, in an adjacent frequency channel. The results are displayed as a bar graph or as spectrum data, with measurement data at specified offsets. For measurement results and views, see ["View/Display" on page 851](#).

This topic contains the following sections:

["Measurement Commands for ACP" on page 646](#)

["Remote Command Results for ACP Measurement" on page 647](#)

## Measurement Commands for ACP

The following commands are used to retrieve the measurement results:

```
:CONFigure:ACP  
:CONFigure:ACP:NDEFault  
:INITiate:ACP  
:FETCh:ACP[n]?  
:READ:ACP[n]?  
:MEASure:ACP[n]?
```

For more measurement related commands, see the SENSE subsystem, and the section "[Remote Measurement Functions](#)" on page 2848.

## Remote Command Results for ACP Measurement

Condition	N	Results Returned
Mode = SA mode, Radio Std = None, Number of carriers = 1 and only offset A is on	Not specified or n = 1	Returns 3 comma-separated values that correspond to: Reference carrier power, lower-adjacent channel power (dBc), and upper-adjacent channel power (dBc).
Mode = DTMB (CTTB) or CMMB, Radio BW = 8 MHz, Number of carriers = 1 and Meas Type = Total power reference	Not specified or n = 1	Returns 32 comma-separated scalar results, in the following order. 1. 0.0 2. Total carrier power (dBm) 3. 0.0 4. Reference carrier power (dBm) 5. Lower offset A - relative power (dB) 6. Lower offset A - absolute power (dBm) 7. Upper offset A - relative power (dB) 8. Upper offset A - absolute power (dBm) 9. Lower offset B - relative power (dB) 10. Lower offset B - absolute power (dBm) 11. Upper offset B - relative power (dB) 12. Upper offset B - absolute power (dBm) ... 25. Lower offset F - relative power (dB) 26. Lower offset F - absolute power (dBm) 27. Upper offset F - relative power (dB) 28. Upper offset F - absolute power (dBm) 29. Inside Adjacent Channel - relative power (dB) 30. Inside Adjacent Channel - absolute power (dBm) 31. Outside Adjacent Channel - relative power (dB) 32. Outside Adjacent Channel - absolute power (dBm) If Radio Device = Exciter, the last four (29, 30, 31 and 32) results returned -999.0. If the results are not available, -999.0 is returned. Note: * Inside Adjacent Channel - absolute power: the maximum of the Lower offset A - absolute power and the Upper offset A - absolute power; ** Inside Adjacent Channel - relative power: the result of Reference carrier power subtracted from Inside Adjacent Channel - absolute power; *** Outside Adjacent Channel - absolute power: the root mean square of the absolute power of the offset B upper/lower, the offset C upper/lower and the offset D upper/lower; **** Outside Adjacent Channel - relative power: the result of Reference carrier power subtracted from Outside Adjacent Channel - absolute power;
Mode = DTMB (CTTB) or	not specified	Returns 32 comma-separated scalar results, in the following order.

Condition	N	Results Returned
CMMB, Radio BW = 8 MHz, Number of carriers = 1 and Meas Type = Power spectral density reference	or n = 1	<ol style="list-style-type: none"> <li>1. 0.0</li> <li>2. Total carrier power (dBm/Hz or dBm/MHz)</li> <li>3. 0.0</li> <li>4. Reference carrier power (dBm/Hz or dBm/MHz)</li> <li>5. Lower offset A - relative power (dB)</li> <li>6. Lower offset A - absolute power (dBm/Hz or dBm/MHz)</li> <li>7. Upper offset A - relative power (dB)</li> <li>8. Upper offset A - absolute power (dBm/Hz or dBm/MHz)</li> <li>9. Lower offset B - relative power (dB)</li> <li>10. Lower offset B - absolute power (dBm/Hz or dBm/MHz)</li> <li>11. Upper offset B - relative power (dB)</li> <li>12. Upper offset B - absolute power (dBm/Hz or dBm/MHz)</li> <li>...</li> <li>25. Lower offset F - relative power (dB)</li> <li>26. Lower offset F - absolute power (dBm/Hz or dBm/MHz)</li> <li>27. Upper offset F - relative power (dB)</li> <li>28. Upper offset F - absolute power (dBm/Hz or dBm/MHz)</li> <li>29. -999.0</li> <li>30. -999.0</li> <li>31. -999.0</li> <li>32. -999.0</li> </ol> <p>The last four (29, 30, 31 and 32) results always returned -999.0. If the results are not available, -999.0 is returned.</p>
Meas Type = Total power reference	Not specified or n = 1	<p>Returns 28 comma-separated scalar results, in the following order.</p> <ol style="list-style-type: none"> <li>1. 0.0</li> <li>2. Total carrier power (dBm)</li> <li>3. 0.0</li> <li>4. Reference carrier power (dBm)</li> <li>5. Lower offset A - relative power (dB)</li> <li>6. Lower offset A - absolute power (dBm)</li> <li>7. Upper offset A - relative power (dB)</li> <li>8. Upper offset A - absolute power (dBm)</li> <li>9. Lower offset B - relative power (dB)</li> <li>10. Lower offset B - absolute power (dBm)</li> <li>11. Upper offset B - relative power (dB)</li> <li>12. Upper offset B - absolute power (dBm)</li> <li>...</li> <li>25. Lower offset F - relative power (dB)</li> <li>26. Lower offset F - absolute power (dBm)</li> </ol>

Condition	N	Results Returned
		27. Upper offset F - relative power (dB) 28. Upper offset F - absolute power (dBm) If the results are not available, -999.0 is returned. When in MSR and LTE-Advanced FDD/TDD, this trace includes only outer offset results and their reference value(s).
Meas Type = Power spectral density reference	not specified or n = 1	Returns 28 comma-separated scalar results, in the following order. 1. 0.0 2. Total carrier power (dBm/Hz or dBm/MHz) 3. 0.0 4. Reference carrier power (dBm/Hz or dBm/MHz) 5. Lower offset A - relative power (dB) 6. Lower offset A - absolute power (dBm/Hz or dBm/MHz) 7. Upper offset A - relative power (dB) 8. Upper offset A - absolute power (dBm/Hz or dBm/MHz) 9. Lower offset B - relative power (dB) 10. Lower offset B - absolute power (dBm/Hz or dBm/MHz) 11. Upper offset B - relative power (dB) 12. Upper offset B - absolute power (dBm/Hz or dBm/MHz) ... 25. Lower offset F - relative power (dB) 26. Lower offset F - absolute power (dBm/Hz or dBm/MHz) 27. Upper offset F - relative power (dB) 28. Upper offset F - absolute power (dBm/Hz or dBm/MHz) If the results are not available, -999.0 is returned. When in MSR and LTE-Advanced FDD/TDD, this trace includes only outer offset results and their reference value(s).
Meas Method = FAST	not specified or n = 1	Returns 5 comma-separated results, in the following order: 1. Reference carrier - absolute power (dBm) 2. Lower offset A - absolute power (dBm) 3. Upper offset A - absolute power (dBm) 4. Lower offset B - absolute power (dBm) 5. Upper offset B - absolute power (dBm)
Mode = MSR, LTEAFDD, LTEATDD, Meas Type = Total power reference and Power Ref = Left & Right Carriers	Not specified or n = 1	Returns 28 comma-separated scalar results, in the following order. 1. 0.0 2. Total carrier power (dBm) 3. Left Reference carrier power (dBm) 4. Right Reference carrier power (dBm) 5. Lower offset A - relative power (dB) 6. Lower offset A - absolute power (dBm) 7. Upper offset A - relative power (dB)

Condition	N	Results Returned
		8. Upper offset A - absolute power (dBm) 9. Lower offset B - relative power (dB) 10. Lower offset B - absolute power (dBm) 11. Upper offset B - relative power (dB) 12. Upper offset B - absolute power (dBm) ... 25. Lower offset F - relative power (dB) 26. Lower offset F - absolute power (dBm) 27. Upper offset F - relative power (dB) 28. Upper offset F - absolute power (dBm) If the results are not available, -999.0 is returned.
Mode = MSR , LTEAFDD, LTEATDD, Meas Type = Power spectral density reference and Power Ref = Left & Right Carriers	not specified or n = 1	Returns 28 comma-separated scalar results, in the following order. 1. 0.0 2. Total carrier power (dBm/Hz or dBm/MHz) 3. Left reference carrier power (dBm/Hz or dBm/MHz) 4. Right reference carrier power (dBm/Hz or dBm/MHz) 5. Lower offset A - relative power (dB) 6. Lower offset A - absolute power (dBm/Hz or dBm/MHz) 7. Upper offset A - relative power (dB) 8. Upper offset A - absolute power (dBm/Hz or dBm/MHz) 9. Lower offset B - relative power (dB) 10. Lower offset B - absolute power (dBm/Hz or dBm/MHz) 11. Upper offset B - relative power (dB) 12. Upper offset B - absolute power (dBm/Hz or dBm/MHz) ... 25. Lower offset F - relative power (dB) 26. Lower offset F - absolute power (dBm/Hz or dBm/MHz) 27. Upper offset F - relative power (dB) 28. Upper offset F - absolute power (dBm/Hz or dBm/MHz) If the results are not available, -999.0 is returned. When in MSR and LTE-Advanced FDD/TDD, this trace includes only outer offset results and their reference value(s).
Meas Type = Total power reference	n = 2	Returns 48 scalar results, in the following order: 1. Channel (1) - relative power (dB) 2. Channel (1) - absolute power (dBm) 3. Channel (2) - relative power (dB) 4. Channel (2) - absolute power (dBm) ... 23. Channel (12) - relative power (dB) 24. Channel (12) - absolute power (dBm)

Condition	N	Results Returned
		25. Lower offset A - relative power (dB) 26. Lower offset A - absolute power (dBm) 27. Upper offset A - relative power (dB) 28. Upper offset A - absolute power (dBm) 29. Lower offset B - relative power (dB) 30. Lower offset B - absolute power (dBm) 31. Upper offset B - relative power (dB) 32. Upper offset B - absolute power (dBm) ... 45. Lower offset F - relative power (dB) 46. Lower offset F - absolute power (dBm) 47. Upper offset F - relative power (dB) 48. Upper offset F - absolute power (dBm) If the results are not available, -999.0 is returned. When in MSR and LTE-Advanced FDD/TDD, this trace includes only outer offset results and their reference value(s).
Meas Type = Power spectral density reference	n = 2	Returns 48 scalar results, in the following order: 1. Channel (1) - relative power (dB) 2. Channel (1) - absolute power (dBm/Hz or dBm/MHz) 3. Channel (2) - relative power (dB) 4. Channel (2) - absolute power (dBm/Hz or dBm/MHz) ... 23. Channel (12) - relative power (dB) 24. Channel (12) - absolute power (dBm/Hz or dBm/MHz) 25. Lower offset A - relative power (dB) 26. Lower offset A - absolute power (dBm/Hz or dBm/MHz) 27. Upper offset A - relative power (dB) 28. Upper offset A - absolute power (dBm/Hz or dBm/MHz) 29. Lower offset B - relative power (dB) 30. Lower offset B - absolute power (dBm/Hz or dBm/MHz) 31. Upper offset B - relative power (dB) 32. Upper offset B - absolute power (dBm/Hz or dBm/MHz) ... 45. Lower offset F - relative power (dB) 46. Lower offset F - absolute power (dBm/Hz or dBm/MHz) 47. Upper offset F - relative power (dB) 48. Upper offset F - absolute power (dBm/Hz or dBm/MHz) If the results are not available, -999.0 is returned. When in MSR and LTE-Advanced FDD/TDD, this trace includes only outer offset

Condition	N	Results Returned
Mode = DTMB (CTTB) or CMMB, Radio BW = 8 MHz and Meas Type = Total power reference	n = 3	<p>results.</p> <hr/> <p>Returns 28 scalar values of the pass/fail (0 = passed, or 1 = failed) determined by testing the relative to the reference carrier and by testing the absolute power limit of the offset frequencies (measured as total power in dB):</p> <ol style="list-style-type: none"> <li>1. Lower offset A - relative limit result</li> <li>2. Lower offset A - absolute limit result</li> <li>3. Upper offset A - relative limit result</li> <li>4. Upper offset A - absolute limit result</li> <li>5. Lower offset B - relative limit result</li> <li>6. Lower offset B - absolute limit result</li> <li>7. Upper offset B - relative limit result</li> <li>8. Upper offset B - absolute limit result</li> </ol> <p>...</p> <ol style="list-style-type: none"> <li>21. Lower offset F - relative limit result</li> <li>22. Lower offset F - absolute limit result</li> <li>23. Upper offset F - relative limit result</li> <li>24. Upper offset F - absolute limit result</li> <li>25. Inside Adjacent Channel - relative limit result</li> <li>26. Inside Adjacent Channel - absolute limit result</li> <li>27. Outside Adjacent Channel - relative limit result</li> <li>28. Outside Adjacent Channel - absolute limit result</li> </ol> <p>If Radio Device = Exciter, the last four (25, 26, 27 and 28) results returned -999.0.</p>
Mode = DTMB (CTTB) or CMMB, Radio BW = 8 MHz and Meas Type = Power spectral density reference	n = 3	<p>Returns 28 scalar values of the pass/fail (0 = passed, or 1 = failed) determined by testing the relative to the reference carrier and by testing the absolute power limit of the offset frequencies (measured as power spectral density in dB):</p> <ol style="list-style-type: none"> <li>1. Lower offset A - relative limit result</li> <li>2. Lower offset A - absolute limit result</li> <li>3. Upper offset A - relative limit result</li> <li>4. Upper offset A - absolute limit result</li> <li>5. Lower offset B - relative limit result</li> <li>6. Lower offset B - absolute limit result</li> <li>7. Upper offset B - relative limit result</li> <li>8. Upper offset B - absolute limit result</li> </ol> <p>...</p> <ol style="list-style-type: none"> <li>21. Lower offset F - relative limit result</li> <li>22. Lower offset F - absolute limit result</li> <li>23. Upper offset F - relative limit result</li> <li>24. Upper offset F - absolute limit result</li> <li>25. -999.0</li> </ol>



Condition	N	Results Returned
Meas Type = Total power reference	n = 3	<p>26. -999.0  27. -999.0  28. -999.0  The last four results always returned -999.0.</p> <hr/> <p>Returns 24 scalar values of the pass/fail (0 = passed, or 1 = failed) determined by testing the relative to the reference carrier and by testing the absolute power limit of the offset frequencies (measured as total power in dB):</p> <ol style="list-style-type: none"> <li>1. Lower offset A - relative limit result</li> <li>2. Lower offset A - absolute limit result</li> <li>3. Upper offset A - relative limit result</li> <li>4. Upper offset A - absolute limit result</li> <li>5. Lower offset B - relative limit result</li> <li>6. Lower offset B - absolute limit result</li> <li>7. Upper offset B - relative limit result</li> <li>8. Upper offset B - absolute limit result</li> </ol> <p>...</p> <ol style="list-style-type: none"> <li>21 Lower offset F - relative limit result</li> <li>22 Lower offset F - absolute limit result</li> <li>23 Upper offset F - relative limit result</li> <li>24 Upper offset F - absolute limit result</li> </ol> <p>When in MSR and LTE-Advanced FDD/TDD, this trace includes only outer offset results.</p>
Meas Type = Power spectral density reference	n = 3	<p>Returns 24 scalar values of the pass/fail (0 = passed, or 1 = failed) determined by testing the relative to the reference carrier and by testing the absolute power limit of the offset frequencies (measured as power spectral density in dB):</p> <ol style="list-style-type: none"> <li>1. Lower offset A - relative limit result</li> <li>2. Lower offset A - absolute limit result</li> <li>3. Upper offset A - relative limit result</li> <li>4. Upper offset A - absolute limit result</li> <li>5. Lower offset B - relative limit result</li> <li>6. Lower offset B - absolute limit result</li> <li>7. Upper offset B - relative limit result</li> <li>8. Upper offset B - absolute limit result</li> </ol> <p>...</p> <ol style="list-style-type: none"> <li>21 Lower offset F - relative limit result</li> <li>22 Lower offset F - absolute limit result</li> <li>23 Upper offset F - relative limit result</li> <li>24 Upper offset F - absolute limit result</li> </ol> <p>When in MSR and LTE-Advanced FDD/TDD, this trace includes only outer offset results.</p>

Condition	N	Results Returned
	n = 4	Returns <Num Pts> comma-separated scalar values representing the Y values in Trace 1
	n = 5	Returns <Num Pts> comma-separated scalar values representing the Y values in Trace 2
	n = 6	Returns <Num Pts> comma-separated scalar values representing the Y values in Trace 3
Meas Type = Total power reference	n = 7	<p>Returns (2 * Number of Carriers) scalar results, in the following order:</p> <p>The Number of Carriers is the value filled in Carriers under Carrier Setup menu. If license N9060A-5FP is enabled, max value of Number of Carriers is 18, otherwise, max value of Number of Carriers is 12. In MSR mode, max value of Number of Carriers is 100. In LTE-Advanced FDD/TDD mode, max value of number of carriers is 5.</p> <ol style="list-style-type: none"> <li>1. Channel (1) - relative power (dB)</li> <li>2. Channel (1) - absolute power (dBm)</li> <li>3. Channel (2) - relative power (dB)</li> <li>4. Channel (2) - absolute power (dBm)</li> </ol> <p>...</p> <p>2 * Number of Carriers -1. Channel (Number of Carriers) - relative power (dB)</p> <p>2 * Number of Carriers. Channel (Number of Carriers) - absolute power (dBm)</p> <p>If the results are not available, 9.91E+37 is returned.</p>
Meas Type = Power spectral density reference	n = 7	<p>Returns (2 * Number of Carriers) scalar results, in the following order: The Number of Carriers is the value filled in Carriers under Carrier Setup menu.</p> <p>If license N9060A-5FP is enabled, max value of Number of Carriers is 18, otherwise, max value of Number of Carriers is 12. In MSR mode, max value of Number of Carriers is 100. In LTE-Advanced FDD/TDD mode, max value of number of carriers is 5.</p> <ol style="list-style-type: none"> <li>1. Channel (1) - relative power (dB)</li> <li>2. Channel (1) - absolute power (dBm/Hz or dBm/MHz)</li> <li>3. Channel (2) - relative power (dB)</li> <li>4. Channel (2) - absolute power (dBm/Hz or dBm/MHz)</li> </ol> <p>...</p> <p>2 * Number of Carriers -1. Channel (Number of Carriers) - relative power (dB)</p> <p>2 * Number of Carriers. Channel (Number of Carriers) - absolute power (dBm/Hz or dBm/MHz)</p> <p>If the results are not available, 9.91E+37 is returned</p>
Mode = MSR,LTEAFDD,LTEATDD	n = 8	<p>Returns scalar results, in the following order:</p> <ol style="list-style-type: none"> <li>1. 0.0</li> <li>2. Total carrier power (dBm)</li> <li>3. 0.0</li> </ol>

Condition	N	Results Returned
		<p>4. Reference carrier power (dBm, dBm/Hz or dBm/MHz)</p> <p>5. Inner Lower offset A - relative power (dB)</p> <p>6. Inner Lower offset A - absolute power (dBm, dBm/Hz or dBm/MHz)</p> <p>7. Inner Upper offset A - relative power (dB)</p> <p>8. Inner Upper offset A - absolute power (dBm, dBm/Hz or dBm/MHz)</p> <p>9. Inner Lower offset B - relative power (dB)</p> <p>10. Inner Lower offset B - absolute power (dBm, dBm/Hz or dBm/MHz)</p> <p>11. Inner Upper offset B - relative power (dB)</p> <p>12. Inner Upper offset B - absolute power (dBm, dBm/Hz or dBm/MHz)</p> <p>...</p> <p>25. Inner Lower offset F - relative power (dB)</p> <p>26. Inner Lower offset F - absolute power (dBm, dBm/Hz or dBm/MHz)</p> <p>27. Inner Upper offset F - relative power (dB)</p> <p>28. Inner Upper offset F - absolute power (dBm, dBm/Hz or dBm/MHz)</p> <p>When Power Ref is either Left &amp; Right Carriers or Max Power Carrier in Sub-block, the first four values are</p> <p>1. 0.0</p> <p>2. Total carrier power (dBm)</p> <p>3. Reference carrier in the lower sub-block (dBm, dBm/Hz or dBm/MHz)</p> <p>4. Reference carrier in the upper sub-block (dBm, dBm/Hz or dBm/MHz)</p> <p>Unit of absolute power results.</p> <p>dBm: Meas Type = Total Pwr Ref</p> <p>dBm/Hz: Meas Type = PSD Ref, PSD Unit = dBm/Hz</p> <p>dBm/MHz: Meas Type = PSD Ref, PSD Unit = dBm/MHz</p> <p>If the results are not available, 9.91E+37 is returned.</p>
Mode = MSR, LTEAFDD,LTEATDD	n = 9	<p>Returns scalar values of the pass/fail (0 = passed, or 1 = failed) determined by testing the relative to the reference carrier and by testing the absolute power limit of the offset frequencies.</p> <p>1. Inner Lower offset A - relative limit result</p> <p>2. Inner Lower offset A - absolute limit result</p> <p>3. Inner Upper offset A - relative limit result</p> <p>4. Inner Upper offset A - absolute limit result</p> <p>5. Inner Lower offset B - relative limit result</p> <p>6. Inner Lower offset B - absolute limit result</p> <p>7. Inner Upper offset B - relative limit result</p> <p>8. Inner Upper offset B - absolute limit result</p> <p>...</p> <p>21. Inner Lower offset F - relative limit result</p> <p>22. Inner Lower offset F - absolute limit result</p> <p>23. Inner Upper offset F - relative limit result</p>

Condition	N	Results Returned
		24. Inner Upper offset F - absolute limit result
Mode = MSR, LTEAFDD,LTEATDD	n = 10	<p>Returns scalar values of offset results. Numbers returned in this trace is 10 x actually measured offsets. Note that upper and lower sides of an offset are returned separately. For example, when only outer offset A is measured with offset side both, 10 x 2 = 20 values are returned.</p> <ol style="list-style-type: none"> <li>1. Inner = 1 or Outer = 2.</li> <li>2. Offset A~F. (A=1, B=2, ... F=6)</li> <li>3. Offset Side. Lower=1 or Upper=2</li> <li>4. Relative power or relative PSD (dBc or dB)</li> <li>5. Absolute power (dBm) or absolute PSD (dBm/Hz or dBm/MHz)</li> <li>6. Reference power (dBm) or reference PSD (dBm/Hz or dBm/MHz)</li> <li>7. Reference Index 1</li> <li>8. Reference Index 2</li> <li>9. 0 (Reserved)</li> <li>10. 0 (Reserved)</li> </ol> <p>...</p> <ol style="list-style-type: none"> <li>10(n-1)+1. Inner = 1 or Outer = 2.</li> <li>10(n-1)+2. Offset A~F. (A=1, B=2, ... F=6)</li> <li>10(n-1)+3. Offset Side. Lower=1 or Upper=2</li> <li>10(n-1)+4. Relative power or relative PSD (dBc or dB)</li> <li>10(n-1)+5. Absolute power (dBm) or absolute PSD (dBm/Hz or dBm/MHz)</li> <li>10(n-1)+6. Reference power (dBm) or reference PSD (dBm/Hz or dBm/MHz)</li> <li>10(n-1)+7. Reference Index 1</li> <li>10(n-1)+8. Reference Index 2</li> <li>10(n-1)+9. 0 (Reserved)</li> <li>10(n-1)+10. 0 (Reserved)</li> </ol> <p>Where n is number of offsets.</p> <p>Meas Type determines which type of power result is returned, i.e. power or PSD. Unit for PSD results is determined by PSD Unit.</p> <p>If result is not available, 9.91E+37 is returned.</p>

Key Path	Front-panel key
Initial S/W Revision	Prior to A.02.00
Modified at S/W Revision	A.13.00

## AMPTD Y Scale

Accesses a menu of functions that enable you to set the vertical scale parameters. The parameter values are measurement independent, except all Attenuation values and the Internal Preamp selections, which are the same across all measurements.

Key Path	Front-panel key
Initial S/W Revision	Prior to A.02.00

### Ref Value

Sets the value for the absolute power reference. However, since the Auto Scaling is defaulted to On, this value is automatically determined by the measurement result. When you set a value manually, Auto Scaling automatically changes to Off.

Key Path	AMPTD Y Scale
Mode	SA, WCDMA, C2K, WIMAX OFDMA, TD-SCDMA, 1xEVDO, DVB-T/H, DTMB (CTTB), ISDB-T, CMMB, LTE, LTE-TDD, Digital Cable TV, MSR, LTEAFDD, LTEATDD
<b>Remote Command</b>	:DISPlay:ACPower:VIEW[1]:WINDow[1]:TRACe:Y[:SCALe]:RLEVel <real> :DISPlay:ACPower:VIEW[1]:WINDow[1]:TRACe:Y[:SCALe]:RLEVel?
<b>Example</b>	DISP:ACP:VIEW:WIND:TRAC:Y:RLEV 100 DISP:ACP:VIEW:WIND:TRAC:Y:RLEV?
Notes	You must be in the mode that includes ACP measurements to use this command. Use :INSTrument:SElect to set the mode.
Couplings	When the Auto Scaling is On, this value is automatically determined by the measurement result. When you set a value manually, Auto Scaling automatically changes to Off.
Preset	10dBm
State Saved	Saved in instrument state.
Min	-250.00 dBm
Max	250.00 dBm
Initial S/W Revision	Prior to A.02.00
Modified at S/W Revision	A.02.00, A.03.00

### Attenuation

This menu controls the attenuator functions and interactions between the attenuation system components.

There are two attenuator configurations in the X-Series. One is a dual attenuator configuration consisting of a mechanical attenuator and an optional electronic attenuator. The other configuration uses a single attenuator with combined mechanical and electronic sections that controls all the attenuation functions. Different models in the X-Series come with different configurations.

See "Dual Attenuator Configurations:" on page 658

See "Single Attenuator Configuration:" on page 659

Most Attenuation settings are the same for all measurements – they do not change as you change measurements. Settings like these are called “Meas Global” and are unaffected by Meas Preset.

Key Path	AMPTD Y Scale
Scope	Meas Global
Dependencies	In measurements that support the I/Q inputs, this key is unavailable when I/Q is the selected input, and is replaced by the Range key in that case.
Readback Line	Contains a summary in [ ] brackets of the current total attenuation. See the descriptions of the , " (Mech) Atten " on page 2783, and "Enable Elec Atten" on page 2785 keys for more detail on the contributors to the total attenuation.  Note that when "Pre-Adjust for Min Clip" is on, this value can change at the start of every measurement.
Initial S/W Revision	Prior to A.02.00
Modified at S/W Revision	A.03.00

### Dual Attenuator Configurations:

Configuration 1: Mechanical attenuator + optional electronic attenuator

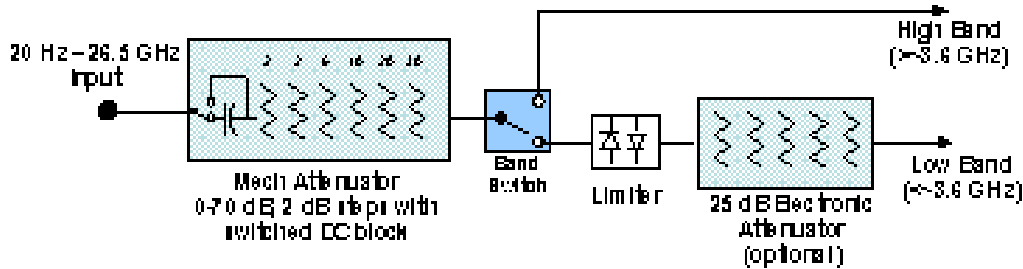

Configuration 2: Mechanical attenuator, no optional electronic attenuator

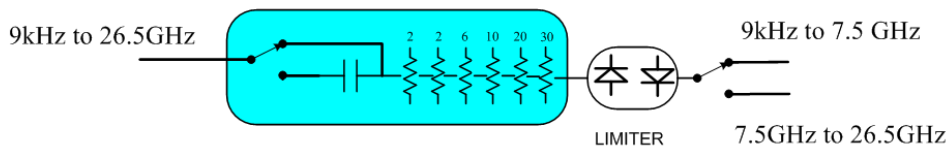

(note that Configuration 2 is not strictly speaking a dual-section attenuator, since there is no electronic section available. However, it behaves exactly like Configuration 1 without the Electronic Attenuator option EA3, therefore for the sake of this document it is grouped into the “Dual Attenuator” configuration)

### Single Attenuator Configuration:

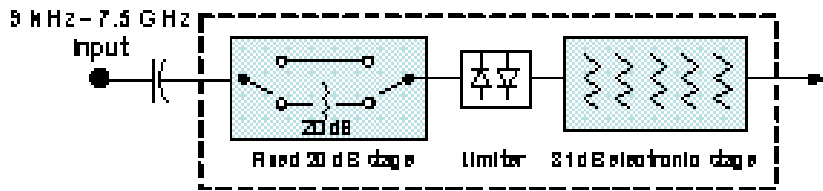

You can tell which attenuator configuration you have by pressing the Attenuation key, which (in most Modes) opens the Attenuation menu. If the first key in the Attenuation menu says Mech Atten you have the dual attenuator configuration. If the first key says Atten you have the single attenuator configuration.

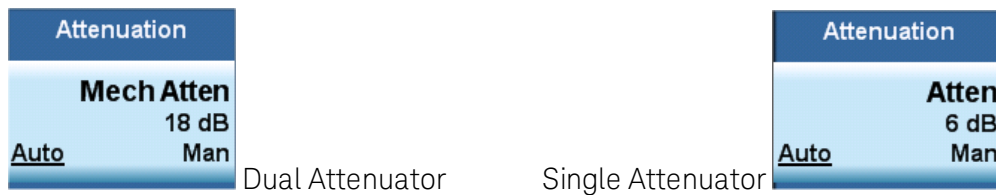

In the single attenuator configuration, you control the attenuation with a single control, as the fixed stage has only two states. In the dual attenuator configuration, both stages have significant range so you are given separate control of the mechanical and electronic attenuator stages.

When you have the dual attenuator configuration, you may still have only a single attenuator, because unless option EA3 (the Electronic Attenuator option) is available, and you purchase it, you will have only the mechanical attenuator.

### (Mech) Atten

This key is labeled Mech Atten in dual attenuator models and Atten in single attenuator models. In the dual attenuator configuration, this key only affects the mechanical attenuator.

This key lets you modify the attenuation applied to the RF input signal path. This value is normally auto coupled to the Ref Level, the Internal Preamp Gain, any External Gain that is entered, and the Max Mixer Level, as described in the table below.

See "[Attenuator Configurations and Auto/Man](#)" on page 661

Key Path	AMPTD Y Scale, Attenuation
<b>Remote Command</b>	<pre>[ :SENSe]:POWer[:RF]:ATTenuation &lt;rel_amp1&gt;</pre> <pre>[ :SENSe]:POWer[:RF]:ATTenuation?</pre> <pre>[ :SENSe]:POWer[:RF]:ATTenuation:AUTO OFF ON 0 1</pre> <pre>[ :SENSe]:POWer[:RF]:ATTenuation:AUTO?</pre>
<b>Example</b>	<p>POW:ATT 20</p> <p>Dual attenuator configuration: sets the mechanical attenuator to 20 dB</p> <p>Single attenuator mode: sets the main attenuation to 20 dB (see below for definition of "main" attenuation).</p> <p>If the attenuator was in Auto, it sets it to Manual.</p>
<b>Dependencies</b>	Some measurements do not support the Auto setting of (Mech) Atten. In these measurements, the

---

Auto/Man selection is not available, and the Auto/Man line on the key disappears.

In dual attenuator configurations, when the electronic attenuator is enabled, the mechanical attenuator has no auto setting and the Auto/Man line on the key disappears. The state of Auto/Man is remembered and restored when the electronic attenuator is once again disabled. This is described in more detail in the ["Enable Elec Atten" on page 2785](#) key description.

See ["Attenuator Configurations and Auto/Man" on page 661](#) for more information on the Auto/Man functionality of Attenuation.

---

Couplings

When (Mech) Atten is in Auto, it uses the following algorithm to determine a value:

If the USB Preamp is connected to USB, use 0 dB.

Otherwise,  $Atten = ReferenceLevel + PreAmpGain + ExternalGain - RefLevelOffset - MaxMixerLevel + IF\ Gain$ .

Limit this value to be between 6 dB and the Max value. No value below 6 dB can ever be chosen by Auto.

The resulting value is rounded up to the largest value possible given the attenuation step setting. That is, 50.01 dB would change to 60 dB (for a 10 dB attenuation step).

The "IF Gain" term in the equation above is either 0 dB or +10 dB, depending on the settings of FFT IF Gain, Swept IF Gain, max Ref Level and the Auto/Man setting of Mech Atten.

In External Mixing and BBIQ, where the Attenuator is not in the signal path, the Attenuator setting changes as described above when (Mech) Atten is in Auto, but no changes are made to the actual attenuator hardware setting until the input is changed back to the RF Input.

---

Preset

The preset for Mech Attenuation is "Auto."

The Auto value of attenuation is:

CXA, EXA, MXA and PXA: 10 dB

---

State Saved

Saved in instrument state

---

Min

0 dB

The attenuation set by this key cannot be decreased below 6 dB with the knob or step keys. To get to a value below 6 dB it has to be directly entered from the keypad or via SCPI. This protects from adjusting the attenuation to a dangerously small value which can put the instrument at risk of damage to input circuitry. However, if the current mechanical attenuation is below 6 dB it can be increased with the knob and step keys, but not decreased.

---

Max

CXA N9000A-503/507: 50 dB

CXA N9000A-513/526: 70dB

EXA: 60 dB

MXA and PXA: 70 dB

In the single attenuator configuration, the total of ATT and EATT cannot exceed 50 dB, so if the EATT is set to 24 dB first, the main attenuation cannot be greater than 26 dB and will be reduced accordingly; if the main attenuator is set to 40 dB first, EATT cannot be greater than 10 dB.

---

Initial S/W Revision

Prior to A.02.00

Modified at S/W Revision

A.03.00

---



## Attenuator Configurations and Auto/Man

As described in the Attenuation key description, there are two distinct attenuator configurations available in the X-Series, the single attenuator and dual attenuator configurations. In dual attenuator configurations, we have the mechanical attenuation and the electronic attenuation, and the current total attenuation is the sum of the electronic + mechanical attenuation. In single attenuator configurations, we refer to the attenuation set using the (Mech) Atten key (or POW:ATT SCPI) as the “main” attenuation; and the attenuation that is set by the SCPI command POW:EATT as the “soft” attenuation (the POW:EATT command is honored even in the single attenuator configuration, for compatibility purposes). Then the current total attenuation is the sum of the main + soft attenuation. See the Elec Atten key description for more on “soft” attenuation.

In the dual attenuator configuration, when the electronic attenuator is enabled, there is no Auto/Man functionality for the mechanical attenuator, and the third line of the key label (the Auto/Man line) disappears:

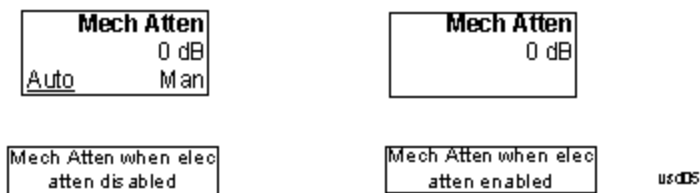

## Enable Elec Atten

Enables the Electronic Attenuator.

The electronic attenuator offers finer steps than the mechanical attenuator, has no acoustical noise, is faster, and is less subject to wear. These advantages primarily aid in remote operation and are negligible for front panel use. See ["Using the Electronic Attenuator: Pros and Cons" on page 663](#) for a detailed discussion of the pros and cons of using the electronic attenuator.

For the single attenuator configuration, for SCPI backwards compatibility, the “soft” attenuation feature replaces the dual attenuator configuration’s electronic attenuator. All the same couplings and limitations apply. See ["Attenuator Configurations and Auto/Man" on page 2785](#)

See ["More Information" on page 662](#)

Key Path	AMPTD Y Scale, Attenuation
<b>Remote Command</b>	[ :SENSE ] :POWER [ :RF ] :EATTenuation :STATE OFF   ON   0   1 [ :SENSE ] :POWER [ :RF ] :EATTenuation :STATE ?
<b>Example</b>	POW:EATT:STAT ON
<b>Dependencies</b>	This key only appears in Dual Attenuator models with an Electronic Attenuator installed. It does not appear in models with the Single Attenuator configuration, as in the single attenuator configuration there is no “electronic attenuator” there is only a single integrated attenuator (which has both a mechanical and electronic stage). However, in the single attenuator configuration, EATT SCPI commands are accepted for compatibility with other X-series instruments and set a “soft” attenuation as described in <a href="#">"Attenuator Configurations and Auto/Man" on page 2785</a> . The electronic attenuator (and the “soft” attenuation function provided in single attenuator configurations) is unavailable above 3.6 GHz. Therefore, if the Stop Frequency of the analyzer is > 3.6 GHz then the Enable Elec Atten key will be OFF and grayed out.

	<p>If the Internal Preamp is on, meaning it is set to Low Band or Full, the electronic attenuator (and the “soft” attenuation function provided in single attenuator configurations) is unavailable. In this case the Enable Elec Atten key will be OFF and grayed out.</p> <p>If either of the above is true, if the SCPI command is sent, an error indicating that the electronic attenuator is unavailable will be sent.</p> <p>If the electronic/soft Attenuator is enabled, then the Stop Freq of the analyzer is limited to 3.6 GHz and the Internal Preamp is unavailable.</p> <p>The SCPI-only “soft” electronic attenuation for the single-attenuator configuration is not available in all measurements; in particular, it is not available in the Swept SA measurement.</p>
Couplings	Enabling and disabling the Electronic Attenuator affects the setting of the Mechanical Attenuator (in dual attenuator configurations). This is described in more detail below this table.
Preset	OFF for Swept SA measurement; ON for all other measurements that support the electronic attenuator
State Saved	Saved in instrument state
Initial S/W Revision	Prior to A.02.00
Modified at S/W Revision	A.03.00

## More Information

### Mechanical Attenuator Transition Rules

When the Electronic Attenuator is enabled, the Mechanical Attenuator transitions to a state that has no Auto function. Below are the rules for transitioning the Mechanical Attenuator. NOTE that the information below ONLY applies to the dual attenuator configurations, and ONLY when the Electronic Attenuator is installed:

#### When the Electronic Attenuation is enabled from a disabled state:

- The Mechanical Attenuator is initialized to 10 dB (this is its optimal performance setting). You can then set it as desired with SCPI, numeric keypad, step keys, or knob, and it behaves as it normally would in manual mode
- The Auto/Man state of (Mech) Atten is saved
- The Auto/Man line on the (Mech) Atten key disappears and the auto rules are disabled
- The Electronic Attenuator is set to 10 dB less than the previous value of the Mechanical Attenuator, within the limitation that it must stay within the range of 0 to 24 dB of attenuation.

#### Examples in the dual attenuator configuration:

- Mech Atten at 20 dB. Elec Atten enabled, Mech Atten set to 10 dB, and Elec Atten set to 10 dB. New total attenuation equals the value before Elec Atten enabled.
- Mech Atten at 0 dB. Elec Atten enabled, Mech Atten set to 10 dB, and Elec Atten set to 0 dB. New total attenuation does not equal the value before Elec Atten enabled.
- Mech Atten at 40 dB. Elec Atten enabled, Mech Atten set to 10 dB, and Elec Atten set to 24 dB. New total attenuation does not equal the value before Elec Atten enabled.

### When the Electronic Attenuation is disabled from an enabled state:

- The Elec Atten key is grayed out
- The Auto/Man state of (Mech) Atten is restored
- If now in Auto, (Mech) Atten recouples
- If now in Man, (Mech) Atten is set to the value of total attenuation that existed before the Elec Atten was disabled. The resulting value is rounded up to the smallest value possible given the (Mech) Atten Step setting - (That is, 57 dB changes to 58 dB when (Mech) Atten Step is 2 dB.)

### Using the Electronic Attenuator: Pros and Cons

The electronic attenuator offers finer steps than the mechanical attenuator, has no acoustical noise, is faster, and is less subject to wear.

The “finer steps” advantage of the electronic attenuator is beneficial in optimizing the alignment of the analyzer dynamic range to the signal power in the front panel as well as remote use. Thus, you can achieve improved relative signal measurement accuracy. Compared to a mechanical attenuator with 2 dB steps, the 1 dB resolution of the electronic attenuator only gives better resolution when the odd-decibel steps are used. Those odd-decibel steps are less accurately calibrated than the even-decibel steps, so one tradeoff for this superior relative accuracy is reduced absolute amplitude accuracy.

Another disadvantage of the electronic attenuator is that the spectrum analyzer loses its “Auto” setting, making operation less convenient.

Also, the relationship between the dynamic range specifications (TOI, SHI, compression and noise) and instrument performance are less well-known with the electrical attenuator. With the mechanical attenuator, TOI, SHI and compression threshold levels increase dB-for-dB with increasing attenuation, and the noise floor does as well. With the electronic attenuator, there is an excess attenuation of about 1 to 3 dB between 0 and 3.6 GHz, making the effective TOI, SHI, and so forth, less well known. Excess attenuation is the actual attenuation relative to stated attenuation. Excess attenuation is accounted for in the analyzer calibration

### Elec Atten

Controls the Electronic Attenuator in dual attenuator configurations. This key does not appear in single attenuator configurations, as the control of both the mechanical and electronic stages of the single attenuator is integrated into the single Atten key.

Key Path	AMPTD Y Scale, Attenuation
<b>Remote Command</b>	<code>[ :SENSe ] :POWer [ :RF ] :EATTenuation &lt;rel_ampl&gt;</code> <code>[ :SENSe ] :POWer [ :RF ] :EATTenuation?</code>
<b>Notes</b>	Electronic Attenuation's specification is defined only when Mechanical Attenuation is 6 dB.
<b>Dependencies</b>	This key only appears in Dual Attenuator models with an Electronic Attenuator installed. It does not appear in models with the Single Attenuator configuration, as in the single attenuator configuration there is no “electronic attenuator” there is only a single integrated attenuator (which has both a mechanical and electronic stage). However, in the single attenuator configuration, EATT SCPI commands are accepted for compatibility with other X-series instruments and set a “soft” attenuation as described in <a href="#">"Attenuator Configurations and Auto/Man" on page 2785</a> . The “soft” attenuation is treated as an addition to the “main” attenuation value set by the Atten softkey or the

	POW:ATT SCPI command and affects the total attenuation displayed on the Attenuation key and the Meas Bar. When Enable Elec Atten is off or grayed out, the Elec Atten key is grayed out.
Preset	0 dB
State Saved	Saved in instrument state
Min	0 dB
Max	Dual attenuator configuration: 24 dB Single attenuator configuration: the total of ATT and EATT cannot exceed 50 dB, so if the EATT is set to 24 dB first, the main attenuation cannot be greater than 26 dB and will be reduced accordingly; if the main attenuator is set to 40 dB first, EATT cannot be greater than 10 dB
Initial S/W Revision	Prior to A.02.00
Modified at S/W Revision	A.03.00

### Adjust Atten for Min Clip

Sets the combination of mechanical and electronic attenuation and gain based on the current measured signal level so that clipping will be at a minimum.

This is an "immediate action" function, that is, it executes once, when the key is pressed.

This key is grayed out in measurements that do not support this functionality. The spectrum analyzer measurement, Swept SA, does not support this functionality.

Key Path	AMPTD Y Scale, Attenuation
Remote Command	<code>[ :SENSe ] :POWer [ :RF ] :RANGe:OPTimize IMMEDIATE</code>
Initial S/W Revision	Prior to A.02.00
Modified at S/W Revision	A.03.00

### Pre-Adjust for Min Clip

If this function is on, it does the adjustment described under ["Adjust Atten for Min Clip" on page 2788](#) each time a measurement restarts. Therefore, in Continuous measurement mode, it only executes before the first measurement.

In dual attenuator models, you can set Elec+Mech Atten, in which case both attenuators participate in the autoranging, or Elec Atten Only, in which case the mechanical attenuator does not participate in the autoranging. This latter case results in less wear on the mechanical attenuator and is usually faster.

This key is grayed out in measurements that do not support this functionality. The spectrum analyzer measurement, Swept SA, does not support this functionality.

Key Path	AMPTD Y Scale, Attenuation
Remote Command	<code>[ :SENSe ] :POWer [ :RF ] :RANGe:OPTimize:ATTenuation OFF   ELECTRical   COMBined</code>

	<code>[ :SENSe ] :POWer [ :RF ] :RANGe:OPTimize:ATTenuation?</code>
Notes	The SCPI parameter <code>ELECTrical</code> sets this function to On in single attenuator models. The SCPI parameter <code>COMBined</code> is mapped to <code>ELECTrical</code> in single attenuator models; if you send <code>COMBined</code> , it sets the function to On and returns <code>ELEC</code> to a query.
Dependencies	This key only appears in Dual Attenuator models with an Electronic Attenuator installed. In instruments with Dual Attenuator model, when Enable Elec Atten is off or grayed out, the Pre-Adjust for Min Clip key is grayed out.
Preset	OFF for Swept SA measurement; ON for all other measurements that support Pre-Adjust for Min Clip
State Saved	Saved in instrument state
Range	Dual attenuator models: Off   Elec Atten Only   Mech + Elec Atten Single attenuator models: Off   On
Initial S/W Revision	Prior to A.02.00
Modified at S/W Revision	A.03.00

<b>Remote Command</b>	<code>[ :SENSe ] :POWer [ :RF ] :RANGe:AUTO ON OFF 1 0</code> <code>[ :SENSe ] :POWer [ :RF ] :RANGe:AUTO?</code>
Notes	ON aliases to "Elec Atten Only" ( <code>:POW:RANG:OPT:ATT ELEC</code> ) OFF aliases to "Off" ( <code>:POW:RANG:OPT:ATT OFF</code> ) The query <code>:POW:RANG:AUTO?</code> returns true if <code>:POW:RANG:OPT:ATT</code> is not "Off"
Initial S/W Revision	Prior to A.02.00

## Off

Turns Pre-Adjust for Min Clip off. This is the default setting.

This key is grayed out in measurements that do not support this functionality. The spectrum analyzer measurement, Swept SA, does not support this functionality.

Key Path	AMPTD Y Scale, Attenuation, Pre-Adjust for Min Clip
Example	<code>:POW:RANGe:OPT:ATT OFF</code>
Initial S/W Revision	Prior to A.02.00

## Elec Atten Only

Selects only the electric attenuator to participate in auto ranging. This offers less wear on the mechanical attenuator and is usually faster.

This key is grayed out in measurements that do not support this functionality. The spectrum analyzer measurement, Swept SA, does not support this functionality.

Key Path	AMPTD Y Scale, Attenuation, Pre-Adjust for Min Clip
Example	:POW:RANGe:OPT:ATT ELEC
Initial S/W Revision	Prior to A.02.00

### Mech + Elec Atten

In dual attenuator models, this selects both attenuators participate in the autoranging.

This key is grayed out in measurements that do not support this functionality. The spectrum analyzer measurement, Swept SA, does not support this functionality.

Key Path	AMPTD Y Scale, Attenuation, Pre-Adjust for Min Clip
Example	:POW:RANGe:OPT:ATT COMB
Initial S/W Revision	Prior to A.02.00

### (Mech) Atten Step

This controls the step size used when making adjustments to the input attenuation.

This key is labeled Mech Atten Step in dual attenuator models and Atten Step in single attenuator models. In the dual attenuator configuration, this key only affects the step size of the mechanical attenuator.

Key Path	AMPTD Y Scale, Attenuation
<b>Remote Command</b>	[ :SENSe ] : POWer [ :RF ] : ATTenuation : STEP [ :INCRement ] 10 dB   2 dB [ :SENSe ] : POWer [ :RF ] : ATTenuation : STEP [ :INCRement ] ?
<b>Example</b>	POW:ATT:STEP 2
Notes	Note this feature works like a 1-N choice from the front panel, but it takes a specific value (in dB) when used remotely. The only valid values are 2 and 10.
Dependencies	Blanked in CXA and EXA if option FSA (2 dB steps) is not present. If blanked, attempts to set it via SCPI will yield an error.
Couplings	When the attenuation step size changes, the current mechanical attenuation value is adjusted (if necessary) to be quantized to the new step size. That is, if step is set to 10 dB, mech atten is increased if necessary so it is a multiple of 10 dB
Preset	PXA and MXA: 2 dB EXA and CXA: 10 dB (2 dB with option FSA)
State Saved	Saved in instrument state
Initial S/W Revision	Prior to A.02.00
Modified at S/W Revision	A.03.00

## Scale/Div

Sets the units-per-division of the vertical scale in the logarithmic display. However, since the Auto Scaling is defaulted to On, this value is automatically determined by the measurement result. When you set a value manually, Auto Scaling automatically changes to Off.

Key Path	AMPTD Y Scale
Mode	SA, WCDMA, C2K, WIMAX OFDMA, TD-SCDMA, 1xEVDO, DVB-T/H, DTMB (CTTB), ISDB-T, CMMB, LTE, LTE-TDD, Digital Cable TV, MSR, LTEAFDD, LTEATDD
Remote Command	:DISPlay:ACPower:VIEW[1]:WINDow[1]:TRACe:Y[:SCALe]:PDIVision <rel_ampl> :DISPlay:ACPower:VIEW[1]:WINDow[1]:TRACe:Y[:SCALe]:PDIVision?
Example	DISP:ACP:VIEW:WIND:TRAC:Y:PDIV 5 DISP:ACP:VIEW:WIND:TRAC:Y:PDIV?
Notes	You must be in the mode that includes ACP measurements to use this command. Use :INSTrument:SElect to set the mode.
Couplings	When the Auto Scaling is On, this value is automatically determined by the measurement result. When you set a value manually, Auto Scaling automatically changes to Off.
Preset	10.00 dB
State Saved	Saved in instrument state.
Min	0.10 dB
Max	20.00 dB
Initial S/W Revision	Prior to A.02.00
Modified at S/W Revision	A.02.00, A.03.00

## Presel Center

When this key is pressed, the centering of the preselector filter is adjusted to optimize the amplitude accuracy at the frequency of the selected marker. If the selected marker is not on when Presel Center is pressed, the analyzer will turn on the selected marker, perform a peak search, and then perform centering on the marker's center frequency. If the selected marker is already on and between the start and stop frequencies of the analyzer, the analyzer performs the preselector calibration on that marker's frequency. If the selected marker is already on, but outside the frequency range between Start Freq and Stop Freq, the analyzer will first perform a peak search, and then perform centering on the marker's center frequency.

The value displayed on the Presel Adjust key will change to reflect the new preselector tuning (see Presel Adjust).

A number of considerations should be observed to ensure proper operation. See ["Proper Preselector Operation" on page 668](#).

Key Path	AMPTD Y Scale
Remote Command	[:SENSe]:POWer[:RF]:PCENter
Example	POW:PCEN
Notes	Note that the rules outlined above under the key description apply for the remote command as well

	as the key. The result of the command is dependent on marker position, and so forth. Any message shown by the key press is also shown in response to the remote command.
Dependencies	<ul style="list-style-type: none"> <li>• Grayed out if the microwave preselector is off. )</li> <li>• If the selected marker's frequency is below Band 1, advisory message 0.5001 is generated and no action is taken.</li> <li>• Grayed out if entirely in Band 0.</li> <li>• Blank in models that do not include a preselector, such as option 503. If the SCPI is sent in these instruments, it is accepted without error, and the query always returns 0.</li> <li>• Grayed out in the Spectrogram View.</li> </ul>
Couplings	<p>The active marker position determines where the centering will be attempted.</p> <p>If the analyzer is in a measurement such as averaging when centering is initiated, the act of centering the preselector will restart averaging but the first average trace will not be taken until the centering is completed.</p>
Status Bits/OPC dependencies	<p>When centering the preselector, *OPC will not return true until the process is complete and a subsequent measurement has completed, nor will results be returned to a READ or MEASURE command.</p> <p>The Measuring bit should remain set while this command is operating and should not go false until the subsequent sweep/measurement has completed.</p>
Initial S/W Revision	Prior to A.02.00
Modified at S/W Revision	A.03.00

## Proper Preselector Operation

A number of considerations should be observed to ensure proper operation:

1. If the selected marker is off, the analyzer will turn on a marker, perform a peak search, and adjust the preselector using the selected marker's frequency. It uses the "highest peak" peak search method unqualified by threshold or excursion, so that there is no chance of a 'no peak found' error. It continues with that peak, even if it is the peak of just noise. Therefore, for this operation to work properly, there should be a signal on screen in a preselected range for the peak search to find.
2. If the selected marker is already on, the analyzer will attempt the centering at that marker's frequency. There is no preselector for signals below about 3.6 GHz, therefore if the marker is on a signal below 3.6 GHz, no centering will be attempted and an advisory message generated
3. In some models, the preselector can be bypassed. If it is bypassed, no centering will be attempted in that range and a message will be generated.

## Preselector Adjust

Allows you to manually adjust the preselector filter frequency to optimize its response to the signal of interest. This function is only available when "[Presel Center](#)" on page 2791 is available.

For general purpose signal analysis, using Presel Center is recommended. Centering the filter minimizes the impact of long-term preselector drift. Presel Adjust can be used instead to manually optimize the



preselector. One application of manual optimization would be to peak the preselector response, which both optimizes the signal-to-noise ratio and minimizes amplitude variations due to small (short-term) preselector drifting.

Key Path	AMPTD Y Scale
Scope	Meas Global
<b>Remote Command</b>	<code>[ :SENSe ] :POWer [ :RF ] :PADJust &lt;freq&gt;</code> <code>[ :SENSe ] :POWer [ :RF ] :PADJust?</code>
<b>Example</b>	POW:PADJ 100KHz POW:PADJ?
Notes	The value on the key reads out to 0.1 MHz resolution.
Dependencies	<ul style="list-style-type: none"> <li>• Grayed out if microwave preselector is off. )</li> <li>• Grayed out if entirely in Band 0.</li> <li>• Blank in models that do not include a preselector, such as option 503. If the SCPI is sent in these instruments, it is accepted without error, and the query always returns 0.</li> <li>• Grayed out in the Spectrogram View.</li> </ul>
Preset	0 MHz
State Saved	The Presel Adjust value set by Presel Center, or by manually adjusting Presel Adjust, is not saved in instrument state, and does not survive a Preset or power cycle.
Min	-500 MHz
Max	500 MHz
Default Unit	Hz
<b>Backwards Compatibility SCPI</b>	<code>[ :SENSe ] :POWer [ :RF ] :MW:PADJust</code> <code>[ :SENSe ] :POWer [ :RF ] :MMW:PADJust</code> PSA had multiple preselectors, but the X-Series has only one. These commands simply alias to <code>[ :SENSe ] :POWer [ :RF ] :PADJust</code>
Initial S/W Revision	Prior to A.02.00
Modified at S/W Revision	A.03.00

<b>Remote Command</b>	<code>[ :SENSe ] :POWer [ :RF ] :PADJust:PRESelector MWAVE   MMWave   EXTernal</code> <code>[ :SENSe ] :POWer [ :RF ] :PADJust:PRESelector?</code>
Notes	PSA had multiple preselectors, and you could select which preselector to adjust. Since the X-Series has only one mm/uW preselector, the preselector selection softkey is no longer available. However, to provide backward compatibility, we accept the legacy remote commands. The command form has no effect, the query always returns MWAVE
Initial S/W Revision	Prior to A.02.00

## μW Path Control

The μW Path Control functions include the μW Preselector Bypass (Option MPB) and Low Noise Path (Option LNP) controls in the High Band path circuits.

When the μW Preselector is bypassed, the user has better flatness, but will be subject to spurs from out of band interfering signals. When the Low Noise Path is enabled, the analyzer automatically switches around certain circuitry in the high frequency bands which can contribute to noise, when it is appropriate based on other analyzer settings.

For most applications, the preset state is Standard Path, which gives the best remote-control throughput, minimizes acoustic noise from switching and minimizes the risk of wear out in the hardware switches. For applications that utilize the wideband IF paths, the preset state is the μW Preselector Bypass path, if option MPB is present. This is because, when using a wideband IF such as the 140 MHz IF, the μW Preselector's bandwidth can be narrower than the available IF bandwidth, causing degraded amplitude flatness and phase linearity, so it is desirable to bypass the preselector in the default case.

Users may choose Low Noise Path Enable. It gives a lower noise floor, especially in the 21–26.5 GHz region, though without improving many measures of dynamic range, and without giving the best possible noise floor. The preamp, if purchased and used, gives better noise floor than does the Low Noise Path, however its compression threshold and third-order intercept are much poorer than that of the non-preamp Low Noise Path. There are some applications, typically for signals around –30 dBm, for which the third-order dynamic range of the standard path is good enough, but the noise floor is not low enough even with 0 dB input attenuation. When the third-order dynamic range of the preamp path is too little and the noise floor of the standard path is too high, the Low Noise Path can provide the best dynamic range.

<b>Key Path</b>	AMPTD Y Scale
<b>Mode</b>	SA, BASIC, PNOISE, VSA , LTE, LTETDD
<b>Scope</b>	Meas Global
<b>Remote Command</b>	[ :SENSe ] :POWer [ :RF ] :MW:PATH STD LNPath MPBypass FULL [ :SENSe ] :POWer [ :RF ] :MW:PATH?
<b>Example</b>	:POW:MW:PATH LNP Enables the Low Noise path
<b>Notes</b>	If a Presel Center is performed, the analyzer will momentarily switch to the Standard Path, regardless of the setting of μW Path Control  The DC Block will always be switched in when the low noise path is switched in, to protect succeeding circuitry from DC. Note that this does not mean “when the low noise path is enabled” but when, based on the Low Noise Path rules, the path is actually switched in. This can happen when the selection is Low Noise Path Enable . In the case where the DC Block is switched in the analyzer is now AC coupled. However, if the user has selected DC coupling, the UI will still behave as though it were DC coupled, including all annunciation, warnings, status bits, and responses to SCPI queries. This is because, based on other settings, the analyzer could switch out the low noise path at any time and hence go back to being DC coupled.  Alignment switching ignores the settings in this menu, and restores them when finished.
<b>Dependencies</b>	Unavailable in BBIQ and External Mixing
<b>Preset</b>	All modes other than IQ Analyzer mode and VXA: STD IQ Analyzer, VXA and WLAN mode: MPB option present and licensed: MPB

	MPB option not present and licensed: STD
State Saved	Save in instrument state
Readback	Value selected in the submenu
Initial S/W Revision	A.04.00
Modified at S/W Revision	A.10.00

## Standard Path

This path gives the best remote-control throughput, minimizes acoustic noise from switching and minimizes the risk of wear in the hardware switches, particularly in remote test scenarios where both low band and high band setups will follow in rapid succession.

In this path, the bypass of the low band/high band switch and microwave preamp is never activated, which can cause some noise degradation but preserves the life of the bypass switch.

Key Path	AMPTD Y Scale, $\mu$ W Path Control
<b>Example</b>	:POW:MW:PATH STD
Readback Text	Standard Path
Initial S/W Revision	A.04.00

## Low Noise Path Enable

You may choose Low Noise Path Enable, which gives a lower noise floor under some circumstances, particularly when operating in the 21–26.5 GHz region. With the Low Noise Path enabled, the low band/high band switch and microwave preamp are bypassed whenever all of the following are true:

- The analyzer is not in the Low Band, meaning:
- the start frequency is above 3.5 GHz and
- the stop frequency is above 3.6 GHz.
- the internal preamp is not installed or (if installed) is set to Off or Low Band

Note that this means that, when any part of a sweep is done in Low Band, the Low Noise Path is not used, whether or not the Low Noise Path Enable is selected in the user interface. Also, if the preamp is turned on, the Low Noise Path is not used, whether or not the Low Noise Path Enable is selected in the user interface. The only time the Low Noise Path is used is when Low Noise Path Enable is selected, the sweep is completely in High Band (> 3.6 GHz) and no preamp is in use.

See "[More Information](#)" on page 672

Key Path	AMPTD Y Scale, $\mu$ W Path Control
Measurement	Swept SA
<b>Example</b>	:POW:MW:PATH LNP

Notes	<p>For measurements that use IQ acquisition, the low noise path is used when the Center Frequency is in High Band (&gt; 3.6 GHz) and no preamp is in use.</p> <p>In other words, the rules above are modified to use only the center frequency to qualify which path to switch in.</p> <p>This is not the case for FFT's in the Swept SA measurement; they use the same rules as swept measurements.</p>
Dependencies	<p>Key is blanked if current mode does not support it.</p> <p>Key is grayed out if mode supports it but current measurement does not support it.</p> <p>Unless Option LNP is present and licensed, key is blank and if SCPI command sent, error -241, "Hardware missing; Option not installed" is generated.</p>
Readback Text	Low Noise Path Enable
Initial S/W Revision	A.04.00

### More Information

The user should understand that the Low Noise Path, while giving improved DANL, has the disadvantage of decreased TOI performance and decreased gain compression performance relative to the standard path.

The user should also understand that the bypass switch is a mechanical switch and has finite life, so if the Low Noise Path is enabled, it is possible to cause frequent cycling of this switch by frequently changing analyzer settings such that the above conditions hold true only some of the time. A user making tests of this nature should consider opting for the Standard Path, which will never throw the bypass switch, at the expense of some degraded noise performance.

The low noise path is useful for situations where the signal level is so low that the analyzer performance is dominated by noise even with 0 dB attenuation, but still high enough that the preamp option would have excessive third-order intermodulation or compression. The preamp, if purchased and used, gives better noise floor than does the "Low Noise Path." However, its compression threshold and third-order intercept are much poorer than that of the non-preamp path. There are some applications, typically for signals around -30 dBm, for which the third-order dynamic range of the standard path is good enough, but the noise floor is not low enough even with 0 dB input attenuation. When the third-order dynamic range of the preamp path is too little and the noise floor of the standard path is too high, the Low Noise Path can provide the best dynamic range

The graph below illustrates the concept. It shows, in red, the performance of an analyzer at different attenuation settings, both with the preamp on and off, in a measurement that is affected by both analyzer noise and analyzer TOI. The green shows the best available dynamic range, offset by 0.5 dB for clarity. The blue shows how the best available dynamic range improves for moderate signal levels with the low noise path switched in. In this illustration, the preamp improves the noise floor by 15 dB while degrading the third-order intercept by 30 dB, and the low noise path reduces loss by 8 dB. The attenuator step size is 2 dB.

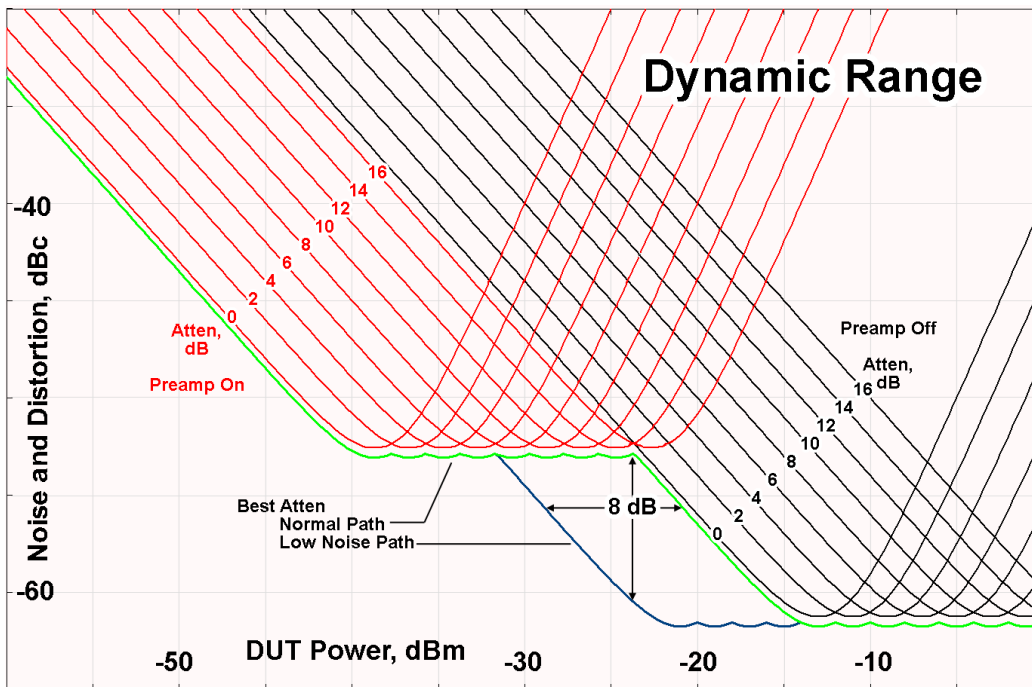

There are other times where selecting the low noise path improves performance, too. Compression-limited measurements such as finding the nulls in a pulsed-RF spectrum can profit from the low noise path in a way similar to the TOI-limited measurement illustrated. Accuracy can be improved when the low noise path allows the optimum attenuation to increase from a small amount like 0, 2 or 4 dB to a larger amount, giving better return loss at the analyzer input. Harmonic measurements, such as second and third harmonic levels, are much improved using the low noise path because of the superiority of that path for harmonic (though not intermodulation) distortion performance.

### $\mu$ W Preselector Bypass

This key toggles the preselector bypass switch for band 1 and higher. When the microwave preselector is on, the signal path is preselected. When the microwave preselector is off, the signal path is not preselected. The preselected path is the normal path for the analyzer.

The preselector is a tunable bandpass filter which prevents signals away from the frequency of interest from combining in the mixer to generate in-band spurious signals (images). The consequences of using a preselector filter are its limited bandwidth, the amplitude and phase ripple in its passband, and any amplitude and phase instability due to center frequency drift.

Option MPB or pre-selector bypass provides an unpreselected input mixer path for certain X-Series signal analyzers with frequency ranges above 3.6 GHz. This signal path allows a wider bandwidth and less amplitude variability, which is an advantage when doing modulation analysis and broadband signal analysis. The disadvantage is that, without the preselector, image signals will be displayed. Another disadvantage of bypassing the preselector is increased LO emission levels at the front panel input port.

Image responses are separated from the real signal by twice the 1st IF. For IF Paths of 10 MHz and 25 MHz, the 1st IF is 322.5 MHz, so the image response and the real signal will be separated by 645 MHz. The 1st IF will be different for other IF Path settings. When viewing a real signal and its corresponding image response in internal mixing, the image response will be to the left of the real signal.

Also, the image response and the real signal typically have the same amplitude and exhibit the same shape factor.

However, if Option FS1, Fast Sweep Capability, is enabled, the image response in the Swept SA measurement will appear lower in amplitude and have a much wider shape factor compared to the real signal.

Key Path	AMPTD Y Scale, $\mu$ W Path Control
Example	:POW:MW:PATH MPB
Dependencies	Key is blanked if current mode does not support it. Key is grayed out if mode supports it but current measurement does not support it. Key is blank unless Option MPB is present and licensed. If SCPI command sent when MPB not present, error -241, "Hardware missing; Option not installed" is generated.
Readback Text	$\mu$ W Preselector Bypass
Initial S/W Revision	A.04.00

Remote Command	[ :SENSe ] :POWeR [ :RF ] :MW :PRESelector [ :STATe ] ON   OFF   0   1 [ :SENSe ] :POWeR [ :RF ] :MW :PRESelector [ :STATe ] ?
Example	:POW:MW:PRES OFF Bypasses the microwave preselector
Notes	The ON parameter sets the STD path (:POW:MW:PATH STD) The OFF parameter sets path MPB (:POW:MW:PATH MPB)
Preset	ON

## Internal Preamp

Accesses a menu of keys that control the internal preamps. Turning on the preamp gives a better noise figure, but a poorer TOI to noise floor dynamic range. You can optimize this setting for your particular measurement.

The instrument takes the preamp gain into account as it sweeps. If you sweep outside of the range of the preamp the instrument will also account for that. The displayed result will always reflect the correct gain.

For some measurements, when the preamp is on and any part of the displayed frequency range is below the lowest frequency for which the preamp has specifications, a warning condition message appears in the status line. For example, for a preamp with a 9 kHz lowest specified frequency: "Preamp: Accy unspec'd below 9 kHz".

Key Path	AMPTD Y Scale
Scope	Meas Global
Remote Command	[ :SENSe ] :POWeR [ :RF ] :GAIN [ :STATe ] OFF   ON   0   1 [ :SENSe ] :POWeR [ :RF ] :GAIN [ :STATe ] ?
Dependencies	Preamp is not available on all hardware platforms. If the preamp is not present or is unlicensed, the

key is not shown.  
The preamp is not available when the electronic/soft attenuator is enabled.

Couplings	<p>The act of connecting the U7227A USB Preamplifier to one of the analyzer's USB ports will cause the Internal Preamp to be switched on. When this happens an informational message will be generated: "Internal Preamp turned on for optimal operation with USB Preamp." Note that if the Internal Preamp was already on, there will be no change to the setting, but if it was Off it will be switched On, to Full Range.</p> <p>Note that this same action occurs when the SA mode is selected while the USB Preamp is connected to one of the analyzer's USB ports, if it is the first time that the SA mode has run since powerup, or if the last time the SA mode was running the USB Preamp was NOT connected.</p> <p>Subsequently disconnecting the USB Preamp from USB does not change the Internal Preamp setting nor restore the previous setting.</p>
Preset	OFF
State Saved	Saved in instrument state
Initial S/W Revision	Prior to A.02.00
Modified at S/W Revision	A.14.00

Key Path	AMPTD Y Scale, Internal Preamp
Scope	Meas Global
<b>Remote Command</b>	<pre>[ :SENSe] :POWer [ :RF] :GAIN:BAND LOW FULL [ :SENSe] :POWer [ :RF] :GAIN:BAND?</pre>
Dependencies	<p>Preamp is not available on all hardware platforms. If the preamp is not present or is unlicensed, the key is not shown.</p> <p>If a POW:GAIN:BAND FULL command is sent when a low band preamp is available, the preamp band parameter is to LOW instead of FULL, and an "Option not installed" message is generated.</p>
Preset	LOW
State Saved	Saved in instrument state
Initial S/W Revision	Prior to A.02.00

## Off

Turns the internal preamp off

Key Path	AMPTD Y Scale, Internal Preamp
<b>Example</b>	:POW:GAIN OFF
Readback	Off
Initial S/W Revision	Prior to A.02.00

## Low Band

Sets the internal preamp to use only the low band.

The frequency range of the installed (optional) low-band preamp is displayed in square brackets on the Low Band key label.

Key Path	AMPTD Y Scale, Internal Preamp
<b>Example</b>	:POW:GAIN ON :POW:GAIN:BAND LOW
Readback	Low Band
Initial S/W Revision	Prior to A.02.00

## Full Range

Sets the internal preamp to use its full range. The low band (0–3.6 GHz or 0–3GHz, depending on the model) is supplied by the low band preamp and the frequencies above low band are supplied by the high band preamp.

The frequency range of the installed (optional) preamp is displayed in square brackets on the Full Range key label. If the high band option is not installed the Full Range key does not appear.

Key Path	AMPTD Y Scale, Internal Preamp
<b>Example</b>	:POW:GAIN ON :POW:GAIN:BAND FULL
Readback	Full Range
Initial S/W Revision	Prior to A.02.00

## Ref Position

Positions the reference level at the top, center, or bottom of the Y- scale display. Changing the reference position does not change the reference level value.

Key Path	AMPTD Y Scale
Mode	SA, WCDMA, C2K, WIMAX OFDMA, TD-SCDMA, 1xEVDO, DVB-T/H, DTMB (CTTB), ISDB-T, CMMB, LTE, LTETDD, Digital Cable TV, MSR, LTEAFDD, LTEATDD
<b>Remote Command</b>	:DISPlay:ACPower:VIEW[1]:WINDow[1]:TRACe:Y[:SCALe]:RPOSition TOP   CENTer   BOTTom :DISPlay:ACPower:VIEW[1]:WINDow[1]:TRACe:Y[:SCALe]:RPOSition?
<b>Example</b>	DISP:ACP:VIEW:WIND:TRAC:Y:RPOS CENT DISP:ACP:VIEW:WIND:TRAC:Y:RPOS?
Notes	You must be in the mode that includes ACP measurements to use this command. Use :INSTRument:SElect to set the mode.
Preset	TOP



State Saved	Saved in instrument state.
Range	Top Ctr Bot
Initial S/W Revision	Prior to A.02.00
Modified at S/W Revision	A.02.00, A.03.00

## Auto Scaling

Toggles the Auto Scaling function between On and Off.

Key Path	AMPTD Y Scale
Mode	SA, WCDMA, C2K, WIMAX OFDMA, TD-SCDMA, 1xEVDO, DVB-T/H, DTMB (CTTB), ISDB-T, CMMB, LTE, LTE-TDD, Digital Cable TV, MSR, LTEAFDD, LTEATDD
Remote Command	:DISPlay:ACPowEr:VIEW[1]:WINDow[1]:TRACe:Y[:SCALe]:COUPLe 0   1   OFF   ON  :DISPlay:ACPowEr:VIEW[1]:WINDow[1]:TRACe:Y[:SCALe]:COUPLe?
Example	DISP:ACP:VIEW:WIND:TRAC:Y:COUP ON DISP:ACP:VIEW:WIND:TRAC:Y:COUP?
Notes	You must be in the mode that includes ACP measurements to use this command. Use :INSTrument:SElect to set the mode.
Couplings	When Auto Scaling is On and the Restart front-panel key is pressed, this function automatically determines the scale per division and reference values based on the measurement results. When you set a value to either Scale/Div or Ref Value manually, Auto Scaling automatically changes to Off.
Preset	ON
State Saved	Saved in instrument state.
Range	On Off
Initial S/W Revision	Prior to A.02.00
Modified at S/W Revision	A.02.00, A.03.00

## Auto Couple

The Auto Couple feature provides a quick and convenient way to automatically couple multiple instrument settings. This helps ensure accurate measurements and optimum dynamic range. When the Auto Couple feature is activated, either from the front panel or remotely, all parameters of the current measurement that have an Auto/Manual mode are set to Auto mode and all measurement settings dependent on (or coupled to) the Auto/Man parameters are automatically adjusted for optimal performance.

However, the Auto Couple key actions are confined to the current measurement only. It does not affect other measurements in the mode, and it does not affect markers, marker functions, or trace or display attributes.

See ["More Information" on page 678](#)

Key Path	Front-panel key
Remote Command	:COUPLe ALL NONE
Example	:COUP ALL
Notes	:COUPLe ALL puts all Auto/Man parameters in Auto mode (equivalent to pressing the Auto Couple key). :COUPLE NONE puts all Auto/Man parameters in manual mode. It decouples all the coupled instrument parameters and is not recommended for making measurements.
Initial S/W Revision	Prior to A.02.00

### More Information

There are two types of functions that have Auto/Manual modes.

#### Auto/Man Active Function keys

An Auto/Man toggle key controls the binary state associated with an instrument parameter by toggling between Auto (where the parameter is automatically coupled to the other parameters it is dependent upon) and Man (where the parameter is controlled independent of the other parameters), as well as making the parameter the active function. The current mode is indicated on the softkey with either Auto or Man underlined as illustrated below.



#### Auto/Man 1-of-N keys

An Auto/Man 1-of-N key allows you to manually pick from a list of parameter values, or place the function in Auto, in which case the value is automatically selected (and indicated) as shown below. If in Auto, Auto is underlined on the calling key. If in manual operation, manual is indicated on the calling key. But the calling key does not actually toggle the function, it simply opens the menu.

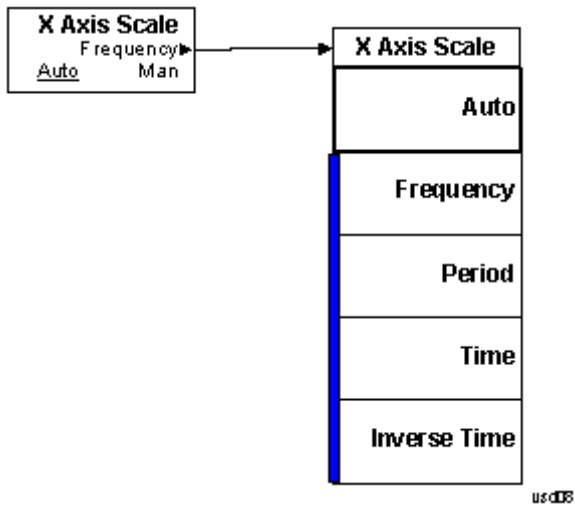

## BW

Accesses a menu of functions that enable you to specify and control the video and resolution bandwidths. You can also select the type of filter for the measurement and set the filter bandwidth.

Key Path	Front-panel key
Initial S/W Revision	Prior to A.02.00

## Res BW

Sets the value of the resolution bandwidth. If an unavailable bandwidth is entered with the numeric keypad, the closest available bandwidth is selected.

LTE-Advanced FDD/TDD Auto RBW:

Bandwidth	RBW (KHz)
1.4MHz	51KHz
3MHz	
5MHz	100 KHz
10MHz	
15MHz	
20MHz	

the resolution bandwidth is predefined based on the corresponding bandwidth of the single LTE carrier, which is listed above. When ResBW mode is Auto, the narrowest RBW over the active carriers is selected for Multi-carriers.

Key Path	BW
Mode	SA, WCDMA, C2K, WIMAX OFDMA, TD-SCDMA, 1xEVDO, DVB-T/H, DTMB (CTTB), ISDB-T, CMMB, LTE, LTE-TDD, Digital Cable TV, MSR, LTEAFDD, LTEATDD
<b>Remote Command</b>	[:SENSe]:ACPower:BANDwidth[:RESolution] <freq> [:SENSe]:ACPower:BANDwidth[:RESolution]? [:SENSe]:ACPower:BANDwidth[:RESolution]:AUTO ON OFF 1 0 [:SENSe]:ACPower:BANDwidth[:RESolution]:AUTO?
<b>Example</b>	ACP:BAND 25kHz ACP:BAND? ACP:BAND:AUTO ON ACP:BAND:AUTO?
<b>Notes</b>	This key is available only in IBW mode. This parameter is preset by the Meas Method selection. Preset values are as follows: IBW: 100 kHz

	IBWR: 27 kHz FAST (WCDMA): 390 kHz You must be in the mode that includes ACP measurements to use this command. Use :INSTrument:SElect to set the mode.
Dependencies	When Meas Method is RBW or FAST, this key is grayed out and disabled. If the key is pressed, an advisory message is generated. If the equivalent remote command is sent, a "Setting conflict" warning is generated.
Couplings	The resolution bandwidth is coupled to the video bandwidth based on the video to resolution bandwidth ratio setting if AUTO is selected.
Preset	SA: 220 kHz WCDMA: 100 kHz WIMAX OFDMA: 100 kHz C2K: 15 kHz TD-SCDMA: 30 kHz 1xEVDO: 30 kHz DVB-T/H: 39 kHz DTMB (CTTB): 39 kHz ISDB-T: 39 kHz CMMB: 39 kHz LTE: 100 kHz LTETDD: 100 kHz Digital Cable TV: 39 kHz MSR: 100 kHz LTEAFDD, LTEATDD: 100kHz LTEAFDD, LTEATDD: 1 Others:0
State Saved	Saved in instrument state.
Min	1 Hz
Max	8 MHz
<b>Backwards Compatibility SCPI</b>	[ :SENSe ] :ACP:Power:BWIDth[:RESolution] [ :SENSe ] :ACP:SWEep:BWIDth BWIDth[:RESolution] (PSA W-CDMA, PSA cdma2000 )
Initial S/W Revision	Prior to A.02.00
Modified at S/W Revision	A.02.00, A.03.00

## Video BW

Changes the analyzer post-detection filter (VBW).

Key Path	BW
Mode	SA, WCDMA, C2K, WIMAX OFDMA, TD-SCDMA, 1xEVDO, DVB-T/H, DTMB (CTTB), ISDB-T, CMMB,

	LTE, LTETDD, Digital Cable TV, MSR, LTEAFDD, LTEATDD
<b>Remote Command</b>	<pre>[ :SENSe ] :ACPower:BA NDwidth:VIDeo &lt;freq&gt; [ :SENSe ] :ACPower:BA NDwidth:VIDeo? [ :SENSe ] :ACPower:BA NDwidth:VIDeo:AUTO OFF ON 0 1 [ :SENSe ] :ACPower:BA NDwidth:VIDeo:AUTO?</pre>
<b>Example</b>	<pre>ACP:BA ND:VID 1kHz ACP:BA ND:VID? ACP:BWID:VID:AUTO ON ACP:BWID:VID:AUTO?</pre>
<b>Notes</b>	The values shown in this table reflect the conditions after a Mode Preset.
<b>Dependencies</b>	When Meas Method is RBW or FAST, this key is grayed out and disabled. If the key is pressed, an advisory message is generated. If the equivalent remote command is sent, a "Setting conflict" warning is generated.
<b>Preset</b>	<pre>SA: 22 kHz WCDMA, WIMAX OFDMA: 1 MHz C2K: Method RBW: grayed out (1.2 MHz) Method IBW: 150 kHz TD-SCDMA: 300 kHz 1xEVDO: 300 kHz DVB-T/H: 390 kHz DTMB (CTTB): 390 kHz ISDB-T: 390 kHz CMMB: 390 kHz LTE, LTETDD, MSR: Auto LTETDD: 1 MHz Digital Cable TV: 390 kHz LTEAFDD, LTEATDD: Auto SA: ON WCDMA: OFF WIMAX OFDMA: OFF TD-SCDMA: OFF DVB-T/H: OFF DTMB (CTTB): OFF CDMA1xEVDO: OFF ISDB-T: OFF CMMB: OFF LTE, MSR: ON LTETDD: ON Digital Cable TV: OFF</pre>

	LTEAFDD, LTEATDD: ON
State Saved	Saved in instrument state.
Min	1 Hz
Max	50 MHz
<b>Backwards Compatibility SCPI</b>	[ :SENSe ] :ACPower :BWIDth :VIDeo
Initial S/W Revision	Prior to A.02.00
Modified at S/W Revision	A.02.00, A.03.00

## RBW Control

Accesses a menu that enables you to select the filter bandwidth and type.

Key Path	BW
Initial S/W Revision	Prior to A.02.00

## Filter Type

Selects the type of bandwidth filter that is used. The choices are Gaussian or Flat top.

Key Path	BW, RBW Control
Mode	SA, WCDMA, C2K, WIMAX OFDMA, TD-SCDMA, 1xEVDO, DVB-T/H, DTMB (CTTB), ISDB-T, CMMB, LTE, LTE-TDD, Digital Cable TV, MSR, LTEAFDD, LTEATDD
<b>Remote Command</b>	[ :SENSe ] :ACPower :BANDwidth :SHAPE GAUSSian   FLATtop [ :SENSe ] :ACPower :BANDwidth :SHAPE?
<b>Example</b>	ACP:BAND:SHAP GAUS ACP:BAND:SHAP?
Dependencies	When Meas Method is FAST, this key is grayed out and disabled. If the key is pressed, an advisory message is generated. If the equivalent remote command is sent, a "Setting conflict" warning is generated.
Preset	GAUSSian C2K: FLATtop
State Saved	Saved in instrument state.
Range	Gaussian (Normal) Flattop
<b>Backwards Compatibility SCPI</b>	[ :SENSe ] :ACPower :BWIDth :SHAPE
Initial S/W Revision	Prior to A.02.00
Modified at S/W Revision	A.02.00, A.03.00

## Filter BW

Selects a Gaussian filter based on its -3 dB (Normal) bandwidth or its -6 dB bandwidth.

Key Path	BW, RBW Control
Mode	SA, WCDMA, C2K, WIMAX OFDMA, TD-SCDMA, 1xEVDO, DVB-T/H, DTMB (CTTB), ISDB-T, CMMB, LTE, LTE-TDD, Digital Cable TV, MSR, LTEAFDD, LTEATDD
<b>Remote Command</b>	<code>[ :SENSe ] :ACPower :BANDwidth :TYPE DB3   DB6</code> <code>[ :SENSe ] :ACPower :BANDwidth :TYPE ?</code>
<b>Example</b>	ACP:BAND:TYPE DB3 ACP:BAND:TYPE?
Dependencies	When Filter Type is Flattop or Meas Method is RBW or FAST, this key is grayed out and disabled. If the key is pressed, an advisory message is generated. If the equivalent remote command is sent, a "Setting conflict" warning is generated.
Preset	DB3
State Saved	Saved in instrument state.
Range	-3 dB (Normal)   -6 dB
<b>Backwards Compatibility SCPI</b>	<code>[ :SENSe ] :ACPower :BWIDth :TYPE</code>
Initial S/W Revision	Prior to A.02.00
Modified at S/W Revision	A.02.00, A.03.00



## Cont (Continuous Measurement/Sweep)

Sets the analyzer for Continuous measurement operation. The single/continuous state is Meas Global so the setting will affect all measurements. If you are Paused, pressing Cont does a Resume.

Key Path	Front-panel key
Remote Command	:INITiate:CONTinuous OFF ON 0 1 :INITiate:CONTinuous?
Example	:INIT:CONT 0 puts analyzer in Single measurement operation. :INIT:CONT 1 puts analyzer in Continuous measurement operation
Preset	ON (Note that SYST:PRESet sets INIT:CONT to ON but *RST sets INIT:CONT to OFF)
State Saved	Saved in instrument state
Backwards Compatibility Notes	For Spectrum Analysis mode in ESA and PSA, there is no Cont hardkey, instead there is a Sweep Single/Cont key. In these analyzers, switching the Sweep Single/Cont key from Single to Cont restarts averages (displayed average count reset to 1), but does not restart Max Hold and Min Hold. The X-Series has Single and Cont keys in place of the SweepSingleCont key. In the X-Series, if in single measurement, the Cont key (and INIT:CONT ON ) switches to continuous measurement, but never restarts a measurement and never resets a sweep.
Initial S/W Revision	Prior to A.02.00

In Swept SA Measurement (Spectrum Analysis Mode):

The analyzer takes repetitive sweeps, averages, measurements, etc., when in Continuous mode. When the average count reaches the Average/Hold Number the count stops incrementing, but the analyzer keeps sweeping. See the Trace/Detector section for the averaging formula used both before and after the Average/Hold Number is reached. The trigger condition must be met prior to each sweep. The type of trace processing for multiple sweeps, is set under the Trace/Detector key, with choices of Trace Average, Max Hold, or Min Hold.

In Other Measurements/Modes:

With Avg/Hold Num (in the Meas Setup menu) set to Off or set to On with a value of 1, a sweep is taken after the trigger condition is met; and the analyzer continues to take new sweeps after the current sweep has completed and the trigger condition is again met. However, with Avg/Hold Num set to On with a value >1, multiple sweeps (data acquisitions) are taken for the measurement. The trigger condition must be met prior to each sweep. The sweep is not stopped when the average count k equals the number N set for Avg/Hold Num is reached, but the number k stops incrementing. A measurement average usually applies to all traces, marker results, and numeric results. But sometimes it only applies to the numeric results.

If the analyzer is in Single measurement, pressing the Cont key does not change k and does not cause the sweep to be reset; the only action is to put the analyzer into Continuous measurement operation.

If it is already in continuous sweep:

the INIT:CONT 1 command has no effect

9 ACP Measurement  
Cont (Continuous Measurement/Sweep)

the INIT:CONT 0 command will place the analyzer in Single Sweep but will have no effect on the current sequence until  $k = N$ , at which point the current sequence will stop and the instrument will go to the idle state.

## File

See "File" on page 354

## FREQ Channel

Accesses a menu of keys that allow you to control the Frequency and Channel parameters of the instrument.

Some features in the Frequency menu are the same for all measurements – they do not change as you change measurements. Settings like these are called “Meas Global” and are unaffected by Meas Preset. For example, the Center Freq setting is the same for all measurements - it does not change as you change measurements.

Key Path	Front-panel key
Initial S/W Revision	Prior to A.02.00

### Center Freq

Sets the frequency that corresponds to the horizontal center of the graticule (when frequency Scale Type is set to linear). While adjusting the Center Frequency the Span is held constant, which means that both Start Frequency and Stop Frequency will change.

Pressing Center Freq also sets the frequency entry mode to Center/Span. In Center/Span mode, the center frequency and span values are displayed below the graticule, and the default active function in the Frequency menu is Center Freq.

The center frequency setting is the same for all measurements within a mode, that is, it is Meas Global. Some modes are also able to share a Mode Global center frequency value. If this is the case, the Mode will have a Global Settings key in its Mode Setup menu.

The Center Freq function sets (and queries) the Center Frequency for the currently selected input. If your analyzer has multiple inputs, and you select another input, the Center Freq changes to the value for that input. SCPI commands are available to directly set the Center Freq for a specific input.

Center Freq is remembered as you go from input to input. Thus you can set a Center Freq of 10 GHz with the RF Input selected, change to BBIQ and set a Center Freq of 20 MHz, then switch to External Mixing and set a Center Freq of 60 GHz, and when you go back to the RF Input the Center Freq will go back to 10 GHz; back to BBIQ and it is 20 MHz; back to External Mixing and it is 60 GHz.

See ["RF Center Freq" on page 691](#)

See [Ext Mix Center Freq](#)

See ["I/Q Center Freq" on page 693](#)

See ["Center Frequency Presets" on page 689](#)

Key Path	FREQ Channel
Scope	Meas Global
Remote Command	<code>[ :SENSe ] :FREQuency:CENTer &lt;freq&gt;</code> <code>[ :SENSe ] :FREQuency:CENTer?</code>

<b>Example</b>	<p>FREQ:CENT 50 MHz</p> <p>FREQ:CENT UP changes the center frequency to 150 MHz if you use FREQ:CENT:STEP 100 MHz to set the center frequency step size to 100 MHz</p> <p>FREQ:CENT?</p>
<b>Notes</b>	<p>This command sets either the RF or I/Q Center Frequency depending on the selected input.</p> <p>For RF input it is equivalent to FREQ:RF:CENT</p> <p>For I/Q input it is equivalent to FREQ:IQ:CENT</p> <p>Preset and Max values are dependent on Hardware Options (5xx)</p> <p>If no terminator (e.g. MHz) is sent the terminator Hz is used. If a terminator with unit other than Frequency is used, an invalid suffix error message is generated.</p>
<b>Dependencies</b>	<p>The Center Frequency can be limited by Start or Stop Freq limits, if the Span is so large that Start or Stop reach their limit.</p>
<b>Couplings</b>	<p>When operating in “swept span”, any value of the Center Frequency or Span that is within the frequency range of the analyzer is allowed when the value is being set through the front panel numeric key pad or the SCPI command. The other parameter is forced to a different value if needed, to keep the Start and the Stop Frequencies within the analyzer’s frequency range</p>
<b>Preset</b>	<p>Depends on instrument maximum frequency, mode, measurement, and selected input.</p> <p>See <a href="#">"Center Frequency Presets" on page 689</a> and <a href="#">"RF Center Freq" on page 691</a> and <a href="#">Ext Mix Center Freq</a> and <a href="#">"I/Q Center Freq" on page 693</a>.</p>
<b>State Saved</b>	<p>Saved in instrument state</p>
<b>Min</b>	<p>Depends on instrument maximum frequency, mode, measurement, and selected input..</p> <p>See <a href="#">"Center Frequency Presets" on page 689</a> and <a href="#">"RF Center Freq" on page 691</a> and <a href="#">"I/Q Center Freq" on page 693</a>.</p>
<b>Max</b>	<p>Depends on instrument maximum frequency, mode, measurement, and selected input..</p> <p>See <a href="#">"Center Frequency Presets" on page 689</a> and <a href="#">"RF Center Freq" on page 691</a> and <a href="#">"I/Q Center Freq" on page 693</a>.</p>
<b>Default Unit</b>	<p>Hz</p>
<b>Status Bits/OPC</b>	<p>Non-overlapped</p>
<b>Dependencies</b>	
<b>Initial S/W Revision</b>	<p>Prior to A.02.00</p>

## Center Frequency Presets

The following table provides the Center Frequency Presets for the Spectrum Analyzer mode, and the Max Freq, for the various frequency options:

Freq Option	CF after Mode Preset	Stop Freq after Mode Preset	Max Freq (can't tune)

9 ACP Measurement  
FREQ Channel

			above)
503 (all but N9000A)	1.805 GHz	3.6 GHz	3.7 GHz
503 (N9000A)	1.505 GHz	3.0 GHz	3.08 GHz
507 (all but N9000A)	3.505 GHz	7.0 GHz	7.1 GHz
507 (N9000A)	3.755 GHz	7.5 GHz	7.58 GHz
508 (all but N9038A)	1.805 GHz	3.6 GHz	8.5 GHz
508 (N9038A)	4.205 GHz	8.4 GHz	8.5 GHz
513	6.805 GHz	13.6 GHz	13.8 GHz
526 (all but N9000A and N9038A)	13.255 GHz	26.5 GHz	27.0 GHz
526 (N9000A)	13.255 GHz	26.5 GHz	26.55 GHz
526 (N9038A)	1.805 GHz	3.6 GHz	27.0 GHz
532	16.005 GHz	32.0 GHz	32.5 GHz
543	21.505 GHz	43.0 GHz	TBD
544	22.005 GHz	44.0 GHz	44.5 GHz
550	25.005 GHz	50.0 GHz	51 GHz

Input 2:

Model	CF after Mode Preset	Stop Freq after Mode Preset	Max Freq (can't tune above)
N9000A opt C75	0.7505GHz	1.5 GHz	1.58 GHz
N9038A	505 MHz	1 GHz	1.000025 GHz

Tracking Generator Frequency Limits (N9000A only):

Tracking Generator Option	Min Freq (clips to this freq when turn TG on and	If above this Freq, Stop Freq clipped to this Freq when	Max Freq (can't tune above) while TG

	can't tune below while TG on)	TG turned on	on
T03	9 kHz	3.0 GHz	3.08 GHz
T06	9 kHz	6.0 GHz	6.05 GHz

The following table shows the Center Frequency Presets for modes other than Spectrum Analyzer:

Mode	CF Preset for RF
WCDMA	1 GHz
WIMAXOFDMA,	1 GHz
BASIC	1 GHz
ADEMOD	1 GHz
VSA	1 GHz
TDSCDMA	1 GHz
PNOISE	1 GHz
LTE	1 GHz
LTETDD	1 GHz
MSR	1 GHz
GSM	935.2 MHz
NFIGURE	1.505 GHz

## RF Center Freq

SCPI command for specifying the RF Center Frequency. This command will set the Center Frequency to be used when the RF input is selected, even if the RF input is not the input that is selected at the time the command is sent. Note that the Center Freq function in the Frequency menu on the front panel always applies to the currently selected input.

Scope	Meas Global
<b>Remote Command</b>	<code>[ :SENSe ] :FREQuency:RF:CENTer &lt;freq&gt;</code> <code>[ :SENSe ] :FREQuency:RF:CENTer?</code>
<b>Example</b>	FREQ:RF:CENT 30 MHz
Notes	This command is the same in all modes, but the parameter is Measurement Global. So the value is independent in each mode and common across all the measurements in the mode.
Dependencies	If the electronic/soft attenuator is enabled, any attempt to set Center Frequency such that the Stop Frequency would be >3.6 GHz fails and results in an advisory message. If the equivalent SCPI command is sent, this same message is generated as part of a “-221, Settings conflict” warning. If Source Mode is set to Tracking, and the Max or Min Center Freq is therefore limited by the limits of the source, a warning message is generated, “Data out of range;clipped to source max/min” if these limits are exceeded. Note that for an external source, these limits can be affected by the settings of

	Source Numerator, Source Denominator and Power Sweep.
Preset	See table above
State Saved	Saved in instrument state.
Min	-79.999995 MHz, unless Source Mode is set to Tracking, in which case it is limited by the minimum frequency of the Source
Max	See table above. Basically instrument maximum frequency – 5 Hz. Note that, if the Source Mode is set to Tracking, the effective instrument maximum frequency may be limited by the source maximum frequency.  If the knob or step keys are being used, also depends on the value of the other three interdependent parameters Span, Start Frequency and Stop Frequency
Initial S/W Revision	Prior to A.02.00
Modified at S/W Revision	A.03.00

## Ext Mix Center Freq

SCPI command for specifying the External Mixer Center Frequency. This command will set the Center Frequency to be used when the External Mixer is selected, even if the External Mixer input is not the input which is selected at the time the command is sent. Note that the Center Freq function in the Frequency menu on the front panel always applies to the currently selected input.

Scope	Meas Global
Remote Command	<code>[ :SENSe ] :FREQuency:EMIXer:CENTer &lt;freq&gt;</code> <code>[ :SENSe ] :FREQuency:EMIXer:CENTer?</code>
Example	<code>:FREQ:EMIX:CENT 60 GHz</code> <code>:FREQ:EMIX:CENT?</code>
Notes	This command is the same in all modes, but the parameter is Measurement Global. So the value is independent in each mode and common across all the measurements in the mode.
Couplings	When returning to External Mixing after having been switched to one of the other inputs (e.g., RF), you will come back into the settings that you had when you left External Mixing. So you will come back to the band you were in with the Center Frequency that you had. However, Span is not an input-dependent parameter, therefore you will bring the span over from the other input. Therefore, the analyzer comes back with the span from the previous input, limited as necessary by the current mixer setup.
Preset	When a Mode Preset is performed while in External Mixing, the Start frequency of the current Mode is set to the nominal Min Freq of the lowest harmonic range in the Harmonic Table for the current mixer setup. Similarly, the Stop frequency of the current Mode is set to the nominal Max Freq of the highest harmonic range in the Harmonic Table. The Center Freq thus presets to the point arithmetically equidistant from these two frequencies.  If the current measurement has a limited Span available to it, and cannot achieve the Span shown in the table (Span=Stop Freq – Start Freq), the analyzer uses the maximum Span the measurement allows, and still sets the Center Freq to the midpoint of the Start and Stop Freq values in the Harmonic Table.



	When Restore Input/Output Defaults is performed, the mixer presets to the 11970A, whose Start and Stop frequencies are 26.5 and 40 GHz respectively. The center of these two frequencies is 33.25 GHz. Therefore, after a Restore Input/Output Defaults, if you go into External Mixing and do a Mode Preset while in the Spectrum Analyzer Mode, the resulting Center Freq is 33.25 GHz.
State Saved	Saved in instrument state.
Min	The minimum frequency in the currently selected mixer band + 5 Hz
Max	The maximum frequency in the currently selected mixer band – 5 Hz If the knob or step keys are being used, also depends on the value of the other three interdependent parameters Span, Start Frequency and Stop Frequency
Initial S/W Revision	A.08.01

### I/Q Center Freq

SCPI command for specifying the I/Q Center Frequency. This command will set the Center Frequency to be used when the I/Q input is selected, even if the I/Q input is not the input which is selected at the time the command is sent. Note that the Center Freq function in the Frequency menu on the front panel always applies to the currently selected input.

Scope	Meas Global
Remote Command	<code>[ :SENSe ] :FREQuency:IQ:CENTer &lt;freq&gt;</code> <code>[ :SENSe ] :FREQuency:IQ:CENTer?</code>
Example	FREQ:IQ:CENT: 30 MHz
Notes	This command is the same in all modes, but the parameter is Measurement Global. So the value is independent in each mode and common across all the measurements in the mode.
Preset	0 Hz
State Saved	Saved in instrument state.
Min	-40.049995 MHz
Max	40.049995 MHz
Initial S/W Revision	Prior to A.02.00

### CF Step

Changes the step size for the center frequency and start and stop frequency functions. Once a step size has been selected and the center frequency function is active, the step keys (and the UP|DOWN parameters for Center Frequency from remote commands) change the center frequency by the step-size value. The step size function is useful for finding harmonics and sidebands beyond the current frequency span of the analyzer.

Note that the start and stop frequencies also step by the CF Step value.

Key Path	FREQ Channel
Remote Command	<pre>[ :SENSe] :FREQuency:CENTer:STEP[:INCRement] &lt;freq&gt; [ :SENSe] :FREQuency:CENTer:STEP[:INCRement] ? [ :SENSe] :FREQuency:CENTer:STEP:AUTO OFF ON 0 1 [ :SENSe] :FREQuency:CENTer:STEP:AUTO?</pre>
Example	<pre>FREQ:CENT:STEP:AUTO ON FREQ:CENT:STEP 500 MHz FREQ:CENT UP increases the current center frequency value by 500 MHz FREQ:CENT:STEP? FREQ:CENT:STEP:AUTO?</pre>
Notes	Preset and Max values are depending on Hardware Options (503, 507, 508, 513, 526)
Notes	Preset and Max values are dependent on Hardware Options (5xx)
Dependencies	Freq Offset is not available in External Mixing. In this case the Freq Offset key is grayed out and shows a value of zero. It will once again be available, and show the previously set value, when you return to the RF Input.
Dependencies	Span, RBW, Center frequency If the electronic/soft attenuator is enabled, any attempt to change the value of the center frequency >3.6 GHz by pressing the Up-arrow key, fails and results in an advisory message. If the equivalent SCPI command is sent, this same message is generated as part of a “-221, Settings conflict” warning.
Couplings	When auto-coupled in a non-zero span, the center frequency step size is set to 10% of the span. When auto-coupled in zero span, the center frequency step size is set to the equivalent -3 dB RBW value.
Preset	Auto ADEMOD: 1 MHz ON
State Saved	Saved in instrument state
Min	– (the maximum frequency of the instrument). That is, 27 GHz max freq instrument has a CF step range of +/- 27 GHz. Note that this is the maximum frequency given the current settings of the instrument, so in External Mixing, for example, it is the maximum frequency of the current mixer band.
Max	The maximum frequency of the instrument. That is, 27 GHz max freq instrument has a CF step range of +/- 27 GHz. Note that this is the maximum frequency given the current settings of the instrument, so in External Mixing, for example, it is the maximum frequency of the current mixer band.
Default Unit	Hz
Status Bits/OPC dependencies	non-overlapped
Initial S/W Revision	Prior to A.02.00
Modified at S/W Revision	A.03.00

## Input/Output

See ["Input/Output" on page 226](#)

## Marker

Accesses a menu that enables you to select, set up and control the markers for the current measurement. Note that this hard key and all sub keys are unavailable when "Meas Method" on page 744 is set to RBW.

Key Path	Front-panel key
Initial S/W Revision	Prior to A.02.00

### Select Marker

Displays 12 markers available for selection. Note that this key is unavailable when "Meas Method" on page 744 is set to RBW.

Key Path	Marker
Initial S/W Revision	Prior to A.02.00

### Marker Type

Sets the marker control mode to Normal, Delta, Fixed or Off. All interactions and dependencies detailed under the key description are enforced when the remote command is sent. If the selected marker is Off, pressing Marker sets it to Normal and places it at the center of the screen on the trace determined by the Marker Trace rules. At the same time, Marker X Axis Value appears on the Active Function area.

The default active function is the active function for the currently selected marker control mode. If the current control mode is Off, there is no active function and the active function is turned off.

Key Path	Marker
Mode	SA, WCDMA, C2K, WIMAX OFDMA, TD-SCDMA, 1xEVDO, DVB-T/H, DTMB (CTTB), ISDB-T, CMMB, LTE, LTE-TDD, Digital Cable TV, MSR, LTEAFDD, LTEATDD
Remote Command	:CALCulate:ACPower:MARKer[1] 2 ... 12:MODE POSition   DELTa   OFF :CALCulate:ACPower:MARKer[1] 2 ... 12:MODE?
Example	CALC:ACP:MARK2:MODE DELT CALC:ACP:MARK2:MODE?
Notes	If the selected marker is Off, pressing Marker sets it to Normal and places it at the center of the screen on the trace determined by the Marker Trace rules. At the same time, Marker X Axis Value appears on the Active Function area. Default Active Function: the active function for the selected marker's current control mode. If the current control mode is Off, there is no active function and the active function is turned off. Active Function Display: the marker X axis value entered in the active function area will display the marker value to its full entered precision. You must be in the mode that includes ACP measurements to use this command. Use :INSTrument:SElect to set the mode.
Dependencies	This key is unavailable when "Meas Method" on page 744 is set to RBW.

Preset	OFF OFF OFF OFF OFF OFF OFF OFF OFF OFF OFF OFF
State Saved	Saved in instrument state.
Range	Normal Delta Off
Initial S/W Revision	Prior to A.02.00
Modified at S/W Revision	A.02.00, A.03.00

## Properties

Accesses the marker properties menu. Note that this key is unavailable when "Meas Method" on page 744 is set to RBW.

Key Path	Marker
Initial S/W Revision	Prior to A.02.00

## Select Marker

Displays 12 markers available for selection. Note that this key is unavailable when "Meas Method" on page 744 is set to RBW.

Key Path	Marker
Initial S/W Revision	Prior to A.02.00

## Relative To

Selects the desired marker. The selected marker will be relative to its reference marker.

Key Path	Marker, Properties
Mode	SA, WCDMA, C2K, WIMAX OFDMA, TD-SCDMA, 1xEVDO, DVB-T/H, DTMB (CTTB), ISDB-T, CMMB, LTE, LTE-TDD, Digital Cable TV, MSR, LTEAFDD, LTEATDD
<b>Remote Command</b>	:CALCulate:ACPpower:MARKer[1] 2 ... 12:REFerence <integer> :CALCulate:ACPpower:MARKer[1] 2 ... 12:REFerence?
<b>Example</b>	CALC:ACP:MARK2:REF 6 CALC:ACP:MARK2:REF?
Notes	A marker cannot be relative to itself so that choice is grayed out, and if sent from a remote command, generates error -221: "Settings conflict; marker cannot be relative to itself." When queried a single value will be returned (the specified marker numbers relative marker). You must be in the mode that includes ACP measurements to use this command. Use :INSTrument:SELect to set the mode.
Dependencies	This key is unavailable when "Meas Method" on page 744 is set to RBW.

Preset	2 3 4 5 6 7 8 9 10 11 12 1
State Saved	Saved in instrument state.
Min	1
Max	12
Initial S/W Revision	Prior to A.02.00
Modified at S/W Revision	A.02.00, A.03.00

## Marker Trace

Selects the trace that you want your marker to be placed on. A marker is associated with one and only one trace. This trace is used to determine the placement, result, and X Axis Scale of the marker. All markers have an associated trace, even Fixed markers; it is from that trace that they determine their attributes and behaviors, and it is to that trace that they go when they become Normal or Delta markers.

Key Path	Marker, Properties
Mode	SA, WCDMA, C2K, WIMAX OFDMA, TD-SCDMA, 1xEVDO, DVB-T/H, DTMB (CTTB), ISDB-T, CMMB, LTE, LTE4DD, Digital Cable TV, MSR, LTEAFDD, LTEATDD
Remote Command	:CALCulate:ACPower:MARKer[1] 2 ... 12:TRACe 1 2 3 :CALCulate:ACPower:MARKer[1] 2 ... 12:TRACe?
Example	CALC:ACP:MARK2:TRAC 2 CALC:ACP:MARK2:TRAC?
Notes	If the selected marker is Off, pressing Marker sets it to Normal and places it at the center of the screen on the trace determined by the Marker Trace rules. At the same time, Marker X Axis Value appears on the Active Function area.  Default Active Function: the active function for the selected marker's current control mode. If the current control mode is Off, there is no active function and the active function is turned off.  Active Function Display: the marker X axis value entered in the active function area will display the marker value to its full entered precision.
Dependencies	This key is unavailable when " <a href="#">Meas Method</a> " on page 744 is set to RBW.
Couplings	This is not affected by Auto Coupling. Sending the remote command causes the addressed marker to become selected.
Preset	All Markers Off
State Saved	Saved in instrument state.
Range	1 2 3
Initial S/W Revision	Prior to A.02.00
Modified at S/W Revision	A.02.00, A.03.00

## Couple Markers

When this function is On, moving any marker causes an equal X axis movement of every other marker which is not Off. By “equal X axis movement” we mean that we preserve the difference between each marker’s X axis value (in the fundamental x-axis units of the trace that marker is on) and the X axis value of the marker being moved (in the same fundamental x-axis units).

Key Path	Marker
Mode	SA, WCDMA, C2K, WIMAX OFDMA, TD-SCDMA, 1xEVDO, DVB-T/H, DTMB (CTTB), ISDB-T, CMMB, LTE, LTE-TDD, Digital Cable TV, MSR, LTEAFDD, LTEATDD
<b>Remote Command</b>	:CALCulate:ACPower:MARKer:COUple[:STATE] ON OFF 1 0 :CALCulate:ACPower:MARKer:COUple[:STATE]?
<b>Example</b>	CALC:ACP:MARK:COUP ON
Dependencies	This key is unavailable when <b>"Meas Method" on page 744</b> is set to RBW.
Preset	OFF
State Saved	Saved in instrument state.
Range	On Off
Initial S/W Revision	Prior to A.02.00
Modified at S/W Revision	A.02.00, A.03.00

## Marker All Off

Turns all active markers off.

Key Path	Marker
Mode	SA, WCDMA, C2K, WIMAX OFDMA, TD-SCDMA, 1xEVDO, DVB-T/H, DTMB (CTTB), ISDB-T, CMMB, LTE, LTE-TDD, Digital Cable TV, MSR, LTEAFDD, LTEATDD
<b>Remote Command</b>	:CALCulate:ACPower:MARKer:AOff
<b>Example</b>	CALC:ACP:MARK:AOff
Dependencies	This key is unavailable when <b>"Meas Method" on page 744</b> is set to RBW.
Initial S/W Revision	Prior to A.02.00
Modified at S/W Revision	A.02.00, A.03.00

## Marker X Axis Value (Remote Command only)

Sets the marker X axis value in the current marker X Axis Scale unit. This value has no effect if the control mode is Off, but is the SCPI equivalent of entering an X value if the control mode is Normal, Delta or Fixed.

Mode	SA, WCDMA, C2K, WIMAX OFDMA, TD-SCDMA, 1xEVDO, DVB-T/H, DTMB (CTTB), ISDB-T, CMMB, LTE, LTE-TDD, Digital Cable TV, MSR, LTEAFDD, LTEATDD
<b>Remote Command</b>	:CALCulate:ACPower:MARKer[1] 2 ... 12:X <freq> :CALCulate:ACPower:MARKer[1] 2 ... 12:X?

<b>Example</b>	CALC:ACP:MARK3:X 0 CALC:ACP:MARK3:X?
Notes	The query returns the marker's absolute X Axis value if the control mode is Normal, or the offset from the marker's reference marker if the control mode is Delta. If the marker is Off the response is not a number.
Dependencies	Unavailable when " <b>Meas Method</b> " on page 744 is set to RBW.
Preset	After a preset, all Markers are turned OFF, so Marker X Axis Value query will return a not a number (NAN).
State Saved	No
Min	-9.9E+37
Max	9.9E+37
Initial S/W Revision	Prior to A.02.00
Modified at S/W Revision	A.02.00, A.03.00

### Marker X Axis Position (Remote Command only)

Sets the marker X position in trace points. It has no effect if the control mode is Off, but is the SCPI equivalent of entering a value if the control mode is Normal, Delta or Fixed. The entered value is immediately translated into the current X Axis Scale units for setting the value of the marker.

Mode	SA, WCDMA, C2K, WIMAX OFDMA, TD-SCDMA, 1xEVDO, DVB-T/H, DTMB (CTTB), ISDB-T, CMMB, LTE, LTE-TDD, Digital Cable TV, MSR, LTEAFDD, LTEATDD
<b>Remote Command</b>	:CALCulate:ACPower:MARKer[1] 2 ... 12:X:POsition <real> :CALCulate:ACPower:MARKer[1] 2 ... 12:X:POsition?
<b>Example</b>	CALC:ACP:MARK10:X:POS 0 CALC:ACP:MARK10:X:POS?
Notes	The query returns the marker's absolute X Axis value in trace points if the control mode is Normal, or the offset from the marker's reference marker in trace points if the control mode is Delta. The value is returned as a real number, not an integer, corresponding to the translation from X Axis Scale units to trace points (see "Fractional Trace Points"). If the marker is Off the response is not a number.  When a Marker is turned on, it is placed center of the screen on the trace. Therefore the default value depends on instrument condition, although the Preset/Default is defined as 500 (this value might be expected value when all offset is on).
Dependencies	Unavailable when " <b>Meas Method</b> " on page 744 is set to RBW.
Preset	After a preset, all Markers are turned OFF, so Marker X Axis Value query will return a not a number (NAN).
State Saved	No
Min	-9.9E+37
Max	9.9E+37
Initial S/W Revision	Prior to A.02.00
Modified at S/W Revision	A.02.00, A.03.00



## Marker Y Axis Value (Remote Command only)

Returns the marker Y axis value in the current marker Y axis unit.

Mode	SA, WCDMA, C2K, WIMAX OFDMA, TD-SCDMA, 1xEVDO, DVB-T/H, DTMB (CTTB), ISDB-T, CMMB, LTE, LTE-TDD, Digital Cable TV, MSR, LTEAFDD, LTEATDD
<b>Remote Command</b>	:CALCulate:ACPower:MARKer [1]   2   ...   12 : Y ?
<b>Example</b>	CALC:ACP:MARK11:Y?
Notes	Since the result value is always calculated from acquisition data, the default value is arbitrary. Although the Preset/Default values are defined.
Dependencies	Unavailable when " <b>Meas Method</b> " on page 744 is set to RBW.
Preset	Result dependent on markers setup and signal source.
State Saved	No
<b>Backwards Compatibility SCPI</b>	:CALCulate:ACPower:MARKer [1]   2   ...   12 : FUNCTION:RESult?
Initial S/W Revision	Prior to A.02.00
Modified at S/W Revision	A.02.00, A.03.00

## Backward Compatibility Remote Commands

Sets or queries the state of a marker. Setting a marker which is off to the on state or 1 puts it in Normal mode and places it at the center of the screen.

Mode	SA, WCDMA, WIMAX OFDMA, CDMA2K, TDSCDMA, CDMA1XEV, DVB, DTMB, ISDBT, CMMB, LTE, LTE-TDD, DCATV, MSR, LTEAFDD, LTEATDD
<b>Remote Command</b>	:CALCulate:ACPower:MARKer [1]   2   ...   12 : STATe OFF   ON   0   1 :CALCulate:ACPower:MARKer [1]   2   ...   12 : STATe?
<b>Example</b>	CALC:ACP:MARK2:STAT ON CALC:ACP:MARK2:STAT?
Notes	This parameter is also accessed from Marker, Properties, 1 You must be in the mode that includes ACP measurements to use this command. Use :INSTrument:SElect to set the mode.
Preset	OFF OFF OFF OFF OFF OFF OFF OFF OFF OFF OFF OFF
State Saved	Saved in instrument state.
Range	On Off
Initial S/W Revision	Prior to A.02.00
Modified at S/W Revision	A.02.00, A.03.00

## Marker Function

There are no Marker Functions supported in the ACP measurement. The front-panel key will display a blank key menu when pressed.

---

Key Path	Front-panel key
Initial S/W Revision	Prior to A.02.00

---

## Marker To

There is no Marker To functionality supported in ACP. The front-panel key will display a blank key menu when pressed.

---

Key Path	Front-panel key
Initial S/W Revision	Prior to A.02.00

---

## Meas

The information in this section is common to all measurements. For key and remote command information for a specific measurement, refer to the section that describes the measurement of interest.

Measurements available under the Meas key are specific to the current Mode.

When viewing Help for measurements, note the following:

**NOTE**

Operation for some keys differs between measurements. The information displayed in Help pertains to the current measurement. To see how a key operates in a different measurement, exit Help (press the Cancel Esc key), select the measurement, then reenter Help (press the Help key) and press that key.

---

Key Path	Front-panel key
Initial S/W Revision	Prior to A.02.00

---

### Remote Measurement Functions

This section contains the following topics:

["Measurement Group of Commands" on page 2849](#)

["Current Measurement Query \(Remote Command Only\)" on page 2851](#)

["Limit Test Current Results \(Remote Command Only\)" on page 2851](#)

["Data Query \(Remote Command Only\)" on page 2851](#)

["Calculate/Compress Trace Data Query \(Remote Command Only\)" on page 2852](#)

["Calculate Peaks of Trace Data \(Remote Command Only\)" on page 2857](#)

[Hardware-Accelerated Fast Power Measurement \(Remote Command Only\)](#)

["Format Data: Numeric Data \(Remote Command Only\)" on page 2858](#)

["Format Data: Byte Order \(Remote Command Only\)" on page 2859](#)

---

Initial S/W Revision	Prior to A.02.00
----------------------	------------------

---

## Measurement Group of Commands

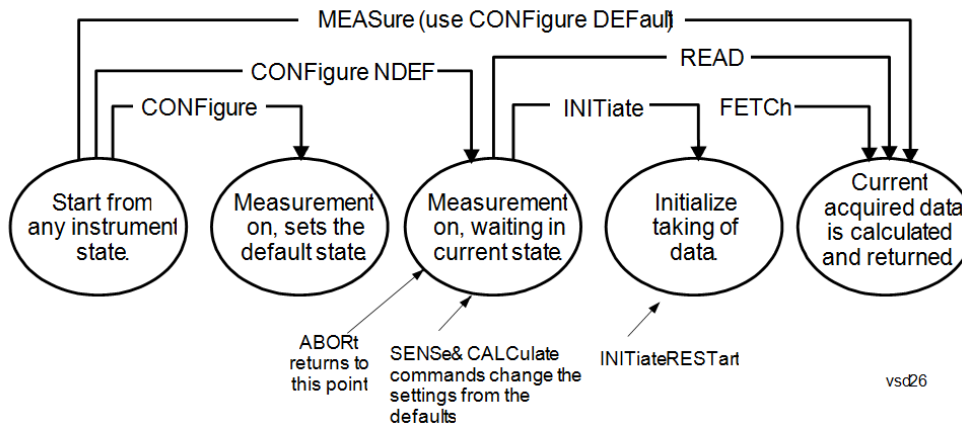

---

### Measure Commands:

:MEASure:<measurement>[n]?

This is a fast single-command way to make a measurement using the factory default instrument settings. These are the settings and units that conform to the Mode Setup settings (e.g. radio standard) that you have currently selected.

- Stops the current measurement (if any) and sets up the instrument for the specified measurement using the factory defaults
- Initiates the data acquisition for the measurement
- Blocks other SCPI communication, waiting until the measurement is complete before returning results.
- If the function does averaging, it is turned on and the number of averages is set to 10.
- After the data is valid it returns the scalar results, or the trace data, for the specified measurement. The type of data returned may be defined by an [n] value that is sent with the command.
- The scalar measurement results will be returned if the optional [n] value is not included, or is set to 1. If the [n] value is set to a value other than 1, the selected trace data results will be returned. See each command for details of what types of scalar results or trace data results are available.
- ASCII is the default format for the data output. (Older versions of Spectrum Analysis and Phase Noise mode measurements only use ASCII.) The binary data formats should be used for handling large blocks of data since they are smaller and faster than the ASCII format. Refer to the FORMat:DATA command for more information.

If you need to change some of the measurement parameters from the factory default settings you can set up the measurement with the CONFigure command. Use the commands in the SENSe:<measurement> and CALCulate:<measurement> subsystems to change the settings. Then you can use the READ? command to initiate the measurement and query the results.

If you need to repeatedly make a given measurement with settings other than the factory defaults, you can use the commands in the SENSe:<measurement> and CALCulate:<measurement> subsystems to set up the measurement. Then use the READ? command to initiate the measurement and query results.

Measurement settings persist if you initiate a different measurement and then return to a previous one. Use READ:<measurement>? if you want to use those persistent settings. If you want to go back to the default settings, use MEASure:<measurement>?.

---

### Configure Commands:

:CONFigure:<measurement>

This command stops the current measurement (if any) and sets up the instrument for the specified measurement using

---

---

the factory default instrument settings. It does not initiate the taking of measurement data unless INIT:CONTinuous is ON. If you change any measurement settings after using the CONFigure command, the READ command can be used to initiate a measurement without changing the settings back to their defaults.

In the Swept SA measurement in Spectrum Analyzer mode the CONFigure command also turns the averaging function on and sets the number of averages to 10 for all measurements.

:CONFigure: <measurement>: NDEFault stops the current measurement and changes to the specified measurement. It does not change the settings to the defaults. It does not initiate the taking of measurement data unless INIT:CONTinuous is ON.

The CONFigure? query returns the current measurement name.

The CONFigure:CATalog? query returns a quoted string of all licensed measurement names in the current mode. For example, "SAN, CHP, OBW, ACP, PST, TXP, SPUR, SEM, LIST".

---

#### Fetch Commands:

---

:FETCh:<measurement>[n]?

This command puts selected data from the most recent measurement into the output buffer. Use FETCh if you have already made a good measurement and you want to return several types of data (different [n] values, for example, both scalars and trace data) from a single measurement. FETCh saves you the time of re-making the measurement. You can only FETCh results from the measurement that is currently active, it will not change to a different measurement. An error message is reported if a measurement other than the current one is specified.

If you need to get new measurement data, use the READ command, which is equivalent to an INITiate followed by a FETCh.

The scalar measurement results will be returned if the optional [n] value is not included, or is set to 1. If the [n] value is set to a value other than 1, the selected trace data results will be returned. See each command for details of what types of scalar results or trace data results are available. The binary data formats should be used for handling large blocks of data since they are smaller and transfer faster than the ASCII format. (FORMat:DATA)

FETCh may be used to return results other than those specified with the original READ or MEASure command that you sent.

---

#### INITiate Commands:

---

:INITiate:<measurement>

This command is not available for measurements in all the instrument modes:

- Initiates a trigger cycle for the specified measurement, but does not output any data. You must then use the FETCh<meas> command to return data. If a measurement other than the current one is specified, the instrument will switch to that measurement and then initiate it.
  - For example, suppose you have previously initiated the ACP measurement, but now you are running the channel power measurement. If you send INIT:ACP? it will change from channel power to ACP and will initiate an ACP measurement.
  - Does not change any of the measurement settings. For example, if you have previously started the ACP measurement and you send INIT:ACP? it will initiate a new ACP measurement using the same instrument settings as the last time ACP was run.
  - If your selected measurement is currently active (in the idle state) it triggers the measurement, assuming the trigger conditions are met. Then it completes one trigger cycle. Depending upon the measurement and the number of averages, there may be multiple data acquisitions, with multiple trigger events, for one full trigger cycle. It also holds off additional commands on GPIB until the acquisition is complete.
- 

#### READ Commands:

---

:READ:<measurement>[n]?

- Does not preset the measurement to the factory default settings. For example, if you have previously initiated the ACP
-

---

measurement and you send READ:ACP? it will initiate a new measurement using the same instrument settings.

- Initiates the measurement and puts valid data into the output buffer. If a measurement other than the current one is specified, the instrument will switch to that measurement before it initiates the measurement and returns results.
  - For example, suppose you have previously initiated the ACP measurement, but now you are running the channel power measurement. Then you send READ:ACP? It will change from channel power back to ACP and, using the previous ACP settings, will initiate the measurement and return results.
  - Blocks other SCPI communication, waiting until the measurement is complete before returning the results
  - If the optional [n] value is not included, or is set to 1, the scalar measurement results will be returned. If the [n] value is set to a value other than 1, the selected trace data results will be returned. See each command for details of what types of scalar results or trace data results are available. The binary data formats should be used when handling large blocks of data since they are smaller and faster than the ASCII format. (FORMat:DATA)
- 

---

Initial S/W Revision	Prior to A.02.00
----------------------	------------------

---

### Current Measurement Query (Remote Command Only)

This command returns the name of the measurement that is currently running.

---

<b>Remote Command</b>	:CONFigure?
-----------------------	-------------

<b>Example</b>	CONF?
----------------	-------

Initial S/W Revision	Prior to A.02.00
----------------------	------------------

---

### Limit Test Current Results (Remote Command Only)

Queries the status of the current measurement limit testing. It returns a 0 if the measured results pass when compared with the current limits. It returns a 1 if the measured results fail any limit tests.

---

<b>Remote Command</b>	:CALCulate:CLIMits:FAIL?
-----------------------	--------------------------

<b>Example</b>	CALC:CLIM:FAIL? queries the current measurement to see if it fails the defined limits. Returns a 0 or 1: 0 it passes, 1 it fails.
----------------	--------------------------------------------------------------------------------------------------------------------------------------

Initial S/W Revision	Prior to A.02.00
----------------------	------------------

---

### Data Query (Remote Command Only)

Returns the designated measurement data for the currently selected measurement and subopcode.

n = any valid subopcode for the current measurement. See the measurement command results table for your current measurement, for information about what data is returned for the subopcodes.

This command uses the data setting specified by the FORMat:BORDER and FORMat:DATA commands and can return real or ASCII data. (See the format command descriptions under Input/Output in the Analyzer Setup section.)

<b>Remote Command</b>	:CALCulate:DATA[n]?
<b>Notes</b>	The return trace depends on the measurement. In CALCulate:<meas>:DATA[n], n is any valid subopcode for the current measurement. It returns the same data as the FETCH:<measurement>? query where <measurement> is the current measurement.
<b>Initial S/W Revision</b>	Prior to A.02.00

### Calculate/Compress Trace Data Query (Remote Command Only)

Returns compressed data for the currently selected measurement and sub-opcode [n].

n = any valid sub-opcode for that measurement. See the MEASure:<measurement>? command description of your specific measurement for information on the data that can be returned.

The data is returned in the current Y Axis Unit of the analyzer. The command is used with a sub-opcode <n> (default=1) to specify the trace. With trace queries, it is best if the analyzer is not sweeping during the query. Therefore, it is generally advisable to be in Single Sweep, or Update=Off.

This command is used to compress or decimate a long trace to extract and return only the desired data. A typical example would be to acquire N frames of GSM data and return the mean power of the first burst in each frame. The command can also be used to identify the best curve fit for the data.

<b>Remote Command</b>	:CALCulate:DATA<n>:COMPRESS? BLOCK   CFIT   MAXimum   MINimum   MEAN   DMEan   RMS   RMSCubed   SAMPLE   SDEVIation   PPHase [,<soffset> [,<length>[,<roffset>[,<rlimit>]]]]
<b>Example</b>	To query the mean power of a set of GSM bursts: Supply a signal that is a set of GSM bursts. Select the IQ Waveform measurement (in IQ Analyzer Mode). Set the sweep time to acquire at least one burst. Set the triggers such that acquisition happens at a known position relative to a burst. Then query the mean burst levels using, CALC:DATA2:COMP? MEAN, 24e-6, 526e-6 (These parameter values correspond to GSM signals, where 526e-6 is the length of the burst in the slot and you just want 1 burst.)
<b>Notes</b>	The command supports 5 parameters. Note that the last 4 (<soffset>, <length>, <roffset>, <rlimit>) are optional. But these optional parameters must be entered in the specified order. For example, if you want to specify <length>, then you must also specify <soffset>. See details below for a definition of each of these parameters.  This command uses the data in the format specified by FORMat:DATA, returning either binary or ASCII data.
<b>Initial S/W Revision</b>	Prior to A.02.00

- BLOCK or block data - returns all the data points from the region of the trace data that you specify. For example, it could be used to return the data points of an input signal over several timeslots, excluding the portions of the trace data that you do not want. (This is x,y pairs for trace data and I,Q pairs for complex data.)



- CFIT or curve fit - applies curve fitting routines to the data. <soffset> and <length> are required to define the data that you want. <roffset> is an optional parameter for the desired order of the curve equation. The query will return the following values: the x-offset (in seconds) and the curve coefficients ((order + 1) values).

MIN, MAX, MEAN, DME, RMS, RMSC, SAMP, SDEV and PPH return one data value for each specified region (or <length>) of trace data, for as many regions as possible until you run out of trace data (using <roffset> to specify regions). Or they return the number of regions you specify (using <rlimit>) ignoring any data beyond that.

- MINimum - returns the minimum data point (y value) for the specified region(s) of trace data. For I/Q trace data, the minimum magnitude of the I/Q pairs is returned.
- MAXimum - returns the maximum data point (y value) for the specified region(s) of trace data. For I/Q trace data, the maximum magnitude of the I/Q pairs is returned.
- MEAN - returns a single value that is the arithmetic mean of the data point values (in dB/ dBm) for the specified region(s) of trace data. For I/Q trace data, the mean of the magnitudes of the I/Q pairs is returned. See the following equations.

- 

**NOTE**

If the original trace data is in dB, this function returns the arithmetic mean of those log values, not log of the mean power which is a more useful value. The mean of the log is the better measurement technique when measuring CW signals in the presence of noise. The mean of the power, expressed in dB, is useful in power measurements such as Channel Power. To achieve the mean of the power, use the RMS option.

Equation 1

Mean Value of Data Points for Specified Region(s)

$$\text{MEAN} = \frac{1}{n} \sum_{X_i \in \text{region}(s)} X_i$$

where  $X_i$  is a data point value, and  $n$  is the number of data points in the specified region(s).

Equation 2

Mean Value of I/Q Data Pairs for Specified Region(s)

$$\text{MEAN} = \frac{1}{n} \sum_{X_i \in \text{region}(s)} |X_i|$$

where  $|X_i|$  is the magnitude of an I/Q pair, and  $n$  is the number of I/Q pairs in the specified region(s).

- DMEan - returns a single value that is the mean power (in dB/ dBm) of the data point values for the specified region(s) of trace data. See the following equation:

Equation 3

DMEan Value of Data Points for Specified Region(s)

$$\text{DME} = 10 \times \log_{10} \left( \frac{1}{n} \sum_{X_i \in \text{region}(s)} 10^{\frac{X_i}{10}} \right)$$

- RMS - returns a single value that is the average power on a root-mean-squared voltage scale (arithmetic rms) of the data point values for the specified region(s) of trace data. See the following equation.

**NOTE** For I/Q trace data, the rms of the magnitudes of the I/Q pairs is returned. See the following equation. This function is very useful for I/Q trace data. However, if the original trace data is in dB, this function returns the rms of the log values which is not usually needed.

Equation 4

RMS Value of Data Points for Specified Region(s)

$$\text{RMS} = \sqrt{\frac{1}{n} \sum_{X_i \in \text{region}(s)} X_i^2}$$

where  $X_i$  is a data point value, and  $n$  is the number of data points in the specified region(s).

Equation 5

RMS Value of I/Q Data Pairs for Specified Region(s)

$$\text{RMS} = \sqrt{\frac{1}{n} \sum_{X_i \in \text{region}(s)} X_i X_i^*}$$

where  $X_i$  is the complex value representation of an I/Q pair,  $X_i^*$  its conjugate complex number, and  $n$  is the number of I/Q pairs in the specified region(s).

Once you have the rms value for a region of trace data (linear or I/Q), you may want to calculate the mean power. You must convert this rms value (peak volts) to power in dBm:

$$10 \times \log[10 \times (\text{rms value})^2]$$

- SAMPLe - returns the first data value (x,y pair) for the specified region(s) of trace data. For I/Q trace data, the first I/Q pair is returned.
- SDEVIation - returns a single value that is the arithmetic standard deviation for the data point values for the specified region(s) of trace data. See the following equation.
- For I/Q trace data, the standard deviation of the magnitudes of the I/Q pairs is returned. See the following equation.

Equation 6

Standard Deviation of Data Point Values for Specified Region(s)

$$\text{SDEV} = \sqrt{\frac{1}{n} \sum_{X_i \in \text{region}(s)} (X_i - \bar{X})^2}$$

where  $X_i$  is a data point value,  $\bar{X}$  is the arithmetic mean of the data point values for the specified region (s), and  $n$  is the number of data points in the specified region(s).

$$\text{SDEV} = \sqrt{\frac{1}{n} \sum_{X_i \in \text{region}(s)} (|X_i| - \bar{X})^2}$$

where  $|X_i|$  is the magnitude of an I/Q pair,  $\bar{X}$  is the mean of the magnitudes for the specified region(s), and  $n$  is the number of data points in the specified region(s).

- PPHase - returns the x,y pairs of both rms power (dBm) and arithmetic mean phase (radian) for every specified region and frequency offset (Hz). The number of pairs is defined by the specified number of regions. This parameter can be used for I/Q vector ( $n=0$ ) in Waveform (time domain) measurement and all parameters are specified by data point in PPHase.

The rms power of the specified region may be expressed as:

$$\text{Power} = 10 \times \log [10 \times (\text{RMS I/Q value})] + 10.$$

The RMS I/Q value (peak volts) is:

$$\sqrt{\frac{1}{n} \sum_{X_i \in \text{region}} X_i X_i^*}$$

where  $X_i$  is the complex value representation of an I/Q pair,  $X_i^*$  its conjugate complex number, and  $n$  is the number of I/Q pairs in the specified region.

The arithmetic mean phase of the specified region may be expressed as:

$$\frac{1}{n} \sum_{Y_i \in \text{region}} Y_i$$

where  $Y_i$  is the unwrapped phase of I/Q pair with applying frequency correction and  $n$  is the number of I/Q pairs in the specified region.

The frequency correction is made by the frequency offset calculated by the arithmetic mean of every specified region's frequency offset. Each frequency offset is calculated by the least square method against the unwrapped phase of I/Q pair.

Sample Trace Data - Constant Envelope

(See below for explanation of variables.)

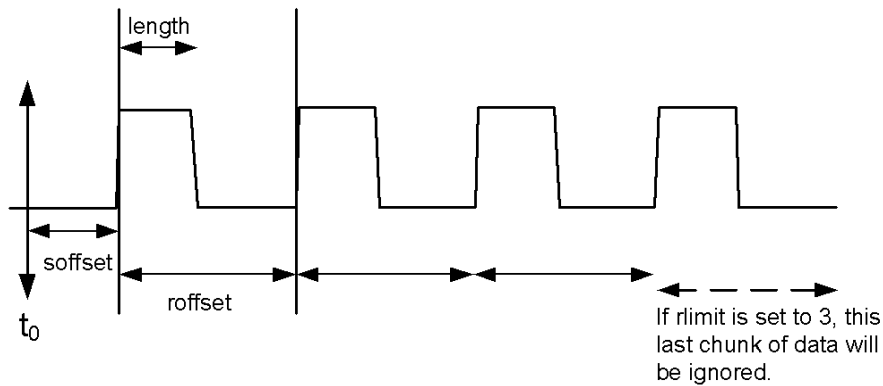

Sample Trace Data - Not Constant Envelope

(See below for explanation of variables.)

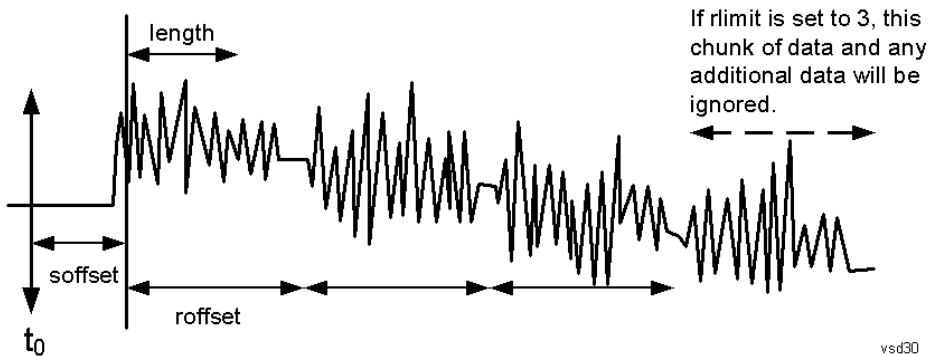

<soffset> - start offset is an optional real number. (It is in seconds for time-domain traces, and is a dimensionless index 0 to Npoints - 1, for frequency-domain traces). It specifies the amount of data at the beginning of the trace that will be ignored before the decimation process starts. It is the time or frequency change from the start of the trace to the point where you want to start using the data. The default value is zero.

<length> - is an optional real number. (It is in seconds for time-domain traces, and is a dimensionless index 0 to Npoints - 1, for frequency-domain traces). It defines how much data will be compressed into one value. This parameter has a default value equal to the current trace length.

<roffset> - repeat offset is an optional real number. (It is in seconds for time-domain traces, and is a dimensionless index 0 to Npoints - 1, for frequency-domain traces). It defines the beginning of the next field of trace elements to be compressed. This is relative to the beginning of the previous field. This parameter has a default value equal to the <length> variable. Note that this parameter is used for a completely different purpose when curve fitting (see CFIT above).

<rlimit> - repeat limit is an optional integer. It specifies the number of data items that you want returned. It will ignore any additional items beyond that number. You can use the Start offset and the Repeat limit to pick out exactly what part of the data you want to use. The default value is all the data.

## Calculate Peaks of Trace Data (Remote Command Only)

Returns a list of all the peaks for the currently selected measurement and sub-opcode [n]. The peaks must meet the requirements of the peak threshold and excursion values.

n = any valid sub-opcode for the current measurement. See the MEASure:<measurement> command description of your specific measurement for information on the data that can be returned.

The command can only be used with specific sub-opcodes with measurement results that are trace data. Both real and complex traces can be searched, but complex traces are converted to magnitude in dBm. In many measurements the sub-opcode n=0, is the raw trace data which cannot be searched for peaks. And Sub-opcode n=1, is often calculated results values which also cannot be searched for peaks.

This command uses the data setting specified by the FORMat:BORDER and FORMat:DATA commands and can return real or ASCII data. If the format is set to INT,32, it returns REAL,32 data.

The command has four types of parameters:

- Threshold (in dBm)
- Excursion (in dB)
- Sorting order (amplitude, frequency, time)
- Optional in some measurements: Display line use (all, > display line, < display line)

---

<b>Remote Command</b>	<p>For Swept SA measurement:</p> <pre>:CALCulate:DATA[1] 2 ... 6:PEAKs? &lt;threshold&gt;,&lt;excursion&gt;[,AMPLitude   FREQuency   TIME[,ALL   GTDLline   LTDLine]]</pre> <p>For most other measurements:</p> <pre>:CALCulate:DATA[1] 2 ... 6:PEAKs? &lt;threshold&gt;,&lt;excursion&gt;[,AMPLitude   FREQuency   TIME]</pre>
-----------------------	---------------------------------------------------------------------------------------------------------------------------------------------------------------------------------------------------------------------------------------------------------------------------------------------------------------------------------

---

<b>Example</b>	<p>Example for Swept SA measurement in Spectrum Analyzer Mode:</p> <p>CALC:DATA4:PEAK? -40, 10, FREQ, GTDL This will identify the peaks of trace 4 that are above -40 dBm, with excursions of at least 10 dB. The peaks are returned in order of increasing frequency, starting with the lowest frequency. Only the peaks that are above the display line are returned.</p> <p>Query Results 1:</p> <p>With FORMat:DATA REAL, 32 selected, it returns a list of floating-point numbers. The first value in the list is the number of peak points that are in the following list. A peak point consists of two values: a peak amplitude followed by its corresponding frequency (or time).</p> <p>If no peaks are found the peak list will consist of only the number of peaks, (0).</p>
----------------	-----------------------------------------------------------------------------------------------------------------------------------------------------------------------------------------------------------------------------------------------------------------------------------------------------------------------------------------------------------------------------------------------------------------------------------------------------------------------------------------------------------------------------------------------------------------------------------------------------------------------------------------------------------------------------------------------------------------------------------------------------------------------------------------

---

<b>Notes</b>	<p>&lt;n&gt; - is the trace that will be used</p> <p>&lt;threshold&gt; - is the level below which trace data peaks are ignored. Note that the threshold value is required and is always used as a peak criterion. To effectively disable the threshold criterion for this command, provide a substantially low threshold value such as -200 dBm. Also note that the threshold value used in this command is independent of and has no effect on the threshold value stored under the Peak Criteria menu.</p> <p>&lt;excursion&gt; - is the minimum amplitude variation (rise and fall) required for a signal to be identified as peak. Note that the excursion value is required and is always used as a peak criterion. To effectively disable the excursion criterion for this command, provide the minimum value of 0.0 dB. Also note that the excursion value used in this command is independent of and has no effect on the</p>
--------------	---------------------------------------------------------------------------------------------------------------------------------------------------------------------------------------------------------------------------------------------------------------------------------------------------------------------------------------------------------------------------------------------------------------------------------------------------------------------------------------------------------------------------------------------------------------------------------------------------------------------------------------------------------------------------------------------------------------------------------------------------------------------------------------------------------------------------------------------------------------------------------------------------------------------------------------

---

excursion value stored under the Peak Criteria menu.

Values must be provided for threshold and excursion. The sorting and display line parameters are optional (defaults are AMPLitude and ALL).

Note that there is always a Y-axis value for the display line, regardless of whether the display line state is on or off. It is the current Y-axis value of the display line which is used by this command to determine whether a peak should be reported

Sorting order:

AMPLitude - lists the peaks in order of descending amplitude, with the highest peak first (default if optional parameter not sent)

FREQuency - lists the peaks in order of occurrence, left to right across the x-axis.

TIME - lists the peaks in order of occurrence, left to right across the x-axis.

Peaks vs. Display Line:

ALL - lists all of the peaks found (default if optional parameter not sent).

GTDLine (greater than display line) - lists all of the peaks found above the display line.

LTDLine (less than display line) - lists all of the peaks found below the display line.

Initial S/W Revision      Prior to A.02.00

### Format Data: Numeric Data (Remote Command Only)

This command specifies the format of the trace data input and output. It specifies the formats used for trace data during data transfer across any remote port. It affects only the data format for setting and querying trace data for the :TRACe[:DATA], TRACe[:DATA]?, :CALCulate:DATA[n]? and FETCh:SANalyzer [n]? commands and queries.

**Remote Command**      :FORMat [:TRACe] [:DATA] ASCii | INTeger, 32 | REAL, 32 | REAL, 64  
:FORMat [:TRACe] [:DATA] ?

**Notes**      The query response is:  
ASCii: ASC,8  
REAL,32: REAL,32  
REAL,64: REAL,64  
INTeger,32: INT,32

When the numeric data format is REAL or ASCii, data is output in the current Y Axis unit. When the data format is INTeger, data is output in units of m dBm (.001 dBm).

The INT,32 format returns binary 32-bit integer values in internal units (m dBm), in a definite length block.

**Dependencies**      Sending a data format spec with an invalid number (for example, INT,48) generates no error. The analyzer simply uses the default (8 for ASCii, 32 for INTeger, 32 for REAL).

Sending data to the analyzer which does not conform to the current FORMat specified, results in an error. Sending ASCII data when a definite block is expected generates message -161 "Invalid Block Data" and sending a definite block when ASCII data is expected generates message -121 "Invalid Character in Number".

**Preset**      ASCii

**Backwards Compatibility Notes**      Note that the INT,32 format is only applicable to the command, TRACe:DATA. This preserves backwards compatibility for the Swept SA measurement. For all other commands/queries which honor FORMat:DATA, if INT,32 is sent the analyzer will behave as though it were set to REAL,32.

Initial S/W Revision      Prior to A.02.00

The specs for each output type follow:

ASCIi - Amplitude values are in ASCII, in the current Y Axis Unit, one ASCII character per digit, values separated by commas, each value in the form:

SX.YYYYYEsZZ

Where:

S = sign (+ or -)

X = one digit to left of decimal point

Y = 5 digits to right of decimal point

E = E, exponent header

s = sign of exponent (+ or -)

ZZ = two digit exponent

REAL,32 - Binary 32-bit real values in the current Y Axis Unit, in a definite length block.

REAL,64 - Binary 64-bit real values in the current Y Axis Unit, in a definite length block.

### Format Data: Byte Order (Remote Command Only)

This command selects the binary data byte order for data transfer and other queries. It controls whether binary data is transferred in normal or swapped mode. This command affects only the byte order for setting and querying trace data for the :TRACe[:DATA], TRACe[:DATA]? , :CALCulate:DATA[n]? and FETCh:SANalyzer[n]? commands and queries.

By definition any command that says it uses FORMat:DATA uses any format supported by FORMat:DATA.

The NORMal order is a byte sequence that begins with the most significant byte (MSB) first, and ends with the least significant byte (LSB) last in the sequence: 1|2|3|4. SWAPPed order is when the byte sequence begins with the LSB first, and ends with the MSB last in the sequence: 4|3|2|1.

<b>Remote Command</b>	:FORMat:BORDER NORMal SWAPPed :FORMat:BORDER?
<b>Preset</b>	NORMal
<b>Initial S/W Revision</b>	Prior to A.02.00

## Meas Setup

Displays the setup menu for the currently selected measurement. The functions included in the measurement setup menu include setting the parameters for the carriers, offsets, bandwidths, measurement methods and types. This menu also allows you to turn noise correction on and off.

Key Path	Front-panel key
Initial S/W Revision	Prior to A.02.00

### Average/Hold Number

Specifies the number of measurement averages used to calculate the measurement result. The average will be displayed at the end of each sweep. After the specified number of average counts, the average mode (termination control) setting determines the average action.

Key Path	Meas Setup
Mode	SA, WCDMA, C2K, WIMAX OFDMA, TD-SCDMA, 1xEVDO, DVB-T/H, DTMB (CTTB), ISDB-T, CMMB, LTE, LTE-TDD, Digital Cable TV, MSR, LTEAFDD, LTEATDD
<b>Remote Command</b>	[:SENSe]:ACPower:AVERage:COUNT <integer> [:SENSe]:ACPower:AVERage:COUNT? [:SENSe]:ACPower:AVERage[:STATe] OFF ON 0 1 [:SENSe]:ACPower:AVERage[:STATe]?
<b>Example</b>	ACP:AVER:COUN 250 ACP:AVER:COUN? ACP:AVER OFF ACP:AVER?
<b>Notes</b>	You must be in the mode that includes ACP measurements to use this command. Use :INSTrument:SElect to set the mode.
Preset	10 ON
State Saved	Saved in instrument state.
Min	1
Max	1000
<b>Backwards Compatibility SCPI</b>	[:SENSe]:ACPR:AVERage:COUNT [:SENSe]:MCPower:AVERage:COUNT (PSA Power Suite, PSA W-CDMA, PSA cdma2000 )
Initial S/W Revision	Prior to A.02.00
Modified at S/W Revision	A.02.00, A.03.00



## Avg Mode

Enables you to set the averaging mode. This determines the averaging action after the specified number of data acquisitions (average count) is reached.

When set to Exponential (Exp) the measurement averaging continues using the specified number of averages to compute each averaged value. The average will be displayed at the end of each sweep.

When set to Repeat, the measurement resets the average counter each time the specified number of averages is reached.

Key Path	Meas Setup
Mode	SA, WCDMA, C2K, WIMAX OFDMA, TD-SCDMA, 1xEVDO, DVB-T/H, DTMB (CTTB), ISDB-T, CMMB, LTE, LTETDD, Digital Cable TV, MSR, LTEAFDD, LTEATDD
Remote Command	[ :SENSe ] :ACPower:AVERage:TCONtrol EXPonential REPeat [ :SENSe ] :ACPower:AVERage:TCONtrol?
Example	ACP:AVER:TCON EXP ACP:AVER:TCON?
Notes	You must be in the mode that includes ACP measurements to use this command. Use :INSTrument:SElect to set the mode.
Preset	EXponential
State Saved	Saved in instrument state.
Range	Exp Repeat
Backwards Compatibility SCPI	[ :SENSe ] :ACPR:AVERage:TCONtrol
Initial S/W Revision	Prior to A.02.00
Modified at S/W Revision	A.02.00, A.03.00

## Carrier Setup (This menu is unavailable in MSR and LTE-Advanced FDD/TDD)

Accesses a menu that contains Carriers, Ref Carrier, Ref Car Freq, Ref Car Pwr and Configure Carriers.

Key Path	Meas Setup
Initial S/W Revision	Prior to A.02.00

## Carriers

Specifies the number of carriers to be measured.

Key Path	Meas Setup, Carrier Setup, Configure Carriers
Mode	SA, WCDMA, C2K, WIMAX OFDMA, 1xEVDO, TD-SCDMA, DVB-T/H, DTMB (CTTB), ISDB-T, CMMB, LTE, LTETDD, Digital Cable TV

<b>Remote Command</b>	<code>[ :SENSe ] :ACPower :CARRier [ 1 ]   2 :COUNT &lt;integer&gt;</code> <code>[ :SENSe ] :ACPower :CARRier [ 1 ]   2 :COUNT?</code>
<b>Example</b>	ACP:CARR:COUN 1 ACP:CARR:COUN?
<b>Notes</b>	Carrier sub op code. 1 for BTS, 2 for MS. Default is BTS. Note that Carrier sub op code 2 is supported only in Non-SA modes. In the SA mode, Carrier sub op code 1 is used for both BTS and MS. You must be in the mode that includes ACP measurements to use this command. Use :INSTrument:SElect to set the mode.
<b>Dependencies</b>	When Number of Carriers is 1, Ref Carrier is grayed out. If N9060A-5FP license is enabled, Max of Carrier is 18, otherwise, Max of Carrier is 12.
<b>Couplings</b>	Changing this parameter might affect the Span.
<b>Preset</b>	1
<b>State Saved</b>	Saved in instrument state.
<b>Min</b>	1
<b>Max</b>	Refer to Dependencies item.
<b>Initial S/W Revision</b>	Prior to A.02.00
<b>Modified at S/W Revision</b>	A.02.00, A.03.00

## Ref Carrier

Sets the reference carrier. Relative power measurements are made from the reference carrier.

If set to Auto, the measurement selects the carrier with the highest power as the reference carrier and the Ref Carrier parameter is updated. If a value is entered when Ref Carrier Mode is set to Auto, the mode changes to Man.

If set to Man, the value that you enter for the Ref Carrier is used as the reference carrier.

<b>Key Path</b>	Meas Setup, Carrier Setup
<b>Mode</b>	SA, WCDMA, C2K, WIMAX OFDMA, 1xEVDO, TD-SCDMA, DVB-T/H, DTMB (CTTB), ISDB-T, CMMB, LTE, LTE-TDD, Digital Cable TV
<b>Remote Command</b>	<code>[ :SENSe ] :ACPower :CARRier [ 1 ]   2 :RCARrier &lt;integer&gt;</code> <code>[ :SENSe ] :ACPower :CARRier [ 1 ]   2 :RCARrier?</code> <code>[ :SENSe ] :ACPower :CARRier [ 1 ]   2 :RCARrier :AUTO OFF   ON   0   1</code> <code>[ :SENSe ] :ACPower :CARRier [ 1 ]   2 :RCARrier :AUTO?</code>
<b>Example</b>	ACP:CARR:RCAR 1 ACP:CARR:RCAR? ACP:CARR:RCAR:AUTO OFF ACP:CARR:RCAR:AUTO?

Notes	Carrier sub op code. 1 for BTS, 2 for MS. Default is BTS. Note that Carrier sub op code 2 is supported only in Non-SA modes. In the SA mode, Carrier sub op code 1 is used for both BTS and MS. You must be in the mode that includes ACP measurements to use this command. Use :INSTrument:SElect to set the mode.
Dependencies	If there is only one carrier, this key will be grayed out.
Couplings	If you enter a carrier value that is currently configured as having no power present, that carrier will be changed to having power present. If you enter a ref carrier this parameter will be set to manual.
Preset	Auto determined
State Saved	Saved in instrument state.
Min	1
Max	Number of available carriers
<b>Backwards Compatibility SCPI</b>	[ :SENSe ] :MCPower:RCARrier [ 1 ]   2 (PSA Power Suite)
Initial S/W Revision	Prior to A.02.00
Modified at S/W Revision	A.02.00, A.03.00

## Ref Car Freq

Sets the reference carrier frequency.

Key Path	Meas Setup, Carrier Setup
Mode	SA, WCDMA, C2K, WIMAX OFDMA, 1xEVDO, TD-SCDMA, DVB-T/H, DTMB (CTTB), ISDB-T, CMMB, LTE, LTETDD, Digital Cable TV
<b>Remote Command</b>	[ :SENSe ] :ACPpower:CARRier [ 1 ]   2 :RCFRrequency <freq> [ :SENSe ] :ACPpower:CARRier [ 1 ]   2 :RCFRrequency? [ :SENSe ] :ACPpower:CARRier [ 1 ]   2 :RCFRrequency:AUTO OFF ON 0 1 [ :SENSe ] :ACPpower:CARRier [ 1 ]   2 :RCFRrequency:AUTO?
<b>Example</b>	ACP:CARR:RCFR 250 MHz ACP:CARR:RCFR? ACP:CARR:RCFR:AUTO OFF ACP:CARR:RCFR:AUTO?
Notes	Carrier sub op code. 1 for BTS, 2 for MS. Default is BTS. Note that Carrier sub op code 2 is supported only in Non-SA modes. In the SA mode, Carrier sub op code 1 is used for both BTS and MS. You must be in the mode that includes ACP measurements to use this command. Use :INSTrument:SElect to set the mode.

Couplings	<p>Coupled to the Center Frequency.</p> <p>If the center frequency changes, the Ref Carrier Frequency is calculated using the following three steps;</p> $\text{Ref Freq1} = \text{Ctr Freq} - (\text{Total of all Carrier Widths} / 2)$ $\text{Ref Freq2} = \text{Ref Freq1} + (\text{Total of all Carrier Widths up to Ref Carrier})$ $\text{Ref Freq} = \text{Ref Freq2} + (0.5 * \text{Carrier Width of Ref Carrier})$ <p>If reference carrier frequency changes the Center Frequency is calculated using the following three steps;</p> $\text{Ctr Freq1} = \text{Ref Freq} - (0.5 * \text{Carrier Width of Ref Carrier})$ $\text{Ctr Freq2} = \text{Ctr Freq1} - (\text{Total of all Carrier Widths up to Ref Carrier})$ $\text{Ctr Freq} = \text{Ctr Freq2} + (\text{Total of all Carrier Widths} / 2)$ <p>This ensures that the carriers are always centered on the screen.</p> <p>If there is only one carrier present the Reference Carrier Frequency will be the same as the Center Frequency.</p>
Preset	Calculated based on the current Center Frequency
State Saved	Saved in instrument state.
Min	-79.999995 MHz
Max	<p>Hardware Dependent:</p> <p>Option 503 = 3.699999995 GHz</p> <p>Option 508 = 8.499999995 GHz</p> <p>Option 513 = 13.799999995 GHz</p> <p>Option 526 = 26.999999995 GHz</p>
Initial S/W Revision	Prior to A.02.00
Modified at S/W Revision	A.02.00, A.03.00

## Power Ref

Sets the power reference in the carrier that will be used to compute the relative values for the offsets.

Key Path	Meas Setup, Carrier Setup
Initial S/W Revision	Prior to A.02.00
Modified at S/W Revision	A.03.00, A.04.00

## Total Power

Sets the multi-carrier power reference.

When set to Auto, the carrier power result reflects the measured power value in the selected reference carrier.

When set to Man, the result is referenced to the last measured value, or you may specify the reference for the multi-carrier power measurement. Relative values are displayed, referenced to the “Power Reference” value.

Key Path	Meas Setup, Carrier Setup, Power Ref
Mode	SA, WCDMA, C2K, WIMAX OFDMA, TD-SCDMA, DVB-T/H, DTMB (CTTB), ISDB-T, CMMB, LTE, LTETDD, Digital Cable TV, MSR
<b>Remote Command</b>	[:SENSe]:ACPower:CARRier[1] 2[:POWer] <real> [:SENSe]:ACPower:CARRier[1] 2[:POWer]? [:SENSe]:ACPower:CARRier[1] 2:AUTO[:STATe] OFF ON 0 1 [:SENSe]:ACPower:CARRier[1] 2:AUTO[:STATe]?
<b>Example</b>	ACP:CARR 10 ACP:CARR? ACP:CARR:AUTO OFF ACP:CARR:AUTO?
Notes	Although the default value is defined, the value is recalculated by the measurement result just after measurement. Carrier sub op code: 1 for BTS, 2 for MS. Default is BTS. Carrier sub op code 2 is supported only in Non-SA modes. MS is not supported in MSR. In the SA mode, Carrier sub op code 1 is used for both BTS and MS. The Unit Terminator keys differ depending on whether or not the mode supports Y Axis Unit and also which Y Axis Unit is selected. You must be in the mode that includes ACP measurements to use this command. Use :INSTrument:SElect to set the mode. Power Ref State ([:SENSe]:ACPower:CARRier[1] 2:AUTO[:STATe]) is not available in MSR mode.
Dependencies	This key is available only when the Meas Type is TPreF. If the Meas Type is not TPreF, this key is grayed out.
Preset	0.0 ON
State Saved	Saved in instrument state.
Min	-200 dBm
Max	200 dBm
<b>Backwards Compatibility SCPI</b>	[:SENSe]:MCPower:CARRier[1] 2[:POWer]
Initial S/W Revision	Prior to A.02.00
Modified at S/W Revision	A.02.00, A.03.00, A.04.00, A.10.00

## PSD

Sets the power spectral density in the carrier (main channel) that is used to compute the relative power spectral density values for the offsets when Meas Type is set to PSD Ref. When the PSD Ref state is set to Auto, this will be set to the measured carrier power spectral density.

Key Path	Meas Setup, Carrier Setup, Power Ref
Mode	SA, WCDMA, C2K, WIMAX OFDMA, TD-SCDMA, DVB-T/H, DTMB (CTTB), ISDB-T, CMMB, LTE, LTETDD, Digital Cable TV, MSR
Remote Command	<code>[ :SENSe ] :ACPower :CARRier [ 1 ]   2 :CPSD &lt;real&gt;</code> <code>[ :SENSe ] :ACPower :CARRier [ 1 ]   2 :CPSD?</code>
Example	ACP:CARR:CPSD 25 ACP:CARR:CPSD?
Notes	Although the default value is defined, the value is recalculated by the measurement result just after measurement. Carrier sub op code. 1 for BTS, 2 for MS. Default is BTS. MS is not supported in MSR. Note that Carrier sub op code 2 is supported only in Non-SA modes. In the SA mode, Carrier sub op code 1 is used for both BTS and MS. You must be in the mode that includes ACP measurements to use this command. Use <code>:INSTrument:SElect</code> to set the mode.
Dependencies	This key is available only when the Meas Type is PSDRef. If the Meas Type is not PSDRef, this key is grayed out.
Couplings	The value of PSD is automatically converted when PSD Unit is changed.
Preset	0.0
State Saved	Saved in instrument state.
Min	-999
Max	999
Initial S/W Revision	Prior to A.02.00
Modified at S/W Revision	A.02.00, A.03.00, A.04.00, A.10.00

## Configure Carriers

Accesses a menu that contains Carrier, Carrier Pwr Present, Carrier Width and Carrier Integ BW parameters.

Key Path	Meas Setup, Carrier Setup
Initial S/W Revision	Prior to A.02.00

## Carrier

Selects the carrier to configure for the current measurement.

Key Path	Meas Setup, Carrier Setup, Configure Carriers
Mode	SA, WCDMA, C2K, WIMAX OFDMA, 1xEVDO, TD-SCDMA, DVB-T/H, DTMB (CTTB), ISDB-T, CMMB, LTE, LTETDD, Digital Cable TV

Couplings	Max value is the number of available carriers, so this value might change when the number of carriers is changed.
Preset	1
State Saved	No
Min	1
Max	Number of available carriers
Initial S/W Revision	Prior to A.02.00
Modified at S/W Revision	A.02.00, A.03.00

### Carrier Pwr Present

Configures the carriers for this measurement. It allows spaces to be inserted between carriers. Carriers with the power present parameter set to Yes are carriers, and those with the power present parameter set to No are spaces. Each carrier power present is set to Yes or No. The individual carriers can be set by selecting the desired carrier on the carrier menu key using the up down arrows, the knob, or numeric keypad, then toggling the carrier power present using the carrier power present menu key.

The query for this parameter returns the current values for all of the carriers. If a carrier is defined as having no power present, the power displayed will be relative to the reference carrier, otherwise the absolute power will be displayed.

If you change the carrier power present to no and that carrier is currently configured as the reference carrier, the next carrier to the left (or the right if there are no carriers to the left) will be assigned as the reference carrier. This also applies to the scenario where there are only two carriers configured as having power present and you configure only one carrier to have no power present.

Key Path	Meas Setup, Carrier Setup, Configure Carriers
Mode	SA, WCDMA, C2K, WIMAX OFDMA, 1xEVDO, TD-SCDMA, DVB-T/H, DTMB (CTTB), ISDB-T, CMMB, LTE, LTETDD, Digital Cable TV
Remote Command	<code>[ :SENSe ] :ACPpower:CARRier [ 1 ]   2 :LIST:PPResent YES   NO, YES   NO, YES   NO, YES   NO, YES   NO, YES   NO, YES   NO</code> <code>[ :SENSe ] :ACPpower:CARRier [ 1 ]   2 :LIST:PPResent?</code>
Example	<code>ACP:CARR2:LIST:PPR YES</code> <code>ACP:CARR2:LIST:PPR?</code>
Notes	Carrier sub op code. 1 for BTS, 2 for MS. Default is BTS. Note that Carrier sub op code 2 is supported only in Non-SA modes. In the SA mode, Carrier sub op code 1 is used for both BTS and MS. When setting these values remotely, the position in the list sent corresponds to the carrier. Missing values are not permitted, therefore if you want to change values 2 and 6 you must send all values up to 6. Subsequent values will remain unchanged, unless the number of values sent is greater than the number of carriers, then subsequent values will be ignored.
Dependencies	If there is only one carrier, this key will be grayed out.
Couplings	Coupled to the number of carriers. When the SCPI command is sent, the number of carriers will be set to the number of entries in the parameter list.

Preset	YES
State Saved	Saved in instrument state.
Range	Yes No
<b>Backwards Compatibility SCPI</b>	<code>[ :SENSe ] :MCPower :CARRier [ 1 ]   2 :LIST :PPResent</code> (PSA Power Suite)
Initial S/W Revision	Prior to A.02.00
Modified at S/W Revision	A.02.00, A.03.00

### Carrier Spacing

Sets the width of the carrier spacing. This will be the value applied to all the current slots, whether they are carriers or spaces.

Enter each carrier spacing value individually by selecting the desired carrier on the carrier menu key using the up down arrows, the knob, or the numeric keypad, then enter the carrier width using the carrier spacing menu key.

Key Path	Meas Setup, Carrier Setup, Configure Carriers
Mode	SA, WCDMA, C2K, WIMAX OFDMA, 1xEVDO, TD-SCDMA, DVB-T/H, DTMB (CTTB), ISDB-T, CMMB, LTE, LTETDD, Digital Cable TV
Remote Command	<code>[ :SENSe ] :ACPower :CARRier [ 1 ]   2 :LIST :WIDTh &lt;freq&gt;, &lt;freq&gt;, &lt;freq&gt;, &lt;freq&gt;, &lt;freq&gt;, &lt;freq&gt;</code> <code>[ :SENSe ] :ACPower :CARRier [ 1 ]   2 :LIST :WIDTh?</code>
Example	ACP:CARR2:LIST:WIDT 25kHz ACP:CARR2:LIST:WIDT?

#### Notes

Carrier sub op code. 1 for BTS, 2 for MS. Default is BTS.  
 Note that Carrier sub op code 2 is supported only in Non-SA modes.  
 In the SA mode, Carrier sub op code 1 is used for both BTS and MS.  
 When setting these values remotely, the position in the list sent corresponds to the carrier. Missing values are not permitted, therefore if you want to change values 2 and 6 you must send all values up to 6. Subsequent values will remain unchanged, unless the number of values sent is greater than the number of carriers, then subsequent values will be ignored.  
 You must be in the mode that includes ACP measurements to use this command. Use `:INSTrument:SElect` to set the mode.

Couplings	Coupled to the number of carriers. When the SCPI command is sent, the number of carriers will be set to the number of entries in the parameter list. Changing Carrier Spacing might affect the Span.
Preset	SA, WCDMA: 5 MHz WIMAX OFDMA: 10 MHz C2K: 1.25 MHz 1xEVDO: 1.25 MHz



	TD-SCDMA: 1.6 MHz DVB-T/H: 8 MHz DTMB (CTTB): 8 MHz ISDB-T: 6 MHz CMMB: 8 MHz LTE: 5 MHz LTE-TDD: 5 MHz Digital Cable TV: 8 MHz
State Saved	Saved in instrument state.
Min	0 Hz
Max	1 GHz
<b>Backwards Compatibility SCPI</b>	<code>[ :SENSe ] :MCPower :CARRier [ 1 ]   2 :LIST :WIDTh (PSA Power Suite)</code>
Initial S/W Revision	Prior to A.02.00
Modified at S/W Revision	A.02.00, A.03.00

## Measurement Noise Bandwidth

Specifies the Measurement Noise Bandwidth used to calculate the power in the carriers.

Each Measurement Noise Bandwidth value is entered individually by selecting the desired carrier on the carrier menu key using the up down arrows, the knob, or the numeric keypad. Then enter the measurement noise bandwidth using the measurement noise bandwidth key.

Key Path	Meas Setup, Carrier Setup, Configure Carriers
Mode	SA, WCDMA, C2K, WIMAX OFDMA, TD-SCDMA, 1xEVDO, DVB-T/H, DTMB (CTTB), ISDB-T, CMMB, LTE, LTE-TDD, Digital Cable TV
Remote Command	<code>[ :SENSe ] :ACPpower :CARRier [ 1 ]   2 :LIST :BANDwidth [ :INTEgration ] &lt;freq&gt;, &lt;freq&gt;, &lt;freq&gt;, &lt;freq&gt;, &lt;freq&gt;</code>  <code>[ :SENSe ] :ACPpower :CARRier [ 1 ]   2 :LIST :BANDwidth [ :INTEgration ] ?</code>
Example	ACP:CARR2:LIST:BAND 25kHz ACP:CARR2:LIST:BAND?
Notes	In the WCDMA mode, the preset/default value is defined as 3.84 MHz. But internally, 4.6848 MHz is used as the default value. Carrier sub op code. 1 for BTS, 2 for MS. Default is BTS. Note that Carrier sub op code 2 is supported only in Non-SA modes. In the SA mode, Carrier sub op code 1 is used for both BTS and MS. When setting these values remotely, the position in the list sent corresponds to the carrier. Missing values are not permitted, therefore if you want to change values 2 and 6 you must send all values up to 6. Subsequent values will remain unchanged, unless the number of values sent is greater than the number of carriers, then subsequent values will be ignored. You must be in the mode that includes ACP measurements to use this command. Use

	:INSTrument:SElect to set the mode.
Couplings	Coupled to the number of carriers. When the SCPI command is sent, the number of carriers is set to the number of entries in the parameter list.
Preset	SA: 2 MHz WCDMA: 3.84 MHz WIMAX OFDMA: 10 MHz C2K: 1.23MHz TD-SCDMA: 1.28 MHz 1xEVDO: 1.23 MHz DVB-T/H: 7.61 MHz DTMB (CTTB): 7.56 MHz ISDB-T: 5.6 MHz CMMB: 7.512 MHz LTE, LTE-TDD: 4.515 MHz 4.5 MHz Digital Cable TV: 8.0 MHz
State Saved	Saved in instrument state.
Min	10 Hz
Max	1 GHz
<b>Backwards Compatibility SCPI</b>	[ :SENSe ] :ACPower :BANDwidth :INTegration [ :SENSe ] :ACPower :BWIDth :INTegration [ :SENSe ] :ACPower :CARRier [ 1 ]   2 :LIST :BWIDth [ :INTegration ] [ :SENSe ] :MCPower :CARRier [ 1 ]   2 :LIST :BANDwidth [ :INTegration ] (PSA Power Suite) [ :SENSe ] :MCPower :CARRier [ 1 ]   2 :LIST :BWIDth [ :INTegration ] (PSA Power Suite)
Initial S/W Revision	Prior to A.02.00
Modified at S/W Revision	A.02.00, A.03.00

## Offset/Limits

Accesses a menu of functions that contains Offset, Offset Freq/Offset To Edge, Offset Integ BW, Upper Offset Limit and Lower Offset parameters. When in the MSR and LTE-Advanced FDD/TDD mode, the softkey label changes to Outer Offset/Limits.

Key Path	Meas Setup
Initial S/W Revision	Prior to A.02.00
Modified at S/W Revision	A.13.00

## Select Offset

Selects the offset to configure.

Key Path	Meas Setup, Offset/Limits, Limits
Mode	SA, WCDMA, C2K, WIMAX OFDMA, TD-SCDMA, 1xEVDO, DVB-T/H, DTMB (CTTB), ISDB-T, CMMB, LTE, LTE-TDD, Digital Cable TV, MSR, LTEAFDD, LTEATDD
Preset	A
State Saved	Saved in instrument state.
Range	Offset A Offset B Offset C Offset D Offset E Offset F
Initial S/W Revision	Prior to A.02.00
Modified at S/W Revision	A.02.00, A.03.00, A.13.00

## Offset Freq

This parameter determines the frequency difference between the center of the main channel and the center of the carrier.

Each Offset Freq state value is entered individually by selecting the desired carrier on the carrier menu key using the up down arrows, RPG or numeric keypad. Then enter the Offset Freq State using the Offset Frequency key.

The list contains up to six (6) entries, depending on the mode selected, for offset frequencies. Each offset frequency in the list corresponds to a reference bandwidth in the bandwidth list.

An offset frequency of zero turns the display of the measurement for that offset off, but the measurement is still made and reported. You can turn off (not use) specific offsets with the [:SENSe]:ACP:OFFSet:LIST:STATe command.

Turning the offset off has the same effect as setting the frequency of the offset to 0 Hz and will cause it to be removed from the results screen.

Key Path	Meas Setup, Offset/Limits
Mode	SA, WCDMA, C2K, WIMAX OFDMA, TD-SCDMA, 1xEVDO, DVB-T/H, DTMB (CTTB), ISDB-T, CMMB, LTE, LTE-TDD, Digital Cable TV, MSR, LTEAFDD, LTEATDD
<b>Remote Command</b>	<pre>[:SENSe]:ACPower:OFFSet[1] 2[:OUTer]:LIST[:FREQuency] &lt;freq&gt;, &lt;freq&gt;, &lt;freq&gt;, &lt;freq&gt;, &lt;freq&gt;, &lt;freq&gt;</pre> <pre>[:SENSe]:ACPower:OFFSet[1] 2[:OUTer]:LIST[:FREQuency]?</pre> <pre>[:SENSe]:ACPower:OFFSet[1] 2[:OUTer]:LIST:STATe OFF   ON   0   1, OFF   ON   0   1, OFF   ON   0   1, OFF   ON   0   1, OFF   ON   0   1, OFF   ON   0   1</pre> <pre>[:SENSe]:ACPower:OFFSet[1] 2[:OUTer]:LIST:STATe?</pre>
<b>Example</b>	<pre>ACP:OFFS1:LIST 0,0,0,0,0,0</pre> <pre>ACP:OFFS1:LIST?</pre> <pre>ACP:OFFS2:LIST:STAT 1,1,0,0,0,0</pre> <pre>ACP:OFFS2:LIST:STAT?</pre>
Notes	The label for this menu key will change depending on the currently selected radio standard or mode. For cdma2000 the label for the menu key will be Offset to Edge. For all other supported standards the label will be Offset Freq.

	<p>When setting these values remotely, the position in the list sent corresponds to the offset. Missing values are not permitted, unless the number of values sent is greater than the number of carriers, then subsequent values will be ignored.</p> <p>Offset sub op code. 1 for BTS, 2 for MS. Default is BTS.</p> <p>Note that Offset sub op code 2 is supported only in Non-SA modes.</p> <p>In the SA mode, Offset sub op code 1 is used for both BTS and MS.</p> <p>You must be in the mode that includes ACP measurements to use this command. Use :INSTrument:SElect to set the mode.</p>
Couplings	Changing Offset Frequency might affect the Span. See the Span key section for details.
Preset	<p>SA: 3 MHz, 0 Hz, 0 Hz, 0 Hz, 0 Hz 3 MHz, 0 Hz, 0 Hz, 0 Hz, 0 Hz</p> <p>WCDMA: 5.0 MHz, 10.0 MHz, 0 Hz, 0 Hz, 0 Hz 5.0 MHz, 10.0 MHz, 0 Hz, 0 Hz, 0 Hz</p> <p>WIMAX OFDMA: 10 MHz, 20 MHz, 0 Hz, 0 Hz, 0 Hz 10 MHz, 20 MHz, 0 Hz, 0 Hz, 0 Hz</p> <p>C2K:750KHz, 1.980 MHz, 0 Hz, 0 Hz, 0 Hz 885 kHz, 1.980 MHz, 0 Hz, 0 Hz, 0 Hz</p> <p>TD-SCDMA: 1.6 MHz, 3.2 MHz, 0 Hz, 0 Hz, 0 Hz 1.6 MHz, 3.2 MHz, 0 Hz, 0 Hz, 0 Hz</p> <p>1xEVDO: 750KHz, 1.98MHz, 3.125MHz, 4.000MHz, 7.500MHz 885KHz, 1.98MHz, 3.125MHz, 4.000MHz, 7.500MHz, 7.500MHz</p> <p>DVB-T/H: 8 MHz, 16 MHz, 0 Hz, 0 Hz, 0 Hz 8 MHz, 16 MHz, 0 Hz, 0 Hz, 0 Hz</p> <p>DTMB (CTTB): 8 MHz, 16 MHz, 24 MHz, 32 MHz, 0 Hz 8 MHz, 16 MHz, 24 MHz, 32 MHz, 0 Hz, 0 Hz</p> <p>ISDB-T: 6 MHz, 12 MHz, 0 Hz, 0 Hz, 0 Hz 6 MHz, 12 MHz, 0 Hz, 0 Hz, 0 Hz</p> <p>CMMB: 8 MHz, 16 MHz, 24 MHz, 32 MHz, 0 Hz 8 MHz, 16 MHz, 24 MHz, 32 MHz, 0 Hz, 0 Hz</p> <p>LTE, LTETDD, MSR, LTEAFDD, LTEATDD: 5 MHz, 10 MHz, 0, 0, 0 5 MHz, 10 MHz, 0, 0, 0</p> <p>Digital Cable TV: 8 MHz, 16 MHz, 0 Hz, 0 Hz, 0 Hz 8 MHz, 16 MHz, 0 Hz, 0 Hz, 0 Hz</p> <p>SA: ON, OFF, OFF, OFF, OFF ON, OFF, OFF, OFF, OFF</p> <p>WCDMA: ON, ON, OFF, OFF, OFF ON, ON, OFF, OFF, OFF</p> <p>WIMAX OFDMA: ON, ON, OFF, OFF, OFF ON, ON, OFF, OFF, OFF</p> <p>TD-SCDMA: ON, ON, OFF, OFF, OFF ON, ON, OFF, OFF, OFF</p> <p>DVB-T/H: ON, ON, OFF, OFF, OFF ON, ON, OFF, OFF, OFF</p> <p>DTMB (CTTB): ON, ON, OFF, OFF, OFF ON, ON, OFF, OFF, OFF</p> <p>CDMA1xEVDO: ON, ON, OFF, OFF, OFF ON, ON, OFF, OFF, OFF</p> <p>ISDB-T: ON, ON, OFF, OFF, OFF ON, ON, OFF, OFF, OFF</p> <p>CMMB: ON, ON, ON, ON, OFF ON, ON, ON, ON, OFF</p> <p>LTE, LTETDD, MSR, LTEAFDD, LTEATDD: ON, ON, OFF, OFF, OFF ON, OFF, OFF, OFF, OFF</p> <p>Digital Cable TV: ON, ON, OFF, OFF, OFF ON, ON, OFF, OFF, OFF</p>
State Saved	Saved in instrument state.
Min	0 Hz
Max	500 MHz
<b>Backwards Compatibility SCPI</b>	<code>[[:SENSE]:MCPower:OFFSet[1] 2:LIST[:FREQuency] (PSA Power Suite)</code>
Initial S/W Revision	Prior to A.02.00
Modified at S/W Revision	A.02.00, A.03.00, A.13.00

## Integ BW

Sets the Integration Bandwidth for the offsets. Each resolution bandwidth in the list corresponds to an offset frequency in the list defined by [:SENSe]:ACP:OFFSet[n][:OUTer]:LIST[:FREQUency].

Enter each value individually by selecting the desired offset on the offset menu key using the up down arrows, the knob, or the numeric keypad, then enter the Offset Integration Bandwidth using the Offset Integration Bandwidth menu key.

You can turn off (not use) specific offsets with the [:SENSe]:ACP:OFFSet[n][:OUTer]:LIST:STATe command.

Key Path	Meas Setup, Offset/Limits
Mode	SA, WCDMA, C2K, WIMAX OFDMA, TD-SCDMA, 1xEVDO, DVB-T/H, DTMB (CTTB), ISDB-T, CMMB, LTE, LTEFDD, Digital Cable TV, MSR, LTEAFDD, LTEATDD
Remote Command	[:SENSe]:ACP:Power:OFFSet [1]   2 [:OUTer]:LIST:BANDwidth[:INTEgration] <freq>, <freq>, <freq>, <freq>, <freq>, <freq>  [:SENSe]:ACP:Power:OFFSet [1]   2 [:OUTer]:LIST:BANDwidth[:INTEgration]?
Example	ACP:OFFS2:LIST:BAND 2MHz, 2MHz, 2MHz, 2MHz, 2MHz, 2MHz ACP:OFFS2:LIST:BAND?
Notes	<p>When setting these values remotely, the position in the list sent corresponds to the offset. Missing values are not permitted i.e. if you want to change the second value, you must send all values up to it. Subsequent values will remain unchanged, unless the number of values sent is greater than the number of carriers, then subsequent values will be ignored.</p> <p>Offset sub op code. 1 for BTS, 2 for MS. Default is BTS.</p> <p>Note that Offset sub op code 2 is supported only in Non-SA modes.</p> <p>In the SA mode, Offset sub op code 1 is used for both BTS and MS.</p> <p>You must be in the mode that includes ACP measurements to use this command. Use :INSTrument:SElect to set the mode.</p>
Couplings	Changing Integ BW might affect the Span. See Span section for details.
Preset	<p>SA: 2 MHz, 2 MHz, 2 MHz, 2 MHz, 2 MHz, 2 MHz 2 MHz, 2 MHz, 2 MHz, 2 MHz, 2 MHz, 2 MHz</p> <p>WCDMA: 3.84 MHz, 3.84 MHz, 3.84 MHz, 3.84 MHz, 3.84 MHz, 3.84 MHz 3.84 MHz, 3.84 MHz, 3.84 MHz, 3.84 MHz</p> <p>WIMAX OFDMA: 10 MHz, 10 MHz, 10 MHz, 10 MHz, 10 MHz, 10 MHz 10 MHz, 10 MHz, 10 MHz, 10 MHz, 10 MHz, 10 MHz</p> <p>C2K: 30 kHz, 30 kHz, 30 kHz, 30 kHz, 30 kHz, 30 kHz 30 kHz, 30 kHz, 30 kHz, 30 kHz, 30 kHz, 30 kHz</p> <p>TD-SCDMA: 1.28 MHz, 1.28 MHz, 1.28 MHz, 1.28 MHz, 1.28 MHz, 1.28 MHz</p> <p>1xEVDO: C2K: 30 kHz, 30 kHz, 30 kHz, 30 kHz, 30 kHz, 30 kHz 30 kHz, 30 kHz, 30 kHz, 30 kHz, 30 kHz, 30 kHz</p> <p>DVB-T/H: 7.61 MHz, 7.61 MHz, 7.61 MHz, 7.61 MHz, 7.61 MHz, 7.61 MHz 7.61 MHz, 7.61 MHz, 7.61 MHz, 7.61 MHz, 7.61 MHz, 7.61 MHz</p> <p>DTMB (CTTB): 7.56 MHz, 7.56 MHz, 7.56 MHz, 7.56 MHz, 7.56 MHz, 7.56 MHz 7.56 MHz, 7.56 MHz, 7.56 MHz, 7.56 MHz, 7.56 MHz, 7.56 MHz</p>

	ISDB-T: 5.6 MHz, 5.6 MHz, 5.6 MHz, 5.6 MHz, 5.6 MHz, 5.6 MHz  5.6 MHz, 5.6 MHz, 5.6 MHz, 5.6 MHz, 5.6 MHz, 5.6 MHz CMMB: 7.512 MHz, 7.512 MHz, 7.512 MHz, 7.512 MHz, 7.512 MHz, 7.512 MHz  7.512 MHz, 7.512 MHz, 7.512 MHz, 7.512 MHz, 7.512 MHz LTE, LTE-TDD, MSR, LTEAFDD, LTEATDD: 4.515 MHz, 4.515 MHz, 4.515 MHz, 4.515 MHz, 4.515 MHz, 4.515 MHz  4.5 MHz, 4.5 MHz, 4.5 MHz, 4.5 MHz, 4.5 MHz, 4.5 MHz Digital Cable TV: 8.0 MHz, 8.0 MHz, 8.0 MHz, 8.0 MHz, 8.0 MHz, 8.0 MHz  8.0 MHz, 8.0 MHz, 8.0 MHz, 8.0 MHz, 8.0 MHz, 8.0 MHz
State Saved	Saved in instrument state.
Min	10 Hz
Max	1 GHz
<b>Backwards Compatibility SCPI</b>	[ :SENSe ] :ACPower:OFFSet [ 1 ]   2 :LIST:BWIDth [ :INTEgration ] [ :SENSe ] :ACPR:OFFSet [ 1 ]   2 :LIST:BANDwidth [ :SENSe ] :ACPR:OFFSet [ 1 ]   2 :LIST:BWIDth [ :SENSe ] :MCPower:OFFSet [ 1 ]   2 :LIST:BANDwidth [ :INTEgration ] (PSA Power Suite) [ :SENSe ] :MCPower:OFFSet [ 1 ]   2 :LIST:BWIDth [ :INTEgration ] (PSA Power Suite)
Initial S/W Revision	Prior to A.02.00
Modified at S/W Revision	A.02.00, A.03.00, A.13.00

## Offset BW

Accesses the offset bandwidth menu.

Key Path	Meas Setup, Offset/Limits
Initial S/W Revision	Prior to A.02.00

## Res BW

Sets the resolution bandwidth. If an unavailable bandwidth is entered with the numeric keypad, the closest available bandwidth is selected.

Key Path	Meas Setup, Offset/Limits
Mode	SA, WCDMA, C2K, WIMAX OFDMA, TD-SCDMA, 1xEVDO, DVB-T/H, DTMB (CTTB), ISDB-T, CMMB, LTE, LTE-TDD, Digital Cable TV, MSR, LTEAFDD, LTEATDD
<b>Remote Command</b>	[ :SENSe ] :ACPower:OFFSet [ 1 ]   2 [ :OUTer ] :LIST:BANDwidth:RESolution <freq>, <freq>, <freq>, <freq>, <freq> [ :SENSe ] :ACPower:OFFSet [ 1 ]   2 [ :OUTer ] :LIST:BANDwidth:RESolution? [ :SENSe ] :ACPower:OFFSet [ 1 ]   2 [ :OUTer ] :LIST:BANDwidth:RESolution:AUTO ON   OFF   1   0, ON   OFF   1   0, ON   OFF   1   0, ON   OFF   1   0, ON   OFF   1   0, ON   OFF   1   0

	<code>[ :SENSE ] :ACPower :OFFSet [ 1 ]   2 [ :OUTer ] :LIST :BANDwidth :RESolution :AUTO?</code>
<b>Example</b>	<p>ACP:OFFS2:LIST:BAND:RES 220kHz, 220kHz, 220kHz, 220kHz, 220kHz, 220kHz</p> <p>ACP:OFFS2:LIST:BAND:RES?</p> <p>ACP:OFFS2:LIST:BAND:RES:AUTO 1,1,1,1,1,1</p> <p>ACP:OFFS2:LIST:BAND:RES:AUTO?</p>
<b>Notes</b>	<p>Offset sub op code. 1 for BTS, 2 for MS. Default is BTS.</p> <p>Note that Offset sub op code 2 is supported only in Non-SA modes.</p> <p>In the SA mode, Offset sub op code 1 is used for both BTS and MS.</p> <p>You must be in the mode that includes ACP measurements to use this command. Use :INSTrument:SElect to set the mode.</p>
<b>Dependencies</b>	When Meas Method is RBW or FAST, this key is grayed out and disabled. If the key is pressed, an advisory message is generated. If the equivalent remote command is sent, a "Setting conflict" warning is generated.
<b>Couplings</b>	When Res BW Mode is AUTO, this value is exactly same as Res BW under BW key. And when this value is changed by user, Res BW Mode is also changed to Man.
<b>Preset</b>	<p>SA: 220 kHz, 220 kHz, 220 kHz, 220 kHz, 220 kHz, 220 kHz</p> <p>WCDMA: 100 kHz, 100 kHz, 100 kHz, 100 kHz, 100 kHz, 100 kHz</p> <p>WIMAX OFDMA: 100 kHz, 100 kHz, 100 kHz, 100 kHz, 100 kHz, 100 kHz</p> <p>C2K:</p> <p>Method:RBW</p> <p>30 kHz</p> <p>Method: IBW</p> <p>C2K: 15 kHz, 15 kHz, 15 kHz, 15 kHz, 15 kHz, 15 kHz 15 kHz, 15 kHz, 15 kHz, 15 kHz, 15 kHz, 15 kHz</p> <p>TD-SCDMA: 30 kHz, 30 kHz, 30 kHz, 30 kHz, 30 kHz, 30 kHz</p> <p>1xEVDO: 30KHz, 30KHz, 30KHz, 30KHz, 30KHz, 30KHz 30KHz, 30KHz, 30KHz, 30KHz, 30KHz, 30KHz</p> <p>DVB-T/H: 39 kHz, 39 kHz, 39 kHz, 39 kHz, 39 kHz, 39 kHz 39 kHz, 39 kHz, 39 kHz, 39 kHz, 39 kHz, 39 kHz</p> <p>DTMB (CTTB): 39 kHz, 39 kHz, 39 kHz, 39 kHz, 39 kHz, 39 kHz 39 kHz, 39 kHz, 39 kHz, 39 kHz, 39 kHz, 39 kHz</p> <p>ISDB-T: 39 kHz, 39 kHz, 39 kHz, 39 kHz, 39 kHz, 39 kHz 39 kHz, 39 kHz, 39 kHz, 39 kHz, 39 kHz, 39 kHz</p> <p>CMMB: 39 kHz, 39 kHz, 39 kHz, 39 kHz, 39 kHz, 39 kHz 39 kHz, 39 kHz, 39 kHz, 39 kHz, 39 kHz, 39 kHz</p> <p>LTE, LTEFDD, MSR, LTEAFDD, LTEATDD: 100 kHz, 100 kHz, 100 kHz, 100 kHz, 100kHz, 100 kHz 100 kHz, 100 kHz, 100 kHz, 100 kHz, 100 kHz, 100 kHz</p> <p>Digital Cable TV: 39 kHz, 39 kHz, 39 kHz, 39 kHz, 39 kHz, 39 kHz 39 kHz, 39 kHz, 39 kHz, 39 kHz, 39 kHz, 39 kHz</p> <p>1, 1, 1, 1, 1, 1</p>
<b>State Saved</b>	Saved in instrument state.

Min	1 Hz
Max	8 MHz
<b>Backwards Compatibility SCPI</b>	<code>[[:SENSe]:ACPower:OFFSet[1] 2[:LIST:BWIDth:RESolution</code>
Initial S/W Revision	Prior to A.02.00
Modified at S/W Revision	A.02.00, A.03.00, A.13.00

## Video BW

Enables you to change the analyzer post-detection filter (VBW).

Key Path	Meas Setup, Offset/Limits, Offset BW
Mode	SA, WCDMA, C2K, WIMAX OFDMA, TD-SCDMA, 1xEVDO, DVB-T/H, DTMB (CTTB), ISDB-T, CMMB, LTE, LTE-TDD, Digital Cable TV, MSR, LTEAFDD, LTEATDD
Remote Command	<pre>[[:SENSe]:ACPower:OFFSet[1] 2[:OUTer]:LIST:BANDwidth:VIDeo &lt;freq&gt;, &lt;freq&gt;, &lt;freq&gt;, &lt;freq&gt;, &lt;freq&gt;  [:SENSe]:ACPower:OFFSet[1] 2[:OUTer]:LIST:BANDwidth:VIDeo?  [:SENSe]:ACPower:OFFSet[1] 2[:OUTer]:LIST:BANDwidth:VIDeo:AUTO OFF   ON   0   1, OFF   ON   0   1, OFF   ON   0   1, OFF   ON   0   1, OFF   ON   0   1, OFF   ON   0   1  [:SENSe]:ACPower:OFFSet[1] 2[:OUTer]:LIST:BANDwidth:VIDeo:AUTO?</pre>
Example	<pre>ACP:OFFS2:LIST:BAND:VID 5MHz, 5MHz, 5MHz, 5MHz, 5MHz, 5MHz ACP:OFFS2:LIST:BAND:VID? ACP:OFFS2:LIST:BAND:VID:AUTO 0,0,0,0,1,1 ACP:OFFS2:LIST:BAND:VID:AUTO?</pre>
Notes	<p>The values shown in this table reflect the conditions after a Mode Preset.</p> <p>Offset sub op code. 1 for BTS, 2 for MS. Default is BTS.</p> <p>Note that Offset sub op code 2 is supported only in Non-SA modes.</p> <p>In the SA mode, Offset sub op code 1 is used for both BTS and MS.</p> <p>You must be in the mode that includes ACP measurements to use this command. Use <code>:INSTrument:SElect</code> to set the mode.</p> <p>.</p>
Dependencies	When Meas Method is RBW or FAST, this key is grayed out and disabled. If the key is pressed, an advisory message is generated. If the equivalent remote command is sent, a "Setting conflict" warning is generated.
Preset	<pre>SA: 22 kHz, 22 kHz, 22 kHz, 22 kHz, 22 kHz, 22 kHz WCDMA, WIMAX OFDMA: 1 MHz, 1 MHz, 1 MHz, 1 MHz, 1 MHz, 1 MHz C2K: 150 kHz, 150 kHz, 150 kHz, 150 kHz, 150 kHz, 150 kHz  150 kHz, 150 kHz, 150 kHz, 1150 kHz, 1150 kHz, 150 kHz TD-SCDMA: 300 kHz, 300 kHz, 300 kHz, 300 kHz, 300 kHz, 300 kHz 1xEVDO: 300KHz, 300KHz, 300KHz, 300KHz, 300KHz, 300KHz   300KHz, 300KHz, 300KHz, 300KHz, 300KHz, 300KHz</pre>



	DVB-T/H: 390 kHz, 390 kHz, 390 kHz, 390 kHz, 390 kHz, 390 kHz 390 kHz, 390 kHz, 390 kHz, 390 kHz, 390 kHz, 390 kHz DTMB (CTTB): 390 kHz, 390 kHz, 390 kHz, 390 kHz, 390 kHz, 390 kHz 390 kHz, 390 kHz, 390 kHz, 390 kHz, 390 kHz, 390 kHz ISDB-T: 390 kHz, 390 kHz, 390 kHz, 390 kHz, 390 kHz, 390 kHz 390 kHz, 390 kHz, 390 kHz, 390 kHz, 390 kHz, 390 kHz CMMB: 390 kHz, 390 kHz, 390 kHz, 390 kHz, 390 kHz, 390 kHz 390 kHz, 390 kHz, 390 kHz, 390 kHz, 390 kHz, 390 kHz LTE, LTE-TDD, MSR, LTEAFDD, LTEATDD: 1 MHz, 1 MHz, 1 MHz, 1 MHz, 1 MHz, 1 MHz Digital Cable TV: 390 kHz, 390 kHz, 390 kHz, 390 kHz, 390 kHz, 390 kHz 390 kHz, 390 kHz, 390 kHz, 390 kHz, 390 kHz, 390 kHz ON, ON, ON, ON, ON, ON
State Saved	Saved in instrument state.
Min	1 Hz
Max	50 MHz
<b>Backwards Compatibility SCPI</b>	[ :SENSe ] :ACPpower :OFFSet [ 1 ]   2 :LIST :BWIth :VIDeo
Initial S/W Revision	Prior to A.02.00
Modified at S/W Revision	A.02.00, A.03.00, A.13.00

## RBW Control

Accesses the resolution bandwidth control menu.

Key Path	Meas Setup, Offset/Limits, Offset BW
Initial S/W Revision	Prior to A.02.00

## Filter Type

Selects the type of bandwidth filter that is used.

Key Path	Meas Setup, Offset/Limits, Offset BW, RBW Control
Mode	SA, WCDMA, C2K, WIMAX OFDMA, TD-SCDMA, 1xEVDO, DVB-T/H, DTMB (CTTB), ISDB-T, CMMB, LTE, LTE-TDD, Digital Cable TV, MSR, LTEAFDD, LTEATDD
<b>Remote Command</b>	[ :SENSe ] :ACPpower :OFFSet [ 1 ]   2 [ :OUTer ] :LIST :BANdwidth :SHAPE GAUSSian   FLATtop, GAUSSian   FLATtop, GAUSSian   FLATtop, GAUSSian   FLATtop, GAUSSian   FLATtop, GAUSSian   FLATtop [ :SENSe ] :ACPpower :OFFSet [ 1 ]   2 [ :OUTer ] :LIST :BANdwidth :SHAPE?
<b>Example</b>	ACP:OFFS2:LIST: BAND: SHAP FLAT, GAUS, GAUS, GAUS, GAUS, GAUS ACP:OFFS2:LIST: BAND: SHAP?
Notes	Offset sub op code. 1 for BTS, 2 for MS. Default is BTS. Note that Offset sub op code 2 is supported only in Non-SA modes.

	In the SA mode, Offset sub op code 1 is used for both BTS and MS. You must be in the mode that includes ACP measurements to use this command. Use :INSTrument:SElect to set the mode.
Dependencies	When Res BW Mode for the offset is Auto, this key is grayed out and disabled. Since Res BW Mode for the offset is preset to Auto on changing Meas Method to RBW or FAST, this key is grayed out and disabled too. If the key is pressed, an advisory message is generated. If the equivalent remote command is sent, a "Setting conflict" warning is generated.
Couplings	See the description above
Preset	GAUSSian, GAUSSian, GAUSSian, GAUSSian, GAUSSian, GAUSSian
State Saved	Saved in instrument state.
Range	GAUSSian FLATtop
<b>Backwards Compatibility SCPI</b>	[ :SENSe ] :ACPoweR:OFFSet [ 1 ]   2 :LIST:BWIDth:SHAPE
Initial S/W Revision	Prior to A.02.00
Modified at S/W Revision	A.02.00, A.03.00, A.13.00

#### Filter BW

Selects a Gaussian filter based on its -3 dB (Normal) bandwidth or its -6 dB bandwidth.

Key Path	Meas Setup, Offset/Limits, Offset BW, RBW Control
Mode	SA, WCDMA, C2K, WIMAX OFDMA, TD-SCDMA, 1xEVDO, DVB-T/H, DTMB (CTTB), ISDB-T, CMMB, LTE, LTE-TDD, Digital Cable TV, MSR, LTEAFDD, LTE-TDD
<b>Remote Command</b>	[ :SENSe ] :ACPoweR:OFFSet [ 1 ]   2 [ :OUTer ] :LIST:BAWIDth:TYPE DB3   DB6, DB3   DB6, DB3   DB6, DB3   DB6, DB3   DB6, DB3   DB6 [ :SENSe ] :ACPoweR:OFFSet [ 1 ]   2 [ :OUTer ] :LIST:BAWIDth:TYPE?
<b>Example</b>	ACP:OFFS2:LIST:BAW:TYPE DB3, DB3, DB3, DB3, DB3, DB3 ACP:OFFS2:LIST:BAW:TYPE?
Notes	Offset sub op code. 1 for BTS, 2 for MS. Default is BTS. Note that Offset sub op code 2 is supported only in Non-SA modes. In the SA mode, Offset sub op code 1 is used for both BTS and MS. You must be in the mode that includes ACP measurements to use this command. Use :INSTrument:SElect to set the mode.
Dependencies	When Filter Type if Flattop or Res BW Mode for the offset is Auto, this key is grayed out and disabled. Since Res BW Mode for the offset is preset to Auto on changing Meas Method to RBW or FAST, this key is grayed out and disabled too. If the key is pressed, an advisory message is generated. If the equivalent remote command is sent, a "Setting conflict" warning is generated.
Preset	DB3, DB3, DB3, DB3, DB3, DB3
State Saved	Saved in instrument state.
Range	-3 dB (Normal)   -6 dB
<b>Backwards Compatibility SCPI</b>	[ :SENSe ] :ACPoweR:OFFSet [ 1 ]   2 :LIST:BWIDth:TYPE

Initial S/W Revision	Prior to A.02.00
Modified at S/W Revision	A.02.00, A.03.00, A.13.00

## Limits

Limits key accesses a menu of functions that contains Select Offset, Abs Limit, Rel Limit and Fail Mask parameters.

Key Path	Meas Setup, Offset/Limits
Initial S/W Revision	A.03.00

## Select Offset

Selects the offset to configure.

Key Path	Meas Setup, Offset/Limits, Limits
Mode	SA, WCDMA, C2K, WIMAX OFDMA, TD-SCDMA, 1xEVDO, DVB-T/H, DTMB (CTTB), ISDB-T, CMMB, LTE, LTE-TDD, Digital Cable TV, MSR, LTEAFDD, LTEATDD
Preset	A
State Saved	Saved in instrument state.
Range	Offset A Offset B Offset C Offset D Offset E Offset F
Initial S/W Revision	Prior to A.02.00
Modified at S/W Revision	A.02.00, A.03.00, A.13.00

## Abs Limit

Enters an absolute limit value, which sets the absolute amplitude levels to test against for each of the custom offsets. The list must contain six (6) entries. If there is more than one offset, the offset closest to the carrier channel is the first one in the list. [:SENSe]:ACP:OFFSet[n][:OUTer]:LIST:TEST selects the type of testing to be done at each offset.

You can turn off (not use) specific offsets with the [:SENSe]:ACP:OFFSet[n][:OUTer]:LIST:STATe command.

The query returns the six (6) sets of real numbers that are the current absolute amplitude test limits.

Key Path	Meas Setup, Offset/Limits, Limits
Mode	SA, WCDMA, C2K, WIMAX OFDMA, TD-SCDMA, 1xEVDO, DVB-T/H, DTMB (CTTB), ISDB-T, CMMB, LTE, LTE-TDD, Digital Cable TV, MSR, LTEAFDD, LTEATDD
Remote Command	[:SENSe]:ACP:OFFSet[1] 2[:OUTer]:LIST:ABSolute <real>, <real>, <real>, <real>, <real>, <real> [:SENSe]:ACP:OFFSet[1] 2[:OUTer]:LIST:ABSolute?
Example	ACP:OFFS2:LIST:ABS -10, -10, -10, -10, -10, -10

	ACP:OFFS2:LIST:ABS?
Notes	<p>Offset sub op code. 1 for BTS, 2 for MS. Default is BTS.</p> <p>Note that Offset sub op code 2 is supported only in Non-SA modes.</p> <p>In the SA mode, Offset sub op code 1 is used for both BTS and MS.</p> <p>You must be in the mode that includes ACP measurements to use this command. Use :INSTrument:SElect to set the mode.</p>
Couplings	<p>None</p> <p>If current mode is DTMB (CTTB) or CMMB and current device type is Transmitter, the value from position 2 to position 4 are coupled, changing any one will change the others.</p>
Preset	<p>SA: 0dBm, 0 dBm, 0 dBm, 0 dBm, 0 dBm, 0 dBm 0dBm, 0 dBm, 0 dBm, 0 dBm, 0 dBm, 0 dBm</p> <p>WCDMA: 50 dBm, 50 dBm, 50 dBm, 50 dBm, 50 dBm, 50 dBm 50 dBm, 50 dBm, 50 dBm, 50 dBm, 50 dBm, 50 dBm</p> <p>C2K: 50 dBm, 50 dBm, 50 dBm, 50 dBm, 50 dBm, 50 dBm 50 dBm, 50 dBm, 50 dBm, 50 dBm, 50 dBm, 50 dBm</p> <p>WIMAX OFDMA: 50,50,50,50,50,50</p> <p>TD-SCDMA: 50 dBm, 50 dBm, 50 dBm, 50 dBm, 50 dBm, 50 dBm 50 dBm, 50 dBm, 50 dBm, 50 dBm, 50 dBm, 50 dBm</p> <p>1xEVDO: -27dBm, -27dBm, -13dBm, -13dBm, -13dBm, -13dBm  -27dBm, -27dBm, -13dBm, -13dBm, -13dBm, -13dBm</p> <p>DVB-T/H: 50 dBm, 50 dBm, 50 dBm, 50 dBm, 50 dBm, 50 dBm 50 dBm, 50 dBm, 50 dBm, 50 dBm, 50 dBm, 50 dBm</p> <p>DTMB (CTTB): 11.14 dBm, 11.14dBm, 11.14 dBm, 11.14 dBm, 50 dBm, 50 dBm 11.14 dBm, 11.14 dBm, 11.14 dBm, 11.14 dBm, 50 dBm, 50 dBm</p> <p>ISDB-T: 50 dBm, 50 dBm, 50 dBm, 50 dBm, 50 dBm, 50 dBm 50 dBm, 50 dBm, 50 dBm, 50 dBm, 50 dBm, 50 dBm</p> <p>CMMB: 11.14 dBm, 11.14dBm, 11.14 dBm, 11.14 dBm, 50 dBm, 50 dBm 11.14 dBm, 11.14 dBm, 11.14 dBm, 11.14 dBm, 50 dBm, 50 dBm</p> <p>LTE, LTETDD, MSR, LTEAFDD, LTEATDD: -8.45, -8.45, -8.45, -8.45, -8.45, -8.45 -50.0, -50.0, -50.0, -50.0, -50.0, -50.0</p> <p>Digital Cable TV: 50 dBm, 50 dBm, 50 dBm, 50 dBm, 50 dBm, 50 dBm 50 dBm, 50 dBm, 50 dBm, 50 dBm, 50 dBm, 50 dBm</p>
State Saved	Saved in instrument state.
Min	-200.0 dBm
Max	50.0 dBm
<b>Backwards Compatibility SCPI</b>	[:SENSE]:ACPR:OFFSet[1] 2:LIST:ABSolute (PSA W-CDMA, PSA cdma2000 )
	[:SENSE]:MCPower:OFFSet[1] 2:LIST:ABSolute (PSA W-CDMA)
Initial S/W Revision	Prior to A.02.00
Modified at S/W Revision	A.02.00, A.03.00, A.13.00

## Rel Lim (Car)

Enters a relative limit value for the carrier level. This sets the amplitude levels to test against for the specified offsets.

The amplitude level is relative to the carrier amplitude. If multiple offsets are available, the list contains six (6) entries. The offset closest to the carrier channel is the first one in the list.

`[:SENSe]:ACP:OFFSet[n][:OUTer]:LIST:TEST` selects the type of testing to be done at each offset.

You can turn off (not use) specific offsets with the `[:SENSe]:ACP:OFFSet[n][:OUTer]:LIST:STATe` command.

The query returns the six (6) sets of real numbers that are the current amplitude test limits, relative to the carrier, for each offset.

Offset[n] n = 1 is base station and n = 2 is mobiles. The default is base station (1).

Key Path	Meas Setup, Offset/Limits, Limits,
Mode	SA, WCDMA, C2K, WIMAX OFDMA, TD-SCDMA, 1xEVDO, DVB-T/H, DTMB (CTTB), ISDB-T, CMMB, LTE, LTEFDD, Digital Cable TV, MSR, LTEAFDD, LTEATDD
Remote Command	<code>[:SENSe]:ACP:OFFSet[1] 2[:OUTer]:LIST:RCARrier &lt;real&gt;, &lt;real&gt;, &lt;real&gt;, &lt;real&gt;, &lt;real&gt;, &lt;real&gt;</code> <code>[:SENSe]:ACP:OFFSet[1] 2[:OUTer]:LIST:RCARrier?</code>
Example	<code>ACP:OFFS2:LIST:RCAR 0,0,0,0,0,0</code> <code>ACP:OFFS2:LIST:RCAR?</code>
Notes	Offset sub op code. 1 for BTS, 2 for MS. Default is BTS. Note that Offset sub op code 2 is supported only in Non-SA modes. In the SA mode, Offset sub op code 1 is used for both BTS and MS. You must be in the mode that includes ACP measurements to use this command. Use <code>:INSTrument:SElect</code> to set the mode.
Couplings	None If current mode is DTMB (CTTB) or CMMB and current device type is Transmitter, the value from position 2 to position 4 are coupled, changing any one will change the others.
Preset	SA: -45, -60, 0, 0, 0, 0 -45, -60, 0, 0, 0, 0 WCDMA: -44.2, -49.2, -49.2, -49.2, -49.2, -49.2 -32.2, -42.2, -42.2, -42.2, -42.2, -42.2 C2K: 0, 0, 0, 0, 0, 0 0, 0, 0, 0, 0, 0 WIMAX OFDMA: -50, -60, 0, 0, 0, 0 TD-SCDMA: -40, -45, -45, -45, -45, -45 -33, -43, -43, -43, -43, -43 1xEVDO: -45, -55, -55, -55, -55, -55 -45, -55, -55, -55, -55, -55 DVB-T/H: -60, -60, 0, 0, 0, 0 -60, -60, 0, 0, 0, 0 DTMB (CTTB): -45, -60, -60, -60, 50, 50 -45, -60, -60, -60, 50, 50 ISDB-T: -60, -60, 0, 0, 0, 0 -60, -60, 0, 0, 0, 0 CMMB: -45, -60, -60, -60, 50, 50 -45, -60, -60, -60, 50, 50 LTE, LTEFDD, MSR, LTEAFDD, LTEATDD: -44.2, -44.2, -44.2, -44.2, -44.2, -44.2 -29.2, -29.2, -29.2, -29.2, -29.2, -29.2

	Digital Cable TV: -58, -62, -65, -73, -73, -73 -58, -62, -65, -73, -73, -73
State Saved	Saved in instrument state.
Min	-150
Max	50.0
<b>Backwards Compatibility SCPI</b>	[ :SENSe]:MCPower:OFFSet[1] 2:LIST:RCARrier (PSA WCDMA)
Initial S/W Revision	Prior to A.02.00
Modified at S/W Revision	A.02.00, A.03.00, A.04.00, A.13.00

### Positive Offset Limit (SCPI only)

Enables you to set the upper limit for the upper segment of the specified offset pair.

Mode	SA, WCDMA, CDMA2K, WIMAXOFDMA, TDSCDMA, CDMA1XEV, DVB, DTMB, LTE, LTETDD, DCATV, MSR, LTEAFDD,LTEATDD
<b>Remote Command</b>	:CALCulate:ACPower:OFFSet[:OUTer]:LIST:LIMit:POSitive[:UPPer]:DATA <real>, <real>, <real>, <real>, <real>, <real> :CALCulate:ACPower:OFFSet[:OUTer]:LIST:LIMit:POSitive[:UPPer]:DATA?
<b>Example</b>	CALC:ACP:OFFS:LIST:LIM:POS:DATA 0, 0, 0, 0, 0, 0 CALC:ACP:OFFS:LIST:LIM:POS:DATA?
Notes	SCPI only command
Preset	SA: -45, -60, 0, 0, 0, 0 -45, -60, 0, 0, 0, 0 WCDMA: -44.2, -49.2, -49.2, -49.2, -49.2, -49.2 -32.2, -42.2, -42.2, -42.2, -42.2, -42.2 C2K: 0, 0, 0, 0, 0, 0 0, 0, 0, 0, 0, 0 WIMAX OFDMA: -50, -60, 0, 0, 0, 0 TD-SCDMA: -40, -45, -45, -45, -45, -45 -33, -43, -43, -43, -43, -43 1xEVDO: -45, -55, -55, -55, -55, -55 -45, -55, -55, -55, -55, -55 DVB-T/H: -60, -60, 0, 0, 0, 0 -60, -60, 0, 0, 0, 0 DTMB (CTTB): -45, -60, -60, -60, 0, 0 -45, -60, -60, -60, 0, 0 Digital Cable TV: -58, -62, -65, -73, -73, -73 -58, -62, -65, -73, -73, -73 LTE, LTETDD, MSR, LTEAFDD, LTEATDD: -44.2, -44.2, -44.2, -44.2, -44.2, -44.2 -29.2, -29.2, -29.2, -29.2, -29.2, -29.2
State Saved	Saved in instrument state.
Min	-150.0
Max	50.0
<b>Backwards Compatibility SCPI</b>	:CALCulate:MCPower:OFFSet:LIST:LIMit:POSitive[:UPPer]:DATA (PSA Power Suite)
Initial S/W Revision	A.04.00
Modified at S/W Revision	A.13.00

## Negative Offset Limit

Enables you to set the upper limit for the lower segment of the specified offset pair.

Mode	SA, WCDMA, CDMA2K, WIMAXOFDMA, TDSCDMA, CDMA1XEV, DVB, DTMB, LTE, LTETDD, DCATV, MSR, LTEAFDD,LTEATDD
Remote Command	:CALCulate:ACPower:OFFSet[:OUTer]:LIST:LIMit:NEGative[:UPPer]:DATA <real>, <real>, <real>, <real>, <real>, <real> :CALCulate:ACPower:OFFSet[:OUTer]:LIST:LIMit:NEGative[:UPPer]:DATA?
Example	CALC:ACP:OFFS:LIST:LIM:NEG:DATA 0, 0, 0, 0, 0, 0 CALC:ACP:OFFS:LIST:LIM:NEG:DATA?
Notes	SCPI only command
Preset	SA: -45, -60, 0, 0, 0, 0 -45, -60, 0, 0, 0, 0 WCDMA: -44.2, -49.2, -49.2, -49.2, -49.2, -49.2 -32.2, -42.2, -42.2, -42.2, -42.2, -42.2 C2K: 0, 0, 0, 0, 0, 0 0, 0, 0, 0, 0, 0 WIMAX OFDMA: -50, -60, 0, 0, 0, 0 TD-SCDMA: -40, -45, -45, -45, -45, -45 -33, -43, -43, -43, -43, -43 1xEVDO: -45, -55, -55, -55, -55, -55 -45, -55, -55, -55, -55, -55 DVB-T/H: -60, -60, 0, 0, 0, 0 -60, -60, 0, 0, 0, 0 DTMB (CTTB): -45, -60, -60, -60, 0, 0 -45, -60, -60, -60, 0, 0 Digital Cable TV: -58, -62, -65, -73, -73, -73 -58, -62, -65, -73, -73, -73 LTE, LTETDD, MSR, LTEAFDD, LTEATDD: -44.2, -44.2, -44.2, -44.2, -44.2, -44.2 -29.2, -29.2, -29.2, -29.2, -29.2, -29.2
State Saved	Saved in instrument state.
Min	-150.0
Max	50.0
Backwards Compatibility SCPI	:CALCulate:MCPower:OFFSet:LIST:LIMit:NEGative[:UPPer]:DATA (PSA Power Suite)
Initial S/W Revision	A.04.00
Modified at S/W Revision	A.13.00

## Rel Limit (PSD)

Enters a relative limit value for the level of the power spectral density. This sets the amplitude levels to test against for any custom offsets. The amplitude level is relative to the power spectral density. If multiple offsets are available, the list contains six (6) entries. The offset closest to the carrier channel is the first one in the list.

[[:SENSE]:ACP:OFFSet[n][:OUTer]:LIST:TEST selects the type of testing to be done at each offset.

You can turn off (not use) specific offsets with the [[:SENSE]:ACP:OFFSet[n][:OUTer]:LIST:STATe command.

The query returns the six (6) sets of real numbers that are the current amplitude test limits, relative to the power spectral density, for each offset.

Offset[n] n = 1 is base station and n = 2 is mobiles. The default is base station (1).

Key Path	Meas Setup, Offset/Limits, Limits
Mode	SA, WCDMA, C2K, WIMAX OFDMA, TD-SCDMA, 1xEVDO, DVB-T/H, DTMB (CTTB), ISDB-T, CMMB, LTE, LTETDD, Digital Cable TV, MSR, LTEAFDD, LTEATDD
Remote Command	<code>[[:SENSe]:ACPower:OFFSet[1] 2[:OUTer]:LIST:RPSDensity &lt;rel_ampl&gt;, &lt;rel_ampl&gt;, &lt;rel_ampl&gt;, &lt;rel_ampl&gt;, &lt;rel_ampl&gt;</code> <code>[[:SENSe]:ACPower:OFFSet[1] 2[:OUTer]:LIST:RPSDensity?</code>
Example	ACP:OFFS2:LIST:RPSD 10,10,10,10,10,10 ACP:OFFS2:LIST:RPSD?
Notes	Offset sub op code. 1 for BTS, 2 for MS. Default is BTS. Note that Offset sub op code 2 is supported only in Non-SA modes. In the SA mode, Offset sub op code 1 is used for both BTS and MS. You must be in the mode that includes ACP measurements to use this command. Use <code>:INSTRument:SElect</code> to set the mode.
Preset	SA: -28.87 dB, -43.87 dB, 0 dB, 0 dB, 0 dB, 0 dB -28.87 dB, -43.87 dB, 0 dB, 0 dB, 0 dB, 0 dB WCDMA: -44.2 dB, -49.2 dB, -49.2 dB, -49.2 dB, -49.2 dB, -49.2 dB -32.2 dB, -42.2 dB, -42.2 dB, -42.2 dB C2K: 0 dB, 0 dB, 0 dB, 0 dB, 0 dB, 0 dB 0 dB, 0 dB, 0 dB, 0 dB, 0 dB, 0 dB WIMAX OFDMA: -25,-35,0,0,0,0 TD-SCDMA: -40 dB, -45 dB, -45 dB, -45 dB, -45 dB, -45 dB -33 dB, -43 dB, -43 dB, -43 dB, -43 dB, -43 dB 1xEVDO: -45, -55, -55, -55, -55, -55 -45, -55, -55, -55, -55, -55 DVB-T/H: -60 dB, -60 dB, 0 dB, 0 dB, 0 dB, 0 dB -60 dB, -60 dB, 0 dB, 0 dB, 0 dB, 0 dB DTMB (CTTB): 50 dB, 50 dB, 50 dB, 50 dB, 50 dB, 50 dB 50 dB, 50 dB, 50 dB, 50 dB, 50 dB, 50 dB ISDB-T: -60 dB, -60 dB, 0 dB, 0 dB, 0 dB, 0 dB -60 dB, -60 dB, 0 dB, 0 dB, 0 dB, 0 dB CMMB: 50 dB, 50 dB, 50 dB, 50 dB, 50 dB, 50 dB 50 dB, 50 dB, 50 dB, 50 dB, 50 dB, 50 dB LTE, LTETDD, MSR, LTEAFDD, LTEATDD: 0, 0, 0, 0, 0, 0 0, 0, 0, 0, 0, 0 Digital Cable TV: 50 dB, 50 dB, 50 dB, 50 dB, 50 dB, 50 dB 50 dB, 50 dB, 50 dB, 50 dB, 50 dB, 50 dB
State Saved	Saved in instrument state.
Min	-150.0 dB
Max	50.0 dB
Initial S/W Revision	Prior to A.02.00
Modified at S/W Revision	A.02.00, A.03.00, A.13.00

## Fail Mask

Accesses a menu that enables you to select one of the logic keys for the fail conditions between the measurement results and the test limits. The setting defines the type of testing to be done at any custom offset frequencies. The measured powers are tested against the absolute values defined with `[[:SENSe]:ACPower:OFFSet[n]:OUTer]:LIST:ABSolute`, or the relative values defined with `[[:SENSe]:ACPower:OFFSet[n]:OUTer]:LIST:RPSDensity` and `[[:SENSe]:ACPower:OFFSet[n]:OUTer]:LIST:RCARrier`.

You can turn off (not use) specific offsets with the `[[:SENSe]:ACPower:OFFSet[n]:OUTer]:LIST:STATe` command.



- Absolute – Fail is shown if one of the absolute ACP measurement results is larger than the limit for Abs Limit.
- Relative – Fail is shown if one of the relative ACP measurement results is larger than the limit for Rel Lim (Car) or Rel Lim (PSD).
- Abs AND Rel – Fail is shown if one of the absolute ACP measurement results is larger than the limit for Abs Limit AND one of the relative ACP measurement results is larger than the limit for Rel Lim (Car) or Rel Lim (PSD).
- Abs OR Rel – Fail is shown if one of the absolute ACP measurement results is larger than the limit for Abs Limit OR one of the relative ACP measurement results is larger than the limit for Rel Lim (Car) or Rel Lim (PSD).

<b>Key Path</b>	Meas Setup, Offset/Limits, Limits
<b>Mode</b>	SA, WCDMA, C2K, WIMAX OFDMA, TD-SCDMA, 1xEVDO, DVB-T/H, DTMB (CTTB), ISDB-T, CMMB, LTE, LTEFDD, Digital Cable TV, MSR, LTEAFDD, LTEATDD
<b>Remote Command</b>	[:SENSe]:ACPower:OFFSet[1] 2[:OUTer]:LIST:TEST ABSolute   AND   OR   RELative, ABSolute   AND   OR   RELative, ABSolute   AND   OR   RELative, ABSolute   AND   OR   RELative, ABSolute   AND   OR   RELative  [:SENSe]:ACPower:OFFSet[1] 2[:OUTer]:LIST:TEST?
<b>Example</b>	ACP:OFFS2:LIST:TEST ABS, ABS, ABS, ABS, ABS, ABS ACP:OFFS2:LIST:TEST?
<b>Notes</b>	Offset sub op code. 1 for BTS, 2 for MS. Default is BTS. Note that Offset sub op code 2 is supported only in Non-SA modes. In the SA mode, Offset sub op code 1 is used for both BTS and MS. You must be in the mode that includes ACP measurements to use this command. Use :INSTrument:SElect to set the mode.
<b>Couplings</b>	None If current mode is DTMB (CTTB) or CMMB and current device type is Transmitter, the value from position 2 to position 4 are coupled, changing any one will change the others.
<b>Preset</b>	SA, WCDMA, C2K, TD-SCDMA: REL, REL, REL, REL, REL, REL REL, REL, REL, REL, REL, REL WIMAX OFDMA: REL, REL, REL, REL, REL, REL DVB-T/H: REL, REL, REL, REL, REL, REL DTMB (CTTB): OR,AND, AND,AND, REL, REL CDMA1xEVDO: REL, REL, ABS, REL, REL, REL REL, REL, ABS, REL, REL, REL ISDB-T: REL, REL, REL, REL, REL, REL CMMB: OR,AND, AND,AND, REL, REL LTE, LTEFDD, MSR, LTEAFDD, LTEATDD: AND, AND, AND, AND, AND, AND AND, AND, AND, AND, AND, AND Digital Cable TV: REL, REL, REL, REL, REL, REL
<b>State Saved</b>	Saved in instrument state.
<b>Range</b>	Absolute Relative Abs AND Rel (fail if both fail) Abs OR Rel (fail if either fails)
<b>Backwards Compatibility SCPI</b>	[:SENSe]:MCPower:OFFSet[1] 2:LIST:TEST

Initial S/W Revision	Prior to A.02.00
Modified at S/W Revision	A.02.00, A.03.00, A.04.00, A13.00

### Offset Side

Enables you to turn off (not use) specific offsets with `[:SENSe]:ACPower:OFFSet[1]|2[:OUTer]:LIST:SIDE`.

- NEGative - Negative (lower) sideband only
- BOTH - Both of the negative (lower) and positive (upper) sidebands
- POSitive - Positive (upper) sideband only

The figure below shows the relation between the negative/positive offset side setups and the upper/lower results in the MSR and LTE-Advanced FDD/TDD.

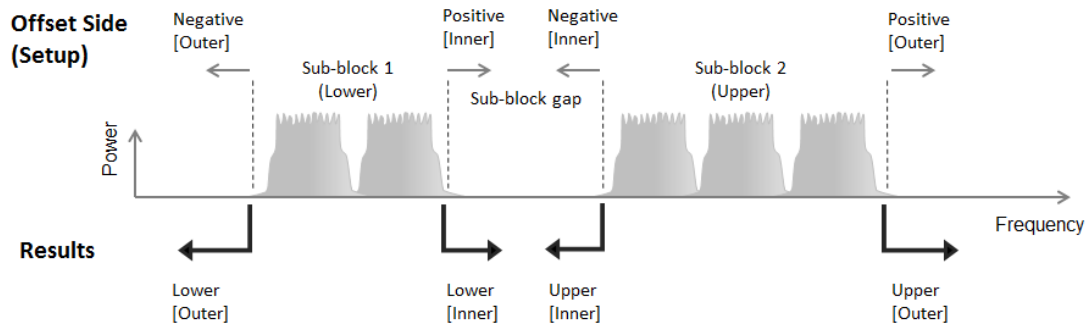

Key Path	Meas Setup, Offset/Limits
Mode	SA, WCDMA, C2K, WIMAX OFDMA, TD-SCDMA, 1xEVDO, DTMB (CTTB), DVB-T/H, LTE, LTETDD, Digital Cable TV, MSR, LTEAFDD, LTEATDD
Remote Command	<code>[:SENSe]:ACPower:OFFSet[1] 2[:OUTer]:LIST:SIDE NEGative   BOTH   POSitive,NEGative   BOTH   POSitive,NEGative   BOTH   POSitive,NEGative   BOTH   POSitive,NEGative   BOTH   POSitive</code> <code>[:SENSe]:ACPower:OFFSet[1] 2[:OUTer]:LIST:SIDE?</code>
Example	ACP:OFFS:LIST:SIDE BOTH ACP:OFFS:LIST:SIDE?
Notes	OFFSet1 is for BTS, 2 for MS. Default is BTS. You must be in the Spectrum Analysis mode, W-CDMA mode, cdma2000 mode, TD-SCDMA mode, DTMB (CTTB) mode, DVB-T/H mode, ISDB-T mode, CMMB mode, Digital Cable TV mode, 1xEVDO mode, WIMAX OFDMA mode, LTE mode, LTETDD, LTEAFDD, LTEATDD or MSR mode to use this command. Use <code>:INSTRument:SElect</code> to set the mode. If you set POS or NEG in an offset, result of the inactive side will return -999.
Preset	BOTH, BOTH, BOTH, BOTH, BOTH, BOTH BOTH, BOTH, BOTH, BOTH, BOTH, BOTH
State Saved	Saved in instrument state.
Range	Neg Both Pos
Initial S/W Revision	A.03.00
Modified at S/W Revision	A.13.00

## Offset Frequency Define

This key allows you to select “Offset” definition. Each standard defines each “Offset” from Carrier.

3GPP2 requires the “From Carrier Center to MeasBW Closer Edge” definition. LTE conformance test requires “From Carrier Edge to MeasBW Center” and/or “From Carrier Edge to MeasBW Closer Edge” definition.

- CTOCenter – From the center of the carrier closest to the adjacent channel to the center of the adjacent channel Offset Integ BW
- CTOEdge – From the center of the carrier closest to the adjacent channel to the edge of the closest adjacent channel Offset Integ BW
- ETOCenter – From Center Frequency - Carrier Spacing / 2 (for lower offset), Center Frequency + Carrier Spacing / 2 (for upper offset) of the carrier closest to the adjacent channel's to the center of the adjacent channel Offset Integ BW
- ETOEdge – From Center Frequency - Carrier Spacing / 2 (for lower offset), Center Frequency + Carrier Spacing / 2 (for upper offset) of the carrier closest to the adjacent channel's to the edge of the closest adjacent channel Offset Integ BW

Key Path	Meas Setup, Offset/Limits
Mode	SA, WCDMA, C2K, WIMAX OFDMA, TD-SCDMA, 1xEVDO, DVB-T/H, DTMB (CTTB), ISDB-T, CMMB, LTE, LTE-TDD, Digital Cable TV, MSR, LTEAFDD, LTEATDD
Remote Command	[ :SENSe ] :ACPower:OFFSet [ 1 ]   2 [ :OUTer ] :TYPE CTOCenter   CTOEdge   ETOCenter   ETOEdge  [ :SENSe ] :ACPower:OFFSet [ 1 ]   2 [ :OUTer ] :TYPE?
Example	ACP:OFFS:TYPE ETOC ACP:OFFS:TYPE?
Notes	You must be in the mode that includes ACP measurements to use this command. Use :INSTrument:SElect to set the mode.
Preset	All Except C2K and 1xEVDO: CTOCenter C2K and 1xEVDO: CTOEdge
State Saved	Saved in instrument state.
Range	Carrier Center To Meas BW Center Carrier Center To Meas BW Edge Carrier Edge To Meas BW Center Carrier Edge To Meas BW Edge
Initial S/W Revision	A.03.00
Modified at S/W Revision	A.13.00

## Carrier Result

Allows you to view and scroll through the carrier power results.

Key Path	Meas Setup
----------	------------

Mode	SA, WCDMA, C2K, WIMAX OFDMA, TD-SCDMA, 1xEVDO, DVB-T/H, DTMB (CTTB), ISDB-T, CMMB, LTE, LTE-TDD, Digital Cable TV, MSR, LTEAFDD, LTEATDD
Couplings	This key will be grayed out if there is only one carrier.
Preset	1
State Saved	No
Min	1
Max	Number of carriers.
Initial S/W Revision	Prior to A.02.00
Modified at S/W Revision	A.02.00, A.03.00

## Meas Method

Sets the desired method to measure ACP.

Integration BW – one sweep of the trace is taken, and the band power for each offset is computed. Depending on the status of the Meas Type parameter (Total Power Reference or PSD Reference), results are displayed relative to the total power or the power spectral density. The display reflects either the current trace or a bar graph view.

Filtered IBW (max dynamic range) – the ACP Path is used to compute ACP when an ACP path is available. This method increases dynamic range, but increases measurement time as it limits the resolution bandwidth. This method is useful for improving dynamic range on a W-CDMA signal because a sharp cutoff bandpass filter is used. The accuracy of the adjacent channel power ratio is not degraded by this method, but the absolute accuracy of both adjacent channel power and carrier power are degraded by up to about 0.5 dB.

RBW – the algorithm uses zero-span and an appropriate RBW setting to capture all of the power in the carrier channel and the offsets. The zero-span algorithm (RBW method) is slower than the IBW method, but greatly improves repeatability.

Fast (in WCDMA mode or SA mode with 3GPP WCDMA radio standard selected) – this provides the same method as the Integration BW method, but is optimized for speed to measure a W-CDMA signal.

Fast (in CDMA2K mode or SA mode with CDMA2K radio standard selected) – this provides faster measurement using the FFT method with a limited parameter flexibility. When this is selected, CDMA2K preset offsets are given and control of the following are grayed out:

BW menu, Sweep/Control menu except Pause/Resume, Trace/Detector menu, Carrier Setup, Offset Limit, RRC Weighting, Filter Alpha, and Noise Correction softkeys in Meas Setup menu.

Key Path	Meas Setup
Mode	SA, WCDMA, C2K, WIMAX OFDMA, 1xEVDO, DVB-T/H, DTMB (CTTB), ISDB-T, CMMB, LTE, LTE-TDD, Digital Cable TV, MSR, LTEAFDD, LTEATDD
Remote Command	[ :SENSe ] :ACPower:METhod IBW IBWRange FAST RBW [ :SENSe ] :ACPower:METhod?
Example	ACP:METh IBW

ACP:METH?	
Notes	<p>FAST mode is only supported for WCDMA and C2K signal. You must be in the WCDMA or C2K mode or SA mode with 3GPP WCDMA or CDMA2K radio standard. Otherwise a setting conflict error message will be reported.</p> <p>In the TDSCDMA mode, only the IBW method is available to use. Therefore, the measure method key is not displayed in the TD-SCDMA mode.</p> <p>CDMA1xEVDO mode only supports RBW and Integration BW method.</p> <p>C2K mode only supports RBW, Integration BW and FAST method.</p> <p>LTETDD mode only supports Integration BW and Filtered IBW method.</p> <p>MSR mode only supports Integration BW and Filtered IBW method.</p> <p>LTE-Advanced FDD/TDD mode only support IBW and Filtered IBW method.</p> <p>You must be in the mode that includes ACP measurements to use this command. Use :INSTrument:SElect to set the mode.</p>
Dependencies	<p>When RBW or FAST is selected, Gate function is not available. If you try to turn Gate On while Meas Method is RBW or FAST, an error is generated.</p> <p>When Gate function is ON, RBW and FAST method is not available. If you try to change Meas Method to RBW or FAST, an error is generated.</p>
Couplings	<p>IBW (Range) restricts the Res BW available for making this measurement to 30 kHz. When selected, the Res BW is clipped to this value if required and an error number displayed.</p>
Preset	<p>SA, LTE, LTETDD, MSR, LTEAFDD, LTEATDD: IBW</p> <p>WCDMA: IBW</p> <p>C2K: RBW</p> <p>WIMAX OFDMA: IBW</p> <p>1xEVDO: IBW</p> <p>DVB-T/H: IBW</p> <p>DTMB (CTTB): IBW</p> <p>ISDB-T: IBW</p> <p>CMMB: IBW</p> <p>Digital Cable TV: IBW</p>
State Saved	<p>Saved in instrument state.</p>
Range	<p>Integration BW Filtered IBW (max dynamic range) RBW Fast</p>
Readback Text	<p>IBW Filtered IBW RBW Fast</p>
<b>Backwards Compatibility SCPI</b>	<p>[ :SENSe ] :ACPR :SWEep :TYPE</p> <p>[ :SENSe ] :MCPower :METHod (PSA Power Suite)</p>
Initial S/W Revision	<p>Prior to A.02.00</p>
Modified at S/W Revision	<p>A.02.00, A.03.00</p>

## Meas Type

Changes the reference used for the measurement. This allows you to make absolute and relative power measurements of either total power or the power normalized to the measurement bandwidth.

Total Pwr Ref (TPR) sets the reference to the total carrier power. PSD Ref (PSDR) sets the reference to the power spectral density of the carrier.

Key Path	Meas Setup
Mode	SA, WCDMA, C2K, WIMAX OFDMA, TD-SCDMA, 1xEVDO, DVB-T/H, DTMB (CTTB), ISDB-T, CMMB, LTE, LTE-TDD, Digital Cable TV, MSR, LTEAFDD, LTEATDD
Remote Command	<code>[ :SENSe ] :ACPower:TYPE TPref PSDRef</code> <code>[ :SENSe ] :ACPower:TYPE?</code>
Example	ACP:TYPE PSDR ACP:TYPE?
Notes	You must be in the mode that includes ACP measurements to use this command. Use <code>:INSTrument:SElect</code> to set the mode.
Preset	TPRef
State Saved	Saved in instrument state.
Range	Total Power Ref PSD Ref
Initial S/W Revision	Prior to A.02.00
Modified at S/W Revision	A.02.00, A.03.00

## PSD Ref

Sets the unit bandwidth for Power Spectral Density. The available units are dBm/Hz and dBm/MHz.

Key Path	Meas Setup
Mode	A, WCDMA, C2K, WIMAX OFDMA, TD-SCDMA, 1xEVDO, DVB-T/H, DTMB (CTTB), ISDB-T, CMMB, LTE, LTE-TDD, Digital Cable TV, MSR, LTEAFDD, LTEATDD
Remote Command	<code>:UNIT:ACPower:POWer:PSD DBMHZ DBMMHZ</code> <code>:UNIT:ACPower:POWer:PSD?</code>
Example	UNIT:ACP:POW:PSD DBMMHZ UNIT:ACP:POW:PSD?
Couplings	When the PSD unit is changed, the PSD reference result of the “MEAS READ FETCH:ACP[n]?” is also changed by the PSD unit basis (in either dBm/Hz or dBm/MHz).
Preset	DBMHZ
State Saved	Saved in instrument state.
Range	dBm/Hz dBm/MHz
Initial S/W Revision	Prior to A.02.00
Modified at S/W Revision	A.02.00, A.03.00

## Limit Test

Turns limit checking for each offset On or Off. The limits may be specified within the Offset menu, for each offset, both sides of the carrier. For results that fail the limit, a red F is appended. In the Combined view, the bar turns red.

Key Path	Meas Setup
Mode	SA, WCDMA, C2K, WIMAX OFDMA, TD-SCDMA, 1xEVDO, DVB-T/H, DTMB (CTTB), ISDB-T, CMMB, LTE, LTETDD, Digital Cable TV, MSR, LTEAFDD, LTEATDD
<b>Remote Command</b>	:CALCulate:ACPower:LIMit:STATe OFF ON 0 1 :CALCulate:ACPower:LIMit:STATe?
<b>Example</b>	CALC:ACP:LIM:STAT OFF CALC:ACP:LIM:STAT?
Notes	You must be in the mode that includes ACP measurements to use this command. Use :INSTrument:SElect to set the mode.
Preset	SA: OFF WCDMA: ON C2K: ON WIMAX OFDMA: OFF TD-SCDMA: ON 1xEVDO: ON DVB-T/H: OFF DTMB (CTTB): ON ISDB-T: OFF CMMB: ON LTE, LTETDD, MSR, LTEAFDD, LTEATDD: ON Digital Cable TV: OFF
State Saved	Saved in instrument state.
Range	On Off
<b>Backwards Compatibility SCPI</b>	[ :SENSe ] :MCPower:LIMit [ :STATe ] [ :SENSe ] :ACPower:LIMit [ :STATe ]
Initial S/W Revision	Prior to A.02.00
Modified at S/W Revision	A.02.00, A.03.00

## Noise Correction

Sets the measurement noise floor correction function to On or Off. On enables measurement noise correction when the measured power in the reference channel or any offset is close to the noise floor of the analyzer. Off turns these corrections off.

In analyzers with the noise floor extensions option (option NFE) enabled, there are two ways to compensate for the analyzer noise floor: through the NFE and through this noise corrections key. The techniques are results are similar but not identical. NFE uses a model of the analyzer noise floor, adapted

to the current conditions such as center frequency, RBW and ambient temperature. The parameters of this model are measured in the factory or field calibration in a highly averaged measurement. So they are consistent. However, because the model is imperfect, the corrections are imperfect. Using NFE is very convenient; the user need not wait for the ACP noise corrections calibration to occur. The ACP NC calibration, though, has advantages of being measured very recently, at the current ambient, and the exact center frequency, with no requirement that the model be perfect. So it will often (but not always) have slightly better dynamic range. If both ACP NC is turned on and NFE is turned on, the analyzer uses only the ACP NC. When ACP NC is turned off but NFE is on, NFE is used and performance should still be excellent.

<b>Key Path</b>	Meas Setup
<b>Mode</b>	SA, WCDMA, C2K, WIMAX OFDMA, TD-SCDMA, 1xEVDO, DVB-T/H, DTMB (CTTB), ISDB-T, CMMB, LTE, LTETDD, Digital Cable TV, MSR, LTEAFDD,LTEATDD
<b>Remote Command</b>	<code>[ :SENSe]:ACPpower:CORRection:NOISe[:AUTO] OFF ON 0 1</code> <code>[ :SENSe]:ACPpower:CORRection:NOISe[:AUTO]?</code>
<b>Example</b>	ACP:CORR:NOIS OFF ACP:CORR:NOIS?
<b>Notes</b>	You must be in the mode that includes ACP measurements to use this command. Use :INSTrument:SElect to set the mode.
<b>Dependencies</b>	This parameter is unavailable when Meas Method is set to RBW or Fast.
<b>Preset</b>	0
<b>State Saved</b>	Saved in instrument state.
<b>Range</b>	On Off
<b>Initial S/W Revision</b>	Prior to A.02.00
<b>Modified at S/W Revision</b>	A.02.00, A.03.00, A.04.00

## Meas Preset

Restores all the measurement parameters to their default values.

<b>Key Path</b>	Meas Setup
<b>Mode</b>	SA, WCDMA, C2K, WIMAX OFDMA, TD-SCDMA, 1xEVDO, DVB-T/H, DTMB (CTTB), ISDB-T, CMMB, LTE, LTETDD, Digital Cable TV, MSR, LTEAFDD,LTEATDD
<b>Remote Command</b>	<code>:CONFIgure:ACPpower</code>
<b>Example</b>	CONF:ACP
<b>Notes</b>	You must be in the mode that includes ACP measurements to use this command. Use :INSTrument:SElect to set the mode.
<b>Couplings</b>	Selecting Meas Preset will restore all measurement parameters to their default values.
<b>Initial S/W Revision</b>	Prior to A.02.00
<b>Modified at S/W Revision</b>	A.02.00, A.03.00



## Offset RRC Weighting (Backward Compatibility SCPI)

Mode	SA, WCDMA, TD-SCDMA, WIMAX OFDMA, DVB-T/H, DTMB (CTTB), ISDB-T, CMMB, LTE, LTETDD, Digital Cable TV, MSR, LTEAFDD,LTEATDD
Remote Command	<code>[ :SENSe ] :ACPower :FILTer [ :RRC ] [ :STATe ] OFF ON 0 1</code> <code>[ :SENSe ] :ACPower :FILTer [ :RRC ] [ :STATe ] ?</code>
Example	ACP:FILT OFF ACP:FILT?
Notes	This parameter is not available for cdma2000 and 1xEVDO The backwards Compatibility SCPI command, <code>[ :SENSe ] :ACPR :FILTer [ :RRC ] [ :STATe ]</code> , is provided to support same functionality as <code>[ :SENSe ] :ACPr :FILTer [ :RRC ] [ :STATe ]</code> (PSA W-CDMA, PSA cdma2000 and PSA 1xEVDO) due to ACPr node conflicts with ACPower node. You must be in the mode that includes ACP measurements to use this command. Use <code>:INSTRument:SElect</code> to set the mode.
Couplings	This command is an alias to <code>[ :SENSe ] :ACPower :OFFSet [ 1 ] 2 :LIST :FILTer [ :RRC ] [ :STATe ]</code> Sending the commands to set values of all offsets for BS and MS, however, sending the query always return a value of BS Offset A.
Preset	SA, WIMAX OFDMA, LTE, LTETDD, MSR: OFF WCDMA: ON C2K: NO TD-SCDMA: ON DVB-T/H: OFF DTMB (CTTB):ON ISDB-T: OFF CMMB: OFF Digital Cable TV: ON LTEAFDD,LTEATDD: OFF
State Saved	Saved in instrument state.
Backwards Compatibility SCPI	<code>[ :SENSe ] :ACPR :FILTer [ :RRC ] [ :STATe ]</code> <code>[ :SENSe ] :MCPower :FILTer [ :RRC ] [ :STATe ]</code>
Initial S/W Revision	Prior to A.02.00
Modified at S/W Revision	A.03.00

## Offset Filter Alpha (Backward Compatibility SCPI)

Mode	SA, WCDMA, WIMAX OFDMA, TD-SCDMA, DVB-T/H, DTMB (CTTB), ISDB-T, CMMB, LTE, LTETDD, Digital Cable TV, MSR, LTEAFDD,LTEATDD
Remote Command	<code>[ :SENSe ] :ACPower :FILTer [ :RRC ] :ALPHa &lt;real&gt;</code> <code>[ :SENSe ] :ACPower :FILTer [ :RRC ] :ALPHa?</code>

<b>Example</b>	ACP:FILT:ALPH 0.5 ACP:FILT:ALPH?
<b>Notes</b>	This parameter is not available for cdma2000 and 1xEVDO The backwards Compatibility SCPI command, [:SENSe]:ACPR:FILTer[:RRC]:ALPHa, is provided to support same functionality as [:SENSe]:ACPr:FILTer[:RRC]:ALPHa (PSA W-CDMA, PSA cdma2000 and PSA 1xEVDO) due to ACPr node conflicts with ACPower node. You must be in the mode that includes ACP measurements to use this command. Use :INSTrument:SElect to set the mode.
<b>Couplings</b>	This command is an alias to [:SENSe]:ACPpower:OFFSet[1]2:LIST:FILTer:ALPHa Sending the commands to set values of all offsets for BS and MS, however, sending the query always return a value of BS Offset A.
<b>Preset</b>	SA, WCDMA, WIMAX OFDMA, TD-SCDMA, DVB-T/H, ISDB-T, CMMB, LTE, LTETDD, MSR: 0.22 C2K: NO DTMB (CTTB): 0.05 Digital Cable TV: 0.15 LTEAFDD,LTEATDD: 0.22
<b>State Saved</b>	Saved in instrument state.
<b>Min</b>	0.01
<b>Max</b>	1.00
<b>Backwards Compatibility SCPI</b>	[:SENSe]:ACPR:FILTer[:RRC]:ALPHa [:SENSe]:MCPower:FILTer[:RRC]:ALPHa
<b>Initial S/W Revision</b>	Prior to A.02.00
<b>Modified at S/W Revision</b>	A.03.00

### Method for Carrier (Backward Compatibility SCPI)

<b>Mode</b>	SA, WCDMA, WIMAX OFDMA, TD-SCDMA, DVB-T/H, DTMB (CTTB), ISDB-T, CMMB, LTE, LTETDD, Digital Cable TV, MSR
<b>Remote Command</b>	[:SENSe]:ACPpower:CARRier[1] 2:LIST:METHod IBW RRC, ... [:SENSe]:ACPpower:CARRier[1] 2:LIST:METHod?
<b>Example</b>	ACP:CARR2:LIST:METH RRC ACP:CARR2:LIST:METH?
<b>Notes</b>	You must be in the mode that includes ACP measurements to use this command. Use :INSTrument:SElect to set the mode. Maximum of Array length depends on the number of carriers.
<b>Couplings</b>	This command is an alias to [:SENSe]:ACPpower:CARRier[1]2:LIST:FILTer[:RRC][:STATe] The enum value translates as follows: RRC Weighted = 1 ON

	Integ BW = 0 OFF Maximum of Array length depends on the number of carriers.
Preset	SA: IBW WCDMA: RRC WIMAX OFDMA: IBW TD-SCDMA: RRC DVB-T/H: IBW DTMB (CTTB): RRC ISDB-T: IBW CMMB: IBW LTE, MSR: IBW LTETDD: IBW Digital Cable TV: RRC
State Saved	Saved in instrument state.
Initial S/W Revision	Prior to A.02.00
Modified at S/W Revision	A.03.00

9 ACP Measurement  
Mode

Mode

See "[Mode](#)" on page 318

## Mode Preset

Returns the active mode to a known state.

Mode Preset does the following for the currently active mode:

- Aborts the currently running measurement.
- Brings up the default menu for the mode, with no active function.
- Sets measurement Global settings to their preset values for the active mode only.
- Activates the default measurement.
- Brings up the default menu for the mode.
- Clears the input and output buffers.
- Sets Status Byte to 0.

Mode Preset does not:

- Cause a mode switch
- Affect mode persistent settings
- Affect system settings

See "[How-To Preset](#)" on page 754 for more information.

Key Path	Front-panel key
<b>Remote Command</b>	:SYSTem:PRESet
<b>Example</b>	:SYST:PRES
Notes	*RST is preferred over :SYST:PRES for remote operation. *RST does a Mode Preset, as done by the :SYST:PRES command, and it sets the measurement mode to Single measurement rather than Continuous for optimal remote control throughput. Clears all pending OPC bits. The Status Byte is set to 0.
Couplings	A Mode Preset aborts the currently running measurement, activates the default measurement, and gets the mode to a consistent state with all of the default couplings set.
Backwards Compatibility Notes	In the X-Series, the legacy "Factory Preset" has been replaced with Mode Preset, which only presets the currently active mode, not the entire instrument. In the X-Series, the way to preset the entire instrument is by using System, Restore System Defaults All, which behaves essentially the same way as restore System Defaults does on ESA and PSA. There is also no "Preset Type" as there is on the PSA. There is a green Mode Preset front-panel key that does a Mode Preset and a white-with-green-letters User Preset front-panel key that does a User Preset. The old PRESet:TYPE command is ignored (without generating an error), and SYST:PRES without a parameter does a Mode Preset, which should cover most backward code compatibility issues. The settings and correction data under the Input/Output front-panel key (examples: Input Z Corr, Ext Amp Gain, etc.) are no longer part of any Mode, so they will not be preset by a Mode Preset. They are preset using Restore Input/Output Defaults, Restore System Defaults All. Note that because User Preset does a Recall State, and all of these settings are saved in State, they ARE recalled when using

	User Preset.
Initial S/W Revision	Prior to A.02.00

## How-To Preset

The table below shows all possible presets, their corresponding SCPI commands and front-panel access (key paths). Instrument settings depend on the current measurement context. Some settings are local to the current measurement, some are global (common) across all the measurements in the current mode, and some are global to all the available modes. In a similar way, restoring the settings to their preset state can be done within the different contexts.

Auto Couple - is a measurement local key. It sets all Auto/Man parameter couplings in the measurement to Auto. Any Auto/Man selection that is local to other measurements in the mode will not be affected.

Meas Preset - is a measurement local key. Meas Preset resets all the variables local to the current measurement except the persistent ones.

Mode Preset - resets all the current mode's measurement local and measurement global variables except the persistent ones.

Restore Mode Defaults - resets ALL the Mode variables (and all the Meas global and Meas local variables), including the persistent ones.

Type Of Preset	SCPI Command	Front Panel Access
Auto Couple	:COUPle ALL	Auto Couple front-panel key
Meas Preset	:CONFigure:<Measurement>	Meas Setup Menu
Mode Preset	:SYSTem:PRESet	Mode Preset (green key)
Restore Mode Defaults	:INSTrument:DEFault	Mode Setup Menu
Restore All Mode Defaults	:SYSTem:DEFault MODes	System Menu; Restore System Default Menu
*RST	*RST	not possible (Mode Preset with Single)
Restore Input/Output Defaults	:SYSTem:DEFault INPUt	System Menu; Restore System Default Menu
Restore Power On Defaults	:SYSTem:DEFault PON	System Menu; Restore System Default Menu
Restore Alignment Defaults	:SYSTem:DEFault ALIGn	System Menu; Restore System Default Menu
Restore Miscellaneous Defaults	:SYSTem:DEFault MISC	System Menu; Restore System Default Menu
Restore All System Defaults	:SYSTem:DEFault [ALL] :SYSTem:PRESet:PERsistent	System Menu; Restore System Default Menu
User Preset	:SYSTem:PRESet:USER	User Preset Menu
User Preset All Modes	:SYSTem:PRESet:USER:ALL	User Preset Menu

Power On Mode Preset	:SYSTem:PON:TYPE MODE	System Menu
Power On User Preset	:SYSTem:PON:TYPE USER	System Menu
Power On Last State	:SYSTem:PON:TYPE LAST	System Menu

### Preset Type (Remote Command Only)

As stated in the Backward Compatibility section, to be compatible with ESA/PSA the PRESet:TYPE command will be implemented as a no-op.

Mode	All
<b>Remote Command</b>	:SYSTem:PRESet:TYPE FACTory MODE USER :SYSTem:PRESet:TYPE?
<b>Example</b>	:SYST:PRESet:TYPE FACT
Notes	This command is supported for backward compatibility only. It is a no-op which does not change the behavior of any preset operation.
Preset	This is unaffected by Preset but is set to Mode on a “Restore System Defaults->All”
State Saved	No
Initial S/W Revision	Prior to A.02.00

## Mode Setup

See "[Mode Setup](#)" on page 348



## Peak Search

Places the selected marker on the trace point with the maximum y-axis value.

Key Path	Peak Search
Mode	SA, WCDMA, C2K, WIMAX OFDMA, TD-SCDMA, 1xEVDO, DVB-T/H, DTMB (CTTB), ISDB-T, CMMB, LTE, LTE-TDD, Digital Cable TV, MSR, LTEAFDD, LTEATDD
<b>Remote Command</b>	:CALCulate:ACPower:MARKer [1]   2   . . .   12:MAXimum
<b>Example</b>	CALC:ACP:MARK2:MAX
Initial S/W Revision	Prior to A.02.00
Modified at S/W Revision	A.02.00, A.03.00

## Next Peak

Moves the selected marker to the peak that has the next highest amplitude.

Key Path	Peak Search
Mode	SA, WCDMA, C2K, WIMAX OFDMA, TD-SCDMA, 1xEVDO, DVB-T/H, DTMB (CTTB), ISDB-T, CMMB, LTE, LTE-TDD, Digital Cable TV, MSR, LTEAFDD, LTEATDD
<b>Remote Command</b>	:CALCulate:ACPower:MARKer [1]   2   . . .   12:MAXimum:NEXT
<b>Example</b>	CALC:ACP:MARK2:MAX:NEXT
Initial S/W Revision	Prior to A.02.00
Modified at S/W Revision	A.02.00, A.03.00

## Next Pk Right

Moves the selected marker to the nearest peak to the right of the current marker that meets all enabled peak criteria.

Key Path	Peak Search
Mode	SA, WCDMA, C2K, WIMAX OFDMA, TD-SCDMA, 1xEVDO, DVB-T/H, DTMB (CTTB), ISDB-T, CMMB, LTE, LTE-TDD, Digital Cable TV, MSR, LTEAFDD, LTEATDD
<b>Remote Command</b>	:CALCulate:ACPower:MARKer [1]   2   . . .   12:MAXimum:RIGHT
<b>Example</b>	CALC:ACP:MARK2:MAX:RIGH
Initial S/W Revision	Prior to A.02.00
Modified at S/W Revision	A.02.00, A.03.00

## Next Pk Left

Moves the selected marker to the nearest peak to the left of the current marker that meets all enabled peak criteria.

Key Path	Peak Search
Mode	SA, WCDMA, C2K, WIMAX OFDMA, TD-SCDMA, 1xEVDO, DVB-T/H, DTMB (CTTB), ISDB-T, CMMB, LTE, LTE-TDD, Digital Cable TV, MSR, LTEAFDD, LTEATDD
<b>Remote Command</b>	:CALCulate:ACPower:MARKer[1] 2 ... 12:MAXimum:LEFT
<b>Example</b>	CALC:ACP:MARK2:MAX:LEFT
Initial S/W Revision	Prior to A.02.00
Modified at S/W Revision	A.02.00, A.03.00

## Marker Delta

Sets the control mode for the selected marker to Delta mode.

See Marker Delta in the "Marker Functions" section for more information.

Key Path	Peak Search
Initial S/W Revision	Prior to A.02.00

## Pk-Pk Search

Finds and displays the amplitude and frequency (or time, if in zero span) differences between the highest and lowest y-axis value.

Key Path	Peak Search
Mode	SA, WCDMA, C2K, WIMAX OFDMA, TD-SCDMA, 1xEVDO, DVB-T/H, DTMB (CTTB), ISDB-T, CMMB, LTE, LTE-TDD, Digital Cable TV, MSR, LTEAFDD, LTEATDD
<b>Remote Command</b>	:CALCulate:ACPower:MARKer[1] 2 ... 12:PTPeak
<b>Example</b>	CALC:ACP:MARK:PTP
Notes	Turns on the Marker $\Delta$ active function.
Couplings	This key is not available (key is grayed out) when Coupled Markers is on.
Initial S/W Revision	Prior to A.02.00
Modified at S/W Revision	A.02.00, A.03.00

## Min Search

Moves the selected marker to the minimum y-axis value on the current trace.

Key Path	Peak Search
Mode	SA, WCDMA, C2K, WIMAX OFDMA, TD-SCDMA, 1xEVDO, DVB-T/H, DTMB (CTTB), ISDB-T, CMMB, LTE, LTE-TDD, Digital Cable TV, MSR, LTEAFDD, LTEATDD
<b>Remote Command</b>	:CALCulate:ACPower:MARKer [1]   2   . . .   12:MINimum
<b>Example</b>	CALC:ACP:MARK:MIN
Initial S/W Revision	Prior to A.02.00
Modified at S/W Revision	A.02.00, A.03.00

9 ACP Measurement  
Print

Print

See ["Print" on page 358](#)

## Quick Save

The Quick Save front-panel key repeats the most recent save that was performed from the Save menu, with the following exceptions:

- Register saves are not remembered as Saves for the purpose of the Quick Save function
- If the current measurement does not support the last non-register save that was performed, an informational message is generated, “File type not supported for this measurement”

Quick Save repeats the last type of qualified save (that is, a save qualified by the above criteria) in the last save directory by creating a unique filename using the Auto File Naming algorithm described below.

If Quick Save is pressed after startup and before any qualified Save has been performed, the Quick Save function performs a Screen Image save using the current settings for Screen Image saves (current theme, current directory), which then becomes the “last save” for the purpose of subsequent Quick Saves.

The Auto File Naming feature automatically generates a file name for use when saving a file. The filename consists of a prefix and suffix separated by a dot, as is standard for the Windows® file system. A default prefix exists for each of the available file types:

Type	Default Prefix	Menu
State	State_	(Save/Recall)
Trace + State	State_	(Save/Recall)
Screen	Screen_	(Save/Recall)
Amplitude Corrections	Ampcor_	(Import/Export)
Traces	Trace_	(Import/Export)
Limit Lines	LLine_	(Import/Export)
Measurement Result	MeasR_	(Import/Export)
Capture Buffer	CapBuf_	(Import/Export)

A four digit number is appended to the prefix to create a unique file name. The numbering sequence starts at 0000 within each Mode for each file type and updates incrementally to 9999, then wraps to 0000 again. It remembers where it was through a Mode Preset and when leaving and returning to the Mode. It is reset by Restore Misc Defaults and Restore System Defaults and subsequent running of the instrument application. So, for example, the first auto file name generated for State files is State\_0000.state. The next is State\_0001, and so forth.

One of the key features of Auto File Name is that we guarantee that the Auto File Name will never conflict with an existing file. The algorithm looks for the next available number. If it gets to 9999, then it looks for holes. If it find no holes, that is no more numbers are available, it gives an error.

For example, if when we get to State\_0010.state there is already a State\_0010.state file in the current directory, it advances the counter to State\_0011.state to ensure that no conflict will exist (and then it verifies that State\_0011.state also does not exist in the current directory and advances again if it does, and so forth).

If you enter a file name for a given file type, then the prefix becomes the filename you entered instead of the default prefix, followed by an underscore. The last four letters (the suffix) are the 4-digit number.

For example, if you save a measurement results file as “fred.csv”, then the next auto file name chosen for a measurement results save will be fred\_0000.csv.

**NOTE**

Although 0000 is used in the example above, the number that is used is actually the current number in the Meas Results sequence, that is, the number that would have been used if you had not entered your own file name.

---

**NOTE**

If the filename you entered ends with \_dddd, where d=any number, making it look just like an auto file name, then the next auto file name picks up where you left off with the suffix being dddd + 1.

---

Key Path	Front-panel key
Notes	No remote command for this key specifically.
Initial S/W Revision	Prior to A.02.00

## Recall

The Recall menu lets you choose what you want to recall, and where you want to recall it from. Among the types of files you can recall are **States and Traces**. In addition, an Import (Data) option lets you recall a number of data types stored in CSV files (as used by Excel and other spreadsheet programs).

The default paths for Recall are data type dependent and are the same as for the Save key.

Key Path	Front-panel key
Notes	<p>No remote command for this key specifically, but the :MMEM:LOAD command is available for specific file types. An example is :MMEM:LOAD:STATe &lt;filename&gt;.</p> <p>If you try to recall a State file for a mode that is not licensed or not available in the instrument, an error message will occur and the state will not change.</p>
Backwards Compatibility Notes	<p>In legacy analyzers, it was possible to load a state without affecting the trace data, limit lines or correction data. Similarly (since User Preset is actually loading a state), it was possible to do a User Preset without affecting the trace data, limit lines or correction data.</p> <p>In the X-Series, “state” always includes all of this data; so whenever state is loaded, all of the traces, limit lines and corrections are affected. Although this differs from previous behavior, it is desirable behavior, and should not cause adverse issues for users.</p>
Backwards Compatibility Notes	<p>Recall for the X-Series supports backward compatibility in the sense that you can recall a state file from any X-Series model number and any version of X-Series software. This is only possible if part of the recalling process goes through a limiting step after recalling the mode settings, at least for settings that may vary with version number, model number, option and license differences. If you try to recall a state file onto an instrument with less capability than what was available on the instrument during the save, the recall will ignore the state it doesn't support and it will limit the recalled setting to what it allows.</p> <p>Example: if the saved state includes preamp ON, but the recalling instrument does not have a preamp; the preamp is limited to OFF. Conversely, if you save a state without a preamp, the preamp is OFF in the state file. When this saved file is recalled on an instrument with a licensed preamp, the preamp is changed to OFF. Another example is if the saved state has center frequency set to 20 GHz, but the instrument recalling the saved state is a different model and only supports 13.5 GHz. In this case, the center frequency is limited along with any other frequency based settings. Since the center frequency can't be preserved in this case, the recall limiting tries to at least preserve span to keep the measurement setup as intact as possible.</p> <p>It may be appropriate to issue a warning if the state is limited on the recall; warnings do not go out to SCPI so this would only affect the manual user.</p> <p>Note that there is no state file compatibility outside of the X-Series. For example, you cannot recall a state file from ESA or PSA.</p>
Initial S/W Revision	Prior to A.02.00

## State

The Recall State menu lets you choose a register or file from which to recall the state.

The content of a state file includes all of the settings and data required to return the analyzer as closely as possible to the Mode it was in, with the exact settings that were in place, when the save occurred. The Mode settings in each state file include the settings that are affected by Mode Preset, as well as the

additional settings affected by Restore Mode Defaults; all of the Mode's settings. In addition, all of the settings of the Input/Output system are included, even though they are outside of the Mode's state, because they are needed to restore the complete setup. Persistent System settings (for example, GPIB address) are not affected by either a Mode Preset or Restore Mode Defaults, nor are they included in a saved State file.

Since each state file is only for one Mode, the settings for other Modes are unaffected when it is loaded. Recall State will cause a mode switch if the state being recalled is not from the current active mode.

After the recall completes, the message "File <filename> recalled" or "Recalled State Register <register number>" is displayed.

For rapid recalls, the State menu lists 16 registers that you can choose from to recall. Pressing a Register key initiates the recall. You can also select a file from which to recall.

The default path for all State Files is:

My Documents\<<mode name>\state

where <mode name> is the parameter used to select the mode with the INST:SEL command (for example, SA for the Spectrum Analyzer).

See ["More Information" on page 765](#).

<b>Key Path</b>	Recall
<b>Mode</b>	All
<b>Remote Command</b>	:MMEMory:LOAD:STATe <filename>
<b>Example</b>	:MMEM:LOAD:STAT "myState.state" This recalls the file myState.state on the default path
<b>Example</b>	MMEM:LOAD:STAT "MyStateFile.state" This loads the state file data (on the default file directory path) into the instrument state.
<b>Notes</b>	<p>When you pick a file to recall, the analyzer first verifies that the file is recallable in the current instrument by checking the software version and model number of the instrument. If everything matches, a full recall proceeds by aborting the currently running measurement, clearing any pending operations, and then loading the State from the saved state file. You can open state files from any mode, so recalling a State file switches to the mode that was active when the save occurred. After switching to the mode of the saved state file, mode settings and data (if any for the mode) are loaded with values from the saved file. The saved measurement of the mode becomes the newly active measurement and the data relevant to the measurement (if there is any) is recalled.</p> <p>If there is a mismatch between file version or model number or instrument version or model number, the recall function tries to recall as much as possible and returns a warning message. It may limit settings that differ based on model number, licensing or version number.</p> <p>After recalling the state, the Recall State function does the following:</p> <ul style="list-style-type: none"> <li>• Makes the saved measurement for the mode the active measurement.</li> <li>• Clears the input and output buffers.</li> <li>• Status Byte is set to 0.</li> <li>• Executes a *CLS</li> </ul> <p>If the file specified is empty an error is generated. If the specified file does not exist, another error is generated. If there is a mismatch between the file and the proper file type, an error is generated. If</p>



	there is a mismatch between file version or model number or instrument version or model number, a warning is displayed. Then it returns to the State menu and File Open dialog goes away. After the Recall, the analyzer exits the Recall menu and returns to the previous menu.
<b>Backwards Compatibility SCPI</b>	:MMEMory:LOAD:STATe 1,<filename> For backwards compatibility, the above syntax is supported. The "1" is simply ignored.
Initial S/W Revision	Prior to A.02.00

## More Information

In measurements that support saving Traces, for example, Swept SA, the Trace data is saved along with the State in the State file. When recalling the State, the Trace data is recalled as well. Traces are recalled exactly as they were stored, including the writing mode and update and display modes. If a Trace was updating and visible when the State was saved, it will come back updating and visible, and its data will be rewritten right away. When you use State to save and recall traces, any trace whose data must be preserved should be placed in View or Blank mode before saving.

The following table describes the Trace Save and Recall possibilities:

You want to recall state and one trace's data, leaving other traces unaffected.	Save Trace+State from 1 trace. Make sure that no other traces are updating (they should all be in View or Blank mode) when the save is performed.	On Recall, specify the trace you want to load the one trace's data into. This trace will load in View. All other traces' data will be unaffected, although their trace mode will be as it was when the state save was performed.
You want to recall all traces	Save Trace+State from ALL traces.	On Recall, all traces will come back in View (or Blank if they were in Blank or Background when saved)
You want all traces to load exactly as they were when saved.	Save State	On recall, all traces' mode and data will be exactly as they were when saved. Any traces that were updating will have their data immediately overwritten.

## From File...

When you press "From File", the analyzer brings up a Windows dialog and a menu entitled "File Open." This menu allows you to navigate to the various fields in the Windows dialog without using a keyboard or mouse. The Tab and Arrow keys can also be used for dialog navigation.

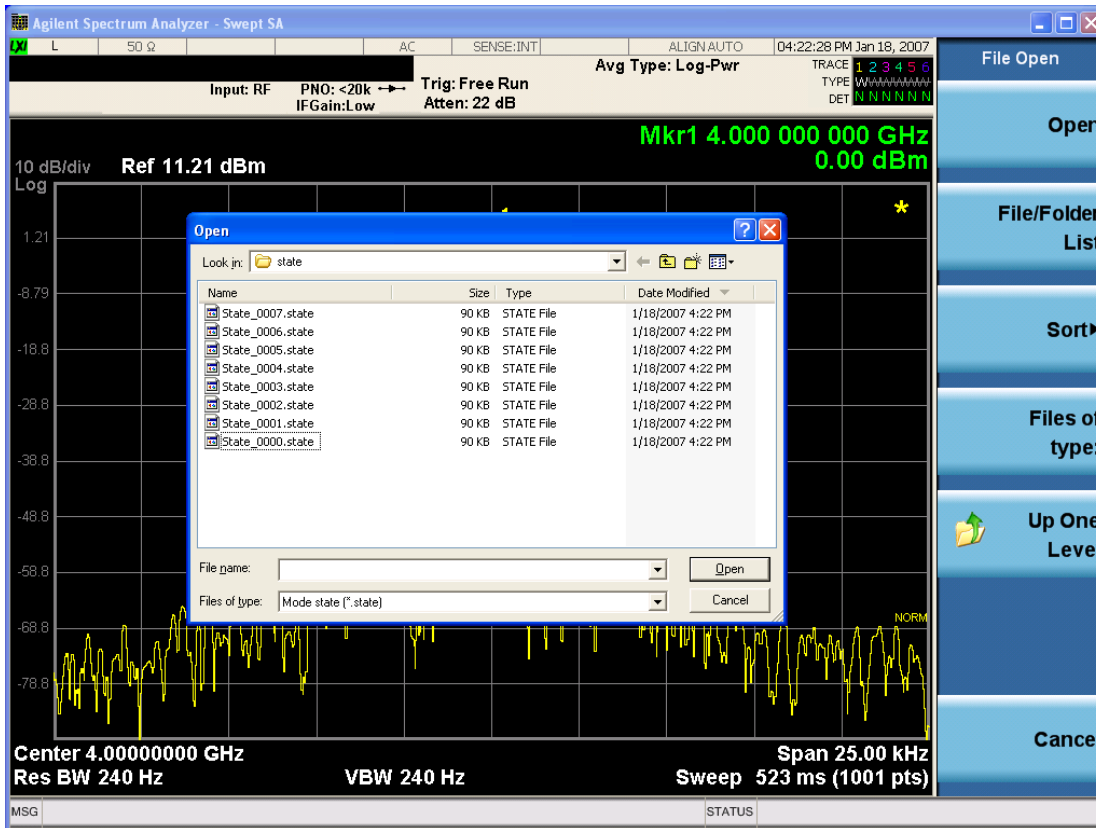

Listed below are the functions of the various fields in the dialog, and the corresponding softkeys:

#### Open

Performs the recall of the specified file. While the recall is being performed, the floppy icon appears briefly in the Meas bar.

#### File/Folder List

Enables you to navigate to the center of the dialog that contains the list of files and folders. Once here you can get information about the file and use the tab keys to navigate to the other fields in the dialog, such as Look In.

#### Look In

The Look In field shows the path from which the file will be recalled and allows you to change the path using the up and down arrow keys to navigate to other paths; the Enter key to open a directory; and the Backspace key to go back one directory. The **Look In field** first uses the last path from the Save As dialog **Save In:** path for that same file type. There is no softkey for directly navigating to the Look In field, but you can use the left tab to get here from the File/Folder List.

User specified paths are remembered when you leave and return to a Mode and are reset back to the default using Restore Mode Defaults.

#### Sort

Accesses a menu that enables you to sort the files within the File Open dialog. Only one sorting type can be selected at a time and the sorting happens immediately. The sorting types are By Date, By Name, By extension, and By Size.

#### Files of Type

This field shows the file suffix for the type of file you have selected to recall. For example, if you navigated here while recalling State, "Mode state (\*.state)" is in the field. If you navigated here while recalling Trace, ""Mode state (\*.trace)" is in the field. If you navigated here while importing a trace data file, "Trace Data (\*.csv)" is in the field. For some file types, there is more than one choice in the dropdown menu, which you can select by using the up and down arrow keys and Enter.

#### Up One Level

This key corresponds to the icon of a folder with the up arrow that is in the tool bar of the dialog. When pressed, it causes the file and folder list to navigate up one level in the directory structure. The Backspace key does the same thing.

#### Cancel

This key corresponds to the Cancel selection in the dialog. It causes the current **Open** request to be cancelled. The ESC key does the same thing.

Key Path	Recall, State
Notes	Brings up the Open dialog for recalling a State Save Type
Initial S/W Revision	Prior to A.02.00

## Edit Register Names

You may enter a custom name on any of the Register keys, to help you remember what you are using that state to save. To do this, press the Edit Register Names key, choose the register whose name you wish to edit, and then enter the desired label using the Alpha Editor or an external PC keyboard.

The maximum number of characters that can be added is 30. In most cases, 30 characters will fit on two lines of the key.

For more information and the SCPI command, see Edit Register Names under the Save, State function.

Key Path	Recall, State
Mode	All
Dependencies	N9060A-7FP or N9060B-2FP license required to edit the register names. When the feature is not licensed, sending the SCPI command generates an error, -221, "Settings conflict;Option not available"
Initial S/W Revision	A.11.00

## Register 1 thru Register 16

Selecting any one of these register keys causes the State of the mode from the specified Register to be recalled. Each of the register keys annotates whether it is empty or at what date and time it was last

modified. In addition, you can use the Edit Register Names key under Save, State to enter custom names for each register.

Registers are shared by all modes, so recalling from any one of the registers will cause a mode switch to the mode that was active when the save to the Register occurred.

Although these 16 registers are the only registers available from the front panel, there are 128 state registers available in the instrument. Registers 17–128 are only available from the SCPI interface, using the \*RCL command.

After the recall completes, the message "Register <register number> recalled" appears in the message bar. If you are in the Spectrum Analyzer Mode, and you are recalling a register that was saved in the Spectrum Analyzer Mode, then after the recall, you will still be in the Recall Register menu. If the Recall causes you to switch modes, then after the Recall, you will be in the Frequency menu.

If a requested register is empty an error is generated.

<b>Key Path</b>	Recall, State
<b>Example</b>	*RCL 1
<b>Range</b>	1–16 from front panel, 1–128 from SCPI
<b>Readback</b>	Date and time with seconds resolution are displayed on the key OR A custom name of up to 30 characters entered using the Save, State, Edit Register Names key OR “(empty)” if no prior save operation has been performed to this register.
<b>Initial S/W Revision</b>	Prior to A.02.00
<b>Modified at S/W Revision</b>	Prior to A.11.00

## Register 1 thru Register 16

Selecting any one of these register keys causes the State of the mode from the specified Register to be recalled. Each of the register keys annotates whether it is empty or at what date and time it was last modified. In addition, you can use the Edit Register Names key under Save, State to enter custom names for each register.

Registers are shared by all modes, so recalling from any one of the registers will cause a mode switch to the mode that was active when the save to the Register occurred.

Although these 16 registers are the only registers available from the front panel, there are 128 state registers available in the instrument. Registers 17–128 are only available from the SCPI interface, using the \*RCL command.

After the recall completes, the message "Register <register number> recalled" appears in the message bar. If you are in the Spectrum Analyzer Mode, and you are recalling a register that was saved in the Spectrum Analyzer Mode, then after the recall, you will still be in the Recall Register menu. If the Recall causes you to switch modes, then after the Recall, you will be in the Frequency menu.

If a requested register is empty an error is generated.

Key Path	Recall, State
<b>Example</b>	*RCL 1
Range	1-16 from front panel, 1-128 from SCPI
Readback	Date and time with seconds resolution are displayed on the key OR A custom name of up to 30 characters entered using the Save, State,Edit Register Names key OR “(empty)” if no prior save operation has been performed to this register.
Initial S/W Revision	Prior to A.02.00
Modified at S/W Revision	Prior to A.11.00

### Trace (+State)

The Recall Trace (+State) menu lets you choose a register or file from which to recall the Trace+State state file.

A saved state contains all of the settings and data required to return the analyzer as closely as possible to the exact setup it had when the save occurred. This includes the Input/Output settings, even though they are outside of the Mode’s state, because they are needed to restore the complete setup. A Trace+State file also includes trace data from one trace or all traces, which will load in View mode when the Trace+State file is recalled. Recall Trace (+State) will also cause a mode switch if the state being recalled is not for the current active mode.

After the recall completes, the message "File <filename> recalled" or “Recalled Trace Register <register number>” is displayed.

For rapid recalls, the Trace (+State) menu lists 5 registers to choose from to recall. Pressing a Register key initiates the recall. You can also select a file from which to recall.

The default path for all State Files including .trace files is:

My Documents\<mode name>\state

where <mode name> is the parameter used to select the mode with the INST:SEL command (for example, SA for the Spectrum Analyzer).

Key Path	Recall
Mode	SA
<b>Remote Command</b>	:MMEMory:LOAD:TRACe TRACE1   TRACE2   TRACE3   TRACE4   TRACE5   TRACE6,<filename>  :MMEMory:LOAD:TRACe:REGister TRACE1   TRACE2   TRACE3   TRACE4   TRACE5   TRACE6,<integer>
<b>Example</b>	MMEM:LOAD:TRAC TRACE2, "MyTraceFile.trace" This loads the trace file data (on the default file directory path) into the specified trace; if it is a "single trace" save file, that trace is loaded to trace 2, and is set to be not updating. :MMEM:LOAD:TRAC:REG TRACE1,2

	restores the trace data in register 2 to Trace 1
Notes	<p>When you perform the recall, the recalling Trace function must first verify the file is recallable in this instrument by checking instrument software version and model number, since it includes State. If everything matches, a full recall proceeds by aborting the currently running measurement, and loading the state from the saved state file to as close as possible to the context in which the save occurred. You can open .trace files from any mode that supports them, so recalling a Trace file switches to the mode that was active when the save occurred. After switching to the mode of the saved state file, mode settings and data (if any for the mode) are loaded with values from the saved file and the saved measurement of the mode becomes the newly active measurement, and the data relevant to the measurement (if there is any) is recalled.</p> <p>Once the state is loaded, the trace data must be loaded. The internal flags are consulted to see which trace to load and the "To Trace" setting to see where to load it. Trace data is always loaded with the specified trace set to View, so that the data is visible and not updating(so as not to erase the recalled data). If the file is an "all trace" file, all traces are loaded with the saved data(to the original trace the data was saved from) and set to View. Traces whose data is not loaded are restored to the update state that existed when they were saved.</p> <p>After the Recall the analyzer exits the Recall menu and returns to the previous menu.</p> <p>Some modes and measurements do not have available all 6 traces. Phase Noise mode command, for example, is: <code>MMEMOry:LOAD:TRACe TRACE1 TRACE2 TRACE3,&lt;filename&gt;</code></p> <p>Some modes and measurements have more than 6 traces available. The Realtime SA mode command, for example, is: <code>MMEMOry:STORe:TRACe TRACE1   TRACE2   TRACE3   TRACE4   TRACE5   TRACE6   TRACE7   TRACE8   TRACE9   TRACE10   TRACE11   TRACE12   ALL,&lt;filename&gt;</code></p>
Initial S/W Revision	Prior to A.02.00

## To Trace

These menu selections let you choose the Trace where the recalled saved trace will go. Not all modes have the full 6 traces available. The default is the currently selected trace, selected in this menu or in the Trace/Detector, Export Data, Import Data, or Save Trace menus, except if you have chosen All, then it remains chosen until you specifically change it to a single trace.

If the .trace file is an "all trace" file, "To Trace" is ignored and the traces each go back to the trace from which they were saved.

Once selected, the key returns back to the Recall Trace menu and the selected Trace number is annotated on the key. Now you have selected exactly where the trace needs to be recalled.To trigger a recall of the selected Trace, you must select the Open key in the Recall Trace menu.

When you select a trace, it makes that trace the current trace, so it displays on top of all of the other traces.

Key Path	Save, Data, Trace
Mode	SA
Initial S/W Revision	Prior to A.02.00

## Register 1 thru Register 16

Selecting any one of these register keys causes the State of the mode from the specified Register to be recalled. Each of the register keys annotates whether it is empty or at what date and time it was last modified. In addition, you can use the Edit Register Names key under Save, State to enter custom names for each register.

Registers are shared by all modes, so recalling from any one of the registers will cause a mode switch to the mode that was active when the save to the Register occurred.

Although these 16 registers are the only registers available from the front panel, there are 128 state registers available in the instrument. Registers 17–128 are only available from the SCPI interface, using the \*RCL command.

After the recall completes, the message "Register <register number> recalled" appears in the message bar. If you are in the Spectrum Analyzer Mode, and you are recalling a register that was saved in the Spectrum Analyzer Mode, then after the recall, you will still be in the Recall Register menu. If the Recall causes you to switch modes, then after the Recall, you will be in the Frequency menu.

If a requested register is empty an error is generated.

Key Path	Recall, State
<b>Example</b>	*RCL 1
Range	1–16 from front panel, 1–128 from SCPI
Readback	Date and time with seconds resolution are displayed on the key OR A custom name of up to 30 characters entered using the Save, State, Edit Register Names key OR “(empty)” if no prior save operation has been performed to this register.
Initial S/W Revision	Prior to A.02.00
Modified at S/W Revision	Prior to A.11.00

## From File...

When you press “From File”, the analyzer brings up a Windows dialog and a menu entitled “File Open.” This menu allows you to navigate to the various fields in the Windows dialog without using a keyboard or mouse. The Tab and Arrow keys can also be used for dialog navigation.

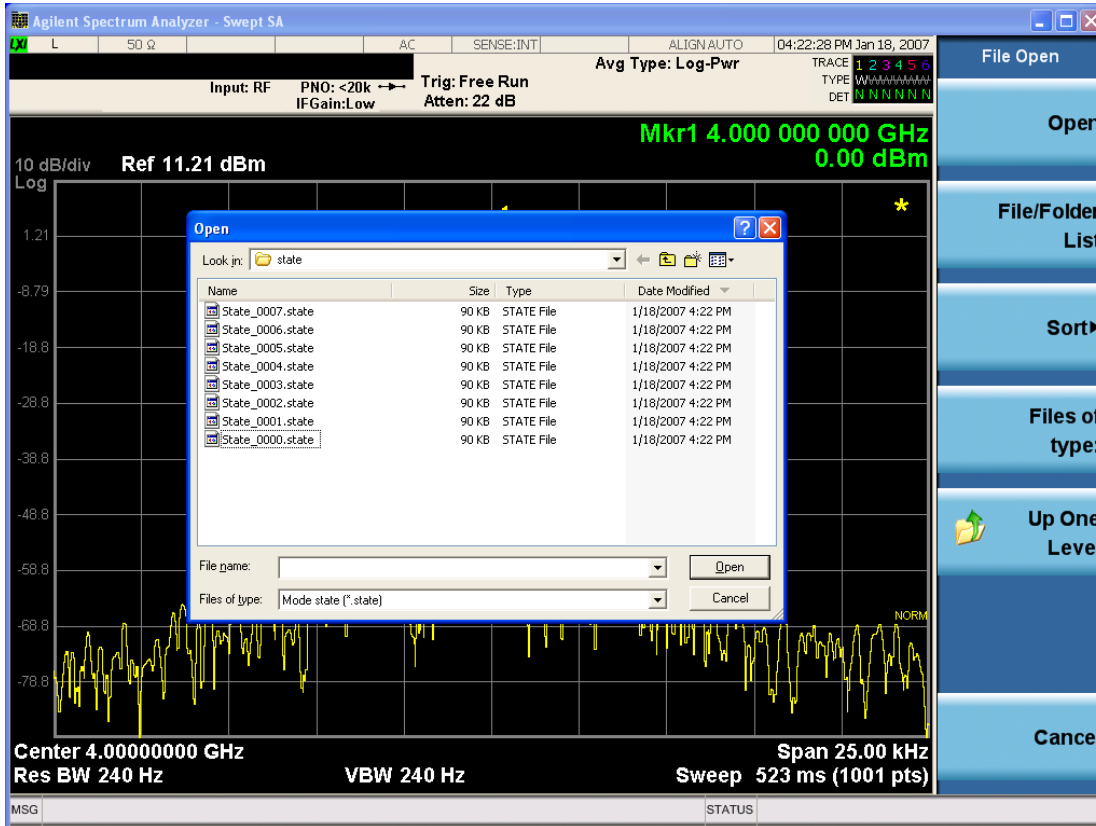

Listed below are the functions of the various fields in the dialog, and the corresponding softkeys:

### Open

Performs the recall of the specified file. While the recall is being performed, the floppy icon appears briefly in the Meas bar.

### File/Folder List

Enables you to navigate to the center of the dialog that contains the list of files and folders. Once here you can get information about the file and use the tab keys to navigate to the other fields in the dialog, such as Look In.

### Look In

The Look In field shows the path from which the file will be recalled and allows you to change the path using the up and down arrow keys to navigate to other paths; the Enter key to open a directory; and the Backspace key to go back one directory. The **Look In field** first uses the last path from the Save As dialog **Save In:** path for that same file type. There is no softkey for directly navigating to the Look In field, but you can use the left tab to get here from the File/Folder List.

User specified paths are remembered when you leave and return to a Mode and are reset back to the default using Restore Mode Defaults.

### Sort



Accesses a menu that enables you to sort the files within the File Open dialog. Only one sorting type can be selected at a time and the sorting happens immediately. The sorting types are By Date, By Name, By extension, and By Size.

#### Files of Type

This field shows the file suffix for the type of file you have selected to recall. For example, if you navigated here while recalling State, "Mode state (\*.state)" is in the field. If you navigated here while recalling Trace, ""Mode state (\*.trace)" is in the field. If you navigated here while importing a trace data file, "Trace Data (\*.csv)" is in the field. For some file types, there is more than one choice in the dropdown menu, which you can select by using the up and down arrow keys and Enter.

#### Up One Level

This key corresponds to the icon of a folder with the up arrow that is in the tool bar of the dialog. When pressed, it causes the file and folder list to navigate up one level in the directory structure. The Backspace key does the same thing.

#### Cancel

This key corresponds to the Cancel selection in the dialog. It causes the current **Open** request to be cancelled. The ESC key does the same thing.

Key Path	Recall, State
Notes	Brings up the Open dialog for recalling a State Save Type
Initial S/W Revision	Prior to A.02.00

## Data (Import)

Importing a data file loads data that was previously saved from the current measurement or from other measurements and/or modes that produce compatible data files. The Import Menu only contains Data Types that are supported by the current measurement.

Since the commonly exported data files are in .csv format, the data can be edited by the user prior to importing. This allows you to export a data file, manipulate the data in Excel (the most common PC Application for manipulating .csv files) and then import it.

Importing Data loads measurement data from the specified file into the specified or default destination, depending on the data type selected. Selecting an Import Data menu key will not actually cause the importing to occur, since the analyzer still needs to know from where to get the data. Pressing the Open key in this menu brings up the Open dialog and Open menu that provides you with the options from where to recall the data. Once a filename has been selected or entered in the Open menu, the recall occurs as soon as the Open button is pressed.

Key Path	Recall
Mode	All
Notes	The menu is built from whatever data types are available for the mode. Some keys will be missing completely, so the key locations in the sub-menu will vary.  No SCPI command directly controls the Data Type that this key controls. The Data Type is included in the MMEM:LOAD commands.

Dependencies	If a file type is not used by a certain measurement, it is grayed out for that measurement. The key for a file type will not show at all if there are no measurements in the Mode that support it.
Preset	Is not affected by Preset or shutdown, but is reset during Restore Mode Defaults
Readback	The data type that is currently selected
Initial S/W Revision	Prior to A.02.00

## Capture Buffer

The captured data is raw data which is not processed.

Key Path	Recall, Data
Mode	<b>CDMA1XEV</b>
Example	MMEM:LOAD:CAPT "MyCaptureData.bin" This loads the file of capture data (on the default file directory path) into the instrument.
Dependencies	In case the capture buffer data is not available from the selected measurement, the key will be grayed out.
Initial S/W Revision	A.11.00

## Open...

When you press "Open", the analyzer brings up a Windows dialog and a menu entitled "**File Open.**" This menu allows you to navigate to the various fields in the Windows dialog without using a keyboard or mouse. The Tab and Arrow keys can also be used for dialog navigation.

See "[From File...](#)" on page 2890 in Recall, State, for a full description of this dialog and menu.

Key Path	Recall, Data
Notes	The key location is mode-dependent and will vary. Brings up Open dialog for recalling a <mode specific> Save Type
Initial S/W Revision	Prior to A.02.00

## Restart

The Restart function restarts the current sweep, or measurement, or set of averaged/held sweeps or measurements. If you are Paused, pressing Restart does a Resume.

The Restart function is accessed in several ways:

- Pressing the Restart key
- Sending the remote command INIT:IMMEDIATE
- Sending the remote command INIT:RESTART

See "[More Information](#)" on page 775

Key Path	Front-panel key
Remote Command	:INITiate[:IMMEDIATE] :INITiate:RESTART
Example	:INIT:IMM :INIT:REST
Notes	:INITiate:RESTART and :INITiate:IMMEDIATE perform exactly the same function.
Couplings	Resets average/hold count k. For the first sweep overwrites all active (update=on) traces with new current data. For application modes, it resets other parameters as required by the measurement.
Status Bits/OPC dependencies	This is an Overlapped command. The STATUS:OPERation register bits 0 through 8 are cleared. The STATUS:QUESTIONable register bit 9 (INTEgrity sum) is cleared. The SWEEPING bit is set. The MEASURING bit is set.
Backwards Compatibility Notes	For Spectrum Analysis mode in ESA and PSA, the Restart hardkey and the INITiate:RESTART command restart trace averages (displayed average count reset to 1) for a trace in Clear Write, but did not restart Max Hold and Min Hold. In the X-Series, the Restart hardkey and the INITiate:RESTART command restart not only Trace Average, but MaxHold and MinHold traces as well. For wireless comms modes in ESA and PSA, the Restart hardkey and the INITiate:RESTART command restart every measurement, which includes all traces and numeric results. There is no change to this operation.
Initial S/W Revision	Prior to A.02.00

### More Information

The **Restart** function first aborts the current sweep/measurement as quickly as possible. It then resets the sweep and trigger systems, sets up the measurement and initiates a new data measurement sequence with a new data acquisition (sweep) taken once the trigger condition is met.

If the analyzer is in the process of aligning when **Restart** is executed, the alignment finishes before the restart function is performed.

Even when set for Single operation, multiple sweeps may be taken when Restart is pressed (for example, when averaging/holding is on). Thus when we say that **Restart** "restarts a measurement," we may mean:

- It restarts the current sweep
- It restarts the current measurement
- It restarts the current set of sweeps if any trace is in Trace Average, Max Hold or Min Hold
- It restarts the current set of measurements if Averaging, or Max Hold, or Min Hold is on for the measurement
- depending on the current settings.

With **Average/Hold Number** (in **Meas Setup** menu) set to 1, or Averaging off, or no trace in Trace Average or Hold, a single sweep is equivalent to a single measurement. A single sweep is taken after the trigger condition is met; and the analyzer stops sweeping once that sweep has completed. However, with **Average/Hold Number** >1 and at least one trace set to **Trace Average, Max Hold, or Min Hold (SA Measurement)** or **Averaging on (most other measurements)**, multiple sweeps/data acquisitions are taken for a single measurement. The trigger condition must be met prior to each sweep. The sweep is stopped when the average count  $k$  equals the number  $N$  set for **Average/Hold Number**. A measurement average usually applies to all traces, marker results, and numeric results; but sometimes it only applies to the numeric results.

Once the full set of sweeps has been taken, the analyzer will go to idle state. To take one more sweep without resetting the average count, increment the average count by 1, by pressing the step up key while **Average/Hold Number** is the active function, or sending the remote command CALC:AVER:TCON UP.

## Save

The Save menu lets you choose what you want to save and where you want to save it. Among the types of files you can save are **States**, **Traces**, and **Screen Images**. In addition, an Export (Data) option lets you save a number of data types as CSV files for easy import into Excel and other spreadsheet programs.

Key Path	Front-panel key
Mode	All
Notes	No remote command for this key specifically, but the :MMEM:STORe command is available for specific file types. An example is :MMEM:STOR:STATe <filename>.
Initial S/W Revision	Prior to A.02.00

## State

The Save State menu lets you choose a register or file for saving the state.

The content of a state file includes all of the settings and data required to return the analyzer as closely as possible to the Mode it was in, with the exact settings which were in place, when the save occurred. The Mode settings in each state file include the settings that are affected by Mode Preset, as well as the additional settings affected by Restore Mode Defaults; all of the Mode's settings. In addition, all of the settings of the Input/Output system are included, even though they are outside of the Mode's state, because they are needed to restore the complete setup. Persistent System settings (for example, Verbose SCPI) are not affected by either Mode Preset or Restore Mode Defaults, nor are they included in a saved State file.

After the save completes, the message "File <filename> saved" or "State Register <register number> saved" is displayed.

For rapid saving, the State menu lists 16 registers to save to. Pressing a Register key initiates the save. You can also select a file to save to.

The default path for all State Files is:

My Documents\<<mode name>\state

where <mode name> is the parameter used to select the mode with the INST:SEL command (for example, SA for the Spectrum Analyzer).

Key Path	Save
Mode	All
Remote Command	:MMEMory:STORe:STATe <filename>
Example	MMEM:STOR:STATe "MyStateFile.state" This stores the current instrument state data in the file MyStateFile.state in the default directory.
Notes	Both single and double quotes are supported for any filename parameter over remote. After saving to a register, that register's menu key is updated with the date the time, unless a custom label has been entered for that key. After saving to a register, you remain in the Save State menu, so that you can see the Register key

update. After saving to a file, the analyzer automatically returns to the previous menu and any Save As dialog goes away.

<b>Backwards Compatibility SCPI</b>	:MMEMory:STORe:STATe 1,<filename>
Initial S/W Revision	Prior to A.02.00

**To File . . .**

When you press “To File”, the analyzer brings up a Windows dialog and a menu entitled “Save As.” This menu allows you to navigate to the various fields in the Windows dialog without using a keyboard or mouse. The Tab and Arrow keys can also be used for dialog navigation.

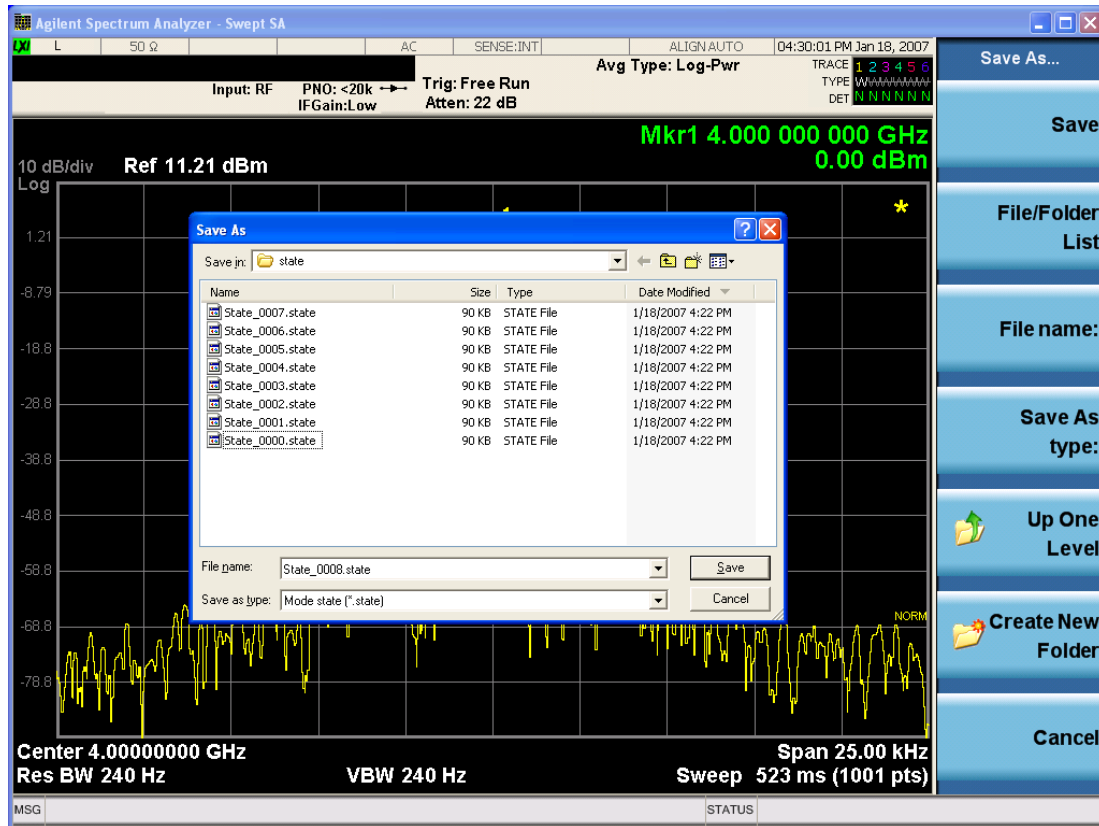

The Listed below

are the functions of the various fields in the dialog, and the corresponding softkeys:

**Save**

Performs the save to the specified file of the selected type. If the file already exists, a dialog will appear that allows you to replace the existing file by selecting OK, or you can Cancel the request. If you select OK, the file will be overwritten. Using the C: drive is strongly discouraged, since it runs the risk of being overwritten during an instrument software upgrade.

While the save is being performed, the floppy icon appears briefly in the Meas bar.

## File/Folder List

Enables you to navigate to the center of the dialog that contains the list of files and folders. Once here you can get information about the file and use the tab keys to navigate to the other fields in the dialog, such as Save In.

## Save In

The Save In field shows the path to which the file will be saved and allows you to change the path using the up and down arrow keys to navigate to other paths; the Enter key to open a directory; and the Backspace key to go back one directory. The **Save In field** defaults to the default path for this type of file and remembers the last path you used to save this type of file. There is no softkey for directly navigating to the Save In field but you can use left tab to get here from the File/Folder List.

User specified paths are remembered when you leave and return to a Mode and are reset back to the default using Restore Mode Defaults.

## File Name

The File Name field is initially loaded with an automatically generated filename specific to the appropriate Save Type. The automatically generated filename is guaranteed not to conflict with any filename currently in the directory. You may replace or modify this filename using the File Name key. See the ["Quick Save " on page 2880](#) documentation for more on the automatic file naming algorithm.

When you press the File Name key the analyzer displays the Alpha Editor. Use the knob to choose the letter to add and the front-panel Enter key to add the letter to the file name. The BK character moves you back and the FW character moves you forward in the filename. The Select key on the front panel generates a space character. When you are done entering the filename press the Done softkey. This returns back to the **File Open** dialog and menu, but does not cause the save to occur.

## Save As Type

This field shows the file suffix for the type of file you have selected to save. For example, if you navigated here while saving State, "Mode state (\*.state)" is in the field. If you navigated here from saving Trace, ""Mode state (\*.trace)" is in the field. If you navigated here while exporting a trace data file, "Trace Data (\*.csv)" is in the field. For some file types, there is more than one choice in the dropdown, which you can select by using the up and down arrow keys and Enter.

## Up One Level

This key corresponds to the icon of a folder with the up arrow that is in the tool bar of the dialog. When pressed, it causes the file and folder list to navigate up one level in the directory structure. The Backspace key does the same thing.

## Create New Folder

This key corresponds to the icon of a folder with the "\*" that is in the tool bar of the dialog. When pressed, a new folder is created in the current directory with the name **New Folder** and you can enter a new folder name using the Alpha Editor.

## Cancel

This key corresponds to the Cancel selection in the dialog. It causes the current **Save As** request to be cancelled. The ESC key does the same thing.

Key Path	Save, State
Mode	All
Notes	Brings up Save As dialog for saving a State Save Type
Initial S/W Revision	Prior to A.02.00

## Edit Register Names

You may enter a custom name on any of the Register keys, to help you remember what you are using that state to save. To do this, press the Edit Register Names key, choose the register whose name you wish to edit, and then enter the desired label using the Alpha Editor or an external PC keyboard.

The maximum number of characters that can be added is 30. In most cases, 30 characters will fit on two lines of the key.

See ["More Information" on page 780](#)

Key Path	Save, State
Mode	All
<b>Remote Command</b>	:MMEMory:REGister:STATe:LABel <reg number>,"label" :MMEMory:REGister:STATe:LABel? <reg number>
<b>Example</b>	:MMEM:REG:STAT:LAB 1,"my label"
Notes	<reg number> is an integer from 1 to 16. If the SCPI specifies an invalid register number an error message is generated, -222,"Data out of range;Invalid register label number" "label" is a string from 0 to 30 characters in length. If a label exceeds 30 characters, an error message is generated, -150,"String data error;Label clipped to 30 characters" "label" of length 0 erases the custom label and restores the default (time and date) label. E.g.: :MMEM:REG:STAT:LAB 1,""
Dependencies	N9060A-7FP or N9060B-2FP license required to edit the register names. When the feature is not licensed, sending this command generates an error, -221,"Settings conflict;Option not available"
Preset	The names are unaffected by Preset or power cycle but are set to the default label (time and date) on a "Restore System Defaults->Misc"
Initial S/W Revision	A.11.00

## More Information

When you edit one of the register names, the time and date field will be replaced by the custom name.

If you delete all the characters in the custom name, it restores the default (time and date).

The register names are stored within the state files, but they are not part of the instrument state; that is, once you have edited a register name, loading a new state will not change that register name. Another consequence of this is that the names will be persistent through a power cycle. Also, if a named state file is transferred to another analyzer, it will bring its custom name along with it.



If you try to edit the name of an empty register, the analyzer will first save the state to have a file to put the name in. If you load a named state file into an analyzer with older firmware it will ignore the metadata.

The \*SAV and \*RCL commands will not be affected by the custom register names, nor will the MMEM commands.

### Register 1 thru Register 16

Selecting any one of these register menu keys causes the State of the currently active mode to be saved to the specified Register. The registers are provided for rapid saving and recalling, since you do not need to specify a filename or navigate to a file. Each of the register menu keys annotates whether it is empty or at what date and time it was last modified. In addition, you can use the Edit Register Names key to enter custom names for each register.

Although these 16 registers are the only registers available from the front panel, there are 128 state registers available in the instrument. Registers 17–128 are only available from the SCPI interface, using the \*SAV command.

There is one set of 128 state registers in the instrument, not one set for each Mode. When a state is saved, the Mode it was saved from is saved with it; then when it is recalled, the instrument switches to that Mode.

After the save completes, the corresponding register menu key annotation is updated with the date and time and the message "Register <register number> saved" is displayed.

Key Path	Save, State
Mode	All
<b>Example</b>	*SAV 1
Range	1–16 from front panel, 1–128 from SCPI
Readback	Date and time with seconds resolution are displayed on the key OR A custom name of up to 30 characters entered using the Edit Register Names key OR “(empty)” if no prior save operation has been performed to this register.
Initial S/W Revision	Prior to A.02.00
Modified at S/W Revision	A.11.00

### Register 1 thru Register 16

Selecting any one of these register menu keys causes the State of the currently active mode to be saved to the specified Register. The registers are provided for rapid saving and recalling, since you do not need to specify a filename or navigate to a file. Each of the register menu keys annotates whether it is empty or at what date and time it was last modified. In addition, you can use the Edit Register Names key to enter custom names for each register.

Although these 16 registers are the only registers available from the front panel, there are 128 state registers available in the instrument. Registers 17–128 are only available from the SCPI interface, using the \*SAV command.

There is one set of 128 state registers in the instrument, not one set for each Mode. When a state is saved, the Mode it was saved from is saved with it; then when it is recalled, the instrument switches to that Mode.

After the save completes, the corresponding register menu key annotation is updated with the date and time and the message "Register <register number> saved" is displayed.

Key Path	Save, State
Mode	All
Example	*SAV 1
Range	1-16 from front panel, 1-128 from SCPI
Readback	Date and time with seconds resolution are displayed on the key OR A custom name of up to 30 characters entered using the Edit Register Names key OR “(empty)” if no prior save operation has been performed to this register.
Initial S/W Revision	Prior to A.02.00
Modified at S/W Revision	A.11.00

## Data (Export)

Exporting a data file stores data from the current measurement to mass storage files. The Export Menu only contains data types that are supported by the current measurement.

Since the commonly exported data files are in .csv format, the data can be edited by you prior to importing. This allows you to export a data file, manipulate the data in Excel (the most common PC Application for manipulating .csv files) and then import it.

Selecting an Export Data menu key will not actually cause the exporting to occur, since the analyzer still needs to know where you wish to save the data. Pressing the Save As key in this menu brings up the Save As dialog and Save As menu that allows you to specify the destination file and directory. Once a filename has been selected or entered in the Open menu, the export will occur as soon as the Save key is pressed.

Key Path	Save
Mode	All
Notes	The menu is built from whatever data types are available for the mode. So the key locations in the sub menu will vary.  No SCPI command directly controls the Data Type that this key controls. The Data Type is included in the MMEM:STORe commands.
Dependencies	If a file type is not used by a certain measurement, that type is grayed out for that measurement. The key for a file type will not show at all if there are no measurements in the Mode that support it.
Preset	Is not affected by a Preset or shutdown, but is reset during Restore Mode Defaults
Readback	The data type that is currently selected
Initial S/W Revision	Prior to A.02.00

## Measurement Results

Pressing this key selects Meas Results as the data type to be exported.

The Meas Results file contains information which describes the current state of the analyzer. It is detailed in Meas Result File Contents below.

Key Path	Save, Data
Remote Command	:MMEMory:STORe:RESults <string>
Example	:MMEM:STOR:RES "MeasR_0000.csv"
Notes	<p>If the save is initiated via SCPI and the file already exists, the file will be overwritten.</p> <p>The SCPI command exports ACP measurement results to the file specified as the parameter in the current path. The default path is My Documents\<current mode&gt;\data\acp\results.<="" p=""> <p>Using the C: drive is strongly discouraged, since it runs the risk of being overwritten during an instrument software upgrade.</p> <p>The SCPI parameter is a quoted string that specifies the filename. Both single and double quotes are supported for any filename parameter over SCPI.</p> </current></p>
Dependencies	The current active measurement must be the ACP measurement to use this command.
Status Bits/OPC dependencies	Sequential – waits for the previous measurement to complete
Initial S/W Revision	Prior to A.02.00

### Meas Results File Contents

A Meas Results File contains measurement results with the following information.

- File ID string, which is “MeasResult”
- Measurement ID following Mode ID, which is “SA:ACP” for example.
- Firmware rev and model number
- Option string
- Auto Scaling
- Auto Sweep Time Rules
- Automatic Trigger Time
- Automatic Trigger Time State
- Average Mode
- Average Number
- Average State
- Bar Graph
- Carrier Coupling
- Carrier Pwr Present

- Carrier Spacing
- Carriers
- Center Frequency
- Center Frequency Step
- Center Frequency Step State
- Detector Auto
- Detector Selection
- Electrical Atten
- Electrical Atten State
- External Array Trigger Delay
- External Array Trigger Delay State
- External Array Trigger Level
- External Array Trigger Slope
- Filter Alpha
- Filter BW
- Filter Type
- Internal Preamp
- Internal Preamp Band
- Limit Test
- Line Trigger Delay
- Line Trigger Delay State
- Line Trigger Slope
- Meas Method
- Meas Type
- Measurement Noise Bandwidth
- Mechanical Atten
- MechanicalAttenStepEnum
- Method
- Noise Correction
- Offset Abs Limit
- Offset Fail

- Offset Filter Alpha
- Offset Filter BW
- Offset Filter Type
- Offset Freq
- Offset Freq State
- Offset Integ BW
- Offset Method
- Offset Rel Lim (Car)
- Offset Rel Lim (PSD)
- Offset Res BW
- Offset Res BW Mode
- Offset Video BW
- Offset Video BW Mode
- Periodic Timer Period
- Periodic Timer Sync Source
- Periodic Timer Trigger Delay
- Periodic Timer Trigger Delay State
- Points
- Power Ref
- Power Ref State
- Preselector Adjust
- PSD Ref
- PSD Unit
- Ref Car Freq
- Ref Car Freq State
- Ref Carrier
- Ref Carrier Mode
- Ref Position
- Ref Value
- Res BW
- Res BW Mode

- RFBurst Trigger Delay
- RFBurst Trigger Delay State
- RFBurst Trigger Level Abs
- RFBurst Trigger Level Rel
- RFBurst Trigger Level Type
- RFBurst Trigger Slope
- Scale/Div
- Span
- Sweep Time
- Sweep Time Auto
- Trigger Holdoff
- Trigger Holdoff State
- Trigger Source
- Video BW
- Video BW Auto

The file contains these data followed by MeasResult1, MeasResult2, and MeasResult3 that flag the start of the measurement results. Each line of Measurement Results consists of three comma separated values, MeasResult1 value, MeasResult2 value, and MeasResult3 value. MeasResult1 contains the same result as MEAS/READ/FETCH:ACPower1; MeasResult2, MEAS/READ/FETCH:ACPower2; MeasResult3, MEAS/READ/FETCH:ACPower3.

Exported file is .csv file. The Meas Results file, when imported into Excel, will show the following data:

---

MeasResult	
SA:ACP	
A.10.53	N9030A
526 ALV ATP	1
B1X B1Y B25	
B40 BBA CR3	
CRP DCF DDA	
DP2 DRD EA3	
EDP EMC EP1	
ERC ESC ESP	
EXM FSA LFE	
LNP MAT MPB	
NFE NUL P26	
PFR PNC RTL	
RTS S40 SB1	
SEC SM1 TVT	
YAS YAV	

---

Auto Scaling	TRUE											
Auto Sweep Time Rules	Accy											
Automatic Trigger Time	0.1											
Automatic Trigger Time State	FALSE											
Average Mode	Exponential											
Average Number	10											
Average State	TRUE											
Bar Graph	TRUE											
Carrier Coupling	TRUE	TRUE	TRUE	TRUE	TRUE	TRUE	TRUE	TRUE	TRUE	TRUE	TRUE	TRUE
Carrier Pwr Present	Yes	Yes	Yes	Yes	Yes	Yes	Yes	Yes	Yes	Yes	Yes	Yes
Carrier Spacing	5000000	500000	500000	500000	500000	500000	500000	500000	500000	500000	500000	500000
Carriers	1											
Center Frequency	1.33E+10											
Center Frequency Step	800000											
Center Frequency Step State	TRUE											
Detector Auto	TRUE											
Detector Selection	Average											
Electrical Atten	0											
Electrical Atten State	FALSE											
External Array Trigger Delay	1.00E-06	1.00E-06										
External Array Trigger Delay State	FALSE	FALSE										
External Array Trigger Level	1.2	1.2										

External Array Trigger Slope	Positive	Positive										
Filter Alpha	0.22	0.22	0.22	0.22	0.22	0.22	0.22	0.22	0.22	0.22	0.22	0.22
Filter BW	Minus3dB											
Filter Type	Gaussian											
Internal Preamp	FALSE											
Internal Preamp Band	Low											
Limit Test	FALSE											
Line Trigger Delay	1.00E-06											
Line Trigger Delay State	FALSE											
Line Trigger Slope	Positive											
Meas Method	IbwSpeed											
Meas Type	TPRef											
Measurement Noise Bandwidth	2000000	2000000	200000	200000	200000	200000	200000	200000	200000	200000	200000	200000
Mechanical Atten	10											
MechanicalAtt enStepEnum	S2dB											
Method	IBW	IBW	IBW	IBW	IBW	IBW	IBW	IBW	IBW	IBW	IBW	IBW
Noise Correction	FALSE											
Offset Abs Limit	0	0	0	0	0	0						
Offset Fail	Relative	Relative	Relative	Relative	Relative	Relative						
Offset Filter Alpha	0.22											
Offset Filter BW	Minus3dB	Minus3dB	Minus3dB	Minus3dB	Minus3dB	Minus3dB						
Offset Filter Type	Gaussian	Gaussian	Gaussian	Gaussian	Gaussian	Gaussian						
Offset Freq	3000000	0	0	0	0	0						



Offset Freq State	TRUE	FALSE	FALSE	FALSE	FALSE	FALSE
Offset Integ BW	2000000	2000000	200000	200000	200000	200000
Offset Method	FALSE					
Offset Rel Lim (Car)	-45	-60	0	0	0	0
Offset Rel Lim (PSD)	-28.87	-43.87	0	0	0	0
Offset Res BW	220000	220000	220000	220000	220000	220000
Offset Res BW Mode	TRUE	TRUE	TRUE	TRUE	TRUE	TRUE
Offset Video BW	22000	22000	22000	22000	22000	22000
Offset Video BW Mode	TRUE	TRUE	TRUE	TRUE	TRUE	TRUE
Periodic Timer Period	0.02					
Periodic Timer Sync Source	None					
Periodic Timer Trigger Delay	1.00E-06					
Periodic Timer Trigger Delay State	FALSE					
Points	1001					
Power Ref	-76.81 dBm					
Power Ref State	On					
Preselector Adjust	0					
PSD Ref	-139.82 dBm/Hz					
PSD Unit	DbmHz					
Ref Car Freq	13.25500000 GHz					
Ref Car Freq State	On					
Ref Carrier	1					

Ref Carrier Mode	On	
Ref Position	Top	
Ref Value	-30	
Res BW	220000	
Res BW Mode	FALSE	
RFBurst Trigger Delay	1.00E-06	
RFBurst Trigger Delay State	FALSE	
RFBurst Trigger Level Abs	-20	
RFBurst Trigger Level Rel	-6	
RFBurst Trigger Level Type	Absolute	
RFBurst Trigger Slope	Positive	
Scale/Div	10	
Span	8000000	
Sweep Time	0.02	
Sweep Time Auto	TRUE	
Trigger Holdoff	0.1	
Trigger Holdoff State	FALSE	
Trigger Source	Free	
Video BW	22000	
Video BW Auto	TRUE	
MeasResult1	MeasResult 2	Meas Result 3
- 76.80585177 44559	0	1
0.084790019 950006	- 76.80585 17744559	0

0.028392912 8313787	-999	1
	-999	0
	-999	1

## Capture Buffer

Capture Buffer functionality is not available for all measurements. The captured data is raw data which is not processed.

Key Path	Save, Data
Mode	CDMA1XEV
Example	MMEM:STOR:CAPT "MyCaptureData.bin" This stores the capture data in the file MyCaptureData.bin in the default directory.
Dependencies	In case the capture buffer data is not available from the selected measurement, the key will be grayed out.
Initial S/W Revision	A.11.00

## Save As . . .

When you press "Save As", the analyzer brings up a Windows dialog and a menu entitled "**Save As.**" This menu allows you to navigate to the various fields in the Windows dialog without using a keyboard or mouse. The Tab and Arrow keys can also be used for dialog navigation.

See "[To File . . .](#)" on page 2897 in Save, State for a full description of this dialog and menu.

The default path for saving files is:

For all of the Trace Data Files:

My Documents\`<mode name>`\data\traces

For all of the Limit Data Files:

My Documents\`<mode name>`\data\limits

For all of the Measurement Results Data Files:

My Documents\`<mode name>`\data\`<measurement name>`\results

For all of the Capture Buffer Data Files:

My Documents\`<mode name>`\data\captureBuffer

Key Path	Save, Data
Mode	All
Notes	The key location is mode-dependent and will vary.

---

Brings up the Save As dialog for saving a <mode specific> Save Type. The save is performed immediately and does not wait until the measurement is complete.

---

Initial S/W Revision      Prior to A.02.00

---

## Screen Image

Pressing Screen Image accesses a menu of functions that enable you to specify a format and location for the saved screen image. It brings up a menu that allows you to specify the color scheme of the Screen Image (Themes) or navigate to the Save As dialog to perform the actual save.

Screen Image files contain an exact representation of the analyzer display. They cannot be loaded back onto the analyzer, but they can be loaded into your PC for use in many popular applications.

The image to be saved is actually captured when the Save front panel key is pressed, and kept in temporary storage to be used if you ask for a Screen Image save. When the Screen Image key is pressed, a "thumbnail" of the captured image is displayed, as shown below:

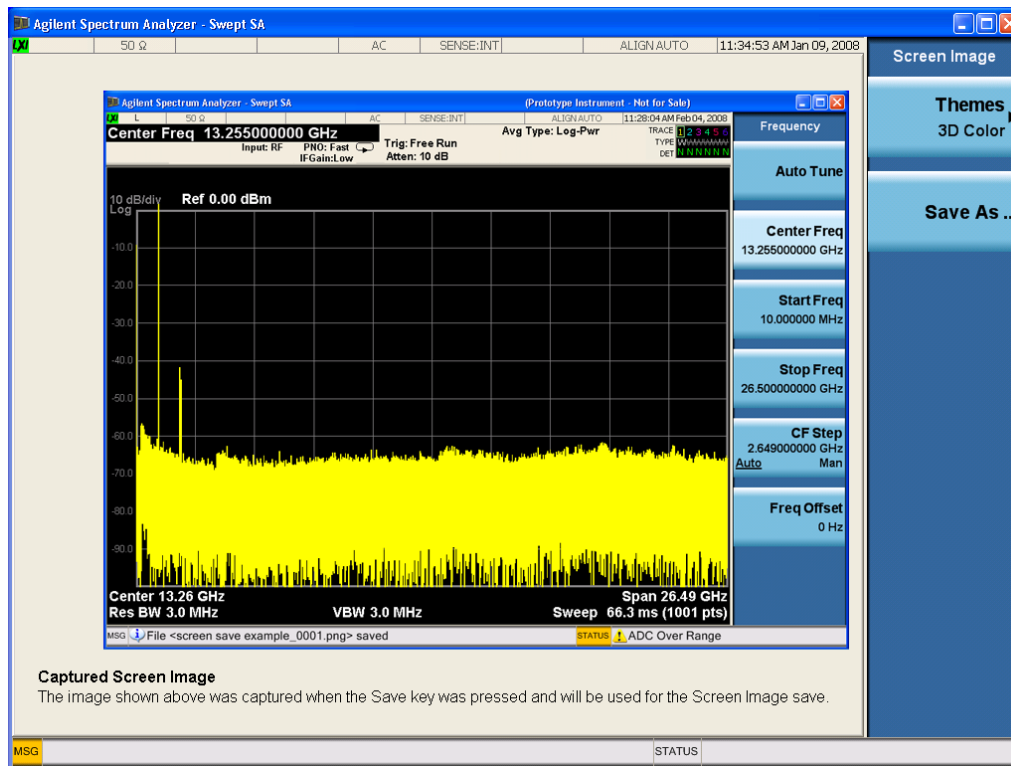

When you continue on into the Save As menu and complete the Screen Image save, the image depicted in the thumbnail is the one that gets saved, showing the menus that were on the screen before going into the Save menus. The save is performed immediately and does not wait until the measurement is complete.

After you have completed the save, the Quick Save front-panel key lets you quickly repeat the last save performed, using an auto-named file, with the current screen data.

**NOTE**

For versions previous to A.01.55, if you initiate a screen image save by navigating through the Save menus, the image that is saved will contain the Save menu softkeys, not the menus and the active function that were on the screen when you first pressed the Save front panel key.

Key Path	Save
Mode	All
<b>Remote Command</b>	:MMEMory:STORe:SCReen <filename>
<b>Example</b>	:MMEM:STOR:SCR "myScreen.png" This stores the current screen image in the file MyScreenFile.png in the default directory.
Initial S/W Revision	Prior to A.02.00

## Themes

Accesses a menu of functions that enable you to choose the theme to be used when saving the screen image.

The **Themes** option is the same as the **Themes** option under the **Display** and **Page Setup** dialogs. It allows you to choose between themes to be used when saving the screen image.

Key Path	Save, Screen Image
<b>Remote Command</b>	:MMEMory:STORe:SCReen:THEMe TDColor   TDMonochrome   FColor   FMONochrome  :MMEMory:STORe:SCReen:THEMe?
<b>Example</b>	:MMEM:STOR:SCR:THEM TDM
Preset	3D Color; Is not part of Preset, but is reset by Restore Misc Defaults or Restore System Defaults All and survives subsequent running of the modes.
Readback	3D Color   3D Mono   Flat Color   Flat Mono
Backwards Compatibility Notes	In ESA and PSA we offer the choice of "Reverse Bitmap" or "Reverse Metafile" when saving screen images. This is much like the "Flat Color" theme available in X-Series. Also, if you selected Reverse Bitmap AND a black & white screen image, that would be much like "Flat Monochrome". In other words, each of the X-Series themes has a similar screen image type in ESA/PSA. But they are not identical.
Initial S/W Revision	Prior to A.02.00

## 3D Color

Selects a standard color theme with each object filled, shaded and colored as designed.

Key Path	Save, Screen Image, Themes
<b>Example</b>	MMEM:STOR:SCR:THEM TDC
Readback	3D Color
Initial S/W Revision	Prior to A.02.00

### 3D Monochrome

Selects a format that is like 3D color but shades of gray are used instead of colors.

Key Path	Save, Screen Image, Themes
<b>Example</b>	MMEM:STOR:SCR:THEM TDM
Readback	3D Mono
Initial S/W Revision	Prior to A.02.00

### Flat Color

Selects a format that is best when the screen is to be printed on an ink printer.

Key Path	Save, Screen Image, Themes
<b>Example</b>	MMEM:STOR:SCR:THEM FCOL
Readback	Flat Color
Initial S/W Revision	Prior to A.02.00

### Flat Monochrome

Selects a format that is like Flat Color. But only black is used (no colors, not even gray), and no fill.

Key Path	Save, Screen Image, Themes
<b>Example</b>	MMEM:STOR:SCR:THEM FMON
Readback	Flat Mono
Initial S/W Revision	Prior to A.02.00

### Save As...

When you press "Save As", the analyzer brings up a Windows dialog and a menu entitled "**Save As.**" This menu allows you to navigate to the various fields in the Windows dialog without using a keyboard or mouse. The Tab and Arrow keys can also be used for dialog navigation.

See "[To File . . .](#)" on page 2897 in Save, State for a full description of this dialog and menu.

The default path for Screen Images is

My Documents\`<mode name>`\screen.

where `<mode name>` is the parameter used to select the mode with the INST:SEL command (for example, SA for the Spectrum Analyzer).

Key Path	Save, Screen Image
Notes	Brings up Save As dialog for saving a Screen Image Save Type
Initial S/W Revision	Prior to A.02.00

## Mass Storage Catalog (Remote Command Only)

Key path	SCPI Only
<b>Remote Command</b>	:MMEMory:CATalog? [<directory_name>]
Notes	<p>The string must be a valid logical path.</p> <p>Queries disk usage information (drive capacity, free space available) and obtains a list of files and directories in a specified directory in the following format:</p> <p>&lt;numeric_value&gt;,&lt;numeric_value&gt;,{&lt;file_entry&gt;}</p> <p>It returns two numeric parameters and as many strings as there are files and directories. The first parameter indicates the total amount of storage currently used in bytes. The second parameter indicates the total amount of storage available, also in bytes. The &lt;file_entry&gt; is a string. Each &lt;file_entry&gt; indicates the name, type, and size of one file in the directory list:</p> <p>&lt;file_name&gt;,&lt;file_type&gt;,&lt;file_size&gt;</p> <p>As the windows file system has an extension that indicates file type, &lt;file_type&gt; is always empty. &lt;file_size&gt; provides the size of the file in bytes. For directories, &lt;file_entry&gt; is surrounded by square brackets and both &lt;file_type&gt; and &lt;file_size&gt; are empty</p>
Initial S/W Revision	Prior to A.02.00

## Mass Storage Change Directory (Remote Command Only)

Key path	SCPI Only
<b>Remote Command</b>	:MMEMory:CDIRectory [<directory_name>] :MMEMory:CDIRectory?
Notes	<p>The string must be a valid logical path.</p> <p>Changes the default directory for a mass memory file system. The &lt;directory_name&gt; parameter is a string. If no parameter is specified, the directory is set to the *RST value.</p> <p>At *RST, this value is set to the default user data storage area, that is defined as System.Environment.SpecialFolder.Personal.</p> <p>Query returns full path of the default directory.</p>
Initial S/W Revision	Prior to A.02.00

## Mass Storage Copy (Remote Command Only)

Key path	SCPI Only
<b>Remote Command</b>	:MMEMory:COPY <string>,<string>[,<string>,<string>]
Notes	<p>The string must be a valid logical path.</p> <p>Copies an existing file to a new file or an existing directory to a new directory.</p> <p>Two forms of parameters are allowed. The first form has two parameters. In this form, the first parameter specifies the source, and the second parameter specifies the destination.</p>

The second form has four parameters. In this form, the first and third parameters specify the source. The second and fourth parameters specify the directories. The first pair of parameters specifies the source. The second pair specifies the destination. An error is generated if the source doesn't exist or the destination file already exists.

This command will generate an "access denied" error if the destination is a restricted folder (e.g., C:\Windows) and the current user does not have Power User or Administrator privileges.

### Mass Storage Device Copy (Remote Command Only)

This command transfers data to/from a file and a peripheral device.

Key path	SCPI Only
<b>Remote Command</b>	:MMEMory:COpy:DEvice <source_string>,<dest_string>
Notes	The strings must be a valid logical path or a valid device keyword. If the dest_string is a device keyword, the data is copied from the source file to the device. If the source_string is a device keyword, the data is copied to the source file from the device. Valid device keywords are: SNS (smart noise source) An error is generated if the file or device is not found.

### Mass Storage Delete (Remote Command Only)

Key path	SCPI Only
<b>Remote Command</b>	:MMEMory:DELeTe <file_name>[,<directory_name>]
Notes	The string must be a valid logical path. Removes a file from the specified directory. The <file_name> parameter specifies the file name to be removed. This command will generate an "access denied" error if the file is in a restricted folder (e.g., C:\Windows) and the current user does not have Power User or Administrator privileges.
Initial S/W Revision	Prior to A.02.00

### Mass Storage Data (Remote Command Only)

Creates a file containing the specified data OR queries the data from an existing file.

Key path	SCPI Only
<b>Remote Command</b>	:MMEMory:DATA <file_name>,<data> :MMEMory:DATA? <file_name>
Notes	The string must be a valid logical path. The command form is MMEMory:DATA <file_name>,<data>. It loads <data> into the file <file_name>. <data> is in 488.2 block format. <file_name> is string data. The query form is MMEMory:DATA? <file_name> with the response being the associated <data> in



	block format.
Initial S/W Revision	Prior to A.02.00

### Mass Storage Make Directory (Remote Command Only)

Key path	SCPI Only
<b>Remote Command</b>	:MMEMory:MDIRectory <directory_name>
Notes	<p>The string must be a valid logical path.</p> <p>Creates a new directory. The &lt;directory_name&gt; parameter specifies the name to be created.</p> <p>This command will generate an “access denied” error if the new directory would be in a restricted folder (e.g., C:\Windows) and the current user does not have Power User or Administrator privileges.</p>
Initial S/W Revision	Prior to A.02.00

### Mass Storage Move (Remote Command Only)

Key path	SCPI Only
<b>Remote Command</b>	:MMEMory:MOVE <string>, <string> [, <string>, <string>]
Notes	<p>The string must be a valid logical path.</p> <p>Moves an existing file to a new file or an existing directory to a new directory.</p> <p>Two forms of parameters are allowed. The first form has two parameters. In this form, the first parameter specifies the source, and the second parameter specifies the destination.</p> <p>The second form has four parameters. In this form, the first and third parameters specify the source. The second and fourth parameters specify the directories. The first pair of parameters specifies the source. The second pair specifies the destination. An error is generated if the source doesn't exist or the destination file already exists.</p> <p>This command will generate an “access denied” error if the destination is a restricted folder (e.g., C:\Windows) and the current user does not have Power User or Administrator privileges.</p>
Initial S/W Revision	Prior to A.02.00

### Mass Storage Remove Directory (Remote Command Only)

Key path	SCPI Only
<b>Remote Command</b>	:MMEMory:RDIRectory <directory_name>
Notes	<p>The string must be a valid logical path.</p> <p>Removes a directory. The &lt;directory_name&gt; parameter specifies the directory name to be removed. All files and directories under the specified directory shall also be removed.</p> <p>This command will generate an “access denied” error if the folder is a restricted folder (e.g., C:\Windows) or is in a restricted folder and the current user does not have Power User or Administrator privileges.</p>
Initial S/W Revision	Prior to A.02.00



## Single (Single Measurement/Sweep)

Sets the analyzer for Single measurement operation. The single/continuous state is Meas Global, so the setting will affect all the measurements. If you are Paused, pressing Single does a Resume.

See ["More Information" on page 799](#)

Key Path	Front-panel key
Example	:INIT:CONT OFF
Notes	See Cont key description.
Backwards Compatibility Notes	<p>For Spectrum Analysis mode in ESA and PSA, the Single hardkey and the INITiate:IMM switched from continuous measurement to single measurement and restarted sweeps and averages (displayed average count reset to 1), but did not restart Max Hold and Min Hold. In the X-Series, the Single hardkey and the INITiate:IMM command initiate a sweep/ measurement/ average sequence/hold sequence including MaxHold and MinHold.</p> <p>For Spectrum Analysis mode in ESA and PSA, the Single hardkey restarted the sweep regardless of whether or not you were in an active sweep or sweep sequence. In the X-Series, Restart does this but Single only restarts the sweep or sweep sequence if you are in the idle state.</p> <p>INIT[:IMM] in ESA &amp; PSA Spectrum Analysis Mode does an implied ABORT. In some other PSA Modes, INIT[:IMM] is ignored if not in the idle state. . The X-Series follows the ESA/PSA SA Mode model, which may cause some Modes to have compatibility problems.</p>
Initial S/W Revision	Prior to A.02.00

### More Information

See ["Restart" on page 2894](#) for details on the INIT:IMMEDIATE (Restart) function.

If you are already in single sweep, the INIT:CONT OFF command has no effect.

If you are already in Single Sweep, then pressing the Single key in the middle of a sweep does not restart the sweep or sequence. Similarly, pressing the Single key does not restart the sweep or sequence if the sweep is not in the idle state (for example, if you are taking a very slow sweep, or the analyzer is waiting for a trigger). Instead, it results in a message. "Already in Single, press Restart to initiate a new sweep or sequence". Even though pressing the Single key in the middle of a sweep does not restart the sweep, sending INIT:IMMEDIATE does reset it.

To take one more sweep without resetting the average count, increment the average count by 1, by pressing the step up key while **Average/Hold Number** is the active function, or sending the remote command CALC:AVER:TCON UP.

## Source

There is no Source control functionality for this measurement. When this key is pressed, the screen either displays a blank menu, or the previously-selected menu remains unchanged.

---

Key Path	Front-panel key
----------	-----------------

---

## SPAN X Scale

Accesses a menu of functions that enable you set the horizontal scale parameters.

Key Path	Front-panel key
Initial S/W Revision	Prior to A.02.00

### Span

Changes the frequency range symmetrically about the center frequency.

The default (and minimum) span is calculated using the number of carriers and the carrier width where;

$$\text{Span} = (\text{Upper Carrier Freq} + (\text{max offset IBW} * (1 + \alpha)) / 2) - (\text{Lower Carrier Freq} - (\text{max offset IBW} * (1 + \alpha)) / 2)$$

The span is increased by a factor of 1 + Filter Alpha if the RRC Filter is on.

Key Path	SPAN X Scale
Mode	SA, WCDMA, C2K, WIMAX OFDMA, TD-SCDMA, 1xEVDO, DVB-T/H, DTMB (CTTB), ISDB-T, CMMB, LTE, LTE-TDD, Digital Cable TV, MSR, LTEAFDD, LTEATDD
Remote Command	[ :SENSe ] :ACPoweR:FREQuency:SPAN <freq> [ :SENSe ] :ACPoweR:FREQuency:SPAN?
Example	ACP:FREQ:SPAN 25MHz ACP:FREQ:SPAN?
Notes	You must be in the mode that includes ACP measurements to use this command. Use :INSTrument:SElect to set the mode.
Couplings	The span value is clipped when the carrier settings and/or the offset settings are changed. The value is changed to satisfy following formula: $\text{Span} = (\text{Upper Carrier Freq} + (\text{max offset IBW} * (1 + \alpha)) / 2) - (\text{Lower Carrier Freq} - (\text{max offset IBW} * (1 + \alpha)) / 2)$
Preset	SA: 8 MHz WCDMA: 24.6848 MHz WIMAX OFDMA: 50 MHz C2K: 4.5 MHz TD-SCDMA: 8 MHz 1xEVDO: 4.05 MHz DVB-T/H: 40 MHz DTMB (CTTB): 72 MHz ISDB-T: 30 MHz CMMB: 72 MHz LTE, LTE-TDD, MSR: 25 MHz Digital Cable TV: 40 MHz LTEAFDD, LTEATDD: 25MHz

State Saved	Saved in instrument state.
Min	10 Hz
Max	Hardware Dependent: Option 503 = 3.7 GHz Option 507 = 7.1 GHz Option 508 = 8.5 GHz Option 513 = 13.8 GHz Option 526 = 27.0 GHz
Initial S/W Revision	Prior to A.02.00
Modified at S/W Revision	A.02.00, A.03.00

## Full Span

Changes the span to show the full frequency range of the spectrum analyzer.

Key Path	SPAN X Scale
Mode	SA, WCDMA, C2K, WiMAX OFDMA, TD-SCDMA, 1xEVDO, DVB-T/H, DTMB (CTTB), ISDB-T, CMMB, LTE, LTETDD, Digital Cable TV
<b>Remote Command</b>	<code>[ :SENSe ] :ACPpower:FREQuency:SPAN:FULL</code>
<b>Example</b>	ACP:FREQ:SPAN:FULL
Notes	You must be in the mode that includes ACP measurements to use this command. Use :INSTrument:SElect to set the mode.
Dependencies	For MSR and LTE-Advanced FDD/TDD mode, this key is blank.
Initial S/W Revision	Prior to A.02.00
Modified at S/W Revision	A.02.00, A.03.00

## Last Span

Changes the span to the previous span setting. If no previous span value exists, then the span will remain unchanged.

Key Path	SPAN X Scale
Mode	SA, WCDMA, C2K, WIMAX OFDMA, TD-SCDMA, 1xEVDO, DVB-T/H, DTMB (CTTB), ISDB-T, CMMB, LTE, LTETDD, Digital Cable TV, MSR, LTEAFDD, LTEATDD
<b>Remote Command</b>	<code>[ :SENSe ] :ACPpower:FREQuency:SPAN:PREVious</code>
<b>Example</b>	ACP:FREQ:SPAN:PREV
Notes	You must be in the mode that includes ACP measurements to use this command. Use :INSTrument:SElect to set the mode.
Initial S/W Revision	Prior to A.02.00
Modified at S/W Revision	A.02.00, A.03.00



## Sweep/Control

Accesses a menu of functions that enable you to set up and control the sweep time, and source.

See "[Sweep/Control](#)" on page 2925 for more information.

Key Path	Front-panel key
Initial S/W Revision	Prior to A.02.00

### Sweep Time

Selects the length of time in which the spectrum analyzer sweeps the displayed frequency span. In swept spans, the sweep time varies from 1 millisecond to 2000 seconds. Additional overhead time, which impacts the sweep rate, is not calculated as part of the sweep time. In fact:

sweep rate = span/sweep time

update rate = 1/(sweep time + overhead)

sweep cycle time = sweep time + overhead

Sweep time is coupled to RBW and VBW, and is impacted by the number of sweep points, so changing those parameters may change the sweep time.

If you increase the sweep time, you increase the length of the time data captured and the number of points measured. You might need to specify a specific sweep speed to accommodate a specific condition in your transmitter. For example, you may have a burst signal and need to measure an exact portion of the burst.

Selecting a specific sweep time may result in a long measurement time since the resulting number of data points may not be the optimum  $2n$ . Use [:SENSe]:ACP:OFFSet:LIST:SWEEp:TIME to set the number of points used for measuring the offset channels for Basic and cdmaOne.

For cdma2000 and W-CDMA, this command sets the sweep time when using the sweep mode. See [:SENSe]:ACP:SWEEp:TYPE

Key Path	Sweep/Control
Mode	SA, WCDMA, C2K, WIMAX OFDMA, TD-SCDMA, 1xEVDO, DVB-T/H, DTMB (CTTB), ISDB-T, CMMB, LTE, LTETDD, Digital Cable TV, MSR, LTEAFDD, LTEATDD
Remote Command	[:SENSe]:ACP:SWEEp:TIME <time> [:SENSe]:ACP:SWEEp:TIME? [:SENSe]:ACP:SWEEp:TIME:AUTO OFF ON 0 1 [:SENSe]:ACP:SWEEp:TIME:AUTO?
Example	ACP:SWEEp:TIME 50ms ACP:SWEEp:TIME? ACP:SWEEp:TIME:AUTO OFF ACP:SWEEp:TIME:AUTO?
Notes	This parameter is preset by Meas Method selection. Preset values are as follows:



	IBW: 29 ms IBWR: 108 ms FAST (WCDMA): 7.5 ms
Preset	SA, LTE, LTETDD, MSR: Automatically calculated WCDMA: 29 ms WIMAX OFDMA: Automatically calculated C2K: Automatically calculated TD-SCDMA: Automatically calculated 1xEVDO: Automatically calculated DVB-T/H: Automatically calculated DTMB (CTTB): Automatically calculated ISDB-T: Automatically calculated CMMB: Automatically calculated Digital Cable TV: Automatically calculated LTEAFDD, LTEATDD: Automatically calculated SA, LTE, LTETDD, MSR, LTEAFDD, LTEATDD: ON WCDMA: OFF C2K: OFF (method IBW) WIMAX OFDMA: ON TD-SCDMA: ON DVB-T/H: ON DTMB (CTTB): ON ISDB-T: ON CMMB: ON Digital Cable TV: ON
State Saved	Saved in instrument state.
Min	1 ms
Max	4000 s
Initial S/W Revision	Prior to A.02.00
Modified at S/W Revision	A.02.00, A.03.00

## Sweep Setup

Accesses the sweep setup menu.

Key Path	Sweep/Control
Initial S/W Revision	Prior to A.02.00

## Auto Sweep Time Rules

Switches the analyzer between normal and accuracy sweep states.

Key Path	Sweep/Control, Sweep Setup
Mode	SA, WCDMA, C2K, WIMAX OFDMA, TD-SCDMA, 1xEVDO, DVB-T/H, DTMB (CTTB), ISDB-T, CMMB, LTE, LTETDD, Digital Cable TV, MSR, LTEAFDD, LTEATDD
Remote Command	[ :SENSe ] :ACPoweR :SWEep :TIME :AUTO :RULes NORMal   ACCuracy [ :SENSe ] :ACPoweR :SWEep :TIME :AUTO :RULes?
Example	ACP:SWE:TIME:AUTO:RUL NORM ACP:SWE:TIME:AUTO:RUL?
Notes	Set to Norm when Auto Couple is pressed or sent remotely.
Preset	SA, WCDMA, C2K, TD-SCDMA, 1xEVDO, DTMB (CTTB), LTE, LTETDD, MSR, LTEAFDD, LTEATDD: ACCuracy WIMAX OFDMA, DVB-T/H: NORMal ISDB-T, CMMB: NORMal Digital Cable TV: NORMal
State Saved	Saved in instrument state.
Range	Norm Accy
Initial S/W Revision	Prior to A.02.00
Modified at S/W Revision	A.02.00, A.03.00

## Pause

Pauses a measurement after the current data acquisition is complete. When Paused, the label on the key changes to Resume. Pressing the Resume key resumes the measurement at the point where it was paused. When Paused, pressing Restart, Single, or Cont does a Resume

See "[Pause/Resume](#)" on page 2925 for more details.

Key Path	Sweep/Control
Initial S/W Revision	Prior to A.02.00

## Gate

Accesses a menu that enables you to control the gating function. The Gate functionality is used to view signals best viewed by qualifying them with other events.

Gate setup parameters are the same for all measurements – they do not change as you change measurements. Settings like these are called “Meas Global” and are unaffected by Meas Preset.

Note that Sweep Time autocoupling rules and annotation are changed by Gate being on.

Key Path	Sweep/Control
Scope	Meas Global
Readback	The state and method of Gate, as [Off, LO] or [On, Video]. Note that for measurements that only support gated LO, the method is nonetheless read back, but always as LO.
Initial S/W Revision	Prior to A.02.00

## Gate On/Off

Turns the gate function on and off.

When the Gate Function is on, the selected Gate Method is used along with the gate settings and the signal at the gate source to control the sweep and video system with the gate signal. Not all measurements allow every type of Gate Methods.

When Gate is on, the annunciation in the measurement bar reflects that it is on and what method is used, as seen in the following "Gate: LO" annunciator graphic.

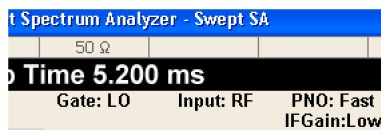

Key Path	Sweep/Control, Gate
Remote Command	[ :SENSE ] :SWEep:EGATE [ :STATE ] OFF   ON   0   1 [ :SENSE ] :SWEep:EGATE [ :STATE ] ?
Example	SWE:EGAT ON SWE:EGAT?

### Dependencies

The function is unavailable (grayed out) and Off when:

- Gate Method is LO or Video and FFT Sweep Type is manually selected.
- Gate Method is FFT and Swept Sweep Type is manually selected.
- Marker Count is ON.

The following are unavailable whenever Gate is on:

- FFT under Sweep Type when Method=LO or Video or Swept under Sweep Type when Method=FFT
- Marker Count

While Gate is on, the Auto Rules for Sweep Type are modified so that the choice agrees with the Gate Method: i.e., FFT for Method = FFT and Swept for Method = LO or Video.

The Gate softkey and all SCPI under the [:SENSE]:SWEep:EGATE SCPI node are grayed out when Source Mode is Tracking with an external source. This is because the Gate circuitry is used to sync the external source. If the Tracking Source is turned on, the Gate is turned off.

When in the ACP measurement:

- When Meas Method is RBW or FAST, this function is unavailable and the key is grayed out.

	<ul style="list-style-type: none"> <li>• Whenever Gate is on, Meas Method, RBW or FAST is unavailable and keys for those are grayed out.</li> <li>• When Gate is on, Offset Res BW and Offset Video BW are ignored (if you set these values) and the measurement works as if all Offset Res BW and all Offset Video BW are coupled with the Res BW and the Video BW under the BW menu. When Gate is on, the Offset BW key in the Offset/Limit menu is grayed out.</li> </ul>
Preset	Off LTETDD: On
State Saved	Saved in instrument state
Range	On Off
<b>Backwards Compatibility SCPI</b>	[:SENSe]:SWEep:TIME:GATE[:STATe] ESA compatibility
Backwards Compatibility Notes	In ESA, Trig Delay (On) and Gate (On) could not be active at the same time.. This dependency does not exist in PSA or in the X-Series.
Initial S/W Revision	Prior to A.02.00

## Gate View On/Off

Turning on Gate View in the Swept SA measurement provides a single-window gate view display..

Turning on Gate View in other measurements shows the split-screen Gate View. In these measurements, when the Gate View is on, the regular view of the current measurement traces and results are reduced vertically to about 70% of the regular height. The Zero Span window, showing the positions of the Gate, is shown between the Measurement Bar and the reduced measurement window. By reducing the height of the measurement window, some of the annotation on the Data Display may not fit and is not shown.

Key Path	Sweep/Control, Gate
<b>Remote Command</b>	[:SENSe]:SWEep:EGATe:VIEW ON OFF 1 0 [:SENSe]:SWEep:EGATe:VIEW?
<b>Example</b>	SWE:EGAT:VIEW ON turns on the gate view.
Dependencies	<p>In the Swept SA measurement:</p> <p>In Gate View, the regular Sweep Time key is grayed out . When pressed, the grayed out key puts up the informational message "Use Gate View Sweep Time in the Gate menu."</p> <p>In the other measurements:</p> <p>When you turn Gate View on, the lower window takes on the current state of the instrument. Upon leaving Gate View, the instrument takes on the state of the lower window.</p> <p>When you turn Gate View on, the upper window Sweep Time is set to the gate view sweep time.</p>
Couplings	<p>These couplings apply to the Swept SA measurement:</p> <ul style="list-style-type: none"> <li>• When Gate View is turned on, the instrument is set to Zero Span.</li> <li>• Gate View automatically turns off whenever a Span other than Zero is selected.</li> <li>• Gate View automatically turns off if you press the Last Span key while in Gate View, and the instrument returns to the Span it was in before entering Gate View (even if that is Zero Span).</li> <li>• When Gate View is turned on, the sweep time used is the gate view sweep time. This is set</li> </ul>

according to the rules in section "Gate View Setup " on page 2725

- When Gate View is turned off, Sweep Time is set to the normal Swept SA measurement sweep time.
- If Gate View is on and Gate is off, then turning on Gate turns off Gate View.

Preset	OFF
State Saved	Saved in instrument state
Range	On Off
Initial S/W Revision	Prior to A.02.00

A sample of the Gate View screen in the Swept SA measurement is shown in the following graphic :

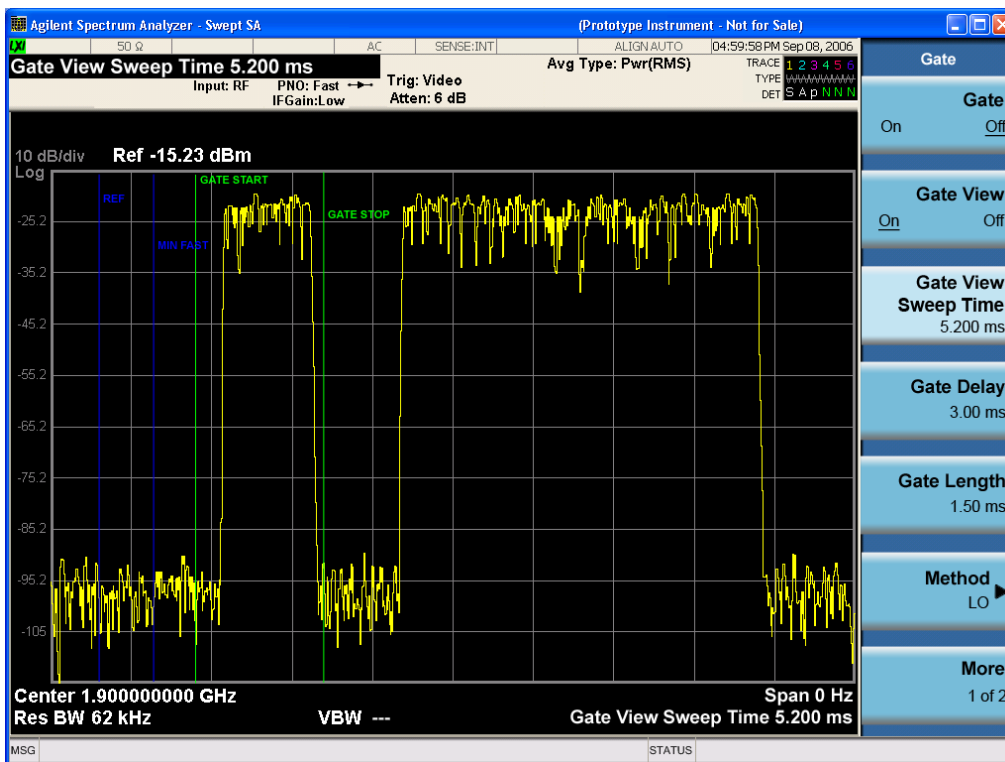

A sample of the Gate View screen in other measurements is shown in the following graphic . This example is for the ACP measurement:

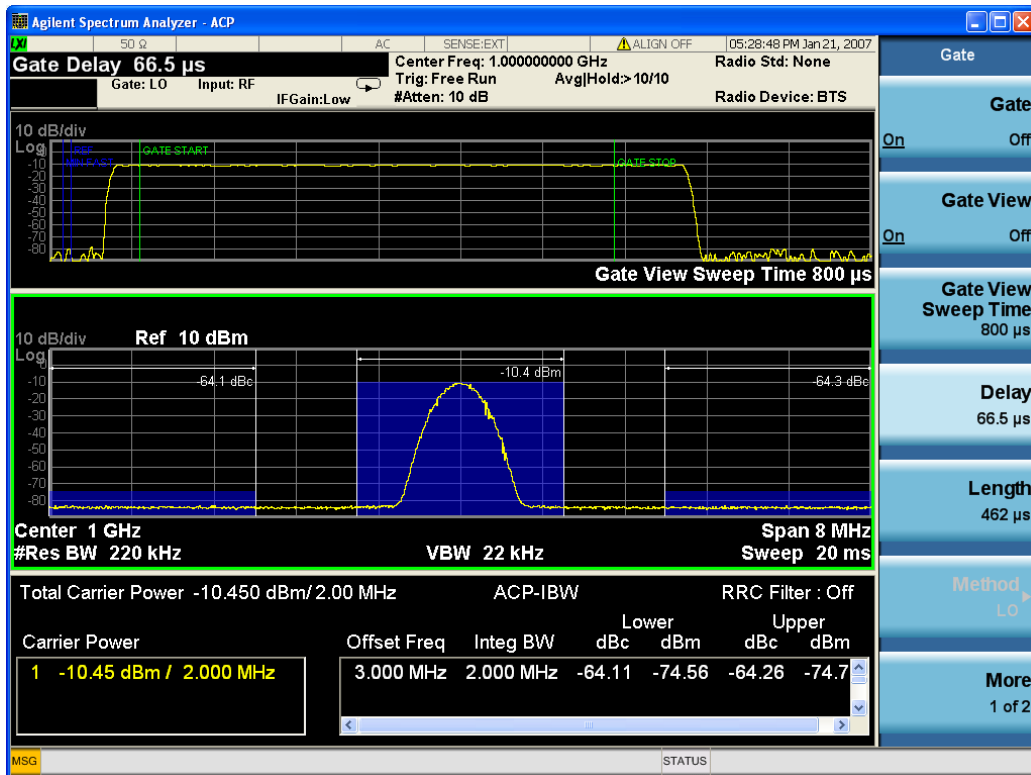

Turning Gate View off returns the analyzer to the Normal measurement view.

In the Swept SA, the normal measurement view is the single-window Swept SA view. When returning to this view, the Swept SA measurement returns to the Span it was in before entering **Gate View** (even if that is Zero Span).

The **Gate View** window is triggered from the Gate Source, with zero trigger delay. Also, when updating the **Gate View** window, the Gate itself must not operate. So it is internally shut off while the gate view window is being updated. For the Swept SA measurement, this means that the Gate is internally shut off whenever the gate view window is displayed. The measurement bar and softkeys continue to show the Trigger source for the main sweep window and give no indication that the Gate is shut off or that the Gate View window is triggered from the Gate Source.

When in **Gate View**, vertical lines are displayed in the Gate View window as follows:

- Green lines are displayed at the gate edges as follows: in Edge Gate, a line is shown for Delay and one for the end of the Gate period, defined by Length. In Level Gate a line is shown only for Delay. You can adjust the position of the green lines by adjusting the gate length and the gate delay. These lines update in the Gate View window as the active function changes, even if the window is not being updated. In Gated LO and Gated Video, these lines are positioned relative to the delay reference line (not relative to 0 time). In Gated FFT, their location is relative to the left edge of the screen.
- A blue line is displayed showing the delay reference, that is, the reference point for the Gate Delay within the Zero Span window. The blue line represents where (in time) the effective location of the gate start would be if the gate were programmed to zero delay.

- The second blue line is labeled "MIN FAST" as shown in the figure above because it represents the minimum Gate Delay for fast Gated LO operation. This line is only displayed in Gated LO. You cannot scroll (knob) or decrement (down key) the Gate Delay to less than that represented by the position of this line, it can only be set below this position manually, although once there it can be moved freely with the knob while below the line.
- A yellow line in the Gated Video case only, is displayed at  $Blength$ , where  $Blength$  is the display point (bucket) length for the swept trace, which is given by the sweep time for that trace divided by number of Points - 1. So it is referenced to 0 time, not to the delay reference. This line is labeled NEXT PT (it is not shown in the figure above because the figure above is for Gated LO).
- The yellow line represents the edge of a display point (bucket). Normally in Gated Video, the bucket length must be selected so that it exceeds the off time of the burst. There is another way to use the analyzer in Gated Video measurements, and that is to set the bucket width much shorter than the off time of the burst. Then use the Max Hold trace function to fill in "missing" buckets more slowly. This allows you to see some of the patterns of the Gated Video results earlier, though seeing a completely filled-in spectrum later.

## Gate View Setup

Accesses a menu that enables you to setup parameters relevant to the Gate View

Key Path	Sweep/Control, Gate
Scope	Meas Global
Initial S/W Revision	A.10.00

## Gate View Sweep Time

Controls the sweep time in the Gate View window. To provide an optimal view of the gate signal, the analyzer initializes Gate View Sweep Time based on the current settings of Gate Delay and Gate Length.

Key Path	Sweep/Control, Gate, Gate View Setup
<b>Remote Command</b>	[ :SENSe ] :SWEep:EGATe:TIME <time> [ :SENSe ] :SWEep:EGATe:TIME?
<b>Example</b>	SWE:EGAT:TIME 500 ms
Dependencies	Gate View Sweep Time is initialized: <ul style="list-style-type: none"> <li>• On Preset (after initializing delay and length).</li> <li>• Every time the Gate Method is set/changed.</li> </ul> <p>Additionally, in the Swept SA measurement, whenever you do a Preset, or leave Gate View, the analyzer remembers the Gate Delay and Gate Length settings. Then, when returning to Gate View, if the current Gate Delay and/or Gate Length do not match the remembered values Gate View Sweep Time is re-initialized.</p> <ol style="list-style-type: none"> <li>1. Compute the location of the "gate stop" line, which you know is at time <math>t = t_{min} + GateDelay + GateLength</math>.</li> </ol>
Preset	519.3 $\mu$ s

	WiMAX OFDMA: 5 ms GSM/EDGE: 1 ms
State Saved	Saved in instrument state
Max	6000 s
Initial S/W Revision	Prior to A.02.00

### Gate View Start Time

Controls the time at the left edge of the Gate View.

Key Path	Sweep/Control, Gate, Gate View Setup
Remote Command	[ :SENSe ] :SWEep:EGATe:VIEW:STARt <time> [ :SENSe ] :SWEep:EGATe:VIEW:STARt?
Example	SWE:EGAT:VIEW:STAR 10ms
Notes	Units of time are required or no units; otherwise an invalid suffix error message will be generated. See error -131.
Preset	0 ms
State Saved	Saved in instrument state
Min	0
Max	500 ms
Initial S/W Revision	A.10.00

### Gate Delay

Controls the length of time from the time the gate condition goes True until the gate is turned on.

Key Path	Sweep/Control, Gate
Remote Command	[ :SENSe ] :SWEep:EGATe:DELAy <time> [ :SENSe ] :SWEep:EGATe:DELAy?
Example	SWE:EGAT:DELAy 500ms SWE:EGAT:DELAy?
Notes	Units of time are required or no units; otherwise an invalid suffix error message will be generated.
Preset	57.7 us WiMAX OFDMA: 71 us GSM/EDGE: 600 us WLAN: 500 us
State Saved	Saved in instrument state



Min	0.0 us
Max	100 s
<b>Backwards Compatibility SCPI</b>	[:SENSe]:SWEep:TIME:GATE:DELay ESA compatibility
Initial S/W Revision	Prior to A.02.00

## Gate Length

Controls the length of time that the gate is on after it opens.

Key Path	Sweep/Control, Gate
<b>Remote Command</b>	[:SENSe]:SWEep:EGATe:LENGth <time> [:SENSe]:SWEep:EGATe:LENGth?
<b>Example</b>	SWE:EGAT:LENG 1 SWE:EGAT:LENG?
Notes	Units of time are required or no units; otherwise an invalid suffix error message will be generated.

### Dependencies

Grayed out when Gate Method is set to FFT in which case the label changes to that shown below.



vsd 39-1

The key is also grayed out if Gate Control = Level.

Preset	461.6 us WiMAX OFDMA: 50 us GSM/EDGE: 200 us WLAN: 1.54 ms
State Saved	Saved in instrument state
Min	100 ns
Max	5 s
<b>Backwards Compatibility SCPI</b>	[:SENSe]:SWEep:TIME:GATE:LENGth ESA compatibility
Initial S/W Revision	Prior to A.02.00

## Gate Source

The menus under the Gate Source key are the same as those under the Trigger key, with the exception that neither Free Run nor Video are available as Gate Source selections. However, a different SCPI command

is used to select the Gate Source (see table below) because you may independently set the Gate Source and the Trigger Source.

Any changes to the settings in the setup menus under each Gate Source selection key (for example: Trigger Level, Trigger Delay, etc.) also affect the corresponding settings under the Trigger menu keys. The SCPI commands used for these are the same for Trigger and Gate, since there is only one setting which affects both Gate and Trigger. Example: to set the Trigger Level for External 1 you use the command :TRIG:EXT1:LEV regardless of whether you are using External 1 as a Trigger Source or a Gate Source.

Key Path	Sweep/Control, Gate
Remote Command	[ :SENSe ] :SWEep:EGATe:SOURce EXTernal1   EXTernal2   LINE   FRAMe   RFBurst [ :SENSe ] :SWEep:EGATe:SOURce?
Dependencies	In some models, there is no second External input. In these models, the External 2 key is blanked and the EXTernal2 parameter will generate a "Hardware missing; Not available for this model number" error.
Preset	EXTernal 1 GSM/EDGE, MSR: FRAMe LTETDD: EXTernal 1When Direction is Downlink, FRAMe when Direction is Uplink.
Backwards Compatibility Notes	In ESA, there is a single Gate input port. In PSA, the Gate Source may be taken from one of two specified input ports. In the X-Series, any Trigger Source can be a Gate Source.
Initial S/W Revision	Prior to A.02.00
Modified at S/W Revision	A.03.00, A.14.00

## Line

Pressing this key, when it is not selected, selects the line signal as the trigger. A new sweep/measurement will start synchronized with the next cycle of the line voltage. Pressing this key, when it is already selected, access the line trigger setup menu.

Key Path	Trigger
Example	TRIG:SOUR LINE Swept SA measurement TRIG:<meas>:SOUR LINE Measurements other than Swept SA
Dependencies	Line trigger is not available when operating from a "dc power source", for example, when the instrument is powered from batteries.
State Saved	Saved in instrument state
Status Bits/OPC dependencies	The Status Operation Register bit 5 "Waiting for Trigger" is set at the same time as the Sweeping or Measuring bit is set. It is cleared when the trigger actually occurs (that is, after the trigger event occurs and all the applicable trigger criteria have been met). A corresponding pop-up message ("Waiting for trigger") is generated if no trigger signal appears after approximately 2 sec. This message goes away when a trigger signal appears.
Initial S/W Revision	Prior to A.02.00

## Trig Slope

Controls the trigger polarity. It is set positive to trigger on a rising edge and negative to trigger on a falling edge.

Key Path	Trigger, Line
<b>Remote Command</b>	:TRIGger[:SEquence]:LINE:SLOPe POSitive NEGative :TRIGger[:SEquence]:LINE:SLOPe?
<b>Example</b>	TRIG:LINE:SLOP NEG
Preset	POSitive
State Saved	Saved in instrument state
Backwards Compatibility Notes	The legacy :TRIGger[:SEquence]:SLOPe command affects the slopes for the VID, LINE, EXT1, EXT2, and RFB triggers.
Initial S/W Revision	Prior to A.02.00

## External 1

Pressing this key, when it is not selected, selects an external input signal as the trigger. A new sweep/measurement will start when the external trigger condition is met using the external 1 input connector on the rear panel.

Pressing this key, when it is already selected, accesses the external 1 trigger setup menu.

Key Path	Trigger
<b>Example</b>	TRIG:SOUR EXT1 Swept SA measurement TRIG:<meas>:SOUR EXT1 Measurements other than Swept SA
Dependencies	Grayed out if in use by Point Trigger in the Source Setup menu. Forced to Free Run if already selected and Point Trigger is set to External 1.
State Saved	Saved in instrument state
Status Bits/OPC dependencies	The Status Operation Register bit 5 "Waiting for Trigger" is set at the same time as the Sweeping or Measuring bit is set. It is cleared when the trigger actually occurs (that is, after the trigger event occurs and all the applicable trigger criteria have been met). A corresponding pop-up message ("Waiting for trigger") is generated if no trigger signal appears after approximately 2 sec. This message goes away when a trigger signal appears.
Initial S/W Revision	Prior to A.02.00

## Trigger Level

Sets the value where the external 1 trigger input will trigger a new sweep/measurement.

Key Path	Trigger, External 1
<b>Remote Command</b>	:TRIGger[:SEquence]:EXTernal1:LEVel <level>

	:TRIGger[:SEquence]:EXTernal1:LEVel?
<b>Example</b>	TRIG:EXT1:LEV 0.4 V
<b>Couplings</b>	This same level is used for the Ext1 trigger source in the Trigger menu, for the Ext1 selection in the Periodic Timer sync source (in the Trigger menu and in the Gate Source menu), and also for the Ext1 selection in the Gate Source menu.
<b>Preset</b>	1.2 V
<b>State Saved</b>	Saved in instrument state
<b>Min</b>	-5 V
<b>Max</b>	5 V
<b>Default Unit</b>	V
<b>Backwards Compatibility SCPI</b>	:TRIGger[:SEquence]:EXTernal:LEVel
<b>Backwards Compatibility SCPI</b>	For backward compatibility, the parameter EXTernal is mapped to EXTernal1
<b>Backwards Compatibility SCPI</b>	:TRIGger[:SEquence]:FRAMe:EXTernal1:LEVel
<b>Initial S/W Revision</b>	Prior to A.02.00

### Trig Slope

Controls the trigger polarity. It is set positive to trigger on a rising edge and negative to trigger on a falling edge.

<b>Key Path</b>	Trigger, External 1
<b>Remote Command</b>	:TRIGger[:SEquence]:EXTernal1:SLOPe POSitive NEGative :TRIGger[:SEquence]:EXTernal1:SLOPe?
<b>Example</b>	TRIG:EXT1:SLOP NEG
<b>Couplings</b>	This same slope is used in the Ext1 selection for the trigger source in the Trigger menu and for the period timer sync source (in the Trigger menu and in the Gate Source menu).
<b>Preset</b>	POSitive
<b>State Saved</b>	Saved in instrument state
<b>Backwards Compatibility SCPI</b>	:TRIGger[:SEquence]:EXTernal:SLOPe
<b>Backwards Compatibility SCPI</b>	For backward compatibility, the parameter EXTernal is mapped to EXTernal1
<b>Backwards Compatibility SCPI</b>	:TRIGger[:SEquence]:FRAMe:EXTernal1:SLOPe
<b>Backwards Compatibility Notes</b>	The legacy :TRIGger[:SEquence]:SLOPe command affects the slopes for the VID, LINE, EXT1, EXT2, and RFB triggers.
<b>Initial S/W Revision</b>	Prior to A.02.00

## External 2

Pressing this key, when it is not selected, selects an external input signal as the trigger. A new sweep/measurement will start when the external trigger condition is met using the external 2 input connector. The external trigger 2 input connector is on the rear panel.

Pressing this key, when it is already selected, accesses the external 2 trigger setup menu.

Key Path	Trigger
<b>Example</b>	TRIG:SOUR EXT2 Swept SA measurement TRIG:<meas>:SOUR EXT2 Measurements other than Swept SA
Dependencies	In some models, there is no second External input. In these models, the External 2 key is blanked and the EXTernal2 parameter will generate a "Hardware missing; Not available for this model number" message. Grayed out if in use by Point Trigger in the Source Setup menu. Forced to Free Run if already selected and Point Trigger is set to External 2.
State Saved	Saved in instrument state
Status Bits/OPC dependencies	The Status Operation Register bit 5 "Waiting for Trigger" is set at the same time as the Sweeping or Measuring bit is set. It is cleared when the trigger actually occurs (that is, after the trigger event occurs and all the applicable trigger criteria have been met). A corresponding pop-up message ("Waiting for trigger") is generated if no trigger signal appears after approximately 2 sec. This message goes away when a trigger signal appears.
Initial S/W Revision	Prior to A.02.00
Modified at S/W Revision	A.03.00

## Trigger Level

Sets the value where the external 2 trigger input will trigger a new sweep/measurement.

Key Path	Trigger, External 2
<b>Remote Command</b>	:TRIGger[:SEquence]:EXTernal2:LEVel :TRIGger[:SEquence]:EXTernal2:LEVel?
<b>Example</b>	TRIG:EXT2:LEV 1.1 V
Couplings	This same level is used for the Ext2 trigger source in the Trigger menu, for the Ext2 selection in the Periodic Timer sync source (in the Trigger menu and in the Gate Source menu), and also for the Ext2 selection in the Gate Source menu.
Preset	1.2 V
State Saved	Saved in instrument state
Min	-5 V
Max	5 V
Default Unit	V
<b>Backwards Compatibility SCPI</b>	:TRIGger[:SEquence]:FRAMe:EXTernal2:LEVel
Initial S/W Revision	Prior to A.02.00

### Trig Slope

Controls the trigger polarity. It is set positive to trigger on a rising edge and negative to trigger on a falling edge.

<b>Key Path</b>	Trigger, External 2
<b>Remote Command</b>	:TRIGger[:SEQuence]:EXTernal2:SLOPe POSitive NEGative :TRIGger[:SEQuence]:EXTernal2:SLOPe?
<b>Example</b>	TRIG:EXT2:SLOP NEG
<b>Couplings</b>	This same slope is used in the Ext2 selection for the trigger source in the Trigger menu and for the period timer sync source (in the Trigger menu and in the Gate Source menu).
<b>Preset</b>	POSitive
<b>State Saved</b>	Saved in instrument state
<b>Backwards Compatibility SCPI</b>	:TRIGger[:SEQuence]:FRAMe:EXTernal2:SLOPe
<b>Backwards Compatibility Notes</b>	The legacy :TRIGger[:SEQuence]:SLOPe command affects the slopes for the VID, LINE, EXT1, EXT2, and RFB triggers.
<b>Initial S/W Revision</b>	Prior to A.02.00

### RF Burst

Pressing this key, when it is not selected, selects the RF Burst as the trigger. A new sweep/measurement will start when an RF burst envelope signal is identified from the signal at the RF Input connector. Pressing this key, when it is already selected, accesses the RF Burst trigger setup menu.

In some models, a variety of burst trigger circuitry is available, resulting in various available burst trigger bandwidths. The analyzer automatically chooses the appropriate trigger path based on the hardware configuration and other settings of the analyzer.

<b>Key Path</b>	Trigger
<b>Example</b>	TRIG:SOUR RFB Swept SA measurement TRIG:<meas>:SOUR RFB Measurements other than Swept SA
<b>State Saved</b>	Saved in instrument state
<b>Status Bits/OPC dependencies</b>	The Status Operation Register bit 5 "Waiting for Trigger" is set at the same time as the Sweeping or Measuring bit is set. It is cleared when the trigger actually occurs (that is, after the trigger event occurs and all the applicable trigger criteria have been met). A corresponding pop-up message ("Waiting for trigger") is generated if no trigger signal appears after approximately 2 sec. This message goes away when a trigger signal appears.
<b>Backwards Compatibility Notes</b>	The legacy command: :TRIGger[:SEQuence]:RFBurst:FSElectivity[:STATe] OFF ON 0 1 is not supported in the X-Series, as the hardware to do Frequency Selective burst triggers does not exist in X-Series.

Initial S/W Revision	Prior to A.02.00
Modified at S/W Revision	A.04.00

### Absolute Trigger Level

Sets the absolute trigger level for the RF burst envelope.

When using the External Mixing path, the Absolute Trigger Level is uncalibrated because the factory default was set to accommodate the expected IF levels for the RF path.

Key Path	Trigger, RF Burst
Scope	Meas Global
<b>Remote Command</b>	:TRIGger[:SEquence]:RFBurst:LEVel:ABSolute <ampl> :TRIGger[:SEquence]:RFBurst:LEVel:ABSolute?
<b>Example</b>	TRIG:RFB:LEV:ABS 10 dBm sets the trigger level of the RF burst envelope signal to the absolute level of 10 dBm
Notes	Sending this command does not switch the setting from relative to absolute; to switch it you need to send the :TRIGger[:SEquence]:RFBurst:LEVel:TYPE command, below.  Amplitude Corrections are not taken into account by the Absolute Trigger Level. For example, if you have given yourself effective gain with an amplitude correction factor, the Absolute Trigger will not fire until you have set the trigger level that far below the displayed signal level, rather than simply to the displayed signal level. This is only true for Amplitude Corrections, not External Gain or Ref Level Offset functions.  If mode is Bluetooth, the default value is -50 dBm.
Couplings	This same level is used for the RF Burst trigger source in the Trigger menu, for the RF Burst selection in the Periodic Timer sync source (in the Trigger menu and in the Gate Source menu), and also for the RF Burst selection in the Gate Source menu
Preset	-20 dBm
State Saved	Saved in instrument state
Min	-200 dBm
Max	100 dBm
Default Unit	depends on the current selected Y-Axis unit
<b>Backwards Compatibility SCPI</b>	:TRIGger[:SEquence]:FRAME:RFBurst:LEVel:ABSolute
Initial S/W Revision	Prior to A.02.00
Modified at S/W Revision	A.04.00

Key Path	Trigger, RF Burst
<b>Remote Command</b>	:TRIGger[:SEquence]:RFBurst:LEVel:TYPE ABSolute RELative :TRIGger[:SEquence]:RFBurst:LEVel:TYPE?

<b>Example</b>	TRIG:RFB:LEV:TYPE REL sets the trigger level type of the RF burst trigger to Relative.
Preset	ABSolute
State Saved	Saved in instrument state
Initial S/W Revision	Prior to A.02.00
Modified at S/W Revision	A.04.00

### Relative Trigger Level

Sets the relative trigger level for the RF burst envelope.

In some models, the relative burst trigger function is implemented in hardware. In other models, without the advanced triggering hardware required, the relative burst trigger function is implemented in software in some measurements, and is unavailable in other measurements.

When implemented in software, the relative RF Burst trigger function is implemented as follows:

1. The measurement starts with the absolute RF Burst trigger setting. If it cannot get a trigger with that level, auto trigger fires and the acquisition starts anyway. After the acquisition, the measurement searches for the peak in the acquired waveform and saves it.
2. Now, in the next cycle of the measurement, the measurement determines a new absolute RF Burst level based on the peak value from the first measurement and the Relative RF Burst Trigger Level (always 0 or negative dB) set by the user. The following formula is used:
3. absolute RF Burst level = peak level of the previous acquisition + relative RF Burst level
4. If the new absolute RF Burst level differs from the previous by more than 0.5 dB, the new level is sent to the hardware; otherwise it is not updated (to avoid slowing down the acquisition)

Steps 2 and 3 repeat for subsequent measurements.

<b>Key Path</b>	Trigger, RF Burst
<b>Scope</b>	Meas Global
<b>Remote Command</b>	:TRIGger[:SEquence]:RFBurst:LEVel:RELative <rel_amp1> :TRIGger[:SEquence]:RFBurst:LEVel:RELative?
<b>Example</b>	TRIG:RFB:LEV:REL -10 dB sets the trigger level of the RF burst envelope signal to the relative level of -10 dB
<b>Notes</b>	Sending this command does not switch the setting from absolute to relative; to switch it you need to send the :TRIGger[:SEquence]:RFBurst:LEVel:TYPE command, above. The relative trigger level is not available in some measurements. In those measurements the RELative parameter, and the :TRIGger[:SEquence]:RFBurst:LEVel:TYPE command (above), will generate an error if sent.
<b>Dependencies</b>	This key is grayed out and Absolute Trigger Level selected if the required hardware is not present in your analyzer and the current measurement does not support Relative triggering.
<b>Preset</b>	-6 dB



	GSM: -25 dB
State Saved	Saved in instrument state
Min	-45 dB
Max	0 dB
Default Unit	dB or dBc
<b>Backwards Compatibility SCPI</b>	:TRIGger[:SEQuence]:RFBurst:LEVel
	This legacy command is aliased to :TRIGger[:SEQuence]:RFBurst:LEVel:RELative because the PSA had ONLY relative burst triggering
Initial S/W Revision	Prior to A.02.00
Modified at S/W Revision	A.04.00

### Trigger Slope

It is set positive to trigger on a rising edge and negative to trigger on a falling edge.

Key Path	Trigger, RF Burst
<b>Remote Command</b>	:TRIGger[:SEQuence]:RFBurst:SLOPe POSitive NEGative :TRIGger[:SEQuence]:RFBurst:SLOPe?
<b>Example</b>	TRIG:RFB:SLOP NEG
Couplings	This same slope is used in the RF Burst selection for the trigger source in the Trigger menu and for the period timer sync source (in the Trigger menu and in the Gate Source menu).
Preset	POSitive
State Saved	Saved in instrument state
<b>Backwards Compatibility SCPI</b>	:TRIGger[:SEQuence]:FRAMe:RFBurst:SLOPe
Backwards Compatibility Notes	The legacy :TRIGger[:SEQuence]:SLOPe command affects the slopes for the VID, LINE, EXT1, EXT2, and RFB triggers.
Initial S/W Revision	Prior to A.02.00

### Periodic Timer (Frame Trigger)

Pressing this key, when it is not selected, selects the internal periodic timer signal as the trigger. Triggering occurrences are set by the **Period** parameter, which is modified by the **Sync Source** and **Offset**. Pressing this key, when it is already selected, accesses the periodic timer trigger setup functions.

If you do not have a sync source selected (it is Off), then the internal timer will not be synchronized with any external timing events.

Key Path	Trigger
<b>Example</b>	TRIG:SOUR FRAM      Swept SA measurement TRIG:<meas>:SOUR FRAM      Measurements other than Swept SA

State Saved	Saved in instrument state
Readback	[Sync: <value of Sync Source>], for example, [Sync: External 1]
Status Bits/OPC dependencies	The Status Operation Register bit 5 "Waiting for Trigger" is set at the same time as the Sweeping or Measuring bit is set. It is cleared when the trigger actually occurs (that is, after the trigger event occurs and all the applicable trigger criteria have been met). A corresponding pop-up message ("Waiting for trigger") is generated if no trigger signal appears after approximately 2 sec. This message goes away when a trigger signal appears.
Initial S/W Revision	Prior to A.02.00

### Periodic Timer Triggering:

This feature selects the internal periodic timer signal as the trigger. Trigger occurrences are set by the **Periodic Timer** parameter, which is modified by the **Sync Source** and **Offset**.

The figure below shows the action of the periodic timer trigger. Before reviewing the figure, we'll explain some uses for the periodic trigger.

A common application is measuring periodic burst RF signals for which a trigger signal is not easily available. For example, we might be measuring a TDMA radio which bursts every 20 ms. Let's assume that the 20 ms period is very consistent. Let's also assume that we do not have an external trigger source available that is synchronized with the period, and that the signal-to-noise ratio of the signal is not high enough to provide a clean RF burst trigger at all of the analysis frequencies. For example, we might want to measure spurious transmissions at an offset from the carrier that is larger than the bandwidth of the RF burst trigger. In this application, we can set the Periodic Timer to a 20.00 ms period and adjust the offset from that timer to position our trigger just where we want it. If we find that the 20.00 ms is not exactly right, we can adjust the period slightly to minimize the drift between the period timer and the signal to be measured.

A second way to use this feature would be to use **Sync Source** temporarily, instead of **Offset**. In this case, we might tune to the signal in a narrow span and use the RF Burst trigger to synchronize the periodic timer. Then we would turn the sync source off so that it would not miss-trigger. Miss-triggering can occur when we are tuned so far away from the RF burst trigger that it is no longer reliable.

A third example would be to synchronize to a signal that has a reference time element of much longer period than the period of interest. In some CDMA applications, it is useful to look at signals with a short periodicity, by synchronizing that periodicity to the "even-second clock" edge that happens every two seconds. Thus, we could connect the even-second clock trigger to Ext1 and use then Ext1 as the sync source for the periodic timer.

The figure below illustrates this third example. The top trace represents the even-second clock. It causes the periodic timer to synchronize with the leading edge shown. The analyzer trigger occurs at a time delayed by the accumulated offset from the period trigger event. The periodic timer continues to run, and triggers continue to occur, with a periodicity determined by the analyzer time base. The timer output (labeled "late event") will drift away from its ideal time due to imperfect matching between the time base of the signal being measured and the time base of the analyzer, and also because of imperfect setting of the period parameter. But the synchronization is restored on the next even-second clock event. ("Accumulated offset" is described in the in the **Offset** function section.)

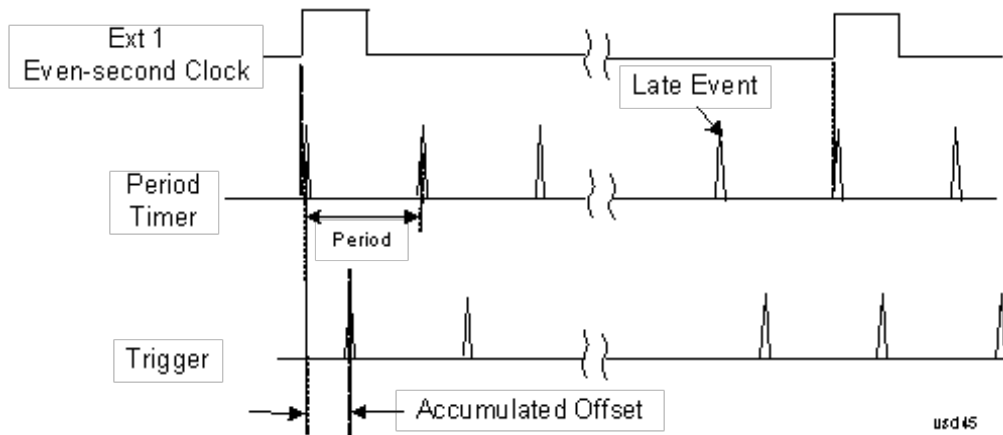

### Period

Sets the period of the internal periodic timer clock. For digital communications signals, this is usually set to the frame period of your current input signal. In the case that sync source is not set to OFF, and the external sync source rate is changed for some reason, the periodic timer is synchronized at the every external synchronization pulse by resetting the internal state of the timer circuit.

Key Path	Trigger, Periodic Timer
Remote Command	:TRIGger[:SEquence]:FRAMe:PERiod <time> :TRIGger[:SEquence]:FRAMe:PERiod?
Example	TRIG:FRAM:PER 100 ms
Dependencies	The invalid data indicator turns on when the period is changed, until the next sweep/measurement completes.
Couplings	The same period is used in the Gate Source selection of the period timer.
Preset	20 ms GSM: 4.615383
State Saved	Saved in instrument state
Min	100.000 ns
Max	559.0000 ms
Default Unit	S
Initial S/W Revision	Prior to A.02.00

### Offset

Adjusts the accumulated offset between the periodic timer events and the trigger event. Adjusting the accumulated offset is different than setting an offset, and requires explanation.

The periodic timer is usually not synchronized with any external events, so the timing of its output events has no absolute meaning. Since the timing relative to external events (RF signals) is important, you need to be able to adjust (offset) it. However, you have no direct way to see when the periodic timer events occur. All that you can see is the trigger timing. When you want to adjust the trigger timing, you will be changing the internal offset between the periodic timer events and the trigger event. Because the absolute value of

that internal offset is unknown, we will just call that the accumulated offset. Whenever the Offset parameter is changed, you are changing that accumulated offset. You can reset the displayed offset using Reset Offset Display. Changing the display does not change the value of the accumulated offset, and you can still make additional changes to accumulated offset.

To avoid ambiguity, we define that an increase in the "offset" parameter, either from the knob or the SCPI adjust command, serves to delay the timing of the trigger event.

<b>Key Path</b>	Trigger, Periodic Timer
<b>Remote Command</b>	:TRIGger[:SEquence]:FRAMe:OFFSet <time> :TRIGger[:SEquence]:FRAMe:OFFSet?
<b>Example</b>	TRIG:FRAM:OFFS 1.2 ms
<b>Notes</b>	The front panel interface (for example, the knob), and this command, adjust the accumulated offset, which is shown on the active function display. However, the actual amount sent to the hardware each time the offset is updated is the delta value, that is, the current accumulated offset value minus the previous accumulated offset value. Note that the accumulated offset value is essentially arbitrary; it represents the accumulated offset from the last time the offset was zeroed (with the Reset Offset Display key).  Note that this command does not change the period of the trigger waveform. Note also that Offset is used only when the sync source is set to OFF, otherwise delay is used, see section " <a href="#">Trig Delay</a> " on <a href="#">page 461</a> .  An increase in the "offset" parameter, either from the knob or the SCPI adjust command, serves to delay the timing of the trigger event.
<b>Notes</b>	When the SCPI command is sent the value shown on the key (and the Active Function, if this happens to be the active function) is updated with the new value. However, the actual amount sent to the hardware is the delta value, that is, the current accumulated offset value minus the previous accumulated offset value.  The SCPI query simply returns the value currently showing on the key.
<b>Dependencies</b>	The invalid data indicator turns on when the offset is changed, until the next sweep/measurement completes.
<b>Couplings</b>	The same offset is used in the Gate Source selection of the period timer.
<b>Preset</b>	0 s
<b>State Saved</b>	Saved in instrument state
<b>Min</b>	-10.000 s
<b>Max</b>	10.000 s
<b>Default Unit</b>	S
<b>Initial S/W Revision</b>	Prior to A.02.00

#### Offset Adjust (Remote Command Only)

This remote command does not work at all like the related front panel keys. This command lets you advance the phase of the frame trigger by the amount you specify.

It does not change the period of the trigger waveform. If the command is sent multiple times, it advances the phase of the frame trigger an additional amount each time it is sent. Negative numbers are permitted.

<b>Remote Command</b>	:TRIGger[:SEquence]:FRAMe:ADJust <time>
<b>Example</b>	TRIG:FRAM:ADJ 1.2 ms
<b>Notes</b>	Note also that Offset is used only when the sync source is set to OFF, otherwise delay is used, see section "Trig Delay" on page 461 An increase in the "offset" parameter, either from the knob or the SCPI adjust command, serves to delay the timing of the trigger event.
<b>Notes</b>	The front panel interface (for example, the knob) and the :TRIG:FRAM:OFFS command adjust the accumulated offset, which is shown on the active function display. However, the actual amount sent to the hardware is the delta value, that is, the current offset value minus the previous offset value. When the SCPI command is sent the value shown on the key (and the Active Function, if this happens to be the active function) is updated by increasing it (or decreasing it if the value sent is negative) by the amount specified in the SCPI command. This is a "command only" SCPI command, with no query.
<b>Dependencies</b>	The invalid data indicator turns on when the offset is changed, until the next sweep/measurement completes.
<b>Couplings</b>	The same offset is used in the Gate Source selection of the period timer.
<b>Preset</b>	0 s
<b>State Saved</b>	Saved in instrument state
<b>Min</b>	-10.000 s
<b>Max</b>	10.000 s
<b>Default Unit</b>	S
<b>Initial S/W Revision</b>	Prior to A.02.00

### Reset Offset Display

Resets the value of the periodic trigger offset display setting to 0.0 seconds. The current displayed trigger location may include an offset value defined with the Offset key. Pressing this key redefines the currently displayed trigger location as the new trigger point that is 0.0 s offset. The Offset key can then be used to add offset relative to this new timing.

<b>Key Path</b>	Trigger, Periodic Timer
<b>Remote Command</b>	:TRIGger[:SEquence]:FRAMe:OFFSet:DISPlay:RESet
<b>Example</b>	TRIG:FRAM:OFFS:DISP:RES
<b>Initial S/W Revision</b>	Prior to A.02.00

### Sync Source

Selects a signal source for you to synchronize your periodic timer trigger to, otherwise you are triggering at some arbitrary location in the frame. Synchronization reduces the precision requirements on the setting of the period.

For convenience you may adjust the level and slope of the selected sync source in a conditional branch setup menu accessed from the Sync Source menu. Note that these settings match those in the **Trigger** and **Gate Source** menus; that is, each trigger source has only one value of level and slope, regardless of which menu it is accessed from.

<b>Key Path</b>	Trigger, Periodic Timer
<b>Remote Command</b>	:TRIGger[:SEquence]:FRAMe:SYNC EXTernal1   EXTernal2   RFBurst   OFF :TRIGger[:SEquence]:FRAMe:SYNC?
<b>Example</b>	TRIG:FRAM:SYNC EXT2
<b>Dependencies</b>	In some models, there is no second External input. In these models, the External 2 key is blanked and the EXTERNAL2 parameter will generate a “Hardware missing; Not available for this model number” message.
<b>Preset</b>	Off GSM/EDGE, MSR,LTE,LTETDD: RFBurst
<b>State Saved</b>	Saved in instrument state
<b>Readback</b>	The current setting is read back to this key and it is also Readback to the previous Periodic Timer trigger key.
<b>Backwards Compatibility SCPI</b>	:TRIGger[:SEquence]:FRAMe:SYNC EXTernal For backward compatibility, the parameter EXTernal is mapped to EXTernal1
<b>Initial S/W Revision</b>	Prior to A.02.00
<b>Modified at S/W Revision</b>	A.03.00, A.14.00

### Off

Turns off the sync source for your periodic trigger. With the sync source off, the timing will drift unless the signal source frequency is locked to the analyzer frequency reference.

<b>Key Path</b>	Trigger, Periodic Timer, Sync Source
<b>Example</b>	TRIG:FRAM:SYNC OFF
<b>Readback</b>	Off
<b>Initial S/W Revision</b>	Prior to A.02.00

### External 1

Pressing this key, when it is not selected, selects an external input signal as the trigger. A new sweep/measurement will start when the external trigger condition is met using the external 1 input connector on the rear panel.

Pressing this key, when it is already selected, accesses the external 1 trigger setup menu.

<b>Key Path</b>	Trigger
<b>Example</b>	TRIG:SOUR EXT1 Swept SA measurement

	TRIG:<meas>:SOUR EXT1 Measurements other than Swept SA
Dependencies	Grayed out if in use by Point Trigger in the Source Setup menu. Forced to Free Run if already selected and Point Trigger is set to External 1.
State Saved	Saved in instrument state
Status Bits/OPC dependencies	The Status Operation Register bit 5 "Waiting for Trigger" is set at the same time as the Sweeping or Measuring bit is set. It is cleared when the trigger actually occurs (that is, after the trigger event occurs and all the applicable trigger criteria have been met). A corresponding pop-up message ("Waiting for trigger") is generated if no trigger signal appears after approximately 2 sec. This message goes away when a trigger signal appears.
Initial S/W Revision	Prior to A.02.00

### Trigger Level

Sets the value where the external 1 trigger input will trigger a new sweep/measurement.

Key Path	Trigger, External 1
<b>Remote Command</b>	:TRIGger[:SEquence]:EXTernal1:LEVel <level> :TRIGger[:SEquence]:EXTernal1:LEVel?
<b>Example</b>	TRIG:EXT1:LEV 0.4 V
Couplings	This same level is used for the Ext1 trigger source in the Trigger menu, for the Ext1 selection in the Periodic Timer sync source (in the Trigger menu and in the Gate Source menu), and also for the Ext1 selection in the Gate Source menu.
Preset	1.2 V
State Saved	Saved in instrument state
Min	-5 V
Max	5 V
Default Unit	V
<b>Backwards Compatibility SCPI</b>	:TRIGger[:SEquence]:EXTernal:LEVel For backward compatibility, the parameter EXTernal is mapped to EXTernal1
<b>Backwards Compatibility SCPI</b>	:TRIGger[:SEquence]:FRAMe:EXTernal1:LEVel
Initial S/W Revision	Prior to A.02.00

### Trig Slope

Controls the trigger polarity. It is set positive to trigger on a rising edge and negative to trigger on a falling edge.

Key Path	Trigger, External 1
<b>Remote Command</b>	:TRIGger[:SEquence]:EXTernal1:SLOPe POSitive NEGative

	:TRIGger[:SEquence]:EXTernal1:SLOPe?
<b>Example</b>	TRIG:EXT1:SLOP NEG
Couplings	This same slope is used in the Ext1 selection for the trigger source in the Trigger menu and for the period timer sync source (in the Trigger menu and in the Gate Source menu).
Preset	POSitive
State Saved	Saved in instrument state
<b>Backwards Compatibility SCPI</b>	:TRIGger[:SEquence]:EXTernal:SLOPe For backward compatibility, the parameter EXTernal is mapped to EXTernal1
<b>Backwards Compatibility SCPI</b>	:TRIGger[:SEquence]:FRAMe:EXTernal1:SLOPe
Backwards Compatibility Notes	The legacy :TRIGger[:SEquence]:SLOPe command affects the slopes for the VID, LINE, EXT1, EXT2, and RFB triggers.
Initial S/W Revision	Prior to A.02.00

## External 2

Pressing this key, when it is not selected, selects an external input signal as the trigger. A new sweep/measurement will start when the external trigger condition is met using the external 2 input connector. The external trigger 2 input connector is on the rear panel.

Pressing this key, when it is already selected, accesses the external 2 trigger setup menu.

Key Path	Trigger
<b>Example</b>	TRIG:SOUR EXT2 Swept SA measurement TRIG:<meas>:SOUR EXT2 Measurements other than Swept SA
Dependencies	In some models, there is no second External input. In these models, the External 2 key is blanked and the EXTernal2 parameter will generate a "Hardware missing; Not available for this model number" message. Grayed out if in use by Point Trigger in the Source Setup menu. Forced to Free Run if already selected and Point Trigger is set to External 2.
State Saved	Saved in instrument state
Status Bits/OPC dependencies	The Status Operation Register bit 5 "Waiting for Trigger" is set at the same time as the Sweeping or Measuring bit is set. It is cleared when the trigger actually occurs (that is, after the trigger event occurs and all the applicable trigger criteria have been met). A corresponding pop-up message ("Waiting for trigger") is generated if no trigger signal appears after approximately 2 sec. This message goes away when a trigger signal appears.
Initial S/W Revision	Prior to A.02.00
Modified at S/W Revision	A.03.00

## Trigger Level

Sets the value where the external 2 trigger input will trigger a new sweep/measurement.



Key Path	Trigger, External 2
<b>Remote Command</b>	:TRIGger[:SEquence]:EXTernal2:LEVel :TRIGger[:SEquence]:EXTernal2:LEVel?
<b>Example</b>	TRIG:EXT2:LEV 1.1 V
Couplings	This same level is used for the Ext2 trigger source in the Trigger menu, for the Ext2 selection in the Periodic Timer sync source (in the Trigger menu and in the Gate Source menu), and also for the Ext2 selection in the Gate Source menu.
Preset	1.2 V
State Saved	Saved in instrument state
Min	-5 V
Max	5 V
Default Unit	V
<b>Backwards Compatibility SCPI</b>	:TRIGger[:SEquence]:FRAMe:EXTernal2:LEVel
Initial S/W Revision	Prior to A.02.00

### Trig Slope

Controls the trigger polarity. It is set positive to trigger on a rising edge and negative to trigger on a falling edge.

Key Path	Trigger, External 2
<b>Remote Command</b>	:TRIGger[:SEquence]:EXTernal2:SLOPe POSitive NEGative :TRIGger[:SEquence]:EXTernal2:SLOPe?
<b>Example</b>	TRIG:EXT2:SLOP NEG
Couplings	This same slope is used in the Ext2 selection for the trigger source in the Trigger menu and for the period timer sync source (in the Trigger menu and in the Gate Source menu).
Preset	POSitive
State Saved	Saved in instrument state
<b>Backwards Compatibility SCPI</b>	:TRIGger[:SEquence]:FRAMe:EXTernal2:SLOPe
Backwards Compatibility Notes	The legacy :TRIGger[:SEquence]:SLOPe command affects the slopes for the VID, LINE, EXT1, EXT2, and RFB triggers.
Initial S/W Revision	Prior to A.02.00

### RF Burst

Pressing this key, when it is not selected, selects the RF Burst as the trigger. A new sweep/measurement will start when an RF burst envelope signal is identified from the signal at the RF Input connector. Pressing this key, when it is already selected, accesses the RF Burst trigger setup menu.

In some models, a variety of burst trigger circuitry is available, resulting in various available burst trigger bandwidths. The analyzer automatically chooses the appropriate trigger path based on the hardware configuration and other settings of the analyzer.

Key Path	Trigger
<b>Example</b>	TRIG:SOUR RFB Swept SA measurement TRIG:<meas>:SOUR RFB Measurements other than Swept SA
State Saved	Saved in instrument state
Status Bits/OPC dependencies	The Status Operation Register bit 5 "Waiting for Trigger" is set at the same time as the Sweeping or Measuring bit is set. It is cleared when the trigger actually occurs (that is, after the trigger event occurs and all the applicable trigger criteria have been met). A corresponding pop-up message ("Waiting for trigger") is generated if no trigger signal appears after approximately 2 sec. This message goes away when a trigger signal appears.
Backwards Compatibility Notes	The legacy command: :TRIGger[:SEQuence]:RFBurst:FSElectivity[:STATe] OFF ON 0 1 is not supported in the X-Series, as the hardware to do Frequency Selective burst triggers does not exist in X-Series.
Initial S/W Revision	Prior to A.02.00
Modified at S/W Revision	A.04.00

### Absolute Trigger Level

Sets the absolute trigger level for the RF burst envelope.

When using the External Mixing path, the Absolute Trigger Level is uncalibrated because the factory default was set to accommodate the expected IF levels for the RF path.

Key Path	Trigger, RF Burst
Scope	Meas Global
<b>Remote Command</b>	:TRIGger[:SEQuence]:RFBurst:LEVel:ABSolute <ampl> :TRIGger[:SEQuence]:RFBurst:LEVel:ABSolute?
<b>Example</b>	TRIG:RFB:LEV:ABS 10 dBm sets the trigger level of the RF burst envelope signal to the absolute level of 10 dBm
Notes	Sending this command does not switch the setting from relative to absolute; to switch it you need to send the :TRIGger[:SEQuence]:RFBurst:LEVel:TYPE command, below.  Amplitude Corrections are not taken into account by the Absolute Trigger Level. For example, if you have given yourself effective gain with an amplitude correction factor, the Absolute Trigger will not fire until you have set the trigger level that far below the displayed signal level, rather than simply to the displayed signal level. This is only true for Amplitude Corrections, not External Gain or Ref Level Offset functions.  If mode is Bluetooth, the default value is -50 dBm.
Couplings	This same level is used for the RF Burst trigger source in the Trigger menu, for the RF Burst selection in the Periodic Timer sync source (in the Trigger menu and in the Gate Source menu), and also for the

	RF Burst selection in the Gate Source menu
Preset	-20 dBm
State Saved	Saved in instrument state
Min	-200 dBm
Max	100 dBm
Default Unit	depends on the current selected Y-Axis unit
<b>Backwards Compatibility SCPI</b>	:TRIGger[:SEquence]:FRAME:RFBurst:LEVel:ABSolute
Initial S/W Revision	Prior to A.02.00
Modified at S/W Revision	A.04.00

Key Path	Trigger, RF Burst
<b>Remote Command</b>	:TRIGger[:SEquence]:RFBurst:LEVel:TYPE ABSolute RELative :TRIGger[:SEquence]:RFBurst:LEVel:TYPE?
<b>Example</b>	TRIG:RFB:LEV:TYPE REL sets the trigger level type of the RF burst trigger to Relative.
Preset	ABSolute
State Saved	Saved in instrument state
Initial S/W Revision	Prior to A.02.00
Modified at S/W Revision	A.04.00

### Trigger Slope

It is set positive to trigger on a rising edge and negative to trigger on a falling edge.

Key Path	Trigger, RF Burst
<b>Remote Command</b>	:TRIGger[:SEquence]:RFBurst:SLOPe POSitive NEGative :TRIGger[:SEquence]:RFBurst:SLOPe?
<b>Example</b>	TRIG:RFB:SLOP NEG
Couplings	This same slope is used in the RF Burst selection for the trigger source in the Trigger menu and for the period timer sync source (in the Trigger menu and in the Gate Source menu).
Preset	POSitive
State Saved	Saved in instrument state
<b>Backwards Compatibility SCPI</b>	:TRIGger[:SEquence]:FRAME:RFBurst:SLOPe
Backwards Compatibility Notes	The legacy :TRIGger[:SEquence]:SLOPe command affects the slopes for the VID, LINE, EXT1, EXT2, and RFB triggers.
Initial S/W Revision	Prior to A.02.00

### Sync Holdoff

Sync Holdoff specifies the duration that the sync source signal must be kept false before the transition to true to be recognized as the sync timing. The periodic timer phase is aligned when the sync source signal becomes true, after the Holdoff time is satisfied.

A holdoff of 2 ms will work with most WiMAX signals, but there may be cases where the burst off duration is less than 1 ms and this value will need to be changed.

Key Path	Trigger, Periodic Timer
Remote Command	:TRIGger[:SEquence]:FRAMe:SYNC:HOLDoff <time> :TRIGger[:SEquence]:FRAMe:SYNC:HOLDoff? :TRIGger[:SEquence]:FRAMe:SYNC:HOLDoff:STATe OFF ON 0 1 :TRIGger[:SEquence]:FRAMe:SYNC:HOLDoff:STATe?
Preset	On, 1.000 ms
State Saved	Saved in instrument state
Min	0 ms
Max	+500 ms
Default Unit	s
Initial S/W Revision	Prior to A.02.00

### Control Edge/Level

Sets the method of controlling the gating function from the gating signal.

#### Edge

In Edge triggering, the gate opens (after the Delay) on the selected edge (for example, positive) of the gate signal and closes on the alternate edge (for example, negative).

#### Level

In Level triggering, the gate opens (after the Delay) when the gate signal has achieved a certain level and stays open as long as that level is maintained.

Key Path	Sweep/Control, Gate
Remote Command	[:SENSe]:SWEep:EGATe:CONTRol EDGE LEVEL [:SENSe]:SWEep:EGATe:CONTRol?
Example	SWE:EGAT:CONT EDGE
Dependencies	If the Gate Method is FFT the Control key is grayed out and Edge is selected. If the Gate Source is TV, Frame or Line, the Control key is grayed out and Edge is selected.
Preset	EDGE
State Saved	Saved in instrument state
Backwards Compatibility SCPI	[:SENSe]:SWEep:TIME:GATE:TYPE ESA Compatibility
Initial S/W Revision	Prior to A.02.00

## Gate Holdoff

Lets you increase or decrease the wait time after a gate event ends before the analyzer will respond to the next gate signal.

After any Gate event finishes, the analyzer must wait for the sweep system to settle before it can respond to another Gate signal. The analyzer calculates a "wait time," taking into account a number of factors, including RBW and Phase Noise Optimization settings. The goal is to achieve the same accuracy when gated as in ungated operation. The figure below illustrates this concept:

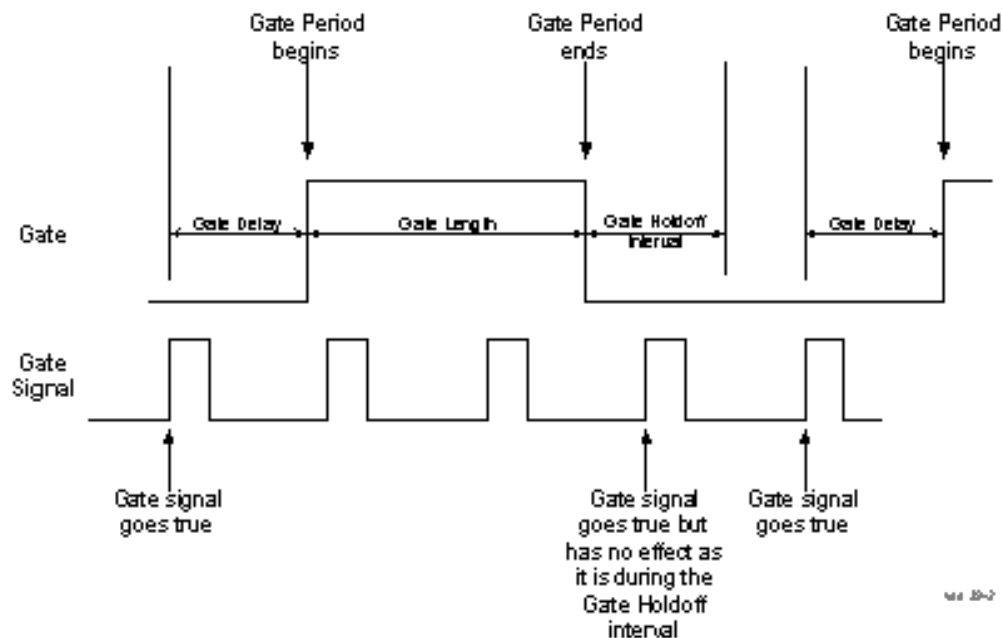

When Gate Holdoff is in Auto, the wait time calculated by the analyzer is used. When Gate Time is in Manual, the user may adjust the wait time, usually decreasing it in order to achieve greater speed, but at the risk of decreasing accuracy.

When the Method key is set to Video or FFT, the Gate Holdoff function has no effect.

In measurements that do not support Auto, the value shown when Auto is selected is "----" and the manually set holdoff is returned to a query.

Key Path	Sweep/Control, Gate
<b>Remote Command</b>	<pre>[ :SENSe ] :SWEep:EGATe:HOLDoff &lt;time&gt; [ :SENSe ] :SWEep:EGATe:HOLDoff? [ :SENSe ] :SWEep:EGATe:HOLDoff:AUTO OFF ON 0 1 [ :SENSe ] :SWEep:EGATe:HOLDoff:AUTO?</pre>
<b>Example</b>	<pre>SWE:EGAT:HOLD 0.0002 SWE:EGAT:HOLD? SWE:EGAT:HOLD:AUTO ON</pre>

SWE:EGAT:HOLD:AUTO?	
Couplings	<p>When Gate Holdoff is Auto, the Gate Holdoff key shows the value calculated by the analyzer for the wait time.</p> <p>Pressing the Gate Holdoff key while it is in Auto and not selected, causes the key to become selected and allows the user to adjust the value. If the value is adjusted, the setting changes to Man.</p> <p>Pressing the Gate Holdoff key, while it is in Auto and selected, does not change the value of Gate Holdoff, but causes the setting to change to Man. Now the user can adjust the value.</p> <p>Pressing the key while it is in Man and selected, cause the value to change back to Auto.</p> <p>Pressing the key while it is in Man and not selected, causes the key to become selected and allows the user to adjust the value.</p> <p>When Method is set to Video or FFT, the Gate Holdoff function has no effect.</p>
Preset	<p>Auto</p> <p>Auto/On</p>
State Saved	Saved in instrument state
Min	1 $\mu$ sec
Max	1 sec
Initial S/W Revision	Prior to A.02.00

## Gate Delay Compensation

This function allows you to select an RBW-dependent value by which to adjust the gate delay, to compensate for changes in the delay caused by RBW effects.

You can select between uncompensated operation and two types of compensation, Delay Until RBW Settled and Compensate for RBW Group Delay.

See ["More Information" on page 835](#)

Key Path	Sweep/Control, Gate
Scope	Meas Global
Remote Command	<pre>[ :SENSe ] :SWEep:EGATe:DELAy:COMPensation:TYPE OFF   SETTled   GDELAy [ :SENSe ] :SWEep:EGATe:DELAy:COMPensation:TYPE?</pre>
Example	<pre>SWE:EGAT:DEL:COMP:TYPE SETT SWE:EGAT:DEL:COMP:TYPE?</pre>
Notes	<p>Although this function is Meas Global, there are some measurements that do not support this function. In those measurements the operation will be Uncompensated. Going into one of those measurements will not change the Meas Global selection; it will simply display the grayed-out menu key with "Uncompensated" showing as the selection. This is a non-forceful grayout, so the SCPI command is still accepted.</p> <p>If Gate Delay Compensation is not supported at all within a particular mode, the key is not displayed, and if the SCPI command is sent while in a measurement within that mode, an "Undefined Header" message is generated.</p> <p>Measurements that do not support this function include:</p>

Swept SA	
Preset	TD-SCDMA mode: Compensate for RBW Group Delay All other modes: Delay Until RBW Settled
State Saved	Saved in instrument state
Range	Uncompensated Delay Until RBW Settled Compensate for RBW Group Delay
Readback text	Uncompensated Settled Group Delay
Initial S/W Revision	Prior to A.02.00
Modified at S/W Revision	A.11.0

### More Information

Selecting Uncompensated means that the actual gate delay is as you sets it.

Selecting Delay Until RBW Settled causes the gate delay to be increased above the user setting by an amount equal to  $3.06/\text{RBW}$ . This compensated delay causes the GATE START and GATE STOP lines on the display to move by the compensation amount, and the actual hardware gate delay to be increased by the same amount. All the other gate lines (for example, MIN FAST) are unaffected. If the RBW subsequently changes, the compensation is readjusted for the new RBW. The value shown on the Gate Delay key does NOT change.

Delay Until RBW Settled allows excellent measurements of gated signals, by allowing the IF to settle following any transient that affects the burst. Excellent measurements also require that the analysis region not extend into the region affected by the falling edge of the burst. Thus, excellent measurements can only be made over a width that declines with narrowing RBWs, which is achieved by decreasing the gate length below the user setting by an amount equal to  $2.53/\text{RBW}$ . Therefore, for general purpose compensation, you will still want to change the gate length with changes in RBW even if the gate delay is compensated. The compensated Gate Length is limited by the analyzer so that it will never go below 10% of the value shown on the Gate Length key, as otherwise the sweep times could get very long. Anytime the Gate Length and RBW values combine in such a way that this limiting takes place, a warning is displayed. For measurements which contain multiple sweeps with different RBW like SEM and SPUR, the smallest RBW is used for this limiting.

Selecting Compensate for RBW Group Delay causes the gate delay to be increased above the user setting by an amount equal to  $1.81/\text{RBW}$ . This compensated delay causes the GATE START, GATE STOP lines on the display to move by the compensation amount, and the actual hardware gate delay to be increased by the same amount. All the other gate lines (for example, MIN FAST) are unaffected. If the RBW subsequently changes, the compensation is readjusted for the new RBW. The value shown on the Gate Delay key does NOT change. Compensate for RBW Group Delay also includes gate length compensation; the gate length itself is adjusted as necessary to attempt to compensate for delay effects imposed by the RBW.

Compensate for RBW Group Delay is similar to Delay Until RBW Settled, but compensates for the group delay of the RBW filter, rather than the filter settling time. As the RBW gets narrow, this can allow the settling tail of the RBW to affect the beginning part of the gated measurement, and allow the beginning of the RBW settling transient to affect the end of the gated measurement. These two effects are symmetric

because the RBW response is symmetric. Because the gate length is not automatically compensated, some users might find this compensation to be more intuitive than compensation for RBW settling.

### Min Fast Position Query (Remote Command Only)

This command queries the position of the MIN FAST line, relative to the delay reference (REF) line. See section "Gate View On/Off" on page 2722. If this query is sent while not in gate view, the MinFast calculation is performed based on the current values of the appropriate parameters and the result is returned. Knowing this value lets you set an optimal gate delay value for the current measurement setup.

<b>Remote Command</b>	<code>[ :SENSe ] :SWEep:EGATe:MINFast?</code>
<b>Example</b>	<code>SWE:EGAT:MIN?</code>
<b>Initial S/W Revision</b>	Prior to A.02.00

### Gate Preset (Remote Command Only)

Presets the time-gated spectrum analysis capability.

This command sets gate parameter values to the ESA preset values, as follows:

Gate trigger type = edge

Gate polarity = positive

Gate delay = 1 us

Gate length = 1 us

<b>Remote Command</b>	<code>[ :SENSe ] :SWEep:TIME:GATE:PRESet</code> ESA Compatibility
<b>Initial S/W Revision</b>	Prior to A.02.00

### Gate Level (Remote Command Only)

Sets the gate input transition point level for the external TRIGGER inputs on the front and rear panel. This is a legacy command for PSA compatibility. It is simply an alias to the equivalent trigger level command.

<b>Remote Command</b>	<code>[ :SENSe ] :SWEep:EGATe:EXTeRnal [ 1 ]   2 :LEVe1 &lt;voltage&gt;</code> <code>[ :SENSe ] :SWEep:EGATe:EXTeRnal [ 1 ]   2 :LEVe1?</code>
<b>Notes</b>	This command is simply an alias to <code>:TRIGger[:SEQuence]:EXTeRnal[1]2:LEVe1</code> For details refer
<b>Initial S/W Revision</b>	Prior to A.02.00

### Gate Polarity (Remote Command Only)

Sets the polarity for the gate signal. This setup is now done using the gate trigger's slope setting.



When Positive (Pos) is selected, a positive-going edge (Edge) or a high voltage (Level) will satisfy the gate condition, after the delay set with the Gate Delay key. When Negative (Neg) is selected, a negative-going edge (Edge) or a low voltage (Level) will satisfy the gate condition after the delay.

<b>Remote Command</b>	<code>[ :SENSe ] :SWEep:EGATe:POLarity NEGative POSitive</code> <code>[ :SENSe ] :SWEep:EGATe:POLarity?</code>
<b>Example</b>	<code>SWE:EGAT:POL NEG</code> <code>SWE:EGAT:POL?</code>
Preset	POSitive
State Saved	Saved in instrument state
<b>Backwards Compatibility SCPI</b>	<code>[ :SENSe ] :SWEep:TIME:GATE:POLarity</code> ESA compatibility
Initial S/W Revision	Prior to A.02.00

<b>Remote Command</b>	<code>[ :SENSe ] :SWEep:TIME:GATE:LEVel HIGH LOW</code> <code>[ :SENSe ] :SWEep:TIME:GATE:LEVel?</code> ESA compatibility
Preset	HIGH
Initial S/W Revision	Prior to A.02.00

## Points

Sets the number of points per sweep, from 1 to 20001. The sweep time resolution setting will depend on the number of points selected.

Key Path	Sweep/Control
Mode	SA, WCDMA, C2K, WIMAX OFDMA, TD-SCDMA, 1xEVDO, DVB-T/H, DTMB (CTTB), ISDB-T, CMMB, LTE, LTE-TDD, Digital Cable TV, MSR, LTEAFDD, LTEATDD
<b>Remote Command</b>	<code>[ :SENSe ] :ACPower:SWEep:POINts &lt;integer&gt;</code> <code>[ :SENSe ] :ACPower:SWEep:POINts?</code>
<b>Example</b>	<code>ACP:SWE:POIN 500</code> <code>ACP:SWE:POIN?</code>
Notes	Whenever the number of sweep points changes: <ul style="list-style-type: none"> <li>• All trace data is erased</li> <li>• Any traces with Update Off will also go to Display Off (like going from View to Blank in the older analyzers)</li> <li>• Sweep time is re-quantized</li> <li>• Any limit lines that are on will be updated</li> <li>• If averaging/hold is on, averaging/hold starts over</li> </ul>
Couplings	Whenever the number of sweep points changes, the sweep time is re-quantized.

---

Preset	Others: 1001 DVB-T/H:2001 DTMB (CTTB): 2001 ISDB-T: 2001 CMMB: 2001 Digital Cable TV: 2001
State Saved	Saved in instrument state.
Min	1
Max	20001
Initial S/W Revision	Prior to A.02.00
Modified at S/W Revision	A.02.00, A.03.00

---

## System

See "System" on page 359

## Trace/Detector

Accesses a menu of functions that enable you to control the detectors for the current measurement.

Key Path	Front-panel key
Initial S/W Revision	Prior to A.02.00

### Select Trace (Front-panel Only)

This key selects which trace the other parameters under the Trace/Detector menu will apply to.

Key Path	Trace/Detector
Notes	Front-panel only.
Couplings	When Meas Method is RBW or FAST, Select Trace is disabled.
Preset	1
State Saved	Saved in instrument state.
Range	1   2   3
Initial S/W Revision	Prior to A.02.00

### Trace Type

Allows you to select the type of trace for the current measurement. The first page of this menu contains a selection of the trace type (Clear Write, Trace Average, Max Hold, Min Hold) for the selected trace.

Key Path	Trace/Detector
Mode	SA, WCDMA, C2K, WIMAX OFDMA, TD-SCDMA, 1xEVDO, DVB-T/H, DTMB (CTTB), ISDB-T, CMMB, LTE, LTEFDD, Digital Cable TV, MSR, LTEAFDD, LTEATDD
<b>Remote Command</b>	:TRACe [1]   2   3 :ACPoweR:TYPE WRITe   AVERAge   MAXHold   MINHold :TRACe [1]   2   3 :ACPoweR:TYPE?
<b>Example</b>	TRAC:ACP:TYPE MINH TRAC:ACP:TYPE?
Notes	WRITe = Clear Write AVERAge = Average MAXHold = Maximum Hold MINHold = Minimum Hold
Couplings	When Detector setting is "Auto" (:SENSe]:ACPoweR:DETeCTOR:AUTO?), Detector is set to what the Radio Standard defaults states (see detector section below) for all conditions of Trace Type and for all traces. When set to Manual, all Traces use the same detector type. When Average State = Off then Trace Types AVERAge, MaxHold and MinHold will not function, since Averaging is required to be 'on' for them to operate.

	When Meas Method is RBW or FAST, Trace Type is disabled.
Preset	AVERage
State Saved	Saved in instrument state.
Initial S/W Revision	Prior to A.02.00
Modified at S/W Revision	A.02.00, A.03.00

## View/Blank

Enables you to select how to view the displayed trace.

Key Path	Trace/Detector
Mode	SA,WCDMA, C2K, WIMAX OFDMA, TD-SCDMA, 1xEVDO, DVB-T/H, DTMB (CTTB), ISDB-T, CMMB, LTE, LTE-TDD, Digital Cable TV, MSR, LTEAFDD,LTEATDD
Notes	No remote control. Front panel only.
Couplings	The four states of this 1-of-N actually set two variables, Update and Display, to their four possible combinations. Trace On: Update and Display both On View: Update Off and Display On (Not implemented) Blank: Update Off and Display Off Background: Update On, Display Off (Not implemented) See tables below for detail on remote commands to control these two variables. Selecting a trace type (Clear Write, Trace Average, Max Hold, Min Hold) for a trace (pressing the key or sending the equivalent remote command) puts the trace in 'Trace On' state (Update On and Display On), even if that trace type was already selected. When Meas Method is RBW or FAST, this key is grayed out.
Preset	Trace On
State Saved	Saved in instrument state.
Range	Trace On Blank
Initial S/W Revision	Prior to A.02.00
Modified at S/W Revision	A.03.00

Key Path	Trace/Detector
Mode	WCDMA, C2K, WIMAX OFDMA, TD-SCDMA, 1xEVDO, DVB-T/H, DTMB (CTTB), ISDB-T, CMMB, LTE, LTE-TDD, Digital Cable TV, MSR, LTEAFDD,LTEATDD
<b>Remote Command</b>	:TRACe[1]   2   3 :ACPpower:UPDate[:STATe] ON OFF 0 1 :TRACe[1]   2   3 :ACPpower:UPDate[:STATe] ?
<b>Example</b>	TRAC:ACP:UPD ON TRAC:ACP:UPD?
Couplings	Whenever you set Update to On for any trace, the Display is set to On for that trace. When Meas Method is RBW or FAST, Trace Update is disabled.
Preset	1 0 0 (On for Trace 1; Off for 2 & 3)

State Saved	Saved in instrument state.
Range	0 1
Initial S/W Revision	Prior to A.02.00
Modified at S/W Revision	A.03.00

Key Path	Trace/Detector
Mode	WCDMA, C2K, WIMAX OFDMA, TD-SCDMA, 1xEVDO, DVB-T/H, DTMB (CTTB), ISDB-T, CMMB, LTE, LTETDD, Digital Cable TV, MSR, LTEAFDD,LTEATDD
<b>Remote Command</b>	:TRACe [1]   2   3 :ACPoweR:DISPlay [ :STATe] ON OFF 0 1 :TRACe [1]   2   3 :ACPoweR:DISPlay [ :STATe] ?
<b>Example</b>	TRAC:ACP:DISP ON TRAC:ACP:DISP?
Couplings	Whenever you set Update to On for any trace, the Display is set to On for that trace. When Meas Method is RBW or FAST, Trace Display is disabled.
Preset	1 0 0 (On for Trace 1; Off for 2 &3)
State Saved	Saved in instrument state.
Range	0 1
Initial S/W Revision	Prior to A.02.00
Modified at S/W Revision	A.03.00

## Detector

Accesses a menu of functions that enables you to control the detectors for the current measurement. Allows up to three (3) traces, but each use the same detector type choice. The following choices are available:

- Auto– the detector selected is set to AVERage, unless the Radio Standard defaults state otherwise e.g. it is set to Peak for Radio Standard = PDC when Device = both MS and BTS, and when Radio Standard = NADC and Device = MS.
- Normal–the detector determines the peak of the CW-like signals, and it yields alternating maximums and minimums of noise-like signals. This is also referred to as Rosenfell detection.
- Average–the detector determines the average of the signal within the sweep points. The averaging method is Power (RMS).
- Peak–the detector determines the maximum of the signal within the sweep points.
- Sample–the detector indicates the instantaneous level of the signal at the center of the sweep points represented by each display point.
- Negative Peak–the detector determines the minimum of the signal within the sweep points.

In swept analysis, the time interval of the data collection for the display sweep points also represents a frequency interval. In FFT analysis, the sweep points represents just a frequency interval. The detector

determines the relationship between the spectrum computed by the FFT and the single data point displayed for the sweep points.

Key Path	Trace/Detector
Initial S/W Revision	Prior to A.02.00

## Auto

Sets the detector for the currently selected trace to auto.

Key Path	Trace/Detector
Mode	SA, WCDMA, C2K, WIMAX OFDMA, TD-SCDMA, 1xEVDO, DVB-T/H, DTMB (CTTB), ISDB-T, CMMB, LTE, LTE-TDD, Digital Cable TV, MSR, LTEAFDD, LTEATDD
<b>Remote Command</b>	<code>[ :SENSe ] :ACPoweR :DETeCtor :AUTO ON   OFF   1   0</code> <code>[ :SENSe ] :ACPoweR :DETeCtor :AUTO ?</code>
<b>Example</b>	ACP:DET:AUTO 1 ACP:DET?
Couplings	When Detector setting is “Auto” ( <code>[ :SENSe ] :ACPoweR :DETeCtor :AUTO ?</code> ), Detector is set to what the Radio Standard defaults states (see detector section) for all conditions of Trace Type and for all traces. When set to Manual, all Traces use the same detector type. When Average State = Off then Trace Types AVERAge, MaxHold and MinHold will not function, since Averaging is required to be ‘on’ for them to operate.
Preset	ON
State Saved	Saved in instrument state.
Range	ON OFF
Initial S/W Revision	Prior to A.02.00
Modified at S/W Revision	A.02.00, A.03.00

## Detector Selection

Selects a detector to be used by the analyzer for the current measurement. All traces will use the same detector type, similar to Monitor Spectrum measurement

Key Path	Trace/Detector
Mode	SA, WCDMA, C2K, WIMAX OFDMA, TD-SCDMA, 1xEVDO, DVB-T/H, DTMB (CTTB), ISDB-T, CMMB, LTE, LTE-TDD, Digital Cable TV, MSR, LTEAFDD, LTEATDD
<b>Remote Command</b>	<code>[ :SENSe ] :ACPoweR :DETeCtor [ :FUNctioN ] AVERAge   NEGAtive   NORMAl   POSitive   SAMPlE</code> <code>[ :SENSe ] :ACPoweR :DETeCtor [ :FUNctioN ] ?</code>
<b>Example</b>	ACP:DET NORM ACP:DET?
Notes	When you manually select a detector (instead of selecting Auto), that detector is used regardless of

---

other analyzer settings.

The detector choices are:

- The Normal detector determines the peak of CW-like signals, and it yields alternating maximums and minimums of noise-like signals. This is also referred to as Rosenfell detection.
- The Average detector determines the average of the signal within the data range. The averaging method is Power (RMS).
- The Peak detector determines the maximum of the signal within the data range.
- The Sample detector indicates the instantaneous level of the signal at the center of the data represented by each display point.
- The Negative Peak detector determines the minimum of the signal within the data range.

Because they may not find a spectral component's true peak, neither average nor sample detectors measure amplitudes of CW signals as accurately as peak or normal, but they do measure noise without the biases of peak detection.

When a detector selection is made, the menu returns to the previous menu.

---

Couplings	<p>When Detector setting is "Auto" (:SENSe]:ACPower:DETECTOR:AUTO?), Detector is set to what the Radio Standard defaults states (see detector section) for all conditions of Trace Type and for all traces. When set to Manual, all Traces use the same detector type. When Average State = Off then Trace Types AVERage, MaxHold and MinHold will not function, since Averaging is required to be 'on' for them to operate.</p> <p>Only one detector type for all 3 traces is allowed.</p> <p>When Meas Method is RBW or FAST, Detector is disabled.</p>
Preset	AVERage
State Saved	Saved in instrument state.
Range	Normal Average Peak Sample Negative Peak
<b>Backwards Compatibility SCPI</b>	[ :SENSe ] :ACPR :SWEep :DETECTOR [ :FUNCTion ]
Initial S/W Revision	Prior to A.02.00
Modified at S/W Revision	A.02.00, A.03.00

---



## Trigger

See ["Trigger" on page 430](#)

### Free Run

See ["Free Run " on page 437](#)

### Video

See ["Video \(IF Envelope\) " on page 438](#)

### Trigger Level

See ["Trigger Level " on page 438](#)

### Trig Slope

See ["Trig Slope " on page 439](#)

### Trig Delay

See ["Trig Delay " on page 440](#)

### Line

See ["Line " on page 2729](#)

### Trig Slope

See ["Trig Slope " on page 2729](#)

### Trig Delay

See ["Trig Delay " on page 442](#)

### External 1

See ["External 1 " on page 2741](#)

### Trigger Level

See ["Trigger Level " on page 2741](#)

### Trig Slope

See ["Trig Slope " on page 2742](#)

### Trig Delay

See ["Trig Delay " on page 445](#)

### External 2

See ["External 2 " on page 2743](#)

### **Trigger Level**

See "[Trigger Level](#) " on page 2743

### **Trig Slope**

See "[Trig Slope](#) " on page 2744

### **Trig Delay**

See "[Trig Delay](#) " on page 447

### **RF Burst**

See "[RF Burst](#) " on page 2744

### **Absolute Trigger**

See "[Absolute Trigger Level](#)" on page 2745

### **Relative Trigger**

See "[Relative Trigger Level](#)" on page 2734

### **Trig Slope**

See "[Trigger Slope](#) " on page 2746

### **Trig Delay**

See "[Trig Delay](#) " on page 451

### **Periodic Timer**

See "[Periodic Timer \(Frame Trigger\)](#) " on page 2736

### **Period**

See "[Period](#) " on page 2737

### **Offset**

See "[Offset](#) " on page 2738

### **Reset Offset Display**

See "[Reset Offset Display](#) " on page 2740

### **Sync Source**

See "[Sync Source](#) " on page 2740

### **Off**

See "[Off](#) " on page 2741

### External 1

See "External 1 " on page 2741

#### Trigger Level

See "Trigger Level " on page 2741

#### Trig Slope

See "Trig Slope " on page 2742

### External 2

See "External 2 " on page 2743

#### Trigger Level

See "Trigger Level " on page 2743

#### Trig Slope

See "Trig Slope " on page 2744

### RF Burst

See "RF Burst " on page 2744

### Absolute Trigger

See "Absolute Trigger Level" on page 2745

#### Trig Slope

See "Trigger Slope " on page 2746

### Trig Delay

See "Trig Delay" on page 461

### Auto/Holdoff

See "Auto/Holdoff " on page 462

### Auto Trig

See "Auto Trig " on page 462

### Trig Holdoff

See "Trig Holdoff " on page 463

## User Preset

Accesses a menu that gives you the following three choices:

- User Preset – recalls a state previously saved using the Save User Preset function.
- User Preset All Modes – presets all of the modes in the analyzer
- Save User Preset– saves the current state for the current mode

Key Path	Front-panel key
Backwards Compatibility Notes	<p>User Preset is actually loading a state, and in legacy analyzers, it was possible to load a state without affecting the trace data, limit lines or correction data. Similarly it was possible to do a User Preset without affecting the trace data, limit lines or correction data.</p> <p>In the X-Series, “state” always includes all of this data; so whenever state is loaded, or User Preset is executed, all of the traces, limit lines and corrections are affected. Although this differs from previous behavior, it is desirable behavior, and should not cause adverse issues for users.</p> <p>On ESA and PSA, User Preset affected the entire instrument’s state. In the X-Series, User Preset only recalls the state for the active mode. There is a User Preset file for each mode. User Preset can never cause a mode switch as it can in legacy analyzers. If you want to recall all modes to their user preset file state, you will need to do a User Preset after mode switching into each mode.</p> <p>User Preset recalls mode state which can now include data like traces; whereas on ESA and PSA, User Preset did not affect data.</p>
Initial S/W Revision	Prior to A.02.00

## User Preset

User Preset sets the state of the currently active mode back to the state that was previously saved for this mode using the Save User Preset menu key or the SCPI command, SYST:PRES:USER:SAV. It not only recalls the Mode Preset settings, but it also recalls all of the mode persistent settings, and the Input/Output system setting that existed at the time Save User Preset was executed.

If a Save User Preset has not been done at any time, User Preset recalls the default user preset file for the currently active mode. The default user preset files are created if, at power-on, a mode detects there is no user preset file. There will never be a scenario when there is no user preset file to restore. For each mode, the default user preset state is the same state that would be saved if a Save User Preset is performed in each mode right after doing a Restore Mode Default and after a Restore Input/Output Defaults.

The User Preset function does the following:

- Aborts the currently running measurement.
- Sets the mode State to the values defined by Save User Preset.
- Makes the saved measurement for the currently running mode the active measurement.
- Brings up the saved menu for the power-on mode.
- Clears the input and output buffers.
- Sets the Status Byte to 0.

Key Path	User Preset
Remote Command	:SYSTem:PRESet:USER
Example	:SYST:PRES:USER:SAVE:SYST:PRES:USER
Notes	:SYST:PRES:USER:SAVE is used to save the current state as the user preset state. Clears all pending OPC bits. The Status Byte is set to 0. Pressing the User Preset front-panel key while already in the User Preset menu will cause the User Preset to get executed
Couplings	A user preset will cause the currently running measurement to be aborted and cause the saved measurement to be active. Recalling a User Preset file has the same issues that recalling a Save State file has. Some settings may need to be limited and therefore re-coupled, since the capabilities of the mode may have changes when the User Preset file was last saved.
Initial S/W Revision	Prior to A.02.00

## User Preset All Modes

Recalls all of the User Preset files for each mode, switches to the power-on mode, and activates the saved measurement from the power-on mode User Preset file.

### NOTE

When the instrument is secured, all of the user preset files are converted back to their default user preset files.

The User Preset function does the following:

- Aborts the currently running measurement.
- Switches the Mode to the power-on mode.
- Restores the User Preset files for each mode.
- Makes the saved measurement for the power-on mode the active measurement.
- Brings up the saved menu for the power-on mode.
- Clears the input and output buffers.
- Sets the Status Byte to 0.

Key Path	User Preset
Remote Command	:SYSTem:PRESet:USER:ALL
Example	:SYST:PRES:USER:SAVE:SYST:PRES:USER:ALL
Notes	Clears all pending OPC bits. The Status Byte is set to 0. :SYST:PRES:USER:SAVE is used to save the current state as the user preset state.
Couplings	A user preset will cause the currently running measurement to be aborted, cause a mode switch to the power-on mode, and cause the saved measurement to be active in the power-on mode. Recalling a User Preset file has the same issues that recalling a Save State file has. Some settings may need to be limited and therefore re-coupled, since the capabilities of the mode may have changes when the User Preset file was last saved.
Initial S/W Revision	Prior to A.02.00

## Save User Preset

Saves the currently active mode and its State. You can recall this User Preset file by pressing the User Preset menu key or sending the SYST:PRES:USER remote command. This same state is also saved by the Save State function.

Key Path	User Preset
Remote Command	:SYSTem:PRESet:USER:SAVE
Example	:SYST:PRES:USER:SAVE
Notes	:SYST:PRES:SAVE creates the same file as if the user requested a *SAV or a MMEM:STOR:STAT, except User Preset Save does not allow the user to specify the filename or the location of the file.
Initial S/W Revision	Prior to A.02.00

## View/Display

Accesses a menu of functions that enable you to control the instrument display as well as turn the bar graph On and Off.

If current mode is NOT MSR and LTE-Advanced FDD/TDD mode, the front panel views only contain one view: Spectrum View.

The results of the measurement can be displayed as a single spectrum trace view or displayed with a Bar Graph trace on the spectrum trace.

The display consists of the following two windows:

"Spectrum Window" on page 853

"Results Window" on page 853

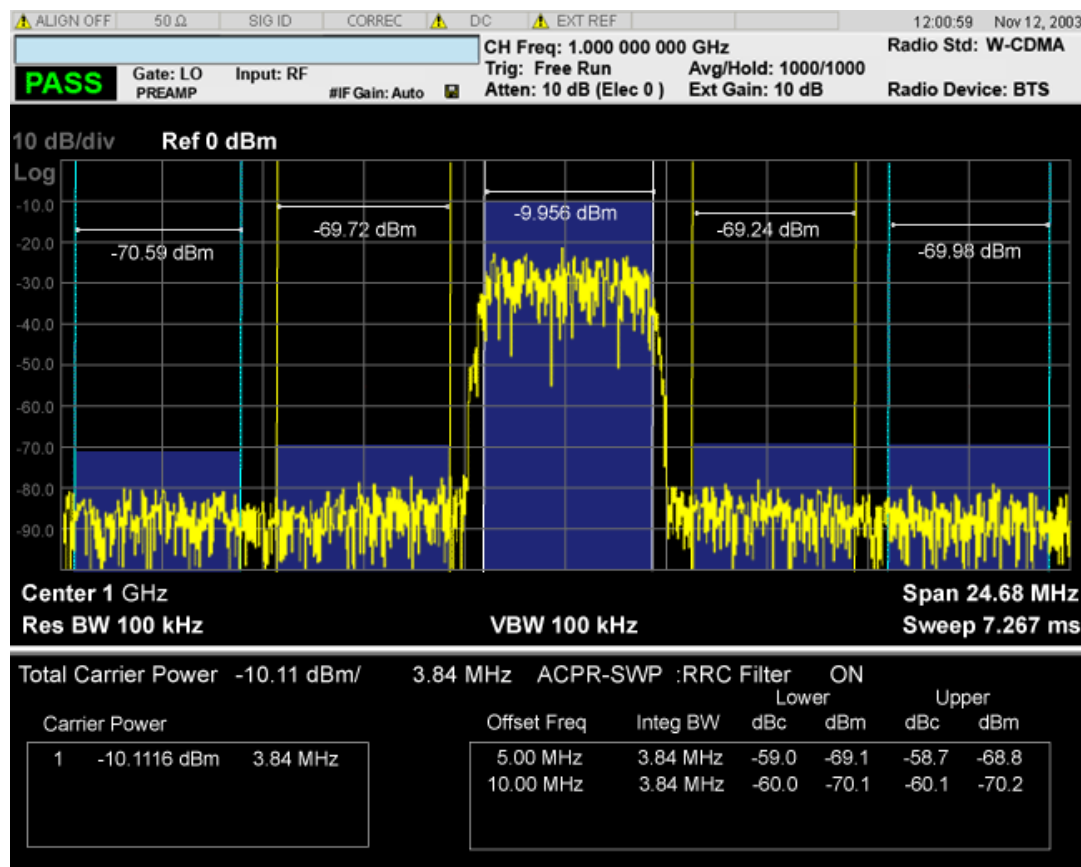

The following two views are only for DTMB (CTTB) and CMMB:

DTMB and CMMB Transmitter:

9 ACP Measurement  
View/Display

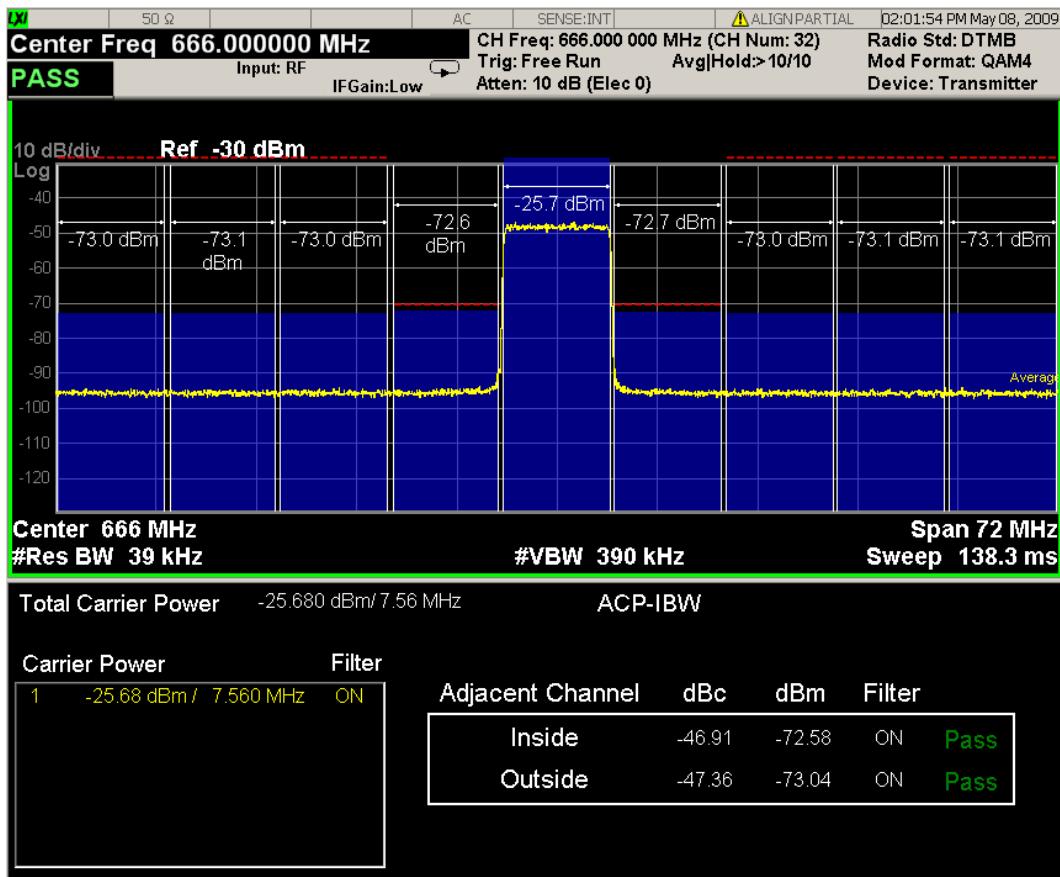

DTMB and CMMB Exciter:



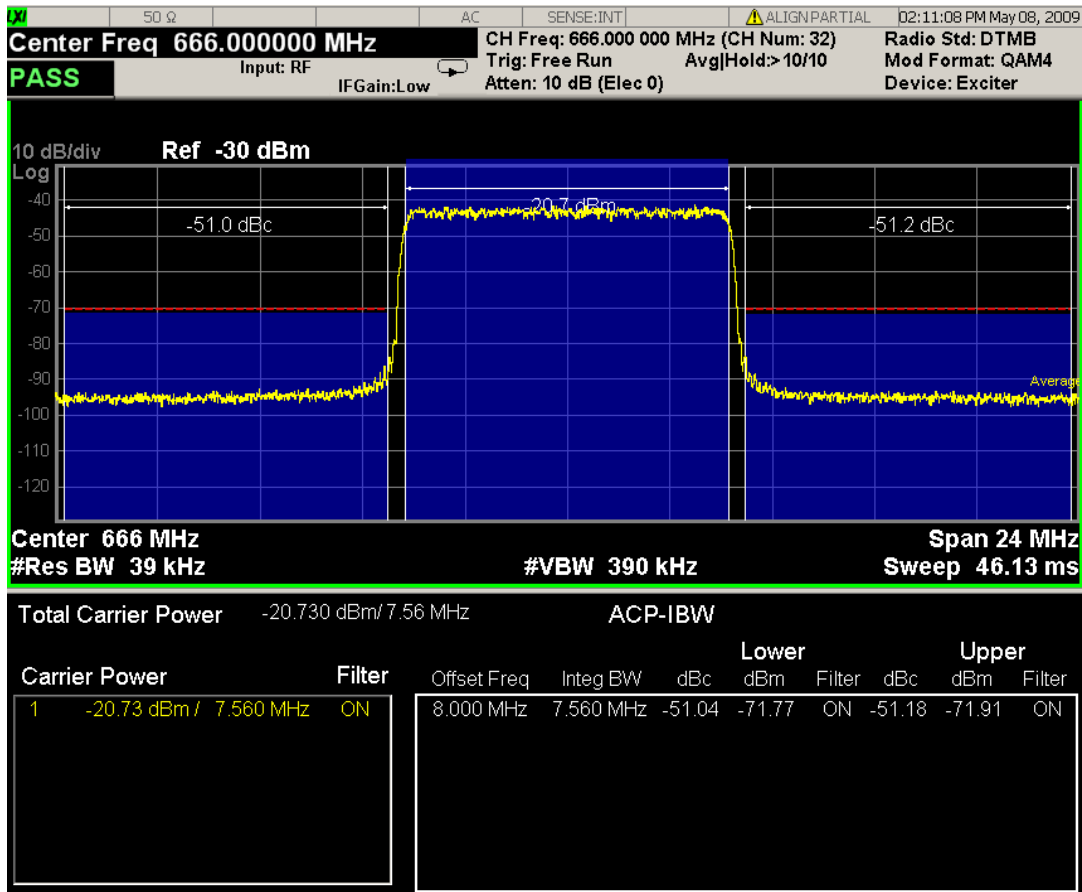

## Spectrum Window

When the Bar Graph is On and Limit Test is On, the color of each bar graph reflects the limit test result. When the limit test fails, the bar color is red, and when limit test passes, the bar color is blue.

When RBW is selected as the measurement method, the spectrum trace is not displayed, only the bar graph is displayed. In addition, the Bar Graph key (under the View/Display front-panel key) is set to ON and is grayed out.

The RRC Filter display item is only displayed when RRC filter is on.

## Results Window

The text window displays the following results:

### Total Carrier Power

This is the total power of all the carriers with carrier power present set to yes. The power is calculated by integrating across the bandwidth declared by the Carrier Integ Bw parameter for each carrier and then totaling the sums. The total integration bandwidth is shown as part of the result. This will be the total of the Carrier Integ Bw of the carriers used in calculating the total carrier power. If the RRC Filter is on, then the integration bandwidth used is  $(1 + \alpha)/T$  where  $T = 1/(\text{Carrier Integ Bw})$  multiplied by the number of carriers with carrier power present set to yes.

### Ref Carrier Power

This is the power in the reference carrier. The power is calculated by integrating across the bandwidth declared by the Carrier Integ Bw parameter for that carrier. The integration bandwidth is shown as part of the result. This is the value of the Carrier Integ Bw for that carrier unless the RRC Filter is on, then the integration bandwidth used is the displayed value, which is  $(1 + \alpha)/T$  where  $T = 1/(\text{Carrier Integ Bw})$ .

#### **Carrier Power**

This is the power in all the currently defined carriers. If the carrier has carrier power present, the power will be absolute. If the carrier is defined as not having power present, the power will be relative to the reference carrier. The power is calculated by integrating across the bandwidth declared by the Carrier Integ Bw parameter. The integration bandwidth is shown as part of the result. This is the value of the Carrier Integ Bw for the carrier unless the RRC Filter is on, then the integration bandwidth used is the displayed value, which is  $(1 + \alpha)/T$  where  $T = 1/(\text{Carrier Integ Bw})$ .

As there are potentially more results than can be easily viewed on the display, a scrollable list is used to display all results. The Carrier Results menu key is used to index the carrier amplitude results. This key is grayed out unless the measurement is in single mode (as in continual measurement mode). The display is continuously updating and will not need to be accessed. The currently selected Carrier Result is displayed on the last line of the carrier power result list unless:

- The selected Carrier Result is 4 or less in normal multi carrier power results view. In this case the first 4 carrier power results will be displayed.
- The selected Carrier Result is 9 or greater in normal multi carrier power results view. In this case the last 4 carrier power results will be displayed.
- The zoom mode is selected. In this case all carrier power ranges can be displayed.

#### **Offset Relative Power**

This is the power in the offsets relative to the reference carrier. The power is calculated by integrating across the bandwidth declared by the Offset Integ Bw parameter. The offset integration bandwidth is shown as part of the result. This is the value on the Offset Integ Bw menu key unless the RRC Filter is on, then the integration bandwidth used is the displayed value, which is  $(1 + \alpha)/T$  where  $T = 1/(\text{Offset Integ Bw})$ .

#### **Offset Absolute Power**

This is the absolute power in the offsets. The power is calculated by integrating across the bandwidth declared by the Offset Integ Bw parameter. The offset integration bandwidth is shown as part of the result. This is the value on the Offset Integ Bw menu key unless the RRC Filter is on, then the integration bandwidth used is the displayed value, which is  $(1 + \alpha)/T$  where  $T = 1/(\text{Offset Integ Bw})$ .

#### **Inside Adjacent Channel Power (DTMB (CTTB) and CMMB only)**

This result is only valid for DTMB (CTTB) transmitter and CMMB transmitter. It contains two parts: Relative Power and Absolute Power. The power is calculated by integrating across the bandwidth (Integ Bw) at the frequency Offset A.

Inside Absolute Power = MAX (P<sub>Lower Offset A</sub>, P<sub>Upper Offset A</sub>);

Inside Relative Power = Inside Absolute Power – Carrier Power;

#### **Outside Adjacent Channel Absolute Power (DTMB (CTTB) and CMMB only)**

This result is only valid for DTMB (CTTB) transmitter and CMMB transmitter. It contains two parts: Relative Power and Absolute Power. The power is the Root-Mean-Square of the power calculated by integrating across the bandwidth (Integ Bw) at frequency Offset B, C and D.

$$\text{Outside Absolute Power} = \sqrt{\frac{P_{\text{Lower OffsetB}}^2 + P_{\text{Upper OffsetB}}^2 + P_{\text{Lower OffsetC}}^2 + P_{\text{Upper OffsetC}}^2 + P_{\text{Lower OffsetD}}^2 + P_{\text{Upper OffsetD}}^2}{6}}$$

Outside Relative Power = Outside Absolute Power – Carrier Power;

If current mode is MSR, there are two views, Result Trace and Carrier Info.

**NOTE** Y Scale/Div, Y Ref Position, Y Auto Scale, Y Ref Value and Bar Graph affect both views. For example, power bars on the traces in both views appear or disappear when Bar Graph is toggled.

View Selection by Name (MSR and LTE-Advanced FDD/TDD Only)

Selects the results view. The following SCPI command allows you to select the desired measurement view by enumeration.

Key Path	No equivalent front-panel key
Mode	MSR, LTEAFDD,LTEATDD
Remote Command	:DISPlay:ACPower:VIEW[:SElect] PRESult CINformation :DISPlay:ACPower:VIEW[:SElect] ?
Example	DISP:ACP:VIEW PRES DISP:ACP:VIEW?
Notes	This SCPI is only available in MSR and LTE-Advanced FDD/TDD.
Preset	PRESult
State Saved	Saved in instrument state
Range	Power Results Carrier Info
Initial S/W Revision	A.10.00

Key Path	No equivalent front-panel key
Mode	MSR, LTEAFDD,LTEATDD
Remote Command	:DISPlay:ACPower:VIEW:NSElect <integer> :DISPlay:ACPower:VIEW:NSElect ?
Example	DISP:ACP:VIEW:NSEL 1 DISP:ACP:VIEW:NSEL?
Notes	This SCPI is only available in MSR and LTE-Advanced FDD/TDD.
Preset	1
State Saved	Saved in instrument state
Min	1
Max	2
Initial S/W Revision	A.10.00

---

Key Path	Front-panel key
Initial S/W Revision	Prior to A.02.00

---

## Display

The Display menu is common to most measurements, and is used for configuring items on the display. Some Display menu settings apply to all the measurements in a mode, and some only to the current measurement. Those under the System Display Settings key apply to all measurements in all modes.

---

Key Path	Display
Key Path	View/Display
Initial S/W Revision	Prior to A.02.00

---

## Annotation

Turns on and off various parts of the display annotation. The annotation is divided up into four categories:

1. Meas Bar: This is the measurement bar at the top of the screen. It does not include the settings panel or the Active Function. Turning off the Meas Bar turns off the settings panel and the Active Function. When the Meas Bar is off, the graticule area expands to fill the area formerly occupied by the Meas Bar.
2. Screen Annotation: this is the annotation and annunciation around the graticule, including any annotation on lines (such as the display line, the threshold line, etc.) This does NOT include the marker number or the N dB result. When off, the graticule expands to fill the entire graticule area.
3. Trace annotation: these are the labels on the traces, showing their detector (or their math mode).
4. Active Function annotation: this is the active function display in the meas bar, and all of the active function values displayed on softkeys.

See the figure below. Each type of annotation can be turned on and off individually.

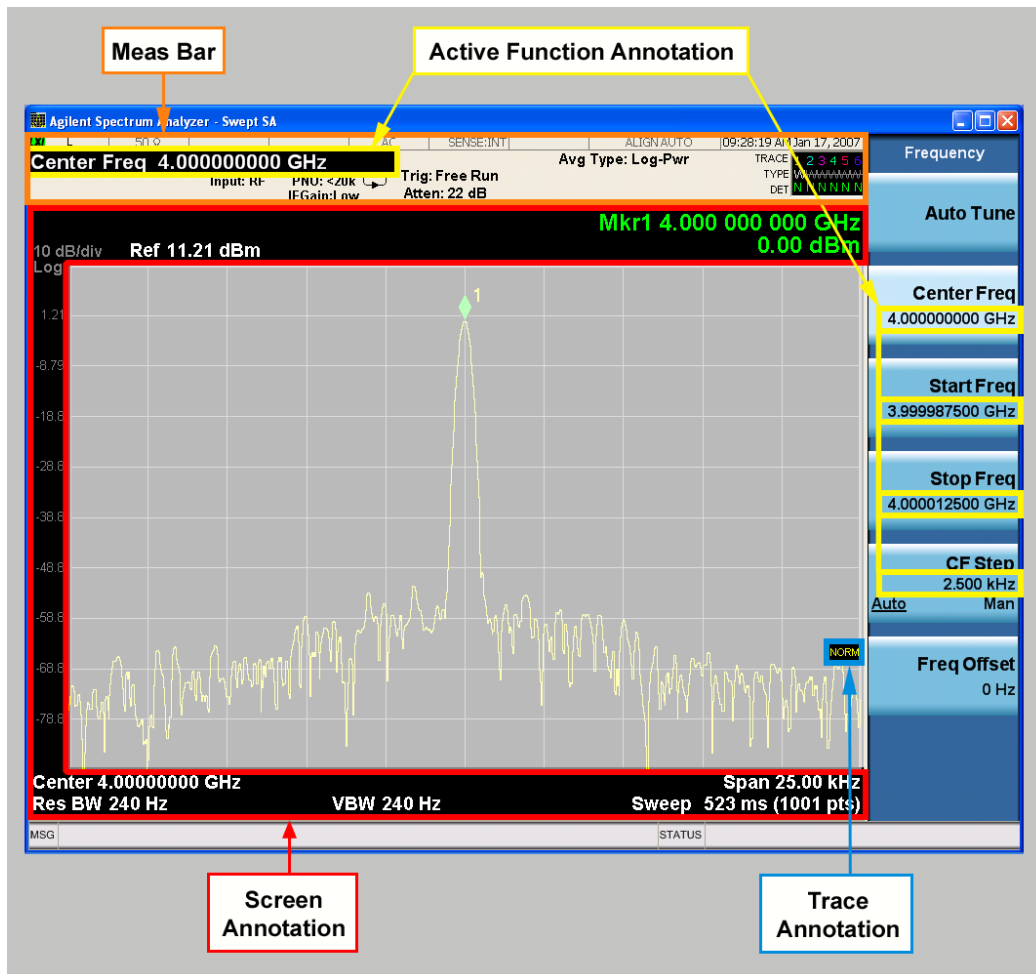

Key Path	View/Display, Display
Initial S/W Revision	Prior to A.02.00

### Meas Bar On/Off

This function turns the Measurement Bar on and off, including the settings panel. When off, the graticule area expands to fill the area formerly occupied by the Measurement Bar.

Key Path	View/Display, Display, Annotation
Remote Command	:DISPlay:ANNotation:MBAR[:STATE] OFF ON 0 1 :DISPlay:ANNotation:MBAR[:STATE]?
Example	DISP:ANN:MBAR OFF
Dependencies	Grayed out and forced to OFF when System Display Settings, Annotation is set to Off.
Preset	On This should remain Off through a Preset when System DisplaySettings, Annotation is set to Off.
State Saved	Saved in instrument state.
Initial S/W Revision	Prior to A.02.00

## Screen

This controls the display of the annunciation and annotation around the graticule, including any annotation on lines (such as the display line, the threshold line, etc.) and the y-axis annotation. This does NOT include marker annotation (or the N dB result). When off, the graticule expands to fill the entire graticule area, leaving only the 1.5% gap above the graticule as described in the Trace/Detector chapter.

<b>Key Path</b>	View/Display, Display, Annotation
<b>Remote Command</b>	:DISPlay:ANNotation:SCReen[:STATe] OFF ON 0 1 :DISPlay:ANNotation:SCReen[:STATe]?
<b>Example</b>	DISP:ANN:SCR OFF
<b>Dependencies</b>	Grayed-out and forced to OFF when System Display Settings, Annotation is set to Off.
<b>Preset</b>	On This should remain Off through a Preset when System DisplaySettings, Annotation is set to Off
<b>State Saved</b>	Saved in instrument state.
<b>Initial S/W Revision</b>	Prior to A.02.00

## Active Function Values On/Off

Turns on and off the active function display in the Meas Bar, and all of the active function values displayed on the softkeys.

Note that all of the softkeys that have active functions have these numeric values blanked when this function is on. This is a security feature..

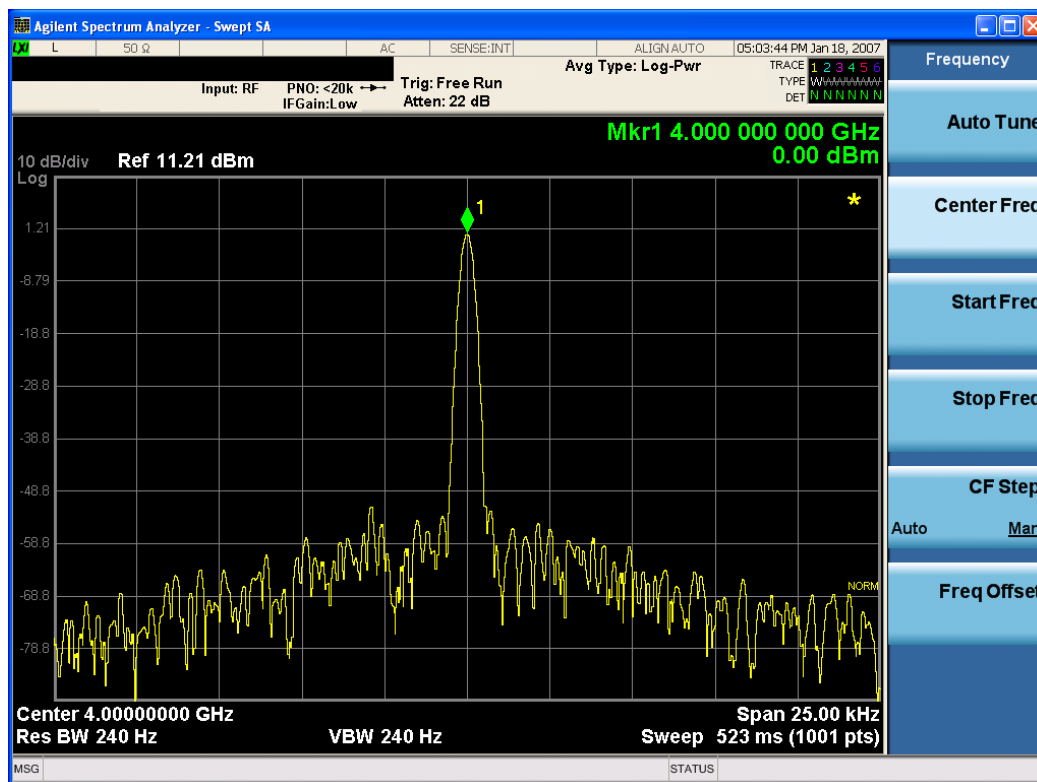

Key Path	View/Display, Display, Annotation
Remote Command	:DISPlay:ACTivefunc[:STATE] ON OFF 1 0 :DISPlay:ACTivefunc[:STATE]?
Example	DISP:ACT OFF
Dependencies	Grayed out and forced to OFF when System Display Settings, Annotation is set to Off.
Preset	On This should remain Off through a Preset when System DisplaySettings, Annotation is set to Off
State Saved	Saved in instrument state.
Initial S/W Revision	Prior to A.02.00

## Title

Displays menu keys that enable you to change or clear a title on your display.

Key Path	View/Display, Display
Initial S/W Revision	Prior to A.02.00

## Change Title

Writes a title into the "measurement name" field in the banner, for example, "Swept SA".

Press Change Title to enter a new title through the alpha editor. Press Enter or Return to complete the entry. Press ESC to cancel the entry and preserve your existing title.

The display title will replace the measurement name. It remains for this measurement until you press Change Title again, or you recall a state, or a Preset is performed. A title can also be cleared by pressing Title, Clear Title.

**NOTE**

Notice the inclusion of the <measurement> parameter in the command below. Because each measurement remembers the Display Title, the command must be qualified with the measurement name. For the Swept SA measurement this is not the case; no <measurement> parameter is used when changing the Display Title for the Swept SA measurement.

Key Path	View/Display, Display, Title
Mode	All
Remote Command	:DISPlay:<measurement>:ANNotation:TITLe:DATA <string> :DISPlay:<measurement>:ANNotation:TITLe:DATA?
Example	DISP:ANN:TITL:DATA "This Is My Title" This example is for the Swept SA measurement in the Spectrum Analyzer mode. The SANalyzer <measurement> name is not used. DISP:ACP:ANN:TITL:DATA "This Is My Title" This example is for Measurements other than Swept SA. Both set the title to: This Is My Title
Notes	Pressing this key cancels any active function. When a title is edited the previous title remains intact (it is not cleared) and the cursor goes at the end so that characters can be added or BKSP can be used to go back over previous characters.
Preset	No title (measurement name instead)
State Saved	Saved in instrument state.
Initial S/W Revision	Prior to A.02.00

### Clear Title

Clears a title from the front-panel display. Once cleared, the title cannot be retrieved. After the title is cleared, the current Measurement Name replaces it in the title bar.

Key Path	View/Display, Display, Title
Example	The following commands clear the title and restore the measurement's original title: DISP:ANN:TITL:DATA "" This example is for the Swept SA measurement in the Spectrum Analyzer mode. The SANalyzer <measurement> name is not used. DISP:ACP:ANN:TITL:DATA "" This example is for ACP; in measurements other than Swept SA the measurement name is required.
Notes	Uses the :DISPlay:<measurement>:ANNotation:TITLe:DATA <string> command with an empty string (in the Swept SA, the <measurement> is omitted).
Preset	Performed on Preset.
Initial S/W Revision	Prior to A.02.00



## Graticule

Pressing Graticule turns the display graticule On or Off. It also turns the graticule y-axis annotation on and off.

Key Path	View/Display, Display
Remote Command	:DISPlay:WINDow[1]:TRACe:GRATicule:GRID[:STATe] OFF ON 0 1 :DISPlay:WINDow[1]:TRACe:GRATicule:GRID[:STATe]?
Example	DISP:WIND:TRAC:GRAT:GRID OFF
Notes	The graticule is the set of horizontal and vertical lines that make up the grid/divisions for the x-axis and y-axis.
Preset	On
State Saved	Saved in instrument state
Initial S/W Revision	Prior to A.02.00

## System Display Settings

These settings are "Mode Global" – they affect all modes and measurements and are reset only by Restore Misc Defaults or Restore System Defaults under System.

Key Path	View/Display, Display
Initial S/W Revision	Prior to A.02.00

## Annotation Local Settings

This is a Mode Global override of the meas local annotation settings. When it is All Off, it forces ScreenAnnotation, Meas Bar, Trace, and Active Function Values settings to be OFF for all measurements in all modes. This provides the security based "annotation off" function of previous analyzers; hence it uses the legacy SCPI command.

When it is All Off, the Screen, Meas Bar, Trace, and Active Function Values keys under the Display, Annotation menu are grayed out and forced to Off. When Local Settings is selected, you are able to set the local annotation settings on a measurement by measurement basis.

Key Path	View/Display, Display, System Display Settings
Remote Command	:DISPlay:WINDow[1]:ANNOtation[:ALL] OFF ON 0 1 :DISPlay:WINDow[1]:ANNOtation[:ALL]?
Example	:DISP:WIND:ANN OFF
Preset	On (Set by Restore Misc Defaults)
State Saved	Not saved in instrument state.
Backwards Compatibility Notes	The WINDow parameter and optional subopcode is included for backwards compatibility but ignored – all windows are equally affected.
Initial S/W Revision	Prior to A.02.00

## Themes

Accesses a menu of functions that enable you to choose the theme to be used when saving the screen image.

The **Themes** option is the same as the **Themes** option under the **Display** and **Page Setup** dialogs. It allows you to choose between themes to be used when saving the screen image.

<b>Key Path</b>	Save, Screen Image
<b>Remote Command</b>	:MMEMory:STORe:SCReen:THEMe TDColor   TDMonochrome   FCOLor   FMONochrome  :MMEMory:STORe:SCReen:THEMe?
<b>Example</b>	:MMEM:STOR:SCR:THEM TDM
<b>Preset</b>	3D Color; Is not part of Preset, but is reset by Restore Misc Defaults or Restore System Defaults All and survives subsequent running of the modes.
<b>Readback</b>	3D Color   3D Mono   Flat Color   Flat Mono
<b>Backwards Compatibility Notes</b>	In ESA and PSA we offer the choice of "Reverse Bitmap" or "Reverse Metafile" when saving screen images. This is much like the "Flat Color" theme available in X-Series. Also, if you selected Reverse Bitmap AND a black & white screen image, that would be much like "Flat Monochrome". In other words, each of the X-Series themes has a similar screen image type in ESA/PSA. But they are not identical.
<b>Initial S/W Revision</b>	Prior to A.02.00

### 3D Color

Selects a standard color theme with each object filled, shaded and colored as designed.

<b>Key Path</b>	Save, Screen Image, Themes
<b>Example</b>	MMEM:STOR:SCR:THEM TDC
<b>Readback</b>	3D Color
<b>Initial S/W Revision</b>	Prior to A.02.00

### 3D Monochrome

Selects a format that is like 3D color but shades of gray are used instead of colors.

<b>Key Path</b>	Save, Screen Image, Themes
<b>Example</b>	MMEM:STOR:SCR:THEM TDM
<b>Readback</b>	3D Mono
<b>Initial S/W Revision</b>	Prior to A.02.00

### Flat Color

Selects a format that is best when the screen is to be printed on an ink printer.

Key Path	Save, Screen Image, Themes
<b>Example</b>	MMEM:STOR:SCR:THEM FCOL
Readback	Flat Color
Initial S/W Revision	Prior to A.02.00

### Flat Monochrome

Selects a format that is like Flat Color. But only black is used (no colors, not even gray), and no fill.

Key Path	Save, Screen Image, Themes
<b>Example</b>	MMEM:STOR:SCR:THEM FMON
Readback	Flat Mono
Initial S/W Revision	Prior to A.02.00

### Backlight

Accesses the display backlight on/off keys. This setting may interact with settings under the Windows "Power" menu.

When the backlight is off, pressing ESC, TAB, SPACE, ENTER, UP, DOWN, LEFT, RIGHT, DEL, BKSP, CTRL, or ALT turns the backlight on without affecting the application. Pressing any other key will turn backlight on and could potentially perform the action as well.

Key Path	View/Display, Display, System Display Settings
<b>Remote Command</b>	:DISPlay:BACKlight ON OFF :DISPlay:BACKlight?
Preset	ON (Set by Restore Misc Defaults)
Initial S/W Revision	Prior to A.02.00

### Backlight Intensity

An active function used to set the backlight intensity. It goes from 0 to 100 where 100 is full on and 0 is off. This value is independent of the values set under the Backlight on/off key.

Key Path	View/Display, Display, System Display Settings
<b>Remote Command</b>	:DISPlay:BACKlight:INTensity <integer> :DISPlay:BACKlight:INTensity?
<b>Example</b>	DISP:BACK:INT 50

Preset	100 (Set by Restore Misc Defaults)
Min	0
Max	100
Initial S/W Revision	Prior to A.02.00

## Bar Graph

Turns the Bar Graph On and Off.

Key Path	View/Display
Mode	SA, WCDMA, C2K, WIMAX OFDMA, TD-SCDMA, 1xEVDO, DVB-T/H, DTMB (CTTB), ISDB-T, CMMB, LTE, LTETDD, Digital Cable TV, MSR, LTEAFDD, LTEATDD
Remote Command	:DISPlay:ACPower:VIEW[1]:WINDow[1]:BGRaph OFF ON 0 1 :DISPlay:ACPower:VIEW[1]:WINDow[1]:BGRaph?
Example	DISP:ACP:VIEW:WIND:BGR OFF DISP:ACP:VIEW:WIND:BGR?
Notes	You must be in the mode that includes ACP measurements to use this command. Use :INSTrument:SElect to set the mode.
Dependencies	When the method is RBW, this key is always set to On and grayed out.
Preset	ON
State Saved	Saved in instrument state.
Range	On Off
Initial S/W Revision	Prior to A.02.00
Modified at S/W Revision	A.02.00, A.03.00

## 10 Occupied Bandwidth Measurement

The Occupied Bandwidth measurement computes and displays the bandwidth occupied by a given percentage of the total mean power of a signal. For measurement results and views, see ["View/Display" on page 1021](#).

This topic contains the following sections:

["Remote Commands for Occupied Bandwidth" on page 866](#)

["Remote Command Results for Occupied Bandwidth Measurement" on page 867](#)

## Remote Commands for Occupied Bandwidth

The following commands and queries can be used to retrieve the measurement results:

```
:CONFigure:OBWidth  
:CONFigure:OBWidth:NDEFault  
:INITiate:OBWidth  
:FETCh:OBWidth[n]?  
:MEASure:OBWidth[n]?  
:READ:OBWidth[n]?  
:FETCh:OBWidth:OBWidth?  
:MEASure:OBWidth:OBWidth?  
:READ:OBWidth:OBWidth?  
:FETCh:OBWidth:FERRor?  
:MEASure:OBWidth:FERRor?  
:READ:OBWidth:FERRor?  
:FETCh:OBWidth:XDB?  
:MEASure:OBWidth:XDB?  
:READ:OBWidth:XDB?
```

See also the section, "[Remote Measurement Functions](#)" on page 2848.

## Remote Command Results for Occupied Bandwidth Measurement

The following table describes the results returned by the FETCh:OBWidth[n]?, MEASure:OBWidth[n]?, and READ:OBWidth[n]? queries listed above, according to the index value n.

n	Results Returned
n=1 (or not specified)	Returns 7 scalar results, in the following order: 1. Occupied bandwidth - Hz 2. Total Power - dBm (Total Power will be obsolete in TD-SCDMA mode, this place will be replaced by NaN) 3. Span - Hz 4. Spectrum Trace Points - points 5. Res BW - Hz 6. Transmit Frequency Error Hz 7. x DB Bandwidth - Hz
2	Returns the frequency-domain spectrum trace (data array) for the entire frequency range being measured.
n = 3 (Mode = MSR, LTEAFDD, LTEATDD)	1. Number of active carriers Returns number of active carriers within Span in Auto detected mode, otherwise the command is out of scope

Key Path	Meas
Initial S/W Revision	Prior to A.02.00

## AMPTD Y Scale (Amplitude/Y Scale)

Activates the Reference Value function and displays the Amplitude menu keys. These functions control how data on the vertical (Y) axis is displayed and control instrument settings that affect the vertical axis

See AMPTD Y Scale for more information.

Key Path	Front-panel key
Initial S/W Revision	Prior to A.02.00

### Ref Value

Sets the absolute power reference value. However, since the Auto Scaling is defaulted to On, this value is automatically determined by the measurement result. When you set a value manually, Auto Scaling automatically changes to Off.

Key Path	AMPTD Y Scale
Mode	SA, WCDMA, C2K, WIMAX OFDMA, TD-SCDMA, 1xEVDO, ISDB-T, CMMB, LTE, LTETDD, BLUETOOTH, WLAN, MSR, LTEAFDD, LTEATDD
Remote Command	:DISPlay:OBWidth:VIEW[1]:WINDow[1]:TRACe:Y[:SCALe]:RLEVel <real> :DISPlay:OBWidth:VIEW[1]:WINDow[1]:TRACe:Y[:SCALe]:RLEVel?
Example	DISP:OBW:VIEW:WIND:TRAC:Y:RLEV 125 DISP:OBW:VIEW:WIND:TRAC:Y:RLEV?
Notes	You must be in the Spectrum Analysis mode, W-CDMA mode, cdma2000 mode, TD-SCDMA mode, ISDB-T mode, CMMB mode, BLUETOOTH mode, LTE mode, LTE TDD mode, WLAN mode, 1xEVDO mode, MSR, LTE-Advanced FDD/TDD or WIMAX OFDMA mode to use this command. Use:INSTrument:SElect to set the mode.
Couplings	When the Auto Scaling is On, this value is automatically determined by the measurement result. When you set a value manually, Auto Scaling automatically changes to Off.
Preset	10.00 dBm
State Saved	Saved in instrument state.
Min	-250.00 dBm
Max	250.00 dBm
Initial S/W Revision	Prior to A.02.00
Modified at S/W Revision	A.03.00

### Attenuation

This menu controls the attenuator functions and interactions between the attenuation system components.

There are two attenuator configurations in the X-Series. One is a dual attenuator configuration consisting of a mechanical attenuator and an optional electronic attenuator. The other configuration uses a single



attenuator with combined mechanical and electronic sections that controls all the attenuation functions. Different models in the X-Series come with different configurations.

See ["Dual Attenuator Configurations:" on page 869](#)

See ["Single Attenuator Configuration:" on page 870](#)

Most Attenuation settings are the same for all measurements – they do not change as you change measurements. Settings like these are called “Meas Global” and are unaffected by Meas Preset.

Key Path	AMPTD Y Scale
Scope	Meas Global
Dependencies	In measurements that support the I/Q inputs, this key is unavailable when I/Q is the selected input, and is replaced by the Range key in that case.
Readback Line	Contains a summary in [ ] brackets of the current total attenuation. See the descriptions of the , " <a href="#">(Mech) Atten</a> " on page 2783, and " <a href="#">Enable Elec Atten</a> " on page 2785 keys for more detail on the contributors to the total attenuation.  Note that when "Pre-Adjust for Min Clip" is on, this value can change at the start of every measurement.
Initial S/W Revision	Prior to A.02.00
Modified at S/W Revision	A.03.00

### Dual Attenuator Configurations:

Configuration 1: Mechanical attenuator + optional electronic attenuator

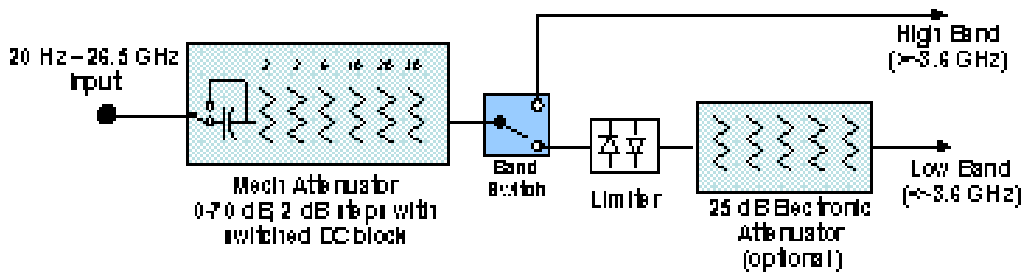

Configuration 2: Mechanical attenuator, no optional electronic attenuator

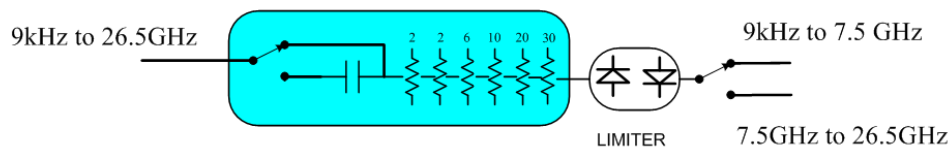

(note that Configuration 2 is not strictly speaking a dual-section attenuator, since there is no electronic section available. However, it behaves exactly like Configuration 1 without the Electronic Attenuator option EA3, therefore for the sake of this document it is grouped into the “Dual Attenuator” configuration)

### Single Attenuator Configuration:

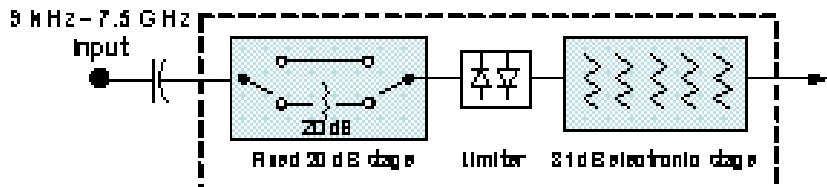

You can tell which attenuator configuration you have by pressing the Attenuation key, which (in most Modes) opens the Attenuation menu. If the first key in the Attenuation menu says Mech Atten you have the dual attenuator configuration. If the first key says Atten you have the single attenuator configuration.

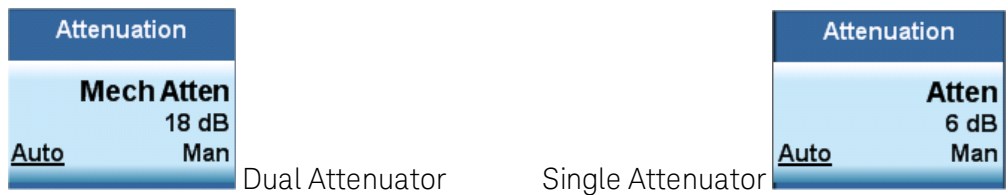

In the single attenuator configuration, you control the attenuation with a single control, as the fixed stage has only two states. In the dual attenuator configuration, both stages have significant range so you are given separate control of the mechanical and electronic attenuator stages.

When you have the dual attenuator configuration, you may still have only a single attenuator, because unless option EA3 (the Electronic Attenuator option) is available, and you purchase it, you will have only the mechanical attenuator.

### (Mech) Atten

This key is labeled Mech Atten in dual attenuator models and Atten in single attenuator models. In the dual attenuator configuration, this key only affects the mechanical attenuator.

This key lets you modify the attenuation applied to the RF input signal path. This value is normally auto coupled to the Ref Level, the Internal Preamp Gain, any External Gain that is entered, and the Max Mixer Level, as described in the table below.

See "[Attenuator Configurations and Auto/Man](#)" on page 872

Key Path	AMPTD Y Scale, Attenuation
<b>Remote Command</b>	<pre>[ :SENSe]:POWeR[:RF]:ATTenuation &lt;rel_ampl&gt; [:SENSe]:POWeR[:RF]:ATTenuation? [:SENSe]:POWeR[:RF]:ATTenuation:AUTO OFF ON 0 1 [:SENSe]:POWeR[:RF]:ATTenuation:AUTO?</pre>
<b>Example</b>	<p>POW:ATT 20</p> <p>Dual attenuator configuration: sets the mechanical attenuator to 20 dB</p> <p>Single attenuator mode: sets the main attenuation to 20 dB (see below for definition of “main” attenuation).</p> <p>If the attenuator was in Auto, it sets it to Manual.</p>
<b>Dependencies</b>	Some measurements do not support the Auto setting of (Mech) Atten. In these measurements, the

Auto/Man selection is not available, and the Auto/Man line on the key disappears.

In dual attenuator configurations, when the electronic attenuator is enabled, the mechanical attenuator has no auto setting and the Auto/Man line on the key disappears. The state of Auto/Man is remembered and restored when the electronic attenuator is once again disabled. This is described in more detail in the ["Enable Elec Atten" on page 2785](#) key description.

See ["Attenuator Configurations and Auto/Man" on page 872](#) for more information on the Auto/Man functionality of Attenuation.

Couplings

When (Mech) Atten is in Auto, it uses the following algorithm to determine a value:  
If the USB Preamp is connected to USB, use 0 dB.  
Otherwise,  $Atten = ReferenceLevel + PreAmpGain + ExternalGain - RefLevelOffset - MaxMixerLevel + IF\ Gain$ .  
Limit this value to be between 6 dB and the Max value. No value below 6 dB can ever be chosen by Auto.  
The resulting value is rounded up to the largest value possible given the attenuation step setting. That is, 50.01 dB would change to 60 dB (for a 10 dB attenuation step).  
The "IF Gain" term in the equation above is either 0 dB or +10 dB, depending on the settings of FFT IF Gain, Swept IF Gain, max Ref Level and the Auto/Man setting of Mech Atten.  
In External Mixing and BBIQ, where the Attenuator is not in the signal path, the Attenuator setting changes as described above when (Mech) Atten is in Auto, but no changes are made to the actual attenuator hardware setting until the input is changed back to the RF Input.

Preset The preset for Mech Attenuation is "Auto."  
The Auto value of attenuation is:  
CXA, EXA, MXA and PXA: 10 dB

State Saved Saved in instrument state

Min 0 dB  
The attenuation set by this key cannot be decreased below 6 dB with the knob or step keys. To get to a value below 6 dB it has to be directly entered from the keypad or via SCPI. This protects from adjusting the attenuation to a dangerously small value which can put the instrument at risk of damage to input circuitry. However, if the current mechanical attenuation is below 6 dB it can be increased with the knob and step keys, but not decreased.

Max CXA N9000A-503/507: 50 dB  
CXA N9000A-513/526: 70dB  
EXA: 60 dB  
MXA and PXA: 70 dB  
In the single attenuator configuration, the total of ATT and EATT cannot exceed 50 dB, so if the EATT is set to 24 dB first, the main attenuation cannot be greater than 26 dB and will be reduced accordingly; if the main attenuator is set to 40 dB first, EATT cannot be greater than 10 dB.

Initial S/W Revision Prior to A.02.00

Modified at S/W Revision A.03.00

### Attenuator Configurations and Auto/Man

As described in the Attenuation key description, there are two distinct attenuator configurations available in the X-Series, the single attenuator and dual attenuator configurations. In dual attenuator configurations, we have the mechanical attenuation and the electronic attenuation, and the current total attenuation is the sum of the electronic + mechanical attenuation. In single attenuator configurations, we refer to the attenuation set using the (Mech) Atten key (or POW:ATT SCPI) as the “main” attenuation; and the attenuation that is set by the SCPI command POW:EATT as the “soft” attenuation (the POW:EATT command is honored even in the single attenuator configuration, for compatibility purposes). Then the current total attenuation is the sum of the main + soft attenuation. See the Elec Atten key description for more on “soft” attenuation.

In the dual attenuator configuration, when the electronic attenuator is enabled, there is no Auto/Man functionality for the mechanical attenuator, and the third line of the key label (the Auto/Man line) disappears:

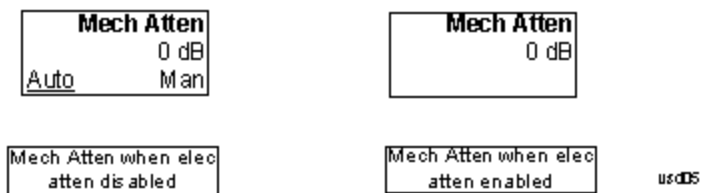

### Enable Elec Atten

Enables the Electronic Attenuator.

The electronic attenuator offers finer steps than the mechanical attenuator, has no acoustical noise, is faster, and is less subject to wear. These advantages primarily aid in remote operation and are negligible for front panel use. See ["Using the Electronic Attenuator: Pros and Cons" on page 874](#) for a detailed discussion of the pros and cons of using the electronic attenuator.

For the single attenuator configuration, for SCPI backwards compatibility, the “soft” attenuation feature replaces the dual attenuator configuration’s electronic attenuator. All the same couplings and limitations apply. See ["Attenuator Configurations and Auto/Man" on page 2785](#)

See ["More Information" on page 873](#)

<b>Key Path</b>	AMPTD Y Scale, Attenuation
<b>Remote Command</b>	[ :SENSe ] : POWer [ :RF ] : EATTenuation : STATE OFF   ON   0   1 [ :SENSe ] : POWer [ :RF ] : EATTenuation : STATE?
<b>Example</b>	POW:EATT:STAT ON
<b>Dependencies</b>	This key only appears in Dual Attenuator models with an Electronic Attenuator installed. It does not appear in models with the Single Attenuator configuration, as in the single attenuator configuration there is no “electronic attenuator” there is only a single integrated attenuator (which has both a mechanical and electronic stage). However, in the single attenuator configuration, EATT SCPI commands are accepted for compatibility with other X-series instruments and set a “soft” attenuation as described in <a href="#">"Attenuator Configurations and Auto/Man" on page 2785</a> . The electronic attenuator (and the “soft” attenuation function provided in single attenuator configurations) is unavailable above 3.6 GHz. Therefore, if the Stop Frequency of the analyzer is > 3.6 GHz then the Enable Elec Atten key will be OFF and grayed out.

	<p>If the Internal Preamp is on, meaning it is set to Low Band or Full, the electronic attenuator (and the “soft” attenuation function provided in single attenuator configurations) is unavailable. In this case the Enable Elec Atten key will be OFF and grayed out.</p> <p>If either of the above is true, if the SCPI command is sent, an error indicating that the electronic attenuator is unavailable will be sent.</p> <p>If the electronic/soft Attenuator is enabled, then the Stop Freq of the analyzer is limited to 3.6 GHz and the Internal Preamp is unavailable.</p> <p>The SCPI-only “soft” electronic attenuation for the single-attenuator configuration is not available in all measurements; in particular, it is not available in the Swept SA measurement.</p>
Couplings	Enabling and disabling the Electronic Attenuator affects the setting of the Mechanical Attenuator (in dual attenuator configurations). This is described in more detail below this table.
Preset	OFF for Swept SA measurement; ON for all other measurements that support the electronic attenuator
State Saved	Saved in instrument state
Initial S/W Revision	Prior to A.02.00
Modified at S/W Revision	A.03.00

## More Information

### Mechanical Attenuator Transition Rules

When the Electronic Attenuator is enabled, the Mechanical Attenuator transitions to a state that has no Auto function. Below are the rules for transitioning the Mechanical Attenuator. NOTE that the information below ONLY applies to the dual attenuator configurations, and ONLY when the Electronic Attenuator is installed:

#### When the Electronic Attenuation is enabled from a disabled state:

- The Mechanical Attenuator is initialized to 10 dB (this is its optimal performance setting). You can then set it as desired with SCPI, numeric keypad, step keys, or knob, and it behaves as it normally would in manual mode
- The Auto/Man state of (Mech) Atten is saved
- The Auto/Man line on the (Mech) Atten key disappears and the auto rules are disabled
- The Electronic Attenuator is set to 10 dB less than the previous value of the Mechanical Attenuator, within the limitation that it must stay within the range of 0 to 24 dB of attenuation.

#### Examples in the dual attenuator configuration:

- Mech Atten at 20 dB. Elec Atten enabled, Mech Atten set to 10 dB, and Elec Atten set to 10 dB. New total attenuation equals the value before Elec Atten enabled.
- Mech Atten at 0 dB. Elec Atten enabled, Mech Atten set to 10 dB, and Elec Atten set to 0 dB. New total attenuation does not equal the value before Elec Atten enabled.
- Mech Atten at 40 dB. Elec Atten enabled, Mech Atten set to 10 dB, and Elec Atten set to 24 dB. New total attenuation does not equal the value before Elec Atten enabled.

**When the Electronic Attenuation is disabled from an enabled state:**

- The Elec Atten key is grayed out
- The Auto/Man state of (Mech) Atten is restored
- If now in Auto, (Mech) Atten recouples
- If now in Man, (Mech) Atten is set to the value of total attenuation that existed before the Elec Atten was disabled. The resulting value is rounded up to the smallest value possible given the (Mech) Atten Step setting - (That is, 57 dB changes to 58 dB when (Mech) Atten Step is 2 dB.)

**Using the Electronic Attenuator: Pros and Cons**

The electronic attenuator offers finer steps than the mechanical attenuator, has no acoustical noise, is faster, and is less subject to wear.

The “finer steps” advantage of the electronic attenuator is beneficial in optimizing the alignment of the analyzer dynamic range to the signal power in the front panel as well as remote use. Thus, you can achieve improved relative signal measurement accuracy. Compared to a mechanical attenuator with 2 dB steps, the 1 dB resolution of the electronic attenuator only gives better resolution when the odd-decibel steps are used. Those odd-decibel steps are less accurately calibrated than the even-decibel steps, so one tradeoff for this superior relative accuracy is reduced absolute amplitude accuracy.

Another disadvantage of the electronic attenuator is that the spectrum analyzer loses its “Auto” setting, making operation less convenient.

Also, the relationship between the dynamic range specifications (TOI, SHI, compression and noise) and instrument performance are less well-known with the electrical attenuator. With the mechanical attenuator, TOI, SHI and compression threshold levels increase dB-for-dB with increasing attenuation, and the noise floor does as well. With the electronic attenuator, there is an excess attenuation of about 1 to 3 dB between 0 and 3.6 GHz, making the effective TOI, SHI, and so forth, less well known. Excess attenuation is the actual attenuation relative to stated attenuation. Excess attenuation is accounted for in the analyzer calibration

**Elec Atten**

Controls the Electronic Attenuator in dual attenuator configurations. This key does not appear in single attenuator configurations, as the control of both the mechanical and electronic stages of the single attenuator is integrated into the single Atten key.

<b>Key Path</b>	AMPTD Y Scale, Attenuation
<b>Remote Command</b>	<code>[ :SENSe ] :POWer [ :RF ] :EATTenuation &lt;rel_amp1&gt;</code> <code>[ :SENSe ] :POWer [ :RF ] :EATTenuation?</code>
<b>Notes</b>	Electronic Attenuation’s specification is defined only when Mechanical Attenuation is 6 dB.
<b>Dependencies</b>	This key only appears in Dual Attenuator models with an Electronic Attenuator installed. It does not appear in models with the Single Attenuator configuration, as in the single attenuator configuration there is no “electronic attenuator” there is only a single integrated attenuator (which has both a mechanical and electronic stage). However, in the single attenuator configuration, EATT SCPI commands are accepted for compatibility with other X-series instruments and set a “soft” attenuation as described in <a href="#">"Attenuator Configurations and Auto/Man" on page 2785</a> . The “soft” attenuation is treated as an addition to the “main” attenuation value set by the Atten softkey or the

	POW:ATT SCPI command and affects the total attenuation displayed on the Attenuation key and the Meas Bar. When Enable Elec Atten is off or grayed out, the Elec Atten key is grayed out.
Preset	0 dB
State Saved	Saved in instrument state
Min	0 dB
Max	Dual attenuator configuration: 24 dB Single attenuator configuration: the total of ATT and EATT cannot exceed 50 dB, so if the EATT is set to 24 dB first, the main attenuation cannot be greater than 26 dB and will be reduced accordingly; if the main attenuator is set to 40 dB first, EATT cannot be greater than 10 dB
Initial S/W Revision	Prior to A.02.00
Modified at S/W Revision	A.03.00

### Adjust Atten for Min Clip

Sets the combination of mechanical and electronic attenuation and gain based on the current measured signal level so that clipping will be at a minimum.

This is an "immediate action" function, that is, it executes once, when the key is pressed.

This key is grayed out in measurements that do not support this functionality. The spectrum analyzer measurement, Swept SA, does not support this functionality.

Key Path	AMPTD Y Scale, Attenuation
Remote Command	[ :SENSe ] :POWer [ :RF ] :RANGe:OPTimize IMMEDIATE
Initial S/W Revision	Prior to A.02.00
Modified at S/W Revision	A.03.00

### Pre-Adjust for Min Clip

If this function is on, it does the adjustment described under "[Adjust Atten for Min Clip](#)" on page 2788 each time a measurement restarts. Therefore, in Continuous measurement mode, it only executes before the first measurement.

In dual attenuator models, you can set Elec+Mech Atten, in which case both attenuators participate in the autoranging, or Elec Atten Only, in which case the mechanical attenuator does not participate in the autoranging. This latter case results in less wear on the mechanical attenuator and is usually faster.

This key is grayed out in measurements that do not support this functionality. The spectrum analyzer measurement, Swept SA, does not support this functionality.

Key Path	AMPTD Y Scale, Attenuation
Remote Command	[ :SENSe ] :POWer [ :RF ] :RANGe:OPTimize:ATTenuation OFF   ELECTRICAL   COMBINED

	<code>[ :SENSe ] :POWer [ :RF ] :RANGe:OPTimize:ATTenuation?</code>
Notes	The SCPI parameter ELECtrical sets this function to On in single attenuator models. The SCPI parameter COMBined is mapped to ELECtrical in single attenuator models; if you send COMBined, it sets the function to On and returns ELEC to a query.
Dependencies	This key only appears in Dual Attenuator models with an Electronic Attenuator installed. In instruments with Dual Attenuator model, when Enable Elec Atten is off or grayed out, the Pre-Adjust for Min Clip key is grayed out.
Preset	OFF for Swept SA measurement; ON for all other measurements that support Pre-Adjust for Min Clip
State Saved	Saved in instrument state
Range	Dual attenuator models: Off   Elec Atten Only   Mech + Elec Atten Single attenuator models: Off   On
Initial S/W Revision	Prior to A.02.00
Modified at S/W Revision	A.03.00

<b>Remote Command</b>	<code>[ :SENSe ] :POWer [ :RF ] :RANGe:AUTO ON OFF 1 0</code> <code>[ :SENSe ] :POWer [ :RF ] :RANGe:AUTO?</code>
Notes	ON aliases to "Elec Atten Only" (:POW:RANG:OPT:ATT ELEC) OFF aliases to "Off" (:POW:RANG:OPT:ATT OFF) The query :POW:RANG:AUTO? returns true if :POW:RANG:OPT:ATT is not "Off"
Initial S/W Revision	Prior to A.02.00

## Off

Turns Pre-Adjust for Min Clip off. This is the default setting.

This key is grayed out in measurements that do not support this functionality. The spectrum analyzer measurement, Swept SA, does not support this functionality.

Key Path	AMPTD Y Scale, Attenuation, Pre-Adjust for Min Clip
Example	:POW:RANGe:OPT:ATT OFF
Initial S/W Revision	Prior to A.02.00

## Elec Atten Only

Selects only the electric attenuator to participate in auto ranging. This offers less wear on the mechanical attenuator and is usually faster.



This key is grayed out in measurements that do not support this functionality. The spectrum analyzer measurement, Swept SA, does not support this functionality.

Key Path	AMPTD Y Scale, Attenuation, Pre-Adjust for Min Clip
Example	:POW:RANGe:OPT:ATT ELEC
Initial S/W Revision	Prior to A.02.00

### Mech + Elec Atten

In dual attenuator models, this selects both attenuators participate in the autoranging.

This key is grayed out in measurements that do not support this functionality. The spectrum analyzer measurement, Swept SA, does not support this functionality.

Key Path	AMPTD Y Scale, Attenuation, Pre-Adjust for Min Clip
Example	:POW:RANGe:OPT:ATT COMB
Initial S/W Revision	Prior to A.02.00

### (Mech) Atten Step

This controls the step size used when making adjustments to the input attenuation.

This key is labeled Mech Atten Step in dual attenuator models and Atten Step in single attenuator models. In the dual attenuator configuration, this key only affects the step size of the mechanical attenuator.

Key Path	AMPTD Y Scale, Attenuation
Remote Command	[[:SENSe]:POWer[:RF]:ATTenuation:STEP[:INCRement] 10 dB   2 dB [:SENSe]:POWer[:RF]:ATTenuation:STEP[:INCRement]?
Example	POW:ATT:STEP 2
Notes	Note this feature works like a 1-N choice from the front panel, but it takes a specific value (in dB) when used remotely. The only valid values are 2 and 10.
Dependencies	Blanked in CXA and EXA if option FSA (2 dB steps) is not present. If blanked, attempts to set it via SCPI will yield an error.
Couplings	When the attenuation step size changes, the current mechanical attenuation value is adjusted (if necessary) to be quantized to the new step size. That is, if step is set to 10 dB, mech atten is increased if necessary so it is a multiple of 10 dB
Preset	PXA and MXA: 2 dB EXA and CXA: 10 dB (2 dB with option FSA)
State Saved	Saved in instrument state
Initial S/W Revision	Prior to A.02.00
Modified at S/W Revision	A.03.00

## Scale/Div

Sets the logarithmic units per vertical graticule division on the display. When the Auto Scaling is On, the Scale/Div is automatically determined by the measurement result. When you set a value manually, Auto Scaling is automatically toggled to Off.

<b>Key Path</b>	AMPTD Y Scale
<b>Mode</b>	SA, WCDMA, C2K, WIMAX OFDMA, TD-SCDMA, 1xEVDO, ISDB-T, CMMB, LTE, LTETDD, BLUETOOTH, WLAN, MSR, LTEAFDD, LTEATDD
<b>Remote Command</b>	:DISPlay:OBWidth:VIEW[1]:WINDow[1]:TRACe:Y[:SCALe]:PDIVision <rel_amp1> :DISPlay:OBWidth:VIEW[1]:WINDow[1]:TRACe:Y[:SCALe]:PDIVision?
<b>Example</b>	DISP:OBW:VIEW:WIND:TRAC:Y:PDIV 5 DISP:OBW:VIEW:WIND:TRAC:Y:PDIV?
<b>Notes</b>	You must be in the Spectrum Analysis mode, W-CDMA mode, cdma2000 mode, TD-SCDMA mode, ISDB-T mode, CMMB mode, LTE mode, LTE TDD mode, BLUETOOTH mode, WLAN mode, 1xEVDO mode, MSR, LTE-Advanced FDD/TDD or WIMAX OFDMA mode to use this command. Use :INSTrument:SElect to set the mode.
<b>Couplings</b>	When the Auto Scaling is On, this value is automatically determined by the measurement result. When you set a value manually, Auto Scaling automatically changes to Off.
<b>Preset</b>	10.00 dB
<b>State Saved</b>	Saved in instrument state.
<b>Min</b>	0.10 dB
<b>Max</b>	20.00 dB
<b>Initial S/W Revision</b>	Prior to A.02.00
<b>Modified at S/W Revision</b>	A.03.00

## Presel Center

When this key is pressed, the centering of the preselector filter is adjusted to optimize the amplitude accuracy at the frequency of the selected marker. If the selected marker is not on when Presel Center is pressed, the analyzer will turn on the selected marker, perform a peak search, and then perform centering on the marker's center frequency. If the selected marker is already on and between the start and stop frequencies of the analyzer, the analyzer performs the preselector calibration on that marker's frequency. If the selected marker is already on, but outside the frequency range between Start Freq and Stop Freq, the analyzer will first perform a peak search, and then perform centering on the marker's center frequency.

The value displayed on the Presel Adjust key will change to reflect the new preselector tuning (see Presel Adjust).

A number of considerations should be observed to ensure proper operation. See ["Proper Preselector Operation" on page 879](#).

<b>Key Path</b>	AMPTD Y Scale
<b>Remote Command</b>	[:SENSE]:POWer[:RF]:PCENTER

<b>Example</b>	POW:PCEN
Notes	Note that the rules outlined above under the key description apply for the remote command as well as the key. The result of the command is dependent on marker position, and so forth. Any message shown by the key press is also shown in response to the remote command.
Dependencies	<ul style="list-style-type: none"> <li>• Grayed out if the microwave preselector is off. )</li> <li>• If the selected marker's frequency is below Band 1, advisory message 0.5001 is generated and no action is taken.</li> <li>• Grayed out if entirely in Band 0.</li> <li>• Blank in models that do not include a preselector, such as option 503. If the SCPI is sent in these instruments, it is accepted without error, and the query always returns 0.</li> <li>• Grayed out in the Spectrogram View.</li> </ul>
Couplings	<p>The active marker position determines where the centering will be attempted.</p> <p>If the analyzer is in a measurement such as averaging when centering is initiated, the act of centering the preselector will restart averaging but the first average trace will not be taken until the centering is completed.</p>
Status Bits/OPC dependencies	<p>When centering the preselector, *OPC will not return true until the process is complete and a subsequent measurement has completed, nor will results be returned to a READ or MEASure command.</p> <p>The Measuring bit should remain set while this command is operating and should not go false until the subsequent sweep/measurement has completed.</p>
Initial S/W Revision	Prior to A.02.00
Modified at S/W Revision	A.03.00

## Proper Preselector Operation

A number of considerations should be observed to ensure proper operation:

1. If the selected marker is off, the analyzer will turn on a marker, perform a peak search, and adjust the preselector using the selected marker's frequency. It uses the "highest peak" peak search method unqualified by threshold or excursion, so that there is no chance of a 'no peak found' error. It continues with that peak, even if it is the peak of just noise. Therefore, for this operation to work properly, there should be a signal on screen in a preselected range for the peak search to find.
2. If the selected marker is already on, the analyzer will attempt the centering at that marker's frequency. There is no preselector for signals below about 3.6 GHz, therefore if the marker is on a signal below 3.6 GHz, no centering will be attempted and an advisory message generated
3. In some models, the preselector can be bypassed. If it is bypassed, no centering will be attempted in that range and a message will be generated.

## Preselector Adjust

Allows you to manually adjust the preselector filter frequency to optimize its response to the signal of interest. This function is only available when **"Presel Center"** on page 2791 is available.

For general purpose signal analysis, using Presel Center is recommended. Centering the filter minimizes the impact of long-term preselector drift. Presel Adjust can be used instead to manually optimize the preselector. One application of manual optimization would be to peak the preselector response, which both optimizes the signal-to-noise ratio and minimizes amplitude variations due to small (short-term) preselector drifting.

<b>Key Path</b>	AMPTD Y Scale
<b>Scope</b>	Meas Global
<b>Remote Command</b>	<code>[ :SENSe ] :POWer [ :RF ] :PADJust &lt;freq&gt;</code> <code>[ :SENSe ] :POWer [ :RF ] :PADJust?</code>
<b>Example</b>	POW:PADJ 100KHz POW:PADJ?
<b>Notes</b>	The value on the key reads out to 0.1 MHz resolution.
<b>Dependencies</b>	<ul style="list-style-type: none"> <li>• Grayed out if microwave preselector is off. )</li> <li>• Grayed out if entirely in Band 0.</li> <li>• Blank in models that do not include a preselector, such as option 503. If the SCPI is sent in these instruments, it is accepted without error, and the query always returns 0.</li> <li>• Grayed out in the Spectrogram View.</li> </ul>
<b>Preset</b>	0 MHz
<b>State Saved</b>	The Presel Adjust value set by Presel Center, or by manually adjusting Presel Adjust, is not saved in instrument state, and does not survive a Preset or power cycle.
<b>Min</b>	-500 MHz
<b>Max</b>	500 MHz
<b>Default Unit</b>	Hz
<b>Backwards Compatibility SCPI</b>	<code>[ :SENSe ] :POWer [ :RF ] :MW :PADJust</code> <code>[ :SENSe ] :POWer [ :RF ] :MMW :PADJust</code> PSA had multiple preselectors, but the X-Series has only one. These commands simply alias to <code>[ :SENSe ] :POWer [ :RF ] :PADJust</code>
<b>Initial S/W Revision</b>	Prior to A.02.00
<b>Modified at S/W Revision</b>	A.03.00

<b>Remote Command</b>	<code>[ :SENSe ] :POWer [ :RF ] :PADJust :PRESelector MWAVE   MMWave   EXTERNAL</code> <code>[ :SENSe ] :POWer [ :RF ] :PADJust :PRESelector?</code>
<b>Notes</b>	PSA had multiple preselectors, and you could select which preselector to adjust. Since the X-Series has only one mm/uW preselector, the preselector selection softkey is no longer available. However, to provide backward compatibility, we accept the legacy remote commands. The command form has no effect, the query always returns MWAVE
<b>Initial S/W Revision</b>	Prior to A.02.00

## μW Path Control

The μW Path Control functions include the μW Preselector Bypass (Option MPB) and Low Noise Path (Option LNP) controls in the High Band path circuits.

When the μW Preselector is bypassed, the user has better flatness, but will be subject to spurs from out of band interfering signals. When the Low Noise Path is enabled, the analyzer automatically switches around certain circuitry in the high frequency bands which can contribute to noise, when it is appropriate based on other analyzer settings.

For most applications, the preset state is Standard Path, which gives the best remote-control throughput, minimizes acoustic noise from switching and minimizes the risk of wear out in the hardware switches. For applications that utilize the wideband IF paths, the preset state is the μW Preselector Bypass path, if option MPB is present. This is because, when using a wideband IF such as the 140 MHz IF, the μW Preselector's bandwidth can be narrower than the available IF bandwidth, causing degraded amplitude flatness and phase linearity, so it is desirable to bypass the preselector in the default case.

Users may choose Low Noise Path Enable. It gives a lower noise floor, especially in the 21–26.5 GHz region, though without improving many measures of dynamic range, and without giving the best possible noise floor. The preamp, if purchased and used, gives better noise floor than does the Low Noise Path, however its compression threshold and third-order intercept are much poorer than that of the non-preamp Low Noise Path. There are some applications, typically for signals around –30 dBm, for which the third-order dynamic range of the standard path is good enough, but the noise floor is not low enough even with 0 dB input attenuation. When the third-order dynamic range of the preamp path is too little and the noise floor of the standard path is too high, the Low Noise Path can provide the best dynamic range.

<b>Key Path</b>	AMPTD Y Scale
<b>Mode</b>	SA, BASIC, PNOISE, VSA , LTE, LTETDD
<b>Scope</b>	Meas Global
<b>Remote Command</b>	[ :SENSe ] :POWer [ :RF ] :MW :PATH STD LNPath MPBypass FULL [ :SENSe ] :POWer [ :RF ] :MW :PATH?
<b>Example</b>	:POW:MW:PATH LNP Enables the Low Noise path
<b>Notes</b>	If a Presel Center is performed, the analyzer will momentarily switch to the Standard Path, regardless of the setting of μW Path Control  The DC Block will always be switched in when the low noise path is switched in, to protect succeeding circuitry from DC. Note that this does not mean “when the low noise path is enabled” but when, based on the Low Noise Path rules, the path is actually switched in. This can happen when the selection is Low Noise Path Enable . In the case where the DC Block is switched in the analyzer is now AC coupled. However, if the user has selected DC coupling, the UI will still behave as though it were DC coupled, including all annunciation, warnings, status bits, and responses to SCPI queries. This is because, based on other settings, the analyzer could switch out the low noise path at any time and hence go back to being DC coupled.  Alignment switching ignores the settings in this menu, and restores them when finished.
<b>Dependencies</b>	Unavailable in BBIQ and External Mixing
<b>Preset</b>	All modes other than IQ Analyzer mode and VXA: STD IQ Analyzer, VXA and WLAN mode:

	MPB option present and licensed: MPB MPB option not present and licensed: STD
State Saved	Save in instrument state
Readback	Value selected in the submenu
Initial S/W Revision	A.04.00
Modified at S/W Revision	A.10.00

## Standard Path

This path gives the best remote-control throughput, minimizes acoustic noise from switching and minimizes the risk of wear in the hardware switches, particularly in remote test scenarios where both low band and high band setups will follow in rapid succession.

In this path, the bypass of the low band/high band switch and microwave preamp is never activated, which can cause some noise degradation but preserves the life of the bypass switch.

Key Path	AMPTD Y Scale, $\mu$ W Path Control
Example	:POW:MW:PATH STD
Readback Text	Standard Path
Initial S/W Revision	A.04.00

## Low Noise Path Enable

You may choose Low Noise Path Enable, which gives a lower noise floor under some circumstances, particularly when operating in the 21–26.5 GHz region. With the Low Noise Path enabled, the low band/high band switch and microwave preamp are bypassed whenever all of the following are true:

- The analyzer is not in the Low Band, meaning:
- the start frequency is above 3.5 GHz and
- the stop frequency is above 3.6 GHz.
- the internal preamp is not installed or (if installed) is set to Off or Low Band

Note that this means that, when any part of a sweep is done in Low Band, the Low Noise Path is not used, whether or not the Low Noise Path Enable is selected in the user interface. Also, if the preamp is turned on, the Low Noise Path is not used, whether or not the Low Noise Path Enable is selected in the user interface. The only time the Low Noise Path is used is when Low Noise Path Enable is selected, the sweep is completely in High Band (> 3.6 GHz) and no preamp is in use.

See "[More Information](#)" on page 883

Key Path	AMPTD Y Scale, $\mu$ W Path Control
Measurement	Swept SA

<b>Example</b>	:POW:MW:PATH LNP
<b>Notes</b>	<p>For measurements that use IQ acquisition, the low noise path is used when the Center Frequency is in High Band (&gt; 3.6 GHz) and no preamp is in use.</p> <p>In other words, the rules above are modified to use only the center frequency to qualify which path to switch in.</p> <p>This is not the case for FFT's in the Swept SA measurement; they use the same rules as swept measurements.</p>
<b>Dependencies</b>	<p>Key is blanked if current mode does not support it.</p> <p>Key is grayed out if mode supports it but current measurement does not support it.</p> <p>Unless Option LNP is present and licensed, key is blank and if SCPI command sent, error -241, "Hardware missing; Option not installed" is generated.</p>
<b>Readback Text</b>	Low Noise Path Enable
<b>Initial S/W Revision</b>	A.04.00

### More Information

The user should understand that the Low Noise Path, while giving improved DANL, has the disadvantage of decreased TOI performance and decreased gain compression performance relative to the standard path.

The user should also understand that the bypass switch is a mechanical switch and has finite life, so if the Low Noise Path is enabled, it is possible to cause frequent cycling of this switch by frequently changing analyzer settings such that the above conditions hold true only some of the time. A user making tests of this nature should consider opting for the Standard Path, which will never throw the bypass switch, at the expense of some degraded noise performance.

The low noise path is useful for situations where the signal level is so low that the analyzer performance is dominated by noise even with 0 dB attenuation, but still high enough that the preamp option would have excessive third-order intermodulation or compression. The preamp, if purchased and used, gives better noise floor than does the "Low Noise Path." However, its compression threshold and third-order intercept are much poorer than that of the non-preamp path. There are some applications, typically for signals around -30 dBm, for which the third-order dynamic range of the standard path is good enough, but the noise floor is not low enough even with 0 dB input attenuation. When the third-order dynamic range of the preamp path is too little and the noise floor of the standard path is too high, the Low Noise Path can provide the best dynamic range

The graph below illustrates the concept. It shows, in red, the performance of an analyzer at different attenuation settings, both with the preamp on and off, in a measurement that is affected by both analyzer noise and analyzer TOI. The green shows the best available dynamic range, offset by 0.5 dB for clarity. The blue shows how the best available dynamic range improves for moderate signal levels with the low noise path switched in. In this illustration, the preamp improves the noise floor by 15 dB while degrading the third-order intercept by 30 dB, and the low noise path reduces loss by 8 dB. The attenuator step size is 2 dB.

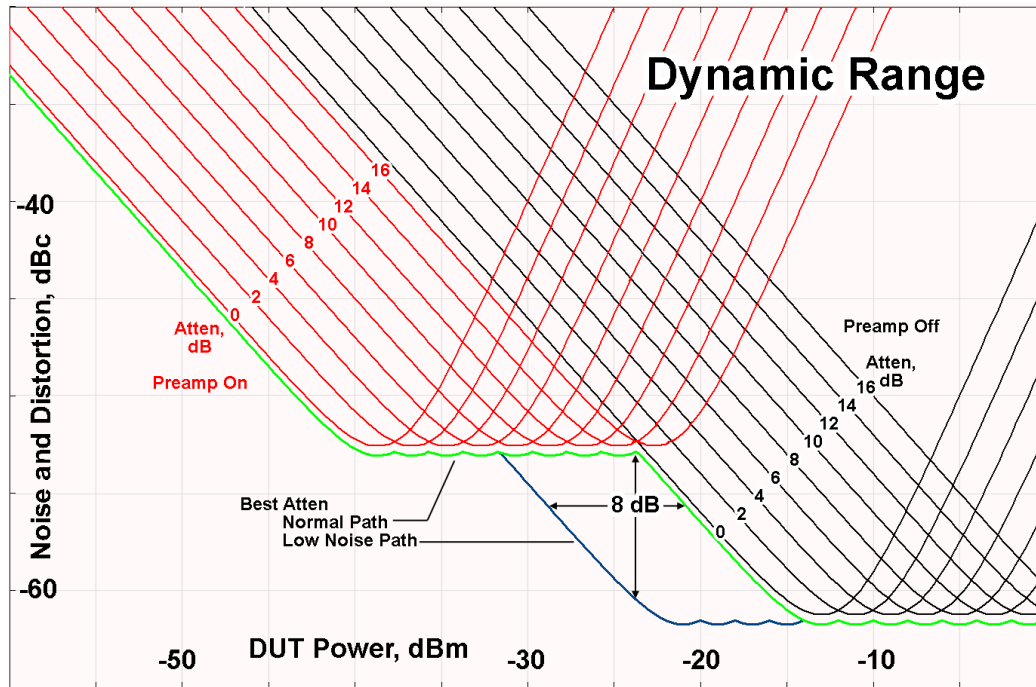

There are other times where selecting the low noise path improves performance, too. Compression-limited measurements such as finding the nulls in a pulsed-RF spectrum can profit from the low noise path in a way similar to the TOI-limited measurement illustrated. Accuracy can be improved when the low noise path allows the optimum attenuation to increase from a small amount like 0, 2 or 4 dB to a larger amount, giving better return loss at the analyzer input. Harmonic measurements, such as second and third harmonic levels, are much improved using the low noise path because of the superiority of that path for harmonic (though not intermodulation) distortion performance.

### μW Preselector Bypass

This key toggles the preselector bypass switch for band 1 and higher. When the microwave preselector is on, the signal path is preselected. When the microwave preselector is off, the signal path is not preselected. The preselected path is the normal path for the analyzer.

The preselector is a tunable bandpass filter which prevents signals away from the frequency of interest from combining in the mixer to generate in-band spurious signals (images). The consequences of using a preselector filter are its limited bandwidth, the amplitude and phase ripple in its passband, and any amplitude and phase instability due to center frequency drift.

Option MPB or pre-selector bypass provides an unpreselected input mixer path for certain X-Series signal analyzers with frequency ranges above 3.6 GHz. This signal path allows a wider bandwidth and less amplitude variability, which is an advantage when doing modulation analysis and broadband signal analysis. The disadvantage is that, without the preselector, image signals will be displayed. Another disadvantage of bypassing the preselector is increased LO emission levels at the front panel input port.

Image responses are separated from the real signal by twice the 1st IF. For IF Paths of 10 MHz and 25 MHz, the 1st IF is 322.5 MHz, so the image response and the real signal will be separated by 645 MHz. The 1st IF will be different for other IF Path settings. When viewing a real signal and its corresponding image response in internal mixing, the image response will be to the left of the real signal.



Also, the image response and the real signal typically have the same amplitude and exhibit the same shape factor.

However, if Option FS1, Fast Sweep Capability, is enabled, the image response in the Swept SA measurement will appear lower in amplitude and have a much wider shape factor compared to the real signal.

Key Path	AMPTD Y Scale, $\mu$ W Path Control
<b>Example</b>	:POW:MW:PATH MPB
Dependencies	Key is blanked if current mode does not support it. Key is grayed out if mode supports it but current measurement does not support it. Key is blank unless Option MPB is present and licensed. If SCPI command sent when MPB not present, error -241, "Hardware missing; Option not installed" is generated.
Readback Text	$\mu$ W Preselector Bypass
Initial S/W Revision	A.04.00

<b>Remote Command</b>	[ :SENSe ] :POWer [ :RF ] :MW:PRESelector [ :STATe ] ON OFF 0 1 [ :SENSe ] :POWer [ :RF ] :MW:PRESelector [ :STATe ] ?
<b>Example</b>	:POW:MW:PRES OFF Bypasses the microwave preselector
Notes	The ON parameter sets the STD path (:POW:MW:PATH STD) The OFF parameter sets path MPB (:POW:MW:PATH MPB)
Preset	ON

## Internal Preamp

Accesses a menu of keys that control the internal preamps. Turning on the preamp gives a better noise figure, but a poorer TOI to noise floor dynamic range. You can optimize this setting for your particular measurement.

The instrument takes the preamp gain into account as it sweeps. If you sweep outside of the range of the preamp the instrument will also account for that. The displayed result will always reflect the correct gain.

For some measurements, when the preamp is on and any part of the displayed frequency range is below the lowest frequency for which the preamp has specifications, a warning condition message appears in the status line. For example ,for a preamp with a 9 kHz lowest specified frequency: "Preamp: Accy unspec'd below 9 kHz".

Key Path	AMPTD Y Scale
Scope	Meas Global
<b>Remote Command</b>	[ :SENSe ] :POWer [ :RF ] :GAIN [ :STATe ] OFF ON 0 1 [ :SENSe ] :POWer [ :RF ] :GAIN [ :STATe ] ?
Dependencies	Preamp is not available on all hardware platforms. If the preamp is not present or is unlicensed, the

---

	key is not shown. The preamp is not available when the electronic/soft attenuator is enabled.
--	--------------------------------------------------------------------------------------------------

---

Couplings	<p>The act of connecting the U7227A USB Preamplifier to one of the analyzer's USB ports will cause the Internal Preamp to be switched on. When this happens an informational message will be generated: "Internal Preamp turned on for optimal operation with USB Preamp." Note that if the Internal Preamp was already on, there will be no change to the setting, but if it was Off it will be switched On, to Full Range.</p> <p>Note that this same action occurs when the SA mode is selected while the USB Preamp is connected to one of the analyzer's USB ports, if it is the first time that the SA mode has run since powerup, or if the last time the SA mode was running the USB Preamp was NOT connected.</p> <p>Subsequently disconnecting the USB Preamp from USB does not change the Internal Preamp setting nor restore the previous setting.</p>
Preset	OFF
State Saved	Saved in instrument state
Initial S/W Revision	Prior to A.02.00
Modified at S/W Revision	A.14.00

---

Key Path	AMPTD Y Scale, Internal Preamp
Scope	Meas Global
<b>Remote Command</b>	[:SENSe]:POWer[:RF]:GAIN:BAND LOW FULL [:SENSe]:POWer[:RF]:GAIN:BAND?
Dependencies	<p>Preamp is not available on all hardware platforms. If the preamp is not present or is unlicensed, the key is not shown.</p> <p>If a POW:GAIN:BAND FULL command is sent when a low band preamp is available, the preamp band parameter is to LOW instead of FULL, and an "Option not installed" message is generated.</p>
Preset	LOW
State Saved	Saved in instrument state
Initial S/W Revision	Prior to A.02.00

---

## Off

Turns the internal preamp off

Key Path	AMPTD Y Scale, Internal Preamp
<b>Example</b>	:POW:GAIN OFF
Readback	Off
Initial S/W Revision	Prior to A.02.00

---

## Low Band

Sets the internal preamp to use only the low band.

The frequency range of the installed (optional) low-band preamp is displayed in square brackets on the Low Band key label.

Key Path	AMPTD Y Scale, Internal Preamp
<b>Example</b>	:POW:GAIN ON :POW:GAIN:BAND LOW
Readback	Low Band
Initial S/W Revision	Prior to A.02.00

## Full Range

Sets the internal preamp to use its full range. The low band (0–3.6 GHz or 0–3GHz, depending on the model) is supplied by the low band preamp and the frequencies above low band are supplied by the high band preamp.

The frequency range of the installed (optional) preamp is displayed in square brackets on the Full Range key label. If the high band option is not installed the Full Range key does not appear.

Key Path	AMPTD Y Scale, Internal Preamp
<b>Example</b>	:POW:GAIN ON :POW:GAIN:BAND FULL
Readback	Full Range
Initial S/W Revision	Prior to A.02.00

## Ref Position

Positions the reference level at the top, center or bottom of the Y Scale display. Changing the reference position does not change the reference level value.

Key Path	AMPTD Y Scale
Mode	SA, WCDMA, C2K, WIMAX OFDMA, TD-SCDMA, 1xEVDO, ISDB-T, CMMB, LTE, LTE-TDD, BLUETOOTH, WLAN, MSR, LTEAFDD, LTEATDD
<b>Remote Command</b>	:DISPlay:OBWidth:VIEW[1]:WINDow[1]:TRACe:Y[:SCALE]:RPOSition TOP   CENTER   BOTTom :DISPlay:OBWidth:VIEW[1]:WINDow[1]:TRACe:Y[:SCALE]:RPOSition?
<b>Example</b>	DISP:OBW:VIEW:WIND:TRAC:Y:RPOS BOTT DISP:OBW:VIEW:WIND:TRAC:Y:RPOS?
Notes	You must be in the Spectrum Analysis mode, W-CDMA mode, cdma2000 mode, TD-SCDMA mode, ISDB-T mode, CMMB mode, LTE mode, LTE TDD mode, BLUETOOTH mode, WLAN mode, 1xEVDO mode, MSR, LTE-Advanced FDD/TDD or WIMAX OFDMA mode to use this command.

	Use:INSTRument:SElect to set the mode.
Preset	TOP
State Saved	Saved in instrument state.
Range	Top   Ctr   Bot
Initial S/W Revision	Prior to A.02.00
Modified at S/W Revision	A.03.00

## Auto Scaling

Allows you to toggle the Auto Scaling function between On and Off.

Key Path	AMPTD Y Scale
Mode	SA, WCDMA, C2K, WIMAX OFDMA, TD-SCDMA, 1xEVDO, ISDB-T, CMMB, LTE, LTETDD, BLUETOOTH, WLAN, MSR, LTEAFDD, LTEATDD
Remote Command	:DISPlay:OBWidth:VIEW[1]:WINDow[1]:TRACe:Y[:SCALe]:COUPle 0   1   OFF   ON :DISPlay:OBWidth:VIEW[1]:WINDow[1]:TRACe:Y[:SCALe]:COUPle?
Example	DISP:OBW:VIEW:WIND:TRAC:Y:COUP ON DISP:OBW:VIEW:WIND:TRAC:Y:COUP?
Couplings	When Auto Scaling is On, upon pressing the Restart front-panel key, this function automatically sets the scale per division to 10 dB and determines reference values based on the measurement results. When you set a value to either Scale/Div or Ref Value manually, Auto Scaling automatically changes to Off.
Preset	1
State Saved	Saved in instrument state.
Range	On   Off
Initial S/W Revision	Prior to A.02.00
Modified at S/W Revision	A.03.00

## Auto Couple

The Auto Couple feature provides a quick and convenient way to automatically couple multiple instrument settings. This helps ensure accurate measurements and optimum dynamic range. When the Auto Couple feature is activated, either from the front panel or remotely, all parameters of the current measurement that have an Auto/Manual mode are set to Auto mode and all measurement settings dependent on (or coupled to) the Auto/Man parameters are automatically adjusted for optimal performance.

However, the Auto Couple key actions are confined to the current measurement only. It does not affect other measurements in the mode, and it does not affect markers, marker functions, or trace or display attributes.

See "[More Information](#)" on page 889

Key Path	Front-panel key
Remote Command	:COUPle ALL NONE
Example	:COUP ALL
Notes	:COUPle ALL puts all Auto/Man parameters in Auto mode (equivalent to pressing the Auto Couple key). :COUPLE NONE puts all Auto/Man parameters in manual mode. It decouples all the coupled instrument parameters and is not recommended for making measurements.
Initial S/W Revision	Prior to A.02.00

### More Information

There are two types of functions that have Auto/Manual modes.

#### Auto/Man Active Function keys

An Auto/Man toggle key controls the binary state associated with an instrument parameter by toggling between Auto (where the parameter is automatically coupled to the other parameters it is dependent upon) and Man (where the parameter is controlled independent of the other parameters), as well as making the parameter the active function. The current mode is indicated on the softkey with either Auto or Man underlined as illustrated below.



#### Auto/Man 1-of-N keys

An Auto/Man 1-of-N key allows you to manually pick from a list of parameter values, or place the function in Auto, in which case the value is automatically selected (and indicated) as shown below. If in Auto, Auto is underlined on the calling key. If in manual operation, manual is indicated on the calling key. But the calling key does not actually toggle the function, it simply opens the menu.

10 Occupied Bandwidth Measurement  
Auto Couple

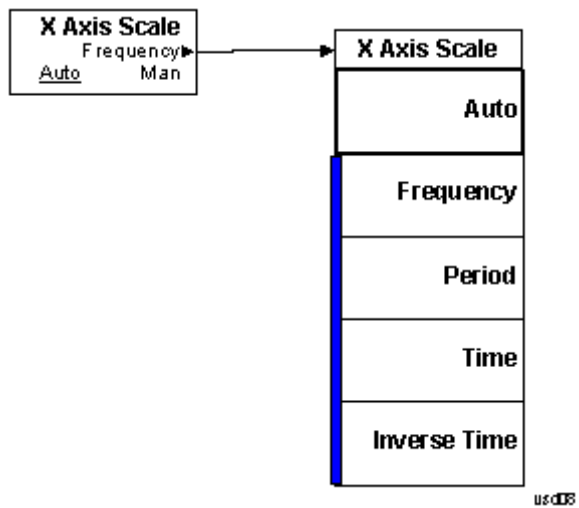

## BW

Accesses a menu of functions that enable you to specify and control the video and resolution bandwidths. You can also select the type of filter for the measurement.

Key Path	Front-panel key
Initial S/W Revision	Prior to A.02.00

## Res BW

Sets the resolution bandwidth for the current measurement. If an unavailable bandwidth is entered with the numeric keypad, the closest available bandwidth is selected.

Key Path	BW
Mode	SA, WCDMA, C2K, WIMAX OFDMA, TD-SCDMA, 1xEVDO, ISDB-T, CMMB, LTE, LTETDD, BLUETOOTH, WLAN, MSR, LTEAFDD, LTEATDD
Remote Command	[:SENSe]:OBWidth:BANDwidth[:RESolution] <bandwidth> [:SENSe]:OBWidth:BANDwidth[:RESolution]? [:SENSe]:OBWidth:BANDwidth[:RESolution]:AUTO ON OFF 1 0 [:SENSe]:OBWidth:BANDwidth[:RESolution]:AUTO?
Example	OBW:BAND 250000 OBW:BAND? OBW:BAND:AUTO OFF OBW:BAND:AUTO?
Notes	You must be in the Spectrum Analysis mode, W-CDMA mode, cdma2000 mode, TD-SCDMA mode, ISDB-T mode, CMMB mode, LTE mode, LTE TDD mode, BLUETOOTH mode, WLAN mode, 1xEVDO mode, MSR, LTE-Advanced FDD/TDD or WIMAX OFDMA mode to use this command. Use:INSTrument:SElect to set the mode.
Couplings	Sweep time is coupled to RBW. As the RBW changes, the sweep time (if set to Auto) is changed to maintain amplitude calibration. Video bandwidth (VBW) is coupled to RBW. As the resolution bandwidth changes, the video bandwidth (if set to Auto) changes to maintain the ratio of VBW/RBW (10:1). When Res BW is set to Auto, the resolution bandwidth is auto-coupled to span. The ratio of Span/RBW is approximately 106:1 when auto coupled. When Res BW is set to Man, bandwidths are entered manually, and these bandwidths are used regardless of other analyzer settings.
Preset	SA: Auto WCDMA: 30 kHz CDMA2K: 12 kHz WIMAX OFDMA: 100 kHz TD-SCDMA: 30 kHz 1xEVDO: 30 kHz ISDB-T: 10 kHz

	CMMB: 3 kHz LTE: 30 kHz LTETDD: 30 kHz BLUETOOTH:10 kHz WLAN: 100kHz MSR: 30 kHz, LTEAFDD, LTEATDD: 30 kHz SA: ON WCDMA, C2K, TD-SCDMA, WIMAX OFDMA, 1xEVDO , ISDB-T, CMMB, LTE, LTETDD, WLAN, MSR, LTEAFDD, LTEATDD: OFF
State Saved	Saved in instrument state.
Min	1 Hz
Max	8 MHz
<b>Backwards Compatibility SCPI</b>	[ :SENSe ] :OBWidth:BWIDth[:RESolution]
Initial S/W Revision	Prior to A.02.00
Modified at S/W Revision	A.03.00

## Video BW

Changes the analyzer post-detection filter.

Key Path	BW
Mode	SA, WCDMA, C2K, WIMAX OFDMA, TD-SCDMA, 1xEVDO, ISDB-T, CMMB, LTE, LTETDD, BLUETOOTH, WLAN, MSR, LTEAFDD, LTEATDD
<b>Remote Command</b>	<pre>[ :SENSe ] :OBWidth:BA NDwidth:VIDeo &lt;bandwidth&gt; [ :SENSe ] :OBWidth:BA NDwidth:VIDeo? [ :SENSe ] :OBWidth:BA NDwidth:VIDeo:AUTO ON OFF 1 0 [ :SENSe ] :OBWidth:BA NDwidth:VIDeo:AUTO?</pre>
<b>Example</b>	<pre>OBW:BA ND:VID 5 MHz OBW:BA ND:VID? OBW:BA ND:VID:AUTO ON OBW:BA ND:VID:AUTO?</pre>
Notes	You must be in the Spectrum Analysis mode, W-CDMA mode, cdma2000 mode, TD-SCDMA mode, ISDB-T mode, CMMB mode, LTE mode, LTE TDD mode, BLUETOOTH mode, WLAN mode, 1xEVDO mode, MSR, LTE-Advanced FDD/TDD or WIMAX OFDMA mode to use this command. Use:INSTrument:SElect to set the mode.
Dependencies	When using the average detector with either Sweep Time set to Man, or in zero span, the VBW setting has no effect and is disabled (grayed out).
Couplings	Video bandwidth (VBW) is coupled to RBW. As the resolution bandwidth changes, the video bandwidth (if set to Auto) changes to maintain the ratio set by VBW/RBW.



Sweep Time is coupled to Video Bandwidth (VBW). As the VBW is changed, the sweep time (when set to Auto) is changed to maintain amplitude calibration. This occurs because of common hardware between the two circuits, even though the Video BW filter is not actually “in-circuit” when the detector is set to Average. Because the purpose of the average detector and the VBW filter are the same, either can be used to reduce the variance of the result.

Although the VBW filter is not “in-circuit” when using the average detector, the Video BW key can have an effect on (Auto) sweep time, and is not disabled. In this case, reducing the VBW setting increases the sweep time, which increases the averaging time, producing a lower-variance trace.

When the video bandwidth is AUTO coupled, the video bandwidth value is set to:

Resolution Bandwidth \* Video Bandwidth to Resolution Bandwidth Ratio

Preset	SA, LTE, LTETDD, WLAN, MSR, LTEAFDD, LTEATDD: Auto WCDMA: 300 kHz CDMA2K:120 kHz WIMAX OFDMA: 1 MHz TD-SCDMA: 300 kHz 1xEVDO: 300 kHz ISDB-T: 300 Hz CMMB: 3 kHz BLUETOOTH: 30 kHz ON ISDB-T, CMMB: OFF
State Saved	Saved in instrument state.
Min	1 Hz
Max	50 MHz
<b>Backwards Compatibility SCPI</b>	[ :SENSe ] :OBwidth :BWIDth :VIDeo
Initial S/W Revision	Prior to A.02.00
Modified at S/W Revision	A.03.00

## Filter Type

Allows you to select the type of filter to be used for the current measurement. Besides the Gaussian filter shape, there are certain special filter types, such as Flat Top, that are desirable under certain conditions.

Key Path	BW
Mode	SA, WCDMA, C2K, WIMAX OFDMA, TD-SCDMA, 1xEVDO, ISDB-T, CMMB, LTE, LTETDD, BLUETOOTH, WLAN, MSR, LTEAFDD, LTEATDD
<b>Remote Command</b>	[ :SENSe ] :OBwidth :BANDwidth :SHAPE GAUSSian   FLATtop [ :SENSe ] :OBwidth :BANDwidth :SHAPE?
<b>Example</b>	OBW:BAND:SHAP GAUS

---

	OBW:BAND:SHAP?
Preset	GAUSSian
State Saved	Saved in instrument state.
Range	Gaussian Flattop
<b>Backwards Compatibility SCPI</b>	[ :SENSe ] :OBWidth:BWIDth:SHAPE
Initial S/W Revision	Prior to A.02.00
Modified at S/W Revision	A.03.00

---

## Cont (Continuous Measurement/Sweep)

Sets the analyzer for Continuous measurement operation. The single/continuous state is Meas Global so the setting will affect all measurements. If you are Paused, pressing Cont does a Resume.

Key Path	Front-panel key
Remote Command	:INITiate:CONTinuous OFF ON 0 1 :INITiate:CONTinuous?
Example	:INIT:CONT 0 puts analyzer in Single measurement operation. :INIT:CONT 1 puts analyzer in Continuous measurement operation
Preset	ON (Note that SYST:PRESet sets INIT:CONT to ON but *RST sets INIT:CONT to OFF)
State Saved	Saved in instrument state
Backwards Compatibility Notes	For Spectrum Analysis mode in ESA and PSA, there is no Cont hardkey, instead there is a Sweep Single/Cont key. In these analyzers, switching the Sweep Single/Cont key from Single to Cont restarts averages (displayed average count reset to 1), but does not restart Max Hold and Min Hold. The X-Series has Single and Cont keys in place of the SweepSingleCont key. In the X-Series, if in single measurement, the Cont key (and INIT:CONT ON ) switches to continuous measurement, but never restarts a measurement and never resets a sweep.
Initial S/W Revision	Prior to A.02.00

In Swept SA Measurement (Spectrum Analysis Mode):

The analyzer takes repetitive sweeps, averages, measurements, etc., when in Continuous mode. When the average count reaches the Average/Hold Number the count stops incrementing, but the analyzer keeps sweeping. See the Trace/Detector section for the averaging formula used both before and after the Average/Hold Number is reached. The trigger condition must be met prior to each sweep. The type of trace processing for multiple sweeps, is set under the Trace/Detector key, with choices of Trace Average, Max Hold, or Min Hold.

In Other Measurements/Modes:

With Avg/Hold Num (in the Meas Setup menu) set to Off or set to On with a value of 1, a sweep is taken after the trigger condition is met; and the analyzer continues to take new sweeps after the current sweep has completed and the trigger condition is again met. However, with Avg/Hold Num set to On with a value >1, multiple sweeps (data acquisitions) are taken for the measurement. The trigger condition must be met prior to each sweep. The sweep is not stopped when the average count k equals the number N set for Avg/Hold Num is reached, but the number k stops incrementing. A measurement average usually applies to all traces, marker results, and numeric results. But sometimes it only applies to the numeric results.

If the analyzer is in Single measurement, pressing the Cont key does not change k and does not cause the sweep to be reset; the only action is to put the analyzer into Continuous measurement operation.

If it is already in continuous sweep:

the INIT:CONT 1 command has no effect

10 Occupied Bandwidth Measurement  
Cont (Continuous Measurement/Sweep)

the INIT:CONT 0 command will place the analyzer in Single Sweep but will have no effect on the current sequence until  $k = N$ , at which point the current sequence will stop and the instrument will go to the idle state.

## File

See "File" on page 354

## FREQ Channel

Accesses a menu of keys that allow you to control the Frequency and Channel parameters of the instrument.

Some features in the Frequency menu are the same for all measurements – they do not change as you change measurements. Settings like these are called “Meas Global” and are unaffected by Meas Preset. For example, the Center Freq setting is the same for all measurements - it does not change as you change measurements.

<b>Key Path</b>	<b>Front-panel key</b>
<b>Initial S/W Revision</b>	<b>Prior to A.02.00</b>

### Center Freq

Sets the frequency that corresponds to the horizontal center of the graticule (when frequency Scale Type is set to linear). While adjusting the Center Frequency the Span is held constant, which means that both Start Frequency and Stop Frequency will change.

Pressing Center Freq also sets the frequency entry mode to Center/Span. In Center/Span mode, the center frequency and span values are displayed below the graticule, and the default active function in the Frequency menu is Center Freq.

The center frequency setting is the same for all measurements within a mode, that is, it is Meas Global. Some modes are also able to share a Mode Global center frequency value. If this is the case, the Mode will have a Global Settings key in its Mode Setup menu.

The Center Freq function sets (and queries) the Center Frequency for the currently selected input. If your analyzer has multiple inputs, and you select another input, the Center Freq changes to the value for that input. SCPI commands are available to directly set the Center Freq for a specific input.

Center Freq is remembered as you go from input to input. Thus you can set a Center Freq of 10 GHz with the RF Input selected, change to BBIQ and set a Center Freq of 20 MHz, then switch to External Mixing and set a Center Freq of 60 GHz, and when you go back to the RF Input the Center Freq will go back to 10 GHz; back to BBIQ and it is 20 MHz; back to External Mixing and it is 60 GHz.

See ["RF Center Freq" on page 901](#)

See [Ext Mix Center Freq](#)

See ["I/Q Center Freq" on page 903](#)

See ["Center Frequency Presets" on page 899](#)

<b>Key Path</b>	<b>FREQ Channel</b>
<b>Scope</b>	<b>Meas Global</b>
<b>Remote Command</b>	<code>[ :SENSe ] :FREQuency:CENTer &lt;freq&gt;</code> <code>[ :SENSe ] :FREQuency:CENTer?</code>

<b>Example</b>	FREQ:CENT 50 MHz FREQ:CENT UP changes the center frequency to 150 MHz if you use FREQ:CENT:STEP 100 MHz to set the center frequency step size to 100 MHz FREQ:CENT?
<b>Notes</b>	This command sets either the RF or I/Q Center Frequency depending on the selected input. For RF input it is equivalent to FREQ:RF:CENT For I/Q input it is equivalent to FREQ:IQ:CENT Preset and Max values are dependent on Hardware Options (5xx) If no terminator (e.g. MHz) is sent the terminator Hz is used. If a terminator with unit other than Frequency is used, an invalid suffix error message is generated.
<b>Dependencies</b>	The Center Frequency can be limited by Start or Stop Freq limits, if the Span is so large that Start or Stop reach their limit.
<b>Couplings</b>	When operating in “swept span”, any value of the Center Frequency or Span that is within the frequency range of the analyzer is allowed when the value is being set through the front panel numeric key pad or the SCPI command. The other parameter is forced to a different value if needed, to keep the Start and the Stop Frequencies within the analyzer’s frequency range
<b>Preset</b>	Depends on instrument maximum frequency, mode, measurement, and selected input. See <a href="#">"Center Frequency Presets" on page 899</a> and <a href="#">"RF Center Freq" on page 901</a> and <a href="#">Ext Mix Center Freq</a> and <a href="#">"I/Q Center Freq" on page 903</a> .
<b>State Saved</b>	Saved in instrument state
<b>Min</b>	Depends on instrument maximum frequency, mode, measurement, and selected input.. See <a href="#">"Center Frequency Presets" on page 899</a> and <a href="#">"RF Center Freq" on page 901</a> and <a href="#">"I/Q Center Freq" on page 903</a> .
<b>Max</b>	Depends on instrument maximum frequency, mode, measurement, and selected input.. See <a href="#">"Center Frequency Presets" on page 899</a> and <a href="#">"RF Center Freq" on page 901</a> and <a href="#">"I/Q Center Freq" on page 903</a> .
<b>Default Unit</b>	Hz
<b>Status Bits/OPC</b>	Non-overlapped
<b>Dependencies</b>	
<b>Initial S/W Revision</b>	Prior to A.02.00

## Center Frequency Presets

The following table provides the Center Frequency Presets for the Spectrum Analyzer mode, and the Max Freq, for the various frequency options:

Freq Option	CF after Mode Preset	Stop Freq after Mode Preset	Max Freq (can't tune)

10 Occupied Bandwidth Measurement  
FREQ Channel

			above)
503 (all but N9000A)	1.805 GHz	3.6 GHz	3.7 GHz
503 (N9000A)	1.505 GHz	3.0 GHz	3.08 GHz
507 (all but N9000A)	3.505 GHz	7.0 GHz	7.1 GHz
507 (N9000A)	3.755 GHz	7.5 GHz	7.58 GHz
508 (all but N9038A)	1.805 GHz	3.6 GHz	8.5 GHz
508 (N9038A)	4.205 GHz	8.4 GHz	8.5 GHz
513	6.805 GHz	13.6 GHz	13.8 GHz
526 (all but N9000A and N9038A)	13.255 GHz	26.5 GHz	27.0 GHz
526 (N9000A)	13.255 GHz	26.5 GHz	26.55 GHz
526 (N9038A)	1.805 GHz	3.6 GHz	27.0 GHz
532	16.005 GHz	32.0 GHz	32.5 GHz
543	21.505 GHz	43.0 GHz	TBD
544	22.005 GHz	44.0 GHz	44.5 GHz
550	25.005 GHz	50.0 GHz	51 GHz

Input 2:

Model	CF after Mode Preset	Stop Freq after Mode Preset	Max Freq (can't tune above)
N9000A opt C75	0.7505GHz	1.5 GHz	1.58 GHz
N9038A	505 MHz	1 GHz	1.000025 GHz

Tracking Generator Frequency Limits (N9000A only):

Tracking Generator Option	Min Freq (clips to this freq when turn TG on and	If above this Freq, Stop Freq clipped to this Freq when	Max Freq (can't tune above) while TG



	can't tune below while TG on)	TG turned on	on
T03	9 kHz	3.0 GHz	3.08 GHz
T06	9 kHz	6.0 GHz	6.05 GHz

The following table shows the Center Frequency Presets for modes other than Spectrum Analyzer:

Mode	CF Preset for RF
WCDMA	1 GHz
WIMAXOFDMA,	1 GHz
BASIC	1 GHz
ADEMOD	1 GHz
VSA	1 GHz
TDSCDMA	1 GHz
PNOISE	1 GHz
LTE	1 GHz
LTETDD	1 GHz
MSR	1 GHz
GSM	935.2 MHz
NFIGURE	1.505 GHz

## RF Center Freq

SCPI command for specifying the RF Center Frequency. This command will set the Center Frequency to be used when the RF input is selected, even if the RF input is not the input that is selected at the time the command is sent. Note that the Center Freq function in the Frequency menu on the front panel always applies to the currently selected input.

Scope	Meas Global
<b>Remote Command</b>	<code>[ :SENSe ] :FREQuency:RF:CENTer &lt;freq&gt;</code> <code>[ :SENSe ] :FREQuency:RF:CENTer?</code>
<b>Example</b>	FREQ:RF:CENT 30 MHz
Notes	This command is the same in all modes, but the parameter is Measurement Global. So the value is independent in each mode and common across all the measurements in the mode.
Dependencies	If the electronic/soft attenuator is enabled, any attempt to set Center Frequency such that the Stop Frequency would be >3.6 GHz fails and results in an advisory message. If the equivalent SCPI command is sent, this same message is generated as part of a “-221, Settings conflict” warning. If Source Mode is set to Tracking, and the Max or Min Center Freq is therefore limited by the limits of the source, a warning message is generated, “Data out of range;clipped to source max/min” if these limits are exceeded. Note that for an external source, these limits can be affected by the settings of

	Source Numerator, Source Denominator and Power Sweep.
Preset	See table above
State Saved	Saved in instrument state.
Min	-79.999995 MHz, unless Source Mode is set to Tracking, in which case it is limited by the minimum frequency of the Source
Max	See table above. Basically instrument maximum frequency - 5 Hz. Note that, if the Source Mode is set to Tracking, the effective instrument maximum frequency may be limited by the source maximum frequency.  If the knob or step keys are being used, also depends on the value of the other three interdependent parameters Span, Start Frequency and Stop Frequency
Initial S/W Revision	Prior to A.02.00
Modified at S/W Revision	A.03.00

### Ext Mix Center Freq

SCPI command for specifying the External Mixer Center Frequency. This command will set the Center Frequency to be used when the External Mixer is selected, even if the External Mixer input is not the input which is selected at the time the command is sent. Note that the Center Freq function in the Frequency menu on the front panel always applies to the currently selected input.

Scope	Meas Global
Remote Command	<code>[ :SENSe ] :FREQuency:EMIXer:CENTer &lt;freq&gt;</code> <code>[ :SENSe ] :FREQuency:EMIXer:CENTer?</code>
Example	<code>:FREQ:EMIX:CENT 60 GHz</code> <code>:FREQ:EMIX:CENT?</code>
Notes	This command is the same in all modes, but the parameter is Measurement Global. So the value is independent in each mode and common across all the measurements in the mode.
Couplings	When returning to External Mixing after having been switched to one of the other inputs (e.g., RF), you will come back into the settings that you had when you left External Mixing. So you will come back to the band you were in with the Center Frequency that you had. However, Span is not an input-dependent parameter, therefore you will bring the span over from the other input. Therefore, the analyzer comes back with the span from the previous input, limited as necessary by the current mixer setup.
Preset	When a Mode Preset is performed while in External Mixing, the Start frequency of the current Mode is set to the nominal Min Freq of the lowest harmonic range in the Harmonic Table for the current mixer setup. Similarly, the Stop frequency of the current Mode is set to the nominal Max Freq of the highest harmonic range in the Harmonic Table. The Center Freq thus presets to the point arithmetically equidistant from these two frequencies.  If the current measurement has a limited Span available to it, and cannot achieve the Span shown in the table (Span=Stop Freq - Start Freq), the analyzer uses the maximum Span the measurement allows, and still sets the Center Freq to the midpoint of the Start and Stop Freq values in the Harmonic Table.

	When Restore Input/Output Defaults is performed, the mixer presets to the 11970A, whose Start and Stop frequencies are 26.5 and 40 GHz respectively. The center of these two frequencies is 33.25 GHz. Therefore, after a Restore Input/Output Defaults, if you go into External Mixing and do a Mode Preset while in the Spectrum Analyzer Mode, the resulting Center Freq is 33.25 GHz.
State Saved	Saved in instrument state.
Min	The minimum frequency in the currently selected mixer band + 5 Hz
Max	The maximum frequency in the currently selected mixer band – 5 Hz If the knob or step keys are being used, also depends on the value of the other three interdependent parameters Span, Start Frequency and Stop Frequency
Initial S/W Revision	A.08.01

### I/Q Center Freq

SCPI command for specifying the I/Q Center Frequency. This command will set the Center Frequency to be used when the I/Q input is selected, even if the I/Q input is not the input which is selected at the time the command is sent. Note that the Center Freq function in the Frequency menu on the front panel always applies to the currently selected input.

Scope	Meas Global
Remote Command	[ :SENSe ] :FREQuency:IQ:CENTer <freq> [ :SENSe ] :FREQuency:IQ:CENTer?
Example	FREQ:IQ:CENT: 30 MHz
Notes	This command is the same in all modes, but the parameter is Measurement Global. So the value is independent in each mode and common across all the measurements in the mode.
Preset	0 Hz
State Saved	Saved in instrument state.
Min	-40.049995 MHz
Max	40.049995 MHz
Initial S/W Revision	Prior to A.02.00

### CF Step

Changes the step size for the center frequency and start and stop frequency functions. Once a step size has been selected and the center frequency function is active, the step keys (and the UP|DOWN parameters for Center Frequency from remote commands) change the center frequency by the step-size value. The step size function is useful for finding harmonics and sidebands beyond the current frequency span of the analyzer.

Note that the start and stop frequencies also step by the CF Step value.

Key Path	FREQ Channel
Remote Command	<pre>[ :SENSe] :FREQuency:CENTer:STEP[:INCRement] &lt;freq&gt; [ :SENSe] :FREQuency:CENTer:STEP[:INCRement] ? [ :SENSe] :FREQuency:CENTer:STEP:AUTO OFF ON 0 1 [ :SENSe] :FREQuency:CENTer:STEP:AUTO?</pre>
Example	<pre>FREQ:CENT:STEP:AUTO ON FREQ:CENT:STEP 500 MHz FREQ:CENT UP increases the current center frequency value by 500 MHz FREQ:CENT:STEP? FREQ:CENT:STEP:AUTO?</pre>
Notes	Preset and Max values are depending on Hardware Options (503, 507, 508, 513, 526)
Notes	Preset and Max values are dependent on Hardware Options (5xx)
Dependencies	Freq Offset is not available in External Mixing. In this case the Freq Offset key is grayed out and shows a value of zero. It will once again be available, and show the previously set value, when you return to the RF Input.
Dependencies	Span, RBW, Center frequency If the electronic/soft attenuator is enabled, any attempt to change the value of the center frequency >3.6 GHz by pressing the Up-arrow key, fails and results in an advisory message. If the equivalent SCPI command is sent, this same message is generated as part of a “-221, Settings conflict” warning.
Couplings	When auto-coupled in a non-zero span, the center frequency step size is set to 10% of the span. When auto-coupled in zero span, the center frequency step size is set to the equivalent -3 dB RBW value.
Preset	Auto ADEM0D: 1 MHz ON
State Saved	Saved in instrument state
Min	– (the maximum frequency of the instrument). That is, 27 GHz max freq instrument has a CF step range of +/- 27 GHz. Note that this is the maximum frequency given the current settings of the instrument, so in External Mixing, for example, it is the maximum frequency of the current mixer band.
Max	The maximum frequency of the instrument. That is, 27 GHz max freq instrument has a CF step range of +/- 27 GHz. Note that this is the maximum frequency given the current settings of the instrument, so in External Mixing, for example, it is the maximum frequency of the current mixer band.
Default Unit	Hz
Status Bits/OPC dependencies	non-overlapped
Initial S/W Revision	Prior to A.02.00
Modified at S/W Revision	A.03.00

## Input/Output

See ["Input/Output" on page 226](#)

## Marker

Accesses a menu that enables you to select, set up and control the markers for the current measurement.

Key Path	Front-panel key
Initial S/W Revision	Prior to A.02.00

### Select Marker

Displays the menu keys that enable you to select, set up and control the markers for the current measurement

Key Path	Marker
Initial S/W Revision	Prior to A.02.00

### Select Marker

Displays 12 markers available for selection.

Key Path	Marker, Properties
Initial S/W Revision	Prior to A.02.00

### Marker Type

Sets the marker control mode to Normal, Delta or Off, If the selected marker is Off, pressing Marker sets it to Normal and places a single marker at the center of the display. At the same time, Marker X Axis Value appears on the Active Function area.

Key Path	Marker
Mode	SA, WCDMA, C2K, WIMAX OFDMA, TD-SCDMA, 1xEVDO, ISDB-T, CMMB, LTE, LTETDD, BLUETOOTH, WLAN, MSR, LTEAFDD, LTEATDD
<b>Remote Command</b>	:CALCulate:OBWidth:MARKer[1] 2 ... 12:MODE POSition   DELTa   OFF :CALCulate:OBWidth:MARKer[1] 2 ... 12:MODE?
<b>Example</b>	CALC:OBW:MARK:MODE POS CALC:OBW:MARK:MODE?
<b>Notes</b>	If the selected marker is Off, pressing Marker sets it to Normal and places it at the center of the screen on the trace determined by the Marker Trace rules. At the same time, Marker X Axis Value appears on the Active Function area.  Default Active Function: the active function for the selected marker's current control mode. If the current control mode is Off, there is no active function and the active function is turned off.  Active Function Display: the marker X axis value entered in the active function area displays the marker value to its full entered precision.

Preset	OFF
State Saved	Saved in instrument state.
Range	Normal   Delta   Off
Initial S/W Revision	Prior to A.02.00
Modified at S/W Revision	A.03.00

## Properties

Accesses the marker properties menu.

Key Path	Marker
Initial S/W Revision	Prior to A.02.00

## Select Marker

Displays the menu keys that enable you to select, set up and control the markers for the current measurement

Key Path	Marker
Initial S/W Revision	Prior to A.02.00

## Select Marker

Displays 12 markers available for selection.

Key Path	Marker, Properties
Initial S/W Revision	Prior to A.02.00

## Relative To

Selects the desired marker. The selected marker will be relative to its reference marker.

Key Path	Marker, Properties
Mode	SA, WCDMA, C2K, WIMAX OFDMA, TD-SCDMA, 1xEVDO, ISDB-T, CMMB, LTE, LTETDD, BLUETOOTH, WLAN, MSR, LTEAFDD, LTEATDD
Remote Command	:CALCulate:OBWidth:MARKer[1] 2 ... 12:REFerence <integer> :CALCulate:OBWidth:MARKer[1] 2 ... 12:REFerence?
Example	CALC:OBW:MARK:REF 2

	<b>CALC:OBW:MARK:REF?</b>
Notes	A marker cannot be relative to itself so that choice is grayed out, and if sent from SCPI generates error -221: "Settings conflict; marker cannot be relative to itself." When queried a single value is returned (the specified marker numbers relative marker). You must be in the Spectrum Analysis mode, WCDMA mode, TD-SCDMA mode, 1xEVDO mode, WIMAX OFDMA mode ISDB-T mode, WLAN mode, CMMB mode, LTE mode, LTETDD mode or BLUETOOTH mode to use this command. Use:INSTrument:SElect to set the mode.
Preset	2 3 4 5 6 7 8 9 10 11 12 1
State Saved	Saved in instrument state.
Min	1
Max	12
Readback	Current selected relative to marker number.
Initial S/W Revision	Prior to A.02.00
Modified at S/W Revision	A.03.00

### All Markers Off

Turns off all markers.

Key Path	Marker
Mode	SA, WCDMA, C2K, WIMAX OFDMA, TD-SCDMA, 1xEVDO, ISDB-T, CMMB, LTE, LTETDD, BLUETOOTH, WLAN, MSR, LTEAFDD, LTEATDD
<b>Remote Command</b>	:CALCulate:OBWidth:MARKer:AOff
<b>Example</b>	CALC:OBW:MARK:AOff
Initial S/W Revision	Prior to A.02.00
Modified at S/W Revision	A.03.00

### Marker X Axis Value (Remote Command Only)

Sets the marker X Axis value in the current marker X Axis Scale unit. It has no effect if the control mode is Off.

Key Path	SCPI only
Mode	SA, WCDMA, C2K, WIMAX OFDMA, TD-SCDMA, 1xEVDO, ISDB-T, CMMB, LTE, LTETDD, BLUETOOTH, WLAN, MSR, LTEAFDD, LTEATDD
<b>Remote Command</b>	:CALCulate:OBWidth:MARKer[1] 2 ... 12:X <freq> :CALCulate:OBWidth:MARKer[1] 2 ... 12:X?
<b>Example</b>	CALC:OBW:MARK3:X 0 CALC:OBW:MARK3:X?
Notes	The query returns the marker's absolute X Axis value if the control mode is Normal, or the offset from



	the marker's reference marker if the control mode is Delta. The query is returned in the fundamental units for the current marker X Axis scale: Hz for Frequency.
Preset	After a preset, all markers are turned OFF, so Marker X Axis Value query returns a not a number (NAN).
State Saved	No
Min	-9.9E+37
Max	9.9E+37
Initial S/W Revision	Prior to A.02.00
Modified at S/W Revision	A.03.00

### Marker X Axis Position (Remote Command Only)

Sets the marker X position in trace points. It has no effect if the control mode is Off.

Key Path	SCPI only
Mode	SA, WCDMA, C2K, WIMAX OFDMA, TD-SCDMA, 1xEVDO, ISDB-T, CMMB, LTE, LTETDD, BLUETOOTH, WLAN, MSR, LTEAFDD, LTEATDD
<b>Remote Command</b>	:CALCulate:OBWidth:MARKer[1] 2 ... 12:X:POSition <real> :CALCulate:OBWidth:MARKer[1] 2 ... 12:X:POSition?
<b>Example</b>	CALC:OBW:MARK10:X:POS 0 CALC:OBW:MARK10:X:POS?
Notes	The query returns the marker's absolute X Axis value in trace points if the control mode is Normal, or the offset from the marker's reference marker in trace points if the control mode is Delta.
Preset	After a preset, all markers are turned OFF, so Marker X Axis Value query returns a not a number (NAN).
State Saved	No
Min	-9.9E+37
Max	9.9E+37
Initial S/W Revision	Prior to A.02.00
Modified at S/W Revision	A.03.00

### Marker Y Axis Value (Remote Command Only)

Returns the marker Y Axis value in the current marker Y Axis unit.

Key Path	SCPI only
Mode	SA, WCDMA, C2K, WIMAX OFDMA, TD-SCDMA, 1xEVDO, ISDB-T, CMMB, LTE, LTETDD, BLUETOOTH, WLAN, MSR, LTEAFDD, LTEATDD
<b>Remote Command</b>	:CALCulate:OBWidth:MARKer[1] 2 ... 12:Y?

<b>Example</b>	CALC:OBW:MARK11:Y?
Preset	Result dependent on Markers setup and signal source.
State Saved	No
Min	-9.9E+37
Max	9.9E+37
Initial S/W Revision	Prior to A.02.00
Modified at S/W Revision	A.03.00

### Backward Compatibility SCPI Commands

Sets or queries the state of a marker. Setting a marker which is OFF to state ON or 1 puts it in Normal mode and places it at the center of the screen.

Key Path	SCPI only
Mode	SA, WCDMA, C2K, WIMAX OFDMA, TD-SCDMA, 1xEVDO, ISDB-T, CMMB, LTE, LTETDD, BLUETOOTH, WLAN, MSR, LTEAFDD, LTEATDD
<b>Remote Command</b>	:CALCulate:OBWidth:MARKer[1] 2 ... 12:STATe OFF ON 0 1 :CALCulate:OBWidth:MARKer[1] 2 ... 12:STATe?
<b>Example</b>	CALC:OBW:MARK3:STAT ON CALC:OBW:MARK3:STAT?
Preset	OFF
State Saved	Saved in instrument state.
Initial S/W Revision	Prior to A.02.00
Modified at S/W Revision	A.03.00

## Marker Function

There are no 'Marker Functions' supported in this measurement. When pressed, this key displays a blank menu.

---

Key Path	Front panel key
Initial S/W Revision	Prior to A.02.00

---

## Marker To

There is no 'Marker To' functionality supported in this measurement. When pressed, this key displays a blank menu.

---

Key Path	Front panel key
Initial S/W Revision	Prior to A.02.00

---

## Meas

The information in this section is common to all measurements. For key and remote command information for a specific measurement, refer to the section that describes the measurement of interest.

Measurements available under the Meas key are specific to the current Mode.

When viewing Help for measurements, note the following:

**NOTE**

Operation for some keys differs between measurements. The information displayed in Help pertains to the current measurement. To see how a key operates in a different measurement, exit Help (press the Cancel Esc key), select the measurement, then reenter Help (press the Help key) and press that key.

---

Key Path	Front-panel key
Initial S/W Revision	Prior to A.02.00

---

### Remote Measurement Functions

This section contains the following topics:

"Measurement Group of Commands" on page 2849

"Current Measurement Query (Remote Command Only)" on page 2851

"Limit Test Current Results (Remote Command Only)" on page 2851

"Data Query (Remote Command Only)" on page 2851

"Calculate/Compress Trace Data Query (Remote Command Only)" on page 2852

"Calculate Peaks of Trace Data (Remote Command Only)" on page 2857

Hardware-Accelerated Fast Power Measurement (Remote Command Only)

"Format Data: Numeric Data (Remote Command Only)" on page 2858

"Format Data: Byte Order (Remote Command Only)" on page 2859

---

Initial S/W Revision	Prior to A.02.00
----------------------	------------------

---

## Measurement Group of Commands

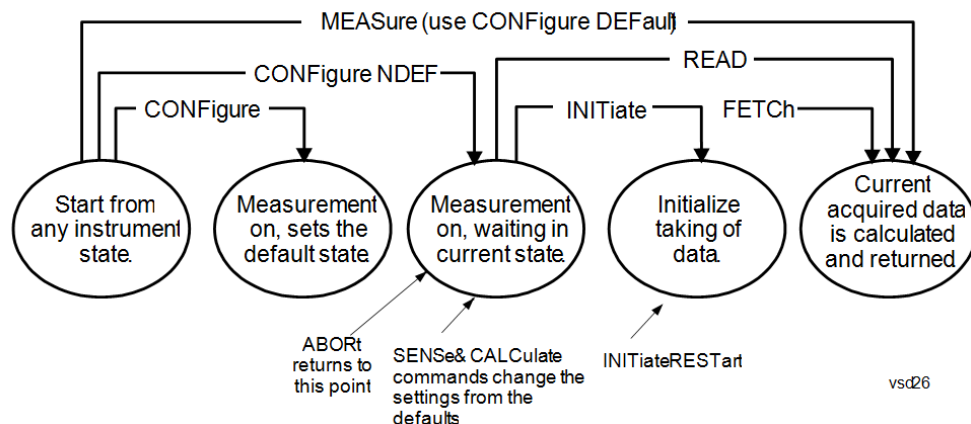

---

### Measure Commands:

:MEASure:<measurement>[n]?

This is a fast single-command way to make a measurement using the factory default instrument settings. These are the settings and units that conform to the Mode Setup settings (e.g. radio standard) that you have currently selected.

- Stops the current measurement (if any) and sets up the instrument for the specified measurement using the factory defaults
- Initiates the data acquisition for the measurement
- Blocks other SCPI communication, waiting until the measurement is complete before returning results.
- If the function does averaging, it is turned on and the number of averages is set to 10.
- After the data is valid it returns the scalar results, or the trace data, for the specified measurement. The type of data returned may be defined by an [n] value that is sent with the command.
- The scalar measurement results will be returned if the optional [n] value is not included, or is set to 1. If the [n] value is set to a value other than 1, the selected trace data results will be returned. See each command for details of what types of scalar results or trace data results are available.
- ASCII is the default format for the data output. (Older versions of Spectrum Analysis and Phase Noise mode measurements only use ASCII.) The binary data formats should be used for handling large blocks of data since they are smaller and faster than the ASCII format. Refer to the FORMat:DATA command for more information.

If you need to change some of the measurement parameters from the factory default settings you can set up the measurement with the CONFigure command. Use the commands in the SENSe:<measurement> and CALCulate:<measurement> subsystems to change the settings. Then you can use the READ? command to initiate the measurement and query the results.

If you need to repeatedly make a given measurement with settings other than the factory defaults, you can use the commands in the SENSe:<measurement> and CALCulate:<measurement> subsystems to set up the measurement. Then use the READ? command to initiate the measurement and query results.

Measurement settings persist if you initiate a different measurement and then return to a previous one. Use READ:<measurement>? if you want to use those persistent settings. If you want to go back to the default settings, use MEASure:<measurement>?.

---

### Configure Commands:

:CONFigure:<measurement>

This command stops the current measurement (if any) and sets up the instrument for the specified measurement using

---

---

the factory default instrument settings. It does not initiate the taking of measurement data unless INIT:CONTinuous is ON. If you change any measurement settings after using the CONFigure command, the READ command can be used to initiate a measurement without changing the settings back to their defaults.

In the Swept SA measurement in Spectrum Analyzer mode the CONFigure command also turns the averaging function on and sets the number of averages to 10 for all measurements.

:CONFigure: <measurement>: NDEFault stops the current measurement and changes to the specified measurement. It does not change the settings to the defaults. It does not initiate the taking of measurement data unless INIT:CONTinuous is ON.

The CONFigure? query returns the current measurement name.

The CONFigure:CATalog? query returns a quoted string of all licensed measurement names in the current mode. For example, "SAN, CHP, OBW, ACP, PST, TXP, SPUR, SEM, LIST".

---

#### Fetch Commands:

:FETCh:<measurement>[n]?

This command puts selected data from the most recent measurement into the output buffer. Use FETCh if you have already made a good measurement and you want to return several types of data (different [n] values, for example, both scalars and trace data) from a single measurement. FETCh saves you the time of re-making the measurement. You can only FETCh results from the measurement that is currently active, it will not change to a different measurement. An error message is reported if a measurement other than the current one is specified.

If you need to get new measurement data, use the READ command, which is equivalent to an INITiate followed by a FETCh.

The scalar measurement results will be returned if the optional [n] value is not included, or is set to 1. If the [n] value is set to a value other than 1, the selected trace data results will be returned. See each command for details of what types of scalar results or trace data results are available. The binary data formats should be used for handling large blocks of data since they are smaller and transfer faster than the ASCII format. (FORMat:DATA)

FETCh may be used to return results other than those specified with the original READ or MEASure command that you sent.

---

#### INITiate Commands:

:INITiate:<measurement>

This command is not available for measurements in all the instrument modes:

- Initiates a trigger cycle for the specified measurement, but does not output any data. You must then use the FETCh<meas> command to return data. If a measurement other than the current one is specified, the instrument will switch to that measurement and then initiate it.
- For example, suppose you have previously initiated the ACP measurement, but now you are running the channel power measurement. If you send INIT:ACP? it will change from channel power to ACP and will initiate an ACP measurement.
- Does not change any of the measurement settings. For example, if you have previously started the ACP measurement and you send INIT:ACP? it will initiate a new ACP measurement using the same instrument settings as the last time ACP was run.
- If your selected measurement is currently active (in the idle state) it triggers the measurement, assuming the trigger conditions are met. Then it completes one trigger cycle. Depending upon the measurement and the number of averages, there may be multiple data acquisitions, with multiple trigger events, for one full trigger cycle. It also holds off additional commands on GPIB until the acquisition is complete.

---

#### READ Commands:

:READ:<measurement>[n]?

- Does not preset the measurement to the factory default settings. For example, if you have previously initiated the ACP
-

---

measurement and you send READ:ACP? it will initiate a new measurement using the same instrument settings.

- Initiates the measurement and puts valid data into the output buffer. If a measurement other than the current one is specified, the instrument will switch to that measurement before it initiates the measurement and returns results.
  - For example, suppose you have previously initiated the ACP measurement, but now you are running the channel power measurement. Then you send READ:ACP? It will change from channel power back to ACP and, using the previous ACP settings, will initiate the measurement and return results.
  - Blocks other SCPI communication, waiting until the measurement is complete before returning the results
  - If the optional [n] value is not included, or is set to 1, the scalar measurement results will be returned. If the [n] value is set to a value other than 1, the selected trace data results will be returned. See each command for details of what types of scalar results or trace data results are available. The binary data formats should be used when handling large blocks of data since they are smaller and faster than the ASCII format. (FORMat:DATA)
- 

---

Initial S/W Revision	Prior to A.02.00
----------------------	------------------

---

### Current Measurement Query (Remote Command Only)

This command returns the name of the measurement that is currently running.

---

<b>Remote Command</b>	:CONFigure?
-----------------------	-------------

<b>Example</b>	CONF?
----------------	-------

Initial S/W Revision	Prior to A.02.00
----------------------	------------------

---

### Limit Test Current Results (Remote Command Only)

Queries the status of the current measurement limit testing. It returns a 0 if the measured results pass when compared with the current limits. It returns a 1 if the measured results fail any limit tests.

---

<b>Remote Command</b>	:CALCulate:CLIMits:FAIL?
-----------------------	--------------------------

<b>Example</b>	CALC:CLIM:FAIL? queries the current measurement to see if it fails the defined limits. Returns a 0 or 1: 0 it passes, 1 it fails.
----------------	--------------------------------------------------------------------------------------------------------------------------------------

Initial S/W Revision	Prior to A.02.00
----------------------	------------------

---

### Data Query (Remote Command Only)

Returns the designated measurement data for the currently selected measurement and subopcode.

n = any valid subopcode for the current measurement. See the measurement command results table for your current measurement, for information about what data is returned for the subopcodes.

This command uses the data setting specified by the FORMat:BORDER and FORMat:DATA commands and can return real or ASCII data. (See the format command descriptions under Input/Output in the Analyzer Setup section.)



<b>Remote Command</b>	:CALCulate:DATA[n]?
<b>Notes</b>	The return trace depends on the measurement. In CALCulate:<meas>:DATA[n], n is any valid subopcode for the current measurement. It returns the same data as the FETCH:<measurement>? query where <measurement> is the current measurement.
<b>Initial S/W Revision</b>	Prior to A.02.00

### Calculate/Compress Trace Data Query (Remote Command Only)

Returns compressed data for the currently selected measurement and sub-opcode [n].

n = any valid sub-opcode for that measurement. See the MEASure:<measurement>? command description of your specific measurement for information on the data that can be returned.

The data is returned in the current Y Axis Unit of the analyzer. The command is used with a sub-opcode <n> (default=1) to specify the trace. With trace queries, it is best if the analyzer is not sweeping during the query. Therefore, it is generally advisable to be in Single Sweep, or Update=Off.

This command is used to compress or decimate a long trace to extract and return only the desired data. A typical example would be to acquire N frames of GSM data and return the mean power of the first burst in each frame. The command can also be used to identify the best curve fit for the data.

<b>Remote Command</b>	:CALCulate:DATA<n>:COMPRESS? BLOCK   CFIT   MAXimum   MINimum   MEAN   DMEan   RMS   RMSCubed   SAMPLE   SDEVIation   PPHase [,<soffset> [,<length>[,<roffset>[,<rlimit>]]]]
<b>Example</b>	To query the mean power of a set of GSM bursts: Supply a signal that is a set of GSM bursts. Select the IQ Waveform measurement (in IQ Analyzer Mode). Set the sweep time to acquire at least one burst. Set the triggers such that acquisition happens at a known position relative to a burst. Then query the mean burst levels using, CALC:DATA2:COMP? MEAN, 24e-6, 526e-6 (These parameter values correspond to GSM signals, where 526e-6 is the length of the burst in the slot and you just want 1 burst.)
<b>Notes</b>	The command supports 5 parameters. Note that the last 4 (<soffset>, <length>, <roffset>, <rlimit>) are optional. But these optional parameters must be entered in the specified order. For example, if you want to specify <length>, then you must also specify <soffset>. See details below for a definition of each of these parameters. This command uses the data in the format specified by FORMat:DATA, returning either binary or ASCII data.
<b>Initial S/W Revision</b>	Prior to A.02.00

- BLOCK or block data - returns all the data points from the region of the trace data that you specify. For example, it could be used to return the data points of an input signal over several timeslots, excluding the portions of the trace data that you do not want. (This is x,y pairs for trace data and I,Q pairs for complex data.)

- CFIT or curve fit - applies curve fitting routines to the data. <soffset> and <length> are required to define the data that you want. <roffset> is an optional parameter for the desired order of the curve equation. The query will return the following values: the x-offset (in seconds) and the curve coefficients ((order + 1) values).

MIN, MAX, MEAN, DME, RMS, RMSC, SAMP, SDEV and PPH return one data value for each specified region (or <length>) of trace data, for as many regions as possible until you run out of trace data (using <roffset> to specify regions). Or they return the number of regions you specify (using <rlimit>) ignoring any data beyond that.

- MINimum - returns the minimum data point (y value) for the specified region(s) of trace data. For I/Q trace data, the minimum magnitude of the I/Q pairs is returned.
- MAXimum - returns the maximum data point (y value) for the specified region(s) of trace data. For I/Q trace data, the maximum magnitude of the I/Q pairs is returned.
- MEAN - returns a single value that is the arithmetic mean of the data point values (in dB/ dBm) for the specified region(s) of trace data. For I/Q trace data, the mean of the magnitudes of the I/Q pairs is returned. See the following equations.

•

**NOTE**

If the original trace data is in dB, this function returns the arithmetic mean of those log values, not log of the mean power which is a more useful value. The mean of the log is the better measurement technique when measuring CW signals in the presence of noise. The mean of the power, expressed in dB, is useful in power measurements such as Channel Power. To achieve the mean of the power, use the RMS option.

Equation 1

Mean Value of Data Points for Specified Region(s)

$$MEAN = \frac{1}{n} \sum_{X_i \in \text{region}(s)} X_i$$

where  $X_i$  is a data point value, and  $n$  is the number of data points in the specified region(s).

Equation 2

Mean Value of I/Q Data Pairs for Specified Region(s)

$$MEAN = \frac{1}{n} \sum_{X_i \in \text{region}(s)} |X_i|$$

where  $|X_i|$  is the magnitude of an I/Q pair, and  $n$  is the number of I/Q pairs in the specified region(s).

- DMEan - returns a single value that is the mean power (in dB/ dBm) of the data point values for the specified region(s) of trace data. See the following equation:

Equation 3

DMEan Value of Data Points for Specified Region(s)

$$\text{DME} = 10 \times \log_{10} \left( \frac{1}{n} \sum_{X_i \in \text{region}(s)} 10^{\frac{X_i}{10}} \right)$$

- RMS - returns a single value that is the average power on a root-mean-squared voltage scale (arithmetic rms) of the data point values for the specified region(s) of trace data. See the following equation.

**NOTE** For I/Q trace data, the rms of the magnitudes of the I/Q pairs is returned. See the following equation. This function is very useful for I/Q trace data. However, if the original trace data is in dB, this function returns the rms of the log values which is not usually needed.

Equation 4

RMS Value of Data Points for Specified Region(s)

$$\text{RMS} = \sqrt{\frac{1}{n} \sum_{X_i \in \text{region}(s)} X_i^2}$$

where  $X_i$  is a data point value, and  $n$  is the number of data points in the specified region(s).

Equation 5

RMS Value of I/Q Data Pairs for Specified Region(s)

$$\text{RMS} = \sqrt{\frac{1}{n} \sum_{X_i \in \text{region}(s)} X_i X_i^*}$$

where  $X_i$  is the complex value representation of an I/Q pair,  $X_i^*$  its conjugate complex number, and  $n$  is the number of I/Q pairs in the specified region(s).

Once you have the rms value for a region of trace data (linear or I/Q), you may want to calculate the mean power. You must convert this rms value (peak volts) to power in dBm:

$$10 \times \log[10 \times (\text{rms value})^2]$$

- SAMPLe - returns the first data value (x,y pair) for the specified region(s) of trace data. For I/Q trace data, the first I/Q pair is returned.
- SDEViation - returns a single value that is the arithmetic standard deviation for the data point values for the specified region(s) of trace data. See the following equation.
- For I/Q trace data, the standard deviation of the magnitudes of the I/Q pairs is returned. See the following equation.

Equation 6

Standard Deviation of Data Point Values for Specified Region(s)

$$\text{SDEV} = \sqrt{\frac{1}{n} \sum_{X_i \in \text{region}(s)} (X_i - \bar{X})^2}$$

where  $X_i$  is a data point value,  $\bar{X}$  is the arithmetic mean of the data point values for the specified region (s), and  $n$  is the number of data points in the specified region(s).

$$\text{SDEV} = \sqrt{\frac{1}{n} \sum_{X_i \in \text{region}(s)} (|X_i| - \bar{X})^2}$$

where  $|X_i|$  is the magnitude of an I/Q pair,  $\bar{X}$  is the mean of the magnitudes for the specified region(s), and  $n$  is the number of data points in the specified region(s).

- PPHase - returns the x,y pairs of both rms power (dBm) and arithmetic mean phase (radian) for every specified region and frequency offset (Hz). The number of pairs is defined by the specified number of regions. This parameter can be used for I/Q vector ( $n=0$ ) in Waveform (time domain) measurement and all parameters are specified by data point in PPHase.

The rms power of the specified region may be expressed as:

$$\text{Power} = 10 \times \log [10 \times (\text{RMS I/Q value})] + 10.$$

The RMS I/Q value (peak volts) is:

$$\sqrt{\frac{1}{n} \sum_{X_i \in \text{region}} X_i X_i^*}$$

where  $X_i$  is the complex value representation of an I/Q pair,  $X_i^*$  its conjugate complex number, and  $n$  is the number of I/Q pairs in the specified region.

The arithmetic mean phase of the specified region may be expressed as:

$$\frac{1}{n} \sum_{Y_i \in \text{region}} Y_i$$

where  $Y_i$  is the unwrapped phase of I/Q pair with applying frequency correction and  $n$  is the number of I/Q pairs in the specified region.

The frequency correction is made by the frequency offset calculated by the arithmetic mean of every specified region's frequency offset. Each frequency offset is calculated by the least square method against the unwrapped phase of I/Q pair.

Sample Trace Data - Constant Envelope

(See below for explanation of variables.)

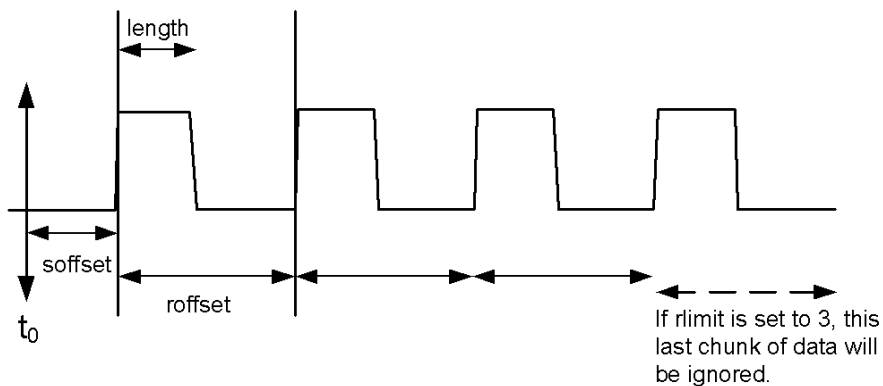

### Sample Trace Data - Not Constant Envelope

(See below for explanation of variables.)



<soffset> - start offset is an optional real number. (It is in seconds for time-domain traces, and is a dimensionless index 0 to Npoints - 1, for frequency-domain traces). It specifies the amount of data at the beginning of the trace that will be ignored before the decimation process starts. It is the time or frequency change from the start of the trace to the point where you want to start using the data. The default value is zero.

<length> - is an optional real number. (It is in seconds for time-domain traces, and is a dimensionless index 0 to Npoints - 1, for frequency-domain traces). It defines how much data will be compressed into one value. This parameter has a default value equal to the current trace length.

<roffset> - repeat offset is an optional real number. (It is in seconds for time-domain traces, and is a dimensionless index 0 to Npoints - 1, for frequency-domain traces). It defines the beginning of the next field of trace elements to be compressed. This is relative to the beginning of the previous field. This parameter has a default value equal to the <length> variable. Note that this parameter is used for a completely different purpose when curve fitting (see CFIT above).

<rlimit> - repeat limit is an optional integer. It specifies the number of data items that you want returned. It will ignore any additional items beyond that number. You can use the Start offset and the Repeat limit to pick out exactly what part of the data you want to use. The default value is all the data.

## Calculate Peaks of Trace Data (Remote Command Only)

Returns a list of all the peaks for the currently selected measurement and sub-opcode [n]. The peaks must meet the requirements of the peak threshold and excursion values.

n = any valid sub-opcode for the current measurement. See the MEASure:<measurement> command description of your specific measurement for information on the data that can be returned.

The command can only be used with specific sub-opcodes with measurement results that are trace data. Both real and complex traces can be searched, but complex traces are converted to magnitude in dBm. In many measurements the sub-opcode n=0, is the raw trace data which cannot be searched for peaks. And Sub-opcode n=1, is often calculated results values which also cannot be searched for peaks.

This command uses the data setting specified by the FORMat:BORDER and FORMat:DATA commands and can return real or ASCII data. If the format is set to INT,32, it returns REAL,32 data.

The command has four types of parameters:

- Threshold (in dBm)
- Excursion (in dB)
- Sorting order (amplitude, frequency, time)
- Optional in some measurements: Display line use (all, > display line, < display line)

<b>Remote Command</b>	<p>For Swept SA measurement:</p> <pre>:CALCulate:DATA[1] 2 ... 6:PEAKs? &lt;threshold&gt;,&lt;excursion&gt;[,AMPLitude   FREQuency   TIME[,ALL   GTDLine   LTDLine]]</pre> <p>For most other measurements:</p> <pre>:CALCulate:DATA[1] 2 ... 6:PEAKs? &lt;threshold&gt;,&lt;excursion&gt;[,AMPLitude   FREQuency   TIME]</pre>
-----------------------	--------------------------------------------------------------------------------------------------------------------------------------------------------------------------------------------------------------------------------------------------------------------------------------------------------------------------------

<b>Example</b>	<p>Example for Swept SA measurement in Spectrum Analyzer Mode:</p> <p>CALC:DATA4:PEAK? -40, 10, FREQ, GTDL This will identify the peaks of trace 4 that are above -40 dBm, with excursions of at least 10 dB. The peaks are returned in order of increasing frequency, starting with the lowest frequency. Only the peaks that are above the display line are returned.</p> <p>Query Results 1:</p> <p>With FORMat:DATA REAL, 32 selected, it returns a list of floating-point numbers. The first value in the list is the number of peak points that are in the following list. A peak point consists of two values: a peak amplitude followed by its corresponding frequency (or time).</p> <p>If no peaks are found the peak list will consist of only the number of peaks, (0).</p>
----------------	-----------------------------------------------------------------------------------------------------------------------------------------------------------------------------------------------------------------------------------------------------------------------------------------------------------------------------------------------------------------------------------------------------------------------------------------------------------------------------------------------------------------------------------------------------------------------------------------------------------------------------------------------------------------------------------------------------------------------------------------------------------------------------------------

<b>Notes</b>	<p>&lt;n&gt; - is the trace that will be used</p> <p>&lt;threshold&gt; - is the level below which trace data peaks are ignored. Note that the threshold value is required and is always used as a peak criterion. To effectively disable the threshold criterion for this command, provide a substantially low threshold value such as -200 dBm. Also note that the threshold value used in this command is independent of and has no effect on the threshold value stored under the Peak Criteria menu.</p> <p>&lt;excursion&gt; - is the minimum amplitude variation (rise and fall) required for a signal to be identified as peak. Note that the excursion value is required and is always used as a peak criterion. To effectively disable the excursion criterion for this command, provide the minimum value of 0.0 dB. Also note that the excursion value used in this command is independent of and has no effect on the</p>
--------------	---------------------------------------------------------------------------------------------------------------------------------------------------------------------------------------------------------------------------------------------------------------------------------------------------------------------------------------------------------------------------------------------------------------------------------------------------------------------------------------------------------------------------------------------------------------------------------------------------------------------------------------------------------------------------------------------------------------------------------------------------------------------------------------------------------------------------------------------------------------------------------------------------------------------------------------

excursion value stored under the Peak Criteria menu.

Values must be provided for threshold and excursion. The sorting and display line parameters are optional (defaults are AMPLitude and ALL).

Note that there is always a Y-axis value for the display line, regardless of whether the display line state is on or off. It is the current Y-axis value of the display line which is used by this command to determine whether a peak should be reported

Sorting order:

AMPLitude - lists the peaks in order of descending amplitude, with the highest peak first (default if optional parameter not sent)

FREQUency - lists the peaks in order of occurrence, left to right across the x-axis.

TIME - lists the peaks in order of occurrence, left to right across the x-axis.

Peaks vs. Display Line:

ALL - lists all of the peaks found (default if optional parameter not sent).

GTDLine (greater than display line) - lists all of the peaks found above the display line.

LTDLine (less than display line) - lists all of the peaks found below the display line.

---

Initial S/W Revision      Prior to A.02.00

---

### Format Data: Numeric Data (Remote Command Only)

This command specifies the format of the trace data input and output. It specifies the formats used for trace data during data transfer across any remote port. It affects only the data format for setting and querying trace data for the :TRACe[:DATA], TRACe[:DATA]?, :CALCulate:DATA[n]? and FETCh:SANalyzer [n]? commands and queries.

---

**Remote Command**      :FORMat[:TRACe] [:DATA] ASCii|INTeger,32|REAL,32 |REAL,64  
:FORMat[:TRACe] [:DATA] ?

---

**Notes**      The query response is:  
ASCii: ASC,8  
REAL,32: REAL,32  
REAL,64: REAL,64  
INTeger,32: INT,32

When the numeric data format is REAL or ASCii, data is output in the current Y Axis unit. When the data format is INTeger, data is output in units of m dBm (.001 dBm).

The INT,32 format returns binary 32-bit integer values in internal units (m dBm), in a definite length block.

---

**Dependencies**      Sending a data format spec with an invalid number (for example, INT,48) generates no error. The analyzer simply uses the default (8 for ASCii, 32 for INTeger, 32 for REAL).

Sending data to the analyzer which does not conform to the current FORMat specified, results in an error. Sending ASCII data when a definite block is expected generates message -161 "Invalid Block Data" and sending a definite block when ASCII data is expected generates message -121 "Invalid Character in Number".

---

**Preset**      ASCii

---

**Backwards Compatibility Notes**      Note that the INT,32 format is only applicable to the command, TRACe:DATA. This preserves backwards compatibility for the Swept SA measurement. For all other commands/queries which honor FORMat:DATA, if INT,32 is sent the analyzer will behave as though it were set to REAL,32.

---

Initial S/W Revision      Prior to A.02.00

---

The specs for each output type follow:

AScii - Amplitude values are in ASCII, in the current Y Axis Unit, one ASCII character per digit, values separated by commas, each value in the form:

SX.YYYYYEsZZ

Where:

S = sign (+ or -)

X = one digit to left of decimal point

Y = 5 digits to right of decimal point

E = E, exponent header

s = sign of exponent (+ or -)

ZZ = two digit exponent

REAL,32 - Binary 32-bit real values in the current Y Axis Unit, in a definite length block.

REAL,64 - Binary 64-bit real values in the current Y Axis Unit, in a definite length block.

### Format Data: Byte Order (Remote Command Only)

This command selects the binary data byte order for data transfer and other queries. It controls whether binary data is transferred in normal or swapped mode. This command affects only the byte order for setting and querying trace data for the :TRACe[:DATA], TRACe[:DATA]? , :CALCulate:DATA[n]? and FETCh:SANalyzer[n]? commands and queries.

By definition any command that says it uses FORMat:DATA uses any format supported by FORMat:DATA.

The NORMal order is a byte sequence that begins with the most significant byte (MSB) first, and ends with the least significant byte (LSB) last in the sequence: 1|2|3|4. SWAPped order is when the byte sequence begins with the LSB first, and ends with the MSB last in the sequence: 4|3|2|1.

---

<b>Remote Command</b>	:FORMat:BORDER NORMal   SWAPped :FORMat:BORDER?
<b>Preset</b>	NORMal
<b>Initial S/W Revision</b>	Prior to A.02.00

---



## Meas Setup

Displays the setup menu for the current measurement. The measurement setup parameters include the number of measurement averages used to calculate the measurement result and the averaging mode. The setup menu also includes the option to reset the measurement settings to their factory defaults.

Key Path	Front-panel key
Initial S/W Revision	Prior to A.02.00

### Avg/Hold Num

Specifies the number of measurement averages used when calculating the measurement result. The average is displayed at the end of each sweep.

Initiates an averaging routine that averages the sweep points in a number of successive sweeps, resulting in trace smoothing.

After the specified number of average counts, the average mode (termination control) setting determines the average action.

Key Path	Meas Setup
Mode	SA, WCDMA, C2K, WIMAX OFDMA, TD-SCDMA, 1xEVDO, ISDB-T, CMMB, LTE, LTETDD, BLUETOOTH, WLAN, MSR, LTEAFDD, LTEATDD
<b>Remote Command</b>	[:SENSe]:OBWidth:AVERage:COUNT <integer> [:SENSe]:OBWidth:AVERage:COUNT? [:SENSe]:OBWidth:AVERage[:STATe] ON OFF 1 0 [:SENSe]:OBWidth:AVERage[:STATe]?
<b>Example</b>	OBW:AVER:COUN 1500 OBW:AVER:COUN? OBW:AVER ON OBW:AVER?
Notes	You must be in the Spectrum Analysis mode, W-CDMA mode, cdma2000 mode, TD-SCDMA mode, ISDB-T mode, CMMB mode, LTE mode, LTE TDD mode, BLUETOOTH mode, WLAN mode, 1xEVDO mode, MSR, LTE-Advanced FDD/TDD or WIMAX OFDMA mode to use this command. Use:INSTRument:SElect to set the mode.
Couplings	None Averaging state is coupled to Max Hold. If Max Hold is changed from Off to On, Averaging state is automatically set to On.
Preset	10 ON
State Saved	Saved in instrument state.
Min	1
Max	10000

<b>Backwards Compatibility SCPI</b>	<code>[ :SENSe ] :EBWidth :AVERage :COUnT</code>
Initial S/W Revision	Prior to A.02.00
Modified at S/W Revision	A.03.00

## Avg Mode

Enables you to set the averaging mode.

- When set to Exponential (Exp) the measurement averaging continues using the specified number of averages to compute each averaged value. The average is displayed at the end of each sweep.
- When set to Repeat, the measurement resets the average counter each time the specified number of averages is reached.

<b>Key Path</b>	Meas Setup
<b>Mode</b>	SA, WCDMA, C2K, WIMAX OFDMA, TD-SCDMA , 1xEVDO, ISDB-T, CMMB, LTE, LTETDD, BLUETOOTH, WLAN, MSR, LTEAFDD, LTEATDD
<b>Remote Command</b>	<code>[ :SENSe ] :OBWidth :AVERage :TCONtrol EXPonential   REPeat</code> <code>[ :SENSe ] :OBWidth :AVERage :TCONtrol ?</code>
<b>Example</b>	OBW:AVER:TCON REP OBW:AVER:TCON?
<b>Notes</b>	You must be in the Spectrum Analysis mode, W-CDMA mode, cdma2000 mode, TD-SCDMA mode, ISDB-T mode, CMMB mode, LTE mode, LTE TDD mode, BLUETOOTH mode, WLAN mode, 1xEVDO mode, MSR, LTE-Advanced FDD/TDD or WIMAX OFDMA mode to use this command. Use:INSTrument:SELEct to set the mode.
<b>Preset</b>	EXP
<b>State Saved</b>	Saved in instrument state.
<b>Range</b>	Exp   Repeat
Initial S/W Revision	Prior to A.02.00
Modified at S/W Revision	A.03.00

## Occ BW % Pwr

Assigns the percentage of the total power that is measured within the Occupied Bandwidth for the current measurement. The resulting Occupied Bandwidth limits are displayed by markers placed on the frequencies of the specified percentage.

<b>Key Path</b>	Meas Setup
<b>Mode</b>	SA, WCDMA, C2K, WIMAX OFDMA, TD-SCDMA, 1xEVDO, ISDB-T, CMMB, LTE, LTETDD, BLUETOOTH, WLAN, MSR, LTEAFDD, LTEATDD
<b>Remote Command</b>	<code>[ :SENSe ] :OBWidth :PERCent &lt;real&gt;</code>

	<code>[ :SENSe ] :OBWidth :PERCent ?</code>
<b>Example</b>	OBW:PERC 75 OBW:PERC?
Notes	You must be in the Spectrum Analysis mode, W-CDMA mode, cdma2000 mode, TD-SCDMA mode, ISDB-T mode, CMMB mode, LTE mode, LTE TDD mode, BLUETOOTH mode, WLAN mode, 1xEVDO mode, MSR, LTE-Advanced FDD/TDD or WIMAX OFDMA mode to use this command. Use:INSTRument:SElect to set the mode. If Mode is BLUETOOTH, the key will be grayed out.
Preset	99.00
State Saved	Saved in instrument state.
Min	10
Max	99.99
Initial S/W Revision	Prior to A.02.00
Modified at S/W Revision	A.03.00

## x dB

Sets the x dB value used for the "x dB bandwidth" result that measures the bandwidth between two points on the signal which is x dB down from the highest signal point within the OBW Span.

Key Path	Meas Setup
Mode	SA, WCDMA, C2K, WIMAX OFDMA, TD-SCDMA, 1xEVDO, ISDB-T, CMMB, LTE, LTE TDD, BLUETOOTH, WLAN, MSR, LTEAFDD, LTEATDD
<b>Remote Command</b>	<code>[ :SENSe ] :OBWidth :XDB &lt;rel_ampl&gt;</code> <code>[ :SENSe ] :OBWidth :XDB ?</code>
<b>Example</b>	OBW:XDB -20 OBW:XDB?
Notes	You must be in the Spectrum Analysis mode, W-CDMA mode, cdma2000 mode, TD-SCDMA mode, ISDB-T mode, CMMB mode, LTE mode, LTE TDD mode, BLUETOOTH mode, WLAN mode, 1xEVDO mode, MSR, LTE-Advanced FDD/TDD or WIMAX OFDMA mode to use this command. Use:INSTRument:SElect to set the mode.
Preset	-26.0 dB BLUETOOTH: -20.0 dB.
State Saved	Saved in instrument state.
Min	-100.0 dB
Max	-0.1 dB
<b>Backwards Compatibility SCPI</b>	<code>[ :SENSe ] :EBWidth :XDB</code>
Initial S/W Revision	Prior to A.02.00
Modified at S/W Revision	A.03.00

## IF Gain

The IF Gain key can be used to set the IF Gain function to Auto, Low Gain or High Gain. These settings affect sensitivity and IF overloads.

This only applies to the RF input. It does not apply to baseband I/Q input.

Key Path	Meas Setup, IF Gain
Dependencies	The IF Gain keys (FFT IF Gain and Swept IF Gain) have no effect when the U7227A USB Preamplifier is connected. This is not annotated or reflected on any softkey; there are no keys grayed out nor any SCPI locked out. The analyzer simply behaves as though both FFT IF Gain and Swept IF Gain are set to Low regardless of the setting on the keys.
Initial S/W Revision	Prior to A.02.00

## IF Gain Auto

Activates the Auto Rules for IF Gain. When Auto is active, the IF Gain is set to High Gain under and of the following conditions:

- the input attenuator is set to 0 dB
- the preamp is turned On and the frequency range is under 3.6 GHz

For other settings, Auto sets the IF Gain to Low Gain.

Key Path	Meas Setup, IF Gain
Mode	SA, WCDMA, C2K, WIMAX OFDMA, TD-SCDMA, 1xEVDO, ISDB-T, CMMB, LTE, LTETDD, BLUETOOTH, WLAN, MSR, LTEAFDD, LTEATDD
Remote Command	[ :SENSe ] :OBWidth :IF :GAIN :AUTO [ :STATe ] ON   OFF   1   0 [ :SENSe ] :OBWidth :IF :GAIN :AUTO [ :STATe ] ?
Example	OBW:IF:GAIN:AUTO OFF OBW:IF:GAIN:AUTO?
Couplings	When the auto attenuation exists (for example, with electrical attenuator), the IF Gain setting is changed as following rule. Auto sets IF Gain to High Gain under any of the following conditions: the input attenuator is set to 0 dB, or the preamp is turned on and the frequency range is less than 3.6 GHz. For other settings, Auto sets IF Gain to Low Gain.
Preset	OFF
State Saved	Saved in instrument state.
Range	Off On
Initial S/W Revision	Prior to A.02.00
Modified at S/W Revision	A.03.00

## IF Gain State

Selects the range of the IF Gain.

Key Path	Meas Setup, IF Gain
Mode	SA, WCDMA, C2K, WIMAX OFDMA, TD-SCDMA, 1xEVDO, ISDB-T, CMMB, LTE, LTETDD, BLUETOOTH, WLAN, MSR, LTEAFDD, LTEATDD
<b>Remote Command</b>	<code>[ :SENSe ] :OBWidth :IF :GAIN [ :STATe ] ON   OFF   1   0</code> <code>[ :SENSe ] :OBWidth :IF :GAIN [ :STATe ] ?</code>
<b>Example</b>	OBW:IF:GAIN ON OBW:IF:GAIN?
Notes	Where ON = high gain OFF = low gain
Couplings	When the auto attenuation exists (for example, with electrical attenuator), the IF Gain setting is changed as following rule. Auto sets IF Gain to High Gain under any of the following conditions: the input attenuator is set to 0 dB, or the preamp is turned on and the frequency range is less than 3.6 GHz. For other settings, Auto sets IF Gain to Low Gain.
Preset	OFF
State Saved	Saved in instrument state.
Range	Low Gain   High Gain
Initial S/W Revision	Prior to A.02.00
Modified at S/W Revision	A.03.00

### Limit (for all modes except MSR and LTE-Advanced FDD/TDD)

Enables you to turn on or off limit checking at the specified frequency. For results that fail the limit test, a red FAIL appears in the measure bar.

Key Path	Meas Setup
Mode	SA, WCDMA, C2K, WIMAX OFDMA, TD-SCDMA, 1xEVDO, ISDB-T, CMMB, LTE, LTETDD, BLUETOOTH, WLAN
<b>Remote Command</b>	<code>:CALCulate:OBWidth:LIMit:FBLimit &lt;freq&gt;</code> <code>:CALCulate:OBWidth:LIMit:FBLimit?</code> <code>:CALCulate:OBWidth:LIMit[:TEST] ON   OFF   1   0</code> <code>:CALCulate:OBWidth:LIMit[:TEST] ?</code>
<b>Example</b>	CALC:OBW:LIM:FBL 50 kHz CALC:OBW:LIM:FBL? CALC:OBW:LIM OFF CALC:OBW:LIM?
Notes	You must be in the Spectrum Analysis mode, W-CDMA mode, cdma2000 mode, TD-SCDMA mode, ISDB-T mode, CMMB mode, LTE mode, LTE TDD mode, BLUETOOTH mode, WLAN mode, 1xEVDO mode or WIMAX OFDMA mode to use this command. Use:INSTrument:SElect to set the mode.

Preset	SA, WCDMA: 5 MHz C2K: 1.48 MHz WIMAX OFDMA: 10 MHz TD-SCDMA: 1.6 MHz 1xEVDO: 1.48 MHz ISDB-T: 5.7 MHz CMMB: 7.512 MHz LTE, LTETDD: 5 MHz BLUETOOTH: 1 MHz WLAN: If Radio Std is 802.11a/g(OFDM/DSSS-OFDM): 20MHz If Radio Std is 802.11b: 25 MHz If Radio Std is 802.11n(20MHz): 20 MHz If Radio Std is 802.11n(40MHz): 40 MHz If Radio Std is 802.11ac(20MHz): 20 MHz If Radio Std is 802.11ac(40MHz): 40 MHz If Radio Std is 802.11ac(80MHz): 80 MHz If Radio Std is 802.11ac(160MHz): 160 MHz SA: OFF WCDMA, WIMAX OFDMA, TD-SCDMA, 1xEVDO, ISDB-T, CMMB, LTE, LTETDD: ON
State Saved	Saved in instrument state.
Min	1 kHz
Max	Depends on instrument maximum frequency.
Initial S/W Revision	Prior to A.02.00
Modified at S/W Revision	A.03.00

## Meas Preset

Restores all measurement parameters to their default values.

Key Path	Meas Setup
Mode	SA, WCDMA, C2K, WIMAX OFDMA, TD-SCDMA, 1xEVDO, ISDB-T, CMMB, LTE, LTETDD, BLUETOOTH, WLAN, MSR, LTEAFDD, LTEATDD
Remote Command	:CONFigure:OBWidth
Example	CONF:OBW
Initial S/W Revision	Prior to A.02.00
Modified at S/W Revision	A.03.00

## Max Hold (Remote Command Only)

When On, Max Hold displays and holds the maximum responses of the current measurement. Turn Max Hold to Off to disable the maximum hold feature.

Key Path	SCPI Only
Mode	SA, WCDMA, C2K, WIMAX OFDMA, TD-SCDMA, 1xEVDO, ISDB-T, CMMB, LTE, LTETDD, BLUETOOTH, WLAN, MSR, LTEAFDD, LTEATDD
<b>Remote Command</b>	<code>[ :SENSe ] :OBwidth:MAXHold ON OFF 1 0</code> <code>[ :SENSe ] :OBwidth:MAXHold?</code>
<b>Example</b>	OBW:MAXH ON OBW:MAXH?
Notes	You must be in the Spectrum Analysis mode, W-CDMA mode, cdma2000 mode, TD-SCDMA mode, ISDB-T mode, CMMB mode, LTE mode, LTE TDD mode, BLUETOOTH mode, WLAN mode, 1xEVDO mode, MSR, LTE-Advanced FDD/TDD or WIMAX OFDMA mode to use this command. Use:INSTrument:SElect to set the mode.
Couplings	Max Hold is coupled to Average/Hold state. The Max Hold function is activated only if Average state is On. If Max Hold is changed to On when Average state is Off, Average state is automatically set to On.
Preset	OFF
State Saved	Saved in instrument state.
Range	On   Off
<b>Backwards Compatibility SCPI</b>	<code>[ :SENSe ] :EBwidth:MAXHold</code>
Initial S/W Revision	Prior to A.02.00
Modified at S/W Revision	A.03.00

10 Occupied Bandwidth Measurement  
Mode

Mode

See "[Mode](#)" on page 318



## Mode Preset

Returns the active mode to a known state.

Mode Preset does the following for the currently active mode:

- Aborts the currently running measurement.
- Brings up the default menu for the mode, with no active function.
- Sets measurement Global settings to their preset values for the active mode only.
- Activates the default measurement.
- Brings up the default menu for the mode.
- Clears the input and output buffers.
- Sets Status Byte to 0.

Mode Preset does not:

- Cause a mode switch
- Affect mode persistent settings
- Affect system settings

See "[How-To Preset](#)" on page 934 for more information.

Key Path	Front-panel key
<b>Remote Command</b>	:SYSTem:PRESet
<b>Example</b>	:SYST:PRES
Notes	*RST is preferred over :SYST:PRES for remote operation. *RST does a Mode Preset, as done by the :SYST:PRES command, and it sets the measurement mode to Single measurement rather than Continuous for optimal remote control throughput. Clears all pending OPC bits. The Status Byte is set to 0.
Couplings	A Mode Preset aborts the currently running measurement, activates the default measurement, and gets the mode to a consistent state with all of the default couplings set.
Backwards Compatibility Notes	In the X-Series, the legacy "Factory Preset" has been replaced with Mode Preset, which only presets the currently active mode, not the entire instrument. In the X-Series, the way to preset the entire instrument is by using System, Restore System Defaults All, which behaves essentially the same way as restore System Defaults does on ESA and PSA. There is also no "Preset Type" as there is on the PSA. There is a green Mode Preset front-panel key that does a Mode Preset and a white-with-green-letters User Preset front-panel key that does a User Preset. The old PRESet:TYPE command is ignored (without generating an error), and SYST:PRES without a parameter does a Mode Preset, which should cover most backward code compatibility issues. The settings and correction data under the Input/Output front-panel key (examples: Input Z Corr, Ext Amp Gain, etc.) are no longer part of any Mode, so they will not be preset by a Mode Preset. They are preset using Restore Input/Output Defaults, Restore System Defaults All. Note that because User Preset does a Recall State, and all of these settings are saved in State, they ARE recalled when using

	User Preset.
Initial S/W Revision	Prior to A.02.00

## How-To Preset

The table below shows all possible presets, their corresponding SCPI commands and front-panel access (key paths). Instrument settings depend on the current measurement context. Some settings are local to the current measurement, some are global (common) across all the measurements in the current mode, and some are global to all the available modes. In a similar way, restoring the settings to their preset state can be done within the different contexts.

Auto Couple - is a measurement local key. It sets all Auto/Man parameter couplings in the measurement to Auto. Any Auto/Man selection that is local to other measurements in the mode will not be affected.

Meas Preset - is a measurement local key. Meas Preset resets all the variables local to the current measurement except the persistent ones.

Mode Preset - resets all the current mode's measurement local and measurement global variables except the persistent ones.

Restore Mode Defaults - resets ALL the Mode variables (and all the Meas global and Meas local variables), including the persistent ones.

Type Of Preset	SCPI Command	Front Panel Access
Auto Couple	:COUPle ALL	Auto Couple front-panel key
Meas Preset	:CONFigure:<Measurement>	Meas Setup Menu
Mode Preset	:SYSTem:PRESet	Mode Preset (green key)
Restore Mode Defaults	:INSTrument:DEFault	Mode Setup Menu
Restore All Mode Defaults	:SYSTem:DEFault MODes	System Menu; Restore System Default Menu
*RST	*RST	not possible (Mode Preset with Single)
Restore Input/Output Defaults	:SYSTem:DEFault INPUt	System Menu; Restore System Default Menu
Restore Power On Defaults	:SYSTem:DEFault PON	System Menu; Restore System Default Menu
Restore Alignment Defaults	:SYSTem:DEFault ALIGN	System Menu; Restore System Default Menu
Restore Miscellaneous Defaults	:SYSTem:DEFault MISC	System Menu; Restore System Default Menu
Restore All System Defaults	:SYSTem:DEFault [ALL] :SYSTem:PRESet:PERsistent	System Menu; Restore System Default Menu
User Preset	:SYSTem:PRESet:USER	User Preset Menu
User Preset All Modes	:SYSTem:PRESet:USER:ALL	User Preset Menu

Power On Mode Preset	:SYSTem:PON:TYPE MODE	System Menu
Power On User Preset	:SYSTem:PON:TYPE USER	System Menu
Power On Last State	:SYSTem:PON:TYPE LAST	System Menu

### Preset Type (Remote Command Only)

As stated in the Backward Compatibility section, to be compatible with ESA/PSA the PRESet:TYPE command will be implemented as a no-op.

Mode	All
<b>Remote Command</b>	:SYSTem:PRESet:TYPE FACTory MODE USER :SYSTem:PRESet:TYPE?
<b>Example</b>	:SYST:PRESet:TYPE FACT
Notes	This command is supported for backward compatibility only. It is a no-op which does not change the behavior of any preset operation.
Preset	This is unaffected by Preset but is set to Mode on a “Restore System Defaults->All”
State Saved	No
Initial S/W Revision	Prior to A.02.00

## Mode Setup

See "[Mode Setup](#)" on page 348

## Peak Search

Places the selected marker on the trace point with the maximum y-axis value for that marker's trace. Pressing Peak Search with the selected marker off causes the selected marker to be set to Normal, then a peak search is immediately performed.

<b>Key Path</b>	Front panel key
<b>Mode</b>	SA, WCDMA, C2K, WIMAX OFDMA, TD-SCDMA, 1xEVDO, ISDB-T, CMMB, LTE, LTETDD, BLUETOOTH, WLAN, MSR, LTEAFDD, LTEATDD
<b>Remote Command</b>	:CALCulate:OBWidth:MARKer[1] 2 ... 12:MAXimum
<b>Example</b>	CALC:OBW:MARK2:MAX
<b>Initial S/W Revision</b>	Prior to A.02.00
<b>Modified at S/W Revision</b>	A.03.00

10 Occupied Bandwidth Measurement  
Print

Print

See "[Print](#)" on page 358

## Quick Save

The Quick Save front-panel key repeats the most recent save that was performed from the Save menu, with the following exceptions:

- Register saves are not remembered as Saves for the purpose of the Quick Save function
- If the current measurement does not support the last non-register save that was performed, an informational message is generated, “File type not supported for this measurement”

Quick Save repeats the last type of qualified save (that is, a save qualified by the above criteria) in the last save directory by creating a unique filename using the Auto File Naming algorithm described below.

If Quick Save is pressed after startup and before any qualified Save has been performed, the Quick Save function performs a Screen Image save using the current settings for Screen Image saves (current theme, current directory), which then becomes the “last save” for the purpose of subsequent Quick Saves.

The Auto File Naming feature automatically generates a file name for use when saving a file. The filename consists of a prefix and suffix separated by a dot, as is standard for the Windows® file system. A default prefix exists for each of the available file types:

Type	Default Prefix	Menu
State	State_	(Save/Recall)
Trace + State	State_	(Save/Recall)
Screen	Screen_	(Save/Recall)
Amplitude Corrections	Ampcor_	(Import/Export)
Traces	Trace_	(Import/Export)
Limit Lines	LLine_	(Import/Export)
Measurement Result	MeasR_	(Import/Export)
Capture Buffer	CapBuf_	(Import/Export)

A four digit number is appended to the prefix to create a unique file name. The numbering sequence starts at 0000 within each Mode for each file type and updates incrementally to 9999, then wraps to 0000 again. It remembers where it was through a Mode Preset and when leaving and returning to the Mode. It is reset by Restore Misc Defaults and Restore System Defaults and subsequent running of the instrument application. So, for example, the first auto file name generated for State files is State\_0000.state. The next is State\_0001, and so forth.

One of the key features of Auto File Name is that we guarantee that the Auto File Name will never conflict with an existing file. The algorithm looks for the next available number. If it gets to 9999, then it looks for holes. If it find no holes, that is no more numbers are available, it gives an error.

For example, if when we get to State\_0010.state there is already a State\_0010.state file in the current directory, it advances the counter to State\_0011.state to ensure that no conflict will exist (and then it verifies that State\_0011.state also does not exist in the current directory and advances again if it does, and so forth).

If you enter a file name for a given file type, then the prefix becomes the filename you entered instead of the default prefix, followed by an underscore. The last four letters (the suffix) are the 4-digit number.

For example, if you save a measurement results file as “fred.csv”, then the next auto file name chosen for a measurement results save will be fred\_0000.csv.

---

**NOTE** Although 0000 is used in the example above, the number that is used is actually the current number in the Meas Results sequence, that is, the number that would have been used if you had not entered your own file name.

---

**NOTE** If the filename you entered ends with \_dddd, where d=any number, making it look just like an auto file name, then the next auto file name picks up where you left off with the suffix being dddd + 1.

---

---

Key Path	Front-panel key
Notes	No remote command for this key specifically.
Initial S/W Revision	Prior to A.02.00

---



## Recall

The Recall menu lets you choose what you want to recall, and where you want to recall it from. Among the types of files you can recall are **States and Traces**. In addition, an Import (Data) option lets you recall a number of data types stored in CSV files (as used by Excel and other spreadsheet programs).

The default paths for Recall are data type dependent and are the same as for the Save key.

Key Path	Front-panel key
Notes	<p>No remote command for this key specifically, but the :MMEM:LOAD command is available for specific file types. An example is :MMEM:LOAD:STATe &lt;filename&gt;.</p> <p>If you try to recall a State file for a mode that is not licensed or not available in the instrument, an error message will occur and the state will not change.</p>
Backwards Compatibility Notes	<p>In legacy analyzers, it was possible to load a state without affecting the trace data, limit lines or correction data. Similarly (since User Preset is actually loading a state), it was possible to do a User Preset without affecting the trace data, limit lines or correction data.</p> <p>In the X-Series, “state” always includes all of this data; so whenever state is loaded, all of the traces, limit lines and corrections are affected. Although this differs from previous behavior, it is desirable behavior, and should not cause adverse issues for users.</p>
Backwards Compatibility Notes	<p>Recall for the X-Series supports backward compatibility in the sense that you can recall a state file from any X-Series model number and any version of X-Series software. This is only possible if part of the recalling process goes through a limiting step after recalling the mode settings, at least for settings that may vary with version number, model number, option and license differences. If you try to recall a state file onto an instrument with less capability than what was available on the instrument during the save, the recall will ignore the state it doesn't support and it will limit the recalled setting to what it allows.</p> <p>Example: if the saved state includes preamp ON, but the recalling instrument does not have a preamp; the preamp is limited to OFF. Conversely, if you save a state without a preamp, the preamp is OFF in the state file. When this saved file is recalled on an instrument with a licensed preamp, the preamp is changed to OFF. Another example is if the saved state has center frequency set to 20 GHz, but the instrument recalling the saved state is a different model and only supports 13.5 GHz. In this case, the center frequency is limited along with any other frequency based settings. Since the center frequency can't be preserved in this case, the recall limiting tries to at least preserve span to keep the measurement setup as intact as possible.</p> <p>It may be appropriate to issue a warning if the state is limited on the recall; warnings do not go out to SCPI so this would only affect the manual user.</p> <p>Note that there is no state file compatibility outside of the X-Series. For example, you cannot recall a state file from ESA or PSA.</p>
Initial S/W Revision	Prior to A.02.00

## State

The Recall State menu lets you choose a register or file from which to recall the state.

The content of a state file includes all of the settings and data required to return the analyzer as closely as possible to the Mode it was in, with the exact settings that were in place, when the save occurred. The Mode settings in each state file include the settings that are affected by Mode Preset, as well as the

additional settings affected by Restore Mode Defaults; all of the Mode's settings. In addition, all of the settings of the Input/Output system are included, even though they are outside of the Mode's state, because they are needed to restore the complete setup. Persistent System settings (for example, GPIB address) are not affected by either a Mode Preset or Restore Mode Defaults, nor are they included in a saved State file.

Since each state file is only for one Mode, the settings for other Modes are unaffected when it is loaded. Recall State will cause a mode switch if the state being recalled is not from the current active mode.

After the recall completes, the message "File <filename> recalled" or "Recalled State Register <register number>" is displayed.

For rapid recalls, the State menu lists 16 registers that you can choose from to recall. Pressing a Register key initiates the recall. You can also select a file from which to recall.

The default path for all State Files is:

My Documents\<<mode name>\state

where <mode name> is the parameter used to select the mode with the INST:SEL command (for example, SA for the Spectrum Analyzer).

See ["More Information" on page 943](#).

<b>Key Path</b>	Recall
<b>Mode</b>	All
<b>Remote Command</b>	:MMEMory:LOAD:STATe <filename>
<b>Example</b>	:MMEM:LOAD:STAT "myState.state" This recalls the file myState.state on the default path
<b>Example</b>	MMEM:LOAD:STAT "MyStateFile.state" This loads the state file data (on the default file directory path) into the instrument state.
<b>Notes</b>	<p>When you pick a file to recall, the analyzer first verifies that the file is recallable in the current instrument by checking the software version and model number of the instrument. If everything matches, a full recall proceeds by aborting the currently running measurement, clearing any pending operations, and then loading the State from the saved state file. You can open state files from any mode, so recalling a State file switches to the mode that was active when the save occurred. After switching to the mode of the saved state file, mode settings and data (if any for the mode) are loaded with values from the saved file. The saved measurement of the mode becomes the newly active measurement and the data relevant to the measurement (if there is any) is recalled.</p> <p>If there is a mismatch between file version or model number or instrument version or model number, the recall function tries to recall as much as possible and returns a warning message. It may limit settings that differ based on model number, licensing or version number.</p> <p>After recalling the state, the Recall State function does the following:</p> <ul style="list-style-type: none"> <li>• Makes the saved measurement for the mode the active measurement.</li> <li>• Clears the input and output buffers.</li> <li>• Status Byte is set to 0.</li> <li>• Executes a *CLS</li> </ul> <p>If the file specified is empty an error is generated. If the specified file does not exist, another error is generated. If there is a mismatch between the file and the proper file type, an error is generated. If</p>

	there is a mismatch between file version or model number or instrument version or model number, a warning is displayed. Then it returns to the State menu and File Open dialog goes away. After the Recall, the analyzer exits the Recall menu and returns to the previous menu.
<b>Backwards Compatibility SCPI</b>	:MMEMory:LOAD:STATe 1,<filename> For backwards compatibility, the above syntax is supported. The "1" is simply ignored.
Initial S/W Revision	Prior to A.02.00

## More Information

In measurements that support saving Traces, for example, Swept SA, the Trace data is saved along with the State in the State file. When recalling the State, the Trace data is recalled as well. Traces are recalled exactly as they were stored, including the writing mode and update and display modes. If a Trace was updating and visible when the State was saved, it will come back updating and visible, and its data will be rewritten right away. When you use State to save and recall traces, any trace whose data must be preserved should be placed in View or Blank mode before saving.

The following table describes the Trace Save and Recall possibilities:

You want to recall state and one trace's data, leaving other traces unaffected.	Save Trace+State from 1 trace. Make sure that no other traces are updating (they should all be in View or Blank mode) when the save is performed.	On Recall, specify the trace you want to load the one trace's data into. This trace will load in View. All other traces' data will be unaffected, although their trace mode will be as it was when the state save was performed.
You want to recall all traces	Save Trace+State from ALL traces.	On Recall, all traces will come back in View (or Blank if they were in Blank or Background when saved)
You want all traces to load exactly as they were when saved.	Save State	On recall, all traces' mode and data will be exactly as they were when saved. Any traces that were updating will have their data immediately overwritten.

## From File...

When you press "From File", the analyzer brings up a Windows dialog and a menu entitled "File Open." This menu allows you to navigate to the various fields in the Windows dialog without using a keyboard or mouse. The Tab and Arrow keys can also be used for dialog navigation.

## 10 Occupied Bandwidth Measurement Recall

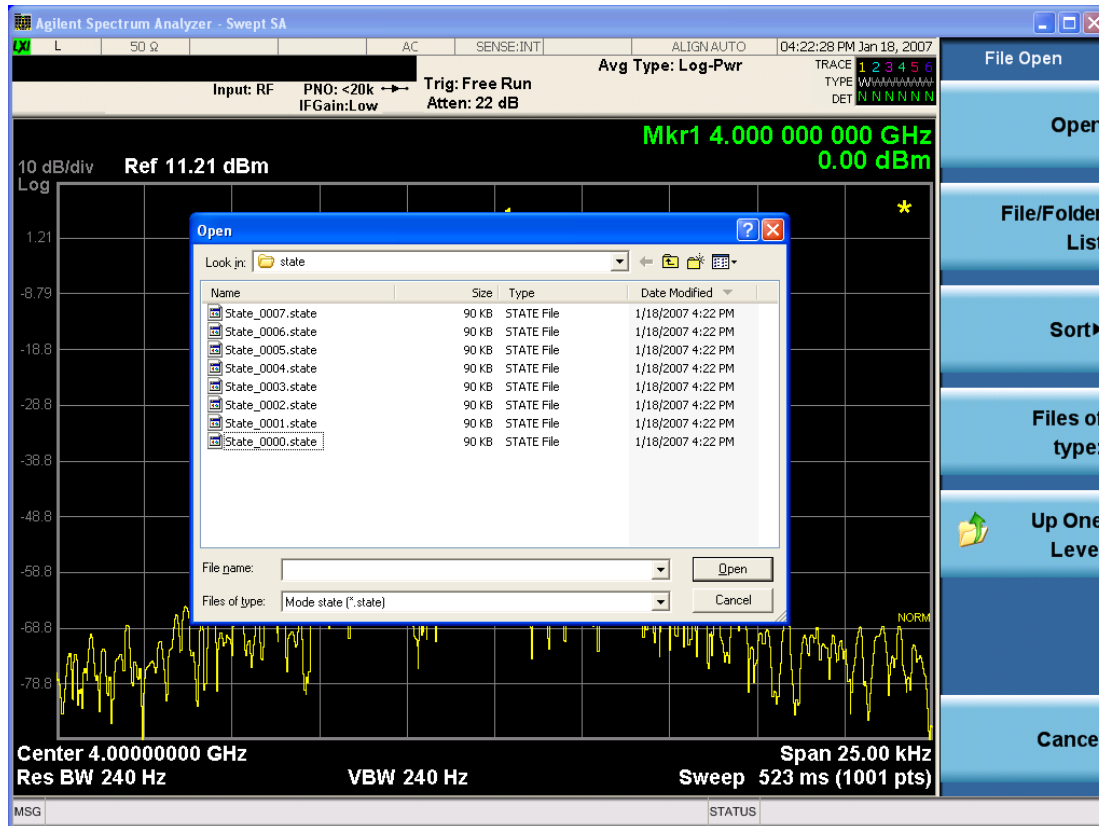

Listed below are the functions of the various fields in the dialog, and the corresponding softkeys:

### Open

Performs the recall of the specified file. While the recall is being performed, the floppy icon appears briefly in the Meas bar.

### File/Folder List

Enables you to navigate to the center of the dialog that contains the list of files and folders. Once here you can get information about the file and use the tab keys to navigate to the other fields in the dialog, such as Look In.

### Look In

The Look In field shows the path from which the file will be recalled and allows you to change the path using the up and down arrow keys to navigate to other paths; the Enter key to open a directory; and the Backspace key to go back one directory. The **Look In field** first uses the last path from the Save As dialog **Save In:** path for that same file type. There is no softkey for directly navigating to the Look In field, but you can use the left tab to get here from the File/Folder List.

User specified paths are remembered when you leave and return to a Mode and are reset back to the default using Restore Mode Defaults.

### Sort

Accesses a menu that enables you to sort the files within the File Open dialog. Only one sorting type can be selected at a time and the sorting happens immediately. The sorting types are By Date, By Name, By extension, and By Size.

#### Files of Type

This field shows the file suffix for the type of file you have selected to recall. For example, if you navigated here while recalling State, "Mode state (\*.state)" is in the field. If you navigated here while recalling Trace, ""Mode state (\*.trace)" is in the field. If you navigated here while importing a trace data file, "Trace Data (\*.csv)" is in the field. For some file types, there is more than one choice in the dropdown menu, which you can select by using the up and down arrow keys and Enter.

#### Up One Level

This key corresponds to the icon of a folder with the up arrow that is in the tool bar of the dialog. When pressed, it causes the file and folder list to navigate up one level in the directory structure. The Backspace key does the same thing.

#### Cancel

This key corresponds to the Cancel selection in the dialog. It causes the current **Open** request to be cancelled. The ESC key does the same thing.

Key Path	Recall, State
Notes	Brings up the Open dialog for recalling a State Save Type
Initial S/W Revision	Prior to A.02.00

### Edit Register Names

You may enter a custom name on any of the Register keys, to help you remember what you are using that state to save. To do this, press the Edit Register Names key, choose the register whose name you wish to edit, and then enter the desired label using the Alpha Editor or an external PC keyboard.

The maximum number of characters that can be added is 30. In most cases, 30 characters will fit on two lines of the key.

For more information and the SCPI command, see Edit Register Names under the Save, State function.

Key Path	Recall, State
Mode	All
Dependencies	N9060A-7FP or N9060B-2FP license required to edit the register names. When the feature is not licensed, sending the SCPI command generates an error, -221, "Settings conflict;Option not available"
Initial S/W Revision	A.11.00

### Register 1 thru Register 16

Selecting any one of these register keys causes the State of the mode from the specified Register to be recalled. Each of the register keys annotates whether it is empty or at what date and time it was last

modified. In addition, you can use the Edit Register Names key under Save, State to enter custom names for each register.

Registers are shared by all modes, so recalling from any one of the registers will cause a mode switch to the mode that was active when the save to the Register occurred.

Although these 16 registers are the only registers available from the front panel, there are 128 state registers available in the instrument. Registers 17–128 are only available from the SCPI interface, using the \*RCL command.

After the recall completes, the message "Register <register number> recalled" appears in the message bar. If you are in the Spectrum Analyzer Mode, and you are recalling a register that was saved in the Spectrum Analyzer Mode, then after the recall, you will still be in the Recall Register menu. If the Recall causes you to switch modes, then after the Recall, you will be in the Frequency menu.

If a requested register is empty an error is generated.

<b>Key Path</b>	Recall, State
<b>Example</b>	*RCL 1
<b>Range</b>	1–16 from front panel, 1–128 from SCPI
<b>Readback</b>	Date and time with seconds resolution are displayed on the key OR A custom name of up to 30 characters entered using the Save, State, Edit Register Names key OR “(empty)” if no prior save operation has been performed to this register.
<b>Initial S/W Revision</b>	Prior to A.02.00
<b>Modified at S/W Revision</b>	Prior to A.11.00

## Register 1 thru Register 16

Selecting any one of these register keys causes the State of the mode from the specified Register to be recalled. Each of the register keys annotates whether it is empty or at what date and time it was last modified. In addition, you can use the Edit Register Names key under Save, State to enter custom names for each register.

Registers are shared by all modes, so recalling from any one of the registers will cause a mode switch to the mode that was active when the save to the Register occurred.

Although these 16 registers are the only registers available from the front panel, there are 128 state registers available in the instrument. Registers 17–128 are only available from the SCPI interface, using the \*RCL command.

After the recall completes, the message "Register <register number> recalled" appears in the message bar. If you are in the Spectrum Analyzer Mode, and you are recalling a register that was saved in the Spectrum Analyzer Mode, then after the recall, you will still be in the Recall Register menu. If the Recall causes you to switch modes, then after the Recall, you will be in the Frequency menu.

If a requested register is empty an error is generated.

Key Path	Recall, State
<b>Example</b>	*RCL 1
Range	1-16 from front panel, 1-128 from SCPI
Readback	Date and time with seconds resolution are displayed on the key OR A custom name of up to 30 characters entered using the Save, State,Edit Register Names key OR “(empty)” if no prior save operation has been performed to this register.
Initial S/W Revision	Prior to A.02.00
Modified at S/W Revision	Prior to A.11.00

### Trace (+State)

The Recall Trace (+State) menu lets you choose a register or file from which to recall the Trace+State state file.

A saved state contains all of the settings and data required to return the analyzer as closely as possible to the exact setup it had when the save occurred. This includes the Input/Output settings, even though they are outside of the Mode’s state, because they are needed to restore the complete setup. A Trace+State file also includes trace data from one trace or all traces, which will load in View mode when the Trace+State file is recalled. Recall Trace (+State) will also cause a mode switch if the state being recalled is not for the current active mode.

After the recall completes, the message "File <filename> recalled" or “Recalled Trace Register <register number>” is displayed.

For rapid recalls, the Trace (+State) menu lists 5 registers to choose from to recall. Pressing a Register key initiates the recall. You can also select a file from which to recall.

The default path for all State Files including .trace files is:

My Documents\<mode name>\state

where <mode name> is the parameter used to select the mode with the INST:SEL command (for example, SA for the Spectrum Analyzer).

Key Path	Recall
Mode	SA
<b>Remote Command</b>	:MMEMory:LOAD:TRACe TRACE1   TRACE2   TRACE3   TRACE4   TRACE5   TRACE6,<filename>  :MMEMory:LOAD:TRACe:REGister TRACE1   TRACE2   TRACE3   TRACE4   TRACE5   TRACE6,<integer>
<b>Example</b>	MMEM:LOAD:TRAC TRACE2, "MyTraceFile.trace" This loads the trace file data (on the default file directory path) into the specified trace; if it is a "single trace" save file, that trace is loaded to trace 2, and is set to be not updating. :MMEM:LOAD:TRAC:REG TRACE1,2

	restores the trace data in register 2 to Trace 1
Notes	<p>When you perform the recall, the recalling Trace function must first verify the file is recallable in this instrument by checking instrument software version and model number, since it includes State. If everything matches, a full recall proceeds by aborting the currently running measurement, and loading the state from the saved state file to as close as possible to the context in which the save occurred. You can open .trace files from any mode that supports them, so recalling a Trace file switches to the mode that was active when the save occurred. After switching to the mode of the saved state file, mode settings and data (if any for the mode) are loaded with values from the saved file and the saved measurement of the mode becomes the newly active measurement, and the data relevant to the measurement (if there is any) is recalled.</p> <p>Once the state is loaded, the trace data must be loaded. The internal flags are consulted to see which trace to load and the "To Trace" setting to see where to load it. Trace data is always loaded with the specified trace set to View, so that the data is visible and not updating(so as not to erase the recalled data). If the file is an "all trace" file, all traces are loaded with the saved data(to the original trace the data was saved from) and set to View. Traces whose data is not loaded are restored to the update state that existed when they were saved.</p> <p>After the Recall the analyzer exits the Recall menu and returns to the previous menu.</p> <p>Some modes and measurements do not have available all 6 traces. Phase Noise mode command, for example, is: <code>MMEMory:LOAD:TRACe TRACE1 TRACE2 TRACE3,&lt;filename&gt;</code></p> <p>Some modes and measurements have more than 6 traces available. The Realtime SA mode command, for example, is: <code>MMEMory:STORe:TRACe TRACE1   TRACE2   TRACE3   TRACE4   TRACE5   TRACE6   TRACE7   TRACE8   TRACE9   TRACE10   TRACE11   TRACE12   ALL,&lt;filename&gt;</code></p>
Initial S/W Revision	Prior to A.02.00

## To Trace

These menu selections let you choose the Trace where the recalled saved trace will go. Not all modes have the full 6 traces available. The default is the currently selected trace, selected in this menu or in the Trace/Detector, Export Data, Import Data, or Save Trace menus, except if you have chosen All, then it remains chosen until you specifically change it to a single trace.

If the .trace file is an "all trace" file, "To Trace" is ignored and the traces each go back to the trace from which they were saved.

Once selected, the key returns back to the Recall Trace menu and the selected Trace number is annotated on the key. Now you have selected exactly where the trace needs to be recalled.To trigger a recall of the selected Trace, you must select the Open key in the Recall Trace menu.

When you select a trace, it makes that trace the current trace, so it displays on top of all of the other traces.

Key Path	Save, Data, Trace
Mode	SA
Initial S/W Revision	Prior to A.02.00



## Register 1 thru Register 16

Selecting any one of these register keys causes the State of the mode from the specified Register to be recalled. Each of the register keys annotates whether it is empty or at what date and time it was last modified. In addition, you can use the Edit Register Names key under Save, State to enter custom names for each register.

Registers are shared by all modes, so recalling from any one of the registers will cause a mode switch to the mode that was active when the save to the Register occurred.

Although these 16 registers are the only registers available from the front panel, there are 128 state registers available in the instrument. Registers 17–128 are only available from the SCPI interface, using the \*RCL command.

After the recall completes, the message "Register <register number> recalled" appears in the message bar. If you are in the Spectrum Analyzer Mode, and you are recalling a register that was saved in the Spectrum Analyzer Mode, then after the recall, you will still be in the Recall Register menu. If the Recall causes you to switch modes, then after the Recall, you will be in the Frequency menu.

If a requested register is empty an error is generated.

Key Path	Recall, State
<b>Example</b>	*RCL 1
Range	1–16 from front panel, 1–128 from SCPI
Readback	Date and time with seconds resolution are displayed on the key OR A custom name of up to 30 characters entered using the Save, State, Edit Register Names key OR “(empty)” if no prior save operation has been performed to this register.
Initial S/W Revision	Prior to A.02.00
Modified at S/W Revision	Prior to A.11.00

## From File...

When you press “From File”, the analyzer brings up a Windows dialog and a menu entitled “File Open.” This menu allows you to navigate to the various fields in the Windows dialog without using a keyboard or mouse. The Tab and Arrow keys can also be used for dialog navigation.

## 10 Occupied Bandwidth Measurement Recall

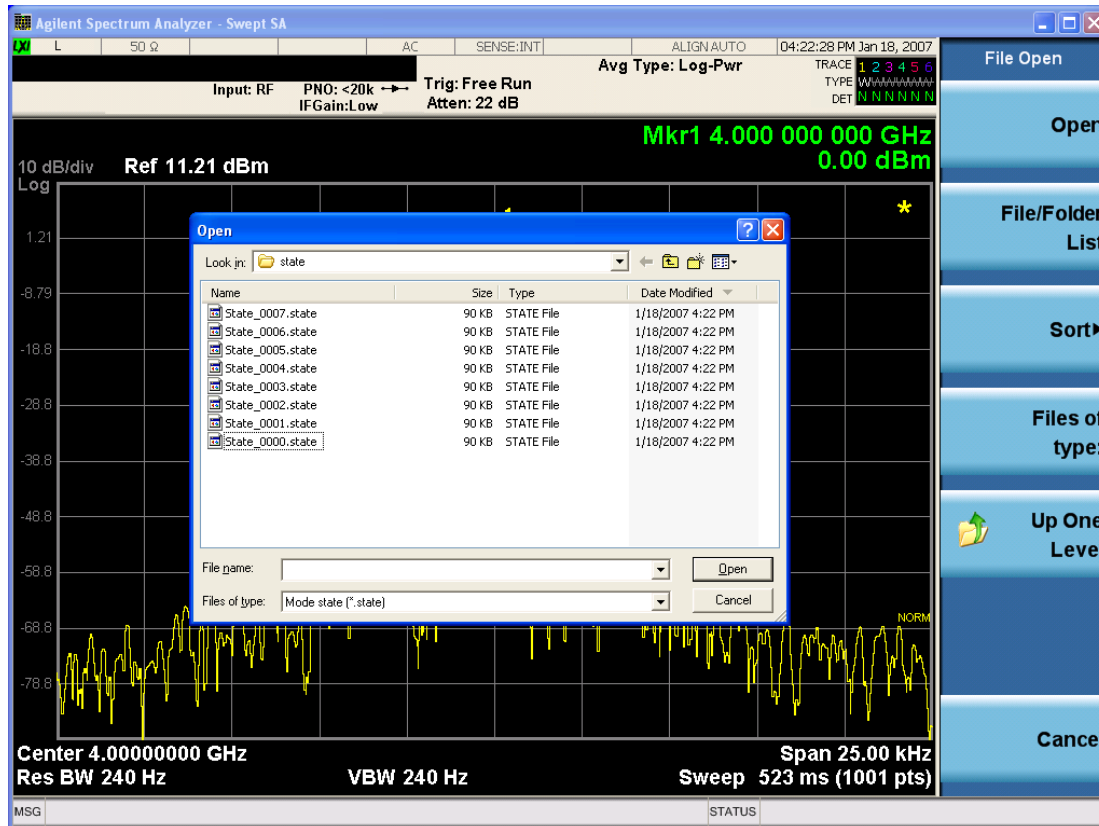

Listed below are the functions of the various fields in the dialog, and the corresponding softkeys:

### Open

Performs the recall of the specified file. While the recall is being performed, the floppy icon appears briefly in the Meas bar.

### File/Folder List

Enables you to navigate to the center of the dialog that contains the list of files and folders. Once here you can get information about the file and use the tab keys to navigate to the other fields in the dialog, such as Look In.

### Look In

The Look In field shows the path from which the file will be recalled and allows you to change the path using the up and down arrow keys to navigate to other paths; the Enter key to open a directory; and the Backspace key to go back one directory. The **Look In field** first uses the last path from the Save As dialog **Save In:** path for that same file type. There is no softkey for directly navigating to the Look In field, but you can use the left tab to get here from the File/Folder List.

User specified paths are remembered when you leave and return to a Mode and are reset back to the default using Restore Mode Defaults.

### Sort

Accesses a menu that enables you to sort the files within the File Open dialog. Only one sorting type can be selected at a time and the sorting happens immediately. The sorting types are By Date, By Name, By extension, and By Size.

#### Files of Type

This field shows the file suffix for the type of file you have selected to recall. For example, if you navigated here while recalling State, "Mode state (\*.state)" is in the field. If you navigated here while recalling Trace, ""Mode state (\*.trace)" is in the field. If you navigated here while importing a trace data file, "Trace Data (\*.csv)" is in the field. For some file types, there is more than one choice in the dropdown menu, which you can select by using the up and down arrow keys and Enter.

#### Up One Level

This key corresponds to the icon of a folder with the up arrow that is in the tool bar of the dialog. When pressed, it causes the file and folder list to navigate up one level in the directory structure. The Backspace key does the same thing.

#### Cancel

This key corresponds to the Cancel selection in the dialog. It causes the current **Open** request to be cancelled. The ESC key does the same thing.

Key Path	Recall, State
Notes	Brings up the Open dialog for recalling a State Save Type
Initial S/W Revision	Prior to A.02.00

### Data (Import)

Importing a data file loads data that was previously saved from the current measurement or from other measurements and/or modes that produce compatible data files. The Import Menu only contains Data Types that are supported by the current measurement.

Since the commonly exported data files are in .csv format, the data can be edited by the user prior to importing. This allows you to export a data file, manipulate the data in Excel (the most common PC Application for manipulating .csv files) and then import it.

Importing Data loads measurement data from the specified file into the specified or default destination, depending on the data type selected. Selecting an Import Data menu key will not actually cause the importing to occur, since the analyzer still needs to know from where to get the data. Pressing the Open key in this menu brings up the Open dialog and Open menu that provides you with the options from where to recall the data. Once a filename has been selected or entered in the Open menu, the recall occurs as soon as the Open button is pressed.

Key Path	Recall
Mode	All
Notes	The menu is built from whatever data types are available for the mode. Some keys will be missing completely, so the key locations in the sub-menu will vary. No SCPI command directly controls the Data Type that this key controls. The Data Type is included in the MMEM:LOAD commands.

Dependencies	If a file type is not used by a certain measurement, it is grayed out for that measurement. The key for a file type will not show at all if there are no measurements in the Mode that support it.
Preset	Is not affected by Preset or shutdown, but is reset during Restore Mode Defaults
Readback	The data type that is currently selected
Initial S/W Revision	Prior to A.02.00

## Capture Buffer

The captured data is raw data which is not processed.

Key Path	Recall, Data
Mode	<b>CDMA1XEV</b>
Example	MMEM:LOAD:CAPT "MyCaptureData.bin" This loads the file of capture data (on the default file directory path) into the instrument.
Dependencies	In case the capture buffer data is not available from the selected measurement, the key will be grayed out.
Initial S/W Revision	A.11.00

## Open...

When you press "Open", the analyzer brings up a Windows dialog and a menu entitled "**File Open.**" This menu allows you to navigate to the various fields in the Windows dialog without using a keyboard or mouse. The Tab and Arrow keys can also be used for dialog navigation.

See "[From File...](#)" on page 2890 in Recall, State, for a full description of this dialog and menu.

Key Path	Recall, Data
Notes	The key location is mode-dependent and will vary. Brings up Open dialog for recalling a <mode specific> Save Type
Initial S/W Revision	Prior to A.02.00

## Restart

The Restart function restarts the current sweep, or measurement, or set of averaged/held sweeps or measurements. If you are Paused, pressing Restart does a Resume.

The Restart function is accessed in several ways:

- Pressing the Restart key
- Sending the remote command INIT:IMMEDIATE
- Sending the remote command INIT:RESTART

See "[More Information](#)" on page 953

Key Path	Front-panel key
Remote Command	:INITiate[:IMMEDIATE] :INITiate:RESTART
Example	:INIT:IMM :INIT:REST
Notes	:INITiate:RESTART and :INITiate:IMMEDIATE perform exactly the same function.
Couplings	Resets average/hold count k. For the first sweep overwrites all active (update=on) traces with new current data. For application modes, it resets other parameters as required by the measurement.
Status Bits/OPC dependencies	This is an Overlapped command. The STATUS:OPERation register bits 0 through 8 are cleared. The STATUS:QUESTIONable register bit 9 (INTEgrity sum) is cleared. The SWEEPING bit is set. The MEASURING bit is set.
Backwards Compatibility Notes	For Spectrum Analysis mode in ESA and PSA, the Restart hardkey and the INITiate:RESTART command restart trace averages (displayed average count reset to 1) for a trace in Clear Write, but did not restart Max Hold and Min Hold. In the X-Series, the Restart hardkey and the INITiate:RESTART command restart not only Trace Average, but MaxHold and MinHold traces as well. For wireless comms modes in ESA and PSA, the Restart hardkey and the INITiate:RESTART command restart every measurement, which includes all traces and numeric results. There is no change to this operation.
Initial S/W Revision	Prior to A.02.00

### More Information

The **Restart** function first aborts the current sweep/measurement as quickly as possible. It then resets the sweep and trigger systems, sets up the measurement and initiates a new data measurement sequence with a new data acquisition (sweep) taken once the trigger condition is met.

If the analyzer is in the process of aligning when **Restart** is executed, the alignment finishes before the restart function is performed.

Even when set for Single operation, multiple sweeps may be taken when Restart is pressed (for example, when averaging/holding is on). Thus when we say that **Restart** "restarts a measurement," we may mean:

- It restarts the current sweep
- It restarts the current measurement
- It restarts the current set of sweeps if any trace is in Trace Average, Max Hold or Min Hold
- It restarts the current set of measurements if Averaging, or Max Hold, or Min Hold is on for the measurement
- depending on the current settings.

With **Average/Hold Number** (in **Meas Setup** menu) set to 1, or Averaging off, or no trace in Trace Average or Hold, a single sweep is equivalent to a single measurement. A single sweep is taken after the trigger condition is met; and the analyzer stops sweeping once that sweep has completed. However, with **Average/Hold Number** >1 and at least one trace set to **Trace Average, Max Hold, or Min Hold (SA Measurement)** or **Averaging on (most other measurements)**, multiple sweeps/data acquisitions are taken for a single measurement. The trigger condition must be met prior to each sweep. The sweep is stopped when the average count  $k$  equals the number  $N$  set for **Average/Hold Number**. A measurement average usually applies to all traces, marker results, and numeric results; but sometimes it only applies to the numeric results.

Once the full set of sweeps has been taken, the analyzer will go to idle state. To take one more sweep without resetting the average count, increment the average count by 1, by pressing the step up key while **Average/Hold Number** is the active function, or sending the remote command CALC:AVER:TCON UP.

## Save

The Save menu lets you choose what you want to save and where you want to save it. Among the types of files you can save are **States**, **Traces**, and **Screen Images**. In addition, an Export (Data) option lets you save a number of data types as CSV files for easy import into Excel and other spreadsheet programs.

Key Path	Front-panel key
Mode	All
Notes	No remote command for this key specifically, but the :MMEM:STORe command is available for specific file types. An example is :MMEM:STOR:STATe <filename>.
Initial S/W Revision	Prior to A.02.00

## State

The Save State menu lets you choose a register or file for saving the state.

The content of a state file includes all of the settings and data required to return the analyzer as closely as possible to the Mode it was in, with the exact settings which were in place, when the save occurred. The Mode settings in each state file include the settings that are affected by Mode Preset, as well as the additional settings affected by Restore Mode Defaults; all of the Mode's settings. In addition, all of the settings of the Input/Output system are included, even though they are outside of the Mode's state, because they are needed to restore the complete setup. Persistent System settings (for example, Verbose SCPI) are not affected by either Mode Preset or Restore Mode Defaults, nor are they included in a saved State file.

After the save completes, the message "File <filename> saved" or "State Register <register number> saved" is displayed.

For rapid saving, the State menu lists 16 registers to save to. Pressing a Register key initiates the save. You can also select a file to save to.

The default path for all State Files is:

My Documents\<<mode name>\state

where <mode name> is the parameter used to select the mode with the INST:SEL command (for example, SA for the Spectrum Analyzer).

Key Path	Save
Mode	All
Remote Command	:MMEMory:STORe:STATe <filename>
Example	MMEM:STOR:STATe "MyStateFile.state" This stores the current instrument state data in the file MyStateFile.state in the default directory.
Notes	Both single and double quotes are supported for any filename parameter over remote. After saving to a register, that register's menu key is updated with the date the time, unless a custom label has been entered for that key. After saving to a register, you remain in the Save State menu, so that you can see the Register key

	update. After saving to a file, the analyzer automatically returns to the previous menu and any Save As dialog goes away.
<b>Backwards Compatibility SCPI</b>	:MMEMory:STORe:STATe 1,<filename>
Initial S/W Revision	Prior to A.02.00

### To File . . .

When you press “To File”, the analyzer brings up a Windows dialog and a menu entitled “Save As.” This menu allows you to navigate to the various fields in the Windows dialog without using a keyboard or mouse. The Tab and Arrow keys can also be used for dialog navigation.

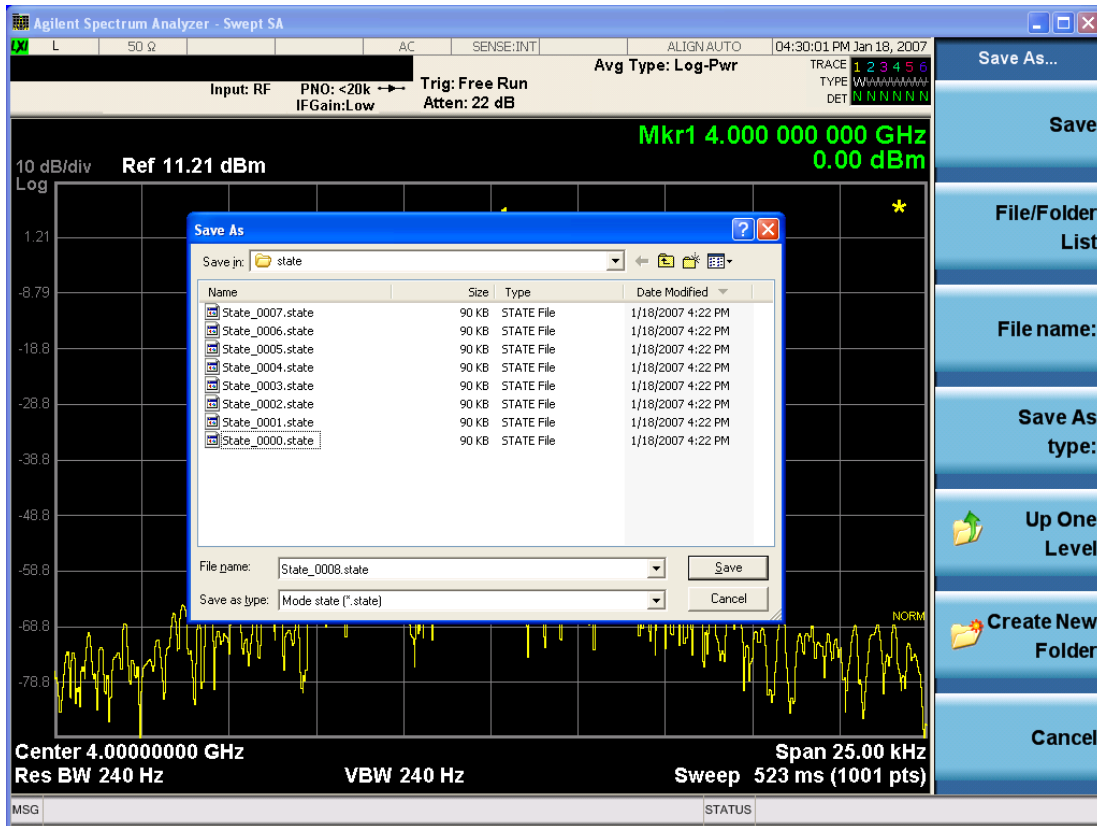

The Listed below

are the functions of the various fields in the dialog, and the corresponding softkeys:

### Save

Performs the save to the specified file of the selected type. If the file already exists, a dialog will appear that allows you to replace the existing file by selecting OK, or you can Cancel the request. If you select OK, the file will be overwritten. Using the C: drive is strongly discouraged, since it runs the risk of being overwritten during an instrument software upgrade.

While the save is being performed, the floppy icon appears briefly in the Meas bar.



## File/Folder List

Enables you to navigate to the center of the dialog that contains the list of files and folders. Once here you can get information about the file and use the tab keys to navigate to the other fields in the dialog, such as Save In.

## Save In

The Save In field shows the path to which the file will be saved and allows you to change the path using the up and down arrow keys to navigate to other paths; the Enter key to open a directory; and the Backspace key to go back one directory. The **Save In field** defaults to the default path for this type of file and remembers the last path you used to save this type of file. There is no softkey for directly navigating to the Save In field but you can use left tab to get here from the File/Folder List.

User specified paths are remembered when you leave and return to a Mode and are reset back to the default using Restore Mode Defaults.

## File Name

The File Name field is initially loaded with an automatically generated filename specific to the appropriate Save Type. The automatically generated filename is guaranteed not to conflict with any filename currently in the directory. You may replace or modify this filename using the File Name key. See the ["Quick Save " on page 2880](#) documentation for more on the automatic file naming algorithm.

When you press the File Name key the analyzer displays the Alpha Editor. Use the knob to choose the letter to add and the front-panel Enter key to add the letter to the file name. The BK character moves you back and the FW character moves you forward in the filename. The Select key on the front panel generates a space character. When you are done entering the filename press the Done softkey. This returns back to the **File Open** dialog and menu, but does not cause the save to occur.

## Save As Type

This field shows the file suffix for the type of file you have selected to save. For example, if you navigated here while saving State, "Mode state (\*.state)" is in the field. If you navigated here from saving Trace, ""Mode state (\*.trace)" is in the field. If you navigated here while exporting a trace data file, "Trace Data (\*.csv)" is in the field. For some file types, there is more than one choice in the dropdown, which you can select by using the up and down arrow keys and Enter.

## Up One Level

This key corresponds to the icon of a folder with the up arrow that is in the tool bar of the dialog. When pressed, it causes the file and folder list to navigate up one level in the directory structure. The Backspace key does the same thing.

## Create New Folder

This key corresponds to the icon of a folder with the "\*" that is in the tool bar of the dialog. When pressed, a new folder is created in the current directory with the name **New Folder** and you can enter a new folder name using the Alpha Editor.

## Cancel

This key corresponds to the Cancel selection in the dialog. It causes the current **Save As** request to be cancelled. The ESC key does the same thing.

Key Path	Save, State
Mode	All
Notes	Brings up Save As dialog for saving a State Save Type
Initial S/W Revision	Prior to A.02.00

## Edit Register Names

You may enter a custom name on any of the Register keys, to help you remember what you are using that state to save. To do this, press the Edit Register Names key, choose the register whose name you wish to edit, and then enter the desired label using the Alpha Editor or an external PC keyboard.

The maximum number of characters that can be added is 30. In most cases, 30 characters will fit on two lines of the key.

See ["More Information" on page 958](#)

Key Path	Save, State
Mode	All
<b>Remote Command</b>	:MMEMory:REGister:STATe:LABel <reg number>,"label" :MMEMory:REGister:STATe:LABel? <reg number>
<b>Example</b>	:MMEM:REG:STAT:LAB 1,"my label"
Notes	<reg number> is an integer from 1 to 16. If the SCPI specifies an invalid register number an error message is generated, -222,"Data out of range;Invalid register label number" "label" is a string from 0 to 30 characters in length. If a label exceeds 30 characters, an error message is generated, -150,"String data error;Label clipped to 30 characters" "label" of length 0 erases the custom label and restores the default (time and date) label. E.g.: :MMEM:REG:STAT:LAB 1,""
Dependencies	N9060A-7FP or N9060B-2FP license required to edit the register names. When the feature is not licensed, sending this command generates an error, -221,"Settings conflict;Option not available"
Preset	The names are unaffected by Preset or power cycle but are set to the default label (time and date) on a "Restore System Defaults->Misc"
Initial S/W Revision	A.11.00

## More Information

When you edit one of the register names, the time and date field will be replaced by the custom name.

If you delete all the characters in the custom name, it restores the default (time and date).

The register names are stored within the state files, but they are not part of the instrument state; that is, once you have edited a register name, loading a new state will not change that register name. Another consequence of this is that the names will be persistent through a power cycle. Also, if a named state file is transferred to another analyzer, it will bring its custom name along with it.

If you try to edit the name of an empty register, the analyzer will first save the state to have a file to put the name in. If you load a named state file into an analyzer with older firmware it will ignore the metadata.

The \*SAV and \*RCL commands will not be affected by the custom register names, nor will the MMEM commands.

### Register 1 thru Register 16

Selecting any one of these register menu keys causes the State of the currently active mode to be saved to the specified Register. The registers are provided for rapid saving and recalling, since you do not need to specify a filename or navigate to a file. Each of the register menu keys annotates whether it is empty or at what date and time it was last modified. In addition, you can use the Edit Register Names key to enter custom names for each register.

Although these 16 registers are the only registers available from the front panel, there are 128 state registers available in the instrument. Registers 17–128 are only available from the SCPI interface, using the \*SAV command.

There is one set of 128 state registers in the instrument, not one set for each Mode. When a state is saved, the Mode it was saved from is saved with it; then when it is recalled, the instrument switches to that Mode.

After the save completes, the corresponding register menu key annotation is updated with the date and time and the message "Register <register number> saved" is displayed.

Key Path	Save, State
Mode	All
<b>Example</b>	*SAV 1
Range	1–16 from front panel, 1–128 from SCPI
Readback	Date and time with seconds resolution are displayed on the key OR A custom name of up to 30 characters entered using the Edit Register Names key OR “(empty)” if no prior save operation has been performed to this register.
Initial S/W Revision	Prior to A.02.00
Modified at S/W Revision	A.11.00

### Register 1 thru Register 16

Selecting any one of these register menu keys causes the State of the currently active mode to be saved to the specified Register. The registers are provided for rapid saving and recalling, since you do not need to specify a filename or navigate to a file. Each of the register menu keys annotates whether it is empty or at what date and time it was last modified. In addition, you can use the Edit Register Names key to enter custom names for each register.

Although these 16 registers are the only registers available from the front panel, there are 128 state registers available in the instrument. Registers 17–128 are only available from the SCPI interface, using the \*SAV command.

There is one set of 128 state registers in the instrument, not one set for each Mode. When a state is saved, the Mode it was saved from is saved with it; then when it is recalled, the instrument switches to that Mode.

After the save completes, the corresponding register menu key annotation is updated with the date and time and the message "Register <register number> saved" is displayed.

Key Path	Save, State
Mode	All
Example	*SAV 1
Range	1-16 from front panel, 1-128 from SCPI
Readback	Date and time with seconds resolution are displayed on the key OR A custom name of up to 30 characters entered using the Edit Register Names key OR “(empty)” if no prior save operation has been performed to this register.
Initial S/W Revision	Prior to A.02.00
Modified at S/W Revision	A.11.00

## Data (Export)

Exporting a data file stores data from the current measurement to mass storage files. The Export Menu only contains data types that are supported by the current measurement.

Since the commonly exported data files are in .csv format, the data can be edited by you prior to importing. This allows you to export a data file, manipulate the data in Excel (the most common PC Application for manipulating .csv files) and then import it.

Selecting an Export Data menu key will not actually cause the exporting to occur, since the analyzer still needs to know where you wish to save the data. Pressing the Save As key in this menu brings up the Save As dialog and Save As menu that allows you to specify the destination file and directory. Once a filename has been selected or entered in the Open menu, the export will occur as soon as the Save key is pressed.

Key Path	Save
Mode	All
Notes	The menu is built from whatever data types are available for the mode. So the key locations in the sub menu will vary.  No SCPI command directly controls the Data Type that this key controls. The Data Type is included in the MMEM:STORe commands.
Dependencies	If a file type is not used by a certain measurement, that type is grayed out for that measurement. The key for a file type will not show at all if there are no measurements in the Mode that support it.
Preset	Is not affected by a Preset or shutdown, but is reset during Restore Mode Defaults
Readback	The data type that is currently selected
Initial S/W Revision	Prior to A.02.00

## Measurement Results

Pressing this key selects Meas Results as the data type to be exported.

The Meas Results file contains measurement result sets, plus information describing the current state of the analyzer, as detailed in ["Meas Results File Definition" on page 961](#) and ["Meas Results File Example" on page 962](#) below.

Key Path	Save, Data
Remote Command	:MMEMory:STORe:RESults <string>
Example	:MMEM:STOR:RES "MeasR_0000.csv"
Notes	<p>If the save is initiated via SCPI and the file already exists, the file will be overwritten.</p> <p>The SCPI command exports Occupied Bandwidth measurement results to the file specified as the parameter in the current path. The default path is My Documents\&lt;current mode&gt;\data\OBW\results.</p> <p>Using the C: drive is strongly discouraged, since it runs the risk of being overwritten during an instrument software upgrade.</p> <p>The SCPI parameter is a quoted string that specifies the filename. Both single and double quotes are supported for any filename parameter over SCPI.</p>
Dependencies	The current active measurement must be the Occupied Bandwidth measurement to use this command.
Status Bits/OPC dependencies	Sequential – waits for the previous measurement to complete
Initial S/W Revision	Prior to A.02.00

## Meas Results File Definition

The content of a Meas Results File is defined in this section.

The first lines in the file consist of identification and instrument configuration details, as follows.

- File ID string, which is "MeasResult"
- Measurement ID following Mode ID, which is "SA:OBW" for example.
- Firmware rev and model number
- Option string
- Auto Sweep Time Rules
- Average Mode
- Average Number
- Average State
- Center Frequency
- Detector
- Electrical Atten

- Electrical Atten State
- IFGain
- IFGainAuto
- Internal Preamp
- Internal Preamp Band
- Limit
- Limit State
- Max Hold
- Mechanical Atten
- MechanicalAttenStepEnum
- OBW Percent Pwr
- Resolution Band Width
- Resolution Bandwidth Shape
- Span
- Sweep Points
- Sweep Time
- Sweep Time Auto
- TriggerSource
- Video Bandwidth
- x DB

The data above is followed in the file by a line containing “MeasResult1” and “MeasResult2”. This line forms a header for each set of measurement results, which appear in subsequent lines. Each line of Measurement Results consists of two comma-separated values, for MeasResult1 and MeasResult2 respectively.

The MeasResult1 set in the file corresponds to the data returned by MEAS|READ|FETCH:OBWidth1, and the MeasResult2 set corresponds to the data returned by MEAS|READ|FETCH:OBWidth2.

The exported file is in CSV format, with a .csv extension.

### Meas Results File Example

When imported into Microsoft Excel, a typical Meas Results CSV file appears as shown in the example below.

---

MeasResult

---

SA:OBW

---

A.10.53	N9030A
526 ALV ATP B1X B1Y B25 B40 BBA CR3 CRP DCF DDA DP2 DRD EA3 EDP EMC EP1 ERC ESC ESP EXM FSA LFE LNP MAT MPB NFE NUL P26 PFR PNC RTL RTS S40 SB1 SEC SM1 TVT YAS YAV	1
Auto Sweep Time Rules	Normal
Average Mode	Exponential
Average Number	10
Average State	TRUE
Center Frequency	1.33E+10
Detector	Average
IFGain	FALSE
IFGainAuto	FALSE
Internal Preamp	FALSE
Internal Preamp Band	Low
Limit	5000000
Limit State	FALSE
Max Hold	FALSE
OBW Percent Pwr	99
Resolution Band Width	27000
Resolution Bandwidth Shape	Gaussian
Span	3000000
Sweep Points	1001
Sweep Time	0.004933
Sweep Time Auto	TRUE
TriggerSource	Free
Video Bandwidth	270000
x DB	-26
MeasResult1	MeasResult2
2971020.10835045	-94.3702543927405
-74.9741251886604	-94.1447790390963

## Capture Buffer

Capture Buffer functionality is not available for all measurements. The captured data is raw data which is not processed.

Key Path	Save, Data
Mode	CDMA1XEV
Example	MMEM:STOR:CAPT "MyCaptureData.bin" This stores the capture data in the file MyCaptureData.bin in the default directory.
Dependencies	In case the capture buffer data is not available from the selected measurement, the key will be grayed out.
Initial S/W Revision	A.11.00

### Save As . . .

When you press “Save As”, the analyzer brings up a Windows dialog and a menu entitled “**Save As.**” This menu allows you to navigate to the various fields in the Windows dialog without using a keyboard or mouse. The Tab and Arrow keys can also be used for dialog navigation.

See ["To File . . ." on page 2897](#) in Save, State for a full description of this dialog and menu.

The default path for saving files is:

For all of the Trace Data Files:

My Documents\<<mode name>\data\traces

For all of the Limit Data Files:

My Documents\<<mode name>\data\limits

For all of the Measurement Results Data Files:

My Documents\<<mode name>\data\<<measurement name>\results

For all of the Capture Buffer Data Files:

My Documents\<<mode name>\data\captureBuffer

Key Path	Save, Data
Mode	All
Notes	The key location is mode-dependent and will vary. Brings up the Save As dialog for saving a <mode specific> Save Type. The save is performed immediately and does not wait until the measurement is complete.
Initial S/W Revision	Prior to A.02.00

### Screen Image

Pressing Screen Image accesses a menu of functions that enable you to specify a format and location for the saved screen image. It brings up a menu that allows you to specify the color scheme of the Screen Image (Themes) or navigate to the Save As dialog to perform the actual save.



Screen Image files contain an exact representation of the analyzer display. They cannot be loaded back onto the analyzer, but they can be loaded into your PC for use in many popular applications.

The image to be saved is actually captured when the Save front panel key is pressed, and kept in temporary storage to be used if you ask for a Screen Image save. When the Screen Image key is pressed, a "thumbnail" of the captured image is displayed, as shown below:

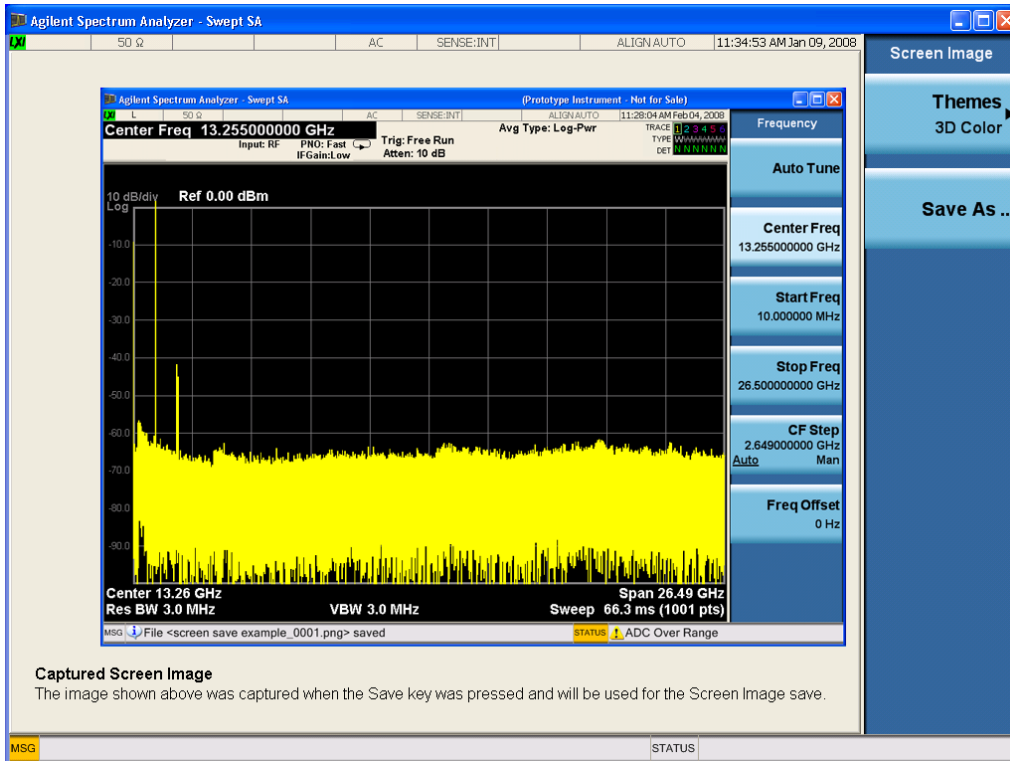

When you continue on into the Save As menu and complete the Screen Image save, the image depicted in the thumbnail is the one that gets saved, showing the menus that were on the screen before going into the Save menus. The save is performed immediately and does not wait until the measurement is complete.

After you have completed the save, the Quick Save front-panel key lets you quickly repeat the last save performed, using an auto-named file, with the current screen data.

**NOTE** For versions previous to A.01.55, if you initiate a screen image save by navigating through the Save menus, the image that is saved will contain the Save menu softkeys, not the menus and the active function that were on the screen when you first pressed the Save front panel key.

Key Path	Save
Mode	All
Remote Command	:MMEMory:STORe:SCReem <filename>
Example	:MMEM:STOR:SCR "myScreen.png" This stores the current screen image in the file MyScreenFile.png in the default directory.
Initial S/W Revision	Prior to A.02.00

## Themes

Accesses a menu of functions that enable you to choose the theme to be used when saving the screen image.

The **Themes** option is the same as the **Themes** option under the **Display** and **Page Setup** dialogs. It allows you to choose between themes to be used when saving the screen image.

<b>Key Path</b>	Save, Screen Image
<b>Remote Command</b>	:MMEMory:STORe:SCReen:THEMe TDColor   TDMonochrome   FCOLor   FMONochrome  :MMEMory:STORe:SCReen:THEMe?
<b>Example</b>	:MMEM:STOR:SCR:THEM TDM
<b>Preset</b>	3D Color; Is not part of Preset, but is reset by Restore Misc Defaults or Restore System Defaults All and survives subsequent running of the modes.
<b>Readback</b>	3D Color   3D Mono   Flat Color   Flat Mono
<b>Backwards Compatibility Notes</b>	In ESA and PSA we offer the choice of "Reverse Bitmap" or "Reverse Metafile" when saving screen images. This is much like the "Flat Color" theme available in X-Series. Also, if you selected Reverse Bitmap AND a black & white screen image, that would be much like "Flat Monochrome". In other words, each of the X-Series themes has a similar screen image type in ESA/PSA. But they are not identical.
<b>Initial S/W Revision</b>	Prior to A.02.00

### 3D Color

Selects a standard color theme with each object filled, shaded and colored as designed.

<b>Key Path</b>	Save, Screen Image, Themes
<b>Example</b>	MMEM:STOR:SCR:THEM TDC
<b>Readback</b>	3D Color
<b>Initial S/W Revision</b>	Prior to A.02.00

### 3D Monochrome

Selects a format that is like 3D color but shades of gray are used instead of colors.

<b>Key Path</b>	Save, Screen Image, Themes
<b>Example</b>	MMEM:STOR:SCR:THEM TDM
<b>Readback</b>	3D Mono
<b>Initial S/W Revision</b>	Prior to A.02.00

### Flat Color

Selects a format that is best when the screen is to be printed on an ink printer.

Key Path	Save, Screen Image, Themes
<b>Example</b>	MMEM:STOR:SCR:THEM FCOL
Readback	Flat Color
Initial S/W Revision	Prior to A.02.00

### Flat Monochrome

Selects a format that is like Flat Color. But only black is used (no colors, not even gray), and no fill.

Key Path	Save, Screen Image, Themes
<b>Example</b>	MMEM:STOR:SCR:THEM FMON
Readback	Flat Mono
Initial S/W Revision	Prior to A.02.00

### Save As...

When you press "Save As", the analyzer brings up a Windows dialog and a menu entitled "**Save As.**" This menu allows you to navigate to the various fields in the Windows dialog without using a keyboard or mouse. The Tab and Arrow keys can also be used for dialog navigation.

See "[To File . . .](#)" on page 2897 in Save, State for a full description of this dialog and menu.

The default path for Screen Images is

My Documents\`<mode name>`\screen.

where `<mode name>` is the parameter used to select the mode with the INST:SEL command (for example, SA for the Spectrum Analyzer).

Key Path	Save, Screen Image
Notes	Brings up Save As dialog for saving a Screen Image Save Type
Initial S/W Revision	Prior to A.02.00

### Mass Storage Catalog (Remote Command Only)

Key path	SCPI Only
<b>Remote Command</b>	:MMEMory:CATalog? [ <code>&lt;directory_name&gt;</code> ]
Notes	<p>The string must be a valid logical path.</p> <p>Queries disk usage information (drive capacity, free space available) and obtains a list of files and directories in a specified directory in the following format:</p> <p><code>&lt;numeric_value&gt;,&lt;numeric_value&gt;,{&lt;file_entry&gt;}</code></p> <p>It returns two numeric parameters and as many strings as there are files and directories. The first</p>

---

parameter indicates the total amount of storage currently used in bytes. The second parameter indicates the total amount of storage available, also in bytes. The <file\_entry> is a string. Each <file\_entry> indicates the name, type, and size of one file in the directory list:

<file\_name>,<file\_type>,<file\_size>

As the windows file system has an extension that indicates file type, <file\_type> is always empty. <file\_size> provides the size of the file in bytes. For directories, <file\_entry> is surrounded by square brackets and both <file\_type> and <file\_size> are empty

---

Initial S/W Revision      Prior to A.02.00

---

### Mass Storage Change Directory (Remote Command Only)

---

Key path                      SCPI Only

**Remote Command**        :MMEMory:CDIRectory [<directory\_name>]  
                              :MMEMory:CDIRectory?

**Notes**                      The string must be a valid logical path.  
                              Changes the default directory for a mass memory file system. The <directory\_name> parameter is a string. If no parameter is specified, the directory is set to the \*RST value.  
                              At \*RST, this value is set to the default user data storage area, that is defined as System.Environment.SpecialFolder.Personal.  
                              Query returns full path of the default directory.

---

Initial S/W Revision      Prior to A.02.00

---

### Mass Storage Copy (Remote Command Only)

---

Key path                      SCPI Only

**Remote Command**        :MMEMory:COPY <string>,<string>[,<string>,<string>]

**Notes**                      The string must be a valid logical path.  
                              Copies an existing file to a new file or an existing directory to a new directory.  
                              Two forms of parameters are allowed. The first form has two parameters. In this form, the first parameter specifies the source, and the second parameter specifies the destination.  
                              The second form has four parameters. In this form, the first and third parameters specify the source. The second and fourth parameters specify the directories. The first pair of parameters specifies the source. The second pair specifies the destination. An error is generated if the source doesn't exist or the destination file already exists.  
                              This command will generate an "access denied" error if the destination is a restricted folder (e.g., C:\Windows) and the current user does not have Power User or Administrator privileges.

---

### Mass Storage Device Copy (Remote Command Only)

This command transfers data to/from a file and a peripheral device.

Key path	SCPI Only
<b>Remote Command</b>	:MMEMory:COpy:DEvIce <source_string>,<dest_string>
Notes	<p>The strings must be a valid logical path or a valid device keyword. If the dest_string is a device keyword, the data is copied from the source file to the device. If the source_string is a device keyword, the data is copied to the source file from the device.</p> <p>Valid device keywords are:          SNS (smart noise source)</p> <p>An error is generated if the file or device is not found.</p>

### Mass Storage Delete (Remote Command Only)

Key path	SCPI Only
<b>Remote Command</b>	:MMEMory:DElete <file_name>[,<directory_name>]
Notes	<p>The string must be a valid logical path.</p> <p>Removes a file from the specified directory. The &lt;file_name&gt; parameter specifies the file name to be removed. This command will generate an “access denied” error if the file is in a restricted folder (e.g., C:\Windows) and the current user does not have Power User or Administrator privileges.</p>
Initial S/W Revision	Prior to A.02.00

### Mass Storage Data (Remote Command Only)

Creates a file containing the specified data OR queries the data from an existing file.

Key path	SCPI Only
<b>Remote Command</b>	:MMEMory:DATA <file_name>, <data> :MMEMory:DATA? <file_name>
Notes	<p>The string must be a valid logical path.</p> <p>The command form is MMEMory:DATA &lt;file_name&gt;,&lt;data&gt;. It loads &lt;data&gt; into the file &lt;file_name&gt;. &lt;data&gt; is in 488.2 block format. &lt;file_name&gt; is string data.</p> <p>The query form is MMEMory:DATA? &lt;file_name&gt; with the response being the associated &lt;data&gt; in block format.</p>
Initial S/W Revision	Prior to A.02.00

### Mass Storage Make Directory (Remote Command Only)

Key path	SCPI Only
<b>Remote Command</b>	:MMEMory:MDIRectory <directory_name>
Notes	<p>The string must be a valid logical path.</p> <p>Creates a new directory. The &lt;directory_name&gt; parameter specifies the name to be created.</p>

---

	This command will generate an “access denied” error if the new directory would be in a restricted folder (e.g., C:\Windows) and the current user does not have Power User or Administrator privileges.
Initial S/W Revision	Prior to A.02.00

---

### Mass Storage Move (Remote Command Only)

---

Key path	SCPI Only
<b>Remote Command</b>	<code>:MMEMory:MOVE &lt;string&gt;,&lt;string&gt;[,&lt;string&gt;,&lt;string&gt;]</code>
Notes	<p>The string must be a valid logical path.</p> <p>Moves an existing file to a new file or an existing directory to a new directory.</p> <p>Two forms of parameters are allowed. The first form has two parameters. In this form, the first parameter specifies the source, and the second parameter specifies the destination.</p> <p>The second form has four parameters. In this form, the first and third parameters specify the source. The second and fourth parameters specify the directories. The first pair of parameters specifies the source. The second pair specifies the destination. An error is generated if the source doesn't exist or the destination file already exists.</p> <p>This command will generate an “access denied” error if the destination is a restricted folder (e.g., C:\Windows) and the current user does not have Power User or Administrator privileges.</p>
Initial S/W Revision	Prior to A.02.00

---

### Mass Storage Remove Directory (Remote Command Only)

---

Key path	SCPI Only
<b>Remote Command</b>	<code>:MMEMory:RDIRECTory &lt;directory_name&gt;</code>
Notes	<p>The string must be a valid logical path.</p> <p>Removes a directory. The &lt;directory_name&gt; parameter specifies the directory name to be removed. All files and directories under the specified directory shall also be removed.</p> <p>This command will generate an “access denied” error if the folder is a restricted folder (e.g., C:\Windows) or is in a restricted folder and the current user does not have Power User or Administrator privileges.</p>
Initial S/W Revision	Prior to A.02.00

---

## Single (Single Measurement/Sweep)

Sets the analyzer for Single measurement operation. The single/continuous state is Meas Global, so the setting will affect all the measurements. If you are Paused, pressing Single does a Resume.

See ["More Information" on page 971](#)

Key Path	Front-panel key
Example	:INIT:CONT OFF
Notes	See Cont key description.
Backwards Compatibility Notes	<p>For Spectrum Analysis mode in ESA and PSA, the Single hardkey and the INITiate:IMM switched from continuous measurement to single measurement and restarted sweeps and averages (displayed average count reset to 1), but did not restart Max Hold and Min Hold. In the X-Series, the Single hardkey and the INITiate:IMM command initiate a sweep/ measurement/ average sequence/hold sequence including MaxHold and MinHold.</p> <p>For Spectrum Analysis mode in ESA and PSA, the Single hardkey restarted the sweep regardless of whether or not you were in an active sweep or sweep sequence. In the X-Series, Restart does this but Single only restarts the sweep or sweep sequence if you are in the idle state.</p> <p>INIT[:IMM] in ESA &amp; PSA Spectrum Analysis Mode does an implied ABORT. In some other PSA Modes, INIT[:IMM] is ignored if not in the idle state. . The X-Series follows the ESA/PSA SA Mode model, which may cause some Modes to have compatibility problems.</p>
Initial S/W Revision	Prior to A.02.00

### More Information

See ["Restart" on page 2894](#) for details on the INIT:IMMEDIATE (Restart) function.

If you are already in single sweep, the INIT:CONT OFF command has no effect.

If you are already in Single Sweep, then pressing the Single key in the middle of a sweep does not restart the sweep or sequence. Similarly, pressing the Single key does not restart the sweep or sequence if the sweep is not in the idle state (for example, if you are taking a very slow sweep, or the analyzer is waiting for a trigger). Instead, it results in a message. "Already in Single, press Restart to initiate a new sweep or sequence". Even though pressing the Single key in the middle of a sweep does not restart the sweep, sending INIT:IMMEDIATE does reset it.

To take one more sweep without resetting the average count, increment the average count by 1, by pressing the step up key while **Average/Hold Number** is the active function, or sending the remote command CALC:AVER:TCON UP.

## Source

There is no Source control functionality for this measurement. When this key is pressed, the screen either displays a blank menu, or the previously-selected menu remains unchanged.

---

Key Path	Front-panel key
----------	-----------------

---



## Span X Scale

Activates the Span function and displays the menu of span functions. The parameter values are measurement independent.

Key Path	Front-panel key
Initial S/W Revision	Prior to A.02.00

## Span

Set the frequency of the occupied bandwidth span for the current measurement.

Key Path	Span X Scale
Mode	SA, WCDMA, C2K, WIMAX OFDMA, TD-SCDMA, 1xEVDO, ISDB-T, CMMB, LTE, LTETDD, BLUETOOTH, WLAN, MSR, LTEAFDD, LTEATDD
Remote Command	[:SENSe]:OBWidth:FREQuency:SPAN <freq> [:SENSe]:OBWidth:FREQuency:SPAN? [:SENSe]:OBWidth:FREQuency:SPAN:AUTO ON OFF 0 1 [:SENSe]:OBWidth:FREQuency:SPAN:AUTO?
Example	OBW:FREQ:SPAN 2.4 MHz OBW:FREQ:SPAN? OBW:FREQ:SPAN:AUTO 0 OBW:FREQ:SPAN:AUTO?
Notes	Span Auto Detector ([:SENSe]:OBWidth:FREQuency:SPAN:AUTO) is only available in MSR and LTE-Advanced FDD/TDD mode. The BAF SCPI is MSR and LTE-Advanced FDD/TDD only.
Couplings	When changing the Occupied Bandwidth Span, the Resolution Bandwidth and Video Bandwidth are set to AUTO to prevent the span from clipping. This is only available in MSR and LTE-Advanced FDD/TDD mode.
Preset	SA: 3 MHz WCDMA: 10 MHz WIMAX OFDMA: 20 MHz CDMA2K: 2 MHz TD-SCDMA: 4.8 MHz 1xEVDO: 3.75 MHz ISDB-T: 20 MHz CMMB: 8 MHz LTE, LTETDD, LTEAFDD, LTEATDD: 10 MHz BLUETOOTH:2 MHz WLAN: If Radio Std is 802.11a/g 802.11n(20MHz) 802.11ac(20MHz): 25 MHz If Radio Std is 802.11b: 30MHz

	If Radio Std is 802.11n(40MHz), 802.11ac (40MHz): 50 MHz If Radio Std is 802.11ac(80MHz): 100MHz If Radio Std is 802.11ac(160MHz): 200MHz MSR: 20MHz ON
State Saved	Saved in instrument state.
Min	100 Hz
Max	Hardware Maximum Span
<b>Backwards Compatibility SCPI</b>	[ :SENSe ] :EBWidth:FREQuency:SPAN
Initial S/W Revision	Prior to A.02.00
Modified at S/W Revision	A.03.00, A.10.00, A.14.00

## Full Span

Changes the Occupied Bandwidth Span to show the full frequency range of the analyzer. When using external mixing, it changes the displayed frequency span to the frequency range specified for the selected external mixing band.

Key Path	Span X Scale
Mode	SA, WCDMA, C2K, WIMAX OFDMA, ISDB-T, CMMB, LTE, LTETDD, BLUETOOTH, WLAN
<b>Remote Command</b>	[ :SENSe ] :OBWidth:FREQuency:SPAN:FULL
<b>Example</b>	OBW:FREQ:SPAN:FULL
Notes	You must be in the Spectrum Analysis mode, W-CDMA mode, ISDB-T mode, CMMB mode, LTE mode, LTE TDD mode, BLUETOOTH mode, WLAN mode, cdma2000 mode, MSR or WIMAX OFDMA mode to use this command. Use:INSTrument:SElect to set the mode.
Dependencies	For MSR and LTE-Advanced FDD/TDD mode, this key is blank.
Couplings	Selecting full span changes the measurement span value.
Initial S/W Revision	Prior to A.02.00
Modified at S/W Revision	A.03.00

## Last Span

Changes the measurement frequency span to previous measurement span setting. If there is no existing previous span value then the span remains unchanged.

Key Path	Span X Scale
Mode	SA, WCDMA, C2K, WIMAX OFDMA, ISDB-T, CMMB, LTE, LTETDD, BLUETOOTH, WLAN, MSR, LTEAFDD, LTEATDD
<b>Remote Command</b>	[ :SENSe ] :OBWidth:FREQuency:SPAN:PREVious

<b>Example</b>	OBW:FREQ:SPAN:PREV
Notes	You must be in the Spectrum Analysis mode, W-CDMA mode, ISDB-T mode, CMMB mode, LTE mode, LTE TDD mode, BLUETOOTH mode, WLAN mode, cdma2000 mode, MSR, LTE-Advanced FDD/TDD or WIMAX OFDMA mode to use this command. Use:INSTRument:SElect to set the mode.
Couplings	Selecting last span changes the measurement span value.
Initial S/W Revision	Prior to A.02.00
Modified at S/W Revision	A.03.00

## Sweep/Control

Displays a menu of functions that enable you to set up and control the sweep time and source for the current measurement.

For details about this key, see ["Sweep/Control" on page 2925](#).

Key Path	Front-panel key
Initial S/W Revision	Prior to A.02.00

### Sweep Time

Selects the length of time in which the spectrum analyzer sweeps the displayed frequency span. Additional overhead time, which impacts the sweep rate, is not calculated as part of the sweep time. In fact:

- sweep rate = span/sweep time
- update rate = 1/(sweep time + overhead)
- sweep cycle time = sweep time + overhead

Sweep time is coupled to RBW and VBW, and is impacted by the number of sweep points, so changing those parameters may change the sweep time.

This function is not available when the selected input is I/Q.

Key Path	Sweep/Control
Mode	SA, WCDMA, C2K, WIMAX OFDMA, TD-SCDMA, 1xEVDO, ISDB-T, CMMB, LTE, LTETDD, BLUETOOTH, WLAN, MSR, LTEAFDD, LTEATDD
Remote Command	[ :SENSe ] :OBWidth :SWEep :TIME <time> [ :SENSe ] :OBWidth :SWEep :TIME? [ :SENSe ] :OBWidth :SWEep :TIME :AUTO OFF   ON   0   1 [ :SENSe ] :OBWidth :SWEep :TIME :AUTO?
Example	OBW:SWE:TIME 50 ms OBW:SWE:TIME? OBW:SWE:TIME:AUTO ON OBW:SWE:TIME:AUTO?
Couplings	When you manually change the Time, this state automatically goes to 'Man'.
Preset	SA, WIMAX OFDMA, C2K, TD-SCDMA, 1xEVDO, ISDB-T, CMMB, LTE, LTETDD, BLUETOOTH, WLAN, MSR, LTEAFDD, LTEATDD: Automatically Calculated WCDMA: 32.6 ms SA, WIMAX OFDMA, C2K, TD-SCDMA, 1xEVDO, ISDB-T, CMMB, LTE, LTETDD, WLAN, MSR, LTEAFDD, LTEATDD: ON WCDMA: OFF
State Saved	Saved in instrument state.

Min	1 ms
Max	4000 s
Initial S/W Revision	Prior to A.02.00
Modified at S/W Revision	A.03.00

## Sweep Setup

Accesses the sweep setup settings for the current measurement.

Key Path	Sweep/Control
Initial S/W Revision	Prior to A.02.00

## Auto Sweep Time Rules

Switches the analyzer between normal and accuracy sweep states.

Setting Auto Sweep Time to Accy results in slower sweep times, usually about three times as long, but better amplitude accuracy for CW signals. The instrument amplitude accuracy specifications only apply when Auto Sweep Time is set to Accy.

Additional amplitude errors which occur when Auto Sweep Time is set to Norm are usually well under 0.1 dB, though this is not guaranteed. Because of the faster sweep times and still low errors, Norm is the preferred setting of Auto Sweep Time. Auto Sweep Time is set to Norm on a Preset or Auto Couple. This means that in the Preset or Auto Coupled state, instrument amplitude accuracy specifications do not apply.

Key Path	Sweep/Control, Sweep Setup
Mode	SA, WCDMA, C2K, WIMAX OFDMA, TD-SCDMA, 1xEVDO, ISDB-T, CMMB, LTE, LTEFDD, BLUETOOTH, WLAN, MSR, LTEAFDD, LTEATDD
<b>Remote Command</b>	[ :SENSe ] :OBWidth :SWEep :TIME :AUTO :RULEs NORMal   ACCuracy [ :SENSe ] :OBWidth :SWEep :TIME :AUTO :RULEs ?
<b>Example</b>	OBW:SWE:TIME:AUTO:RUL NORM OBW:SWE:TIME:AUTO:RUL?
Notes	Set to Norm when Auto Couple is pressed or sent remotely.
Preset	NORMal
State Saved	Saved in instrument state.
Range	Norm   Accy
Initial S/W Revision	Prior to A.02.00
Modified at S/W Revision	A.03.00

## Pause

Pauses the measurement after the current data acquisition is complete.

When Paused, the label on the key changes to Resume. Pressing Resume resumes the measurement at the point where it had been paused.

See "[Pause/Resume](#)" on page 2925 for more information.

Key Path	Sweep/Control
Initial S/W Revision	Prior to A.02.00

## Gate

Accesses a menu that enables you to control the gating function. The Gate functionality is used to view signals best viewed by qualifying them with other events.

Gate setup parameters are the same for all measurements – they do not change as you change measurements. Settings like these are called “Meas Global” and are unaffected by Meas Preset.

Note that Sweep Time autocoupling rules and annotation are changed by Gate being on.

Key Path	Sweep/Control
Scope	Meas Global
Readback	The state and method of Gate, as [Off, LO] or [On, Video]. Note that for measurements that only support gated LO, the method is nonetheless read back, but always as LO.
Initial S/W Revision	Prior to A.02.00

## Gate On/Off

Turns the gate function on and off.

When the Gate Function is on, the selected Gate Method is used along with the gate settings and the signal at the gate source to control the sweep and video system with the gate signal. Not all measurements allow every type of Gate Methods.

When Gate is on, the annunciation in the measurement bar reflects that it is on and what method is used, as seen in the following "Gate: LO" annunciator graphic.

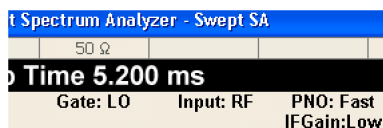

Key Path	Sweep/Control, Gate
Remote Command	[ :SENSe ] :SWEep:EGATE [ :STATe ] OFF ON 0 1

	[ :SENSe ] :SWEep:EGATe [ :STATe ] ?
<b>Example</b>	SWE:EGAT ON SWE:EGAT?
<b>Dependencies</b>	<p>The function is unavailable (grayed out) and Off when:</p> <ul style="list-style-type: none"> <li>• Gate Method is LO or Video and FFT Sweep Type is manually selected.</li> <li>• Gate Method is FFT and Swept Sweep Type is manually selected.</li> <li>• Marker Count is ON.</li> </ul> <p>The following are unavailable whenever Gate is on:</p> <ul style="list-style-type: none"> <li>• FFT under Sweep Type when Method=LO or Video or Swept under Sweep Type when Method=FFT</li> <li>• Marker Count</li> </ul> <p>While Gate is on, the Auto Rules for Sweep Type are modified so that the choice agrees with the Gate Method: i.e., FFT for Method = FFT and Swept for Method = LO or Video.</p> <p>The Gate softkey and all SCPI under the [:SENSe]:SWEep:EGATe SCPI node are grayed out when Source Mode is Tracking with an external source. This is because the Gate circuitry is used to sync the external source. If the Tracking Source is turned on, the Gate is turned off.</p> <p>When in the ACP measurement:</p> <ul style="list-style-type: none"> <li>• When Meas Method is RBW or FAST, this function is unavailable and the key is grayed out.</li> <li>• Whenever Gate is on, Meas Method, RBW or FAST is unavailable and keys for those are grayed out.</li> <li>• When Gate is on, Offset Res BW and Offset Video BW are ignored (if you set these values) and the measurement works as if all Offset Res BW and all Offset Video BW are coupled with the Res BW and the Video BW under the BW menu. When Gate is on, the Offset BW key in the Offset/Limit menu is grayed out.</li> </ul>
Preset	Off LTETDD: On
State Saved	Saved in instrument state
Range	On Off
<b>Backwards Compatibility SCPI</b>	[:SENSe]:SWEep:TIME:GATE[:STATe] ESA compatibility
Backwards Compatibility Notes	In ESA, Trig Delay (On) and Gate (On) could not be active at the same time.. This dependency does not exist in PSA or in the X-Series.
Initial S/W Revision	Prior to A.02.00

## Gate View On/Off

Turning on Gate View in the Swept SA measurement provides a single-window gate view display..

Turning on Gate View in other measurements shows the split-screen Gate View. In these measurements, when the Gate View is on, the regular view of the current measurement traces and results are reduced vertically to about 70% of the regular height. The Zero Span window, showing the positions of the Gate, is shown between the Measurement Bar and the reduced measurement window. By reducing the height of the measurement window, some of the annotation on the Data Display may not fit and is not shown.

Key Path	Sweep/Control, Gate
Remote Command	[ :SENSe ] :SWEep:EGATe:VIEW ON OFF 1 0 [ :SENSe ] :SWEep:EGATe:VIEW?
Example	SWE:EGAT:VIEW ON turns on the gate view.
Dependencies	In the Swept SA measurement: In Gate View, the regular Sweep Time key is grayed out . When pressed, the grayed out key puts up the informational message "Use Gate View Sweep Time in the Gate menu." In the other measurements: When you turn Gate View on, the lower window takes on the current state of the instrument. Upon leaving Gate View, the instrument takes on the state of the lower window. When you turn Gate View on, the upper window Sweep Time is set to the gate view sweep time.
Couplings	These couplings apply to the Swept SA measurement: <ul style="list-style-type: none"> <li>• When Gate View is turned on, the instrument is set to Zero Span.</li> <li>• Gate View automatically turns off whenever a Span other than Zero is selected.</li> <li>• Gate View automatically turns off if you press the Last Span key while in Gate View, and the instrument returns to the Span it was in before entering Gate View (even if that is Zero Span).</li> <li>• When Gate View is turned on, the sweep time used is the gate view sweep time. This is set according to the rules in section "<a href="#">Gate View Setup</a> " on page 2725</li> <li>• When Gate View is turned off, Sweep Time is set to the normal Swept SA measurement sweep time.</li> <li>• If Gate View is on and Gate is off, then turning on Gate turns off Gate View.</li> </ul>
Preset	OFF
State Saved	Saved in instrument state
Range	On Off
Initial S/W Revision	Prior to A.02.00

A sample of the Gate View screen in the Swept SA measurement is shown in the following graphic :



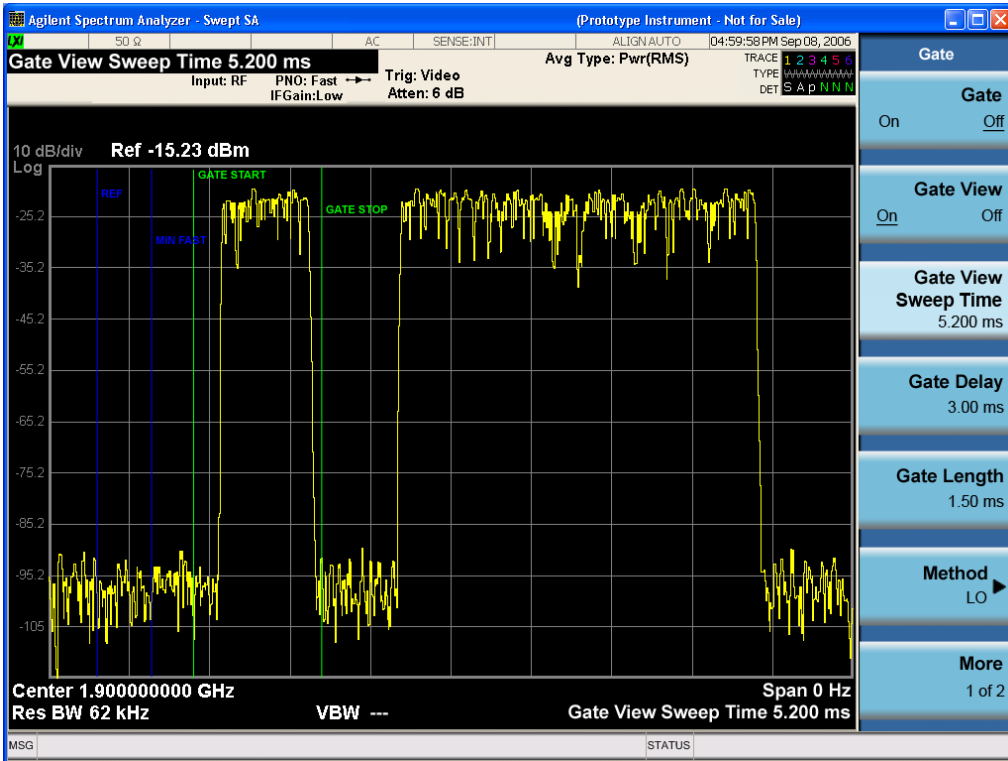

A sample of the Gate View screen in other measurements is shown in the following graphic. This example is for the ACP measurement:

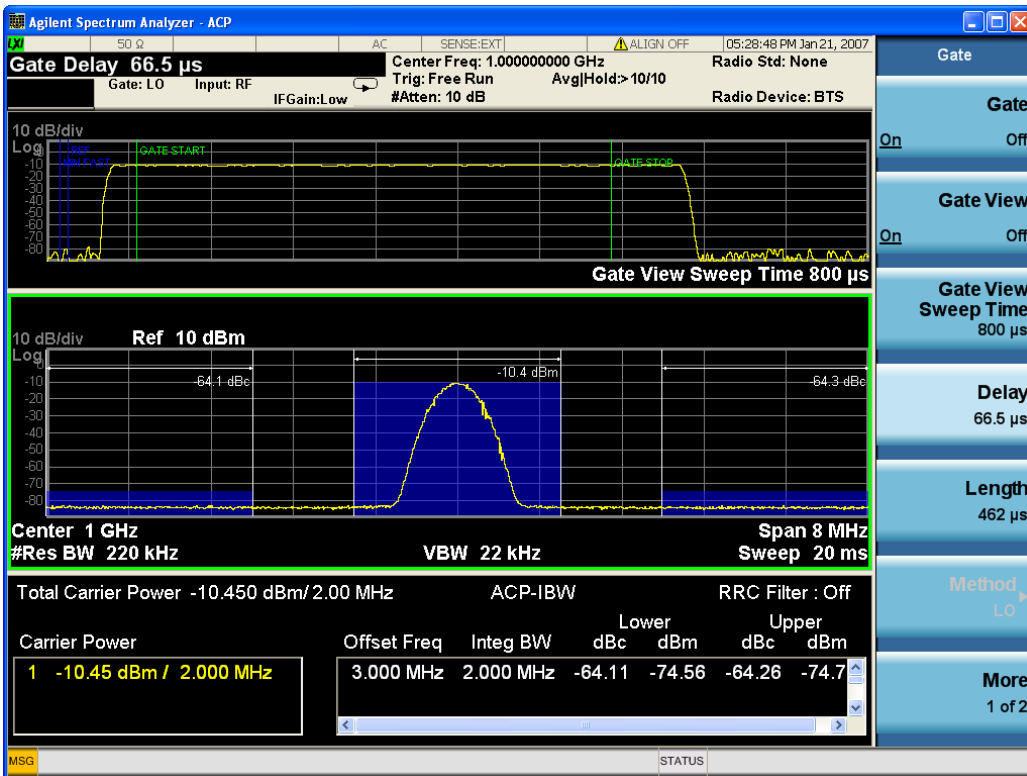

Turning Gate View off returns the analyzer to the Normal measurement view.

In the Swept SA, the normal measurement view is the single-window Swept SA view. When returning to this view, the Swept SA measurement returns to the Span it was in before entering **Gate View** (even if that is Zero Span).

The **Gate View** window is triggered from the Gate Source, with zero trigger delay. Also, when updating the **Gate View** window, the Gate itself must not operate. So it is internally shut off while the gate view window is being updated. For the Swept SA measurement, this means that the Gate is internally shut off whenever the gate view window is displayed. The measurement bar and softkeys continue to show the Trigger source for the main sweep window and give no indication that the Gate is shut off or that the Gate View window is triggered from the Gate Source.

When in **Gate View**, vertical lines are displayed in the Gate View window as follows:

- Green lines are displayed at the gate edges as follows: in Edge Gate, a line is shown for Delay and one for the end of the Gate period, defined by Length. In Level Gate a line is shown only for Delay. You can adjust the position of the green lines by adjusting the gate length and the gate delay. These lines update in the Gate View window as the active function changes, even if the window is not being updated. In Gated LO and Gated Video, these lines are positioned relative to the delay reference line (not relative to 0 time). In Gated FFT, their location is relative to the left edge of the screen.
- A blue line is displayed showing the delay reference, that is, the reference point for the Gate Delay within the Zero Span window. The blue line represents where (in time) the effective location of the gate start would be if the gate were programmed to zero delay.
- 
- The second blue line is labeled "MIN FAST" as shown in the figure above because it represents the minimum Gate Delay for fast Gated LO operation. This line is only displayed in Gated LO. You cannot scroll (knob) or decrement (down key) the Gate Delay to less than that represented by the position of this line, it can only be set below this position manually, although once there it can be moved freely with the knob while below the line.
- A yellow line in the Gated Video case only, is displayed at Blength, where Blength is the display point (bucket) length for the swept trace, which is given by the sweep time for that trace divided by number of Points – 1. So it is referenced to 0 time, not to the delay reference. This line is labeled NEXT PT (it is not shown in the figure above because the figure above is for Gated LO).
- The yellow line represents the edge of a display point (bucket). Normally in Gated Video, the bucket length must be selected so that it exceeds the off time of the burst. There is another way to use the analyzer in Gated Video measurements, and that is to set the bucket width much shorter than the off time of the burst. Then use the Max Hold trace function to fill in "missing" buckets more slowly. This allows you to see some of the patterns of the Gated Video results earlier, though seeing a completely filled-in spectrum later.

## Gate View Setup

Accesses a menu that enables you to setup parameters relevant to the Gate View

Key Path	Sweep/Control, Gate
Scope	Meas Global
Initial S/W Revision	A.10.00

## Gate View Sweep Time

Controls the sweep time in the Gate View window. To provide an optimal view of the gate signal, the analyzer initializes Gate View Sweep Time based on the current settings of Gate Delay and Gate Length.

<b>Key Path</b>	Sweep/Control, Gate, Gate View Setup
<b>Remote Command</b>	[ :SENSe ] :SWEep:EGATe:TIME <time> [ :SENSe ] :SWEep:EGATe:TIME?
<b>Example</b>	SWE:EGAT:TIME 500 ms
<b>Dependencies</b>	Gate View Sweep Time is initialized: <ul style="list-style-type: none"> <li>• On Preset (after initializing delay and length).</li> <li>• Every time the Gate Method is set/changed.</li> </ul> <p>Additionally, in the Swept SA measurement, whenever you do a Preset, or leave Gate View, the analyzer remembers the Gate Delay and Gate Length settings. Then, when returning to Gate View, if the current Gate Delay and/or Gate Length do not match the remembered values Gate View Sweep Time is re-initialized.</p> <ol style="list-style-type: none"> <li>1. Compute the location of the "gate stop" line, which you know is at time <math>t = t_{min} + \text{GateDelay} + \text{GateLength}</math>.</li> </ol>
<b>Preset</b>	519.3 $\mu$ s WiMAX OFDMA: 5 ms GSM/EDGE: 1 ms
<b>State Saved</b>	Saved in instrument state
<b>Max</b>	6000 s
<b>Initial S/W Revision</b>	Prior to A.02.00

## Gate View Start Time

Controls the time at the left edge of the Gate View.

<b>Key Path</b>	Sweep/Control, Gate, Gate View Setup
<b>Remote Command</b>	[ :SENSe ] :SWEep:EGATe:VIEW:STARt <time> [ :SENSe ] :SWEep:EGATe:VIEW:STARt?
<b>Example</b>	SWE:EGAT:VIEW:STAR 10ms
<b>Notes</b>	Units of time are required or no units; otherwise an invalid suffix error message will be generated. See error -131.
<b>Preset</b>	0 ms
<b>State Saved</b>	Saved in instrument state
<b>Min</b>	0
<b>Max</b>	500 ms
<b>Initial S/W Revision</b>	A.10.00

## Gate Delay

Controls the length of time from the time the gate condition goes True until the gate is turned on.

Key Path	Sweep/Control, Gate
Remote Command	[ :SENSe ] :SWEep:EGATe:DELay <time> [ :SENSe ] :SWEep:EGATe:DELay?
Example	SWE:EGAT:DELay 500ms SWE:EGAT:DELay?
Notes	Units of time are required or no units; otherwise an invalid suffix error message will be generated.
Preset	57.7 us WiMAX OFDMA: 71 us GSM/EDGE: 600 us WLAN: 500 us
State Saved	Saved in instrument state
Min	0.0 us
Max	100 s
Backwards Compatibility SCPI	[ :SENSe ] :SWEep:TIME:GATE:DELay ESA compatibility
Initial S/W Revision	Prior to A.02.00

## Gate Length

Controls the length of time that the gate is on after it opens.

Key Path	Sweep/Control, Gate
Remote Command	[ :SENSe ] :SWEep:EGATe:LENGth <time> [ :SENSe ] :SWEep:EGATe:LENGth?
Example	SWE:EGAT:LENG 1 SWE:EGAT:LENG?
Notes	Units of time are required or no units; otherwise an invalid suffix error message will be generated.
Dependencies	<p>Grayed out when Gate Method is set to FFT in which case the label changes to that shown below.</p>  <p>The key is also grayed out if Gate Control = Level.</p>
Preset	461.6 us

	WiMAX OFDMA: 50 us GSM/EDGE: 200 us WLAN: 1.54 ms
State Saved	Saved in instrument state
Min	100 ns
Max	5 s
<b>Backwards Compatibility SCPI</b>	[:SENSe]:SWEep:TIME:GATE:LENGth ESA compatibility
Initial S/W Revision	Prior to A.02.00

## Gate Source

The menus under the Gate Source key are the same as those under the Trigger key, with the exception that neither Free Run nor Video are available as Gate Source selections. However, a different SCPI command is used to select the Gate Source (see table below) because you may independently set the Gate Source and the Trigger Source.

Any changes to the settings in the setup menus under each Gate Source selection key (for example: Trigger Level, Trigger Delay, etc.) also affect the corresponding settings under the Trigger menu keys. The SCPI commands used for these are the same for Trigger and Gate, since there is only one setting which affects both Gate and Trigger. Example: to set the Trigger Level for External 1 you use the command :TRIG:EXT1:LEV regardless of whether you are using External 1 as a Trigger Source or a Gate Source.

Key Path	Sweep/Control, Gate
<b>Remote Command</b>	[:SENSe]:SWEep:EGATe:SOURce EXTernal1   EXTernal2   LINE   FRAMe   RFBurst  [:SENSe]:SWEep:EGATe:SOURce?
Dependencies	In some models, there is no second External input. In these models, the External 2 key is blanked and the EXTernal2 parameter will generate a "Hardware missing; Not available for this model number" error.
Preset	EXTernal 1 GSM/EDGE, MSR: FRAMe LTETDD: EXTernal 1When Direction is Downlink, FRAMe when Direction is Uplink.
Backwards Compatibility Notes	In ESA, there is a single Gate input port. In PSA, the Gate Source may be taken from one of two specified input ports. In the X-Series, any Trigger Source can be a Gate Source.
Initial S/W Revision	Prior to A.02.00
Modified at S/W Revision	A.03.00, A.14.00

## Line

Pressing this key, when it is not selected, selects the line signal as the trigger. A new sweep/measurement will start synchronized with the next cycle of the line voltage. Pressing this key, when it is already selected, access the line trigger setup menu.

Key Path	Trigger
<b>Example</b>	TRIG:SOUR LINE Swept SA measurement TRIG:<meas>:SOUR LINE Measurements other than Swept SA
Dependencies	Line trigger is not available when operating from a "dc power source", for example, when the instrument is powered from batteries.
State Saved	Saved in instrument state
Status Bits/OPC dependencies	The Status Operation Register bit 5 "Waiting for Trigger" is set at the same time as the Sweeping or Measuring bit is set. It is cleared when the trigger actually occurs (that is, after the trigger event occurs and all the applicable trigger criteria have been met). A corresponding pop-up message ("Waiting for trigger") is generated if no trigger signal appears after approximately 2 sec. This message goes away when a trigger signal appears.
Initial S/W Revision	Prior to A.02.00

## Trig Slope

Controls the trigger polarity. It is set positive to trigger on a rising edge and negative to trigger on a falling edge.

Key Path	Trigger, Line
<b>Remote Command</b>	:TRIGger[:SEquence]:LINE:SLOPe POSitive NEGative :TRIGger[:SEquence]:LINE:SLOPe?
<b>Example</b>	TRIG:LINE:SLOP NEG
Preset	POSitive
State Saved	Saved in instrument state
Backwards Compatibility Notes	The legacy :TRIGger[:SEquence]:SLOPe command affects the slopes for the VID, LINE, EXT1, EXT2, and RFB triggers.
Initial S/W Revision	Prior to A.02.00

## External 1

Pressing this key, when it is not selected, selects an external input signal as the trigger. A new sweep/measurement will start when the external trigger condition is met using the external 1 input connector on the rear panel.

Pressing this key, when it is already selected, accesses the external 1 trigger setup menu.

Key Path	Trigger
<b>Example</b>	TRIG:SOUR EXT1 Swept SA measurement TRIG:<meas>:SOUR EXT1 Measurements other than Swept SA
Dependencies	Grayed out if in use by Point Trigger in the Source Setup menu. Forced to Free Run if already selected and Point Trigger is set to External 1.
State Saved	Saved in instrument state
Status Bits/OPC dependencies	The Status Operation Register bit 5 "Waiting for Trigger" is set at the same time as the Sweeping or Measuring bit is set. It is cleared when the trigger actually occurs (that is, after the trigger event occurs and all the applicable trigger criteria have been met). A corresponding pop-up message ("Waiting for trigger") is generated if no trigger signal appears after approximately 2 sec. This message goes away when a trigger signal appears.
Initial S/W Revision	Prior to A.02.00

### Trigger Level

Sets the value where the external 1 trigger input will trigger a new sweep/measurement.

Key Path	Trigger, External 1
<b>Remote Command</b>	:TRIGger[:SEquence]:EXTernal1:LEVel <level> :TRIGger[:SEquence]:EXTernal1:LEVel?
<b>Example</b>	TRIG:EXT1:LEV 0.4 V
Couplings	This same level is used for the Ext1 trigger source in the Trigger menu, for the Ext1 selection in the Periodic Timer sync source (in the Trigger menu and in the Gate Source menu), and also for the Ext1 selection in the Gate Source menu.
Preset	1.2 V
State Saved	Saved in instrument state
Min	-5 V
Max	5 V
Default Unit	V
<b>Backwards Compatibility SCPI</b>	:TRIGger[:SEquence]:EXTernal:LEVel For backward compatibility, the parameter EXTernal is mapped to EXTernal1
<b>Backwards Compatibility SCPI</b>	:TRIGger[:SEquence]:FRAME:EXTernal1:LEVel
Initial S/W Revision	Prior to A.02.00

### Trig Slope

Controls the trigger polarity. It is set positive to trigger on a rising edge and negative to trigger on a falling edge.

Key Path	Trigger, External 1
Remote Command	:TRIGger[:SEquence]:EXTErnal1:SLOPe POSitive NEGative :TRIGger[:SEquence]:EXTErnal1:SLOPe?
Example	TRIG:EXT1:SLOP NEG
Couplings	This same slope is used in the Ext1 selection for the trigger source in the Trigger menu and for the period timer sync source (in the Trigger menu and in the Gate Source menu).
Preset	POSitive
State Saved	Saved in instrument state
Backwards Compatibility SCPI	:TRIGger[:SEquence]:EXTErnal:SLOPe For backward compatibility, the parameter EXTErnal is mapped to EXTErnal1
Backwards Compatibility SCPI	:TRIGger[:SEquence]:FRAMe:EXTErnal1:SLOPe
Backwards Compatibility Notes	The legacy :TRIGger[:SEquence]:SLOPe command affects the slopes for the VID, LINE, EXT1, EXT2, and RFB triggers.
Initial S/W Revision	Prior to A.02.00

## External 2

Pressing this key, when it is not selected, selects an external input signal as the trigger. A new sweep/measurement will start when the external trigger condition is met using the external 2 input connector. The external trigger 2 input connector is on the rear panel.

Pressing this key, when it is already selected, accesses the external 2 trigger setup menu.

Key Path	Trigger
Example	TRIG:SOUR EXT2 Swept SA measurement TRIG:<meas>:SOUR EXT2 Measurements other than Swept SA
Dependencies	In some models, there is no second External input. In these models, the External 2 key is blanked and the EXTErnal2 parameter will generate a "Hardware missing; Not available for this model number" message.  Grayed out if in use by Point Trigger in the Source Setup menu. Forced to Free Run if already selected and Point Trigger is set to External 2.
State Saved	Saved in instrument state
Status Bits/OPC dependencies	The Status Operation Register bit 5 "Waiting for Trigger" is set at the same time as the Sweeping or Measuring bit is set. It is cleared when the trigger actually occurs (that is, after the trigger event occurs and all the applicable trigger criteria have been met). A corresponding pop-up message ("Waiting for trigger") is generated if no trigger signal appears after approximately 2 sec. This message goes away when a trigger signal appears.
Initial S/W Revision	Prior to A.02.00
Modified at S/W Revision	A.03.00



## Trigger Level

Sets the value where the external 2 trigger input will trigger a new sweep/measurement.

Key Path	Trigger, External 2
<b>Remote Command</b>	:TRIGger[:SEquence]:EXTernal2:LEVel :TRIGger[:SEquence]:EXTernal2:LEVel?
<b>Example</b>	TRIG:EXT2:LEV 1.1 V
Couplings	This same level is used for the Ext2 trigger source in the Trigger menu, for the Ext2 selection in the Periodic Timer sync source (in the Trigger menu and in the Gate Source menu), and also for the Ext2 selection in the Gate Source menu.
Preset	1.2 V
State Saved	Saved in instrument state
Min	-5 V
Max	5 V
Default Unit	V
<b>Backwards Compatibility SCPI</b>	:TRIGger[:SEquence]:FRAMe:EXTernal2:LEVel
Initial S/W Revision	Prior to A.02.00

## Trig Slope

Controls the trigger polarity. It is set positive to trigger on a rising edge and negative to trigger on a falling edge.

Key Path	Trigger, External 2
<b>Remote Command</b>	:TRIGger[:SEquence]:EXTernal2:SLOPe POSitive NEGative :TRIGger[:SEquence]:EXTernal2:SLOPe?
<b>Example</b>	TRIG:EXT2:SLOP NEG
Couplings	This same slope is used in the Ext2 selection for the trigger source in the Trigger menu and for the period timer sync source (in the Trigger menu and in the Gate Source menu).
Preset	POSitive
State Saved	Saved in instrument state
<b>Backwards Compatibility SCPI</b>	:TRIGger[:SEquence]:FRAMe:EXTernal2:SLOPe
Backwards Compatibility Notes	The legacy :TRIGger[:SEquence]:SLOPe command affects the slopes for the VID, LINE, EXT1, EXT2, and RFB triggers.
Initial S/W Revision	Prior to A.02.00

## RF Burst

Pressing this key, when it is not selected, selects the RF Burst as the trigger. A new sweep/measurement will start when an RF burst envelope signal is identified from the signal at the RF Input connector. Pressing this key, when it is already selected, accesses the RF Burst trigger setup menu.

In some models, a variety of burst trigger circuitry is available, resulting in various available burst trigger bandwidths. The analyzer automatically chooses the appropriate trigger path based on the hardware configuration and other settings of the analyzer.

<b>Key Path</b>	<b>Trigger</b>
<b>Example</b>	TRIG:SOUR RFB      Swept SA measurement TRIG:< meas>:SOUR RFB   Measurements other than Swept SA
<b>State Saved</b>	Saved in instrument state
<b>Status Bits/OPC dependencies</b>	The Status Operation Register bit 5 "Waiting for Trigger" is set at the same time as the Sweeping or Measuring bit is set. It is cleared when the trigger actually occurs (that is, after the trigger event occurs and all the applicable trigger criteria have been met). A corresponding pop-up message ("Waiting for trigger") is generated if no trigger signal appears after approximately 2 sec. This message goes away when a trigger signal appears.
<b>Backwards Compatibility Notes</b>	The legacy command: :TRIGger[:SEQuence]:RFBurst:FSElectivity[:STATe] OFF ON 0 1 is not supported in the X-Series, as the hardware to do Frequency Selective burst triggers does not exist in X-Series.
<b>Initial S/W Revision</b>	Prior to A.02.00
<b>Modified at S/W Revision</b>	A.04.00

## Absolute Trigger Level

Sets the absolute trigger level for the RF burst envelope.

When using the External Mixing path, the Absolute Trigger Level is uncalibrated because the factory default was set to accommodate the expected IF levels for the RF path.

<b>Key Path</b>	<b>Trigger, RF Burst</b>
<b>Scope</b>	Meas Global
<b>Remote Command</b>	:TRIGger[:SEQuence]:RFBurst:LEVel:ABSolute <ampl> :TRIGger[:SEQuence]:RFBurst:LEVel:ABSolute?
<b>Example</b>	TRIG:RFB:LEV:ABS 10 dBm sets the trigger level of the RF burst envelope signal to the absolute level of 10 dBm
<b>Notes</b>	Sending this command does not switch the setting from relative to absolute; to switch it you need to send the :TRIGger[:SEQuence]:RFBurst:LEVel:TYPE command, below. Amplitude Corrections are not taken into account by the Absolute Trigger Level. For example, if you have given yourself effective gain with an amplitude correction factor, the Absolute Trigger will not fire until you have set the trigger level that far below the displayed signal level, rather than simply to

	the displayed signal level. This is only true for Amplitude Corrections, not External Gain or Ref Level Offset functions. If mode is Bluetooth, the default value is -50 dBm.
Couplings	This same level is used for the RF Burst trigger source in the Trigger menu, for the RF Burst selection in the Periodic Timer sync source (in the Trigger menu and in the Gate Source menu), and also for the RF Burst selection in the Gate Source menu
Preset	-20 dBm
State Saved	Saved in instrument state
Min	-200 dBm
Max	100 dBm
Default Unit	depends on the current selected Y-Axis unit
<b>Backwards Compatibility SCPI</b>	:TRIGger[:SEquence]:FRAMe:RFBurst:LEVel:ABSolute
Initial S/W Revision	Prior to A.02.00
Modified at S/W Revision	A.04.00

Key Path	Trigger, RF Burst
<b>Remote Command</b>	:TRIGger[:SEquence]:RFBurst:LEVel:TYPE ABSolute RELative :TRIGger[:SEquence]:RFBurst:LEVel:TYPE?
<b>Example</b>	TRIG:RFB:LEV:TYPE REL sets the trigger level type of the RF burst trigger to Relative.
Preset	ABSolute
State Saved	Saved in instrument state
Initial S/W Revision	Prior to A.02.00
Modified at S/W Revision	A.04.00

### Relative Trigger Level

Sets the relative trigger level for the RF burst envelope.

In some models, the relative burst trigger function is implemented in hardware. In other models, without the advanced triggering hardware required, the relative burst trigger function is implemented in software in some measurements, and is unavailable in other measurements.

When implemented in software, the relative RF Burst trigger function is implemented as follows:

1. The measurement starts with the absolute RF Burst trigger setting. If it cannot get a trigger with that level, auto trigger fires and the acquisition starts anyway. After the acquisition, the measurement searches for the peak in the acquired waveform and saves it.

2. Now, in the next cycle of the measurement, the measurement determines a new absolute RF Burst level based on the peak value from the first measurement and the Relative RF Burst Trigger Level (always 0 or negative dB) set by the user. The following formula is used:
  3. absolute RF Burst level = peak level of the previous acquisition + relative RF Burst level
  4. If the new absolute RF Burst level differs from the previous by more than 0.5 dB, the new level is sent to the hardware; otherwise it is not updated (to avoid slowing down the acquisition)
- Steps 2 and 3 repeat for subsequent measurements.

Key Path	Trigger, RF Burst
Scope	Meas Global
<b>Remote Command</b>	:TRIGger[:SEquence]:RFBurst:LEVel:RELative <rel_ampl> :TRIGger[:SEquence]:RFBurst:LEVel:RELative?
<b>Example</b>	TRIG:RFB:LEV:REL -10 dB sets the trigger level of the RF burst envelope signal to the relative level of -10 dB
Notes	Sending this command does not switch the setting from absolute to relative; to switch it you need to send the :TRIGger[:SEquence]:RFBurst:LEVel:TYPE command, above. The relative trigger level is not available in some measurements. In those measurements the RELative parameter, and the :TRIGger[:SEquence]:RFBurst:LEVel:TYPE command (above), will generate an error if sent.
Dependencies	This key is grayed out and Absolute Trigger Level selected if the required hardware is not present in your analyzer and the current measurement does not support Relative triggering.
Preset	-6 dB GSM: -25 dB
State Saved	Saved in instrument state
Min	-45 dB
Max	0 dB
Default Unit	dB or dBc
<b>Backwards Compatibility SCPI</b>	:TRIGger[:SEquence]:RFBurst:LEVel This legacy command is aliased to :TRIGger[:SEquence]:RFBurst:LEVel:RELative because the PSA had ONLY relative burst triggering
Initial S/W Revision	Prior to A.02.00
Modified at S/W Revision	A.04.00

### Trigger Slope

It is set positive to trigger on a rising edge and negative to trigger on a falling edge.

Key Path	Trigger, RF Burst
<b>Remote Command</b>	:TRIGger[:SEquence]:RFBurst:SLOPe POSitive NEGative :TRIGger[:SEquence]:RFBurst:SLOPe?

<b>Example</b>	TRIG:RFB:SLOP NEG
Couplings	This same slope is used in the RF Burst selection for the trigger source in the Trigger menu and for the period timer sync source (in the Trigger menu and in the Gate Source menu).
Preset	POSitive
State Saved	Saved in instrument state
<b>Backwards Compatibility SCPI</b>	:TRIGger[:SEQuence]:FRAMe:RFBurst:SLOPe
Backwards Compatibility Notes	The legacy :TRIGger[:SEQuence]:SLOPe command affects the slopes for the VID, LINE, EXT1, EXT2, and RFB triggers.
Initial S/W Revision	Prior to A.02.00

### Periodic Timer (Frame Trigger)

Pressing this key, when it is not selected, selects the internal periodic timer signal as the trigger. Triggering occurrences are set by the **Period** parameter, which is modified by the **Sync Source** and **Offset**. Pressing this key, when it is already selected, accesses the periodic timer trigger setup functions.

If you do not have a sync source selected (it is Off), then the internal timer will not be synchronized with any external timing events.

<b>Key Path</b>	<b>Trigger</b>
<b>Example</b>	TRIG:SOUR FRAM                      Swept SA measurement TRIG:<meas>:SOUR FRAM      Measurements other than Swept SA
State Saved	Saved in instrument state
Readback	[Sync: <value of Sync Source>], for example, [Sync: External 1]
Status Bits/OPC dependencies	The Status Operation Register bit 5 "Waiting for Trigger" is set at the same time as the Sweeping or Measuring bit is set. It is cleared when the trigger actually occurs (that is, after the trigger event occurs and all the applicable trigger criteria have been met). A corresponding pop-up message ("Waiting for trigger") is generated if no trigger signal appears after approximately 2 sec. This message goes away when a trigger signal appears.
Initial S/W Revision	Prior to A.02.00

### Periodic Timer Triggering:

This feature selects the internal periodic timer signal as the trigger. Trigger occurrences are set by the **Periodic Timer** parameter, which is modified by the **Sync Source** and **Offset**.

The figure below shows the action of the periodic timer trigger. Before reviewing the figure, we'll explain some uses for the periodic trigger.

A common application is measuring periodic burst RF signals for which a trigger signal is not easily available. For example, we might be measuring a TDMA radio which bursts every 20 ms. Let's assume that the 20 ms period is very consistent. Let's also assume that we do not have an external trigger source

available that is synchronized with the period, and that the signal-to-noise ratio of the signal is not high enough to provide a clean RF burst trigger at all of the analysis frequencies. For example, we might want to measure spurious transmissions at an offset from the carrier that is larger than the bandwidth of the RF burst trigger. In this application, we can set the Periodic Timer to a 20.00 ms period and adjust the offset from that timer to position our trigger just where we want it. If we find that the 20.00 ms is not exactly right, we can adjust the period slightly to minimize the drift between the period timer and the signal to be measured.

A second way to use this feature would be to use **Sync Source** temporarily, instead of **Offset**. In this case, we might tune to the signal in a narrow span and use the RF Burst trigger to synchronize the periodic timer. Then we would turn the sync source off so that it would not miss-trigger. Miss-triggering can occur when we are tuned so far away from the RF burst trigger that it is no longer reliable.

A third example would be to synchronize to a signal that has a reference time element of much longer period than the period of interest. In some CDMA applications, it is useful to look at signals with a short periodicity, by synchronizing that periodicity to the "even-second clock" edge that happens every two seconds. Thus, we could connect the even-second clock trigger to Ext1 and use then Ext1 as the sync source for the periodic timer.

The figure below illustrates this third example. The top trace represents the even-second clock. It causes the periodic timer to synchronize with the leading edge shown. The analyzer trigger occurs at a time delayed by the accumulated offset from the period trigger event. The periodic timer continues to run, and triggers continue to occur, with a periodicity determined by the analyzer time base. The timer output (labeled "late event") will drift away from its ideal time due to imperfect matching between the time base of the signal being measured and the time base of the analyzer, and also because of imperfect setting of the period parameter. But the synchronization is restored on the next even-second clock event. ("Accumulated offset" is described in the in the **Offset** function section.)

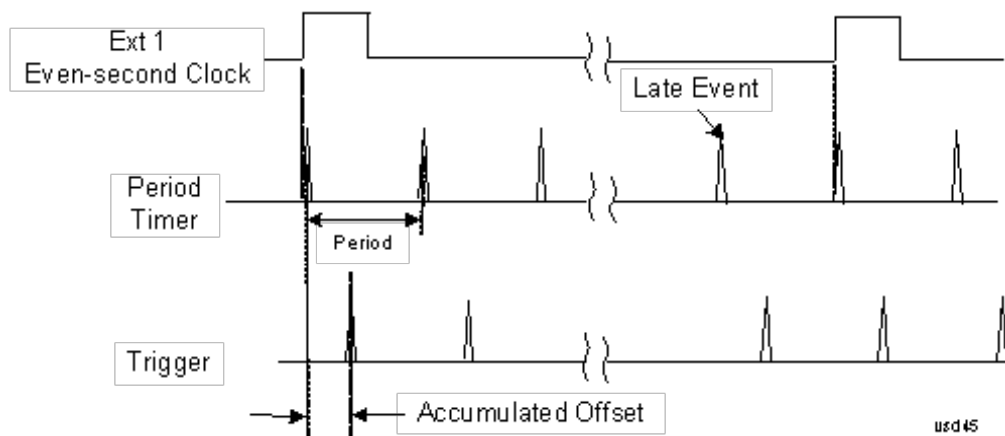

### Period

Sets the period of the internal periodic timer clock. For digital communications signals, this is usually set to the frame period of your current input signal. In the case that sync source is not set to OFF, and the external sync source rate is changed for some reason, the periodic timer is synchronized at the every external synchronization pulse by resetting the internal state of the timer circuit.

<b>Key Path</b>	Trigger, Periodic Timer
<b>Remote Command</b>	:TRIGger[:SEquence]:FRAME:PERiod <time>

	:TRIGger[:SEquence]:FRAMe:PERiod?
<b>Example</b>	TRIG:FRAM:PER 100 ms
Dependencies	The invalid data indicator turns on when the period is changed, until the next sweep/measurement completes.
Couplings	The same period is used in the Gate Source selection of the period timer.
Preset	20 ms GSM: 4.615383
State Saved	Saved in instrument state
Min	100.000 ns
Max	559.0000 ms
Default Unit	S
Initial S/W Revision	Prior to A.02.00

### Offset

Adjusts the accumulated offset between the periodic timer events and the trigger event. Adjusting the accumulated offset is different than setting an offset, and requires explanation.

The periodic timer is usually not synchronized with any external events, so the timing of its output events has no absolute meaning. Since the timing relative to external events (RF signals) is important, you need to be able to adjust (offset) it. However, you have no direct way to see when the periodic timer events occur. All that you can see is the trigger timing. When you want to adjust the trigger timing, you will be changing the internal offset between the periodic timer events and the trigger event. Because the absolute value of that internal offset is unknown, we will just call that the accumulated offset. Whenever the Offset parameter is changed, you are changing that accumulated offset. You can reset the displayed offset using Reset Offset Display. Changing the display does not change the value of the accumulated offset, and you can still make additional changes to accumulated offset.

To avoid ambiguity, we define that an increase in the "offset" parameter, either from the knob or the SCPI adjust command, serves to delay the timing of the trigger event.

Key Path	Trigger, Periodic Timer
<b>Remote Command</b>	:TRIGger[:SEquence]:FRAMe:OFFSet <time> :TRIGger[:SEquence]:FRAMe:OFFSet?
<b>Example</b>	TRIG:FRAM:OFFS 1.2 ms
Notes	The front panel interface (for example, the knob), and this command, adjust the accumulated offset, which is shown on the active function display. However, the actual amount sent to the hardware each time the offset is updated is the delta value, that is, the current accumulated offset value minus the previous accumulated offset value. Note that the accumulated offset value is essentially arbitrary; it represents the accumulated offset from the last time the offset was zeroed (with the Reset Offset Display key).  Note that this command does not change the period of the trigger waveform. Note also that Offset is used only when the sync source is set to OFF, otherwise delay is used, see section "Trig Delay" on page 461.

	An increase in the "offset" parameter, either from the knob or the SCPI adjust command, serves to delay the timing of the trigger event.
Notes	When the SCPI command is sent the value shown on the key (and the Active Function, if this happens to be the active function) is updated with the new value. However, the actual amount sent to the hardware is the delta value, that is, the current accumulated offset value minus the previous accumulated offset value.  The SCPI query simply returns the value currently showing on the key.
Dependencies	The invalid data indicator turns on when the offset is changed, until the next sweep/measurement completes.
Couplings	The same offset is used in the Gate Source selection of the period timer.
Preset	0 s
State Saved	Saved in instrument state
Min	-10.000 s
Max	10.000 s
Default Unit	S
Initial S/W Revision	Prior to A.02.00

#### Offset Adjust (Remote Command Only)

This remote command does not work at all like the related front panel keys. This command lets you advance the phase of the frame trigger by the amount you specify.

It does not change the period of the trigger waveform. If the command is sent multiple times, it advances the phase of the frame trigger an additional amount each time it is sent. Negative numbers are permitted.

<b>Remote Command</b>	:TRIGger[:SEquence]:FRAMe:ADJust <time>
<b>Example</b>	TRIG:FRAM:ADJ 1.2 ms
Notes	Note also that Offset is used only when the sync source is set to OFF, otherwise delay is used, see section <a href="#">"Trig Delay" on page 461</a>  An increase in the "offset" parameter, either from the knob or the SCPI adjust command, serves to delay the timing of the trigger event.
Notes	The front panel interface (for example, the knob) and the :TRIG:FRAM:OFFS command adjust the accumulated offset, which is shown on the active function display. However, the actual amount sent to the hardware is the delta value, that is, the current offset value minus the previous offset value.  When the SCPI command is sent the value shown on the key (and the Active Function, if this happens to be the active function) is updated by increasing it (or decreasing it if the value sent is negative) by the amount specified in the SCPI command.  This is a "command only" SCPI command, with no query.
Dependencies	The invalid data indicator turns on when the offset is changed, until the next sweep/measurement completes.
Couplings	The same offset is used in the Gate Source selection of the period timer.
Preset	0 s



State Saved	Saved in instrument state
Min	-10.000 s
Max	10.000 s
Default Unit	S
Initial S/W Revision	Prior to A.02.00

### Reset Offset Display

Resets the value of the periodic trigger offset display setting to 0.0 seconds. The current displayed trigger location may include an offset value defined with the Offset key. Pressing this key redefines the currently displayed trigger location as the new trigger point that is 0.0 s offset. The Offset key can then be used to add offset relative to this new timing.

Key Path	Trigger, Periodic Timer
<b>Remote Command</b>	:TRIGger[:SEquence]:FRAMe:OFFSet:DISPlay:RESet
<b>Example</b>	TRIG:FRAM:OFFS:DISP:RES
Initial S/W Revision	Prior to A.02.00

### Sync Source

Selects a signal source for you to synchronize your periodic timer trigger to, otherwise you are triggering at some arbitrary location in the frame. Synchronization reduces the precision requirements on the setting of the period.

For convenience you may adjust the level and slope of the selected sync source in a conditional branch setup menu accessed from the Sync Source menu. Note that these settings match those in the **Trigger** and **Gate Source** menus; that is, each trigger source has only one value of level and slope, regardless of which menu it is accessed from.

Key Path	Trigger, Periodic Timer
<b>Remote Command</b>	:TRIGger[:SEquence]:FRAMe:SYNC EXTernal1   EXTernal2   RFBurst   OFF :TRIGger[:SEquence]:FRAMe:SYNC?
<b>Example</b>	TRIG:FRAM:SYNC EXT2
Dependencies	In some models, there is no second External input. In these models, the External 2 key is blanked and the EXTernal2 parameter will generate a "Hardware missing; Not available for this model number" message.
Preset	Off GSM/EDGE, MSR,LTE,LTETDD: RFBurst
State Saved	Saved in instrument state
Readback	The current setting is read back to this key and it is also Readback to the previous Periodic Timer trigger key.

<b>Backwards Compatibility SCPI</b>	:TRIGger[:SEquence]:FRAMe:SYNC EXTernal
Initial S/W Revision	Prior to A.02.00
Modified at S/W Revision	A.03.00, A.14.00

### Off

Turns off the sync source for your periodic trigger. With the sync source off, the timing will drift unless the signal source frequency is locked to the analyzer frequency reference.

<b>Key Path</b>	Trigger, Periodic Timer, Sync Source
<b>Example</b>	TRIG:FRAM:SYNC OFF
Readback	Off
Initial S/W Revision	Prior to A.02.00

### External 1

Pressing this key, when it is not selected, selects an external input signal as the trigger. A new sweep/measurement will start when the external trigger condition is met using the external 1 input connector on the rear panel.

Pressing this key, when it is already selected, accesses the external 1 trigger setup menu.

<b>Key Path</b>	Trigger
<b>Example</b>	TRIG:SOUR EXT1 Swept SA measurement TRIG:<meas>:SOUR EXT1 Measurements other than Swept SA
<b>Dependencies</b>	Grayed out if in use by Point Trigger in the Source Setup menu. Forced to Free Run if already selected and Point Trigger is set to External 1.
<b>State Saved</b>	Saved in instrument state
<b>Status Bits/OPC dependencies</b>	The Status Operation Register bit 5 "Waiting for Trigger" is set at the same time as the Sweeping or Measuring bit is set. It is cleared when the trigger actually occurs (that is, after the trigger event occurs and all the applicable trigger criteria have been met). A corresponding pop-up message ("Waiting for trigger") is generated if no trigger signal appears after approximately 2 sec. This message goes away when a trigger signal appears.
Initial S/W Revision	Prior to A.02.00

### Trigger Level

Sets the value where the external 1 trigger input will trigger a new sweep/measurement.

Key Path	Trigger, External 1
<b>Remote Command</b>	:TRIGger[:SEquence]:EXTernal1:LEVel <level> :TRIGger[:SEquence]:EXTernal1:LEVel?
<b>Example</b>	TRIG:EXT1:LEV 0.4 V
Couplings	This same level is used for the Ext1 trigger source in the Trigger menu, for the Ext1 selection in the Periodic Timer sync source (in the Trigger menu and in the Gate Source menu), and also for the Ext1 selection in the Gate Source menu.
Preset	1.2 V
State Saved	Saved in instrument state
Min	-5 V
Max	5 V
Default Unit	V
<b>Backwards Compatibility SCPI</b>	:TRIGger[:SEquence]:EXTernal:LEVel For backward compatibility, the parameter EXTernal is mapped to EXTernal1
<b>Backwards Compatibility SCPI</b>	:TRIGger[:SEquence]:FRAMe:EXTernal1:LEVel
Initial S/W Revision	Prior to A.02.00

### Trig Slope

Controls the trigger polarity. It is set positive to trigger on a rising edge and negative to trigger on a falling edge.

Key Path	Trigger, External 1
<b>Remote Command</b>	:TRIGger[:SEquence]:EXTernal1:SLOPe POSitive NEGative :TRIGger[:SEquence]:EXTernal1:SLOPe?
<b>Example</b>	TRIG:EXT1:SLOP NEG
Couplings	This same slope is used in the Ext1 selection for the trigger source in the Trigger menu and for the period timer sync source (in the Trigger menu and in the Gate Source menu).
Preset	POSitive
State Saved	Saved in instrument state
<b>Backwards Compatibility SCPI</b>	:TRIGger[:SEquence]:EXTernal:SLOPe For backward compatibility, the parameter EXTernal is mapped to EXTernal1
<b>Backwards Compatibility SCPI</b>	:TRIGger[:SEquence]:FRAMe:EXTernal1:SLOPe
Backwards Compatibility Notes	The legacy :TRIGger[:SEquence]:SLOPe command affects the slopes for the VID, LINE, EXT1, EXT2, and RFB triggers.
Initial S/W Revision	Prior to A.02.00

## External 2

Pressing this key, when it is not selected, selects an external input signal as the trigger. A new sweep/measurement will start when the external trigger condition is met using the external 2 input connector. The external trigger 2 input connector is on the rear panel.

Pressing this key, when it is already selected, accesses the external 2 trigger setup menu.

Key Path	Trigger
<b>Example</b>	TRIG:SOUR EXT2 Swept SA measurement TRIG:<meas>:SOUR EXT2 Measurements other than Swept SA
Dependencies	In some models, there is no second External input. In these models, the External 2 key is blanked and the EXTERNAL2 parameter will generate a "Hardware missing; Not available for this model number" message. Grayed out if in use by Point Trigger in the Source Setup menu. Forced to Free Run if already selected and Point Trigger is set to External 2.
State Saved	Saved in instrument state
Status Bits/OPC dependencies	The Status Operation Register bit 5 "Waiting for Trigger" is set at the same time as the Sweeping or Measuring bit is set. It is cleared when the trigger actually occurs (that is, after the trigger event occurs and all the applicable trigger criteria have been met). A corresponding pop-up message ("Waiting for trigger") is generated if no trigger signal appears after approximately 2 sec. This message goes away when a trigger signal appears.
Initial S/W Revision	Prior to A.02.00
Modified at S/W Revision	A.03.00

## Trigger Level

Sets the value where the external 2 trigger input will trigger a new sweep/measurement.

Key Path	Trigger, External 2
<b>Remote Command</b>	:TRIGger[:SEquence]:EXTernal2:LEVel :TRIGger[:SEquence]:EXTernal2:LEVel?
<b>Example</b>	TRIG:EXT2:LEV 1.1 V
Couplings	This same level is used for the Ext2 trigger source in the Trigger menu, for the Ext2 selection in the Periodic Timer sync source (in the Trigger menu and in the Gate Source menu), and also for the Ext2 selection in the Gate Source menu.
Preset	1.2 V
State Saved	Saved in instrument state
Min	-5 V
Max	5 V
Default Unit	V
<b>Backwards Compatibility SCPI</b>	:TRIGger[:SEquence]:FRAME:EXTernal2:LEVel
Initial S/W Revision	Prior to A.02.00

## Trig Slope

Controls the trigger polarity. It is set positive to trigger on a rising edge and negative to trigger on a falling edge.

Key Path	Trigger, External 2
<b>Remote Command</b>	:TRIGger[:SEquence]:EXTernal2:SLOPe POSitive NEGative :TRIGger[:SEquence]:EXTernal2:SLOPe?
<b>Example</b>	TRIG:EXT2:SLOP NEG
Couplings	This same slope is used in the Ext2 selection for the trigger source in the Trigger menu and for the period timer sync source (in the Trigger menu and in the Gate Source menu).
Preset	POSitive
State Saved	Saved in instrument state
<b>Backwards Compatibility SCPI</b>	:TRIGger[:SEquence]:FRAMe:EXTernal2:SLOPe
Backwards Compatibility Notes	The legacy :TRIGger[:SEquence]:SLOPe command affects the slopes for the VID, LINE, EXT1, EXT2, and RFB triggers.
Initial S/W Revision	Prior to A.02.00

## RF Burst

Pressing this key, when it is not selected, selects the RF Burst as the trigger. A new sweep/measurement will start when an RF burst envelope signal is identified from the signal at the RF Input connector. Pressing this key, when it is already selected, accesses the RF Burst trigger setup menu.

In some models, a variety of burst trigger circuitry is available, resulting in various available burst trigger bandwidths. The analyzer automatically chooses the appropriate trigger path based on the hardware configuration and other settings of the analyzer.

Key Path	Trigger
<b>Example</b>	TRIG:SOUR RFB            Swept SA measurement TRIG:<meas>:SOUR RFB   Measurements other than Swept SA
State Saved	Saved in instrument state
Status Bits/OPC dependencies	The Status Operation Register bit 5 "Waiting for Trigger" is set at the same time as the Sweeping or Measuring bit is set. It is cleared when the trigger actually occurs (that is, after the trigger event occurs and all the applicable trigger criteria have been met). A corresponding pop-up message ("Waiting for trigger") is generated if no trigger signal appears after approximately 2 sec. This message goes away when a trigger signal appears.
Backwards Compatibility Notes	The legacy command: :TRIGger[:SEquence]:RFBurst:FSElectivity[:STATe] OFF ON 0 1 is not supported in the X-Series, as the hardware to do Frequency Selective burst triggers does not exist in X-Series.

Initial S/W Revision	Prior to A.02.00
Modified at S/W Revision	A.04.00

### Absolute Trigger Level

Sets the absolute trigger level for the RF burst envelope.

When using the External Mixing path, the Absolute Trigger Level is uncalibrated because the factory default was set to accommodate the expected IF levels for the RF path.

Key Path	Trigger, RF Burst
Scope	Meas Global
<b>Remote Command</b>	:TRIGger[:SEquence]:RFBurst:LEVel:ABSolute <ampl> :TRIGger[:SEquence]:RFBurst:LEVel:ABSolute?
<b>Example</b>	TRIG:RFB:LEV:ABS 10 dBm sets the trigger level of the RF burst envelope signal to the absolute level of 10 dBm
Notes	Sending this command does not switch the setting from relative to absolute; to switch it you need to send the :TRIGger[:SEquence]:RFBurst:LEVel:TYPE command, below.  Amplitude Corrections are not taken into account by the Absolute Trigger Level. For example, if you have given yourself effective gain with an amplitude correction factor, the Absolute Trigger will not fire until you have set the trigger level that far below the displayed signal level, rather than simply to the displayed signal level. This is only true for Amplitude Corrections, not External Gain or Ref Level Offset functions.  If mode is Bluetooth, the default value is -50 dBm.
Couplings	This same level is used for the RF Burst trigger source in the Trigger menu, for the RF Burst selection in the Periodic Timer sync source (in the Trigger menu and in the Gate Source menu), and also for the RF Burst selection in the Gate Source menu
Preset	-20 dBm
State Saved	Saved in instrument state
Min	-200 dBm
Max	100 dBm
Default Unit	depends on the current selected Y-Axis unit
<b>Backwards Compatibility SCPI</b>	:TRIGger[:SEquence]:FRAME:RFBurst:LEVel:ABSolute
Initial S/W Revision	Prior to A.02.00
Modified at S/W Revision	A.04.00

Key Path	Trigger, RF Burst
<b>Remote Command</b>	:TRIGger[:SEquence]:RFBurst:LEVel:TYPE ABSolute RELative :TRIGger[:SEquence]:RFBurst:LEVel:TYPE?

<b>Example</b>	TRIG:RFB:LEV:TYPE REL sets the trigger level type of the RF burst trigger to Relative.
Preset	ABSolute
State Saved	Saved in instrument state
Initial S/W Revision	Prior to A.02.00
Modified at S/W Revision	A.04.00

### Trigger Slope

It is set positive to trigger on a rising edge and negative to trigger on a falling edge.

Key Path	Trigger, RF Burst
<b>Remote Command</b>	:TRIGger[:SEquence]:RFBurst:SLOPe POSitive NEGative :TRIGger[:SEquence]:RFBurst:SLOPe?
<b>Example</b>	TRIG:RFB:SLOP NEG
Couplings	This same slope is used in the RF Burst selection for the trigger source in the Trigger menu and for the period timer sync source (in the Trigger menu and in the Gate Source menu).
Preset	POSitive
State Saved	Saved in instrument state
<b>Backwards Compatibility SCPI</b>	:TRIGger[:SEquence]:FRAME:RFBurst:SLOPe
Backwards Compatibility Notes	The legacy :TRIGger[:SEquence]:SLOPe command affects the slopes for the VID, LINE, EXT1, EXT2, and RFB triggers.
Initial S/W Revision	Prior to A.02.00

### Sync Holdoff

Sync Holdoff specifies the duration that the sync source signal must be kept false before the transition to true to be recognized as the sync timing. The periodic timer phase is aligned when the sync source signal becomes true, after the Holdoff time is satisfied.

A holdoff of 2 ms will work with most WiMAX signals, but there may be cases where the burst off duration is less than 1 ms and this value will need to be changed.

Key Path	Trigger, Periodic Timer
<b>Remote Command</b>	:TRIGger[:SEquence]:FRAME:SYNC:HOLDoff <time> :TRIGger[:SEquence]:FRAME:SYNC:HOLDoff? :TRIGger[:SEquence]:FRAME:SYNC:HOLDoff:STATe OFF ON 0 1 :TRIGger[:SEquence]:FRAME:SYNC:HOLDoff:STATe?
Preset	On, 1.000 ms

State Saved	Saved in instrument state
Min	0 ms
Max	+500 ms
Default Unit	s
Initial S/W Revision	Prior to A.02.00

## Control Edge/Level

Sets the method of controlling the gating function from the gating signal.

### Edge

In Edge triggering, the gate opens (after the Delay) on the selected edge (for example, positive) of the gate signal and closes on the alternate edge (for example, negative).

### Level

In Level triggering, the gate opens (after the Delay) when the gate signal has achieved a certain level and stays open as long as that level is maintained.

Key Path	Sweep/Control, Gate
Remote Command	[ :SENSe] :SWEep:EGATe:CONTRol EDGE LEVeL [ :SENSe] :SWEep:EGATe:CONTRol?
Example	SWE:EGAT:CONT EDGE
Dependencies	If the Gate Method is FFT the Control key is grayed out and Edge is selected. If the Gate Source is TV, Frame or Line, the Control key is grayed out and Edge is selected.
Preset	EDGE
State Saved	Saved in instrument state
Backwards Compatibility SCPI	[:SENSe]:SWEep:TIME:GATE:TYPE ESA Compatibility
Initial S/W Revision	Prior to A.02.00

## Gate Holdoff

Lets you increase or decrease the wait time after a gate event ends before the analyzer will respond to the next gate signal.

After any Gate event finishes, the analyzer must wait for the sweep system to settle before it can respond to another Gate signal. The analyzer calculates a "wait time," taking into account a number of factors, including RBW and Phase Noise Optimization settings. The goal is to achieve the same accuracy when gated as in ungated operation. The figure below illustrates this concept:



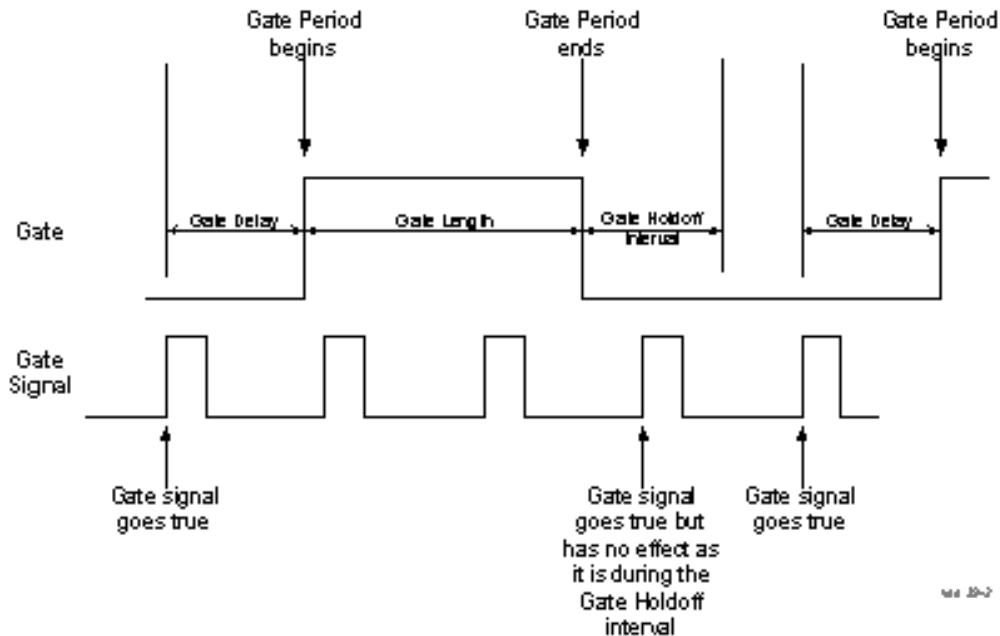

When Gate Holdoff is in Auto, the wait time calculated by the analyzer is used. When Gate Time is in Manual, the user may adjust the wait time, usually decreasing it in order to achieve greater speed, but at the risk of decreasing accuracy.

When the Method key is set to Video or FFT, the Gate Holdoff function has no effect.

In measurements that do not support Auto, the value shown when Auto is selected is “---” and the manually set holdoff is returned to a query.

Key Path	Sweep/Control, Gate
<b>Remote Command</b>	<pre>[ :SENSe ] :SWEep:EGATe:HOLDoff &lt;time&gt; [ :SENSe ] :SWEep:EGATe:HOLDoff? [ :SENSe ] :SWEep:EGATe:HOLDoff:AUTO OFF ON 0 1 [ :SENSe ] :SWEep:EGATe:HOLDoff:AUTO?</pre>
<b>Example</b>	<pre>SWE:EGAT:HOLD 0.0002 SWE:EGAT:HOLD? SWE:EGAT:HOLD:AUTO ON SWE:EGAT:HOLD:AUTO?</pre>
<b>Couplings</b>	<p>When Gate Holdoff is Auto, the Gate Holdoff key shows the value calculated by the analyzer for the wait time.</p> <p>Pressing the Gate Holdoff key while it is in Auto and not selected, causes the key to become selected and allows the user to adjust the value. If the value is adjusted, the setting changes to Man.</p> <p>Pressing the Gate Holdoff key, while it is in Auto and selected, does not change the value of Gate Holdoff, but causes the setting to change to Man. Now the user can adjust the value.</p> <p>Pressing the key while it is in Man and selected, cause the value to change back to Auto.</p> <p>Pressing the key while it is in Man and not selected, causes the key to become selected and allows the user to adjust the value.</p>

	When Method is set to Video or FFT, the Gate Holdoff function has no effect.
Preset	Auto Auto/On
State Saved	Saved in instrument state
Min	1 µsec
Max	1 sec
Initial S/W Revision	Prior to A.02.00

## Gate Delay Compensation

This function allows you to select an RBW-dependent value by which to adjust the gate delay, to compensate for changes in the delay caused by RBW effects.

You can select between uncompensated operation and two types of compensation, Delay Until RBW Settled and Compensate for RBW Group Delay.

See "[More Information](#)" on page 1007

Key Path	Sweep/Control, Gate
Scope	Meas Global
Remote Command	[ :SENSe ] :SWEep:EGATe:DELAy:COMPensation:TYPE OFF   SETTled   GDELAy [ :SENSe ] :SWEep:EGATe:DELAy:COMPensation:TYPE?
Example	SWE:EGAT:DEL:COMP:TYPE SETT SWE:EGAT:DEL:COMP:TYPE?
Notes	Although this function is Meas Global, there are some measurements that do not support this function. In those measurements the operation will be Uncompensated. Going into one of those measurements will not change the Meas Global selection; it will simply display the grayed-out menu key with “Uncompensated” showing as the selection. This is a non-forceful grayout, so the SCPI command is still accepted.  If Gate Delay Compensation is not supported at all within a particular mode, the key is not displayed, and if the SCPI command is sent while in a measurement within that mode, an “Undefined Header” message is generated.  Measurements that do not support this function include: Swept SA
Preset	TD-SCDMA mode: Compensate for RBW Group Delay All other modes: Delay Until RBW Settled
State Saved	Saved in instrument state
Range	Uncompensated Delay Until RBW Settled Compensate for RBW Group Delay
Readback text	Uncompensated Settled Group Delay
Initial S/W Revision	Prior to A.02.00
Modified at S/W Revision	A.11.0

## More Information

Selecting Uncompensated means that the actual gate delay is as you sets it.

Selecting Delay Until RBW Settled causes the gate delay to be increased above the user setting by an amount equal to  $3.06/\text{RBW}$ . This compensated delay causes the GATE START and GATE STOP lines on the display to move by the compensation amount, and the actual hardware gate delay to be increased by the same amount. All the other gate lines (for example, MIN FAST) are unaffected. If the RBW subsequently changes, the compensation is readjusted for the new RBW. The value shown on the Gate Delay key does NOT change.

Delay Until RBW Settled allows excellent measurements of gated signals, by allowing the IF to settle following any transient that affects the burst. Excellent measurements also require that the analysis region not extend into the region affected by the falling edge of the burst. Thus, excellent measurements can only be made over a width that declines with narrowing RBWs, which is achieved by decreasing the gate length below the user setting by an amount equal to  $2.53/\text{RBW}$ . Therefore, for general purpose compensation, you will still want to change the gate length with changes in RBW even if the gate delay is compensated. The compensated Gate Length is limited by the analyzer so that it will never go below 10% of the value shown on the Gate Length key, as otherwise the sweep times could get very long. Anytime the Gate Length and RBW values combine in such a way that this limiting takes place, a warning is displayed. For measurements which contain multiple sweeps with different RBW like SEM and SPUR, the smallest RBW is used for this limiting.

Selecting Compensate for RBW Group Delay causes the gate delay to be increased above the user setting by an amount equal to  $1.81/\text{RBW}$ . This compensated delay causes the GATE START, GATE STOP lines on the display to move by the compensation amount, and the actual hardware gate delay to be increased by the same amount. All the other gate lines (for example, MIN FAST) are unaffected. If the RBW subsequently changes, the compensation is readjusted for the new RBW. The value shown on the Gate Delay key does NOT change. Compensate for RBW Group Delay also includes gate length compensation; the gate length itself is adjusted as necessary to attempt to compensate for delay effects imposed by the RBW.

Compensate for RBW Group Delay is similar to Delay Until RBW Settled, but compensates for the group delay of the RBW filter, rather than the filter settling time. As the RBW gets narrow, this can allow the settling tail of the RBW to affect the beginning part of the gated measurement, and allow the beginning of the RBW settling transient to affect the end of the gated measurement. These two effects are symmetric because the RBW response is symmetric. Because the gate length is not automatically compensated, some users might find this compensation to be more intuitive than compensation for RBW settling.

## Min Fast Position Query (Remote Command Only)

This command queries the position of the MIN FAST line, relative to the delay reference (REF) line. See section "[Gate View On/Off](#)" on page 2722. If this query is sent while not in gate view, the MinFast calculation is performed based on the current values of the appropriate parameters and the result is returned. Knowing this value lets you set an optimal gate delay value for the current measurement setup.

<b>Remote Command</b>	[ :SENSe ] :SWEep:EGATe:MINFast?
<b>Example</b>	SWE:EGAT:MIN?
<b>Initial S/W Revision</b>	Prior to A.02.00

### Gate Preset (Remote Command Only)

Presets the time-gated spectrum analysis capability.

This command sets gate parameter values to the ESA preset values, as follows:

Gate trigger type = edge

Gate polarity = positive

Gate delay = 1 us

Gate length = 1 us

<b>Remote Command</b>	<code>[:SENSe]:SWEep:TIME:GATE:PRESet</code> ESA Compatibility
Initial S/W Revision	Prior to A.02.00

### Gate Level (Remote Command Only)

Sets the gate input transition point level for the external TRIGGER inputs on the front and rear panel. This is a legacy command for PSA compatibility. It is simply an alias to the equivalent trigger level command.

<b>Remote Command</b>	<code>[:SENSe]:SWEep:EGATE:EXTErnal[1] 2:LEVel &lt;voltage&gt;</code> <code>[:SENSe]:SWEep:EGATE:EXTErnal[1] 2:LEVel?</code>
Notes	This command is simply an alias to <code>:TRIGger[:SEQuence]:EXTErnal[1] 2:LEVel</code> For details refer
Initial S/W Revision	Prior to A.02.00

### Gate Polarity (Remote Command Only)

Sets the polarity for the gate signal. This setup is now done using the gate trigger's slope setting.

When Positive (Pos) is selected, a positive-going edge (Edge) or a high voltage (Level) will satisfy the gate condition, after the delay set with the Gate Delay key. When Negative (Neg) is selected, a negative-going edge (Edge) or a low voltage (Level) will satisfy the gate condition after the delay.

<b>Remote Command</b>	<code>[:SENSe]:SWEep:EGATE:POLarity</code> NEGative POSitive <code>[:SENSe]:SWEep:EGATE:POLarity?</code>
<b>Example</b>	<code>SWE:EGAT:POL</code> NEG <code>SWE:EGAT:POL?</code>
Preset	POSitive
State Saved	Saved in instrument state
<b>Backwards Compatibility SCPI</b>	<code>[:SENSe]:SWEep:TIME:GATE:POLarity</code> ESA compatibility
Initial S/W Revision	Prior to A.02.00

<b>Remote Command</b>	<code>[ :SENSe ] :SWEep:TIME:GATE:LEVel HIGH LOW</code> <code>[ :SENSe ] :SWEep:TIME:GATE:LEVel?</code> ESA compatibility
Preset	HIGH
Initial S/W Revision	Prior to A.02.00

## Points

Sets the number of points per sweep. The resolution of setting the sweep time depends on the number of points selected. The current value of points is displayed parenthetically, next to the sweep time in the lower-right corner of the display.

Key Path	Sweep/Control
Mode	SA, WCDMA, C2K, WIMAX OFDMA, TD-SCDMA, 1xEVDO, ISDB-T, CMMB, LTE, LTETDD, BLUETOOTH, WLAN, MSR, LTEAFDD, LTEATDD
<b>Remote Command</b>	<code>[ :SENSe ] :OBWidth:SWEep:POINts &lt;integer&gt;</code> <code>[ :SENSe ] :OBWidth:SWEep:POINts?</code>
<b>Example</b>	OBW:SWE:POIN 1500 OBW:SWE:POIN?
Notes	This function is not available when signal identification is set to On (external mixing). Affected by: log sweep Grayed out in measurements that don't support swept Blanked in modes that do not support swept. Whenever the number of sweep points change: - All trace data is erased - Any traces with Update Off also go to Display Off (like going from View to Blank in the older analyzers) - Sweep time is re-quantized - Any limit lines that are on are updated - If averaging/hold is on, averaging/hold starts over
Couplings	Whenever the number of sweep points change, the sweep time is re-quantized.
Preset	LTE, LTETDD, MSR, LTEAFDD, LTEATDD: 2001 Other: 1001
State Saved	Saved in instrument state.
Min	101
Max	20001
Initial S/W Revision	Prior to A.02.00
Modified at S/W Revision	A.03.00



## System

See "System" on page 359

## Trace/Detector

Accesses a menu of functions that enable you to control the detectors for the current measurement.

Key Path	Front-panel key
Initial S/W Revision	Prior to A.02.00

### Trace Type

Allows you to select the type of trace you want to use for the current measurement.

The first page of this menu contains a 1-of-N selection of the trace type (Clear Write, Average, Max Hold, Min Hold) for the selected trace.

Key Path	Trace/Detector
Mode	SA, WCDMA, C2K, WIMAX OFDMA, TD-SCDMA, 1xEVDO, ISDB-T, CMMB, LTE, LTETDD, BLUETOOTH, WLAN, MSR, LTEAFDD, LTEATDD
Remote Command	:TRACe:OBWidth:TYPE WRITe AVERAge MAXHold MINHold :TRACe:OBWidth:TYPE?
Example	TRAC:OBW:TYPE MINH TRAC:OBW:TYPE?
Notes	WRITe = Clear Write AVERAge = Average MAXHold = Maximum Hold MINHold = Minimum Hold
Couplings	When Detector setting is "Auto" (:SENSe]:OBWidth:DETEctor:AUTO?), Detector (:SENSe]:OBWidth:DETEctor[:FUNCTion]?) switches aligning with the switch of this parameter: "NORMal" with WRITe (Clear Write), "AVERAge" with AVERAge, "POSitive (peak)" with MAXHold, and "NEGative (peak)" with MINHold.
Preset	AVERAge BLUETOOTH: MAX HOLD.
State Saved	Saved in instrument state.
Range	WRITe AVERAge MAXHold MINHold
Initial S/W Revision	Prior to A.02.00
Modified at S/W Revision	A.03.00

### Detector

Accesses a menu of functions that enables you to control the detectors for the current measurement. The following choices are available:

- **Auto**– the detector selected depends on marker functions, trace functions, average type, and the trace averaging function.



- **Normal**–the detector determines the peak of the CW-like signals, and it yields alternating maximums and minimums of noise-like signals. This is also referred to as Rosenfell detection.
- **Average**–the detector determines the average of the signal within the sweep points. The averaging method depends upon the Average Type selection (voltage, power or log scales).
- **Peak (Positive)**–the detector determines the maximum of the signal within the sweep points.
- **Sample**–the detector indicates the instantaneous level of the signal at the center of the sweep points represented by each display point.
- **Negative Peak**–the detector determines the minimum of the signal within the sweep points.

Key Path	Detector
Initial S/W Revision	Prior to A.02.00

## Auto

When the detector choice is Auto, the analyzer selects the detector. The selected detector depends on marker functions, trace functions, and trace averaging functions for the current measurement.

Key Path	Trace/Detector
<b>Remote Command</b>	<code>[[:SENSe]:OBWidth:DETECTOR:AUTO ON OFF 1 0</code> <code>[[:SENSe]:OBWidth:DETECTOR:AUTO?</code>
<b>Example</b>	OBW:DET:AUTO ON OBW:DET:AUTO?
Couplings	When Detector setting is “Auto” ( <code>[[:SENSe]:OBWidth:DETECTOR:AUTO?</code> ), Detector ( <code>[[:SENSe]:OBWidth:DETECTOR[:FUNCTION]?</code> ) switches aligning with the switch of this parameter: “NORMal” with Clear Write, “AVERage” with AVERage, “POSitive (peak)” with MAXHold, and “NEGative (peak)” with MINHold.
Preset	ON ISDB-T: OFF
State Saved	Saved in instrument state.
Initial S/W Revision	Prior to A.02.00
Modified at S/W Revision	A.03.00

## Detector Selection

Allows you to select a specific detector for the current measurement. When the detector choice is Auto, the analyzer selects the detector. The selected detector depends on marker functions, trace functions, and trace averaging functions for the current measurement.

Key Path	Trace/Detector
Mode	SA, WCDMA, C2K, WIMAX OFDMA, TD-SCDMA, 1xEVDO, ISDB-T, CMMB, LTE, LTE4DD, BLUETOOTH, WLAN, MSR, LTEAFDD, LTEATDD

<b>Remote Command</b>	<code>[[:SENSe]:OBWidth:DETEctor[:FUNction] NORMal   AVERage   POSitive   SAMPlE   NEGative [:SENSe]:OBWidth:DETEctor[:FUNction]?</code>
<b>Example</b>	<code>OBW:DET NORM OBW:DET?</code>
<b>Notes</b>	<p>When you manually select a detector (instead of selecting Auto), that detector is used regardless of other analyzer settings.</p> <p>The detector choices are:</p> <p>The Normal detector determines the peak of CW-like signals, and it yields alternating maximums and minimums of noise-like signals. This is also referred to as Rosenfell detection.</p> <p>The Average detector determines the average of the signal within the sweep points. The averaging method is Power Average (RMS).</p> <p>The Peak detector determines the maximum of the signal within the sweep points.</p> <p>The Sample detector indicates the instantaneous level of the signal at the center of the sweep points represented by each display point.</p> <p>The Negative Peak detector determines the minimum of the signal within the sweep points.</p>
<b>Couplings</b>	When Detector setting is "Auto" ( <code>[[:SENSe]:OBWidth:DETEctor:AUTO?</code> ), Detector ( <code>[[:SENSe]:OBWidth:DETEctor[:FUNction]?</code> ) switches aligning with the switch of this parameter: "NORMal" with Clear Write, "AVERage" with AVERage, "POSitive (peak)" with MAXHold, and "NEGative (peak)" with MINHold.
<b>Preset</b>	AVERage ISDB-T: Peak BLUETOOTH: Peak
<b>State Saved</b>	Saved in instrument state.
<b>Range</b>	Normal   Average   Peak   Sample   Negative Peak
<b>Initial S/W Revision</b>	Prior to A.02.00
<b>Modified at S/W Revision</b>	A.03.00

## Trigger

See ["Trigger" on page 430](#)

### Free Run

See ["Free Run " on page 437](#)

### Video

See ["Video \(IF Envelope\) " on page 438](#)

### Trigger Level

See ["Trigger Level " on page 438](#)

### Trig Slope

See ["Trig Slope " on page 439](#)

### Trig Delay

See ["Trig Delay " on page 440](#)

### Line

See ["Line " on page 2729](#)

### Trig Slope

See ["Trig Slope " on page 2729](#)

### Trig Delay

See ["Trig Delay " on page 442](#)

### External 1

See ["External 1 " on page 2741](#)

### Trigger Level

See ["Trigger Level " on page 2741](#)

### Trig Slope

See ["Trig Slope " on page 2742](#)

### Trig Delay

See ["Trig Delay " on page 445](#)

### External 2

See ["External 2 " on page 2743](#)

### **Trigger Level**

See ["Trigger Level "](#) on page 2743

### **Trig Slope**

See ["Trig Slope "](#) on page 2744

### **Trig Delay**

See ["Trig Delay "](#) on page 447

### **RF Burst**

See ["RF Burst "](#) on page 2744

### **Absolute Trigger**

See ["Absolute Trigger Level"](#) on page 2745

### **Relative Trigger**

See ["Relative Trigger Level"](#) on page 2734

### **Trig Slope**

See ["Trigger Slope "](#) on page 2746

### **Trig Delay**

See ["Trig Delay "](#) on page 451

### **Periodic Timer**

See ["Periodic Timer \(Frame Trigger\) "](#) on page 2736

### **Period**

See ["Period "](#) on page 2737

### **Offset**

See ["Offset "](#) on page 2738

### **Reset Offset Display**

See ["Reset Offset Display "](#) on page 2740

### **Sync Source**

See ["Sync Source "](#) on page 2740

### **Off**

See ["Off "](#) on page 2741

## External 1

See "External 1 " on page 2741

### Trigger Level

See "Trigger Level " on page 2741

### Trig Slope

See "Trig Slope " on page 2742

## External 2

See "External 2 " on page 2743

### Trigger Level

See "Trigger Level " on page 2743

### Trig Slope

See "Trig Slope " on page 2744

## RF Burst

See "RF Burst " on page 2744

## Absolute Trigger

See "Absolute Trigger Level" on page 2745

### Trig Slope

See "Trigger Slope " on page 2746

## Trig Delay

See "Trig Delay" on page 461

## Auto/Holdoff

See "Auto/Holdoff " on page 462

## Auto Trig

See "Auto Trig " on page 462

## Trig Holdoff

See "Trig Holdoff " on page 463

## User Preset

Accesses a menu that gives you the following three choices:

- User Preset – recalls a state previously saved using the Save User Preset function.
- User Preset All Modes – presets all of the modes in the analyzer
- Save User Preset– saves the current state for the current mode

Key Path	Front-panel key
Backwards Compatibility Notes	<p>User Preset is actually loading a state, and in legacy analyzers, it was possible to load a state without affecting the trace data, limit lines or correction data. Similarly it was possible to do a User Preset without affecting the trace data, limit lines or correction data.</p> <p>In the X-Series, “state” always includes all of this data; so whenever state is loaded, or User Preset is executed, all of the traces, limit lines and corrections are affected. Although this differs from previous behavior, it is desirable behavior, and should not cause adverse issues for users.</p> <p>On ESA and PSA, User Preset affected the entire instrument’s state. In the X-Series, User Preset only recalls the state for the active mode. There is a User Preset file for each mode. User Preset can never cause a mode switch as it can in legacy analyzers. If you want to recall all modes to their user preset file state, you will need to do a User Preset after mode switching into each mode.</p> <p>User Preset recalls mode state which can now include data like traces; whereas on ESA and PSA, User Preset did not affect data.</p>
Initial S/W Revision	Prior to A.02.00

## User Preset

User Preset sets the state of the currently active mode back to the state that was previously saved for this mode using the Save User Preset menu key or the SCPI command, SYST:PRES:USER:SAV. It not only recalls the Mode Preset settings, but it also recalls all of the mode persistent settings, and the Input/Output system setting that existed at the time Save User Preset was executed.

If a Save User Preset has not been done at any time, User Preset recalls the default user preset file for the currently active mode. The default user preset files are created if, at power-on, a mode detects there is no user preset file. There will never be a scenario when there is no user preset file to restore. For each mode, the default user preset state is the same state that would be saved if a Save User Preset is performed in each mode right after doing a Restore Mode Default and after a Restore Input/Output Defaults.

The User Preset function does the following:

- Aborts the currently running measurement.
- Sets the mode State to the values defined by Save User Preset.
- Makes the saved measurement for the currently running mode the active measurement.
- Brings up the saved menu for the power-on mode.
- Clears the input and output buffers.
- Sets the Status Byte to 0.

Key Path	User Preset
Remote Command	:SYSTem:PRESet:USER
Example	:SYST:PRES:USER:SAVE:SYST:PRES:USER
Notes	:SYST:PRES:USER:SAVE is used to save the current state as the user preset state. Clears all pending OPC bits. The Status Byte is set to 0. Pressing the User Preset front-panel key while already in the User Preset menu will cause the User Preset to get executed
Couplings	A user preset will cause the currently running measurement to be aborted and cause the saved measurement to be active. Recalling a User Preset file has the same issues that recalling a Save State file has. Some settings may need to be limited and therefore re-coupled, since the capabilities of the mode may have changes when the User Preset file was last saved.
Initial S/W Revision	Prior to A.02.00

## User Preset All Modes

Recalls all of the User Preset files for each mode, switches to the power-on mode, and activates the saved measurement from the power-on mode User Preset file.

**NOTE**

When the instrument is secured, all of the user preset files are converted back to their default user preset files.

The User Preset function does the following:

- Aborts the currently running measurement.
- Switches the Mode to the power-on mode.
- Restores the User Preset files for each mode.
- Makes the saved measurement for the power-on mode the active measurement.
- Brings up the saved menu for the power-on mode.
- Clears the input and output buffers.
- Sets the Status Byte to 0.

Key Path	User Preset
Remote Command	:SYSTem:PRESet:USER:ALL
Example	:SYST:PRES:USER:SAVE:SYST:PRES:USER:ALL
Notes	Clears all pending OPC bits. The Status Byte is set to 0. :SYST:PRES:USER:SAVE is used to save the current state as the user preset state.
Couplings	A user preset will cause the currently running measurement to be aborted, cause a mode switch to the power-on mode, and cause the saved measurement to be active in the power-on mode. Recalling a User Preset file has the same issues that recalling a Save State file has. Some settings may need to be limited and therefore re-coupled, since the capabilities of the mode may have changes when the User Preset file was last saved.
Initial S/W Revision	Prior to A.02.00

## Save User Preset

Saves the currently active mode and its State. You can recall this User Preset file by pressing the User Preset menu key or sending the SYST:PRES:USER remote command. This same state is also saved by the Save State function.

Key Path	User Preset
Remote Command	:SYSTem:PRESet:USER:SAVE
Example	:SYST:PRES:USER:SAVE
Notes	:SYST:PRES:SAVE creates the same file as if the user requested a *SAV or a MMEM:STOR:STAT, except User Preset Save does not allow the user to specify the filename or the location of the file.
Initial S/W Revision	Prior to A.02.00



## View/Display

Accesses a menu of functions that enable you to set the view and display parameters for the current measurement.

There is a single results view available for this measurement. For more details, and samples of screen content for each supported mode, see ["Spectrum View" on page 1021](#) below.

The following result descriptions are available:

### Occupied Bandwidth

The occupied bandwidth result is  $f_2 - f_1$ , where  $f_1$  and  $f_2$  are calculated.

### Total Power

The total power is the power integrated in the specified span setting.

### Transmit Freq Error

The transmit freq error (transmit frequency error) result is calculated as the difference between  $(f_2+f_1)/2$  and the tuned center frequency of the signal, where  $f_1$  and  $f_2$  are calculated.

### x dB Bandwidth

The x dB result is a bandwidth measured between two points on the signal which are a certain number of dBs down from the highest signal point within the OBW Span. For example, If the 'x dB' parameter is set to -26 dB, and the 'Occupied BW Span' is set to 10 MHz, then the maximum signal power level is first determined from the 10 MHz wide trace sweep. Next, the two furthest frequencies below ( $x_{db\_f1}$ ) and above ( $x_{db\_f2}$ ) the frequency of the maximum level occurrence are found where the signal level is 26 dB below the peak level. This calculation also uses linear interpolation to find the lower and upper carrier boundary point within the width of a sweep point (the span divided by the number of sweep points).

The x dB bandwidth is calculated to be  $x_{db\_f2} - x_{db\_f1}$ .

## Spectrum View

For SA, WCDMA, C2K, 1xEVDO, WIMAX OFDMA, WLAN modes:

10 Occupied Bandwidth Measurement  
View/Display

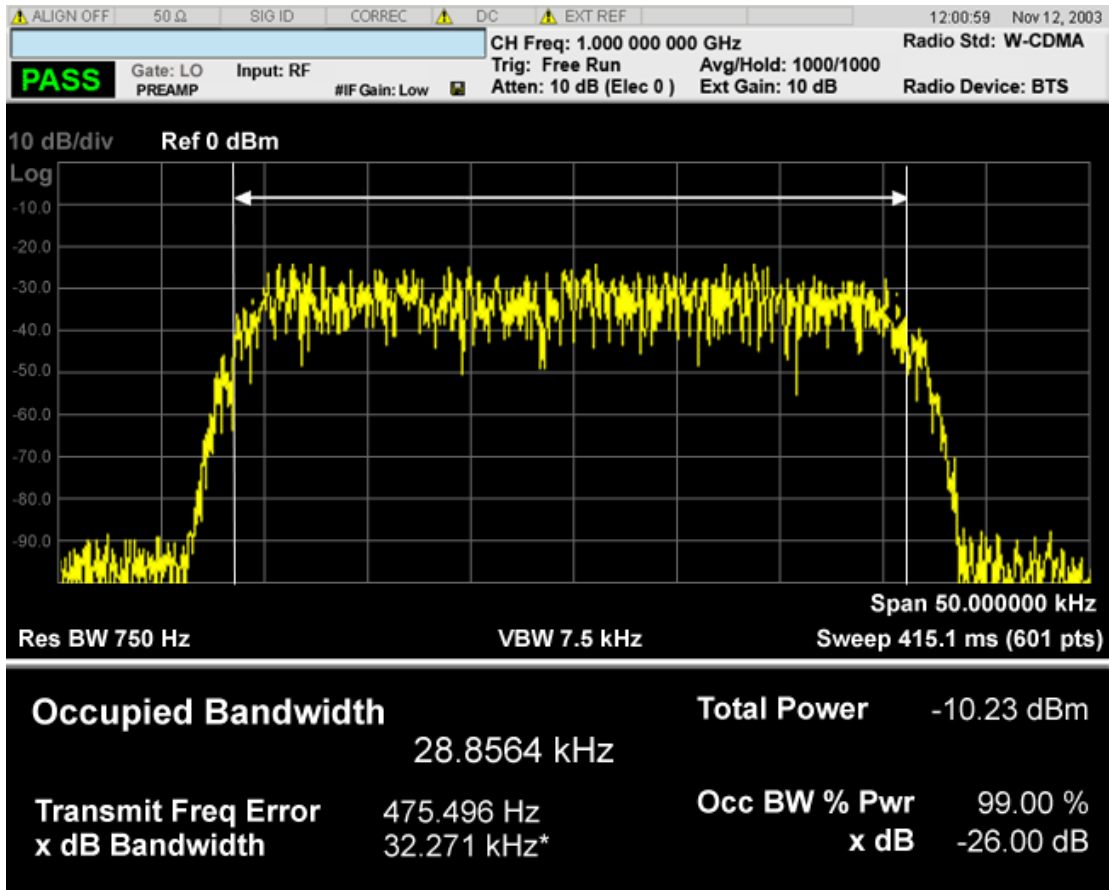

For TD-SCDMA mode only:

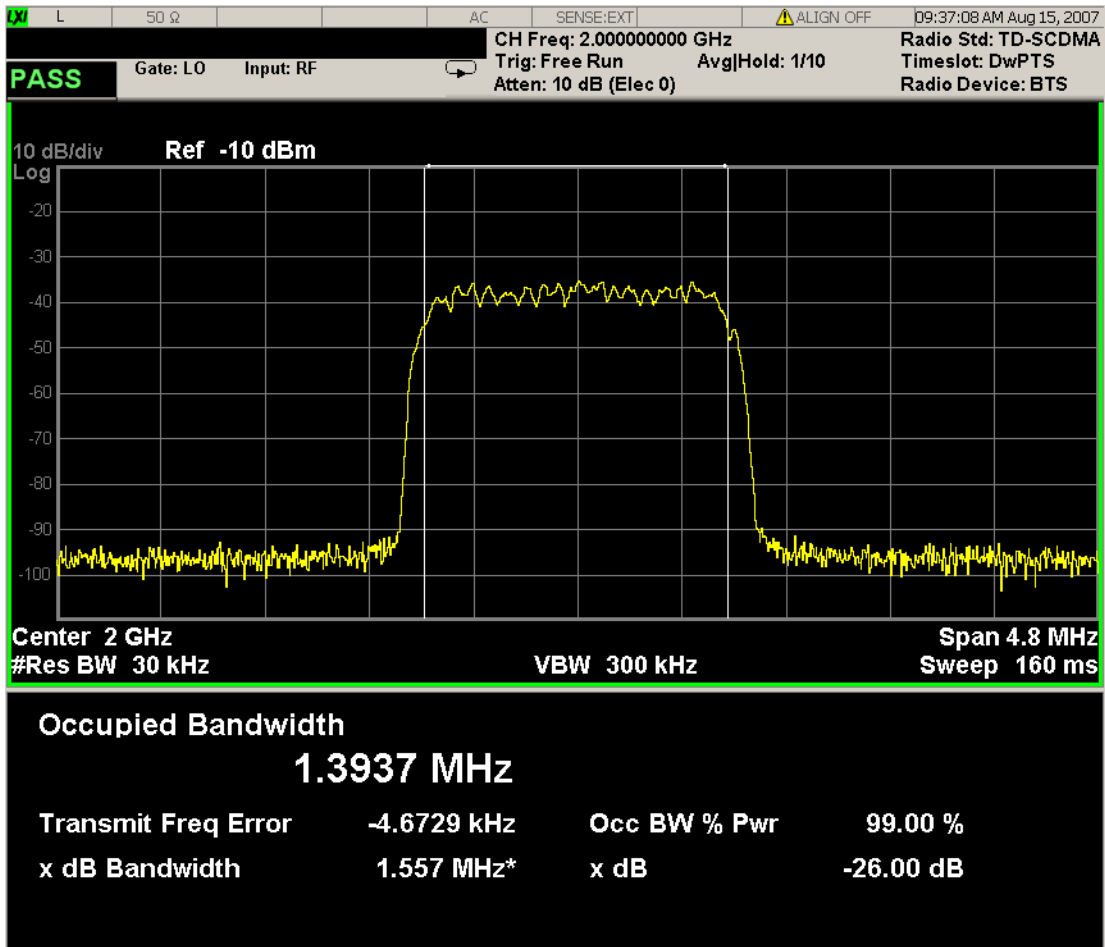

For Bluetooth mode only:

10 Occupied Bandwidth Measurement  
View/Display

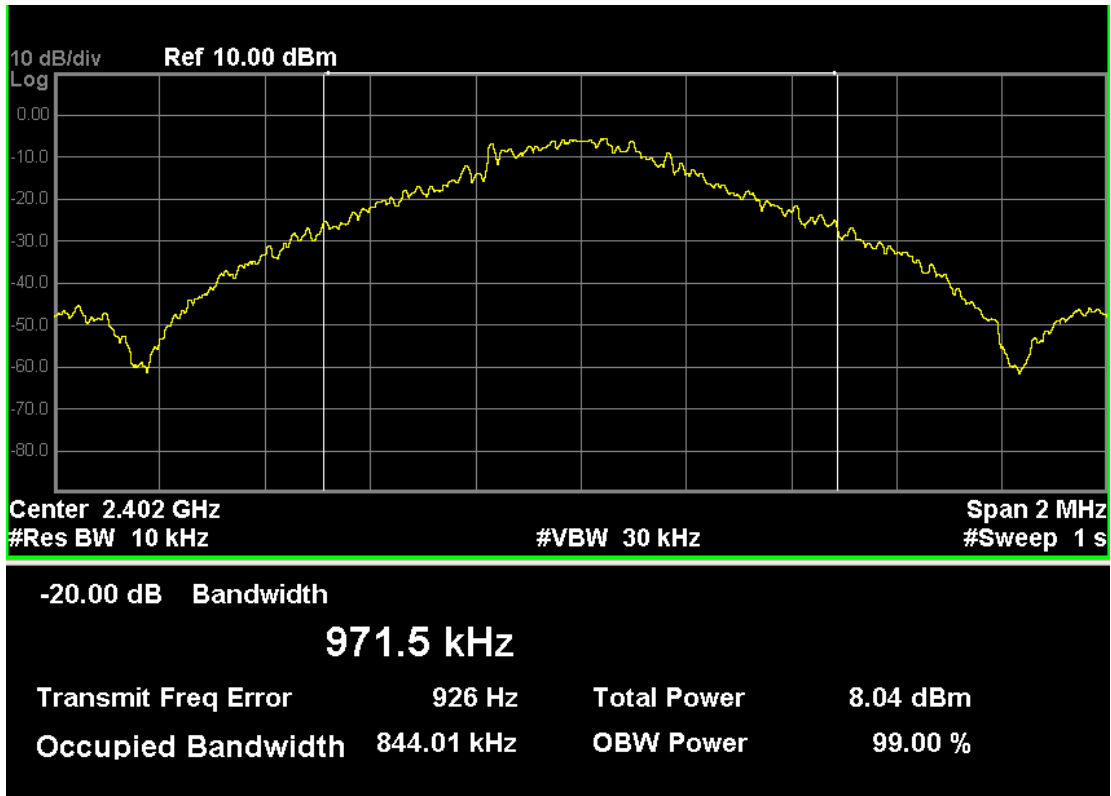

For MSR mode only:

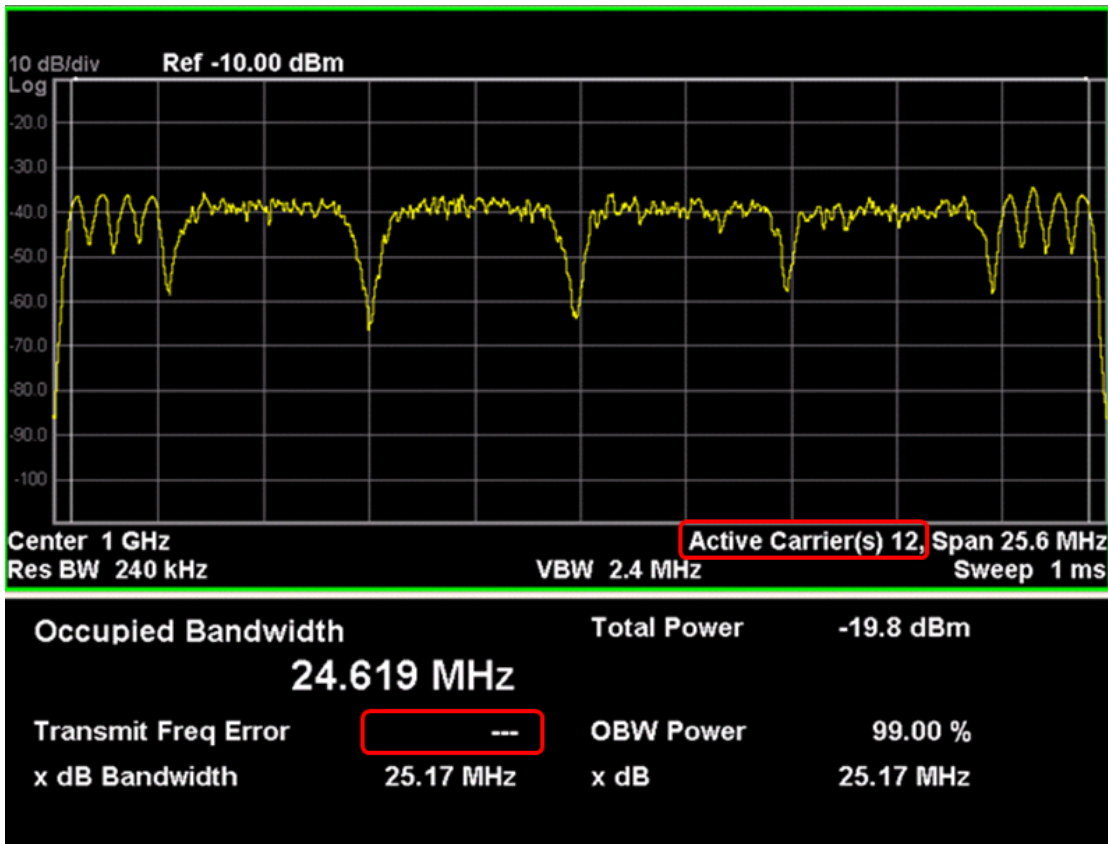

The number of active carriers is displayed. Since span is determined from detected carriers in auto mode, it is necessary to show how many carriers are identified as active., as highlighted above.

When there is one active carrier, Transmit Freq Error is displayed. Otherwise, “---” is displayed, as shown above.

For LTE-Advanced FDD/TDD mode only:

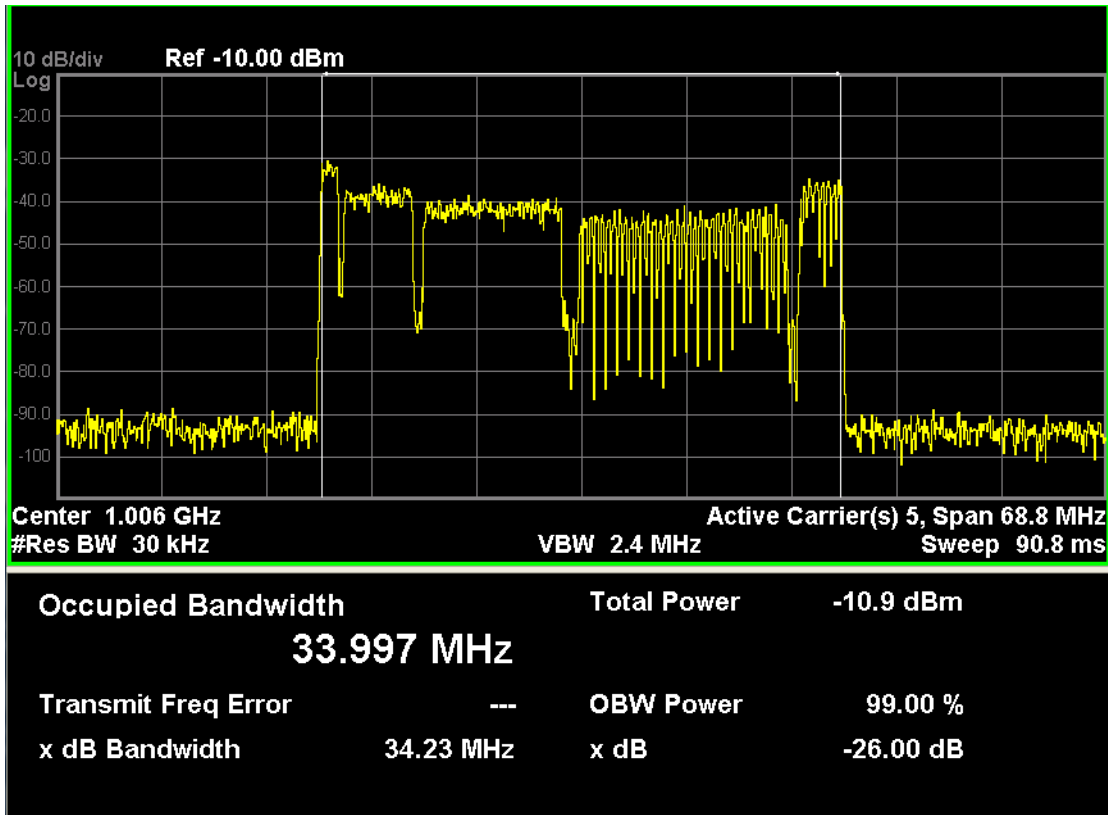

The number of active carriers is displayed to show how many carriers are identified as active in auto detected mode of span, otherwise “-” is displayed to indicate that it is out of scope.

When there is one active carrier, Transmit Freq Error is displayed. Otherwise, “---” is displayed.

Key Path	Front-panel key
Initial S/W Revision	Prior to A.02.00

## Display

The Display menu is common to most measurements, and is used for configuring items on the display. Some Display menu settings apply to all the measurements in a mode, and some only to the current measurement. Those under the System Display Settings key apply to all measurements in all modes.

Key Path	Display
Key Path	View/Display
Initial S/W Revision	Prior to A.02.00

## Annotation

Turns on and off various parts of the display annotation. The annotation is divided up into four categories:

1. Meas Bar: This is the measurement bar at the top of the screen. It does not include the settings panel or the Active Function. Turning off the Meas Bar turns off the settings panel and the Active Function. When the Meas Bar is off, the graticule area expands to fill the area formerly occupied by the Meas Bar.
2. Screen Annotation: this is the annotation and annunciation around the graticule, including any annotation on lines (such as the display line, the threshold line, etc.) This does NOT include the marker number or the N dB result. When off, the graticule expands to fill the entire graticule area.
3. Trace annotation: these are the labels on the traces, showing their detector (or their math mode).
4. Active Function annotation: this is the active function display in the meas bar, and all of the active function values displayed on softkeys.

See the figure below. Each type of annotation can be turned on and off individually.

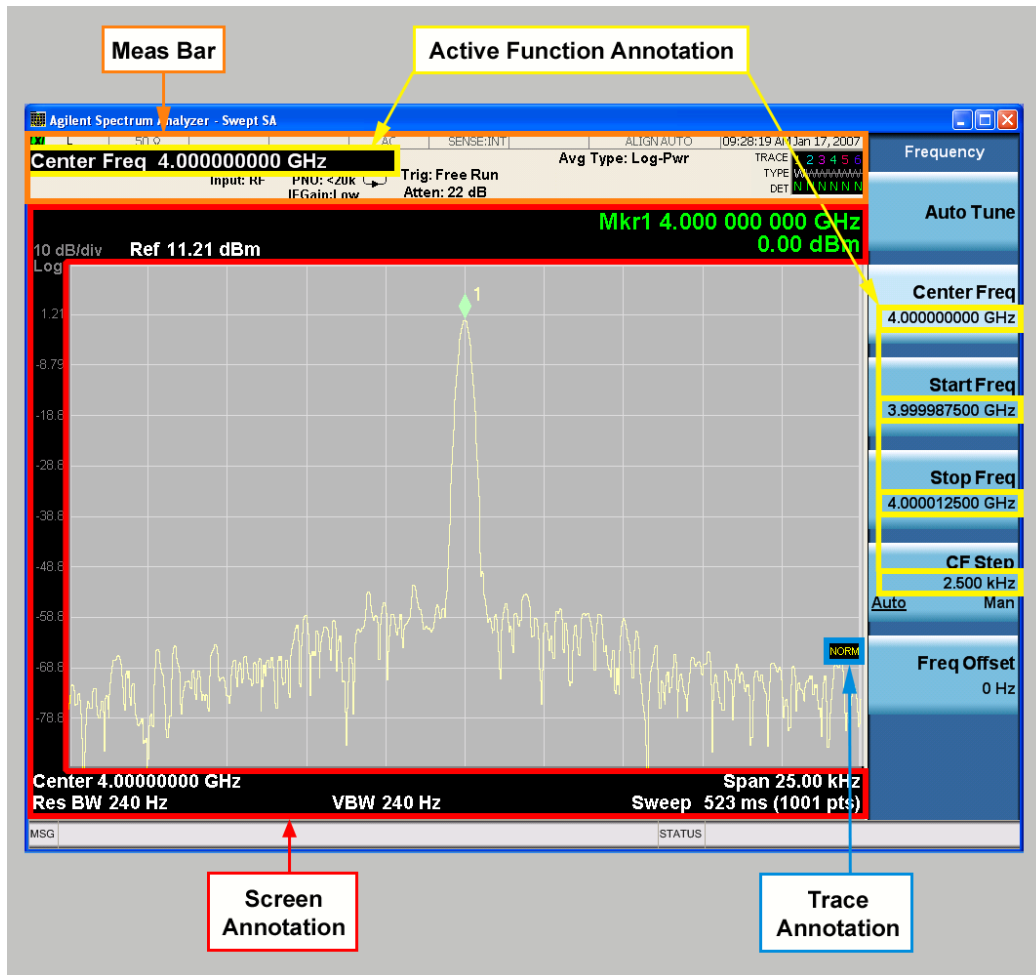

Key Path	View/Display, Display
Initial S/W Revision	Prior to A.02.00

### Meas Bar On/Off

This function turns the Measurement Bar on and off, including the settings panel. When off, the graticule area expands to fill the area formerly occupied by the Measurement Bar.

Key Path	View/Display, Display, Annotation
Remote Command	:DISPlay:ANNotation:MBAR[:STATe] OFF ON 0 1 :DISPlay:ANNotation:MBAR[:STATe]?
Example	DISP:ANN:MBAR OFF
Dependencies	Grayed out and forced to OFF when System Display Settings, Annotation is set to Off.
Preset	On This should remain Off through a Preset when System DisplaySettings, Annotation is set to Off.
State Saved	Saved in instrument state.
Initial S/W Revision	Prior to A.02.00

### Screen

This controls the display of the annunciation and annotation around the graticule, including any annotation on lines (such as the display line, the threshold line, etc.) and the y-axis annotation. This does NOT include marker annotation (or the N dB result). When off, the graticule expands to fill the entire graticule area, leaving only the 1.5% gap above the graticule as described in the Trace/Detector chapter.

Key Path	View/Display, Display, Annotation
Remote Command	:DISPlay:ANNotation:SCReen[:STATe] OFF ON 0 1 :DISPlay:ANNotation:SCReen[:STATe]?
Example	DISP:ANN:SCR OFF
Dependencies	Grayed-out and forced to OFF when System Display Settings, Annotation is set to Off.
Preset	On This should remain Off through a Preset when System DisplaySettings, Annotation is set to Off
State Saved	Saved in instrument state.
Initial S/W Revision	Prior to A.02.00

### Active Function Values On/Off

Turns on and off the active function display in the Meas Bar, and all of the active function values displayed on the softkeys.

Note that all of the softkeys that have active functions have these numeric values blanked when this function is on. This is a security feature..





Key Path	View/Display, Display, Annotation
Remote Command	:DISPlay:ACTivefunc[:STATE] ON OFF 1 0 :DISPlay:ACTivefunc[:STATE]?
Example	DISP:ACT OFF
Dependencies	Grayed out and forced to OFF when System Display Settings, Annotation is set to Off.
Preset	On This should remain Off through a Preset when System DisplaySettings, Annotation is set to Off
State Saved	Saved in instrument state.
Initial S/W Revision	Prior to A.02.00

## Title

Displays menu keys that enable you to change or clear a title on your display.

Key Path	View/Display, Display
Initial S/W Revision	Prior to A.02.00

## Change Title

Writes a title into the "measurement name" field in the banner, for example, "Swept SA".

Press Change Title to enter a new title through the alpha editor. Press Enter or Return to complete the entry. Press ESC to cancel the entry and preserve your existing title.

The display title will replace the measurement name. It remains for this measurement until you press Change Title again, or you recall a state, or a Preset is performed. A title can also be cleared by pressing Title, Clear Title.

**NOTE**

Notice the inclusion of the <measurement> parameter in the command below. Because each measurement remembers the Display Title, the command must be qualified with the measurement name. For the Swept SA measurement this is not the case; no <measurement> parameter is used when changing the Display Title for the Swept SA measurement.

Key Path	View/Display, Display, Title
Mode	All
Remote Command	:DISPlay:<measurement>:ANNotation:TITLe:DATA <string> :DISPlay:<measurement>:ANNotation:TITLe:DATA?
Example	DISP:ANN:TITL:DATA "This Is My Title" This example is for the Swept SA measurement in the Spectrum Analyzer mode. The SANalyzer <measurement> name is not used. DISP:ACP:ANN:TITL:DATA "This Is My Title" This example is for Measurements other than Swept SA. Both set the title to: This Is My Title
Notes	Pressing this key cancels any active function. When a title is edited the previous title remains intact (it is not cleared) and the cursor goes at the end so that characters can be added or BKSP can be used to go back over previous characters.
Preset	No title (measurement name instead)
State Saved	Saved in instrument state.
Initial S/W Revision	Prior to A.02.00

**Clear Title**

Clears a title from the front-panel display. Once cleared, the title cannot be retrieved. After the title is cleared, the current Measurement Name replaces it in the title bar.

Key Path	View/Display, Display, Title
Example	The following commands clear the title and restore the measurement's original title: DISP:ANN:TITL:DATA "" This example is for the Swept SA measurement in the Spectrum Analyzer mode. The SANalyzer <measurement> name is not used. DISP:ACP:ANN:TITL:DATA "" This example is for ACP; in measurements other than Swept SA the measurement name is required.
Notes	Uses the :DISPlay:<measurement>:ANNotation:TITLe:DATA <string> command with an empty string (in the Swept SA, the <measurement> is omitted).
Preset	Performed on Preset.
Initial S/W Revision	Prior to A.02.00

## Graticule

Pressing Graticule turns the display graticule On or Off. It also turns the graticule y-axis annotation on and off.

Key Path	View/Display, Display
Remote Command	:DISPlay:WINDow[1]:TRACe:GRATicule:GRID[:STATe] OFF ON 0 1 :DISPlay:WINDow[1]:TRACe:GRATicule:GRID[:STATe]?
Example	DISP:WIND:TRAC:GRAT:GRID OFF
Notes	The graticule is the set of horizontal and vertical lines that make up the grid/divisions for the x-axis and y-axis.
Preset	On
State Saved	Saved in instrument state
Initial S/W Revision	Prior to A.02.00

## System Display Settings

These settings are "Mode Global" – they affect all modes and measurements and are reset only by Restore Misc Defaults or Restore System Defaults under System.

Key Path	View/Display, Display
Initial S/W Revision	Prior to A.02.00

## Annotation Local Settings

This is a Mode Global override of the meas local annotation settings. When it is All Off, it forces ScreenAnnotation, Meas Bar, Trace, and Active Function Values settings to be OFF for all measurements in all modes. This provides the security based "annotation off" function of previous analyzers; hence it uses the legacy SCPI command.

When it is All Off, the Screen, Meas Bar, Trace, and Active Function Values keys under the Display, Annotation menu are grayed out and forced to Off. When Local Settings is selected, you are able to set the local annotation settings on a measurement by measurement basis.

Key Path	View/Display, Display, System Display Settings
Remote Command	:DISPlay:WINDow[1]:ANNotation[:ALL] OFF ON 0 1 :DISPlay:WINDow[1]:ANNotation[:ALL]?
Example	:DISP:WIND:ANN OFF
Preset	On (Set by Restore Misc Defaults)
State Saved	Not saved in instrument state.
Backwards Compatibility Notes	The WINDow parameter and optional subopcode is included for backwards compatibility but ignored – all windows are equally affected.
Initial S/W Revision	Prior to A.02.00

## Themes

Accesses a menu of functions that enable you to choose the theme to be used when saving the screen image.

The **Themes** option is the same as the **Themes** option under the **Display** and **Page Setup** dialogs. It allows you to choose between themes to be used when saving the screen image.

<b>Key Path</b>	Save, Screen Image
<b>Remote Command</b>	:MMEMory:STORe:SCReen:THEMe TDColor   TDMonochrome   FCOLor   FMONochrome  :MMEMory:STORe:SCReen:THEMe?
<b>Example</b>	:MMEM:STOR:SCR:THEM TDM
<b>Preset</b>	3D Color; Is not part of Preset, but is reset by Restore Misc Defaults or Restore System Defaults All and survives subsequent running of the modes.
<b>Readback</b>	3D Color   3D Mono   Flat Color   Flat Mono
<b>Backwards Compatibility Notes</b>	In ESA and PSA we offer the choice of "Reverse Bitmap" or "Reverse Metafile" when saving screen images. This is much like the "Flat Color" theme available in X-Series. Also, if you selected Reverse Bitmap AND a black & white screen image, that would be much like "Flat Monochrome". In other words, each of the X-Series themes has a similar screen image type in ESA/PSA. But they are not identical.
<b>Initial S/W Revision</b>	Prior to A.02.00

### 3D Color

Selects a standard color theme with each object filled, shaded and colored as designed.

<b>Key Path</b>	Save, Screen Image, Themes
<b>Example</b>	MMEM:STOR:SCR:THEM TDC
<b>Readback</b>	3D Color
<b>Initial S/W Revision</b>	Prior to A.02.00

### 3D Monochrome

Selects a format that is like 3D color but shades of gray are used instead of colors.

<b>Key Path</b>	Save, Screen Image, Themes
<b>Example</b>	MMEM:STOR:SCR:THEM TDM
<b>Readback</b>	3D Mono
<b>Initial S/W Revision</b>	Prior to A.02.00

### Flat Color

Selects a format that is best when the screen is to be printed on an ink printer.

Key Path	Save, Screen Image, Themes
<b>Example</b>	MMEM:STOR:SCR:THEM FCOL
Readback	Flat Color
Initial S/W Revision	Prior to A.02.00

### Flat Monochrome

Selects a format that is like Flat Color. But only black is used (no colors, not even gray), and no fill.

Key Path	Save, Screen Image, Themes
<b>Example</b>	MMEM:STOR:SCR:THEM FMON
Readback	Flat Mono
Initial S/W Revision	Prior to A.02.00

### Backlight

Accesses the display backlight on/off keys. This setting may interact with settings under the Windows "Power" menu.

When the backlight is off, pressing ESC, TAB, SPACE, ENTER, UP, DOWN, LEFT, RIGHT, DEL, BKSP, CTRL, or ALT turns the backlight on without affecting the application. Pressing any other key will turn backlight on and could potentially perform the action as well.

Key Path	View/Display, Display, System Display Settings
<b>Remote Command</b>	:DISPlay:BACKlight ON OFF :DISPlay:BACKlight?
Preset	ON (Set by Restore Misc Defaults)
Initial S/W Revision	Prior to A.02.00

### Backlight Intensity

An active function used to set the backlight intensity. It goes from 0 to 100 where 100 is full on and 0 is off. This value is independent of the values set under the Backlight on/off key.

Key Path	View/Display, Display, System Display Settings
<b>Remote Command</b>	:DISPlay:BACKlight:INTensity <integer> :DISPlay:BACKlight:INTensity?
<b>Example</b>	DISP:BACK:INT 50

10 Occupied Bandwidth Measurement  
View/Display

Preset	100 (Set by Restore Misc Defaults)
Min	0
Max	100
Initial S/W Revision	Prior to A.02.00

## 11 Power vs Time

This key invokes the Power vs Time measurement.

Key Path	Measure
Initial S/W Revision	Prior to A.02.00

## Amplitude (AMPTD) Y Scale

Accesses the AMPTD Y Scale menu that allows you to set desired vertical scale settings.

Key Path	Front panel key
Initial S/W Revision	Prior to A.02.00

### Ref Value (Burst view RF Envelope window)

Sets the absolute power reference in the Burst view RF Envelope window.

Key Path	AMPTD Y Scale
Mode	1xEVDO
Remote Command	:DISPlay:PVTime:VIEW[1]:WINDow[1]:TRACe:Y[:SCALe]:RLEVel <real> :DISPlay:PVTime:VIEW[1]:WINDow[1]:TRACe:Y[:SCALe]:RLEVel?
Example	DISPlay:PVTime:VIEW:WINDow:TRACe:Y:SCALe:RLEVel 5dbm
Couplings	When Y Auto Scaling is set to On, this value is automatically determined by the measurement result. When you set this value manually, Y Auto Scaling is automatically set to Off.
Preset	10.00
State Saved	Saved in instrument state.
Min	-250.0
Max	250.0
Initial S/W Revision	Prior to A.02.00

## Attenuation

This menu controls the attenuator functions and interactions between the attenuation system components.

There are two attenuator configurations in the X-Series. One is a dual attenuator configuration consisting of a mechanical attenuator and an optional electronic attenuator. The other configuration uses a single attenuator with combined mechanical and electronic sections that controls all the attenuation functions. Different models in the X-Series come with different configurations.

See ["Dual Attenuator Configurations:" on page 1037](#)

See ["Single Attenuator Configuration:" on page 1037](#)

Most Attenuation settings are the same for all measurements – they do not change as you change measurements. Settings like these are called “Meas Global” and are unaffected by Meas Preset.

Key Path	AMPTD Y Scale
Scope	Meas Global
Dependencies	In measurements that support the I/Q inputs, this key is unavailable when I/Q is the selected input,



and is replaced by the Range key in that case.

Readback Line	Contains a summary in [ ] brackets of the current total attenuation. See the descriptions of the , " <b>(Mech) Atten</b> " on page 2783, and " <b>Enable Elec Atten</b> " on page 2785 keys for more detail on the contributors to the total attenuation.  Note that when "Pre-Adjust for Min Clip" is on, this value can change at the start of every measurement.
Initial S/W Revision	Prior to A.02.00
Modified at S/W Revision	A.03.00

### Dual Attenuator Configurations:

Configuration 1: Mechanical attenuator + optional electronic attenuator

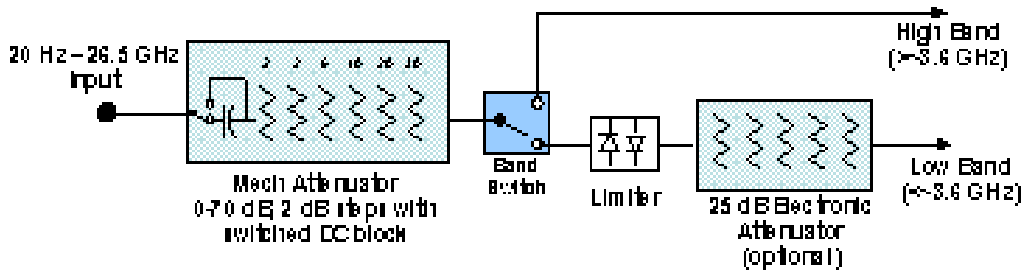

Configuration 2: Mechanical attenuator, no optional electronic attenuator

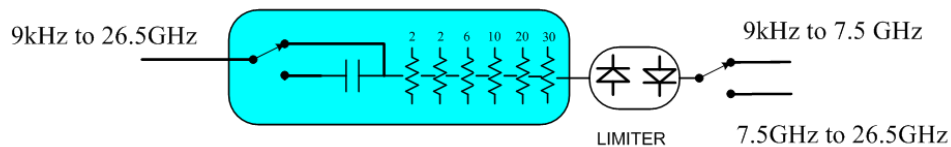

(note that Configuration 2 is not strictly speaking a dual-section attenuator, since there is no electronic section available. However, it behaves exactly like Configuration 1 without the Electronic Attenuator option EA3, therefore for the sake of this document it is grouped into the "Dual Attenuator" configuration)

### Single Attenuator Configuration:

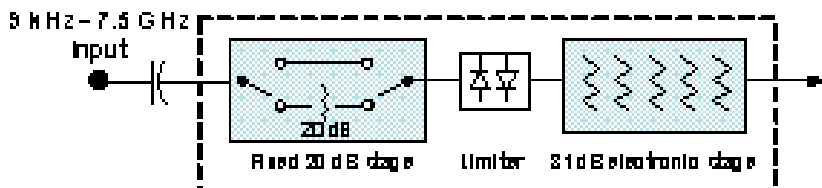

You can tell which attenuator configuration you have by pressing the Attenuation key, which (in most Modes) opens the Attenuation menu. If the first key in the Attenuation menu says Mech Atten you have the dual attenuator configuration. If the first key says Atten you have the single attenuator configuration.

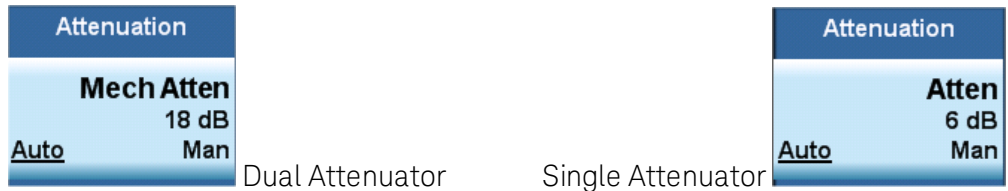

In the single attenuator configuration, you control the attenuation with a single control, as the fixed stage has only two states. In the dual attenuator configuration, both stages have significant range so you are given separate control of the mechanical and electronic attenuator stages.

When you have the dual attenuator configuration, you may still have only a single attenuator, because unless option EA3 (the Electronic Attenuator option) is available, and you purchase it, you will have only the mechanical attenuator.

### (Mech) Atten

This key is labeled Mech Atten in dual attenuator models and Atten in single attenuator models. In the dual attenuator configuration, this key only affects the mechanical attenuator.

This key lets you modify the attenuation applied to the RF input signal path. This value is normally auto coupled to the Ref Level, the Internal Preamp Gain, any External Gain that is entered, and the Max Mixer Level, as described in the table below.

See "[Attenuator Configurations and Auto/Man](#)" on page 1039

Key Path	AMPTD Y Scale, Attenuation
<b>Remote Command</b>	<pre>[ :SENSe ] : POWer [ :RF ] : ATTenuation &lt;rel_ampl&gt; [ :SENSe ] : POWer [ :RF ] : ATTenuation? [ :SENSe ] : POWer [ :RF ] : ATTenuation : AUTO OFF   ON   0   1 [ :SENSe ] : POWer [ :RF ] : ATTenuation : AUTO ?</pre>
<b>Example</b>	<p>POW:ATT 20</p> <p>Dual attenuator configuration: sets the mechanical attenuator to 20 dB</p> <p>Single attenuator mode: sets the main attenuation to 20 dB (see below for definition of "main" attenuation).</p> <p>If the attenuator was in Auto, it sets it to Manual.</p>
<b>Dependencies</b>	<p>Some measurements do not support the Auto setting of (Mech) Atten. In these measurements, the Auto/Man selection is not available, and the Auto/Man line on the key disappears.</p> <p>In dual attenuator configurations, when the electronic attenuator is enabled, the mechanical attenuator has no auto setting and the Auto/Man line on the key disappears. The state of Auto/Man is remembered and restored when the electronic attenuator is once again disabled. This is described in more detail in the "<a href="#">Enable Elec Atten</a>" on page 2785 key description.</p> <p>See "<a href="#">Attenuator Configurations and Auto/Man</a>" on page 1039 for more information on the Auto/Man functionality of Attenuation.</p>

### Couplings

---

	<p>When (Mech) Atten is in Auto, it uses the following algorithm to determine a value:          If the USB Preamp is connected to USB, use 0 dB.          Otherwise, Atten = ReferenceLevel + PreAmpGain + ExternalGain – RefLevelOffset - MaxMixerLevel + IF Gain.          Limit this value to be between 6 dB and the Max value. No value below 6 dB can ever be chosen by Auto.          The resulting value is rounded up to the largest value possible given the attenuation step setting. That is, 50.01 dB would change to 60 dB (for a 10 dB attenuation step).          The “IF Gain” term in the equation above is either 0 dB or +10 dB, depending on the settings of FFT IF Gain, Swept IF Gain, max Ref Level and the Auto/Man setting of Mech Atten.          In External Mixing and BBIQ, where the Attenuator is not in the signal path, the Attenuator setting changes as described above when (Mech) Atten is in Auto, but no changes are made to the actual attenuator hardware setting until the input is changed back to the RF Input.</p>
Preset	<p>The preset for Mech Attenuation is “Auto.”          The Auto value of attenuation is:          CXA, EXA, MXA and PXA: 10 dB</p>
State Saved	<p>Saved in instrument state</p>
Min	<p>0 dB          The attenuation set by this key cannot be decreased below 6 dB with the knob or step keys. To get to a value below 6 dB it has to be directly entered from the keypad or via SCPI. This protects from adjusting the attenuation to a dangerously small value which can put the instrument at risk of damage to input circuitry. However, if the current mechanical attenuation is below 6 dB it can be increased with the knob and step keys, but not decreased.</p>
Max	<p>CXA N9000A–503/507: 50 dB          CXA N9000A–513/526: 70dB          EXA: 60 dB          MXA and PXA: 70 dB          In the single attenuator configuration, the total of ATT and EATT cannot exceed 50 dB, so if the EATT is set to 24 dB first, the main attenuation cannot be greater than 26 dB and will be reduced accordingly; if the main attenuator is set to 40 dB first, EATT cannot be greater than 10 dB.</p>
Initial S/W Revision	<p>Prior to A.02.00</p>
Modified at S/W Revision	<p>A.03.00</p>

---

### Attenuator Configurations and Auto/Man

As described in the Attenuation key description, there are two distinct attenuator configurations available in the X-Series, the single attenuator and dual attenuator configurations. In dual attenuator configurations, we have the mechanical attenuation and the electronic attenuation, and the current total attenuation is the sum of the electronic + mechanical attenuation. In single attenuator configurations, we refer to the attenuation set using the (Mech) Atten key (or POW:ATT SCPI) as the “main” attenuation; and the attenuation that is set by the SCPI command POW:EATT as the “soft” attenuation (the POW:EATT command is honored even in the single attenuator configuration, for compatibility purposes). Then the

current total attenuation is the sum of the main + soft attenuation. See the Elec Atten key description for more on “soft” attenuation.

In the dual attenuator configuration, when the electronic attenuator is enabled, there is no Auto/Man functionality for the mechanical attenuator, and the third line of the key label (the Auto/Man line) disappears:



### Enable Elec Atten

Enables the Electronic Attenuator.

The electronic attenuator offers finer steps than the mechanical attenuator, has no acoustical noise, is faster, and is less subject to wear. These advantages primarily aid in remote operation and are negligible for front panel use. See ["Using the Electronic Attenuator: Pros and Cons" on page 1042](#) for a detailed discussion of the pros and cons of using the electronic attenuator.

For the single attenuator configuration, for SCPI backwards compatibility, the “soft” attenuation feature replaces the dual attenuator configuration’s electronic attenuator. All the same couplings and limitations apply. See ["Attenuator Configurations and Auto/Man" on page 2785](#)

See ["More Information" on page 1041](#)

<b>Key Path</b>	AMPTD Y Scale, Attenuation
<b>Remote Command</b>	[ :SENSE ] :POWER [ :RF ] :EATTenuation :STATe OFF   ON   0   1 [ :SENSE ] :POWER [ :RF ] :EATTenuation :STATe ?
<b>Example</b>	POW:EATT:STAT ON
<b>Dependencies</b>	<p>This key only appears in Dual Attenuator models with an Electronic Attenuator installed. It does not appear in models with the Single Attenuator configuration, as in the single attenuator configuration there is no “electronic attenuator” there is only a single integrated attenuator (which has both a mechanical and electronic stage). However, in the single attenuator configuration, EATT SCPI commands are accepted for compatibility with other X-series instruments and set a “soft” attenuation as described in <a href="#">"Attenuator Configurations and Auto/Man" on page 2785</a>.</p> <p>The electronic attenuator (and the “soft” attenuation function provided in single attenuator configurations) is unavailable above 3.6 GHz. Therefore, if the Stop Frequency of the analyzer is &gt; 3.6 GHz then the Enable Elec Atten key will be OFF and grayed out.</p> <p>If the Internal Preamp is on, meaning it is set to Low Band or Full, the electronic attenuator (and the “soft” attenuation function provided in single attenuator configurations) is unavailable. In this case the Enable Elec Atten key will be OFF and grayed out.</p> <p>If either of the above is true, if the SCPI command is sent, an error indicating that the electronic attenuator is unavailable will be sent.</p> <p>If the electronic/soft Attenuator is enabled, then the Stop Freq of the analyzer is limited to 3.6 GHz and the Internal Preamp is unavailable.</p> <p>The SCPI-only “soft” electronic attenuation for the single-attenuator configuration is not available in</p>

	all measurements; in particular, it is not available in the Swept SA measurement.
Couplings	Enabling and disabling the Electronic Attenuator affects the setting of the Mechanical Attenuator (in dual attenuator configurations). This is described in more detail below this table.
Preset	OFF for Swept SA measurement; ON for all other measurements that support the electronic attenuator
State Saved	Saved in instrument state
Initial S/W Revision	Prior to A.02.00
Modified at S/W Revision	A.03.00

## More Information

### Mechanical Attenuator Transition Rules

When the Electronic Attenuator is enabled, the Mechanical Attenuator transitions to a state that has no Auto function. Below are the rules for transitioning the Mechanical Attenuator. NOTE that the information below ONLY applies to the dual attenuator configurations, and ONLY when the Electronic Attenuator is installed:

#### When the Electronic Attenuation is enabled from a disabled state:

- The Mechanical Attenuator is initialized to 10 dB (this is its optimal performance setting). You can then set it as desired with SCPI, numeric keypad, step keys, or knob, and it behaves as it normally would in manual mode
- The Auto/Man state of (Mech) Atten is saved
- The Auto/Man line on the (Mech) Atten key disappears and the auto rules are disabled
- The Electronic Attenuator is set to 10 dB less than the previous value of the Mechanical Attenuator, within the limitation that it must stay within the range of 0 to 24 dB of attenuation.

#### Examples in the dual attenuator configuration:

- Mech Atten at 20 dB. Elec Atten enabled, Mech Atten set to 10 dB, and Elec Atten set to 10 dB. New total attenuation equals the value before Elec Atten enabled.
- Mech Atten at 0 dB. Elec Atten enabled, Mech Atten set to 10 dB, and Elec Atten set to 0 dB. New total attenuation does not equal the value before Elec Atten enabled.
- Mech Atten at 40 dB. Elec Atten enabled, Mech Atten set to 10 dB, and Elec Atten set to 24 dB. New total attenuation does not equal the value before Elec Atten enabled.

#### When the Electronic Attenuation is disabled from an enabled state:

- The Elec Atten key is grayed out
- The Auto/Man state of (Mech) Atten is restored
- If now in Auto, (Mech) Atten recouples

- If now in Man, (Mech) Atten is set to the value of total attenuation that existed before the Elec Atten was disabled. The resulting value is rounded up to the smallest value possible given the (Mech) Atten Step setting - (That is, 57 dB changes to 58 dB when (Mech) Atten Step is 2 dB.)

### Using the Electronic Attenuator: Pros and Cons

The electronic attenuator offers finer steps than the mechanical attenuator, has no acoustical noise, is faster, and is less subject to wear.

The “finer steps” advantage of the electronic attenuator is beneficial in optimizing the alignment of the analyzer dynamic range to the signal power in the front panel as well as remote use. Thus, you can achieve improved relative signal measurement accuracy. Compared to a mechanical attenuator with 2 dB steps, the 1 dB resolution of the electronic attenuator only gives better resolution when the odd-decibel steps are used. Those odd-decibel steps are less accurately calibrated than the even-decibel steps, so one tradeoff for this superior relative accuracy is reduced absolute amplitude accuracy.

Another disadvantage of the electronic attenuator is that the spectrum analyzer loses its “Auto” setting, making operation less convenient.

Also, the relationship between the dynamic range specifications (TOI, SHI, compression and noise) and instrument performance are less well-known with the electrical attenuator. With the mechanical attenuator, TOI, SHI and compression threshold levels increase dB-for-dB with increasing attenuation, and the noise floor does as well. With the electronic attenuator, there is an excess attenuation of about 1 to 3 dB between 0 and 3.6 GHz, making the effective TOI, SHI, and so forth, less well known. Excess attenuation is the actual attenuation relative to stated attenuation. Excess attenuation is accounted for in the analyzer calibration

### Elec Atten

Controls the Electronic Attenuator in dual attenuator configurations. This key does not appear in single attenuator configurations, as the control of both the mechanical and electronic stages of the single attenuator is integrated into the single Atten key.

Key Path	AMPTD Y Scale, Attenuation
Remote Command	<code>[ :SENSe ] :POWer [ :RF ] :EATTenuation &lt;rel_amp1&gt;</code> <code>[ :SENSe ] :POWer [ :RF ] :EATTenuation?</code>
Notes	Electronic Attenuation's specification is defined only when Mechanical Attenuation is 6 dB.
Dependencies	This key only appears in Dual Attenuator models with an Electronic Attenuator installed. It does not appear in models with the Single Attenuator configuration, as in the single attenuator configuration there is no “electronic attenuator” there is only a single integrated attenuator (which has both a mechanical and electronic stage). However, in the single attenuator configuration, EATT SCPI commands are accepted for compatibility with other X-series instruments and set a “soft” attenuation as described in <a href="#">"Attenuator Configurations and Auto/Man" on page 2785</a> . The “soft” attenuation is treated as an addition to the “main” attenuation value set by the Atten softkey or the POW:ATT SCPI command and affects the total attenuation displayed on the Attenuation key and the Meas Bar.  When Enable Elec Atten is off or grayed out, the Elec Atten key is grayed out.
Preset	0 dB
State Saved	Saved in instrument state

Min	0 dB
Max	Dual attenuator configuration: 24 dB Single attenuator configuration: the total of ATT and EATT cannot exceed 50 dB, so if the EATT is set to 24 dB first, the main attenuation cannot be greater than 26 dB and will be reduced accordingly; if the main attenuator is set to 40 dB first, EATT cannot be greater than 10 dB
Initial S/W Revision	Prior to A.02.00
Modified at S/W Revision	A.03.00

### Adjust Atten for Min Clip

Sets the combination of mechanical and electronic attenuation and gain based on the current measured signal level so that clipping will be at a minimum.

This is an "immediate action" function, that is, it executes once, when the key is pressed.

This key is grayed out in measurements that do not support this functionality. The spectrum analyzer measurement, Swept SA, does not support this functionality.

Key Path	AMPTD Y Scale, Attenuation
Remote Command	<code>[ :SENSe ] :POWer [ :RF ] :RANGe:OPTimize IMMEDIATE</code>
Initial S/W Revision	Prior to A.02.00
Modified at S/W Revision	A.03.00

### Pre-Adjust for Min Clip

If this function is on, it does the adjustment described under "[Adjust Atten for Min Clip](#)" on page 2788 each time a measurement restarts. Therefore, in Continuous measurement mode, it only executes before the first measurement.

In dual attenuator models, you can set Elec+Mech Atten, in which case both attenuators participate in the autoranging, or Elec Atten Only, in which case the mechanical attenuator does not participate in the autoranging. This latter case results in less wear on the mechanical attenuator and is usually faster.

This key is grayed out in measurements that do not support this functionality. The spectrum analyzer measurement, Swept SA, does not support this functionality.

Key Path	AMPTD Y Scale, Attenuation
Remote Command	<code>[ :SENSe ] :POWer [ :RF ] :RANGe:OPTimize:ATTenuation OFF   ELECTrical   COMBined</code>  <code>[ :SENSe ] :POWer [ :RF ] :RANGe:OPTimize:ATTenuation?</code>
Notes	The SCPI parameter ELECTrical sets this function to On in single attenuator models. The SCPI parameter COMBined is mapped to ELECTrical in single attenuator models; if you send COMBined, it sets the function to On and returns ELEC to a query.
Dependencies	This key only appears in Dual Attenuator models with an Electronic Attenuator installed.

	In instruments with Dual Attenuator model, when Enable Elec Atten is off or grayed out, the Pre-Adjust for Min Clip key is grayed out.
Preset	OFF for Swept SA measurement; ON for all other measurements that support Pre-Adjust for Min Clip
State Saved	Saved in instrument state
Range	Dual attenuator models: Off   Elec Atten Only   Mech + Elec Atten Single attenuator models: Off   On
Initial S/W Revision	Prior to A.02.00
Modified at S/W Revision	A.03.00

<b>Remote Command</b>	<code>[ :SENSe ] :POWer [ :RF ] :RANGe :AUTO ON   OFF   1   0</code> <code>[ :SENSe ] :POWer [ :RF ] :RANGe :AUTO ?</code>
Notes	ON aliases to "Elec Atten Only" (:POW:RANG:OPT:ATT ELEC) OFF aliases to "Off" (:POW:RANG:OPT:ATT OFF) The query :POW:RANG:AUTO? returns true if :POW:RANG:OPT:ATT is not "Off"
Initial S/W Revision	Prior to A.02.00

## Off

Turns Pre-Adjust for Min Clip off. This is the default setting.

This key is grayed out in measurements that do not support this functionality. The spectrum analyzer measurement, Swept SA, does not support this functionality.

Key Path	AMPTD Y Scale, Attenuation, Pre-Adjust for Min Clip
Example	:POW:RANGe:OPT:ATT OFF
Initial S/W Revision	Prior to A.02.00

## Elec Atten Only

Selects only the electric attenuator to participate in auto ranging. This offers less wear on the mechanical attenuator and is usually faster.

This key is grayed out in measurements that do not support this functionality. The spectrum analyzer measurement, Swept SA, does not support this functionality.

Key Path	AMPTD Y Scale, Attenuation, Pre-Adjust for Min Clip
Example	:POW:RANGe:OPT:ATT ELEC
Initial S/W Revision	Prior to A.02.00



## Mech + Elec Atten

In dual attenuator models, this selects both attenuators participate in the autoranging.

This key is grayed out in measurements that do not support this functionality. The spectrum analyzer measurement, Swept SA, does not support this functionality.

Key Path	AMPTD Y Scale, Attenuation, Pre-Adjust for Min Clip
Example	:POW:RANGe:OPT:ATT COMB
Initial S/W Revision	Prior to A.02.00

## (Mech) Atten Step

This controls the step size used when making adjustments to the input attenuation.

This key is labeled Mech Atten Step in dual attenuator models and Atten Step in single attenuator models. In the dual attenuator configuration, this key only affects the step size of the mechanical attenuator.

Key Path	AMPTD Y Scale, Attenuation
<b>Remote Command</b>	[ :SENSe ] :POWer [ :RF ] :ATTenuation :STEP [ :INCRement ] 10 dB   2 dB [ :SENSe ] :POWer [ :RF ] :ATTenuation :STEP [ :INCRement ] ?
<b>Example</b>	POW:ATT:STEP 2
Notes	Note this feature works like a 1-N choice from the front panel, but it takes a specific value (in dB) when used remotely. The only valid values are 2 and 10.
Dependencies	Blanked in CXA and EXA if option FSA (2 dB steps) is not present. If blanked, attempts to set it via SCPI will yield an error.
Couplings	When the attenuation step size changes, the current mechanical attenuation value is adjusted (if necessary) to be quantized to the new step size. That is, if step is set to 10 dB, mech atten is increased if necessary so it is a multiple of 10 dB
Preset	PXA and MXA: 2 dB EXA and CXA: 10 dB (2 dB with option FSA)
State Saved	Saved in instrument state
Initial S/W Revision	Prior to A.02.00
Modified at S/W Revision	A.03.00

## Scale/Div (Burst view RF Envelope window)

Sets the vertical scale by changing a value per division in the Burst view RF Envelope window.

Key Path	AMPTD Y Scale
----------	---------------

Mode	1xEVDO
Remote Command	:DISPlay:PVTime:VIEW[1]:WINDow[1]:TRACe:Y[:SCALe]:PDIVision <rel_ampl> :DISPlay:PVTime:VIEW[1]:WINDow[1]:TRACe:Y[:SCALe]:PDIVision?
Example	DISPlay:PVT:VIEW:WINDow:TRACe:Y:SCALe:PDIVision 10dB
Couplings	When the Y Auto Scaling is set to On, this value is automatically determined by the measurement result. When you set a value manually, Y Auto Scaling is automatically set to Off.
Preset	10.00 dB
State Saved	Saved in instrument state.
Min	0.1 dB
Max	20.00 dB
Initial S/W Revision	Prior to A.02.00

## Presel Center

When this key is pressed, the centering of the preselector filter is adjusted to optimize the amplitude accuracy at the frequency of the selected marker. If the selected marker is not on when Presel Center is pressed, the analyzer will turn on the selected marker, perform a peak search, and then perform centering on the marker's center frequency. If the selected marker is already on and between the start and stop frequencies of the analyzer, the analyzer performs the preselector calibration on that marker's frequency. If the selected marker is already on, but outside the frequency range between Start Freq and Stop Freq, the analyzer will first perform a peak search, and then perform centering on the marker's center frequency.

The value displayed on the Presel Adjust key will change to reflect the new preselector tuning (see Presel Adjust).

A number of considerations should be observed to ensure proper operation. See ["Proper Preselector Operation" on page 1047](#).

Key Path	AMPTD Y Scale
Remote Command	[:SENSe]:POWer[:RF]:PCENter
Example	POW:PCEN
Notes	Note that the rules outlined above under the key description apply for the remote command as well as the key. The result of the command is dependent on marker position, and so forth. Any message shown by the key press is also shown in response to the remote command.
Dependencies	<ul style="list-style-type: none"> <li>• Grayed out if the microwave preselector is off. )</li> <li>• If the selected marker's frequency is below Band 1, advisory message 0.5001 is generated and no action is taken.</li> <li>• Grayed out if entirely in Band 0.</li> <li>• Blank in models that do not include a preselector, such as option 503. If the SCPI is sent in these instruments, it is accepted without error, and the query always returns 0.</li> <li>• Grayed out in the Spectrogram View.</li> </ul>
Couplings	The active marker position determines where the centering will be attempted.

	If the analyzer is in a measurement such as averaging when centering is initiated, the act of centering the preselector will restart averaging but the first average trace will not be taken until the centering is completed.
Status Bits/OPC dependencies	When centering the preselector, *OPC will not return true until the process is complete and a subsequent measurement has completed, nor will results be returned to a READ or MEASure command.  The Measuring bit should remain set while this command is operating and should not go false until the subsequent sweep/measurement has completed.
Initial S/W Revision	Prior to A.02.00
Modified at S/W Revision	A.03.00

## Proper Preselector Operation

A number of considerations should be observed to ensure proper operation:

1. If the selected marker is off, the analyzer will turn on a marker, perform a peak search, and adjust the preselector using the selected marker's frequency. It uses the "highest peak" peak search method unqualified by threshold or excursion, so that there is no chance of a 'no peak found' error. It continues with that peak, even if it is the peak of just noise. Therefore, for this operation to work properly, there should be a signal on screen in a preselected range for the peak search to find.
2. If the selected marker is already on, the analyzer will attempt the centering at that marker's frequency. There is no preselector for signals below about 3.6 GHz, therefore if the marker is on a signal below 3.6 GHz, no centering will be attempted and an advisory message generated
3. In some models, the preselector can be bypassed. If it is bypassed, no centering will be attempted in that range and a message will be generated.

## Preselector Adjust

Allows you to manually adjust the preselector filter frequency to optimize its response to the signal of interest. This function is only available when "[Presel Center](#)" on page 2791 is available.

For general purpose signal analysis, using Presel Center is recommended. Centering the filter minimizes the impact of long-term preselector drift. Presel Adjust can be used instead to manually optimize the preselector. One application of manual optimization would be to peak the preselector response, which both optimizes the signal-to-noise ratio and minimizes amplitude variations due to small (short-term) preselector drifting.

Key Path	AMPTD Y Scale
Scope	Meas Global
Remote Command	<code>[ :SENSe ] :POWer [ :RF ] :PADJust &lt;freq&gt;</code> <code>[ :SENSe ] :POWer [ :RF ] :PADJust?</code>
Example	<code>POW:PADJ 100KHz</code> <code>POW:PADJ?</code>

Notes	The value on the key reads out to 0.1 MHz resolution.
Dependencies	<ul style="list-style-type: none"> <li>• Grayed out if microwave preselector is off. )</li> <li>• Grayed out if entirely in Band 0.</li> <li>• Blank in models that do not include a preselector, such as option 503. If the SCPI is sent in these instruments, it is accepted without error, and the query always returns 0.</li> <li>• Grayed out in the Spectrogram View.</li> </ul>
Preset	0 MHz
State Saved	The Presel Adjust value set by Presel Center, or by manually adjusting Presel Adjust, is not saved in instrument state, and does not survive a Preset or power cycle.
Min	-500 MHz
Max	500 MHz
Default Unit	Hz
<b>Backwards Compatibility SCPI</b>	<pre>[ :SENSe ] : POWer [ :RF ] : MW : PADJust</pre> <pre>[ :SENSe ] : POWer [ :RF ] : MMW : PADJust</pre> <p>PSA had multiple preselectors, but the X-Series has only one. These commands simply alias to [ :SENSe ] : POWer [ :RF ] : PADJust</p>
Initial S/W Revision	Prior to A.02.00
Modified at S/W Revision	A.03.00

<b>Remote Command</b>	<pre>[ :SENSe ] : POWer [ :RF ] : PADJust : PRESelector MWAVE   MMWave   EXTernal</pre> <pre>[ :SENSe ] : POWer [ :RF ] : PADJust : PRESelector?</pre>
Notes	<p>PSA had multiple preselectors, and you could select which preselector to adjust. Since the X-Series has only one mm/uW preselector, the preselector selection softkey is no longer available. However, to provide backward compatibility, we accept the legacy remote commands.</p> <p>The command form has no effect, the query always returns MWAVE</p>
Initial S/W Revision	Prior to A.02.00

## μW Path Control

The μW Path Control functions include the μW Preselector Bypass (Option MPB) and Low Noise Path (Option LNP) controls in the High Band path circuits.

When the μW Preselector is bypassed, the user has better flatness, but will be subject to spurs from out of band interfering signals. When the Low Noise Path is enabled, the analyzer automatically switches around certain circuitry in the high frequency bands which can contribute to noise, when it is appropriate based on other analyzer settings.

For most applications, the preset state is Standard Path, which gives the best remote-control throughput, minimizes acoustic noise from switching and minimizes the risk of wear out in the hardware switches. For applications that utilize the wideband IF paths, the preset state is the  $\mu$ W Preselector Bypass path, if option MPB is present. This is because, when using a wideband IF such as the 140 MHz IF, the  $\mu$ W Preselector's bandwidth can be narrower than the available IF bandwidth, causing degraded amplitude flatness and phase linearity, so it is desirable to bypass the preselector in the default case.

Users may choose Low Noise Path Enable. It gives a lower noise floor, especially in the 21–26.5 GHz region, though without improving many measures of dynamic range, and without giving the best possible noise floor. The preamp, if purchased and used, gives better noise floor than does the Low Noise Path, however its compression threshold and third-order intercept are much poorer than that of the non-preamp Low Noise Path. There are some applications, typically for signals around –30 dBm, for which the third-order dynamic range of the standard path is good enough, but the noise floor is not low enough even with 0 dB input attenuation. When the third-order dynamic range of the preamp path is too little and the noise floor of the standard path is too high, the Low Noise Path can provide the best dynamic range.

<b>Key Path</b>	AMPTD Y Scale
<b>Mode</b>	SA, BASIC, PNOISE, VSA , LTE, LTETDD
<b>Scope</b>	Meas Global
<b>Remote Command</b>	[ :SENSe ] :POWer [ :RF ] :MW:PATH STD LNPath MPBypass FULL [ :SENSe ] :POWer [ :RF ] :MW:PATH?
<b>Example</b>	:POW:MW:PATH LNP Enables the Low Noise path
<b>Notes</b>	If a Presel Center is performed, the analyzer will momentarily switch to the Standard Path, regardless of the setting of $\mu$ W Path Control  The DC Block will always be switched in when the low noise path is switched in, to protect succeeding circuitry from DC. Note that this does not mean “when the low noise path is enabled” but when, based on the Low Noise Path rules, the path is actually switched in. This can happen when the selection is Low Noise Path Enable . In the case where the DC Block is switched in the analyzer is now AC coupled. However, if the user has selected DC coupling, the UI will still behave as though it were DC coupled, including all annunciation, warnings, status bits, and responses to SCPI queries. This is because, based on other settings, the analyzer could switch out the low noise path at any time and hence go back to being DC coupled.  Alignment switching ignores the settings in this menu, and restores them when finished.
<b>Dependencies</b>	Unavailable in BBIQ and External Mixing
<b>Preset</b>	All modes other than IQ Analyzer mode and VXA: STD IQ Analyzer, VXA and WLAN mode: MPB option present and licensed: MPB MPB option not present and licensed: STD
<b>State Saved</b>	Save in instrument state
<b>Readback</b>	Value selected in the submenu
<b>Initial S/W Revision</b>	A.04.00
<b>Modified at S/W Revision</b>	A.10.00

## Standard Path

This path gives the best remote-control throughput, minimizes acoustic noise from switching and minimizes the risk of wear in the hardware switches, particularly in remote test scenarios where both low band and high band setups will follow in rapid succession.

In this path, the bypass of the low band/high band switch and microwave preamp is never activated, which can cause some noise degradation but preserves the life of the bypass switch.

Key Path	AMPTD Y Scale, $\mu$ W Path Control
<b>Example</b>	:POW:MW:PATH STD
Readback Text	Standard Path
Initial S/W Revision	A.04.00

## Low Noise Path Enable

You may choose Low Noise Path Enable, which gives a lower noise floor under some circumstances, particularly when operating in the 21–26.5 GHz region. With the Low Noise Path enabled, the low band/high band switch and microwave preamp are bypassed whenever all of the following are true:

- The analyzer is not in the Low Band, meaning:
- the start frequency is above 3.5 GHz and
- the stop frequency is above 3.6 GHz.
- the internal preamp is not installed or (if installed) is set to Off or Low Band

Note that this means that, when any part of a sweep is done in Low Band, the Low Noise Path is not used, whether or not the Low Noise Path Enable is selected in the user interface. Also, if the preamp is turned on, the Low Noise Path is not used, whether or not the Low Noise Path Enable is selected in the user interface. The only time the Low Noise Path is used is when Low Noise Path Enable is selected, the sweep is completely in High Band (> 3.6 GHz) and no preamp is in use.

See "[More Information](#)" on page 1051

Key Path	AMPTD Y Scale, $\mu$ W Path Control
Measurement	Swept SA
<b>Example</b>	:POW:MW:PATH LNP
Notes	<p>For measurements that use IQ acquisition, the low noise path is used when the Center Frequency is in High Band (&gt; 3.6 GHz) and no preamp is in use.</p> <p>In other words, the rules above are modified to use only the center frequency to qualify which path to switch in.</p> <p>This is not the case for FFT's in the Swept SA measurement; they use the same rules as swept measurements.</p>
Dependencies	<p>Key is blanked if current mode does not support it.</p> <p>Key is grayed out if mode supports it but current measurement does not support it.</p> <p>Unless Option LNP is present and licensed, key is blank and if SCPI command sent, error -241,</p>

	"Hardware missing; Option not installed" is generated.
Readback Text	Low Noise Path Enable
Initial S/W Revision	A.04.00

### More Information

The user should understand that the Low Noise Path, while giving improved DANL, has the disadvantage of decreased TOI performance and decreased gain compression performance relative to the standard path.

The user should also understand that the bypass switch is a mechanical switch and has finite life, so if the Low Noise Path is enabled, it is possible to cause frequent cycling of this switch by frequently changing analyzer settings such that the above conditions hold true only some of the time. A user making tests of this nature should consider opting for the Standard Path, which will never throw the bypass switch, at the expense of some degraded noise performance.

The low noise path is useful for situations where the signal level is so low that the analyzer performance is dominated by noise even with 0 dB attenuation, but still high enough that the preamp option would have excessive third-order intermodulation or compression. The preamp, if purchased and used, gives better noise floor than does the "Low Noise Path." However, its compression threshold and third-order intercept are much poorer than that of the non-preamp path. There are some applications, typically for signals around -30 dBm, for which the third-order dynamic range of the standard path is good enough, but the noise floor is not low enough even with 0 dB input attenuation. When the third-order dynamic range of the preamp path is too little and the noise floor of the standard path is too high, the Low Noise Path can provide the best dynamic range

The graph below illustrates the concept. It shows, in red, the performance of an analyzer at different attenuation settings, both with the preamp on and off, in a measurement that is affected by both analyzer noise and analyzer TOI. The green shows the best available dynamic range, offset by 0.5 dB for clarity. The blue shows how the best available dynamic range improves for moderate signal levels with the low noise path switched in. In this illustration, the preamp improves the noise floor by 15 dB while degrading the third-order intercept by 30 dB, and the low noise path reduces loss by 8 dB. The attenuator step size is 2 dB.

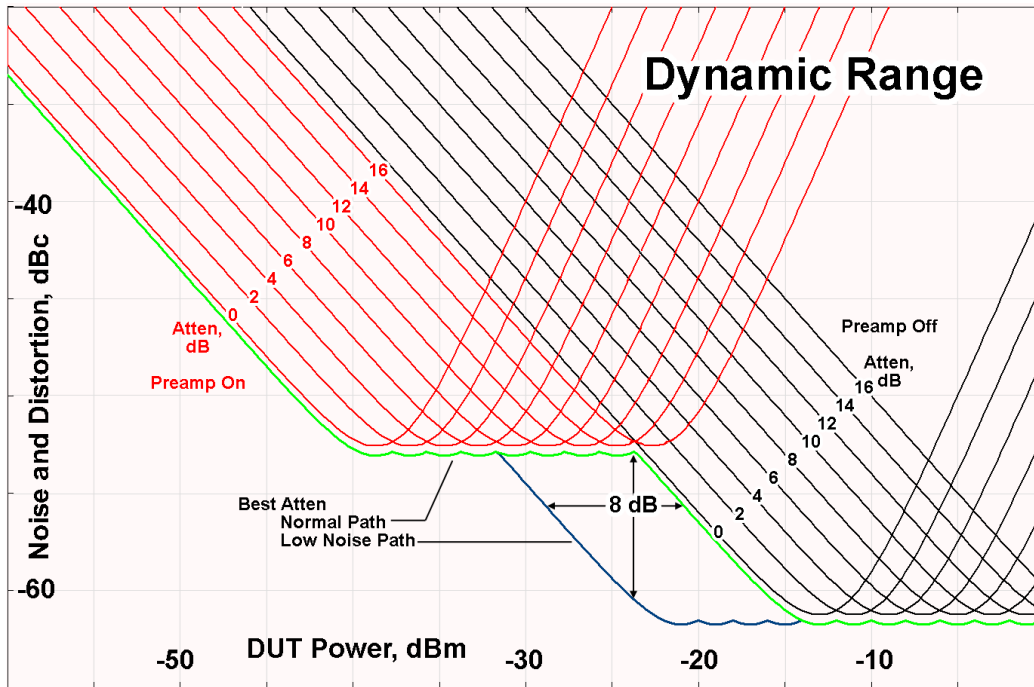

There are other times where selecting the low noise path improves performance, too. Compression-limited measurements such as finding the nulls in a pulsed-RF spectrum can profit from the low noise path in a way similar to the TOI-limited measurement illustrated. Accuracy can be improved when the low noise path allows the optimum attenuation to increase from a small amount like 0, 2 or 4 dB to a larger amount, giving better return loss at the analyzer input. Harmonic measurements, such as second and third harmonic levels, are much improved using the low noise path because of the superiority of that path for harmonic (though not intermodulation) distortion performance.

### μW Preselector Bypass

This key toggles the preselector bypass switch for band 1 and higher. When the microwave preselector is on, the signal path is preselected. When the microwave preselector is off, the signal path is not preselected. The preselected path is the normal path for the analyzer.

The preselector is a tunable bandpass filter which prevents signals away from the frequency of interest from combining in the mixer to generate in-band spurious signals (images). The consequences of using a preselector filter are its limited bandwidth, the amplitude and phase ripple in its passband, and any amplitude and phase instability due to center frequency drift.

Option MPB or pre-selector bypass provides an unpreselected input mixer path for certain X-Series signal analyzers with frequency ranges above 3.6 GHz. This signal path allows a wider bandwidth and less amplitude variability, which is an advantage when doing modulation analysis and broadband signal analysis. The disadvantage is that, without the preselector, image signals will be displayed. Another disadvantage of bypassing the preselector is increased LO emission levels at the front panel input port.

Image responses are separated from the real signal by twice the 1st IF. For IF Paths of 10 MHz and 25 MHz, the 1st IF is 322.5 MHz, so the image response and the real signal will be separated by 645 MHz. The 1st IF will be different for other IF Path settings. When viewing a real signal and its corresponding image response in internal mixing, the image response will be to the left of the real signal.



Also, the image response and the real signal typically have the same amplitude and exhibit the same shape factor.

However, if Option FS1, Fast Sweep Capability, is enabled, the image response in the Swept SA measurement will appear lower in amplitude and have a much wider shape factor compared to the real signal.

Key Path	AMPTD Y Scale, $\mu$ W Path Control
<b>Example</b>	:POW:MW:PATH MPB
Dependencies	Key is blanked if current mode does not support it. Key is grayed out if mode supports it but current measurement does not support it. Key is blank unless Option MPB is present and licensed. If SCPI command sent when MPB not present, error -241, "Hardware missing; Option not installed" is generated.
Readback Text	$\mu$ W Preselector Bypass
Initial S/W Revision	A.04.00

<b>Remote Command</b>	[ :SENSe ] :POWer [ :RF ] :MW :PRESelector [ :STATe ] ON   OFF   0   1 [ :SENSe ] :POWer [ :RF ] :MW :PRESelector [ :STATe ] ?
<b>Example</b>	:POW:MW:PRES OFF Bypasses the microwave preselector
Notes	The ON parameter sets the STD path (:POW:MW:PATH STD) The OFF parameter sets path MPB (:POW:MW:PATH MPB)
Preset	ON

## Internal Preamp

Accesses a menu of keys that control the internal preamps. Turning on the preamp gives a better noise figure, but a poorer TOI to noise floor dynamic range. You can optimize this setting for your particular measurement.

The instrument takes the preamp gain into account as it sweeps. If you sweep outside of the range of the preamp the instrument will also account for that. The displayed result will always reflect the correct gain.

For some measurements, when the preamp is on and any part of the displayed frequency range is below the lowest frequency for which the preamp has specifications, a warning condition message appears in the status line. For example ,for a preamp with a 9 kHz lowest specified frequency: "Preamp: Accy unspc'd below 9 kHz".

Key Path	AMPTD Y Scale
Scope	Meas Global
<b>Remote Command</b>	[ :SENSe ] :POWer [ :RF ] :GAIN [ :STATe ] OFF   ON   0   1 [ :SENSe ] :POWer [ :RF ] :GAIN [ :STATe ] ?
Dependencies	Preamp is not available on all hardware platforms. If the preamp is not present or is unlicensed, the

---

	key is not shown. The preamp is not available when the electronic/soft attenuator is enabled.
--	--------------------------------------------------------------------------------------------------

---

Couplings	<p>The act of connecting the U7227A USB Preamplifier to one of the analyzer's USB ports will cause the Internal Preamp to be switched on. When this happens an informational message will be generated: "Internal Preamp turned on for optimal operation with USB Preamp." Note that if the Internal Preamp was already on, there will be no change to the setting, but if it was Off it will be switched On, to Full Range.</p> <p>Note that this same action occurs when the SA mode is selected while the USB Preamp is connected to one of the analyzer's USB ports, if it is the first time that the SA mode has run since powerup, or if the last time the SA mode was running the USB Preamp was NOT connected.</p> <p>Subsequently disconnecting the USB Preamp from USB does not change the Internal Preamp setting nor restore the previous setting.</p>
Preset	OFF
State Saved	Saved in instrument state
Initial S/W Revision	Prior to A.02.00
Modified at S/W Revision	A.14.00

---

Key Path	AMPTD Y Scale, Internal Preamp
Scope	Meas Global
<b>Remote Command</b>	[:SENSe]:POWer[:RF]:GAIN:BAND LOW FULL [:SENSe]:POWer[:RF]:GAIN:BAND?
Dependencies	<p>Preamp is not available on all hardware platforms. If the preamp is not present or is unlicensed, the key is not shown.</p> <p>If a POW:GAIN:BAND FULL command is sent when a low band preamp is available, the preamp band parameter is to LOW instead of FULL, and an "Option not installed" message is generated.</p>
Preset	LOW
State Saved	Saved in instrument state
Initial S/W Revision	Prior to A.02.00

---

## Off

Turns the internal preamp off

---

Key Path	AMPTD Y Scale, Internal Preamp
<b>Example</b>	:POW:GAIN OFF
Readback	Off
Initial S/W Revision	Prior to A.02.00

---

## Low Band

Sets the internal preamp to use only the low band.

The frequency range of the installed (optional) low-band preamp is displayed in square brackets on the Low Band key label.

Key Path	AMPTD Y Scale, Internal Preamp
<b>Example</b>	:POW:GAIN ON :POW:GAIN:BAND LOW
Readback	Low Band
Initial S/W Revision	Prior to A.02.00

## Full Range

Sets the internal preamp to use its full range. The low band (0–3.6 GHz or 0–3GHz, depending on the model) is supplied by the low band preamp and the frequencies above low band are supplied by the high band preamp.

The frequency range of the installed (optional) preamp is displayed in square brackets on the Full Range key label. If the high band option is not installed the Full Range key does not appear.

Key Path	AMPTD Y Scale, Internal Preamp
<b>Example</b>	:POW:GAIN ON :POW:GAIN:BAND FULL
Readback	Full Range
Initial S/W Revision	Prior to A.02.00

## Ref Position (Burst view RF Envelope window)

Sets the display reference position in the Burst view RF Envelope window.

Key Path	AMPTD Y Scale, More
Mode	1xEVDO
<b>Remote Command</b>	:DISPlay:PVTime:VIEW[1]:WINDow[1]:TRACe:Y[:SCALe]:RPOStion TOP   CENTer   BOTTom :DISPlay:PVTime:VIEW[1]:WINDow[1]:TRACe:Y[:SCALe]:RPOStion?
<b>Example</b>	:DISPlay:PVT:VIEW:WINDow:TRACe:Y:SCALe:RPOStion CENTER
Preset	TOP
State Saved	Saved in instrument state.
Range	Top Ctr Bot
Initial S/W Revision	Prior to A.02.00

## Auto Scaling (Burst view RF Envelope window)

Sets the Y axis Auto Scaling in the Burst view RF Envelope window.

Key Path	AMPTD Y Scale, More
Mode	1xEVDO
Remote Command	:DISPlay:PVTime:VIEW[1]:WINDow[1]:TRACe:Y[:SCALe]:COUPlE 0   1   OFF   ON :DISPlay:PVTime:VIEW[1]:WINDow[1]:TRACe:Y[:SCALe]:COUPlE?
Example	:DISPlay:PVT:VIEW:WINDow:TRACe:Y:SCALe:COUPlE?
Couplings	When Auto Scaling is On, and you press the Restart front-panel key, this function automatically determines the scale per division and reference values based on the measurement results. When you manually set a value for the Y Rel Value or Y Scale/Div, this parameter is automatically set to Off.
Preset	ON
State Saved	Saved in instrument state.
Range	On Off
Initial S/W Revision	Prior to A.02.00

## Auto Couple

The Auto Couple feature provides a quick and convenient way to automatically couple multiple instrument settings. This helps ensure accurate measurements and optimum dynamic range. When the Auto Couple feature is activated, either from the front panel or remotely, all parameters of the current measurement that have an Auto/Manual mode are set to Auto mode and all measurement settings dependent on (or coupled to) the Auto/Man parameters are automatically adjusted for optimal performance.

However, the Auto Couple key actions are confined to the current measurement only. It does not affect other measurements in the mode, and it does not affect markers, marker functions, or trace or display attributes.

See "[More Information](#)" on page 1057

Key Path	Front-panel key
Remote Command	:COUPle ALL NONE
Example	:COUP ALL
Notes	:COUPle ALL puts all Auto/Man parameters in Auto mode (equivalent to pressing the Auto Couple key). :COUPLE NONE puts all Auto/Man parameters in manual mode. It decouples all the coupled instrument parameters and is not recommended for making measurements.
Initial S/W Revision	Prior to A.02.00

### More Information

There are two types of functions that have Auto/Manual modes.

#### Auto/Man Active Function keys

An Auto/Man toggle key controls the binary state associated with an instrument parameter by toggling between Auto (where the parameter is automatically coupled to the other parameters it is dependent upon) and Man (where the parameter is controlled independent of the other parameters), as well as making the parameter the active function. The current mode is indicated on the softkey with either Auto or Man underlined as illustrated below.



#### Auto/Man 1-of-N keys

An Auto/Man 1-of-N key allows you to manually pick from a list of parameter values, or place the function in Auto, in which case the value is automatically selected (and indicated) as shown below. If in Auto, Auto is underlined on the calling key. If in manual operation, manual is indicated on the calling key. But the calling key does not actually toggle the function, it simply opens the menu.

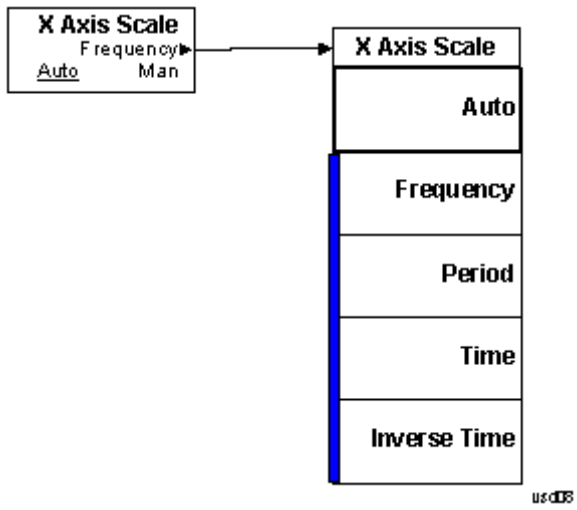

## BW

Accesses a menu that allows you to control bandwidth settings.

Key Path	Front Panel key
Initial S/W Revision	Prior to A.02.00

### Info BW

Sets to the information bandwidth. This is the bandwidth used for the power measurement. The optimal setting occurs when the bandwidth is wide enough to pass all the power of the burst signal, while not being so wide that it passes noise, which reduces dynamic range and diminishes the accuracy of low level measurements.

Key Path	BW
Mode	1xEVDO
<b>Remote Command</b>	<code>[ :SENSe ] :PVTime:BAWdwidth[ :RESolution ] &lt;freq&gt;</code> <code>[ :SENSe ] :PVTime:BAWdwidth[ :RESolution ] ?</code>
<b>Example</b>	<code>:PVT:BAW 1 KHZ</code>
Preset	1.5 MHz
State Saved	Saved in instrument state.
Min	1 kHz
Max	Hardware Dependent: No Option = 10 MHz Option B25 = 25 MHz
<b>Backwards Compatibility SCPI</b>	<code>[ :SENSe ] :PVTime:BWIDth[ :RESolution ]</code>
Initial S/W Revision	Prior to A.02.00

### Filter Type

Allows you to select a Gaussian or a Flattop filter. A Gaussian is typically preferred but a Flattop is desirable under certain conditions.

Key Path	BW
Mode	1xEVDO
<b>Remote Command</b>	<code>[ :SENSe ] :PVTime:BAWdwidth:TYPE GAUSSian FLATtop</code> <code>[ :SENSe ] :PVTime:BAWdwidth:TYPE ?</code>
<b>Example</b>	<code>:SENS:PVT:BAW:TYPE GAUS</code>
Notes	This selects either a Gaussian or Flat (Flattop) filter. Gaussian is the better choice when looking at the overall burst, or rising and falling edges, because it has excellent pulse response. For most Time

---

vs. Power measurements, the user is not mainly interested in trading off time domain accuracy vs. noise, but is more interested in total power accuracy vs. noise.

If you want to examine just the useful part of the burst, choose Flat. This is an advanced control that normally does not need to be changed. Setting this to a value other than the factory default, may cause invalid measurement results.

FLATtop – a filter with a flat amplitude response, that provides the best amplitude accuracy.

GAUSSian – a filter with Gaussian characteristics, that provides the best pulse response.

---

Preset	FLATtop
State Saved	Saved in instrument state.
Range	Gaussian Flattop
<b>Backwards Compatibility SCPI</b>	<code>[ :SENSe ] :PVTime :BANDwidth   BWIDth [ :RESolution ] :TYPE</code>
Initial S/W Revision	Prior to A.02.00

---



## Cont (Continuous Measurement/Sweep)

Sets the analyzer for Continuous measurement operation. The single/continuous state is Meas Global so the setting will affect all measurements. If you are Paused, pressing Cont does a Resume.

Key Path	Front-panel key
Remote Command	:INITiate:CONTinuous OFF ON 0 1 :INITiate:CONTinuous?
Example	:INIT:CONT 0 puts analyzer in Single measurement operation. :INIT:CONT 1 puts analyzer in Continuous measurement operation
Preset	ON (Note that SYST:PRESet sets INIT:CONT to ON but *RST sets INIT:CONT to OFF)
State Saved	Saved in instrument state
Backwards Compatibility Notes	For Spectrum Analysis mode in ESA and PSA, there is no Cont hardkey, instead there is a Sweep Single/Cont key. In these analyzers, switching the Sweep Single/Cont key from Single to Cont restarts averages (displayed average count reset to 1), but does not restart Max Hold and Min Hold. The X-Series has Single and Cont keys in place of the SweepSingleCont key. In the X-Series, if in single measurement, the Cont key (and INIT:CONT ON ) switches to continuous measurement, but never restarts a measurement and never resets a sweep.
Initial S/W Revision	Prior to A.02.00

In Swept SA Measurement (Spectrum Analysis Mode):

The analyzer takes repetitive sweeps, averages, measurements, etc., when in Continuous mode. When the average count reaches the Average/Hold Number the count stops incrementing, but the analyzer keeps sweeping. See the Trace/Detector section for the averaging formula used both before and after the Average/Hold Number is reached. The trigger condition must be met prior to each sweep. The type of trace processing for multiple sweeps, is set under the Trace/Detector key, with choices of Trace Average, Max Hold, or Min Hold.

In Other Measurements/Modes:

With Avg/Hold Num (in the Meas Setup menu) set to Off or set to On with a value of 1, a sweep is taken after the trigger condition is met; and the analyzer continues to take new sweeps after the current sweep has completed and the trigger condition is again met. However, with Avg/Hold Num set to On with a value >1, multiple sweeps (data acquisitions) are taken for the measurement. The trigger condition must be met prior to each sweep. The sweep is not stopped when the average count k equals the number N set for Avg/Hold Num is reached, but the number k stops incrementing. A measurement average usually applies to all traces, marker results, and numeric results. But sometimes it only applies to the numeric results.

If the analyzer is in Single measurement, pressing the Cont key does not change k and does not cause the sweep to be reset; the only action is to put the analyzer into Continuous measurement operation.

If it is already in continuous sweep:

the INIT:CONT 1 command has no effect

11 Power vs Time  
Cont (Continuous Measurement/Sweep)

the INIT:CONT 0 command will place the analyzer in Single Sweep but will have no effect on the current sequence until  $k = N$ , at which point the current sequence will stop and the instrument will go to the idle state.

File

See "File" on page 354

## FREQ Channel

Accesses a menu of keys that allow you to control the Frequency and Channel parameters of the instrument.

Some features in the Frequency menu are the same for all measurements – they do not change as you change measurements. Settings like these are called “Meas Global” and are unaffected by Meas Preset. For example, the Center Freq setting is the same for all measurements - it does not change as you change measurements.

<b>Key Path</b>	<b>Front-panel key</b>
<b>Initial S/W Revision</b>	<b>Prior to A.02.00</b>

### Center Freq

Sets the frequency that corresponds to the horizontal center of the graticule (when frequency Scale Type is set to linear). While adjusting the Center Frequency the Span is held constant, which means that both Start Frequency and Stop Frequency will change.

Pressing Center Freq also sets the frequency entry mode to Center/Span. In Center/Span mode, the center frequency and span values are displayed below the graticule, and the default active function in the Frequency menu is Center Freq.

The center frequency setting is the same for all measurements within a mode, that is, it is Meas Global. Some modes are also able to share a Mode Global center frequency value. If this is the case, the Mode will have a Global Settings key in its Mode Setup menu.

The Center Freq function sets (and queries) the Center Frequency for the currently selected input. If your analyzer has multiple inputs, and you select another input, the Center Freq changes to the value for that input. SCPI commands are available to directly set the Center Freq for a specific input.

Center Freq is remembered as you go from input to input. Thus you can set a Center Freq of 10 GHz with the RF Input selected, change to BBIQ and set a Center Freq of 20 MHz, then switch to External Mixing and set a Center Freq of 60 GHz, and when you go back to the RF Input the Center Freq will go back to 10 GHz; back to BBIQ and it is 20 MHz; back to External Mixing and it is 60 GHz.

See ["RF Center Freq" on page 1067](#)

See [Ext Mix Center Freq](#)

See ["I/Q Center Freq" on page 1069](#)

See ["Center Frequency Presets" on page 1065](#)

<b>Key Path</b>	<b>FREQ Channel</b>
<b>Scope</b>	<b>Meas Global</b>
<b>Remote Command</b>	<code>[ :SENSe ] :FREQuency:CENTer &lt;freq&gt;</code> <code>[ :SENSe ] :FREQuency:CENTer?</code>

<b>Example</b>	FREQ:CENT 50 MHz FREQ:CENT UP changes the center frequency to 150 MHz if you use FREQ:CENT:STEP 100 MHz to set the center frequency step size to 100 MHz FREQ:CENT?
<b>Notes</b>	This command sets either the RF or I/Q Center Frequency depending on the selected input. For RF input it is equivalent to FREQ:RF:CENT For I/Q input it is equivalent to FREQ:IQ:CENT Preset and Max values are dependent on Hardware Options (5xx) If no terminator (e.g. MHz) is sent the terminator Hz is used. If a terminator with unit other than Frequency is used, an invalid suffix error message is generated.
<b>Dependencies</b>	The Center Frequency can be limited by Start or Stop Freq limits, if the Span is so large that Start or Stop reach their limit.
<b>Couplings</b>	When operating in "swept span", any value of the Center Frequency or Span that is within the frequency range of the analyzer is allowed when the value is being set through the front panel numeric key pad or the SCPI command. The other parameter is forced to a different value if needed, to keep the Start and the Stop Frequencies within the analyzer's frequency range
<b>Preset</b>	Depends on instrument maximum frequency, mode, measurement, and selected input. See <a href="#">"Center Frequency Presets" on page 1065</a> and <a href="#">"RF Center Freq" on page 1067</a> and <a href="#">Ext Mix Center Freq</a> and <a href="#">"I/Q Center Freq" on page 1069</a> .
<b>State Saved</b>	Saved in instrument state
<b>Min</b>	Depends on instrument maximum frequency, mode, measurement, and selected input.. See <a href="#">"Center Frequency Presets" on page 1065</a> and <a href="#">"RF Center Freq" on page 1067</a> and <a href="#">"I/Q Center Freq" on page 1069</a> .
<b>Max</b>	Depends on instrument maximum frequency, mode, measurement, and selected input.. See <a href="#">"Center Frequency Presets" on page 1065</a> and <a href="#">"RF Center Freq" on page 1067</a> and <a href="#">"I/Q Center Freq" on page 1069</a> .
<b>Default Unit</b>	Hz
<b>Status Bits/OPC</b>	Non-overlapped
<b>Dependencies</b>	
<b>Initial S/W Revision</b>	Prior to A.02.00

## Center Frequency Presets

The following table provides the Center Frequency Presets for the Spectrum Analyzer mode, and the Max Freq, for the various frequency options:

Freq Option	CF after Mode Preset	Stop Freq after Mode Preset	Max Freq (can't tune)

11 Power vs Time  
FREQ Channel

			above)
503 (all but N9000A)	1.805 GHz	3.6 GHz	3.7 GHz
503 (N9000A)	1.505 GHz	3.0 GHz	3.08 GHz
507 (all but N9000A)	3.505 GHz	7.0 GHz	7.1 GHz
507 (N9000A)	3.755 GHz	7.5 GHz	7.58 GHz
508 (all but N9038A)	1.805 GHz	3.6 GHz	8.5 GHz
508 (N9038A)	4.205 GHz	8.4 GHz	8.5 GHz
513	6.805 GHz	13.6 GHz	13.8 GHz
526 (all but N9000A and N9038A)	13.255 GHz	26.5 GHz	27.0 GHz
526 (N9000A)	13.255 GHz	26.5 GHz	26.55 GHz
526 (N9038A)	1.805 GHz	3.6 GHz	27.0 GHz
532	16.005 GHz	32.0 GHz	32.5 GHz
543	21.505 GHz	43.0 GHz	TBD
544	22.005 GHz	44.0 GHz	44.5 GHz
550	25.005 GHz	50.0 GHz	51 GHz

Input 2:

Model	CF after Mode Preset	Stop Freq after Mode Preset	Max Freq (can't tune above)
N9000A opt C75	0.7505GHz	1.5 GHz	1.58 GHz
N9038A	505 MHz	1 GHz	1.000025 GHz

Tracking Generator Frequency Limits (N9000A only):

Tracking Generator Option	Min Freq (clips to this freq when turn TG on and	If above this Freq, Stop Freq clipped to this Freq when	Max Freq (can't tune above) while TG

	can't tune below while TG on)	TG turned on	on
T03	9 kHz	3.0 GHz	3.08 GHz
T06	9 kHz	6.0 GHz	6.05 GHz

The following table shows the Center Frequency Presets for modes other than Spectrum Analyzer:

Mode	CF Preset for RF
WCDMA	1 GHz
WIMAXOFDMA,	1 GHz
BASIC	1 GHz
ADEMOD	1 GHz
VSA	1 GHz
TDSCDMA	1 GHz
PNOISE	1 GHz
LTE	1 GHz
LTETDD	1 GHz
MSR	1 GHz
GSM	935.2 MHz
NFIGURE	1.505 GHz

## RF Center Freq

SCPI command for specifying the RF Center Frequency. This command will set the Center Frequency to be used when the RF input is selected, even if the RF input is not the input that is selected at the time the command is sent. Note that the Center Freq function in the Frequency menu on the front panel always applies to the currently selected input.

Scope	Meas Global
<b>Remote Command</b>	<code>[ :SENSe ] :FREQuency:RF:CENTer &lt;freq&gt;</code> <code>[ :SENSe ] :FREQuency:RF:CENTer?</code>
<b>Example</b>	FREQ:RF:CENT 30 MHz
Notes	This command is the same in all modes, but the parameter is Measurement Global. So the value is independent in each mode and common across all the measurements in the mode.
Dependencies	If the electronic/soft attenuator is enabled, any attempt to set Center Frequency such that the Stop Frequency would be >3.6 GHz fails and results in an advisory message. If the equivalent SCPI command is sent, this same message is generated as part of a “-221, Settings conflict” warning. If Source Mode is set to Tracking, and the Max or Min Center Freq is therefore limited by the limits of the source, a warning message is generated, “Data out of range;clipped to source max/min” if these limits are exceeded. Note that for an external source, these limits can be affected by the settings of

	Source Numerator, Source Denominator and Power Sweep.
Preset	See table above
State Saved	Saved in instrument state.
Min	-79.999995 MHz, unless Source Mode is set to Tracking, in which case it is limited by the minimum frequency of the Source
Max	See table above. Basically instrument maximum frequency - 5 Hz. Note that, if the Source Mode is set to Tracking, the effective instrument maximum frequency may be limited by the source maximum frequency.  If the knob or step keys are being used, also depends on the value of the other three interdependent parameters Span, Start Frequency and Stop Frequency
Initial S/W Revision	Prior to A.02.00
Modified at S/W Revision	A.03.00

### Ext Mix Center Freq

SCPI command for specifying the External Mixer Center Frequency. This command will set the Center Frequency to be used when the External Mixer is selected, even if the External Mixer input is not the input which is selected at the time the command is sent. Note that the Center Freq function in the Frequency menu on the front panel always applies to the currently selected input.

Scope	Meas Global
Remote Command	<code>[ :SENSe ] :FREQuency:EMIXer:CENTer &lt;freq&gt;</code> <code>[ :SENSe ] :FREQuency:EMIXer:CENTer?</code>
Example	<code>:FREQ:EMIX:CENT 60 GHz</code> <code>:FREQ:EMIX:CENT?</code>
Notes	This command is the same in all modes, but the parameter is Measurement Global. So the value is independent in each mode and common across all the measurements in the mode.
Couplings	When returning to External Mixing after having been switched to one of the other inputs (e.g., RF), you will come back into the settings that you had when you left External Mixing. So you will come back to the band you were in with the Center Frequency that you had. However, Span is not an input-dependent parameter, therefore you will bring the span over from the other input. Therefore, the analyzer comes back with the span from the previous input, limited as necessary by the current mixer setup.
Preset	When a Mode Preset is performed while in External Mixing, the Start frequency of the current Mode is set to the nominal Min Freq of the lowest harmonic range in the Harmonic Table for the current mixer setup. Similarly, the Stop frequency of the current Mode is set to the nominal Max Freq of the highest harmonic range in the Harmonic Table. The Center Freq thus presets to the point arithmetically equidistant from these two frequencies.  If the current measurement has a limited Span available to it, and cannot achieve the Span shown in the table (Span=Stop Freq - Start Freq), the analyzer uses the maximum Span the measurement allows, and still sets the Center Freq to the midpoint of the Start and Stop Freq values in the Harmonic Table.



	When Restore Input/Output Defaults is performed, the mixer presets to the 11970A, whose Start and Stop frequencies are 26.5 and 40 GHz respectively. The center of these two frequencies is 33.25 GHz. Therefore, after a Restore Input/Output Defaults, if you go into External Mixing and do a Mode Preset while in the Spectrum Analyzer Mode, the resulting Center Freq is 33.25 GHz.
State Saved	Saved in instrument state.
Min	The minimum frequency in the currently selected mixer band + 5 Hz
Max	The maximum frequency in the currently selected mixer band – 5 Hz If the knob or step keys are being used, also depends on the value of the other three interdependent parameters Span, Start Frequency and Stop Frequency
Initial S/W Revision	A.08.01

## I/Q Center Freq

SCPI command for specifying the I/Q Center Frequency. This command will set the Center Frequency to be used when the I/Q input is selected, even if the I/Q input is not the input which is selected at the time the command is sent. Note that the Center Freq function in the Frequency menu on the front panel always applies to the currently selected input.

Scope	Meas Global
<b>Remote Command</b>	<code>[ :SENSe ] :FREQuency:IQ:CENTer &lt;freq&gt;</code> <code>[ :SENSe ] :FREQuency:IQ:CENTer?</code>
<b>Example</b>	FREQ:IQ:CENT: 30 MHz
Notes	This command is the same in all modes, but the parameter is Measurement Global. So the value is independent in each mode and common across all the measurements in the mode.
Preset	0 Hz
State Saved	Saved in instrument state.
Min	-40.049995 MHz
Max	40.049995 MHz
Initial S/W Revision	Prior to A.02.00

## CF Step

Changes the step size for the center frequency and start and stop frequency functions. Once a step size has been selected and the center frequency function is active, the step keys (and the UP|DOWN parameters for Center Frequency from remote commands) change the center frequency by the step-size value. The step size function is useful for finding harmonics and sidebands beyond the current frequency span of the analyzer.

Note that the start and stop frequencies also step by the CF Step value.

Key Path	FREQ Channel
Remote Command	<pre>[ :SENSe] :FREQuency:CENTer:STEP[:INCRement] &lt;freq&gt; [ :SENSe] :FREQuency:CENTer:STEP[:INCRement] ? [ :SENSe] :FREQuency:CENTer:STEP:AUTO OFF ON 0 1 [ :SENSe] :FREQuency:CENTer:STEP:AUTO?</pre>
Example	<pre>FREQ:CENT:STEP:AUTO ON FREQ:CENT:STEP 500 MHz FREQ:CENT UP increases the current center frequency value by 500 MHz FREQ:CENT:STEP? FREQ:CENT:STEP:AUTO?</pre>
Notes	Preset and Max values are depending on Hardware Options (503, 507, 508, 513, 526)
Notes	Preset and Max values are dependent on Hardware Options (5xx)
Dependencies	Freq Offset is not available in External Mixing. In this case the Freq Offset key is grayed out and shows a value of zero. It will once again be available, and show the previously set value, when you return to the RF Input.
Dependencies	Span, RBW, Center frequency If the electronic/soft attenuator is enabled, any attempt to change the value of the center frequency >3.6 GHz by pressing the Up-arrow key, fails and results in an advisory message. If the equivalent SCPI command is sent, this same message is generated as part of a “-221, Settings conflict” warning.
Couplings	When auto-coupled in a non-zero span, the center frequency step size is set to 10% of the span. When auto-coupled in zero span, the center frequency step size is set to the equivalent -3 dB RBW value.
Preset	Auto ADEM0D: 1 MHz ON
State Saved	Saved in instrument state
Min	– (the maximum frequency of the instrument). That is, 27 GHz max freq instrument has a CF step range of +/- 27 GHz. Note that this is the maximum frequency given the current settings of the instrument, so in External Mixing, for example, it is the maximum frequency of the current mixer band.
Max	The maximum frequency of the instrument. That is, 27 GHz max freq instrument has a CF step range of +/- 27 GHz. Note that this is the maximum frequency given the current settings of the instrument, so in External Mixing, for example, it is the maximum frequency of the current mixer band.
Default Unit	Hz
Status Bits/OPC dependencies	non-overlapped
Initial S/W Revision	Prior to A.02.00
Modified at S/W Revision	A.03.00

## Input/Output

See "Input/Output" on page 226

## Marker

Allows you to select, set up, and control the markers for the current measurement. Sets the marker control mode as described under Normal, Delta, and Off, below. All interactions and dependencies detailed under the soft key description are enforced when the remote command is sent.

Key Path	Front Panel key
Initial S/W Revision	Prior to A.02.00

### Select Marker

Accesses menus that allow you to select one or more markers

Key Path	Marker, Properties
Initial S/W Revision	Prior to A.02.00

### Marker Type

Sets the marker control mode Normal, Delta and Off. All interactions and dependencies detailed under the key description are enforced when the remote command is sent.

Key Path	Marker
Mode	1xEVD0
<b>Remote Command</b>	:CALCulate:PVTime:MARKer[1] 2 ...12:MODE POSition DELTA OFF :CALCulate:PVTime:MARKer[1] 2 ...12:MODE?
<b>Example</b>	:CALC:PVT:MARK:MODE OFF
<b>Notes</b>	If the selected marker is Off, pressing Marker sets it to Normal and places it at the center of the screen on the trace determined by the Marker Trace rules. At the same time, Marker X Axis Value appears in the Active Function area.  Default Active Function: the active function for the selected marker's current control mode. Note that if the current control mode is Off, there is no active function and the active function is turned off.  Active Function Display: the marker X axis value entered in the active function area will display the marker value to its fully entered precision.
Preset	OFF
State Saved	Saved in instrument state.
Range	Normal Delta Off
Initial S/W Revision	Prior to A.02.00

### Properties

Accesses a menu that allow you to set marker properties and to access the marker trace menu.

Key Path	Marker
Initial S/W Revision	Prior to A.02.00

## Select Marker

Accesses menus that allow you to select one or more markers

Key Path	Marker, Properties
Initial S/W Revision	Prior to A.02.00

## Relative To

Selects the marker that the selected marker will be relative to, which is referred to as its “reference marker”.

Key Path	Marker, Properties
Mode	1xEVDO
<b>Remote Command</b>	:CALCulate:PVTime:MARKer[1] 2 ...12:REFerence <integer> :CALCulate:PVTime:MARKer[1] 2 ...12:REFerence?
<b>Example</b>	:CALC:PVT:MARK:REF?
Notes	When queried, a single value will be returned - the specified marker number's relative marker. A marker cannot be relative to itself so that choice is grayed out, and if sent from SCPI, generates error -221: “Settings conflict; marker cannot be relative to itself.”
Preset	2 3 4 5 6 7 8 9 10 11 12 1
State Saved	Saved in instrument state.
Min	1
Max	12
Initial S/W Revision	Prior to A.02.00

## Marker Trace

Assigns the specified marker to the designated trace.

Key Path	Marker
Mode	WIMAXOFDMA
<b>Remote Command</b>	:CALCulate:PVTime:MARKer[1] 2 ...12:TRACe RFENvelope   UMASk   LMASk   MAXHold   MINHold :CALCulate:PVTime:MARKer[1] 2 ...12:TRACe?
<b>Example</b>	CALC:PVT:MARK:TRAC MINH

	CALC:PVT:MARK:TRAC?
Dependencies	Max Hold RF Envelop is only available when Max Trace is set to On. Min Hold RF Envelop is only available when Min Hold Trace is set to On. Otherwise, the menu keys are grayed out and the commands are unavailable.
Preset	RFENvelope
State Saved	Saved in instrument state.
Range	RF Envelope Upper Mask Lower Mask Max Hold RF Envelope  Min Hold RF Envelope
Initial S/W Revision	Prior to A.02.00

### Couple Marker

When this function is invoked, moving any marker causes an “equal X Axis movement” of every other marker which is active. By “equal X Axis movement” we mean that the difference between each marker’s X Axis value (in the fundamental x-axis units of the trace that marker is on) is preserved, as is the X Axis value of the marker being moved (in the same fundamental X-axis units).

**NOTE** This may result in markers going off screen.

Key Path	Marker, More
Mode	1xEVDO
Remote Command	:CALCulate:PVTime:MARKer:COUPle[:STATe] ON OFF 1 0 :CALCulate:PVTime:MARKer:COUPle[:STATe]?
Example	CALC:PVT:MARK:COUP ON
Preset	OFF
State Saved	Saved in instrument state.
Range	On Off
Initial S/W Revision	Prior to A.02.00

### All Markers Off

Turns all markers Off.

Key Path	Marker, More
Mode	1xEVDO
Remote Command	:CALCulate:PVTime:MARKer:AOFF
Example	:CALC:PVT:MARK:AOFF
Initial S/W Revision	Prior to A.02.00

## Marker Fctn

There are no Marker Functions.

---

Key Path	Front Panel key
Initial S/W Revision	Prior to A.02.00

---

## Marker To

There is no Marker To functionality.

---

Key Path	Front Panel key
Initial S/W Revision	Prior to A.02.00

---



## Meas

The information in this section is common to all measurements. For key and remote command information for a specific measurement, refer to the section that describes the measurement of interest.

Measurements available under the Meas key are specific to the current Mode.

When viewing Help for measurements, note the following:

**NOTE**

Operation for some keys differs between measurements. The information displayed in Help pertains to the current measurement. To see how a key operates in a different measurement, exit Help (press the Cancel Esc key), select the measurement, then reenter Help (press the Help key) and press that key.

---

Key Path	Front-panel key
Initial S/W Revision	Prior to A.02.00

---

### Remote Measurement Functions

This section contains the following topics:

"Measurement Group of Commands" on page 2849

"Current Measurement Query (Remote Command Only)" on page 2851

"Limit Test Current Results (Remote Command Only)" on page 2851

"Data Query (Remote Command Only)" on page 2851

"Calculate/Compress Trace Data Query (Remote Command Only)" on page 2852

"Calculate Peaks of Trace Data (Remote Command Only)" on page 2857

Hardware-Accelerated Fast Power Measurement (Remote Command Only)

"Format Data: Numeric Data (Remote Command Only)" on page 2858

"Format Data: Byte Order (Remote Command Only)" on page 2859

---

Initial S/W Revision	Prior to A.02.00
----------------------	------------------

---

## Measurement Group of Commands

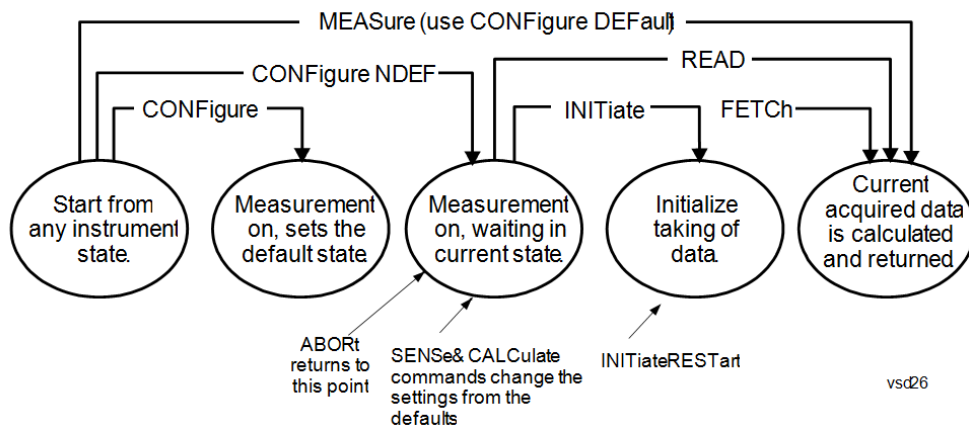

---

### Measure Commands:

:MEASure:<measurement>[n]?

This is a fast single-command way to make a measurement using the factory default instrument settings. These are the settings and units that conform to the Mode Setup settings (e.g. radio standard) that you have currently selected.

- Stops the current measurement (if any) and sets up the instrument for the specified measurement using the factory defaults
- Initiates the data acquisition for the measurement
- Blocks other SCPI communication, waiting until the measurement is complete before returning results.
- If the function does averaging, it is turned on and the number of averages is set to 10.
- After the data is valid it returns the scalar results, or the trace data, for the specified measurement. The type of data returned may be defined by an [n] value that is sent with the command.
- The scalar measurement results will be returned if the optional [n] value is not included, or is set to 1. If the [n] value is set to a value other than 1, the selected trace data results will be returned. See each command for details of what types of scalar results or trace data results are available.
- ASCII is the default format for the data output. (Older versions of Spectrum Analysis and Phase Noise mode measurements only use ASCII.) The binary data formats should be used for handling large blocks of data since they are smaller and faster than the ASCII format. Refer to the FORMat:DATA command for more information.

If you need to change some of the measurement parameters from the factory default settings you can set up the measurement with the CONFigure command. Use the commands in the SENSE:<measurement> and CALCulate:<measurement> subsystems to change the settings. Then you can use the READ? command to initiate the measurement and query the results.

If you need to repeatedly make a given measurement with settings other than the factory defaults, you can use the commands in the SENSE:<measurement> and CALCulate:<measurement> subsystems to set up the measurement. Then use the READ? command to initiate the measurement and query results.

Measurement settings persist if you initiate a different measurement and then return to a previous one. Use READ:<measurement>? if you want to use those persistent settings. If you want to go back to the default settings, use MEASure:<measurement>?.

---

### Configure Commands:

:CONFigure:<measurement>

This command stops the current measurement (if any) and sets up the instrument for the specified measurement using

---

---

the factory default instrument settings. It does not initiate the taking of measurement data unless INIT:CONTInuous is ON. If you change any measurement settings after using the CONFigure command, the READ command can be used to initiate a measurement without changing the settings back to their defaults.

In the Swept SA measurement in Spectrum Analyzer mode the CONFigure command also turns the averaging function on and sets the number of averages to 10 for all measurements.

:CONFigure: <measurement>: NDEFault stops the current measurement and changes to the specified measurement. It does not change the settings to the defaults. It does not initiate the taking of measurement data unless INIT:CONTInuous is ON.

The CONFigure? query returns the current measurement name.

The CONFigure:CATalog? query returns a quoted string of all licensed measurement names in the current mode. For example, "SAN, CHP, OBW, ACP, PST, TXP, SPUR, SEM, LIST".

---

#### Fetch Commands:

:FETCh:<measurement>[n]?

This command puts selected data from the most recent measurement into the output buffer. Use FETCh if you have already made a good measurement and you want to return several types of data (different [n] values, for example, both scalars and trace data) from a single measurement. FETCh saves you the time of re-making the measurement. You can only FETCh results from the measurement that is currently active, it will not change to a different measurement. An error message is reported if a measurement other than the current one is specified.

If you need to get new measurement data, use the READ command, which is equivalent to an INITiate followed by a FETCh.

The scalar measurement results will be returned if the optional [n] value is not included, or is set to 1. If the [n] value is set to a value other than 1, the selected trace data results will be returned. See each command for details of what types of scalar results or trace data results are available. The binary data formats should be used for handling large blocks of data since they are smaller and transfer faster than the ASCII format. (FORMat:DATA)

FETCh may be used to return results other than those specified with the original READ or MEASure command that you sent.

---

#### INITiate Commands:

:INITiate:<measurement>

This command is not available for measurements in all the instrument modes:

- Initiates a trigger cycle for the specified measurement, but does not output any data. You must then use the FETCh<meas> command to return data. If a measurement other than the current one is specified, the instrument will switch to that measurement and then initiate it.
- For example, suppose you have previously initiated the ACP measurement, but now you are running the channel power measurement. If you send INIT:ACP? it will change from channel power to ACP and will initiate an ACP measurement.
- Does not change any of the measurement settings. For example, if you have previously started the ACP measurement and you send INIT:ACP? it will initiate a new ACP measurement using the same instrument settings as the last time ACP was run.
- If your selected measurement is currently active (in the idle state) it triggers the measurement, assuming the trigger conditions are met. Then it completes one trigger cycle. Depending upon the measurement and the number of averages, there may be multiple data acquisitions, with multiple trigger events, for one full trigger cycle. It also holds off additional commands on GPIB until the acquisition is complete.

---

#### READ Commands:

:READ:<measurement>[n]?

- Does not preset the measurement to the factory default settings. For example, if you have previously initiated the ACP
-

---

measurement and you send READ:ACP? it will initiate a new measurement using the same instrument settings.

- Initiates the measurement and puts valid data into the output buffer. If a measurement other than the current one is specified, the instrument will switch to that measurement before it initiates the measurement and returns results.
  - For example, suppose you have previously initiated the ACP measurement, but now you are running the channel power measurement. Then you send READ:ACP? It will change from channel power back to ACP and, using the previous ACP settings, will initiate the measurement and return results.
  - Blocks other SCPI communication, waiting until the measurement is complete before returning the results
  - If the optional [n] value is not included, or is set to 1, the scalar measurement results will be returned. If the [n] value is set to a value other than 1, the selected trace data results will be returned. See each command for details of what types of scalar results or trace data results are available. The binary data formats should be used when handling large blocks of data since they are smaller and faster than the ASCII format. (FORMat:DATA)
- 

---

Initial S/W Revision	Prior to A.02.00
----------------------	------------------

---

### Current Measurement Query (Remote Command Only)

This command returns the name of the measurement that is currently running.

---

<b>Remote Command</b>	:CONFigure?
-----------------------	-------------

<b>Example</b>	CONF?
----------------	-------

Initial S/W Revision	Prior to A.02.00
----------------------	------------------

---

### Limit Test Current Results (Remote Command Only)

Queries the status of the current measurement limit testing. It returns a 0 if the measured results pass when compared with the current limits. It returns a 1 if the measured results fail any limit tests.

---

<b>Remote Command</b>	:CALCulate:CLIMits:FAIL?
-----------------------	--------------------------

<b>Example</b>	CALC:CLIM:FAIL? queries the current measurement to see if it fails the defined limits. Returns a 0 or 1: 0 it passes, 1 it fails.
----------------	--------------------------------------------------------------------------------------------------------------------------------------

Initial S/W Revision	Prior to A.02.00
----------------------	------------------

---

### Data Query (Remote Command Only)

Returns the designated measurement data for the currently selected measurement and subopcode.

n = any valid subopcode for the current measurement. See the measurement command results table for your current measurement, for information about what data is returned for the subopcodes.

This command uses the data setting specified by the FORMat:BORDER and FORMat:DATA commands and can return real or ASCII data. (See the format command descriptions under Input/Output in the Analyzer Setup section.)

<b>Remote Command</b>	:CALCulate:DATA[n]?
<b>Notes</b>	The return trace depends on the measurement. In CALCulate:<meas>:DATA[n], n is any valid subopcode for the current measurement. It returns the same data as the FETCH:<measurement>? query where <measurement> is the current measurement.
<b>Initial S/W Revision</b>	Prior to A.02.00

## Calculate/Compress Trace Data Query (Remote Command Only)

Returns compressed data for the currently selected measurement and sub-opcode [n].

n = any valid sub-opcode for that measurement. See the MEASure:<measurement>? command description of your specific measurement for information on the data that can be returned.

The data is returned in the current Y Axis Unit of the analyzer. The command is used with a sub-opcode <n> (default=1) to specify the trace. With trace queries, it is best if the analyzer is not sweeping during the query. Therefore, it is generally advisable to be in Single Sweep, or Update=Off.

This command is used to compress or decimate a long trace to extract and return only the desired data. A typical example would be to acquire N frames of GSM data and return the mean power of the first burst in each frame. The command can also be used to identify the best curve fit for the data.

<b>Remote Command</b>	:CALCulate:DATA<n>:COMPRESS? BLOCK   CFIT   MAXimum   MINimum   MEAN   DMEan   RMS   RMSCubed   SAMPLE   SDEVIation   PPHase [,<soffset> [,<length>[,<roffset>[,<rlimit>]]]]
<b>Example</b>	To query the mean power of a set of GSM bursts: Supply a signal that is a set of GSM bursts. Select the IQ Waveform measurement (in IQ Analyzer Mode). Set the sweep time to acquire at least one burst. Set the triggers such that acquisition happens at a known position relative to a burst. Then query the mean burst levels using, CALC:DATA2:COMP? MEAN, 24e-6, 526e-6 (These parameter values correspond to GSM signals, where 526e-6 is the length of the burst in the slot and you just want 1 burst.)
<b>Notes</b>	The command supports 5 parameters. Note that the last 4 (<soffset>, <length>, <roffset>, <rlimit>) are optional. But these optional parameters must be entered in the specified order. For example, if you want to specify <length>, then you must also specify <soffset>. See details below for a definition of each of these parameters.  This command uses the data in the format specified by FORMat:DATA, returning either binary or ASCII data.
<b>Initial S/W Revision</b>	Prior to A.02.00

- BLOCK or block data - returns all the data points from the region of the trace data that you specify. For example, it could be used to return the data points of an input signal over several timeslots, excluding the portions of the trace data that you do not want. (This is x,y pairs for trace data and I,Q pairs for complex data.)

- CFIT or curve fit - applies curve fitting routines to the data. <soffset> and <length> are required to define the data that you want. <roffset> is an optional parameter for the desired order of the curve equation. The query will return the following values: the x-offset (in seconds) and the curve coefficients ((order + 1) values).

MIN, MAX, MEAN, DME, RMS, RMSC, SAMP, SDEV and PPH return one data value for each specified region (or <length>) of trace data, for as many regions as possible until you run out of trace data (using <roffset> to specify regions). Or they return the number of regions you specify (using <rlimit>) ignoring any data beyond that.

- MINimum - returns the minimum data point (y value) for the specified region(s) of trace data. For I/Q trace data, the minimum magnitude of the I/Q pairs is returned.
- MAXimum - returns the maximum data point (y value) for the specified region(s) of trace data. For I/Q trace data, the maximum magnitude of the I/Q pairs is returned.
- MEAN - returns a single value that is the arithmetic mean of the data point values (in dB/ dBm) for the specified region(s) of trace data. For I/Q trace data, the mean of the magnitudes of the I/Q pairs is returned. See the following equations.

**NOTE** If the original trace data is in dB, this function returns the arithmetic mean of those log values, not log of the mean power which is a more useful value. The mean of the log is the better measurement technique when measuring CW signals in the presence of noise. The mean of the power, expressed in dB, is useful in power measurements such as Channel Power. To achieve the mean of the power, use the RMS option.

Equation 1

Mean Value of Data Points for Specified Region(s)

$$MEAN = \frac{1}{n} \sum_{X_i \in \text{region}(s)} X_i$$

where  $X_i$  is a data point value, and  $n$  is the number of data points in the specified region(s).

Equation 2

Mean Value of I/Q Data Pairs for Specified Region(s)

$$MEAN = \frac{1}{n} \sum_{X_i \in \text{region}(s)} |X_i|$$

where  $|X_i|$  is the magnitude of an I/Q pair, and  $n$  is the number of I/Q pairs in the specified region(s).

- DMEan - returns a single value that is the mean power (in dB/ dBm) of the data point values for the specified region(s) of trace data. See the following equation:

Equation 3

DMEan Value of Data Points for Specified Region(s)

$$\text{DME} = 10 \times \log_{10} \left( \frac{1}{n} \sum_{X_i \in \text{region}(s)} 10^{\frac{X_i}{10}} \right)$$

- RMS - returns a single value that is the average power on a root-mean-squared voltage scale (arithmetic rms) of the data point values for the specified region(s) of trace data. See the following equation.

**NOTE**

For I/Q trace data, the rms of the magnitudes of the I/Q pairs is returned. See the following equation. This function is very useful for I/Q trace data. However, if the original trace data is in dB, this function returns the rms of the log values which is not usually needed.

Equation 4

RMS Value of Data Points for Specified Region(s)

$$\text{RMS} = \sqrt{\frac{1}{n} \sum_{X_i \in \text{region}(s)} X_i^2}$$

where  $X_i$  is a data point value, and  $n$  is the number of data points in the specified region(s).

Equation 5

RMS Value of I/Q Data Pairs for Specified Region(s)

$$\text{RMS} = \sqrt{\frac{1}{n} \sum_{X_i \in \text{region}(s)} X_i X_i^*}$$

where  $X_i$  is the complex value representation of an I/Q pair,  $X_i^*$  its conjugate complex number, and  $n$  is the number of I/Q pairs in the specified region(s).

Once you have the rms value for a region of trace data (linear or I/Q), you may want to calculate the mean power. You must convert this rms value (peak volts) to power in dBm:

$$10 \times \log[10 \times (\text{rms value})^2]$$

- SAMPLe - returns the first data value (x,y pair) for the specified region(s) of trace data. For I/Q trace data, the first I/Q pair is returned.
- SDEVIation - returns a single value that is the arithmetic standard deviation for the data point values for the specified region(s) of trace data. See the following equation.
- For I/Q trace data, the standard deviation of the magnitudes of the I/Q pairs is returned. See the following equation.

Equation 6

Standard Deviation of Data Point Values for Specified Region(s)

$$\text{SDEV} = \sqrt{\frac{1}{n} \sum_{X_i \in \text{region}(s)} (X_i - \bar{X})^2}$$

where  $X_i$  is a data point value,  $\bar{X}$  is the arithmetic mean of the data point values for the specified region (s), and  $n$  is the number of data points in the specified region(s).

$$\text{SDEV} = \sqrt{\frac{1}{n} \sum_{X_i \in \text{region}(s)} (|X_i| - \bar{X})^2}$$

where  $|X_i|$  is the magnitude of an I/Q pair,  $\bar{X}$  is the mean of the magnitudes for the specified region(s), and  $n$  is the number of data points in the specified region(s).

- PPHase - returns the x,y pairs of both rms power (dBm) and arithmetic mean phase (radian) for every specified region and frequency offset (Hz). The number of pairs is defined by the specified number of regions. This parameter can be used for I/Q vector ( $n=0$ ) in Waveform (time domain) measurement and all parameters are specified by data point in PPHase.

The rms power of the specified region may be expressed as:

$$\text{Power} = 10 \times \log [10 \times (\text{RMS I/Q value})] + 10.$$

The RMS I/Q value (peak volts) is:

$$\sqrt{\frac{1}{n} \sum_{X_i \in \text{region}} X_i X_i^*}$$

where  $X_i$  is the complex value representation of an I/Q pair,  $X_i^*$  its conjugate complex number, and  $n$  is the number of I/Q pairs in the specified region.

The arithmetic mean phase of the specified region may be expressed as:

$$\frac{1}{n} \sum_{Y_i \in \text{region}} Y_i$$

where  $Y_i$  is the unwrapped phase of I/Q pair with applying frequency correction and  $n$  is the number of I/Q pairs in the specified region.

The frequency correction is made by the frequency offset calculated by the arithmetic mean of every specified region's frequency offset. Each frequency offset is calculated by the least square method against the unwrapped phase of I/Q pair.

Sample Trace Data - Constant Envelope

(See below for explanation of variables.)



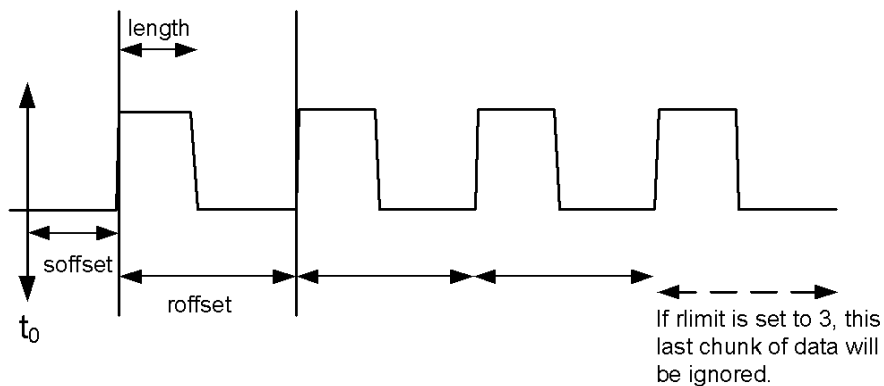

### Sample Trace Data - Not Constant Envelope

(See below for explanation of variables.)

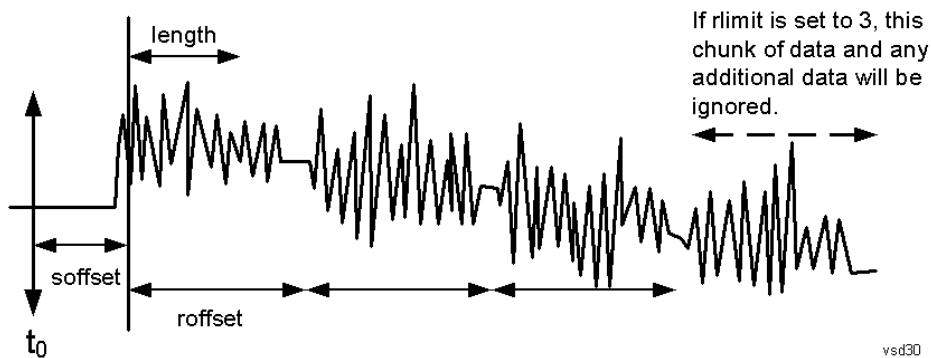

<soffset> - start offset is an optional real number. (It is in seconds for time-domain traces, and is a dimensionless index 0 to Npoints - 1, for frequency-domain traces). It specifies the amount of data at the beginning of the trace that will be ignored before the decimation process starts. It is the time or frequency change from the start of the trace to the point where you want to start using the data. The default value is zero.

<length> - is an optional real number. (It is in seconds for time-domain traces, and is a dimensionless index 0 to Npoints - 1, for frequency-domain traces). It defines how much data will be compressed into one value. This parameter has a default value equal to the current trace length.

<roffset> - repeat offset is an optional real number. (It is in seconds for time-domain traces, and is a dimensionless index 0 to Npoints - 1, for frequency-domain traces). It defines the beginning of the next field of trace elements to be compressed. This is relative to the beginning of the previous field. This parameter has a default value equal to the <length> variable. Note that this parameter is used for a completely different purpose when curve fitting (see CFIT above).

<rlimit> - repeat limit is an optional integer. It specifies the number of data items that you want returned. It will ignore any additional items beyond that number. You can use the Start offset and the Repeat limit to pick out exactly what part of the data you want to use. The default value is all the data.

## Calculate Peaks of Trace Data (Remote Command Only)

Returns a list of all the peaks for the currently selected measurement and sub-opcode [n]. The peaks must meet the requirements of the peak threshold and excursion values.

n = any valid sub-opcode for the current measurement. See the MEASure:<measurement> command description of your specific measurement for information on the data that can be returned.

The command can only be used with specific sub-opcodes with measurement results that are trace data. Both real and complex traces can be searched, but complex traces are converted to magnitude in dBm. In many measurements the sub-opcode n=0, is the raw trace data which cannot be searched for peaks. And Sub-opcode n=1, is often calculated results values which also cannot be searched for peaks.

This command uses the data setting specified by the FORMat:BORDER and FORMat:DATA commands and can return real or ASCII data. If the format is set to INT,32, it returns REAL,32 data.

The command has four types of parameters:

- Threshold (in dBm)
- Excursion (in dB)
- Sorting order (amplitude, frequency, time)
- Optional in some measurements: Display line use (all, > display line, < display line)

---

<b>Remote Command</b>	<p>For Swept SA measurement:</p> <pre>:CALCulate:DATA[1] 2 ... 6:PEAKs? &lt;threshold&gt;,&lt;excursion&gt;[,AMPLitude   FREQuency   TIME[,ALL   GTDLine   LTDLine]]</pre> <p>For most other measurements:</p> <pre>:CALCulate:DATA[1] 2 ... 6:PEAKs? &lt;threshold&gt;,&lt;excursion&gt;[,AMPLitude   FREQuency   TIME]</pre>
-----------------------	--------------------------------------------------------------------------------------------------------------------------------------------------------------------------------------------------------------------------------------------------------------------------------------------------------------------------------

---

<b>Example</b>	<p>Example for Swept SA measurement in Spectrum Analyzer Mode:</p> <p>CALC:DATA4:PEAK? -40, 10, FREQ, GTDL This will identify the peaks of trace 4 that are above -40 dBm, with excursions of at least 10 dB. The peaks are returned in order of increasing frequency, starting with the lowest frequency. Only the peaks that are above the display line are returned.</p> <p>Query Results 1:</p> <p>With FORMat:DATA REAL, 32 selected, it returns a list of floating-point numbers. The first value in the list is the number of peak points that are in the following list. A peak point consists of two values: a peak amplitude followed by its corresponding frequency (or time).</p> <p>If no peaks are found the peak list will consist of only the number of peaks, (0).</p>
----------------	-----------------------------------------------------------------------------------------------------------------------------------------------------------------------------------------------------------------------------------------------------------------------------------------------------------------------------------------------------------------------------------------------------------------------------------------------------------------------------------------------------------------------------------------------------------------------------------------------------------------------------------------------------------------------------------------------------------------------------------------------------------------------------------------

---

<b>Notes</b>	<p>&lt;n&gt; - is the trace that will be used</p> <p>&lt;threshold&gt; - is the level below which trace data peaks are ignored. Note that the threshold value is required and is always used as a peak criterion. To effectively disable the threshold criterion for this command, provide a substantially low threshold value such as -200 dBm. Also note that the threshold value used in this command is independent of and has no effect on the threshold value stored under the Peak Criteria menu.</p> <p>&lt;excursion&gt; - is the minimum amplitude variation (rise and fall) required for a signal to be identified as peak. Note that the excursion value is required and is always used as a peak criterion. To effectively disable the excursion criterion for this command, provide the minimum value of 0.0 dB. Also note that the excursion value used in this command is independent of and has no effect on the</p>
--------------	---------------------------------------------------------------------------------------------------------------------------------------------------------------------------------------------------------------------------------------------------------------------------------------------------------------------------------------------------------------------------------------------------------------------------------------------------------------------------------------------------------------------------------------------------------------------------------------------------------------------------------------------------------------------------------------------------------------------------------------------------------------------------------------------------------------------------------------------------------------------------------------------------------------------------------------

---

---

excursion value stored under the Peak Criteria menu.

Values must be provided for threshold and excursion. The sorting and display line parameters are optional (defaults are AMPLitude and ALL).

Note that there is always a Y-axis value for the display line, regardless of whether the display line state is on or off. It is the current Y-axis value of the display line which is used by this command to determine whether a peak should be reported. Sorting order:

AMPLitude - lists the peaks in order of descending amplitude, with the highest peak first (default if optional parameter not sent)

FREQUency - lists the peaks in order of occurrence, left to right across the x-axis.

TIME - lists the peaks in order of occurrence, left to right across the x-axis.

Peaks vs. Display Line:

ALL - lists all of the peaks found (default if optional parameter not sent).

GTDLine (greater than display line) - lists all of the peaks found above the display line.

LTDLine (less than display line) - lists all of the peaks found below the display line.

---

Initial S/W Revision      Prior to A.02.00

---

## Format Data: Numeric Data (Remote Command Only)

This command specifies the format of the trace data input and output. It specifies the formats used for trace data during data transfer across any remote port. It affects only the data format for setting and querying trace data for the :TRACe[:DATA], TRACe[:DATA]?, :CALCulate:DATA[n]? and FETCh:SANalyzer[n]? commands and queries.

---

<b>Remote Command</b>	:FORMat[:TRACe][:DATA] ASCii INTeger,32 REAL,32  REAL,64 :FORMat[:TRACe][:DATA]?
-----------------------	-------------------------------------------------------------------------------------

---

Notes	<p>The query response is:</p> <p>ASCii: ASC,8</p> <p>REAL,32: REAL,32</p> <p>REAL,64: REAL,64</p> <p>INTeger,32: INT,32</p> <p>When the numeric data format is REAL or ASCii, data is output in the current Y Axis unit. When the data format is INTeger, data is output in units of m dBm (.001 dBm).</p> <p>The INT,32 format returns binary 32-bit integer values in internal units (m dBm), in a definite length block.</p>
-------	---------------------------------------------------------------------------------------------------------------------------------------------------------------------------------------------------------------------------------------------------------------------------------------------------------------------------------------------------------------------------------------------------------------------------------

---

Dependencies	<p>Sending a data format spec with an invalid number (for example, INT,48) generates no error. The analyzer simply uses the default (8 for ASCii, 32 for INTeger, 32 for REAL).</p> <p>Sending data to the analyzer which does not conform to the current FORMat specified, results in an error. Sending ASCII data when a definite block is expected generates message -161 "Invalid Block Data" and sending a definite block when ASCII data is expected generates message -121 "Invalid Character in Number".</p>
--------------	----------------------------------------------------------------------------------------------------------------------------------------------------------------------------------------------------------------------------------------------------------------------------------------------------------------------------------------------------------------------------------------------------------------------------------------------------------------------------------------------------------------------

---

Preset	ASCii
--------	-------

---

Backwards Compatibility Notes	Note that the INT,32 format is only applicable to the command, TRACe:DATA. This preserves backwards compatibility for the Swept SA measurement. For all other commands/queries which honor FORMat:DATA, if INT,32 is sent the analyzer will behave as though it were set to REAL,32.
-------------------------------	--------------------------------------------------------------------------------------------------------------------------------------------------------------------------------------------------------------------------------------------------------------------------------------

---

Initial S/W Revision	Prior to A.02.00
----------------------	------------------

---

The specs for each output type follow:

AScii - Amplitude values are in ASCII, in the current Y Axis Unit, one ASCII character per digit, values separated by commas, each value in the form:

SX.YYYYYEsZZ

Where:

S = sign (+ or -)

X = one digit to left of decimal point

Y = 5 digits to right of decimal point

E = E, exponent header

s = sign of exponent (+ or -)

ZZ = two digit exponent

REAL,32 - Binary 32-bit real values in the current Y Axis Unit, in a definite length block.

REAL,64 - Binary 64-bit real values in the current Y Axis Unit, in a definite length block.

### Format Data: Byte Order (Remote Command Only)

This command selects the binary data byte order for data transfer and other queries. It controls whether binary data is transferred in normal or swapped mode. This command affects only the byte order for setting and querying trace data for the :TRACe[:DATA], TRACe[:DATA]? , :CALCulate:DATA[n]? and FETCh:SANalyzer[n]? commands and queries.

By definition any command that says it uses FORMat:DATA uses any format supported by FORMat:DATA.

The NORMal order is a byte sequence that begins with the most significant byte (MSB) first, and ends with the least significant byte (LSB) last in the sequence: 1|2|3|4. SWAPped order is when the byte sequence begins with the LSB first, and ends with the MSB last in the sequence: 4|3|2|1.

---

<b>Remote Command</b>	:FORMat:BORDER NORMal   SWAPped :FORMat:BORDER?
<b>Preset</b>	NORMal
<b>Initial S/W Revision</b>	Prior to A.02.00

---

## Meas Setup

Accesses the measurement setup menu for the current measurement.

Key Path	Front panel key
Initial S/W Revision	Prior to A.02.00

### Avg/Hold Num

Used to specify the number of data acquisitions that will be averaged. After the specified number of average counts, the averaging mode (termination control) setting determines the averaging action.

- On - Sets measurement averaging on.
- Off - Sets measurement averaging off.

Key Path	Meas Setup
Mode	1xEVDO
<b>Remote Command</b>	[:SENSe]:PVTime:AVERage:COUNT <integer> [:SENSe]:PVTime:AVERage:COUNT? [:SENSe]:PVTime:AVERage[:STATe] OFF ON 0 1 [:SENSe]:PVTime:AVERage[:STATe]?
Preset	512 ON
State Saved	Saved in instrument state.
Min	1
Max	10000
Initial S/W Revision	Prior to A.02.00

### Avg Mode

Selects the type of termination control used for the averaging function. This determines the averaging action after the specified number of data acquisitions (average count) is reached.

KEY:Exponential SCPI:EXPonential	After the average count is reached, each successive data acquisition is exponentially weighted and combined with the existing average.
KEY:Repeat SCPI:REPeat	After reaching the average count, the averaging is reset and a new average is started. The default value is Exp.

Key Path	Meas Setup
Mode	1xEVDO
<b>Remote Command</b>	[ :SENSe ] :PVTime:AVERage:TCONtrol EXPonential REPeat [ :SENSe ] :PVTime:AVERage:TCONtrol?
Preset	REPeat
State Saved	Saved in instrument state.
Range	Exp Repeat
Initial S/W Revision	Prior to A.02.00

## Avg Type

Selects the averaging type from the following selections:

KEY:Pwr Avg (RMS) SCPI:RMS POWer	True power averaging that is equivalent to taking the RMS value of the voltage. It is the most accurate type of averaging.
KEY:Log-Pwr Avg (Video) SCPI:LOG LPOWer	Simulates the traditional spectrum analyzer type of averaging by averaging the log of the power.
KEY:Voltage Avg SCPI:SCALar	The amplitude level of power is averaged to provide a voltage value.
KEY:Maximum SCPI:MAXimum	Keeps track of the maximum values.
KEY:Minimum SCPI:MINimum	Keeps track of the minimum values.

Selecting MAXimum|MINimum, the displayed measured trace is in fact the same with Max Hold Trace or Min Hold Trace.

Key Path	Meas Setup
Mode	1xEVDO
<b>Remote Command</b>	[ :SENSe ] :PVTime:AVERage:TYPE LOG MAX MIN RMS SCALar [ :SENSe ] :PVTime:AVERage:TYPE?
Preset	RMS
State Saved	Saved in instrument state.
Range	Pwr Avg (RMS) Log-Pwr Avg(Video) Voltage Avg Maximum Minimum
Initial S/W Revision	Prior to A.02.00

## Slot Type

Sets the slot type to either Idle (including Pilot and MAC) or Active (including Pilot, MAC, and Data). Define the reference point of the mask timing.

- IDLE - Set to the idle slot that includes the Pilot and MAC channels, of which waveform is bursted.
- ACTive - Set to the active slot that includes the Pilot, MAC, and Data channels, of which signal is continuous.

Key Path	Meas Setup
Mode	1xEVDO
<b>Remote Command</b>	[ :SENSe ] :PVTime:SLOT[:TYPE] IDLE ACTive [ :SENSe ] :PVTime:SLOT[:TYPE] ?
<b>Example</b>	:SENS:PVT:SLOT ACT
Preset	IDLE
State Saved	Saved in instrument state.
Range	Idle Slot (Pilot+MAC) Active Slot (Plt+MAC+Data)
Initial S/W Revision	Prior to A.02.00

## Idle Slot Filtering

Allows you to toggle the idle slot filtering On and Off.

**NOTE** This key is available only when Slot Type is Active Slot.

When Slot Type key is set to Active Slot, but the current captured signal is Idle Slot, if the Idle Slot Filtering Key is set to Off, the current captured signal is used as Active Slot. Otherwise, if Idle Slot Filtering Key is set to On, the current captured signal is ignored and the signal is recaptured.

Key Path	Meas Setup
Mode	1xEVDO
<b>Remote Command</b>	[ :SENSe ] :PVTime:ISLot:FILTerIng 0 1 OFF ON [ :SENSe ] :PVTime:ISLot:FILTerIng?
<b>Example</b>	PVT:ISL:FILT?
Notes	This key is grayed out when Slot Type is Idle Slot
Preset	ON
State Saved	Saved in instrument state.
Range	On Off
Initial S/W Revision	Prior to A.02.00

## Region/Limits

Accesses the Region/Limits menu allows you to set up the test limit mask for the specified time period. A time period is called a region. You can define multiple regions if Slot Type is Idle Slot. The start and stop time of the regions, interval and the relative power of the upper and lower limit masks for the regions, are configurable. If Slot Type is set to Active Slot, you can define the Interval and the relative power of upper and lower limit mask for the entire slot.

If Slot Type is Idle Slot, following menu is available.

Key Path	Meas Setup
Initial S/W Revision	Prior to A.02.00

## Region

Time slices along the burst are called regions. You can define up to 5 regions, which are designated by the characters A to E. You can configure the following parameters for each region: Offset Start, Offset Stop, Interval, Upper Mask and Lower Mask if Slot Type is Idle Slot.

Key Path	Meas Setup, More, Region/Limits
Mode	1xEVDO
Preset	A
Range	Region A Region B Region C Region D Region E
Initial S/W Revision	Prior to A.02.00

## Offset Start

Specifies the start time for each region.

Key Path	Meas Setup, More, Region/Limits
Mode	1xEVDO
<b>Remote Command</b>	<code>[ :SENSe ] :PVTime:MASK:LIST:TIME:START &lt;time&gt;, &lt;time&gt;, &lt;time&gt;, &lt;time&gt;, &lt;time&gt;</code> <code>[ :SENSe ] :PVTime:MASK:LIST:TIME:START?</code>
<b>Example</b>	<code>:PVT:MASK:LIST:TIME:STAR?</code>
Couplings	Coupled to Region Stop Time. When Region Start Time is set to a larger value than the Region Stop Time, the Region Stop Time is forced to increase to the same value as the new Region Start Time. When Region Stop Time is set to a smaller value than the Region Start Time, the Region Start Time is forced to decrease to the same value as the new Region Stop Time.
Preset	-416.67us, -97.33us, -90.33us, 90.33us, 97.33us
State Saved	Saved in instrument state.
Min	-10ms
Max	10ms
Initial S/W Revision	Prior to A.02.00



## Offset Stop

Specifies the stop time of each region.

Key Path	Meas Setup, More, Region/Limits
Mode	1xEVDO
Remote Command	[ :SENSe ] :PVTime:MASK:LIST:TIME:STOP <time>, <time>, <time>, <time>, <time>  [ :SENSe ] :PVTime:MASK:LIST:TIME:STOP?
Example	:PVT:MASK:LIST:TIME:STOP?
Couplings	Coupled to Region Start Time and Region Interval. Region Stop Time = Region Start Time + Region Interval When Region Start Time is set to a larger value than the Region Stop Time, the Region Stop Time is forced to increase to the same value as the new Region Start Time. When Region Stop Time is set to a smaller value than the Region Start Time, the Region Start Time is forced to decrease to the same value as the new Region Stop Time.
Preset	-97.33us, -90.33us, 90.33us, 97.33us, 416.67us
State Saved	Saved in instrument state.
Min	-10ms
Max	10ms
Initial S/W Revision	Prior to A.02.00

## Interval

Specifies the time interval of each region.

Key Path	Meas Setup, More, Region/Limits
Mode	1xEVDO
Remote Command	[ :SENSe ] :PVTime:MASK:LIST:SWEep:TIME <time>, <time>, <time>, <time>, <time>  [ :SENSe ] :PVTime:MASK:LIST:SWEep:TIME?
Example	PVT:MASK:LIST:SWE:TIME?
Couplings	Coupled to Region Start Time and Region Stop Time. Region Interval = Region Stop Time- Region Start Time
Preset	319.34us, 7.00us, 180.66us, 7.00us, 319.34us
State Saved	Saved in instrument state.
Min	0
Max	20ms
Initial S/W Revision	Prior to A.02.00

## Upper Mask

Enter the relative power level for each horizontal line segment in the upper limit mask. There should be a power level for each time point entered using [:SENSe]:PVTIME:MASK:LIST:UPPER:TIME, and they must be entered in the same order. These power levels are all relative to the defined Reference Power Level (the average power in the useful part of the data). When an upper and lower limit masks have been defined, the Reference Power Level is the mid-point between these two limits at time t0.

<b>Key Path</b>	Meas Setup, More, Region/Limits
<b>Mode</b>	1xEVDO
<b>Remote Command</b>	[:SENSe]:PVTIME:MASK:LIST:UPPER:RELATIVE <rel_ampl>, <rel_ampl>, <rel_ampl>, <rel_ampl>, <rel_ampl>, <rel_ampl> [:SENSe]:PVTIME:MASK:LIST:UPPER:RELATIVE?
<b>Example</b>	:PVT:MASK:LIST:UPPER:REL?
<b>Preset</b>	-7.0, 2.5, 2.5, 2.5, -7.0
<b>State Saved</b>	Saved in instrument state.
<b>Min</b>	-100 dB
<b>Max</b>	200 dB
<b>Initial S/W Revision</b>	Prior to A.02.00

## Lower Mask

Sets the relative power level for each horizontal line segment in the lower limit mask. There should be a power level for each time point entered using [:SENSe]:PVTIME:MASK:LIST:LOWER:TIME, and they must be entered in the same order. These power levels are all relative to the defined Reference Power Level (the average power in the useful part of the data). When an upper and lower limit masks have been defined, the Reference Power Level is the mid-point between these two limits at time t0. Any portion of the signal that has no limit line segment defined for it, will default to a very low limit (-100 dB relative to the reference power). This will keep the measurement from indicating a failure for that portion of the data.

<b>Key Path</b>	Meas Setup, More, Region/Limits
<b>Mode</b>	1xEVDO
<b>Remote Command</b>	[:SENSe]:PVTIME:MASK:LIST:LOWER:RELATIVE <rel_ampl>, <rel_ampl>, <rel_ampl>, <rel_ampl>, <rel_ampl>, <rel_ampl> [:SENSe]:PVTIME:MASK:LIST:LOWER:RELATIVE?
<b>Example</b>	:PVT:MASK:LIST:LOW:REL?
<b>Preset</b>	-100.0, -100.0, -2.5, -100.0, -100.0
<b>State Saved</b>	Saved in instrument state.
<b>Min</b>	-100 dB
<b>Max</b>	200 dB
<b>Initial S/W Revision</b>	Prior to A.02.00

## Power Reference

Selects one of the regions to be used as the power reference.

Key Path	Meas Setup, More
Mode	1xEVDO
Remote Command	[ :SENSe ] :PVTime:MASK:PREFERENCE A B C D E [ :SENSe ] :PVTime:MASK:PREFERENCE?
Example	PVT:MASK:PREF D
Preset	C
State Saved	Saved in instrument state.
Range	Region A Region B Region C Region D Region E
Initial S/W Revision	Prior to A.02.00

## Time Reference

Specifies a reference position along the burst for start time and stop time settings for all regions. If you want to fine tune the reference position, set the Time Ref Offset parameter in the Advanced menu.

KEY:Burst Rising SCPI:RISE	Uses the burst rising edge of the burst determined after acquisition process.
KEY:Burst Center SCPI:CENTER	Uses the burst center between the rising and falling edges of the burst determined after acquisition process.
KEY:Trigger SCPI:TRIGGER	Uses the trigger timing as the time reference in applying the limit mask.

Key Path	Meas Setup, More
Mode	1xEVDO
Remote Command	[ :SENSe ] :PVTime:MASK:TREFERENCE RISE CENTER TRIGGER [ :SENSe ] :PVTime:MASK:TREFERENCE?
Example	PVT:MASK:TREF TRIG
Preset	CENTER
State Saved	Saved in instrument state.
Range	Burst Rising Burst Center Trigger
Initial S/W Revision	Prior to A.02.00

## Burst Search Threshold

Specifies the relative power threshold level to search for bursts. Burst Slope Threshold and Burst Slope Detect Interval in advanced menu are also used in the burst detection algorithm.

Key Path	Meas Setup, More
Mode	1xEVDO
<b>Remote Command</b>	<code>[ :SENSe ] :PVTime :BURSt :STHReshold &lt;rel_ampl&gt;</code> <code>[ :SENSe ] :PVTime :BURSt :STHReshold?</code>
<b>Example</b>	PVT:BURS:STHR -20
Couplings	No
Preset	-10
State Saved	Saved in instrument state.
Min	-100.0
Max	0.0
Initial S/W Revision	Prior to A.02.00

## Meas Preset

Returns parameters for the current measurement to those set by the factory.

Key Path	Meas Setup, More
<b>Remote Command</b>	<code>:CONFigure:PVTime</code>
<b>Example</b>	:CONF:PVT
Initial S/W Revision	Prior to A.02.00

## Advanced

Accesses advanced measurement setup features. These features are intended for the advanced user.

Key Path	Meas Setup
Initial S/W Revision	Prior to A.02.00

## Burst Slope Threshold

Specifies the minimum slope in the relative power level change per  $\mu\text{s}$ , to search for bursts at the specified threshold level.

Key Path	Meas Setup, More, Advanced
Mode	1xEVDO
<b>Remote Command</b>	<code>[ :SENSe ] :PVTime :BURSt :SLOPe &lt;real&gt;</code>

	<code>[ :SENSe ] :PVTime:BURSt:SLOPe?</code>
<b>Example</b>	<code>:SENS:PVT:BURS:SLOP?</code>
Notes	This SCPI command does not accept units such as dB/us
Preset	2.0
State Saved	Saved in instrument state.
Min	0.1
Max	10.0
Initial S/W Revision	Prior to A.02.00

### Burst Slope Detect Intvl

Specifies the integration time in the number of chips, to calculate the minimum slope to search for bursts at the specified threshold level.

Key Path	Meas Setup, More, Advanced
Mode	1xEVDO
<b>Remote Command</b>	<code>[ :SENSe ] :PVTime:BURSt:SLOPe:DETection:TIME &lt;real&gt;</code> <code>[ :SENSe ] :PVTime:BURSt:SLOPe:DETection:TIME?</code>
<b>Example</b>	<code>:SENS:PVT:BURS:SLOP:DET:TIME?</code>
Preset	2.0 chips
State Saved	Saved in instrument state.
Min	0.5 chips
Max	3.0 chips
Initial S/W Revision	Prior to A.02.00

### Idle Slot Threshold

Sets the threshold value for the Idle Slot detection. A slot is identified as Idle when power ratio of average power over Data channel in the slot to average power over Pilot and MAC channels in the slot is smaller than the value specified by this parameter.

Key Path	Meas Setup, More, Advanced
Mode	1xEVDO
<b>Remote Command</b>	<code>[ :SENSe ] :PVTime:ISLot:THReshold &lt;rel_amp1&gt;</code> <code>[ :SENSe ] :PVTime:ISLot:THReshold?</code>
<b>Example</b>	<code>:PVT:ISL:THR -5</code>
Preset	-7.0 dB
State Saved	Saved in instrument state.

Min	-100.0 dB
Max	0.0 dB
Initial S/W Revision	Prior to A.02.00

### Time Ref Offset

Defines the time offset of the mask timing reference. This is an advanced control that normally does not need to be changed.

Key Path	Meas Setup, More, Advanced
Mode	1xEVDO
<b>Remote Command</b>	[ :SENSe ] :PVTime:MASK:REFeRence[:OFFSet]:TIME <time> [ :SENSe ] :PVTime:MASK:REFeRence[:OFFSet]:TIME?
Example	:SENS:PVT:MASK:REF:OFFS:TIME?
Preset	0.0
State Saved	Saved in instrument state.
Min	-10.0 ms
Max	10.0 ms
Initial S/W Revision	Prior to A.02.00

### IF Gain

Accesses the menu that sets ranging in the digital IF when acquiring an I/Q time record. Note: This function is not affected by RF Input Range attenuation.

Key Path	Meas Setup, Advanced
Initial S/W Revision	Prior to A.02.00

### IF Gain Auto

Allows the instrument to pick the IF Gain method that is appropriate. This “Auto” state is set by the Auto Couple key, and it always selects “Low Gain” for the IF Gain State.

Key Path	Meas Setup, More, Advanced, IF Gain
Mode	1xEVDO
<b>Remote Command</b>	[ :SENSe ] :PVTime:IF:GAIN:AUTO OFF ON 0 1 [ :SENSe ] :PVTime:IF:GAIN:AUTO?
<b>Example</b>	:SENS:PVT:IF:GAIN:AUTO ON
Couplings	When this parameter is set to “ON”, the IF Gain State parameter is set to “LOW”.

	When this parameter is set to "OFF", the IF Gain State parameter does not change, and keeps its previous value.
Preset	OFF
State Saved	Saved in instrument state.
Initial S/W Revision	Prior to A.02.00

## IF Gain State

Sets the digital IF gain.

KEY:Low Gain SCPI:LOW	Low gain. This setting is optimal for Large Signals.
KEY:High Gain SCPI:HIGH	High gain. This setting is optimal for Noise Level.

Key Path	Meas Setup, More, Advanced, IF Gain
Mode	1xEVDO
<b>Remote Command</b>	[ :SENSe ] :PVTime:IF:GAIN [ :STATe ] LOW HIGH [ :SENSe ] :PVTime:IF:GAIN [ :STATe ] ?
<b>Example</b>	:SENSe:PVTime:IF:GAIN HIGH
Couplings	Couple to <b>IF Gain Auto</b> force it to Man.
Preset	LOW
State Saved	Saved in instrument state.
Range	Low Gain (Best for Large Signals) High Gain (Best Noise Level)
Initial S/W Revision	Prior to A.02.00

11 Power vs Time  
Mode

Mode

See "[Mode](#)" on page 318



## Mode Preset

Returns the active mode to a known state.

Mode Preset does the following for the currently active mode:

- Aborts the currently running measurement.
- Brings up the default menu for the mode, with no active function.
- Sets measurement Global settings to their preset values for the active mode only.
- Activates the default measurement.
- Brings up the default menu for the mode.
- Clears the input and output buffers.
- Sets Status Byte to 0.

Mode Preset does not:

- Cause a mode switch
- Affect mode persistent settings
- Affect system settings

See "[How-To Preset](#)" on page 1102 for more information.

Key Path	Front-panel key
<b>Remote Command</b>	:SYSTem:PRESet
<b>Example</b>	:SYST:PRES
Notes	*RST is preferred over :SYST:PRES for remote operation. *RST does a Mode Preset, as done by the :SYST:PRES command, and it sets the measurement mode to Single measurement rather than Continuous for optimal remote control throughput. Clears all pending OPC bits. The Status Byte is set to 0.
Couplings	A Mode Preset aborts the currently running measurement, activates the default measurement, and gets the mode to a consistent state with all of the default couplings set.
Backwards Compatibility Notes	In the X-Series, the legacy "Factory Preset" has been replaced with Mode Preset, which only presets the currently active mode, not the entire instrument. In the X-Series, the way to preset the entire instrument is by using System, Restore System Defaults All, which behaves essentially the same way as restore System Defaults does on ESA and PSA. There is also no "Preset Type" as there is on the PSA. There is a green Mode Preset front-panel key that does a Mode Preset and a white-with-green-letters User Preset front-panel key that does a User Preset. The old PRESet:TYPE command is ignored (without generating an error), and SYST:PRES without a parameter does a Mode Preset, which should cover most backward code compatibility issues. The settings and correction data under the Input/Output front-panel key (examples: Input Z Corr, Ext Amp Gain, etc.) are no longer part of any Mode, so they will not be preset by a Mode Preset. They are preset using Restore Input/Output Defaults, Restore System Defaults All. Note that because User Preset does a Recall State, and all of these settings are saved in State, they ARE recalled when using

	User Preset.
Initial S/W Revision	Prior to A.02.00

## How-To Preset

The table below shows all possible presets, their corresponding SCPI commands and front-panel access (key paths). Instrument settings depend on the current measurement context. Some settings are local to the current measurement, some are global (common) across all the measurements in the current mode, and some are global to all the available modes. In a similar way, restoring the settings to their preset state can be done within the different contexts.

Auto Couple - is a measurement local key. It sets all Auto/Man parameter couplings in the measurement to Auto. Any Auto/Man selection that is local to other measurements in the mode will not be affected.

Meas Preset - is a measurement local key. Meas Preset resets all the variables local to the current measurement except the persistent ones.

Mode Preset - resets all the current mode's measurement local and measurement global variables except the persistent ones.

Restore Mode Defaults - resets ALL the Mode variables (and all the Meas global and Meas local variables), including the persistent ones.

Type Of Preset	SCPI Command	Front Panel Access
Auto Couple	:COUPle ALL	Auto Couple front-panel key
Meas Preset	:CONFigure:<Measurement>	Meas Setup Menu
Mode Preset	:SYSTem:PRESet	Mode Preset (green key)
Restore Mode Defaults	:INSTrument:DEFault	Mode Setup Menu
Restore All Mode Defaults	:SYSTem:DEFault MODes	System Menu; Restore System Default Menu
*RST	*RST	not possible (Mode Preset with Single)
Restore Input/Output Defaults	:SYSTem:DEFault INPUt	System Menu; Restore System Default Menu
Restore Power On Defaults	:SYSTem:DEFault PON	System Menu; Restore System Default Menu
Restore Alignment Defaults	:SYSTem:DEFault ALIGN	System Menu; Restore System Default Menu
Restore Miscellaneous Defaults	:SYSTem:DEFault MISC	System Menu; Restore System Default Menu
Restore All System Defaults	:SYSTem:DEFault [ALL] :SYSTem:PRESet:PERsistent	System Menu; Restore System Default Menu
User Preset	:SYSTem:PRESet:USER	User Preset Menu
User Preset All Modes	:SYSTem:PRESet:USER:ALL	User Preset Menu

Power On Mode Preset	:SYSTem:PON:TYPE MODE	System Menu
Power On User Preset	:SYSTem:PON:TYPE USER	System Menu
Power On Last State	:SYSTem:PON:TYPE LAST	System Menu

### Preset Type (Remote Command Only)

As stated in the Backward Compatibility section, to be compatible with ESA/PSA the PRESet:TYPE command will be implemented as a no-op.

Mode	All
<b>Remote Command</b>	:SYSTem:PRESet:TYPE FACTory MODE USER :SYSTem:PRESet:TYPE?
<b>Example</b>	:SYST:PRESet:TYPE FACT
Notes	This command is supported for backward compatibility only. It is a no-op which does not change the behavior of any preset operation.
Preset	This is unaffected by Preset but is set to Mode on a "Restore System Defaults->All"
State Saved	No
Initial S/W Revision	Prior to A.02.00

11 Power vs Time  
Mode Setup

## Mode Setup

See "[Mode Setup](#)" on page 348

## Peak Search

Places the selected marker on the trace point that has the maximum y-axis value for that marker's trace. Pressing Peak Search with the selected marker Off causes the selected marker to be set to Normal; then a peak search is immediately performed.

Key Path	Peak Search
Mode	1xEVDO
<b>Remote Command</b>	:CALCulate:PVTime:MARKer[1] 2 ...12:MAXimum
<b>Example</b>	CALC:PVT:MARK2:MAX
Initial S/W Revision	Prior to A.02.00

11 Power vs Time  
Print

Print

See "[Print](#)" on page 358

## Quick Save

The Quick Save front-panel key repeats the most recent save that was performed from the Save menu, with the following exceptions:

- Register saves are not remembered as Saves for the purpose of the Quick Save function
- If the current measurement does not support the last non-register save that was performed, an informational message is generated, “File type not supported for this measurement”

Quick Save repeats the last type of qualified save (that is, a save qualified by the above criteria) in the last save directory by creating a unique filename using the Auto File Naming algorithm described below.

If Quick Save is pressed after startup and before any qualified Save has been performed, the Quick Save function performs a Screen Image save using the current settings for Screen Image saves (current theme, current directory), which then becomes the “last save” for the purpose of subsequent Quick Saves.

The Auto File Naming feature automatically generates a file name for use when saving a file. The filename consists of a prefix and suffix separated by a dot, as is standard for the Windows® file system. A default prefix exists for each of the available file types:

Type	Default Prefix	Menu
State	State_	(Save/Recall)
Trace + State	State_	(Save/Recall)
Screen	Screen_	(Save/Recall)
Amplitude Corrections	Ampcor_	(Import/Export)
Traces	Trace_	(Import/Export)
Limit Lines	LLine_	(Import/Export)
Measurement Result	MeasR_	(Import/Export)
Capture Buffer	CapBuf_	(Import/Export)

A four digit number is appended to the prefix to create a unique file name. The numbering sequence starts at 0000 within each Mode for each file type and updates incrementally to 9999, then wraps to 0000 again. It remembers where it was through a Mode Preset and when leaving and returning to the Mode. It is reset by Restore Misc Defaults and Restore System Defaults and subsequent running of the instrument application. So, for example, the first auto file name generated for State files is State\_0000.state. The next is State\_0001, and so forth.

One of the key features of Auto File Name is that we guarantee that the Auto File Name will never conflict with an existing file. The algorithm looks for the next available number. If it gets to 9999, then it looks for holes. If it find no holes, that is no more numbers are available, it gives an error.

For example, if when we get to State\_0010.state there is already a State\_0010.state file in the current directory, it advances the counter to State\_0011.state to ensure that no conflict will exist (and then it verifies that State\_0011.state also does not exist in the current directory and advances again if it does, and so forth).

If you enter a file name for a given file type, then the prefix becomes the filename you entered instead of the default prefix, followed by an underscore. The last four letters (the suffix) are the 4-digit number.

For example, if you save a measurement results file as “fred.csv”, then the next auto file name chosen for a measurement results save will be fred\_0000.csv.

**NOTE**

Although 0000 is used in the example above, the number that is used is actually the current number in the Meas Results sequence, that is, the number that would have been used if you had not entered your own file name.

---

**NOTE**

If the filename you entered ends with \_dddd, where d=any number, making it look just like an auto file name, then the next auto file name picks up where you left off with the suffix being dddd + 1.

---

Key Path	Front-panel key
Notes	No remote command for this key specifically.
Initial S/W Revision	Prior to A.02.00



## Recall

The Recall menu lets you choose what you want to recall, and where you want to recall it from. Among the types of files you can recall are **States and Traces**. In addition, an Import (Data) option lets you recall a number of data types stored in CSV files (as used by Excel and other spreadsheet programs).

The default paths for Recall are data type dependent and are the same as for the Save key.

Key Path	Front-panel key
Notes	<p>No remote command for this key specifically, but the :MMEM:LOAD command is available for specific file types. An example is :MMEM:LOAD:STATe &lt;filename&gt;.</p> <p>If you try to recall a State file for a mode that is not licensed or not available in the instrument, an error message will occur and the state will not change.</p>
Backwards Compatibility Notes	<p>In legacy analyzers, it was possible to load a state without affecting the trace data, limit lines or correction data. Similarly (since User Preset is actually loading a state), it was possible to do a User Preset without affecting the trace data, limit lines or correction data.</p> <p>In the X-Series, “state” always includes all of this data; so whenever state is loaded, all of the traces, limit lines and corrections are affected. Although this differs from previous behavior, it is desirable behavior, and should not cause adverse issues for users.</p>
Backwards Compatibility Notes	<p>Recall for the X-Series supports backward compatibility in the sense that you can recall a state file from any X-Series model number and any version of X-Series software. This is only possible if part of the recalling process goes through a limiting step after recalling the mode settings, at least for settings that may vary with version number, model number, option and license differences. If you try to recall a state file onto an instrument with less capability than what was available on the instrument during the save, the recall will ignore the state it doesn't support and it will limit the recalled setting to what it allows.</p> <p>Example: if the saved state includes preamp ON, but the recalling instrument does not have a preamp; the preamp is limited to OFF. Conversely, if you save a state without a preamp, the preamp is OFF in the state file. When this saved file is recalled on an instrument with a licensed preamp, the preamp is changed to OFF. Another example is if the saved state has center frequency set to 20 GHz, but the instrument recalling the saved state is a different model and only supports 13.5 GHz. In this case, the center frequency is limited along with any other frequency based settings. Since the center frequency can't be preserved in this case, the recall limiting tries to at least preserve span to keep the measurement setup as intact as possible.</p> <p>It may be appropriate to issue a warning if the state is limited on the recall; warnings do not go out to SCPI so this would only affect the manual user.</p> <p>Note that there is no state file compatibility outside of the X-Series. For example, you cannot recall a state file from ESA or PSA.</p>
Initial S/W Revision	Prior to A.02.00

## State

The Recall State menu lets you choose a register or file from which to recall the state.

The content of a state file includes all of the settings and data required to return the analyzer as closely as possible to the Mode it was in, with the exact settings that were in place, when the save occurred. The Mode settings in each state file include the settings that are affected by Mode Preset, as well as the

additional settings affected by Restore Mode Defaults; all of the Mode's settings. In addition, all of the settings of the Input/Output system are included, even though they are outside of the Mode's state, because they are needed to restore the complete setup. Persistent System settings (for example, GPIB address) are not affected by either a Mode Preset or Restore Mode Defaults, nor are they included in a saved State file.

Since each state file is only for one Mode, the settings for other Modes are unaffected when it is loaded. Recall State will cause a mode switch if the state being recalled is not from the current active mode.

After the recall completes, the message "File <filename> recalled" or "Recalled State Register <register number>" is displayed.

For rapid recalls, the State menu lists 16 registers that you can choose from to recall. Pressing a Register key initiates the recall. You can also select a file from which to recall.

The default path for all State Files is:

My Documents\<<mode name>\state

where <mode name> is the parameter used to select the mode with the INST:SEL command (for example, SA for the Spectrum Analyzer).

See "[More Information](#)" on page 1111.

<b>Key Path</b>	Recall
<b>Mode</b>	All
<b>Remote Command</b>	:MMEMory:LOAD:STATe <filename>
<b>Example</b>	:MMEM:LOAD:STAT "myState.state" This recalls the file myState.state on the default path
<b>Example</b>	MMEM:LOAD:STAT "MyStateFile.state" This loads the state file data (on the default file directory path) into the instrument state.
<b>Notes</b>	<p>When you pick a file to recall, the analyzer first verifies that the file is recallable in the current instrument by checking the software version and model number of the instrument. If everything matches, a full recall proceeds by aborting the currently running measurement, clearing any pending operations, and then loading the State from the saved state file. You can open state files from any mode, so recalling a State file switches to the mode that was active when the save occurred. After switching to the mode of the saved state file, mode settings and data (if any for the mode) are loaded with values from the saved file. The saved measurement of the mode becomes the newly active measurement and the data relevant to the measurement (if there is any) is recalled.</p> <p>If there is a mismatch between file version or model number or instrument version or model number, the recall function tries to recall as much as possible and returns a warning message. It may limit settings that differ based on model number, licensing or version number.</p> <p>After recalling the state, the Recall State function does the following:</p> <ul style="list-style-type: none"> <li>• Makes the saved measurement for the mode the active measurement.</li> <li>• Clears the input and output buffers.</li> <li>• Status Byte is set to 0.</li> <li>• Executes a *CLS</li> </ul> <p>If the file specified is empty an error is generated. If the specified file does not exist, another error is generated. If there is a mismatch between the file and the proper file type, an error is generated. If</p>

---

	there is a mismatch between file version or model number or instrument version or model number, a warning is displayed. Then it returns to the State menu and File Open dialog goes away. After the Recall, the analyzer exits the Recall menu and returns to the previous menu.
<b>Backwards Compatibility SCPI</b>	:MMEMory:LOAD:STATe 1,<filename> For backwards compatibility, the above syntax is supported. The "1" is simply ignored.
Initial S/W Revision	Prior to A.02.00

---

## More Information

In measurements that support saving Traces, for example, Swept SA, the Trace data is saved along with the State in the State file. When recalling the State, the Trace data is recalled as well. Traces are recalled exactly as they were stored, including the writing mode and update and display modes. If a Trace was updating and visible when the State was saved, it will come back updating and visible, and its data will be rewritten right away. When you use State to save and recall traces, any trace whose data must be preserved should be placed in View or Blank mode before saving.

The following table describes the Trace Save and Recall possibilities:

You want to recall state and one trace's data, leaving other traces unaffected.	Save Trace+State from 1 trace. Make sure that no other traces are updating (they should all be in View or Blank mode) when the save is performed.	On Recall, specify the trace you want to load the one trace's data into. This trace will load in View. All other traces' data will be unaffected, although their trace mode will be as it was when the state save was performed.
You want to recall all traces	Save Trace+State from ALL traces.	On Recall, all traces will come back in View (or Blank if they were in Blank or Background when saved)
You want all traces to load exactly as they were when saved.	Save State	On recall, all traces' mode and data will be exactly as they were when saved. Any traces that were updating will have their data immediately overwritten.

---

## From File...

When you press "From File", the analyzer brings up a Windows dialog and a menu entitled "File Open." This menu allows you to navigate to the various fields in the Windows dialog without using a keyboard or mouse. The Tab and Arrow keys can also be used for dialog navigation.

## 11 Power vs Time Recall

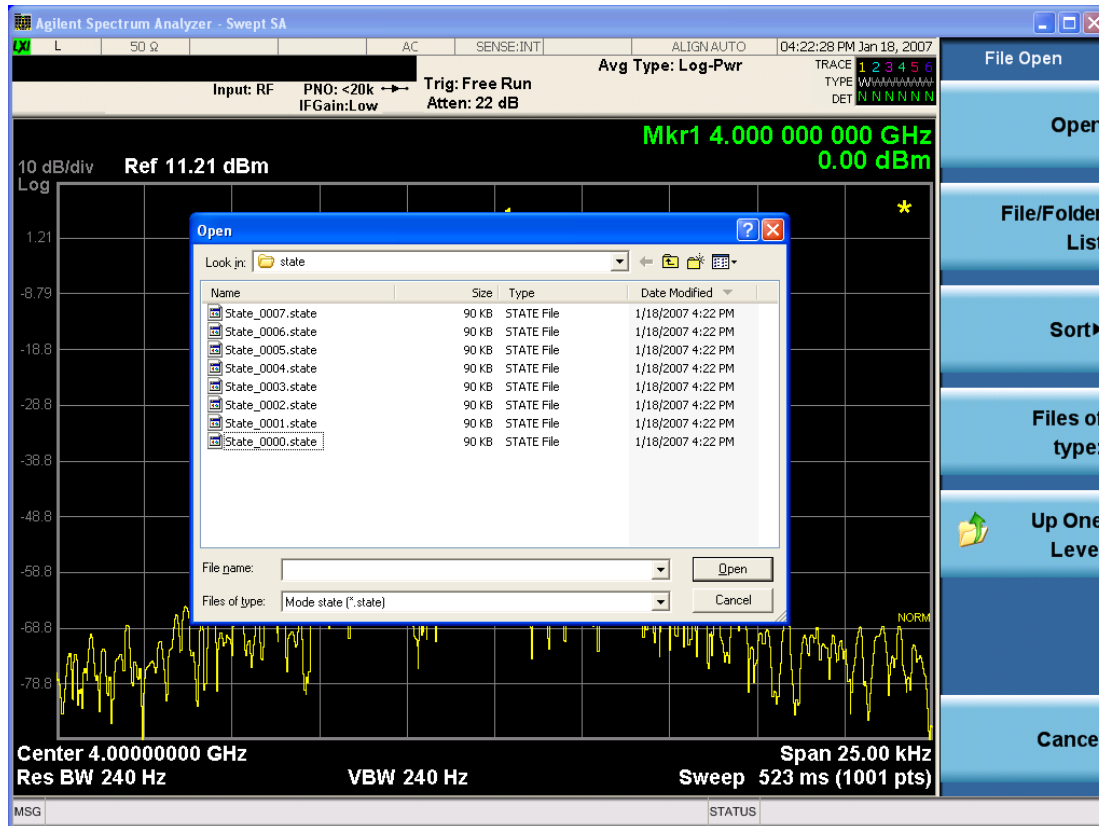

Listed below are the functions of the various fields in the dialog, and the corresponding softkeys:

### Open

Performs the recall of the specified file. While the recall is being performed, the floppy icon appears briefly in the Meas bar.

### File/Folder List

Enables you to navigate to the center of the dialog that contains the list of files and folders. Once here you can get information about the file and use the tab keys to navigate to the other fields in the dialog, such as Look In.

### Look In

The Look In field shows the path from which the file will be recalled and allows you to change the path using the up and down arrow keys to navigate to other paths; the Enter key to open a directory; and the Backspace key to go back one directory. The **Look In field** first uses the last path from the Save As dialog **Save In:** path for that same file type. There is no softkey for directly navigating to the Look In field, but you can use the left tab to get here from the File/Folder List.

User specified paths are remembered when you leave and return to a Mode and are reset back to the default using Restore Mode Defaults.

### Sort

Accesses a menu that enables you to sort the files within the File Open dialog. Only one sorting type can be selected at a time and the sorting happens immediately. The sorting types are By Date, By Name, By extension, and By Size.

#### Files of Type

This field shows the file suffix for the type of file you have selected to recall. For example, if you navigated here while recalling State, "Mode state (\*.state)" is in the field. If you navigated here while recalling Trace, ""Mode state (\*.trace)" is in the field. If you navigated here while importing a trace data file, "Trace Data (\*.csv)" is in the field. For some file types, there is more than one choice in the dropdown menu, which you can select by using the up and down arrow keys and Enter.

#### Up One Level

This key corresponds to the icon of a folder with the up arrow that is in the tool bar of the dialog. When pressed, it causes the file and folder list to navigate up one level in the directory structure. The Backspace key does the same thing.

#### Cancel

This key corresponds to the Cancel selection in the dialog. It causes the current **Open** request to be cancelled. The ESC key does the same thing.

Key Path	Recall, State
Notes	Brings up the Open dialog for recalling a State Save Type
Initial S/W Revision	Prior to A.02.00

### Edit Register Names

You may enter a custom name on any of the Register keys, to help you remember what you are using that state to save. To do this, press the Edit Register Names key, choose the register whose name you wish to edit, and then enter the desired label using the Alpha Editor or an external PC keyboard.

The maximum number of characters that can be added is 30. In most cases, 30 characters will fit on two lines of the key.

For more information and the SCPI command, see Edit Register Names under the Save, State function.

Key Path	Recall, State
Mode	All
Dependencies	N9060A-7FP or N9060B-2FP license required to edit the register names. When the feature is not licensed, sending the SCPI command generates an error, -221, "Settings conflict;Option not available"
Initial S/W Revision	A.11.00

### Register 1 thru Register 16

Selecting any one of these register keys causes the State of the mode from the specified Register to be recalled. Each of the register keys annotates whether it is empty or at what date and time it was last

modified. In addition, you can use the Edit Register Names key under Save, State to enter custom names for each register.

Registers are shared by all modes, so recalling from any one of the registers will cause a mode switch to the mode that was active when the save to the Register occurred.

Although these 16 registers are the only registers available from the front panel, there are 128 state registers available in the instrument. Registers 17–128 are only available from the SCPI interface, using the \*RCL command.

After the recall completes, the message "Register <register number> recalled" appears in the message bar. If you are in the Spectrum Analyzer Mode, and you are recalling a register that was saved in the Spectrum Analyzer Mode, then after the recall, you will still be in the Recall Register menu. If the Recall causes you to switch modes, then after the Recall, you will be in the Frequency menu.

If a requested register is empty an error is generated.

<b>Key Path</b>	Recall, State
<b>Example</b>	*RCL 1
<b>Range</b>	1–16 from front panel, 1–128 from SCPI
<b>Readback</b>	Date and time with seconds resolution are displayed on the key OR A custom name of up to 30 characters entered using the Save, State, Edit Register Names key OR “(empty)” if no prior save operation has been performed to this register.
<b>Initial S/W Revision</b>	Prior to A.02.00
<b>Modified at S/W Revision</b>	Prior to A.11.00

## Register 1 thru Register 16

Selecting any one of these register keys causes the State of the mode from the specified Register to be recalled. Each of the register keys annotates whether it is empty or at what date and time it was last modified. In addition, you can use the Edit Register Names key under Save, State to enter custom names for each register.

Registers are shared by all modes, so recalling from any one of the registers will cause a mode switch to the mode that was active when the save to the Register occurred.

Although these 16 registers are the only registers available from the front panel, there are 128 state registers available in the instrument. Registers 17–128 are only available from the SCPI interface, using the \*RCL command.

After the recall completes, the message "Register <register number> recalled" appears in the message bar. If you are in the Spectrum Analyzer Mode, and you are recalling a register that was saved in the Spectrum Analyzer Mode, then after the recall, you will still be in the Recall Register menu. If the Recall causes you to switch modes, then after the Recall, you will be in the Frequency menu.

If a requested register is empty an error is generated.

Key Path	Recall, State
<b>Example</b>	*RCL 1
Range	1-16 from front panel, 1-128 from SCPI
Readback	Date and time with seconds resolution are displayed on the key OR A custom name of up to 30 characters entered using the Save, State,Edit Register Names key OR “(empty)” if no prior save operation has been performed to this register.
Initial S/W Revision	Prior to A.02.00
Modified at S/W Revision	Prior to A.11.00

### Trace (+State)

The Recall Trace (+State) menu lets you choose a register or file from which to recall the Trace+State state file.

A saved state contains all of the settings and data required to return the analyzer as closely as possible to the exact setup it had when the save occurred. This includes the Input/Output settings, even though they are outside of the Mode’s state, because they are needed to restore the complete setup. A Trace+State file also includes trace data from one trace or all traces, which will load in View mode when the Trace+State file is recalled. Recall Trace (+State) will also cause a mode switch if the state being recalled is not for the current active mode.

After the recall completes, the message "File <filename> recalled" or “Recalled Trace Register <register number>” is displayed.

For rapid recalls, the Trace (+State) menu lists 5 registers to choose from to recall. Pressing a Register key initiates the recall. You can also select a file from which to recall.

The default path for all State Files including .trace files is:

My Documents\<mode name>\state

where <mode name> is the parameter used to select the mode with the INST:SEL command (for example, SA for the Spectrum Analyzer).

Key Path	Recall
Mode	SA
<b>Remote Command</b>	:MMEMory:LOAD:TRACe TRACE1   TRACE2   TRACE3   TRACE4   TRACE5   TRACE6,<filename>  :MMEMory:LOAD:TRACe:REGister TRACE1   TRACE2   TRACE3   TRACE4   TRACE5   TRACE6,<integer>
<b>Example</b>	MMEM:LOAD:TRAC TRACE2, "MyTraceFile.trace" This loads the trace file data (on the default file directory path) into the specified trace; if it is a "single trace" save file, that trace is loaded to trace 2, and is set to be not updating. :MMEM:LOAD:TRAC:REG TRACE1,2

	restores the trace data in register 2 to Trace 1
Notes	<p>When you perform the recall, the recalling Trace function must first verify the file is recallable in this instrument by checking instrument software version and model number, since it includes State. If everything matches, a full recall proceeds by aborting the currently running measurement, and loading the state from the saved state file to as close as possible to the context in which the save occurred. You can open .trace files from any mode that supports them, so recalling a Trace file switches to the mode that was active when the save occurred. After switching to the mode of the saved state file, mode settings and data (if any for the mode) are loaded with values from the saved file and the saved measurement of the mode becomes the newly active measurement, and the data relevant to the measurement (if there is any) is recalled.</p> <p>Once the state is loaded, the trace data must be loaded. The internal flags are consulted to see which trace to load and the "To Trace" setting to see where to load it. Trace data is always loaded with the specified trace set to View, so that the data is visible and not updating (so as not to erase the recalled data). If the file is an "all trace" file, all traces are loaded with the saved data (to the original trace the data was saved from) and set to View. Traces whose data is not loaded are restored to the update state that existed when they were saved.</p> <p>After the Recall the analyzer exits the Recall menu and returns to the previous menu.</p> <p>Some modes and measurements do not have available all 6 traces. Phase Noise mode command, for example, is: <code>MMEMoRY:LOAD:TRACe TRACE1 TRACE2 TRACE3,&lt;filename&gt;</code></p> <p>Some modes and measurements have more than 6 traces available. The Realtime SA mode command, for example, is: <code>MMEMoRY:STORe:TRACe TRACE1   TRACE2   TRACE3   TRACE4   TRACE5   TRACE6   TRACE7   TRACE8   TRACE9   TRACE10   TRACE11   TRACE12   ALL,&lt;filename&gt;</code></p>
Initial S/W Revision	Prior to A.02.00

## To Trace

These menu selections let you choose the Trace where the recalled saved trace will go. Not all modes have the full 6 traces available. The default is the currently selected trace, selected in this menu or in the Trace/Detector, Export Data, Import Data, or Save Trace menus, except if you have chosen All, then it remains chosen until you specifically change it to a single trace.

If the .trace file is an "all trace" file, "To Trace" is ignored and the traces each go back to the trace from which they were saved.

Once selected, the key returns back to the Recall Trace menu and the selected Trace number is annotated on the key. Now you have selected exactly where the trace needs to be recalled. To trigger a recall of the selected Trace, you must select the Open key in the Recall Trace menu.

When you select a trace, it makes that trace the current trace, so it displays on top of all of the other traces.

Key Path	Save, Data, Trace
Mode	SA
Initial S/W Revision	Prior to A.02.00



## Register 1 thru Register 16

Selecting any one of these register keys causes the State of the mode from the specified Register to be recalled. Each of the register keys annotates whether it is empty or at what date and time it was last modified. In addition, you can use the Edit Register Names key under Save, State to enter custom names for each register.

Registers are shared by all modes, so recalling from any one of the registers will cause a mode switch to the mode that was active when the save to the Register occurred.

Although these 16 registers are the only registers available from the front panel, there are 128 state registers available in the instrument. Registers 17–128 are only available from the SCPI interface, using the \*RCL command.

After the recall completes, the message "Register <register number> recalled" appears in the message bar. If you are in the Spectrum Analyzer Mode, and you are recalling a register that was saved in the Spectrum Analyzer Mode, then after the recall, you will still be in the Recall Register menu. If the Recall causes you to switch modes, then after the Recall, you will be in the Frequency menu.

If a requested register is empty an error is generated.

Key Path	Recall, State
<b>Example</b>	*RCL 1
Range	1–16 from front panel, 1–128 from SCPI
Readback	Date and time with seconds resolution are displayed on the key OR A custom name of up to 30 characters entered using the Save, State, Edit Register Names key OR “(empty)” if no prior save operation has been performed to this register.
Initial S/W Revision	Prior to A.02.00
Modified at S/W Revision	Prior to A.11.00

## From File...

When you press “From File”, the analyzer brings up a Windows dialog and a menu entitled “File Open.” This menu allows you to navigate to the various fields in the Windows dialog without using a keyboard or mouse. The Tab and Arrow keys can also be used for dialog navigation.

## 11 Power vs Time Recall

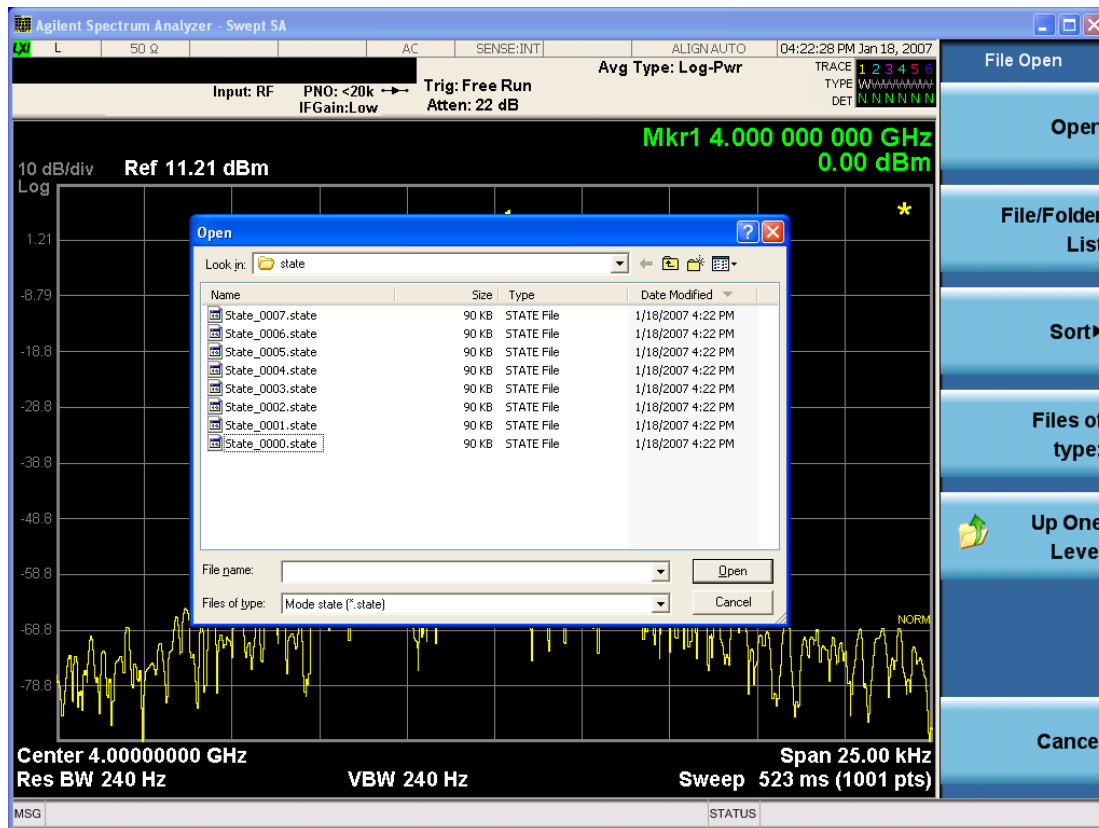

Listed below are the functions of the various fields in the dialog, and the corresponding softkeys:

### Open

Performs the recall of the specified file. While the recall is being performed, the floppy icon appears briefly in the Meas bar.

### File/Folder List

Enables you to navigate to the center of the dialog that contains the list of files and folders. Once here you can get information about the file and use the tab keys to navigate to the other fields in the dialog, such as Look In.

### Look In

The Look In field shows the path from which the file will be recalled and allows you to change the path using the up and down arrow keys to navigate to other paths; the Enter key to open a directory; and the Backspace key to go back one directory. The **Look In field** first uses the last path from the Save As dialog **Save In:** path for that same file type. There is no softkey for directly navigating to the Look In field, but you can use the left tab to get here from the File/Folder List.

User specified paths are remembered when you leave and return to a Mode and are reset back to the default using Restore Mode Defaults.

### Sort

Accesses a menu that enables you to sort the files within the File Open dialog. Only one sorting type can be selected at a time and the sorting happens immediately. The sorting types are By Date, By Name, By extension, and By Size.

#### Files of Type

This field shows the file suffix for the type of file you have selected to recall. For example, if you navigated here while recalling State, "Mode state (\*.state)" is in the field. If you navigated here while recalling Trace, ""Mode state (\*.trace)" is in the field. If you navigated here while importing a trace data file, "Trace Data (\*.csv)" is in the field. For some file types, there is more than one choice in the dropdown menu, which you can select by using the up and down arrow keys and Enter.

#### Up One Level

This key corresponds to the icon of a folder with the up arrow that is in the tool bar of the dialog. When pressed, it causes the file and folder list to navigate up one level in the directory structure. The Backspace key does the same thing.

#### Cancel

This key corresponds to the Cancel selection in the dialog. It causes the current **Open** request to be cancelled. The ESC key does the same thing.

Key Path	Recall, State
Notes	Brings up the Open dialog for recalling a State Save Type
Initial S/W Revision	Prior to A.02.00

## Data (Import)

Importing a data file loads data that was previously saved from the current measurement or from other measurements and/or modes that produce compatible data files. The Import Menu only contains Data Types that are supported by the current measurement.

Since the commonly exported data files are in .csv format, the data can be edited by the user prior to importing. This allows you to export a data file, manipulate the data in Excel (the most common PC Application for manipulating .csv files) and then import it.

Importing Data loads measurement data from the specified file into the specified or default destination, depending on the data type selected. Selecting an Import Data menu key will not actually cause the importing to occur, since the analyzer still needs to know from where to get the data. Pressing the Open key in this menu brings up the Open dialog and Open menu that provides you with the options from where to recall the data. Once a filename has been selected or entered in the Open menu, the recall occurs as soon as the Open button is pressed.

Key Path	Recall
Mode	All
Notes	The menu is built from whatever data types are available for the mode. Some keys will be missing completely, so the key locations in the sub-menu will vary. No SCPI command directly controls the Data Type that this key controls. The Data Type is included in the MMEM:LOAD commands.

Dependencies	If a file type is not used by a certain measurement, it is grayed out for that measurement. The key for a file type will not show at all if there are no measurements in the Mode that support it.
Preset	Is not affected by Preset or shutdown, but is reset during Restore Mode Defaults
Readback	The data type that is currently selected
Initial S/W Revision	Prior to A.02.00

## Capture Buffer

The captured data is raw data which is not processed.

Key Path	Recall, Data
Mode	<b>CDMA1XEV</b>
Example	MMEM:LOAD:CAPT "MyCaptureData.bin" This loads the file of capture data (on the default file directory path) into the instrument.
Dependencies	In case the capture buffer data is not available from the selected measurement, the key will be grayed out.
Initial S/W Revision	A.11.00

## Open...

When you press "Open", the analyzer brings up a Windows dialog and a menu entitled "**File Open.**" This menu allows you to navigate to the various fields in the Windows dialog without using a keyboard or mouse. The Tab and Arrow keys can also be used for dialog navigation.

See "[From File...](#)" on page 2890 in Recall, State, for a full description of this dialog and menu.

Key Path	Recall, Data
Notes	The key location is mode-dependent and will vary. Brings up Open dialog for recalling a <mode specific> Save Type
Initial S/W Revision	Prior to A.02.00

## Restart

The Restart function restarts the current sweep, or measurement, or set of averaged/held sweeps or measurements. If you are Paused, pressing Restart does a Resume.

The Restart function is accessed in several ways:

- Pressing the Restart key
- Sending the remote command INIT:IMMEDIATE
- Sending the remote command INIT:RESTART

See "[More Information](#)" on page 1121

Key Path	Front-panel key
Remote Command	:INITiate[:IMMEDIATE] :INITiate:RESTART
Example	:INIT:IMM :INIT:REST
Notes	:INITiate:RESTART and :INITiate:IMMEDIATE perform exactly the same function.
Couplings	Resets average/hold count k. For the first sweep overwrites all active (update=on) traces with new current data. For application modes, it resets other parameters as required by the measurement.
Status Bits/OPC dependencies	This is an Overlapped command. The STATUS:OPERation register bits 0 through 8 are cleared. The STATUS:QUESTIONable register bit 9 (INTEgrity sum) is cleared. The SWEEPING bit is set. The MEASURING bit is set.
Backwards Compatibility Notes	For Spectrum Analysis mode in ESA and PSA, the Restart hardkey and the INITiate:RESTART command restart trace averages (displayed average count reset to 1) for a trace in Clear Write, but did not restart Max Hold and Min Hold. In the X-Series, the Restart hardkey and the INITiate:RESTART command restart not only Trace Average, but MaxHold and MinHold traces as well. For wireless comms modes in ESA and PSA, the Restart hardkey and the INITiate:RESTART command restart every measurement, which includes all traces and numeric results. There is no change to this operation.
Initial S/W Revision	Prior to A.02.00

### More Information

The **Restart** function first aborts the current sweep/measurement as quickly as possible. It then resets the sweep and trigger systems, sets up the measurement and initiates a new data measurement sequence with a new data acquisition (sweep) taken once the trigger condition is met.

If the analyzer is in the process of aligning when **Restart** is executed, the alignment finishes before the restart function is performed.

Even when set for Single operation, multiple sweeps may be taken when Restart is pressed (for example, when averaging/holding is on). Thus when we say that **Restart** "restarts a measurement," we may mean:

- It restarts the current sweep
- It restarts the current measurement
- It restarts the current set of sweeps if any trace is in Trace Average, Max Hold or Min Hold
- It restarts the current set of measurements if Averaging, or Max Hold, or Min Hold is on for the measurement
- depending on the current settings.

With **Average/Hold Number** (in **Meas Setup** menu) set to 1, or Averaging off, or no trace in Trace Average or Hold, a single sweep is equivalent to a single measurement. A single sweep is taken after the trigger condition is met; and the analyzer stops sweeping once that sweep has completed. However, with **Average/Hold Number** >1 and at least one trace set to **Trace Average, Max Hold, or Min Hold (SA Measurement)** or **Averaging on (most other measurements)**, multiple sweeps/data acquisitions are taken for a single measurement. The trigger condition must be met prior to each sweep. The sweep is stopped when the average count  $k$  equals the number  $N$  set for **Average/Hold Number**. A measurement average usually applies to all traces, marker results, and numeric results; but sometimes it only applies to the numeric results.

Once the full set of sweeps has been taken, the analyzer will go to idle state. To take one more sweep without resetting the average count, increment the average count by 1, by pressing the step up key while **Average/Hold Number** is the active function, or sending the remote command CALC:AVER:TCON UP.

## Save

The Save menu lets you choose what you want to save and where you want to save it. Among the types of files you can save are **States**, **Traces**, and **Screen Images**. In addition, an Export (Data) option lets you save a number of data types as CSV files for easy import into Excel and other spreadsheet programs.

Key Path	Front-panel key
Mode	All
Notes	No remote command for this key specifically, but the :MMEM:STORe command is available for specific file types. An example is :MMEM:STOR:STATe <filename>.
Initial S/W Revision	Prior to A.02.00

## State

The Save State menu lets you choose a register or file for saving the state.

The content of a state file includes all of the settings and data required to return the analyzer as closely as possible to the Mode it was in, with the exact settings which were in place, when the save occurred. The Mode settings in each state file include the settings that are affected by Mode Preset, as well as the additional settings affected by Restore Mode Defaults; all of the Mode's settings. In addition, all of the settings of the Input/Output system are included, even though they are outside of the Mode's state, because they are needed to restore the complete setup. Persistent System settings (for example, Verbose SCPI) are not affected by either Mode Preset or Restore Mode Defaults, nor are they included in a saved State file.

After the save completes, the message "File <filename> saved" or "State Register <register number> saved" is displayed.

For rapid saving, the State menu lists 16 registers to save to. Pressing a Register key initiates the save. You can also select a file to save to.

The default path for all State Files is:

My Documents\<>mode name>\state

where <mode name> is the parameter used to select the mode with the INST:SEL command (for example, SA for the Spectrum Analyzer).

Key Path	Save
Mode	All
Remote Command	:MMEMory:STORe:STATe <filename>
Example	MMEM:STOR:STATe "MyStateFile.state" This stores the current instrument state data in the file MyStateFile.state in the default directory.
Notes	Both single and double quotes are supported for any filename parameter over remote. After saving to a register, that register's menu key is updated with the date the time, unless a custom label has been entered for that key. After saving to a register, you remain in the Save State menu, so that you can see the Register key

update. After saving to a file, the analyzer automatically returns to the previous menu and any Save As dialog goes away.

**Backwards Compatibility SCPI** :MMEMory:STORe:STATe 1,<filename>

For backwards compatibility, the above syntax is supported. The "1" is simply ignored. The command is sequential.

Initial S/W Revision Prior to A.02.00

### To File . . .

When you press “To File”, the analyzer brings up a Windows dialog and a menu entitled “Save As.” This menu allows you to navigate to the various fields in the Windows dialog without using a keyboard or mouse. The Tab and Arrow keys can also be used for dialog navigation.

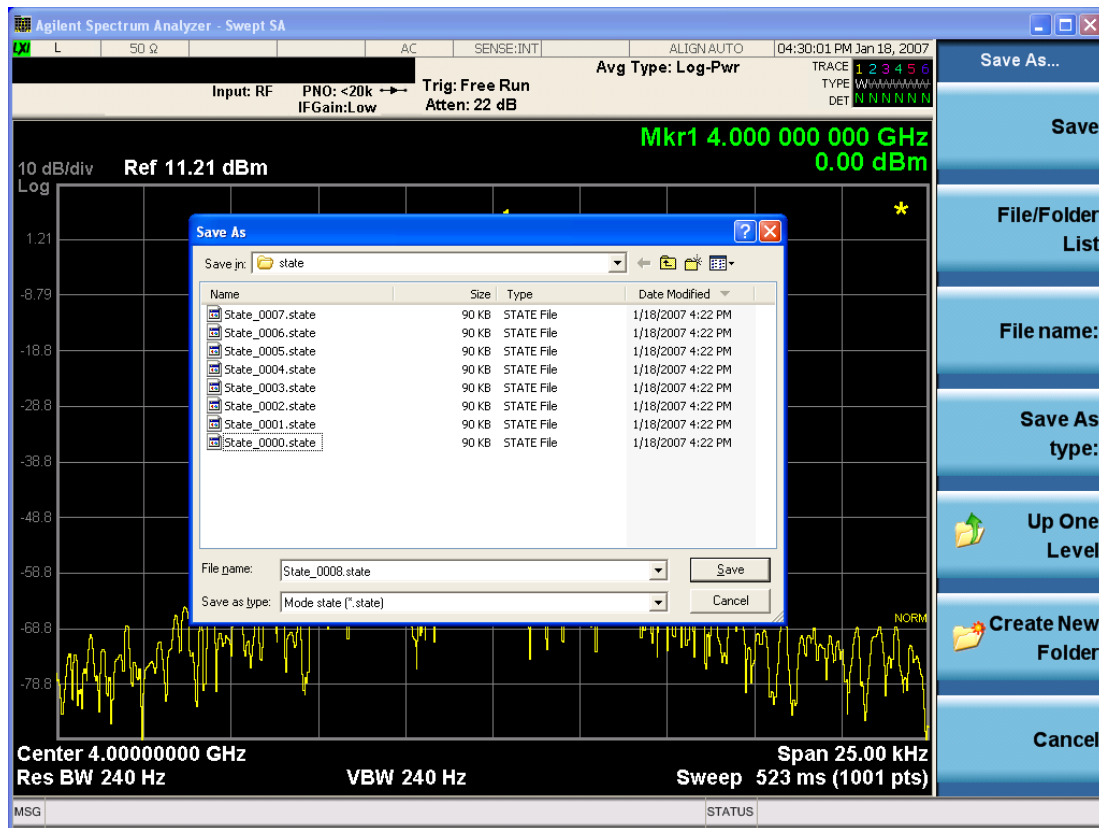

The Listed below

are the functions of the various fields in the dialog, and the corresponding softkeys:

#### Save

Performs the save to the specified file of the selected type. If the file already exists, a dialog will appear that allows you to replace the existing file by selecting OK, or you can Cancel the request. If you select OK, the file will be overwritten. Using the C: drive is strongly discouraged, since it runs the risk of being overwritten during an instrument software upgrade.

While the save is being performed, the floppy icon appears briefly in the Meas bar.



## File/Folder List

Enables you to navigate to the center of the dialog that contains the list of files and folders. Once here you can get information about the file and use the tab keys to navigate to the other fields in the dialog, such as Save In.

## Save In

The Save In field shows the path to which the file will be saved and allows you to change the path using the up and down arrow keys to navigate to other paths; the Enter key to open a directory; and the Backspace key to go back one directory. The **Save In field** defaults to the default path for this type of file and remembers the last path you used to save this type of file. There is no softkey for directly navigating to the Save In field but you can use left tab to get here from the File/Folder List.

User specified paths are remembered when you leave and return to a Mode and are reset back to the default using Restore Mode Defaults.

## File Name

The File Name field is initially loaded with an automatically generated filename specific to the appropriate Save Type. The automatically generated filename is guaranteed not to conflict with any filename currently in the directory. You may replace or modify this filename using the File Name key. See the ["Quick Save " on page 2880](#) documentation for more on the automatic file naming algorithm.

When you press the File Name key the analyzer displays the Alpha Editor. Use the knob to choose the letter to add and the front-panel Enter key to add the letter to the file name. The BK character moves you back and the FW character moves you forward in the filename. The Select key on the front panel generates a space character. When you are done entering the filename press the Done softkey. This returns back to the **File Open** dialog and menu, but does not cause the save to occur.

## Save As Type

This field shows the file suffix for the type of file you have selected to save. For example, if you navigated here while saving State, "Mode state (\*.state)" is in the field. If you navigated here from saving Trace, ""Mode state (\*.trace)" is in the field. If you navigated here while exporting a trace data file, "Trace Data (\*.csv)" is in the field. For some file types, there is more than one choice in the dropdown, which you can select by using the up and down arrow keys and Enter.

## Up One Level

This key corresponds to the icon of a folder with the up arrow that is in the tool bar of the dialog. When pressed, it causes the file and folder list to navigate up one level in the directory structure. The Backspace key does the same thing.

## Create New Folder

This key corresponds to the icon of a folder with the "\*" that is in the tool bar of the dialog. When pressed, a new folder is created in the current directory with the name **New Folder** and you can enter a new folder name using the Alpha Editor.

## Cancel

This key corresponds to the Cancel selection in the dialog. It causes the current **Save As** request to be cancelled. The ESC key does the same thing.

Key Path	Save, State
Mode	All
Notes	Brings up Save As dialog for saving a State Save Type
Initial S/W Revision	Prior to A.02.00

## Edit Register Names

You may enter a custom name on any of the Register keys, to help you remember what you are using that state to save. To do this, press the Edit Register Names key, choose the register whose name you wish to edit, and then enter the desired label using the Alpha Editor or an external PC keyboard.

The maximum number of characters that can be added is 30. In most cases, 30 characters will fit on two lines of the key.

See ["More Information" on page 1126](#)

Key Path	Save, State
Mode	All
<b>Remote Command</b>	:MMEMory:REGister:STATe:LABel <reg number>,"label" :MMEMory:REGister:STATe:LABel? <reg number>
<b>Example</b>	:MMEM:REG:STAT:LAB 1,"my label"
Notes	<reg number> is an integer from 1 to 16. If the SCPI specifies an invalid register number an error message is generated, -222,"Data out of range;Invalid register label number" "label" is a string from 0 to 30 characters in length. If a label exceeds 30 characters, an error message is generated, -150,"String data error;Label clipped to 30 characters" "label" of length 0 erases the custom label and restores the default (time and date) label. E.g.: :MMEM:REG:STAT:LAB 1,""
Dependencies	N9060A-7FP or N9060B-2FP license required to edit the register names. When the feature is not licensed, sending this command generates an error, -221,"Settings conflict;Option not available"
Preset	The names are unaffected by Preset or power cycle but are set to the default label (time and date) on a "Restore System Defaults->Misc"
Initial S/W Revision	A.11.00

## More Information

When you edit one of the register names, the time and date field will be replaced by the custom name.

If you delete all the characters in the custom name, it restores the default (time and date).

The register names are stored within the state files, but they are not part of the instrument state; that is, once you have edited a register name, loading a new state will not change that register name. Another consequence of this is that the names will be persistent through a power cycle. Also, if a named state file is transferred to another analyzer, it will bring its custom name along with it.

If you try to edit the name of an empty register, the analyzer will first save the state to have a file to put the name in. If you load a named state file into an analyzer with older firmware it will ignore the metadata.

The \*SAV and \*RCL commands will not be affected by the custom register names, nor will the MMEM commands.

### Register 1 thru Register 16

Selecting any one of these register menu keys causes the State of the currently active mode to be saved to the specified Register. The registers are provided for rapid saving and recalling, since you do not need to specify a filename or navigate to a file. Each of the register menu keys annotates whether it is empty or at what date and time it was last modified. In addition, you can use the Edit Register Names key to enter custom names for each register.

Although these 16 registers are the only registers available from the front panel, there are 128 state registers available in the instrument. Registers 17–128 are only available from the SCPI interface, using the \*SAV command.

There is one set of 128 state registers in the instrument, not one set for each Mode. When a state is saved, the Mode it was saved from is saved with it; then when it is recalled, the instrument switches to that Mode.

After the save completes, the corresponding register menu key annotation is updated with the date and time and the message "Register <register number> saved" is displayed.

Key Path	Save, State
Mode	All
<b>Example</b>	*SAV 1
Range	1–16 from front panel, 1–128 from SCPI
Readback	Date and time with seconds resolution are displayed on the key OR A custom name of up to 30 characters entered using the Edit Register Names key OR “(empty)” if no prior save operation has been performed to this register.
Initial S/W Revision	Prior to A.02.00
Modified at S/W Revision	A.11.00

### Register 1 thru Register 16

Selecting any one of these register menu keys causes the State of the currently active mode to be saved to the specified Register. The registers are provided for rapid saving and recalling, since you do not need to specify a filename or navigate to a file. Each of the register menu keys annotates whether it is empty or at what date and time it was last modified. In addition, you can use the Edit Register Names key to enter custom names for each register.

Although these 16 registers are the only registers available from the front panel, there are 128 state registers available in the instrument. Registers 17–128 are only available from the SCPI interface, using the \*SAV command.

There is one set of 128 state registers in the instrument, not one set for each Mode. When a state is saved, the Mode it was saved from is saved with it; then when it is recalled, the instrument switches to that Mode.

After the save completes, the corresponding register menu key annotation is updated with the date and time and the message "Register <register number> saved" is displayed.

Key Path	Save, State
Mode	All
Example	*SAV 1
Range	1-16 from front panel, 1-128 from SCPI
Readback	Date and time with seconds resolution are displayed on the key OR A custom name of up to 30 characters entered using the Edit Register Names key OR “(empty)” if no prior save operation has been performed to this register.
Initial S/W Revision	Prior to A.02.00
Modified at S/W Revision	A.11.00

## Data (Export)

Exporting a data file stores data from the current measurement to mass storage files. The Export Menu only contains data types that are supported by the current measurement.

Since the commonly exported data files are in .csv format, the data can be edited by you prior to importing. This allows you to export a data file, manipulate the data in Excel (the most common PC Application for manipulating .csv files) and then import it.

Selecting an Export Data menu key will not actually cause the exporting to occur, since the analyzer still needs to know where you wish to save the data. Pressing the Save As key in this menu brings up the Save As dialog and Save As menu that allows you to specify the destination file and directory. Once a filename has been selected or entered in the Open menu, the export will occur as soon as the Save key is pressed.

Key Path	Save
Mode	All
Notes	The menu is built from whatever data types are available for the mode. So the key locations in the sub menu will vary.  No SCPI command directly controls the Data Type that this key controls. The Data Type is included in the MMEM:STORe commands.
Dependencies	If a file type is not used by a certain measurement, that type is grayed out for that measurement. The key for a file type will not show at all if there are no measurements in the Mode that support it.
Preset	Is not affected by a Preset or shutdown, but is reset during Restore Mode Defaults
Readback	The data type that is currently selected
Initial S/W Revision	Prior to A.02.00

## Measurement Results

Pressing this key selects Meas Results as the data type to be exported. Pressing the key a second time brings up the Meas Results menu, which allows you to select which **Meas Result** to save. In the Swept SA measurement, there are three types of Measurement Results files: Peak Table, Marker Table and Spectrogram.

See "Meas Results File Contents" on page 1129.

See "Marker Table" on page 1129.

See "Peak Table" on page 1132.

See "Spectrogram" on page 1135

<b>Remote Command</b>	:MMEMory:STORe:RESults:MTABle PTABle SPEctrogram <filename>
<b>Example</b>	:MMEM:STOR:RES:MTAB "myResults.csv" Saves the results from the current marker table to the file myResults.csv in the current path. :MMEM:STOR:RES:PTAB "myResults.csv" Saves the results from the current peak table to the file myResults.csv in the current path. :MMEM:STOR:RES:SPEC "myResults.csv" Saves the results from the current Spectrogram display to the file myResults.csv in the current path. The default path is My Documents\SA\data\SAN\results
<b>Notes</b>	If the save is initiated via SCPI, and the file already exists, the file will be overwritten. Using the C: drive is strongly discouraged, since it runs the risk of being overwritten during an instrument software upgrade. Both single and double quotes are supported for any filename parameter over SCPI.
<b>Dependencies</b>	If a save of Marker Table results is requested and the Marker Table is not on, no file is saved and a message is generated If a save of Peak Table results is requested and the Peak Table is not on, no file is saved and a message is generated If a save of Spectrogram results is requested and the Spectrogram is not on, no file is saved and a message is generated. The Spectrogram choice only appears if option EDP is licensed.
<b>Preset</b>	Not part of Preset, but is reset to Peak Table by Restore Mode Defaults. Survives a shutdown.
<b>Initial S/W Revision</b>	Prior to A.02.00

## Meas Results File Contents

All files are .csv files. The following section details the data in each file type.

### Marker Table

This section discusses the Marker Table Meas Results file format.

Imagine that, at the point where a Marker Table Meas Result is requested, the following screen is showing:

11 Power vs Time  
Save

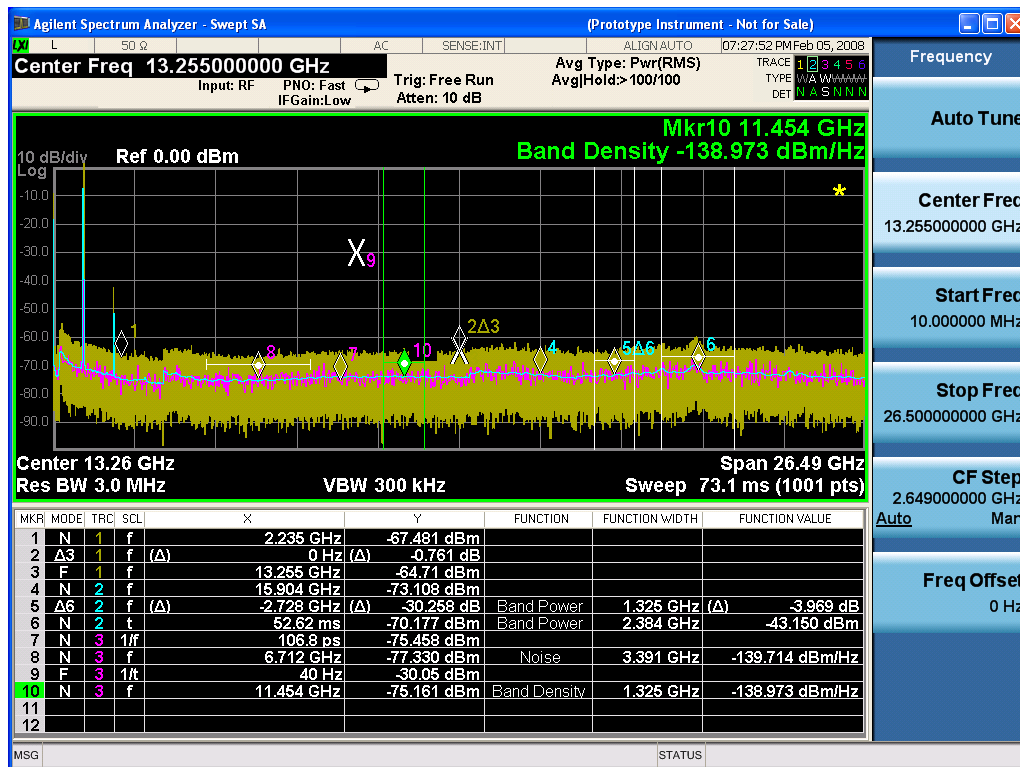

Then the Meas Results file, when opened, would show the following data:

MeasurementResult	
Swept SA	
A.01.40_R0017	N9020A
526 B25 PFR	1
P26 EA3	
Result Type	Marker Table
Ref Level	0
Number of Points	1001
Sweep Time	0.0662666 67
Start Frequency	10000000
Stop Frequency	26500000 000
Average Count	0
Average Type	LogPower (Video)
RBW	3000000

RBW Filter	Gaussian
RBW Filter BW	3dB
VBW	3000000
Sweep Type	Swept
X Axis Scale	Lin
PreAmp State	Off
PreAmp Band	Low
Trigger Source	Free
Trigger Level	1.2
Trigger Slope	Positive
Trigger Delay	1.00E-06
Phase Noise Optimization	Fast
Swept If Gain	Low
FFT If Gain	Autorange
RF Coupling	AC
FFT Width	411900
Ext Ref	10000000
Input	RF
RF Calibrator	Off
Attenuation	10
Ref Level Offset	0
External Gain	0
X Axis Units	Hz
Y Axis Units	dBm

DATA									
MKR	MODE	TR C	SCL	X	Y	FUNCTI ON	FUNCTIO N WIDTH	FUNCTI ON VALUE	FUNCTI ON UNIT
1	Normal	1	Freque ncy	2.2350E+09	- 67.481	Off	0.0000E+00	0	None
2	Delta3	1	Freque ncy	0.0000E+00	- 0.761	Off	0.0000E+00	0	None
3	Fixed	1	Freque ncy	1.3255E+10	- 64.71	Off	0.0000E+00	0	None
4	Normal	2	Freque ncy	1.5904E+10	- 73.1	Off	0.0000E+00	0	None

08									
5	Delta7	2	Frequ ncy	- 2.7280E+ 09	- 30.2 58	Band Power	1.3250E+ 06	-3.969	dB
6	Normal	2	Time	5.2620E- 02	- 70.1 77	Band Power	2.3840E+ 06	-43.15	dBm
7	Normal	3	Period	1.0680E- 10	- 75.4 58	Off	0.0000E+ 00	0	None
8	Normal	3	Frequ ncy	6.7120E+ 09	- 77.3 3	Noise	3.3910E+ 06	- 139.71 4	dBm/Hz
9	Fixed	3	Inverse Time	4.0000E+ 01	- 30.0 5	Off	0.0000E+ 00	0	None
10	Normal	3	Frequ ncy	1.1454E+ 10	- 75.1 61	Band Density	1.3250E+ 06	- 138.97 3	dBm/Hz
11	Off	1	Frequ ncy	0.0000E+ 00	0	Off	0.0000E+ 00	0	None
12	Off	1	Frequ ncy	0.0000E+ 00	0	Off	0.0000E+ 00	0	None

The numbers appear in the file exactly as they appear onscreen. If it says 11.454 GHz onscreen, then in the file it is 11.454E+09.

The metadata header is very similar to the metadata used in the trace data .csv files. See Trace File Contents. The only new information concerns the 1-of-N fields in the marker table itself.

### Peak Table

This section discusses the Peak Table Meas Results file format.

Imagine that, at the point where a Marker Table Meas Result is requested, the following screen is showing:



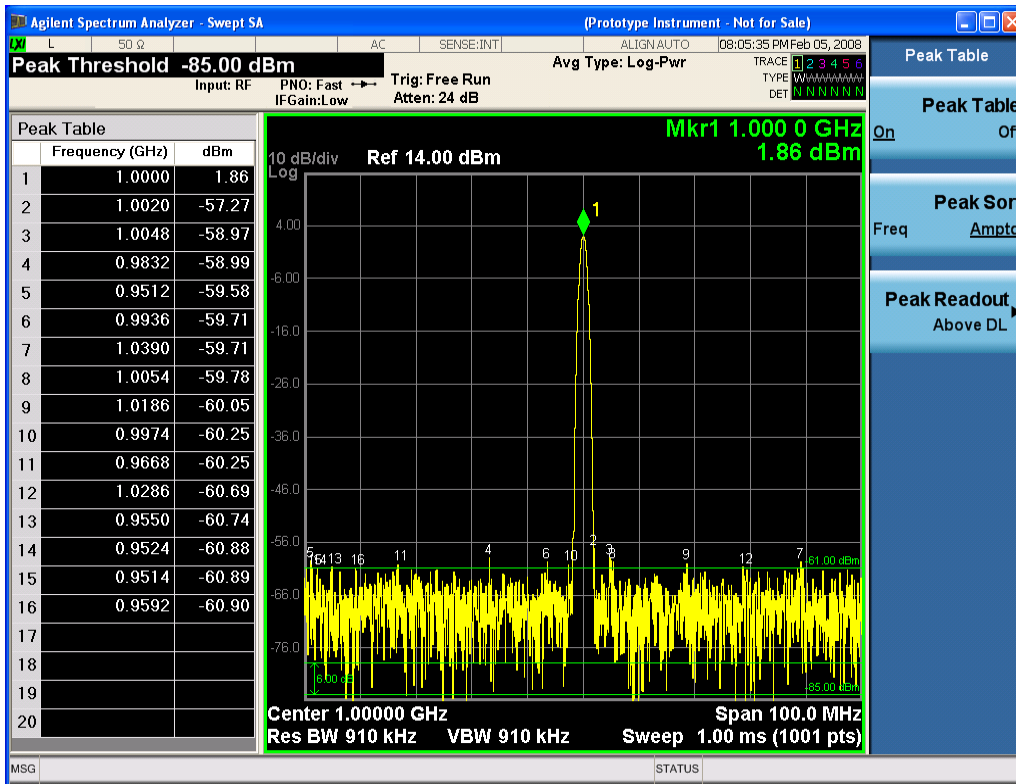

Then the Meas Results file, when opened, would show the header data (the same as for the Marker Table except that the Result Type is Peak Table) ending with a few fields of specific interest to Peak Table users:

- Peak Threshold
- Peak Threshold State (On|Off)
- Peak Excursion
- Peak Excursion State (On|Off)
- Display Line
- Peak Readout (All|AboveDL|BelowDL)
- Peak Sort (Freq|Amptd)

These fields are then followed by the data for the Peak Table itself.

Note that the label for the Frequency column changes to Time in 0 span.

Here is what the table for the above display looks like:

MeasurementResult	
Swept SA	
A.01.40_R0017	N9020A
526 B25 PFR P26 EA3	1

Result Type	Peak Table
Ref Level	0
Number of Points	1001
Sweep Time	0.066266667
Start Frequency	10000000
Stop Frequency	26500000000
Average Count	0
Average Type	LogPower(Video)
RBW	3000000
RBW Filter	Gaussian
RBW Filter BW	3dB
VBW	3000000
Sweep Type	Swept
X Axis Scale	Lin
PreAmp State	Off
PreAmp Band	Low
Trigger Source	Free
Trigger Level	1.2
Trigger Slope	Positive
Trigger Delay	1.00E-06
Phase Noise Optimization	Fast
Swept If Gain	Low
FFT If Gain	Autorange
RF Coupling	AC
FFT Width	411900
Ext Ref	10000000
Input	RF
RF Calibrator	Off
Attenuation	10
Ref Level Offset	0
External Gain	0
X Axis Units	Hz
Y Axis Units	dBm
Peak Threshold	-85
Peak Threshold State	On
Peak Excursion	6
Peak Excursion State	On

Display Line	-61	
Peak Readout	AboveDL	
Peak Sort	Amptd	
DATA		
Peak	Frequency	Amplitude
1	1.0000E+06	1.86
2	1.0020E+06	-57.27
3	1.0048E+06	-58.97
4	9.8320E+05	-58.99
5	9.5120E+05	-59.58
6	9.9360E+05	-59.71
7	1.0390E+06	-59.71
8	1.0054E+06	-59.78
9	1.1086E+06	-60.05
10	9.9740E+05	-60.25
11	9.6680E+05	-60.25
12	1.0286E+06	-60.69
13	9.5500E+05	-60.74
14	9.5240E+05	-60.88
15	9.5140E+05	-60.89
16	9.5920E+05	-60.90
17		
18		
19		
20		

## Spectrogram

This section discusses the Spectrogram Results file format. The Spectrogram choice only appears if option EDP is licensed.

The Spectrogram results are the same as a Trace data export, except that instead of having just one trace's data, all 300 traces appear one after the other.

Each trace has its own data mark; the data for Spectrogram Trace 0 follows the row marked DATA, the data for Spectrogram Trace 1 follows the row marked DATA1, for Spectrogram Trace 2 follows the row marked DATA2, and so on.

Each DATA row has a timestamp in the second column (as of firmware revision A.11.01). So, for example, if Trace 0 had a relative start time of 1729.523 sec, then the first DATA row would look like this:

DATA,1729.523

And if Trace 13 had a relative start time of 100.45 sec, then the fourteenth data row would look like:

DATA13,100.453

To find the absolute time for the relative timestamps of each trace, the last row before the first DATA row gives the absolute start time of the Spectrogram, in the form YYYYMMDDHHMMSS

So, for example, if the absolute start time is 13:23:45:678 on January 30, 2012, this row would look like:

Start Time,20120130132345678

**NOTE** The resolution of the absolute time stored is 1 ms, which matches up with the fact that the fastest sweep time is also 1 ms. However, there is no specification for the absolute accuracy of the clock in the analyzer, nor is there any facility provided to allow the user to set this time to any particular degree of accuracy.

Traces that have not yet been filled in the Spectrogram display are empty; there is no DATA header for them. The file ends after the last non-empty trace.

Imagine that, at the point where a Spectrogram Meas Result is requested, the following screen is showing:

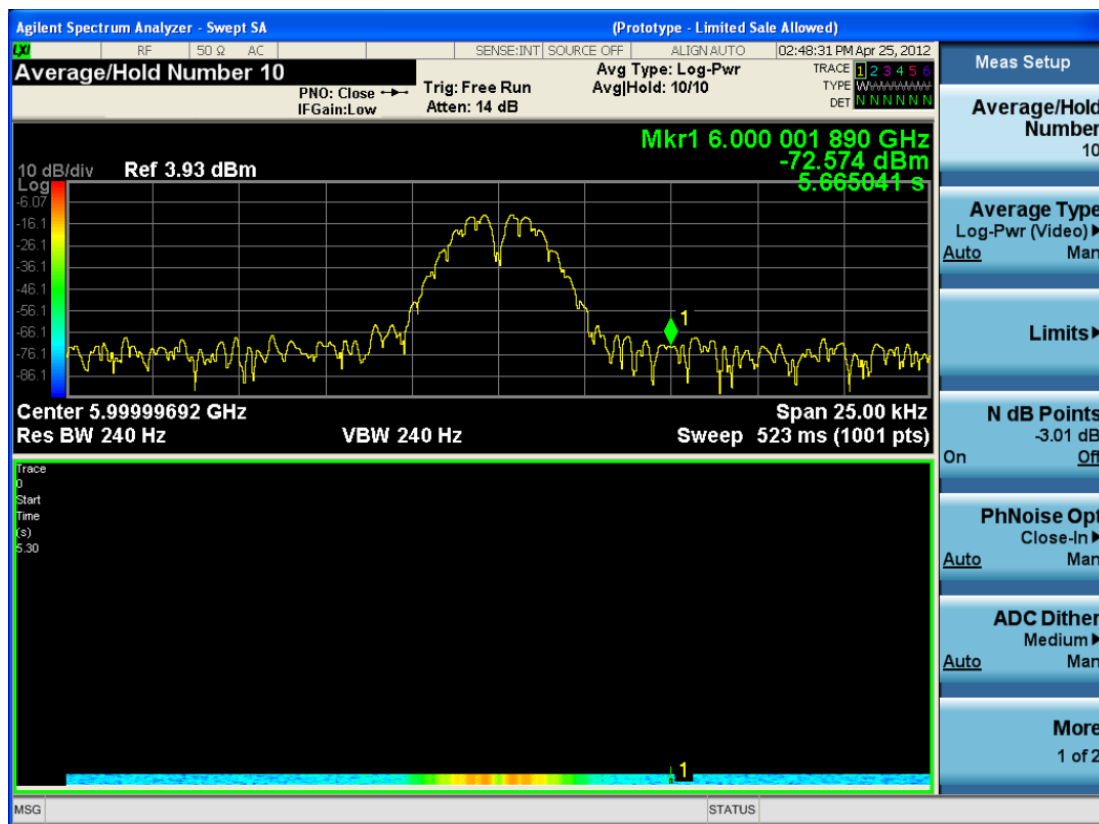

For the purpose of this example, we have set the Average/Hold Number to 10, thus we have only traces 0 thru 10. The Spectrogram was started at 02:28:08:700 pm on April 25, 2012 (that is, 700 ms after 2:28:08 pm), although the screen dump itself shows a different time, as it was taken ten minutes after the

Spectrogram data. Trace 0 is showing a start time of 5.30 seconds, meaning 5.3 seconds after the Spectrogram started (trace 10 has a start time of 0, as it was the first trace taken but has now rolled up into the tenth trace slot).

The Meas Results file, when opened, shows the header data and ten traces of trace data. Below is an extract from the result file for the above display. Note the start time of 20120425142808700 showing in the last row before the first DATA row, and the relative time of 5.299231048 showing in the first DATA row:

<b>Result Type</b>	<b>Spectrogram</b>
MeasResult	
Swept SA	
A.11.00.01	N9020A
503 508 513 526 ALL ALV B1C B1X B25 B2X B40 BAB BBA CR3 CRP DP2 DRD EA3 EDP EMC EP1 ERC ESC ESP EXM FSA HBA K03 LFE MPB P03 P08 P13 P26 PFR RTL RTS S40 SB1 SEC SM1 UK6 YAS YAV	1
Segment	0
Number of Points	1001
Sweep Time	0.523333333
Start Frequency	5999984415
Stop Frequency	6000009415
Average Count	0
Average Type	LogPower(Video)
RBW	240
RBW Filter	Gaussian
RBW Filter BW	3dB
VBW	240
Sweep Type	Swept
X Axis Scale	Lin
PreAmp State	Off
PreAmp Band	Low
Trigger Source	Free
Trigger Level	1.2
Trigger Slope	Positive
Trigger Delay	0
Phase Noise Optimization	Wide
Swept If Gain	Low
FFT If Gain	Autorange
RF Coupling	AC

Result Type	Spectrogram
FFT Width	411900
Ext Ref	10000000
Input	RF
RF Calibrator	Off
Attenuation	14
Ref Level Offset	0
External Gain	0
Trace Type	Clearwrite
Detector	Normal
Trace Math	Off
Trace Math Oper1	Trace5
Trace Math Oper2	Trace6
Trace Math Offset	0
Trace Name	Trace1
X Axis Units	Hz
Y Axis Units	dBm
Start Time	20120425142808700
DATA	5.299231048
5999984415	-76.34749519
5999984440	-77.28097006
5999984465	-75.32317869
5999984490	-73.64417681
5999984515	-72.67154604

o  
o  
o

6000009315	-77.94423277
6000009340	-79.51829697
6000009365	-78.46108961
6000009390	-78.46108957
6000009415	-76.59570596
DATA2	4.708697055
5999984415	-80.98197882
5999984440	-80.98197879

5999984465	-75.83142132
5999984490	-74.02712079
5999984515	-73.57213005

- 
- 
- 

6000009315	-75.9183103
6000009340	-79.53787488
6000009365	-78.82602191
6000009390	-78.82602188
6000009415	-76.37486709
DATA10	0
5999984415	-75.56751112
5999984440	-75.76485645
5999984465	-76.67718717
5999984490	-78.79238489
5999984515	-83.72680212

- 
- 
- 

6000009315	-71.3942461
6000009340	-72.28308332
6000009365	-73.92684489
6000009390	-75.45548832
6000009415	-75.17904815

### Capture Buffer

Capture Buffer functionality is not available for all measurements. The captured data is raw data which is not processed.

Key Path	Save, Data
----------	------------

Mode	CDMA1XEV
Example	MMEM:STOR:CAPT "MyCaptureData.bin" This stores the capture data in the file MyCaptureData.bin in the default directory.
Dependencies	In case the capture buffer data is not available from the selected measurement, the key will be grayed out.
Initial S/W Revision	A.11.00

## Save As . . .

When you press "Save As", the analyzer brings up a Windows dialog and a menu entitled "**Save As.**" This menu allows you to navigate to the various fields in the Windows dialog without using a keyboard or mouse. The Tab and Arrow keys can also be used for dialog navigation.

See "[To File . . .](#)" on page 2897 in Save, State for a full description of this dialog and menu.

The default path for saving files is:

For all of the Trace Data Files:

My Documents\<<mode name>\data\traces

For all of the Limit Data Files:

My Documents\<<mode name>\data\limits

For all of the Measurement Results Data Files:

My Documents\<<mode name>\data\<<measurement name>\results

For all of the Capture Buffer Data Files:

My Documents\<<mode name>\data\captureBuffer

Key Path	Save, Data
Mode	All
Notes	The key location is mode-dependent and will vary. Brings up the Save As dialog for saving a <mode specific> Save Type. The save is performed immediately and does not wait until the measurement is complete.
Initial S/W Revision	Prior to A.02.00

## Screen Image

Pressing Screen Image accesses a menu of functions that enable you to specify a format and location for the saved screen image. It brings up a menu that allows you to specify the color scheme of the Screen Image (Themes) or navigate to the Save As dialog to perform the actual save.

Screen Image files contain an exact representation of the analyzer display. They cannot be loaded back onto the analyzer, but they can be loaded into your PC for use in many popular applications.



The image to be saved is actually captured when the Save front panel key is pressed, and kept in temporary storage to be used if you ask for a Screen Image save. When the Screen Image key is pressed, a "thumbnail" of the captured image is displayed, as shown below:

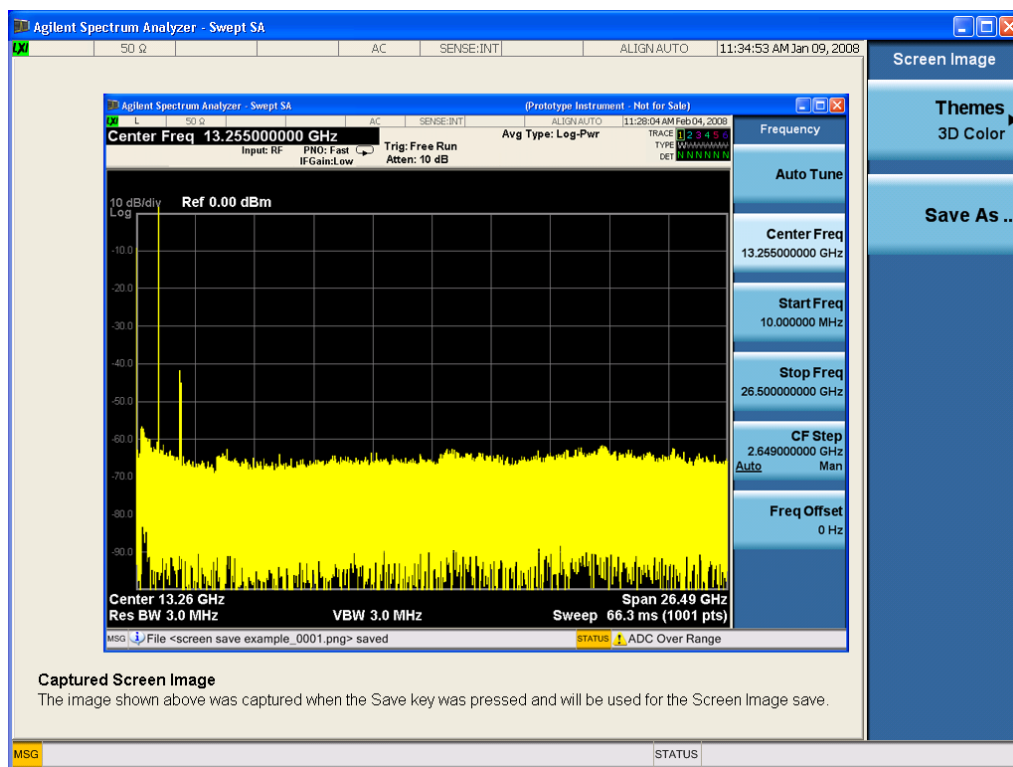

When you continue on into the Save As menu and complete the Screen Image save, the image depicted in the thumbnail is the one that gets saved, showing the menus that were on the screen before going into the Save menu. The save is performed immediately and does not wait until the measurement is complete.

After you have completed the save, the Quick Save front-panel key lets you quickly repeat the last save performed, using an auto-named file, with the current screen data.

**NOTE** For versions previous to A.01.55, if you initiate a screen image save by navigating through the Save menus, the image that is saved will contain the Save menu softkeys, not the menus and the active function that were on the screen when you first pressed the Save front panel key.

Key Path	Save
Mode	All
Remote Command	:MMEMory:STORe:SCReen <filename>
Example	:MMEM:STOR:SCR "myScreen.png" This stores the current screen image in the file MyScreenFile.png in the default directory.
Initial S/W Revision	Prior to A.02.00

## Themes

Accesses a menu of functions that enable you to choose the theme to be used when saving the screen image.

The **Themes** option is the same as the **Themes** option under the **Display** and **Page Setup** dialogs. It allows you to choose between themes to be used when saving the screen image.

<b>Key Path</b>	Save, Screen Image
<b>Remote Command</b>	:MMEMory:STORe:SCReen:THEMe TDColor   TDMonochrome   FCOLor   FMONochrome  :MMEMory:STORe:SCReen:THEMe?
<b>Example</b>	:MMEM:STOR:SCR:THEM TDM
<b>Preset</b>	3D Color; Is not part of Preset, but is reset by Restore Misc Defaults or Restore System Defaults All and survives subsequent running of the modes.
<b>Readback</b>	3D Color   3D Mono   Flat Color   Flat Mono
<b>Backwards Compatibility Notes</b>	In ESA and PSA we offer the choice of "Reverse Bitmap" or "Reverse Metafile" when saving screen images. This is much like the "Flat Color" theme available in X-Series. Also, if you selected Reverse Bitmap AND a black & white screen image, that would be much like "Flat Monochrome". In other words, each of the X-Series themes has a similar screen image type in ESA/PSA. But they are not identical.
<b>Initial S/W Revision</b>	Prior to A.02.00

### 3D Color

Selects a standard color theme with each object filled, shaded and colored as designed.

<b>Key Path</b>	Save, Screen Image, Themes
<b>Example</b>	MMEM:STOR:SCR:THEM TDC
<b>Readback</b>	3D Color
<b>Initial S/W Revision</b>	Prior to A.02.00

### 3D Monochrome

Selects a format that is like 3D color but shades of gray are used instead of colors.

<b>Key Path</b>	Save, Screen Image, Themes
<b>Example</b>	MMEM:STOR:SCR:THEM TDM
<b>Readback</b>	3D Mono
<b>Initial S/W Revision</b>	Prior to A.02.00

### Flat Color

Selects a format that is best when the screen is to be printed on an ink printer.

Key Path	Save, Screen Image, Themes
<b>Example</b>	MMEM:STOR:SCR:THEM FCOL
Readback	Flat Color
Initial S/W Revision	Prior to A.02.00

### Flat Monochrome

Selects a format that is like Flat Color. But only black is used (no colors, not even gray), and no fill.

Key Path	Save, Screen Image, Themes
<b>Example</b>	MMEM:STOR:SCR:THEM FMON
Readback	Flat Mono
Initial S/W Revision	Prior to A.02.00

### Save As...

When you press "Save As", the analyzer brings up a Windows dialog and a menu entitled "**Save As.**" This menu allows you to navigate to the various fields in the Windows dialog without using a keyboard or mouse. The Tab and Arrow keys can also be used for dialog navigation.

See "[To File . . .](#)" on page 2897 in Save, State for a full description of this dialog and menu.

The default path for Screen Images is

My Documents\`<mode name>`\screen.

where `<mode name>` is the parameter used to select the mode with the INST:SEL command (for example, SA for the Spectrum Analyzer).

Key Path	Save, Screen Image
Notes	Brings up Save As dialog for saving a Screen Image Save Type
Initial S/W Revision	Prior to A.02.00

### Mass Storage Catalog (Remote Command Only)

Key path	SCPI Only
<b>Remote Command</b>	:MMEMory:CATalog? [ <code>&lt;directory_name&gt;</code> ]
Notes	<p>The string must be a valid logical path.</p> <p>Queries disk usage information (drive capacity, free space available) and obtains a list of files and directories in a specified directory in the following format:</p> <p><code>&lt;numeric_value&gt;,&lt;numeric_value&gt;,{&lt;file_entry&gt;}</code></p> <p>It returns two numeric parameters and as many strings as there are files and directories. The first</p>

parameter indicates the total amount of storage currently used in bytes. The second parameter indicates the total amount of storage available, also in bytes. The <file\_entry> is a string. Each <file\_entry> indicates the name, type, and size of one file in the directory list:

<file\_name>,<file\_type>,<file\_size>

As the windows file system has an extension that indicates file type, <file\_type> is always empty. <file\_size> provides the size of the file in bytes. For directories, <file\_entry> is surrounded by square brackets and both <file\_type> and <file\_size> are empty

---

Initial S/W Revision      Prior to A.02.00

---

## Mass Storage Change Directory (Remote Command Only)

---

Key path                      SCPI Only

**Remote Command**        :MMEMory:CDIRectory [<directory\_name>]  
                                  :MMEMory:CDIRectory?

**Notes**                      The string must be a valid logical path.  
  
Changes the default directory for a mass memory file system. The <directory\_name> parameter is a string. If no parameter is specified, the directory is set to the \*RST value.  
  
At \*RST, this value is set to the default user data storage area, that is defined as System.Environment.SpecialFolder.Personal.  
  
Query returns full path of the default directory.

---

Initial S/W Revision      Prior to A.02.00

---

## Mass Storage Copy (Remote Command Only)

---

Key path                      SCPI Only

**Remote Command**        :MMEMory:COPY <string>,<string>[,<string>,<string>]

**Notes**                      The string must be a valid logical path.  
  
Copies an existing file to a new file or an existing directory to a new directory.  
  
Two forms of parameters are allowed. The first form has two parameters. In this form, the first parameter specifies the source, and the second parameter specifies the destination.  
  
The second form has four parameters. In this form, the first and third parameters specify the source. The second and fourth parameters specify the directories. The first pair of parameters specifies the source. The second pair specifies the destination. An error is generated if the source doesn't exist or the destination file already exists.  
  
This command will generate an "access denied" error if the destination is a restricted folder (e.g., C:\Windows) and the current user does not have Power User or Administrator privileges.

## Mass Storage Device Copy (Remote Command Only)

This command transfers data to/from a file and a peripheral device.

Key path	SCPI Only
<b>Remote Command</b>	:MMEMory:COpy:DEvIce <source_string>,<dest_string>
Notes	<p>The strings must be a valid logical path or a valid device keyword. If the dest_string is a device keyword, the data is copied from the source file to the device. If the source_string is a device keyword, the data is copied to the source file from the device.</p> <p>Valid device keywords are:          SNS (smart noise source)</p> <p>An error is generated if the file or device is not found.</p>

### Mass Storage Delete (Remote Command Only)

Key path	SCPI Only
<b>Remote Command</b>	:MMEMory:DELeTe <file_name>[,<directory_name>]
Notes	<p>The string must be a valid logical path.</p> <p>Removes a file from the specified directory. The &lt;file_name&gt; parameter specifies the file name to be removed. This command will generate an “access denied” error if the file is in a restricted folder (e.g., C:\Windows) and the current user does not have Power User or Administrator privileges.</p>
Initial S/W Revision	Prior to A.02.00

### Mass Storage Data (Remote Command Only)

Creates a file containing the specified data OR queries the data from an existing file.

Key path	SCPI Only
<b>Remote Command</b>	:MMEMory:DATA <file_name>, <data> :MMEMory:DATA? <file_name>
Notes	<p>The string must be a valid logical path.</p> <p>The command form is MMEMory:DATA &lt;file_name&gt;,&lt;data&gt;. It loads &lt;data&gt; into the file &lt;file_name&gt;. &lt;data&gt; is in 488.2 block format. &lt;file_name&gt; is string data.</p> <p>The query form is MMEMory:DATA? &lt;file_name&gt; with the response being the associated &lt;data&gt; in block format.</p>
Initial S/W Revision	Prior to A.02.00

### Mass Storage Make Directory (Remote Command Only)

Key path	SCPI Only
<b>Remote Command</b>	:MMEMory:MDIRectory <directory_name>
Notes	<p>The string must be a valid logical path.</p> <p>Creates a new directory. The &lt;directory_name&gt; parameter specifies the name to be created.</p>

---

	This command will generate an “access denied” error if the new directory would be in a restricted folder (e.g., C:\Windows) and the current user does not have Power User or Administrator privileges.
Initial S/W Revision	Prior to A.02.00

---

### Mass Storage Move (Remote Command Only)

---

Key path	SCPI Only
<b>Remote Command</b>	:MMEMory:MOVE <string>,<string>[,<string>,<string>]
Notes	<p>The string must be a valid logical path.</p> <p>Moves an existing file to a new file or an existing directory to a new directory.</p> <p>Two forms of parameters are allowed. The first form has two parameters. In this form, the first parameter specifies the source, and the second parameter specifies the destination.</p> <p>The second form has four parameters. In this form, the first and third parameters specify the source. The second and fourth parameters specify the directories. The first pair of parameters specifies the source. The second pair specifies the destination. An error is generated if the source doesn't exist or the destination file already exists.</p> <p>This command will generate an “access denied” error if the destination is a restricted folder (e.g., C:\Windows) and the current user does not have Power User or Administrator privileges.</p>
Initial S/W Revision	Prior to A.02.00

---

### Mass Storage Remove Directory (Remote Command Only)

---

Key path	SCPI Only
<b>Remote Command</b>	:MMEMory:RDIRECTory <directory_name>
Notes	<p>The string must be a valid logical path.</p> <p>Removes a directory. The &lt;directory_name&gt; parameter specifies the directory name to be removed. All files and directories under the specified directory shall also be removed.</p> <p>This command will generate an “access denied” error if the folder is a restricted folder (e.g., C:\Windows) or is in a restricted folder and the current user does not have Power User or Administrator privileges.</p>
Initial S/W Revision	Prior to A.02.00

---

## Single (Single Measurement/Sweep)

Sets the analyzer for Single measurement operation. The single/continuous state is Meas Global, so the setting will affect all the measurements. If you are Paused, pressing Single does a Resume.

See "[More Information](#)" on page 1147

Key Path	Front-panel key
Example	:INIT:CONT OFF
Notes	See Cont key description.
Backwards Compatibility Notes	<p>For Spectrum Analysis mode in ESA and PSA, the Single hardkey and the INITiate:IMM switched from continuous measurement to single measurement and restarted sweeps and averages (displayed average count reset to 1), but did not restart Max Hold and Min Hold. In the X-Series, the Single hardkey and the INITiate:IMM command initiate a sweep/ measurement/ average sequence/hold sequence including MaxHold and MinHold.</p> <p>For Spectrum Analysis mode in ESA and PSA, the Single hardkey restarted the sweep regardless of whether or not you were in an active sweep or sweep sequence. In the X-Series, Restart does this but Single only restarts the sweep or sweep sequence if you are in the idle state.</p> <p>INIT[:IMM] in ESA &amp; PSA Spectrum Analysis Mode does an implied ABORt. In some other PSA Modes, INIT[:IMM] is ignored if not in the idle state. . The X-Series follows the ESA/PSA SA Mode model, which may cause some Modes to have compatibility problems.</p>
Initial S/W Revision	Prior to A.02.00

### More Information

See "[Restart](#)" on page 2894 for details on the INIT:IMMediate (Restart) function.

If you are already in single sweep, the INIT:CONT OFF command has no effect.

If you are already in Single Sweep, then pressing the Single key in the middle of a sweep does not restart the sweep or sequence. Similarly, pressing the Single key does not restart the sweep or sequence if the sweep is not in the idle state (for example, if you are taking a very slow sweep, or the analyzer is waiting for a trigger). Instead, it results in a message. "Already in Single, press Restart to initiate a new sweep or sequence". Even though pressing the Single key in the middle of a sweep does not restart the sweep, sending INIT:IMMediate does reset it.

To take one more sweep without resetting the average count, increment the average count by 1, by pressing the step up key while **Average/Hold Number** is the active function, or sending the remote command CALC:AVER:TCON UP.

## Source

See ["Source" on page 2921](#) for more information.

---

Key Path	Front Panel key
Initial S/W Revision	Prior to A.02.00

---



## SPAN X Scale

Allows you to set the desired horizontal scale settings.

Key Path	Front Panel key
Initial S/W Revision	Prior to A.02.00

### Ref Value (Burst view RF Envelope window)

Sets the display X reference value in the Burst view RF Envelope window .

Key Path	SPAN X Scale
Mode	1xEVDO
<b>Remote Command</b>	:DISPlay:PVTime:VIEW[1]:WINDow[1]:TRACe:X[:SCALe]:RLEVel <time> :DISPlay:PVTime:VIEW[1]:WINDow[1]:TRACe:X[:SCALe]:RLEVel?
<b>Example</b>	DISP:PVT:VIEW:WIND:TRAC:X:RLEV 1s
Notes	If <b>X Auto Scaling</b> is On, this value is automatically determined by the measurement result. When a value is set manually, <b>X Auto Scaling</b> is automatically set to Off.
Couplings	See Notes
Preset	-416.67 us
State Saved	Saved in instrument state.
Min	-10.0 s
Max	10.00 s
Initial S/W Revision	Prior to A.02.00

### Scale/Div (Burst view RF Envelope window)

Sets the display X scale/division value in the Burst view RF Envelope window.

Key Path	SPAN X Scale
Mode	1xEVDO
<b>Remote Command</b>	:DISPlay:PVTime:VIEW[1]:WINDow[1]:TRACe:X[:SCALe]:PDIVision <time> :DISPlay:PVTime:VIEW[1]:WINDow[1]:TRACe:X[:SCALe]:PDIVision?
<b>Example</b>	:DISP:PVT:VIEW:WIND:TRAC:X:PDIV 1ms
Notes	If <b>X Auto Scaling</b> is set to On, this value is automatically determined by the measurement result. When a value is set manually, <b>X Auto Scaling</b> is automatically set to Off.
Couplings	See Notes
Preset	83.3 us
State Saved	Saved in instrument state.

Min	1.00 ns
Max	1.00 s
Initial S/W Revision	Prior to A.02.00

### Ref Position (Burst view RF Envelope window)

Sets the display X reference position in the Burst view RF Envelope window.

Key Path	SPAN X Scale
Mode	1xEVDO
Remote Command	:DISPlay:PVTime:VIEW[1]:WINDow[1]:TRACe:X[:SCALe]:RPOStion LEFT   CENTER   RIGHT  :DISPlay:PVTime:VIEW[1]:WINDow[1]:TRACe:X[:SCALe]:RPOStion?
Example	:DISP:PVT:VIEW:WIND:TRAC:X:RPOS LEFT
Preset	LEFT
State Saved	Saved in instrument state.
Range	Left Ctr Right
Initial S/W Revision	Prior to A.02.00

### Auto Scaling (Burst view RF Envelope window)

Sets the display X Auto Scaling in the Burst view RF Envelope window.

Key Path	SPAN X Scale
Mode	1xEVDO
Remote Command	:DISPlay:PVTime:VIEW[1]:WINDow[1]:TRACe:X[:SCALe]:COUPle 0   1   OFF   ON  :DISPlay:PVTime:VIEW[1]:WINDow[1]:TRACe:X[:SCALe]:COUPle?
Example	:DISP:PVT:VIEW:WIND:TRAC:X:COUP OFF
Notes	Upon pressing the Restart front-panel key, or Restart key under the Meas Control menu, the scale coupling function automatically determines the scale per division and reference values, based on the measurement results, if this parameter is set to On. When you manually set a value to either <b>X Rel Value</b> or <b>X Scale/Div</b> , X Auto Scaling is automatically set to Off.
Couplings	See Notes
Preset	ON
State Saved	Saved in instrument state.
Range	On Off
Initial S/W Revision	Prior to A.02.00

## Sweep/Control

Accesses a menu that allows you to select parameters that affect the sweep of the displayed measurement signal.

Only the Pause/Resume key is available.

Key Path	Front panel key
Initial S/W Revision	Prior to A.02.00

## Pause/Resume

This key allows you to pause or resume the measurement of the displayed signal.

See "[Pause/Resume](#)" on page 2925 function.

Key Path	Sweep/Control
Initial S/W Revision	Prior to A.02.00

11 Power vs Time  
System

System

See "System" on page 359

## Trace/Detector

Accesses a menu that allows you to control trace settings.

Key Path	Front Panel key
Initial S/W Revision	Prior to A.02.00

Max Hold Trace and Min Hold Trace would be hold during the averaging cycle.

### Max Hold Trace

This key allows you to visible/invisible Max Hold Trace.

Key Path	Trace/Detector
Mode	1xEVDO
<b>Remote Command</b>	:DISPlay:PVTime:VIEW:WINDow:TRACe:MAXHold[:STATe] ON OFF 1 0 :DISPlay:PVTime:VIEW:WINDow:TRACe:MAXHold[:STATe]?
<b>Example</b>	:DISP:PVT:VIEW:WIND:TRAC:MAXH ON
Couplings	Selecting [:SENSe]:PVTime:AVERAge:TYPE MAXimum MXMinimum forces this parameter to ON.
Preset	OFF
State Saved	Saved in instrument state.
Range	On Off
Initial S/W Revision	Prior to A.02.00

### Min Hold Trace

This key allows you to visible/invisible Min Hold Trace.

Key Path	Trace/Detector
Mode	1xEVDO
<b>Remote Command</b>	:DISPlay:PVTime:VIEW:WINDow:TRACe:MINHold[:STATe] ON OFF 1 0 :DISPlay:PVTime:VIEW:WINDow:TRACe:MINHold[:STATe]?
<b>Example</b>	:DISP:PVT:VIEW:WIND:TRAC:MINH ON
Couplings	Selecting [:SENSe]:PVTime:AVERAge:TYPE MINimum MXMinimum forces this parameter to ON.
Preset	OFF
State Saved	Saved in instrument state.
Range	On Off
Initial S/W Revision	Prior to A.02.00

## Trigger

See ["Trigger" on page 430](#)

### Free Run

See ["Free Run " on page 437](#)

### Video

See ["Video \(IF Envelope\) " on page 438](#)

### Trigger Level

See ["Trigger Level " on page 438](#)

### Trig Slope

See ["Trig Slope " on page 439](#)

### Trig Delay

See ["Trig Delay " on page 440](#)

### Line

See ["Line " on page 2729](#)

### Trig Slope

See ["Trig Slope " on page 2729](#)

### Trig Delay

See ["Trig Delay " on page 442](#)

### External 1

See ["External 1 " on page 2741](#)

### Trigger Level

See ["Trigger Level " on page 2741](#)

### Trig Slope

See ["Trig Slope " on page 2742](#)

### Trig Delay

See ["Trig Delay " on page 445](#)

### External 2

See ["External 2 " on page 2743](#)

## Trigger Level

See ["Trigger Level "](#) on page 2743

## Trig Slope

See ["Trig Slope "](#) on page 2744

## Trig Delay

See ["Trig Delay "](#) on page 447

## RF Burst

See ["RF Burst "](#) on page 2744

## Absolute Trigger

See ["Absolute Trigger Level"](#) on page 2745

## Relative Trigger

See ["Relative Trigger Level"](#) on page 2734

## Trig Slope

See ["Trigger Slope "](#) on page 2746

## Trig Delay

See ["Trig Delay "](#) on page 451

## Periodic Timer

See ["Periodic Timer \(Frame Trigger\) "](#) on page 2736

## Period

See ["Period "](#) on page 2737

## Offset

See ["Offset "](#) on page 2738

## Offset Adjust (Remote Command Only)

See ["Offset Adjust \(Remote Command Only\)"](#) on page 2739

## Reset Offset Display

See ["Reset Offset Display "](#) on page 2740

## Sync Source

See ["Sync Source "](#) on page 2740

## Off

See ["Off "](#) on page 2741

## External 1

See ["External 1 "](#) on page 2741

## Trigger Level

See ["Trigger Level "](#) on page 2741

## Trig Slope

See ["Trig Slope "](#) on page 2742

## External 2

See ["External 2 "](#) on page 2743

## Trigger Level

See ["Trigger Level "](#) on page 2743

## Trig Slope

See ["Trig Slope "](#) on page 2744

## RF Burst

See ["RF Burst "](#) on page 2744

## Absolute Trigger

See ["Absolute Trigger Level"](#) on page 2745

## Trig Slope

See ["Trigger Slope "](#) on page 2746

## Trig Delay

See ["Trig Delay"](#) on page 461

## Auto/Holdoff

See ["Auto/Holdoff "](#) on page 462

## Auto Trig

See ["Auto Trig "](#) on page 462

## Trig Holdoff

See ["Trig Holdoff "](#) on page 463

## Holdoff Type

See [\\_\\_](#) on page X



## User Preset

Accesses a menu that gives you the following three choices:

- User Preset – recalls a state previously saved using the Save User Preset function.
- User Preset All Modes – presets all of the modes in the analyzer
- Save User Preset– saves the current state for the current mode

Key Path	Front-panel key
Backwards Compatibility Notes	<p>User Preset is actually loading a state, and in legacy analyzers, it was possible to load a state without affecting the trace data, limit lines or correction data. Similarly it was possible to do a User Preset without affecting the trace data, limit lines or correction data.</p> <p>In the X-Series, “state” always includes all of this data; so whenever state is loaded, or User Preset is executed, all of the traces, limit lines and corrections are affected. Although this differs from previous behavior, it is desirable behavior, and should not cause adverse issues for users.</p> <p>On ESA and PSA, User Preset affected the entire instrument’s state. In the X-Series, User Preset only recalls the state for the active mode. There is a User Preset file for each mode. User Preset can never cause a mode switch as it can in legacy analyzers. If you want to recall all modes to their user preset file state, you will need to do a User Preset after mode switching into each mode.</p> <p>User Preset recalls mode state which can now include data like traces; whereas on ESA and PSA, User Preset did not affect data.</p>
Initial S/W Revision	Prior to A.02.00

## User Preset

User Preset sets the state of the currently active mode back to the state that was previously saved for this mode using the Save User Preset menu key or the SCPI command, SYST:PRES:USER:SAV. It not only recalls the Mode Preset settings, but it also recalls all of the mode persistent settings, and the Input/Output system setting that existed at the time Save User Preset was executed.

If a Save User Preset has not been done at any time, User Preset recalls the default user preset file for the currently active mode. The default user preset files are created if, at power-on, a mode detects there is no user preset file. There will never be a scenario when there is no user preset file to restore. For each mode, the default user preset state is the same state that would be saved if a Save User Preset is performed in each mode right after doing a Restore Mode Default and after a Restore Input/Output Defaults.

The User Preset function does the following:

- Aborts the currently running measurement.
- Sets the mode State to the values defined by Save User Preset.
- Makes the saved measurement for the currently running mode the active measurement.
- Brings up the saved menu for the power-on mode.
- Clears the input and output buffers.
- Sets the Status Byte to 0.

Key Path	User Preset
<b>Remote Command</b>	:SYSTem:PRESet:USER
<b>Example</b>	:SYST:PRES:USER:SAVE:SYST:PRES:USER
Notes	:SYST:PRES:USER:SAVE is used to save the current state as the user preset state. Clears all pending OPC bits. The Status Byte is set to 0. Pressing the User Preset front-panel key while already in the User Preset menu will cause the User Preset to get executed
Couplings	A user preset will cause the currently running measurement to be aborted and cause the saved measurement to be active. Recalling a User Preset file has the same issues that recalling a Save State file has. Some settings may need to be limited and therefore re-coupled, since the capabilities of the mode may have changes when the User Preset file was last saved.
Initial S/W Revision	Prior to A.02.00

## User Preset All Modes

Recalls all of the User Preset files for each mode, switches to the power-on mode, and activates the saved measurement from the power-on mode User Preset file.

**NOTE**

When the instrument is secured, all of the user preset files are converted back to their default user preset files.

The User Preset function does the following:

- Aborts the currently running measurement.
- Switches the Mode to the power-on mode.
- Restores the User Preset files for each mode.
- Makes the saved measurement for the power-on mode the active measurement.
- Brings up the saved menu for the power-on mode.
- Clears the input and output buffers.
- Sets the Status Byte to 0.

Key Path	User Preset
<b>Remote Command</b>	:SYSTem:PRESet:USER:ALL
<b>Example</b>	:SYST:PRES:USER:SAVE:SYST:PRES:USER:ALL
Notes	Clears all pending OPC bits. The Status Byte is set to 0. :SYST:PRES:USER:SAVE is used to save the current state as the user preset state.
Couplings	A user preset will cause the currently running measurement to be aborted, cause a mode switch to the power-on mode, and cause the saved measurement to be active in the power-on mode. Recalling a User Preset file has the same issues that recalling a Save State file has. Some settings may need to be limited and therefore re-coupled, since the capabilities of the mode may have changes when the User Preset file was last saved.
Initial S/W Revision	Prior to A.02.00

## Save User Preset

Saves the currently active mode and its State. You can recall this User Preset file by pressing the User Preset menu key or sending the SYST:PRES:USER remote command. This same state is also saved by the Save State function.

Key Path	User Preset
<b>Remote Command</b>	:SYSTem:PRESet:USER:SAVE
<b>Example</b>	:SYST:PRES:USER:SAVE
Notes	:SYST:PRES:SAVE creates the same file as if the user requested a *SAV or a MMEM:STOR:STAT, except User Preset Save does not allow the user to specify the filename or the location of the file.
Initial S/W Revision	Prior to A.02.00

## View/Display

Accesses a menu of functions that enable you to control the instrument display.

The View/Display key accesses a menu that allows you to select the desired view of the measurement from the following selections:

- Burst (SCPI: ALL) – views the entire burst of interest as determined by the current trigger source and slot type settings.
- Rise & Fall (SCPI: BOTH) – zooms in on the rising and falling portions of the burst being tested.
- Region A- zooms in Region A portions of the burst being tested.
- Region B- zooms in Region B portions of the burst being tested.
- Region C- zooms in Region C portions of the burst being tested.
- Region D- zooms in Region D portions of the burst being tested.
- Region E- zooms in Region E portions of the burst being tested.

Key Path	Front Panel key
Mode	CDMA1XEV
Remote Command	:DISPlay:PVTime:VIEW ALL BOTH A B C D E :DISPlay:PVTime:VIEW?
Example	:DISP:PVT:VIEW BOTH
Notes	These key are grayed out when Slot Type is Active Slot.
Preset	ALL
State Saved	Saved in instrument state.
Range	Burst Rise & Fall Region A Region B Region C Region D RegionE
Initial S/W Revision	Prior to A.02.00

## Display

The Display menu is common to most measurements, and is used for configuring items on the display. Some Display menu settings apply to all the measurements in a mode, and some only to the current measurement. Those under the System Display Settings key apply to all measurements in all modes.

Key Path	Display
Key Path	View/Display
Initial S/W Revision	Prior to A.02.00

## Annotation

Turns on and off various parts of the display annotation. The annotation is divided up into four categories:

1. Meas Bar: This is the measurement bar at the top of the screen. It does not include the settings panel or the Active Function. Turning off the Meas Bar turns off the settings panel and the Active Function. When the Meas Bar is off, the graticule area expands to fill the area formerly occupied by the Meas Bar.
2. Screen Annotation: this is the annotation and annunciation around the graticule, including any annotation on lines (such as the display line, the threshold line, etc.) This does NOT include the marker number or the N dB result. When off, the graticule expands to fill the entire graticule area.
3. Trace annotation: these are the labels on the traces, showing their detector (or their math mode).
4. Active Function annotation: this is the active function display in the meas bar, and all of the active function values displayed on softkeys.

See the figure below. Each type of annotation can be turned on and off individually.

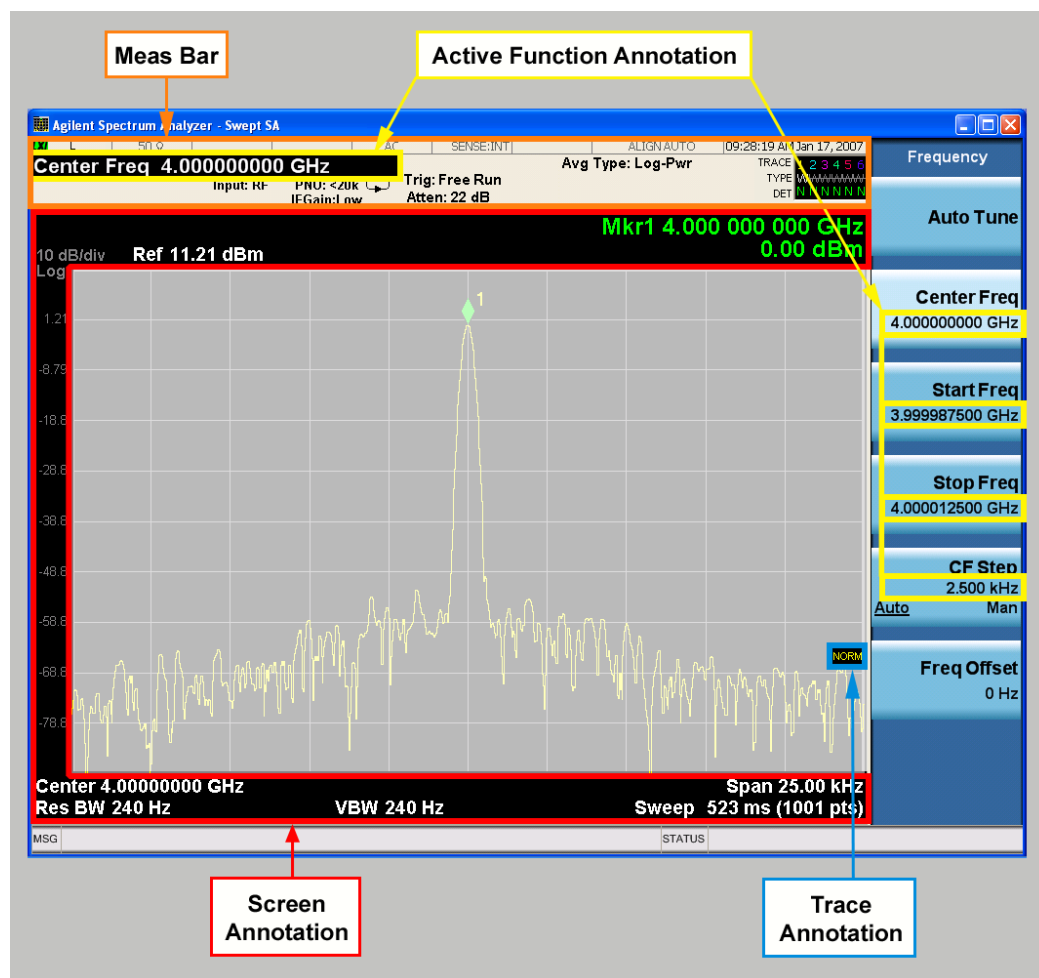

Key Path	View/Display, Display
Initial S/W Revision	Prior to A.02.00

### Meas Bar On/Off

This function turns the Measurement Bar on and off, including the settings panel. When off, the graticule area expands to fill the area formerly occupied by the Measurement Bar.

Key Path	View/Display, Display, Annotation
Remote Command	:DISPlay:ANNotation:MBAR[:STATe] OFF ON 0 1 :DISPlay:ANNotation:MBAR[:STATe]?
Example	DISP:ANN:MBAR OFF
Dependencies	Grayed out and forced to OFF when System Display Settings, Annotation is set to Off.
Preset	On This should remain Off through a Preset when System DisplaySettings, Annotation is set to Off.
State Saved	Saved in instrument state.
Initial S/W Revision	Prior to A.02.00

### Screen

This controls the display of the annunciation and annotation around the graticule, including any annotation on lines (such as the display line, the threshold line, etc.) and the y-axis annotation. This does NOT include marker annotation (or the N dB result). When off, the graticule expands to fill the entire graticule area, leaving only the 1.5% gap above the graticule as described in the Trace/Detector chapter.

Key Path	View/Display, Display, Annotation
Remote Command	:DISPlay:ANNotation:SCReen[:STATe] OFF ON 0 1 :DISPlay:ANNotation:SCReen[:STATe]?
Example	DISP:ANN:SCR OFF
Dependencies	Grayed-out and forced to OFF when System Display Settings, Annotation is set to Off.
Preset	On This should remain Off through a Preset when System DisplaySettings, Annotation is set to Off
State Saved	Saved in instrument state.
Initial S/W Revision	Prior to A.02.00

### Active Function Values On/Off

Turns on and off the active function display in the Meas Bar, and all of the active function values displayed on the softkeys.

Note that all of the softkeys that have active functions have these numeric values blanked when this function is on. This is a security feature..

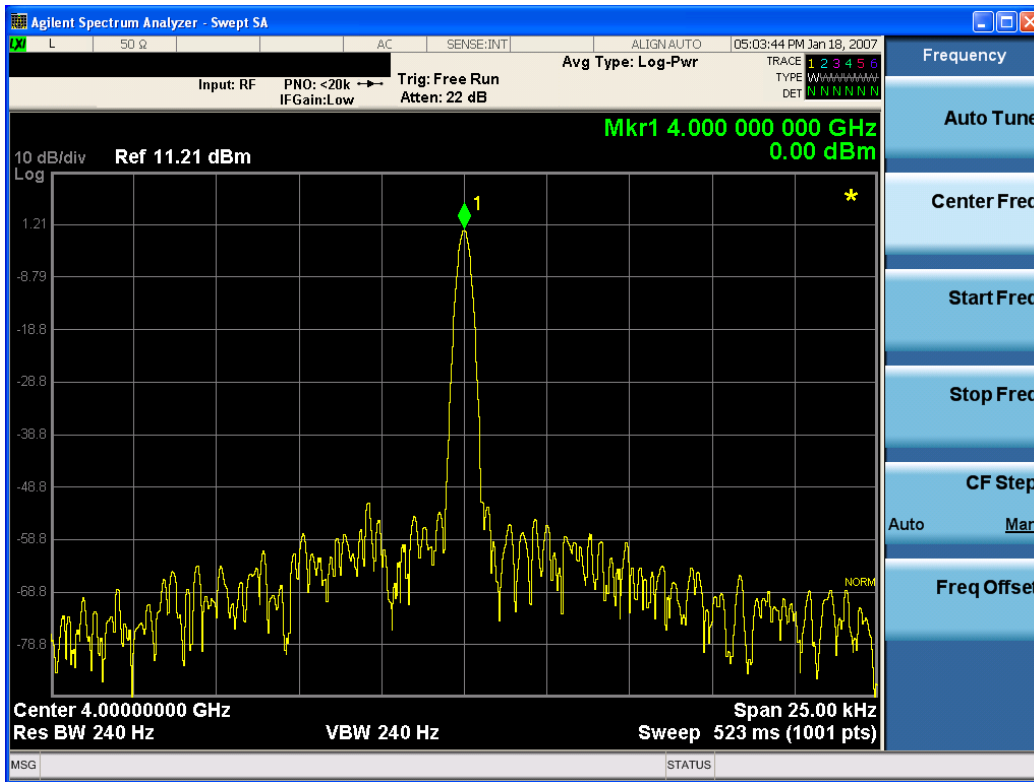

Key Path	View/Display, Display, Annotation
Remote Command	:DISPlay:ACTivefunc[:STATE] ON OFF 1 0 :DISPlay:ACTivefunc[:STATE]?
Example	DISP:ACT OFF
Dependencies	Grayed out and forced to OFF when System Display Settings, Annotation is set to Off.
Preset	On This should remain Off through a Preset when System DisplaySettings, Annotation is set to Off
State Saved	Saved in instrument state.
Initial S/W Revision	Prior to A.02.00

## Title

Displays menu keys that enable you to change or clear a title on your display.

Key Path	View/Display, Display
Initial S/W Revision	Prior to A.02.00

## Change Title

Writes a title into the "measurement name" field in the banner, for example, "Swept SA".

Press Change Title to enter a new title through the alpha editor. Press Enter or Return to complete the entry. Press ESC to cancel the entry and preserve your existing title.

The display title will replace the measurement name. It remains for this measurement until you press Change Title again, or you recall a state, or a Preset is performed. A title can also be cleared by pressing Title, Clear Title.

**NOTE**

Notice the inclusion of the <measurement> parameter in the command below. Because each measurement remembers the Display Title, the command must be qualified with the measurement name. For the Swept SA measurement this is not the case; no <measurement> parameter is used when changing the Display Title for the Swept SA measurement.

Key Path	View/Display, Display, Title
Mode	All
Remote Command	:DISPlay:<measurement>:ANNotation:TITLe:DATA <string> :DISPlay:<measurement>:ANNotation:TITLe:DATA?
Example	DISP:ANN:TITL:DATA "This Is My Title" This example is for the Swept SA measurement in the Spectrum Analyzer mode. The SANalyzer <measurement> name is not used. DISP:ACP:ANN:TITL:DATA "This Is My Title" This example is for Measurements other than Swept SA. Both set the title to: This Is My Title
Notes	Pressing this key cancels any active function. When a title is edited the previous title remains intact (it is not cleared) and the cursor goes at the end so that characters can be added or BKSP can be used to go back over previous characters.
Preset	No title (measurement name instead)
State Saved	Saved in instrument state.
Initial S/W Revision	Prior to A.02.00

**Clear Title**

Clears a title from the front-panel display. Once cleared, the title cannot be retrieved. After the title is cleared, the current Measurement Name replaces it in the title bar.

Key Path	View/Display, Display, Title
Example	The following commands clear the title and restore the measurement's original title: DISP:ANN:TITL:DATA "" This example is for the Swept SA measurement in the Spectrum Analyzer mode. The SANalyzer <measurement> name is not used. DISP:ACP:ANN:TITL:DATA "" This example is for ACP; in measurements other than Swept SA the measurement name is required.
Notes	Uses the :DISPlay:<measurement>:ANNotation:TITLe:DATA <string> command with an empty string (in the Swept SA, the <measurement> is omitted).
Preset	Performed on Preset.
Initial S/W Revision	Prior to A.02.00



## Graticule

Pressing Graticule turns the display graticule On or Off. It also turns the graticule y-axis annotation on and off.

Key Path	View/Display, Display
Remote Command	:DISPlay:WINDow[1]:TRACe:GRATicule:GRID[:STATe] OFF ON 0 1 :DISPlay:WINDow[1]:TRACe:GRATicule:GRID[:STATe]?
Example	DISP:WIND:TRAC:GRAT:GRID OFF
Notes	The graticule is the set of horizontal and vertical lines that make up the grid/divisions for the x-axis and y-axis.
Preset	On
State Saved	Saved in instrument state
Initial S/W Revision	Prior to A.02.00

## System Display Settings

These settings are "Mode Global" – they affect all modes and measurements and are reset only by Restore Misc Defaults or Restore System Defaults under System.

Key Path	View/Display, Display
Initial S/W Revision	Prior to A.02.00

## Annotation Local Settings

This is a Mode Global override of the meas local annotation settings. When it is All Off, it forces ScreenAnnotation, Meas Bar, Trace, and Active Function Values settings to be OFF for all measurements in all modes. This provides the security based "annotation off" function of previous analyzers; hence it uses the legacy SCPI command.

When it is All Off, the Screen, Meas Bar, Trace, and Active Function Values keys under the Display, Annotation menu are grayed out and forced to Off. When Local Settings is selected, you are able to set the local annotation settings on a measurement by measurement basis.

Key Path	View/Display, Display, System Display Settings
Remote Command	:DISPlay:WINDow[1]:ANNOtation[:ALL] OFF ON 0 1 :DISPlay:WINDow[1]:ANNOtation[:ALL]?
Example	:DISP:WIND:ANN OFF
Preset	On (Set by Restore Misc Defaults)
State Saved	Not saved in instrument state.
Backwards Compatibility Notes	The WINDow parameter and optional subopcode is included for backwards compatibility but ignored – all windows are equally affected.
Initial S/W Revision	Prior to A.02.00

## Themes

Accesses a menu of functions that enable you to choose the theme to be used when saving the screen image.

The **Themes** option is the same as the **Themes** option under the **Display** and **Page Setup** dialogs. It allows you to choose between themes to be used when saving the screen image.

<b>Key Path</b>	Save, Screen Image
<b>Remote Command</b>	:MMEMory:STORe:SCReen:THEMe TDColor   TDMonochrome   FCOLor   FMONochrome  :MMEMory:STORe:SCReen:THEMe?
<b>Example</b>	:MMEM:STOR:SCR:THEM TDM
<b>Preset</b>	3D Color; Is not part of Preset, but is reset by Restore Misc Defaults or Restore System Defaults All and survives subsequent running of the modes.
<b>Readback</b>	3D Color   3D Mono   Flat Color   Flat Mono
<b>Backwards Compatibility Notes</b>	In ESA and PSA we offer the choice of "Reverse Bitmap" or "Reverse Metafile" when saving screen images. This is much like the "Flat Color" theme available in X-Series. Also, if you selected Reverse Bitmap AND a black & white screen image, that would be much like "Flat Monochrome". In other words, each of the X-Series themes has a similar screen image type in ESA/PSA. But they are not identical.
<b>Initial S/W Revision</b>	Prior to A.02.00

### 3D Color

Selects a standard color theme with each object filled, shaded and colored as designed.

<b>Key Path</b>	Save, Screen Image, Themes
<b>Example</b>	MMEM:STOR:SCR:THEM TDC
<b>Readback</b>	3D Color
<b>Initial S/W Revision</b>	Prior to A.02.00

### 3D Monochrome

Selects a format that is like 3D color but shades of gray are used instead of colors.

<b>Key Path</b>	Save, Screen Image, Themes
<b>Example</b>	MMEM:STOR:SCR:THEM TDM
<b>Readback</b>	3D Mono
<b>Initial S/W Revision</b>	Prior to A.02.00

### Flat Color

Selects a format that is best when the screen is to be printed on an ink printer.

Key Path	Save, Screen Image, Themes
<b>Example</b>	MMEM:STOR:SCR:THEM FCOL
Readback	Flat Color
Initial S/W Revision	Prior to A.02.00

### Flat Monochrome

Selects a format that is like Flat Color. But only black is used (no colors, not even gray), and no fill.

Key Path	Save, Screen Image, Themes
<b>Example</b>	MMEM:STOR:SCR:THEM FMON
Readback	Flat Mono
Initial S/W Revision	Prior to A.02.00

### Backlight

Accesses the display backlight on/off keys. This setting may interact with settings under the Windows "Power" menu.

When the backlight is off, pressing ESC, TAB, SPACE, ENTER, UP, DOWN, LEFT, RIGHT, DEL, BKSP, CTRL, or ALT turns the backlight on without affecting the application. Pressing any other key will turn backlight on and could potentially perform the action as well.

Key Path	View/Display, Display, System Display Settings
<b>Remote Command</b>	:DISPlay:BACKlight ON OFF :DISPlay:BACKlight?
Preset	ON (Set by Restore Misc Defaults)
Initial S/W Revision	Prior to A.02.00

### Backlight Intensity

An active function used to set the backlight intensity. It goes from 0 to 100 where 100 is full on and 0 is off. This value is independent of the values set under the Backlight on/off key.

Key Path	View/Display, Display, System Display Settings
<b>Remote Command</b>	:DISPlay:BACKlight:INTensity <integer> :DISPlay:BACKlight:INTensity?
<b>Example</b>	DISP:BACK:INT 50

Preset	100 (Set by Restore Misc Defaults)
Min	0
Max	100
Initial S/W Revision	Prior to A.02.00

### Burst View

This view shows power vs. time and mask result for 1xEV-DO burst.

There are two windows:

- RF Envelope window (upper)
- Numeric Results window (lower)

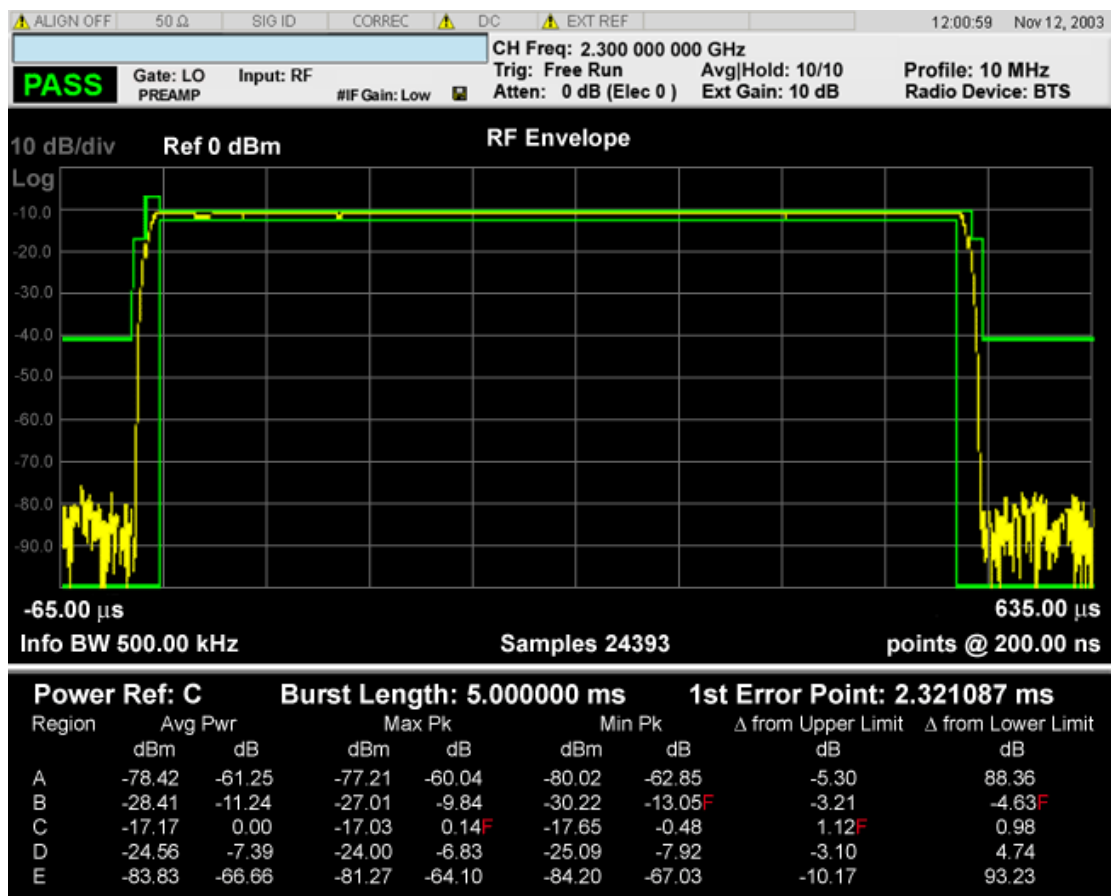

Figure 0-1 View for Power vs. Time Measurement (temp)

### RF Envelope window

Show traces and mask line.

1. Measured Trace

Marker Operation	Yes
Corresponding Trace	Corrected measured trace (n=2)

2. Max Hold Trace

Marker Operation	Yes
Corresponding Trace	Corrected measured trace (n=3)

3. Min Hold Trace

Marker Operation	Yes
Corresponding Trace	Corrected measured trace (n=4)

4. Upper Mask

Marker Operation	Yes
Corresponding Trace	Corrected measured trace (n=5)

5. Lower Mask

Marker Operation	Yes
Corresponding Trace	Corrected measured trace (n=6)

6. Burst Search Threshold Line

Marker Operation	No
Corresponding Trace	Corrected measured trace (n=7)

**Numeric Results window**

Name	Corresponding Results	Display Format
Power Ref Region	n=1 Power reference	99.99 ms
Burst Length	n=2 Burst Length	99.99 ms
Avg Pwr dBm	n=3 Averaged absolute power of the regions (in dBm)	99.99 dBm

Avg Pwr dB	n=4 Averaged relative power of the regions (in dB)	99.99 dB
Max Pk dBm	n=5 Max hold absolute power of the regions (in dBm)	99.99 dBm
Max Pk dB	n=6 Max hold relative power of the regions (in dB)	99.99 dB
Min Pk dBm	n=7 Min hold absolute power of the regions (in dBm)	99.99 dBm
Min Pk dB	n=8 Min hold relative power of the regions (in dB)	99.99 dB

Key Path	View/Display
Initial S/W Revision	Prior to A.02.00

## Rise & Fall View

There are three windows:

- Rising RF Envelope window (upper left)
- Falling RF Envelope window (upper right)
- Numeric Result window (lower)

### Rising RF Envelope Window

Shown traces are the same as those of RF Envelope on Burst View.

### Falling RF Envelope Window

Shown traces are the same as those of RF Envelope on Burst View.

### Numeric Results Window

Shown results are the same as those in Numeric Results on Burst View.

Key Path	View/Display
Initial S/W Revision	Prior to A.02.00

## Region View

There are two windows in each region view:

- Region RF Envelope window (upper )

- Numeric Result window (lower)

## Region RF Envelope Window

Shown traces are the same as those of RF Envelope on Burst View.

## Numeric Results Window

Shown results are the same as those in Numeric Results on Burst View.

Key Path	View/Display
Initial S/W Revision	Prior to A.02.00

## Limit Mask State

This setting is used to show (On) or hide (Off) the limit mask that is displayed on the RF Envelope window.  
Note: This does not affect any calculation taking place.

Key Path	View/Display, More
Mode	1xEVDO
<b>Remote Command</b>	:DISPlay:PVTime:LIMit:MASK ON OFF 1 0 :DISPlay:PVTime:LIMit:MASK?
<b>Example</b>	:DISP:PVT:LIM:MASK ON
Preset	ON
State Saved	Saved in instrument state.
Range	On Off
Initial S/W Revision	Prior to A.02.00

## Burst Search Threshold Line

This setting is used to show (On) or hide (Off) the burst search threshold line on RF Envelop window.

Key Path	View/Display, More
Mode	1xEVDO
<b>Remote Command</b>	:DISPlay:PVTime:BURSt:STHReshold ON OFF 1 0 :DISPlay:PVTime:BURSt:STHReshold?
<b>Example</b>	:DISP:PVT:BURS:STHR ON
Notes	This key is grayed out when Slot Type is Active Slot.
Preset	ON
State Saved	Saved in instrument state.
Range	On Off
Initial S/W Revision	Prior to A.02.00





## 12 Spectrum Emission Mask Measurement

The spectrum emission mask measures spurious signal levels in up to six pairs of offset frequencies and relates them to the carrier power. For measurement results and views, see ["View/Display" on page 1381](#).

This topic contains the following sections:

["Measurement Commands for Spectrum Emission Mask" on page 1174](#)

["Remote Command Results for Spectrum Emission Mask Measurement" on page 1175](#)

["Number of Offsets" on page 1195](#)

## Measurement Commands for Spectrum Emission Mask

Offsets that are turned off (inactive) return -999.0 when their results are queried via SCPI.

`:CONFigure:SEMask`

`:CONFigure:SEMask:NDEFault`

`:INITiate:SEMask`

`:FETCh:SEMask[n]?`

`:MEASure:SEMask[n]?`

`:READ:SEMask[n]?`

For more measurement related commands, see the SENSE subsystem, and the section ["Remote Measurement Functions" on page 2848](#).

## Remote Command Results for Spectrum Emission Mask Measurement

The following table describes the results returned by the FETCh, MEASure, and READ queries listed above, according to the index value n:

Modes	n	Return Value
All except MSR, WLAN, LTEAFDD, LTEATDD	1	<p><b>Meas Type: Total Power Reference</b></p> <p>Returns 82 comma-separated scalar results, in the following order:</p> <ol style="list-style-type: none"> <li>1. Reserved for the future use, returns -999.0</li> <li>2. Absolute power at the center frequency (reference) area (dBm)</li> <li>3. Reserved for the future use, returns -999.0</li> <li>4. Reserved for the future use, returns -999.0</li> <li>5. Peak frequency in the center frequency (reference) area (Hz)</li> <li>6. Reserved for the future use, returns -999.0</li> <li>7. Reserved for the future use, returns -999.0</li> <li>8. Reserved for the future use, returns -999.0</li> <li>9. Reserved for the future use, returns -999.0</li> <li>10. Reserved for the future use, returns -999.0</li> <li>11. Relative integrated power on the negative offset A (dBc)</li> <li>12. Absolute integrated power on the negative offset A (dBm)</li> <li>13. Relative peak power on the negative offset A (dBc)</li> <li>14. Absolute peak power on the negative offset A (dBm)</li> <li>15. Peak power offset frequency from the center or carrier edge frequency in the negative offset A, depending on Offset Frequency Define settings (Hz)</li> <li>16. Relative integrated power on the positive offset A (dBc)</li> <li>17. Absolute integrated power on the positive offset A (dBm)</li> <li>18. Relative peak power on the positive offset A (dBc)</li> <li>19. Absolute peak power on the positive offset A (dBm)</li> <li>20. Peak power offset frequency from the center or carrier edge frequency in the positive offset A, depending on Offset Frequency Define settings (Hz)</li> <li>21. Relative integrated power on the negative offset B (dBc)</li> <li>---</li> <li>69. Absolute peak power on the positive offset F (dBm)</li> <li>70. Peak power offset frequency from the center or carrier edge frequency in the positive offset F, depending on Offset Frequency Define settings (Hz)</li> <li>71. Minimum margin from limit line on the negative offset A (dB)</li> <li>72. Minimum margin from limit line on the positive offset A (dB)</li> <li>73. Minimum margin from limit line on the negative offset B (dB)</li> <li>74. Minimum margin from limit line on the positive offset B (dB)</li> <li>75. Minimum margin from limit line on the negative offset C (dB)</li> <li>76. Minimum margin from limit line on the positive offset C (dB)</li> </ol>

Modes	n	Return Value
		77. Minimum margin from limit line on the negative offset D (dB) 78. Minimum margin from limit line on the positive offset D (dB) 79. Minimum margin from limit line on the negative offset E (dB) 80. Minimum margin from limit line on the positive offset E (dB) 81. Minimum margin from limit line on the negative offset F (dB) 82. Minimum margin from limit line on the positive offset F (dB)
All except MSR, WLAN, LTEAFDD, LTEATDD	1	<b>Meas Type: Power Spectral Density Reference</b> Returns 82 comma-separated scalar results, in the following order: <ol style="list-style-type: none"> <li>1. Reserved for the future use, returns -999.0</li> <li>2. Absolute power at the center frequency (reference) area (dBm/Hz)</li> <li>3. Reserved for the future use, returns -999.0</li> <li>4. Reserved for the future use, returns -999.0</li> <li>5. Peak frequency in the center frequency (reference) area (Hz)</li> <li>6. Reserved for the future use, returns -999.0</li> <li>7. Reserved for the future use, returns -999.0</li> <li>8. Reserved for the future use, returns -999.0</li> <li>9. Reserved for the future use, returns -999.0</li> <li>10. Reserved for the future use, returns -999.0</li> <li>11. Relative integrated power on the negative offset A (dB)</li> <li>12. Absolute integrated power on the negative offset A (dBm/Hz)</li> <li>13. Relative peak power on the negative offset A (dB)</li> <li>14. Absolute peak power on the negative offset A (dBm/Hz)</li> <li>15. Peak power offset frequency from the center or carrier edge frequency in the negative offset A, depending on Offset Frequency Define settings (Hz)</li> <li>16. Relative integrated power on the positive offset A (dB)</li> <li>17. Absolute integrated power on the positive offset A (dBm/Hz)</li> <li>18. Relative peak power on the positive offset A (dB)</li> <li>19. Absolute peak power on the positive offset A (dBm/Hz)</li> <li>20. Peak power offset frequency from the center or carrier edge frequency in the positive offset A, depending on Offset Frequency Define settings (Hz)</li> <li>21. Relative integrated power on the negative offset B (dB)</li> <li>---</li> <li>69. Absolute peak power on the positive offset F (dBm/Hz)</li> <li>70. Peak power offset frequency from the center or carrier edge frequency in the positive offset F, depending on Offset Frequency Define settings (Hz)</li> <li>71. Minimum margin from limit line on the negative offset A (dB)</li> <li>72. Minimum margin from limit line on the positive offset A (dB)</li> <li>73. Minimum margin from limit line on the negative offset B (dB)</li> <li>74. Minimum margin from limit line on the positive offset B (dB)</li> </ol>

Modes	n	Return Value
		75. Minimum margin from limit line on the negative offset C (dB) 76. Minimum margin from limit line on the positive offset C (dB) 77. Minimum margin from limit line on the negative offset D (dB) 78. Minimum margin from limit line on the positive offset D (dB) 79. Minimum margin from limit line on the negative offset E (dB) 80. Minimum margin from limit line on the positive offset E (dB) 81. Minimum margin from limit line on the negative offset F (dB) 82. Minimum margin from limit line on the positive offset F (dB)
All except MSR, WLAN, LTEAFDD, LTEATDD	1	<b>Meas Type: Spectrum Peak Reference</b> Returns 82 comma-separated scalar results, in the following order: <ol style="list-style-type: none"> <li>1. Reserved for the future use, returns -999.0</li> <li>2. Peak power at the center frequency (reference) area (dBm)</li> <li>3. Reserved for the future use, returns -999.0</li> <li>4. Reserved for the future use, returns -999.0</li> <li>5. Peak frequency in the center frequency (reference) area (Hz)</li> <li>6. Reserved for the future use, returns -999.0</li> <li>7. Reserved for the future use, returns -999.0</li> <li>8. Reserved for the future use, returns -999.0</li> <li>9. Reserved for the future use, returns -999.0</li> <li>10. Reserved for the future use, returns -999.0</li> <li>11. Reserved for the future use, returns -999.0</li> <li>12. Reserved for the future use, returns -999.0</li> <li>13. Relative peak power on the negative offset A (dB)</li> <li>14. Absolute peak power on the negative offset A (dBm)</li> <li>15. Peak power offset frequency from the center or carrier edge frequency in the negative offset A, depending on Offset Frequency Define settings (Hz)</li> <li>16. Reserved for the future use, returns -999.0</li> <li>17. Reserved for the future use, returns -999.0</li> <li>18. Relative peak power on the positive offset A (dB)</li> <li>19. Absolute peak power on the positive offset A (dBm)</li> <li>20. Peak power offset frequency from the center or carrier edge frequency in the positive offset A, depending on Offset Frequency Define settings (Hz)</li> <li>21. Reserved for the future use, returns -999.0</li> <li>---</li> <li>69. Absolute peak power on the positive offset F (dBm)</li> <li>70. Peak power offset frequency from the center or carrier edge frequency in the positive offset F, depending on Offset Frequency Define settings (Hz)</li> <li>71. Minimum margin from limit line on the negative offset A (dB)</li> <li>72. Minimum margin from limit line on the positive offset A (dB)</li> </ol>

Modes	n	Return Value
		73. Minimum margin from limit line on the negative offset B (dB)
		74. Minimum margin from limit line on the positive offset B (dB)
		75. Minimum margin from limit line on the negative offset C (dB)
		76. Minimum margin from limit line on the positive offset C (dB)
		77. Minimum margin from limit line on the negative offset D (dB)
		78. Minimum margin from limit line on the positive offset D (dB)
		79. Minimum margin from limit line on the negative offset E (dB)
		80. Minimum margin from limit line on the positive offset E (dB)
		81. Minimum margin from limit line on the negative offset F (dB)
		82. Minimum margin from limit line on the positive offset F (dB)
MSR, LTEAFDD, LTEATDD	1	<p><b>Meas Type: Total Power Reference</b></p> <p>Returns outer offset results when Non-Contiguous Meas Region is set to Outer, and returns inner offset results when it is set to Inner, in the following order.</p> <ol style="list-style-type: none"> <li>1. Total Absolute power of carriers of Measure Carrier On if available. Otherwise -999.0 is returned.</li> <li>2. Absolute reference power. Absolute power at the left reference carrier if Power Ref type is "Left &amp; Right Carriers." Absolute power at the reference carrier of the left sub-block if Power Ref type is "Max Power Carrier in Sub-block." (dBm)</li> <li>3. Absolute power at the right reference carrier if Power Ref type is "Left &amp; Right Carriers." Absolute power at the reference carrier of the right sub-block if Power Ref type is "Max Power Carrier in Sub-block." Otherwise -999.0 is returned. (dBm)</li> <li>4. Reserved for the future use, returns -999.0</li> <li>5. Peak frequency in the ref carrier channel spacing frequency range. Peak frequency in the left ref carrier frequency range if Power Ref Type is "Left &amp; Right Carriers." Peak frequency in the ref carrier frequency range of the left sub-block if Power Ref type is "Max Power Carrier in Sub-block."</li> <li>6. Peak frequency in the right ref carrier channel spacing frequency range if Power Ref type is "Left &amp; Right Carriers." Peak frequency in the ref carrier frequency range of the right sub-block if Power Ref type is "Max Power Carrier in Sub-block." Otherwise -999.0 is returned.</li> <li>7. Reserved for the future use, returns -999.0</li> <li>8. Reserved for the future use, returns -999.0</li> <li>9. Reserved for the future use, returns -999.0</li> <li>10. Reserved for the future use, returns -999.0</li> <li>11. Relative integrated power on the negative offset A (dBc)</li> <li>12. Absolute integrated power on the negative offset A (dBm)</li> <li>13. Relative peak power on the negative offset A (dBc)</li> <li>14. Absolute peak power on the negative offset A (dBm)</li> <li>15. Peak power offset frequency from the center or carrier edge frequency in the negative offset A, depending on Offset Frequency Define settings (Hz)</li> <li>16. Relative integrated power on the positive offset A (dBc)</li> <li>17. Absolute integrated power on the positive offset A (dBm)</li> </ol>

Modes	n	Return Value
		18. Relative peak power on the positive offset A (dBc)
		19. Absolute peak power on the positive offset A (dBm)
		20. Peak power offset frequency from the center or carrier edge frequency in the positive offset A, depending on Offset Frequency Define settings (Hz)
		21. Relative integrated power on the negative offset B (dBc)
		---
		69. Absolute peak power on the positive offset F (dBm)
		70. Peak power offset frequency from the center or carrier edge frequency in the positive offset F, depending on Offset Frequency Define settings (Hz)
		71. Minimum margin from limit line on the negative offset A (dB)
		72. Minimum margin from limit line on the positive offset A (dB)
		73. Minimum margin from limit line on the negative offset B (dB)
		74. Minimum margin from limit line on the positive offset B (dB)
		75. Minimum margin from limit line on the negative offset C (dB)
		76. Minimum margin from limit line on the positive offset C (dB)
		77. Minimum margin from limit line on the negative offset D (dB)
		78. Minimum margin from limit line on the positive offset D (dB)
		79. Minimum margin from limit line on the negative offset E (dB)
		80. Minimum margin from limit line on the positive offset E (dB)
		81. Minimum margin from limit line on the negative offset F (dB)
		82. Minimum margin from limit line on the positive offset F (dB)
MSR , LTEAFDD, LTEATDD	1	<p><b>Meas Type: Power Spectral Density Reference</b> Returns outer offset results when Non-Contiguous Meas Region is set to Outer, and returns inner offset results when it is set to Inner, in the following order.</p> <ol style="list-style-type: none"> <li>1. Total Absolute power of carriers of Measure Carrier On if available. Otherwise -999.0 is returned. (dBm)</li> <li>2. Absolute reference power. Absolute power at the left reference carrier if Power Ref type is "Left &amp; Right Carriers." Absolute power at the reference carrier of the left sub-block if Power Ref type is "Max Power Carrier in Sub-block." (dBm/Hz)</li> <li>3. Absolute power at the right reference carrier if Power Ref type is "Left &amp; Right Carriers." Absolute power at the reference carrier of the right sub-block if Power Ref type is "Max Power Carrier in Sub-block." Otherwise -999.0 is returned. (dBm/Hz)</li> <li>4. Reserved for the future use, returns -999.0</li> <li>5. Peak frequency in the ref carrier channel spacing frequency range . Peak frequency in the left ref carrier frequency range if Power Ref type is "Left &amp; Right Carriers." Peak frequency in the ref carrier frequency range of the left sub-block if Power Ref type is "Max Power Carrier in Sub-block."</li> <li>6. Peak frequency in the right ref carrier channel spacing frequency range if Power Ref type is "Left &amp; Right Carriers." Peak frequency in the ref carrier frequency range of the right sub-block if Power Ref type is "Max Power Carrier in Sub-block." Otherwise -999.0 is returned.</li> <li>7. Reserved for the future use, returns -999.0</li> </ol>

Modes	n	Return Value
		8. Reserved for the future use, returns -999.0
		9. Reserved for the future use, returns -999.0
		10. Reserved for the future use, returns -999.0
		11. Relative integrated power on the negative offset A (dBc)
		12. Absolute integrated power on the negative offset A (dBm/Hz)
		13. Relative peak power on the negative offset A (dBc)
		14. Absolute peak power on the negative offset A (dBm/Hz)
		15. Peak power offset frequency from the center or carrier edge frequency in the negative offset A, depending on Offset Frequency Define settings (Hz)
		16. Relative integrated power on the positive offset A (dBc)
		17. Absolute integrated power on the positive offset A (dBm/Hz)
		18. Relative peak power on the positive offset A (dBc)
		19. Absolute peak power on the positive offset A (dBm/Hz)
		20. Peak power offset frequency from the center or carrier edge frequency in the positive offset A, depending on Offset Frequency Define settings (Hz)
		21. Relative integrated power on the negative offset B (dBc)
		---
		69. Absolute peak power on the positive offset F (dBm/Hz)
		70. Peak power offset frequency from the center or carrier edge frequency in the positive offset F, depending on Offset Frequency Define settings (Hz)
		71. Minimum margin from limit line on the negative offset A (dB)
		72. Minimum margin from limit line on the positive offset A (dB)
		73. Minimum margin from limit line on the negative offset B (dB)
		74. Minimum margin from limit line on the positive offset B (dB)
		75. Minimum margin from limit line on the negative offset C (dB)
		76. Minimum margin from limit line on the positive offset C (dB)
		77. Minimum margin from limit line on the negative offset D (dB)
		78. Minimum margin from limit line on the positive offset D (dB)
		79. Minimum margin from limit line on the negative offset E (dB)
		80. Minimum margin from limit line on the positive offset E (dB)
		81. Minimum margin from limit line on the negative offset F (dB)
		82. Minimum margin from limit line on the positive offset F (dB)
MSR, LTEAFDD, LTEATDD	1	<p><b>Meas Type: Spectrum Peak Reference</b></p> <p>Returns outer offset results when Non-Contiguous Meas Region is set to Outer, and returns inner offset results when it is set to Inner, in the following order.</p> <ol style="list-style-type: none"> <li>1. Total Absolute power of carriers of Measure Carrier On if available. Otherwise -999.0 is returned. (dBm)</li> <li>2. Peak reference power. Peak power at the left reference carrier if Power Ref type is "Left &amp; Right Carriers." Peak power at the reference carrier of the left sub-block if Power Ref type is "Max Power Carrier in Sub-block." (dBm)</li> </ol>



Modes	n	Return Value
		3. Peak power at the right reference carrier if Power Ref type is "Left & Right Carriers." Peak power at the reference carrier of the right sub-block if Power Ref type is "Max Power Carrier in Sub-block." Otherwise -999.0 is returned. (dBm)
		4. Reserved for the future use, returns -999.0
		5. Peak frequency in the ref carrier channel spacing frequency range. Peak frequency in the left ref carrier frequency range if Power Ref type is "Left & Right Carriers." Peak frequency in the ref carrier frequency range of the left sub-block if Power Ref type is "Max Power Carrier in Sub-block."
		6. Peak frequency in the right ref carrier channel spacing frequency range if Power Ref type is "Left & Right Carriers." Peak frequency in the ref carrier frequency range of the right sub-block if Power Ref type is "Max Power Carrier in Sub-block." Otherwise -999.0 is returned.
		7. Reserved for the future use, returns -999.0
		8. Reserved for the future use, returns -999.0
		9. Reserved for the future use, returns -999.0
		10. Reserved for the future use, returns -999.0
		11. Relative integrated power on the negative offset A (dBc)
		12. Absolute integrated power on the negative offset A (dBm)
		13. Relative peak power on the negative offset A (dBc)
		14. Absolute peak power on the negative offset A (dBm)
		15. Peak power offset frequency from the center or carrier edge frequency in the negative offset A, depending on Offset Frequency Define settings (Hz)
		16. Relative integrated power on the positive offset A (dBc)
		17. Absolute integrated power on the positive offset A (dBm)
		18. Relative peak power on the positive offset A (dBc)
		19. Absolute peak power on the positive offset A (dBm)
		20. Peak power offset frequency from the center or carrier edge frequency in the positive offset A, depending on Offset Frequency Define settings (Hz)
		21. Relative integrated power on the negative offset B (dBc)
		---
		69. Absolute peak power on the positive offset F (dBm)
		70. Peak power offset frequency from the center or carrier edge frequency in the positive offset F, depending on Offset Frequency Define settings (Hz)
		71. Minimum margin from limit line on the negative offset A (dB)
		72. Minimum margin from limit line on the positive offset A (dB)
		73. Minimum margin from limit line on the negative offset B (dB)
		74. Minimum margin from limit line on the positive offset B (dB)
		75. Minimum margin from limit line on the negative offset C (dB)
		76. Minimum margin from limit line on the positive offset C (dB)
		77. Minimum margin from limit line on the negative offset D (dB)
		78. Minimum margin from limit line on the positive offset D (dB)
		79. Minimum margin from limit line on the negative offset E (dB)
		80. Minimum margin from limit line on the positive offset E (dB)

Modes	n	Return Value
		81. Minimum margin from limit line on the negative offset F (dB)
		82. Minimum margin from limit line on the positive offset F (dB)
WLAN, with radio standard 802.11 ac (80 MHz + 80 MHz)	1	<p><b>Meas Type: Total Power Reference</b> Returns 82 comma-separated scalar results, in the following order:</p> <ol style="list-style-type: none"> <li>1. Reserved for the future use, returns -999.0</li> <li>2. Absolute reference power (dBm)</li> <li>3. Absolute power of the carrier of which the frequency is indicated by Freq Segment 1 (dBm)</li> <li>4. Absolute power of the carrier of which the frequency is indicated by Freq Segment 2 (dBm)</li> <li>5. Peak frequency in the center frequency (reference) area (Hz)</li> <li>6. Reserved for the future use, returns -999.0</li> <li>7. Reserved for the future use, returns -999.0</li> <li>8. Reserved for the future use, returns -999.0</li> <li>9. Reserved for the future use, returns -999.0</li> <li>10. Reserved for the future use, returns -999.0</li> <li>11. Relative integrated power on the negative offset A (dBc)</li> <li>12. Absolute integrated power on the negative offset A (dBm)</li> <li>13. Relative peak power on the negative offset A (dBc)</li> <li>14. Absolute peak power on the negative offset A (dBm)</li> <li>15. Peak power offset frequency from the center or carrier edge frequency in the negative offset A, depending on Offset Frequency Define settings (Hz)</li> <li>16. Relative integrated power on the positive offset A (dBc)</li> <li>17. Absolute integrated power on the positive offset A (dBm)</li> <li>18. Relative peak power on the positive offset A (dBc)</li> <li>19. Absolute peak power on the positive offset A (dBm)</li> <li>20. Peak power offset frequency from the center or carrier edge frequency in the positive offset A, depending on Offset Frequency Define settings (Hz)</li> <li>21. Relative integrated power on the negative offset B (dBc)</li> </ol> <p>---</p> <ol style="list-style-type: none"> <li>69. Absolute peak power on the positive offset F (dBm)</li> <li>70. Peak power offset frequency from the center or carrier edge frequency in the positive offset F, depending on Offset Frequency Define settings (Hz)</li> <li>71. Minimum margin from limit line on the negative offset A (dB)</li> <li>72. Minimum margin from limit line on the positive offset A (dB)</li> <li>73. Minimum margin from limit line on the negative offset B (dB)</li> <li>74. Minimum margin from limit line on the positive offset B (dB)</li> <li>75. Minimum margin from limit line on the negative offset C (dB)</li> <li>76. Minimum margin from limit line on the positive offset C (dB)</li> <li>77. Minimum margin from limit line on the negative offset D (dB)</li> <li>78. Minimum margin from limit line on the positive offset D (dB)</li> </ol>

Modes	n	Return Value
		79. Minimum margin from limit line on the negative offset E (dB)
		80. Minimum margin from limit line on the positive offset E (dB)
		81. Minimum margin from limit line on the negative offset F (dB)
		82. Minimum margin from limit line on the positive offset F (dB)
WLAN, with radio standard 802.11 ac (80 MHz + 80 MHz)	1	<p><b>Meas Type: Power Spectral Density Reference</b> Returns 82 comma-separated scalar results, in the following order:</p> <ol style="list-style-type: none"> <li>1. Reserved for the future use, returns -999.0</li> <li>2. Absolute reference power (dBm/Hz)</li> <li>3. Absolute power of the carrier of which the frequency is indicated by Freq Segment 1 (dBm/Hz)</li> <li>4. Absolute power of the carrier of which the frequency is indicated by Freq Segment 2 (dBm/Hz)</li> <li>5. Peak frequency in the center frequency (reference) area (Hz)</li> <li>6. Reserved for the future use, returns -999.0</li> <li>7. Reserved for the future use, returns -999.0</li> <li>8. Reserved for the future use, returns -999.0</li> <li>9. Reserved for the future use, returns -999.0</li> <li>10. Reserved for the future use, returns -999.0</li> <li>11. Relative integrated power on the negative offset A (dB)</li> <li>12. Absolute integrated power on the negative offset A (dBm/Hz)</li> <li>13. Relative peak power on the negative offset A (dB)</li> <li>14. Absolute peak power on the negative offset A (dBm/Hz)</li> <li>15. Peak power offset frequency from the center or carrier edge frequency in the negative offset A, depending on Offset Frequency Define settings (Hz)</li> <li>16. Relative integrated power on the positive offset A (dB)</li> <li>17. Absolute integrated power on the positive offset A (dBm/Hz)</li> <li>18. Relative peak power on the positive offset A (dB)</li> <li>19. Absolute peak power on the positive offset A (dBm/Hz)</li> <li>20. Peak power offset frequency from the center or carrier edge frequency in the positive offset A, depending on Offset Frequency Define settings (Hz)</li> <li>21. Relative integrated power on the negative offset B (dB)</li> <li>---</li> <li>69. Absolute peak power on the positive offset F (dBm/Hz)</li> <li>70. Peak power offset frequency from the center or carrier edge frequency in the positive offset F, depending on Offset Frequency Define settings (Hz)</li> <li>71. Minimum margin from limit line on the negative offset A (dB)</li> <li>72. Minimum margin from limit line on the positive offset A (dB)</li> <li>73. Minimum margin from limit line on the negative offset B (dB)</li> <li>74. Minimum margin from limit line on the positive offset B (dB)</li> <li>75. Minimum margin from limit line on the negative offset C (dB)</li> <li>76. Minimum margin from limit line on the positive offset C (dB)</li> </ol>

Modes	n	Return Value
		77. Minimum margin from limit line on the negative offset D (dB) 78. Minimum margin from limit line on the positive offset D (dB) 79. Minimum margin from limit line on the negative offset E (dB) 80. Minimum margin from limit line on the positive offset E (dB) 81. Minimum margin from limit line on the negative offset F (dB) 82. Minimum margin from limit line on the positive offset F (dB)
All	2	Returns the displayed frequency domain spectrum trace data separated by comma. The number of data points is 2001.
All	3	Returns the displayed frequency domain absolute limit trace data separated by comma. The number of data points is 2001.
All	4	Returns the displayed frequency domain relative limit trace data separated by comma. The number of data points is 2001.
All (see details)	5	<p><b>Meas Type: Total Power Reference</b> Returns comma-separated scalar values (in dBm) of the absolute integrated power of the segment frequencies. The length of the result depends on the number of available offset (See <a href="#">"Number of Offsets" on page 1195</a>).</p> <ol style="list-style-type: none"> <li>1. Total power reference (dBm)</li> <li>2. Reserved for the future use, returns -999.0</li> <li>3. Absolute integrated power at negative offset frequency (A)</li> <li>4. Absolute integrated power at positive offset frequency (A)</li> </ol> <p>---</p> <ol style="list-style-type: none"> <li>25. Absolute integrated power at negative offset frequency (L)</li> <li>26. Absolute integrated power at positive offset frequency (L)</li> </ol> <p>In <b>MSR and LTE-Advanced FDD/TDD</b> mode. Returns outer offset results when Non-Contiguous Meas Region is set to Outer, and returns inner offset results when it is set to Inner, in the following order.</p> <ol style="list-style-type: none"> <li>1. Ref carrier power. Left ref carrier power if Power Ref type is "Left &amp; Right Carriers." Ref carrier power of the left sub-block if Power Ref type is "Max Power Carrier in Sub-block." (dBm)</li> <li>2. Right ref carrier power if Ref channel type is "Left &amp; Right Carriers." Ref carrier power of the right sub-block if Power Ref type is "Max Power Carrier in Sub-block." Otherwise -999.0 is returned. (dBm)</li> <li>3. Absolute integrated power at negative offset frequency (A)</li> <li>4. Absolute integrated power at positive offset frequency (A)</li> </ol> <p>---</p> <ol style="list-style-type: none"> <li>25. Absolute integrated power at negative offset frequency (L)</li> <li>26. Absolute integrated power at positive offset frequency (L)</li> </ol> <p>In <b>WLAN</b> mode. Returns 26 comma-separated scalar values (in dBm) of the absolute integrated power of the segment frequencies:</p> <ol style="list-style-type: none"> <li>1. Ref carrier power (dBm)</li> <li>2. Reserved for the future use, returns -999.0</li> </ol>

Modes	n	Return Value
		3. Absolute integrated power at negative offset frequency (A) 4. Absolute integrated power at positive offset frequency (A) --- 25. Absolute integrated power at negative offset frequency (L) 26. Absolute integrated power at positive offset frequency (L) If the result is not available, -999.0 is returned. The number of values returned is subject to change in future releases.
All (see details)	5	<p><b>Meas Type: Power Spectral Density Reference</b>            Returns comma-separated scalar values (in dBm/Hz) of the absolute integrated power of the segment frequencies. The length of the result depends on the number of available offset (See <a href="#">"Number of Offsets" on page 1195</a>).</p> 1. Power spectral density reference (dBm/Hz) 2. Reserved for the future use, returns -999.0 3. Absolute integrated power at negative offset frequency (A) 4. Absolute integrated power at positive offset frequency (A) --- 25. Absolute integrated power at negative offset frequency (L) 26. Absolute integrated power at positive offset frequency (L) <b>In MSR and LTE-Advanced FDD/TDD mode.</b> Returns outer offset results when Non-Contiguous Meas Region is set to Outer, and returns inner offset results when it is set to Inner, in the following order. 1. Ref carrier power. Left ref carrier power if Power Ref type is "Left & Right Carriers" Ref carrier power of the left sub-block if Power Ref type is "Max Power Carrier in Sub-block." (dBm/Hz) 2. Right ref carrier power if Power Ref type is "Left & Right Carriers." Ref carrier power of the right sub-block if Power Ref type is "Max Power Carrier in Sub-block." Otherwise -999.0 is returned. (dBm/Hz) 3. Absolute integrated power at negative offset frequency (A) 4. Absolute integrated power at positive offset frequency (A) --- 25. Absolute integrated power at negative offset frequency (L) 26. Absolute integrated power at positive offset frequency (L) <b>In WLAN mode.</b> Returns 26 comma-separated scalar values (in dBm/Hz) of the absolute integrated power of the segment frequencies: 1. Ref carrier power (dBm/Hz) 2. Reserved for the future use, returns -999.0 3. Absolute integrated power at negative offset frequency (A) 4. Absolute integrated power at positive offset frequency (A) --- 25. Absolute integrated power at negative offset frequency (L)

Modes	n	Return Value
		<p>26. Absolute integrated power at positive offset frequency (L) If the result is not available, -999.0 is returned. The number of values returned is subject to change in future releases.</p>
All (see details)	5	<p><b>Meas Type: Spectrum Peak Reference</b> Returns comma-separated scalar values (in dBm) of the absolute peak power of the segment frequencies. The length of the result depends on the number of available offset (See "<a href="#">Number of Offsets</a>" on page 1195).</p> <ol style="list-style-type: none"> <li>1. Spectrum Peak Power reference (dBm)</li> <li>2. Reserved for the future use, returns -999.0</li> <li>3. Absolute peak power at negative offset frequency (A)</li> <li>4. Absolute peak power at positive offset frequency (A)</li> </ol> <p>---</p> <p>25. Absolute peak power at negative offset frequency (L) 26. Absolute peak power at positive offset frequency (L) In <b>MSR and LTE-Advanced FDD/TDD</b> mode. Returns outer offset results when Non-Contiguous Meas Region is set to Outer, and returns inner offset results when it is set to Inner, in the following order.</p> <ol style="list-style-type: none"> <li>1. Spectrum Peak Power reference of ref carrier. Spectrum Peak Power reference of left ref carrier if Power Ref type is "Left &amp; Right Carriers." Spectrum Peak Power reference of the left sub-block if Power Ref type is "Max Power Carrier in Sub-block." (dBm)</li> <li>2. Spectrum Peak Power reference of right ref carrier power if Power Ref type is "Left &amp; Right carriers." Spectrum Peak Power reference of the right sub-block if Power Ref type is "Max Power Carrier in Sub-block." Otherwise -999.0 is returned. (dBm)</li> <li>3. Absolute peak power at negative offset frequency (A)</li> <li>4. Absolute peak power at positive offset frequency (A)</li> </ol> <p>---</p> <p>25. Absolute peak power at negative offset frequency (L) 26. Absolute peak power at positive offset frequency (L) If the result is not available, -999.0 is returned. The number of values returned is subject to change in future releases.</p>
All	6	<p><b>Meas Type: Total Power Reference</b> Returns comma-separated scalar values (in dBc) of the integrated power relative to the carrier at the segment frequencies. The length of the result depends on the number of available offset (See "<a href="#">Number of Offsets</a>" on page 1195).</p> <p>When in the MSR and LTE-Advanced FDD/TDD mode, returns outer offset results when Non-Contiguous Meas Region is set to Outer, and returns inner offset results when it is set to Inner, in the following order.</p> <ol style="list-style-type: none"> <li>1. Reserved for the future use, returns -999.0</li> <li>2. Reserved for the future use, returns -999.0</li> <li>3. Relative integrated power at negative offset frequency (A)</li> </ol>

Modes	n	Return Value
		<p>4. Relative integrated power at positive offset frequency (A)</p> <p>---</p> <p>25. Relative integrated power at negative offset frequency (L)</p> <p>26. Relative integrated power at positive offset frequency (L)</p> <p>If the result is not available, -999.0 is returned.</p> <p>The number of values returned is subject to change in future releases.</p>
All	6	<p><b>Meas Type: Power Spectral Density Reference</b></p> <p>Returns comma-separated scalar values (in dBc/Hz) of the integrated power relative to the carrier at the segment frequencies. The length of the result depends on the number of available offset (See "<a href="#">Number of Offsets</a>" on page 1195).</p> <p>When in the MSR and LTE-Advanced FDD/TDD mode, returns outer offset results when Non-Contiguous Meas Region is set to Outer, and returns inner offset results when it is set to Inner, in the following order.</p> <p>Returns -999.0 for the offsets if in WLAN:</p> <ol style="list-style-type: none"> <li>1. Reserved for the future use, returns -999.0</li> <li>2. Reserved for the future use, returns -999.0</li> <li>3. Relative integrated power at negative offset frequency (A)</li> <li>4. Relative integrated power at positive offset frequency (A)</li> </ol> <p>---</p> <p>25. Relative integrated power at negative offset frequency (L)</p> <p>26. Relative integrated power at positive offset frequency (L)</p> <p>If the result is not available, -999.0 is returned.</p> <p>The number of values returned is subject to change in future releases.</p>
All	6	<p><b>Meas Type: Spectrum Peak Reference</b></p> <p>Returns comma-separated scalar values (in dB) of the integrated power relative to the carrier at the segment frequencies. The length of the result depends on the number of available offset (See "<a href="#">Number of Offsets</a>" on page 1195).</p> <p>When in the MSR and LTE-Advanced FDD/TDD mode, returns outer offset results when Non-Contiguous Meas Region is set to Outer, and returns inner offset results when it is set to Inner, in the following order.</p> <ol style="list-style-type: none"> <li>1. Reserved for the future use, returns -999.0</li> <li>2. Reserved for the future use, returns -999.0</li> <li>3. Relative peak power at negative offset frequency (A)</li> <li>4. Relative peak power at positive offset frequency (A)</li> </ol> <p>---</p> <p>25. Relative peak power at negative offset frequency (L)</p> <p>26. Relative peak power at positive offset frequency (L)</p> <p>If the result is not available, -999.0 is returned.</p> <p>The number of values returned is subject to change in future releases.</p>
All	7	

Modes	n	Return Value
		<p>Returns comma-separated pass/fail test results (0=passed, or 1=failed) determined by testing the minimum margin point from the limit line that is determined each offset's Limits setting. The length of the result depends on the number of available offset (See <a href="#">"Number of Offsets" on page 1195</a>).</p> <p>When in the MSR and LTE-Advanced FDD/TDD mode, returns outer offset results when Non-Contiguous Meas Region is set to Outer, and returns inner offset results when it is set to Inner, in the following order.</p> <ol style="list-style-type: none"> <li>1. Reserved for the future use, returns -999.0</li> <li>2. Reserved for the future use, returns -999.0</li> <li>3. At negative offset frequency (A)</li> <li>4. At positive offset frequency (A)</li> <li>---</li> <li>25. At negative offset frequency (L)</li> <li>26. At positive offset frequency (L)</li> </ol> <p>The number of values returned is subject to change in future releases.</p>
All	8	<p>Offset Pass/Fail.</p> <p>Returns comma-separated pass/fail test results (0=passed, or 1=failed) determined by testing the minimum margin point from the limit line that is determined each offset's Limits setting. The length of the result depends on the number of available offset (See <a href="#">"Number of Offsets" on page 1195</a>).</p> <p>When in the MSR and LTE-Advanced FDD/TDD mode, returns outer offset results when Non-Contiguous Meas Region is set to Outer, and returns inner offset results when it is set to Inner, in the following order.</p> <p>Note: These results (n=8) are the same as n=7 result.</p> <ol style="list-style-type: none"> <li>1. Reserved for the future use, returns -999.0</li> <li>2. Reserved for the future use, returns -999.0</li> <li>3. At negative offset frequency (A)</li> <li>4. At positive offset frequency (A)</li> <li>---</li> <li>25. At negative offset frequency (L)</li> <li>26. At positive offset frequency (L)</li> </ol> <p>The number of values returned is subject to change in future releases.</p>
All	9	<p>Offset Peak Power Freq.</p> <p>Returns comma-separated scalar values of frequency (in Hz) that have peak power from center or carrier edge frequency in each offset, depending on Offset Frequency Define settings. The length of the result depends on the number of available offset (See <a href="#">"Number of Offsets" on page 1195</a>).</p> <p>When in the MSR and LTE-Advanced FDD/TDD mode, returns outer offset results when Non-Contiguous Meas Region is set to Outer, and returns inner offset results when it is set to Inner, in the following order.</p> <ol style="list-style-type: none"> <li>1. Reserved for the future use, returns -999.0</li> <li>2. Reserved for the future use, returns -999.0</li> <li>3. Negative offset frequency (A)</li> </ol>



Modes	n	Return Value
		<p>4. Positive offset frequency (A)</p> <p>---</p> <p>25. Negative offset frequency (L)</p> <p>26. Positive offset frequency (L)</p> <p>If the result is not available, -999.0 is returned.</p> <p>The number of values returned is subject to change in future releases.</p>
All	10	<p>Offset Abs Peak Power.</p> <p>Returns comma-separated scalar values (in dBm) of the absolute peak power of the segment frequencies. The length of the result depends on the number of available offset (See "<a href="#">Number of Offsets</a>" on page 1195).</p> <p>When in the MSR and LTE-Advanced FDD/TDD mode, returns outer offset results when Non-Contiguous Meas Region is set to Outer, and returns inner offset results when it is set to Inner, in the following order.</p> <ol style="list-style-type: none"> <li>1. Reserved for the future use, returns -999.0</li> <li>2. Reserved for the future use, returns -999.0</li> <li>3. At negative offset frequency (A)</li> <li>4. At positive offset frequency (A)</li> </ol> <p>---</p> <ol style="list-style-type: none"> <li>25. At negative offset frequency (L)</li> <li>26. At positive offset frequency (L)</li> </ol> <p>If the result is not available, -999.0 is returned.</p> <p>The number of values returned is subject to change in future releases.</p>
All	11	<p>Offset Rel Peak Power.</p> <p>Returns comma-separated scalar values in dBc (dB if MeasType = PSD) of the peak power relative to the carrier at the segment frequencies. The length of the result depends on the number of available offset (See "<a href="#">Number of Offsets</a>" on page 1195).</p> <p>When in the MSR and LTE-Advanced FDD/TDD mode, returns outer offset results when Non-Contiguous Meas Region is set to Outer, and returns inner offset results when it is set to Inner, in the following order.</p> <ol style="list-style-type: none"> <li>1. Reserved for the future use, returns -999.0</li> <li>2. Reserved for the future use, returns -999.0</li> <li>3. At negative offset frequency (A)</li> <li>4. At positive offset frequency (A)</li> </ol> <p>---</p> <ol style="list-style-type: none"> <li>25. At negative offset frequency (L)</li> <li>26. At positive offset frequency (L)</li> </ol> <p>If the result is not available, -999.0 is returned.</p> <p>The number of values returned is subject to change in future releases.</p>
All	12	<p>Returns the power result (the peak power of the signal in the ref channel) when Meas Type is Spectrum Peak reference. Otherwise, the value returned will be -999.0.</p> <p>When in the MSR and LTE-Advanced FDD/TDD mode, returns outer offset results when Non-</p>

Modes	n	Return Value
		<p>Contiguous Meas Region is set to Outer, and returns inner offset results when it is set to Inner, in the following order.</p>
MSR, LTEAFDD, LTEATDD only	13	<p><b>Meas Type: Total Power Reference</b>  Returns outer offset results when Non-Contiguous Meas Region is set to Outer, and returns inner offset results when it is set to Inner, in the following order.</p> <ol style="list-style-type: none"> <li>1. Total Absolute power of carriers of Measure Carrier On if Power Ref Type is “Max Power Carrier,” “Max Power Carrier in Sub-block,” or “RF Bandwidth.” Otherwise NaN (9.91E+37) is returned. (dBm)</li> <li>2. Absolute reference power. Absolute power at the left reference carrier if Power Ref type is “Left &amp; Right Carriers.” Absolute power at the reference carrier of the left sub-block if Power Ref type is “Max Power Carrier in Sub-block.” (dBm)</li> <li>3. Absolute power at the right reference carrier if Power Ref type is “Left &amp; Right Carriers.” Absolute power at the reference carrier of the right sub-block if Power Ref type is “Max Power Carrier in Sub-block.” Otherwise NaN (9.91E+37) is returned. (dBm)</li> <li>4. Peak frequency in the measured ref carrier frequency range. Peak frequency in the left ref carrier frequency range if Power Ref type is “Left &amp; Right Carriers.” Peak frequency in the ref carrier frequency range of the left sub-block if Power Ref type is “Max Power Carrier in Sub-block.” (Hz)</li> <li>5. Peak frequency in the right ref carrier frequency range if Power Ref type is “Left &amp; Right Carriers.” Peak frequency in the ref carrier frequency range of the right sub-block if Power Ref type is “Max Power Carrier in Sub-block.” Otherwise NaN (9.91E+37) is returned. (Hz)</li> </ol> <p>If the result is not available, NaN (9.91E+37) is returned.  The number of values returned is subject to change in future releases.</p>
MSR, LTEAFDD, LTEATDD only	13	<p><b>Meas Type: Power Spectral Density Reference</b>  Returns outer offset results when Non-Contiguous Meas Region is set to Outer, and returns inner offset results when it is set to Inner, in the following order.</p> <ol style="list-style-type: none"> <li>1. Total Absolute power of carriers of Measure Carrier On if Power Ref Type is “Max Power Carrier,” “Max Power Carrier in Sub-block,” or “RF Bandwidth.” Otherwise NaN (9.91E+37) is returned. (dBm)</li> <li>2. Absolute reference power. Absolute power at the left reference carrier if Power Ref type is “Left &amp; Right Carriers.” Absolute power at the reference carrier of the left sub-block if Power Ref type is “Max Power Carrier in Sub-block.” (dBm/Hz)</li> <li>3. Absolute power at the right reference carrier if Power Ref type is “Left &amp; Right Carriers.” Absolute power at the reference carrier of the right sub-block if Power Ref type is “Max Power Carrier in Sub-block.” Otherwise NaN (9.91E+37) is returned. (dBm/Hz)</li> <li>4. Peak frequency in the measured ref carrier frequency range. Peak frequency in the left ref carrier frequency range if Power Ref type is “Left &amp; Right Carriers.” Peak frequency in the ref carrier frequency range of the left sub-block if Power Ref type is “Max Power Carrier in Sub-block.” (Hz)</li> <li>5. Peak frequency in the right ref carrier frequency range if Power Ref type is “Left &amp; Right Carriers.” Peak frequency in the ref carrier frequency range of the right sub-block if Power Ref</li> </ol>

Modes	n	Return Value
		<p>type is "Max Power Carrier in Sub-block." Otherwise NaN (9.91E+37) is returned. (Hz)</p> <p>If the result is not available, NaN (9.91E+37) is returned.</p> <p>The number of values returned is subject to change in future releases.</p>
MSR, LTEAFDD, LTEATDD only	13	<p><b>Meas Type: Power Spectrum Peak Reference</b></p> <p>Returns outer offset results when Non-Contiguous Meas Region is set to Outer, and returns inner offset results when it is set to Inner, in the following order.</p> <ol style="list-style-type: none"> <li>1. Total Absolute power of carriers of Measure Carrier On if Power Ref Type is "Max Power Carrier," "Max Power Carrier in Sub-block," or "RF Bandwidth." Otherwise NaN (9.91E+37) is returned. (dBm)</li> <li>2. Peak reference power. Peak power at the left reference carrier if Power Ref type is "Left &amp; Right Carriers." Peak power at the reference carrier of the left sub-block if Power Ref type is "Max Power Carrier in Sub-block." (dBm)</li> <li>3. Peak power at the right reference carrier if Power Ref type is "Left &amp; Right Carriers." Peak power at the reference carrier of the right sub-block if Power Ref type is "Max Power Carrier in Sub-block." Otherwise NaN (9.91E+37) is returned. (dBm)</li> <li>4. Peak frequency in the measured ref carrier frequency range. Peak frequency in the left ref carrier frequency range if Power Ref type is "Left &amp; Right Carriers." Peak frequency in the ref carrier frequency range of the left sub-block if Power Ref type is "Max Power Carrier in Sub-block." (Hz)</li> <li>5. Peak frequency in the right ref carrier frequency range if Power Ref type is "Left &amp; Right Carriers." Peak frequency in the ref carrier frequency range of the right sub-block if Power Ref type is "Max Power Carrier in Sub-block." Otherwise NaN (9.91E+37) is returned. (Hz)</li> </ol> <p>If the result is not available, NaN (9.91E+37) is returned.</p> <p>The number of values returned is subject to change in future releases.</p>
All	14	<p><b>Meas Type: Total Power Reference</b></p> <p>Returns comma-separated scalar results, in the following order:</p> <p>When in the MSR and LTE-Advanced FDD/TDD mode, returns outer offset results when Non-Contiguous Meas Region is set to Outer, and returns inner offset results when it is set to Inner, in the following order.</p> <ol style="list-style-type: none"> <li>1. Relative integrated power on the negative offset A (dBc)</li> <li>2. Absolute integrated power on the negative offset A (dBm)</li> <li>3. Relative peak power on the negative offset A (dBc)</li> <li>4. Absolute peak power on the negative offset A (dBm)</li> <li>5. Peak power offset frequency from the center or carrier edge frequency in the negative offset A, depending on Offset Frequency Define settings (Hz)</li> <li>6. Relative integrated power on the positive offset A (dBc)</li> <li>7. Absolute integrated power on the positive offset A (dBm)</li> <li>8. Relative peak power on the positive offset A (dBc)</li> <li>9. Absolute peak power on the positive offset A (dBm)</li> </ol>

Modes	n	Return Value
		<p>10. Peak power offset frequency from the center or carrier edge frequency in the positive offset A, depending on Offset Frequency Define settings (Hz)</p> <p>11. Relative integrated power on the negative offset B (dBc)</p> <p>---</p> <p>119. Absolute peak power on the positive offset L (dBm)</p> <p>120. Peak power offset frequency from the center or carrier edge frequency in the positive offset L, depending on Offset Frequency Define settings (Hz)</p> <p>If the result is not available, NaN (9.91 E+37) is returned.</p> <p>The length of the result depends on the number of available offset (See <a href="#">"Number of Offsets" on page 1195</a>).</p> <p>The number of values returned is subject to change in future releases.</p>
All	14	<p><b>Meas Type: Power Spectral Density Reference</b></p> <p>Returns comma-separated scalar results, in the following order:</p> <p>When in the MSR and LTE-Advanced FDD/TDD mode, returns outer offset results when Non-Contiguous Meas Region is set to Outer, and returns inner offset results when it is set to Inner, in the following order.</p> <ol style="list-style-type: none"> <li>1. Relative integrated power on the negative offset A (dB)</li> <li>2. Absolute integrated power on the negative offset A (dBm/Hz)</li> <li>3. Relative peak power on the negative offset A (dB)</li> <li>4. Absolute peak power on the negative offset A (dBm/Hz)</li> <li>5. Peak power offset frequency from the center or carrier edge frequency in the negative offset A, depending on Offset Frequency Define settings (Hz)</li> <li>6. Relative integrated power on the positive offset A (dB)</li> <li>7. Absolute integrated power on the positive offset A (dBm/Hz)</li> <li>8. Relative peak power on the positive offset A (dB)</li> <li>9. Absolute peak power on the positive offset A (dBm/Hz)</li> <li>10. Peak power offset frequency from the center or carrier edge frequency in the positive offset A, depending on Offset Frequency Define settings (Hz)</li> <li>11. Relative integrated power on the negative offset B (dB)</li> </ol> <p>---</p> <p>119. Absolute peak power on the positive offset L (dBm/Hz)</p> <p>120. Peak power offset frequency from the center or carrier edge frequency in the positive offset L, depending on Offset Frequency Define settings (Hz)</p> <p>If the result is not available, NaN (9.91 E+37) is returned.</p> <p>The length of the result depends on the number of available offset (See <a href="#">"Number of Offsets" on page 1195</a>).</p> <p>The number of values returned is subject to change in future releases.</p>
All	14	<p><b>Meas Type: Spectrum Peak Reference</b></p> <p>Returns comma-separated scalar results, in the following order:</p>

Modes	n	Return Value
		<p>When in the MSR and LTE-Advanced FDD/TDD mode, returns outer offset results when Non-Contiguous Meas Region is set to Outer, and returns inner offset results when it is set to Inner, in the following order.</p> <ol style="list-style-type: none"> <li>1. Reserved for the future use, returns NaN (9.91E+37)</li> <li>2. Reserved for the future use, returns NaN (9.91E+37)</li> <li>3. Relative peak power on the negative offset A (dB)</li> <li>4. Absolute peak power on the negative offset A (dBm)</li> <li>5. Peak power offset frequency from the center or carrier edge frequency in the negative offset A, depending on Offset Frequency Define settings (Hz)</li> <li>6. Reserved for the future use, returns NaN (9.91E+37)</li> <li>7. Reserved for the future use, returns NaN (9.91E+37)</li> <li>8. Relative peak power on the positive offset A (dB)</li> <li>9. Absolute peak power on the positive offset A (dBm)</li> <li>10. Peak power offset frequency from the center or carrier edge frequency in the positive offset A, depending on Offset Frequency Define settings (Hz)</li> <li>11. Relative integrated power on the negative offset B (dB)</li> </ol> <p>---</p> <ol style="list-style-type: none"> <li>119. Absolute peak power on the positive offset L (dBm)</li> <li>120. Peak power offset frequency from the center or carrier edge frequency in the positive offset L, depending on Offset Frequency Define settings (Hz)</li> </ol> <p>If the result is not available, NaN (9.91E+37) is returned.</p> <p>The length of the result depends on the number of available offset (See <a href="#">"Number of Offsets" on page 1195</a>).</p> <p>The number of values returned is subject to change in future releases.</p>
All	15	<p><b>Meas Type: Total Power Reference</b></p> <p>Returns comma-separated scalar results, in the following order:</p> <p>When in the MSR and LTE-Advanced FDD/TDD mode, returns outer offset results when Non-Contiguous Meas Region is set to Outer, and returns inner offset results when it is set to Inner, in the following order.</p> <ol style="list-style-type: none"> <li>1. Minimum margin from limit line on the negative offset A (dB)</li> <li>2. Minimum margin from limit line on the positive offset A (dB)</li> <li>3. Minimum margin from limit line on the negative offset B (dB)</li> <li>4. Minimum margin from limit line on the positive offset B (dB)</li> </ol> <p>---</p> <ol style="list-style-type: none"> <li>23. Minimum margin from limit line on the negative offset L (dB)</li> <li>24. Minimum margin from limit line on the positive offset L (dB)</li> </ol> <p>If the result is not available, NaN (9.91E+37) is returned.</p> <p>The length of the result depends on the number of available offset (See <a href="#">"Number of Offsets" on page 1195</a>).</p> <p>The number of values returned is subject to change in future releases.</p>
MSR, LTEAFDD,	16	

<b>Modes</b>	<b>n</b>	<b>Return Value</b>
LTEATDD only		Returns number of carriers comma-separated scalar results, in the following order: 1. Absolute power of carrier 1 (dBm) 2. Absolute power of carrier 2 (dBm) --- number of carriers-1. Absolute power of carrier (number of carriers)-1 (dBm) number of carriers. Absolute power of carrier (number of carriers)-1 (dBm) If Measure Carrier of the corresponding carrier is no, NaN (9.91E+37) is returned.
WLAN only	16	Returns two carriers comma-separated scalar results when the radio standard is 802.11 ac 80+80 MHz. And returns NaN otherwise. 1. Absolute power of carrier segment 1 (dBm) 2. Absolute power of carrier segment 2 (dBm)
MSR, LTEAFDD, LTEATDD only	17	Returns the displayed frequency domain combined limit trace data separated by comma. Combined trace is a mixed trace of both absolute limit trace and relative limit trace according to the fail mask condition. The number of data points is 2001.

## Number of Offsets

The number of available offsets varies depending on the mode and option as below.

<b>Mode</b>	<b>The number of available offsets</b>
MSR, LTEAFDD, LTEATDD	12 (Offset A to L)
WLAN	12 (Offset A to L)
Other modes with option N9060A-7FP	12 (Offset A to L)
Other modes without option N9060A-7FP	6 (Offset A to F)

<b>Key Path</b>	<b>Meas</b>
Initial S/W Revision	Prior to A.02.00
Modified at S/W Revision	A.11.00, A.14.00

## AMPTD Y Scale

Accesses a menu of functions that enable you to set the vertical scale parameters. The parameter values are measurement independent except all Attenuation values and Internal Preamp selections that are measurement global.

Key Path	Front-panel key
Initial S/W Revision	Prior to A.02.00

### Ref Value

Sets the value for the absolute power reference. However, since Auto Scaling defaults to On, this value is automatically determined by the measurement result. When you set a value manually, Auto Scaling automatically changes to Off.

Key Path	AMPTD Y Scale
Mode	SA, WCDMA, C2K, WIMAX OFDMA, TD-SCDMA, 1xEVDO, DTMB (CTTB), DVB-T/H, ISDB-T, CMMB, LTE, LTETDD, Digital Cable TV, WLAN, MSR, LTEAFDD, LTEATDD
Remote Command	:DISPlay:SEMAsk:VIEW[1]:WINDow[1]:TRACe:Y[:SCALE]:RLEVel <real> :DISPlay:SEMAsk:VIEW[1]:WINDow[1]:TRACe:Y[:SCALE]:RLEVel?
Example	DISP:SEM:VIEW:WIND:TRAC:Y:RLEV 100 DISP:SEM:VIEW:WIND:TRAC:Y:RLEV?
Notes	You must be in the mode that includes SEM measurement to use this command. Use :INSTrument:SElect to set the mode.
Couplings	When the Auto Scaling is On, this value is automatically determined by the measurement result. When you set a value manually, Auto Scaling automatically changed to Off.
Preset	10.0 dBm
State Saved	Saved in instrument state.
Min	-250 dBm
Max	250 dBm
Initial S/W Revision	Prior to A.02.00
Modified at S/W Revision	A.02.00, A.03.00

### Attenuation

This menu controls the attenuator functions and interactions between the attenuation system components.

There are two attenuator configurations in the X-Series. One is a dual attenuator configuration consisting of a mechanical attenuator and an optional electronic attenuator. The other configuration uses a single attenuator with combined mechanical and electronic sections that controls all the attenuation functions. Different models in the X-Series come with different configurations.



See "Dual Attenuator Configurations:" on page 1197

See "Single Attenuator Configuration:" on page 1198

Most Attenuation settings are the same for all measurements – they do not change as you change measurements. Settings like these are called “Meas Global” and are unaffected by Meas Preset.

Key Path	AMPTD Y Scale
Scope	Meas Global
Dependencies	In measurements that support the I/Q inputs, this key is unavailable when I/Q is the selected input, and is replaced by the Range key in that case.
Readback Line	Contains a summary in [ ] brackets of the current total attenuation. See the descriptions of the , " (Mech) Atten " on page 2783, and "Enable Elec Atten" on page 2785 keys for more detail on the contributors to the total attenuation.  Note that when "Pre-Adjust for Min Clip" is on, this value can change at the start of every measurement.
Initial S/W Revision	Prior to A.02.00
Modified at S/W Revision	A.03.00

### Dual Attenuator Configurations:

Configuration 1: Mechanical attenuator + optional electronic attenuator

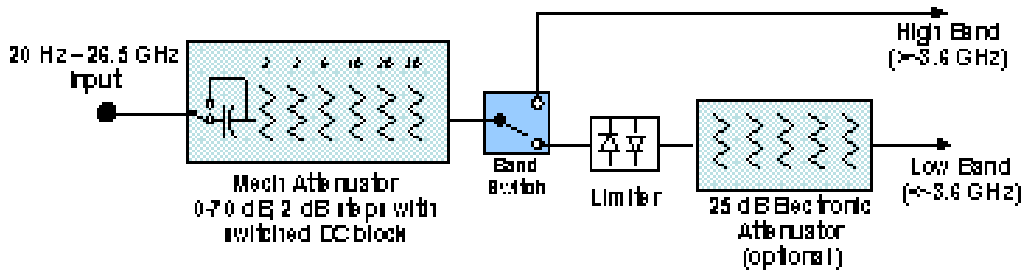

Configuration 2: Mechanical attenuator, no optional electronic attenuator

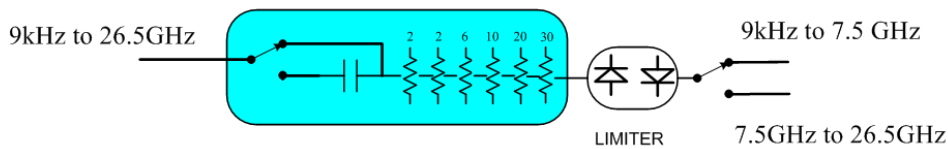

(note that Configuration 2 is not strictly speaking a dual-section attenuator, since there is no electronic section available. However, it behaves exactly like Configuration 1 without the Electronic Attenuator option EA3, therefore for the sake of this document it is grouped into the “Dual Attenuator” configuration)

### Single Attenuator Configuration:

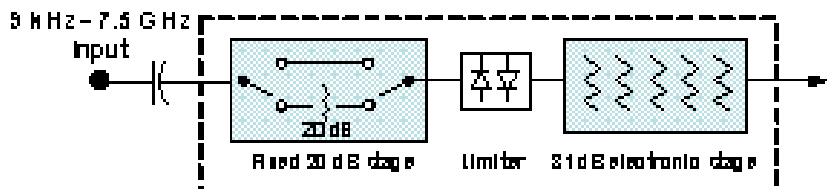

You can tell which attenuator configuration you have by pressing the Attenuation key, which (in most Modes) opens the Attenuation menu. If the first key in the Attenuation menu says Mech Atten you have the dual attenuator configuration. If the first key says Atten you have the single attenuator configuration.

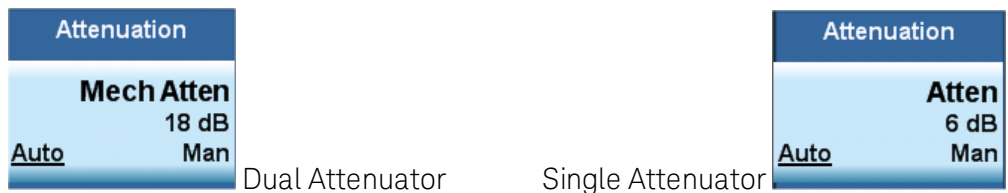

In the single attenuator configuration, you control the attenuation with a single control, as the fixed stage has only two states. In the dual attenuator configuration, both stages have significant range so you are given separate control of the mechanical and electronic attenuator stages.

When you have the dual attenuator configuration, you may still have only a single attenuator, because unless option EA3 (the Electronic Attenuator option) is available, and you purchase it, you will have only the mechanical attenuator.

### (Mech) Atten

This key is labeled Mech Atten in dual attenuator models and Atten in single attenuator models. In the dual attenuator configuration, this key only affects the mechanical attenuator.

This key lets you modify the attenuation applied to the RF input signal path. This value is normally auto coupled to the Ref Level, the Internal Preamp Gain, any External Gain that is entered, and the Max Mixer Level, as described in the table below.

See "[Attenuator Configurations and Auto/Man](#)" on page 1200

Key Path	AMPTD Y Scale, Attenuation
<b>Remote Command</b>	<pre>[ :SENSe]:POWeR[:RF]:ATTenuation &lt;rel_ampl&gt; [:SENSe]:POWeR[:RF]:ATTenuation? [:SENSe]:POWeR[:RF]:ATTenuation:AUTO OFF ON 0 1 [:SENSe]:POWeR[:RF]:ATTenuation:AUTO?</pre>
<b>Example</b>	<p>POW:ATT 20</p> <p>Dual attenuator configuration: sets the mechanical attenuator to 20 dB</p> <p>Single attenuator mode: sets the main attenuation to 20 dB (see below for definition of “main” attenuation).</p> <p>If the attenuator was in Auto, it sets it to Manual.</p>
<b>Dependencies</b>	Some measurements do not support the Auto setting of (Mech) Atten. In these measurements, the

Auto/Man selection is not available, and the Auto/Man line on the key disappears.

In dual attenuator configurations, when the electronic attenuator is enabled, the mechanical attenuator has no auto setting and the Auto/Man line on the key disappears. The state of Auto/Man is remembered and restored when the electronic attenuator is once again disabled. This is described in more detail in the ["Enable Elec Atten" on page 2785](#) key description.

See ["Attenuator Configurations and Auto/Man" on page 1200](#) for more information on the Auto/Man functionality of Attenuation.

Couplings

When (Mech) Atten is in Auto, it uses the following algorithm to determine a value:  
 If the USB Preamp is connected to USB, use 0 dB.  
 Otherwise,  $Atten = ReferenceLevel + PreAmpGain + ExternalGain - RefLevelOffset - MaxMixerLevel + IF\ Gain$ .  
 Limit this value to be between 6 dB and the Max value. No value below 6 dB can ever be chosen by Auto.  
 The resulting value is rounded up to the largest value possible given the attenuation step setting. That is, 50.01 dB would change to 60 dB (for a 10 dB attenuation step).  
 The "IF Gain" term in the equation above is either 0 dB or +10 dB, depending on the settings of FFT IF Gain, Swept IF Gain, max Ref Level and the Auto/Man setting of Mech Atten.  
 In External Mixing and BBIQ, where the Attenuator is not in the signal path, the Attenuator setting changes as described above when (Mech) Atten is in Auto, but no changes are made to the actual attenuator hardware setting until the input is changed back to the RF Input.

Preset The preset for Mech Attenuation is "Auto."  
 The Auto value of attenuation is:  
 CXA, EXA, MXA and PXA: 10 dB

State Saved Saved in instrument state

Min 0 dB  
 The attenuation set by this key cannot be decreased below 6 dB with the knob or step keys. To get to a value below 6 dB it has to be directly entered from the keypad or via SCPI. This protects from adjusting the attenuation to a dangerously small value which can put the instrument at risk of damage to input circuitry. However, if the current mechanical attenuation is below 6 dB it can be increased with the knob and step keys, but not decreased.

Max CXA N9000A-503/507: 50 dB  
 CXA N9000A-513/526: 70dB  
 EXA: 60 dB  
 MXA and PXA: 70 dB  
 In the single attenuator configuration, the total of ATT and EATT cannot exceed 50 dB, so if the EATT is set to 24 dB first, the main attenuation cannot be greater than 26 dB and will be reduced accordingly; if the main attenuator is set to 40 dB first, EATT cannot be greater than 10 dB.

Initial S/W Revision Prior to A.02.00

Modified at S/W Revision A.03.00

### Attenuator Configurations and Auto/Man

As described in the Attenuation key description, there are two distinct attenuator configurations available in the X-Series, the single attenuator and dual attenuator configurations. In dual attenuator configurations, we have the mechanical attenuation and the electronic attenuation, and the current total attenuation is the sum of the electronic + mechanical attenuation. In single attenuator configurations, we refer to the attenuation set using the (Mech) Atten key (or POW:ATT SCPI) as the “main” attenuation; and the attenuation that is set by the SCPI command POW:EATT as the “soft” attenuation (the POW:EATT command is honored even in the single attenuator configuration, for compatibility purposes). Then the current total attenuation is the sum of the main + soft attenuation. See the Elec Atten key description for more on “soft” attenuation.

In the dual attenuator configuration, when the electronic attenuator is enabled, there is no Auto/Man functionality for the mechanical attenuator, and the third line of the key label (the Auto/Man line) disappears:

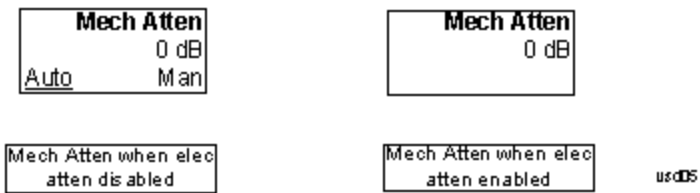

### Enable Elec Atten

Enables the Electronic Attenuator.

The electronic attenuator offers finer steps than the mechanical attenuator, has no acoustical noise, is faster, and is less subject to wear. These advantages primarily aid in remote operation and are negligible for front panel use. See ["Using the Electronic Attenuator: Pros and Cons" on page 1202](#) for a detailed discussion of the pros and cons of using the electronic attenuator.

For the single attenuator configuration, for SCPI backwards compatibility, the “soft” attenuation feature replaces the dual attenuator configuration’s electronic attenuator. All the same couplings and limitations apply. See ["Attenuator Configurations and Auto/Man" on page 2785](#)

See ["More Information" on page 1201](#)

<b>Key Path</b>	AMPTD Y Scale, Attenuation
<b>Remote Command</b>	[ :SENSe ] : POWer [ :RF ] : EATTenuation : STATE OFF   ON   0   1 [ :SENSe ] : POWer [ :RF ] : EATTenuation : STATE ?
<b>Example</b>	POW:EATT:STAT ON
<b>Dependencies</b>	This key only appears in Dual Attenuator models with an Electronic Attenuator installed. It does not appear in models with the Single Attenuator configuration, as in the single attenuator configuration there is no “electronic attenuator” there is only a single integrated attenuator (which has both a mechanical and electronic stage). However, in the single attenuator configuration, EATT SCPI commands are accepted for compatibility with other X-series instruments and set a “soft” attenuation as described in <a href="#">"Attenuator Configurations and Auto/Man" on page 2785</a> . The electronic attenuator (and the “soft” attenuation function provided in single attenuator configurations) is unavailable above 3.6 GHz. Therefore, if the Stop Frequency of the analyzer is > 3.6 GHz then the Enable Elec Atten key will be OFF and grayed out.

---

	<p>If the Internal Preamp is on, meaning it is set to Low Band or Full, the electronic attenuator (and the “soft” attenuation function provided in single attenuator configurations) is unavailable. In this case the Enable Elec Atten key will be OFF and grayed out.</p> <p>If either of the above is true, if the SCPI command is sent, an error indicating that the electronic attenuator is unavailable will be sent.</p> <p>If the electronic/soft Attenuator is enabled, then the Stop Freq of the analyzer is limited to 3.6 GHz and the Internal Preamp is unavailable.</p> <p>The SCPI-only “soft” electronic attenuation for the single-attenuator configuration is not available in all measurements; in particular, it is not available in the Swept SA measurement.</p>
Couplings	Enabling and disabling the Electronic Attenuator affects the setting of the Mechanical Attenuator (in dual attenuator configurations). This is described in more detail below this table.
Preset	OFF for Swept SA measurement; ON for all other measurements that support the electronic attenuator
State Saved	Saved in instrument state
Initial S/W Revision	Prior to A.02.00
Modified at S/W Revision	A.03.00

---

## More Information

### Mechanical Attenuator Transition Rules

When the Electronic Attenuator is enabled, the Mechanical Attenuator transitions to a state that has no Auto function. Below are the rules for transitioning the Mechanical Attenuator. NOTE that the information below ONLY applies to the dual attenuator configurations, and ONLY when the Electronic Attenuator is installed:

#### When the Electronic Attenuation is enabled from a disabled state:

- The Mechanical Attenuator is initialized to 10 dB (this is its optimal performance setting). You can then set it as desired with SCPI, numeric keypad, step keys, or knob, and it behaves as it normally would in manual mode
- The Auto/Man state of (Mech) Atten is saved
- The Auto/Man line on the (Mech) Atten key disappears and the auto rules are disabled
- The Electronic Attenuator is set to 10 dB less than the previous value of the Mechanical Attenuator, within the limitation that it must stay within the range of 0 to 24 dB of attenuation.

#### Examples in the dual attenuator configuration:

- Mech Atten at 20 dB. Elec Atten enabled, Mech Atten set to 10 dB, and Elec Atten set to 10 dB. New total attenuation equals the value before Elec Atten enabled.
- Mech Atten at 0 dB. Elec Atten enabled, Mech Atten set to 10 dB, and Elec Atten set to 0 dB. New total attenuation does not equal the value before Elec Atten enabled.
- Mech Atten at 40 dB. Elec Atten enabled, Mech Atten set to 10 dB, and Elec Atten set to 24 dB. New total attenuation does not equal the value before Elec Atten enabled.

**When the Electronic Attenuation is disabled from an enabled state:**

- The Elec Atten key is grayed out
- The Auto/Man state of (Mech) Atten is restored
- If now in Auto, (Mech) Atten recouples
- If now in Man, (Mech) Atten is set to the value of total attenuation that existed before the Elec Atten was disabled. The resulting value is rounded up to the smallest value possible given the (Mech) Atten Step setting - (That is, 57 dB changes to 58 dB when (Mech) Atten Step is 2 dB.)

**Using the Electronic Attenuator: Pros and Cons**

The electronic attenuator offers finer steps than the mechanical attenuator, has no acoustical noise, is faster, and is less subject to wear.

The “finer steps” advantage of the electronic attenuator is beneficial in optimizing the alignment of the analyzer dynamic range to the signal power in the front panel as well as remote use. Thus, you can achieve improved relative signal measurement accuracy. Compared to a mechanical attenuator with 2 dB steps, the 1 dB resolution of the electronic attenuator only gives better resolution when the odd-decibel steps are used. Those odd-decibel steps are less accurately calibrated than the even-decibel steps, so one tradeoff for this superior relative accuracy is reduced absolute amplitude accuracy.

Another disadvantage of the electronic attenuator is that the spectrum analyzer loses its “Auto” setting, making operation less convenient.

Also, the relationship between the dynamic range specifications (TOI, SHI, compression and noise) and instrument performance are less well-known with the electrical attenuator. With the mechanical attenuator, TOI, SHI and compression threshold levels increase dB-for-dB with increasing attenuation, and the noise floor does as well. With the electronic attenuator, there is an excess attenuation of about 1 to 3 dB between 0 and 3.6 GHz, making the effective TOI, SHI, and so forth, less well known. Excess attenuation is the actual attenuation relative to stated attenuation. Excess attenuation is accounted for in the analyzer calibration

**Elec Atten**

Controls the Electronic Attenuator in dual attenuator configurations. This key does not appear in single attenuator configurations, as the control of both the mechanical and electronic stages of the single attenuator is integrated into the single Atten key.

<b>Key Path</b>	AMPTD Y Scale, Attenuation
<b>Remote Command</b>	[ :SENSe ] :POWer [ :RF ] :EATTenuation <rel_amp1> [ :SENSe ] :POWer [ :RF ] :EATTenuation?
<b>Notes</b>	Electronic Attenuation’s specification is defined only when Mechanical Attenuation is 6 dB.
<b>Dependencies</b>	This key only appears in Dual Attenuator models with an Electronic Attenuator installed. It does not appear in models with the Single Attenuator configuration, as in the single attenuator configuration there is no “electronic attenuator” there is only a single integrated attenuator (which has both a mechanical and electronic stage). However, in the single attenuator configuration, EATT SCPI commands are accepted for compatibility with other X-series instruments and set a “soft” attenuation as described in <a href="#">"Attenuator Configurations and Auto/Man" on page 2785</a> . The “soft” attenuation is treated as an addition to the “main” attenuation value set by the Atten softkey or the

	POW:ATT SCPI command and affects the total attenuation displayed on the Attenuation key and the Meas Bar. When Enable Elec Atten is off or grayed out, the Elec Atten key is grayed out.
Preset	0 dB
State Saved	Saved in instrument state
Min	0 dB
Max	Dual attenuator configuration: 24 dB Single attenuator configuration: the total of ATT and EATT cannot exceed 50 dB, so if the EATT is set to 24 dB first, the main attenuation cannot be greater than 26 dB and will be reduced accordingly; if the main attenuator is set to 40 dB first, EATT cannot be greater than 10 dB
Initial S/W Revision	Prior to A.02.00
Modified at S/W Revision	A.03.00

### Adjust Atten for Min Clip

Sets the combination of mechanical and electronic attenuation and gain based on the current measured signal level so that clipping will be at a minimum.

This is an "immediate action" function, that is, it executes once, when the key is pressed.

This key is grayed out in measurements that do not support this functionality. The spectrum analyzer measurement, Swept SA, does not support this functionality.

Key Path	AMPTD Y Scale, Attenuation
Remote Command	<code>[ :SENSe ] :POWer [ :RF ] :RANGe:OPTimize IMMEDIATE</code>
Initial S/W Revision	Prior to A.02.00
Modified at S/W Revision	A.03.00

### Pre-Adjust for Min Clip

If this function is on, it does the adjustment described under "[Adjust Atten for Min Clip](#)" on page 2788 each time a measurement restarts. Therefore, in Continuous measurement mode, it only executes before the first measurement.

In dual attenuator models, you can set Elec+Mech Atten, in which case both attenuators participate in the autoranging, or Elec Atten Only, in which case the mechanical attenuator does not participate in the autoranging. This latter case results in less wear on the mechanical attenuator and is usually faster.

This key is grayed out in measurements that do not support this functionality. The spectrum analyzer measurement, Swept SA, does not support this functionality.

Key Path	AMPTD Y Scale, Attenuation
Remote Command	<code>[ :SENSe ] :POWer [ :RF ] :RANGe:OPTimize:ATTenuation OFF   ELECTRical   COMBined</code>

	<code>[ :SENSe ] :POWer [ :RF ] :RANGe:OPTimize:ATTenuation?</code>
Notes	The SCPI parameter ELECtrical sets this function to On in single attenuator models. The SCPI parameter COMBined is mapped to ELECtrical in single attenuator models; if you send COMBined, it sets the function to On and returns ELEC to a query.
Dependencies	This key only appears in Dual Attenuator models with an Electronic Attenuator installed. In instruments with Dual Attenuator model, when Enable Elec Atten is off or grayed out, the Pre-Adjust for Min Clip key is grayed out.
Preset	OFF for Swept SA measurement; ON for all other measurements that support Pre-Adjust for Min Clip
State Saved	Saved in instrument state
Range	Dual attenuator models: Off   Elec Atten Only   Mech + Elec Atten Single attenuator models: Off   On
Initial S/W Revision	Prior to A.02.00
Modified at S/W Revision	A.03.00

<b>Remote Command</b>	<code>[ :SENSe ] :POWer [ :RF ] :RANGe:AUTO ON OFF 1 0</code> <code>[ :SENSe ] :POWer [ :RF ] :RANGe:AUTO?</code>
Notes	ON aliases to "Elec Atten Only" (:POW:RANG:OPT:ATT ELEC) OFF aliases to "Off" (:POW:RANG:OPT:ATT OFF) The query :POW:RANG:AUTO? returns true if :POW:RANG:OPT:ATT is not "Off"
Initial S/W Revision	Prior to A.02.00

## Off

Turns Pre-Adjust for Min Clip off. This is the default setting.

This key is grayed out in measurements that do not support this functionality. The spectrum analyzer measurement, Swept SA, does not support this functionality.

Key Path	AMPTD Y Scale, Attenuation, Pre-Adjust for Min Clip
Example	:POW:RANGe:OPT:ATT OFF
Initial S/W Revision	Prior to A.02.00

## Elec Atten Only

Selects only the electric attenuator to participate in auto ranging. This offers less wear on the mechanical attenuator and is usually faster.



This key is grayed out in measurements that do not support this functionality. The spectrum analyzer measurement, Swept SA, does not support this functionality.

Key Path	AMPTD Y Scale, Attenuation, Pre-Adjust for Min Clip
Example	:POW:RANGe:OPT:ATT ELEC
Initial S/W Revision	Prior to A.02.00

### Mech + Elec Atten

In dual attenuator models, this selects both attenuators participate in the autoranging.

This key is grayed out in measurements that do not support this functionality. The spectrum analyzer measurement, Swept SA, does not support this functionality.

Key Path	AMPTD Y Scale, Attenuation, Pre-Adjust for Min Clip
Example	:POW:RANGe:OPT:ATT COMB
Initial S/W Revision	Prior to A.02.00

### (Mech) Atten Step

This controls the step size used when making adjustments to the input attenuation.

This key is labeled Mech Atten Step in dual attenuator models and Atten Step in single attenuator models. In the dual attenuator configuration, this key only affects the step size of the mechanical attenuator.

Key Path	AMPTD Y Scale, Attenuation
Remote Command	[[:SENSe]:POWer[:RF]:ATTenuation:STEP[:INCRement] 10 dB   2 dB [:SENSe]:POWer[:RF]:ATTenuation:STEP[:INCRement]?
Example	POW:ATT:STEP 2
Notes	Note this feature works like a 1-N choice from the front panel, but it takes a specific value (in dB) when used remotely. The only valid values are 2 and 10.
Dependencies	Blanked in CXA and EXA if option FSA (2 dB steps) is not present. If blanked, attempts to set it via SCPI will yield an error.
Couplings	When the attenuation step size changes, the current mechanical attenuation value is adjusted (if necessary) to be quantized to the new step size. That is, if step is set to 10 dB, mech atten is increased if necessary so it is a multiple of 10 dB
Preset	PXA and MXA: 2 dB EXA and CXA: 10 dB (2 dB with option FSA)
State Saved	Saved in instrument state
Initial S/W Revision	Prior to A.02.00
Modified at S/W Revision	A.03.00

## Scale/Div

Sets the units-per-division of the vertical scale in the logarithmic display. When Auto Scaling is On, the scale per division value is automatically determined by the measurement result. When you set a value manually, Auto Scaling automatically changes to Off.

Key Path	AMPTD Y Scale
Mode	SA, WCDMA, C2K, WIMAX OFDMA, TD-SCDMA, 1xEVDO, DTMB (CTTB), DVB-T/H, ISDB-T, CMMB, LTE, LTEFDD, Digital Cable TV, WLAN, MSR, LTEAFDD, LTEATDD
Remote Command	:DISPlay:SEMAsk:VIEW[1]:WINDow[1]:TRACe:Y[:SCALe]:PDIVision <rel_ampl> :DISPlay:SEMAsk:VIEW[1]:WINDow[1]:TRACe:Y[:SCALe]:PDIVision?
Example	DISP:SEM:VIEW:WIND:TRAC:Y:PDIV 15dB DISP:SEM:VIEW:WIND:TRAC:Y:PDIV?
Notes	You must be in the mode that includes SEM measurement to use this command. Use :INSTrument:SElect to set the mode.
Couplings	When the Auto Scaling is On, this value is automatically determined by the measurement result. When you set a value manually, Auto Scaling automatically changes to Off.
Preset	10 dB
State Saved	Saved in instrument state
Min	0.10 dB
Max	20.00 dB
Initial S/W Revision	Prior to A.02.00
Modified at S/W Revision	A.02.00, A.03.00

## Presel Center

When this key is pressed, the centering of the preselector filter is adjusted to optimize the amplitude accuracy at the frequency of the selected marker. If the selected marker is not on when Presel Center is pressed, the analyzer will turn on the selected marker, perform a peak search, and then perform centering on the marker's center frequency. If the selected marker is already on and between the start and stop frequencies of the analyzer, the analyzer performs the preselector calibration on that marker's frequency. If the selected marker is already on, but outside the frequency range between Start Freq and Stop Freq, the analyzer will first perform a peak search, and then perform centering on the marker's center frequency.

The value displayed on the Presel Adjust key will change to reflect the new preselector tuning (see Presel Adjust).

A number of considerations should be observed to ensure proper operation. See ["Proper Preselector Operation" on page 1207](#).

Key Path	AMPTD Y Scale
Remote Command	[:SENSe]:POWer[:RF]:PCENter
Example	POW:PCEN
Notes	Note that the rules outlined above under the key description apply for the remote command as well

	as the key. The result of the command is dependent on marker position, and so forth. Any message shown by the key press is also shown in response to the remote command.
Dependencies	<ul style="list-style-type: none"> <li>• Grayed out if the microwave preselector is off. )</li> <li>• If the selected marker's frequency is below Band 1, advisory message 0.5001 is generated and no action is taken.</li> <li>• Grayed out if entirely in Band 0.</li> <li>• Blank in models that do not include a preselector, such as option 503. If the SCPI is sent in these instruments, it is accepted without error, and the query always returns 0.</li> <li>• Grayed out in the Spectrogram View.</li> </ul>
Couplings	<p>The active marker position determines where the centering will be attempted.</p> <p>If the analyzer is in a measurement such as averaging when centering is initiated, the act of centering the preselector will restart averaging but the first average trace will not be taken until the centering is completed.</p>
Status Bits/OPC dependencies	<p>When centering the preselector, *OPC will not return true until the process is complete and a subsequent measurement has completed, nor will results be returned to a READ or MEASure command.</p> <p>The Measuring bit should remain set while this command is operating and should not go false until the subsequent sweep/measurement has completed.</p>
Initial S/W Revision	Prior to A.02.00
Modified at S/W Revision	A.03.00

## Proper Preselector Operation

A number of considerations should be observed to ensure proper operation:

1. If the selected marker is off, the analyzer will turn on a marker, perform a peak search, and adjust the preselector using the selected marker's frequency. It uses the "highest peak" peak search method unqualified by threshold or excursion, so that there is no chance of a 'no peak found' error. It continues with that peak, even if it is the peak of just noise. Therefore, for this operation to work properly, there should be a signal on screen in a preselected range for the peak search to find.
2. If the selected marker is already on, the analyzer will attempt the centering at that marker's frequency. There is no preselector for signals below about 3.6 GHz, therefore if the marker is on a signal below 3.6 GHz, no centering will be attempted and an advisory message generated
3. In some models, the preselector can be bypassed. If it is bypassed, no centering will be attempted in that range and a message will be generated.

## Preselector Adjust

Allows you to manually adjust the preselector filter frequency to optimize its response to the signal of interest. This function is only available when **"Presel Center" on page 2791** is available.

For general purpose signal analysis, using Presel Center is recommended. Centering the filter minimizes the impact of long-term preselector drift. Presel Adjust can be used instead to manually optimize the

preselector. One application of manual optimization would be to peak the preselector response, which both optimizes the signal-to-noise ratio and minimizes amplitude variations due to small (short-term) preselector drifting.

<b>Key Path</b>	AMPTD Y Scale
<b>Scope</b>	Meas Global
<b>Remote Command</b>	<code>[ :SENSe ] :POWer [ :RF ] :PADJust &lt;freq&gt;</code> <code>[ :SENSe ] :POWer [ :RF ] :PADJust?</code>
<b>Example</b>	POW:PADJ 100KHz POW:PADJ?
<b>Notes</b>	The value on the key reads out to 0.1 MHz resolution.
<b>Dependencies</b>	<ul style="list-style-type: none"> <li>• Grayed out if microwave preselector is off. )</li> <li>• Grayed out if entirely in Band 0.</li> <li>• Blank in models that do not include a preselector, such as option 503. If the SCPI is sent in these instruments, it is accepted without error, and the query always returns 0.</li> <li>• Grayed out in the Spectrogram View.</li> </ul>
<b>Preset</b>	0 MHz
<b>State Saved</b>	The Presel Adjust value set by Presel Center, or by manually adjusting Presel Adjust, is not saved in instrument state, and does not survive a Preset or power cycle.
<b>Min</b>	-500 MHz
<b>Max</b>	500 MHz
<b>Default Unit</b>	Hz
<b>Backwards Compatibility SCPI</b>	<code>[ :SENSe ] :POWer [ :RF ] :MW :PADJust</code> <code>[ :SENSe ] :POWer [ :RF ] :MMW :PADJust</code> PSA had multiple preselectors, but the X-Series has only one. These commands simply alias to <code>[ :SENSe ] :POWer [ :RF ] :PADJust</code>
<b>Initial S/W Revision</b>	Prior to A.02.00
<b>Modified at S/W Revision</b>	A.03.00

<b>Remote Command</b>	<code>[ :SENSe ] :POWer [ :RF ] :PADJust :PRESelector MWAVE   MMWave   EXTERNAL</code> <code>[ :SENSe ] :POWer [ :RF ] :PADJust :PRESelector?</code>
<b>Notes</b>	PSA had multiple preselectors, and you could select which preselector to adjust. Since the X-Series has only one mm/uW preselector, the preselector selection softkey is no longer available. However, to provide backward compatibility, we accept the legacy remote commands. The command form has no effect, the query always returns MWAVE
<b>Initial S/W Revision</b>	Prior to A.02.00

## μW Path Control

The μW Path Control functions include the μW Preselector Bypass (Option MPB) and Low Noise Path (Option LNP) controls in the High Band path circuits.

When the μW Preselector is bypassed, the user has better flatness, but will be subject to spurs from out of band interfering signals. When the Low Noise Path is enabled, the analyzer automatically switches around certain circuitry in the high frequency bands which can contribute to noise, when it is appropriate based on other analyzer settings.

For most applications, the preset state is Standard Path, which gives the best remote-control throughput, minimizes acoustic noise from switching and minimizes the risk of wear out in the hardware switches. For applications that utilize the wideband IF paths, the preset state is the μW Preselector Bypass path, if option MPB is present. This is because, when using a wideband IF such as the 140 MHz IF, the μW Preselector's bandwidth can be narrower than the available IF bandwidth, causing degraded amplitude flatness and phase linearity, so it is desirable to bypass the preselector in the default case.

Users may choose Low Noise Path Enable. It gives a lower noise floor, especially in the 21–26.5 GHz region, though without improving many measures of dynamic range, and without giving the best possible noise floor. The preamp, if purchased and used, gives better noise floor than does the Low Noise Path, however its compression threshold and third-order intercept are much poorer than that of the non-preamp Low Noise Path. There are some applications, typically for signals around –30 dBm, for which the third-order dynamic range of the standard path is good enough, but the noise floor is not low enough even with 0 dB input attenuation. When the third-order dynamic range of the preamp path is too little and the noise floor of the standard path is too high, the Low Noise Path can provide the best dynamic range.

<b>Key Path</b>	AMPTD Y Scale
<b>Mode</b>	SA, BASIC, PNOISE, VSA , LTE, LTETDD
<b>Scope</b>	Meas Global
<b>Remote Command</b>	[ :SENSe ] :POWer [ :RF ] :MW:PATH STD LNPath MPBypass FULL [ :SENSe ] :POWer [ :RF ] :MW:PATH?
<b>Example</b>	:POW:MW:PATH LNP Enables the Low Noise path
<b>Notes</b>	If a Presel Center is performed, the analyzer will momentarily switch to the Standard Path, regardless of the setting of μW Path Control  The DC Block will always be switched in when the low noise path is switched in, to protect succeeding circuitry from DC. Note that this does not mean “when the low noise path is enabled” but when, based on the Low Noise Path rules, the path is actually switched in. This can happen when the selection is Low Noise Path Enable . In the case where the DC Block is switched in the analyzer is now AC coupled. However, if the user has selected DC coupling, the UI will still behave as though it were DC coupled, including all annunciation, warnings, status bits, and responses to SCPI queries. This is because, based on other settings, the analyzer could switch out the low noise path at any time and hence go back to being DC coupled.  Alignment switching ignores the settings in this menu, and restores them when finished.
<b>Dependencies</b>	Unavailable in BBIQ and External Mixing
<b>Preset</b>	All modes other than IQ Analyzer mode and VXA: STD IQ Analyzer, VXA and WLAN mode: MPB option present and licensed: MPB

	MPB option not present and licensed: STD
State Saved	Save in instrument state
Readback	Value selected in the submenu
Initial S/W Revision	A.04.00
Modified at S/W Revision	A.10.00

## Standard Path

This path gives the best remote-control throughput, minimizes acoustic noise from switching and minimizes the risk of wear in the hardware switches, particularly in remote test scenarios where both low band and high band setups will follow in rapid succession.

In this path, the bypass of the low band/high band switch and microwave preamp is never activated, which can cause some noise degradation but preserves the life of the bypass switch.

Key Path	AMPTD Y Scale, $\mu$ W Path Control
<b>Example</b>	:POW:MW:PATH STD
Readback Text	Standard Path
Initial S/W Revision	A.04.00

## Low Noise Path Enable

You may choose Low Noise Path Enable, which gives a lower noise floor under some circumstances, particularly when operating in the 21–26.5 GHz region. With the Low Noise Path enabled, the low band/high band switch and microwave preamp are bypassed whenever all of the following are true:

- The analyzer is not in the Low Band, meaning:
- the start frequency is above 3.5 GHz and
- the stop frequency is above 3.6 GHz.
- the internal preamp is not installed or (if installed) is set to Off or Low Band

Note that this means that, when any part of a sweep is done in Low Band, the Low Noise Path is not used, whether or not the Low Noise Path Enable is selected in the user interface. Also, if the preamp is turned on, the Low Noise Path is not used, whether or not the Low Noise Path Enable is selected in the user interface. The only time the Low Noise Path is used is when Low Noise Path Enable is selected, the sweep is completely in High Band (> 3.6 GHz) and no preamp is in use.

See "[More Information](#)" on page 1211

Key Path	AMPTD Y Scale, $\mu$ W Path Control
Measurement	Swept SA
<b>Example</b>	:POW:MW:PATH LNP

Notes	<p>For measurements that use IQ acquisition, the low noise path is used when the Center Frequency is in High Band (&gt; 3.6 GHz) and no preamp is in use.</p> <p>In other words, the rules above are modified to use only the center frequency to qualify which path to switch in.</p> <p>This is not the case for FFT's in the Swept SA measurement; they use the same rules as swept measurements.</p>
Dependencies	<p>Key is blanked if current mode does not support it.</p> <p>Key is grayed out if mode supports it but current measurement does not support it.</p> <p>Unless Option LNP is present and licensed, key is blank and if SCPI command sent, error -241, "Hardware missing; Option not installed" is generated.</p>
Readback Text	Low Noise Path Enable
Initial S/W Revision	A.04.00

### More Information

The user should understand that the Low Noise Path, while giving improved DANL, has the disadvantage of decreased TOI performance and decreased gain compression performance relative to the standard path.

The user should also understand that the bypass switch is a mechanical switch and has finite life, so if the Low Noise Path is enabled, it is possible to cause frequent cycling of this switch by frequently changing analyzer settings such that the above conditions hold true only some of the time. A user making tests of this nature should consider opting for the Standard Path, which will never throw the bypass switch, at the expense of some degraded noise performance.

The low noise path is useful for situations where the signal level is so low that the analyzer performance is dominated by noise even with 0 dB attenuation, but still high enough that the preamp option would have excessive third-order intermodulation or compression. The preamp, if purchased and used, gives better noise floor than does the "Low Noise Path." However, its compression threshold and third-order intercept are much poorer than that of the non-preamp path. There are some applications, typically for signals around -30 dBm, for which the third-order dynamic range of the standard path is good enough, but the noise floor is not low enough even with 0 dB input attenuation. When the third-order dynamic range of the preamp path is too little and the noise floor of the standard path is too high, the Low Noise Path can provide the best dynamic range

The graph below illustrates the concept. It shows, in red, the performance of an analyzer at different attenuation settings, both with the preamp on and off, in a measurement that is affected by both analyzer noise and analyzer TOI. The green shows the best available dynamic range, offset by 0.5 dB for clarity. The blue shows how the best available dynamic range improves for moderate signal levels with the low noise path switched in. In this illustration, the preamp improves the noise floor by 15 dB while degrading the third-order intercept by 30 dB, and the low noise path reduces loss by 8 dB. The attenuator step size is 2 dB.

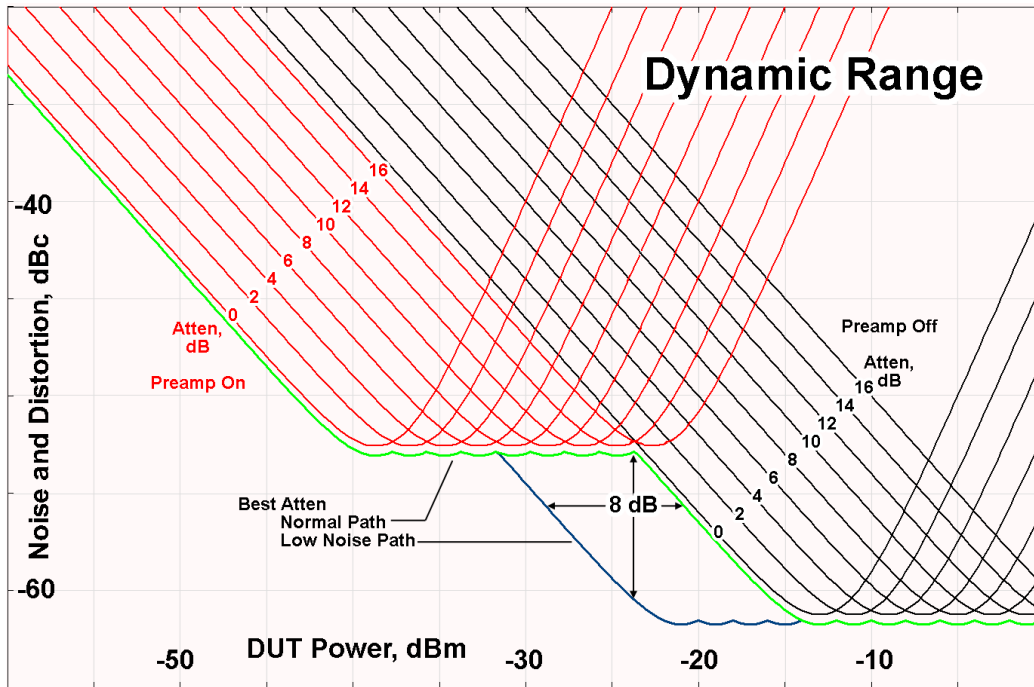

There are other times where selecting the low noise path improves performance, too. Compression-limited measurements such as finding the nulls in a pulsed-RF spectrum can profit from the low noise path in a way similar to the TOI-limited measurement illustrated. Accuracy can be improved when the low noise path allows the optimum attenuation to increase from a small amount like 0, 2 or 4 dB to a larger amount, giving better return loss at the analyzer input. Harmonic measurements, such as second and third harmonic levels, are much improved using the low noise path because of the superiority of that path for harmonic (though not intermodulation) distortion performance.

### μW Preselector Bypass

This key toggles the preselector bypass switch for band 1 and higher. When the microwave preselector is on, the signal path is preselected. When the microwave preselector is off, the signal path is not preselected. The preselected path is the normal path for the analyzer.

The preselector is a tunable bandpass filter which prevents signals away from the frequency of interest from combining in the mixer to generate in-band spurious signals (images). The consequences of using a preselector filter are its limited bandwidth, the amplitude and phase ripple in its passband, and any amplitude and phase instability due to center frequency drift.

Option MPB or pre-selector bypass provides an unpreselected input mixer path for certain X-Series signal analyzers with frequency ranges above 3.6 GHz. This signal path allows a wider bandwidth and less amplitude variability, which is an advantage when doing modulation analysis and broadband signal analysis. The disadvantage is that, without the preselector, image signals will be displayed. Another disadvantage of bypassing the preselector is increased LO emission levels at the front panel input port.

Image responses are separated from the real signal by twice the 1st IF. For IF Paths of 10 MHz and 25 MHz, the 1st IF is 322.5 MHz, so the image response and the real signal will be separated by 645 MHz. The 1st IF will be different for other IF Path settings. When viewing a real signal and its corresponding image response in internal mixing, the image response will be to the left of the real signal.



Also, the image response and the real signal typically have the same amplitude and exhibit the same shape factor.

However, if Option FS1, Fast Sweep Capability, is enabled, the image response in the Swept SA measurement will appear lower in amplitude and have a much wider shape factor compared to the real signal.

Key Path	AMPTD Y Scale, $\mu$ W Path Control
<b>Example</b>	:POW:MW:PATH MPB
Dependencies	Key is blanked if current mode does not support it. Key is grayed out if mode supports it but current measurement does not support it. Key is blank unless Option MPB is present and licensed. If SCPI command sent when MPB not present, error -241, "Hardware missing; Option not installed" is generated.
Readback Text	$\mu$ W Preselector Bypass
Initial S/W Revision	A.04.00

<b>Remote Command</b>	[ :SENSe ] :POWer [ :RF ] :MW :PRESelector [ :STATe ] ON   OFF   0   1 [ :SENSe ] :POWer [ :RF ] :MW :PRESelector [ :STATe ] ?
<b>Example</b>	:POW:MW:PRES OFF Bypasses the microwave preselector
Notes	The ON parameter sets the STD path (:POW:MW:PATH STD) The OFF parameter sets path MPB (:POW:MW:PATH MPB)
Preset	ON

## Internal Preamp

Accesses a menu of keys that control the internal preamps. Turning on the preamp gives a better noise figure, but a poorer TOI to noise floor dynamic range. You can optimize this setting for your particular measurement.

The instrument takes the preamp gain into account as it sweeps. If you sweep outside of the range of the preamp the instrument will also account for that. The displayed result will always reflect the correct gain.

For some measurements, when the preamp is on and any part of the displayed frequency range is below the lowest frequency for which the preamp has specifications, a warning condition message appears in the status line. For example, for a preamp with a 9 kHz lowest specified frequency: "Preamp: Accy unspec'd below 9 kHz".

Key Path	AMPTD Y Scale
Scope	Meas Global
<b>Remote Command</b>	[ :SENSe ] :POWer [ :RF ] :GAIN [ :STATe ] OFF   ON   0   1 [ :SENSe ] :POWer [ :RF ] :GAIN [ :STATe ] ?
Dependencies	Preamp is not available on all hardware platforms. If the preamp is not present or is unlicensed, the

---

	key is not shown. The preamp is not available when the electronic/soft attenuator is enabled.
--	--------------------------------------------------------------------------------------------------

---

Couplings	The act of connecting the U7227A USB Preamplifier to one of the analyzer's USB ports will cause the Internal Preamp to be switched on. When this happens an informational message will be generated: "Internal Preamp turned on for optimal operation with USB Preamp." Note that if the Internal Preamp was already on, there will be no change to the setting, but if it was Off it will be switched On, to Full Range.  Note that this same action occurs when the SA mode is selected while the USB Preamp is connected to one of the analyzer's USB ports, if it is the first time that the SA mode has run since powerup, or if the last time the SA mode was running the USB Preamp was NOT connected.  Subsequently disconnecting the USB Preamp from USB does not change the Internal Preamp setting nor restore the previous setting.
Preset	OFF
State Saved	Saved in instrument state
Initial S/W Revision	Prior to A.02.00
Modified at S/W Revision	A.14.00

---

Key Path	AMPTD Y Scale, Internal Preamp
Scope	Meas Global
<b>Remote Command</b>	[ :SENSe ] : POWer [ :RF ] : GAIN : BAND LOW   FULL [ :SENSe ] : POWer [ :RF ] : GAIN : BAND ?
Dependencies	Preamp is not available on all hardware platforms. If the preamp is not present or is unlicensed, the key is not shown.  If a POW:GAIN:BAND FULL command is sent when a low band preamp is available, the preamp band parameter is to LOW instead of FULL, and an "Option not installed" message is generated.
Preset	LOW
State Saved	Saved in instrument state
Initial S/W Revision	Prior to A.02.00

---

## Off

Turns the internal preamp off

---

Key Path	AMPTD Y Scale, Internal Preamp
<b>Example</b>	:POW:GAIN OFF
Readback	Off
Initial S/W Revision	Prior to A.02.00

---

## Low Band

Sets the internal preamp to use only the low band.

The frequency range of the installed (optional) low-band preamp is displayed in square brackets on the Low Band key label.

Key Path	AMPTD Y Scale, Internal Preamp
<b>Example</b>	:POW:GAIN ON :POW:GAIN:BAND LOW
Readback	Low Band
Initial S/W Revision	Prior to A.02.00

## Full Range

Sets the internal preamp to use its full range. The low band (0–3.6 GHz or 0–3GHz, depending on the model) is supplied by the low band preamp and the frequencies above low band are supplied by the high band preamp.

The frequency range of the installed (optional) preamp is displayed in square brackets on the Full Range key label. If the high band option is not installed the Full Range key does not appear.

Key Path	AMPTD Y Scale, Internal Preamp
<b>Example</b>	:POW:GAIN ON :POW:GAIN:BAND FULL
Readback	Full Range
Initial S/W Revision	Prior to A.02.00

## Ref Position

Positions the reference level at the top, center or bottom of the Y scale display. Changing the reference position does not affect the reference level value.

Key Path	AMPTD Y Scale
Mode	SA, WCDMA, C2K, WIMAX OFDMA, TD-SCDMA, 1xEVDO, DTMB (CTTB), DVB-T/H, ISDB-T, CMMB, LTE, LTE-TDD, Digital Cable TV, WLAN, MSR, LTEAFDD, LTEATDD
<b>Remote Command</b>	:DISPlay:SEMask:VIEW[1]:WINDow[1]:TRACe:Y[:SCALe]:RPOSition TOP   CENTer   BOTTom :DISPlay:SEMask:VIEW[1]:WINDow[1]:TRACe:Y[:SCALe]:RPOSition?
<b>Example</b>	DISP:SEM:VIEW:WIND:TRAC:Y:RPOS BOTT DISP:SEM:VIEW:WIND:TRAC:Y:RPOS?
Notes	You must be in the mode that includes SEM measurement to use this command. Use :INSTrument:SElect to set the mode.
Preset	TOP

State Saved	Saved in instrument state
Range	Top Ctr Bot
Initial S/W Revision	Prior to A.02.00
Modified at S/W Revision	A.02.00, A.03.00

## Auto Scaling

Toggles the Auto Scaling function between On and Off.

When Auto Scaling is On and the Restart front-panel key is pressed, the analyzer automatically determines the scale per division and reference values based on the measurement results. When you set a value to either Scale/Div or Ref Value manually, Auto Scaling automatically changes to Off.

Key Path	AMPTD Y Scale
Mode	SA, WCDMA, C2K, WIMAX OFDMA, TD-SCDMA, 1xEVDO, DTMB (CTTB), DVB-T/H, ISDB-T, CMMB, LTE, LTEFDD, Digital Cable TV, WLAN, MSR, LTEAFDD, LTEATDD
Remote Command	:DISPlay:SEMask:VIEW[1]:WINDow[1]:TRACe:Y[:SCALE]:COUPle 0   1   ON   OFF :DISPlay:SEMask:VIEW[1]:WINDow[1]:TRACe:Y[:SCALE]:COUPle?
Example	DISP:SEM:VIEW:WIND:TRAC:Y:COUP OFF DISP:SEM:VIEW:WIND:TRAC:Y:COUP?
Notes	You must be in the mode that includes SEM measurement to use this command. Use :INSTrument:SElect to set the mode.
Couplings	When Auto Scaling is On, upon pressing the Restart front-panel key, this function automatically determines the scale per division and reference values based on the measurement results. When you set a value to either Scale/Div or Ref Value manually, Auto Scaling automatically changes to Off.
Preset	ON
State Saved	Saved in instrument state
Range	On Off
Initial S/W Revision	Prior to A.02.00
Modified at S/W Revision	A.02.00, A.03.00

## Auto Couple

The Auto Couple feature provides a quick and convenient way to automatically couple multiple instrument settings. This helps ensure accurate measurements and optimum dynamic range. When the Auto Couple feature is activated, either from the front panel or remotely, all parameters of the current measurement that have an Auto/Manual mode are set to Auto mode and all measurement settings dependent on (or coupled to) the Auto/Man parameters are automatically adjusted for optimal performance.

However, the Auto Couple key actions are confined to the current measurement only. It does not affect other measurements in the mode, and it does not affect markers, marker functions, or trace or display attributes.

See "[More Information](#)" on page 1217

Key Path	Front-panel key
Remote Command	:COUPle ALL NONE
Example	:COUP ALL
Notes	:COUPle ALL puts all Auto/Man parameters in Auto mode (equivalent to pressing the Auto Couple key). :COUPLE NONE puts all Auto/Man parameters in manual mode. It decouples all the coupled instrument parameters and is not recommended for making measurements.
Initial S/W Revision	Prior to A.02.00

### More Information

There are two types of functions that have Auto/Manual modes.

#### Auto/Man Active Function keys

An Auto/Man toggle key controls the binary state associated with an instrument parameter by toggling between Auto (where the parameter is automatically coupled to the other parameters it is dependent upon) and Man (where the parameter is controlled independent of the other parameters), as well as making the parameter the active function. The current mode is indicated on the softkey with either Auto or Man underlined as illustrated below.



#### Auto/Man 1-of-N keys

An Auto/Man 1-of-N key allows you to manually pick from a list of parameter values, or place the function in Auto, in which case the value is automatically selected (and indicated) as shown below. If in Auto, Auto is underlined on the calling key. If in manual operation, manual is indicated on the calling key. But the calling key does not actually toggle the function, it simply opens the menu.

12 Spectrum Emission Mask Measurement  
Auto Couple

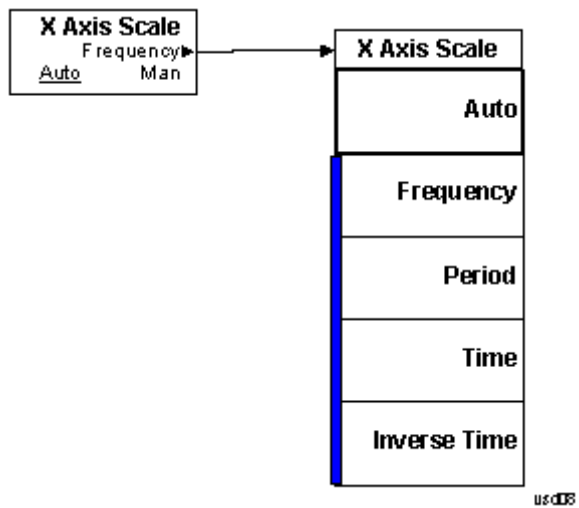

## BW

Accesses a menu of functions that enable you to select the type of filter for the measurement.

Key Path	Front-panel key
Initial S/W Revision	Prior to A.02.00
Modified at S/W Revision	A.03.00

### Filter Type

Selects the type of bandwidth filter that is used in Carrier and Offsets.

When Gaussian or Flattop is selected, selected filter is applied to carriers and all offsets.

When Auto Sense is selected, filter type is automatically selected for each carriers and offsets, so that measurement speed and accuracy is optimized.

Key Path	BW
Mode	SA, WCDMA, C2K, WIMAX OFDMA, TD-SCDMA, 1xEVDO, DVB-T/H, DTMB (CTTB), ISDB-T, CMMB, LTE, LTE-TDD, Digital Cable TV, WLAN, MSR, LTEAFDD, LTEATDD
<b>Remote Command</b>	[ :SENSe ] :SEMAsk :BANDwidth :SHAPE ASENse   GAUSsian   FLATtop [ :SENSe ] :SEMAsk :BANDwidth :SHAPE?
<b>Example</b>	SEM:BAND:SHAP GAUS SEM:BAND:SHAP?
Couplings	See the description above
Preset	ASENse
State Saved	Saved in instrument state
Range	Auto Sense (each offset and carrier) Gaussian (all offsets and carriers) Flattop (all offsets and carriers)
Initial S/W Revision	A.03.00

## Cont (Continuous Measurement/Sweep)

Sets the analyzer for Continuous measurement operation. The single/continuous state is Meas Global so the setting will affect all measurements. If you are Paused, pressing Cont does a Resume.

<b>Key Path</b>	Front-panel key
<b>Remote Command</b>	:INITiate:CONTinuous OFF ON 0 1 :INITiate:CONTinuous?
<b>Example</b>	:INIT:CONT 0 puts analyzer in Single measurement operation. :INIT:CONT 1 puts analyzer in Continuous measurement operation
<b>Preset</b>	ON (Note that SYST:PRESet sets INIT:CONT to ON but *RST sets INIT:CONT to OFF)
<b>State Saved</b>	Saved in instrument state
<b>Backwards Compatibility Notes</b>	For Spectrum Analysis mode in ESA and PSA, there is no Cont hardkey, instead there is a Sweep Single/Cont key. In these analyzers, switching the Sweep Single/Cont key from Single to Cont restarts averages (displayed average count reset to 1), but does not restart Max Hold and Min Hold. The X-Series has Single and Cont keys in place of the SweepSingleCont key. In the X-Series, if in single measurement, the Cont key (and INIT:CONT ON ) switches to continuous measurement, but never restarts a measurement and never resets a sweep.
<b>Initial S/W Revision</b>	Prior to A.02.00

In Swept SA Measurement (Spectrum Analysis Mode):

The analyzer takes repetitive sweeps, averages, measurements, etc., when in Continuous mode. When the average count reaches the Average/Hold Number the count stops incrementing, but the analyzer keeps sweeping. See the Trace/Detector section for the averaging formula used both before and after the Average/Hold Number is reached. The trigger condition must be met prior to each sweep. The type of trace processing for multiple sweeps, is set under the Trace/Detector key, with choices of Trace Average, Max Hold, or Min Hold.

In Other Measurements/Modes:

With Avg/Hold Num (in the Meas Setup menu) set to Off or set to On with a value of 1, a sweep is taken after the trigger condition is met; and the analyzer continues to take new sweeps after the current sweep has completed and the trigger condition is again met. However, with Avg/Hold Num set to On with a value >1, multiple sweeps (data acquisitions) are taken for the measurement. The trigger condition must be met prior to each sweep. The sweep is not stopped when the average count k equals the number N set for Avg/Hold Num is reached, but the number k stops incrementing. A measurement average usually applies to all traces, marker results, and numeric results. But sometimes it only applies to the numeric results.

If the analyzer is in Single measurement, pressing the Cont key does not change k and does not cause the sweep to be reset; the only action is to put the analyzer into Continuous measurement operation.

If it is already in continuous sweep:

the INIT:CONT 1 command has no effect



the INIT:CONT 0 command will place the analyzer in Single Sweep but will have no effect on the current sequence until  $k = N$ , at which point the current sequence will stop and the instrument will go to the idle state.

12 Spectrum Emission Mask Measurement  
File

File

See "File" on page 354

## FREQ Channel

Accesses a menu of keys that allow you to control the Frequency and Channel parameters of the instrument.

Some features in the Frequency menu are the same for all measurements – they do not change as you change measurements. Settings like these are called “Meas Global” and are unaffected by Meas Preset. For example, the Center Freq setting is the same for all measurements – it does not change as you change measurements.

<b>Key Path</b>	Front-panel key
<b>Initial S/W Revision</b>	Prior to A.02.00

### Center Freq

Sets the frequency that corresponds to the horizontal center of the graticule (when frequency Scale Type is set to linear). While adjusting the Center Frequency the Span is held constant, which means that both Start Frequency and Stop Frequency will change.

Pressing Center Freq also sets the frequency entry mode to Center/Span. In Center/Span mode, the center frequency and span values are displayed below the graticule, and the default active function in the Frequency menu is Center Freq.

The center frequency setting is the same for all measurements within a mode, that is, it is Meas Global. Some modes are also able to share a Mode Global center frequency value. If this is the case, the Mode will have a Global Settings key in its Mode Setup menu.

The Center Freq function sets (and queries) the Center Frequency for the currently selected input. If your analyzer has multiple inputs, and you select another input, the Center Freq changes to the value for that input. SCPI commands are available to directly set the Center Freq for a specific input.

Center Freq is remembered as you go from input to input. Thus you can set a Center Freq of 10 GHz with the RF Input selected, change to BBIQ and set a Center Freq of 20 MHz, then switch to External Mixing and set a Center Freq of 60 GHz, and when you go back to the RF Input the Center Freq will go back to 10 GHz; back to BBIQ and it is 20 MHz; back to External Mixing and it is 60 GHz.

See ["RF Center Freq" on page 1226](#)

See [Ext Mix Center Freq](#)

See ["I/Q Center Freq" on page 1228](#)

See ["Center Frequency Presets" on page 1224](#)

<b>Key Path</b>	FREQ Channel
<b>Scope</b>	Meas Global
<b>Remote Command</b>	[ :SENSe ] :FREQuency :CENTer <freq> [ :SENSe ] :FREQuency :CENTer?

<b>Example</b>	FREQ:CENT 50 MHz FREQ:CENT UP changes the center frequency to 150 MHz if you use FREQ:CENT:STEP 100 MHz to set the center frequency step size to 100 MHz FREQ:CENT?
<b>Notes</b>	This command sets either the RF or I/Q Center Frequency depending on the selected input. For RF input it is equivalent to FREQ:RF:CENT For I/Q input it is equivalent to FREQ:IQ:CENT Preset and Max values are dependent on Hardware Options (5xx) If no terminator (e.g. MHz) is sent the terminator Hz is used. If a terminator with unit other than Frequency is used, an invalid suffix error message is generated.
<b>Dependencies</b>	The Center Frequency can be limited by Start or Stop Freq limits, if the Span is so large that Start or Stop reach their limit.
<b>Couplings</b>	When operating in “swept span”, any value of the Center Frequency or Span that is within the frequency range of the analyzer is allowed when the value is being set through the front panel numeric key pad or the SCPI command. The other parameter is forced to a different value if needed, to keep the Start and the Stop Frequencies within the analyzer’s frequency range
<b>Preset</b>	Depends on instrument maximum frequency, mode, measurement, and selected input. See <a href="#">"Center Frequency Presets" on page 1224</a> and <a href="#">"RF Center Freq" on page 1226</a> and <a href="#">Ext Mix Center Freq</a> and <a href="#">"I/Q Center Freq" on page 1228</a> .
<b>State Saved</b>	Saved in instrument state
<b>Min</b>	Depends on instrument maximum frequency, mode, measurement, and selected input.. See <a href="#">"Center Frequency Presets" on page 1224</a> and <a href="#">"RF Center Freq" on page 1226</a> and <a href="#">"I/Q Center Freq" on page 1228</a> .
<b>Max</b>	Depends on instrument maximum frequency, mode, measurement, and selected input.. See <a href="#">"Center Frequency Presets" on page 1224</a> and <a href="#">"RF Center Freq" on page 1226</a> and <a href="#">"I/Q Center Freq" on page 1228</a> .
<b>Default Unit</b>	Hz
<b>Status Bits/OPC</b>	Non-overlapped
<b>Dependencies</b>	
<b>Initial S/W Revision</b>	Prior to A.02.00

### Center Frequency Presets

The following table provides the Center Frequency Presets for the Spectrum Analyzer mode, and the Max Freq, for the various frequency options:

Freq Option	CF after Mode Preset	Stop Freq after Mode Preset	Max Freq (can't tune)

			above)
503 (all but N9000A)	1.805 GHz	3.6 GHz	3.7 GHz
503 (N9000A)	1.505 GHz	3.0 GHz	3.08 GHz
507 (all but N9000A)	3.505 GHz	7.0 GHz	7.1 GHz
507 (N9000A)	3.755 GHz	7.5 GHz	7.58 GHz
508 (all but N9038A)	1.805 GHz	3.6 GHz	8.5 GHz
508 (N9038A)	4.205 GHz	8.4 GHz	8.5 GHz
513	6.805 GHz	13.6 GHz	13.8 GHz
526 (all but N9000A and N9038A)	13.255 GHz	26.5 GHz	27.0 GHz
526 (N9000A)	13.255 GHz	26.5 GHz	26.55 GHz
526 (N9038A)	1.805 GHz	3.6 GHz	27.0 GHz
532	16.005 GHz	32.0 GHz	32.5 GHz
543	21.505 GHz	43.0 GHz	TBD
544	22.005 GHz	44.0 GHz	44.5 GHz
550	25.005 GHz	50.0 GHz	51 GHz

Input 2:

Model	CF after Mode Preset	Stop Freq after Mode Preset	Max Freq (can't tune above)
N9000A opt C75	0.7505GHz	1.5 GHz	1.58 GHz
N9038A	505 MHz	1 GHz	1.000025 GHz

Tracking Generator Frequency Limits (N9000A only):

Tracking Generator Option	Min Freq (clips to this freq when turn TG on and	If above this Freq, Stop Freq clipped to this Freq when	Max Freq (can't tune above) while TG

	can't tune below while TG on)	TG turned on	on
T03	9 kHz	3.0 GHz	3.08 GHz
T06	9 kHz	6.0 GHz	6.05 GHz

The following table shows the Center Frequency Presets for modes other than Spectrum Analyzer:

Mode	CF Preset for RF
WCDMA	1 GHz
WIMAXOFDMA,	1 GHz
BASIC	1 GHz
ADEMOD	1 GHz
VSA	1 GHz
TDSCDMA	1 GHz
PNOISE	1 GHz
LTE	1 GHz
LTETDD	1 GHz
MSR	1 GHz
GSM	935.2 MHz
NFIGURE	1.505 GHz

### RF Center Freq

SCPI command for specifying the RF Center Frequency. This command will set the Center Frequency to be used when the RF input is selected, even if the RF input is not the input that is selected at the time the command is sent. Note that the Center Freq function in the Frequency menu on the front panel always applies to the currently selected input.

Scope	Meas Global
<b>Remote Command</b>	<code>[ :SENSe ] :FREQuency:RF:CENTer &lt;freq&gt;</code> <code>[ :SENSe ] :FREQuency:RF:CENTer?</code>
<b>Example</b>	FREQ:RF:CENT 30 MHz
Notes	This command is the same in all modes, but the parameter is Measurement Global. So the value is independent in each mode and common across all the measurements in the mode.
Dependencies	If the electronic/soft attenuator is enabled, any attempt to set Center Frequency such that the Stop Frequency would be >3.6 GHz fails and results in an advisory message. If the equivalent SCPI command is sent, this same message is generated as part of a “-221, Settings conflict” warning. If Source Mode is set to Tracking, and the Max or Min Center Freq is therefore limited by the limits of the source, a warning message is generated, “Data out of range;clipped to source max/min” if these limits are exceeded. Note that for an external source, these limits can be affected by the settings of

	Source Numerator, Source Denominator and Power Sweep.
Preset	See table above
State Saved	Saved in instrument state.
Min	-79.999995 MHz, unless Source Mode is set to Tracking, in which case it is limited by the minimum frequency of the Source
Max	See table above. Basically instrument maximum frequency - 5 Hz. Note that, if the Source Mode is set to Tracking, the effective instrument maximum frequency may be limited by the source maximum frequency.  If the knob or step keys are being used, also depends on the value of the other three interdependent parameters Span, Start Frequency and Stop Frequency
Initial S/W Revision	Prior to A.02.00
Modified at S/W Revision	A.03.00

## Ext Mix Center Freq

SCPI command for specifying the External Mixer Center Frequency. This command will set the Center Frequency to be used when the External Mixer is selected, even if the External Mixer input is not the input which is selected at the time the command is sent. Note that the Center Freq function in the Frequency menu on the front panel always applies to the currently selected input.

Scope	Meas Global
<b>Remote Command</b>	<code>[ :SENSe ] :FREQuency:EMIXer:CENTer &lt;freq&gt;</code> <code>[ :SENSe ] :FREQuency:EMIXer:CENTer?</code>
<b>Example</b>	<code>:FREQ:EMIX:CENT 60 GHz</code> <code>:FREQ:EMIX:CENT?</code>
Notes	This command is the same in all modes, but the parameter is Measurement Global. So the value is independent in each mode and common across all the measurements in the mode.
Couplings	When returning to External Mixing after having been switched to one of the other inputs (e.g., RF), you will come back into the settings that you had when you left External Mixing. So you will come back to the band you were in with the Center Frequency that you had. However, Span is not an input-dependent parameter, therefore you will bring the span over from the other input. Therefore, the analyzer comes back with the span from the previous input, limited as necessary by the current mixer setup.
Preset	When a Mode Preset is performed while in External Mixing, the Start frequency of the current Mode is set to the nominal Min Freq of the lowest harmonic range in the Harmonic Table for the current mixer setup. Similarly, the Stop frequency of the current Mode is set to the nominal Max Freq of the highest harmonic range in the Harmonic Table. The Center Freq thus presets to the point arithmetically equidistant from these two frequencies.  If the current measurement has a limited Span available to it, and cannot achieve the Span shown in the table ( $\text{Span} = \text{Stop Freq} - \text{Start Freq}$ ), the analyzer uses the maximum Span the measurement allows, and still sets the Center Freq to the midpoint of the Start and Stop Freq values in the Harmonic Table.

	<p>When Restore Input/Output Defaults is performed, the mixer presets to the 11970A, whose Start and Stop frequencies are 26.5 and 40 GHz respectively. The center of these two frequencies is 33.25 GHz.</p> <p>Therefore, after a Restore Input/Output Defaults, if you go into External Mixing and do a Mode Preset while in the Spectrum Analyzer Mode, the resulting Center Freq is 33.25 GHz.</p>
State Saved	Saved in instrument state.
Min	The minimum frequency in the currently selected mixer band + 5 Hz
Max	<p>The maximum frequency in the currently selected mixer band – 5 Hz</p> <p>If the knob or step keys are being used, also depends on the value of the other three interdependent parameters Span, Start Frequency and Stop Frequency</p>
Initial S/W Revision	A.08.01

### I/Q Center Freq

SCPI command for specifying the I/Q Center Frequency. This command will set the Center Frequency to be used when the I/Q input is selected, even if the I/Q input is not the input which is selected at the time the command is sent. Note that the Center Freq function in the Frequency menu on the front panel always applies to the currently selected input.

Scope	Meas Global
<b>Remote Command</b>	<pre>[ :SENSe ] :FREQuency:IQ:CENTer &lt;freq&gt;</pre> <pre>[ :SENSe ] :FREQuency:IQ:CENTer?</pre>
<b>Example</b>	FREQ:IQ:CENT: 30 MHz
Notes	This command is the same in all modes, but the parameter is Measurement Global. So the value is independent in each mode and common across all the measurements in the mode.
Preset	0 Hz
State Saved	Saved in instrument state.
Min	-40.049995 MHz
Max	40.049995 MHz
Initial S/W Revision	Prior to A.02.00

### CF Step

Changes the step size for the center frequency and start and stop frequency functions. Once a step size has been selected and the center frequency function is active, the step keys (and the UP|DOWN parameters for Center Frequency from remote commands) change the center frequency by the step-size value. The step size function is useful for finding harmonics and sidebands beyond the current frequency span of the analyzer.

Note that the start and stop frequencies also step by the CF Step value.



Key Path	FREQ Channel
Remote Command	[:SENSe]:FREQuency:CENTer:STEP[:INCRement] <freq> [:SENSe]:FREQuency:CENTer:STEP[:INCRement]? [:SENSe]:FREQuency:CENTer:STEP:AUTO OFF ON 0 1 [:SENSe]:FREQuency:CENTer:STEP:AUTO?
Example	FREQ:CENT:STEP:AUTO ON FREQ:CENT:STEP 500 MHz FREQ:CENT UP increases the current center frequency value by 500 MHz FREQ:CENT:STEP? FREQ:CENT:STEP:AUTO?
Notes	Preset and Max values are depending on Hardware Options (503, 507, 508, 513, 526)
Notes	Preset and Max values are dependent on Hardware Options (5xx)
Dependencies	Freq Offset is not available in External Mixing. In this case the Freq Offset key is grayed out and shows a value of zero. It will once again be available, and show the previously set value, when you return to the RF Input.
Dependencies	Span, RBW, Center frequency If the electronic/soft attenuator is enabled, any attempt to change the value of the center frequency >3.6 GHz by pressing the Up-arrow key, fails and results in an advisory message. If the equivalent SCPI command is sent, this same message is generated as part of a “-221, Settings conflict” warning.
Couplings	When auto-coupled in a non-zero span, the center frequency step size is set to 10% of the span. When auto-coupled in zero span, the center frequency step size is set to the equivalent -3 dB RBW value.
Preset	Auto ADEMOD: 1 MHz ON
State Saved	Saved in instrument state
Min	– (the maximum frequency of the instrument). That is, 27 GHz max freq instrument has a CF step range of +/- 27 GHz. Note that this is the maximum frequency given the current settings of the instrument, so in External Mixing, for example, it is the maximum frequency of the current mixer band.
Max	The maximum frequency of the instrument. That is, 27 GHz max freq instrument has a CF step range of +/- 27 GHz. Note that this is the maximum frequency given the current settings of the instrument, so in External Mixing, for example, it is the maximum frequency of the current mixer band.
Default Unit	Hz
Status Bits/OPC dependencies	non-overlapped
Initial S/W Revision	Prior to A.02.00
Modified at S/W Revision	A.03.00

## Input/Output

See ["Input/Output" on page 226](#)

## Marker

Accesses a menu that enables you to select, set up and control the markers for the current measurement. If there are no active markers, Marker selects marker 1, sets it to Normal and places it at the center of the display. You can turn on and control up to 12 markers.

Key Path	Front-panel key
Initial S/W Revision	Prior to A.02.00

### Select Marker

Displays 12 markers available for selection.

Key Path	Marker
Initial S/W Revision	Prior to A.02.00

### Marker Type

Sets the marker control mode to Normal and Off. If the selected marker is Off, pressing Marker sets it to Normal and places it at the center of the screen on the trace determined by the Marker Trace rules. At the same time, Marker X Axis Value appears on the Active Function area. The marker X axis value entered in the active function area will display the marker value to its full entered precision. If the current control mode for the measurement is Off, there is no active function and the active function is turned off.

Key Path	Marker
Mode	SA, WCDMA, C2K, WIMAX OFDMA, TD-SCDMA, 1xEVDO, DTMB (CTTB), DVB-T/H, ISDB-T, CMMB, LTE, LTE-TDD, Digital Cable TV, WLAN, MSR, LTEAFDD, LTEATDD
Remote Command	:CALCulate:SEMask:MARKer[1] 2 ... 12:MODE POSITION OFF :CALCulate:SEMask:MARKer[1] 2 ... 12:MODE?
Example	CALC:SEM:MARK:MODE POS CALC:SEM:MARK:MODE?
Notes	If the selected marker is Off, pressing Marker sets it to Normal and places it at the center of the screen on the trace determined by the Marker Trace rules. At the same time, Marker X Axis Value appears on the Active Function area.  Default Active Function: the active function for the selected marker's current control mode. Note that if the current control mode is Off, there is no active function and the active function is turned off.  Active Function Display: the marker X axis value entered in the active function area will display the marker value to its full entered precision.
Preset	OFF OFF OFF OFF OFF OFF OFF OFF OFF OFF OFF OFF
State Saved	Saved in instrument state
Range	Normal Off
Initial S/W Revision	Prior to A.02.00
Modified at S/W Revision	A.02.00, A.03.00

## Couple Markers

When this function is true, moving any marker causes an equal X Axis movement of every other marker that is not Off. By “equal X Axis movement” we mean that we preserve the difference between each marker’s X Axis value (in the fundamental x-axis units of the trace that marker is on) and the X Axis value of the marker being moved (in the same fundamental x-axis units).

Key Path	Marker
Mode	SA, WCDMA, C2K, WIMAX OFDMA, TD-SCDMA, 1xEVDO, DTMB (CTTB), DVB-T/H, ISDB-T, CMMB, LTE, LTETDD, Digital Cable TV, WLAN, MSR, LTEAFDD, LTEATDD
Remote Command	:CALCulate:SEMask:MARKer:COUPle[:STATe] ON OFF 1 0 :CALCulate:SEMask:MARKer:COUPle[:STATe]?
Example	CALC:SEM:MARK:COUP ON CALC:SEM:MARK:COUP?
Preset	OFF
State Saved	Saved in instrument state
Range	On Off
Initial S/W Revision	Prior to A.02.00
Modified at S/W Revision	A.02.00, A.03.00

## All Markers Off

Turns all active markers off in all views.

Key Path	Marker
Mode	SA, WCDMA, C2K, WIMAX OFDMA, TD-SCDMA, 1xEVDO, DTMB (CTTB), DVB-T/H, ISDB-T, CMMB, LTE, LTETDD, Digital Cable TV, WLAN, MSR, LTEAFDD, LTEATDD
Remote Command	:CALCulate:SEMask:MARKer:AOFF
Example	CALC:SEM:MARK:AOFF
Initial S/W Revision	Prior to A.02.00
Modified at S/W Revision	A.02.00, A.03.00

## Marker X Axis Value (Remote Command Only)

Sets the marker X Axis value in the current marker X Axis Scale unit. It has no effect if the control mode is Off, but is the SCPI equivalent of entering an X value if the control mode is Normal.

Mode	SA, WCDMA, C2K, WIMAX OFDMA, TD-SCDMA, 1xEVDO, DTMB (CTTB), DVB-T/H ISDB-T, CMMB, LTE, LTETDD, Digital Cable TV, WLAN, MSR, LTEAFDD, LTEATDD
Remote Command	:CALCulate:SEMask:MARKer[1] 2 ... 12:X <freq>

	:CALCulate:SEMask:MARKer[1] 2 ... 12:X?
<b>Example</b>	CALC:SEM:MARK3:X 1.0 GHz CALC:SEM:MARK3:X?
<b>Notes</b>	<p>If no suffix is sent it will use the fundamental units for the current marker X Axis Scale. If a suffix is sent that does not match the current marker X Axis Scale unit, an error "Invalid suffix" will be generated.</p> <p>The query returns the marker's absolute X Axis value if the control mode is Normal. The query is returned in the fundamental units for the current marker X Axis scale. If the marker is Off the response is not a number.</p> <p>When a Marker is turned on, it is placed center of the screen on the trace. Therefore the default value depends on instrument condition, although the Preset/Default is defined as 1.5 GHz.</p>
<b>Preset</b>	After a preset, , all Markers are turned OFF, , so a Marker X Axis Value query will return a not a number (NAN).
<b>State Saved</b>	No
<b>Min</b>	-9.9E+37
<b>Max</b>	9.9E+37
<b>Initial S/W Revision</b>	Prior to A.02.00
<b>Modified at S/W Revision</b>	A.02.00, A.03.00

### Marker X Axis Position (Remote Command Only)

Sets the marker X position in trace points. It has no effect if the control mode is Off, but is the SCPI equivalent of entering a value if the control mode is Normal, except in trace points rather than X Axis Scale units. The entered value is immediately translated into the current X Axis Scale units for setting the value of the marker.

<b>Mode</b>	SA, WCDMA, C2K, WIMAX OFDMA, TD-SCDMA, 1xEVDO, DTMB (CTTB), DVB-T/H, ISDB-T, CMMB, LTE, LTE-TDD, Digital Cable TV, WLAN, MSR, LTEAFDD, LTEATDD
<b>Remote Command</b>	:CALCulate:SEMask:MARKer[1] 2 ... 12:X:POsition <real> :CALCulate:SEMask:MARKer[1] 2 ... 12:X:POsition?
<b>Example</b>	CALC:SEM:MARK10:X:POS 1001 CALC:SEM:MARK10:X:POS?
<b>Notes</b>	<p>The query returns the marker's absolute X Axis value in trace points if the control mode is Normal. The value is returned as a real number, not an integer, corresponding to the translation from X Axis Scale units to trace points . If the marker is Off the response is not a number.</p> <p>When a Marker is turned on, it is placed center of the screen on the trace. Therefore the default value depends on the instrument condition although the Preset/Default is defined as 6507 (this value might be the expected value when all the offsets are on).</p>
<b>Preset</b>	After a preset, , all Markers are turned OFF, , so a Marker X Axis Value query will return a not a number (NAN).
<b>State Saved</b>	No

Min	-9.9E+37
Max	9.9E+37
Initial S/W Revision	Prior to A.02.00
Modified at S/W Revision	A.02.00, A.03.00

### Marker Y Axis Value (Remote Command Only)

Returns the marker Y Axis value in the current marker Y Axis unit.

Mode	SA, WCDMA, C2K, WIMAX OFDMA, TD-SCDMA, 1xEVDO, DTMB (CTTB), DVB-T/H, ISDB-T, CMMB, LTE, LTE-TDD, Digital Cable TV, WLAN, MSR, LTEAFDD, LTEATDD
<b>Remote Command</b>	:CALCulate:SEMask:MARKer[1] 2 ... 12:Y?
<b>Example</b>	CALC:SEM:MARK11:Y 10 dBm CALC:SEM:MARK11:Y?
Notes	Since the result value is always calculated from acquisition data, the default value is arbitrary, although the Preset/Default values is defined.
Preset	Result dependent on markers setup and signal source
State Saved	No
<b>Backwards Compatibility SCPI</b>	:CALCulate:SEMask:MARKer[1] 2 ... 12:FUNction:RESult?
Initial S/W Revision	Prior to A.02.00
Modified at S/W Revision	A.02.00, A.03.00

# Marker Function

There are no 'Marker Functions' supported in Spectrum Emission Mask so this front-panel key displays a blank menu when pressed.

---

Key Path	Front-panel key
Initial S/W Revision	Prior to A.02.00

---

## Marker To

There is no 'Marker To' functionality supported in Spectrum Emission Mask so this front-panel key displays a blank menu when pressed.

---

Key Path	Front-panel key
Initial S/W Revision	Prior to A.02.00

---



## Meas

The information in this section is common to all measurements. For key and remote command information for a specific measurement, refer to the section that describes the measurement of interest.

Measurements available under the Meas key are specific to the current Mode.

When viewing Help for measurements, note the following:

**NOTE**

Operation for some keys differs between measurements. The information displayed in Help pertains to the current measurement. To see how a key operates in a different measurement, exit Help (press the Cancel Esc key), select the measurement, then reenter Help (press the Help key) and press that key.

---

Key Path	Front-panel key
Initial S/W Revision	Prior to A.02.00

---

### Remote Measurement Functions

This section contains the following topics:

"Measurement Group of Commands" on page 2849

"Current Measurement Query (Remote Command Only)" on page 2851

"Limit Test Current Results (Remote Command Only)" on page 2851

"Data Query (Remote Command Only)" on page 2851

"Calculate/Compress Trace Data Query (Remote Command Only)" on page 2852

"Calculate Peaks of Trace Data (Remote Command Only)" on page 2857

Hardware-Accelerated Fast Power Measurement (Remote Command Only)

"Format Data: Numeric Data (Remote Command Only)" on page 2858

"Format Data: Byte Order (Remote Command Only)" on page 2859

---

Initial S/W Revision	Prior to A.02.00
----------------------	------------------

---

## Measurement Group of Commands

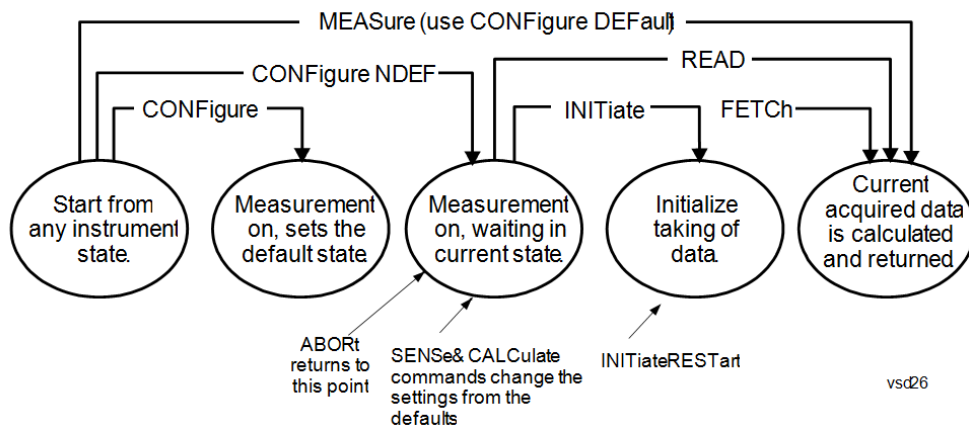

---

### Measure Commands:

:MEASure:<measurement>[n]?

This is a fast single-command way to make a measurement using the factory default instrument settings. These are the settings and units that conform to the Mode Setup settings (e.g. radio standard) that you have currently selected.

- Stops the current measurement (if any) and sets up the instrument for the specified measurement using the factory defaults
- Initiates the data acquisition for the measurement
- Blocks other SCPI communication, waiting until the measurement is complete before returning results.
- If the function does averaging, it is turned on and the number of averages is set to 10.
- After the data is valid it returns the scalar results, or the trace data, for the specified measurement. The type of data returned may be defined by an [n] value that is sent with the command.
- The scalar measurement results will be returned if the optional [n] value is not included, or is set to 1. If the [n] value is set to a value other than 1, the selected trace data results will be returned. See each command for details of what types of scalar results or trace data results are available.
- ASCII is the default format for the data output. (Older versions of Spectrum Analysis and Phase Noise mode measurements only use ASCII.) The binary data formats should be used for handling large blocks of data since they are smaller and faster than the ASCII format. Refer to the FORMat:DATA command for more information.

If you need to change some of the measurement parameters from the factory default settings you can set up the measurement with the CONFigure command. Use the commands in the SENSe:<measurement> and CALCulate:<measurement> subsystems to change the settings. Then you can use the READ? command to initiate the measurement and query the results.

If you need to repeatedly make a given measurement with settings other than the factory defaults, you can use the commands in the SENSe:<measurement> and CALCulate:<measurement> subsystems to set up the measurement. Then use the READ? command to initiate the measurement and query results.

Measurement settings persist if you initiate a different measurement and then return to a previous one. Use READ:<measurement>? if you want to use those persistent settings. If you want to go back to the default settings, use MEASure:<measurement>?.

---

### Configure Commands:

:CONFigure:<measurement>

This command stops the current measurement (if any) and sets up the instrument for the specified measurement using

---

---

the factory default instrument settings. It does not initiate the taking of measurement data unless INIT:CONTinuous is ON. If you change any measurement settings after using the CONFigure command, the READ command can be used to initiate a measurement without changing the settings back to their defaults.

In the Swept SA measurement in Spectrum Analyzer mode the CONFigure command also turns the averaging function on and sets the number of averages to 10 for all measurements.

:CONFigure: <measurement>: NDEFault stops the current measurement and changes to the specified measurement. It does not change the settings to the defaults. It does not initiate the taking of measurement data unless INIT:CONTinuous is ON.

The CONFigure? query returns the current measurement name.

The CONFigure:CATalog? query returns a quoted string of all licensed measurement names in the current mode. For example, "SAN, CHP, OBW, ACP, PST, TXP, SPUR, SEM, LIST".

---

#### Fetch Commands:

:FETCh:<measurement>[n]?

This command puts selected data from the most recent measurement into the output buffer. Use FETCh if you have already made a good measurement and you want to return several types of data (different [n] values, for example, both scalars and trace data) from a single measurement. FETCh saves you the time of re-making the measurement. You can only FETCh results from the measurement that is currently active, it will not change to a different measurement. An error message is reported if a measurement other than the current one is specified.

If you need to get new measurement data, use the READ command, which is equivalent to an INITiate followed by a FETCh.

The scalar measurement results will be returned if the optional [n] value is not included, or is set to 1. If the [n] value is set to a value other than 1, the selected trace data results will be returned. See each command for details of what types of scalar results or trace data results are available. The binary data formats should be used for handling large blocks of data since they are smaller and transfer faster than the ASCII format. (FORMat:DATA)

FETCh may be used to return results other than those specified with the original READ or MEASure command that you sent.

---

#### INITiate Commands:

:INITiate:<measurement>

This command is not available for measurements in all the instrument modes:

- Initiates a trigger cycle for the specified measurement, but does not output any data. You must then use the FETCh<meas> command to return data. If a measurement other than the current one is specified, the instrument will switch to that measurement and then initiate it.
- For example, suppose you have previously initiated the ACP measurement, but now you are running the channel power measurement. If you send INIT:ACP? it will change from channel power to ACP and will initiate an ACP measurement.
- Does not change any of the measurement settings. For example, if you have previously started the ACP measurement and you send INIT:ACP? it will initiate a new ACP measurement using the same instrument settings as the last time ACP was run.
- If your selected measurement is currently active (in the idle state) it triggers the measurement, assuming the trigger conditions are met. Then it completes one trigger cycle. Depending upon the measurement and the number of averages, there may be multiple data acquisitions, with multiple trigger events, for one full trigger cycle. It also holds off additional commands on GPIB until the acquisition is complete.

---

#### READ Commands:

:READ:<measurement>[n]?

- Does not preset the measurement to the factory default settings. For example, if you have previously initiated the ACP
-

---

measurement and you send READ:ACP? it will initiate a new measurement using the same instrument settings.

- Initiates the measurement and puts valid data into the output buffer. If a measurement other than the current one is specified, the instrument will switch to that measurement before it initiates the measurement and returns results.
  - For example, suppose you have previously initiated the ACP measurement, but now you are running the channel power measurement. Then you send READ:ACP? It will change from channel power back to ACP and, using the previous ACP settings, will initiate the measurement and return results.
  - Blocks other SCPI communication, waiting until the measurement is complete before returning the results
  - If the optional [n] value is not included, or is set to 1, the scalar measurement results will be returned. If the [n] value is set to a value other than 1, the selected trace data results will be returned. See each command for details of what types of scalar results or trace data results are available. The binary data formats should be used when handling large blocks of data since they are smaller and faster than the ASCII format. (FORMat:DATA)
- 

---

Initial S/W Revision	Prior to A.02.00
----------------------	------------------

---

### Current Measurement Query (Remote Command Only)

This command returns the name of the measurement that is currently running.

---

<b>Remote Command</b>	:CONFigure?
-----------------------	-------------

<b>Example</b>	CONF?
----------------	-------

Initial S/W Revision	Prior to A.02.00
----------------------	------------------

---

### Limit Test Current Results (Remote Command Only)

Queries the status of the current measurement limit testing. It returns a 0 if the measured results pass when compared with the current limits. It returns a 1 if the measured results fail any limit tests.

---

<b>Remote Command</b>	:CALCulate:CLIMits:FAIL?
-----------------------	--------------------------

<b>Example</b>	CALC:CLIM:FAIL? queries the current measurement to see if it fails the defined limits. Returns a 0 or 1: 0 it passes, 1 it fails.
----------------	--------------------------------------------------------------------------------------------------------------------------------------

Initial S/W Revision	Prior to A.02.00
----------------------	------------------

---

### Data Query (Remote Command Only)

Returns the designated measurement data for the currently selected measurement and subopcode.

n = any valid subopcode for the current measurement. See the measurement command results table for your current measurement, for information about what data is returned for the subopcodes.

This command uses the data setting specified by the FORMat:BORDER and FORMat:DATA commands and can return real or ASCII data. (See the format command descriptions under Input/Output in the Analyzer Setup section.)

<b>Remote Command</b>	:CALCulate:DATA[n]?
<b>Notes</b>	The return trace depends on the measurement. In CALCulate:<meas>:DATA[n], n is any valid subopcode for the current measurement. It returns the same data as the FETCH:<measurement>? query where <measurement> is the current measurement.
<b>Initial S/W Revision</b>	Prior to A.02.00

### Calculate/Compress Trace Data Query (Remote Command Only)

Returns compressed data for the currently selected measurement and sub-opcode [n].

n = any valid sub-opcode for that measurement. See the MEASure:<measurement>? command description of your specific measurement for information on the data that can be returned.

The data is returned in the current Y Axis Unit of the analyzer. The command is used with a sub-opcode <n> (default=1) to specify the trace. With trace queries, it is best if the analyzer is not sweeping during the query. Therefore, it is generally advisable to be in Single Sweep, or Update=Off.

This command is used to compress or decimate a long trace to extract and return only the desired data. A typical example would be to acquire N frames of GSM data and return the mean power of the first burst in each frame. The command can also be used to identify the best curve fit for the data.

<b>Remote Command</b>	:CALCulate:DATA<n>:COMPRESS? BLOCK   CFIT   MAXimum   MINimum   MEAN   DMEan   RMS   RMSCubed   SAMPLE   SDEVIation   PPHase [,<soffset> [,<length>[,<roffset>[,<rlimit>]]]]
<b>Example</b>	To query the mean power of a set of GSM bursts: Supply a signal that is a set of GSM bursts. Select the IQ Waveform measurement (in IQ Analyzer Mode). Set the sweep time to acquire at least one burst. Set the triggers such that acquisition happens at a known position relative to a burst. Then query the mean burst levels using, CALC:DATA2:COMP? MEAN, 24e-6, 526e-6 (These parameter values correspond to GSM signals, where 526e-6 is the length of the burst in the slot and you just want 1 burst.)
<b>Notes</b>	The command supports 5 parameters. Note that the last 4 (<soffset>, <length>, <roffset>, <rlimit>) are optional. But these optional parameters must be entered in the specified order. For example, if you want to specify <length>, then you must also specify <soffset>. See details below for a definition of each of these parameters. This command uses the data in the format specified by FORMat:DATA, returning either binary or ASCII data.
<b>Initial S/W Revision</b>	Prior to A.02.00

- BLOCK or block data - returns all the data points from the region of the trace data that you specify. For example, it could be used to return the data points of an input signal over several timeslots, excluding the portions of the trace data that you do not want. (This is x,y pairs for trace data and I,Q pairs for complex data.)

- CFIT or curve fit - applies curve fitting routines to the data. <soffset> and <length> are required to define the data that you want. <roffset> is an optional parameter for the desired order of the curve equation. The query will return the following values: the x-offset (in seconds) and the curve coefficients ((order + 1) values).

MIN, MAX, MEAN, DME, RMS, RMSC, SAMP, SDEV and PPH return one data value for each specified region (or <length>) of trace data, for as many regions as possible until you run out of trace data (using <roffset> to specify regions). Or they return the number of regions you specify (using <rlimit>) ignoring any data beyond that.

- MINimum - returns the minimum data point (y value) for the specified region(s) of trace data. For I/Q trace data, the minimum magnitude of the I/Q pairs is returned.
- MAXimum - returns the maximum data point (y value) for the specified region(s) of trace data. For I/Q trace data, the maximum magnitude of the I/Q pairs is returned.
- MEAN - returns a single value that is the arithmetic mean of the data point values (in dB/ dBm) for the specified region(s) of trace data. For I/Q trace data, the mean of the magnitudes of the I/Q pairs is returned. See the following equations.

**NOTE** If the original trace data is in dB, this function returns the arithmetic mean of those log values, not log of the mean power which is a more useful value. The mean of the log is the better measurement technique when measuring CW signals in the presence of noise. The mean of the power, expressed in dB, is useful in power measurements such as Channel Power. To achieve the mean of the power, use the RMS option.

Equation 1

Mean Value of Data Points for Specified Region(s)

$$MEAN = \frac{1}{n} \sum_{X_i \in \text{region}(s)} X_i$$

where  $X_i$  is a data point value, and  $n$  is the number of data points in the specified region(s).

Equation 2

Mean Value of I/Q Data Pairs for Specified Region(s)

$$MEAN = \frac{1}{n} \sum_{X_i \in \text{region}(s)} |X_i|$$

where  $|X_i|$  is the magnitude of an I/Q pair, and  $n$  is the number of I/Q pairs in the specified region(s).

- DMEan - returns a single value that is the mean power (in dB/ dBm) of the data point values for the specified region(s) of trace data. See the following equation:

Equation 3

DMEan Value of Data Points for Specified Region(s)

$$\text{DME} = 10 \times \log_{10} \left( \frac{1}{n} \sum_{X_i \in \text{region}(s)} 10^{\frac{X_i}{10}} \right)$$

- RMS - returns a single value that is the average power on a root-mean-squared voltage scale (arithmetic rms) of the data point values for the specified region(s) of trace data. See the following equation.

**NOTE**

For I/Q trace data, the rms of the magnitudes of the I/Q pairs is returned. See the following equation. This function is very useful for I/Q trace data. However, if the original trace data is in dB, this function returns the rms of the log values which is not usually needed.

Equation 4

RMS Value of Data Points for Specified Region(s)

$$\text{RMS} = \sqrt{\frac{1}{n} \sum_{X_i \in \text{region}(s)} X_i^2}$$

where  $X_i$  is a data point value, and  $n$  is the number of data points in the specified region(s).

Equation 5

RMS Value of I/Q Data Pairs for Specified Region(s)

$$\text{RMS} = \sqrt{\frac{1}{n} \sum_{X_i \in \text{region}(s)} X_i X_i^*}$$

where  $X_i$  is the complex value representation of an I/Q pair,  $X_i^*$  its conjugate complex number, and  $n$  is the number of I/Q pairs in the specified region(s).

Once you have the rms value for a region of trace data (linear or I/Q), you may want to calculate the mean power. You must convert this rms value (peak volts) to power in dBm:

$$10 \times \log[10 \times (\text{rms value})^2]$$

- SAMPLe - returns the first data value (x,y pair) for the specified region(s) of trace data. For I/Q trace data, the first I/Q pair is returned.
- SDEViation - returns a single value that is the arithmetic standard deviation for the data point values for the specified region(s) of trace data. See the following equation.
- For I/Q trace data, the standard deviation of the magnitudes of the I/Q pairs is returned. See the following equation.

Equation 6

Standard Deviation of Data Point Values for Specified Region(s)

$$\text{SDEV} = \sqrt{\frac{1}{n} \sum_{X_i \in \text{region}(s)} (X_i - \bar{X})^2}$$

where  $X_i$  is a data point value,  $\bar{X}$  is the arithmetic mean of the data point values for the specified region (s), and  $n$  is the number of data points in the specified region(s).

$$\text{SDEV} = \sqrt{\frac{1}{n} \sum_{X_i \in \text{region}(s)} (|X_i| - \bar{X})^2}$$

where  $|X_i|$  is the magnitude of an I/Q pair,  $\bar{X}$  is the mean of the magnitudes for the specified region(s), and  $n$  is the number of data points in the specified region(s).

- PPHase - returns the x,y pairs of both rms power (dBm) and arithmetic mean phase (radian) for every specified region and frequency offset (Hz). The number of pairs is defined by the specified number of regions. This parameter can be used for I/Q vector ( $n=0$ ) in Waveform (time domain) measurement and all parameters are specified by data point in PPHase.

The rms power of the specified region may be expressed as:

$$\text{Power} = 10 \times \log [10 \times (\text{RMS I/Q value})] + 10.$$

The RMS I/Q value (peak volts) is:

$$\sqrt{\frac{1}{n} \sum_{X_i \in \text{region}} X_i X_i^*}$$

where  $X_i$  is the complex value representation of an I/Q pair,  $X_i^*$  its conjugate complex number, and  $n$  is the number of I/Q pairs in the specified region.

The arithmetic mean phase of the specified region may be expressed as:

$$\frac{1}{n} \sum_{Y_i \in \text{region}} Y_i$$

where  $Y_i$  is the unwrapped phase of I/Q pair with applying frequency correction and  $n$  is the number of I/Q pairs in the specified region.

The frequency correction is made by the frequency offset calculated by the arithmetic mean of every specified region's frequency offset. Each frequency offset is calculated by the least square method against the unwrapped phase of I/Q pair.

Sample Trace Data - Constant Envelope

(See below for explanation of variables.)



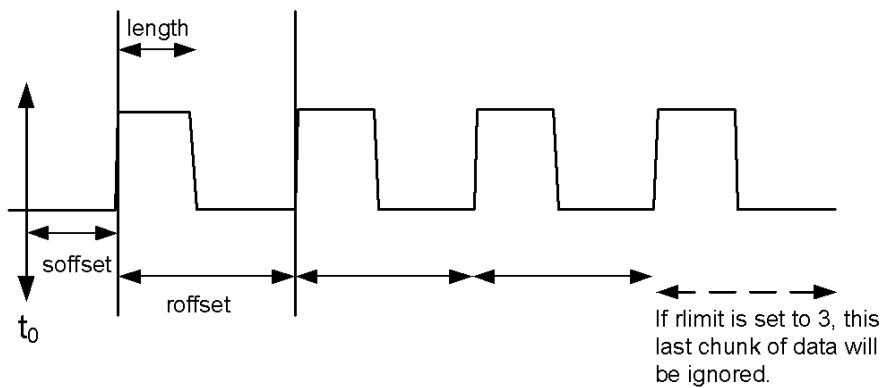

### Sample Trace Data - Not Constant Envelope

(See below for explanation of variables.)

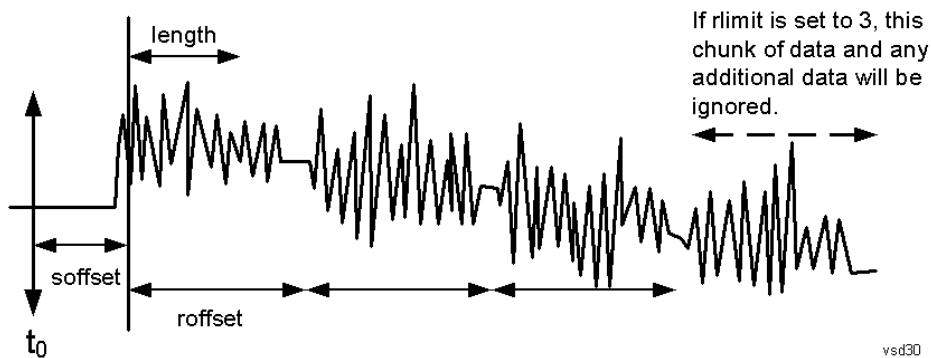

<soffset> - start offset is an optional real number. (It is in seconds for time-domain traces, and is a dimensionless index 0 to Npoints - 1, for frequency-domain traces). It specifies the amount of data at the beginning of the trace that will be ignored before the decimation process starts. It is the time or frequency change from the start of the trace to the point where you want to start using the data. The default value is zero.

<length> - is an optional real number. (It is in seconds for time-domain traces, and is a dimensionless index 0 to Npoints - 1, for frequency-domain traces). It defines how much data will be compressed into one value. This parameter has a default value equal to the current trace length.

<roffset> - repeat offset is an optional real number. (It is in seconds for time-domain traces, and is a dimensionless index 0 to Npoints - 1, for frequency-domain traces). It defines the beginning of the next field of trace elements to be compressed. This is relative to the beginning of the previous field. This parameter has a default value equal to the <length> variable. Note that this parameter is used for a completely different purpose when curve fitting (see CFIT above).

<rlimit> - repeat limit is an optional integer. It specifies the number of data items that you want returned. It will ignore any additional items beyond that number. You can use the Start offset and the Repeat limit to pick out exactly what part of the data you want to use. The default value is all the data.

## Calculate Peaks of Trace Data (Remote Command Only)

Returns a list of all the peaks for the currently selected measurement and sub-opcode [n]. The peaks must meet the requirements of the peak threshold and excursion values.

n = any valid sub-opcode for the current measurement. See the MEASure:<measurement> command description of your specific measurement for information on the data that can be returned.

The command can only be used with specific sub-opcodes with measurement results that are trace data. Both real and complex traces can be searched, but complex traces are converted to magnitude in dBm. In many measurements the sub-opcode n=0, is the raw trace data which cannot be searched for peaks. And Sub-opcode n=1, is often calculated results values which also cannot be searched for peaks.

This command uses the data setting specified by the FORMat:BORDER and FORMat:DATA commands and can return real or ASCII data. If the format is set to INT,32, it returns REAL,32 data.

The command has four types of parameters:

- Threshold (in dBm)
- Excursion (in dB)
- Sorting order (amplitude, frequency, time)
- Optional in some measurements: Display line use (all, > display line, < display line)

---

<b>Remote Command</b>	<p>For Swept SA measurement:</p> <pre>:CALCulate:DATA[1] 2 ... 6:PEAKs? &lt;threshold&gt;,&lt;excursion&gt;[,AMPLitude   FREQuency   TIME[,ALL   GTDLine   LTDLine]]</pre> <p>For most other measurements:</p> <pre>:CALCulate:DATA[1] 2 ... 6:PEAKs? &lt;threshold&gt;,&lt;excursion&gt;[,AMPLitude   FREQuency   TIME]</pre>
-----------------------	--------------------------------------------------------------------------------------------------------------------------------------------------------------------------------------------------------------------------------------------------------------------------------------------------------------------------------

---

<b>Example</b>	<p>Example for Swept SA measurement in Spectrum Analyzer Mode:</p> <p>CALC:DATA4:PEAK? -40, 10, FREQ, GTDL This will identify the peaks of trace 4 that are above -40 dBm, with excursions of at least 10 dB. The peaks are returned in order of increasing frequency, starting with the lowest frequency. Only the peaks that are above the display line are returned.</p> <p>Query Results 1:</p> <p>With FORMat:DATA REAL, 32 selected, it returns a list of floating-point numbers. The first value in the list is the number of peak points that are in the following list. A peak point consists of two values: a peak amplitude followed by its corresponding frequency (or time).</p> <p>If no peaks are found the peak list will consist of only the number of peaks, (0).</p>
----------------	-----------------------------------------------------------------------------------------------------------------------------------------------------------------------------------------------------------------------------------------------------------------------------------------------------------------------------------------------------------------------------------------------------------------------------------------------------------------------------------------------------------------------------------------------------------------------------------------------------------------------------------------------------------------------------------------------------------------------------------------------------------------------------------------

---

<b>Notes</b>	<p>&lt;n&gt; - is the trace that will be used</p> <p>&lt;threshold&gt; - is the level below which trace data peaks are ignored. Note that the threshold value is required and is always used as a peak criterion. To effectively disable the threshold criterion for this command, provide a substantially low threshold value such as -200 dBm. Also note that the threshold value used in this command is independent of and has no effect on the threshold value stored under the Peak Criteria menu.</p> <p>&lt;excursion&gt; - is the minimum amplitude variation (rise and fall) required for a signal to be identified as peak. Note that the excursion value is required and is always used as a peak criterion. To effectively disable the excursion criterion for this command, provide the minimum value of 0.0 dB. Also note that the excursion value used in this command is independent of and has no effect on the</p>
--------------	---------------------------------------------------------------------------------------------------------------------------------------------------------------------------------------------------------------------------------------------------------------------------------------------------------------------------------------------------------------------------------------------------------------------------------------------------------------------------------------------------------------------------------------------------------------------------------------------------------------------------------------------------------------------------------------------------------------------------------------------------------------------------------------------------------------------------------------------------------------------------------------------------------------------------------------

---

excursion value stored under the Peak Criteria menu.

Values must be provided for threshold and excursion. The sorting and display line parameters are optional (defaults are AMPLitude and ALL).

Note that there is always a Y-axis value for the display line, regardless of whether the display line state is on or off. It is the current Y-axis value of the display line which is used by this command to determine whether a peak should be reported

Sorting order:

AMPLitude - lists the peaks in order of descending amplitude, with the highest peak first (default if optional parameter not sent)

FREQUency - lists the peaks in order of occurrence, left to right across the x-axis.

TIME - lists the peaks in order of occurrence, left to right across the x-axis.

Peaks vs. Display Line:

ALL - lists all of the peaks found (default if optional parameter not sent).

GTDLine (greater than display line) - lists all of the peaks found above the display line.

LTDLine (less than display line) - lists all of the peaks found below the display line.

Initial S/W Revision      Prior to A.02.00

### Format Data: Numeric Data (Remote Command Only)

This command specifies the format of the trace data input and output. It specifies the formats used for trace data during data transfer across any remote port. It affects only the data format for setting and querying trace data for the :TRACe[:DATA], TRACe[:DATA]?, :CALCulate:DATA[n]? and FETCh:SANalyzer [n]? commands and queries.

**Remote Command**      :FORMat[:TRACe] [:DATA] ASCii|INTeger,32|REAL,32 |REAL,64  
:FORMat[:TRACe] [:DATA] ?

**Notes**      The query response is:  
ASCii: ASC,8  
REAL,32: REAL,32  
REAL,64: REAL,64  
INTeger,32: INT,32

When the numeric data format is REAL or ASCii, data is output in the current Y Axis unit. When the data format is INTeger, data is output in units of m dBm (.001 dBm).

The INT,32 format returns binary 32-bit integer values in internal units (m dBm), in a definite length block.

**Dependencies**      Sending a data format spec with an invalid number (for example, INT,48) generates no error. The analyzer simply uses the default (8 for ASCii, 32 for INTeger, 32 for REAL).

Sending data to the analyzer which does not conform to the current FORMat specified, results in an error. Sending ASCII data when a definite block is expected generates message -161 "Invalid Block Data" and sending a definite block when ASCII data is expected generates message -121 "Invalid Character in Number".

**Preset**      ASCii

**Backwards Compatibility Notes**      Note that the INT,32 format is only applicable to the command, TRACe:DATA. This preserves backwards compatibility for the Swept SA measurement. For all other commands/queries which honor FORMat:DATA, if INT,32 is sent the analyzer will behave as though it were set to REAL,32.

Initial S/W Revision      Prior to A.02.00

The specs for each output type follow:

AScii - Amplitude values are in ASCII, in the current Y Axis Unit, one ASCII character per digit, values separated by commas, each value in the form:

SX.YYYYYEsZZ

Where:

S = sign (+ or -)

X = one digit to left of decimal point

Y = 5 digits to right of decimal point

E = E, exponent header

s = sign of exponent (+ or -)

ZZ = two digit exponent

REAL,32 - Binary 32-bit real values in the current Y Axis Unit, in a definite length block.

REAL,64 - Binary 64-bit real values in the current Y Axis Unit, in a definite length block.

### Format Data: Byte Order (Remote Command Only)

This command selects the binary data byte order for data transfer and other queries. It controls whether binary data is transferred in normal or swapped mode. This command affects only the byte order for setting and querying trace data for the :TRACe[:DATA], TRACe[:DATA]? , :CALCulate:DATA[n]? and FETCh:SANalyzer[n]? commands and queries.

By definition any command that says it uses FORMat:DATA uses any format supported by FORMat:DATA.

The NORMal order is a byte sequence that begins with the most significant byte (MSB) first, and ends with the least significant byte (LSB) last in the sequence: 1|2|3|4. SWAPped order is when the byte sequence begins with the LSB first, and ends with the MSB last in the sequence: 4|3|2|1.

---

**Remote Command** :FORMat:BORDER NORMal | SWAPped

:FORMat:BORDER?

---

**Preset** NORMal

---

**Initial S/W Revision** Prior to A.02.00

---

## Meas Setup

Displays the setup menu for the currently selected measurement.

Key Path	Front-panel key
Initial S/W Revision	Prior to A.02.00

### Avg/Hold Num

Toggles averaging On or Off in addition to enabling you to set the number of measurement averages used to calculate the measurement result. The average is displayed at the end of each sweep. After the specified number of average counts, the average mode (termination control) setting determines the average action.

In the remote mode, use the Average State command to turn averaging on or off.

Key Path	Meas Setup
Mode	SA, WCDMA, C2K, WIMAX OFDMA, TD-SCDMA, 1xEVDO, DTMB (CTTB), DVB-T/H, ISDB-T, CMMB, LTE, LTE-TDD, Digital Cable TV, WLAN, MSR, LTEAFDD, LTEATDD
<b>Remote Command</b>	[:SENSe]:SEMask:AVERage:COUNT <integer> [:SENSe]:SEMask:AVERage:COUNT? [:SENSe]:SEMask:AVERage[:STATe] ON OFF 1 0 [:SENSe]:SEMask:AVERage[:STATe]?
<b>Example</b>	SEM:AVER:COUN 100 SEM:AVER:COUN? SEM:AVER ON SEM:AVER?
Notes	You must be in the mode that includes SEM measurement to use this command. Use :INSTrument:SElect to set the mode.
Preset	10 OFF
State Saved	Saved in instrument state.
Min	1
Max	10000
Initial S/W Revision	Prior to A.02.00
Modified at S/W Revision	A.02.00, A.03.00

### Meas Type

Accesses a menu that enables you to select one of the following measurement reference types:

- Total Pwr Ref – Sets the reference to the total carrier power and the measured data is shown in dBc and dBm.
- PSD Ref – Sets the reference to the mean power spectral density of the carrier and the measured data is shown in dB and dBm/Hz.
- Spectrum Peak Ref – Sets the reference to the spectrum peak power of the carrier and the measured data is shown in dB and dBm.

Key Path	Meas Setup
Mode	SA, WCDMA, C2K, WIMAX OFDMA, TD-SCDMA, 1xEVDO, DTMB (CTTB), DVB-T/H, ISDB-T, CMMB, LTE, LTETDD, Digital Cable TV, WLAN, MSR, LTEAFDD, LTEATDD
Remote Command	[ :SENSe ] :SEMAsk:TYPE PSDRef TPRef SPRef [ :SENSe ] :SEMAsk:TYPE?
Example	SEM:TYPE PSDR SEM:TYPE?
Notes	You must be in the mode that includes SEM measurement to use this command. Use :INSTRument:SElect to set the mode.
Preset	SA, , WCDMA, , C2K, , TD-SCDMA, , 1xEVDO, , DTMB (CTTB), , DVB-T/H, , ISDB-T, , CMMB, , LTE, , LTETDD, , Digital Cable TV, , MSR, , LTEAFDD, , LTEATDD: TPRef WIMAX OFDMA, WLAN: SPRef
State Saved	Saved in instrument state.
Range	Total Pwr Ref PSD Ref Spectrum Peak Ref
Initial S/W Revision	Prior to A.02.00
Modified at S/W Revision	A.02.00, A.03.00

## Ref Channel

Accesses a menu that enables you to set up the measurement parameters used to calculate the power in the reference channel.

Key Path	Meas Setup
Initial S/W Revision	Prior to A.02.00

## Integ BW

Specifies the integration bandwidth used to calculate the power in the reference channel.

Key Path	Meas Setup, Ref Channel
Mode	SA, WCDMA, C2K, WIMAX OFDMA, TD-SCDMA, 1xEVDO, DTMB (CTTB), DVB-T/H, ISDB-T, CMMB, LTE, LTETDD, Digital Cable TV, WLAN
Remote Command	[ :SENSe ] :SEMAsk:BANDwidth[1]  2:INTegration <bandwidth> [ :SENSe ] :SEMAsk:BANDwidth[1]  2:INTegration?

<b>Example</b>	SEM:BAND:INT 10 MHz SEM:BAND:INT?
Notes	10% . 100% of Channel Span Parameter Value Bandwidth sub op code, 1 is for BTS, 2 for MS. Default is BTS. You must be in the mode that includes SEM measurement to use this command. Use :INSTrument:SElect to set the mode.
Dependencies	For MSR and LTE-Advanced FDD/TDD mode, this key is blank.
Couplings	Cannot be higher than the channel Span. If lower than 1/10 of channel Span, then the channel Span is reduced to be 10 times the Integ BW.
Preset	SA: 3.84 MHz WCDMA: 3.84 MHz 3.84 MHz C2K: 1.23 MHz 1.23 MHz WIMAX OFDMA: 10 MHz 10 MHz TD-SCDMA: 1.28 MHz 1.28 MHz 1xEVDO: 1.23MHz DTMB (CTTB): 7.56MHz DVB-T/H: 7.61MHz ISDB-T: 5.6MHz CMMB: 7.512MHz LTE: 4.515MHz 4.5MHz LTETDD: 4.515MHz 4.5MHz Digital Cable TV: 6.9MHz WLAN: if Radio Std is 802.11a/g(OFDM/DSSS-OFDM)/802.11n(20 MHz)/ 802.11ac (20 MHz): 18 MHz if Radio Std is 802.11b/g(DSSS/CCK/PBCC): 22 MHz if Radio Std is 802.11n(40MHz)/ 802.11ac (40 MHz): 38 MHz if Radio Std is 802.11ac (80 MHz): 78 MHz if Radio Std is 802.11ac (160 MHz): 158 MHz if Radio Std is 802.11ac (80 MHz + 80 MHz): 78 MHz
State Saved	Saved in instrument state.
Min	1 kHz
Max	645 MHz
Initial S/W Revision	Prior to A.02.00
Modified at S/W Revision	A.02.00, A.03.00

## Span

Specifies the span used to calculate the power in the reference channel.

Key Path	Meas Setup, Ref Channel
----------	-------------------------

Mode	SA, WCDMA, C2K, WIMAX OFDMA, TD-SCDMA, 1xEVDO, DTMB (CTTB), DVB-T/H, ISDB-T, LTE, LTETDD, CMMB, Digital Cable TV, WLAN
Remote Command	[ :SENSe ] :SEMAsk:FREQuency [ 1 ]   2 :SPAN <freq> [ :SENSe ] :SEMAsk:FREQuency [ 1 ]   2 :SPAN?
Example	SEM:FREQ:SPAN 3MHz SEM:FREQ:SPAN?
Notes	Frequency sub op code, 1 is for BTS, 2 for MS. Default is BTS. You must be in the mode that includes SEM measurement to use this command. Use :INSTrument:SElect to set the mode.
Dependencies	For MSR and LTE-Advanced FDD/TDD mode, this key is blank.
Couplings	Range 1 kHz to 50 MHz (although restricted by Integ BW). If you set the channel Span lower than channel Integ BW, they will both track each other. As you increase the channel Span, the Integ BW will also increase if it is less than 1/10 of the channel Span. For WLAN 802.11ac (80 + 80 MHz), the channel span is coupled with the difference between the center frequencies of the two carriers. When the difference is either less than 80 MHz or greater than 565 MHz, a “setting conflict” error message is displayed. Chan Span = Carrier Spacing + Chan IntegBW;
Preset	SA: 5.0 MHz WCDMA: 5.0 MHz 5.0 MHz C2K: 1.25 MHz 1.25 MHz WIMAX OFDMA: 10 MHz  10 MHz TD-SCDMA: 1.6 MHz 1.6 MHz 1xEVDO: 1.25 MHz DTMB (CTTB): 10 MHz DVB-T/H: 10 MHz ISDB-T: 8 MHz CMMB: 10 MHz LTE: 5 MHz LTETDD: 5 MHz Digital Cable TV: 10 MHz WLAN: if Radio Std is 802.11a/g(OFDM/DSSS-OFDM)/802.11n(20 MHz)/ 802.11ac (20 MHz): 18 MHz if Radio Std is 802.11b/g(DSSS/CCK/PBCC): 22 MHz if Radio Std is 802.11n(40MHz)/ 802.11ac (40 MHz): 38 MHz if Radio Std is 802.11ac (80 MHz): 78 MHz if Radio Std is 802.11ac (160 MHz): 158 MHz if Radio Std is 802.11ac (80 MHz + 80 MHz): 240 MHz
State Saved	Saved in instrument state.
Min	1 kHz
Max	645 MHz
Initial S/W Revision	Prior to A.02.00
Modified at S/W Revision	A.02.00, A.03.00



## Sweep Time

Sets the sweep time used to calculate the power in the reference channel. Sweep Time can be set manually or put in auto mode.

Key Path	Meas Setup, Ref Channel
Mode	SA, WCDMA, C2K, WIMAX OFDMA, TD-SCDMA, 1xEVDO, DTMB (CTTB), DVB-T/H, ISDB-T, CMMB, LTE, LTE-TDD, Digital Cable TV, WLAN, MSR, LTEAFDD, LTEATDD
Remote Command	[:SENSe]:SEMask:SWEep[1] 2:TIME <time> [:SENSe]:SEMask:SWEep[1] 2:TIME? [:SENSe]:SEMask:SWEep[1] 2:TIME:AUTO OFF 0 ON 1 [:SENSe]:SEMask:SWEep[1] 2:TIME:AUTO?
Example	SEM:SWE:TIME 9ms SEM:SWE:TIME? SEM:SWE:TIME:AUTO OFF SEM:SWE:TIME:AUTO?
Notes	Sub op code, 1 is for BTS, 2 for MS. Default is BTS. You must be in the mode that includes SEM measurement to use this command. Use :INSTrument:SElect to set the mode.
Couplings	When the time is set manually, Auto is set to OFF. Value is coupled with Channel Detector selection, Channel Resolution BW, Channel Video BW if the state is Auto. When set to Auto, the Sweep Time is automatically calculated
Preset	Automatically calculated ON
State Saved	Saved in instrument state.
Min	1 ms
Max	4000 s
Initial S/W Revision	Prior to A.02.00
Modified at S/W Revision	A.02.00, A.03.00

## Res BW

Sets the resolution bandwidth used to calculate the power in the reference channel. The Channel Resolution BW can be set manually or put in to auto mode.

MSR Auto RBW:

In the MSR resolution bandwidth is predefined for each radio format. When carriers are configured with multiple radio formats, the narrowest RBW is selected.

LTE	1.4 MHz	13
	3 MHz	27
	5 MHz	47
	10 MHz	91
	15 MHz	150
	20 MHz	180
W-CDMA		75
GSM		30

In LTE-Advanced FDD/TDD, the resolution bandwidth is predefined based on the corresponding bandwidth of the single LTE carrier, which is listed above. When ResBW mode is Auto, the narrowest RBW is selected.

Key Path	Meas Setup, Ref Channel
Mode	SA, WCDMA, C2K, WIMAX OFDMA, TD-SCDMA, 1xEVDO, DTMB (CTTB), DVB-T/H, ISDB-T, CMMB, LTE, LTE-TDD, Digital Cable TV, WLAN, MSR, LTEAFDD, LTEATDD
Remote Command	<pre>[ :SENSe]:SEMAsk:BANDwidth[1] 2[:RESolution] &lt;bandwidth&gt; [:SENSe]:SEMAsk:BANDwidth[1] 2[:RESolution]? [:SENSe]:SEMAsk:BANDwidth[1] 2[:RESolution]:AUTO OFF ON 1 0 [:SENSe]:SEMAsk:BANDwidth[1] 2[:RESolution]:AUTO?</pre>
Example	<pre>SEM:BAND 100 kHz SEM:BAND? SEM:BAND:AUTO ON SEM:BAND:AUTO?</pre>
Notes	<p>Bandwidth sub op code, 1 is for BTS, 2 for MS. Default is BTS.</p> <p>You must be in the mode that includes SEM measurement to use this command. Use :INSTrument:SElect to set the mode.</p>
Couplings	<p>When Res BW is set manually, Channel Resolution BW Mode is set to MANual.</p> <p>Value is coupled with Channel Detector selection, Channel Sweep Time, Channel Video BW.</p> <p>When set to Auto, the resolution bandwidth is automatically calculated.</p>
Preset	<pre>SA: 100 kHz WCDMA: 75 kHz C2K: 24 kHz WIMAX OFDMA: 100 kHz TD-SCDMA: 30 kHz 1xEVDO: 30.0 kHz DTMB (CTTB): 3.9 kHz DVB-T/H: 3.9 kHz ISDB-T: 10 kHz CMMB: 3.9 kHz</pre>

	LTE, , LTETDD, , MSR, , LTEAFDD, , LTEATDD:Auto (47 kHz) Digital Cable TV: 3.9 kHz WLAN: 100 kHz ON
State Saved	Saved in instrument state.
Min	1 Hz
Max	8 MHz
<b>Backwards Compatibility SCPI</b>	[ :SENSe ] :SEMAsk :BWiDth [ 1 ]   2 [ :RESolution ]
Initial S/W Revision	Prior to A.02.00
Modified at S/W Revision	A.02.00, A.03.00

## Video BW

Sets the video bandwidth used to calculate the power in the reference channel. The Channel Video BW can be set manually or put in to auto mode.

Key Path	Meas Setup, Ref Channel
Mode	SA, WCDMA, C2K, WIMAX OFDMA, TD-SCDMA, 1xEVDO, DTMB (CTTB), DVB-T/H, ISDB-T, CMMB, LTE, LTETDD, Digital Cable TV, WLAN, MSR, LTEAFDD, LTEATDD
<b>Remote Command</b>	[ :SENSe ] :SEMAsk :BANDwidth [ 1 ]   2 :VIDeo <bandwidth> [ :SENSe ] :SEMAsk :BANDwidth [ 1 ]   2 :VIDeo ? [ :SENSe ] :SEMAsk :BANDwidth [ 1 ]   2 :VIDeo :AUTO OFF   ON   1   0 [ :SENSe ] :SEMAsk :BANDwidth [ 1 ]   2 :VIDeo :AUTO ?
<b>Example</b>	SEM:BAND:VID 100 kHz SEM:BAND:VID? SEM:BAND:VID:AUTO ON SEM:BAND:VID:AUTO?
Notes	Bandwidth sub op code, 1 is for BTS, 2 for MS. Default is BTS. You must be in the mode that includes SEM measurement to use this command. Use :INSTrument:SElect to set the mode.
Couplings	When Video BW is set manually, Channel Video BW Mode is set to MANual Value is coupled with Channel Detector selection, Channel Sweep Time, Channel Resolution BW. When set to Auto, the video bandwidth is automatically calculated.
Preset	SA: 100 kHz WCDMA: 75 kHz C2K: 24 kHz WIMAX OFDMA: 30 kHz TD-SCDMA: 300 kHz 1xEVDO: 300.0 kHz

	DTMB (CTTB): 39 kHz DVB-T/H: 39 kHz ISDB-T: 1 kHz CMMB: 39 kHz LTE, MSR, LTEAFDD, LTEATDD: Auto LTETDD: Auto Digital Cable TV: 39 kHz WLAN: Auto ON
State Saved	Saved in instrument state.
Min	1 Hz
Max	50 MHz
<b>Backwards Compatibility SCPI</b>	[ :SENSe ] :SEMAsk:BWIDth [ 1 ]   2 :VIDeo
Initial S/W Revision	Prior to A.02.00
Modified at S/W Revision	A.02.00, A.03.00

## VBW/RBW

Sets the Video BW/Resolution BW Ratio to calculate the Channel Resolution BW and Channel Video BW. The VBW/RBW Ratio can be set manually or put in to auto mode.

Key Path	Meas Setup, Ref Channel
Mode	SA, WCDMA, C2K, WIMAX OFDMA, TD-SCDMA mode, 1xEVDO, DTMB (CTTB), DVB-T/H, ISDB-T, CMMB, LTE, LTETDD, Digital Cable TV, WLAN, MSR, LTEAFDD, LTEATDD
<b>Remote Command</b>	[ :SENSe ] :SEMAsk:BAWIDth [ 1 ]   2 :VIDeo:RATio <real> [ :SENSe ] :SEMAsk:BAWIDth [ 1 ]   2 :VIDeo:RATio [ :SENSe ] :SEMAsk:BAWIDth [ 1 ]   2 :VIDeo:RATio:AUTO OFF   ON   1   0 [ :SENSe ] :SEMAsk:BAWIDth [ 1 ]   2 :VIDeo:RATio:AUTO?
<b>Example</b>	SEM:BAWID:VID:RAT 0.1 SEM:BAWID:VID:RAT? SEM:BAWID:VID:RAT:AUTO ON SEM:BAWID:VID:RAT:AUTO?
Notes	Bandwidth sub op code, 1 is for BTS, 2 for MS. Default is BTS. You must be in the mode that includes SEM measurement to use this command. Use :INSTrument:SElect to set the mode.
Couplings	When Video BW/Res BW is set manually, Channel VBW/RBW Ratio Mode is set to MANual When set to Auto, the VBW/RBW Ratio is automatically calculated.
Preset	SA, WCDMA, C2K: 1.0 WIMAX OFDMA: 0.3

	TD-SCDMA: 10 1xEVDO: 10.0 DTMB (CTTB): 10 DVB-T/H: 10 ISDB-T: 0.1 CMMB: 10 LTE, MSR: Auto LTEAFDD,LTEATDD:Auto LTETDD: Auto Digital Cable TV: 10 WLAN: Auto ON
State Saved	Saved in instrument state.
Min	0.00001
Max	3000000
<b>Backwards Compatibility SCPI</b>	[ :SENSe ] :SEMask:BWIDth [ 1 ]   2 :VIDeo:RATio
Initial S/W Revision	Prior to A.02.00
Modified at S/W Revision	A.02.00, A.03.00

### Power Ref (for the modes except MSR and LTE-Advanced FDD/TDD)

Sets the power reference in the carrier that will be used to compute the relative values for the offsets.

Key Path	Meas Setup, Ref Channel
Initial S/W Revision	Prior to A.02.00

### Total Power

Sets the power in the carrier (ref channel) that is used to compute the relative power values for the offsets. When the state is set to auto, this value is set to the measured carrier reference power. When set to manual, the result takes on the last measured value, or can be manually entered.

For WLAN 802.11ac (80 MHz + 80 MHz), the higher of the power readouts of the two carriers is used for computing the relative power values for the offset.

Key Path	Meas Setup, Ref Channel, Power Ref
Mode	SA, WCDMA, C2K, WIMAX OFDMA, TD-SCDMA, 1xEVDO, DTMB (CTTB), DVB-T/H, ISDB-T, CMMB, LTE, LTETDD, Digital Cable TV, WLAN, MSR, LTEAFDD, LTEATDD
<b>Remote Command</b>	[ :SENSe ] :SEMask:CARRier [ :POWER ] <real> [ :SENSe ] :SEMask:CARRier [ :POWER ] ?

	<code>[ :SENSe ] :SEMAsk :CARRier :AUTO [ :STATe ] OFF   ON   1   0</code>
	<code>[ :SENSe ] :SEMAsk :CARRier :AUTO [ :STATe ] ?</code>
<b>Example</b>	SEM:CARR 100dBm SEM:CARR? SEM:CARR:AUTO OFF SEM:CARR:AUTO?
<b>Notes</b>	The min and max values given are for Meas Type = Total Pwr Ref. You must be in the mode that includes SEM measurement to use this command. Use :INSTrument:SElect to set the mode.. This BAF SCPI command is available in all the Meas Type case. This BAF SCPI command is not available in MSR and LTE-Advanced FDD/TDD mode.
<b>Dependencies</b>	This "Total Power Ref" parameter is coupled with the "Meas Type" parameter. The softkey is active when Meas Type is set to Total Power Ref. Otherwise, it is grayed out.
<b>Preset</b>	Measured carrier reference power
<b>State Saved</b>	Saved in instrument state.
<b>Min</b>	-200 dBm
<b>Max</b>	200 dBm
<b>Initial S/W Revision</b>	Prior to A.02.00
<b>Modified at S/W Revision</b>	A.02.00, A.03.00

## PSD

Sets the power spectral density in the carrier that is used to compute the relative power spectral density values for the offsets when Meas Type is set to PSD Ref. When the state is set to auto, this will be set to the measured carrier power spectral density.

For WLAN 802.11ac (80 MHz + 80 MHz), the higher of the power density readouts of the two carriers is used for computing the relative PSD values for the offset.

<b>Key Path</b>	Meas Setup, Ref Chan, Power Ref
<b>Mode</b>	SA, WCDMA, C2K , WIMAX OFDMA, TD-SCDMA, 1xEVDO, DTMB (CTTB), DVB-T/H, ISDB-T, CMMB, LTE, LTE-TDD, Digital Cable TV, WLAN, MSR, LTEAFDD, LTEATDD
<b>Remote Command</b>	<code>[ :SENSe ] :SEMAsk :CARRier :CPSD &lt;real&gt;</code> <code>[ :SENSe ] :SEMAsk :CARRier :CPSD?</code>
<b>Example</b>	SEM:CARR:CPSD -80 SEM:CARR:CPSD?
<b>Notes</b>	Although the default value is defined, the value is recalculated by the measurement result just after completing the measurement. Carrier sub op code. 1 for BTS, 2 for MS. Default is BTS. You must be in the mode that includes SEM measurement to use this command. Use :INSTrument:SElect to set the mode.

Dependencies	See Couplings
Couplings	This "PSD" parameter is coupled with the "Meas Type" parameter. The key will be active if the Meas Type is set to PSD. Otherwise, it is grayed out.
Preset	Measured carrier PSD reference power
State Saved	Saved in instrument state.
Min	-200
Max	200
Initial S/W Revision	Prior to A.02.00
Modified at S/W Revision	A.02.00, A.03.00

## Spectrum Peak

Sets the spectrum peak power in the carrier that is used to compute the relative power spectral density values for the offsets when Meas Type is set to Spectrum Peak. When the state is set to auto, this is set to the measured carrier spectrum peak power. When set to manual, the result takes on the last measured value, or can be manually entered

Key Path	Meas Setup, Ref Channel, Power Ref
Mode	SA, WCDMA, C2K, WIMAX OFDMA, TD-SCDMA, 1xEVDO, DTMB (CTTB), DVB-T/H, ISDB-T, CMMB, LTE, LTE-TDD, Digital Cable TV, WLAN
Remote Command	<code>[ :SENSe ] :SEMAsk :CARRier :PEAK [ :POWer ] &lt;real&gt;</code> <code>[ :SENSe ] :SEMAsk :CARRier :PEAK [ :POWer ] ?</code>
Example	<code>SEM:CARR:PEAK -80</code> <code>SEM:CARR:PEAK:POWER?</code>
Notes	Although the default value is defined, the value is recalculated by the measurement result just after completing the measurement. Carrier sub op code. 1 for BTS, 2 for MS. Default is BTS. You must be in the mode that includes SEM measurement to use this command. Use <code>:INSTrument:SElect</code> to set the mode.
Dependencies	See Couplings
Couplings	This "Spectrum Peak Ref" parameter is coupled with the "Meas Type" parameter. This softkey is active when the "Meas Type" is set to "Spectrum Peak Ref". Otherwise, grayout.
Preset	Measured carrier Spectrum Peak reference power
State Saved	Saved in instrument state.
Min	-200
Max	200
Initial S/W Revision	Prior to A.02.00
Modified at S/W Revision	A.02.00, A.03.00

## Offset/Limits

Accesses a menu that enables you to set up the measurement parameters for offset pairs. For example, you can assign the start and stop frequencies, select the resolution bandwidth, and set the sweep time. When in the MSR and LTE-Advanced FDD/TDD mode, the softkey label changes to Outer Offset/Limits.

Key Path	Meas Setup
Initial S/W Revision	Prior to A.02.00
Modified at S/W Revision	A.14.00

## Select Offset

Selects the offset (upper and lower) and displays the memory selection menu that enables you to store a set of parameter values for the offset, such as Start Freq, Stop Freq, Sweep Time, Res BW, Meas BW, Abs Start, and Abs Stop. Only one selection at a time is shown on this menu key label.

Key Path	Meas Setup, Offset/Limits
Mode	SA, WCDMA, C2K, WIMAX OFDMA, TD-SCDMA, 1xEVDO, DTMB (CTTB), DVB-T/H, ISDB-T, CMMB, LTE, LTE-TDD, Digital Cable TV, WLAN, MSR, LTEAFDD, LTEATDD
Preset	A
Range	MSR, LTEATDD, LTEAFDD, WLAN: A B C D E F G H I J K L Other modes without option N9060A-7FP: A B C D E F Other modes with option N9060A-7FP: A B C D E F G H I J K L
Initial S/W Revision	Prior to A.02.00
Modified at S/W Revision	A.02.00, A.03.00, A.10.00, A.11.00, A.14.00

## Start Freq

Specifies the start frequency for the currently selected offset. Also enables you to toggle that offset between On and Off.

Missing values are not permitted; that is, if you want to change values 2 and 6, you must send all values up to 6. Subsequent values will remain as they were. The query for this parameter always returns 12 values.

Key Path	Meas Setup, Offset/Limits
Mode	SA, WCDMA, C2K, WIMAX OFDMA, TD-SCDMA, 1xEVDO, DTMB (CTTB), DVB-T/H, ISDB-T, CMMB, LTE, LTE-TDD, Digital Cable TV, WLAN, MSR, LTEAFDD, LTEATDD
Remote Command	[ :SENSE ] :SEMAsk:OFFSet [ 1 ]   2 [ :OUTer ] :LIST:FREQuency:STARt <freq>, ... [ :SENSE ] :SEMAsk:OFFSet [ 1 ]   2 [ :OUTer ] :LIST:FREQuency:STARt? [ :SENSE ] :SEMAsk:OFFSet [ 1 ]   2 [ :OUTer ] :LIST:STATE ON OFF 1 0, ... [ :SENSE ] :SEMAsk:OFFSet [ 1 ]   2 [ :OUTer ] :LIST:STATE?
Example	SEM:OFFS2:LIST:FREQ:STAR 2.515 MHz, , 2.715 MHz, , 3.515 MHz, , 4.00 MHz, , 8.00 MHz, , 12.50 MHz



	<p>SEM:OFFS2:LIST:FREQ:STAR?  SEM:OFFS:LIST:STAT ON, , ON, , ON, , OFF, , OFF, , OFF  SEM:OFFS:LIST:STAT?</p>
Notes	<p>Comma separated list of values.  OFFSet1 is for BTS, 2 for MS. Default is BTS.  You must be in the mode that includes SEM measurement to use this command. Use  :INSTrument:SElect to set the mode.</p>
Couplings	<p>Coupled to Stop Freq. When the start freq goes above the stop freq, the stop freq is automatically adjusted to the start freq plus 100 Hz.  If the current mode is DVB-T/H, this value will be modified automatically according to the limit type and the output power of the transmitter which is less or more than 25 W.  If the current mode is ISDB-T, this value will be modified automatically according to the limit type.</p>
Preset	<p>For modes (except MSR, , LTEAFDD, , LTEATDD and WLAN) without option N9060A-7FP, , the preset value is as follows.  SA: 2.515 MHz, , 2.715 MHz, , 3.515 MHz, , 4.00 MHz, , 8.00 MHz, , 12.50 MHz  WCDMA: 2.515 MHz, , 2.715 MHz, , 3.515 MHz, , 4.000 MHz, , 8.000 MHz, , 12.50 MHz 2.515MHz, , 4.000 MHz, , 7.500 MHz, , 8.500 MHz, , 12.5 MHz, , 15 MHz  C2K: 750.0 kHz, , 780.0 kHz, , 1.980 MHz, , 3.25 MHz, , 7.0 MHz, , 7.0 MHz 885 kHz, , 1.980 MHz, , 2.250 MHz, , 8.0 MHz, , 12.0 MHz, , 12.0 MHz  WIMAX OFDMA: 4.75 MHz, 5.45 MHz, 9.75 MHz, 14.75 MHz, 19.75 MHz, 24.75 MHz 4.75 MHz, 5.45 MHz, 9.75 MHz, 14.75 MHz, 19.75 MHz, 24.75 MHz  TD-SCDMA:  81 5kHz, 1015 kHz, 1815 kHz, 2.3 MHz, , , 2.3 MHz, , 2.3 MHz  815 kHz, 1.8 MHz, 2.9 MHz, , 2.9 MHz, 2.9 MHz, , 2.9 MHz  1xEVDO: 750.0 kHz, , 780.0 kHz, , 1.98 MHz, , 3.25 MHz, , 7 MHz, , 7 MHz 885.0 kHz, , 1.98 MHz, , 1.98 MHz, , 1.98 MHz, , 1.98 MHz  DTMB (CTTB): 3.8 MHz, , 4.2 MHz, , 6 MHz, , 6 MHz, , 6 MHz, 6 MHz  6MHz, , 6MHz, , 6MHz, , 6MHz, , 6MHz, , 6MHz  DVB-T/H: 3.81 MHz, , 4.2 MHz, , 6 MHz, , 6 MHz, , 6 MHz, , 6 MHz  6MHz, , 6MHz, , 6MHz, , 6MHz, , 6MHz  ISDB-T: 2.79 MHz, , 2.86 MHz, , 3.0 MHz, , 4.36 MHz, , 6 MHz, , 6 MHz  6MHz, , 6MHz, , 6MHz, , 6MHz, , 6MHz, , 6MHz  CMMB: 3.8 MHz, , 4.2 MHz, , 8.0 MHz, , 6 MHz, , 6 MHz, , 6 MHz  6MHz, , 6MHz, , 6MHz, , 6MHz, , 6MHz  LTE, , LTETDD: 50 kHz, , 5.05 MHz, , 10.5 MHz, , 15.00 MHz, , 30 MHz, , 40 MHz 15.00 kHz, 1.5 MHz, 5.5 MHz, 6.5 MHz, 10 MHz, 20MHz  Digital Cable TV: 3.8 MHz, , 4.2 MHz, , 6 MHz, , 6 MHz, , 6 MHz, , 6 MHz  6MHz, , 6MHz, , 6MHz, , 6MHz, , 6MHz, , 6MHz  When option N9060A-7FP is installed in these modes, the preset value of Offset G ~ L is the same as the Offset F value.  -----  WLAN:  if Radio Std is 802.11a/g(OFDM/DSSS-OFDM)/802.11n(20MHz): 9 MHz, , 11 MHz, , 20 MHz, , 30</p>

---

MHz, , 50 MHz, , 216 MHz, , 216 MHz, , 216 MHz, , 216 MHz, , 216 MHz, , 216 MHz, , 216 MHz

if Radio Std is 802.11b/g(DSSS/CCK/PBCC): 11 MHz, , 22 MHz, , 50 MHz, , 70 MHz, , 90 MHz, , 100 MHz, , 100 MHz, , 100 MHz, , 100 MHz, , 100 MHz, , 100 MHz, , 100 MHz

if Radio Std is 802.11n(20MHz): 9 MHz, , 11 MHz, , 20 MHz, , 30 MHz, , 50 MHz, , 100 MHz, , 100 MHz, , 100 MHz, , 100 MHz, , 100 MHz

if Radio Std is 802.11n(40MHz): 19 MHz, , 21 MHz, , 40 MHz, , 60 MHz, , 100 MHz, , 200 MHz, , 200 MHz, , 200 MHz, , 200 MHz, , 200 MHz, , 200 MHz

if Radio Std is 802.11ac(20MHz): 9 MHz, , 11 MHz, , 20 MHz, , 30 MHz, , 30 MHz, , 30 MHz, , 30 MHz, , 30 MHz, , 30 MHz, , 30 MHz

if Radio Std is 802.11ac(40MHz): 19 MHz, , 21 MHz, , 40 MHz, , 60 MHz, , 60 MHz, , 60 MHz, , 60 MHz, , 60 MHz, , 60 MHz, , 60 MHz

if Radio Std is 802.11ac(80MHz): 39 MHz, , 41 MHz, , 80 MHz, , 120 MHz, , 120 MHz, , 120 MHz, , 120 MHz, , 120 MHz, , 120 MHz, , 120 MHz

if Radio Std is 802.11ac(160MHz): 79 MHz, , 81 MHz, , 160 MHz, , 240 MHz, , 240 MHz, , 240 MHz, , 240 MHz, , 240 MHz, , 240 MHz

if Radio Std is 802.11ac(80 MHz + 80MHz): 0 MHz, , 40 MHz, , 79 MHz, , 159 MHz, , 161 MHz, , 200 MHz, , 240 MHz, , 240 MHz, , 240 MHz, , 240 MHz, , 240 MHz, , 240 MHz

MSR:15 kHz, , 215kHz, , 1.015MHz, , 1.5MHz, , 10.5MHz, , 15.00MHz, , 30MHz, , 30MHz, , 30MHz, , 30MHz, , 30MHz, , 30MHz | 15kHz, , 215kHz, , 1.015MHz, , 1.5MHz, , 10.5MHz, , 15.00MHz, , 30MHz, , 30MHz, , 30MHz, , 30MHz, , 30MHz, , 30MHz

LTEAFDD, , LTEATDD: 50 kHz, , 5.05 MHz, , 10.5 MHz, , 15.00 MHz, , 30 MHz, , 40 MHz, , 40 MHz, , 40 MHz, , 40 MHz, , 40 MHz, , 40 MHz | 15.00 kHz, , 1.5 MHz, , 5.5 MHz, , 6.5 MHz, , 10 MHz, , 20MHz, , 20MHz, , 20MHz, , 20MHz, , 20MHz, , 20MHz

For modes (except MSR, , LTEAFDD, , LTEATDD and WLAN) without option N9060A-7FP, , the preset value is as follows.

SA: ON, ON, ON, ON, ON, OFF

WCDMA: ON, , ON, , ON, , ON, , OFF|ON, , ON, , ON, , OFF, , OFF

C2K: ON, , ON, , ON, , OFF, , OFF, , OFF|ON, , ON, , OFF, , OFF, , OFF, , OFF

WIMAX OFDMA: ON, , ON, , ON, , OFF, , OFF, , OFF|ON, , ON, , ON, , OFF, , OFF, , OFF

TD-SCDMA: ON, , ON, , ON, , ON, , OFF, , OFF|ON, , ON, , ON, , OFF, , OFF, , OFF

1xEVDO: ON, , ON, , ON, , OFF, , OFF, , OFF| ON, , ON, , OFF, , OFF, , OFF, , OFF

DTMB (CTTB), , DVB-T/H, , CMMB, , Digital Cable TV: ON, , ON, , ON, , OFF, , OFF, , OFF

ISDB-T: ON, ON, ON, ON, OFF, OFF

LTE, , LTETDD: ON, , ON, , ON, , OFF, , OFF, , OFF|ON, ON, ON, ON, OFF, OFF

When option N9060A-7FP is installed in these modes, , the preset value of Offset G ~ L is the same as the Offset F value.

-----

WLAN:

if Radio Std is 802.11b/g(DSSS/CCK/PBCC): ON, , ON, , OFF, , OFF, , OFF, , OFF, , OFF, , OFF, , OFF, , OFF

if Radio Std is 802.11a/g(OFDM/DSSS-OFDM)/802.11n(20MHz/40MHz): ON, , ON, , ON, , ON, , OFF, , OFF, , OFF, , OFF, , OFF, , OFF, , OFF

if Radio Std is 802.11ac (20 MHz/ 40 MHz/ 80 MHz/ 160 MHz): ON, , ON, , ON, , ON, , OFF, , OFF, , OFF, , OFF, , OFF, , OFF, , OFF

---

	if Radio Std is 802.11ac (80 MHz + 80 MHz): ON, , ON, , ON, , ON, , ON, , ON, , OFF, , OFF, , OFF, , OFF, , OFF MSR:ON, , ON, , ON, , ON, , ON, , OFF, , OFF, , OFF, , OFF, , OFF, , OFF, , OFF, , ON, , ON, , ON, , ON, , ON, , OFF, , OFF, , OFF, , OFF, , OFF, , OFF, , OFF, , OFF LTEAFDD, , LTEATDD: ON, , ON, , ON, , OFF, , OFF, , OFF, , OFF, , OFF, , OFF, , OFF, , OFF, , OFF, , OFF, , OFF, , ON, , ON, , ON, , ON, , OFF, , OFF, , OFF, , OFF, , OFF, , OFF, , OFF, , OFF, , OFF, , OFF, , OFF
State Saved	Saved in instrument state.
Min	0 Hz
Max	499.9999 MHz
Initial S/W Revision	Prior to A.02.00
Modified at S/W Revision	A.02.00, A.03.00, A.10.00, A.11.00, A.14.00

## Stop Freq

Specifies the stop frequency for the currently selected offset.

Missing values are not permitted; that is, if you want to change values 2 and 6, you must send all values up to 6. Subsequent values will remain as they were. The query for this parameter always returns 12 values.

Key Path	Meas Setup, Offset/Limits
Mode	SA, WCDMA, C2K, WIMAX OFDMA, TD-SCDMA, 1xEVDO, DTMB (CTTB), DVB-T/H, ISDB-T, CMMB, LTE, LTE-TDD, Digital Cable TV, WLAN, MSR, LTEAFDD, LTEATDD
Remote Command	[ :SENSe ] :SEMAsk:OFFSet [1]   2 [ :OUTer ] :LIST:FREQuency:STOP <freq>, ... [ :SENSe ] :SEMAsk:OFFSet [1]   2 [ :OUTer ] :LIST:FREQuency:STOP?
Example	SEM:OFFS:LIST:FREQ:STOP 2.715 MHz, , 3.515 MHz, , 4.00 MHz, , 8.00 MHz, , 12.50 MHz, , 15.0 MHz SEM:OFFS:LIST:FREQ:STOP?
Notes	Comma separated list of values. OFFSet1 is for BTS, 2 for MS. Default is BTS. You must be in the mode that includes SEM measurement to use this command. Use :INSTrument:SElect to set the mode.
Couplings	Coupled to Start Freq. When the stop freq goes below the start freq, the start freq is automatically adjusted to the stop freq minus 100 Hz. If the current mode is DVB-T/H, this value will be modified automatically according to the limit type and the output power of the transmitter which is less or more than 25 W. If the current mode is ISDB-T, this value will be modified automatically according to the limit type.
Preset	For modes (except MSR, , LTEAFDD, , LTEATDD and WLAN) without option N9060A-7FP, , the preset value is as follows. SA: 2.715 MHz, , 3.515 MHz, , 4.00 MHz, , 8.00 MHz, , 12.50 MHz, , 15.0 MHz WCDMA:2.715 MHz, , 3.515 MHz, , 4.000 MHz, , 8.000 MHz, , 12.50 MHz, , 15.0 MHz 3.485 MHz, , 7.500 MHz, , 8.500 MHz, , 12.00 MHz, , 15.00 MHz, , 18.0 MHz

---

C2K: 780.0kHz, 1.980 MHz, 4.0 MHz, 4.0 MHz, 12.0 MHz, 12.0 MHz|1.980 MHz, 4.0 MHz, 4.0 MHz, 11.5 MHz, 14.5 MHz, 14.5 MHz

WIMAX OFDMA: 5.45 MHz, 9.75 MHz, 14.75 MHz, 19.75 MHz, 24.75 MHz, 29.75 MHz|5.45 MHz, 9.75 MHz, 14.75 MHz, 19.75 MHz, 24.75 MHz, 29.75 MHz

TD-SCDMA:

1015 kHz, 1815kHz, 2.3 MHz, 4 MHz, 4 MHz, 4 MHz|1.8 MHz, 2385 kHz, 3.5 MHz, 3.5 MHz, 3.5 MHz, 3.5 MHz

1xEVDO: 780.0 kHz, 1.98 MHz, 4.0 MHz, 4.0 MHz, 12 MHz, 12 MHz|1.98 MHz, 4.0 MHz, 4.0 MHz, 4.0 MHz, 4.0 MHz, 4.0 MHz

DTMB (CTTB): 4.2 MHz, 6 MHz, 12 MHz, 12 MHz, 12 MHz, 12 MHz|12 MHz, 12 MHz, 12 MHz, 12 MHz, 12 MHz, 12 MHz, 12 MHz

DVB-T/H: 4.2 MHz, 6 MHz, 12 MHz, 12 MHz, 12 MHz, 12 MHz|12 MHz, 12 MHz, 12 MHz, 12 MHz, 12 MHz, 12 MHz

ISDB-T: 2.86 MHz, 3.0 MHz, 4.36 MHz, 15.0 MHz, 15.0 MHz, 15.0 MHz|15MHz, 15MHz, 15MHz, 15MHz, 15MHz, 15MHz

CMMB: 4.2 MHz, 8.0 MHz, 12.0 MHz, 12.0 MHz, 12.0 MHz, 12.0 MHz|12 MHz, 12 MHz, 12 MHz, 12 MHz, 12 MHz, 12 MHz

LTE, LTETDD: 5.05 MHz, 10.05 MHz, 15 MHz, 30 MHz, 40 MHz, 50 MHz|985.0 kHz, 4.50 MHz, 5.5001 MHz, 9.50 MHz, 20 MHz, 40 MHz

Digital Cable TV: 4.2 MHz, 6.0 MHz, 12.0 MHz, 12.0 MHz, 12.0 MHz, 12.0 MHz, 12 MHz, 12 MHz, 12 MHz, 12 MHz, 12 MHz, 12 MHz

When option N9060A-7FP is installed in these modes, the preset value of Offset G ~ L is the same as the Offset F value.

-----

WLAN:

if Radio Std is 802.11a/g(OFDM/DSSS-OFDM)/802.11n(20MHz): 11 MHz, 20 MHz, 30 MHz, 50 MHz, 100 MHz, 250 MHz, 250 MHz, 250 MHz, 250 MHz, 250 MHz, 250 MHz, 250 MHz

if Radio Std is 802.11b/g(DSSS/CCK/PBCC): 22 MHz, 50 MHz, 70 MHz, 90 MHz, 100 MHz, 120 MHz, 120 MHz, 120 MHz, 120 MHz, 120 MHz, 120 MHz, 120 MHz

if Radio Std is 802.11n(20MHz): 11 MHz, 20 MHz, 30 MHz, 50 MHz, 100 MHz, 200 MHz, 200 MHz, 200 MHz, 200 MHz, 200 MHz, 200 MHz, 200 MHz

if Radio Std is 802.11n(40MHz): 21 MHz, 40 MHz, 60 MHz, 100 MHz, 200 MHz, 300 MHz, 300 MHz, 300 MHz, 300 MHz, 300 MHz, 300 MHz, 300 MHz

if Radio Std is 802.11ac(20MHz): 11 MHz, 20 MHz, 30 MHz, 50 MHz, 50 MHz, 50 MHz, 50 MHz, 50 MHz, 50 MHz, 50 MHz, 50 MHz, 50 MHz

if Radio Std is 802.11ac(40MHz): 21 MHz, 40 MHz, 60 MHz, 100 MHz, 100 MHz, 100 MHz, 100 MHz, 100 MHz, 100 MHz, 100 MHz, 100 MHz, 100 MHz

if Radio Std is 802.11ac(80MHz): 41 MHz, 80 MHz, 120 MHz, 200 MHz, 200 MHz, 200 MHz, 200 MHz, 200 MHz, 200 MHz, 200 MHz, 200 MHz, 200 MHz

if Radio Std is 802.11ac(160MHz): 81 MHz, 160 MHz, 240 MHz, 400 MHz, 400 MHz, 400 MHz, 400 MHz, 400 MHz, 400 MHz, 400 MHz, 400 MHz, 400 MHz

if Radio Std is 802.11ac(80 MHz + 80MHz): 40 MHz, 79 MHz, 81 MHz, 161 MHz, 200 MHz, 240 MHz, 260 MHz, 260 MHz, 260 MHz, 260 MHz, 260 MHz, 260 MHz

MSR: 215kHz, 1.015MHz, 1.5MHz, 10.5MHz, 50MHz, 50MHz, 50MHz, 50MHz, 50MHz, 50MHz, 50MHz, 50MHz

---

	50MHz, , 50MHz, , 50MHz LTEAFDD, , LTEATDD: 5.05 MHz, , 10.05 MHz, , 15 MHz, , 30 MHz, , 40 MHz, , 50 MHz, , 50 MHz, , 50 MHz, , 50 MHz, , 50 MHz, , 50 MHz   985.0 kHz, , 4.50 MHz, , 5.5001 MHz, , 9.50 MHz, 20 MHz, , 40 MHz, , 40 MHz, , 40 MHz, , 40 MHz, , 40 MHz, , 40 MHz, , 40 MHz, , 40 MHz
State Saved	Saved in instrument state.
Min	100 Hz
Max	500 MHz
Initial S/W Revision	Prior to A.02.00
Modified at S/W Revision	A.02.00, A.03.00, A.10.00, A.11.00, A.14.00

## Sweep Time

Specifies the sweep time for the currently selected offset and enables you to toggle the Sweep Time mode between Auto and Man.

Missing values are not permitted; that is, if you want to change values 2 and 6, you must send all values up to 6. Subsequent values will remain as they were. The query for this parameter always returns 12 values.

Key Path	Meas Setup, Offset/Limits
Mode	SA, WCDMA, C2K, WIMAX OFDMA, TD-SCDMA, 1xEVDO, DTMB (CTTB), DVB-T/H, ISDB-T, CMMB, LTE, LTE-TDD, Digital Cable TV, WLAN, MSR, LTEAFDD, LTEATDD
Remote Command	[ :SENSe ] :SEMask:OFFSet [ 1 ]   2 [ :OUTer ] :LIST:SWEep:TIME <time>, ... [ :SENSe ] :SEMask:OFFSet [ 1 ]   2 [ :OUTer ] :LIST:SWEep:TIME? [ :SENSe ] :SEMask:OFFSet [ 1 ]   2 [ :OUTer ] :LIST:SWEep:TIME:AUTO ON   OFF   1   0, ... [ :SENSe ] :SEMask:OFFSet [ 1 ]   2 [ :OUTer ] :LIST:SWEep:TIME:AUTO?
Example	SEM:OFFS2:LIST:SWE:TIME 1.0 ms, , 3.4 ms, , 2.08 ms, , 1.0 ms, , 1.0 ms, , 1.0 ms SEM:OFFS2:LIST:SWE:TIME? SEM:OFFS2:LIST:SWE:TIME:AUTO ON, , ON, , ON, , ON, , OFF, , OFF SEM:OFFS2:LIST:SWE:TIME:AUTO?
Notes	Comma separated list of values. OFFSet1 is for BTS, 2 for MS. Default is BTS. You must be in the mode that includes SEM measurement to use this command. Use :INSTrument:SElect to set the mode.
Couplings	When the sweep time is set manually, Sweep Time Mode is set to MANual. If the current mode is DVB-T/H, this value will be modified automatically according to the output power of the transmitter which is less or more than 25W. If the current mode is ISDB-T, this value will be modified automatically according to the limit type.
Preset	Automatically calculated Modes (except MSR, , LTEAFDD, , LTEATDD and WLAN) without option N9060A-7FP: ON, ON, ON, ON, ON, ON

	Modes (except MSR, , LTEAFDD, , LTEATDD and WLAN) with option N9060A-7FP: ON, ON, ON, ON, ON, ON, ON, ON, ON, ON, ON, ON, ON, ON, ON, ON WLAN: ON, ON, ON, ON, ON, ON, ON, ON, ON, , ON, ON, ON, ON, ON MSR: ON,ON,ON,ON,ON,ON,ON,ON,ON,ON,ON,ON,ON,ON,ON,ON LTEAFDD, , LTEATDD: ON, ON, ON, ON, ON, ON, ON, ON, ON, ON, ON, ON   ON, ON, ON, ON, ON, ON, ON, ON, ON, ON, ON, ON
State Saved	Saved in instrument state.
Min	1 ms
Max	4000 s
<b>Backwards Compatibility SCPI</b>	[ :SENSE ] :SEMAsk:OFFSet [ 1 ]   2 :LIST:SWEep [ :TIME ]
Initial S/W Revision	Prior to A.02.00
Modified at S/W Revision	A.02.00, A.03.00, A.10.00, A.11.00, A.14.00

### Offset Side

Specifies which offset side to measure.

You can turn off (not use) specific offsets with [:SENSE]:SEMAsk:OFFSet[n][:OUTer]:LIST:STATe.

- **BOTH** – Both of the negative (lower) and positive (upper) sidebands
- **NEGative** – Negative (lower) sideband only
- **POSitive** – Positive (upper) sideband only

Missing values are not permitted; that is, if you want to change values 2 and 6, you must send all values up to 6. Subsequent values will remain as they were. The query for this parameter always returns 12 values.

The figure below shows the relation between the negative/positive offset side setups and the upper/lower results in the MSR and LTE-Advanced FDD/TDD.

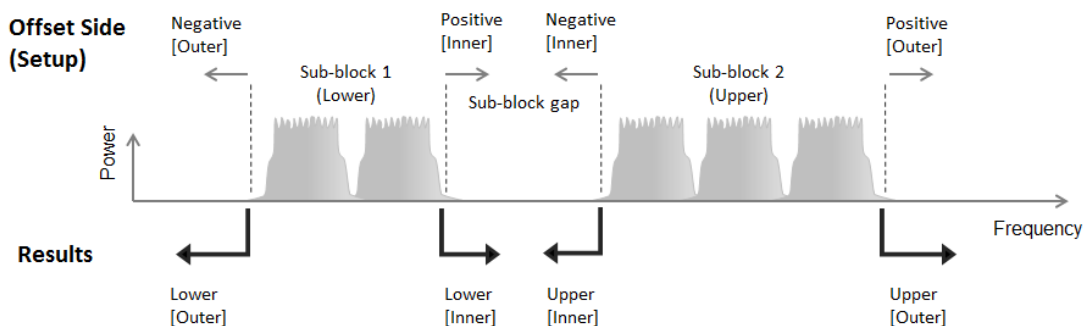

Key Path	Meas Setup, Offset/Limits
Mode	SA, WCDMA, C2K, WIMAX OFDMA, TD-SCDMA, 1xEVDO, DTMB (CTTB), DVB-T/H, ISDB-T, CMMB, LTE, LTE-TDD, Digital Cable TV, WLAN, MSR, LTEAFDD, LTEATDD
Remote Command	[ :SENSE ] :SEMAsk:OFFSet [ 1 ]   2 [ :OUTer ] :LIST:SIDE BOTH   NEGative

	POSitive, ... [:SENSe]:SEMask:OFFSet[1] 2[:OUTer]:LIST:SIDE?
<b>Example</b>	SEM:OFFS:LIST:SIDE BOTH, , NEG, , NEG, , POS, , POS, , POS SEM:OFFS:LIST:SIDE?
<b>Notes</b>	Comma separated list of values. OFFSet1 is for BTS, 2 for MS. Default is BTS. You must be in the mode that includes SEM measurement to use this command. Use :INSTrument:SElect to set the mode.
<b>Preset</b>	Modes (except MSR, , LTEAFDD, , LTEATDD and WLAN) without option N9060A-7FP: BOTH, , BOTH, , BOTH, , BOTH, , BOTH Modes (except MSR, , LTEAFDD, , LTEATDD and WLAN) with option N9060A-7FP: BOTH, , BOTH, , BOTH, , BOTH, , BOTH, , BOTH, , BOTH, , BOTH, , BOTH, , BOTH MSR: BOTH, , BOTH, , BOTH, , BOTH, , BOTH, , BOTH, , BOTH, , BOTH, , BOTH, , BOTH, , BOTH, , BOTH LTEAFDD, LTEATDD: BOTH, , BOTH, , BOTH, , BOTH, , BOTH, , BOTH, , BOTH, , BOTH, , BOTH, , BOTH, , BOTH, , BOTH   BOTH, , BOTH, , BOTH, , BOTH, , BOTH, , BOTH, , BOTH, , BOTH, , BOTH, , BOTH, , BOTH WLAN: BOTH, , BOTH, , BOTH, , BOTH, , BOTH, , BOTH, , BOTH, , BOTH, , BOTH, , BOTH, , BOTH, , BOTH
<b>State Saved</b>	Saved in instrument state.
<b>Range</b>	Neg Both Pos
<b>Initial S/W Revision</b>	Prior to A.02.00
<b>Modified at S/W Revision</b>	A.02.00, A.03.00, A.10.00, A.11.00, A.14.00

## Res BW

Specifies which Resolution BW filter to use when measuring the currently selected offset.

Offset Res BW Mode allows the instrument to determine the optimum Resolution BW filter to use when measuring the currently selected offset.. When changing the Meas BW parameter, if the Res BW needs to be changed to adhere to the rule

$(N \times \text{Res BW}) \leq (\text{Stop freq of the offset} - \text{Start freq of the offset})$ ,

where N is the multiplier, this setting will automatically be changed to manual.

Missing values are not permitted; that is, if you want to change values 2 and 6, you must send all values up to 6. Subsequent values will remain as they were. The query for this parameter always returns 12 values.

<b>Key Path</b>	Meas Setup, Offset/Limits
<b>Mode</b>	SA, WCDMA, C2K, WIMAX OFDMA, TD-SCDMA, 1xEVDO mode, DTMB (CTTB), DVB-T/H, ISDB-T, CMMB, LTE, LTE-TDD, Digital Cable TV, WLAN, MSR, LTEAFDD, LTEATDD
<b>Remote Command</b>	[:SENSe]:SEMask:OFFSet[1] 2[:OUTer]:LIST:BANDwidth[:RESolution] <bandwidth>, ... [:SENSe]:SEMask:OFFSet[1] 2[:OUTer]:LIST:BANDwidth[:RESolution]?

	<pre>[ :SENSe ] :SEMAsk:OFFSet [1]   2 [ :OUTer ] :LIST:BANDwidth [ :RESolution ] :AUTO OFF   ON   1   0, ...  [ :SENSe ] :SEMAsk:OFFSet [1]   2 [ :OUTer ] :LIST:BANDwidth [ :RESolution ] :AUTO?</pre>
<b>Example</b>	<pre>SEM:OFFS2:LIST:BAND 30.0 kHz, , 30.0 kHz, , 30.0 kHz, , 1.00 MHz, 1.00 MHz, , 1.00 MHz SEM:OFFS2:LIST:BAND? SEM:OFFS:LIST:BAND:AUTO 1,1,1,1,1,1 SEM:OFFS:LIST:BAND:AUTO?</pre>
<b>Notes</b>	<p>Comma separated list of values.</p> <p>OFFSet1 is for BTS, 2 for MS. Default is BTS.</p> <p>You must be in the mode that includes SEM measurement to use this command. Use :INSTrument:SElect to set the mode.</p>
<b>Couplings</b>	<p>Coupled to Start and Stop offset and Meas BW multiplier. This parameter must adhere to the rule (N x Res BW) &lt;= (Stop freq of the offset - Start freq of the offset), where N is the multiplier. If the multiplier is changed, the Res BW will be changed to ensure this. When set manually, Res BW Coupling is set to manual.</p> <p>The resolution bandwidth is coupled to the offset width determined by the start frequency and stop frequency.</p>
<b>Preset</b>	<p>For modes (except MSR, , LTEAFDD, , LTEATDD and WLAN) without option N9060A-7FP, , the preset value is as follows.</p> <p>SA: 30.0 kHz, , 30.0 kHz, , 30.0 kHz, , 1.00 MHz, 1.00 MHz, , 1.00 MHz</p> <p>WCDMA: 30.00 kHz, , 30.00 kHz, , 30.00 kHz, , 100.00 kHz, , 1.000 MHz, , 1.00 MHz 30.00 kHz, , 1.000 MHz, , 1.000 MHz, , 1.000 MHz, , 1.000 MHz, , 1.00 MHz</p> <p>C2K: 3.00 kHz, , 30.00 kHz, , 30.00 kHz, , 6.2 kHz, , 1.000 MHz, , 1.00 MHz 30.00 kHz, , 30.00 kHz, , 6.2 kHz, , 1.000 MHz, , 1.000 MHz, , 1.00 MHz</p> <p>WIMAX OFDMA: 100 KHz, , 100 KHz, , 100 KHz, , 100 KHz, , 100 KHz, , 100 KHz  100 KHz, , 100 KHz, , 100 KHz, , 100 KHz, , 100 KHz</p> <p>TD-SCDMA: 30 kHz, , 30 kHz, , 30 kHz, , 50 kHz, , 1 MHz, , 1 MHz  30 kHz, , 30 kHz, , 50 kHz, , 1 MHz, , 1 MHz, , 1 MHz</p> <p>1xEVDO: 30.00 kHz, , 30.00 kHz, , 30.00 kHz, , 6.2 kHz, , 1.000 MHz, , 1.000 MHz 30.00 kHz, , 30.00 kHz, , 30.00 kHz, , 30.00 kHz, , 30.00 kHz</p> <p>DTMB (CTTB), , DVB-T/H, , CMMB, , Digital Cable TV: 3.9 kHz, , 3.9 kHz, , 3.9 kHz, , 3.9 kHz, , 3.9 kHz, , 3.9 kHz  30.00 kHz, , 1.000 MHz, , 1.000 MHz, , 1.000 MHz, , 1.000 MHz, , 1.00 MHz</p> <p>ISDB-T: 10.0 kHz, , 10.0 kHz, , 10.0 kHz, , 10.0 kHz, , 10. kHz, , 10.0 kHz  30.00 kHz, , 1.000 MHz, , 1.000 MHz, , 1.000 MHz, , 1.000 MHz, , 1.00 MHz</p> <p>LTE, , LTETDD: 51 kHz, , 100 kHz, , 1.0 MHz, , 1.0 MHz, 1.0 MHz, , 1.0 MHz 15.0 kHz, , 510 kHz, 1.0 MHz, 1.0 MHz, 1.0 MHz, 1.0 MHz</p> <p>When option N9060A-7FP is installed in these modes, , the preset value of Offset G ~ L is the same as the Offset F value.</p> <p>-----</p> <p>WLAN: 100 KHz, , 100 KHz, , 100 KHz, , 100 KHz, , 100 KHz, , 100 KHz, , 100 KHz, , 100 KHz, , 100 KHz, , 100 KHz, , 100 KHz</p> <p>MSR: 30kHz, , 30kHz, , 30kHz, , 1.0MHz, 1.0MHz, , 1.0MHz, , 1.0MHz, , 1.0MHz, , 1.0MHz, , 1.0MHz, , 1.0MHz   30kHz, , 30kHz, , 30kHz, , 1.0MHz, 1.0MHz, , 1.0MHz, , 1.0MHz, , 1.0MHz, , 1.0MHz, , 1.0MHz, , 1.0MHz</p>



	LTEAFDD, , LTEATDD: 51 kHz, , 100 kHz, , 1.0 MHz, , 1.0 MHz, 1.0 MHz, , 1.0 MHz, 1.0 MHz, 1.0 MHz, 1.0 MHz, 1.0 MHz, 1.0 MHz, 1.0 MHz   15.0 kHz, , 510 kHz, 1.0 MHz, 1.0 MHz, 1.0 MHz, 1.0 MHz, 1.0 MHz, 1.0 MHz, 1.0 MHz, 1.0 MHz
	Modes (except MSR, , LTEAFDD, , LTEATDD and WLAN) without option N9060A-7FP: OFF, , OFF, , OFF, , OFF, , OFF   OFF, , OFF, , OFF, , OFF, , OFF, , OFF
	Modes (except MSR, , LTEAFDD, , LTEATDD and WLAN) with option N9060A-7FP: OFF, , OFF, , OFF, , OFF, , OFF, , OFF, , OFF, , OFF, , OFF   OFF, , OFF, , OFF, , OFF, , OFF, , OFF, , OFF, , OFF, , OFF, , OFF, , OFF, , OFF, , OFF, , OFF, , OFF, , OFF
	MSR: OFF, , OFF, , OFF, , OFF, , OFF, , OFF, , OFF, , OFF, , OFF   OFF, , OFF, , OFF, , OFF, , OFF, , OFF, , OFF, , OFF, , OFF, , OFF
	LTEAFDD, , LTEATDD: OFF, , OFF, , OFF, , OFF, , OFF, , OFF, , OFF, , OFF, , OFF, , OFF, , OFF, , OFF   OFF, , OFF, , OFF, , OFF, , OFF, , OFF, , OFF, , OFF, , OFF, , OFF, , OFF
	WLAN: OFF, , OFF, , OFF, , OFF, , OFF, , OFF, , OFF, , OFF, , OFF, , OFF   OFF, , OFF, , OFF, , OFF, , OFF, , OFF, , OFF, , OFF, , OFF, , OFF
State Saved	Saved in instrument state.
Min	1 Hz
Max	8 MHz
<b>Backwards Compatibility SCPI</b>	<code>[ :SENSe ] :SEMAsk:OFFSet [ 1 ]   2 :LIST:BWIDth [ :RESolution ]</code>
Initial S/W Revision	Prior to A.02.00
Modified at S/W Revision	A.02.00, A.03.00, A.10.00, A.11.00, A.14.00

**Meas BW**

Allows you to specify a multiplier of Res BW for the measurement integration bandwidth.

Meas BW is multiplier integer number. It shows a ratio between Integration BW and Resolution BW of the measurement result.

$$\text{Integ BW} = \text{Meas BW} * \text{Resolution BW}$$

Integration BW is desired resolution bandwidth and Resolution BW is actual bandwidth for sweep. Measurement sweeps with Resolution BW and Meas BW compensates sweep resolution bandwidth to Integration BW.

If you set this parameter greater than 1, you can set Resolution BW narrower to avoid carrier power leakage effect to the offset power integration.

Missing values are not permitted; that is, if you want to change values 2 and 6, you must send all values up to 6. Subsequent values will remain as they were. The query for this parameter always returns 12 values.

Key Path	Meas Setup, Offset/Limits
Mode	SA, WCDMA, C2K, WIMAX OFDMA, TD-SCDMA, 1xEVDO, DTMB (CTTB), DVB-T/HISDB-T, CMMB, LTE, LTETDD, Digital Cable TV, WLAN
Remote Command	<code>[ :SENSe ] :SEMAsk:OFFSet [ 1 ]   2 [ :OUTer ] :LIST:Bandwidth:IMULti &lt;integer&gt;, ...</code> <code>[ :SENSe ] :SEMAsk:OFFSet [ 1 ]   2 [ :OUTer ] :LIST:Bandwidth:IMULti?</code>

<b>Example</b>	SEM:OFFS2:LIST:BAND:IMUL 1,1,1,1,1,1 SEM:OFFS2:LIST:BAND:IMUL?
<b>Notes</b>	Comma separated list of values. OFFSet1 is for BTS, 2 for MS. Default is BTS. You must be in the mode that includes SEM measurement to use this command. Use :INSTrument:SElect to set the mode.
<b>Couplings</b>	This parameter must adhere to the rule (N x Res BW) <= (Stop freq of the offset - Start freq of the offset), where N is the multiplier. If the Res Bw is changed, the multiplier will be changed to ensure this.
<b>Preset</b>	For modes (except MSR, , LTEAFDD, , LTEATDD and WLAN) without option N9060A-7FP, , the preset value is as follows. SA: 1, 1, 1, 1, 1, 1 WCDMA: 1, , 1, , 1, , 10, , 1, , 1 1, , 1, , 1, , 1, , 1 C2K: 10, 1, 1, 1, 1, 1 1, 1, 1, 1, 1, 1 WIMAX OFDMA, , 1xEVDO: 1, , 1, , 1, , 1, , 1 1, , 1, , 1, , 1, , 1 TD-SCDMA:1, , 1, , 1, , 20, , 1, , 1 1, , 1, , 20, , 1, , 1, , 1 DTMB (CTTB), , DVB-T/H, , ISDB-T, , CMMB, , Digital Cable TV: 1, , 1, , 1, , 1, , 1  1, , 1, , 1, , 1, , 1 LTE, , LTETDD: 2, , 1, , 1, , 1, , 1, , 1 2, , 2, , 1, , 1, , 1, , 1 When option N9060A-7FP is installed in these modes, , the preset value of Offset G ~ L is the same as the Offset F value. ----- WLAN: 1, 1, 1, 1, 1, 1, 1, 1, 1, 1, 1, 1 MSR: 1, , 1, , 1, , 1, , 1, , 1, , 1, , 1, , 1, , 1 1, , 1, , 1, , 1, , 1, , 1, , 1, , 1, , 1, , 1 LTEAFDD, , LTEATDD: 2, , 1, , 1, , 1, , 1, , 1, , 1, , 1, , 1, , 1 2, , 2, , 1, , 1, , 1, , 1, , 1, , 1, , 1, , 1 1, , 1, , 1
<b>State Saved</b>	Saved in instrument state.
<b>Min</b>	1
<b>Max</b>	1000
<b>Backwards Compatibility SCPI</b>	[ :SENSe ] :SEMAsk:OFFSet [ 1 ]   2 :LIST:BWIDth:IMULti
<b>Initial S/W Revision</b>	Prior to A.02.00
<b>Modified at S/W Revision</b>	A.02.00, A.03.00, A.10.00, A.11.00, A.14.00

### Video BW

Changes the analyzer post-detection filter.

Missing values are not permitted; that is, if you want to change values 2 and 6, you must send all values up to 6. Subsequent values will remain as they were. The query for this parameter always returns 12 values.

<b>Key Path</b>	Meas Setup, Offset/Limits
-----------------	---------------------------

Mode	SA, WCDMA, C2K, WIMAXOFDMA, TD-SCDMA, 1xEVDO, DTMB (CTTB), DVB-T/H, ISDB-T, CMMB, LTE, LTE-TDD, Digital Cable TV, WLAN, MSR, LTEAFDD, LTEATDD
Remote Command	[:SENSe]:SEMask:OFFSet [1]   2[:OUTer]:LIST:BANDwidth:VIDeo <freq>, ... [:SENSe]:SEMask:OFFSet [1]   2[:OUTer]:LIST:BANDwidth:VIDeo? [:SENSe]:SEMask:OFFSet [1]   2[:OUTer]:LIST:BANDwidth:VIDeo:AUTO OFF   ON   0   1, ... [:SENSe]:SEMask:OFFSet [1]   2[:OUTer]:LIST:BANDwidth:VIDeo:AUTO?
Example	SEM:OFFS2:LIST:BAND:VID 3.00 kHz, , 3.00 kHz, , 3.00 kHz, , 100.0 kHz, 100.0 kHz, , 100.0 kHz SEM:OFFS2:LIST:BAND:VID? SEM:OFFS2:LIST:BAND:VID:AUTO ON, , ON, , ON, , ON, , ON, , ON SEM:OFFS2:LIST:BAND:VID:AUTO?
Notes	Comma separated list of values. OFFSet1 is for BTS, 2 for MS. Default is BTS. You must be in the mode that includes SEM measurement to use this command. Use :INSTrument:SElect to set the mode.
Preset	ISDB-T: 1.0kHz, , 1.0kHz, , 1.0kHz, , 1.0kHz, , 1.0kHz, , 1.0kHz Other than ISDB-T: Automatically Calculated Modes (except MSR, , LTEAFDD, , LTEATDD, , WLAN, , ISDB-T) without option N9060A-7FP: ON, , ON, , ON, , ON, , ON ON, , ON, , ON, , ON, , ON Modes (except MSR, , LTEAFDD, , LTEATDD, , WLAN, , ISDB-T) with option N9060A-7FP:ON, , ON, , ON, , ON, , ON, , ON, , ON, , ON, , ON, , ON, , ON ON, , ON, , ON, , ON, , ON, , ON, , ON, , ON, , ON ----- MSR, , LTEAFDD, , LTEATDD: ON, , ON, , ON, , ON, , ON, , ON, , ON, , ON, , ON, , ON ON, , ON, , ON, , ON, , ON, , ON, , ON, , ON, , ON, , ON, , ON WLAN: ON, , ON, , ON, , ON, , ON, , ON, , ON, , ON, , ON, , ON, , ON ON, , ON, , ON, , ON, , ON, , ON, , ON, , ON, , ON ISDB-T: OFF, , OFF, , OFF, , OFF, , OFF OFF, , OFF, , OFF, , OFF, , OFF, , OFF
State Saved	Saved in instrument state.
Min	1 Hz
Max	50 MHz
Backwards Compatibility SCPI	[:SENSe]:SEMask:OFFSet [1]   2:LIST:BWIDth:VIDeo
Initial S/W Revision	Prior to A.02.00
Modified at S/W Revision	A.02.00, A.03.00, A.10.00, A.11.00, A.14.00

## VBW/RBW

Selects the ratio between the video and resolution bandwidths.

Missing values are not permitted; that is, if you want to change values 2 and 6, you must send all values up to 6. Subsequent values will remain as they were. The query for this parameter always returns 12 values.

<b>Key Path</b>	Meas Setup, Offset/Limits
<b>Mode</b>	SA, WCDMA, C2K, WIMAX OFDMA, TD-SCDMA, 1xEVDO, DTMB (CTTB), DVB-T/H, ISDB-T, CMMB, LTE, LTETDD, Digital Cable TV, WLAN, MSR, LTEAFDD, LTEATDD
<b>Remote Command</b>	<pre>[:SENSe]:SEMAsk:OFFSet[1] 2[:OUTer]:LIST:BANDwidth:VIDeo:RATio &lt;real&gt;, ... [:SENSe]:SEMAsk:OFFSet[1] 2[:OUTer]:LIST:BANDwidth:VIDeo:RATio? [:SENSe]:SEMAsk:OFFSet[1] 2[:OUTer]:LIST:BANDwidth:VIDeo:RATio:AUTO OFF   ON   0   1, ... [:SENSe]:SEMAsk:OFFSet[1] 2[:OUTer]:LIST:BANDwidth:VIDeo:RATio:AUTO?</pre>
<b>Example</b>	<pre>SEM:OFFS2:LIST:BAND:VID:RAT 0.1, , 0.1, , 0.1, , 0.1, , 0.1, , 0.1 SEM:OFFS2:LIST:BAND:VID:RAT? SEM:OFFS2:LIST:BAND:VID:RAT:AUTO ON, , ON, , ON, , ON, , ON SEM:OFFS2:LIST:BAND:VID:RAT:AUTO?</pre>
<b>Notes</b>	<p>Comma separated list of values.</p> <p>OFFSet1 is for BTS, 2 for MS. Default is BTS.</p> <p>You must be in the mode that includes SEM measurement to use this command. Use :INSTrument:SElect to set the mode.</p>
<b>Preset</b>	<p>For modes (except MSR, , LTEAFDD, , LTEATDD and WLAN) without option N9060A-7FP, , the preset value is as follows.</p> <p>SA, , WCDMA, , C2K, , LTE, , LTETDD: 0.01, , 0.01, , 0.01, , 0.01, , 0.01, , 0.01 0.01, , 0.01, , 0.01, , 0.01, , 0.01, , 0.01</p> <p>WIMAX OFDMA: 0.3, , 0.3, , 0.3, , 0.3, , 0.3</p> <p>TD-SCDMA: 10, , 10, , 10, , 10, , 1, , 1 10, , 10, , 10, , 1, , 1, , 1</p> <p>1xEVDO: 10, , 10, , 10, , 10, , 10, , 10 10, , 10, , 10, , 10, , 10</p> <p>DTMB (CTTB), , DVB-T/H, , CMMB, , Digital Cable TV: 10, , 10, , 10, , 10, , 10, , 10 10, , 10, , 10, , 10, , 10</p> <p>ISDB-T: 0.1, , 0.1, , 0.1, , 0.1, , 0.1, , 0.1 10, , 10, , 10, , 10, , 10</p> <p>When option N9060A-7FP is installed in these modes, , the preset value of Offset G ~ L is the same as the Offset F value.</p> <p>-----</p> <p>WLAN: 0.3, , 0.3, , 0.3, , 0.3, , 0.3, , 0.3, , 0.3, , 0.3, , 0.3, , 0.3</p> <p>MSR, , LTEAFDD, , LTEATDD: 0.01, , 0.01, , 0.01, , 0.01, , 0.01, , 0.01, , 0.01, , 0.01, , 0.01, , 0.01, , 0.01, , 0.01 0.01, , 0.01, , 0.01, , 0.01, , 0.01, , 0.01, , 0.01, , 0.01, , 0.01, , 0.01, , 0.01, , 0.01</p> <p>Modes (except MSR, , LTEAFDD, , LTEATDD and WLAN) without option N9060A-7FP: OFF, , OFF, , OFF, , OFF, , OFF, , OFF OFF, , OFF, , OFF, , OFF, , OFF, , OFF</p> <p>Modes (except MSR, , LTEAFDD, , LTEATDD and WLAN) with option N9060A-7FP: OFF, , OFF, , OFF, , OFF, , OFF, , OFF, , OFF, , OFF, , OFF, , OFF, , OFF, , OFF OFF, , OFF, , OFF, , OFF, , OFF, , OFF, , OFF, , OFF, , OFF, , OFF, , OFF, , OFF, , OFF, , OFF</p> <p>MSR, , LTEAFDD, , LTEATDD: OFF, , OFF, , OFF, , OFF, , OFF, , OFF, , OFF, , OFF, , OFF, , OFF, , OFF, , OFF OFF, , OFF, , OFF, , OFF, , OFF, , OFF, , OFF, , OFF, , OFF, , OFF, , OFF, , OFF</p> <p>WLAN: OFF, , OFF, , OFF, , OFF, , OFF, , OFF, , OFF, , OFF, , OFF, , OFF, , OFF, , OFF OFF, , OFF, , OFF, , OFF, , OFF, , OFF, , OFF, , OFF, , OFF, , OFF, , OFF, , OFF</p>

State Saved	Saved in instrument state.
Min	0.00001
Max	3000000
Initial S/W Revision	Prior to A.02.00
Modified at S/W Revision	A.02.00, A.03.00, A.10.00, A.11.00, A.14.00

## Limits

Accesses a menu that enables you to set the power limits for start and stop frequencies of the selected offsets.

Key Path	Meas Setup
Initial S/W Revision	Prior to A.02.00

## Select Offset

Selects the offset (upper and lower) and displays the memory selection menu that enables you to store a set of parameter values for the offset, such as Start Freq, Stop Freq, Sweep Time, Res BW, Meas BW, Abs Start, and Abs Stop. Only one selection at a time is shown on this menu key label.

Key Path	Meas Setup, Offset/Limits
Mode	SA, WCDMA, C2K, WIMAX OFDMA, TD-SCDMA, 1xEVDO, DTMB (CTTB), DVB-T/H, ISDB-T, CMMB, LTE, LTE-TDD, Digital Cable TV, WLAN, MSR, LTEAFDD, LTEATDD
Preset	A
Range	MSR, LTEATDD, LTEAFDD, WLAN: A B C D E F G H  J K L Other modes without option N9060A-7FP: A B C D E F Other modes with option N9060A-7FP: A B C D E F G H  J K L
Initial S/W Revision	Prior to A.02.00
Modified at S/W Revision	A.02.00, A.03.00, A.10.00, A.11.00, A.14.00

## Abs Start

Sets the absolute power level limit at the start frequency for the selected offset. The absolute power level limit ranges from -200 to +50 dBm.

The fail condition for each offset channel is set remotely by [:SENSe]:SEMAsk:OFFSet[n]  
[:OUTer]:LIST:TEST.

You can turn off (not use) specific offset channels remotely with [:SENSe]:SEMAsk:OFFSet[n]  
[:OUTer]:LIST:STATe.

The SCPI query returns values currently set to the absolute power test limits.

Missing values are not permitted; that is, if you want to change values 2 and 6, you must send all values up to 6. Subsequent values will remain as they were. The query for this parameter always returns 12 values.

<b>Key Path</b>	Meas Setup, Offset/Limit, Limits
<b>Mode</b>	SA, WCDMA, C2K, WIMAX OFDMA, TD-SCDMA, 1xEVDO, DTMB (CTTB), DVB-T/H, ISDB-T, CMMB, LTE, LTETDD, Digital Cable TV, WLAN, MSR, LTEAFDD, LTEATDD
<b>Remote Command</b>	[ :SENSe ] :SEMAsk:OFFSet [ 1 ]   2 [ :OUTer ] :LIST:STARt:ABSolute <real>, ... [ :SENSe ] :SEMAsk:OFFSet [ 1 ]   2 [ :OUTer ] :LIST:STARt:ABSolute?
<b>Example</b>	SEM:OFFS2:LIST:STAR:ABS -12.50 dBm, , -12.50 dBm, , -24.50 dBm, , -11.50 dBm, , -11.50 dBm, , -11.50 dBm SEM:OFFS2:LIST:STAR:ABS?
<b>Notes</b>	Comma separated list of values. OFFSet1 is for BTS, 2 for MS. Default is BTS. You must be in the mode that includes SEM measurement to use this command. Use :INSTrument:SElect to set the mode.
<b>Couplings</b>	If the current mode is DVB-T/H, this value will be modified automatically according to the limit type and the output power of the transmitter which is less or more than 25W. If the current mode is ISDB-T, this value will be modified automatically according to the limit type.
<b>Preset</b>	For modes (except MSR, , LTEAFDD, , LTEATDD and WLAN) without option N9060A-7FP, , the preset value is as follows. SA, , WIMAX OFDMA: -14.00 dBm, , -14.00 dBm, , -26.00 dBm, , -13.00 dBm, , -13.00 dBm, , -13.00 dBm WCDMA: -12.50 dBm, , -12.50 dBm, , -24.50 dBm, , -11.50 dBm, , -11.50 dBm, , -11.50 dBm -69.6 dBm, , -54.3 dBm, , -54.3 dBm, , -54.3 dBm, , -54.3 dBm C2K: -27.00 dBm, , -27.00 dBm, , -27.00 dBm, , -46.00 dBm, , -13.00 dBm, , -13.00 dBm -70.13 dBm, , -70.13 dBm, , -35.00 dBm, , -13.00 dBm, , -13.00 dBm, , -13.00 dBm TD-SCDMA: -28 dBm, , -28 dBm, , -36 dBm, , -21 dBm, , -21 dBm, , -21 dBm -71.3 dBm, , -71.3 dBm, , -56.07 dBm, , -56.07 dBm, , -56.07 dBm, , -56.07 dBm 1xEVDO: -27.0dBm, , -27.00 dBm, , -27.00 dBm, , -46.00 dBm, , -13.00 dBm, , -13.00 dBm -70.13 dBm, , -70.13 dBm, , -70.13 dBm, , -70.13 dBm, , -70.13 dBm, , -70.13 dBm DTMB (CTTB): -14.0 dBm, , -14.0 dBm, , -26.0 dBm, , -13.0 dBm, , -13.0 dBm, , -13.0 dBm -13.0 dBm, , -13.0 dBm, , -13.0 dBm, , -13.0 dBm, , -13.0 dBm, , -13.0 dBm DVB-T/H: 11.2 dBm, , -29 dBm, , -41 dBm, , -66 dBm, , -82 dBm, , -82 dBm  -82 dBm, , -82 dBm, , -82 dBm, , -82 dBm, , -82 dBm ISDB-T, , CMMB, , Digital Cable TV: 50.0 dBm, , 50.0 dBm, , 50.0 dBm, , 50.0 dBm, , 50.0 dBm, , 50.0 dBm  50.0 dBm, , 50.0 dBm, , 50.0 dBm, , 50.0 dBm, , 50.0 dBm, , 50.0 dBm LTE, , LTETDD: -5.5 dBm, , -12.5 dBm, , -15.0 dBm, , -15.0 dBm, , -15.0 dBm, , -15.0 dBm -13.5 dBm, , -8.5 dBm, , -11.5 dBm, , -23.5 dBm, , -23.5 dBm, , -23.5 dBm When option N9060A-7FP is installed in these modes, , the preset value of Offset G ~ L is the same as the Offset F value. ----- WLAN: if Radio Std is 802.11a/g(OFDM/DSSS-OFDM): 16.00 dBm, , -4.00 dBm, , -12.00 dBm, , -

24.00 dBm, , -24.00 dBm, , -24.00 dBm, , -24.00 dBm, , -24.00 dBm, , -24.00 dBm, , -24.00 dBm, , -24.00 dBm  
if Radio Std is 802.11b/g(DSSS/CCK/PBCC): -10 dBm, , -30 dBm, , -30 dBm, , -30 dBm, , -30 dBm, , -30 dBm, , -30 dBm, , -30 dBm, , -30 dBm, , -30 dBm, , -30 dBm  
if Radio Std is 802.11n(20MHz) or 802.11ac(20MHz): 16.00 dBm, , -4.00 dBm, , -12.00 dBm, , -63.00 dBm, , -63.00 dBm, , -63.00 dBm, , -63.00 dBm, , -63.00 dBm, , -63.00 dBm, , -63.00 dBm, , -63.00 dBm  
if Radio Std is 802.11n(40MHz) or 802.11ac(40MHz): 16.00 dBm, , -4.00 dBm, , -12.00 dBm, , -66.00 dBm, , -66.00 dBm, , -66.00 dBm, -66.00 dBm, , -66.00 dBm, , -66.00 dBm, , -66.00 dBm, -66.00 dBm, , -66.00 dBm  
if Radio Std is 802.11ac(80MHz/160MHz): 16.00 dBm, , -4.00 dBm, , -12.00 dBm, , -69.00 dBm, , -69.00 dBm, , -69.00 dBm, , -69.00 dBm, , -69.00 dBm, , -69.00 dBm, , -69.00 dBm, , -69.00 dBm, , -69.00 dBm  
if Radio Std is 802.11ac (80 MHz + 80 MHz): -69.00 dBm, , -69.00 dBm, , -69.00 dBm, , -69.00 dBm, , -69.00 dBm, , -69.00 dBm, , -69.00 dBm, , -69.00 dBm, , -69.00 dBm, , -69.00 dBm, , -69.00 dBm, , -69.00 dBm, , -69.00 dBm  
MSR: -12.5 dBm, , -12.5 dBm, , -24.5 dBm, , -11.5 dBm, , -15.0 dBm, , -15.0 dBm, , -15.0 dBm, , -15.0 dBm, , -15.0 dBm, , -15.0 dBm, -12.5 dBm, , -12.5 dBm, , -24.5 dBm, , -11.5 dBm, , -15.0 dBm, , -15.0 dBm, , -15.0 dBm, , -15.0 dBm, , -15.0 dBm, , -15.0 dBm, , -15.0 dBm, , -15.0 dBm  
LTEAFDD, LTEATDD: -5.5 dBm, , -12.5 dBm, , -15.0 dBm, , -15.0 dBm, , -15.0 dBm, , -15.0 dBm, , -15.0 dBm, , -15.0 dBm, , -15.0 dBm, -13.5 dBm, , -8.5 dBm, , -11.5 dBm, , -23.5 dBm, , -23.5 dBm, , -23.5 dBm, , -23.5 dBm, , -23.5 dBm, , -23.5 dBm, , -23.5 dBm, , -23.5 dBm

State Saved	Saved in instrument state.
Min	-200 dBm
Max	50 dBm
Initial S/W Revision	Prior to A.02.00
Modified at S/W Revision	A.02.00, A.03.00, A.10.00, A.11.00, A.14.00

### Abs Stop

Sets the absolute power level limit at the stop frequency for the selected offset. The absolute power level limit ranges from -200 to +50 dBm. You can also toggle this function between couple and manual. If set to Couple, the Abs Stop power level limit is coupled to Abs Start to result in a flat limit line. If set to Man, Abs Start and Abs Stop take different values to result in a sloped limit line.

The SCPI query returns values currently set to the offset stop absolute power limits.

Missing values are not permitted; that is, if you want to change values 2 and 6, you must send all values up to 6. Subsequent values will remain as they were. The query for this parameter always returns 12 values.

Key Path	Meas Setup, Offset/Limits, Limits
Mode	SA, WCDMA, C2K, WIMAX OFDMA, TD-SCDMA, 1xEVDO, DTMB (CTTB), DVB-T/H, ISDB-T, CMMB, LTE, LTE-TDD, Digital Cable TV, WLAN, MSR, LTEAFDD, LTEATDD

<b>Remote Command</b>	<pre>[ :SENSe ] :SEMAsk:OFFSet [ 1 ]   2 [ :OUTer ] :LIST:STOP:ABSolute &lt;real&gt;, ... [ :SENSe ] :SEMAsk:OFFSet [ 1 ]   2 [ :OUTer ] :LIST:STOP:ABSolute? [ :SENSe ] :SEMAsk:OFFSet [ 1 ]   2 [ :OUTer ] :LIST:STOP:ABSolute:COUPle ON   OFF   1   0, ... [ :SENSe ] :SEMAsk:OFFSet [ 1 ]   2 [ :OUTer ] :LIST:STOP:ABSolute:COUPle?</pre>
<b>Example</b>	<pre>SEM:OFFS:LIST:STOP:ABS -12.50 dBm, , -24.50 dBm, , -24.50 dBm, , -11.50 dBm, , -11.50 dBm, , -11.50 dBm SEM:OFFS1:LIST:STOP:ABS? SEM:OFFS:LIST:STOP:ABS:COUP ON, , OFF, , ON, , ON, , ON, , ON SEM:OFFS:LIST:STOP:ABS:COUP?</pre>
<b>Notes</b>	<p>Comma separated list of values.  OFFSet1 is for BTS, 2 for MS. Default is BTS.  You must be in the mode that includes SEM measurement to use this command. Use  :INSTrument:SElect to set the mode.</p>
<b>Couplings</b>	<p>Coupled to Abs Start if "Auto" is selected, that is, the Stop value is equal to the Start value.  If the current mode is DVB-T/H, this value will be modified automatically according to the limit type  and the output power of the transmitter which is less or more than 25W.  If the current mode is ISDB-T, this value will be modified automatically according to the limit type.</p>
<b>Preset</b>	<p>For modes (except MSR, , LTEAFDD, , LTEATDD and WLAN) without option N9060A-7FP, , the  preset value is as follows.</p> <pre>SA, , WIMAX OFDMA: -14.00 dBm, , -26.00 dBm, , -26.00 dBm, , -13.00 dBm, , -13.00 dBm, , - 13.00 dBm WCDMA: -12.50 dBm, , -24.50 dBm, , -24.50 dBm, , -11.50 dBm, , -11.50 dBm, , -11.50 dBm - 69.6 dBm, , -54.3 dBm, , -54.3 dBm, , -54.3 dBm, , -54.3 dBm, , -54.3 dBm C2K: -27.00 dBm, , -27.00 dBm, , -27.00 dBm, , -46.00 dBm, , -13.00 dBm, , -13.00 dBm - 70.13 dBm, , -70.13 dBm, , -35.00 dBm, , -13.00 dBm, , -13.00 dBm, , -13.00 dBm TD-SCDMA: -28 dBm, , -36 dBm, , -36 dBm, , -21 dBm, , -21 dBm, , -21 dBm -71.3 dBm, , -71.3 dBm, , -56.07 dBm, , -56.07 dBm, , -56.07 dBm, , -56.07 dBm 1xEVDO: -27dBm, , -27.00 dBm, , -27.00 dBm, , -46.00 dBm, , -13.00 dBm, , -13.00 dBm - 70.13 dBm, , -70.13 dBm, , -70.13 dBm, , -70.13 dBm, , -70.13 dBm, , -70.13 dBm DTMB (CTTB): -14.0 dBm, , -26.0 dBm, , -26.0 dBm, , -13.0 dBm, , -13.0 dBm, , -13.0 dBm  - 13.0 dBm, , -13.0 dBm, , -13.0 dBm, , -13.0 dBm, , -13.0 dBm, , -13.0 dBm DVB-T/H: -29 dBm, , -41 dBm, , -66 dBm, , -82 dBm, , -82 dBm, , -82 dBm  -82 dBm, , -82 dBm, , -82 dBm, , -82 dBm, , -82 dBm, , -82 dBm, ISDB-TCMMB, , Digital Cable TV: 50.0 dBm, , 50.0 dBm, , 50.0 dBm, , 50.0 dBm, , 50.0 dBm  50.0 dBm, , 50.0 dBm, , 50.0 dBm, , 50.0 dBm, , 50.0 dBm, , 50.0 dBm LTE, , LTETDD:-12.5 dBm, , -12.5 dBm, , -15.0 dBm, , -15.0 dBm, , -15.0 dBm, , -15.0 dBm - 13.5 dBm, , -8.5 dBm, , -11.5 dBm, , -23.5 dBm, , -23.5 dBm, , -23.5 dBm When option N9060A-7FP is installed in these modes, , the preset value of Offset G ~ L is the same as the Offset F value. ----- WLAN:</pre>



---

if Radio Std is 802.11a/g(OFDM/DSSS-OFDM): -4.00 dBm, , -12.00 dBm, , -24.00 dBm, , -24.00 dBm, , -24.00 dBm, , -24.00 dBm, , -24.00 dBm, , -24.00 dBm, , -24.00 dBm, , -24.00 dBm

if Radio Std is 802.11b/g(DSSS/CCK/PBCC): -10 dBm, , -30 dBm, , -30 dBm, , -30 dBm, , -30 dBm, , -30 dBm, , -30 dBm, , -30 dBm, , -30 dBm, , -30 dBm

if Radio Std is 802.11n(20MHz) or 802.11ac(20MHz): -4.00 dBm, , -12.00 dBm, , -24.00 dBm, , -63.00 dBm, , -63.00 dBm, , -63.00 dBm, , -63.00 dBm, , -63.00 dBm, , -63.00 dBm, , -63.00 dBm

if Radio Std is 802.11n(40MHz) or 802.11ac(40MHz): -4.00 dBm, , -12.00 dBm, , -24.00 dBm, , -66.00 dBm, , -66.00 dBm, , -66.00 dBm, , -66.00 dBm, , -66.00 dBm, , -66.00 dBm, , -66.00 dBm

if Radio Std is 802.11ac(80MHz/160MHz): -4.00 dBm, , -12.00 dBm, , -24.00 dBm, , -69.00 dBm, , -69.00 dBm, , -69.00 dBm, , -69.00 dBm, , -69.00 dBm, , -69.00 dBm, , -69.00 dBm

if Radio Std is 802.11ac (80 + 80 MHz): -69.00 dBm, , -69.00 dBm, , -69.00 dBm, , -69.00 dBm, , -69.00 dBm, , -69.00 dBm, , -69.00 dBm, , -69.00 dBm, , -69.00 dBm, , -69.00 dBm

MSR:-12.5 dBm, , -24.5 dBm, , -11.5 dBm, , -15.0 dBm, , -15.0 dBm, , -15.0 dBm, , -15.0 dBm, , -15.0 dBm, , -15.0 dBm, , -15.0 dBm| -12.5 dBm, , -24.5 dBm, , -11.5 dBm, , -15.0 dBm, , -15.0 dBm, , -15.0 dBm, , -15.0 dBm, , -15.0 dBm, , -15.0 dBm, , -15.0 dBm, , -15.0 dBm

LTEAFDD, , LTEATDD:-12.5 dBm, , -12.5 dBm, , -15.0 dBm, , -15.0 dBm, , -15.0 dBm, , -15.0 dBm, , -15.0 dBm, , -15.0 dBm, , -15.0 dBm, , -15.0 dBm| -13.5 dBm, , -8.5 dBm, , -11.5 dBm, , -23.5 dBm, , -23.5 dBm, , -23.5 dBm, , -23.5 dBm, , -23.5 dBm, , -23.5 dBm

For modes (except MSR, , LTEAFDD, , LTEATDD and WLAN) without option N9060A-7FP, , the preset value is as follows.

SA,WIMAX OFDMA: ON, OFF, ON, ON, ON, ON

WCDMA: ON, , OFF, , ON, , ON, , ON, , ON|ON, , ON, , ON, , ON, , ON

C2K: ON, , ON, , ON, , ON, , OFF|ON, , ON, , ON, , ON, , OFF

TD-SCDMA: ON, , OFF, , ON, , ON, , ON, , ON|ON, , ON, , ON, , ON, , ON

1xEVDO: ON, , ON, , ON, , ON, , ON, , OFF|ON, , ON, , ON, , ON, , ON, , OFF

DTMB (CTTB): ON, OFF, ON, ON, ON, ON

DVB-T/H, , ISDB-T, , CMMB, , Digital Cable TV: OFF, , OFF, , OFF, , OFF, , OFF, , OFF

LTE, , LTEATDD: OFF, , ON, , ON, , ON, , ON, , ON|ON, , ON, , ON, , ON, , ON

When option N9060A-7FP is installed in these modes, , the preset value of Offset G ~ L is the same as the Offset F value.

-----

WLAN:

if Radio Std is 802.11a/g(OFDM/DSSS-OFDM)/802.11n(20MHz/40MHz)/802.11 ac (20MHz/40MHz/80MHz/160MHz): OFF, , OFF, , OFF, , ON, , ON, , ON, , ON, , ON, , ON, , ON, , ON

if Radio Std is 802.11 ac(80+80 MHz): ON, , ON, , ON, , ON, , ON, , ON, , ON, , ON, , ON, , ON, , ON, , ON

if Radio Std is 802.11b/g(DSSS/CCK/PBCC): ON, , ON, , ON, , ON, , ON, , ON, , ON, , ON, , ON, , ON, , ON

---

---

	, ON, , ON MSR: ON, , OFF, , OFF, , OFF, , ON, , OFF, , OFF, , OFF, , OFF, , OFF, , OFF ON, , OFF, , OFF, , OFF, , ON, , OFF, , OFF, , OFF, , OFF, , OFF, , OFF, , OFF, , OFF, , OFF LTEAFDD, , LTEATDD: OFF, , ON, , ON, , ON, , ON, , ON, , ON, , ON, , ON, , ON, , ON ON, , ON, , ON, , ON, , ON, , ON, , ON, , ON, , ON, , ON, , ON, , ON
State Saved	Saved in instrument state.
Min	-200 dBm
Max	50 dBm
Initial S/W Revision	Prior to A.02.00
Modified at S/W Revision	A.02.00, A.03.00, A.10.00, A.11.00, A.14.00

---

### Rel Start

Sets a relative power level limit at the start frequency for the selected offset. The relative power level limit ranges from -200 to +50 dBc.

The fail condition is set remotely by [:SENSE]:SEMask:OFFSet[n][:OUTer]:LIST:TEST for each offset channel test.

You can turn off (not use) specific offset channels remotely with [:SENSE]:SEMask:OFFSet[n][:OUTer]:LIST:STATe.

The SCPI query returns values currently set to the relative power test limits.

Missing values are not permitted; that is, if you want to change values 2 and 6, you must send all values up to 6. Subsequent values will remain as they were. The query for this parameter always returns 12 values.

---

Key Path	Meas Setup, Offset/Limits, Limits
Mode	SA, WCDMA, C2K, WIMAX OFDMA, TD-SCDMA, 1xEVDO, DTMB (CTTB), DVB-T/H, ISDB-T, CMMB, LTE, LTE-TDD, Digital Cable TV, WLAN, MSR, LTEAFDD, LTEATDD
Remote Command	[:SENSE]:SEMask:OFFSet[1] 2[:OUTer]:LIST:STARt:RCARrier <rel_ampl>, ... [:SENSE]:SEMask:OFFSet[1] 2[:OUTer]:LIST:STARt:RCARrier?
Example	SEM:OFFS:LIST:STAR:RCAR -30, , -30, , -30, , -30, , -30, , -30 SEM:OFFS:LIST:STAR:RCAR?

---

### Notes

Comma separated list of values.

OFFSet1 is for BTS, 2 for MS. Default is BTS.

You must be in the mode that includes SEM measurement to use this command. Use :INSTrument:SElect to set the mode.

### Couplings

If the current mode is DVB-T/H, this value will be modified automatically according to the limit type the output power of the transmitter which is less or more than 25W.

If the current mode is ISDB-T, this value will be modified automatically according to the limit type.

If the current mode is WLAN and radio std is 802.11n, Rel Start limits will be set to following values

when frequency changed to above 5GHz:

0 dB, -20.00 dB, -28.00 dB, -40.00 dB, -40.00 dB, -40.00 dB, -40.00 dB, -40.00 dB, -40.00 dB, -40.00 dB, -40.00 dB, -40.00 dB

Preset

For modes (except MSR, LTEAFDD, LTEATDD and WLAN) without option N9060A-7FP, the preset value is as follows.

SA: -30.00 dB, -30.00 dB, -30.00 dB, -30.00 dB, -30.00 dB, -30.00 dB

WCDMA: -30.00 dB, -30.00 dB, -30.00 dB, -30.00 dB, -30.00 dB, -30.00 dB, -30.00 dB, -30.00 dB, -33.73 dB, -34.00 dB, -37.50 dB, -47.50 dB, -47.50 dB, -47.50 dB

C2K: -45.00 dB, -45.00 dB, -55.00 dB, -55.00 dB, -55.00 dB, -55.00 dB, -55.00 dB, -55.00 dB, -42.00 dB, -54.00 dB, -54.00 dB, -54.00 dB, -54.00 dB, -54.00 dB

WIMAX OFDMA: 0 dB, -25 dB, -32 dB, -50 dB, -50 dB, -50 dB

TD-SCDMA: -54.00 dB, -54.00 dB, -62.00 dB, -47.00 dB, -47.00 dB, -47.00 dB, -47.00 dB, -47.00 dB, -49.00 dB, -44.00 dB, -44.00 dB, -44.00 dB, -44.00 dB, -44.00 dB

1xEVDO: -45dBc, -45.00 dB, -55.00 dB, -55.00 dB, -55.00 dB, -55.00 dB, -55.00 dB, -55.00 dB, -42dBc, -54.00 dB, -54.00 dB, -54.00 dB, -54.00 dB, -54.00 dB

DTMB (CTTB): -32.8 dB, -83 dB, -95 dB, -120 dB, -120 dB, -120 dB, -120 dB, -120 dB, -120 dB, -120 dB, -120 dB, -120 dB, -120 dB, -120 dB, -120 dB

DVB-T/H: -30 dB, -30 dB, -30 dB, -30 dB, -30 dB, -30 dB, -30 dB, -30 dB, -30 dB, -30 dB, -30 dB, -30 dB, -30 dB, -30 dB, -30 dB

ISDB-T: -27.4 dB, -47.4 dB, -54.4 dB, XXX, 50 dB, 50 dB, 50 dB, 50 dB, 50 dB, 50 dB, 50 dB, 50 dB, 50 dB, 50 dB, 50 dB; XXX is coupled with the total power reference, it is -57.4 dB when  $P \leq 0.025 W$ , -67.4 dB when  $P = 0.25 W$ ,  $-(73.4 + 10 \log P)$  dB when  $0.25 W < P < 2.5 W$  or  $0.025 W < P < 0.25 W$ , -77.4 dB when  $P > 2.5 W$ .

CMMB: -37 dB, -72 dB, -84 dB, -90 dB, -90 dB, -90 dB, -90 dB, -90 dB, -90 dB, -90 dB, -90 dB, -90 dB, -90 dB, -90 dB, -90 dB

LTE, LTEATDD: 0 dB, 0 dB, 0 dB, 0 dB, 0 dB, 0 dB, 0 dB, 0 dB, 0 dB, 0 dB, 0 dB, 0 dB, 0 dB, 0 dB, 0 dB

Digital Cable TV: 0 dB, 0 dB, 0 dB, 0 dB, 0 dB, 0 dB, 0 dB, 0 dB, 0 dB, 0 dB, 0 dB, 0 dB, 0 dB, 0 dB, 0 dB

When option N9060A-7FP is installed in these modes, the preset value of Offset G ~ L is the same as the Offset F value.

-----

WLAN:

if Radio Std is 802.11a/g(OFDM/DSSS-OFDM): 0 dB, -20.00 dB, -28.00 dB, -40.00 dB, -40.00 dB, -47.00 dB, -47.00 dB, -47.00 dB, -47.00 dB, -47.00 dB, -47.00 dB, -47.00 dB, -47.00 dB, -47.00 dB, -47.00 dB

if Radio Std is 802.11b/g(DSSS/CCK/PBCC): -30 dB, -50 dB, -50 dB, -50 dB, -50 dB, -50 dB, -50 dB, -50 dB, -50 dB, -50 dB, -50 dB, -50 dB, -50 dB, -50 dB, -50 dB

if Radio Std is 802.11n(20MHz/40MHz): 0 dB, -20.00 dB, -28.00 dB, -45.00 dB, -45.00 dB, -45.00 dB, -45.00 dB, -45.00 dB, -45.00 dB, -45.00 dB, -45.00 dB, -45.00 dB, -45.00 dB, -45.00 dB, -45.00 dB

if Radio Std is 802.11ac (20 MHz/ 40 MHz/ 80 MHz/ 160 MHz): 0 dB, -20.00 dB, -28.00 dB, -40.00 dB, -40.00 dB, -40.00 dB, -40.00 dB, -40.00 dB, -40.00 dB, -40.00 dB, -40.00 dB, -40.00 dB, -40.00 dB, -40.00 dB, -40.00 dB

if Radio Std is 802.11ac(80 MHz + 80MHz): -40.00 dB, -28.00 dB, -20 dB, 0 dB, -20 dB, -28 dB, -40 dB, -40 dB, -40.00 dB, -40.00 dB, -40.00 dB, -40.00 dB, -40.00 dB, -40.00 dB, -40.00 dB

MSR, LTEAFDD, LTEATDD: 0 dB, 0 dB, 0 dB, 0 dB, 0 dB, 0 dB, 0 dB, 0 dB, 0 dB, 0 dB, 0 dB, 0 dB, 0 dB, 0 dB, 0 dB

	0 dB, , 0 dB 0 dB, , 0 dB, , 0 dB, , 0 dB, , 0 dB, , 0 dB, , 0 dB, , 0 dB, , 0 dB, , 0 dB, , 0 dB
State Saved	Saved in instrument state.
Min	-200 dB
Max	50 dB
Initial S/W Revision	Prior to A.02.00
Modified at S/W Revision	A.02.00, A.03.00, A.10.00, A.11.00, A.14.00

### Rel Stop

Sets a relative power level limit at the stop frequency for the selected offset. The relative power level limit ranges from -200 to +50 dBc.

The fail condition is set remotely by [:SENSe]:SEMask:OFFSet[n][:OUTer]:LIST:TEST for each offset channel.

You can turn off (not use) specific offset channels remotely with [:SENSe]:SEMask:OFFSet[n][:OUTer]:LIST:STATe.

The SCPI query returns values currently set to the offset stop relative power limits.

Missing values are not permitted; that is, if you want to change values 2 and 6, you must send all values up to 6. Subsequent values will remain as they were. The query for this parameter always returns 12 values.

Key Path	Meas Setup, Offset/Limits, Limits
Mode	SA, WCDMA, C2K, WIMAX OFDMA, TD-SCDMA, 1xEVDO, DTMB (CTTB), DVB-T/H, ISDB-T, CMMB, LTE, LTE-TDD, Digital Cable TV, WLAN, MSR, LTEAFDD, LTEATDD
Remote Command	[:SENSe]:SEMask:OFFSet[1] 2[:OUTer]:LIST:STOP:RCARrier <rel_ampl>, ... [:SENSe]:SEMask:OFFSet[1] 2[:OUTer]:LIST:STOP:RCARrier? [:SENSe]:SEMask:OFFSet[1] 2[:OUTer]:LIST:STOP:RCARrier:COUPle ON   OFF   1   0, ... [:SENSe]:SEMask:OFFSet[1] 2[:OUTer]:LIST:STOP:RCARrier:COUPle?
Example	SEM:OFFS:LIST:STOP:RCAR -30, , -30, , -30, , -30, , -30, , -30 SEM:OFFS:LIST:STOP:RCAR? SEM:OFFS:LIST:STOP:RCAR:COUP ON, , ON, , ON, , ON, , ON SEM:OFFS:LIST:STOP:RCAR:COUP?
Notes	Comma separated list of values. OFFSet1 is for BTS, 2 for MS. Default is BTS. You must be in the mode that includes SEM measurement to use this command. Use :INSTrument:SElect to set the mode.
Couplings	Coupled to Rel Start if "Auto" is selected, that is, Start is made the same as Stop. If the current mode is DVB-T/H, this value will be modified automatically according to the limit type and the output power of the transmitter which is less or more than 25W. If the current mode is ISDB-T, this value will be modified automatically according to the limit type.

If the current mode is WLAN and radio std is 802.11n, Rel Stop limits will be set to following values when frequency changed to above 5GHz:

-20.00 dB, -28.00 dB, -40.00 dB, -40.00 dB, -40.00 dB, -40.00 dB, -40.00 dB, -40.00 dB, -40.00 dB, -40.00 dB, -40.00 dB, -40.00 dB

Preset

For modes (except MSR, , LTEAFDD, , LTEATDD and WLAN) without option N9060A-7FP, , the preset value is as follows.

SA: -30.00 dB, , -30.00 dB, , -30.00 dB, , -30.00 dB, , -30.00 dB, , -30.00 dB

WCDMA: -30.00 dB, , -30.00 dB, , -30.00 dB, , -30.00 dB, , -30.00 dB, , -30.00 dB|-48.28 dB, , -37.50 dB, , -47.50 dB, , -47.50 dB, , -47.50 dB, , -47.50 dB

C2K: -45.00 dB, , -45.00 dB, , -55.00 dB, , -55.00 dB, , -55.00 dB, , -55.00 dB|-42.00 dB, , -54.00 dB, , -54.00 dB, , -54.00 dB, , -54.00 dB, , -54.00 dB

WIMAX OFDMA: -25 dB, , -32 dB, , -50 dB, , -50 dB, , -50 dB, , -50 dB

TD-SCDMA: -54.00 dB, , -62.00 dB, , -62.00 dB, , -47.00 dB, , -47.00 dB, , -47.00 dB|-49.00 dB, , -58.945 dB, , -44.00 dB, , -44.00 dB, , -44.00 dB, , -44.00 dB

1xEVDO: -45dB, , -45.00 dB, , -55.00 dB, , -55.00 dB, , -55.00 dB, , -55.00 dB|-42dB, , -54.00 dB, , -54.00 dB, , -54.00 dB, , -54.00 dB, , -54.00 dB

DTMB (CTTB): -83 dB, , -95 dB, , -120 dB, , -120 dB, , -120 dB, , -120 dB|-120 dB, , -120 dB, , -120 dB, , -120 dB, , -120 dB, , -120 dB

DVB-T/H: -73 dB, , -85 dB, , -110 dB, , -126 dB, , -126 dB, , -126 dB|-126 dB, , -126 dB, , -126 dB, , -126 dB, , -126 dB, , -126 dB

ISDB-T: -47.4 dB, , -54.4 dB, , XXX, , 50 dB, , 50 dB, , 50 dB |50 dB, , 50 dB, , 50 dB, , 50 dB, , 50 dB, , 50 dB; XXX is coupled with the total power reference P, it is -57.4 dB when  $P \leq 0.025$  W, , -67.4 dB when  $P = 0.25$  W, ,  $-(73.4 + 10 \log P)$  dB when  $0.25$  W  $< P \leq 2.5$  W or  $0.025$  W  $< P < 0.25$  W, , -77.4 dB when  $P > 2.5$  W.

CMMB: -72 dB, , -84 dB, , -90 dB, , -90 dB, , -90 dB, , -90 dB|-90 dB, , -90 dB, , -90 dB, , -90 dB, , -90 dB, , -90 dB

LTE, , LTETDD: 0 dB, , 0 dB, , 0 dB, , 0 dB, , 0 dB, , 0 dB

Digital Cable TV: 0 dB, , 0 dB, , 0 dB, , 0 dB, , 0 dB, , 0 dB |0 dB, , 0 dB, , 0 dB, , 0 dB, , 0 dB, , 0 dB

When option N9060A-7FP is installed in these modes, , the preset value of Offset G ~ L is the same as the Offset F value.

-----

WLAN:

if Radio Std is 802.11a/g(OFDM/DSSS-OFDM): -20.00 dB, , -28.00 dB, , -40.00 dB, , -40.00 dB, , -47.00 dB, , -47.00 dB, , -47.00 dB, , -47.00 dB, , -47.00 dB, , -47.00 dB, , -47.00 dB, , -47.00 dB

if Radio Std is 802.11b/g(DSSS/CCK/PBCC): -30 dB, , -50 dB, , -50 dB, , -50 dB, , -50 dB, , -50 dB, , -50 dB, , -50 dB, , -50 dB, , -50 dB, , -50 dB

if Radio Std is 802.11n(20MHz/40MHz): -20.00 dB, , -28.00 dB, , -45.00 dB, , -45.00 dB, , -45.00 dB, , -45.00 dB, , -45.00 dB, , -45.00 dB, , -45.00 dB, , -45.00 dB, , -45.00 dB

if Radio Std is 802.11ac (20 MHz/ 40 MHz/ 80 MHz/ 160 MHz): -20.00 dB, , -28.00 dB, , -40.00 dB, , -40.00 dB, , -40.00 dB, , -40.00 dB, , -40.00 dB, , -40.00 dB, , -40.00 dB, , -40.00 dB, , -40.00 dB, , -40.00 dB

if Radio Std is 802.11ac(80 MHz + 80MHz): -28.00 dB, , -20.00 dB, , 0 dB, , -20.00 dB, , -28.00



- OR checks against both limits, failing if either of the limits is broken.
- AND will only display a fail if both of the limits are broken.

The absolute or relative power limit value for each offset channel can be set remotely with [:SENSe]:SEMask:OFFSet[n][:OUTer]:LIST:ABSolute or [:SENSe]:SEMask:OFFSet[n][:OUTer]:LIST:RCARrier.

You can turn off (not use) specific offset channels remotely with [:SENSe]:SEMask:OFFSet[n][:OUTer]:LIST:STATe.

Missing values are not permitted; that is, if you want to change values 2 and 6, you must send all values up to 6. Subsequent values will remain as they were. The query for this parameter always returns 12 values.

Key Path	Meas Setup, Offset/Limits, Limits
Mode	SA, WCDMA, C2K, WIMAX OFDMA, TD-SCDMA, 1xEVDO, DTMB (CTTB), DVB-T/H, ISDB-T, CMMB, LTE, LTE-TDD, Digital Cable TV, WLAN, MSR, LTEAFDD, LTEATDD
Remote Command	[:SENSe]:SEMask:OFFSet[1] 2[:OUTer]:LIST:TEST ABSolute   AND   OR   RELative, ... [:SENSe]:SEMask:OFFSet[1] 2[:OUTer]:LIST:TEST?
Example	SEM:OFFS:LIST:TEST ABS, , ABS, , ABS, , ABS, , ABS SEM:OFFS:LIST:TEST?
Notes	Comma separated list of values. You must be in the mode that includes SEM measurement to use this command. Use :INSTrument:SElect to set the mode.
Couplings	None If the current mode is DVB-T/H, this value will be modified automatically according to the limit type and the output power of the transmitter which is less or more than 25W.
Preset	For modes (except MSR, LTEAFDD, , LTEATDD and WLAN) without option N9060A-7FP, , the preset value is as follows. SA: ABS, ABS, ABS, ABS, ABS, ABS WCDMA: ABS, , ABS, , ABS, , ABS, , ABS AND, , AND, , AND, , AND, , AND C2K: REL, , REL, , REL, , ABS, , REL, , REL AND, , AND, , ABS, , REL, , REL, , REL WIMAX OFDMA: REL, , REL, , REL, , REL, , REL REL, , REL, , REL, , REL, , REL TD-SCDMA: ABS, , ABS, , ABS, , ABS, , ABS AND, , AND, , AND, , AND, , AND, , AND 1xEVDO: REL, , REL, , REL, , ABS, , REL, , REL AND, , AND, , AND, , OR, , AND, , AND DTMB (CTTB), ISDB-T, , CMMB: REL, , REL, , REL, , REL, , REL   REL, , REL, , REL, , REL, , REL, , REL DVB-T/H: ABS, , ABS, , ABS, , ABS, , ABS   ABS, , ABS, , ABS, , ABS, , ABS LTE, , LTDTDD: ABS, , ABS, , ABS, , ABS, , ABS Digital Cable TV: REL, , REL, , REL, , REL, , REL   REL, , REL, , REL, , REL, , REL When option N9060A-7FP is installed in these modes, , the preset value of Offset G ~ L is the same as the Offset F value. ----- WLAN:

	if Radio Std is 802.11a/g(OFDM/DSSS-OFDM) or 802.11b/g(DSSS/CCK/PBCC): REL, , REL, , REL, , REL, , REL, , REL, , REL, , REL, , REL, , REL, , REL
	if Radio Std is 802.11n(20MHz/40MHz): REL, , REL, , REL, , AND, , AND, , AND, , AND, , AND, , AND, , AND, , AND
	if Radio Std is 802.11ac (20 MHz/ 40 MHz/ 80 MHz/ 160 MHz): REL, , REL, , REL, , AND, , AND, , AND, , AND, , AND, , AND, , AND, , AND, , AND
	if Radio Std is 802.11ac (80 MHz + 80MHz): REL, , REL, , REL, , REL, , REL, , REL, , AND, , AND, , AND, , AND, , AND, , AND
	MSR, , LTEAFDD, , LTEATDD: ABS, , ABS, , ABS, , ABS, , ABS, , ABS, , ABS, , ABS, , ABS, , ABS, , ABS
State Saved	Saved in instrument state.
Range	Absolute Relative Abs AND Rel Abs OR Rel
Initial S/W Revision	Prior to A.02.00
Modified at S/W Revision	A.02.00, A.03.00, A.10.00, A.11.00, A.14.00

## Offset Freq Define

This key enables you to select “Offset” definition. Each standard defines each “Offset” from Carrier.

Meas BW Edge means the edge of resolution band width that is represented by Meas BW and Res BW settings. Actual center frequency of Meas BW and the limit line have ½ Meas BW offset when the Meas BW Edge is selected.

3GPP2 requires the “Carrier Center to Meas BW Edge” definition. LTE conformance test requires “Carrier Edge to Meas BW Center” and/or “Carrier Edge to Meas BW Edge” definition

- **CTOCenter** – From carrier center to the center of offset measuring filter\*
- **CTOEdge** – From carrier center to the nominal –3 dB point of the offset measuring filter\* closer to the carrier
- **ETOCenter** – From Center Frequency – Span of Ref Channel / 2 (for lower offset), Center Frequency + Span of Ref Channel / 2 (for upper offset) of the carrier closest to each offset to the center of offset measuring filter\*
- **ETOEdge** – From Center Frequency – Span of Ref Channel / 2 (for lower offset), Center Frequency + Span of Ref Channel / 2 (for upper offset) of the carrier closest to each offset to the nominal –3 dB point of the offset measuring filter\* closer to the carrier

\*Measuring filter = Meas BW (N) x Res BW



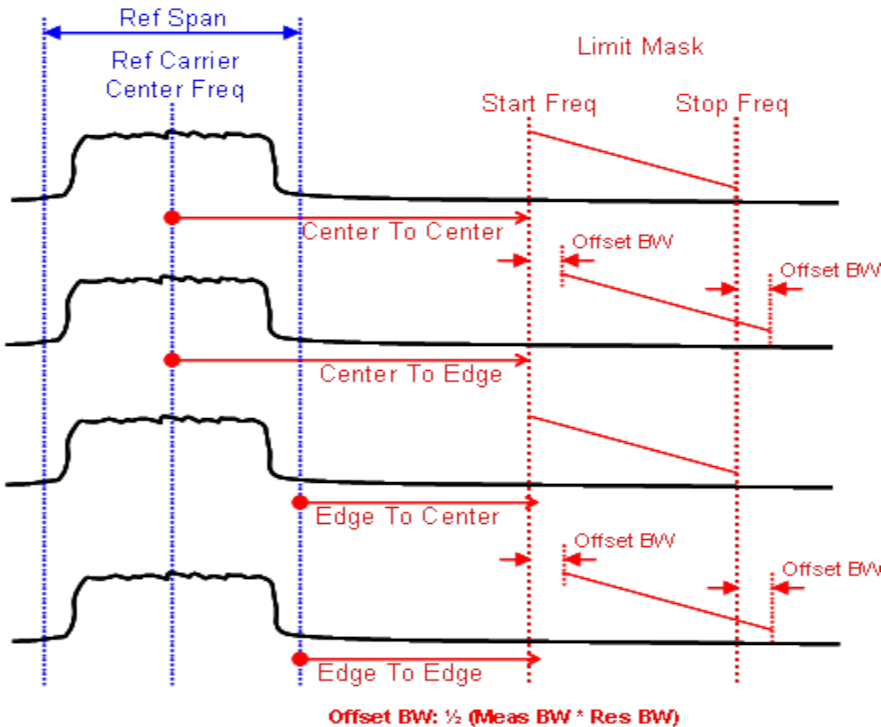
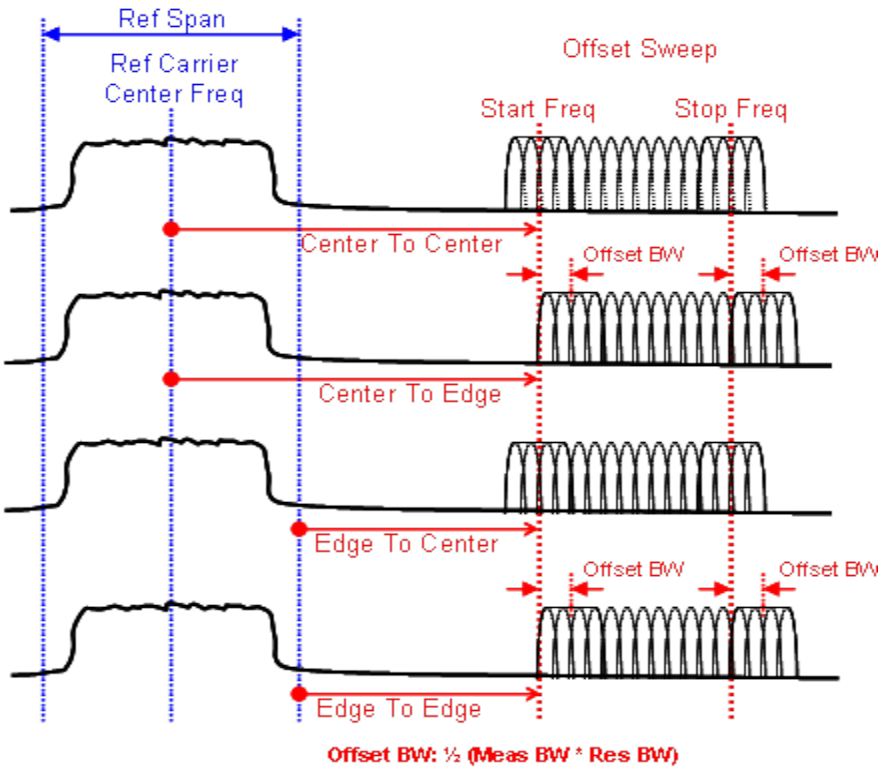

Key Path	Meas Setup, Offset/Limits
Mode	SA, WCDMA, C2K, WIMAX OFDMA, TD-SCDMA, 1xEVDO, DVB-T/H, DTMB (CTTB), ISDB-T, CMMB, LTE, LTETDD, Digital Cable TV, WLAN
Remote Command	[ :SENSe ] :SEMAsk:OFFSet [ 1 ]   2 :TYPE CTOCenter   CTOEdge   ETOCenter   ETOEdge [ :SENSe ] :SEMAsk:OFFSet [ 1 ]   2 :TYPE?
Example	SEM:OFFS:TYPE ETOC SEM:OFFS:TYPE?
Notes	You must be in the mode that includes SEM measurements to use this command. Use :INSTrument:SElect to set the mode. For the MSR and LTE-Advanced FDD/TDD mode, see <a href="#">Offset Freq Define (Only for MSR and LTE-Advanced FDD/TDD)</a> .
Preset	SA, , WCDMA, , WIMAX OFDMA, , TD-SCDMA, , DVB-T/H, , DTMB (CTTB), , ISDB-T, , CMMB, , Digital Cable TV: CTOC C2K: CTOE 1xEVDO: CTOE LTE: ETOC LTETDD: ETOC
State Saved	Saved in instrument state.
Range	Carrier Center To Meas BW Center Carrier Center To Meas BW Edge Carrier Edge To Meas BW Center Carrier Edge To Meas BW Edge
Initial S/W Revision	A.03.00

## Meas Preset

Restores all the measurement parameters to their default values.

Key Path	Meas Setup
Mode	SA, WCDMA, C2K, WIMAX OFDMA, TD-SCDMA, 1xEVDO, DTMB (CTTB), DVB-T/H, ISDB-T, CMMB, LTE, LTETDD, Digital Cable TV, WLAN, MSR, LTEAFDD, LTEATDD
Remote Command	:CONFigure:SEMAsk
Example	CONF:SEM
Notes	You must be in the mode that includes SEM measurement to use this command. Use :INSTrument:SElect to set the mode.
Couplings	Selecting Meas Preset will restore all measurement parameters to their default values.
Initial S/W Revision	Prior to A.02.00
Modified at S/W Revision	A.02.00, A.03.00

Mode

See "Mode" on page 318

## Mode Preset

Returns the active mode to a known state.

Mode Preset does the following for the currently active mode:

- Aborts the currently running measurement.
- Brings up the default menu for the mode, with no active function.
- Sets measurement Global settings to their preset values for the active mode only.
- Activates the default measurement.
- Brings up the default menu for the mode.
- Clears the input and output buffers.
- Sets Status Byte to 0.

Mode Preset does not:

- Cause a mode switch
- Affect mode persistent settings
- Affect system settings

See "[How-To Preset](#)" on page 1289 for more information.

<b>Key Path</b>	Front-panel key
<b>Remote Command</b>	:SYSTem:PRESet
<b>Example</b>	:SYST:PRES
<b>Notes</b>	*RST is preferred over :SYST:PRES for remote operation. *RST does a Mode Preset, as done by the :SYST:PRES command, and it sets the measurement mode to Single measurement rather than Continuous for optimal remote control throughput. Clears all pending OPC bits. The Status Byte is set to 0.
<b>Couplings</b>	A Mode Preset aborts the currently running measurement, activates the default measurement, and gets the mode to a consistent state with all of the default couplings set.
<b>Backwards Compatibility Notes</b>	In the X-Series, the legacy "Factory Preset" has been replaced with Mode Preset, which only presets the currently active mode, not the entire instrument. In the X-Series, the way to preset the entire instrument is by using System, Restore System Defaults All, which behaves essentially the same way as restore System Defaults does on ESA and PSA. There is also no "Preset Type" as there is on the PSA. There is a green Mode Preset front-panel key that does a Mode Preset and a white-with-green-letters User Preset front-panel key that does a User Preset. The old PRESet:TYPE command is ignored (without generating an error), and SYST:PRES without a parameter does a Mode Preset, which should cover most backward code compatibility issues. The settings and correction data under the Input/Output front-panel key (examples: Input Z Corr, Ext Amp Gain, etc.) are no longer part of any Mode, so they will not be preset by a Mode Preset. They are preset using Restore Input/Output Defaults, Restore System Defaults All. Note that because User Preset does a Recall State, and all of these settings are saved in State, they ARE recalled when using

	User Preset.
Initial S/W Revision	Prior to A.02.00

## How-To Preset

The table below shows all possible presets, their corresponding SCPI commands and front-panel access (key paths). Instrument settings depend on the current measurement context. Some settings are local to the current measurement, some are global (common) across all the measurements in the current mode, and some are global to all the available modes. In a similar way, restoring the settings to their preset state can be done within the different contexts.

Auto Couple - is a measurement local key. It sets all Auto/Man parameter couplings in the measurement to Auto. Any Auto/Man selection that is local to other measurements in the mode will not be affected.

Meas Preset - is a measurement local key. Meas Preset resets all the variables local to the current measurement except the persistent ones.

Mode Preset - resets all the current mode's measurement local and measurement global variables except the persistent ones.

Restore Mode Defaults - resets ALL the Mode variables (and all the Meas global and Meas local variables), including the persistent ones.

Type Of Preset	SCPI Command	Front Panel Access
Auto Couple	:COUPlE ALL	Auto Couple front-panel key
Meas Preset	:CONFIgure:<Measurement>	Meas Setup Menu
Mode Preset	:SYSTem:PRESet	Mode Preset (green key)
Restore Mode Defaults	:INSTrument:DEFault	Mode Setup Menu
Restore All Mode Defaults	:SYSTem:DEFault MODEs	System Menu; Restore System Default Menu
*RST	*RST	not possible (Mode Preset with Single)
Restore Input/Output Defaults	:SYSTem:DEFault INPut	System Menu; Restore System Default Menu
Restore Power On Defaults	:SYSTem:DEFault PON	System Menu; Restore System Default Menu
Restore Alignment Defaults	:SYSTem:DEFault ALIGN	System Menu; Restore System Default Menu
Restore Miscellaneous Defaults	:SYSTem:DEFault MISC	System Menu; Restore System Default Menu
Restore All System Defaults	:SYSTem:DEFault [ALL] :SYSTem:PRESet:PERSistent	System Menu; Restore System Default Menu
User Preset	:SYSTem:PRESet:USER	User Preset Menu
User Preset All Modes	:SYSTem:PRESet:USER:ALL	User Preset Menu

Power On Mode Preset	:SYSTem:PON:TYPE MODE	System Menu
Power On User Preset	:SYSTem:PON:TYPE USER	System Menu
Power On Last State	:SYSTem:PON:TYPE LAST	System Menu

### Preset Type (Remote Command Only)

As stated in the Backward Compatibility section, to be compatible with ESA/PSA the PRESet:TYPE command will be implemented as a no-op.

<b>Mode</b>	All
<b>Remote Command</b>	:SYSTem:PRESet:TYPE FACTory MODE USER :SYSTem:PRESet:TYPE?
<b>Example</b>	:SYST:PRESet:TYPE FACT
<b>Notes</b>	This command is supported for backward compatibility only. It is a no-op which does not change the behavior of any preset operation.
<b>Preset</b>	This is unaffected by Preset but is set to Mode on a "Restore System Defaults->All"
<b>State Saved</b>	No
<b>Initial S/W Revision</b>	Prior to A.02.00

## Mode Setup

See ["Mode Setup" on page 348](#)

## Peak Search

There is no 'Peak Search' supported in Spectrum Emission Mask so this front-panel key displays a blank menu when pressed.

---

Key Path	Front-panel key
Initial S/W Revision	Prior to A.02.00

---



Print

See "Print" on page 358

## Quick Save

The Quick Save front-panel key repeats the most recent save that was performed from the Save menu, with the following exceptions:

- Register saves are not remembered as Saves for the purpose of the Quick Save function
- If the current measurement does not support the last non-register save that was performed, an informational message is generated, “File type not supported for this measurement”

Quick Save repeats the last type of qualified save (that is, a save qualified by the above criteria) in the last save directory by creating a unique filename using the Auto File Naming algorithm described below.

If Quick Save is pressed after startup and before any qualified Save has been performed, the Quick Save function performs a Screen Image save using the current settings for Screen Image saves (current theme, current directory), which then becomes the “last save” for the purpose of subsequent Quick Saves.

The Auto File Naming feature automatically generates a file name for use when saving a file. The filename consists of a prefix and suffix separated by a dot, as is standard for the Windows® file system. A default prefix exists for each of the available file types:

Type	Default Prefix	Menu
State	State_	(Save/Recall)
Trace + State	State_	(Save/Recall)
Screen	Screen_	(Save/Recall)
Amplitude Corrections	Ampcor_	(Import/Export)
Traces	Trace_	(Import/Export)
Limit Lines	LLine_	(Import/Export)
Measurement Result	MeasR_	(Import/Export)
Capture Buffer	CapBuf_	(Import/Export)

A four digit number is appended to the prefix to create a unique file name. The numbering sequence starts at 0000 within each Mode for each file type and updates incrementally to 9999, then wraps to 0000 again. It remembers where it was through a Mode Preset and when leaving and returning to the Mode. It is reset by Restore Misc Defaults and Restore System Defaults and subsequent running of the instrument application. So, for example, the first auto file name generated for State files is State\_0000.state. The next is State\_0001, and so forth.

One of the key features of Auto File Name is that we guarantee that the Auto File Name will never conflict with an existing file. The algorithm looks for the next available number. If it gets to 9999, then it looks for holes. If it find no holes, that is no more numbers are available, it gives an error.

For example, if when we get to State\_0010.state there is already a State\_0010.state file in the current directory, it advances the counter to State\_0011.state to ensure that no conflict will exist (and then it verifies that State\_0011.state also does not exist in the current directory and advances again if it does, and so forth).

If you enter a file name for a given file type, then the prefix becomes the filename you entered instead of the default prefix, followed by an underscore. The last four letters (the suffix) are the 4-digit number.

For example, if you save a measurement results file as “fred.csv”, then the next auto file name chosen for a measurement results save will be fred\_0000.csv.

**NOTE** Although 0000 is used in the example above, the number that is used is actually the current number in the Meas Results sequence, that is, the number that would have been used if you had not entered your own file name.

**NOTE** If the filename you entered ends with \_dddd, where d=any number, making it look just like an auto file name, then the next auto file name picks up where you left off with the suffix being dddd + 1.

Key Path	Front-panel key
Notes	No remote command for this key specifically.
Initial S/W Revision	Prior to A.02.00

## Recall

The Recall menu lets you choose what you want to recall, and where you want to recall it from. Among the types of files you can recall are **States and Traces**. In addition, an Import (Data) option lets you recall a number of data types stored in CSV files (as used by Excel and other spreadsheet programs).

The default paths for Recall are data type dependent and are the same as for the Save key.

Key Path	Front-panel key
Notes	<p>No remote command for this key specifically, but the :MMEM:LOAD command is available for specific file types. An example is :MMEM:LOAD:STATe &lt;filename&gt;.</p> <p>If you try to recall a State file for a mode that is not licensed or not available in the instrument, an error message will occur and the state will not change.</p>
Backwards Compatibility Notes	<p>In legacy analyzers, it was possible to load a state without affecting the trace data, limit lines or correction data. Similarly (since User Preset is actually loading a state), it was possible to do a User Preset without affecting the trace data, limit lines or correction data.</p> <p>In the X-Series, “state” always includes all of this data; so whenever state is loaded, all of the traces, limit lines and corrections are affected. Although this differs from previous behavior, it is desirable behavior, and should not cause adverse issues for users.</p>
Backwards Compatibility Notes	<p>Recall for the X-Series supports backward compatibility in the sense that you can recall a state file from any X-Series model number and any version of X-Series software. This is only possible if part of the recalling process goes through a limiting step after recalling the mode settings, at least for settings that may vary with version number, model number, option and license differences. If you try to recall a state file onto an instrument with less capability than what was available on the instrument during the save, the recall will ignore the state it doesn't support and it will limit the recalled setting to what it allows.</p> <p>Example: if the saved state includes preamp ON, but the recalling instrument does not have a preamp; the preamp is limited to OFF. Conversely, if you save a state without a preamp, the preamp is OFF in the state file. When this saved file is recalled on an instrument with a licensed preamp, the preamp is changed to OFF. Another example is if the saved state has center frequency set to 20 GHz, but the instrument recalling the saved state is a different model and only supports 13.5 GHz. In this case, the center frequency is limited along with any other frequency based settings. Since the center frequency can't be preserved in this case, the recall limiting tries to at least preserve span to keep the measurement setup as intact as possible.</p> <p>It may be appropriate to issue a warning if the state is limited on the recall; warnings do not go out to SCPI so this would only affect the manual user.</p> <p>Note that there is no state file compatibility outside of the X-Series. For example, you cannot recall a state file from ESA or PSA.</p>
Initial S/W Revision	Prior to A.02.00

## State

The Recall State menu lets you choose a register or file from which to recall the state.

The content of a state file includes all of the settings and data required to return the analyzer as closely as possible to the Mode it was in, with the exact settings that were in place, when the save occurred. The Mode settings in each state file include the settings that are affected by Mode Preset, as well as the

additional settings affected by Restore Mode Defaults; all of the Mode’s settings. In addition, all of the settings of the Input/Output system are included, even though they are outside of the Mode’s state, because they are needed to restore the complete setup. Persistent System settings (for example, GPIB address) are not affected by either a Mode Preset or Restore Mode Defaults, nor are they included in a saved State file.

Since each state file is only for one Mode, the settings for other Modes are unaffected when it is loaded. Recall State will cause a mode switch if the state being recalled is not from the current active mode.

After the recall completes, the message "File <filename> recalled" or “Recalled State Register <register number>” is displayed.

For rapid recalls, the State menu lists 16 registers that you can choose from to recall. Pressing a Register key initiates the recall. You can also select a file from which to recall.

The default path for all State Files is:

My Documents\<<mode name>\state

where <mode name> is the parameter used to select the mode with the INST:SEL command (for example, SA for the Spectrum Analyzer).

See "[More Information](#)" on page 1298.

<b>Key Path</b>	Recall
<b>Mode</b>	All
<b>Remote Command</b>	:MMEMory:LOAD:STATe <filename>
<b>Example</b>	:MMEM:LOAD:STAT "myState.state" This recalls the file myState.state on the default path
<b>Example</b>	MMEM:LOAD:STAT "MyStateFile.state" This loads the state file data (on the default file directory path) into the instrument state.
<b>Notes</b>	<p>When you pick a file to recall, the analyzer first verifies that the file is recallable in the current instrument by checking the software version and model number of the instrument. If everything matches, a full recall proceeds by aborting the currently running measurement, clearing any pending operations, and then loading the State from the saved state file. You can open state files from any mode, so recalling a State file switches to the mode that was active when the save occurred. After switching to the mode of the saved state file, mode settings and data (if any for the mode) are loaded with values from the saved file. The saved measurement of the mode becomes the newly active measurement and the data relevant to the measurement (if there is any) is recalled.</p> <p>If there is a mismatch between file version or model number or instrument version or model number, the recall function tries to recall as much as possible and returns a warning message. It may limit settings that differ based on model number, licensing or version number.</p> <p>After recalling the state, the Recall State function does the following:</p> <ul style="list-style-type: none"> <li>• Makes the saved measurement for the mode the active measurement.</li> <li>• Clears the input and output buffers.</li> <li>• Status Byte is set to 0.</li> <li>• Executes a *CLS</li> </ul> <p>If the file specified is empty an error is generated. If the specified file does not exist, another error is generated. If there is a mismatch between the file and the proper file type, an error is generated. If</p>

	there is a mismatch between file version or model number or instrument version or model number, a warning is displayed. Then it returns to the State menu and File Open dialog goes away. After the Recall, the analyzer exits the Recall menu and returns to the previous menu.
<b>Backwards Compatibility SCPI</b>	:MMEMory:LOAD:STATe 1,<filename> For backwards compatibility, the above syntax is supported. The "1" is simply ignored.
Initial S/W Revision	Prior to A.02.00

## More Information

In measurements that support saving Traces, for example, Swept SA, the Trace data is saved along with the State in the State file. When recalling the State, the Trace data is recalled as well. Traces are recalled exactly as they were stored, including the writing mode and update and display modes. If a Trace was updating and visible when the State was saved, it will come back updating and visible, and its data will be rewritten right away. When you use State to save and recall traces, any trace whose data must be preserved should be placed in View or Blank mode before saving.

The following table describes the Trace Save and Recall possibilities:

You want to recall state and one trace's data, leaving other traces unaffected.	Save Trace+State from 1 trace. Make sure that no other traces are updating (they should all be in View or Blank mode) when the save is performed.	On Recall, specify the trace you want to load the one trace's data into. This trace will load in View. All other traces' data will be unaffected, although their trace mode will be as it was when the state save was performed.
You want to recall all traces	Save Trace+State from ALL traces.	On Recall, all traces will come back in View (or Blank if they were in Blank or Background when saved)
You want all traces to load exactly as they were when saved.	Save State	On recall, all traces' mode and data will be exactly as they were when saved. Any traces that were updating will have their data immediately overwritten.

## From File...

When you press "From File", the analyzer brings up a Windows dialog and a menu entitled "File Open." This menu allows you to navigate to the various fields in the Windows dialog without using a keyboard or mouse. The Tab and Arrow keys can also be used for dialog navigation.

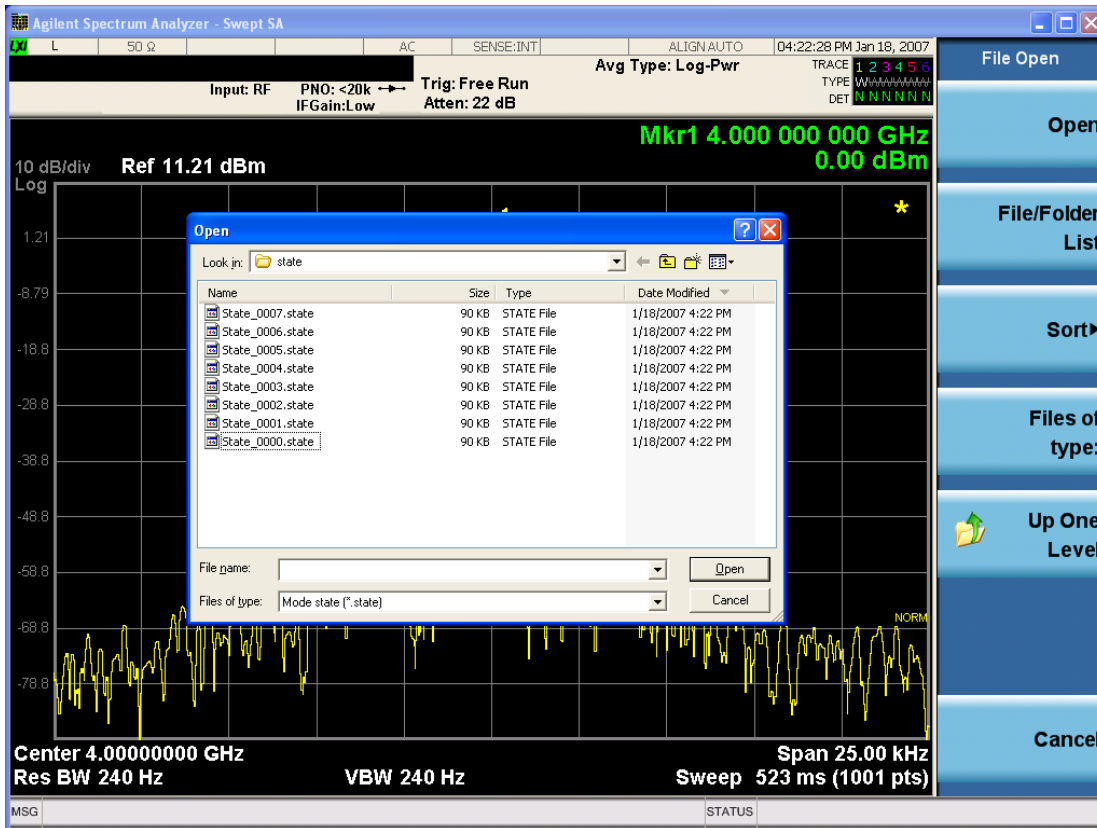

Listed below are the functions of the various fields in the dialog, and the corresponding softkeys:

#### Open

Performs the recall of the specified file. While the recall is being performed, the floppy icon appears briefly in the Meas bar.

#### File/Folder List

Enables you to navigate to the center of the dialog that contains the list of files and folders. Once here you can get information about the file and use the tab keys to navigate to the other fields in the dialog, such as Look In.

#### Look In

The Look In field shows the path from which the file will be recalled and allows you to change the path using the up and down arrow keys to navigate to other paths; the Enter key to open a directory; and the Backspace key to go back one directory. The **Look In field** first uses the last path from the Save As dialog **Save In:** path for that same file type. There is no softkey for directly navigating to the Look In field, but you can use the left tab to get here from the File/Folder List.

User specified paths are remembered when you leave and return to a Mode and are reset back to the default using Restore Mode Defaults.

#### Sort

Accesses a menu that enables you to sort the files within the File Open dialog. Only one sorting type can be selected at a time and the sorting happens immediately. The sorting types are By Date, By Name, By extension, and By Size.

#### Files of Type

This field shows the file suffix for the type of file you have selected to recall. For example, if you navigated here while recalling State, "Mode state (\*.state)" is in the field. If you navigated here while recalling Trace, ""Mode state (\*.trace)" is in the field. If you navigated here while importing a trace data file, "Trace Data (\*.csv)" is in the field. For some file types, there is more than one choice in the dropdown menu, which you can select by using the up and down arrow keys and Enter.

#### Up One Level

This key corresponds to the icon of a folder with the up arrow that is in the tool bar of the dialog. When pressed, it causes the file and folder list to navigate up one level in the directory structure. The Backspace key does the same thing.

#### Cancel

This key corresponds to the Cancel selection in the dialog. It causes the current **Open** request to be cancelled. The ESC key does the same thing.

Key Path	Recall, State
Notes	Brings up the Open dialog for recalling a State Save Type
Initial S/W Revision	Prior to A.02.00

### Edit Register Names

You may enter a custom name on any of the Register keys, to help you remember what you are using that state to save. To do this, press the Edit Register Names key, choose the register whose name you wish to edit, and then enter the desired label using the Alpha Editor or an external PC keyboard.

The maximum number of characters that can be added is 30. In most cases, 30 characters will fit on two lines of the key.

For more information and the SCPI command, see Edit Register Names under the Save, State function.

Key Path	Recall, State
Mode	All
Dependencies	N9060A-7FP or N9060B-2FP license required to edit the register names. When the feature is not licensed, sending the SCPI command generates an error, -221, "Settings conflict;Option not available"
Initial S/W Revision	A.11.00

### Register 1 thru Register 16

Selecting any one of these register keys causes the State of the mode from the specified Register to be recalled. Each of the register keys annotates whether it is empty or at what date and time it was last



modified. In addition, you can use the Edit Register Names key under Save, State to enter custom names for each register.

Registers are shared by all modes, so recalling from any one of the registers will cause a mode switch to the mode that was active when the save to the Register occurred.

Although these 16 registers are the only registers available from the front panel, there are 128 state registers available in the instrument. Registers 17–128 are only available from the SCPI interface, using the \*RCL command.

After the recall completes, the message "Register <register number> recalled" appears in the message bar. If you are in the Spectrum Analyzer Mode, and you are recalling a register that was saved in the Spectrum Analyzer Mode, then after the recall, you will still be in the Recall Register menu. If the Recall causes you to switch modes, then after the Recall, you will be in the Frequency menu.

If a requested register is empty an error is generated.

Key Path	Recall, State
<b>Example</b>	*RCL 1
Range	1–16 from front panel, 1–128 from SCPI
Readback	Date and time with seconds resolution are displayed on the key OR A custom name of up to 30 characters entered using the Save, State, Edit Register Names key OR “(empty)” if no prior save operation has been performed to this register.
Initial S/W Revision	Prior to A.02.00
Modified at S/W Revision	Prior to A.11.00

## Register 1 thru Register 16

Selecting any one of these register keys causes the State of the mode from the specified Register to be recalled. Each of the register keys annotates whether it is empty or at what date and time it was last modified. In addition, you can use the Edit Register Names key under Save, State to enter custom names for each register.

Registers are shared by all modes, so recalling from any one of the registers will cause a mode switch to the mode that was active when the save to the Register occurred.

Although these 16 registers are the only registers available from the front panel, there are 128 state registers available in the instrument. Registers 17–128 are only available from the SCPI interface, using the \*RCL command.

After the recall completes, the message "Register <register number> recalled" appears in the message bar. If you are in the Spectrum Analyzer Mode, and you are recalling a register that was saved in the Spectrum Analyzer Mode, then after the recall, you will still be in the Recall Register menu. If the Recall causes you to switch modes, then after the Recall, you will be in the Frequency menu.

If a requested register is empty an error is generated.

Key Path	Recall, State
Example	*RCL 1
Range	1-16 from front panel, 1-128 from SCPI
Readback	Date and time with seconds resolution are displayed on the key OR A custom name of up to 30 characters entered using the Save, State, Edit Register Names key OR “(empty)” if no prior save operation has been performed to this register.
Initial S/W Revision	Prior to A.02.00
Modified at S/W Revision	Prior to A.11.00

### Trace (+State)

The Recall Trace (+State) menu lets you choose a register or file from which to recall the Trace+State state file.

A saved state contains all of the settings and data required to return the analyzer as closely as possible to the exact setup it had when the save occurred. This includes the Input/Output settings, even though they are outside of the Mode’s state, because they are needed to restore the complete setup. A Trace+State file also includes trace data from one trace or all traces, which will load in View mode when the Trace+State file is recalled. Recall Trace (+State) will also cause a mode switch if the state being recalled is not for the current active mode.

After the recall completes, the message "File <filename> recalled" or “Recalled Trace Register <register number>” is displayed.

For rapid recalls, the Trace (+State) menu lists 5 registers to choose from to recall. Pressing a Register key initiates the recall. You can also select a file from which to recall.

The default path for all State Files including .trace files is:

My Documents\<mode name>\state

where <mode name> is the parameter used to select the mode with the INST:SEL command (for example, SA for the Spectrum Analyzer).

Key Path	Recall
Mode	SA
Remote Command	:MMEMory:LOAD:TRACe TRACE1   TRACE2   TRACE3   TRACE4   TRACE5   TRACE6, <filename>  :MMEMory:LOAD:TRACe:REGister TRACE1   TRACE2   TRACE3   TRACE4   TRACE5   TRACE6, <integer>
Example	MMEM:LOAD:TRAC TRACE2, "MyTraceFile.trace" This loads the trace file data (on the default file directory path) into the specified trace; if it is a "single trace" save file, that trace is loaded to trace 2, and is set to be not updating. :MMEM:LOAD:TRAC:REG TRACE1,2

	restores the trace data in register 2 to Trace 1
Notes	<p>When you perform the recall, the recalling Trace function must first verify the file is recallable in this instrument by checking instrument software version and model number, since it includes State. If everything matches, a full recall proceeds by aborting the currently running measurement, and loading the state from the saved state file to as close as possible to the context in which the save occurred. You can open .trace files from any mode that supports them, so recalling a Trace file switches to the mode that was active when the save occurred. After switching to the mode of the saved state file, mode settings and data (if any for the mode) are loaded with values from the saved file and the saved measurement of the mode becomes the newly active measurement, and the data relevant to the measurement (if there is any) is recalled.</p> <p>Once the state is loaded, the trace data must be loaded. The internal flags are consulted to see which trace to load and the "To Trace" setting to see where to load it. Trace data is always loaded with the specified trace set to View, so that the data is visible and not updating(so as not to erase the recalled data). If the file is an "all trace" file, all traces are loaded with the saved data(to the original trace the data was saved from) and set to View. Traces whose data is not loaded are restored to the update state that existed when they were saved.</p> <p>After the Recall the analyzer exits the Recall menu and returns to the previous menu.</p> <p>Some modes and measurements do not have available all 6 traces. Phase Noise mode command, for example, is: <code>MMEMory:LOAD:TRACe TRACE1 TRACE2 TRACE3,&lt;filename&gt;</code></p> <p>Some modes and measurements have more than 6 traces available. The Realtime SA mode command, for example, is: <code>MMEMory:STORe:TRACe TRACE1   TRACE2   TRACE3   TRACE4   TRACE5   TRACE6   TRACE7   TRACE8   TRACE9   TRACE10   TRACE11   TRACE12   ALL,&lt;filename&gt;</code></p>
Initial S/W Revision	Prior to A.02.00

## To Trace

These menu selections let you choose the Trace where the recalled saved trace will go. Not all modes have the full 6 traces available. The default is the currently selected trace, selected in this menu or in the Trace/Detector, Export Data, Import Data, or Save Trace menus, except if you have chosen All, then it remains chosen until you specifically change it to a single trace.

If the .trace file is an "all trace" file, "To Trace" is ignored and the traces each go back to the trace from which they were saved.

Once selected, the key returns back to the Recall Trace menu and the selected Trace number is annotated on the key. Now you have selected exactly where the trace needs to be recalled.To trigger a recall of the selected Trace, you must select the Open key in the Recall Trace menu.

When you select a trace, it makes that trace the current trace, so it displays on top of all of the other traces.

Key Path	Save, Data, Trace
Mode	SA
Initial S/W Revision	Prior to A.02.00

## Register 1 thru Register 16

Selecting any one of these register keys causes the State of the mode from the specified Register to be recalled. Each of the register keys annotates whether it is empty or at what date and time it was last modified. In addition, you can use the Edit Register Names key under Save, State to enter custom names for each register.

Registers are shared by all modes, so recalling from any one of the registers will cause a mode switch to the mode that was active when the save to the Register occurred.

Although these 16 registers are the only registers available from the front panel, there are 128 state registers available in the instrument. Registers 17–128 are only available from the SCPI interface, using the \*RCL command.

After the recall completes, the message "Register <register number> recalled" appears in the message bar. If you are in the Spectrum Analyzer Mode, and you are recalling a register that was saved in the Spectrum Analyzer Mode, then after the recall, you will still be in the Recall Register menu. If the Recall causes you to switch modes, then after the Recall, you will be in the Frequency menu.

If a requested register is empty an error is generated.

Key Path	Recall, State
<b>Example</b>	*RCL 1
Range	1–16 from front panel, 1–128 from SCPI
Readback	Date and time with seconds resolution are displayed on the key OR A custom name of up to 30 characters entered using the Save, State, Edit Register Names key OR “(empty)” if no prior save operation has been performed to this register.
Initial S/W Revision	Prior to A.02.00
Modified at S/W Revision	Prior to A.11.00

## From File...

When you press “From File”, the analyzer brings up a Windows dialog and a menu entitled “File Open.” This menu allows you to navigate to the various fields in the Windows dialog without using a keyboard or mouse. The Tab and Arrow keys can also be used for dialog navigation.



Listed below are the functions of the various fields in the dialog, and the corresponding softkeys:

### Open

Performs the recall of the specified file. While the recall is being performed, the floppy icon appears briefly in the Meas bar.

### File/Folder List

Enables you to navigate to the center of the dialog that contains the list of files and folders. Once here you can get information about the file and use the tab keys to navigate to the other fields in the dialog, such as Look In.

### Look In

The Look In field shows the path from which the file will be recalled and allows you to change the path using the up and down arrow keys to navigate to other paths; the Enter key to open a directory; and the Backspace key to go back one directory. The **Look In field** first uses the last path from the Save As dialog **Save In:** path for that same file type. There is no softkey for directly navigating to the Look In field, but you can use the left tab to get here from the File/Folder List.

User specified paths are remembered when you leave and return to a Mode and are reset back to the default using Restore Mode Defaults.

### Sort

Accesses a menu that enables you to sort the files within the File Open dialog. Only one sorting type can be selected at a time and the sorting happens immediately. The sorting types are By Date, By Name, By extension, and By Size.

#### Files of Type

This field shows the file suffix for the type of file you have selected to recall. For example, if you navigated here while recalling State, "Mode state (\*.state)" is in the field. If you navigated here while recalling Trace, ""Mode state (\*.trace)" is in the field. If you navigated here while importing a trace data file, "Trace Data (\*.csv)" is in the field. For some file types, there is more than one choice in the dropdown menu, which you can select by using the up and down arrow keys and Enter.

#### Up One Level

This key corresponds to the icon of a folder with the up arrow that is in the tool bar of the dialog. When pressed, it causes the file and folder list to navigate up one level in the directory structure. The Backspace key does the same thing.

#### Cancel

This key corresponds to the Cancel selection in the dialog. It causes the current **Open** request to be cancelled. The ESC key does the same thing.

Key Path	Recall, State
Notes	Brings up the Open dialog for recalling a State Save Type
Initial S/W Revision	Prior to A.02.00

## Data (Import)

Importing a data file loads data that was previously saved from the current measurement or from other measurements and/or modes that produce compatible data files. The Import Menu only contains Data Types that are supported by the current measurement.

Since the commonly exported data files are in .csv format, the data can be edited by the user prior to importing. This allows you to export a data file, manipulate the data in Excel (the most common PC Application for manipulating .csv files) and then import it.

Importing Data loads measurement data from the specified file into the specified or default destination, depending on the data type selected. Selecting an Import Data menu key will not actually cause the importing to occur, since the analyzer still needs to know from where to get the data. Pressing the Open key in this menu brings up the Open dialog and Open menu that provides you with the options from where to recall the data. Once a filename has been selected or entered in the Open menu, the recall occurs as soon as the Open button is pressed.

Key Path	Recall
Mode	All
Notes	The menu is built from whatever data types are available for the mode. Some keys will be missing completely, so the key locations in the sub-menu will vary. No SCPI command directly controls the Data Type that this key controls. The Data Type is included in the MMEM:LOAD commands.

Dependencies	If a file type is not used by a certain measurement, it is grayed out for that measurement. The key for a file type will not show at all if there are no measurements in the Mode that support it.
Preset	Is not affected by Preset or shutdown, but is reset during Restore Mode Defaults
Readback	The data type that is currently selected
Initial S/W Revision	Prior to A.02.00

## Capture Buffer

The captured data is raw data which is not processed.

Key Path	Recall, Data
Mode	<b>CDMA1XEV</b>
Example	MMEM:LOAD:CAPT "MyCaptureData.bin" This loads the file of capture data (on the default file directory path) into the instrument.
Dependencies	In case the capture buffer data is not available from the selected measurement, the key will be grayed out.
Initial S/W Revision	A.11.00

## Open...

When you press "Open", the analyzer brings up a Windows dialog and a menu entitled "**File Open.**" This menu allows you to navigate to the various fields in the Windows dialog without using a keyboard or mouse. The Tab and Arrow keys can also be used for dialog navigation.

See "[From File...](#)" on page 2890 in Recall, State, for a full description of this dialog and menu.

Key Path	Recall, Data
Notes	The key location is mode-dependent and will vary. Brings up Open dialog for recalling a <mode specific> Save Type
Initial S/W Revision	Prior to A.02.00

## Restart

The Restart function restarts the current sweep, or measurement, or set of averaged/held sweeps or measurements. If you are Paused, pressing Restart does a Resume.

The Restart function is accessed in several ways:

- Pressing the Restart key
- Sending the remote command INIT:IMMEDIATE
- Sending the remote command INIT:RESTART

See "[More Information](#)" on page 1308

Key Path	Front-panel key
Remote Command	:INITiate[:IMMEDIATE] :INITiate:RESTART
Example	:INIT:IMM :INIT:REST
Notes	:INITiate:RESTART and :INITiate:IMMEDIATE perform exactly the same function.
Couplings	Resets average/hold count k. For the first sweep overwrites all active (update=on) traces with new current data. For application modes, it resets other parameters as required by the measurement.
Status Bits/OPC dependencies	This is an Overlapped command. The STATus:OPERation register bits 0 through 8 are cleared. The STATus:QUESTionable register bit 9 (INTegrity sum) is cleared. The SWEEPING bit is set. The MEASURING bit is set.
Backwards Compatibility Notes	For Spectrum Analysis mode in ESA and PSA, the Restart hardkey and the INITiate:RESTART command restart trace averages (displayed average count reset to 1) for a trace in Clear Write, but did not restart Max Hold and Min Hold.  In the X-Series, the Restart hardkey and the INITiate:RESTART command restart not only Trace Average, but MaxHold and MinHold traces as well.  For wireless comms modes in ESA and PSA, the Restart hardkey and the INITiate:RESTART command restart every measurement, which includes all traces and numeric results. There is no change to this operation.
Initial S/W Revision	Prior to A.02.00

### More Information

The **Restart** function first aborts the current sweep/measurement as quickly as possible. It then resets the sweep and trigger systems, sets up the measurement and initiates a new data measurement sequence with a new data acquisition (sweep) taken once the trigger condition is met.

If the analyzer is in the process of aligning when **Restart** is executed, the alignment finishes before the restart function is performed.



Even when set for Single operation, multiple sweeps may be taken when Restart is pressed (for example, when averaging/holding is on). Thus when we say that **Restart** "restarts a measurement," we may mean:

- It restarts the current sweep
- It restarts the current measurement
- It restarts the current set of sweeps if any trace is in Trace Average, Max Hold or Min Hold
- It restarts the current set of measurements if Averaging, or Max Hold, or Min Hold is on for the measurement
- depending on the current settings.

With **Average/Hold Number** (in **Meas Setup** menu) set to 1, or Averaging off, or no trace in Trace Average or Hold, a single sweep is equivalent to a single measurement. A single sweep is taken after the trigger condition is met; and the analyzer stops sweeping once that sweep has completed. However, with **Average/Hold Number** >1 and at least one trace set to **Trace Average, Max Hold, or Min Hold (SA Measurement)** or **Averaging on (most other measurements)**, multiple sweeps/data acquisitions are taken for a single measurement. The trigger condition must be met prior to each sweep. The sweep is stopped when the average count  $k$  equals the number  $N$  set for **Average/Hold Number**. A measurement average usually applies to all traces, marker results, and numeric results; but sometimes it only applies to the numeric results.

Once the full set of sweeps has been taken, the analyzer will go to idle state. To take one more sweep without resetting the average count, increment the average count by 1, by pressing the step up key while **Average/Hold Number** is the active function, or sending the remote command `CALC:AVER:TCON UP`.

## Save

The Save menu lets you choose what you want to save and where you want to save it. Among the types of files you can save are **States**, **Traces**, and **Screen Images**. In addition, an Export (Data) option lets you save a number of data types as CSV files for easy import into Excel and other spreadsheet programs.

Key Path	Front-panel key
Mode	All
Notes	No remote command for this key specifically, but the :MMEM:STOR:STATe <filename> command is available for specific file types. An example is :MMEM:STOR:STATe <filename>.
Initial S/W Revision	Prior to A.02.00

## State

The Save State menu lets you choose a register or file for saving the state.

The content of a state file includes all of the settings and data required to return the analyzer as closely as possible to the Mode it was in, with the exact settings which were in place, when the save occurred. The Mode settings in each state file include the settings that are affected by Mode Preset, as well as the additional settings affected by Restore Mode Defaults; all of the Mode's settings. In addition, all of the settings of the Input/Output system are included, even though they are outside of the Mode's state, because they are needed to restore the complete setup. Persistent System settings (for example, Verbose SCPI) are not affected by either Mode Preset or Restore Mode Defaults, nor are they included in a saved State file.

After the save completes, the message "File <filename> saved" or "State Register <register number> saved" is displayed.

For rapid saving, the State menu lists 16 registers to save to. Pressing a Register key initiates the save. You can also select a file to save to.

The default path for all State Files is:

My Documents\<<mode name>\state

where <mode name> is the parameter used to select the mode with the INST:SEL command (for example, SA for the Spectrum Analyzer).

Key Path	Save
Mode	All
Remote Command	:MMEMory:STORe:STATe <filename>
Example	MMEM:STOR:STATe "MyStateFile.state" This stores the current instrument state data in the file MyStateFile.state in the default directory.
Notes	Both single and double quotes are supported for any filename parameter over remote. After saving to a register, that register's menu key is updated with the date the time, unless a custom label has been entered for that key. After saving to a register, you remain in the Save State menu, so that you can see the Register key

update. After saving to a file, the analyzer automatically returns to the previous menu and any Save As dialog goes away.

<b>Backwards Compatibility SCPI</b>	:MMEMory:STORe:STATe 1,<filename>
Initial S/W Revision	Prior to A.02.00

### To File . . .

When you press “To File”, the analyzer brings up a Windows dialog and a menu entitled “**Save As.**” This menu allows you to navigate to the various fields in the Windows dialog without using a keyboard or mouse. The Tab and Arrow keys can also be used for dialog navigation.

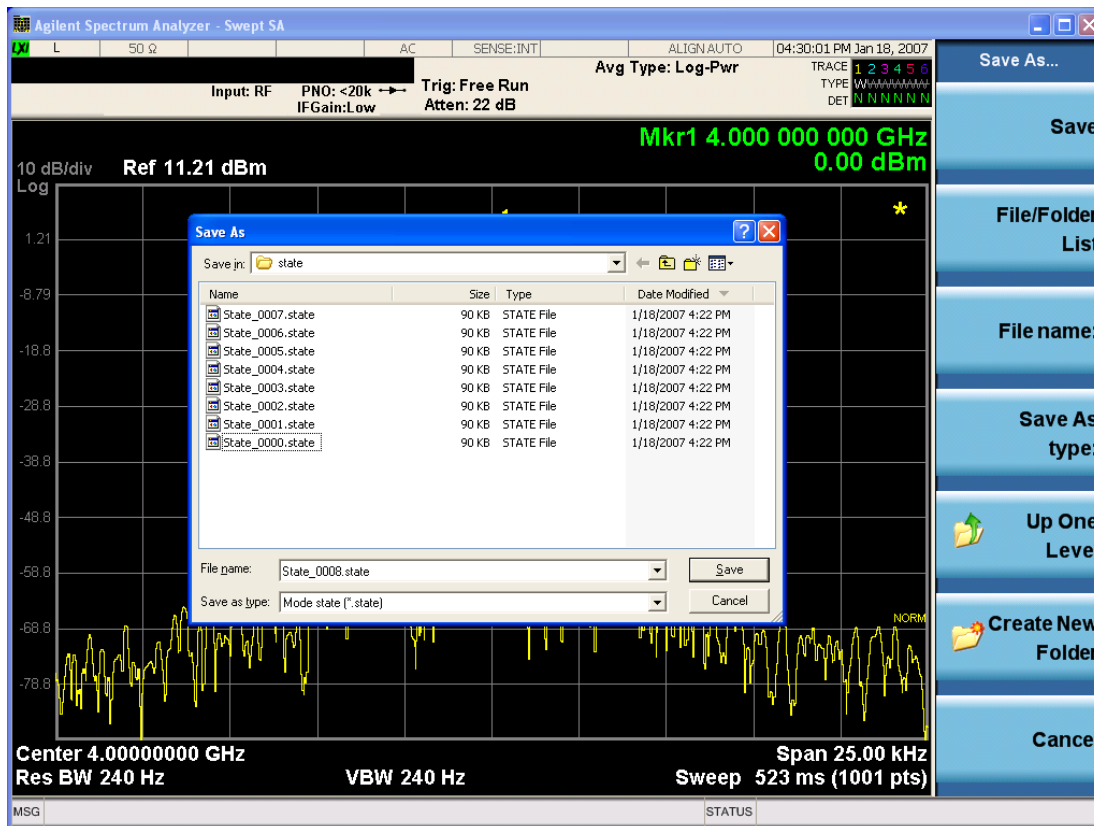

The Listed below

are the functions of the various fields in the dialog, and the corresponding softkeys:

#### Save

Performs the save to the specified file of the selected type. If the file already exists, a dialog will appear that allows you to replace the existing file by selecting OK, or you can Cancel the request. If you select OK, the file will be overwritten. Using the C: drive is strongly discouraged, since it runs the risk of being overwritten during an instrument software upgrade.

While the save is being performed, the floppy icon appears briefly in the Meas bar.

### File/Folder List

Enables you to navigate to the center of the dialog that contains the list of files and folders. Once here you can get information about the file and use the tab keys to navigate to the other fields in the dialog, such as Save In.

### Save In

The Save In field shows the path to which the file will be saved and allows you to change the path using the up and down arrow keys to navigate to other paths; the Enter key to open a directory; and the Backspace key to go back one directory. The **Save In field** defaults to the default path for this type of file and remembers the last path you used to save this type of file. There is no softkey for directly navigating to the Save In field but you can use left tab to get here from the File/Folder List.

User specified paths are remembered when you leave and return to a Mode and are reset back to the default using Restore Mode Defaults.

### File Name

The File Name field is initially loaded with an automatically generated filename specific to the appropriate Save Type. The automatically generated filename is guaranteed not to conflict with any filename currently in the directory. You may replace or modify this filename using the File Name key. See the ["Quick Save " on page 2880](#) documentation for more on the automatic file naming algorithm.

When you press the File Name key the analyzer displays the Alpha Editor. Use the knob to choose the letter to add and the front-panel Enter key to add the letter to the file name. The BK character moves you back and the FW character moves you forward in the filename. The Select key on the front panel generates a space character. When you are done entering the filename press the Done softkey. This returns back to the **File Open** dialog and menu, but does not cause the save to occur.

### Save As Type

This field shows the file suffix for the type of file you have selected to save. For example, if you navigated here while saving State, "Mode state (\*.state)" is in the field. If you navigated here from saving Trace, ""Mode state (\*.trace)" is in the field. If you navigated here while exporting a trace data file, "Trace Data (\*.csv)" is in the field. For some file types, there is more than one choice in the dropdown, which you can select by using the up and down arrow keys and Enter.

### Up One Level

This key corresponds to the icon of a folder with the up arrow that is in the tool bar of the dialog. When pressed, it causes the file and folder list to navigate up one level in the directory structure. The Backspace key does the same thing.

### Create New Folder

This key corresponds to the icon of a folder with the "\*" that is in the tool bar of the dialog. When pressed, a new folder is created in the current directory with the name **New Folder** and you can enter a new folder name using the Alpha Editor.

### Cancel

This key corresponds to the Cancel selection in the dialog. It causes the current **Save As** request to be cancelled. The ESC key does the same thing.

Key Path	Save, State
Mode	All
Notes	Brings up Save As dialog for saving a State Save Type
Initial S/W Revision	Prior to A.02.00

## Edit Register Names

You may enter a custom name on any of the Register keys, to help you remember what you are using that state to save. To do this, press the Edit Register Names key, choose the register whose name you wish to edit, and then enter the desired label using the Alpha Editor or an external PC keyboard.

The maximum number of characters that can be added is 30. In most cases, 30 characters will fit on two lines of the key.

See ["More Information" on page 1313](#)

Key Path	Save, State
Mode	All
<b>Remote Command</b>	:MMEMory:REGister:STATe:LABel <reg number>,"label" :MMEMory:REGister:STATe:LABel? <reg number>
<b>Example</b>	:MMEM:REG:STAT:LAB 1,"my label"
Notes	<reg number> is an integer from 1 to 16. If the SCPI specifies an invalid register number an error message is generated, -222,"Data out of range;Invalid register label number" "label" is a string from 0 to 30 characters in length. If a label exceeds 30 characters, an error message is generated, -150,"String data error;Label clipped to 30 characters" "label" of length 0 erases the custom label and restores the default (time and date) label. E.g.: :MMEM:REG:STAT:LAB 1,""
Dependencies	N9060A-7FP or N9060B-2FP license required to edit the register names. When the feature is not licensed, sending this command generates an error, -221,"Settings conflict;Option not available"
Preset	The names are unaffected by Preset or power cycle but are set to the default label (time and date) on a "Restore System Defaults->Misc"
Initial S/W Revision	A.11.00

## More Information

When you edit one of the register names, the time and date field will be replaced by the custom name.

If you delete all the characters in the custom name, it restores the default (time and date).

The register names are stored within the state files, but they are not part of the instrument state; that is, once you have edited a register name, loading a new state will not change that register name. Another consequence of this is that the names will be persistent through a power cycle. Also, if a named state file is transferred to another analyzer, it will bring its custom name along with it.

If you try to edit the name of an empty register, the analyzer will first save the state to have a file to put the name in. If you load a named state file into an analyzer with older firmware it will ignore the metadata.

The \*SAV and \*RCL commands will not be affected by the custom register names, nor will the MMEM commands.

### Register 1 thru Register 16

Selecting any one of these register menu keys causes the State of the currently active mode to be saved to the specified Register. The registers are provided for rapid saving and recalling, since you do not need to specify a filename or navigate to a file. Each of the register menu keys annotates whether it is empty or at what date and time it was last modified. In addition, you can use the Edit Register Names key to enter custom names for each register.

Although these 16 registers are the only registers available from the front panel, there are 128 state registers available in the instrument. Registers 17–128 are only available from the SCPI interface, using the \*SAV command.

There is one set of 128 state registers in the instrument, not one set for each Mode. When a state is saved, the Mode it was saved from is saved with it; then when it is recalled, the instrument switches to that Mode.

After the save completes, the corresponding register menu key annotation is updated with the date and time and the message "Register <register number> saved" is displayed.

Key Path	Save, State
Mode	All
Example	*SAV 1
Range	1–16 from front panel, 1–128 from SCPI
Readback	Date and time with seconds resolution are displayed on the key OR A custom name of up to 30 characters entered using the Edit Register Names key OR “(empty)” if no prior save operation has been performed to this register.
Initial S/W Revision	Prior to A.02.00
Modified at S/W Revision	A.11.00

### Register 1 thru Register 16

Selecting any one of these register menu keys causes the State of the currently active mode to be saved to the specified Register. The registers are provided for rapid saving and recalling, since you do not need to specify a filename or navigate to a file. Each of the register menu keys annotates whether it is empty or at what date and time it was last modified. In addition, you can use the Edit Register Names key to enter custom names for each register.

Although these 16 registers are the only registers available from the front panel, there are 128 state registers available in the instrument. Registers 17–128 are only available from the SCPI interface, using the \*SAV command.

There is one set of 128 state registers in the instrument, not one set for each Mode. When a state is saved, the Mode it was saved from is saved with it; then when it is recalled, the instrument switches to that Mode.

After the save completes, the corresponding register menu key annotation is updated with the date and time and the message "Register <register number> saved" is displayed.

Key Path	Save, State
Mode	All
Example	*SAV 1
Range	1–16 from front panel, 1–128 from SCPI
Readback	Date and time with seconds resolution are displayed on the key OR A custom name of up to 30 characters entered using the Edit Register Names key OR “(empty)” if no prior save operation has been performed to this register.
Initial S/W Revision	Prior to A.02.00
Modified at S/W Revision	A.11.00

## Data (Export)

Exporting a data file stores data from the current measurement to mass storage files. The Export Menu only contains data types that are supported by the current measurement.

Since the commonly exported data files are in .csv format, the data can be edited by you prior to importing. This allows you to export a data file, manipulate the data in Excel (the most common PC Application for manipulating .csv files) and then import it.

Selecting an Export Data menu key will not actually cause the exporting to occur, since the analyzer still needs to know where you wish to save the data. Pressing the Save As key in this menu brings up the Save As dialog and Save As menu that allows you to specify the destination file and directory. Once a filename has been selected or entered in the Open menu, the export will occur as soon as the Save key is pressed.

Key Path	Save
Mode	All
Notes	The menu is built from whatever data types are available for the mode. So the key locations in the sub menu will vary.  No SCPI command directly controls the Data Type that this key controls. The Data Type is included in the MMEM:STORe commands.
Dependencies	If a file type is not used by a certain measurement, that type is grayed out for that measurement. The key for a file type will not show at all if there are no measurements in the Mode that support it.
Preset	Is not affected by a Preset or shutdown, but is reset during Restore Mode Defaults
Readback	The data type that is currently selected
Initial S/W Revision	Prior to A.02.00

## Measurement Results

Pressing this key selects Meas Results as the data type to be exported.

The Meas Results file contains information that describes the current state of the analyzer. It is detailed in ["Meas Results File Contents" on page 1316](#) below.

<b>Key Path</b>	Save, Data
<b>Remote Command</b>	:MMEMory:STORe:RESults <string>
<b>Example</b>	:MMEM:STOR:RES "MeasR_0000.csv"
<b>Notes</b>	<p>If the save is initiated via SCPI and the file already exists, the file will be overwritten.</p> <p>The SCPI command exports Spectrum Emission Mask measurement results to the file specified as the parameter in the current path. The default path is My Documents\<current mode&gt;\data\sem\results.<="" p=""> <p>Using the C: drive is strongly discouraged, since it runs the risk of being overwritten during an instrument software upgrade.</p> <p>The SCPI parameter is a quoted string that specifies the filename. Both single and double quotes are supported for any filename parameter over SCPI.</p> </current></p>
<b>Dependencies</b>	The current active measurement must be the Spectrum Emission Mask measurement to use this command.
<b>Status Bits/OPC dependencies</b>	Sequential – waits for the previous measurement to complete
<b>Initial S/W Revision</b>	Prior to A.02.00

## Meas Results File Contents

A Meas Results File contains measurement results with the following information.

- File ID string, which is "MeasResult"
- Measurement ID following Mode ID, which is "SA:SEM" for example.
- Firmware rev and model number
- Option string
- Automatic Trigger Time
- Automatic Trigger Time State
- Center Frequency
- ChanIntegBW
- ChannelDetector
- ChannelDetectorState
- ChanPwrRefAuto
- ChanResBW



- ChanResBWAuto
- ChanSpan
- ChanSweepTime
- ChanSweepTimeAuto
- ChanVbwRbwRatio
- ChanVbwRbwRatioAuto
- ChanVideoBW
- ChanVideoBWAuto
- Electrical Atten
- Electrical Atten Bypass
- Electrical Atten State
- External1 Trigger Delay
- External1 Trigger Delay State
- External1 Trigger Level
- External1 Trigger Slope
- External2 Trigger Delay
- External2 Trigger Delay State
- External2 Trigger Level
- External2 Trigger Slope
- FilterAlpha
- Internal Preamp
- Internal Preamp Band
- Line Trigger Delay
- Line Trigger Delay State
- Line Trigger Slope
- Mechanical Atten
- Mechanical Atten Auto
- OffsetDetector
- OffsetDetectorState
- OffsetLimitAbsStartBTS
- OffsetLimitAbsStartMS

- OffsetLimitAbsStopBTS
- OffsetLimitAbsStopMS
- OffsetLimitFailMaskBTS
- OffsetLimitFailMaskMS
- OffsetLimitRelStartBTS
- OffsetLimitRelStartMS
- OffsetLimitRelStopBTS
- OffsetLimitRelStopMS
- OffsetMeasBWBTS
- OffsetMeasBWMS
- OffsetResolutionBWAUTOBTS
- OffsetResolutionBWAUTOMS
- OffsetResolutionBWBTS
- OffsetResolutionBWMS
- OffsetSideBTS
- OffsetSideMS
- OffsetStartFrequencyBTS
- OffsetStartFrequencyMS
- OffsetStateBTS
- OffsetStateMS
- OffsetStopFrequencyBTS
- OffsetStopFrequencyMS
- OffsetSweepTimeAutoBTS
- OffsetSweepTimeAutoMS
- OffsetSweepTimeBTS
- OffsetSweepTimeMS
- OffsetVbwRbwRatioAutoBTS
- OffsetVbwRbwRatioAutoMS
- OffsetVbwRbwRatioBTS
- OffsetVbwRbwRatioMS
- OffsetVideoBWAUTOBTS

- OffsetVideoBWAutoMS
- OffsetVideoBW BTS
- OffsetVideoBW MS
- PeakReference
- Periodic Timer Period
- Periodic Timer Sync Source
- Periodic Timer Trigger Delay
- Periodic Timer Trigger Delay State
- PowerReference
- PSDReference
- Radio Device
- RFBurst Trigger Delay
- RFBurst Trigger Delay State
- RFBurst Trigger Level Abs
- RFBurst Trigger Level Rel
- RFBurst Trigger Level Type
- RFBurst Trigger Slope
- RrcFilter
- SemAverageNumber
- SemAverageState
- TotalAtten
- Trigger Holdoff
- Trigger Holdoff State
- TriggerSource
- Video Trigger Delay
- Video Trigger Delay State
- Video Trigger Level
- Video Trigger Slope
- ViewSelection

The file contains these data followed by MeasResult1 to MeasResult12 that flag the start of the measurement results. Each line of Measurement Results consists of twelve comma separated values from MeasResult1 value to MeasResult12 value. MeasResult1 contains the same results as

MEAS/READ/FETCH:SEMask1; MeasResult2, MEAS/READ/FETCH:SEMask2; MeasResult3,  
MEAS/READ/FETCH:SEMask3;... (continues in the same manner)

The exported file is in CSV format, with a.csv extension. The Meas Results file, when imported into Excel, shows the following data:

MeasResult		
SA:SEM		
A.10.53	N90 30A	
526 ALV ATP B1X B1Y B25 B40 BBA CR3 CRP DCF DDA DP2 DRD EA3 EDP EMC EP1 ERC ESC ESP EXM FSA LFE LNP MAT MPB NFE NUL P26 PFR PNC RTL RTS S40 SB1 SEC SM1 TVT YAS YAV	1	
Automatic Trigger Time	0.1	
Automatic Trigger Time State	FALS E	
Center Frequency	1.33 E+10	
ChanIntegBW	384 000 0	384 000 0
ChannelDetec tor	Aver age	
ChannelDetec torState	TRUE	
ChanPwrRefA uto	TRUE	
ChanResBW	100 000	100 000
ChanResBWA uto	FALS E	FALS E
ChanSpan	500 000	500 000

	0	0
ChanSweepTime	0.00 250 7	0.00 250 7
ChanSweepTimeAuto	TRUE	TRUE
ChanVbwRbwRatio	1	1
ChanVbwRbwRatioAuto	FALSE	FALSE
ChanVideoBW	100 000	100 000
ChanVideoBWAuto	TRUE	TRUE
Electrical Atten	0	
Electrical Atten Bypass	TRUE	
Electrical Atten State	FALSE	
External1 Trigger Delay	1.00 E-06	
External1 Trigger Delay State	FALSE	
External1 Trigger Level	1.2	
External1 Trigger Slope	Positive	
External2 Trigger Delay	1.00 E-06	
External2 Trigger Delay State	FALSE	
External2 Trigger Level	1.2	
External2 Trigger Slope	Positive	
FilterAlpha	0.22	
Internal Preamp	FALSE	
Internal Preamp Band	Low	

Line Trigger Delay	1.00E-06					
Line Trigger Delay State	FALSE					
Line Trigger Slope	Positive					
Mechanical Atten	10					
Mechanical Atten Auto	TRUE					
OffsetDetector	Peak					
OffsetDetectorState	TRUE					
OffsetLimitAbsStartBTS	-14	-14	-26	-13	-13	-13
OffsetLimitAbsStartMS	-14	-14	-26	-13	-13	-13
OffsetLimitAbsStopBTS	-14	-26	-26	-13	-13	-13
OffsetLimitAbsStopMS	-14	-26	-26	-13	-13	-13
OffsetLimitFailMaskBTS	ABSolute	ABSolute	ABSolute	ABSolute	ABSolute	ABSolute
OffsetLimitFailMaskMS	ABSolute	ABSolute	ABSolute	ABSolute	ABSolute	ABSolute
OffsetLimitRelStartBTS	-30	-30	-30	-30	-30	-30
OffsetLimitRelStartMS	-30	-30	-30	-30	-30	-30
OffsetLimitRelStopBTS	-30	-30	-30	-30	-30	-30
OffsetLimitRelStopMS	-30	-30	-30	-30	-30	-30
OffsetMeasBWBTS	1	1	1	1	1	1
OffsetMeasBWMMS	1	1	1	1	1	1
OffsetResolutionBWAUTOBTS	FALSE	FALSE	FALSE	FALSE	FALSE	FALSE
OffsetResolutionBWAUTOMS	FALSE	FALSE	FALSE	FALSE	FALSE	FALSE

OffsetResolutionBWBS	30000	30000	30000	1000000	100000	100000
OffsetResolutionBWS	30000	30000	30000	1000000	100000	100000
OffsetSideBTS	Both	Both	Both	Both	Both	Both
OffsetSideMS	Both	Both	Both	Both	Both	Both
OffsetStartFrequencyBTS	2515000	2715000	3515000	4000000	800000	125000
OffsetStartFrequencyMS	2515000	2715000	3515000	4000000	800000	125000
OffsetStateBTS	TRUE	TRUE	TRUE	TRUE	TRUE	FALSE
OffsetStateMS	TRUE	TRUE	TRUE	TRUE	TRUE	FALSE
OffsetStopFrequencyBTS	2715000	3515000	4000000	8000000	125000	150000
OffsetStopFrequencyMS	2715000	3515000	4000000	8000000	125000	150000
OffsetSweepTimeAutoBTS	TRUE	TRUE	TRUE	TRUE	TRUE	TRUE
OffsetSweepTimeAutoMS	TRUE	TRUE	TRUE	TRUE	TRUE	TRUE
OffsetSweepTimeBTS	0.01733	0.06932	0.04202	0.002053	0.00225	0.00125
OffsetSweepTimeMS	0.01733	0.06932	0.04202	0.002053	0.00225	0.00125
OffsetVbwRbwRatioAutoBTS	FALSE	FALSE	FALSE	FALSE	FALSE	FALSE
OffsetVbwRbwRatioAutoMS	FALSE	FALSE	FALSE	FALSE	FALSE	FALSE
OffsetVbwRbwRatioBTS	0.01	0.01	0.01	0.01	0.01	0.01
OffsetVbwRbwRatioMS	0.01	0.01	0.01	0.01	0.01	0.01

OffsetVideoB WAutoBTS	TRUE	TRUE	TRUE	TRUE	TRUE	TRUE
OffsetVideoB WAutoMS	TRUE	TRUE	TRUE	TRUE	TRUE	TRUE
OffsetVideoB WBTS	300	300	300	10000	100 00	100 00
OffsetVideoB WMS	300	300	300	10000	100 00	100 00
PeakReferenc e	- 82.9 957					
Periodic Timer Period	0.02					
Periodic Timer Sync Source	None					
Periodic Timer Trigger Delay	1.00 E-06					
Periodic Timer Trigger Delay State	FALS E					
PowerReferen ce	- 73.6 966					
PSDReferenc e	- 139. 54					
Radio Device	Bts					
RFBurst Trigger Delay	1.00 E-06					
RFBurst Trigger Delay State	FALS E					
RFBurst Trigger Level Abs	-20					
RFBurst Trigger Level Rel	-6					
RFBurst Trigger Level Type	Absol ute					
RFBurst Trigger Slope	Posit ive					



RrcFilter	FALSE											
SemAverageNumber	10											
SemAverageState	FALSE											
TotalAtten	10											
Trigger Holdoff	0.1											
Trigger Holdoff State	FALSE											
TriggerSource	Free											
Video Trigger Delay	1.00E-06											
Video Trigger Delay State	FALSE											
Video Trigger Level	-25											
Video Trigger Slope	Positive											
Video Selection	AbsPwrFreq											
MeasResult1	Meas Result2	Meas Result3	Meas Result4	MeasResult5	Meas Result6	Meas Result7	Meas Result8	Meas Result9	Meas Result10	Meas Result11	Meas Result12	
-999	-	-13	999	-	-999	-999	-999	-999	-999	-999	-999	
	78.89359			73.6966334099879								
-	-	-13	999	-999	-999	-999	-999	-999	-999	-999		
73.6966334099879	78.95235											

### Capture Buffer

Capture Buffer functionality is not available for all measurements. The captured data is raw data which is not processed.

Key Path	Save, Data
Mode	CDMA1XEV
Example	MMEM:STOR:CAPT "MyCaptureData.bin"

	This stores the capture data in the file MyCaptureData.bin in the default directory.
Dependencies	In case the capture buffer data is not available from the selected measurement, the key will be grayed out.
Initial S/W Revision	A.11.00

### Save As . . .

When you press “Save As”, the analyzer brings up a Windows dialog and a menu entitled “**Save As.**” This menu allows you to navigate to the various fields in the Windows dialog without using a keyboard or mouse. The Tab and Arrow keys can also be used for dialog navigation.

See "[To File . . .](#)" on page 2897 in Save, State for a full description of this dialog and menu.

The default path for saving files is:

For all of the Trace Data Files:

My Documents\<<mode name>\data\traces

For all of the Limit Data Files:

My Documents\<<mode name>\data\limits

For all of the Measurement Results Data Files:

My Documents\<<mode name>\data\<<measurement name>\results

For all of the Capture Buffer Data Files:

My Documents\<<mode name>\data\captureBuffer

Key Path	Save, Data
Mode	All
Notes	The key location is mode-dependent and will vary. Brings up the Save As dialog for saving a <mode specific> Save Type. The save is performed immediately and does not wait until the measurement is complete.
Initial S/W Revision	Prior to A.02.00

### Screen Image

Pressing Screen Image accesses a menu of functions that enable you to specify a format and location for the saved screen image. It brings up a menu that allows you to specify the color scheme of the Screen Image (Themes) or navigate to the Save As dialog to perform the actual save.

Screen Image files contain an exact representation of the analyzer display. They cannot be loaded back onto the analyzer, but they can be loaded into your PC for use in many popular applications.

The image to be saved is actually captured when the Save front panel key is pressed, and kept in temporary storage to be used if you ask for a Screen Image save. When the Screen Image key is pressed, a "thumbnail" of the captured image is displayed, as shown below:

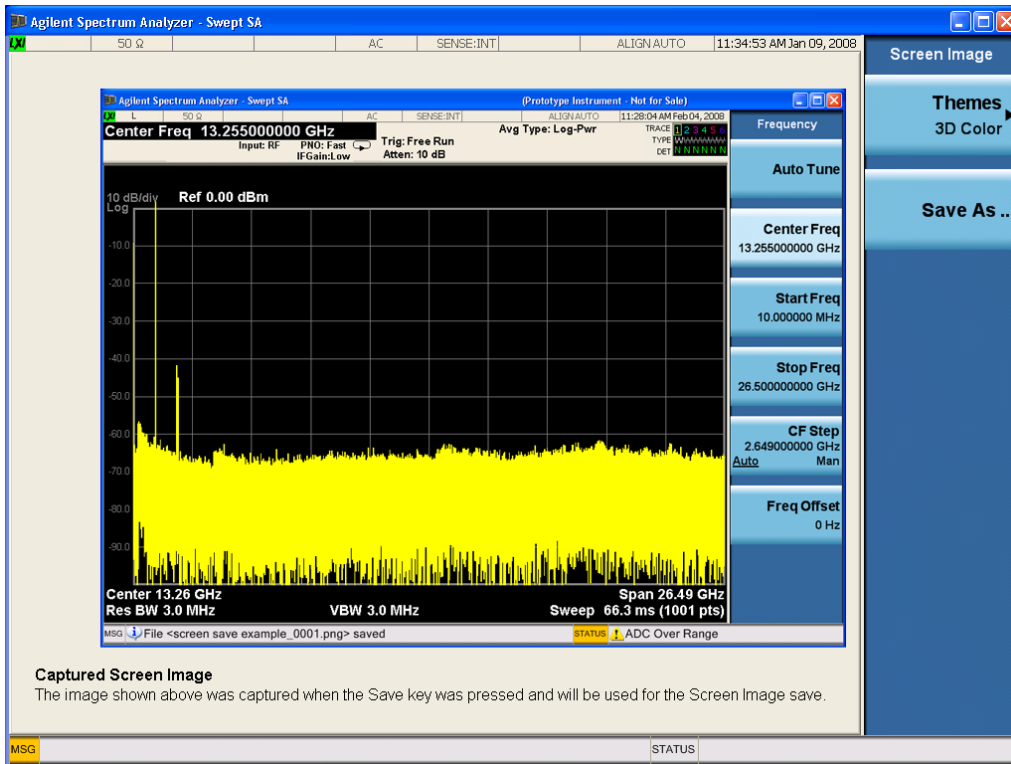

When you continue on into the Save As menu and complete the Screen Image save, the image depicted in the thumbnail is the one that gets saved, showing the menus that were on the screen before going into the Save menu. The save is performed immediately and does not wait until the measurement is complete.

After you have completed the save, the Quick Save front-panel key lets you quickly repeat the last save performed, using an auto-named file, with the current screen data.

**NOTE** For versions previous to A.01.55, if you initiate a screen image save by navigating through the Save menus, the image that is saved will contain the Save menu softkeys, not the menus and the active function that were on the screen when you first pressed the Save front panel key.

Key Path	Save
Mode	All
Remote Command	:MMEMory:STORe:SCReen <filename>
Example	:MMEM:STOR:SCR "myScreen.png" This stores the current screen image in the file MyScreenFile.png in the default directory.
Initial S/W Revision	Prior to A.02.00

## Themes

Accesses a menu of functions that enable you to choose the theme to be used when saving the screen image.

The **Themes** option is the same as the **Themes** option under the **Display** and **Page Setup** dialogs. It allows you to choose between themes to be used when saving the screen image.

<b>Key Path</b>	Save, Screen Image
<b>Remote Command</b>	:MMEMory:STORe:SCReen:THEMe TDColor   TDMonochrome   FCOLor   FMONochrome  :MMEMory:STORe:SCReen:THEMe?
<b>Example</b>	:MMEM:STOR:SCR:THEM TDM
<b>Preset</b>	3D Color; Is not part of Preset, but is reset by Restore Misc Defaults or Restore System Defaults All and survives subsequent running of the modes.
<b>Readback</b>	3D Color   3D Mono   Flat Color   Flat Mono
<b>Backwards Compatibility Notes</b>	In ESA and PSA we offer the choice of "Reverse Bitmap" or "Reverse Metafile" when saving screen images. This is much like the "Flat Color" theme available in X-Series. Also, if you selected Reverse Bitmap AND a black & white screen image, that would be much like "Flat Monochrome". In other words, each of the X-Series themes has a similar screen image type in ESA/PSA. But they are not identical.
<b>Initial S/W Revision</b>	Prior to A.02.00

### 3D Color

Selects a standard color theme with each object filled, shaded and colored as designed.

<b>Key Path</b>	Save, Screen Image, Themes
<b>Example</b>	MMEM:STOR:SCR:THEM TDC
<b>Readback</b>	3D Color
<b>Initial S/W Revision</b>	Prior to A.02.00

### 3D Monochrome

Selects a format that is like 3D color but shades of gray are used instead of colors.

<b>Key Path</b>	Save, Screen Image, Themes
<b>Example</b>	MMEM:STOR:SCR:THEM TDM
<b>Readback</b>	3D Mono
<b>Initial S/W Revision</b>	Prior to A.02.00

### Flat Color

Selects a format that is best when the screen is to be printed on an ink printer.

Key Path	Save, Screen Image, Themes
<b>Example</b>	MMEM:STOR:SCR:THEM FCOL
Readback	Flat Color
Initial S/W Revision	Prior to A.02.00

### Flat Monochrome

Selects a format that is like Flat Color. But only black is used (no colors, not even gray), and no fill.

Key Path	Save, Screen Image, Themes
<b>Example</b>	MMEM:STOR:SCR:THEM FMON
Readback	Flat Mono
Initial S/W Revision	Prior to A.02.00

### Save As...

When you press "Save As", the analyzer brings up a Windows dialog and a menu entitled "**Save As.**" This menu allows you to navigate to the various fields in the Windows dialog without using a keyboard or mouse. The Tab and Arrow keys can also be used for dialog navigation.

See "[To File . . .](#)" on page 2897 in Save, State for a full description of this dialog and menu.

The default path for Screen Images is

My Documents\`<mode name>`\screen.

where `<mode name>` is the parameter used to select the mode with the INST:SEL command (for example, SA for the Spectrum Analyzer).

Key Path	Save, Screen Image
Notes	Brings up Save As dialog for saving a Screen Image Save Type
Initial S/W Revision	Prior to A.02.00

### Mass Storage Catalog (Remote Command Only)

Key path	SCPI Only
<b>Remote Command</b>	:MMEMory:CATalog? [ <code>&lt;directory_name&gt;</code> ]
Notes	<p>The string must be a valid logical path.</p> <p>Queries disk usage information (drive capacity, free space available) and obtains a list of files and directories in a specified directory in the following format:</p> <p><code>&lt;numeric_value&gt;,&lt;numeric_value&gt;,{&lt;file_entry&gt;}</code></p> <p>It returns two numeric parameters and as many strings as there are files and directories. The first</p>

parameter indicates the total amount of storage currently used in bytes. The second parameter indicates the total amount of storage available, also in bytes. The <file\_entry> is a string. Each <file\_entry> indicates the name, type, and size of one file in the directory list:

<file\_name>,<file\_type>,<file\_size>

As the windows file system has an extension that indicates file type, <file\_type> is always empty. <file\_size> provides the size of the file in bytes. For directories, <file\_entry> is surrounded by square brackets and both <file\_type> and <file\_size> are empty

---

Initial S/W Revision      Prior to A.02.00

---

### Mass Storage Change Directory (Remote Command Only)

---

Key path                    SCPI Only

**Remote Command**        :MMEMory:CDIRectory [<directory\_name>]  
                               :MMEMory:CDIRectory?

**Notes**                    The string must be a valid logical path.  
 Changes the default directory for a mass memory file system. The <directory\_name> parameter is a string. If no parameter is specified, the directory is set to the \*RST value.  
 At \*RST, this value is set to the default user data storage area, that is defined as System.Environment.SpecialFolder.Personal.  
 Query returns full path of the default directory.

---

Initial S/W Revision      Prior to A.02.00

---

### Mass Storage Copy (Remote Command Only)

---

Key path                    SCPI Only

**Remote Command**        :MMEMory:COPY <string>,<string>[,<string>,<string>]

**Notes**                    The string must be a valid logical path.  
 Copies an existing file to a new file or an existing directory to a new directory.  
 Two forms of parameters are allowed. The first form has two parameters. In this form, the first parameter specifies the source, and the second parameter specifies the destination.  
 The second form has four parameters. In this form, the first and third parameters specify the source. The second and fourth parameters specify the directories. The first pair of parameters specifies the source. The second pair specifies the destination. An error is generated if the source doesn't exist or the destination file already exists.  
 This command will generate an "access denied" error if the destination is a restricted folder (e.g., C:\Windows) and the current user does not have Power User or Administrator privileges.

### Mass Storage Device Copy (Remote Command Only)

This command transfers data to/from a file and a peripheral device.

Key path	SCPI Only
<b>Remote Command</b>	:MMEMory:COpy:DEvice <source_string>,<dest_string>
Notes	The strings must be a valid logical path or a valid device keyword. If the dest_string is a device keyword, the data is copied from the source file to the device. If the source_string is a device keyword, the data is copied to the source file from the device.  Valid device keywords are: SNS (smart noise source)  An error is generated if the file or device is not found.

### Mass Storage Delete (Remote Command Only)

Key path	SCPI Only
<b>Remote Command</b>	:MMEMory:DElete <file_name>[,<directory_name>]
Notes	The string must be a valid logical path.  Removes a file from the specified directory. The <file_name> parameter specifies the file name to be removed. This command will generate an “access denied” error if the file is in a restricted folder (e.g., C:\Windows) and the current user does not have Power User or Administrator privileges.
Initial S/W Revision	Prior to A.02.00

### Mass Storage Data (Remote Command Only)

Creates a file containing the specified data OR queries the data from an existing file.

Key path	SCPI Only
<b>Remote Command</b>	:MMEMory:DATA <file_name>, <data>  :MMEMory:DATA? <file_name>
Notes	The string must be a valid logical path.  The command form is MMEMory:DATA <file_name>,<data>. It loads <data> into the file <file_name>. <data> is in 488.2 block format. <file_name> is string data.  The query form is MMEMory:DATA? <file_name> with the response being the associated <data> in block format.
Initial S/W Revision	Prior to A.02.00

### Mass Storage Make Directory (Remote Command Only)

Key path	SCPI Only
<b>Remote Command</b>	:MMEMory:MDIRectory <directory_name>
Notes	The string must be a valid logical path.  Creates a new directory. The <directory_name> parameter specifies the name to be created.

---

	This command will generate an “access denied” error if the new directory would be in a restricted folder (e.g., C:\Windows) and the current user does not have Power User or Administrator privileges.
Initial S/W Revision	Prior to A.02.00

---

### Mass Storage Move (Remote Command Only)

---

Key path	SCPI Only
<b>Remote Command</b>	:MMEMory:MOVE <string>,<string>[,<string>,<string>]
Notes	<p>The string must be a valid logical path.</p> <p>Moves an existing file to a new file or an existing directory to a new directory.</p> <p>Two forms of parameters are allowed. The first form has two parameters. In this form, the first parameter specifies the source, and the second parameter specifies the destination.</p> <p>The second form has four parameters. In this form, the first and third parameters specify the source. The second and fourth parameters specify the directories. The first pair of parameters specifies the source. The second pair specifies the destination. An error is generated if the source doesn't exist or the destination file already exists.</p> <p>This command will generate an “access denied” error if the destination is a restricted folder (e.g., C:\Windows) and the current user does not have Power User or Administrator privileges.</p>
Initial S/W Revision	Prior to A.02.00

---

### Mass Storage Remove Directory (Remote Command Only)

---

Key path	SCPI Only
<b>Remote Command</b>	:MMEMory:RDIRECTory <directory_name>
Notes	<p>The string must be a valid logical path.</p> <p>Removes a directory. The &lt;directory_name&gt; parameter specifies the directory name to be removed. All files and directories under the specified directory shall also be removed.</p> <p>This command will generate an “access denied” error if the folder is a restricted folder (e.g., C:\Windows) or is in a restricted folder and the current user does not have Power User or Administrator privileges.</p>
Initial S/W Revision	Prior to A.02.00

---



## Single (Single Measurement/Sweep)

Sets the analyzer for Single measurement operation. The single/continuous state is Meas Global, so the setting will affect all the measurements. If you are Paused, pressing Single does a Resume.

See ["More Information" on page 1333](#)

Key Path	Front-panel key
Example	:INIT:CONT OFF
Notes	See Cont key description.
Backwards Compatibility Notes	<p>For Spectrum Analysis mode in ESA and PSA, the Single hardkey and the INITiate:IMM switched from continuous measurement to single measurement and restarted sweeps and averages (displayed average count reset to 1), but did not restart Max Hold and Min Hold. In the X-Series, the Single hardkey and the INITiate:IMM command initiate a sweep/ measurement/ average sequence/hold sequence including MaxHold and MinHold.</p> <p>For Spectrum Analysis mode in ESA and PSA, the Single hardkey restarted the sweep regardless of whether or not you were in an active sweep or sweep sequence. In the X-Series, Restart does this but Single only restarts the sweep or sweep sequence if you are in the idle state.</p> <p>INIT[:IMM] in ESA &amp; PSA Spectrum Analysis Mode does an implied ABORT. In some other PSA Modes, INIT[:IMM] is ignored if not in the idle state. . The X-Series follows the ESA/PSA SA Mode model, which may cause some Modes to have compatibility problems.</p>
Initial S/W Revision	Prior to A.02.00

### More Information

See ["Restart" on page 2894](#) for details on the INIT:IMMEDIATE (Restart) function.

If you are already in single sweep, the INIT:CONT OFF command has no effect.

If you are already in Single Sweep, then pressing the Single key in the middle of a sweep does not restart the sweep or sequence. Similarly, pressing the Single key does not restart the sweep or sequence if the sweep is not in the idle state (for example, if you are taking a very slow sweep, or the analyzer is waiting for a trigger). Instead, it results in a message. "Already in Single, press Restart to initiate a new sweep or sequence". Even though pressing the Single key in the middle of a sweep does not restart the sweep, sending INIT:IMMEDIATE does reset it.

To take one more sweep without resetting the average count, increment the average count by 1, by pressing the step up key while **Average/Hold Number** is the active function, or sending the remote command CALC:AVER:TCON UP.

## Source

There is no Source control functionality for this measurement. When this key is pressed, the screen either displays a blank menu, or the previously-selected menu remains unchanged.

---

Key Path	Front-panel key
----------	-----------------

---

## Span X Scale

Accesses a menu of functions that enable you to set the horizontal scale parameters.

Key Path	Front-panel key
Initial S/W Revision	A.11.00

### Ref Value

Sets the X reference value.

Key Path	SPAN X Scale
Mode	BASIC, PNOISE, WCDMA, C2K, GSM, WIMAXOFDMA, TDSCDMA, 1XEVDO, DVB, DTMB, ISDBT, CMMB, LTE, LTETDD, DCTV, WLAN, MSR, LTEAFDD, LTEATDD
Remote Command	:DISPlay:SEMask:VIEW[1]:WINDow[1]:TRACe:X[:SCALE]:RLEVel <freq> :DISPlay:SEMask:VIEW[1]:WINDow[1]:TRACe:X[:SCALE]:RLEVel?
Example	DISP:SEM:VIEW:WIND:TRAC:X:RLEV 10 DISP:SEM:VIEW:WIND:TRAC:X:RLEV?
Notes	You must be in the mode that includes SEM measurement to use this command. Use :INSTrument:SElect to set the mode.
Couplings	If Auto Scaling is set to On, this value is automatically determined by the measurement result. When you set this value manually, Auto Scaling automatically changes to Off.
Preset	1.0 GHz
State Saved	Saved in instrument state.
Min	-1000 GHz
Max	1000 GHz
Default Unit	Hz
Initial S/W Revision	A.11.00

### Scale/Div

Sets the horizontal scale.

Key Path	SPAN X Scale
Mode	BASIC, PNOISE, WCDMA, C2K, GSM, WIMAXOFDMA, TDSCDMA, 1XEVDO, DVB, DTMB, ISDBT, CMMB, LTE, LTETDD, DCTV, WLAN, MSR, LTEAFDD, LTEATDD
Remote Command	:DISPlay:SEMask:VIEW[1]:WINDow[1]:TRACe:X[:SCALE]:PDIVision <freq> :DISPlay:SEMask:VIEW[1]:WINDow[1]:TRACe:X[:SCALE]:PDIVision ?
Example	DISP:SEM:VIEW:WIND:TRAC:X:PDIV 500 DISP:SEM:VIEW:WIND:TRAC:X:PDIV?

Notes	You must be in a mode that includes the SEM measurement to use this command. Use INSTRUMENT:SElect to set the mode.
Couplings	If Auto Scaling is set to On, this value is automatically determined by the measurement result. When you set this value manually, Auto Scaling automatically changes to Off.
Preset	Automatically Calculated
State Saved	Yes Saved in instrument state.
Min	1 Hz
Max	10.0 GHz
Initial S/W Revision	A.11.00

## Ref Position

Sets the reference position for the X axis to Left, Center or Right.

Key Path	SPAN X Scale
Mode	BASIC, PNOISE, WCDMA, C2K, GSM, WIMAXOFDMA, TDSCDMA, 1XEVD0, DVB, DTMB, ISDBT, CMMB, LTE, LTETDD, DCTV, WLAN, MSR, LTEAFDD, LTEATDD
Remote Command	:DISPlay:SEMAsk:VIEW[1]:WINDow[1]:TRACe:X[:SCALe]:RPOSition LEFT   CENTER   RIGHT :DISPlay:SEMAsk:VIEW[1]:WINDow[1]:TRACe:X[:SCALe]:RPOSition?
Example	DISP:SEM:VIEW:WIND:TRAC:X:RPOS LEFT DISP:SEM:VIEW:WIND:TRAC:X:RPOS?
Notes	You must be in a mode that includes the SEM measurement to use this command. Use INSTRUMENT:SElect to set the mode.
Preset	CENTER
State Saved	Yes Saved in instrument state.
Range	Left Ctr Right
Initial S/W Revision	A.11.00

## Auto Scaling

Toggles the scale coupling function between On and Off.

Key Path	SPAN X Scale
Mode	BASIC, PNOISE, WCDMA, C2K, GSM, WIMAXOFDMA, TDSCDMA, 1XEVD0, DVB, DTMB, ISDBT, CMMB, LTE, LTETDD, DCTV, WLAN, MSR, LTEAFDD, LTEATDD
Remote Command	:DISPlay:SEMAsk:VIEW[1]:WINDow[1]:TRACe:X[:SCALe]:COUPlE 0   1   OFF   ON :DISPlay:SEMAsk:VIEW[1]:WINDow[1]:TRACe:X[:SCALe]:COUPlE?
Example	DISP:SEM:VIEW:WIND:TRAC:X:COUP ON

DISP:SEM:VIEW:WIND:TRAC:X:COUP?	
Notes	You must be in a mode that includes the SEM measurement to use this command. Use INSTRument:SElect to set the mode.
Couplings	When Auto Scaling is On and the Restart front-panel key is pressed, this function automatically determines the scale per division and reference values based on the measurement results. When you set a value to either Scale/Div or Ref Value manually, Auto Scaling automatically changes to Off.
Preset	1
State Saved	Yes Saved in instrument state.
Range	On Off
Initial S/W Revision	A.11.00

## Sweep/Control

Displays a menu that enables you to set up and control the sweep time, gate method, and source of the current measurement. See "[Sweep/Control](#)" on page 2925 for more information.

Key Path	Front-panel key
Initial S/W Revision	Prior to A.02.00

### Pause

Pauses a measurement after the current data acquisition is complete. When Paused, the label on the key changes to Resume. Pressing the Resume key resumes the measurement at the point it was at when paused. See "[Pause/Resume](#)" on page 2925 for more details.

Key Path	Sweep/Control
Initial S/W Revision	Prior to A.02.00

### Gate

Accesses a menu that enables you to control the gating function. The Gate functionality is used to view signals best viewed by qualifying them with other events.

Gate setup parameters are the same for all measurements – they do not change as you change measurements. Settings like these are called “Meas Global” and are unaffected by Meas Preset.

Note that Sweep Time autocoupling rules and annotation are changed by Gate being on.

Key Path	Sweep/Control
Scope	Meas Global
Readback	The state and method of Gate, as [Off, LO] or [On, Video]. Note that for measurements that only support gated LO, the method is nonetheless read back, but always as LO.
Initial S/W Revision	Prior to A.02.00

### Gate On/Off

Turns the gate function on and off.

When the Gate Function is on, the selected Gate Method is used along with the gate settings and the signal at the gate source to control the sweep and video system with the gate signal. Not all measurements allow every type of Gate Methods.

When Gate is on, the annunciation in the measurement bar reflects that it is on and what method is used, as seen in the following "Gate: LO" annunciator graphic.

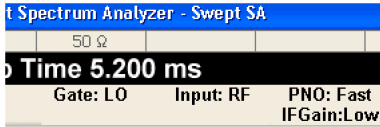

Key Path	Sweep/Control, Gate
Remote Command	[ :SENSe ] :SWEep:EGATe [ :STATe ] OFF ON 0 1 [ :SENSe ] :SWEep:EGATe [ :STATe ] ?
Example	SWE:EGAT ON SWE:EGAT?
Dependencies	<p>The function is unavailable (grayed out) and Off when:</p> <ul style="list-style-type: none"> <li>• Gate Method is LO or Video and FFT Sweep Type is manually selected.</li> <li>• Gate Method is FFT and Swept Sweep Type is manually selected.</li> <li>• Marker Count is ON.</li> </ul> <p>The following are unavailable whenever Gate is on:</p> <ul style="list-style-type: none"> <li>• FFT under Sweep Type when Method=LO or Video or Swept under Sweep Type when Method=FFT</li> <li>• Marker Count</li> </ul> <p>While Gate is on, the Auto Rules for Sweep Type are modified so that the choice agrees with the Gate Method: i.e., FFT for Method = FFT and Swept for Method = LO or Video.</p> <p>The Gate softkey and all SCPI under the [:SENSe]:SWEep:EGATe SCPI node are grayed out when Source Mode is Tracking with an external source. This is because the Gate circuitry is used to sync the external source. If the Tracking Source is turned on, the Gate is turned off.</p> <p>When in the ACP measurement:</p> <ul style="list-style-type: none"> <li>• When Meas Method is RBW or FAST, this function is unavailable and the key is grayed out.</li> <li>• Whenever Gate is on, Meas Method, RBW or FAST is unavailable and keys for those are grayed out.</li> <li>• When Gate is on, Offset Res BW and Offset Video BW are ignored (if you set these values) and the measurement works as if all Offset Res BW and all Offset Video BW are coupled with the Res BW and the Video BW under the BW menu. When Gate is on, the Offset BW key in the Offset/Limit menu is grayed out.</li> </ul>
Preset	Off LTETDD: On
State Saved	Saved in instrument state
Range	On Off
Backwards Compatibility SCPI	[ :SENSe ] :SWEep:TIME:GATE[:STATe] ESA compatibility
Backwards Compatibility Notes	In ESA, Trig Delay (On) and Gate (On) could not be active at the same time.. This dependency does not exist in PSA or in the X-Series.
Initial S/W Revision	Prior to A.02.00

### Gate View On/Off

Turning on Gate View in the Swept SA measurement provides a single-window gate view display..

Turning on Gate View in other measurements shows the split-screen Gate View. In these measurements, when the Gate View is on, the regular view of the current measurement traces and results are reduced vertically to about 70% of the regular height. The Zero Span window, showing the positions of the Gate, is shown between the Measurement Bar and the reduced measurement window. By reducing the height of the measurement window, some of the annotation on the Data Display may not fit and is not shown.

<b>Key Path</b>	Sweep/Control, Gate
<b>Remote Command</b>	[ :SENSe ] :SWEep:EGATe:VIEW ON OFF 1 0 [ :SENSe ] :SWEep:EGATe:VIEW?
<b>Example</b>	SWE:EGAT:VIEW ON turns on the gate view.
<b>Dependencies</b>	In the Swept SA measurement: In Gate View, the regular Sweep Time key is grayed out . When pressed, the grayed out key puts up the informational message "Use Gate View Sweep Time in the Gate menu." In the other measurements: When you turn Gate View on, the lower window takes on the current state of the instrument. Upon leaving Gate View, the instrument takes on the state of the lower window. When you turn Gate View on, the upper window Sweep Time is set to the gate view sweep time.
<b>Couplings</b>	These couplings apply to the Swept SA measurement: <ul style="list-style-type: none"> <li>• When Gate View is turned on, the instrument is set to Zero Span.</li> <li>• Gate View automatically turns off whenever a Span other than Zero is selected.</li> <li>• Gate View automatically turns off if you press the Last Span key while in Gate View, and the instrument returns to the Span it was in before entering Gate View (even if that is Zero Span).</li> <li>• When Gate View is turned on, the sweep time used is the gate view sweep time. This is set according to the rules in section "<a href="#">Gate View Setup</a>" on page 2725</li> <li>• When Gate View is turned off, Sweep Time is set to the normal Swept SA measurement sweep time.</li> <li>• If Gate View is on and Gate is off, then turning on Gate turns off Gate View.</li> </ul>
<b>Preset</b>	OFF
<b>State Saved</b>	Saved in instrument state
<b>Range</b>	On Off
<b>Initial S/W Revision</b>	Prior to A.02.00

A sample of the Gate View screen in the Swept SA measurement is shown in the following graphic :



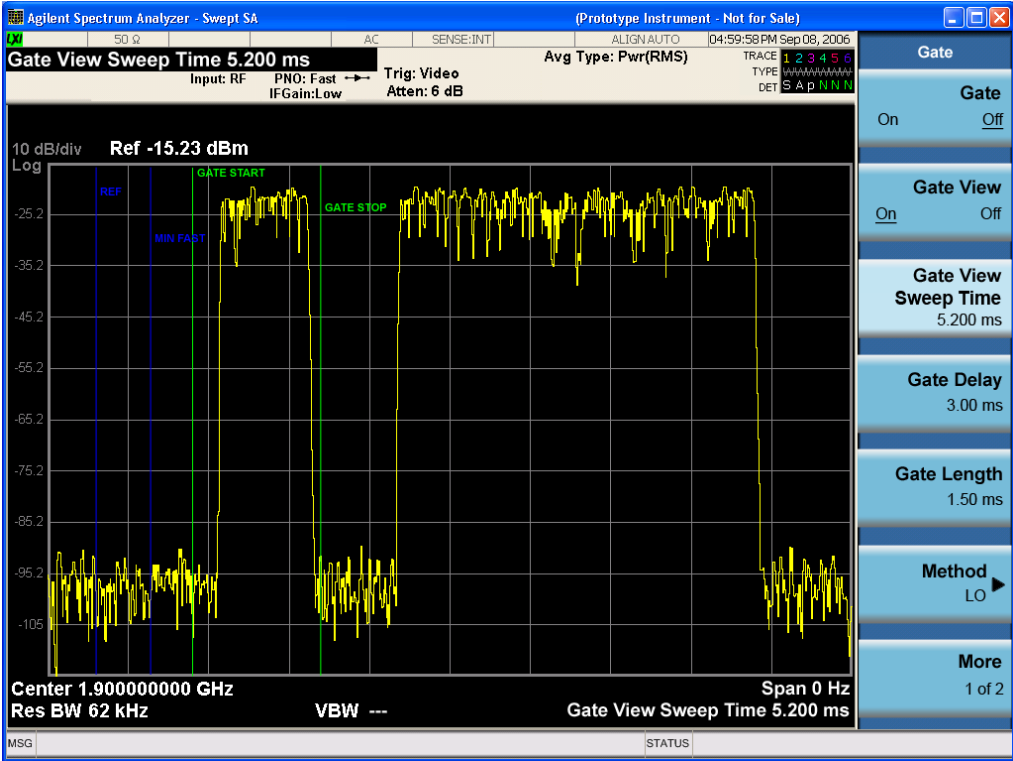

A sample of the Gate View screen in other measurements is shown in the following graphic. This example is for the ACP measurement:

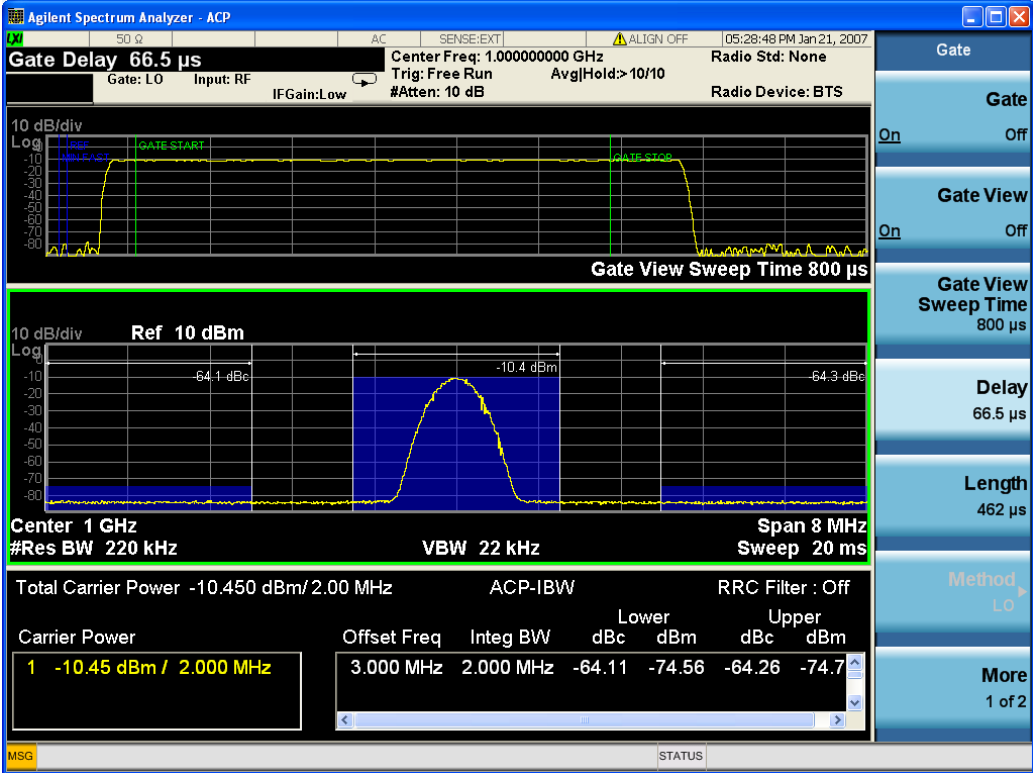

Turning Gate View off returns the analyzer to the Normal measurement view.

In the Swept SA, the normal measurement view is the single-window Swept SA view. When returning to this view, the Swept SA measurement returns to the Span it was in before entering **Gate View** (even if that is Zero Span).

The **Gate View** window is triggered from the Gate Source, with zero trigger delay. Also, when updating the **Gate View** window, the Gate itself must not operate. So it is internally shut off while the gate view window is being updated. For the Swept SA measurement, this means that the Gate is internally shut off whenever the gate view window is displayed. The measurement bar and softkeys continue to show the Trigger source for the main sweep window and give no indication that the Gate is shut off or that the Gate View window is triggered from the Gate Source.

When in **Gate View**, vertical lines are displayed in the Gate View window as follows:

- Green lines are displayed at the gate edges as follows: in Edge Gate, a line is shown for Delay and one for the end of the Gate period, defined by Length. In Level Gate a line is shown only for Delay. You can adjust the position of the green lines by adjusting the gate length and the gate delay. These lines update in the Gate View window as the active function changes, even if the window is not being updated. In Gated LO and Gated Video, these lines are positioned relative to the delay reference line (not relative to 0 time). In Gated FFT, their location is relative to the left edge of the screen.
- A blue line is displayed showing the delay reference, that is, the reference point for the Gate Delay within the Zero Span window. The blue line represents where (in time) the effective location of the gate start would be if the gate were programmed to zero delay.
- 
- The second blue line is labeled "MIN FAST" as shown in the figure above because it represents the minimum Gate Delay for fast Gated LO operation. This line is only displayed in Gated LO. You cannot scroll (knob) or decrement (down key) the Gate Delay to less than that represented by the position of this line, it can only be set below this position manually, although once there it can be moved freely with the knob while below the line.
- A yellow line in the Gated Video case only, is displayed at Blength, where Blength is the display point (bucket) length for the swept trace, which is given by the sweep time for that trace divided by number of Points – 1. So it is referenced to 0 time, not to the delay reference. This line is labeled NEXT PT (it is not shown in the figure above because the figure above is for Gated LO).
- The yellow line represents the edge of a display point (bucket). Normally in Gated Video, the bucket length must be selected so that it exceeds the off time of the burst. There is another way to use the analyzer in Gated Video measurements, and that is to set the bucket width much shorter than the off time of the burst. Then use the Max Hold trace function to fill in "missing" buckets more slowly. This allows you to see some of the patterns of the Gated Video results earlier, though seeing a completely filled-in spectrum later.

## Gate View Setup

Accesses a menu that enables you to setup parameters relevant to the Gate View

Key Path	Sweep/Control, Gate
Scope	Meas Global
Initial S/W Revision	A.10.00

## Gate View Sweep Time

Controls the sweep time in the Gate View window. To provide an optimal view of the gate signal, the analyzer initializes Gate View Sweep Time based on the current settings of Gate Delay and Gate Length.

<b>Key Path</b>	Sweep/Control, Gate, Gate View Setup
<b>Remote Command</b>	[ :SENSe ] :SWEep:EGATe:TIME <time> [ :SENSe ] :SWEep:EGATe:TIME?
<b>Example</b>	SWE:EGAT:TIME 500 ms
<b>Dependencies</b>	Gate View Sweep Time is initialized: <ul style="list-style-type: none"> <li>• On Preset (after initializing delay and length).</li> <li>• Every time the Gate Method is set/changed.</li> </ul> <p>Additionally, in the Swept SA measurement, whenever you do a Preset, or leave Gate View, the analyzer remembers the Gate Delay and Gate Length settings. Then, when returning to Gate View, if the current Gate Delay and/or Gate Length do not match the remembered values Gate View Sweep Time is re-initialized.</p> <ol style="list-style-type: none"> <li>1. Compute the location of the "gate stop" line, which you know is at time <math>t = t_{min} + \text{GateDelay} + \text{GateLength}</math>.</li> </ol>
<b>Preset</b>	519.3 $\mu$ s WiMAX OFDMA: 5 ms GSM/EDGE: 1 ms
<b>State Saved</b>	Saved in instrument state
<b>Max</b>	6000 s
<b>Initial S/W Revision</b>	Prior to A.02.00

## Gate View Start Time

Controls the time at the left edge of the Gate View.

<b>Key Path</b>	Sweep/Control, Gate, Gate View Setup
<b>Remote Command</b>	[ :SENSe ] :SWEep:EGATe:VIEW:STARt <time> [ :SENSe ] :SWEep:EGATe:VIEW:STARt?
<b>Example</b>	SWE:EGAT:VIEW:STAR 10ms
<b>Notes</b>	Units of time are required or no units; otherwise an invalid suffix error message will be generated. See error -131.
<b>Preset</b>	0 ms
<b>State Saved</b>	Saved in instrument state
<b>Min</b>	0
<b>Max</b>	500 ms
<b>Initial S/W Revision</b>	A.10.00

## Gate Delay

Controls the length of time from the time the gate condition goes True until the gate is turned on.

Key Path	Sweep/Control, Gate
Remote Command	[ :SENSe ] :SWEep:EGATe:DELay <time> [ :SENSe ] :SWEep:EGATe:DELay?
Example	SWE:EGAT:DELay 500ms SWE:EGAT:DELay?
Notes	Units of time are required or no units; otherwise an invalid suffix error message will be generated.
Preset	57.7 us WiMAX OFDMA: 71 us GSM/EDGE: 600 us WLAN: 500 us
State Saved	Saved in instrument state
Min	0.0 us
Max	100 s
Backwards Compatibility SCPI	[ :SENSe ] :SWEep:TIME:GATE:DELay ESA compatibility
Initial S/W Revision	Prior to A.02.00

## Gate Length

Controls the length of time that the gate is on after it opens.

Key Path	Sweep/Control, Gate
Remote Command	[ :SENSe ] :SWEep:EGATe:LENGth <time> [ :SENSe ] :SWEep:EGATe:LENGth?
Example	SWE:EGAT:LENG 1 SWE:EGAT:LENG?
Notes	Units of time are required or no units; otherwise an invalid suffix error message will be generated.
Dependencies	<p>Grayed out when Gate Method is set to FFT in which case the label changes to that shown below.</p>  <p>The key is also grayed out if Gate Control = Level.</p>
Preset	461.6 us

	WiMAX OFDMA: 50 us GSM/EDGE: 200 us WLAN: 1.54 ms
State Saved	Saved in instrument state
Min	100 ns
Max	5 s
<b>Backwards Compatibility SCPI</b>	[:SENSe]:SWEep:TIME:GATE:LENGth ESA compatibility
Initial S/W Revision	Prior to A.02.00

## Gate Source

The menus under the Gate Source key are the same as those under the Trigger key, with the exception that neither Free Run nor Video are available as Gate Source selections. However, a different SCPI command is used to select the Gate Source (see table below) because you may independently set the Gate Source and the Trigger Source.

Any changes to the settings in the setup menus under each Gate Source selection key (for example: Trigger Level, Trigger Delay, etc.) also affect the corresponding settings under the Trigger menu keys. The SCPI commands used for these are the same for Trigger and Gate, since there is only one setting which affects both Gate and Trigger. Example: to set the Trigger Level for External 1 you use the command :TRIG:EXT1:LEV regardless of whether you are using External 1 as a Trigger Source or a Gate Source.

Key Path	Sweep/Control, Gate
<b>Remote Command</b>	[:SENSe]:SWEep:EGATe:SOURce EXTernal1   EXTernal2   LINE   FRAME   RFBurst  [:SENSe]:SWEep:EGATe:SOURce?
Dependencies	In some models, there is no second External input. In these models, the External 2 key is blanked and the EXTernal2 parameter will generate a "Hardware missing; Not available for this model number" error.
Preset	EXTernal 1 GSM/EDGE, MSR: FRAME LTETDD: EXTernal 1When Direction is Downlink, FRAME when Direction is Uplink.
Backwards Compatibility Notes	In ESA, there is a single Gate input port. In PSA, the Gate Source may be taken from one of two specified input ports. In the X-Series, any Trigger Source can be a Gate Source.
Initial S/W Revision	Prior to A.02.00
Modified at S/W Revision	A.03.00, A.14.00

## Line

Pressing this key, when it is not selected, selects the line signal as the trigger. A new sweep/measurement will start synchronized with the next cycle of the line voltage. Pressing this key, when it is already selected, access the line trigger setup menu.

Key Path	Trigger
<b>Example</b>	TRIG:SOUR LINE Swept SA measurement TRIG:<meas>:SOUR LINE Measurements other than Swept SA
Dependencies	Line trigger is not available when operating from a "dc power source", for example, when the instrument is powered from batteries.
State Saved	Saved in instrument state
Status Bits/OPC dependencies	The Status Operation Register bit 5 "Waiting for Trigger" is set at the same time as the Sweeping or Measuring bit is set. It is cleared when the trigger actually occurs (that is, after the trigger event occurs and all the applicable trigger criteria have been met). A corresponding pop-up message ("Waiting for trigger") is generated if no trigger signal appears after approximately 2 sec. This message goes away when a trigger signal appears.
Initial S/W Revision	Prior to A.02.00

## Trig Slope

Controls the trigger polarity. It is set positive to trigger on a rising edge and negative to trigger on a falling edge.

Key Path	Trigger, Line
<b>Remote Command</b>	:TRIGger[:SEquence]:LINE:SLOPe POSitive NEGative :TRIGger[:SEquence]:LINE:SLOPe?
<b>Example</b>	TRIG:LINE:SLOP NEG
Preset	POSitive
State Saved	Saved in instrument state
Backwards Compatibility Notes	The legacy :TRIGger[:SEquence]:SLOPe command affects the slopes for the VID, LINE, EXT1, EXT2, and RFB triggers.
Initial S/W Revision	Prior to A.02.00

## External 1

Pressing this key, when it is not selected, selects an external input signal as the trigger. A new sweep/measurement will start when the external trigger condition is met using the external 1 input connector on the rear panel.

Pressing this key, when it is already selected, accesses the external 1 trigger setup menu.

Key Path	Trigger
<b>Example</b>	TRIG:SOUR EXT1 Swept SA measurement TRIG:<meas>:SOUR EXT1 Measurements other than Swept SA
Dependencies	Grayed out if in use by Point Trigger in the Source Setup menu. Forced to Free Run if already selected and Point Trigger is set to External 1.
State Saved	Saved in instrument state
Status Bits/OPC dependencies	The Status Operation Register bit 5 "Waiting for Trigger" is set at the same time as the Sweeping or Measuring bit is set. It is cleared when the trigger actually occurs (that is, after the trigger event occurs and all the applicable trigger criteria have been met). A corresponding pop-up message ("Waiting for trigger") is generated if no trigger signal appears after approximately 2 sec. This message goes away when a trigger signal appears.
Initial S/W Revision	Prior to A.02.00

### Trigger Level

Sets the value where the external 1 trigger input will trigger a new sweep/measurement.

Key Path	Trigger, External 1
<b>Remote Command</b>	:TRIGger[:SEquence]:EXTernal1:LEVel <level> :TRIGger[:SEquence]:EXTernal1:LEVel?
<b>Example</b>	TRIG:EXT1:LEV 0.4 V
Couplings	This same level is used for the Ext1 trigger source in the Trigger menu, for the Ext1 selection in the Periodic Timer sync source (in the Trigger menu and in the Gate Source menu), and also for the Ext1 selection in the Gate Source menu.
Preset	1.2 V
State Saved	Saved in instrument state
Min	-5 V
Max	5 V
Default Unit	V
<b>Backwards Compatibility SCPI</b>	:TRIGger[:SEquence]:EXTernal:LEVel For backward compatibility, the parameter EXTernal is mapped to EXTernal1
<b>Backwards Compatibility SCPI</b>	:TRIGger[:SEquence]:FRAME:EXTernal1:LEVel
Initial S/W Revision	Prior to A.02.00

### Trig Slope

Controls the trigger polarity. It is set positive to trigger on a rising edge and negative to trigger on a falling edge.

Key Path	Trigger, External 1
Remote Command	:TRIGger[:SEquence]:EXTErnal1:SLOPe POSitive NEGative :TRIGger[:SEquence]:EXTErnal1:SLOPe?
Example	TRIG:EXT1:SLOP NEG
Couplings	This same slope is used in the Ext1 selection for the trigger source in the Trigger menu and for the period timer sync source (in the Trigger menu and in the Gate Source menu).
Preset	POSitive
State Saved	Saved in instrument state
Backwards Compatibility SCPI	:TRIGger[:SEquence]:EXTErnal:SLOPe For backward compatibility, the parameter EXTErnal is mapped to EXTErnal1
Backwards Compatibility SCPI	:TRIGger[:SEquence]:FRAMe:EXTErnal1:SLOPe
Backwards Compatibility Notes	The legacy :TRIGger[:SEquence]:SLOPe command affects the slopes for the VID, LINE, EXT1, EXT2, and RFB triggers.
Initial S/W Revision	Prior to A.02.00

## External 2

Pressing this key, when it is not selected, selects an external input signal as the trigger. A new sweep/measurement will start when the external trigger condition is met using the external 2 input connector. The external trigger 2 input connector is on the rear panel.

Pressing this key, when it is already selected, accesses the external 2 trigger setup menu.

Key Path	Trigger
Example	TRIG:SOUR EXT2 Swept SA measurement TRIG:<meas>:SOUR EXT2 Measurements other than Swept SA
Dependencies	In some models, there is no second External input. In these models, the External 2 key is blanked and the EXTErnal2 parameter will generate a "Hardware missing; Not available for this model number" message.  Grayed out if in use by Point Trigger in the Source Setup menu. Forced to Free Run if already selected and Point Trigger is set to External 2.
State Saved	Saved in instrument state
Status Bits/OPC dependencies	The Status Operation Register bit 5 "Waiting for Trigger" is set at the same time as the Sweeping or Measuring bit is set. It is cleared when the trigger actually occurs (that is, after the trigger event occurs and all the applicable trigger criteria have been met). A corresponding pop-up message ("Waiting for trigger") is generated if no trigger signal appears after approximately 2 sec. This message goes away when a trigger signal appears.
Initial S/W Revision	Prior to A.02.00
Modified at S/W Revision	A.03.00



## Trigger Level

Sets the value where the external 2 trigger input will trigger a new sweep/measurement.

Key Path	Trigger, External 2
<b>Remote Command</b>	:TRIGger[:SEquence]:EXTernal2:LEVel :TRIGger[:SEquence]:EXTernal2:LEVel?
<b>Example</b>	TRIG:EXT2:LEV 1.1 V
Couplings	This same level is used for the Ext2 trigger source in the Trigger menu, for the Ext2 selection in the Periodic Timer sync source (in the Trigger menu and in the Gate Source menu), and also for the Ext2 selection in the Gate Source menu.
Preset	1.2 V
State Saved	Saved in instrument state
Min	-5 V
Max	5 V
Default Unit	V
<b>Backwards Compatibility SCPI</b>	:TRIGger[:SEquence]:FRAMe:EXTernal2:LEVel
Initial S/W Revision	Prior to A.02.00

## Trig Slope

Controls the trigger polarity. It is set positive to trigger on a rising edge and negative to trigger on a falling edge.

Key Path	Trigger, External 2
<b>Remote Command</b>	:TRIGger[:SEquence]:EXTernal2:SLOPe POSitive NEGative :TRIGger[:SEquence]:EXTernal2:SLOPe?
<b>Example</b>	TRIG:EXT2:SLOP NEG
Couplings	This same slope is used in the Ext2 selection for the trigger source in the Trigger menu and for the period timer sync source (in the Trigger menu and in the Gate Source menu).
Preset	POSitive
State Saved	Saved in instrument state
<b>Backwards Compatibility SCPI</b>	:TRIGger[:SEquence]:FRAMe:EXTernal2:SLOPe
Backwards Compatibility Notes	The legacy :TRIGger[:SEquence]:SLOPe command affects the slopes for the VID, LINE, EXT1, EXT2, and RFB triggers.
Initial S/W Revision	Prior to A.02.00

## RF Burst

Pressing this key, when it is not selected, selects the RF Burst as the trigger. A new sweep/measurement will start when an RF burst envelope signal is identified from the signal at the RF Input connector. Pressing this key, when it is already selected, accesses the RF Burst trigger setup menu.

In some models, a variety of burst trigger circuitry is available, resulting in various available burst trigger bandwidths. The analyzer automatically chooses the appropriate trigger path based on the hardware configuration and other settings of the analyzer.

Key Path	Trigger
<b>Example</b>	TRIG:SOUR RFB Swept SA measurement TRIG:< meas>:SOUR RFB Measurements other than Swept SA
State Saved	Saved in instrument state
Status Bits/OPC dependencies	The Status Operation Register bit 5 "Waiting for Trigger" is set at the same time as the Sweeping or Measuring bit is set. It is cleared when the trigger actually occurs (that is, after the trigger event occurs and all the applicable trigger criteria have been met). A corresponding pop-up message ("Waiting for trigger") is generated if no trigger signal appears after approximately 2 sec. This message goes away when a trigger signal appears.
Backwards Compatibility Notes	The legacy command: :TRIGger[:SEQuence]:RFBurst:FSElectivity[:STATe] OFF ON 0 1 is not supported in the X-Series, as the hardware to do Frequency Selective burst triggers does not exist in X-Series.
Initial S/W Revision	Prior to A.02.00
Modified at S/W Revision	A.04.00

## Absolute Trigger Level

Sets the absolute trigger level for the RF burst envelope.

When using the External Mixing path, the Absolute Trigger Level is uncalibrated because the factory default was set to accommodate the expected IF levels for the RF path.

Key Path	Trigger, RF Burst
Scope	Meas Global
<b>Remote Command</b>	:TRIGger[:SEQuence]:RFBurst:LEVel:ABSolute <ampl> :TRIGger[:SEQuence]:RFBurst:LEVel:ABSolute?
<b>Example</b>	TRIG:RFB:LEV:ABS 10 dBm sets the trigger level of the RF burst envelope signal to the absolute level of 10 dBm
Notes	Sending this command does not switch the setting from relative to absolute; to switch it you need to send the :TRIGger[:SEQuence]:RFBurst:LEVel:TYPE command, below. Amplitude Corrections are not taken into account by the Absolute Trigger Level. For example, if you have given yourself effective gain with an amplitude correction factor, the Absolute Trigger will not fire until you have set the trigger level that far below the displayed signal level, rather than simply to

	the displayed signal level. This is only true for Amplitude Corrections, not External Gain or Ref Level Offset functions. If mode is Bluetooth, the default value is -50 dBm.
Couplings	This same level is used for the RF Burst trigger source in the Trigger menu, for the RF Burst selection in the Periodic Timer sync source (in the Trigger menu and in the Gate Source menu), and also for the RF Burst selection in the Gate Source menu
Preset	-20 dBm
State Saved	Saved in instrument state
Min	-200 dBm
Max	100 dBm
Default Unit	depends on the current selected Y-Axis unit
<b>Backwards Compatibility SCPI</b>	:TRIGger[:SEquence]:FRAMe:RFBurst:LEVel:ABSolute
Initial S/W Revision	Prior to A.02.00
Modified at S/W Revision	A.04.00

Key Path	Trigger, RF Burst
<b>Remote Command</b>	:TRIGger[:SEquence]:RFBurst:LEVel:TYPE ABSolute RELative :TRIGger[:SEquence]:RFBurst:LEVel:TYPE?
<b>Example</b>	TRIG:RFB:LEV:TYPE REL sets the trigger level type of the RF burst trigger to Relative.
Preset	ABSolute
State Saved	Saved in instrument state
Initial S/W Revision	Prior to A.02.00
Modified at S/W Revision	A.04.00

### Relative Trigger Level

Sets the relative trigger level for the RF burst envelope.

In some models, the relative burst trigger function is implemented in hardware. In other models, without the advanced triggering hardware required, the relative burst trigger function is implemented in software in some measurements, and is unavailable in other measurements.

When implemented in software, the relative RF Burst trigger function is implemented as follows:

1. The measurement starts with the absolute RF Burst trigger setting. If it cannot get a trigger with that level, auto trigger fires and the acquisition starts anyway. After the acquisition, the measurement searches for the peak in the acquired waveform and saves it.

2. Now, in the next cycle of the measurement, the measurement determines a new absolute RF Burst level based on the peak value from the first measurement and the Relative RF Burst Trigger Level (always 0 or negative dB) set by the user. The following formula is used:
3. absolute RF Burst level = peak level of the previous acquisition + relative RF Burst level
4. If the new absolute RF Burst level differs from the previous by more than 0.5 dB, the new level is sent to the hardware; otherwise it is not updated (to avoid slowing down the acquisition)

Steps 2 and 3 repeat for subsequent measurements.

Key Path	Trigger, RF Burst
Scope	Meas Global
<b>Remote Command</b>	:TRIGger[:SEquence]:RFBurst:LEVel:RELative <rel_ampl> :TRIGger[:SEquence]:RFBurst:LEVel:RELative?
<b>Example</b>	TRIG:RFB:LEV:REL -10 dB sets the trigger level of the RF burst envelope signal to the relative level of -10 dB
Notes	Sending this command does not switch the setting from absolute to relative; to switch it you need to send the :TRIGger[:SEquence]:RFBurst:LEVel:TYPE command, above. The relative trigger level is not available in some measurements. In those measurements the RELative parameter, and the :TRIGger[:SEquence]:RFBurst:LEVel:TYPE command (above), will generate an error if sent.
Dependencies	This key is grayed out and Absolute Trigger Level selected if the required hardware is not present in your analyzer and the current measurement does not support Relative triggering.
Preset	-6 dB GSM: -25 dB
State Saved	Saved in instrument state
Min	-45 dB
Max	0 dB
Default Unit	dB or dBc
<b>Backwards Compatibility SCPI</b>	:TRIGger[:SEquence]:RFBurst:LEVel This legacy command is aliased to :TRIGger[:SEquence]:RFBurst:LEVel:RELative because the PSA had ONLY relative burst triggering
Initial S/W Revision	Prior to A.02.00
Modified at S/W Revision	A.04.00

### Trigger Slope

It is set positive to trigger on a rising edge and negative to trigger on a falling edge.

Key Path	Trigger, RF Burst
<b>Remote Command</b>	:TRIGger[:SEquence]:RFBurst:SLOPe POSitive NEGative :TRIGger[:SEquence]:RFBurst:SLOPe?

<b>Example</b>	TRIG:RFB:SLOP NEG
Couplings	This same slope is used in the RF Burst selection for the trigger source in the Trigger menu and for the period timer sync source (in the Trigger menu and in the Gate Source menu).
Preset	POSitive
State Saved	Saved in instrument state
<b>Backwards Compatibility SCPI</b>	:TRIGger[:SEQuence]:FRAMe:RFBurst:SLOPe
Backwards Compatibility Notes	The legacy :TRIGger[:SEQuence]:SLOPe command affects the slopes for the VID, LINE, EXT1, EXT2, and RFB triggers.
Initial S/W Revision	Prior to A.02.00

### Periodic Timer (Frame Trigger)

Pressing this key, when it is not selected, selects the internal periodic timer signal as the trigger. Triggering occurrences are set by the **Period** parameter, which is modified by the **Sync Source** and **Offset**. Pressing this key, when it is already selected, accesses the periodic timer trigger setup functions.

If you do not have a sync source selected (it is Off), then the internal timer will not be synchronized with any external timing events.

<b>Key Path</b>	<b>Trigger</b>
<b>Example</b>	TRIG:SOUR FRAM                      Swept SA measurement TRIG:<meas>:SOUR FRAM      Measurements other than Swept SA
State Saved	Saved in instrument state
Readback	[Sync: <value of Sync Source>], for example, [Sync: External 1]
Status Bits/OPC dependencies	The Status Operation Register bit 5 "Waiting for Trigger" is set at the same time as the Sweeping or Measuring bit is set. It is cleared when the trigger actually occurs (that is, after the trigger event occurs and all the applicable trigger criteria have been met). A corresponding pop-up message ("Waiting for trigger") is generated if no trigger signal appears after approximately 2 sec. This message goes away when a trigger signal appears.
Initial S/W Revision	Prior to A.02.00

### Periodic Timer Triggering:

This feature selects the internal periodic timer signal as the trigger. Trigger occurrences are set by the **Periodic Timer** parameter, which is modified by the **Sync Source** and **Offset**.

The figure below shows the action of the periodic timer trigger. Before reviewing the figure, we'll explain some uses for the periodic trigger.

A common application is measuring periodic burst RF signals for which a trigger signal is not easily available. For example, we might be measuring a TDMA radio which bursts every 20 ms. Let's assume that the 20 ms period is very consistent. Let's also assume that we do not have an external trigger source

available that is synchronized with the period, and that the signal-to-noise ratio of the signal is not high enough to provide a clean RF burst trigger at all of the analysis frequencies. For example, we might want to measure spurious transmissions at an offset from the carrier that is larger than the bandwidth of the RF burst trigger. In this application, we can set the Periodic Timer to a 20.00 ms period and adjust the offset from that timer to position our trigger just where we want it. If we find that the 20.00 ms is not exactly right, we can adjust the period slightly to minimize the drift between the period timer and the signal to be measured.

A second way to use this feature would be to use **Sync Source** temporarily, instead of **Offset**. In this case, we might tune to the signal in a narrow span and use the RF Burst trigger to synchronize the periodic timer. Then we would turn the sync source off so that it would not miss-trigger. Miss-triggering can occur when we are tuned so far away from the RF burst trigger that it is no longer reliable.

A third example would be to synchronize to a signal that has a reference time element of much longer period than the period of interest. In some CDMA applications, it is useful to look at signals with a short periodicity, by synchronizing that periodicity to the "even-second clock" edge that happens every two seconds. Thus, we could connect the even-second clock trigger to Ext1 and use then Ext1 as the sync source for the periodic timer.

The figure below illustrates this third example. The top trace represents the even-second clock. It causes the periodic timer to synchronize with the leading edge shown. The analyzer trigger occurs at a time delayed by the accumulated offset from the period trigger event. The periodic timer continues to run, and triggers continue to occur, with a periodicity determined by the analyzer time base. The timer output (labeled "late event") will drift away from its ideal time due to imperfect matching between the time base of the signal being measured and the time base of the analyzer, and also because of imperfect setting of the period parameter. But the synchronization is restored on the next even-second clock event. ("Accumulated offset" is described in the in the **Offset** function section.)

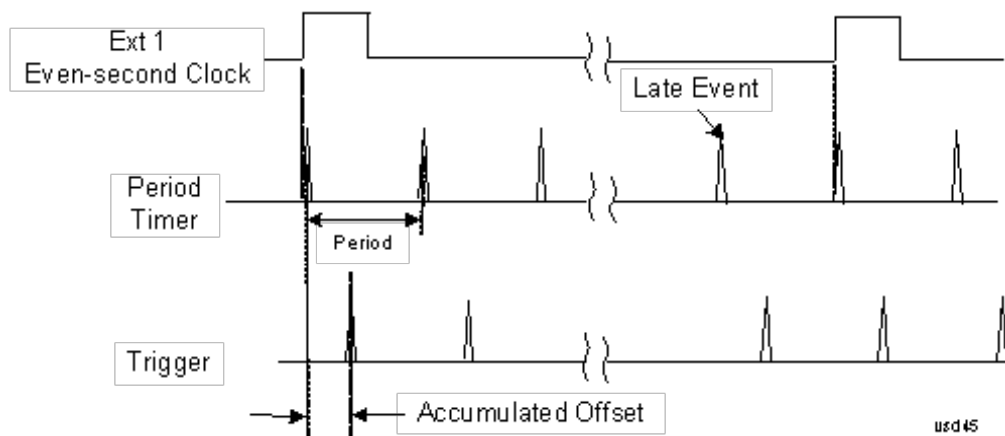

### Period

Sets the period of the internal periodic timer clock. For digital communications signals, this is usually set to the frame period of your current input signal. In the case that sync source is not set to OFF, and the external sync source rate is changed for some reason, the periodic timer is synchronized at the every external synchronization pulse by resetting the internal state of the timer circuit.

<b>Key Path</b>	Trigger, Periodic Timer
<b>Remote Command</b>	:TRIGger[:SEquence]:FRAME:PERiod <time>

	:TRIGger[:SEquence]:FRAMe:PERiod?
<b>Example</b>	TRIG:FRAM:PER 100 ms
Dependencies	The invalid data indicator turns on when the period is changed, until the next sweep/measurement completes.
Couplings	The same period is used in the Gate Source selection of the period timer.
Preset	20 ms GSM: 4.615383
State Saved	Saved in instrument state
Min	100.000 ns
Max	559.0000 ms
Default Unit	S
Initial S/W Revision	Prior to A.02.00

### Offset

Adjusts the accumulated offset between the periodic timer events and the trigger event. Adjusting the accumulated offset is different than setting an offset, and requires explanation.

The periodic timer is usually not synchronized with any external events, so the timing of its output events has no absolute meaning. Since the timing relative to external events (RF signals) is important, you need to be able to adjust (offset) it. However, you have no direct way to see when the periodic timer events occur. All that you can see is the trigger timing. When you want to adjust the trigger timing, you will be changing the internal offset between the periodic timer events and the trigger event. Because the absolute value of that internal offset is unknown, we will just call that the accumulated offset. Whenever the Offset parameter is changed, you are changing that accumulated offset. You can reset the displayed offset using Reset Offset Display. Changing the display does not change the value of the accumulated offset, and you can still make additional changes to accumulated offset.

To avoid ambiguity, we define that an increase in the "offset" parameter, either from the knob or the SCPI adjust command, serves to delay the timing of the trigger event.

Key Path	Trigger, Periodic Timer
<b>Remote Command</b>	:TRIGger[:SEquence]:FRAMe:OFFSet <time> :TRIGger[:SEquence]:FRAMe:OFFSet?
<b>Example</b>	TRIG:FRAM:OFFS 1.2 ms
Notes	The front panel interface (for example, the knob), and this command, adjust the accumulated offset, which is shown on the active function display. However, the actual amount sent to the hardware each time the offset is updated is the delta value, that is, the current accumulated offset value minus the previous accumulated offset value. Note that the accumulated offset value is essentially arbitrary; it represents the accumulated offset from the last time the offset was zeroed (with the Reset Offset Display key).  Note that this command does not change the period of the trigger waveform. Note also that Offset is used only when the sync source is set to OFF, otherwise delay is used, see section "Trig Delay" on page 461.

	An increase in the "offset" parameter, either from the knob or the SCPI adjust command, serves to delay the timing of the trigger event.
Notes	When the SCPI command is sent the value shown on the key (and the Active Function, if this happens to be the active function) is updated with the new value. However, the actual amount sent to the hardware is the delta value, that is, the current accumulated offset value minus the previous accumulated offset value.  The SCPI query simply returns the value currently showing on the key.
Dependencies	The invalid data indicator turns on when the offset is changed, until the next sweep/measurement completes.
Couplings	The same offset is used in the Gate Source selection of the period timer.
Preset	0 s
State Saved	Saved in instrument state
Min	-10.000 s
Max	10.000 s
Default Unit	S
Initial S/W Revision	Prior to A.02.00

#### Offset Adjust (Remote Command Only)

This remote command does not work at all like the related front panel keys. This command lets you advance the phase of the frame trigger by the amount you specify.

It does not change the period of the trigger waveform. If the command is sent multiple times, it advances the phase of the frame trigger an additional amount each time it is sent. Negative numbers are permitted.

<b>Remote Command</b>	:TRIGger[:SEquence]:FRAMe:ADJust <time>
<b>Example</b>	TRIG:FRAM:ADJ 1.2 ms
Notes	Note also that Offset is used only when the sync source is set to OFF, otherwise delay is used, see section " <a href="#">Trig Delay</a> " on page 461  An increase in the "offset" parameter, either from the knob or the SCPI adjust command, serves to delay the timing of the trigger event.
Notes	The front panel interface (for example, the knob) and the :TRIG:FRAM:OFFS command adjust the accumulated offset, which is shown on the active function display. However, the actual amount sent to the hardware is the delta value, that is, the current offset value minus the previous offset value.  When the SCPI command is sent the value shown on the key (and the Active Function, if this happens to be the active function) is updated by increasing it (or decreasing it if the value sent is negative) by the amount specified in the SCPI command.  This is a "command only" SCPI command, with no query.
Dependencies	The invalid data indicator turns on when the offset is changed, until the next sweep/measurement completes.
Couplings	The same offset is used in the Gate Source selection of the period timer.
Preset	0 s



State Saved	Saved in instrument state
Min	-10.000 s
Max	10.000 s
Default Unit	S
Initial S/W Revision	Prior to A.02.00

### Reset Offset Display

Resets the value of the periodic trigger offset display setting to 0.0 seconds. The current displayed trigger location may include an offset value defined with the Offset key. Pressing this key redefines the currently displayed trigger location as the new trigger point that is 0.0 s offset. The Offset key can then be used to add offset relative to this new timing.

Key Path	Trigger, Periodic Timer
<b>Remote Command</b>	:TRIGger[:SEquence]:FRAMe:OFFSet:DISPlay:RESet
<b>Example</b>	TRIG:FRAM:OFFS:DISP:RES
Initial S/W Revision	Prior to A.02.00

### Sync Source

Selects a signal source for you to synchronize your periodic timer trigger to, otherwise you are triggering at some arbitrary location in the frame. Synchronization reduces the precision requirements on the setting of the period.

For convenience you may adjust the level and slope of the selected sync source in a conditional branch setup menu accessed from the Sync Source menu. Note that these settings match those in the **Trigger** and **Gate Source** menus; that is, each trigger source has only one value of level and slope, regardless of which menu it is accessed from.

Key Path	Trigger, Periodic Timer
<b>Remote Command</b>	:TRIGger[:SEquence]:FRAMe:SYNC EXTernal1   EXTernal2   RFBurst   OFF :TRIGger[:SEquence]:FRAMe:SYNC?
<b>Example</b>	TRIG:FRAM:SYNC EXT2
Dependencies	In some models, there is no second External input. In these models, the External 2 key is blanked and the EXTernal2 parameter will generate a "Hardware missing; Not available for this model number" message.
Preset	Off GSM/EDGE, MSR,LTE,LTETDD: RFBurst
State Saved	Saved in instrument state
Readback	The current setting is read back to this key and it is also Readback to the previous Periodic Timer trigger key.

<b>Backwards Compatibility SCPI</b>	:TRIGger[:SEquence]:FRAMe:SYNC EXTernal
Initial S/W Revision	Prior to A.02.00
Modified at S/W Revision	A.03.00, A.14.00

### Off

Turns off the sync source for your periodic trigger. With the sync source off, the timing will drift unless the signal source frequency is locked to the analyzer frequency reference.

<b>Key Path</b>	Trigger, Periodic Timer, Sync Source
<b>Example</b>	TRIG:FRAM:SYNC OFF
Readback	Off
Initial S/W Revision	Prior to A.02.00

### External 1

Pressing this key, when it is not selected, selects an external input signal as the trigger. A new sweep/measurement will start when the external trigger condition is met using the external 1 input connector on the rear panel.

Pressing this key, when it is already selected, accesses the external 1 trigger setup menu.

<b>Key Path</b>	Trigger
<b>Example</b>	TRIG:SOUR EXT1 Swept SA measurement TRIG:<meas>:SOUR EXT1 Measurements other than Swept SA
<b>Dependencies</b>	Grayed out if in use by Point Trigger in the Source Setup menu. Forced to Free Run if already selected and Point Trigger is set to External 1.
<b>State Saved</b>	Saved in instrument state
<b>Status Bits/OPC dependencies</b>	The Status Operation Register bit 5 "Waiting for Trigger" is set at the same time as the Sweeping or Measuring bit is set. It is cleared when the trigger actually occurs (that is, after the trigger event occurs and all the applicable trigger criteria have been met). A corresponding pop-up message ("Waiting for trigger") is generated if no trigger signal appears after approximately 2 sec. This message goes away when a trigger signal appears.
Initial S/W Revision	Prior to A.02.00

### Trigger Level

Sets the value where the external 1 trigger input will trigger a new sweep/measurement.

Key Path	Trigger, External 1
<b>Remote Command</b>	:TRIGger[:SEquence]:EXTernal1:LEVel <level> :TRIGger[:SEquence]:EXTernal1:LEVel?
<b>Example</b>	TRIG:EXT1:LEV 0.4 V
Couplings	This same level is used for the Ext1 trigger source in the Trigger menu, for the Ext1 selection in the Periodic Timer sync source (in the Trigger menu and in the Gate Source menu), and also for the Ext1 selection in the Gate Source menu.
Preset	1.2 V
State Saved	Saved in instrument state
Min	-5 V
Max	5 V
Default Unit	V
<b>Backwards Compatibility SCPI</b>	:TRIGger[:SEquence]:EXTernal:LEVel For backward compatibility, the parameter EXTernal is mapped to EXTernal1
<b>Backwards Compatibility SCPI</b>	:TRIGger[:SEquence]:FRAMe:EXTernal1:LEVel
Initial S/W Revision	Prior to A.02.00

### Trig Slope

Controls the trigger polarity. It is set positive to trigger on a rising edge and negative to trigger on a falling edge.

Key Path	Trigger, External 1
<b>Remote Command</b>	:TRIGger[:SEquence]:EXTernal1:SLOPe POSitive NEGative :TRIGger[:SEquence]:EXTernal1:SLOPe?
<b>Example</b>	TRIG:EXT1:SLOP NEG
Couplings	This same slope is used in the Ext1 selection for the trigger source in the Trigger menu and for the period timer sync source (in the Trigger menu and in the Gate Source menu).
Preset	POSitive
State Saved	Saved in instrument state
<b>Backwards Compatibility SCPI</b>	:TRIGger[:SEquence]:EXTernal:SLOPe For backward compatibility, the parameter EXTernal is mapped to EXTernal1
<b>Backwards Compatibility SCPI</b>	:TRIGger[:SEquence]:FRAMe:EXTernal1:SLOPe
Backwards Compatibility Notes	The legacy :TRIGger[:SEquence]:SLOPe command affects the slopes for the VID, LINE, EXT1, EXT2, and RFB triggers.
Initial S/W Revision	Prior to A.02.00

## External 2

Pressing this key, when it is not selected, selects an external input signal as the trigger. A new sweep/measurement will start when the external trigger condition is met using the external 2 input connector. The external trigger 2 input connector is on the rear panel.

Pressing this key, when it is already selected, accesses the external 2 trigger setup menu.

Key Path	Trigger
<b>Example</b>	TRIG:SOUR EXT2 Swept SA measurement TRIG:<meas>:SOUR EXT2 Measurements other than Swept SA
Dependencies	In some models, there is no second External input. In these models, the External 2 key is blanked and the EXTERNAL2 parameter will generate a "Hardware missing; Not available for this model number" message. Grayed out if in use by Point Trigger in the Source Setup menu. Forced to Free Run if already selected and Point Trigger is set to External 2.
State Saved	Saved in instrument state
Status Bits/OPC dependencies	The Status Operation Register bit 5 "Waiting for Trigger" is set at the same time as the Sweeping or Measuring bit is set. It is cleared when the trigger actually occurs (that is, after the trigger event occurs and all the applicable trigger criteria have been met). A corresponding pop-up message ("Waiting for trigger") is generated if no trigger signal appears after approximately 2 sec. This message goes away when a trigger signal appears.
Initial S/W Revision	Prior to A.02.00
Modified at S/W Revision	A.03.00

## Trigger Level

Sets the value where the external 2 trigger input will trigger a new sweep/measurement.

Key Path	Trigger, External 2
<b>Remote Command</b>	:TRIGger[:SEquence]:EXTernal2:LEVel :TRIGger[:SEquence]:EXTernal2:LEVel?
<b>Example</b>	TRIG:EXT2:LEV 1.1 V
Couplings	This same level is used for the Ext2 trigger source in the Trigger menu, for the Ext2 selection in the Periodic Timer sync source (in the Trigger menu and in the Gate Source menu), and also for the Ext2 selection in the Gate Source menu.
Preset	1.2 V
State Saved	Saved in instrument state
Min	-5 V
Max	5 V
Default Unit	V
<b>Backwards Compatibility SCPI</b>	:TRIGger[:SEquence]:FRAME:EXTernal2:LEVel
Initial S/W Revision	Prior to A.02.00

## Trig Slope

Controls the trigger polarity. It is set positive to trigger on a rising edge and negative to trigger on a falling edge.

Key Path	Trigger, External 2
<b>Remote Command</b>	:TRIGger[:SEquence]:EXTernal2:SLOPe POSitive NEGative :TRIGger[:SEquence]:EXTernal2:SLOPe?
<b>Example</b>	TRIG:EXT2:SLOP NEG
Couplings	This same slope is used in the Ext2 selection for the trigger source in the Trigger menu and for the period timer sync source (in the Trigger menu and in the Gate Source menu).
Preset	POSitive
State Saved	Saved in instrument state
<b>Backwards Compatibility SCPI</b>	:TRIGger[:SEquence]:FRAMe:EXTernal2:SLOPe
Backwards Compatibility Notes	The legacy :TRIGger[:SEquence]:SLOPe command affects the slopes for the VID, LINE, EXT1, EXT2, and RFB triggers.
Initial S/W Revision	Prior to A.02.00

## RF Burst

Pressing this key, when it is not selected, selects the RF Burst as the trigger. A new sweep/measurement will start when an RF burst envelope signal is identified from the signal at the RF Input connector. Pressing this key, when it is already selected, accesses the RF Burst trigger setup menu.

In some models, a variety of burst trigger circuitry is available, resulting in various available burst trigger bandwidths. The analyzer automatically chooses the appropriate trigger path based on the hardware configuration and other settings of the analyzer.

Key Path	Trigger
<b>Example</b>	TRIG:SOUR RFB            Swept SA measurement TRIG:<meas>:SOUR RFB    Measurements other than Swept SA
State Saved	Saved in instrument state
Status Bits/OPC dependencies	The Status Operation Register bit 5 "Waiting for Trigger" is set at the same time as the Sweeping or Measuring bit is set. It is cleared when the trigger actually occurs (that is, after the trigger event occurs and all the applicable trigger criteria have been met). A corresponding pop-up message ("Waiting for trigger") is generated if no trigger signal appears after approximately 2 sec. This message goes away when a trigger signal appears.
Backwards Compatibility Notes	The legacy command: :TRIGger[:SEquence]:RFBurst:FSElectivity[:STATe] OFF ON 0 1 is not supported in the X-Series, as the hardware to do Frequency Selective burst triggers does not exist in X-Series.

Initial S/W Revision	Prior to A.02.00
Modified at S/W Revision	A.04.00

### Absolute Trigger Level

Sets the absolute trigger level for the RF burst envelope.

When using the External Mixing path, the Absolute Trigger Level is uncalibrated because the factory default was set to accommodate the expected IF levels for the RF path.

Key Path	Trigger, RF Burst
Scope	Meas Global
<b>Remote Command</b>	:TRIGger[:SEquence]:RFBurst:LEVel:ABSolute <ampl> :TRIGger[:SEquence]:RFBurst:LEVel:ABSolute?
<b>Example</b>	TRIG:RFB:LEV:ABS 10 dBm sets the trigger level of the RF burst envelope signal to the absolute level of 10 dBm
Notes	Sending this command does not switch the setting from relative to absolute; to switch it you need to send the :TRIGger[:SEquence]:RFBurst:LEVel:TYPE command, below.  Amplitude Corrections are not taken into account by the Absolute Trigger Level. For example, if you have given yourself effective gain with an amplitude correction factor, the Absolute Trigger will not fire until you have set the trigger level that far below the displayed signal level, rather than simply to the displayed signal level. This is only true for Amplitude Corrections, not External Gain or Ref Level Offset functions.  If mode is Bluetooth, the default value is -50 dBm.
Couplings	This same level is used for the RF Burst trigger source in the Trigger menu, for the RF Burst selection in the Periodic Timer sync source (in the Trigger menu and in the Gate Source menu), and also for the RF Burst selection in the Gate Source menu
Preset	-20 dBm
State Saved	Saved in instrument state
Min	-200 dBm
Max	100 dBm
Default Unit	depends on the current selected Y-Axis unit
<b>Backwards Compatibility SCPI</b>	:TRIGger[:SEquence]:FRAME:RFBurst:LEVel:ABSolute
Initial S/W Revision	Prior to A.02.00
Modified at S/W Revision	A.04.00

Key Path	Trigger, RF Burst
<b>Remote Command</b>	:TRIGger[:SEquence]:RFBurst:LEVel:TYPE ABSolute RELative :TRIGger[:SEquence]:RFBurst:LEVel:TYPE?

<b>Example</b>	TRIG:RFB:LEV:TYPE REL sets the trigger level type of the RF burst trigger to Relative.
Preset	ABSolute
State Saved	Saved in instrument state
Initial S/W Revision	Prior to A.02.00
Modified at S/W Revision	A.04.00

### Trigger Slope

It is set positive to trigger on a rising edge and negative to trigger on a falling edge.

Key Path	Trigger, RF Burst
<b>Remote Command</b>	:TRIGger[:SEQuence]:RFBurst:SLOPe POSitive NEGative :TRIGger[:SEQuence]:RFBurst:SLOPe?
<b>Example</b>	TRIG:RFB:SLOP NEG
Couplings	This same slope is used in the RF Burst selection for the trigger source in the Trigger menu and for the period timer sync source (in the Trigger menu and in the Gate Source menu).
Preset	POSitive
State Saved	Saved in instrument state
<b>Backwards Compatibility SCPI</b>	:TRIGger[:SEQuence]:FRAME:RFBurst:SLOPe
Backwards Compatibility Notes	The legacy :TRIGger[:SEQuence]:SLOPe command affects the slopes for the VID, LINE, EXT1, EXT2, and RFB triggers.
Initial S/W Revision	Prior to A.02.00

### Sync Holdoff

Sync Holdoff specifies the duration that the sync source signal must be kept false before the transition to true to be recognized as the sync timing. The periodic timer phase is aligned when the sync source signal becomes true, after the Holdoff time is satisfied.

A holdoff of 2 ms will work with most WiMAX signals, but there may be cases where the burst off duration is less than 1 ms and this value will need to be changed.

Key Path	Trigger, Periodic Timer
<b>Remote Command</b>	:TRIGger[:SEQuence]:FRAME:SYNC:HOLDoff <time> :TRIGger[:SEQuence]:FRAME:SYNC:HOLDoff? :TRIGger[:SEQuence]:FRAME:SYNC:HOLDoff:STATe OFF ON 0 1 :TRIGger[:SEQuence]:FRAME:SYNC:HOLDoff:STATe?
Preset	On, 1.000 ms

State Saved	Saved in instrument state
Min	0 ms
Max	+500 ms
Default Unit	s
Initial S/W Revision	Prior to A.02.00

## Control Edge/Level

Sets the method of controlling the gating function from the gating signal.

### Edge

In Edge triggering, the gate opens (after the Delay) on the selected edge (for example, positive) of the gate signal and closes on the alternate edge (for example, negative).

### Level

In Level triggering, the gate opens (after the Delay) when the gate signal has achieved a certain level and stays open as long as that level is maintained.

Key Path	Sweep/Control, Gate
Remote Command	<code>[ :SENSe ] :SWEep:EGATe:CONTRol EDGE LEVe1</code> <code>[ :SENSe ] :SWEep:EGATe:CONTRol?</code>
Example	SWE:EGAT:CONT EDGE
Dependencies	If the Gate Method is FFT the Control key is grayed out and Edge is selected. If the Gate Source is TV, Frame or Line, the Control key is grayed out and Edge is selected.
Preset	EDGE
State Saved	Saved in instrument state
Backwards Compatibility SCPI	<code>[ :SENSe ] :SWEep:TIME:GATE:TYPE</code> ESA Compatibility
Initial S/W Revision	Prior to A.02.00

## Gate Holdoff

Lets you increase or decrease the wait time after a gate event ends before the analyzer will respond to the next gate signal.

After any Gate event finishes, the analyzer must wait for the sweep system to settle before it can respond to another Gate signal. The analyzer calculates a "wait time," taking into account a number of factors, including RBW and Phase Noise Optimization settings. The goal is to achieve the same accuracy when gated as in ungated operation. The figure below illustrates this concept:



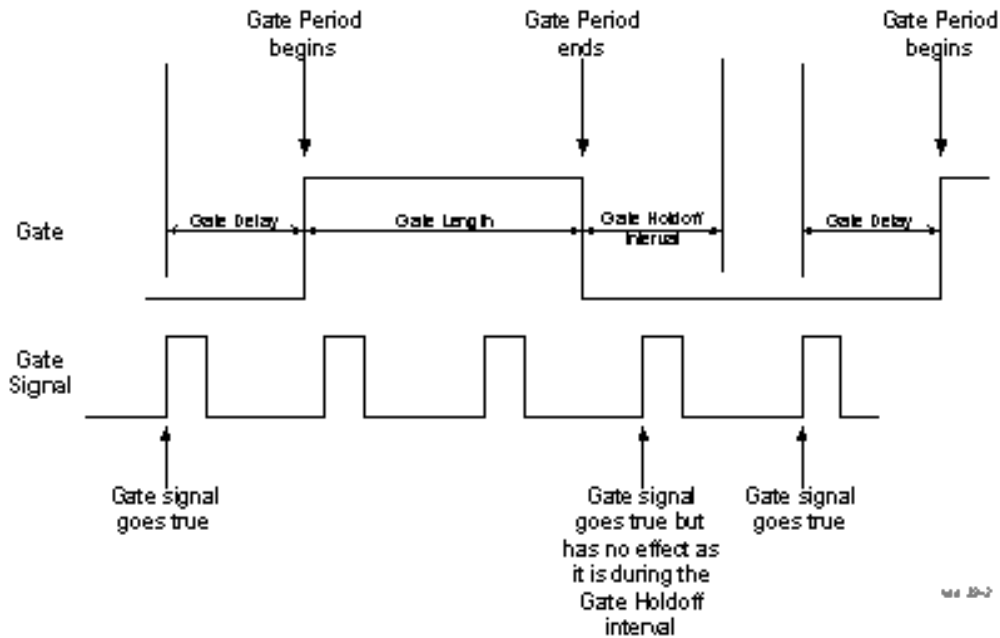

When Gate Holdoff is in Auto, the wait time calculated by the analyzer is used. When Gate Time is in Manual, the user may adjust the wait time, usually decreasing it in order to achieve greater speed, but at the risk of decreasing accuracy.

When the Method key is set to Video or FFT, the Gate Holdoff function has no effect.

In measurements that do not support Auto, the value shown when Auto is selected is “---” and the manually set holdoff is returned to a query.

Key Path	Sweep/Control, Gate
<b>Remote Command</b>	<pre>[ :SENSe ] :SWEep:EGATe:HOLDoff &lt;time&gt; [ :SENSe ] :SWEep:EGATe:HOLDoff? [ :SENSe ] :SWEep:EGATe:HOLDoff:AUTO OFF ON 0 1 [ :SENSe ] :SWEep:EGATe:HOLDoff:AUTO?</pre>
<b>Example</b>	<pre>SWE:EGAT:HOLD 0.0002 SWE:EGAT:HOLD? SWE:EGAT:HOLD:AUTO ON SWE:EGAT:HOLD:AUTO?</pre>
<b>Couplings</b>	<p>When Gate Holdoff is Auto, the Gate Holdoff key shows the value calculated by the analyzer for the wait time.</p> <p>Pressing the Gate Holdoff key while it is in Auto and not selected, causes the key to become selected and allows the user to adjust the value. If the value is adjusted, the setting changes to Man.</p> <p>Pressing the Gate Holdoff key, while it is in Auto and selected, does not change the value of Gate Holdoff, but causes the setting to change to Man. Now the user can adjust the value.</p> <p>Pressing the key while it is in Man and selected, cause the value to change back to Auto.</p> <p>Pressing the key while it is in Man and not selected, causes the key to become selected and allows the user to adjust the value.</p>

	When Method is set to Video or FFT, the Gate Holdoff function has no effect.
Preset	Auto Auto/On
State Saved	Saved in instrument state
Min	1 µsec
Max	1 sec
Initial S/W Revision	Prior to A.02.00

## Gate Delay Compensation

This function allows you to select an RBW-dependent value by which to adjust the gate delay, to compensate for changes in the delay caused by RBW effects.

You can select between uncompensated operation and two types of compensation, Delay Until RBW Settled and Compensate for RBW Group Delay.

See "[More Information](#)" on page 1367

Key Path	Sweep/Control, Gate
Scope	Meas Global
Remote Command	[ :SENSe ] :SWEep:EGATe:DELay:COMPensation:TYPE OFF   SETTled   GDELay [ :SENSe ] :SWEep:EGATe:DELay:COMPensation:TYPE?
Example	SWE:EGAT:DEL:COMP:TYPE SETT SWE:EGAT:DEL:COMP:TYPE?
Notes	Although this function is Meas Global, there are some measurements that do not support this function. In those measurements the operation will be Uncompensated. Going into one of those measurements will not change the Meas Global selection; it will simply display the grayed-out menu key with “Uncompensated” showing as the selection. This is a non-forceful grayout, so the SCPI command is still accepted.  If Gate Delay Compensation is not supported at all within a particular mode, the key is not displayed, and if the SCPI command is sent while in a measurement within that mode, an “Undefined Header” message is generated.  Measurements that do not support this function include: Swept SA
Preset	TD-SCDMA mode: Compensate for RBW Group Delay All other modes: Delay Until RBW Settled
State Saved	Saved in instrument state
Range	Uncompensated Delay Until RBW Settled Compensate for RBW Group Delay
Readback text	Uncompensated Settled Group Delay
Initial S/W Revision	Prior to A.02.00
Modified at S/W Revision	A.11.0

## More Information

Selecting Uncompensated means that the actual gate delay is as you sets it.

Selecting Delay Until RBW Settled causes the gate delay to be increased above the user setting by an amount equal to  $3.06/\text{RBW}$ . This compensated delay causes the GATE START and GATE STOP lines on the display to move by the compensation amount, and the actual hardware gate delay to be increased by the same amount. All the other gate lines (for example, MIN FAST) are unaffected. If the RBW subsequently changes, the compensation is readjusted for the new RBW. The value shown on the Gate Delay key does NOT change.

Delay Until RBW Settled allows excellent measurements of gated signals, by allowing the IF to settle following any transient that affects the burst. Excellent measurements also require that the analysis region not extend into the region affected by the falling edge of the burst. Thus, excellent measurements can only be made over a width that declines with narrowing RBWs, which is achieved by decreasing the gate length below the user setting by an amount equal to  $2.53/\text{RBW}$ . Therefore, for general purpose compensation, you will still want to change the gate length with changes in RBW even if the gate delay is compensated. The compensated Gate Length is limited by the analyzer so that it will never go below 10% of the value shown on the Gate Length key, as otherwise the sweep times could get very long. Anytime the Gate Length and RBW values combine in such a way that this limiting takes place, a warning is displayed. For measurements which contain multiple sweeps with different RBW like SEM and SPUR, the smallest RBW is used for this limiting.

Selecting Compensate for RBW Group Delay causes the gate delay to be increased above the user setting by an amount equal to  $1.81/\text{RBW}$ . This compensated delay causes the GATE START, GATE STOP lines on the display to move by the compensation amount, and the actual hardware gate delay to be increased by the same amount. All the other gate lines (for example, MIN FAST) are unaffected. If the RBW subsequently changes, the compensation is readjusted for the new RBW. The value shown on the Gate Delay key does NOT change. Compensate for RBW Group Delay also includes gate length compensation; the gate length itself is adjusted as necessary to attempt to compensate for delay effects imposed by the RBW.

Compensate for RBW Group Delay is similar to Delay Until RBW Settled, but compensates for the group delay of the RBW filter, rather than the filter settling time. As the RBW gets narrow, this can allow the settling tail of the RBW to affect the beginning part of the gated measurement, and allow the beginning of the RBW settling transient to affect the end of the gated measurement. These two effects are symmetric because the RBW response is symmetric. Because the gate length is not automatically compensated, some users might find this compensation to be more intuitive than compensation for RBW settling.

## Min Fast Position Query (Remote Command Only)

This command queries the position of the MIN FAST line, relative to the delay reference (REF) line. See section "[Gate View On/Off](#)" on page 2722. If this query is sent while not in gate view, the MinFast calculation is performed based on the current values of the appropriate parameters and the result is returned. Knowing this value lets you set an optimal gate delay value for the current measurement setup.

<b>Remote Command</b>	[ :SENSe ] :SWEep:EGATe:MINFast?
<b>Example</b>	SWE:EGAT:MIN?
<b>Initial S/W Revision</b>	Prior to A.02.00

### Gate Preset (Remote Command Only)

Presets the time-gated spectrum analysis capability.

This command sets gate parameter values to the ESA preset values, as follows:

Gate trigger type = edge

Gate polarity = positive

Gate delay = 1 us

Gate length = 1 us

<b>Remote Command</b>	<code>[:SENSe]:SWEep:TIME:GATE:PRESet</code> ESA Compatibility
Initial S/W Revision	Prior to A.02.00

### Gate Level (Remote Command Only)

Sets the gate input transition point level for the external TRIGGER inputs on the front and rear panel. This is a legacy command for PSA compatibility. It is simply an alias to the equivalent trigger level command.

<b>Remote Command</b>	<code>[:SENSe]:SWEep:EGATE:EXTErnal[1] 2:LEVel &lt;voltage&gt;</code> <code>[:SENSe]:SWEep:EGATE:EXTErnal[1] 2:LEVel?</code>
Notes	This command is simply an alias to <code>:TRIGger[:SEQuence]:EXTErnal[1] 2:LEVel</code> For details refer
Initial S/W Revision	Prior to A.02.00

### Gate Polarity (Remote Command Only)

Sets the polarity for the gate signal. This setup is now done using the gate trigger's slope setting.

When Positive (Pos) is selected, a positive-going edge (Edge) or a high voltage (Level) will satisfy the gate condition, after the delay set with the Gate Delay key. When Negative (Neg) is selected, a negative-going edge (Edge) or a low voltage (Level) will satisfy the gate condition after the delay.

<b>Remote Command</b>	<code>[:SENSe]:SWEep:EGATE:POLarity</code> NEGative POSitive <code>[:SENSe]:SWEep:EGATE:POLarity?</code>
<b>Example</b>	<code>SWE:EGAT:POL</code> NEG <code>SWE:EGAT:POL?</code>
Preset	POSitive
State Saved	Saved in instrument state
<b>Backwards Compatibility SCPI</b>	<code>[:SENSe]:SWEep:TIME:GATE:POLarity</code> ESA compatibility
Initial S/W Revision	Prior to A.02.00

---

<b>Remote Command</b>	[ :SENSe ] :SWEep:TIME:GATE:LEVel HIGH LOW [ :SENSe ] :SWEep:TIME:GATE:LEVel? ESA compatibility
Preset	HIGH
Initial S/W Revision	Prior to A.02.00

---

## System

See "[System](#)" on page 359

## Trace/Detector

Accesses a menu of functions that enable you to control trace and detector for the current measurement.

Key Path	Front-panel key
Initial S/W Revision	Prior to A.02.00

### Trace Type

Allows you to select the type of trace for the current measurement. The menu contains a 1-of-N selection of the trace type (Clear Write, Average, Max Hold, Min Hold).

Key Path	Trace/Detector
Mode	SA, WCDMA, C2K, WIMAX OFDMA, TD-SCDMA, 1xEVDO, DTMB (CTTB), DVB-T/H, ISDB-T, CMMB, LTE, LTE-TDD, Digital Cable TV, WLAN, MSR, LTEAFDD, LTEATDD
Remote Command	:TRACe:SEMAsk:TYPE WRITe AVERAge MAXHold MINHold :TRACe:SEMAsk:TYPE?
Example	TRAC:SEM:TYPE MINH TRAC:SEM:TYPE?
Notes	WRITe = Clear Write AVERAge = Average MAXHold = Maximum Hold MINHold = Minimum Hold
Couplings	When Detector setting is "Auto" ([:SENSe]:SEMAsk:DETECTOR:AUTO?), Detector ([:SENSe]:SEMAsk:DETECTOR[:FUNCTION]?) switches aligning with the switch of this parameter: "NORMal" with WRITe (Clear Write), "AVERAge" with AVERAge, "POSitive (peak)" with MAXHold, and "NEGative (peak)" with MINHold.
Preset	AVERAge
State Saved	Saved in instrument state.
Range	WRITe AVERAge MAXHold MINHold
Initial S/W Revision	Prior to A.02.00
Modified at S/W Revision	A.02.00, A.03.00

### Chan Detector

Accesses a menu of functions that enable you to control the detectors for reference channel. The following choices are available:

- Auto—the detector selected depends on marker functions, trace functions, average type, and the trace averaging function.
- Normal—the detector determines the peak of the CW-like signals, and it yields alternating maximums and minimums of noise-like signals. This is also referred to as Rosenfell detection.

- Average—the detector determines the average of the signal within the sweep points. The averaging method depends upon the Average Type selection (voltage, power or log scales).
- Peak—the detector determines the maximum of the signal within the sweep points.
- Sample—the detector indicates the instantaneous level of the signal at the center of the sweep points represented by each display point.
- Negative Peak—the detector determines the minimum of the signal within the sweep points.

Key Path	Trace/Detector
Initial S/W Revision	Prior to A.02.00

### Chan Detector Auto

Sets the detector to the default detection mode for the reference channel. This mode is dependent upon the current reference channel conditions.

Key Path	Trace/Detector
Mode	SA, WCDMA, C2K, WIMAX OFDMA, TD-SCDMA, 1xEVDO, DTMB (CTTB), DVB-T/H, ISDB-T, CMMB, LTE, LTETDD, Digital Cable TV, WLAN, MSR, LTEAFDD, LTEATDD
Remote Command	<code>[ :SENSe ] :SEMAsk:DETEctor:CARRier:AUTO ON OFF 1 0</code> <code>[ :SENSe ] :SEMAsk:DETEctor:CARRier:AUTO?</code>
Example	<code>SEM:DET:CARR:AUTO OFF</code> <code>SEM:DET:CARR:AUTO?</code>
Notes	See Couplings in the Trace Type section. You must be in the mode that includes SEM measurement to use this command. Use <code>:INSTRument:SElect</code> to set the mode.
Preset	ON
State Saved	Saved in instrument state
Range	On Off
Initial S/W Revision	Prior to A.02.00
Modified at S/W Revision	A.02.00, A.03.00

### Chan Detector Selection

Selects the detector mode for the reference channel.

Key Path	Trace/Detector
Mode	SA, WCDMA, C2K, WIMAX OFDMA, TD-SCDMA, 1xEVDO, DTMB (CTTB), DVB-T/H, ISDB-T, CMMB, LTE, LTETDD, Digital Cable TV, WLAN, MSR, LTEAFDD, LTEATDD
Remote Command	<code>[ :SENSe ] :SEMAsk:DETEctor:CARRier[:FUNCTion] AVERAge   NEGAtive   NORMAl</code> <code>  POSitive   SAMPlE</code> <code>[ :SENSe ] :SEMAsk:DETEctor:CARRier[:FUNCTion]?</code>



<b>Example</b>	SEM:DET:CARR NEG SEM:DET:CARR?
<b>Notes</b>	When you manually select a detector (instead of selecting Auto), that detector is used regardless of other analyzer settings. <b>Note:</b> This detector setting affects the reference channel. There is not a per trace detector. You must be in the mode that includes SEM measurement to use this command. Use :INSTrument:SElect to set the mode.
<b>Couplings</b>	See Couplings in the Trace Type section.
<b>Preset</b>	AVERage
<b>State Saved</b>	Saved in instrument state.
<b>Range</b>	Normal Average Peak Sample Negative Peak
<b>Initial S/W Revision</b>	Prior to A.02.00
<b>Modified at S/W Revision</b>	A.02.00, A.03.00

## Offset Detector

Accesses a menu of functions that enable you to control the detector for offsets. The following choices are available.

- Auto– the detector selected depends on marker functions, trace functions, average type, and the trace averaging function.
- Normal–the detector determines the peak of the CW-like signals, and it yields alternating maximums and minimums of noise-like signals. This is also referred to as Rosenfell detection.
- Average–the detector determines the average of the signal within the sweep points. The averaging method depends upon the Average Type selection (voltage, power or log scales).
- Peak–the detector determines the maximum of the signal within the sweep points.
- Sample–the detector indicates the instantaneous level of the signal at the center of the sweep points represented by each display point.
- Negative Peak–the detector determines the minimum of the signal within the sweep points.

<b>Key Path</b>	Trace/Detector
<b>Initial S/W Revision</b>	Prior to A.02.00

## Offset Detector Auto

Sets the detector to the default detection mode for the offsets. This mode is dependent upon the current signal conditions of the offsets.

<b>Key Path</b>	Trace/Detector
<b>Mode</b>	SA, WCDMA, C2K, WIMAX OFDMA, TD-SCDMA, 1xEVDO, DTMB (CTTB), DVB-T/H, ISDB-T, CMMB,

	LTE, LTE-TDD, Digital Cable TV, WLAN, MSR, LTE-AFDD, LTE-TDD
<b>Remote Command</b>	<code>[ :SENSe ] :SEMAsk:DETEctor:OFFSet:AUTO ON OFF 1 0</code> <code>[ :SENSe ] :SEMAsk:DETEctor:OFFSet:AUTO?</code>
<b>Example</b>	<code>SEM:DET:OFFS:AUTO OFF</code> <code>SEM:DET:OFFS:AUTO?</code>
<b>Notes</b>	See Couplings in the Trace Type section. You must be in the mode that includes SEM measurement to use this command. Use <code>:INSTRument:SElect</code> to set the mode.
<b>Preset</b>	ON
<b>State Saved</b>	Saved in instrument state.
<b>Range</b>	On Off
<b>Initial S/W Revision</b>	Prior to A.02.00
<b>Modified at S/W Revision</b>	A.02.00, A.03.00

## Offset Detector Selection

Selects the detector mode for the offsets.

<b>Key Path</b>	Trace/Detector
<b>Mode</b>	SA, WCDMA, C2K, WIMAX OFDMA, TD-SCDMA, 1xEVDO, DTMB (CTTB), DVB-T/H, ISDB-T, CMMB, LTE, LTE-TDD, Digital Cable TV, WLAN, MSR, LTE-AFDD, LTE-TDD
<b>Remote Command</b>	<code>[ :SENSe ] :SEMAsk:DETEctor:OFFSet[:FUNction] AVERAge   NEGAtive   NORMAl   POSitive   SAMPlE</code> <code>[ :SENSe ] :SEMAsk:DETEctor:OFFSet[:FUNction]?</code>
<b>Example</b>	<code>SEM:DET:OFFS AVER</code> <code>SEM:DET:OFFS?</code>
<b>Notes</b>	When you manually select a detector (instead of selecting Auto), that detector is used regardless of other analyzer settings. Note: This detector setting has effects all offsets. There is not a per trace detector. You must be in the mode that includes SEM measurement to use this command. Use <code>:INSTRument:SElect</code> to set the mode.
<b>Couplings</b>	See Couplings in the Trace Type section.
<b>Preset</b>	POSitive
<b>State Saved</b>	Saved in instrument state.
<b>Range</b>	Normal Average Peak Sample Negative Peak
<b>Initial S/W Revision</b>	Prior to A.02.00
<b>Modified at S/W Revision</b>	A.02.00, A.03.00

## Trigger

See ["Trigger" on page 430](#)

### Free Run

See ["Free Run " on page 437](#)

### Video

See ["Video \(IF Envelope\) " on page 438](#)

### Trigger Level

See ["Trigger Level " on page 438](#)

### Trig Slope

See ["Trig Slope " on page 439](#)

### Trig Delay

See ["Trig Delay " on page 440](#)

### Line

See ["Line " on page 2729](#)

### Trig Slope

See ["Trig Slope " on page 2729](#)

### Trig Delay

See ["Trig Delay " on page 442](#)

### External 1

See ["External 1 " on page 2741](#)

### Trigger Level

See ["Trigger Level " on page 2741](#)

### Trig Slope

See ["Trig Slope " on page 2742](#)

### Trig Delay

See ["Trig Delay " on page 445](#)

### External 2

See ["External 2 " on page 2743](#)

### **Trigger Level**

See ["Trigger Level "](#) on page 2743

### **Trig Slope**

See ["Trig Slope "](#) on page 2744

### **Trig Delay**

See ["Trig Delay "](#) on page 447

### **RF Burst**

See ["RF Burst "](#) on page 2744

### **Absolute Trigger**

See ["Absolute Trigger Level"](#) on page 2745

### **Relative Trigger**

See ["Relative Trigger Level"](#) on page 2734

### **Trig Slope**

See ["Trigger Slope "](#) on page 2746

### **Trig Delay**

See ["Trig Delay "](#) on page 451

### **Periodic Timer**

See ["Periodic Timer \(Frame Trigger\) "](#) on page 2736

### **Period**

See ["Period "](#) on page 2737

### **Offset**

See ["Offset "](#) on page 2738

### **Reset Offset Display**

See ["Reset Offset Display "](#) on page 2740

### **Sync Source**

See ["Sync Source "](#) on page 2740

### **Off**

See ["Off "](#) on page 2741

### External 1

See "External 1 " on page 2741

#### Trigger Level

See "Trigger Level " on page 2741

#### Trig Slope

See "Trig Slope " on page 2742

### External 2

See "External 2 " on page 2743

#### Trigger Level

See "Trigger Level " on page 2743

#### Trig Slope

See "Trig Slope " on page 2744

### RF Burst

See "RF Burst " on page 2744

### Absolute Trigger

See "Absolute Trigger Level" on page 2745

#### Trig Slope

See "Trigger Slope " on page 2746

### Trig Delay

See "Trig Delay" on page 461

### Auto/Holdoff

See "Auto/Holdoff " on page 462

### Auto Trig

See "Auto Trig " on page 462

### Trig Holdoff

See "Trig Holdoff " on page 463

## User Preset

Accesses a menu that gives you the following three choices:

- User Preset – recalls a state previously saved using the Save User Preset function.
- User Preset All Modes – presets all of the modes in the analyzer
- Save User Preset– saves the current state for the current mode

Key Path	Front-panel key
Backwards Compatibility Notes	<p>User Preset is actually loading a state, and in legacy analyzers, it was possible to load a state without affecting the trace data, limit lines or correction data. Similarly it was possible to do a User Preset without affecting the trace data, limit lines or correction data.</p> <p>In the X-Series, “state” always includes all of this data; so whenever state is loaded, or User Preset is executed, all of the traces, limit lines and corrections are affected. Although this differs from previous behavior, it is desirable behavior, and should not cause adverse issues for users.</p> <p>On ESA and PSA, User Preset affected the entire instrument’s state. In the X-Series, User Preset only recalls the state for the active mode. There is a User Preset file for each mode. User Preset can never cause a mode switch as it can in legacy analyzers. If you want to recall all modes to their user preset file state, you will need to do a User Preset after mode switching into each mode.</p> <p>User Preset recalls mode state which can now include data like traces; whereas on ESA and PSA, User Preset did not affect data.</p>
Initial S/W Revision	Prior to A.02.00

## User Preset

User Preset sets the state of the currently active mode back to the state that was previously saved for this mode using the Save User Preset menu key or the SCPI command, SYST:PRES:USER:SAV. It not only recalls the Mode Preset settings, but it also recalls all of the mode persistent settings, and the Input/Output system setting that existed at the time Save User Preset was executed.

If a Save User Preset has not been done at any time, User Preset recalls the default user preset file for the currently active mode. The default user preset files are created if, at power-on, a mode detects there is no user preset file. There will never be a scenario when there is no user preset file to restore. For each mode, the default user preset state is the same state that would be saved if a Save User Preset is performed in each mode right after doing a Restore Mode Default and after a Restore Input/Output Defaults.

The User Preset function does the following:

- Aborts the currently running measurement.
- Sets the mode State to the values defined by Save User Preset.
- Makes the saved measurement for the currently running mode the active measurement.
- Brings up the saved menu for the power-on mode.
- Clears the input and output buffers.
- Sets the Status Byte to 0.

Key Path	User Preset
Remote Command	:SYSTem:PRESet:USER
Example	:SYST:PRES:USER:SAVE:SYST:PRES:USER
Notes	:SYST:PRES:USER:SAVE is used to save the current state as the user preset state. Clears all pending OPC bits. The Status Byte is set to 0. Pressing the User Preset front-panel key while already in the User Preset menu will cause the User Preset to get executed
Couplings	A user preset will cause the currently running measurement to be aborted and cause the saved measurement to be active. Recalling a User Preset file has the same issues that recalling a Save State file has. Some settings may need to be limited and therefore re-coupled, since the capabilities of the mode may have changes when the User Preset file was last saved.
Initial S/W Revision	Prior to A.02.00

## User Preset All Modes

Recalls all of the User Preset files for each mode, switches to the power-on mode, and activates the saved measurement from the power-on mode User Preset file.

### NOTE

When the instrument is secured, all of the user preset files are converted back to their default user preset files.

The User Preset function does the following:

- Aborts the currently running measurement.
- Switches the Mode to the power-on mode.
- Restores the User Preset files for each mode.
- Makes the saved measurement for the power-on mode the active measurement.
- Brings up the saved menu for the power-on mode.
- Clears the input and output buffers.
- Sets the Status Byte to 0.

Key Path	User Preset
Remote Command	:SYSTem:PRESet:USER:ALL
Example	:SYST:PRES:USER:SAVE:SYST:PRES:USER:ALL
Notes	Clears all pending OPC bits. The Status Byte is set to 0. :SYST:PRES:USER:SAVE is used to save the current state as the user preset state.
Couplings	A user preset will cause the currently running measurement to be aborted, cause a mode switch to the power-on mode, and cause the saved measurement to be active in the power-on mode. Recalling a User Preset file has the same issues that recalling a Save State file has. Some settings may need to be limited and therefore re-coupled, since the capabilities of the mode may have changes when the User Preset file was last saved.
Initial S/W Revision	Prior to A.02.00

## Save User Preset

Saves the currently active mode and its State. You can recall this User Preset file by pressing the User Preset menu key or sending the SYST:PRES:USER remote command. This same state is also saved by the Save State function.

Key Path	User Preset
Remote Command	:SYSTem:PRESet:USER:SAVE
Example	:SYST:PRES:USER:SAVE
Notes	:SYST:PRES:SAVE creates the same file as if the user requested a *SAV or a MMEM:STOR:STAT, except User Preset Save does not allow the user to specify the filename or the location of the file.
Initial S/W Revision	Prior to A.02.00



## View/Display

Accesses a menu of functions that enable you to control the instrument display.

The following keys select how the results are displayed:

- **Abs Pwr Freq**—displays the absolute power levels in dBm and the corresponding frequencies in the text window.
- **Rel Pwr Freq**—displays the relative power levels in dBc and the corresponding frequencies in the text window.
- **Integrated Power**—displays the absolute and relative power levels integrated throughout the bandwidths between the start and stop frequencies in the text window.
- **Carrier Info**—displays the carrier configuration information with measure powers. (Only available in MSR and LTE-Advanced FDD/TDD)

"View Selection by Name (Remote Command Only)" on page 1381

"Views Selection by Number (Remote Command only)" on page 1382

### View Selection by Name (Remote Command Only)

Key Path	View/Display
Mode	SA, WCDMA, C2K, WIMAX OFDMA, TD-SCDMA, 1xEVDO, DTMB (CTTB), DVB-T/H, ISDB-T, CMMB, LTE, LTE-TDD, Digital Cable TV, WLAN, MSR, LTEAFDD, LTEATDD
Remote Command	:DISPlay:SEMask:VIEW[:SElect] APFReq   RPFReq   IPOWer   CINformation :DISPlay:SEMask:VIEW[:SElect]?
Example	DISP:SEM:VIEW IPOW DISP:SEM:VIEW?
Notes	You must be in the mode that includes SEM measurement to use this command. Use :INSTrument:SElect to set the mode.
Dependencies	In the SA mode, when "Radio Standard" is set to WLAN, IPOWer is not available and the key is grayed out. CINformation is available only in MSR and LTE-Advanced FDD/TDD mode, otherwise the key is blank.
Preset	SA, , WCDMA, , C2K, , TD-SCDMA, , 1xEVDO, , DTMB (CTTB), , DVB-T/H, , ISDB-T, , CMMB, , LTE, , LTE-TDD, , Digital Cable TV, , MSR, , LTEAFDD, , LTEATDD: APFReq WIMAX OFDMA, WLAN: RPFReq
State Saved	Saved in instrument state.
Range	Abs Pwr & Freq  Rel Pwr & Freq Integrated Power Carrier Info
Initial S/W Revision	Prior to A.02.00
Modified at S/W Revision	A.02.00, A.03.00, A.10.00

### Views Selection by Number (Remote Command only)

The following numerical selections determine how the results are displayed:

1. displays the absolute power levels in dBm and the corresponding frequencies in the text window.
2. displays the relative power levels in dBc and the corresponding frequencies in the text window.
3. displays the absolute and relative power levels integrated throughout the bandwidths between the start and stop frequencies in the text window.
4. displays the carrier info table. (Only available in MSR and LTE-Advanced FDD/TDD)

<b>Mode</b>	SA, WCDMA, C2K, WIMAX OFDMA, TD-SCDMA, 1xEVDO, DTMB (CTTB), DVB-T/H, ISDB-T, CMMB, LTE, LTETDD, Digital Cable TV, WLAN, MSR, LTEAFDD, LTEATDD
<b>Remote Command</b>	:DISPlay:SEMask:VIEW:NSElect <integer> :DISPlay:SEMask:VIEW:NSElect?
<b>Example</b>	DISP:SEM:VIEW:NSEL 2 DISP:SEM:VIEW:NSEL?
<b>Notes</b>	In the SA mode, when "Radio Standard" is set to WLAN, Option 3 is not available. Option 4 is available only in MSR and LTE-Advanced FDD/TDD mode. You must be in the mode that includes SEM measurement to use this command. Use :INSTrument:SElect to set the mode.
<b>Preset</b>	SA, , WCDMA, , C2K, , TD-SCDMA, , 1xEVDO, , DTMB (CTTB), , DVB-T/H, , ISDB-T, , CMMB, , LTE, , LTETDD, , Digital Cable TV, , MSR, , LTEAFDD, , LTEATDD: 1 WIMAX OFDMA, WLAN: 2
<b>State Saved</b>	Saved in instrument state.
<b>Min</b>	1
<b>Max</b>	MSR, LTEAFDD, LTEATDD: 4 Other modes: 3
<b>Initial S/W Revision</b>	Prior to A.02.00
<b>Modified at S/W Revision</b>	A.02.00, A.03.00, A.10.00

<b>Key Path</b>	Front-panel key
<b>Initial S/W Revision</b>	Prior to A.02.00

### Display

The Display menu is common to most measurements, and is used for configuring items on the display. Some Display menu settings apply to all the measurements in a mode, and some only to the current measurement. Those under the System Display Settings key apply to all measurements in all modes.

<b>Key Path</b>	Display
-----------------	---------

Key Path	View/Display
Initial S/W Revision	Prior to A.02.00

## Annotation

Turns on and off various parts of the display annotation. The annotation is divided up into four categories:

1. Meas Bar: This is the measurement bar at the top of the screen. It does not include the settings panel or the Active Function. Turning off the Meas Bar turns off the settings panel and the Active Function. When the Meas Bar is off, the graticule area expands to fill the area formerly occupied by the Meas Bar.
2. Screen Annotation: this is the annotation and annunciation around the graticule, including any annotation on lines (such as the display line, the threshold line, etc.) This does NOT include the marker number or the N dB result. When off, the graticule expands to fill the entire graticule area.
3. Trace annotation: these are the labels on the traces, showing their detector (or their math mode).
4. Active Function annotation: this is the active function display in the meas bar, and all of the active function values displayed on softkeys.

See the figure below. Each type of annotation can be turned on and off individually.

12 Spectrum Emission Mask Measurement  
View/Display

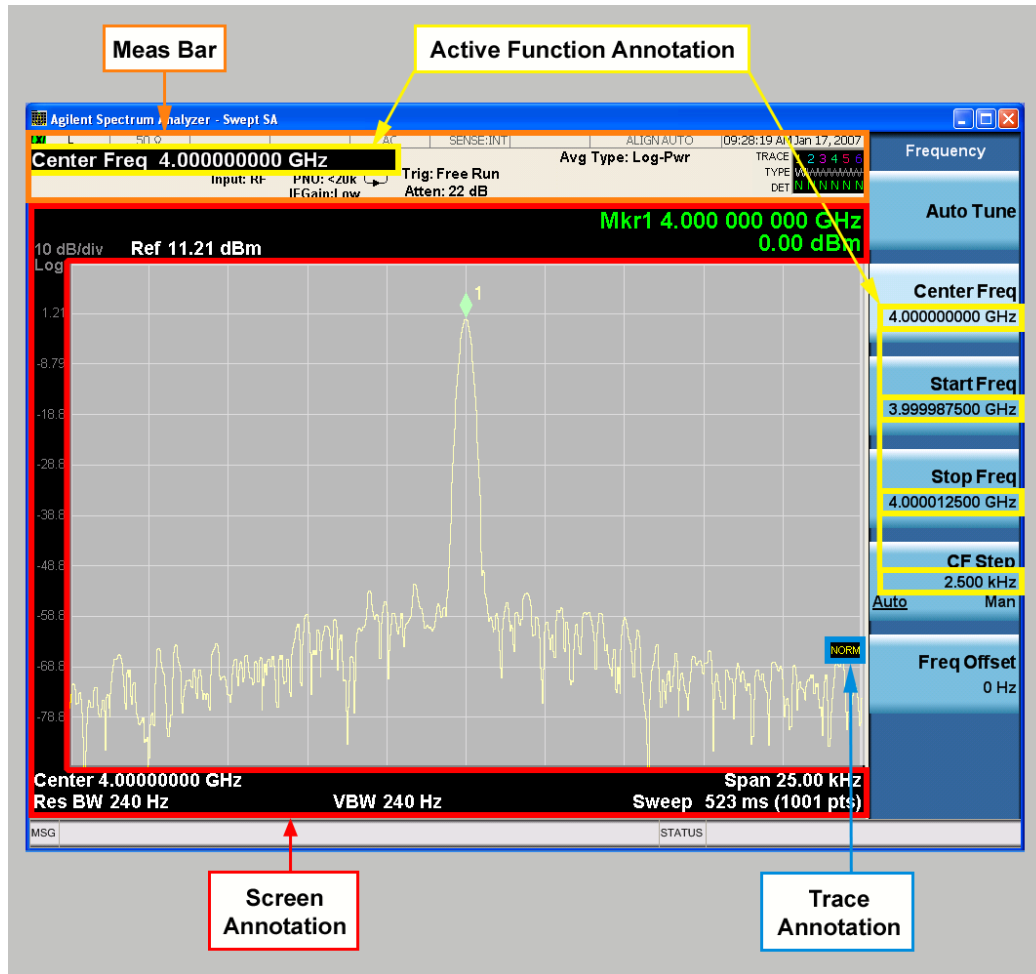

Key Path	View/Display, Display
Initial S/W Revision	Prior to A.02.00

Meas Bar On/Off

This function turns the Measurement Bar on and off, including the settings panel. When off, the graticule area expands to fill the area formerly occupied by the Measurement Bar.

Key Path	View/Display, Display, Annotation
Remote Command	:DISPlay:ANNOtation:MBAR[:STATe] OFF ON 0 1 :DISPlay:ANNOtation:MBAR[:STATe]?
Example	DISP:ANN:MBAR OFF
Dependencies	Grayed out and forced to OFF when System Display Settings, Annotation is set to Off.
Preset	On This should remain Off through a Preset when System DisplaySettings, Annotation is set to Off.
State Saved	Saved in instrument state.
Initial S/W Revision	Prior to A.02.00

## Screen

This controls the display of the annunciation and annotation around the graticule, including any annotation on lines (such as the display line, the threshold line, etc.) and the y-axis annotation. This does NOT include marker annotation (or the N dB result). When off, the graticule expands to fill the entire graticule area, leaving only the 1.5% gap above the graticule as described in the Trace/Detector chapter.

Key Path	View/Display, Display, Annotation
Remote Command	:DISPlay:ANNotation:SCReen[:STATe] OFF ON 0 1 :DISPlay:ANNotation:SCReen[:STATe]?
Example	DISP:ANN:SCR OFF
Dependencies	Grayed-out and forced to OFF when System Display Settings, Annotation is set to Off.
Preset	On This should remain Off through a Preset when System DisplaySettings, Annotation is set to Off
State Saved	Saved in instrument state.
Initial S/W Revision	Prior to A.02.00

## Active Function Values On/Off

Turns on and off the active function display in the Meas Bar, and all of the active function values displayed on the softkeys.

Note that all of the softkeys that have active functions have these numeric values blanked when this function is on. This is a security feature..

## 12 Spectrum Emission Mask Measurement View/Display

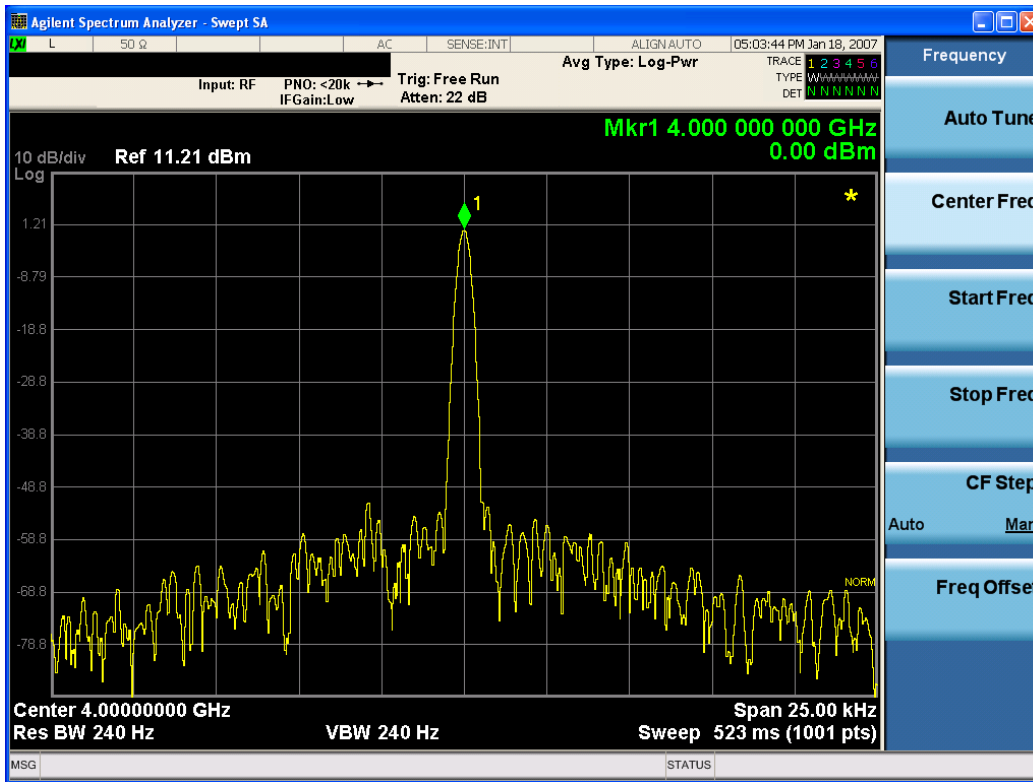

Key Path	View/Display, Display, Annotation
Remote Command	:DISPlay:ACTivefunc[:STATE] ON OFF 1 0 :DISPlay:ACTivefunc[:STATE] ?
Example	DISP:ACT OFF
Dependencies	Grayed out and forced to OFF when System Display Settings, Annotation is set to Off.
Preset	On This should remain Off through a Preset when System DisplaySettings, Annotation is set to Off
State Saved	Saved in instrument state.
Initial S/W Revision	Prior to A.02.00

### Title

Displays menu keys that enable you to change or clear a title on your display.

Key Path	View/Display, Display
Initial S/W Revision	Prior to A.02.00

### Change Title

Writes a title into the "measurement name" field in the banner, for example, "Swept SA".

Press Change Title to enter a new title through the alpha editor. Press Enter or Return to complete the entry. Press ESC to cancel the entry and preserve your existing title.

The display title will replace the measurement name. It remains for this measurement until you press Change Title again, or you recall a state, or a Preset is performed. A title can also be cleared by pressing Title, Clear Title.

**NOTE**

Notice the inclusion of the <measurement> parameter in the command below. Because each measurement remembers the Display Title, the command must be qualified with the measurement name. For the Swept SA measurement this is not the case; no <measurement> parameter is used when changing the Display Title for the Swept SA measurement.

Key Path	View/Display, Display, Title
Mode	All
Remote Command	:DISPlay:<measurement>:ANNotation:TITLe:DATA <string> :DISPlay:<measurement>:ANNotation:TITLe:DATA?
Example	DISP:ANN:TITL:DATA "This Is My Title" This example is for the Swept SA measurement in the Spectrum Analyzer mode. The SANalyzer <measurement> name is not used. DISP:ACP:ANN:TITL:DATA "This Is My Title" This example is for Measurements other than Swept SA. Both set the title to: This Is My Title
Notes	Pressing this key cancels any active function. When a title is edited the previous title remains intact (it is not cleared) and the cursor goes at the end so that characters can be added or BKSP can be used to go back over previous characters.
Preset	No title (measurement name instead)
State Saved	Saved in instrument state.
Initial S/W Revision	Prior to A.02.00

### Clear Title

Clears a title from the front-panel display. Once cleared, the title cannot be retrieved. After the title is cleared, the current Measurement Name replaces it in the title bar.

Key Path	View/Display, Display, Title
Example	The following commands clear the title and restore the measurement's original title: DISP:ANN:TITL:DATA "" This example is for the Swept SA measurement in the Spectrum Analyzer mode. The SANalyzer <measurement> name is not used. DISP:ACP:ANN:TITL:DATA "" This example is for ACP; in measurements other than Swept SA the measurement name is required.
Notes	Uses the :DISPlay:<measurement>:ANNotation:TITLe:DATA <string> command with an empty string (in the Swept SA, the <measurement> is omitted).
Preset	Performed on Preset.
Initial S/W Revision	Prior to A.02.00

## Graticule

Pressing Graticule turns the display graticule On or Off. It also turns the graticule y-axis annotation on and off.

Key Path	View/Display, Display
Remote Command	:DISPlay:WINDow[1]:TRACe:GRATicule:GRID[:STATe] OFF ON 0 1 :DISPlay:WINDow[1]:TRACe:GRATicule:GRID[:STATe]?
Example	DISP:WIND:TRAC:GRAT:GRID OFF
Notes	The graticule is the set of horizontal and vertical lines that make up the grid/divisions for the x-axis and y-axis.
Preset	On
State Saved	Saved in instrument state
Initial S/W Revision	Prior to A.02.00

## System Display Settings

These settings are "Mode Global" – they affect all modes and measurements and are reset only by Restore Misc Defaults or Restore System Defaults under System.

Key Path	View/Display, Display
Initial S/W Revision	Prior to A.02.00

## Annotation Local Settings

This is a Mode Global override of the meas local annotation settings. When it is All Off, it forces ScreenAnnotation, Meas Bar, Trace, and Active Function Values settings to be OFF for all measurements in all modes. This provides the security based "annotation off" function of previous analyzers; hence it uses the legacy SCPI command.

When it is All Off, the Screen, Meas Bar, Trace, and Active Function Values keys under the Display, Annotation menu are grayed out and forced to Off. When Local Settings is selected, you are able to set the local annotation settings on a measurement by measurement basis.

Key Path	View/Display, Display, System Display Settings
Remote Command	:DISPlay:WINDow[1]:ANNotation[:ALL] OFF ON 0 1 :DISPlay:WINDow[1]:ANNotation[:ALL]?
Example	:DISP:WIND:ANN OFF
Preset	On (Set by Restore Misc Defaults)
State Saved	Not saved in instrument state.
Backwards Compatibility Notes	The WINDow parameter and optional subopcode is included for backwards compatibility but ignored – all windows are equally affected.
Initial S/W Revision	Prior to A.02.00



## Themes

Accesses a menu of functions that enable you to choose the theme to be used when saving the screen image.

The **Themes** option is the same as the **Themes** option under the **Display** and **Page Setup** dialogs. It allows you to choose between themes to be used when saving the screen image.

<b>Key Path</b>	Save, Screen Image
<b>Remote Command</b>	:MMEMory:STORe:SCReen:THEMe TDColor   TDMonochrome   FCOLor   FMONochrome  :MMEMory:STORe:SCReen:THEMe?
<b>Example</b>	:MMEM:STOR:SCR:THEM TDM
<b>Preset</b>	3D Color; Is not part of Preset, but is reset by Restore Misc Defaults or Restore System Defaults All and survives subsequent running of the modes.
<b>Readback</b>	3D Color   3D Mono   Flat Color   Flat Mono
<b>Backwards Compatibility Notes</b>	In ESA and PSA we offer the choice of "Reverse Bitmap" or "Reverse Metafile" when saving screen images. This is much like the "Flat Color" theme available in X-Series. Also, if you selected Reverse Bitmap AND a black & white screen image, that would be much like "Flat Monochrome". In other words, each of the X-Series themes has a similar screen image type in ESA/PSA. But they are not identical.
<b>Initial S/W Revision</b>	Prior to A.02.00

### 3D Color

Selects a standard color theme with each object filled, shaded and colored as designed.

<b>Key Path</b>	Save, Screen Image, Themes
<b>Example</b>	MMEM:STOR:SCR:THEM TDC
<b>Readback</b>	3D Color
<b>Initial S/W Revision</b>	Prior to A.02.00

### 3D Monochrome

Selects a format that is like 3D color but shades of gray are used instead of colors.

<b>Key Path</b>	Save, Screen Image, Themes
<b>Example</b>	MMEM:STOR:SCR:THEM TDM
<b>Readback</b>	3D Mono
<b>Initial S/W Revision</b>	Prior to A.02.00

### Flat Color

Selects a format that is best when the screen is to be printed on an ink printer.

Key Path	Save, Screen Image, Themes
<b>Example</b>	MMEM:STOR:SCR:THEM FCOL
Readback	Flat Color
Initial S/W Revision	Prior to A.02.00

### Flat Monochrome

Selects a format that is like Flat Color. But only black is used (no colors, not even gray), and no fill.

Key Path	Save, Screen Image, Themes
<b>Example</b>	MMEM:STOR:SCR:THEM FMON
Readback	Flat Mono
Initial S/W Revision	Prior to A.02.00

### Backlight

Accesses the display backlight on/off keys. This setting may interact with settings under the Windows "Power" menu.

When the backlight is off, pressing ESC, TAB, SPACE, ENTER, UP, DOWN, LEFT, RIGHT, DEL, BKSP, CTRL, or ALT turns the backlight on without affecting the application. Pressing any other key will turn backlight on and could potentially perform the action as well.

Key Path	View/Display, Display, System Display Settings
<b>Remote Command</b>	:DISPlay:BACKlight ON OFF :DISPlay:BACKlight?
Preset	ON (Set by Restore Misc Defaults)
Initial S/W Revision	Prior to A.02.00

### Backlight Intensity

An active function used to set the backlight intensity. It goes from 0 to 100 where 100 is full on and 0 is off. This value is independent of the values set under the Backlight on/off key.

Key Path	View/Display, Display, System Display Settings
<b>Remote Command</b>	:DISPlay:BACKlight:INTensity <integer> :DISPlay:BACKlight:INTensity?
<b>Example</b>	DISP:BACK:INT 50

Preset	100 (Set by Restore Misc Defaults)
Min	0
Max	100
Initial S/W Revision	Prior to A.02.00

## Abs Pwr Freq

Sets the display to the Absolute Peak Power and Frequency view. The views differ depending on the setting of the measurement type (Meas Type) under the Measurement Setup menu.

"Abs Peak Pwr & Freq (Total Pwr Ref)" on page 1391

"Abs Peak Pwr & Freq (PSD Ref)" on page 1393

"Abs Peak Pwr & Freq (Spectrum Pk Ref)" on page 1395

### Abs Peak Pwr & Freq (Total Pwr Ref)

This view consists of the following two windows:

"Trace Window" on page 1393

"Results Window " on page 1393

12 Spectrum Emission Mask Measurement  
View/Display

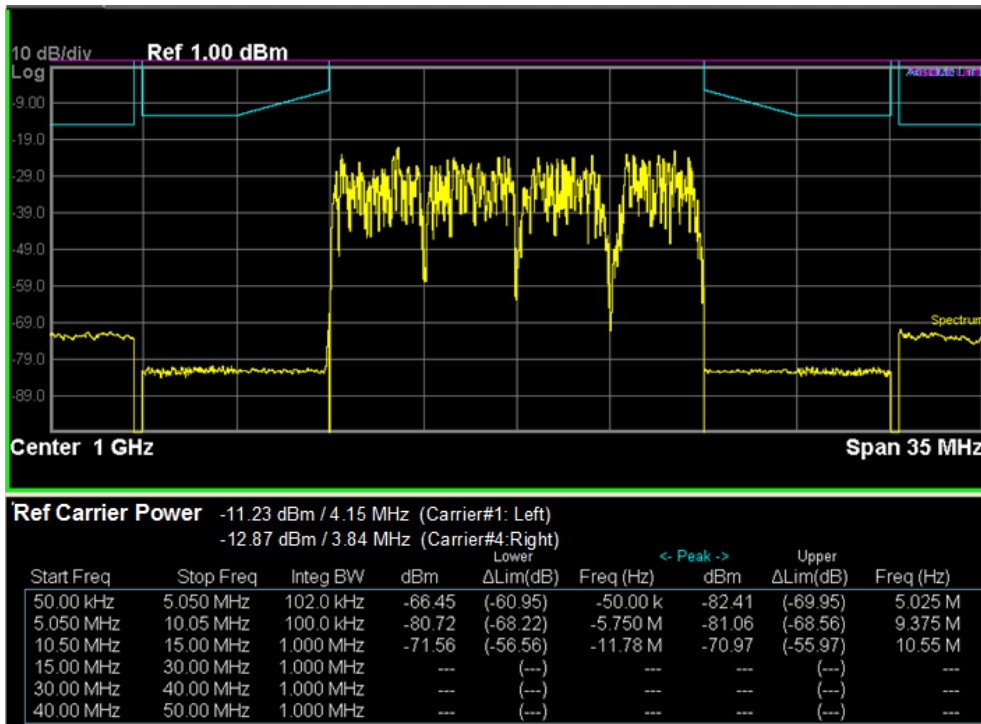
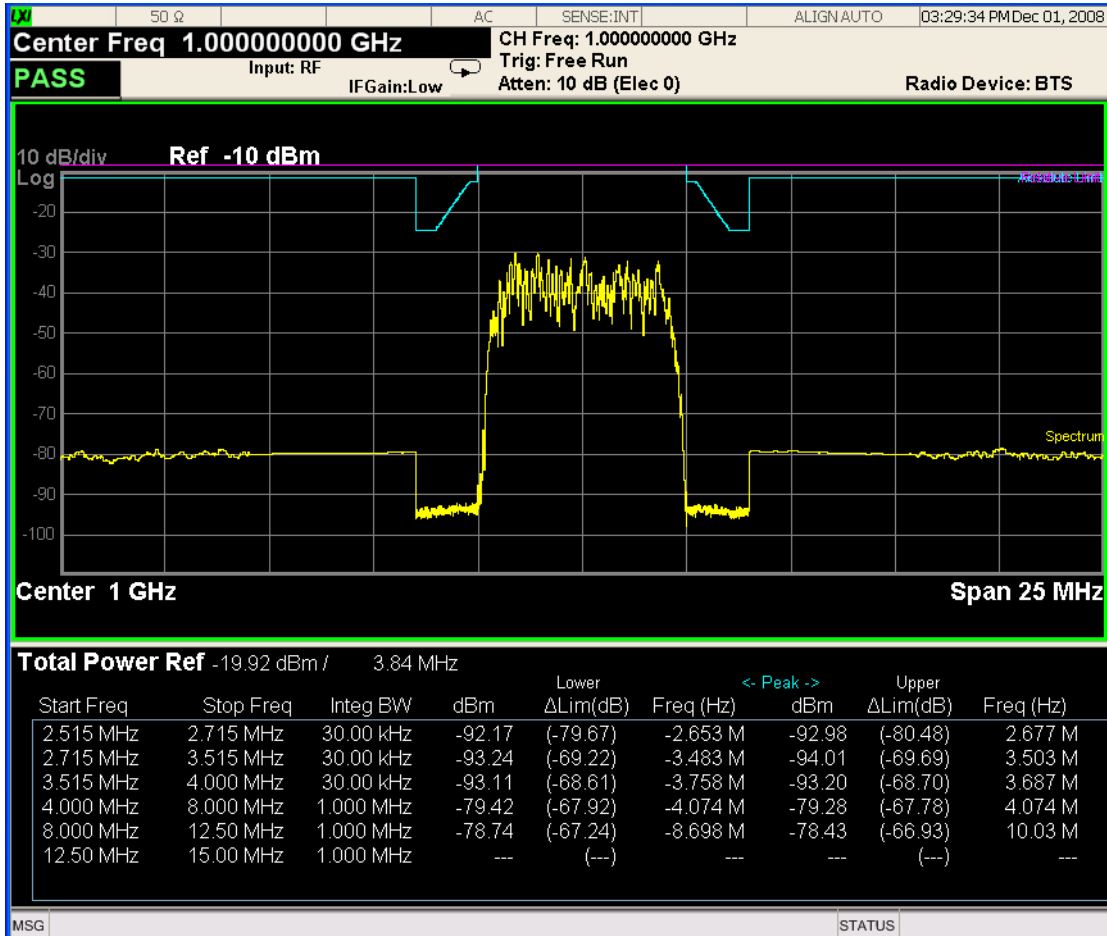

## Trace Window

Corresponding Trace	yellow - Combined trace from carrier and each offset
---------------------	------------------------------------------------------

## Results Window

Name	Corresponding Results
Total Pwr Ref	n=1 2nd element Absolute power at the reference area. Channel Integration Bandwidth
Start (Hz)	Start frequency for offset
Stop (Hz)	Stop frequency for offset
Meas BW (Hz)	Measurement bandwidth for offset
Lower Peak (dBm)	Absolute peak power on minimum margin point of the negative offset
Lower $\Delta$ lim (dB)	Minimum margin from limit line which is decided by Fail Mask setting on the negative offset
Lower Freq (Hz)	Frequency on minimum margin point of the negative offset
Upper Peak (dBm)	Absolute peak power on minimum margin point of the positive offset
Upper $\Delta$ lim (dB)	Minimum margin from limit line which is decided by Fail Mask setting on the positive offset
Upper Freq (Hz)	Frequency on minimum margin point of the positive offset

## Abs Peak Pwr & Freq (PSD Ref)

This view consists of the following two windows:

"Trace Window" on page 1395

"Results Window " on page 1395

12 Spectrum Emission Mask Measurement  
View/Display

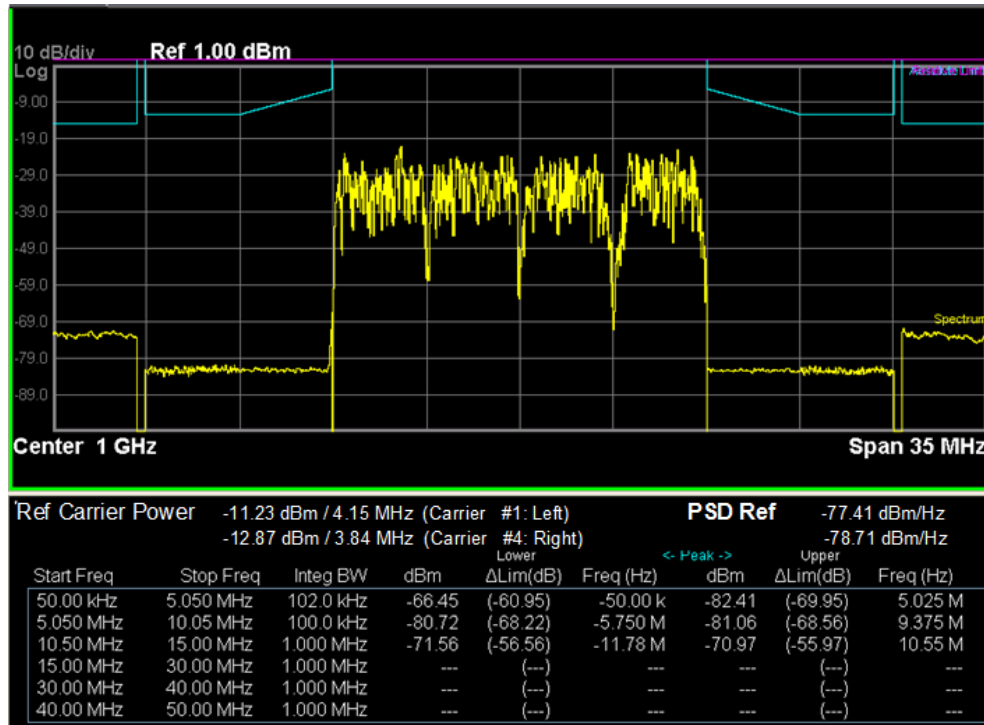
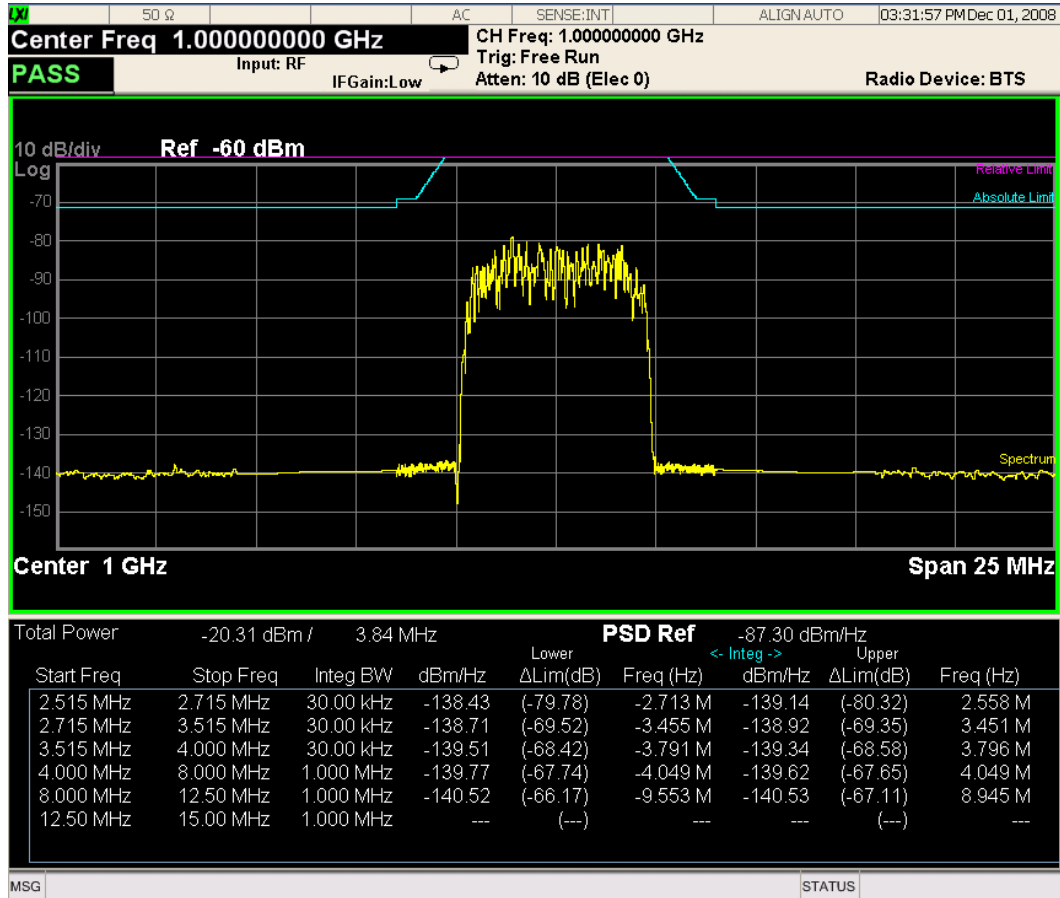

## Trace Window

Corresponding Trace	yellow - Combined trace from carrier and each offset
---------------------	------------------------------------------------------

## Results Window

Name	Corresponding Results
Total Pwr	n=1 2nd element Absolute power at the reference area.
	Channel Integration Bandwidth
PSD Ref	n=5 1st element Power spectral density reference at the reference area
Start (Hz)	Start frequency for offset
Stop (Hz)	Stop frequency for offset
Meas BW (Hz)	Measurement bandwidth for offset
Lower (dBm/Hz)	Absolute power spectrum density of the negative offset
Lower $\Delta$ lim (dB)	Minimum margin from limit line which is decided by Fail Mask setting on the negative offset
Lower Freq (Hz)	Frequency on minimum margin point of the negative offset
Upper (dBm/Hz)	Absolute power spectrum density of the positive offset
Upper $\Delta$ lim (dB)	Minimum margin from limit line which is decided by Fail Mask setting on the positive offset
Upper Freq (Hz)	Frequency on minimum margin point of the positive offset

## Abs Peak Pwr & Freq (Spectrum Pk Ref)

This view consists of the following two windows:

"Trace Window" on page 1395

"Results Window " on page 1395

12 Spectrum Emission Mask Measurement  
View/Display

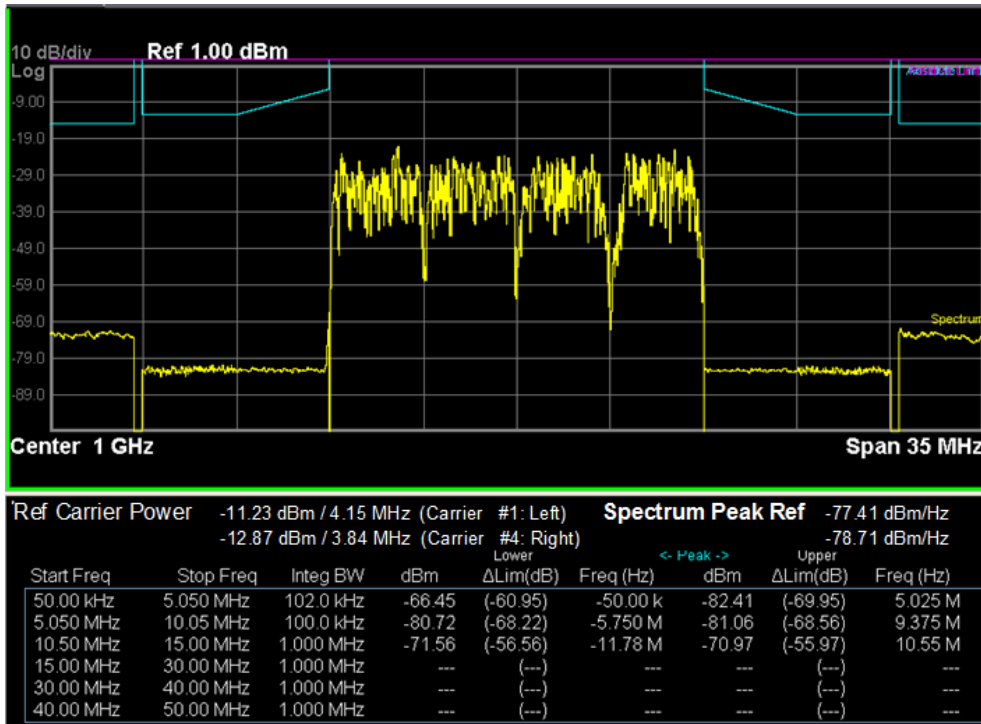
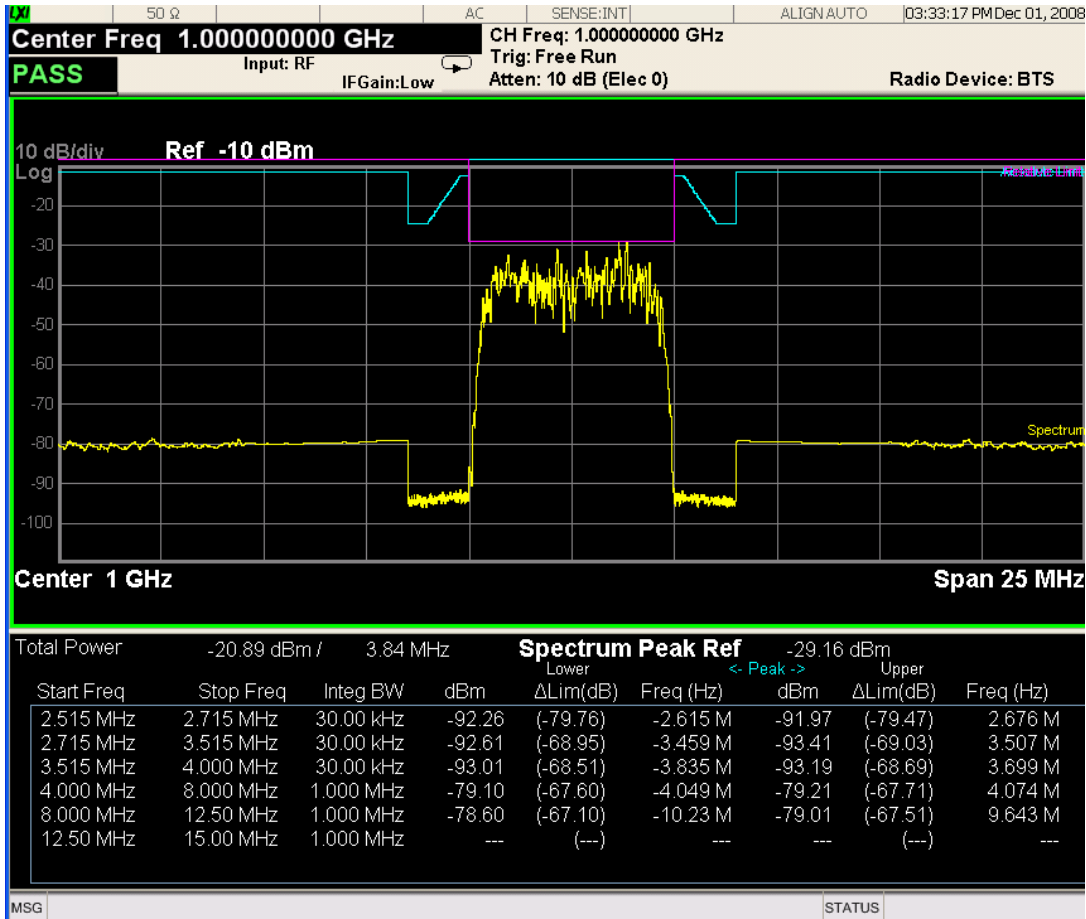



## Trace Window

Corresponding Trace	yellow - Combined trace from carrier and each offset
---------------------	------------------------------------------------------

## Results Window

Name	Corresponding Results
Total Pwr	Absolute power at the reference area. Channel Integration Bandwidth
Spectrum Peak Ref	n=5 1st element Spectrum peak power reference at the reference area
Start (Hz)	Start frequency for offset
Stop (Hz)	Stop frequency for offset
Meas BW (Hz)	Measurement bandwidth for offset
Lower(dBm)	Absolute peak power on minimum margin point of the negative offset
Lower $\Delta$ lim (dB)	Minimum margin from limit line which is decided by Fail Mask setting on the negative offset
Lower Freq (Hz)	Frequency on minimum margin point of the negative offset
Upper (dBm)	Absolute peak power on minimum margin point of the positive offset
Upper $\Delta$ lim (dB)	Minimum margin from limit line which is decided by Fail Mask setting on the positive offset
Upper Freq (Hz)	Frequency on minimum margin point of the positive offset

Key Path	View/Display
Initial S/W Revision	Prior to A.02.00

## Rel Pwr Freq

Sets the display to the Relative Peak Power and Frequency view. The views differ depending on the setting of the measurement type (Meas Type) under the Measurement Setup menu.

"Rel Peak Pwr & Freq (Total Pwr Ref)" on page 1397

"Rel Peak Pwr & Freq (PSD Ref)" on page 1399

"Rel Peak Pwr & Freq (Spectrum Pk Ref)" on page 1400

## Rel Peak Pwr & Freq (Total Pwr Ref)

This view consists of the following two windows:

"Trace Window" on page 1398

"Results Window" on page 1398

12 Spectrum Emission Mask Measurement  
View/Display

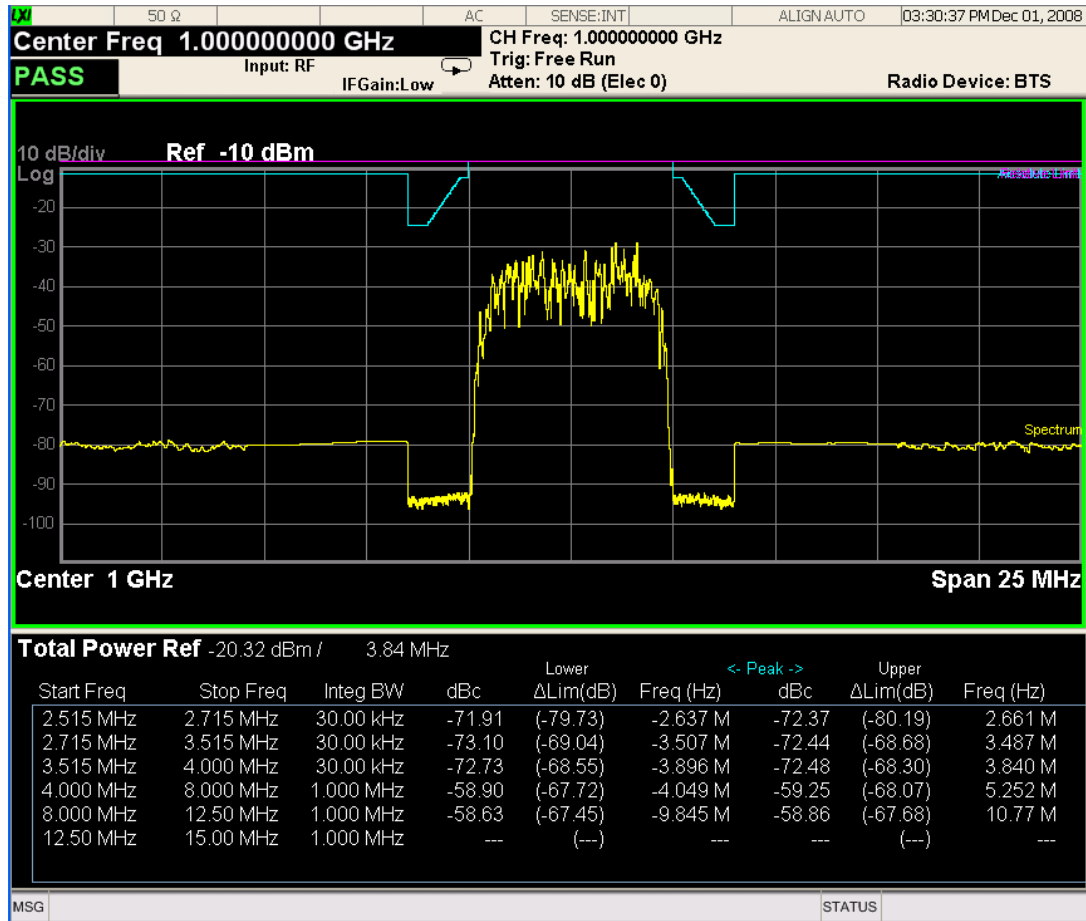

Trace Window

Corresponding Trace	yellow - Combined trace from carrier and each offset
---------------------	------------------------------------------------------

Results Window

Name	Corresponding Results
Total Pwr Ref	n=1 2nd element Absolute power at the reference area.
	Channel Integration Bandwidth
Start (Hz)	Start frequency for offset
Stop (Hz)	Stop frequency for offset
Meas BW (Hz)	Measurement bandwidth for offset
Lower Peak (dBc)	Relative peak power on minimum margin point of the negative offset
Lower ΔLim (dB)	Minimum margin from limit line which is decided by Fail Mask setting on the negative offset

Name	Corresponding Results
Lower Freq (Hz)	Frequency on minimum margin point of the negative offset
Upper Peak (dBc)	Relative peak power on minimum margin point of the positive offset
Upper ΔLim (dB)	Minimum margin from limit line which is decided by Fail Mask setting on the positive offset
Upper Freq (Hz)	Frequency on minimum margin point of the positive offset

**Rel Peak Pwr & Freq (PSD Ref)**

This view consists of the following two windows:

"Trace Window" on page 1399

"Results Window" on page 1400

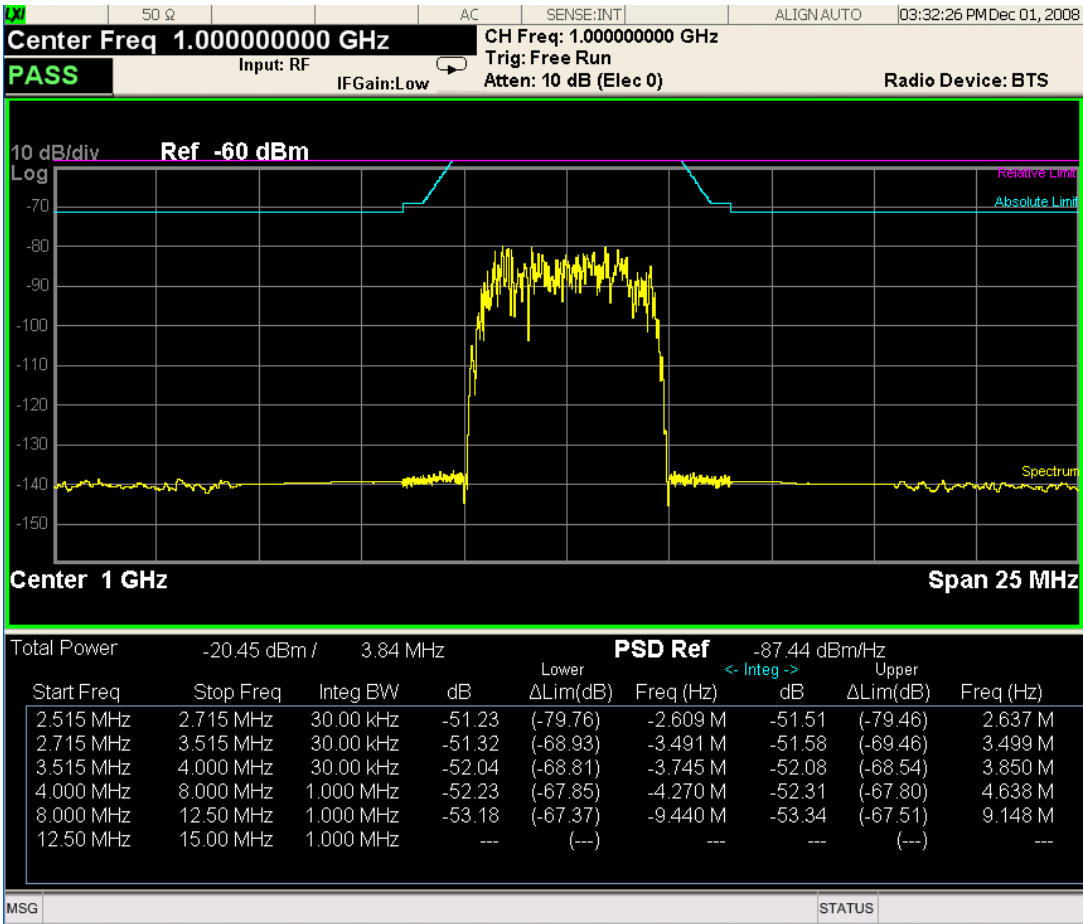

**Trace Window**

Corresponding Trace	yellow - Combined trace from carrier and each offset
---------------------	------------------------------------------------------

## Results Window

Name	Corresponding Results
Total Pwr	n=1 2nd element Absolute power at the reference area.
	Channel Integration Bandwidth
PSD Ref	n=5 1st element Power spectral density reference at the reference area
Start (Hz)	Start frequency for offset
Stop (Hz)	Stop frequency for offset
Meas BW (Hz)	Measurement bandwidth for offset
Lower (dB)	Relative power spectrum density of the negative offset
Lower $\Delta$ Lim (dB)	Minimum margin from limit line which is decided by Fail Mask setting on the negative offset
Lower Freq (Hz)	Frequency on minimum margin point of the negative offset
Upper (dB)	Relative power spectrum density of the positive offset
Upper $\Delta$ Lim (dB)	Minimum margin from limit line which is decided by Fail Mask setting on the positive offset
Upper Freq (Hz)	Frequency on minimum margin point of the positive offset

### Rel Peak Pwr & Freq (Spectrum Pk Ref)

This view consists of the following two windows:

"Trace Window" on page 1398

"Results Window" on page 1398

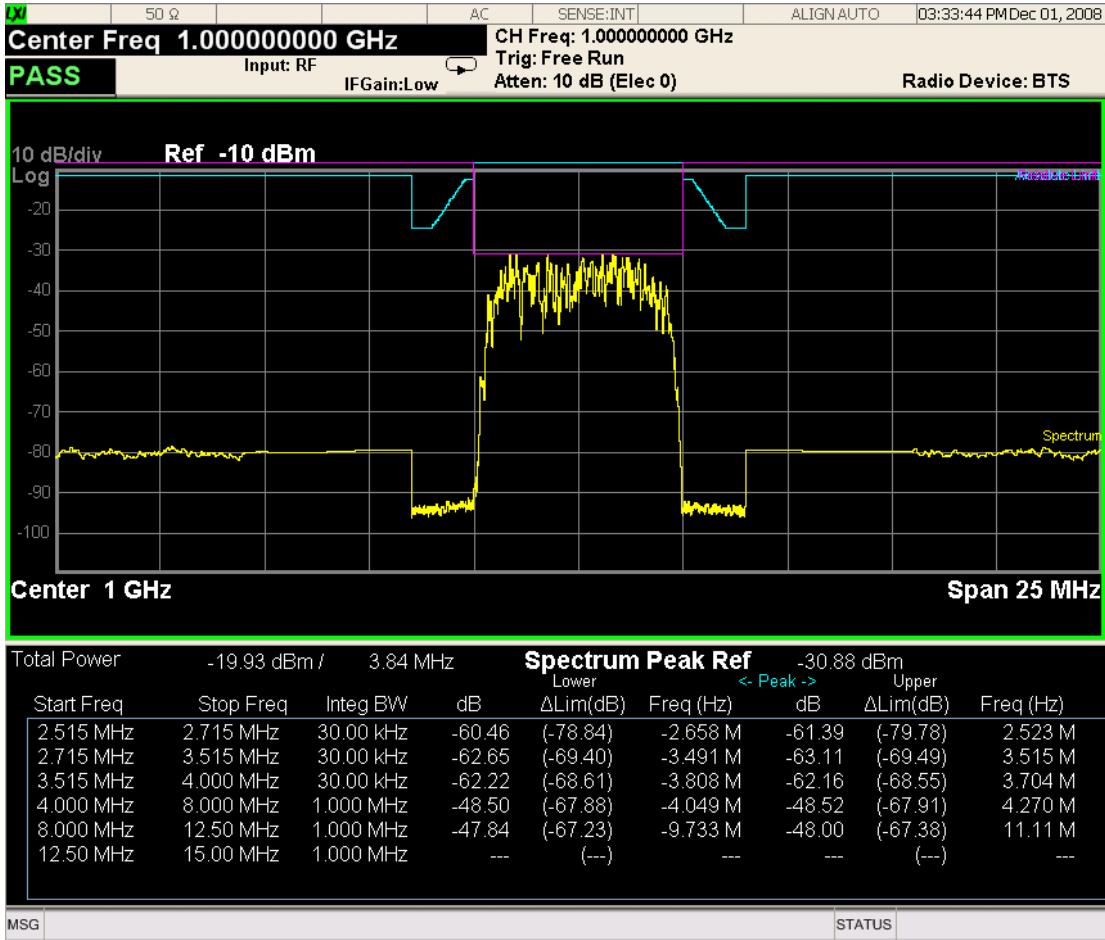

Trace Window

Corresponding Trace	yellow - Combined trace from carrier and each offset
---------------------	------------------------------------------------------

Results Window

Name	Corresponding Results
Total Pwr	Absolute power at the reference area. Channel Integration Bandwidth
Spectrum Peak Ref	n=5 1st element Spectrum peak power reference at the reference area
Start (Hz)	Start frequency for offset
Stop (Hz)	Stop frequency for offset
Meas BW (Hz)	Measurement bandwidth for offset
Lower Peak (dB)	Relative peak power on minimum margin point of the negative offset
Lower ΔLim (dB)	Minimum margin from limit line which is decided by Fail Mask setting

Name	Corresponding Results
	on the negative offset
Lower Freq (Hz)	Frequency on minimum margin point of the negative offset
Upper Peak (dB)	Relative peak power on minimum margin point of the positive offset
Upper $\Delta$ Lim (dB)	Minimum margin from limit line which is decided by Fail Mask setting on the positive offset
Upper Freq (Hz)	Frequency on minimum margin point of the positive offset

Key Path	View/Display
Initial S/W Revision	Prior to A.02.00

## Integrated Power

Sets the display to the Integrated Power view. The views differ depending on the setting of the measurement type (Meas Type) under the Measurement Setup menu.

"Integrated Power (Total Pwr Ref)" on page 1402

"Integrated Power (PSD Ref)" on page 1405

"Integrated Power (Spectrum Pk Ref)" on page 1408

### Integrated Power (Total Pwr Ref)

"Trace Window" on page 1404

"Results Window" on page 1404

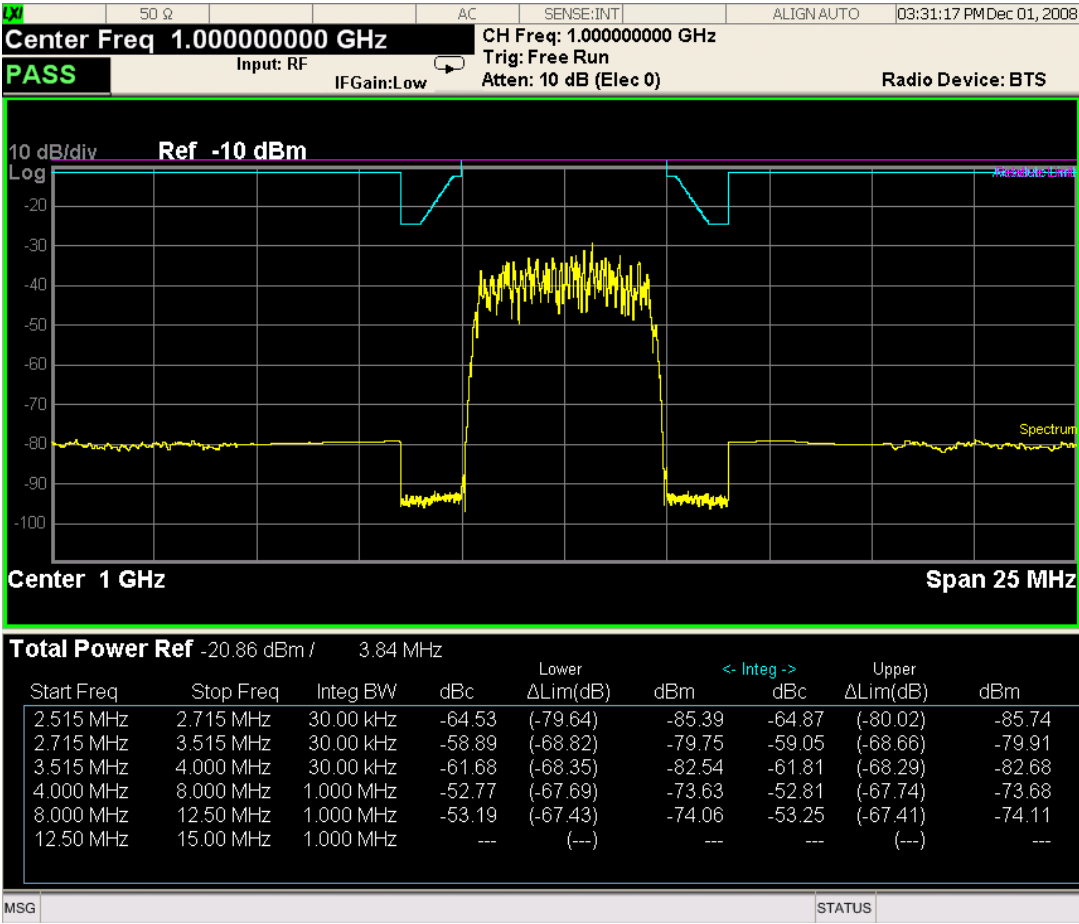

For WLAN 802.11 ac (80 + 80 MHz), power readouts of both of the carriers are displayed in the lower result window.

12 Spectrum Emission Mask Measurement  
View/Display

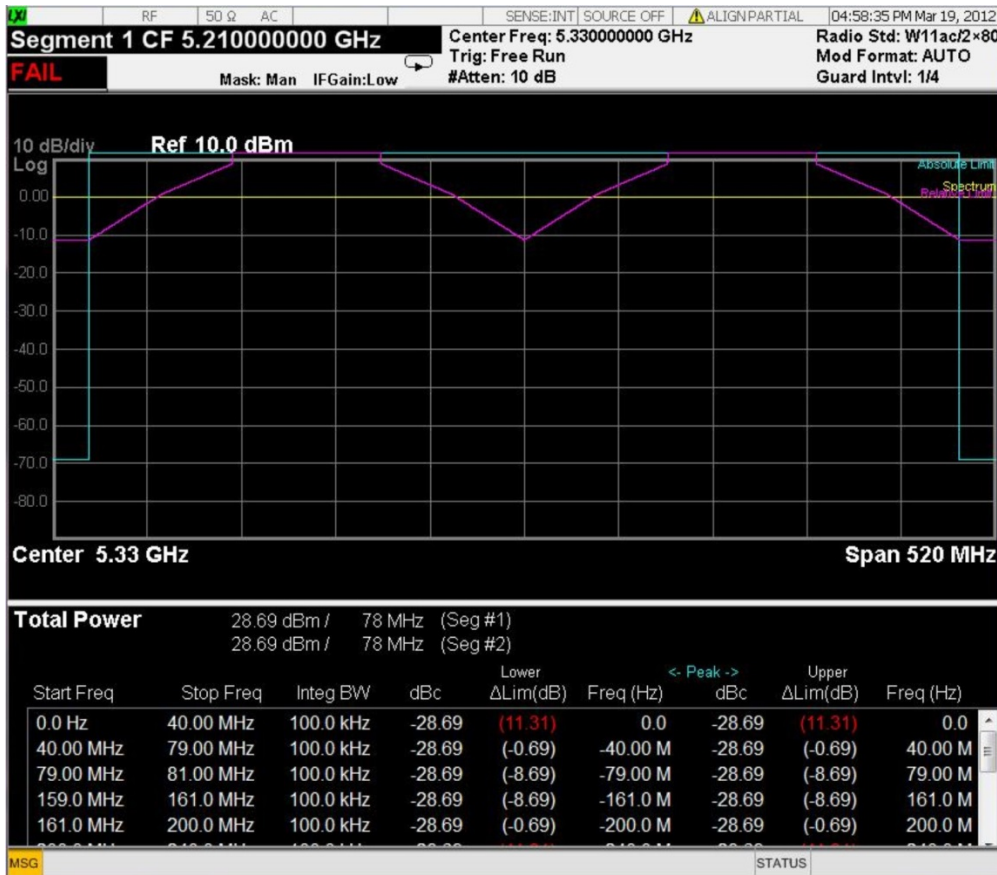

Trace Window

Corresponding Trace                      yellow - Combined trace from carrier and each offset

Results Window

Name	Corresponding Results
Total Pwr Ref	n=1 2nd element Absolute power at the reference area.
	Channel Integration Bandwidth
Start (Hz)	Start frequency for offset
Stop (Hz)	Stop frequency for offset
Meas BW (Hz)	Measurement bandwidth for offset
Lower Integ (dBc)	Relative integrated power on the negative offset
Lower ΔLim (dB)	Minimum margin from limit line which is decided by Fail Mask setting on the negative offset
Lower Integ (dBm)	Absolute integrated power on the negative offset



Name	Corresponding Results
Upper Integ (dBc)	Relative integrated power on the positive offset
Upper ΔLim (dB)	Minimum margin from limit line which is decided by Fail Mask setting on the positive offset
Upper Integ (dBm)	Absolute integrated power on the positive offset

Integrated Power (PSD Ref)

"Trace Window" on page 1407

"Results Window" on page 1407

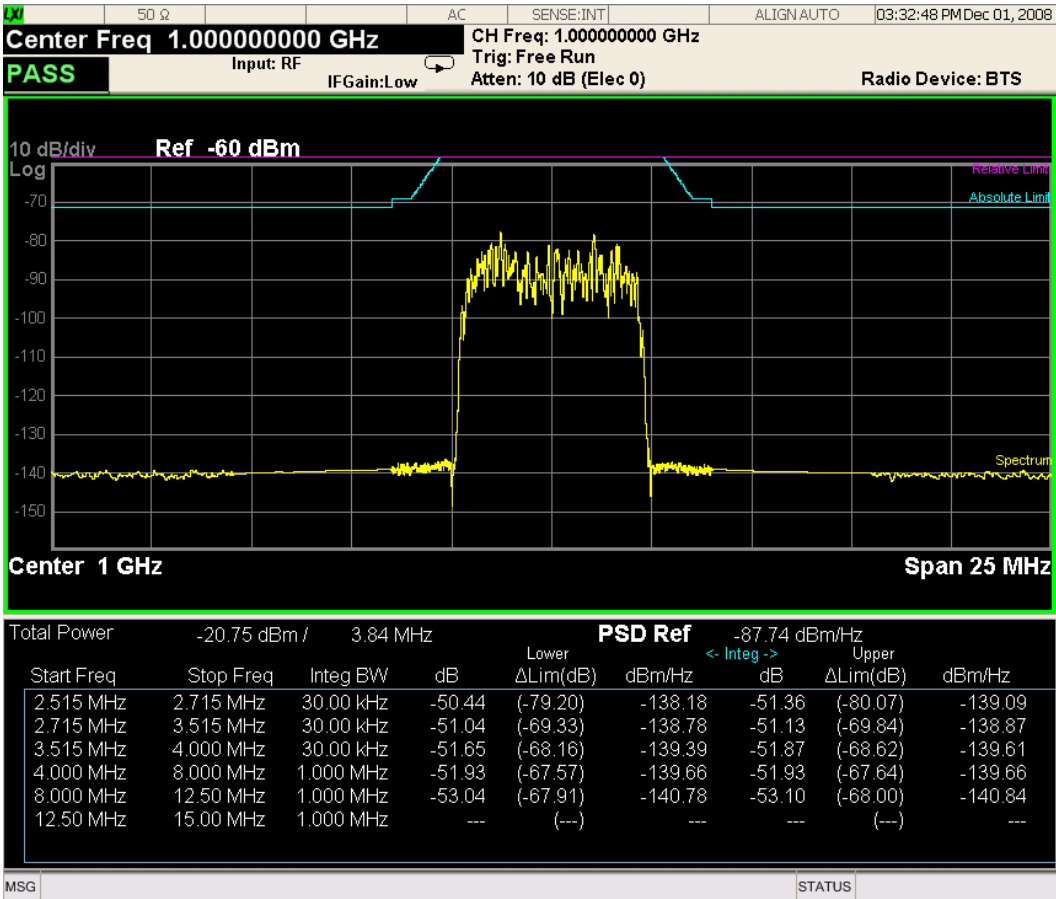

# 12 Spectrum Emission Mask Measurement View/Display

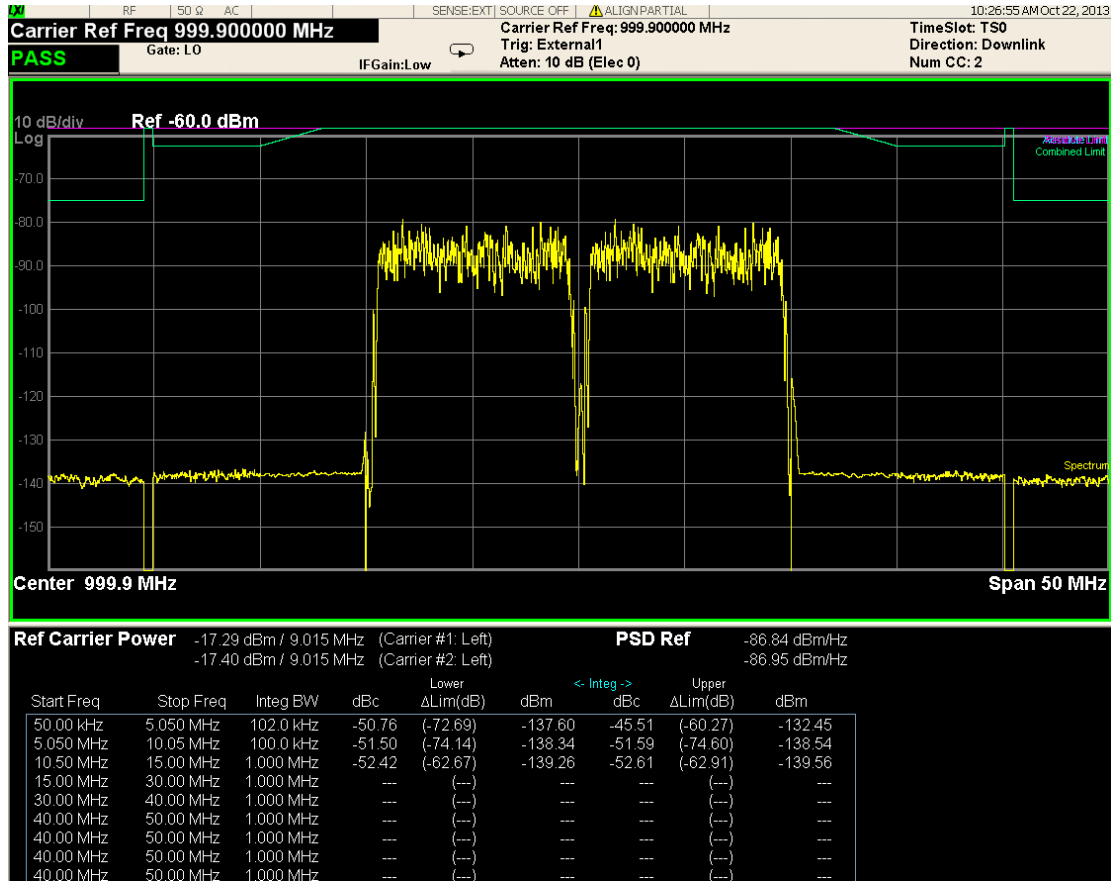

For WLAN 802.11ac (80 + 80 MHz), power readouts of both of the carriers are displayed in the lower result window.

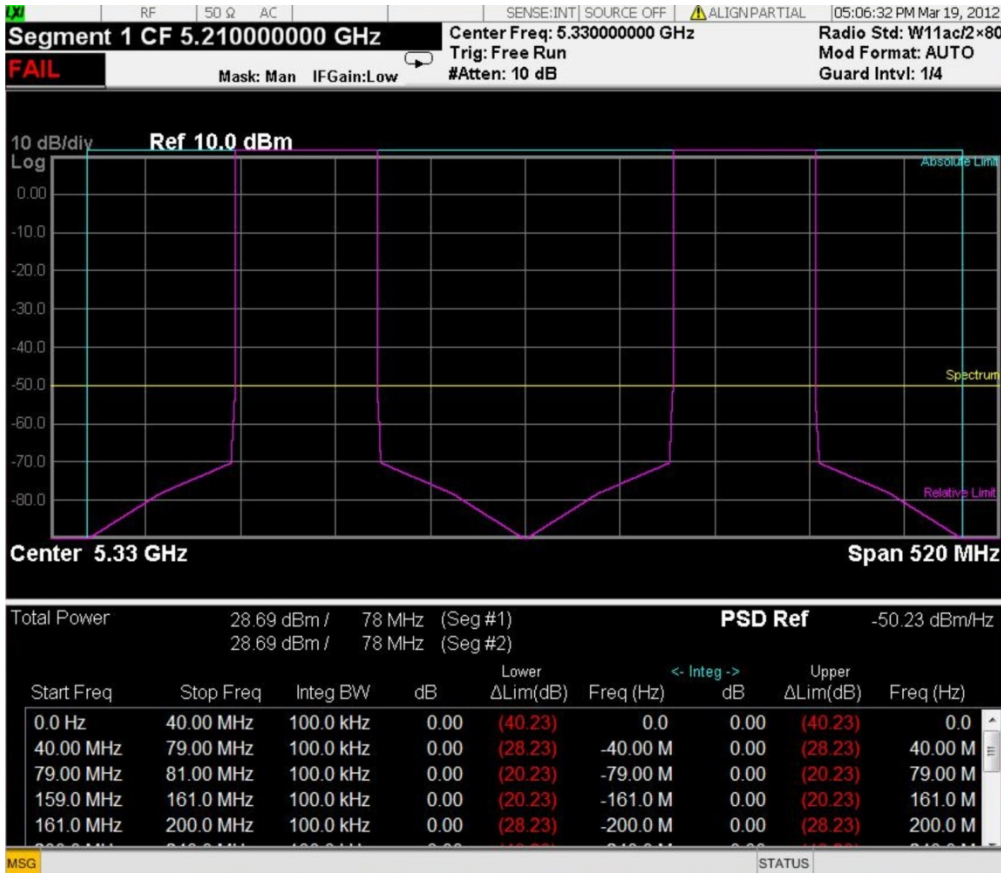

Trace Window

Corresponding Trace                    yellow - Combined trace from carrier and each offset

Results Window

Name	Corresponding Results
Total Pwr	n=1 2nd element Absolute power at the reference area.
PSD Ref	n=5 1st element Power spectral density reference at the reference area
Start (Hz)	Start frequency for offset
Stop (Hz)	Stop frequency for offset
Meas BW (Hz)	Measurement bandwidth for offset
Lower (dB)	Relative power spectrum density of the negative offset
Lower ΔLim (dB)	Minimum margin from limit line which is decided by Fail Mask setting on the negative offset

Name	Corresponding Results
Lower (dBm/Hz)	Absolute power spectrum density of the negative offset
Upper (dB)	Relative power spectrum density of the positive offset
Upper ΔLim (dB)	Minimum margin from limit line which is decided by Fail Mask setting on the positive offset
Upper (dBm/Hz)	Absolute power spectrum density of the negative offset

### Integrated Power (Spectrum Pk Ref)

"Trace Window" on page 1404

"Results Window" on page 1404

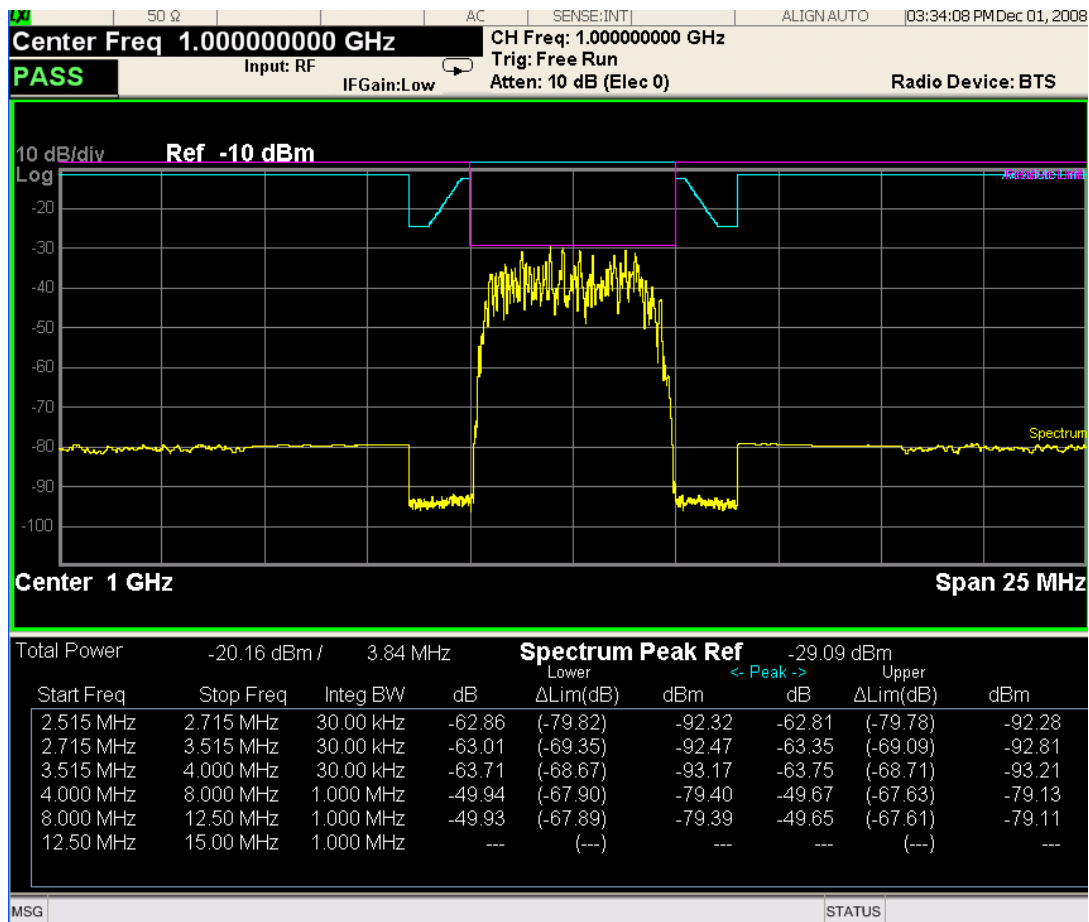

For WLAN 802.11ac (80 + 80 MHz), power readouts of both of the carriers are displayed in the lower result window.

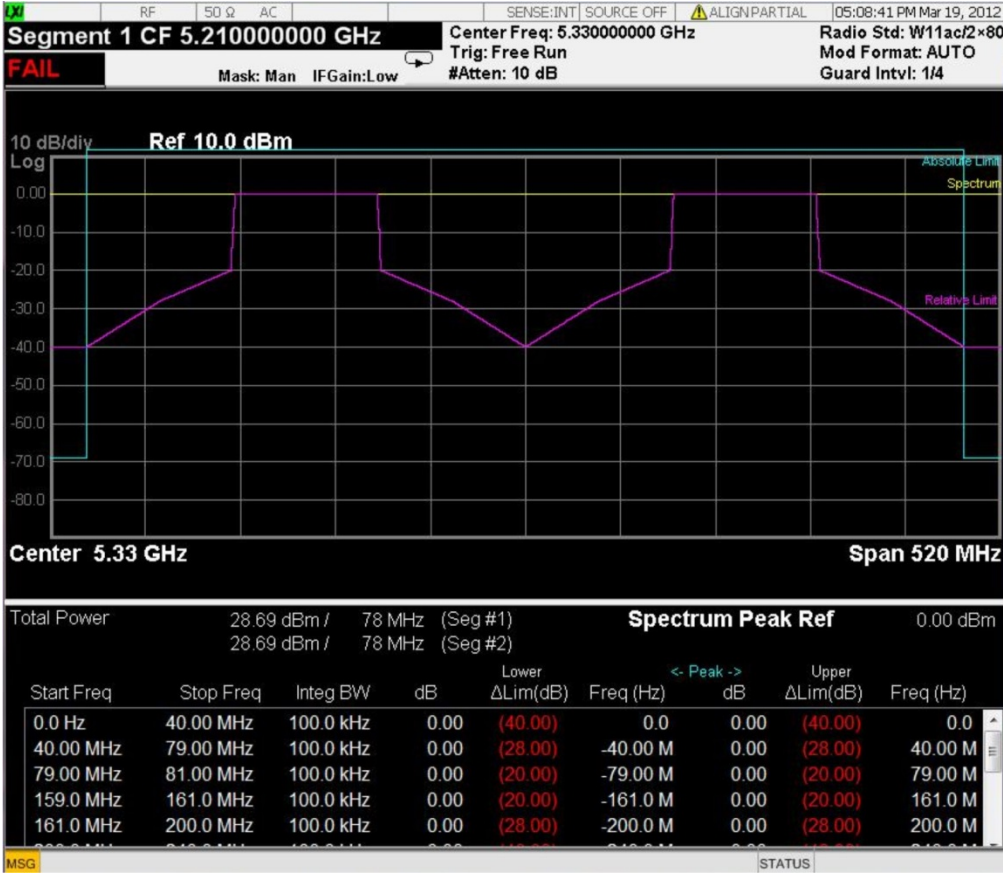

Trace Window

Corresponding Trace                    yellow - Combined trace from carrier and each offset

Results Window

Name	Corresponding Results
Total Pwr	Absolute power at the reference area.
	Channel Integration Bandwidth
Spectrum Peak Ref	n=5 1st element Peak power at the reference area
Start (Hz)	Start frequency for offset
Stop (Hz)	Stop frequency for offset
Meas BW (Hz)	Measurement bandwidth for offset
Lower Peak (dB)	Relative peak power on minimum margin point of the negative offset
Lower Δlim (dB)	Minimum margin from limit line which is decided by Fail Mask setting on the negative offset

Name	Corresponding Results
Lower Peak (dBm)	Absolute peak power on minimum margin point of the negative offset
Upper Peak (dB)	Relative peak power on minimum margin point of the positive offset
Upper $\Delta$ lim (dB)	Minimum margin from limit line which is decided by Fail Mask setting on the positive offset
Upper Peak (dBm)	Absolute peak power on minimum margin point of the positive offset

Key Path	View/Display
Initial S/W Revision	Prior to A.02.00

## Limit Lines

Toggles the limit lines display function for the spectrum emission mask measurements On and Off.

Key Path	View/Display
Mode	SA, WCDMA, C2K, WIMAX OFDMA, TD-SCDMA, 1xEVDO, DTMB (CTTB), DVB-T/H, ISDB-T, CMMB, LTE, LTE-TDD, Digital Cable TV, WLAN, MSR, LTEAFDD, LTEATDD
<b>Remote Command</b>	:CALCulate:SEMask:LLINe:STATe ON OFF 1 0 :CALCulate:SEMask:LLINe:STATe?
<b>Example</b>	CALC:SEM:LLIN:STAT OFF CALC:SEM:LLIN:STAT?
Notes	You must be in the mode that includes SEM measurement to use this command. Use :INSTrument:SElect to set the mode.
Preset	ON
State Saved	Saved in instrument state.
Range	On Off
Initial S/W Revision	Prior to A.02.00
Modified at S/W Revision	A.02.00, A.03.00

## 13 Spurious Emissions Measurement

The Spurious Emissions measurement identifies and determines the power level of spurious emissions in certain frequency bands. For measurement results and views, see ["View/Display" on page 1579](#).

This topic contains the following sections:

["Measurement Commands for Spurious Emissions" on page 1412](#)

["Remote Command Results for Spurious Emissions Measurement" on page 1413](#)

## Measurement Commands for Spurious Emissions

The following commands can be used to retrieve the measurement results:

`:CONFigure:SPURious`

`:CONFigure:SPURious:NDEFault`

`:INITiate:SPURious`

`:FETCh:SPURious [n]?`

`:READ:SPURious [n]?`

`:MEASure:SPURious [n]?`

For more measurement related commands, see the SENSE subsystem, and the section "[Remote Measurement Functions](#)" on page 2848.



## Remote Command Results for Spurious Emissions Measurement

The following table describes the results returned by the FETCh, MEASure, and READ queries listed above, according to the index value n. Note that the queries are not available when viewing the Range Table.

n	Return Value
1 (or not supplied)	Returns a variable-length (1+6*Spurs – up to 1201 entries) comma separated list containing detailed information in the following format: 1. Number of spurs in following list (Integer) 2.[Repeat the following for each spur] a.Spur # b.Range # Spur was located (Integer) c.Frequency of Spur (Hz, Float64) d.Amplitude of Spur (dBm, Float32) e.Absolute Limit (dBm, Float32) f.Pass or Fail (1 0, Boolean)
2 – 21	Returns a comma separated list of the trace data for the selected range (where range number = n – 1) using Detector 1. If selected range is not active SCPI_NAN is returned for each trace data element where SCPI_NAN = 9.91E37.
22	Returns the number of spurs found.
23 – 42	Returns a comma separated list of the trace data for the selected range (where range number = n – 22) using Detector 2. If selected range is not active or Detector 2 selection is off, SCPI_NAN is returned for each trace data element where SCPI_NAN = 9.91E37.
Key Path	Meas
Initial S/W Revision	Prior to A.02.00

## AMPTD Y Scale

AMPTD Y Scale opens a menu of functions that enable you to modify the Amplitude parameters.

Key Path	Front-panel key
Initial S/W Revision	Prior to A.02.00

### Ref Value

Sets the value for the absolute power reference. When Auto Scaling for the Y-axis is off, the measurement uses the current reference level settings. When Auto Scaling for the Y-axis is on, the analyzer will set the reference level such that the absolute limit will be positioned two divisions down from the top of the display.

Key Path	AMPTD Y Scale
Mode	SA, WCDMA, WIMAX OFDMA, TD-SCDMA,C2k, 1xEV-DO, DVB-T/H, LTE, LTETDD, WLAN, MSR, LTEAFDD, LTEATDD
Remote Command	:DISPlay:SPURious:VIEW[1]:WINDow[1]:TRACe:Y[:SCALE]:RLEVel < real> :DISPlay:SPURious:VIEW[1]:WINDow[1]:TRACe:Y[:SCALE]:RLEVel?
Example	DISP:SPUR:VIEW:WIND:TRAC:Y:RLEV -50 dBm DISP:SPUR:VIEW:WIND:TRAC:Y:RLEV?
Notes	You must be in the Spectrum Analysis mode, W-CDMA mode, cdma2000 mode, DVB-T/H mode, TD-SCDMA mode, LTE mode, LTETDD mode, WLAN mode, MSR, LTE-Advanced FDD/TDD mode or WiMAX mode to use this command. Use INSTRument:SElect to set the mode.
Couplings	When the Y Auto Scaling is off, the measurement uses the current reference level settings. When the Y Auto Scaling is on, the analyzer automatically sets the reference level such that the absolute limit is positioned two divisions down from the top of the display. This is the most useful setting when searching for spurs. The algorithm used for determining the ref level is Ref Level = Absolute Limit + (2 * Scale/Div). All other reference level settings are left as the current base instrument settings.
Preset	0.00 dBm
State Saved	Saved in instrument state.
Min	-250.0 dBm
Max	250.0 dBm
Initial S/W Revision	Prior to A.02.00
Modified at S/W Revision	A.03.00

### Attenuation

This menu controls the attenuator functions and interactions between the attenuation system components.

There are two attenuator configurations in the X-Series. One is a dual attenuator configuration consisting of a mechanical attenuator and an optional electronic attenuator. The other configuration uses a single

attenuator with combined mechanical and electronic sections that controls all the attenuation functions. Different models in the X-Series come with different configurations.

See ["Dual Attenuator Configurations:" on page 1415](#)

See ["Single Attenuator Configuration:" on page 1416](#)

Most Attenuation settings are the same for all measurements – they do not change as you change measurements. Settings like these are called “Meas Global” and are unaffected by Meas Preset.

Key Path	AMPTD Y Scale
Scope	Meas Global
Dependencies	In measurements that support the I/Q inputs, this key is unavailable when I/Q is the selected input, and is replaced by the Range key in that case.
Readback Line	Contains a summary in [ ] brackets of the current total attenuation. See the descriptions of the , " <a href="#">(Mech) Atten</a> " on page 2783, and " <a href="#">Enable Elec Atten</a> " on page 2785 keys for more detail on the contributors to the total attenuation.  Note that when "Pre-Adjust for Min Clip" is on, this value can change at the start of every measurement.
Initial S/W Revision	Prior to A.02.00
Modified at S/W Revision	A.03.00

## Dual Attenuator Configurations:

Configuration 1: Mechanical attenuator + optional electronic attenuator

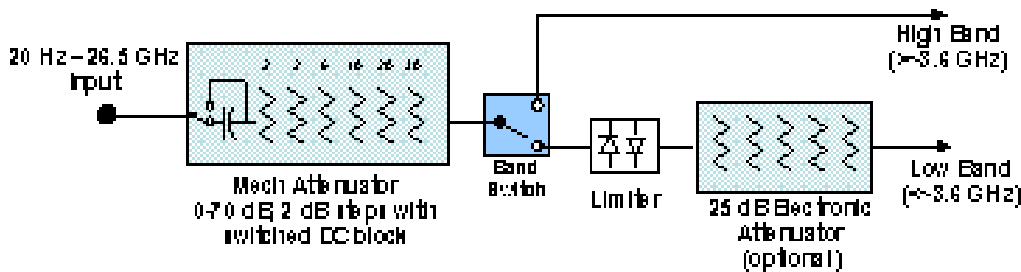

Configuration 2: Mechanical attenuator, no optional electronic attenuator

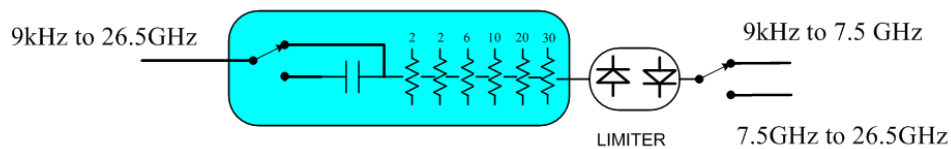

(note that Configuration 2 is not strictly speaking a dual-section attenuator, since there is no electronic section available. However, it behaves exactly like Configuration 1 without the Electronic Attenuator option EA3, therefore for the sake of this document it is grouped into the “Dual Attenuator” configuration)

### Single Attenuator Configuration:

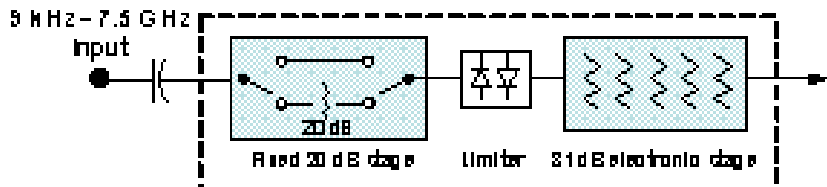

You can tell which attenuator configuration you have by pressing the Attenuation key, which (in most Modes) opens the Attenuation menu. If the first key in the Attenuation menu says Mech Atten you have the dual attenuator configuration. If the first key says Atten you have the single attenuator configuration.

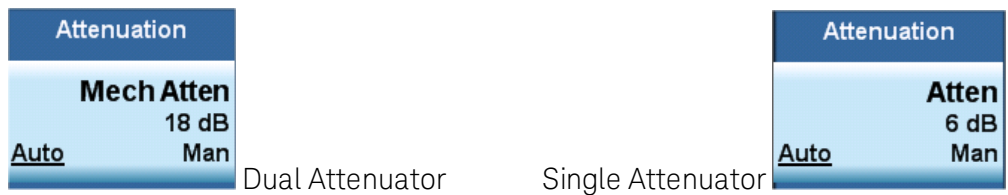

In the single attenuator configuration, you control the attenuation with a single control, as the fixed stage has only two states. In the dual attenuator configuration, both stages have significant range so you are given separate control of the mechanical and electronic attenuator stages.

When you have the dual attenuator configuration, you may still have only a single attenuator, because unless option EA3 (the Electronic Attenuator option) is available, and you purchase it, you will have only the mechanical attenuator.

### (Mech) Atten

This key is labeled Mech Atten in dual attenuator models and Atten in single attenuator models. In the dual attenuator configuration, this key only affects the mechanical attenuator.

This key lets you modify the attenuation applied to the RF input signal path. This value is normally auto coupled to the Ref Level, the Internal Preamp Gain, any External Gain that is entered, and the Max Mixer Level, as described in the table below.

See ["Attenuator Configurations and Auto/Man" on page 1418](#)

Key Path	AMPTD Y Scale, Attenuation
<b>Remote Command</b>	<pre>[ :SENSe]:POWer[:RF]:ATTenuation &lt;rel_ampl&gt; [:SENSe]:POWer[:RF]:ATTenuation? [:SENSe]:POWer[:RF]:ATTenuation:AUTO OFF ON 0 1 [:SENSe]:POWer[:RF]:ATTenuation:AUTO?</pre>
<b>Example</b>	<p>POW:ATT 20</p> <p>Dual attenuator configuration: sets the mechanical attenuator to 20 dB</p> <p>Single attenuator mode: sets the main attenuation to 20 dB (see below for definition of “main” attenuation).</p> <p>If the attenuator was in Auto, it sets it to Manual.</p>
<b>Dependencies</b>	Some measurements do not support the Auto setting of (Mech) Atten. In these measurements, the

---

Auto/Man selection is not available, and the Auto/Man line on the key disappears.

In dual attenuator configurations, when the electronic attenuator is enabled, the mechanical attenuator has no auto setting and the Auto/Man line on the key disappears. The state of Auto/Man is remembered and restored when the electronic attenuator is once again disabled. This is described in more detail in the ["Enable Elec Atten" on page 2785](#) key description.

See ["Attenuator Configurations and Auto/Man" on page 1418](#) for more information on the Auto/Man functionality of Attenuation.

---

Couplings

When (Mech) Atten is in Auto, it uses the following algorithm to determine a value:

If the USB Preamp is connected to USB, use 0 dB.

Otherwise,  $Atten = ReferenceLevel + PreAmpGain + ExternalGain - RefLevelOffset - MaxMixerLevel + IF\ Gain$ .

Limit this value to be between 6 dB and the Max value. No value below 6 dB can ever be chosen by Auto.

The resulting value is rounded up to the largest value possible given the attenuation step setting. That is, 50.01 dB would change to 60 dB (for a 10 dB attenuation step).

The "IF Gain" term in the equation above is either 0 dB or +10 dB, depending on the settings of FFT IF Gain, Swept IF Gain, max Ref Level and the Auto/Man setting of Mech Atten.

In External Mixing and BBIQ, where the Attenuator is not in the signal path, the Attenuator setting changes as described above when (Mech) Atten is in Auto, but no changes are made to the actual attenuator hardware setting until the input is changed back to the RF Input.

---

Preset

The preset for Mech Attenuation is "Auto."

The Auto value of attenuation is:

CXA, EXA, MXA and PXA: 10 dB

---

State Saved

Saved in instrument state

---

Min

0 dB

The attenuation set by this key cannot be decreased below 6 dB with the knob or step keys. To get to a value below 6 dB it has to be directly entered from the keypad or via SCPI. This protects from adjusting the attenuation to a dangerously small value which can put the instrument at risk of damage to input circuitry. However, if the current mechanical attenuation is below 6 dB it can be increased with the knob and step keys, but not decreased.

---

Max

CXA N9000A-503/507: 50 dB

CXA N9000A-513/526: 70dB

EXA: 60 dB

MXA and PXA: 70 dB

In the single attenuator configuration, the total of ATT and EATT cannot exceed 50 dB, so if the EATT is set to 24 dB first, the main attenuation cannot be greater than 26 dB and will be reduced accordingly; if the main attenuator is set to 40 dB first, EATT cannot be greater than 10 dB.

---

Initial S/W Revision

Prior to A.02.00

---

Modified at S/W Revision

A.03.00

---

### Attenuator Configurations and Auto/Man

As described in the Attenuation key description, there are two distinct attenuator configurations available in the X-Series, the single attenuator and dual attenuator configurations. In dual attenuator configurations, we have the mechanical attenuation and the electronic attenuation, and the current total attenuation is the sum of the electronic + mechanical attenuation. In single attenuator configurations, we refer to the attenuation set using the (Mech) Atten key (or POW:ATT SCPI) as the “main” attenuation; and the attenuation that is set by the SCPI command POW:EATT as the “soft” attenuation (the POW:EATT command is honored even in the single attenuator configuration, for compatibility purposes). Then the current total attenuation is the sum of the main + soft attenuation. See the Elec Atten key description for more on “soft” attenuation.

In the dual attenuator configuration, when the electronic attenuator is enabled, there is no Auto/Man functionality for the mechanical attenuator, and the third line of the key label (the Auto/Man line) disappears:

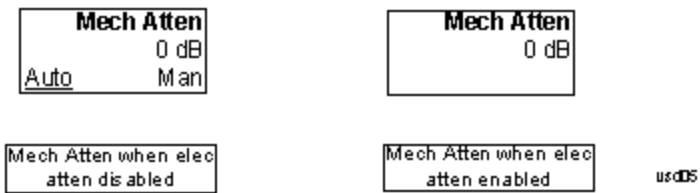

### Enable Elec Atten

Enables the Electronic Attenuator.

The electronic attenuator offers finer steps than the mechanical attenuator, has no acoustical noise, is faster, and is less subject to wear. These advantages primarily aid in remote operation and are negligible for front panel use. See ["Using the Electronic Attenuator: Pros and Cons" on page 1420](#) for a detailed discussion of the pros and cons of using the electronic attenuator.

For the single attenuator configuration, for SCPI backwards compatibility, the “soft” attenuation feature replaces the dual attenuator configuration’s electronic attenuator. All the same couplings and limitations apply. See ["Attenuator Configurations and Auto/Man" on page 2785](#)

See ["More Information" on page 1419](#)

<b>Key Path</b>	AMPTD Y Scale, Attenuation
<b>Remote Command</b>	[ :SENSE ] : POWer [ :RF ] : EATTenuation : STATE OFF   ON   0   1 [ :SENSe ] : POWer [ :RF ] : EATTenuation : STATE?
<b>Example</b>	POW:EATT:STAT ON
<b>Dependencies</b>	This key only appears in Dual Attenuator models with an Electronic Attenuator installed. It does not appear in models with the Single Attenuator configuration, as in the single attenuator configuration there is no “electronic attenuator” there is only a single integrated attenuator (which has both a mechanical and electronic stage). However, in the single attenuator configuration, EATT SCPI commands are accepted for compatibility with other X-series instruments and set a “soft” attenuation as described in <a href="#">"Attenuator Configurations and Auto/Man" on page 2785</a> . The electronic attenuator (and the “soft” attenuation function provided in single attenuator configurations) is unavailable above 3.6 GHz. Therefore, if the Stop Frequency of the analyzer is > 3.6 GHz then the Enable Elec Atten key will be OFF and grayed out.

---

	<p>If the Internal Preamp is on, meaning it is set to Low Band or Full, the electronic attenuator (and the “soft” attenuation function provided in single attenuator configurations) is unavailable. In this case the Enable Elec Atten key will be OFF and grayed out.</p> <p>If either of the above is true, if the SCPI command is sent, an error indicating that the electronic attenuator is unavailable will be sent.</p> <p>If the electronic/soft Attenuator is enabled, then the Stop Freq of the analyzer is limited to 3.6 GHz and the Internal Preamp is unavailable.</p> <p>The SCPI-only “soft” electronic attenuation for the single-attenuator configuration is not available in all measurements; in particular, it is not available in the Swept SA measurement.</p>
Couplings	Enabling and disabling the Electronic Attenuator affects the setting of the Mechanical Attenuator (in dual attenuator configurations). This is described in more detail below this table.
Preset	OFF for Swept SA measurement; ON for all other measurements that support the electronic attenuator
State Saved	Saved in instrument state
Initial S/W Revision	Prior to A.02.00
Modified at S/W Revision	A.03.00

---

## More Information

### Mechanical Attenuator Transition Rules

When the Electronic Attenuator is enabled, the Mechanical Attenuator transitions to a state that has no Auto function. Below are the rules for transitioning the Mechanical Attenuator. NOTE that the information below ONLY applies to the dual attenuator configurations, and ONLY when the Electronic Attenuator is installed:

#### When the Electronic Attenuation is enabled from a disabled state:

- The Mechanical Attenuator is initialized to 10 dB (this is its optimal performance setting). You can then set it as desired with SCPI, numeric keypad, step keys, or knob, and it behaves as it normally would in manual mode
- The Auto/Man state of (Mech) Atten is saved
- The Auto/Man line on the (Mech) Atten key disappears and the auto rules are disabled
- The Electronic Attenuator is set to 10 dB less than the previous value of the Mechanical Attenuator, within the limitation that it must stay within the range of 0 to 24 dB of attenuation.

#### Examples in the dual attenuator configuration:

- Mech Atten at 20 dB. Elec Atten enabled, Mech Atten set to 10 dB, and Elec Atten set to 10 dB. New total attenuation equals the value before Elec Atten enabled.
- Mech Atten at 0 dB. Elec Atten enabled, Mech Atten set to 10 dB, and Elec Atten set to 0 dB. New total attenuation does not equal the value before Elec Atten enabled.
- Mech Atten at 40 dB. Elec Atten enabled, Mech Atten set to 10 dB, and Elec Atten set to 24 dB. New total attenuation does not equal the value before Elec Atten enabled.

**When the Electronic Attenuation is disabled from an enabled state:**

- The Elec Atten key is grayed out
- The Auto/Man state of (Mech) Atten is restored
- If now in Auto, (Mech) Atten recouples
- If now in Man, (Mech) Atten is set to the value of total attenuation that existed before the Elec Atten was disabled. The resulting value is rounded up to the smallest value possible given the (Mech) Atten Step setting - (That is, 57 dB changes to 58 dB when (Mech) Atten Step is 2 dB.)

**Using the Electronic Attenuator: Pros and Cons**

The electronic attenuator offers finer steps than the mechanical attenuator, has no acoustical noise, is faster, and is less subject to wear.

The “finer steps” advantage of the electronic attenuator is beneficial in optimizing the alignment of the analyzer dynamic range to the signal power in the front panel as well as remote use. Thus, you can achieve improved relative signal measurement accuracy. Compared to a mechanical attenuator with 2 dB steps, the 1 dB resolution of the electronic attenuator only gives better resolution when the odd-decibel steps are used. Those odd-decibel steps are less accurately calibrated than the even-decibel steps, so one tradeoff for this superior relative accuracy is reduced absolute amplitude accuracy.

Another disadvantage of the electronic attenuator is that the spectrum analyzer loses its “Auto” setting, making operation less convenient.

Also, the relationship between the dynamic range specifications (TOI, SHI, compression and noise) and instrument performance are less well-known with the electrical attenuator. With the mechanical attenuator, TOI, SHI and compression threshold levels increase dB-for-dB with increasing attenuation, and the noise floor does as well. With the electronic attenuator, there is an excess attenuation of about 1 to 3 dB between 0 and 3.6 GHz, making the effective TOI, SHI, and so forth, less well known. Excess attenuation is the actual attenuation relative to stated attenuation. Excess attenuation is accounted for in the analyzer calibration

**Elec Atten**

Controls the Electronic Attenuator in dual attenuator configurations. This key does not appear in single attenuator configurations, as the control of both the mechanical and electronic stages of the single attenuator is integrated into the single Atten key.

<b>Key Path</b>	AMPTD Y Scale, Attenuation
<b>Remote Command</b>	[ :SENSe ] :POWer [ :RF ] :EATTenuation <rel_amp1> [ :SENSe ] :POWer [ :RF ] :EATTenuation?
<b>Notes</b>	Electronic Attenuation’s specification is defined only when Mechanical Attenuation is 6 dB.
<b>Dependencies</b>	This key only appears in Dual Attenuator models with an Electronic Attenuator installed. It does not appear in models with the Single Attenuator configuration, as in the single attenuator configuration there is no “electronic attenuator” there is only a single integrated attenuator (which has both a mechanical and electronic stage). However, in the single attenuator configuration, EATT SCPI commands are accepted for compatibility with other X-series instruments and set a “soft” attenuation as described in <a href="#">"Attenuator Configurations and Auto/Man" on page 2785</a> . The “soft” attenuation is treated as an addition to the “main” attenuation value set by the Atten softkey or the



	POW:ATT SCPI command and affects the total attenuation displayed on the Attenuation key and the Meas Bar. When Enable Elec Atten is off or grayed out, the Elec Atten key is grayed out.
Preset	0 dB
State Saved	Saved in instrument state
Min	0 dB
Max	Dual attenuator configuration: 24 dB Single attenuator configuration: the total of ATT and EATT cannot exceed 50 dB, so if the EATT is set to 24 dB first, the main attenuation cannot be greater than 26 dB and will be reduced accordingly; if the main attenuator is set to 40 dB first, EATT cannot be greater than 10 dB
Initial S/W Revision	Prior to A.02.00
Modified at S/W Revision	A.03.00

### Adjust Atten for Min Clip

Sets the combination of mechanical and electronic attenuation and gain based on the current measured signal level so that clipping will be at a minimum.

This is an "immediate action" function, that is, it executes once, when the key is pressed.

This key is grayed out in measurements that do not support this functionality. The spectrum analyzer measurement, Swept SA, does not support this functionality.

Key Path	AMPTD Y Scale, Attenuation
Remote Command	<code>[ :SENSe ] :POWer [ :RF ] :RANGe:OPTimize IMMEDIATE</code>
Initial S/W Revision	Prior to A.02.00
Modified at S/W Revision	A.03.00

### Pre-Adjust for Min Clip

If this function is on, it does the adjustment described under "[Adjust Atten for Min Clip](#)" on page 2788 each time a measurement restarts. Therefore, in Continuous measurement mode, it only executes before the first measurement.

In dual attenuator models, you can set Elec+Mech Atten, in which case both attenuators participate in the autoranging, or Elec Atten Only, in which case the mechanical attenuator does not participate in the autoranging. This latter case results in less wear on the mechanical attenuator and is usually faster.

This key is grayed out in measurements that do not support this functionality. The spectrum analyzer measurement, Swept SA, does not support this functionality.

Key Path	AMPTD Y Scale, Attenuation
Remote Command	<code>[ :SENSe ] :POWer [ :RF ] :RANGe:OPTimize:ATTenuation OFF   ELECTRical   COMBined</code>

	<code>[ :SENSe ] :POWer [ :RF ] :RANGe:OPTimize:ATTenuation?</code>
Notes	The SCPI parameter ELECtrical sets this function to On in single attenuator models. The SCPI parameter COMBined is mapped to ELECtrical in single attenuator models; if you send COMBined, it sets the function to On and returns ELEC to a query.
Dependencies	This key only appears in Dual Attenuator models with an Electronic Attenuator installed. In instruments with Dual Attenuator model, when Enable Elec Atten is off or grayed out, the Pre-Adjust for Min Clip key is grayed out.
Preset	OFF for Swept SA measurement; ON for all other measurements that support Pre-Adjust for Min Clip
State Saved	Saved in instrument state
Range	Dual attenuator models: Off   Elec Atten Only   Mech + Elec Atten Single attenuator models: Off   On
Initial S/W Revision	Prior to A.02.00
Modified at S/W Revision	A.03.00

<b>Remote Command</b>	<code>[ :SENSe ] :POWer [ :RF ] :RANGe:AUTO ON OFF 1 0</code> <code>[ :SENSe ] :POWer [ :RF ] :RANGe:AUTO?</code>
Notes	ON aliases to "Elec Atten Only" (:POW:RANG:OPT:ATT ELEC) OFF aliases to "Off" (:POW:RANG:OPT:ATT OFF) The query :POW:RANG:AUTO? returns true if :POW:RANG:OPT:ATT is not "Off"
Initial S/W Revision	Prior to A.02.00

## Off

Turns Pre-Adjust for Min Clip off. This is the default setting.

This key is grayed out in measurements that do not support this functionality. The spectrum analyzer measurement, Swept SA, does not support this functionality.

Key Path	AMPTD Y Scale, Attenuation, Pre-Adjust for Min Clip
Example	:POW:RANGe:OPT:ATT OFF
Initial S/W Revision	Prior to A.02.00

## Elec Atten Only

Selects only the electric attenuator to participate in auto ranging. This offers less wear on the mechanical attenuator and is usually faster.

This key is grayed out in measurements that do not support this functionality. The spectrum analyzer measurement, Swept SA, does not support this functionality.

Key Path	AMPTD Y Scale, Attenuation, Pre-Adjust for Min Clip
Example	:POW:RANGe:OPT:ATT ELEC
Initial S/W Revision	Prior to A.02.00

### Mech + Elec Atten

In dual attenuator models, this selects both attenuators participate in the autoranging.

This key is grayed out in measurements that do not support this functionality. The spectrum analyzer measurement, Swept SA, does not support this functionality.

Key Path	AMPTD Y Scale, Attenuation, Pre-Adjust for Min Clip
Example	:POW:RANGe:OPT:ATT COMB
Initial S/W Revision	Prior to A.02.00

### (Mech) Atten Step

This controls the step size used when making adjustments to the input attenuation.

This key is labeled Mech Atten Step in dual attenuator models and Atten Step in single attenuator models. In the dual attenuator configuration, this key only affects the step size of the mechanical attenuator.

Key Path	AMPTD Y Scale, Attenuation
Remote Command	[[:SENSe]:POWer[:RF]:ATTenuation:STEP[:INCRement] 10 dB   2 dB [:SENSe]:POWer[:RF]:ATTenuation:STEP[:INCRement]?
Example	POW:ATT:STEP 2
Notes	Note this feature works like a 1-N choice from the front panel, but it takes a specific value (in dB) when used remotely. The only valid values are 2 and 10.
Dependencies	Blanked in CXA and EXA if option FSA (2 dB steps) is not present. If blanked, attempts to set it via SCPI will yield an error.
Couplings	When the attenuation step size changes, the current mechanical attenuation value is adjusted (if necessary) to be quantized to the new step size. That is, if step is set to 10 dB, mech atten is increased if necessary so it is a multiple of 10 dB
Preset	PXA and MXA: 2 dB EXA and CXA: 10 dB (2 dB with option FSA)
State Saved	Saved in instrument state
Initial S/W Revision	Prior to A.02.00
Modified at S/W Revision	A.03.00

## Scale/Div

Sets the units per division of the vertical scale in the logarithmic display. However, since the Auto Scaling is defaulted to On, this value is automatically determined by the measurement result. When you set a value manually, Auto Scaling automatically changes to Off.

<b>Key Path</b>	AMPTD Y Scale
<b>Mode</b>	SA, WCDMA, C2K, WIMAX OFDMA, TD-SCDMA, DVB-T/H, LTE, LTE-TDD, WLAN, MSR, LTEAFDD, LTEATDD
<b>Remote Command</b>	:DISPlay:SPURious:VIEW[1]:WINDow[1]:TRACe:Y[:SCALe]:PDIVision <rel_ ampl> :DISPlay:SPURious:VIEW[1]:WINDow[1]:TRACe:Y[:SCALe]:PDIVision?
<b>Example</b>	DISP:SPUR:VIEW:WIND:TRAC:Y:PDIV 10 dB DISP:SPUR:VIEW:WIND:TRAC:Y:PDIV?
<b>Notes</b>	You must be in the Spectrum Analysis mode, W-CDMA mode, cdma2000 mode, DVB-T/H mode, TD-SCDMA, LTE mode, LTE TDD mode, WLAN mode, MSR, LTE-Advanced FDD/TDD mode or WiMAX mode to use this command. Use INSTRument:SElect to set the mode.
<b>Couplings</b>	When Auto Scaling is On, this value is automatically determined by the measurement result. When you set a value manually, Auto Scaling automatically changes to Off.
<b>Preset</b>	10.00 dB
<b>State Saved</b>	Saved in instrument state.
<b>Range</b>	0.10 dB to 20.00 dB
<b>Min</b>	0.10 dB
<b>Max</b>	20.00 dB
<b>Initial S/W Revision</b>	Prior to A.02.00
<b>Modified at S/W Revision</b>	A.03.00

## Presel Center

When this key is pressed, the centering of the preselector filter is adjusted to optimize the amplitude accuracy at the frequency of the selected marker. If the selected marker is not on when Presel Center is pressed, the analyzer will turn on the selected marker, perform a peak search, and then perform centering on the marker's center frequency. If the selected marker is already on and between the start and stop frequencies of the analyzer, the analyzer performs the preselector calibration on that marker's frequency. If the selected marker is already on, but outside the frequency range between Start Freq and Stop Freq, the analyzer will first perform a peak search, and then perform centering on the marker's center frequency.

The value displayed on the Presel Adjust key will change to reflect the new preselector tuning (see Presel Adjust).

A number of considerations should be observed to ensure proper operation. See ["Proper Preselector Operation" on page 1425](#).

<b>Key Path</b>	AMPTD Y Scale
-----------------	---------------

<b>Remote Command</b>	<code>[ :SENSe ] :POWer [ :RF ] :PCENter</code>
<b>Example</b>	POW:PCEN
<b>Notes</b>	Note that the rules outlined above under the key description apply for the remote command as well as the key. The result of the command is dependent on marker position, and so forth. Any message shown by the key press is also shown in response to the remote command.
<b>Dependencies</b>	<ul style="list-style-type: none"> <li>• Grayed out if the microwave preselector is off. )</li> <li>• If the selected marker's frequency is below Band 1, advisory message 0.5001 is generated and no action is taken.</li> <li>• Grayed out if entirely in Band 0.</li> <li>• Blank in models that do not include a preselector, such as option 503. If the SCPI is sent in these instruments, it is accepted without error, and the query always returns 0.</li> <li>• Grayed out in the Spectrogram View.</li> </ul>
<b>Couplings</b>	<p>The active marker position determines where the centering will be attempted.</p> <p>If the analyzer is in a measurement such as averaging when centering is initiated, the act of centering the preselector will restart averaging but the first average trace will not be taken until the centering is completed.</p>
<b>Status Bits/OPC dependencies</b>	<p>When centering the preselector, *OPC will not return true until the process is complete and a subsequent measurement has completed, nor will results be returned to a READ or MEASure command.</p> <p>The Measuring bit should remain set while this command is operating and should not go false until the subsequent sweep/measurement has completed.</p>
<b>Initial S/W Revision</b>	Prior to A.02.00
<b>Modified at S/W Revision</b>	A.03.00

## Proper Preselector Operation

A number of considerations should be observed to ensure proper operation:

1. If the selected marker is off, the analyzer will turn on a marker, perform a peak search, and adjust the preselector using the selected marker's frequency. It uses the "highest peak" peak search method unqualified by threshold or excursion, so that there is no chance of a 'no peak found' error. It continues with that peak, even if it is the peak of just noise. Therefore, for this operation to work properly, there should be a signal on screen in a preselected range for the peak search to find.
2. If the selected marker is already on, the analyzer will attempt the centering at that marker's frequency. There is no preselector for signals below about 3.6 GHz, therefore if the marker is on a signal below 3.6 GHz, no centering will be attempted and an advisory message generated
3. In some models, the preselector can be bypassed. If it is bypassed, no centering will be attempted in that range and a message will be generated.

## Preselector Adjust

Allows you to manually adjust the preselector filter frequency to optimize its response to the signal of interest. This function is only available when "Presel Center" on page 2791 is available.

For general purpose signal analysis, using Presel Center is recommended. Centering the filter minimizes the impact of long-term preselector drift. Presel Adjust can be used instead to manually optimize the preselector. One application of manual optimization would be to peak the preselector response, which both optimizes the signal-to-noise ratio and minimizes amplitude variations due to small (short-term) preselector drifting.

Key Path	AMPTD Y Scale
Scope	Meas Global
Remote Command	<code>[ :SENSe ] :POWer [ :RF ] :PADJust &lt;freq&gt;</code> <code>[ :SENSe ] :POWer [ :RF ] :PADJust?</code>
Example	POW:PADJ 100KHz POW:PADJ?
Notes	The value on the key reads out to 0.1 MHz resolution.
Dependencies	<ul style="list-style-type: none"> <li>• Grayed out if microwave preselector is off. )</li> <li>• Grayed out if entirely in Band 0.</li> <li>• Blank in models that do not include a preselector, such as option 503. If the SCPI is sent in these instruments, it is accepted without error, and the query always returns 0.</li> <li>• Grayed out in the Spectrogram View.</li> </ul>
Preset	0 MHz
State Saved	The Presel Adjust value set by Presel Center, or by manually adjusting Presel Adjust, is not saved in instrument state, and does not survive a Preset or power cycle.
Min	-500 MHz
Max	500 MHz
Default Unit	Hz
Backwards Compatibility SCPI	<code>[ :SENSe ] :POWer [ :RF ] :MW :PADJust</code> <code>[ :SENSe ] :POWer [ :RF ] :MMW :PADJust</code> PSA had multiple preselectors, but the X-Series has only one. These commands simply alias to <code>[ :SENSe ] :POWer [ :RF ] :PADJust</code>
Initial S/W Revision	Prior to A.02.00
Modified at S/W Revision	A.03.00

Remote Command	<code>[ :SENSe ] :POWer [ :RF ] :PADJust :PRESelector MWAVE   MMWave   EXTERNAL</code> <code>[ :SENSe ] :POWer [ :RF ] :PADJust :PRESelector?</code>
Notes	PSA had multiple preselectors, and you could select which preselector to adjust. Since the X-Series has only one mm/uW preselector, the preselector selection softkey is no longer available. However,

---

to provide backward compatibility, we accept the legacy remote commands.  
The command form has no effect, the query always returns MWAVE

---

Initial S/W Revision      Prior to A.02.00

---

## μW Path Control

The μW Path Control functions include the μW Preselector Bypass (Option MPB) and Low Noise Path (Option LNP) controls in the High Band path circuits.

When the μW Preselector is bypassed, the user has better flatness, but will be subject to spurs from out of band interfering signals. When the Low Noise Path is enabled, the analyzer automatically switches around certain circuitry in the high frequency bands which can contribute to noise, when it is appropriate based on other analyzer settings.

For most applications, the preset state is Standard Path, which gives the best remote-control throughput, minimizes acoustic noise from switching and minimizes the risk of wear out in the hardware switches. For applications that utilize the wideband IF paths, the preset state is the μW Preselector Bypass path, if option MPB is present. This is because, when using a wideband IF such as the 140 MHz IF, the μW Preselector's bandwidth can be narrower than the available IF bandwidth, causing degraded amplitude flatness and phase linearity, so it is desirable to bypass the preselector in the default case.

Users may choose Low Noise Path Enable. It gives a lower noise floor, especially in the 21–26.5 GHz region, though without improving many measures of dynamic range, and without giving the best possible noise floor. The preamp, if purchased and used, gives better noise floor than does the Low Noise Path, however its compression threshold and third-order intercept are much poorer than that of the non-preamp Low Noise Path. There are some applications, typically for signals around –30 dBm, for which the third-order dynamic range of the standard path is good enough, but the noise floor is not low enough even with 0 dB input attenuation. When the third-order dynamic range of the preamp path is too little and the noise floor of the standard path is too high, the Low Noise Path can provide the best dynamic range.

<b>Key Path</b>	AMPTD Y Scale
<b>Mode</b>	SA, BASIC, PNOISE, VSA , LTE, LTETDD
<b>Scope</b>	Meas Global
<b>Remote Command</b>	[ :SENSe ] :POWer [ :RF ] :MW :PATH STD LNPath MPBypass FULL [ :SENSe ] :POWer [ :RF ] :MW :PATH?
<b>Example</b>	:POW:MW:PATH LNP    Enables the Low Noise path
<b>Notes</b>	If a Presel Center is performed, the analyzer will momentarily switch to the Standard Path, regardless of the setting of μW Path Control  The DC Block will always be switched in when the low noise path is switched in, to protect succeeding circuitry from DC. Note that this does not mean “when the low noise path is enabled” but when, based on the Low Noise Path rules, the path is actually switched in. This can happen when the selection is Low Noise Path Enable . In the case where the DC Block is switched in the analyzer is now AC coupled. However, if the user has selected DC coupling, the UI will still behave as though it were DC coupled, including all annunciation, warnings, status bits, and responses to SCPI queries. This is because, based on other settings, the analyzer could switch out the low noise path at any time

---

	and hence go back to being DC coupled. Alignment switching ignores the settings in this menu, and restores them when finished.
Dependencies	Unavailable in BBIQ and External Mixing
Preset	All modes other than IQ Analyzer mode and VXA: STD IQ Analyzer, VXA and WLAN mode: MPB option present and licensed: MPB MPB option not present and licensed: STD
State Saved	Save in instrument state
Readback	Value selected in the submenu
Initial S/W Revision	A.04.00
Modified at S/W Revision	A.10.00

## Standard Path

This path gives the best remote-control throughput, minimizes acoustic noise from switching and minimizes the risk of wear in the hardware switches, particularly in remote test scenarios where both low band and high band setups will follow in rapid succession.

In this path, the bypass of the low band/high band switch and microwave preamp is never activated, which can cause some noise degradation but preserves the life of the bypass switch.

Key Path	AMPTD Y Scale, $\mu$ W Path Control
Example	:POW:MW:PATH STD
Readback Text	Standard Path
Initial S/W Revision	A.04.00

## Low Noise Path Enable

You may choose Low Noise Path Enable, which gives a lower noise floor under some circumstances, particularly when operating in the 21–26.5 GHz region. With the Low Noise Path enabled, the low band/high band switch and microwave preamp are bypassed whenever all of the following are true:

- The analyzer is not in the Low Band, meaning:
  - the start frequency is above 3.5 GHz and
  - the stop frequency is above 3.6 GHz.
- the internal preamp is not installed or (if installed) is set to Off or Low Band

Note that this means that, when any part of a sweep is done in Low Band, the Low Noise Path is not used, whether or not the Low Noise Path Enable is selected in the user interface. Also, if the preamp is turned on, the Low Noise Path is not used, whether or not the Low Noise Path Enable is selected in the user interface. The only time the Low Noise Path is used is when Low Noise Path Enable is selected, the sweep is completely in High Band (> 3.6 GHz) and no preamp is in use.



See ["More Information" on page 1429](#)

Key Path	AMPTD Y Scale, $\mu$ W Path Control
Measurement	Swept SA
<b>Example</b>	:POW:MW:PATH LNP
Notes	<p>For measurements that use IQ acquisition, the low noise path is used when the Center Frequency is in High Band (&gt; 3.6 GHz) and no preamp is in use.</p> <p>In other words, the rules above are modified to use only the center frequency to qualify which path to switch in.</p> <p>This is not the case for FFT's in the Swept SA measurement; they use the same rules as swept measurements.</p>
Dependencies	<p>Key is blanked if current mode does not support it.</p> <p>Key is grayed out if mode supports it but current measurement does not support it.</p> <p>Unless Option LNP is present and licensed, key is blank and if SCPI command sent, error -241, "Hardware missing; Option not installed" is generated.</p>
Readback Text	Low Noise Path Enable
Initial S/W Revision	A.04.00

## More Information

The user should understand that the Low Noise Path, while giving improved DANL, has the disadvantage of decreased TOI performance and decreased gain compression performance relative to the standard path.

The user should also understand that the bypass switch is a mechanical switch and has finite life, so if the Low Noise Path is enabled, it is possible to cause frequent cycling of this switch by frequently changing analyzer settings such that the above conditions hold true only some of the time. A user making tests of this nature should consider opting for the Standard Path, which will never throw the bypass switch, at the expense of some degraded noise performance.

The low noise path is useful for situations where the signal level is so low that the analyzer performance is dominated by noise even with 0 dB attenuation, but still high enough that the preamp option would have excessive third-order intermodulation or compression. The preamp, if purchased and used, gives better noise floor than does the "Low Noise Path." However, its compression threshold and third-order intercept are much poorer than that of the non-preamp path. There are some applications, typically for signals around -30 dBm, for which the third-order dynamic range of the standard path is good enough, but the noise floor is not low enough even with 0 dB input attenuation. When the third-order dynamic range of the preamp path is too little and the noise floor of the standard path is too high, the Low Noise Path can provide the best dynamic range

The graph below illustrates the concept. It shows, in red, the performance of an analyzer at different attenuation settings, both with the preamp on and off, in a measurement that is affected by both analyzer noise and analyzer TOI. The green shows the best available dynamic range, offset by 0.5 dB for clarity. The blue shows how the best available dynamic range improves for moderate signal levels with the low noise path switched in. In this illustration, the preamp improves the noise floor by 15 dB while degrading the third-order intercept by 30 dB, and the low noise path reduces loss by 8 dB. The attenuator step size is 2 dB.

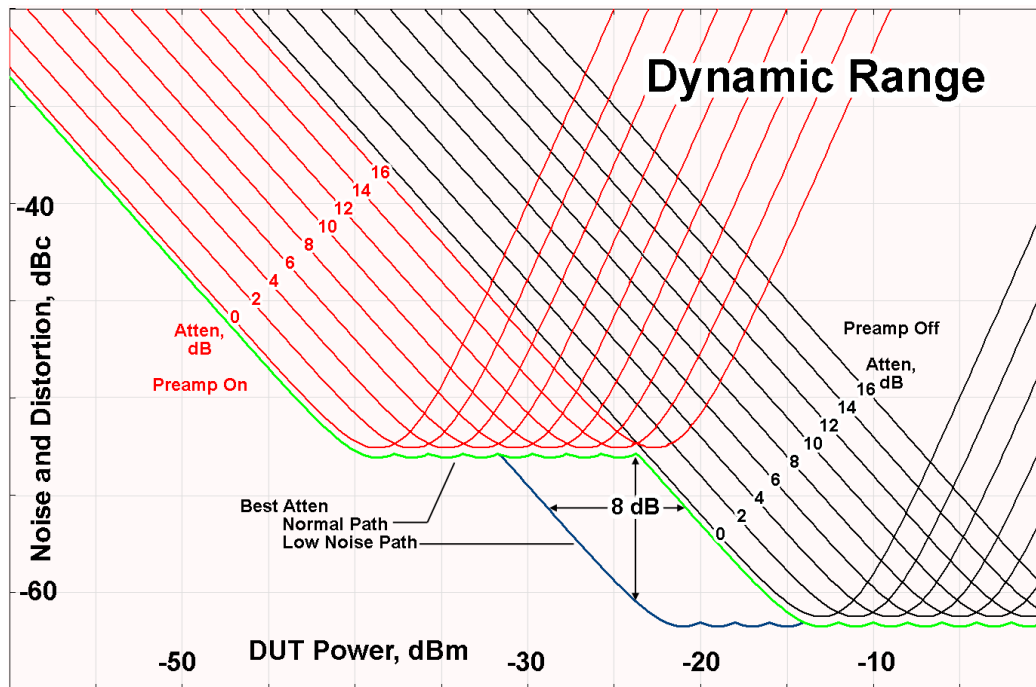

There are other times where selecting the low noise path improves performance, too. Compression-limited measurements such as finding the nulls in a pulsed-RF spectrum can profit from the low noise path in a way similar to the TOI-limited measurement illustrated. Accuracy can be improved when the low noise path allows the optimum attenuation to increase from a small amount like 0, 2 or 4 dB to a larger amount, giving better return loss at the analyzer input. Harmonic measurements, such as second and third harmonic levels, are much improved using the low noise path because of the superiority of that path for harmonic (though not intermodulation) distortion performance.

### μW Preselector Bypass

This key toggles the preselector bypass switch for band 1 and higher. When the microwave preselector is on, the signal path is preselected. When the microwave preselector is off, the signal path is not preselected. The preselected path is the normal path for the analyzer.

The preselector is a tunable bandpass filter which prevents signals away from the frequency of interest from combining in the mixer to generate in-band spurious signals (images). The consequences of using a preselector filter are its limited bandwidth, the amplitude and phase ripple in its passband, and any amplitude and phase instability due to center frequency drift.

Option MPB or pre-selector bypass provides an unpreselected input mixer path for certain X-Series signal analyzers with frequency ranges above 3.6 GHz. This signal path allows a wider bandwidth and less amplitude variability, which is an advantage when doing modulation analysis and broadband signal analysis. The disadvantage is that, without the preselector, image signals will be displayed. Another disadvantage of bypassing the preselector is increased LO emission levels at the front panel input port.

Image responses are separated from the real signal by twice the 1st IF. For IF Paths of 10 MHz and 25 MHz, the 1st IF is 322.5 MHz, so the image response and the real signal will be separated by 645 MHz. The 1st IF will be different for other IF Path settings. When viewing a real signal and its corresponding image response in internal mixing, the image response will be to the left of the real signal.

Also, the image response and the real signal typically have the same amplitude and exhibit the same shape factor.

However, if Option FS1, Fast Sweep Capability, is enabled, the image response in the Swept SA measurement will appear lower in amplitude and have a much wider shape factor compared to the real signal.

Key Path	AMPTD Y Scale, $\mu$ W Path Control
<b>Example</b>	:POW:MW:PATH MPB
Dependencies	Key is blanked if current mode does not support it. Key is grayed out if mode supports it but current measurement does not support it. Key is blank unless Option MPB is present and licensed. If SCPI command sent when MPB not present, error -241, "Hardware missing; Option not installed" is generated.
Readback Text	$\mu$ W Preselector Bypass
Initial S/W Revision	A.04.00

<b>Remote Command</b>	[ :SENSe ] :POWer [ :RF ] :MW:PRESelector [ :STATe ] ON OFF 0 1 [ :SENSe ] :POWer [ :RF ] :MW:PRESelector [ :STATe ] ?
<b>Example</b>	:POW:MW:PRES OFF Bypasses the microwave preselector
Notes	The ON parameter sets the STD path (:POW:MW:PATH STD) The OFF parameter sets path MPB (:POW:MW:PATH MPB)
Preset	ON

## Internal Preamp

Accesses a menu of keys that control the internal preamps. Turning on the preamp gives a better noise figure, but a poorer TOI to noise floor dynamic range. You can optimize this setting for your particular measurement.

The instrument takes the preamp gain into account as it sweeps. If you sweep outside of the range of the preamp the instrument will also account for that. The displayed result will always reflect the correct gain.

For some measurements, when the preamp is on and any part of the displayed frequency range is below the lowest frequency for which the preamp has specifications, a warning condition message appears in the status line. For example ,for a preamp with a 9 kHz lowest specified frequency: "Preamp: Accy unspec'd below 9 kHz".

Key Path	AMPTD Y Scale
Scope	Meas Global
<b>Remote Command</b>	[ :SENSe ] :POWer [ :RF ] :GAIN [ :STATe ] OFF ON 0 1 [ :SENSe ] :POWer [ :RF ] :GAIN [ :STATe ] ?
Dependencies	Preamp is not available on all hardware platforms. If the preamp is not present or is unlicensed, the

---

	key is not shown. The preamp is not available when the electronic/soft attenuator is enabled.
--	--------------------------------------------------------------------------------------------------

---

Couplings	The act of connecting the U7227A USB Preamplifier to one of the analyzer's USB ports will cause the Internal Preamp to be switched on. When this happens an informational message will be generated: "Internal Preamp turned on for optimal operation with USB Preamp." Note that if the Internal Preamp was already on, there will be no change to the setting, but if it was Off it will be switched On, to Full Range.  Note that this same action occurs when the SA mode is selected while the USB Preamp is connected to one of the analyzer's USB ports, if it is the first time that the SA mode has run since powerup, or if the last time the SA mode was running the USB Preamp was NOT connected.  Subsequently disconnecting the USB Preamp from USB does not change the Internal Preamp setting nor restore the previous setting.
Preset	OFF
State Saved	Saved in instrument state
Initial S/W Revision	Prior to A.02.00
Modified at S/W Revision	A.14.00

---

Key Path	AMPTD Y Scale, Internal Preamp
Scope	Meas Global
<b>Remote Command</b>	[ :SENSe ] :POWer [ :RF ] :GAIN:BAND LOW FULL [ :SENSe ] :POWer [ :RF ] :GAIN:BAND?
Dependencies	Preamp is not available on all hardware platforms. If the preamp is not present or is unlicensed, the key is not shown.  If a POW:GAIN:BAND FULL command is sent when a low band preamp is available, the preamp band parameter is to LOW instead of FULL, and an "Option not installed" message is generated.
Preset	LOW
State Saved	Saved in instrument state
Initial S/W Revision	Prior to A.02.00

---

## Off

Turns the internal preamp off

Key Path	AMPTD Y Scale, Internal Preamp
<b>Example</b>	:POW:GAIN OFF
Readback	Off
Initial S/W Revision	Prior to A.02.00

---

## Low Band

Sets the internal preamp to use only the low band.

The frequency range of the installed (optional) low-band preamp is displayed in square brackets on the Low Band key label.

Key Path	AMPTD Y Scale, Internal Preamp
<b>Example</b>	:POW:GAIN ON :POW:GAIN:BAND LOW
Readback	Low Band
Initial S/W Revision	Prior to A.02.00

## Full Range

Sets the internal preamp to use its full range. The low band (0–3.6 GHz or 0–3GHz, depending on the model) is supplied by the low band preamp and the frequencies above low band are supplied by the high band preamp.

The frequency range of the installed (optional) preamp is displayed in square brackets on the Full Range key label. If the high band option is not installed the Full Range key does not appear.

Key Path	AMPTD Y Scale, Internal Preamp
<b>Example</b>	:POW:GAIN ON :POW:GAIN:BAND FULL
Readback	Full Range
Initial S/W Revision	Prior to A.02.00

## Auto Scaling

Toggles the Auto Scaling function between On and Off.

Key Path	AMPTD Y Scale
Mode	SA, WCDMA, C2K, WIMAX OFDMA, TD-SCDMA, DVB-T/H, LTE, LTETDD, WLAN, MSR, LTEAFDD, LTEATDD
<b>Remote Command</b>	:DISPlay:SPURious:VIEW[1]:WINDow[1]:TRACe:Y[:SCALe]:COUPle 0   1   OFF   ON  :DISPlay:SPURious:VIEW[1]:WINDow[1]:TRACe:Y[:SCALe]:COUPle?
<b>Example</b>	DISP:SPUR:VIEW:WIND:TRAC:Y:COUP OFF DISP:SPUR:VIEW:WIND:TRAC:Y:COUP?
Couplings	When Auto Scaling is On and the Restart front-panel key is pressed, this function automatically determines the scale per division and reference values based on the measurement results. When you set a value to either Scale/Div or Ref Value manually, Auto Scaling automatically changes to Off.

---

	When the Y Auto Scaling is off, the measurement uses the current reference level settings. When the Y Auto Scaling is on, the analyzer automatically sets the reference level such that the absolute limit is positioned two divisions down from the top of the display. This is the most useful setting when searching for spurs. The algorithm used for determining the ref level is $\text{Ref Level} = \text{Absolute Limit} + (2 * \text{Scale/Div})$ . All other reference level settings are left as the current base instrument settings.
Preset	1
State Saved	Saved in instrument state.
Range	On Off
<b>Backwards Compatibility SCPI</b>	[ :SENSe ] : SPURious : POWer [ :RF ] : RANGe : AUTO
Initial S/W Revision	Prior to A.02.00
Modified at S/W Revision	A.03.00

---

## Auto Couple

The Auto Couple feature provides a quick and convenient way to automatically couple multiple instrument settings. This helps ensure accurate measurements and optimum dynamic range. When the Auto Couple feature is activated, either from the front panel or remotely, all parameters of the current measurement that have an Auto/Manual mode are set to Auto mode and all measurement settings dependent on (or coupled to) the Auto/Man parameters are automatically adjusted for optimal performance.

However, the Auto Couple key actions are confined to the current measurement only. It does not affect other measurements in the mode, and it does not affect markers, marker functions, or trace or display attributes.

See ["More Information" on page 1435](#)

Key Path	Front-panel key
Remote Command	:COUPle ALL NONE
Example	:COUP ALL
Notes	:COUPle ALL puts all Auto/Man parameters in Auto mode (equivalent to pressing the Auto Couple key). :COUPLE NONE puts all Auto/Man parameters in manual mode. It decouples all the coupled instrument parameters and is not recommended for making measurements.
Initial S/W Revision	Prior to A.02.00

### More Information

There are two types of functions that have Auto/Manual modes.

#### Auto/Man Active Function keys

An Auto/Man toggle key controls the binary state associated with an instrument parameter by toggling between Auto (where the parameter is automatically coupled to the other parameters it is dependent upon) and Man (where the parameter is controlled independent of the other parameters), as well as making the parameter the active function. The current mode is indicated on the softkey with either Auto or Man underlined as illustrated below.



#### Auto/Man 1-of-N keys

An Auto/Man 1-of-N key allows you to manually pick from a list of parameter values, or place the function in Auto, in which case the value is automatically selected (and indicated) as shown below. If in Auto, Auto is underlined on the calling key. If in manual operation, manual is indicated on the calling key. But the calling key does not actually toggle the function, it simply opens the menu.

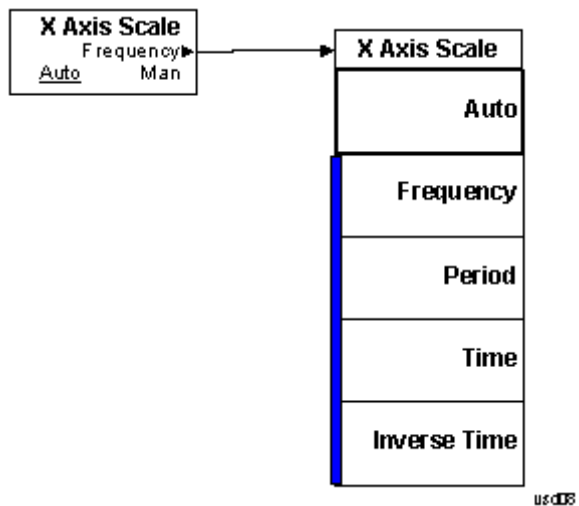



## BW

BW is unavailable in the Spurious Emissions measurement. When pressed, this key displays a blank menu.

Key Path	Front-panel key
Initial S/W Revision	Prior to A.02.00

## Cont (Continuous Measurement/Sweep)

Sets the analyzer for Continuous measurement operation. The single/continuous state is Meas Global so the setting will affect all measurements. If you are Paused, pressing Cont does a Resume.

<b>Key Path</b>	Front-panel key
<b>Remote Command</b>	:INITiate:CONTinuous OFF ON 0 1 :INITiate:CONTinuous?
<b>Example</b>	:INIT:CONT 0 puts analyzer in Single measurement operation. :INIT:CONT 1 puts analyzer in Continuous measurement operation
<b>Preset</b>	ON (Note that SYST:PRESet sets INIT:CONT to ON but *RST sets INIT:CONT to OFF)
<b>State Saved</b>	Saved in instrument state
<b>Backwards Compatibility Notes</b>	For Spectrum Analysis mode in ESA and PSA, there is no Cont hardkey, instead there is a Sweep Single/Cont key. In these analyzers, switching the Sweep Single/Cont key from Single to Cont restarts averages (displayed average count reset to 1), but does not restart Max Hold and Min Hold. The X-Series has Single and Cont keys in place of the SweepSingleCont key. In the X-Series, if in single measurement, the Cont key (and INIT:CONT ON ) switches to continuous measurement, but never restarts a measurement and never resets a sweep.
<b>Initial S/W Revision</b>	Prior to A.02.00

In Swept SA Measurement (Spectrum Analysis Mode):

The analyzer takes repetitive sweeps, averages, measurements, etc., when in Continuous mode. When the average count reaches the Average/Hold Number the count stops incrementing, but the analyzer keeps sweeping. See the Trace/Detector section for the averaging formula used both before and after the Average/Hold Number is reached. The trigger condition must be met prior to each sweep. The type of trace processing for multiple sweeps, is set under the Trace/Detector key, with choices of Trace Average, Max Hold, or Min Hold.

In Other Measurements/Modes:

With Avg/Hold Num (in the Meas Setup menu) set to Off or set to On with a value of 1, a sweep is taken after the trigger condition is met; and the analyzer continues to take new sweeps after the current sweep has completed and the trigger condition is again met. However, with Avg/Hold Num set to On with a value >1, multiple sweeps (data acquisitions) are taken for the measurement. The trigger condition must be met prior to each sweep. The sweep is not stopped when the average count k equals the number N set for Avg/Hold Num is reached, but the number k stops incrementing. A measurement average usually applies to all traces, marker results, and numeric results. But sometimes it only applies to the numeric results.

If the analyzer is in Single measurement, pressing the Cont key does not change k and does not cause the sweep to be reset; the only action is to put the analyzer into Continuous measurement operation.

If it is already in continuous sweep:

the INIT:CONT 1 command has no effect

the INIT:CONT 0 command will place the analyzer in Single Sweep but will have no effect on the current sequence until  $k = N$ , at which point the current sequence will stop and the instrument will go to the idle state.

13 Spurious Emissions Measurement  
File

File

See "File" on page 354

## FREQ Channel

Accesses a menu of keys that allow you to control the Frequency and Channel parameters of the instrument.

Some features in the Frequency menu are the same for all measurements – they do not change as you change measurements. Settings like these are called “Meas Global” and are unaffected by Meas Preset. For example, the Center Freq setting is the same for all measurements – it does not change as you change measurements.

<b>Key Path</b>	Front-panel key
<b>Initial S/W Revision</b>	Prior to A.02.00

### Center Freq

Sets the frequency that corresponds to the horizontal center of the graticule (when frequency Scale Type is set to linear). While adjusting the Center Frequency the Span is held constant, which means that both Start Frequency and Stop Frequency will change.

Pressing Center Freq also sets the frequency entry mode to Center/Span. In Center/Span mode, the center frequency and span values are displayed below the graticule, and the default active function in the Frequency menu is Center Freq.

The center frequency setting is the same for all measurements within a mode, that is, it is Meas Global. Some modes are also able to share a Mode Global center frequency value. If this is the case, the Mode will have a Global Settings key in its Mode Setup menu.

The Center Freq function sets (and queries) the Center Frequency for the currently selected input. If your analyzer has multiple inputs, and you select another input, the Center Freq changes to the value for that input. SCPI commands are available to directly set the Center Freq for a specific input.

Center Freq is remembered as you go from input to input. Thus you can set a Center Freq of 10 GHz with the RF Input selected, change to BBIQ and set a Center Freq of 20 MHz, then switch to External Mixing and set a Center Freq of 60 GHz, and when you go back to the RF Input the Center Freq will go back to 10 GHz; back to BBIQ and it is 20 MHz; back to External Mixing and it is 60 GHz.

See ["RF Center Freq" on page 1444](#)

See [Ext Mix Center Freq](#)

See ["I/Q Center Freq" on page 1446](#)

See ["Center Frequency Presets" on page 1442](#)

<b>Key Path</b>	FREQ Channel
<b>Scope</b>	Meas Global
<b>Remote Command</b>	[ :SENSe ] :FREQuency :CENTer <freq> [ :SENSe ] :FREQuency :CENTer?

<b>Example</b>	FREQ:CENT 50 MHz FREQ:CENT UP changes the center frequency to 150 MHz if you use FREQ:CENT:STEP 100 MHz to set the center frequency step size to 100 MHz FREQ:CENT?
<b>Notes</b>	This command sets either the RF or I/Q Center Frequency depending on the selected input. For RF input it is equivalent to FREQ:RF:CENT For I/Q input it is equivalent to FREQ:IQ:CENT Preset and Max values are dependent on Hardware Options (5xx) If no terminator (e.g. MHz) is sent the terminator Hz is used. If a terminator with unit other than Frequency is used, an invalid suffix error message is generated.
<b>Dependencies</b>	The Center Frequency can be limited by Start or Stop Freq limits, if the Span is so large that Start or Stop reach their limit.
<b>Couplings</b>	When operating in “swept span”, any value of the Center Frequency or Span that is within the frequency range of the analyzer is allowed when the value is being set through the front panel numeric key pad or the SCPI command. The other parameter is forced to a different value if needed, to keep the Start and the Stop Frequencies within the analyzer’s frequency range
<b>Preset</b>	Depends on instrument maximum frequency, mode, measurement, and selected input. See <a href="#">"Center Frequency Presets" on page 1442</a> and <a href="#">"RF Center Freq" on page 1444</a> and <a href="#">Ext Mix Center Freq</a> and <a href="#">"I/Q Center Freq" on page 1446</a> .
<b>State Saved</b>	Saved in instrument state
<b>Min</b>	Depends on instrument maximum frequency, mode, measurement, and selected input.. See <a href="#">"Center Frequency Presets" on page 1442</a> and <a href="#">"RF Center Freq" on page 1444</a> and <a href="#">"I/Q Center Freq" on page 1446</a> .
<b>Max</b>	Depends on instrument maximum frequency, mode, measurement, and selected input.. See <a href="#">"Center Frequency Presets" on page 1442</a> and <a href="#">"RF Center Freq" on page 1444</a> and <a href="#">"I/Q Center Freq" on page 1446</a> .
<b>Default Unit</b>	Hz
<b>Status Bits/OPC</b>	Non-overlapped
<b>Dependencies</b>	
<b>Initial S/W Revision</b>	Prior to A.02.00

### Center Frequency Presets

The following table provides the Center Frequency Presets for the Spectrum Analyzer mode, and the Max Freq, for the various frequency options:

Freq Option	CF after Mode Preset	Stop Freq after Mode Preset	Max Freq (can't tune
-------------	-------------------------	--------------------------------	----------------------------

			above)
503 (all but N9000A)	1.805 GHz	3.6 GHz	3.7 GHz
503 (N9000A)	1.505 GHz	3.0 GHz	3.08 GHz
507 (all but N9000A)	3.505 GHz	7.0 GHz	7.1 GHz
507 (N9000A)	3.755 GHz	7.5 GHz	7.58 GHz
508 (all but N9038A)	1.805 GHz	3.6 GHz	8.5 GHz
508 (N9038A)	4.205 GHz	8.4 GHz	8.5 GHz
513	6.805 GHz	13.6 GHz	13.8 GHz
526 (all but N9000A and N9038A)	13.255 GHz	26.5 GHz	27.0 GHz
526 (N9000A)	13.255 GHz	26.5 GHz	26.55 GHz
526 (N9038A)	1.805 GHz	3.6 GHz	27.0 GHz
532	16.005 GHz	32.0 GHz	32.5 GHz
543	21.505 GHz	43.0 GHz	TBD
544	22.005 GHz	44.0 GHz	44.5 GHz
550	25.005 GHz	50.0 GHz	51 GHz

Input 2:

Model	CF after Mode Preset	Stop Freq after Mode Preset	Max Freq (can't tune above)
N9000A opt C75	0.7505GHz	1.5 GHz	1.58 GHz
N9038A	505 MHz	1 GHz	1.000025 GHz

Tracking Generator Frequency Limits (N9000A only):

Tracking Generator Option	Min Freq (clips to this freq when turn TG on and	If above this Freq, Stop Freq clipped to this Freq when	Max Freq (can't tune above) while TG

	can't tune below while TG on)	TG turned on	on
T03	9 kHz	3.0 GHz	3.08 GHz
T06	9 kHz	6.0 GHz	6.05 GHz

The following table shows the Center Frequency Presets for modes other than Spectrum Analyzer:

Mode	CF Preset for RF
WCDMA	1 GHz
WIMAXOFDMA,	1 GHz
BASIC	1 GHz
ADEMOD	1 GHz
VSA	1 GHz
TDSCDMA	1 GHz
PNOISE	1 GHz
LTE	1 GHz
LTETDD	1 GHz
MSR	1 GHz
GSM	935.2 MHz
NFIGURE	1.505 GHz

## RF Center Freq

SCPI command for specifying the RF Center Frequency. This command will set the Center Frequency to be used when the RF input is selected, even if the RF input is not the input that is selected at the time the command is sent. Note that the Center Freq function in the Frequency menu on the front panel always applies to the currently selected input.

Scope	Meas Global
<b>Remote Command</b>	<code>[ :SENSe ] :FREQuency:RF:CENTer &lt;freq&gt;</code> <code>[ :SENSe ] :FREQuency:RF:CENTer?</code>
<b>Example</b>	FREQ:RF:CENT 30 MHz
Notes	This command is the same in all modes, but the parameter is Measurement Global. So the value is independent in each mode and common across all the measurements in the mode.
Dependencies	If the electronic/soft attenuator is enabled, any attempt to set Center Frequency such that the Stop Frequency would be >3.6 GHz fails and results in an advisory message. If the equivalent SCPI command is sent, this same message is generated as part of a “-221, Settings conflict” warning. If Source Mode is set to Tracking, and the Max or Min Center Freq is therefore limited by the limits of the source, a warning message is generated, “Data out of range;clipped to source max/min” if these limits are exceeded. Note that for an external source, these limits can be affected by the settings of



	Source Numerator, Source Denominator and Power Sweep.
Preset	See table above
State Saved	Saved in instrument state.
Min	-79.999995 MHz, unless Source Mode is set to Tracking, in which case it is limited by the minimum frequency of the Source
Max	See table above. Basically instrument maximum frequency - 5 Hz. Note that, if the Source Mode is set to Tracking, the effective instrument maximum frequency may be limited by the source maximum frequency.  If the knob or step keys are being used, also depends on the value of the other three interdependent parameters Span, Start Frequency and Stop Frequency
Initial S/W Revision	Prior to A.02.00
Modified at S/W Revision	A.03.00

## Ext Mix Center Freq

SCPI command for specifying the External Mixer Center Frequency. This command will set the Center Frequency to be used when the External Mixer is selected, even if the External Mixer input is not the input which is selected at the time the command is sent. Note that the Center Freq function in the Frequency menu on the front panel always applies to the currently selected input.

Scope	Meas Global
<b>Remote Command</b>	<code>[ :SENSe ] :FREQuency:EMIXer:CENTer &lt;freq&gt;</code> <code>[ :SENSe ] :FREQuency:EMIXer:CENTer?</code>
<b>Example</b>	<code>:FREQ:EMIX:CENT 60 GHz</code> <code>:FREQ:EMIX:CENT?</code>
Notes	This command is the same in all modes, but the parameter is Measurement Global. So the value is independent in each mode and common across all the measurements in the mode.
Couplings	When returning to External Mixing after having been switched to one of the other inputs (e.g., RF), you will come back into the settings that you had when you left External Mixing. So you will come back to the band you were in with the Center Frequency that you had. However, Span is not an input-dependent parameter, therefore you will bring the span over from the other input. Therefore, the analyzer comes back with the span from the previous input, limited as necessary by the current mixer setup.
Preset	When a Mode Preset is performed while in External Mixing, the Start frequency of the current Mode is set to the nominal Min Freq of the lowest harmonic range in the Harmonic Table for the current mixer setup. Similarly, the Stop frequency of the current Mode is set to the nominal Max Freq of the highest harmonic range in the Harmonic Table. The Center Freq thus presets to the point arithmetically equidistant from these two frequencies.  If the current measurement has a limited Span available to it, and cannot achieve the Span shown in the table ( $\text{Span} = \text{Stop Freq} - \text{Start Freq}$ ), the analyzer uses the maximum Span the measurement allows, and still sets the Center Freq to the midpoint of the Start and Stop Freq values in the Harmonic Table.

	<p>When Restore Input/Output Defaults is performed, the mixer presets to the 11970A, whose Start and Stop frequencies are 26.5 and 40 GHz respectively. The center of these two frequencies is 33.25 GHz.</p> <p>Therefore, after a Restore Input/Output Defaults, if you go into External Mixing and do a Mode Preset while in the Spectrum Analyzer Mode, the resulting Center Freq is 33.25 GHz.</p>
State Saved	Saved in instrument state.
Min	The minimum frequency in the currently selected mixer band + 5 Hz
Max	<p>The maximum frequency in the currently selected mixer band – 5 Hz</p> <p>If the knob or step keys are being used, also depends on the value of the other three interdependent parameters Span, Start Frequency and Stop Frequency</p>
Initial S/W Revision	A.08.01

### I/Q Center Freq

SCPI command for specifying the I/Q Center Frequency. This command will set the Center Frequency to be used when the I/Q input is selected, even if the I/Q input is not the input which is selected at the time the command is sent. Note that the Center Freq function in the Frequency menu on the front panel always applies to the currently selected input.

Scope	Meas Global
<b>Remote Command</b>	<pre>[ :SENSe ] :FREQuency:IQ:CENTer &lt;freq&gt;</pre> <pre>[ :SENSe ] :FREQuency:IQ:CENTer?</pre>
<b>Example</b>	FREQ:IQ:CENT: 30 MHz
Notes	This command is the same in all modes, but the parameter is Measurement Global. So the value is independent in each mode and common across all the measurements in the mode.
Preset	0 Hz
State Saved	Saved in instrument state.
Min	-40.049995 MHz
Max	40.049995 MHz
Initial S/W Revision	Prior to A.02.00

### CF Step

Changes the step size for the center frequency and start and stop frequency functions. Once a step size has been selected and the center frequency function is active, the step keys (and the UP|DOWN parameters for Center Frequency from remote commands) change the center frequency by the step-size value. The step size function is useful for finding harmonics and sidebands beyond the current frequency span of the analyzer.

Note that the start and stop frequencies also step by the CF Step value.

Key Path	FREQ Channel
Remote Command	[:SENSe]:FREQuency:CENTer:STEP[:INCRement] <freq> [:SENSe]:FREQuency:CENTer:STEP[:INCRement]? [:SENSe]:FREQuency:CENTer:STEP:AUTO OFF ON 0 1 [:SENSe]:FREQuency:CENTer:STEP:AUTO?
Example	FREQ:CENT:STEP:AUTO ON FREQ:CENT:STEP 500 MHz FREQ:CENT UP increases the current center frequency value by 500 MHz FREQ:CENT:STEP? FREQ:CENT:STEP:AUTO?
Notes	Preset and Max values are depending on Hardware Options (503, 507, 508, 513, 526)
Notes	Preset and Max values are dependent on Hardware Options (5xx)
Dependencies	Freq Offset is not available in External Mixing. In this case the Freq Offset key is grayed out and shows a value of zero. It will once again be available, and show the previously set value, when you return to the RF Input.
Dependencies	Span, RBW, Center frequency If the electronic/soft attenuator is enabled, any attempt to change the value of the center frequency >3.6 GHz by pressing the Up-arrow key, fails and results in an advisory message. If the equivalent SCPI command is sent, this same message is generated as part of a “-221, Settings conflict” warning.
Couplings	When auto-coupled in a non-zero span, the center frequency step size is set to 10% of the span. When auto-coupled in zero span, the center frequency step size is set to the equivalent -3 dB RBW value.
Preset	Auto ADEMOD: 1 MHz ON
State Saved	Saved in instrument state
Min	– (the maximum frequency of the instrument). That is, 27 GHz max freq instrument has a CF step range of +/- 27 GHz. Note that this is the maximum frequency given the current settings of the instrument, so in External Mixing, for example, it is the maximum frequency of the current mixer band.
Max	The maximum frequency of the instrument. That is, 27 GHz max freq instrument has a CF step range of +/- 27 GHz. Note that this is the maximum frequency given the current settings of the instrument, so in External Mixing, for example, it is the maximum frequency of the current mixer band.
Default Unit	Hz
Status Bits/OPC dependencies	non-overlapped
Initial S/W Revision	Prior to A.02.00
Modified at S/W Revision	A.03.00

13 Spurious Emissions Measurement  
Input/Output

Input/Output

See "[Input/Output](#)" on page 226

## Marker

Displays the menu keys that enable you to select, set up and control the markers for the current measurement.

Key Path	Front-panel key
Initial S/W Revision	Prior to A.02.00

## Select Marker

Displays 12 markers available for selection.

Key Path	Marker
Initial S/W Revision	Prior to A.02.00

## Marker Type

Sets the marker control mode to Normal, Delta and Off. Normal enables you to activate the selected marker to read the power level and time. Delta enables you to read the differences in the power levels and time scales between the selected marker and the next marker. Off enables you to turn off the selected marker.

All interactions and dependencies detailed under the key description are enforced when the remote command is sent.

Key Path	Marker
Mode	SA, WCDMA, C2K, WIMAX OFDMA, TD-SCDMA, 1xEV-DO, DVB-T/H, LTE, LTETDD, WLAN, MSR, LTEAFDD, LTEATDD
Remote Command	:CALCulate:SPURious:MARKer[1] 2 ... 12:MODE POSition   DELTA   OFF :CALCulate:SPURious:MARKer[1] 2 ... 12:MODE?
Example	CALC:SPUR:MARK:MODE POS CALC:SPUR:MARK:MODE?
Notes	<p>If the selected marker is Off, pressing Marker sets it to Normal and places it at the center of the screen on the trace determined by the Marker Trace rules. At the same time, Marker X Axis Value appears on the Active Function area.</p> <p>Default Active Function: the active function for the selected marker's current control mode. If the current control mode is Off, there is no active function and the active function is turned off.</p> <p>Active Function Display: the marker X axis value entered in the active function area will display the marker value to its full entered precision.</p> <p>You must be in the cdma2000 mode, 1xEV-DO mode, TD-SCDMA mode, W-CDMA mode, DVB-T/H mode, GSM/EDGE mode, LTE mode, LTE TDD mode, WLAN mode, MSR, LTE-Advanced FDD/TDD mode or WiMAX mode to use this command. Use INSTRument:SElect to set the mode.</p>

Preset	=OFF
State Saved	Saved in instrument state.
Range	Normal Delta Off
Initial S/W Revision	Prior to A.02.00
Modified at S/W Revision	A.03.00

## Properties

Accesses the Properties menu to set certain properties of the selected marker.

Key Path	Marker
Initial S/W Revision	Prior to A.02.00

## Select Marker

Displays 12 markers available for selection.

Key Path	Marker
Initial S/W Revision	Prior to A.02.00

## Relative To

Selects the marker the selected marker will be relative to (its reference marker).

Every marker has another marker to which it is relative. This marker is referred to as the "reference marker" for that marker. This attribute is set by the Marker, Properties, Relative To key. The marker must be a Delta marker to make this attribute relevant. If it is a Delta marker, the reference marker determines how the marker is controlled and how its value is displayed. A marker cannot be relative to itself.

Key Path	Marker, Properties
Mode	SA, WCDMA, C2K, WIMAX OFDMA, TD-SCDMA, 1xEV-DO, DVB-T/H, LTE, LTE-TDD, WLAN, MSR, LTE-FDD, LTE-TDD
<b>Remote Command</b>	:CALCulate:SPURious:MARKer[1] 2 ... 12:REFerence <integer> :CALCulate:SPURious:MARKer[1] 2 ... 12:REFerence?
<b>Example</b>	CALC:SPUR:MARK3:REF 5 CALC:SPUR:MARK:REF?
Notes	A marker cannot be relative to itself so that choice is grayed out, and if sent from SCPI generates error -221: "Settings conflict; marker cannot be relative to itself." When queried a single value will be returned (the specified marker numbers relative marker). You must be in the Spectrum Analysis mode, GSM mode, LTE mode, LTE TDD mode, WLAN mode, MSR, LTE-Advanced FDD/TDD mode or WiMAX mode or TD-SCDMA mode to use this command.

	Use INSTRument:SElect to set the mode.
Preset	2 3 4 5 6 7 8 9 10 11 12 1
State Saved	Saved in instrument state.
Min	1
Max	12
Initial S/W Revision	Prior to A.02.00
Modified at S/W Revision	A.03.00

## Couple Markers

When this function is true, moving any marker causes an equal X Axis movement of every other marker which is not Off. By “equal X Axis movement” we mean that we preserve the difference between each marker’s X Axis value (in the fundamental x-axis units of the trace that marker is on) and the X Axis value of the marker being moved (in the same fundamental x-axis units).

Key Path	Marker
Mode	SA, WCDMA, C2K, WIMAX OFDMA, TD-SCDMA, 1xEV-DO, DVB-T/H, LTE, LTETDD, WLAN, MSR, LTEAFDD, LTEATDD
<b>Remote Command</b>	:CALCulate:SPURious:MARKer:COUPle[:STATe] ON OFF 1 0 :CALCulate:SPURious:MARKer:COUPle[:STATe]?
<b>Example</b>	CALC:SPUR:MARK:COUP ON CALC:SPUR:MARK:COUP?
Preset	OFF
State Saved	Saved in instrument state.
Range	On Off
Initial S/W Revision	Prior to A.02.00
Modified at S/W Revision	A.03.00

## All Markers Off

Turns off all markers.

Key Path	Marker
Mode	SA, WCDMA, C2K, WIMAX OFDMA, TD-SCDMA, 1xEV-DO, DVB-T/H, LTE, LTETDD, WLAN, MSR, LTEAFDD, LTEATDD
<b>Remote Command</b>	:CALCulate:SPURious:MARKer:AOff
<b>Example</b>	CALC:SPUR:MARK:AOff
Initial S/W Revision	Prior to A.02.00
Modified at S/W Revision	A.03.00

### Marker X Axis Value (Remote Command only)

Sets the Marker X Axis value in the current marker X Axis Scale unit. It has no effect if the control mode is Off, but is the SCPI equivalent of entering an X value if the control mode is Normal or Delta.

Mode	SA, WCDMA, C2K, WIMAX OFDMA, TD-SCDMA, DVB-T/H, LTE, LTE-TDD, WLAN, MSR, LTEAFDD, LTEATDD
Remote Command	:CALCulate:SPURious:MARKer[1] 2 ... 12:X <freq> :CALCulate:SPURious:MARKer[1] 2 ... 12:X?
Example	CALC:SPUR:MARK2:X 25 kHz CALC:SPUR:MARK3:X?
Notes	If no suffix is sent it will use the fundamental units for the current marker X Axis Scale. If a suffix is sent that does not match the current marker X Axis Scale unit, an error "Invalid suffix" will be generated.  The query returns the absolute X Axis marker value if the control mode is Normal, or the offset from the reference marker if the control mode is Delta. The query is returned in the fundamental units for the current marker X Axis scale: Hz for Frequency and Inverse Time, seconds for Period and Time. If the marker is Off, the response is not a number.
Preset	1 GHz
State Saved	No
Min	-9.9E+37
Max	9.9E+37
Initial S/W Revision	Prior to A.02.00
Modified at S/W Revision	A.03.00

### Marker X Axis Position (Remote Command only)

Sets the Marker X position in trace points. It has no effect if the control mode is Off, but is the SCPI equivalent of entering a value if the control mode is Normal or Delta - except in trace points rather than X Axis Scale units. The entered value is immediately translated into the current X Axis Scale units for setting the value of the marker.

Mode	SA, WCDMA, C2K, WIMAX OFDMA, TD-SCDMA, 1xEV-DO, DVB-T/H, LTE, LTE-TDD, WLAN, MSR, LTEAFDD, LTEATDD
Remote Command	:CALCulate:SPURious:MARKer[1] 2 ... 12:X:POSition <integer> :CALCulate:SPURious:MARKer[1] 2 ... 12:X:POSition?
Example	CALC:SPUR:MARK10:X:POS 300 CALC:SPUR:MARK10:X:POS?
Notes	The query returns the absolute X Axis marker value in trace points if the control mode is Normal, or the offset from the reference marker in trace points if the control mode is Delta. The value is returned as a real number, not an integer, corresponding to the translation from X Axis Scale units to trace points. If the marker is Off the response is not a number.
Preset	300



State Saved	No
Min	-9.9E+37
Max	9.9E+37
Initial S/W Revision	Prior to A.02.00
Modified at S/W Revision	A.03.00

### Marker Y Axis Value (Remote Command only)

Returns the marker Y Axis value in the current marker Y Axis unit.

Mode	SA, WCDMA, C2K, WIMAX OFDMA, TD-SCDMA, 1xEV-DO, DVB-T/H, LTE, LTE-TDD, WLAN, MSR, LTE-AFDD, LTE-TDD
<b>Remote Command</b>	:CALCulate:SPURious:MARKer[1] 2 ... 12:Y?
<b>Example</b>	CALC:SPUR:MARK11:Y?
Notes	If no suffix is sent, it will use the current Y Axis unit. If a suffix is sent that does not have units of absolute amplitude, an error "Invalid suffix" will be generated.
Preset	Depends on Y axis range of selected Trace.
State Saved	No
Initial S/W Revision	Prior to A.02.00
Modified at S/W Revision	A.03.00

## Marker Function

There are no 'Marker Functions' supported in Spurious Emissions so this front-panel key displays a blank menu when pressed.

---

Key Path	Front-panel key
Initial S/W Revision	Prior to A.02.00

---

## Marker To

There is no 'Marker To' functionality supported in Spurious Emissions, so this front-panel key displays a blank menu when pressed.

---

Key Path	Front-panel key
Initial S/W Revision	Prior to A.02.00

---

## Meas

The information in this section is common to all measurements. For key and remote command information for a specific measurement, refer to the section that describes the measurement of interest.

Measurements available under the Meas key are specific to the current Mode.

When viewing Help for measurements, note the following:

**NOTE**

Operation for some keys differs between measurements. The information displayed in Help pertains to the current measurement. To see how a key operates in a different measurement, exit Help (press the Cancel Esc key), select the measurement, then reenter Help (press the Help key) and press that key.

---

Key Path	Front-panel key
Initial S/W Revision	Prior to A.02.00

---

### Remote Measurement Functions

This section contains the following topics:

["Measurement Group of Commands" on page 2849](#)

["Current Measurement Query \(Remote Command Only\)" on page 2851](#)

["Limit Test Current Results \(Remote Command Only\)" on page 2851](#)

["Data Query \(Remote Command Only\)" on page 2851](#)

["Calculate/Compress Trace Data Query \(Remote Command Only\)" on page 2852](#)

["Calculate Peaks of Trace Data \(Remote Command Only\)" on page 2857](#)

[Hardware-Accelerated Fast Power Measurement \(Remote Command Only\)](#)

["Format Data: Numeric Data \(Remote Command Only\)" on page 2858](#)

["Format Data: Byte Order \(Remote Command Only\)" on page 2859](#)

---

Initial S/W Revision	Prior to A.02.00
----------------------	------------------

---

## Measurement Group of Commands

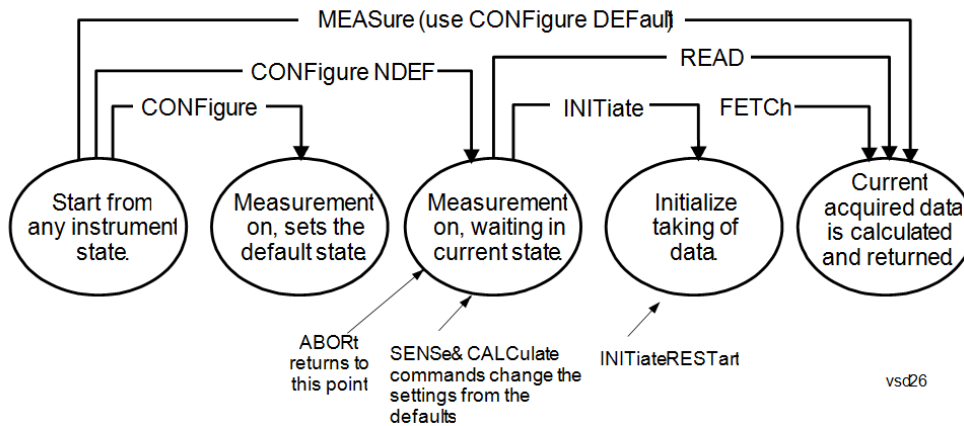

---

### Measure Commands:

:MEASure:<measurement>[n]?

This is a fast single-command way to make a measurement using the factory default instrument settings. These are the settings and units that conform to the Mode Setup settings (e.g. radio standard) that you have currently selected.

- Stops the current measurement (if any) and sets up the instrument for the specified measurement using the factory defaults
- Initiates the data acquisition for the measurement
- Blocks other SCPI communication, waiting until the measurement is complete before returning results.
- If the function does averaging, it is turned on and the number of averages is set to 10.
- After the data is valid it returns the scalar results, or the trace data, for the specified measurement. The type of data returned may be defined by an [n] value that is sent with the command.
- The scalar measurement results will be returned if the optional [n] value is not included, or is set to 1. If the [n] value is set to a value other than 1, the selected trace data results will be returned. See each command for details of what types of scalar results or trace data results are available.
- ASCII is the default format for the data output. (Older versions of Spectrum Analysis and Phase Noise mode measurements only use ASCII.) The binary data formats should be used for handling large blocks of data since they are smaller and faster than the ASCII format. Refer to the FORMat:DATA command for more information.

If you need to change some of the measurement parameters from the factory default settings you can set up the measurement with the CONFigure command. Use the commands in the SENSe:<measurement> and CALCulate:<measurement> subsystems to change the settings. Then you can use the READ? command to initiate the measurement and query the results.

If you need to repeatedly make a given measurement with settings other than the factory defaults, you can use the commands in the SENSe:<measurement> and CALCulate:<measurement> subsystems to set up the measurement. Then use the READ? command to initiate the measurement and query results.

Measurement settings persist if you initiate a different measurement and then return to a previous one. Use READ:<measurement>? if you want to use those persistent settings. If you want to go back to the default settings, use MEASure:<measurement>?.

---

### Configure Commands:

:CONFigure:<measurement>

This command stops the current measurement (if any) and sets up the instrument for the specified measurement using

---

---

the factory default instrument settings. It does not initiate the taking of measurement data unless INIT:CONTinuous is ON. If you change any measurement settings after using the CONFigure command, the READ command can be used to initiate a measurement without changing the settings back to their defaults.

In the Swept SA measurement in Spectrum Analyzer mode the CONFigure command also turns the averaging function on and sets the number of averages to 10 for all measurements.

:CONFigure: <measurement>: NDEFault stops the current measurement and changes to the specified measurement. It does not change the settings to the defaults. It does not initiate the taking of measurement data unless INIT:CONTinuous is ON.

The CONFigure? query returns the current measurement name.

The CONFigure:CATalog? query returns a quoted string of all licensed measurement names in the current mode. For example, "SAN, CHP, OBW, ACP, PST, TXP, SPUR, SEM, LIST".

---

#### Fetch Commands:

---

:FETCh:<measurement>[n]?

This command puts selected data from the most recent measurement into the output buffer. Use FETCh if you have already made a good measurement and you want to return several types of data (different [n] values, for example, both scalars and trace data) from a single measurement. FETCh saves you the time of re-making the measurement. You can only FETCh results from the measurement that is currently active, it will not change to a different measurement. An error message is reported if a measurement other than the current one is specified.

If you need to get new measurement data, use the READ command, which is equivalent to an INITiate followed by a FETCh.

The scalar measurement results will be returned if the optional [n] value is not included, or is set to 1. If the [n] value is set to a value other than 1, the selected trace data results will be returned. See each command for details of what types of scalar results or trace data results are available. The binary data formats should be used for handling large blocks of data since they are smaller and transfer faster than the ASCII format. (FORMat:DATA)

FETCh may be used to return results other than those specified with the original READ or MEASure command that you sent.

---

#### INITiate Commands:

---

:INITiate:<measurement>

This command is not available for measurements in all the instrument modes:

- Initiates a trigger cycle for the specified measurement, but does not output any data. You must then use the FETCh<meas> command to return data. If a measurement other than the current one is specified, the instrument will switch to that measurement and then initiate it.
  - For example, suppose you have previously initiated the ACP measurement, but now you are running the channel power measurement. If you send INIT:ACP? it will change from channel power to ACP and will initiate an ACP measurement.
  - Does not change any of the measurement settings. For example, if you have previously started the ACP measurement and you send INIT:ACP? it will initiate a new ACP measurement using the same instrument settings as the last time ACP was run.
  - If your selected measurement is currently active (in the idle state) it triggers the measurement, assuming the trigger conditions are met. Then it completes one trigger cycle. Depending upon the measurement and the number of averages, there may be multiple data acquisitions, with multiple trigger events, for one full trigger cycle. It also holds off additional commands on GPIB until the acquisition is complete.
- 

#### READ Commands:

---

:READ:<measurement>[n]?

- Does not preset the measurement to the factory default settings. For example, if you have previously initiated the ACP
-

---

measurement and you send READ:ACP? it will initiate a new measurement using the same instrument settings.

- Initiates the measurement and puts valid data into the output buffer. If a measurement other than the current one is specified, the instrument will switch to that measurement before it initiates the measurement and returns results.
  - For example, suppose you have previously initiated the ACP measurement, but now you are running the channel power measurement. Then you send READ:ACP? It will change from channel power back to ACP and, using the previous ACP settings, will initiate the measurement and return results.
  - Blocks other SCPI communication, waiting until the measurement is complete before returning the results
  - If the optional [n] value is not included, or is set to 1, the scalar measurement results will be returned. If the [n] value is set to a value other than 1, the selected trace data results will be returned. See each command for details of what types of scalar results or trace data results are available. The binary data formats should be used when handling large blocks of data since they are smaller and faster than the ASCII format. (FORMat:DATA)
- 

---

Initial S/W Revision	Prior to A.02.00
----------------------	------------------

---

### Current Measurement Query (Remote Command Only)

This command returns the name of the measurement that is currently running.

---

<b>Remote Command</b>	:CONFigure?
-----------------------	-------------

<b>Example</b>	CONF?
----------------	-------

Initial S/W Revision	Prior to A.02.00
----------------------	------------------

---

### Limit Test Current Results (Remote Command Only)

Queries the status of the current measurement limit testing. It returns a 0 if the measured results pass when compared with the current limits. It returns a 1 if the measured results fail any limit tests.

---

<b>Remote Command</b>	:CALCulate:CLIMits:FAIL?
-----------------------	--------------------------

<b>Example</b>	CALC:CLIM:FAIL? queries the current measurement to see if it fails the defined limits. Returns a 0 or 1: 0 it passes, 1 it fails.
----------------	--------------------------------------------------------------------------------------------------------------------------------------

Initial S/W Revision	Prior to A.02.00
----------------------	------------------

---

### Data Query (Remote Command Only)

Returns the designated measurement data for the currently selected measurement and subopcode.

n = any valid subopcode for the current measurement. See the measurement command results table for your current measurement, for information about what data is returned for the subopcodes.

This command uses the data setting specified by the FORMat:BORDER and FORMat:DATA commands and can return real or ASCII data. (See the format command descriptions under Input/Output in the Analyzer Setup section.)

<b>Remote Command</b>	:CALCulate:DATA[n]?
<b>Notes</b>	The return trace depends on the measurement. In CALCulate:<meas>:DATA[n], n is any valid subopcode for the current measurement. It returns the same data as the FETCH:<measurement>? query where <measurement> is the current measurement.
<b>Initial S/W Revision</b>	Prior to A.02.00

### Calculate/Compress Trace Data Query (Remote Command Only)

Returns compressed data for the currently selected measurement and sub-opcode [n].

n = any valid sub-opcode for that measurement. See the MEASure:<measurement>? command description of your specific measurement for information on the data that can be returned.

The data is returned in the current Y Axis Unit of the analyzer. The command is used with a sub-opcode <n> (default=1) to specify the trace. With trace queries, it is best if the analyzer is not sweeping during the query. Therefore, it is generally advisable to be in Single Sweep, or Update=Off.

This command is used to compress or decimate a long trace to extract and return only the desired data. A typical example would be to acquire N frames of GSM data and return the mean power of the first burst in each frame. The command can also be used to identify the best curve fit for the data.

<b>Remote Command</b>	:CALCulate:DATA<n>:COMPRESS? BLOCK   CFIT   MAXimum   MINimum   MEAN   DMEan   RMS   RMSCubed   SAMPLE   SDEVIation   PPHase [,<soffset> [,<length>[,<roffset>[,<rlimit>]]]]
<b>Example</b>	To query the mean power of a set of GSM bursts: Supply a signal that is a set of GSM bursts. Select the IQ Waveform measurement (in IQ Analyzer Mode). Set the sweep time to acquire at least one burst. Set the triggers such that acquisition happens at a known position relative to a burst. Then query the mean burst levels using, CALC:DATA2:COMP? MEAN, 24e-6, 526e-6 (These parameter values correspond to GSM signals, where 526e-6 is the length of the burst in the slot and you just want 1 burst.)
<b>Notes</b>	The command supports 5 parameters. Note that the last 4 (<soffset>, <length>, <roffset>, <rlimit>) are optional. But these optional parameters must be entered in the specified order. For example, if you want to specify <length>, then you must also specify <soffset>. See details below for a definition of each of these parameters.  This command uses the data in the format specified by FORMat:DATA, returning either binary or ASCII data.
<b>Initial S/W Revision</b>	Prior to A.02.00

- BLOCK or block data - returns all the data points from the region of the trace data that you specify. For example, it could be used to return the data points of an input signal over several timeslots, excluding the portions of the trace data that you do not want. (This is x,y pairs for trace data and I,Q pairs for complex data.)



- CFIT or curve fit - applies curve fitting routines to the data. <soffset> and <length> are required to define the data that you want. <roffset> is an optional parameter for the desired order of the curve equation. The query will return the following values: the x-offset (in seconds) and the curve coefficients ((order + 1) values).

MIN, MAX, MEAN, DME, RMS, RMSC, SAMP, SDEV and PPH return one data value for each specified region (or <length>) of trace data, for as many regions as possible until you run out of trace data (using <roffset> to specify regions). Or they return the number of regions you specify (using <rlimit>) ignoring any data beyond that.

- MINimum - returns the minimum data point (y value) for the specified region(s) of trace data. For I/Q trace data, the minimum magnitude of the I/Q pairs is returned.
- MAXimum - returns the maximum data point (y value) for the specified region(s) of trace data. For I/Q trace data, the maximum magnitude of the I/Q pairs is returned.
- MEAN - returns a single value that is the arithmetic mean of the data point values (in dB/ dBm) for the specified region(s) of trace data. For I/Q trace data, the mean of the magnitudes of the I/Q pairs is returned. See the following equations.

- 

**NOTE**

If the original trace data is in dB, this function returns the arithmetic mean of those log values, not log of the mean power which is a more useful value. The mean of the log is the better measurement technique when measuring CW signals in the presence of noise. The mean of the power, expressed in dB, is useful in power measurements such as Channel Power. To achieve the mean of the power, use the RMS option.

Equation 1

Mean Value of Data Points for Specified Region(s)

$$\text{MEAN} = \frac{1}{n} \sum_{X_i \in \text{region}(s)} X_i$$

where  $X_i$  is a data point value, and  $n$  is the number of data points in the specified region(s).

Equation 2

Mean Value of I/Q Data Pairs for Specified Region(s)

$$\text{MEAN} = \frac{1}{n} \sum_{X_i \in \text{region}(s)} |X_i|$$

where  $|X_i|$  is the magnitude of an I/Q pair, and  $n$  is the number of I/Q pairs in the specified region(s).

- DMEan - returns a single value that is the mean power (in dB/ dBm) of the data point values for the specified region(s) of trace data. See the following equation:

Equation 3

DMEan Value of Data Points for Specified Region(s)

$$\text{DME} = 10 \times \log_{10} \left( \frac{1}{n} \sum_{X_i \in \text{region}(s)} 10^{\frac{X_i}{10}} \right)$$

- RMS - returns a single value that is the average power on a root-mean-squared voltage scale (arithmetic rms) of the data point values for the specified region(s) of trace data. See the following equation.

**NOTE**

For I/Q trace data, the rms of the magnitudes of the I/Q pairs is returned. See the following equation. This function is very useful for I/Q trace data. However, if the original trace data is in dB, this function returns the rms of the log values which is not usually needed.

Equation 4

RMS Value of Data Points for Specified Region(s)

$$\text{RMS} = \sqrt{\frac{1}{n} \sum_{X_i \in \text{region}(s)} X_i^2}$$

where  $X_i$  is a data point value, and  $n$  is the number of data points in the specified region(s).

Equation 5

RMS Value of I/Q Data Pairs for Specified Region(s)

$$\text{RMS} = \sqrt{\frac{1}{n} \sum_{X_i \in \text{region}(s)} X_i X_i^*}$$

where  $X_i$  is the complex value representation of an I/Q pair,  $X_i^*$  its conjugate complex number, and  $n$  is the number of I/Q pairs in the specified region(s).

Once you have the rms value for a region of trace data (linear or I/Q), you may want to calculate the mean power. You must convert this rms value (peak volts) to power in dBm:

$$10 \times \log[10 \times (\text{rms value})^2]$$

- SAMPlE - returns the first data value (x,y pair) for the specified region(s) of trace data. For I/Q trace data, the first I/Q pair is returned.
- SDEViation - returns a single value that is the arithmetic standard deviation for the data point values for the specified region(s) of trace data. See the following equation.
- For I/Q trace data, the standard deviation of the magnitudes of the I/Q pairs is returned. See the following equation.

Equation 6

Standard Deviation of Data Point Values for Specified Region(s)

$$\text{SDEV} = \sqrt{\frac{1}{n} \sum_{X_i \in \text{region}(s)} (X_i - \bar{X})^2}$$

where  $X_i$  is a data point value,  $\bar{X}$  is the arithmetic mean of the data point values for the specified region (s), and  $n$  is the number of data points in the specified region(s).

$$\text{SDEV} = \sqrt{\frac{1}{n} \sum_{X_i \in \text{region}(s)} (|X_i| - \bar{X})^2}$$

where  $|X_i|$  is the magnitude of an I/Q pair,  $\bar{X}$  is the mean of the magnitudes for the specified region(s), and  $n$  is the number of data points in the specified region(s).

- PPHase - returns the x,y pairs of both rms power (dBm) and arithmetic mean phase (radian) for every specified region and frequency offset (Hz). The number of pairs is defined by the specified number of regions. This parameter can be used for I/Q vector (n=0) in Waveform (time domain) measurement and all parameters are specified by data point in PPHase.

The rms power of the specified region may be expressed as:

$$\text{Power} = 10 \times \log [10 \times (\text{RMS I/Q value})] + 10.$$

The RMS I/Q value (peak volts) is:

$$\sqrt{\frac{1}{n} \sum_{X_i \in \text{region}} X_i X_i^*}$$

where  $X_i$  is the complex value representation of an I/Q pair,  $X_i^*$  its conjugate complex number, and  $n$  is the number of I/Q pairs in the specified region.

The arithmetic mean phase of the specified region may be expressed as:

$$\frac{1}{n} \sum_{Y_i \in \text{region}} Y_i$$

where  $Y_i$  is the unwrapped phase of I/Q pair with applying frequency correction and  $n$  is the number of I/Q pairs in the specified region.

The frequency correction is made by the frequency offset calculated by the arithmetic mean of every specified region's frequency offset. Each frequency offset is calculated by the least square method against the unwrapped phase of I/Q pair.

Sample Trace Data - Constant Envelope

(See below for explanation of variables.)

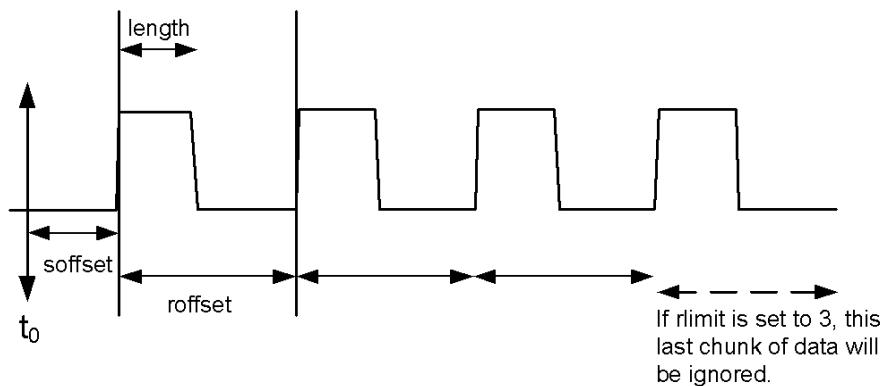

Sample Trace Data - Not Constant Envelope

(See below for explanation of variables.)

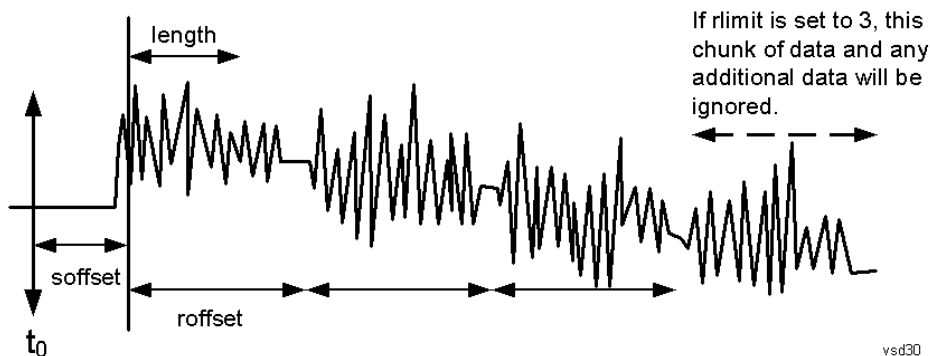

<soffset> - start offset is an optional real number. (It is in seconds for time-domain traces, and is a dimensionless index 0 to Npoints - 1, for frequency-domain traces). It specifies the amount of data at the beginning of the trace that will be ignored before the decimation process starts. It is the time or frequency change from the start of the trace to the point where you want to start using the data. The default value is zero.

<length> - is an optional real number. (It is in seconds for time-domain traces, and is a dimensionless index 0 to Npoints - 1, for frequency-domain traces). It defines how much data will be compressed into one value. This parameter has a default value equal to the current trace length.

<roffset> - repeat offset is an optional real number. (It is in seconds for time-domain traces, and is a dimensionless index 0 to Npoints - 1, for frequency-domain traces). It defines the beginning of the next field of trace elements to be compressed. This is relative to the beginning of the previous field. This parameter has a default value equal to the <length> variable. Note that this parameter is used for a completely different purpose when curve fitting (see CFIT above).

<rlimit> - repeat limit is an optional integer. It specifies the number of data items that you want returned. It will ignore any additional items beyond that number. You can use the Start offset and the Repeat limit to pick out exactly what part of the data you want to use. The default value is all the data.

## Calculate Peaks of Trace Data (Remote Command Only)

Returns a list of all the peaks for the currently selected measurement and sub-opcode [n]. The peaks must meet the requirements of the peak threshold and excursion values.

n = any valid sub-opcode for the current measurement. See the MEASure:<measurement> command description of your specific measurement for information on the data that can be returned.

The command can only be used with specific sub-opcodes with measurement results that are trace data. Both real and complex traces can be searched, but complex traces are converted to magnitude in dBm. In many measurements the sub-opcode n=0, is the raw trace data which cannot be searched for peaks. And Sub-opcode n=1, is often calculated results values which also cannot be searched for peaks.

This command uses the data setting specified by the FORMat:BORDER and FORMat:DATA commands and can return real or ASCII data. If the format is set to INT,32, it returns REAL,32 data.

The command has four types of parameters:

- Threshold (in dBm)
- Excursion (in dB)
- Sorting order (amplitude, frequency, time)
- Optional in some measurements: Display line use (all, > display line, < display line)

<b>Remote Command</b>	<p>For Swept SA measurement:</p> <pre>:CALCulate:DATA[1] 2 ... 6:PEAKs? &lt;threshold&gt;,&lt;excursion&gt;[,AMPLitude   FREQuency   TIME[,ALL   GTDLline   LTDLine]]</pre> <p>For most other measurements:</p> <pre>:CALCulate:DATA[1] 2 ... 6:PEAKs? &lt;threshold&gt;,&lt;excursion&gt;[,AMPLitude   FREQuency   TIME]</pre>
<b>Example</b>	<p>Example for Swept SA measurement in Spectrum Analyzer Mode:</p> <p>CALC:DATA4:PEAK? -40, 10, FREQ, GTDL This will identify the peaks of trace 4 that are above -40 dBm, with excursions of at least 10 dB. The peaks are returned in order of increasing frequency, starting with the lowest frequency. Only the peaks that are above the display line are returned.</p> <p>Query Results 1:</p> <p>With FORMat:DATA REAL, 32 selected, it returns a list of floating-point numbers. The first value in the list is the number of peak points that are in the following list. A peak point consists of two values: a peak amplitude followed by its corresponding frequency (or time).</p> <p>If no peaks are found the peak list will consist of only the number of peaks, (0).</p>
<b>Notes</b>	<p>&lt;n&gt; - is the trace that will be used</p> <p>&lt;threshold&gt; - is the level below which trace data peaks are ignored. Note that the threshold value is required and is always used as a peak criterion. To effectively disable the threshold criterion for this command, provide a substantially low threshold value such as -200 dBm. Also note that the threshold value used in this command is independent of and has no effect on the threshold value stored under the Peak Criteria menu.</p> <p>&lt;excursion&gt; - is the minimum amplitude variation (rise and fall) required for a signal to be identified as peak. Note that the excursion value is required and is always used as a peak criterion. To effectively disable the excursion criterion for this command, provide the minimum value of 0.0 dB. Also note that the excursion value used in this command is independent of and has no effect on the</p>

---

excursion value stored under the Peak Criteria menu.

Values must be provided for threshold and excursion. The sorting and display line parameters are optional (defaults are AMPLitude and ALL).

Note that there is always a Y-axis value for the display line, regardless of whether the display line state is on or off. It is the current Y-axis value of the display line which is used by this command to determine whether a peak should be reported

Sorting order:

AMPLitude - lists the peaks in order of descending amplitude, with the highest peak first (default if optional parameter not sent)

FREQuency - lists the peaks in order of occurrence, left to right across the x-axis.

TIME - lists the peaks in order of occurrence, left to right across the x-axis.

Peaks vs. Display Line:

ALL - lists all of the peaks found (default if optional parameter not sent).

GTDLine (greater than display line) - lists all of the peaks found above the display line.

LTDLine (less than display line) - lists all of the peaks found below the display line.

---

Initial S/W Revision      Prior to A.02.00

---

### Format Data: Numeric Data (Remote Command Only)

This command specifies the format of the trace data input and output. It specifies the formats used for trace data during data transfer across any remote port. It affects only the data format for setting and querying trace data for the :TRACe[:DATA], TRACe[:DATA]?, :CALCulate:DATA[n]? and FETCh:SANalyzer [n]? commands and queries.

---

**Remote Command**      :FORMat [:TRACe] [:DATA] ASCii|INTeger,32|REAL,32 |REAL,64  
:FORMat [:TRACe] [:DATA] ?

---

**Notes**      The query response is:  
ASCii: ASC,8  
REAL,32: REAL,32  
REAL,64: REAL,64  
INTeger,32: INT,32

When the numeric data format is REAL or ASCii, data is output in the current Y Axis unit. When the data format is INTeger, data is output in units of m dBm (.001 dBm).

The INT,32 format returns binary 32-bit integer values in internal units (m dBm), in a definite length block.

---

**Dependencies**      Sending a data format spec with an invalid number (for example, INT,48) generates no error. The analyzer simply uses the default (8 for ASCii, 32 for INTeger, 32 for REAL).

Sending data to the analyzer which does not conform to the current FORMat specified, results in an error. Sending ASCII data when a definite block is expected generates message -161 "Invalid Block Data" and sending a definite block when ASCII data is expected generates message -121 "Invalid Character in Number".

---

**Preset**      ASCii

---

**Backwards Compatibility Notes**      Note that the INT,32 format is only applicable to the command, TRACe:DATA. This preserves backwards compatibility for the Swept SA measurement. For all other commands/queries which honor FORMat:DATA, if INT,32 is sent the analyzer will behave as though it were set to REAL,32.

---

Initial S/W Revision      Prior to A.02.00

---

The specs for each output type follow:

ASCIi - Amplitude values are in ASCII, in the current Y Axis Unit, one ASCII character per digit, values separated by commas, each value in the form:

SX.YYYYYEsZZ

Where:

S = sign (+ or -)

X = one digit to left of decimal point

Y = 5 digits to right of decimal point

E = E, exponent header

s = sign of exponent (+ or -)

ZZ = two digit exponent

REAL,32 - Binary 32-bit real values in the current Y Axis Unit, in a definite length block.

REAL,64 - Binary 64-bit real values in the current Y Axis Unit, in a definite length block.

### Format Data: Byte Order (Remote Command Only)

This command selects the binary data byte order for data transfer and other queries. It controls whether binary data is transferred in normal or swapped mode. This command affects only the byte order for setting and querying trace data for the :TRACe[:DATA], TRACe[:DATA]? , :CALCulate:DATA[n]? and FETCh:SANalyzer[n]? commands and queries.

By definition any command that says it uses FORMat:DATA uses any format supported by FORMat:DATA.

The NORMal order is a byte sequence that begins with the most significant byte (MSB) first, and ends with the least significant byte (LSB) last in the sequence: 1|2|3|4. SWAPPed order is when the byte sequence begins with the LSB first, and ends with the MSB last in the sequence: 4|3|2|1.

<b>Remote Command</b>	:FORMat:BORDER NORMal SWAPPed :FORMat:BORDER?
<b>Preset</b>	NORMal
<b>Initial S/W Revision</b>	Prior to A.02.00

## Meas Setup

Displays the measurement setup menu for the currently selected measurement.

Key Path	Front-panel key
Initial S/W Revision	Prior to A.02.00

### Avg/Hold Num

Specifies the number of measurement averages used to calculate the measurement result. The average is displayed at the end of each sweep.

Average State allows you to turn averaging on or off.

Key Path	Meas Setup
Mode	SA, WCDMA, C2K, WIMAX OFDMA, CDMA1xEVDO, TD-SCDMA, DVB-T/H, LTE, LTE-TDD, WLAN, MSR, LTEAFDD, LTEATDD
Remote Command	[:SENSe]:SPURious:AVErAge:COUNt <integer> [:SENSe]:SPURious:AVErAge:COUNt? [:SENSe]:SPURious:AVErAge[:STATe] ON OFF 1 0 [:SENSe]:SPURious:AVErAge[:STATe]?
Example	SPUR:AVER:COUN 2500 SPUR:AVER:COUN? SPUR:AVER ON SPUR:AVER?
Notes	You must be in the Spectrum Analysis mode, W-CDMA mode, cdma2000 mode, DVB-T/H mode, TD-SCDMA mode, LTE mode, LTE TDD mode, WLAN mode, MSR, LTE-Advanced FDD/TDD mode or WiMAX mode to use this command. Use INSTRUMENT:SElect to set the mode.
Preset	10 OFF
State Saved	Saved in instrument state.
Min	1
Max	10000
Initial S/W Revision	Prior to A.02.00
Modified at S/W Revision	A.03.00

### Avg Mode

Enables you to set the averaging mode.

- When set to Exponential (Exp) the measurement averaging continues using the specified number of averages to compute each averaged value. The average will be displayed at the end of each sweep.



- When set to Repeat, the measurement resets the average counter each time the specified number of averages is reached.

Key Path	Meas Setup
Mode	SA, WCDMA, WIMAX OFDMA, TD-SCDMA, DVB-T/H, LTE, LTE-TDD, WLAN, MSR, LTEAFDD, LTEATDD
Remote Command	[ :SENSe ] :SPURious :AVERage :TCONtrol EXPonential   REPeat [ :SENSe ] :SPURious :AVERage :TCONtrol ?
Example	SPUR: AVER: TCON REP SPUR: AVER: TCON ?
Notes	You must be in the cdma2000 mode, TD-SCDMA mode, W-CDMA mode, DVB-T/H mode, GSM/EDGE mode, LTE mode, LTE TDD mode, WLAN mode, MSR, LTE-Advanced FDD/TDD mode or WiMAX mode to use this command. Use INSTRUMENT: SElect to set the mode.
Preset	EXPonential
State Saved	Saved in instrument state.
Range	Exp Repeat
Initial S/W Revision	Prior to A.02.00
Modified at S/W Revision	A.03.00

## Range Table

Enables you to set range parameters.

To change a parameter, select the appropriate menu softkey and enter the value using the numeric keypad or the knob. The analyzer settings will be updated with the new parameter values.

When the current view is the Range Table view, the selected range is highlighted and displayed in the Range Table automatically. With the normal window arrangement, up to five ranges are displayed. In the zoom mode, all 20 ranges can be displayed.

In the Range Table window, there are three tables corresponding to each page of the Range Table menu. When the Range Table key is pressed, the table of the first menu page is displayed.

The Displayed table is changed by changing the Range Table menu page. It can also be changed by a remote command. When the Range Table is changed by the command, the menu page changes accordingly if the Range Table menu is displayed.

Key Path	Meas Setup
Initial S/W Revision	Prior to A.02.00

## Range

Changing the range updates the values on the other menu keys so that they reflect the settings for the selected range. If Range is turned on, it will be used as part of the measurement. If it is off, it will be excluded. A range is made up of the next fifteen parameters. This parameter can send up to 20 values. The



## Start Freq

Sets the start frequency of the analyzer. This parameter can send up to 20 values. The location where the start frequency occurs in the list sent to the measurement corresponds to the range the value is associated with.

Missing values are not permitted. If you want to change values 2 and 6 you must send all values up to 6. Subsequent values will remain as they were. The query for this parameter always returns 20 values.

Key Path	Meas Setup, Range Table
Mode	SA, WCDMA, C2K, WIMAX OFDMA, TD-SCDMA, 1xEV-DO, DVB-T/H, LTE, LTETDD, WLAN
Remote Command	[:SENSe]:SPURious[:RANGe][:LIST]:FREQuency:STARt <freq>, <freq>, <freq>, <freq>, <freq>, <freq>, <freq>, <freq>, <freq>, <freq>, <freq>, <freq>, <freq>, <freq>, <freq>, <freq>, <freq>, <freq>, <freq>, <freq>  [:SENSe]:SPURious[:RANGe][:LIST]:FREQuency:STARt?
Example	SPUR:FREQ:STAR 9 kHz, 150 kHz, 30 MHz, 1GHz, 1.5 GHz, 1.5 GHz, 1.5 GHz, 1.5 GHz, 1.5 GHz, 1.5 GHz, 1.5 GHz, 1.5 GHz, 1.5 GHz, 1.5 GHz, 1.5 GHz, 1.5 GHz, 1.5 GHz, 1.5 GHz, 1.5 GHz, 1.5 GHz  SPUR:FREQ:STAR?
Notes	You must be in cdma2000 mode, TD-SCDMA mode, W-CDMA mode, DVB-T/H, GSM/EDGE mode, LTE mode, LTE TDD mode, WLAN mode, MSR or WiMAX mode to use this command. Use INSTRument:SElect to set the mode.
Preset	SA, WIMAX OFDMA:+1.92000000E+009, +1.89350000E+009, +2.10000000E+009, +2.17500000E+009, +8.00000000E+008, +1.50000000E+009, +1.50000000E+009, +1.50000000E+009, +1.50000000E+009, +1.50000000E+009, +1.50000000E+009, +1.50000000E+009, +1.50000000E+009, +1.50000000E+009, +1.50000000E+009, +1.50000000E+009, +1.50000000E+009, +1.50000000E+009, +1.50000000E+009, +1.50000000E+009  WCDMA:9kHz, 150kHz, 30MHz, 1GHz, 2.1GHz, 2.1GHz, 2.1774GHz, 2.18GHz, 1.5GHz, 1.5GHz, 1.5GHz, 1.5GHz, 1.5GHz, 1.5GHz, 1.5GHz, 1.5GHz, 1.5GHz, 1.5GHz, 1.5GHz  C2K, 1xEV-DO: 9kHz, 150kHz, 30 MHz, 1GHz, 2.5GHz, 2.5GHz, 2.5GHz, 2.5 GHz, 2.5 GHz, 2.5 GHz, 2.5 GHz, 2.5 GHz, 2.5 GHz, 2.5 GHz, 2.5 GHz, 2.5 GHz, 2.5 GHz, 2.5 GHz, 2.5 GHz  TD-SCDMA: 9 kHz, 150 kHz, 30 MHz, 1GHz, 1.5 GHz, 1.5 GHz, 1.5 GHz, 1.5 GHz, 1.5 GHz, 1.5 GHz, 1.5 GHz, 1.5 GHz, 1.5 GHz, 1.5 GHz, 1.5 GHz, 1.5 GHz, 1.5 GHz, 1.5 GHz, 1.5 GHz, 1.5 GHz  DVB-T/H: 9kHz, 174MHz, 400MHz, 790MHz, 862MHz, 1GHz, 1.5GHz, 1.5GHz, 1.5GHz, 1.5GHz, 1.5GHz, 1.5GHz, 1.5GHz, 1.5GHz, 1.5GHz, 1.5GHz, 1.5GHz, 1.5GHz, 1.5GHz  LTE, MSR: 9 kHz, 150 kHz, 30 MHz, 1 GHz, 1.92GHz, 1.98 GHz, 2.18 GHz, 1.5 GHz, 1.5 GHz, 1.5 GHz, 1.5 GHz, 1.5 GHz, 1.5 GHz, 1.5 GHz, 1.5 GHz, 1.5 GHz, 1.5 GHz  LTETDD: 9 kHz, 150 kHz, 30 MHz, 1 GHz, 1.90GHz, 2.01 GHz, 2.025 GHz, 1.5 GHz, 1.5 GHz, 1.5 GHz, 1.5 GHz, 1.5 GHz, 1.5 GHz, 1.5 GHz, 1.5 GHz, 1.5 GHz, 1.5 GHz, 1.5 GHz  WLAN: 9 kHz, 150 kHz, 30 MHz, 1 GHz, 1.5 GHz, 1.5 GHz, 1.5 GHz, 1.5 GHz, 1.5 GHz, 1.5 GHz, 1.5 GHz, 1.5 GHz, 1.5 GHz, 1.5 GHz, 1.5 GHz, 1.5 GHz, 1.5 GHz, 1.5 GHz, 1.5 GHz, 1.5 GHz
State Saved	Saved in instrument state.
Min	-80 MHz

Max	Hardware Dependent: Option 503: 3699999990 Option 508: 8499999990 Option 513: 1379999990 Option 526: 2699999990
Initial S/W Revision	Prior to A.02.00
Modified at S/W Revision	A.03.00

## Stop Freq

Sets the stop frequency of the analyzer. This parameter can send up to 20 values.

The location of where the stop frequency occurs in the list sent to the measurement corresponds to the range the value is associated with.

Missing values are not permitted. If you want to change values 2 and 6 you must send all values up to 6. Subsequent values will remain as they were. The query for this parameter always returns 20 values.

Key Path	Meas Setup, Range Table
Mode	SA, WCDMA, C2K, WIMAX OFDMA, TD-SCDMA, 1xEV-DO, DVB-T/H, WLAN
Remote Command	<code>[ :SENSE ] :SPURious [ :RANGE ] [ :LIST ] :FREQuency:STOP &lt;freq&gt;, &lt;freq&gt;, &lt;freq&gt;, &lt;freq&gt;, &lt;freq&gt;, &lt;freq&gt;, &lt;freq&gt;, &lt;freq&gt;, &lt;freq&gt;, &lt;freq&gt;, &lt;freq&gt;, &lt;freq&gt;, &lt;freq&gt;, &lt;freq&gt;, &lt;freq&gt;, &lt;freq&gt;, &lt;freq&gt;, &lt;freq&gt;</code>  <code>[ :SENSE ] :SPURious [ :RANGE ] [ :LIST ] :FREQuency:STOP?</code>
Example	SPUR:FREQ:STOP 150kHz, 30MHz, 1GHz, 2.1GHz, 2.1GHz, 2.1774GHz, 2.18GHz, 12.75GHz, 2.5GHz, 2.5GHz, 2.5GHz, 2.5GHz, 2.5GHz, 2.5GHz, 2.5GHz, 2.5GHz, 2.5GHz, 2.5GHz, 2.5GHz, 2.5GHz SPUR:FREQ:STOP?
Notes	You must be in cdma2000 mode, TD-SCDMA mode, W-CDMA mode, DVB-T/H, GSM/EDGE mode, LTE mode, LTE TDD mode, WLAN mode, MSR or WiMAX mode to use this command. Use INSTRument:SElect to set the mode.
Preset	SA, WIMAX OFDMA: +1.98000000E+009, +1.91960000E+009, +2.10150000E+009, +2.18000000E+009, +1.00000000E+009, +2.50000000E+009, +2.50000000E+009, +2.50000000E+009, +2.50000000E+009, +2.50000000E+009, +2.50000000E+009, +2.50000000E+009, +2.50000000E+009, +2.50000000E+009, +2.50000000E+009, +2.50000000E+009, +2.50000000E+009, +2.50000000E+009, +2.50000000E+009 WCDMA: 150kHz, 30MHz, 1GHz, 2.1GHz, 2.1GHz, 2.1774GHz, 2.18GHz, 12.75GHz, 2.5GHz, 2.5GHz, 2.5GHz, 2.5GHz, 2.5GHz, 2.5GHz, 2.5GHz, 2.5GHz, 2.5GHz, 2.5GHz, 2.5GHz, 2.5GHz C2K, 1xEV-DO: 150kHz, 30 MHz, 1GHz, 5GHz, 2.5GHz, 2.5GHz, 2.5GHz, 2.5 GHz, 2.5 GHz, 2.5 GHz, 2.5 GHz, 2.5 GHz, 2.5 GHz, 2.5 GHz, 2.5 GHz, 2.5 GHz, 2.5 GHz, 2.5 GHz, 2.5 GHz TD-SCDMA: 150kHz, 30 MHz, 1GHz, 12.75GHz, 2.5 GHz, 2.5 GHz, 2.5 GHz, 2.5 GHz, 2.5 GHz, 2.5 GHz, 2.5 GHz, 2.5 GHz, 2.5 GHz, 2.5 GHz, 2.5 GHz, 2.5 GHz, 2.5 GHz DVB-T/H: 174MHz, 400MHz, 790MHz, 862MHz, 1GHz, 4.5GHz, 2.5GHz, 2.5GHz, 2.5GHz,

	2.5GHz, 2.5GHz, 2.5GHz, 2.5GHz, 2.5GHz, 2.5GHz, 2.5GHz, 2.5GHz, 2.5GHz, 2.5GHz, 2.5GHz LTE, MSR: 150kHz, 30MHz, 1GHz, 1.92GHz, 1.98GHz, 2.1GHz, 12.75GHz, 2.5GHz, 2.5GHz, 2.5GHz, 2.5GHz, 2.5GHz, 2.5GHz, 2.5GHz, 2.5GHz, 2.5GHz, 2.5GHz, 2.5GHz, 2.5GHz, 2.5GHz LTETDD: 150kHz, 30MHz, 1GHz, 1.90GHz, 2.01GHz, 2.025GHz, 12.75GHz, 2.5GHz, 2.5GHz, 2.5GHz, 2.5GHz, 2.5GHz, 2.5GHz, 2.5GHz, 2.5GHz, 2.5GHz, 2.5GHz, 2.5GHz, 2.5GHz WLAN: 150 kHz, 30 MHz, 1 GHz, 12.75 GHz, 2.5 GHz, 2.5 GHz, 2.5 GHz, 2.5 GHz, 2.5 GHz, 2.5 GHz, 2.5 GHz, 2.5 GHz, 2.5 GHz, 2.5 GHz, 2.5 GHz, 2.5 GHz, 2.5 GHz, 2.5 GHz, 2.5 GHz
State Saved	Saved in instrument state.
Min	-79999990
Max	Hardware Dependent: Option 503: 3.7 GHz Option 508: 8.5 GHz Option 513: 13.8 GHz Option 526: 27.0 GHz
Initial S/W Revision	Prior to A.02.00
Modified at S/W Revision	A.03.00

## Res BW

Sets the resolution bandwidth of the analyzer. This parameter can send up to 20 values.

The location of where the resolution bandwidth occurs in the list sent to the measurement corresponds to the range the value is associated with.

Missing values are not permitted. In other words, if you want to change values 2 and 6 you must send all values up to 6. Subsequent values will remain as they were. The query for this parameter always returns 20 values.

Key Path	Meas Setup, Range Table
Mode	SA, WCDMA, C2K, WIMAX OFDMA, TD-SCDMA, 1xEV-DO, DVB-T/H, LTE, LTETDD, WLAN, MSR, LTEAFDD, LTEATDD
Remote Command	[ :SENSe ] :SPURious [ :RANGe ] [ :LIST ] :BANDwidth [ :RESolution ] <freq>, <freq>, <freq>, <freq>, <freq>, <freq>, <freq>, <freq>, <freq>, <freq>, <freq>, <freq>, <freq>, <freq>, <freq>, <freq>, <freq>, <freq>, <freq>, <freq> [ :SENSe ] :SPURious [ :RANGe ] [ :LIST ] :BANDwidth [ :RESolution ] ? [ :SENSe ] :SPURious [ :RANGe ] [ :LIST ] :BANDwidth [ :RESolution ] :AUTO OFF   ON   0   1, OFF   ON   0   1, OFF   ON   0   1, OFF   ON   0   1, OFF   ON   0   1, OFF   ON   0   1, OFF   ON   0   1, OFF   ON   0   1, OFF   ON   0   1, OFF   ON   0   1, OFF   ON   0   1, OFF   ON   0   1, OFF   ON   0   1, OFF   ON   0   1, OFF   ON   0   1, OFF   ON   0   1, OFF   ON   0   1, OFF   ON   0   1, OFF   ON   0   1, OFF   ON   0   1, OFF   ON   0   1, OFF   ON   0   1 [ :SENSe ] :SPURious [ :RANGe ] [ :LIST ] :BANDwidth [ :RESolution ] :AUTO?
Example	SPUR:BAND 1kHz, 10kHz, 100kHz, 1MHz, 1MHz, 1MHz, 1MHz, 3MHz, 3MHz, 3MHz, 3MHz,

	3MHz, 3MHz, 3MHz, 3MHz, 3MHz, 3MHz, 3MHz, 3MHz, 3MHz SPUR:BAND? SPUR:BWID:AUTO ON, ON, ON, OFF, OFF, OFF, OFF, OFF, ON, ON, ON, ON, OFF, OFF, OFF, OFF, OFF, OFF, ON, ON SPUR:BWID:AUTO?
Notes	You must be in cdma2000 mode, TD-SCDMA mode, W-CDMA mode, DVB-T/H, GSM/EDGE mode, LTE mode, LTE TDD mode, WLAN mode, MSR, LTE-Advanced FDD/TDD mode or WiMAX mode to use this command. Use INSTRument:SElect to set the mode.
Preset	SA, WIMAX OFDMA:1.2MHz, 0.51MHz, 0.1MHz, 0.1MHz, 4MHz, 3MHz, 3MHz, 3MHz, 3MHz, 3MHz, 3MHz, 3MHz, 3MHz, 3MHz, 3MHz, 3MHz, 3MHz, 3MHz, 3MHz WCDMA:1kHz, 10kHz, 100kHz, 1MHz, 1MHz, 1MHz, 1MHz, 1MHz, 3MHz, 3MHz, 3MHz, 3MHz, 3MHz, 3MHz, 3MHz, 3MHz, 3MHz, 3MHz, 3MHz, 3MHz C2k, 1xEV-DO: 1kHz, 10kHz, 100kHz, 1MHz, 1MHz, 1MHz, 1MHz, 3MHz, 3MHz, 3MHz, 3MHz, 3MHz, 3MHz, 3MHz, 3MHz, 3MHz, 3MHz, 3MHz, 3MHz TD-SCDMA: 1kHz, 10kHz, 100kHz, 1MHz, 3MHz, 3MHz, 3MHz, 3MHz, 3MHz, 3MHz, 3MHz, 3MHz, 3MHz, 3MHz, 3MHz, 3MHz, 3MHz, 3MHz, 3MHz DVB-T/H: 100kHz, 3.9kHz, 100kHz, 3.9kHz, 100kHz, 100kHz, 3MHz, 3MHz, 3MHz, 3MHz, 3MHz, 3MHz, 3MHz, 3MHz, 3MHz, 3MHz, 3MHz, 3MHz, 3MHz LTE, MSR, LTEAFDD: 1kHz, 10kHz, 100kHz, 1MHz, 100kHz, 1MHz, 1MHz, 3MHz, 3MHz, 3MHz, 3MHz, 3MHz, 3MHz, 3MHz, 3MHz, 3MHz, 3MHz, 3MHz, 3MHz LTETDD, LTEATDD: 1kHz, 10kHz, 100kHz, 1MHz, 1MHz, 1MHz, 1MHz, 3MHz, 3MHz, 3MHz, 3MHz, 3MHz, 3MHz, 3MHz, 3MHz, 3MHz, 3MHz, 3MHz, 3MHz WLAN: 1kHz, 10kHz, 100kHz, 1MHz, 3MHz, 3MHz, 3MHz, 3MHz, 3MHz, 3MHz, 3MHz, 3MHz, 3MHz, 3MHz, 3MHz, 3MHz, 3MHz, 3MHz, 3MHz, 3MHz SA, WIMAX OFDMA:OFF, OFF, OFF, OFF, OFF, ON, ON, ON, ON, ON, ON, ON, ON, ON, ON, ON, ON, ON, ON, ON WCDMA:OFF, OFF, OFF, OFF, OFF, OFF, OFF, OFF, ON, ON, ON, ON, ON, ON, ON, ON, ON, ON, ON C2k, 1xEV-DO:OFF, OFF, OFF, OFF, OFF, OFF, OFF, ON, ON, ON, ON, ON,ON,ON,ON,ON,ON,ON,ON,ON TD-SCDMA: OFF, OFF, OFF, OFF, ON, ON, ON, ON, ON, ON, ON, ON, ON, ON, ON, ON, ON, ON, ON DVB-T/H: OFF, OFF, OFF, OFF, OFF, OFF, ON, ON, ON, ON, ON, ON, ON, ON, ON, ON, ON, ON, ON LTE, MSR, LTEAFDD: OFF, OFF, OFF, OFF, OFF, OFF, OFF, ON, ON, ON, ON, ON, ON, ON, ON, ON, ON, ON, ON, ON LTETDD, LTEATDD: OFF, OFF, OFF, OFF, OFF, OFF, OFF, ON, ON, ON, ON, ON, ON, ON, ON, ON, ON, ON, ON WLAN: OFF, OFF, OFF, OFF, ON, ON, ON, ON, ON, ON, ON, ON, ON, ON, ON, ON, ON, ON, ON, ON
State Saved	Saved in instrument state.
Min	1 Hz

Max	8 MHz
<b>Backwards Compatibility SCPI</b>	<code>[ :SENSe ] :SPURious [ :RANGe ] [ :LIST ] :BWIDth [ :RESolution ]</code>
Initial S/W Revision	Prior to A.02.00
Modified at S/W Revision	A.03.00

## Video BW

Sets the Video BW mode of the analyzer. This can be Auto, where the analyzer determines the optimum setting, or Manual, where you determine the setting. This parameter can send up to 20 values. The location in the list sent corresponds to the range the value is associated with. Missing values are not permitted; that is, if you want to change values 2 and 6 you must send all values up to 6. Subsequent values will remain as they were. The query for this parameter always returns 20 values.

Key Path	Meas Setup, Range Table
Mode	SA, WCDMA, C2K, WIMAX OFDMA, TD-SCDMA, 1xEV-DO, DVB-T/H, LTE, LTETDD, WLAN, MSR, LTEAFDD, LTEATDD
Remote Command	<pre>[ :SENSe ] :SPURious [ :RANGe ] [ :LIST ] :BANDwidth:VIDeo &lt;freq&gt;, &lt;freq&gt;, &lt;freq&gt;, &lt;freq&gt;, &lt;freq&gt;, &lt;freq&gt;, &lt;freq&gt;, &lt;freq&gt;, &lt;freq&gt;, &lt;freq&gt;, &lt;freq&gt;, &lt;freq&gt;, &lt;freq&gt;, &lt;freq&gt;, &lt;freq&gt;, &lt;freq&gt;, &lt;freq&gt;, &lt;freq&gt;, &lt;freq&gt;  [ :SENSe ] :SPURious [ :RANGe ] [ :LIST ] :BANDwidth:VIDeo?  [ :SENSe ] :SPURious [ :RANGe ] [ :LIST ] :BANDwidth:VIDeo:AUTO OFF   ON   0   1, OFF   ON   0   1, OFF   ON   0   1, OFF   ON   0   1, OFF   ON   0   1, OFF   ON   0   1, OFF   ON   0   1, OFF   ON   0   1, OFF   ON   0   1, OFF   ON   0   1, OFF   ON   0   1, OFF   ON   0   1, OFF   ON   0   1, OFF   ON   0   1, OFF   ON   0   1, OFF   ON   0   1, OFF   ON   0   1, OFF   ON   0   1, OFF   ON   0   1, OFF   ON   0   1, OFF   ON   0   1, OFF   ON   0   1  [ :SENSe ] :SPURious [ :RANGe ] [ :LIST ] :BANDwidth:VIDeo:AUTO?</pre>
Example	<pre>SPUR:BAND:VID 1kHz, 10kHz, 100kHz, 1MHz, 1MHz, 1MHz, 1MHz, 3MHz, 3MHz, 3MHz, 3MHz, 3MHz, 3MHz, 3MHz, 3MHz, 3MHz, 3MHz, 3MHz, 3MHz, 3MHz, 3MHz SPUR:BAND:VID? SPUR:BAND:VID:AUTO ON, ON, OFF, OFF, OFF, ON, ON, ON, OFF, OFF, OFF, OFF, OFF, OFF, OFF, ON, ON, ON, ON, ON SPUR:BAND:VID:AUTO?</pre>
Notes	You must be in the cdma2000 mode, 1xEV-DO mode, TD-SCDMA mode, W-CDMA mode, DVB-TH mode, GSM/EDGE mode, LTE mode, LTE TDD mode, WLAN mode, MSR, LTE-Advanced FDD/TDD mode or WiMAX mode to use this command. Use INSTRUMENT:SElect to set the mode.
Preset	<p>SA, WCDMA, C2K, WIMAX OFDMA, TD-SCDMA, 1xEV-DO, DVB-T/H WLAN: Automatically calculated</p> <p>LTE, MSR, LTEATDD: 4.7kHz, 47kHz, 470kHz, 5MHz, 470kHz, 5MHz, 5MHz, 300kHz, 300kHz, 300kHz, 300kHz, 300kHz, 300kHz, 300kHz, 300kHz, 300kHz, 300kHz, 300kHz, 300kHz, 300kHz, 300kHz</p> <p>LTETDD, LTEATDD: 4.7kHz, 47kHz, 470kHz, 5MHz, 470kHz, 5MHz, 5MHz, 300kHz, 300kHz, 300kHz, 300kHz, 300kHz, 300kHz, 300kHz, 300kHz, 300kHz, 300kHz, 300kHz, 300kHz, 300kHz, 300kHz</p> <p>ON, ON, ON, ON, ON, ON, ON, ON, ON, ON, ON, ON, ON, ON, ON, ON, ON, ON, ON, ON</p>





## Abs Start Limit

Determines the limit above which spurs will report a failing. If Abs Stop Limit Mode is set to Auto, this is coupled to Abs Stop Limit to make a flat limit line. If set to Man, Abs Start Limit and Abs Stop Limit can take different values to make a sloped limit line.

If the Limit Line Test parameter is off then any spurs which are found to be above the current 'Peak Excursion' will be added to the results table. From these spurs, the amplitude will be checked using the abs limit start and abs limit stop parameters and then calculate the limit. An 'F' will be appended to the amplitude value of the spur if the measured amplitude is above the limit. If the Limit Line Test is on, only the spurs whose amplitudes exceed the limit will be reported.

This parameter can send up to 20 values. The location in the list sent corresponds to the range of the associated value. Missing values are not permitted. If you want to change values 2 and 6 you must send all values up to 6. Subsequent values will remain as they were. The query for this parameter always returns 20 values.

<b>Key Path</b>	Meas Setup, Range Table
<b>Mode</b>	SA, WCDMA, C2K, WIMAX OFDMA, TD-SCDMA, 1xEV-DO, DVB-T/H, LTE, LTETDD, WLAN, MSR, LTEAFDD, LTEATDD
<b>Remote Command</b>	:CALCulate:SPURious[:RANGE][:LIST]:LIMit:ABSolute[:UPPer]:DATA[:START] <ampl>, <ampl>, <ampl>, <ampl>, <ampl>, <ampl>, <ampl>, <ampl>, <ampl>, <ampl>, <ampl>, <ampl>, <ampl>, <ampl>, <ampl>, <ampl>, <ampl>, <ampl>, <ampl>, <ampl>  :CALCulate:SPURious[:RANGE][:LIST]:LIMit:ABSolute[:UPPer]:DATA[:START]?
<b>Example</b>	CALC:SPUR:LIM:ABS:DATA 0, 0, 0, 0, 0, 0, 0, 0, 0, 0, 0, 0, 0, 0, 0, 0, 0, 0, 0, 0 CALC:SPUR:LIM:ABS:DATA?
<b>Preset</b>	SA, WIMAX OFDMA: -5.00000000E+001, -5.00000000E+001, -5.00000000E+001, -5.00000000E+001, -5.00000000E+001, -5.00000000E+001, -5.00000000E+001, -5.00000000E+001, -5.00000000E+001, -5.00000000E+001, -5.00000000E+001, -5.00000000E+001, -5.00000000E+001, -5.00000000E+001, -5.00000000E+001, -5.00000000E+001, -5.00000000E+001, -5.00000000E+001, -5.00000000E+001, -5.00000000E+001 WCDMA: -36dBm, -36dBm, -36dBm, -30dBm, -25dBm, -15dBm, -25dBm, -30dBm, -50dBm, -50dBm, -50dBm, -50dBm, -50dBm, -50dBm, -50dBm, -50dBm, -50dBm, -50dBm, -50dBm, -50dBm, -50dBm C2K, 1xEV-DO: -13 dBm, -13dBm, -13 dBm, -13 dBm, -50 dBm, -50 dBm, -50 dBm, -50 dBm, -50 dBm, -50 dBm, -50 dBm, -50 dBm, -50 dBm, -50 dBm, -50 dBm, -50 dBm, -50 dBm, -50 dBm, -50 dBm, -50 dBm TD-SCDMA: -13 dBm, -13dBm, -13 dBm, -13 dBm, -50 dBm, -50 dBm, -50 dBm, -50 dBm, -50 dBm, -50 dBm, -50 dBm, -50 dBm, -50 dBm, -50 dBm, -50 dBm, -50 dBm, -50 dBm, -50 dBm, -50 dBm DVB-T/H: -36dBm, -82dBm, -36dBm, -76dBm, -36dBm, -30dBm, -50dBm, -50dBm, -50dBm, -50dBm, -50dBm, -50dBm, -50dBm, -50dBm, -50dBm, -50dBm, -50dBm, -50dBm, -50dBm, -50dBm LTE, MSR, LTEAFDD: -36dBm, -36dBm, -36dBm, -30dBm, -96dBm, -30dBm, -30dBm, -50dBm,

---

	-50dBm, -50dBm, -50dBm, -50dBm, -50dBm, -50dBm, -50dBm, -50dBm, -50dBm, -50dBm, -50dBm, -50dBm, -50dBm, -50dBm
	LTETDD, LTEATDD: -36dBm, -36dBm, -36dBm, -30dBm, -96dBm, -30dBm, -30dBm, -50dBm, -50dBm, -50dBm, -50dBm, -50dBm, -50dBm, -50dBm, -50dBm, -50dBm, -50dBm, -50dBm, -50dBm, -50dBm
	WLAN: -36dBm, -36dBm, -36dBm, -30dBm, -50dBm, -50dBm, -50dBm, -50dBm, -50dBm, -50dBm, -50dBm, -50dBm, -50dBm, -50dBm, -50dBm, -50dBm, -50dBm, -50dBm, -50dBm, -50dBm
State Saved	Saved in instrument state.
Min	-150.0 dBm
Max	50.0 dBm
Initial S/W Revision	Prior to A.02.00
Modified at S/W Revision	A.03.00

---

**Abs Stop Limit**

Abs Stop Limit is used to determine the limit above which spurs will report a failing. If Abs Stop Limit Mode is set to Auto, this is coupled to Abs Start Limit to make a flat limit line. If set to Man, Abs Start Limit and Abs Stop Limit can take different values to make a sloped limit line.

Abs Stop Limit Mode, when set to Couple, couples Abs Start Limit and Abs Stop Limit to make a flat limit line. If set to Man, Abs Start and Abs Stop can take different values to make a sloped limit line.

This parameter can send up to 20 values. The location in the list sent corresponds to the range of the associated value. Missing values are not permitted; that is, if you want to change values 2 and 6 you must send all values up to 6. Subsequent values will remain as they were. The query for this parameter always returns 20 values.

Key Path	Meas Setup, Range Table
Mode	SA, WCDMA, C2K, WIMAX OFDMA, TD-SCDMA, 1xEV-DO, DVB-T/H, LTE, LTETDD, WLAN, MSR, LTEAFDD, LTEATDD
Remote Command	:CALCulate:SPURious[:RANGe][:LIST]:LIMit:ABSolute[:UPPer]:DATA:STOP <ampl>, <ampl>, <ampl>, <ampl>, <ampl>, <ampl>, <ampl>, <ampl>, <ampl>, <ampl>, <ampl>, <ampl>, <ampl>, <ampl>, <ampl>, <ampl>, <ampl>, <ampl>, <ampl>, <ampl>  :CALCulate:SPURious[:RANGe][:LIST]:LIMit:ABSolute[:UPPer]:DATA:STOP?  :CALCulate:SPURious[:RANGe][:LIST]:LIMit:ABSolute[:UPPer]:DATA:STOP:AUTO OFF   ON   0   1, OFF   ON   0   1, OFF   ON   0   1, OFF   ON   0   1, OFF   ON   0   1, OFF   ON   0   1, OFF   ON   0   1, OFF   ON   0   1, OFF   ON   0   1, OFF   ON   0   1, OFF   ON   0   1, OFF   ON   0   1 0   1, OFF   ON   0   1, OFF   ON   0   1, OFF   ON   0   1, OFF   ON   0   1, OFF   ON   0   1, OFF   ON   0   1, OFF   ON   0   1, OFF   ON   0   1, OFF   ON   0   1, OFF   ON   0   1, OFF   ON   0   1, OFF   ON   0   1  :CALCulate:SPURious[:RANGe][:LIST]:LIMit:ABSolute[:UPPer]:DATA:STOP:AUTO?
Example	CALC:SPUR:LIM:ABS:DATA:STOP -25, -25, -25, -25, -25, -25, -25, -25, -25, -25, -25, -25, -25, -25, -25, -25, -25, -25, -25, -25, -25

---



## Peak Excursion

Sets the minimum amplitude variation of signals that can be identified as peaks. If a value of 6 dB is selected, peaks that rise and fall more than 6 dB above the peak threshold value are identified.

This parameter can send up to 20 values. The location in the list sent corresponds to the range of the associated value. Missing values are not permitted. If you want to change values 2 and 6 you must send all values up to 6. Subsequent values will remain as they were. The query for this parameter always returns 20 values.

<b>Key Path</b>	Meas Setup, Range Table
<b>Mode</b>	SA, WCDMA, C2K, WIMAX OFDMA, TD-SCDMA, 1xEV-DO, DVB-T/H, LTE, LTETDD, WLAN, MSR, LTEAFDD, LTEATDD
<b>Remote Command</b>	[ :SENSE ] : SPURious [ :RANGE ] [ :LIST ] : PEAK : EXCursion <rel_ampl>, <rel_ampl>, <rel_ampl>, <rel_ampl>, <rel_ampl>, <rel_ampl>, <rel_ampl>, <rel_ampl>, <rel_ampl>, <rel_ampl>, <rel_ampl>, <rel_ampl>, <rel_ampl>, <rel_ampl>, <rel_ampl>, <rel_ampl>, <rel_ampl>, <rel_ampl>, <rel_ampl>, <rel_ampl>  [ :SENSE ] : SPURious [ :RANGE ] [ :LIST ] : PEAK : EXCursion?
<b>Example</b>	SPUR:PEAK:EXC 20, 20, 20, 20, 20, 20, 20, 20, 20, 20, 20, 20, 20, 20, 20, 20, 20, 20, 20, 20, 20 SPUR:PEAK:EXC?
<b>Preset</b>	+6.00000000E+000, +6.00000000E+000, +6.00000000E+000, +6.00000000E+000, +6.00000000E+000, +6.00000000E+000, +6.00000000E+000, +6.00000000E+000, +6.00000000E+000, +6.00000000E+000, +6.00000000E+000, +6.00000000E+000, +6.00000000E+000, +6.00000000E+000, +6.00000000E+000, +6.00000000E+000, +6.00000000E+000, +6.00000000E+000, +6.00000000E+000, +6.00000000E+000
<b>State Saved</b>	Saved in instrument state.
<b>Min</b>	0.0 dB
<b>Max</b>	100.0 dB
<b>Initial S/W Revision</b>	Prior to A.02.00
<b>Modified at S/W Revision</b>	A.03.00

## Pk Threshold

Sets the minimum amplitude of signals that can be identified as peaks. For example, if a value of -90 dBm is selected, only peaks that rise and fall more than the peak excursion value which are above -90 dBm are identified.

This parameter can send up to 20 values. The location in the list sent corresponds to the range of the associated value. Missing values are not permitted. If you want to change values 2 and 6 you must send all values up to 6. Subsequent values will remain as they were. The query for this parameter always returns 20 values.

<b>Key Path</b>	Meas Setup, Range Table
<b>Mode</b>	SA, WCDMA, C2K, WIMAX OFDMA, TD-SCDMA, 1xEV-DO, DVB-T/H, LTE, LTETDD, WLAN, MSR, LTEAFDD, LTEATDD
<b>Remote Command</b>	[ :SENSE ] : SPURious [ :RANGE ] [ :LIST ] : PEAK : THReshold <real>, <real>, <real>,

	<pre>&lt;real&gt;, &lt;real&gt;, &lt;real&gt;, &lt;real&gt;, &lt;real&gt;, &lt;real&gt;, &lt;real&gt;, &lt;real&gt;, &lt;real&gt;, &lt;real&gt;, &lt;real&gt;, &lt;real&gt;, &lt;real&gt;, &lt;real&gt;, &lt;real&gt;, &lt;real&gt;, &lt;real&gt;, &lt;real&gt;  [:SENSe]:SPURious[:RANGe][:LIST]:PEAK:THReshold?</pre>
<b>Example</b>	<pre>SPUR:PEAK:THR 0,0,0 SPUR:PEAK:THR?</pre>
Preset	<pre>-9.00000000E+001, -9.00000000E+001, -9.00000000E+001, -9.00000000E+001, - 9.00000000E+001, -9.00000000E+001, -9.00000000E+001, -9.00000000E+001, - 9.00000000E+001, -9.00000000E+001, -9.00000000E+001, -9.00000000E+001, - 9.00000000E+001, -9.00000000E+001, -9.00000000E+001, -9.00000000E+001, - 9.00000000E+001, -9.00000000E+001, -9.00000000E+001, -9.00000000E+001</pre>
State Saved	Saved in instrument state.
Min	-200
Max	0
Initial S/W Revision	Prior to A.02.00
Modified at S/W Revision	A.03.00, A.07.00

## Attenuation

Defines attenuation value for each range.

- When Auto state is ON, attenuation value under AMPTD Y Scale is used.
- When Auto state is OFF, this value is used as mechanical attenuation value without electric attenuation.

Key Path	Meas Setup, Range Table
Mode	SA, WCDMA, C2K, WIMAX OFDMA, TD-SCDMA, 1xEV-DO, DVB-T/H, LTE, LTETDD, WLAN, MSR, LTEAFDD, LTEATDD
<b>Remote Command</b>	<pre>[:SENSe]:SPURious[:RANGe][:LIST]:ATTenuation &lt;rel_ampl&gt;, &lt;rel_ampl&gt;, &lt;rel_ampl&gt;, &lt;rel_ampl&gt;, &lt;rel_ampl&gt;, &lt;rel_ampl&gt;, &lt;rel_ampl&gt;, &lt;rel_ampl&gt;, &lt;rel_ampl&gt;, &lt;rel_ampl&gt;, &lt;rel_ampl&gt;, &lt;rel_ampl&gt;, &lt;rel_ampl&gt;, &lt;rel_ampl&gt;, &lt;rel_ampl&gt;, &lt;rel_ampl&gt;, &lt;rel_ampl&gt;, &lt;rel_ampl&gt;, &lt;rel_ampl&gt;, &lt;rel_ampl&gt;  [:SENSe]:SPURious[:RANGe][:LIST]:ATTenuation?  [:SENSe]:SPURious[:RANGe][:LIST]:ATTenuation:AUTO OFF   ON   0   1, OFF   ON   0   1, OFF   ON   0   1, OFF   ON   0   1, OFF   ON   0   1, OFF   ON   0   1, OFF   ON   0   1, OFF   ON   0   1, OFF   ON   0   1, OFF   ON   0   1, OFF   ON   0   1, OFF   ON   0   1, OFF   ON   0   1, OFF   ON   0   1, OFF   ON   0   1, OFF   ON   0   1, OFF   ON   0   1, OFF   ON   0   1, OFF   ON   0   1, OFF   ON   0   1  [:SENSe]:SPURious[:RANGe][:LIST]:ATTenuation:AUTO?</pre>
<b>Example</b>	<pre>SPUR:ATT 10dB, 10dB, 10dB, 10dB, 10dB, 10dB, 10dB, 10dB, 10dB, 10dB, 10dB, 10dB, 10dB, 10dB, 10dB, 10dB, 10dB, 10dB, 10dB, 10dB  SPUR:ATT?  SPUR:ATT:AUTO 0, 0, 0, 0, 0, 0, 0, 0, 0, 0, 0, 0, 0, 0, 0, 0, 0, 0, 0, 0  SPUR:ATT:AUTO?</pre>

Notes	You must be in cdma2000 mode, 1xEV-DO mode, TD-SCDMA mode, W-CDMA mode, DVB-T/H, SA mode, LTE mode, LTE TDD mode, WLAN mode, MSR, LTE-Advanced FDD/TDD or WiMAX mode to use this command. Use INSTRument:SElect to set the mode.
Couplings	“---“ is displayed as value when Auto state is ON, to indicate attenuation value under AMPTD Y Scale is being used.
Preset	10dB, 10dB, 10dB, 10dB, 10dB, 10dB, 10dB, 10dB, 10dB, 10dB, 10dB, 10dB, 10dB, 10dB, 10dB, 10dB, 10dB ON, ON, ON, ON, ON, ON, ON, ON, ON, ON, ON, ON, ON, ON, ON, ON, ON, ON, ON, ON, ON, ON
State Saved	Saved in instrument state.
Min	0 dB
Max	70 dB
Initial S/W Revision	Prior to A.02.00
Modified at S/W Revision	A.03.00

### Detector 1

Sets the detector to be used by the trace for spur detection and limit line testing.

Key Path	Meas Setup, Range Table
Mode	SA, WCDMA, C2K, WIMAX OFDMA, TD-SCDMA, 1xEV-DO, DVB-T/H, LTE, LTE-TDD, WLAN, MSR, LTE-AFDD, LTEATDD
Remote Command	<pre>[:SENSe]:SPURious[:RANGE][:LIST]:DETECTOR[1][:FUNCTION] AVERAge   NEGAtive   NORMAl   POSitive   SAMPlE   RMS, AVERAge   NEGAtive   NORMAl   POSitive   SAMPlE   RMS, AVERAge   NEGAtive   NORMAl   POSitive   SAMPlE   RMS, AVERAge   NEGAtive   NORMAl   POSitive   SAMPlE   RMS, AVERAge   NEGAtive   NORMAl   POSitive   SAMPlE   RMS, AVERAge   NEGAtive   NORMAl   POSitive   SAMPlE   RMS, AVERAge   NEGAtive   NORMAl   POSitive   SAMPlE   RMS, AVERAge   NEGAtive   NORMAl   POSitive   SAMPlE   RMS, AVERAge   NEGAtive   NORMAl   POSitive   SAMPlE   RMS, AVERAge   NEGAtive   NORMAl   POSitive   SAMPlE   RMS, AVERAge   NEGAtive   NORMAl   POSitive   SAMPlE   RMS, AVERAge   NEGAtive   NORMAl   POSitive   SAMPlE   RMS, AVERAge   NEGAtive   NORMAl   POSitive   SAMPlE   RMS, AVERAge   NEGAtive   NORMAl   POSitive   SAMPlE   RMS, AVERAge   NEGAtive   NORMAl   POSitive   SAMPlE   RMS, AVERAge   NEGAtive   NORMAl   POSitive   SAMPlE   RMS, AVERAge   NEGAtive   NORMAl   POSitive   SAMPlE   RMS, AVERAge   NEGAtive   NORMAl   POSitive   SAMPlE   RMS, AVERAge   NEGAtive   NORMAl   POSitive   SAMPlE   RMS, AVERAge   NEGAtive   NORMAl   POSitive   SAMPlE   RMS</pre> <pre>[:SENSe]:SPURious[:RANGE][:LIST]:DETECTOR[1][:FUNCTION]?</pre>
Example	<pre>SPUR:DET NORM, NORM, NORM, NORM, NORM, NORM, NORM, NORM, NORM, NORM, NORM, NORM, NORM, NORM, NORM, NORM, NORM, NORM, NORM, NORM</pre> <pre>SPUR:DET?</pre>
Notes	For backward compatibility, “NORMAl” is available as a SCPI command parameter. However this is treated the same as “RMS” internally, so the query never returns “NORMAl” as its results.
Preset	POS, POS, POS, POS, POS, POS, POS, POS, POS, POS, POS, POS, POS, POS, POS, POS, POS, POS, POS, POS, POS

	POS, POS
State Saved	Saved in instrument state.
Range	Normal Average Peak Sample Negative Peak
Initial S/W Revision	Prior to A.02.00
Modified at S/W Revision	A.03.00

## Detector 2

Sets the detector to be used by the trace for display purposes only.

Key Path	Meas Setup, Range Table
Mode	SA, WCDMA, C2K, WIMAX OFDMA, TD-SCDMA, 1xEV-DO, DVB-T/H, LTE, LTEFDD, WLAN, MSR, LTEAFDD, LTEATDD
Remote Command	<pre>[[:SENSe]:SPURious[:RANGe][:LIST]:DETEctor2[:FUNctioN] OFF   AVERage   NEGative   NORMal   POSitive   SAMple   RMS, OFF   AVERage   NEGative   NORMal   POSitive   SAMple   RMS, OFF   AVERage   NEGative   NORMal   POSitive   SAMple   RMS, OFF   AVERage   NEGative   NORMal   POSitive   SAMple   RMS, OFF   AVERage   NEGative   NORMal   POSitive   SAMple   RMS, OFF   AVERage   NEGative   NORMal   POSitive   SAMple   RMS, OFF   AVERage   NEGative   NORMal   POSitive   SAMple   RMS, OFF   AVERage   NEGative   NORMal   POSitive   SAMple   RMS, OFF   AVERage   NEGative   NORMal   POSitive   SAMple   RMS, OFF   AVERage   NEGative   NORMal   POSitive   SAMple   RMS, OFF   AVERage   NEGative   NORMal   POSitive   SAMple   RMS, OFF   AVERage   NEGative   NORMal   POSitive   SAMple   RMS, OFF   AVERage   NEGative   NORMal   POSitive   SAMple   RMS, OFF   AVERage   NEGative   NORMal   POSitive   SAMple   RMS, OFF   AVERage   NEGative   NORMal   POSitive   SAMple   RMS, OFF   AVERage   NEGative   NORMal   POSitive   SAMple   RMS, OFF   AVERage   NEGative   NORMal   POSitive   SAMple   RMS, OFF   AVERage   NEGative   NORMal   POSitive   SAMple   RMS, OFF   AVERage   NEGative   NORMal   POSitive   SAMple   RMS, OFF   AVERage   NEGative   NORMal   POSitive   SAMple   RMS</pre> <pre>[[:SENSe]:SPURious[:RANGe][:LIST]:DETEctor2[:FUNctioN]?</pre>
Example	<pre>SPUR:DET2 AVER, AVER, AVER, AVER, AVER, AVER, AVER, AVER, AVER, AVER, AVER, AVER, AVER, AVER, AVER, AVER, AVER, AVER, AVER, AVER SPUR:DET2?</pre>
Notes	For backward compatibility, “NORMal” is available as a SCPI command parameter. However this is treated same as “RMS” internally, so the query never returns “NORMal” as its results.
Preset	OFF, OFF, OFF, OFF, OFF, OFF, OFF, OFF, OFF, OFF, OFF, OFF, OFF, OFF, OFF, OFF, OFF, OFF
State Saved	Saved in instrument state.
Range	Off Normal Average Peak Sample Negative Peak
Initial S/W Revision	Prior to A.02.00
Modified at S/W Revision	A.03.00

## Sweep Time

Sets the sweep time mode of the analyzer. This can be Auto, where the analyzer determines the optimum setting, or Manual, where you determine the setting.

This parameter can send up to 20 values. The location in the list sent corresponds to the range of the associated value. Missing values are not permitted. If you want to change values 2 and 6 you must send all values up to 6. Subsequent values will remain as they were. The query for this parameter always returns 20 values.

Key Path	Meas Setup, Range Table
Mode	SA, WCDMA, C2K, WIMAX OFDMA, TD-SCDMA, 1xEV-DO, DVB-T/H, LTE, LTETDD, WLAN, MSR, LTEAFDD, LTEATDD
Remote Command	<pre>[ :SENSE]:SPURious[:RANGE][:LIST]:SWEep:TIME &lt;time&gt;, &lt;time&gt;, &lt;time&gt;, &lt;time&gt;, &lt;time&gt;, &lt;time&gt;, &lt;time&gt;, &lt;time&gt;, &lt;time&gt;, &lt;time&gt;, &lt;time&gt;, &lt;time&gt;, &lt;time&gt;, &lt;time&gt;, &lt;time&gt;, &lt;time&gt;, &lt;time&gt;, &lt;time&gt;, &lt;time&gt;, &lt;time&gt;  [:SENSE]:SPURious[:RANGE][:LIST]:SWEep:TIME?  [:SENSE]:SPURious[:RANGE][:LIST]:SWEep:TIME:AUTO OFF   ON   0   1,OFF   ON   0   1,OFF   ON   0   1,OFF   ON   0   1,OFF   ON   0   1,OFF   ON   0   1,OFF   ON   0   1,OFF   ON   0   1,OFF   ON   0   1,OFF   ON   0   1,OFF   ON   0   1,OFF   ON   0   1,OFF   ON   0   1,OFF   ON   0   1,OFF   ON   0   1,OFF   ON   0   1,OFF   ON   0   1,OFF   ON   0   1,OFF   ON   0   1,OFF   ON   0   1  [:SENSE]:SPURious[:RANGE][:LIST]:SWEep:TIME:AUTO?</pre>
Example	<pre>SPUR:SWE:TIME 10, 10, 10, 10, 10, 10, 10, 10, 10, 10, 10, 10, 10, 10, 10, 10, 10, 10, 10, 10 SPUR:SWE:TIME? SPUR:SWE:TIME:AUTO ON, ON, ON, ON, ON, ON, ON, ON, ON, ON, ON, ON, ON, ON, ON, ON, ON, ON, ON, ON, ON SPUR:SWE:TIME:AUTO?</pre>
Notes	You must be in cdma2000 mode, TD-SCDMA mode, W-CDMA mode, DVB-T/H, SA mode, LTE mode, LTE TDD mode, WLAN mode, MSR, LTE-Advanced FDD/TDD mode or WiMAX mode to use this command. Use INSTRUMENT:SElect to set the mode.
Preset	Automatically calculated
State Saved	Saved in instrument state.
Min	1.0E-3
Max	2.0E+3
Initial S/W Revision	Prior to A.02.00
Modified at S/W Revision	A.03.00

## Points

Sets the number of points per sweep for the measurement. This parameter can send up to 20 values. The location in the list sent corresponds to the range of the associated value. Missing values are not permitted. If you want to change values 2 and 6 you must send all values up to 6. Subsequent values will remain as they were. The query for this parameter always returns 20 values.



The Points mode can be manual, where you determine the setting or auto, where the analyzer determines the number of trace points to ensure the sweep points resolution equals RBW/2. This is calculated using the following algorithm:

Points = (Stop Freq – Start Freq) / (ResBW / 2), with the computed values being clipped to a minimum of 601 and a maximum of 20001.

This parameter can send up to 20 values. The location in the list sent corresponds to the range the value is associated with. Missing values are not permitted; that is, if you want to change values 2 and 6 you must send all values up to 6. Subsequent values will remain as they were. The query for this parameter always returns 20 values.

<b>Key Path</b>	Meas Setup, Range Table
<b>Mode</b>	SA, WCDMA, C2K, WIMAX OFDMA, TD-SCDMA, 1xEV-DO, DVB-T/H, LTE, LTETDD, WLAN, MSR, LTEAFDD, LTEATDD
<b>Remote Command</b>	<pre>[:SENSe]:SPURious[:RANGe][:LIST]:SWEep:POINts &lt;integer&gt; [:SENSe]:SPURious[:RANGe][:LIST]:SWEep:POINts? [:SENSe]:SPURious[:RANGe][:LIST]:SWEep:POINts:AUTO OFF   ON   0   1, OFF   ON   0   1, OFF   ON   0   1, OFF   ON   0   1, OFF   ON   0   1, OFF   ON   0   1, OFF   ON   0   1, OFF   ON   0   1, OFF   ON   0   1, OFF   ON   0   1, OFF   ON   0   1, OFF   ON   0   1, OFF   ON   0   1, OFF   ON   0   1, OFF   ON   0   1, OFF   ON   0   1, OFF   ON   0   1, OFF   ON   0   1, OFF   ON   0   1, OFF   ON   0   1, OFF   ON   0   1</pre> <pre>[:SENSe]:SPURious[:RANGe][:LIST]:SWEep:POINts:AUTO?</pre>
<b>Example</b>	<pre>SPUR:SWE:POIN 1001,1001,1001 SPUR:SWE:POIN? SPUR:SWE:POIN:AUTO ON,ON,ON SPUR:SWE:POIN:AUTO?</pre>
<b>Preset</b>	<pre>SA, WIMAX OFDMA, DVB-T/H, WLAN: +601, +601, +601, +601, +601, +601, +601, +601, +601, +601, +601, +601, +601, +601, +601, +601, +601, +601, +601, +601, +601, +601 WCDMA: 601, 2985, 9700, 1100, 601, 601, 601, 10570, 601, 601, 601, 601, 601, 601, 601, 601, 601, 601, 601, 601 C2K: 601, 601, 9970, 11750, , 601, 601, 601, 601, 601, 601, 601, 601, 601, 601, 601, 601, 601, 601, 601, 601 CDMA1xEVDO: 601, 601, 9970, 11750, 601, 601, 601, 10570, 601, 601, 601, 601, 601, 601, 601, 601, 601, 601, 601, 601 TD-SCDMA: 601, 5970, 19400, 20001, 601, 601, 601, 601, 601, 601, 601, 601, 601, 601, 601, 601, 601, 601, 601, 601 LTE, LTETDD, MSR, LTEAFDD, LTEATDD : Automatically calculated. WLAN: Automatically calculated. OFF, OFF, OFF, OFF, OFF, OFF, OFF, OFF, OFF, OFF, OFF, OFF, OFF, OFF, OFF, OFF, OFF, OFF, OFF LTE, LTETDD, WLAN, MSR, LTEAFDD, LTEATDD: ON, ON, ON, ON, ON, ON, ON, ON, ON, ON, ON, ON, ON, ON, ON, ON, ON, ON, ON</pre>
<b>State Saved</b>	Saved in instrument state.
<b>Min</b>	101

Max	20001
Initial S/W Revision	Prior to A.02.00
Modified at S/W Revision	A.03.00

### IF Gain

Sets the IF Gain function to Auto, On (the extra 10 dB) or Off. These settings affect sensitivity and IF overloads. A switched IF amplifier with approximately 10 dB of gain is available. This amplifier takes full advantage of the RF dynamic range of the analyzer. When it can be turned on without an overload, the dynamic range is always better with the amplifier on than off.

Key Path	Meas Setup, Range Table
Dependencies	The IF Gain keys (FFT IF Gain and Swept IF Gain) have no effect when the U7227A USB Preamplifier is connected. This is not annotated or reflected on any softkey; there are no keys grayed out nor any SCPI locked out. The analyzer simply behaves as though both FFT IF Gain and Swept IF Gain are set to Low regardless of the setting on the keys.
Initial S/W Revision	Prior to A.02.00

### IF Gain Auto

Activates the rules for auto IF Gain.

Mode	SA, WCDMA, C2K, WIMAX OFDMA, TD-SCDMA, 1xEV-DO, DVB-T/H, LTE, LTE-TDD, WLAN, MSR, LTEAFDD, LTEATDD
Remote Command	<code>[ :SENSe ] :SPURious:IF:GAIN:AUTO[ :STATe ]</code> OFF   ON   0   1, OFF   ON   0   1, OFF   ON   0   1, OFF   ON   0   1, OFF   ON   0   1, OFF   ON   0   1, OFF   ON   0   1, OFF   ON   0   1, OFF   ON   0   1, OFF   ON   0   1 <code>[ :SENSe ] :SPURious:IF:GAIN:AUTO[ :STATe ] ?</code>
Example	SPUR:IF:GAIN:AUTO ON,ON SPUR:IF:GAIN:AUTO?
Couplings	When the sweep type is Swept, 'Auto' sets IF Gain to High Gain under any of the following conditions: the input attenuator is set to 0 dB, the preamp is turned on, or the Max Mixer Level is -20 dBm or lower. For other settings using the swept sweep type, auto sets IF Gain to Low Gain.
Preset	OFF, OFF, OFF, OFF, OFF, OFF, OFF, OFF, OFF, OFF, OFF, OFF, OFF, OFF, OFF, OFF, OFF, OFF, OFF
State Saved	Saved in instrument state.
Range	Auto Man
Initial S/W Revision	Prior to A.02.00
Modified at S/W Revision	A.03.00

## IF Gain State

Selects the range of IF Gain.

<b>Mode</b>	SA, WCDMA, C2K, WIMAX OFDMA, TD-SCDMA, 1xEV-DO, DVB-T/H, LTE, LTE4DD, WLAN, MSR, LTEAFDD, LTEATDD
<b>Remote Command</b>	<code>[:SENSe]:SPURious:IF:GAIN[:STATe] OFF   ON   0   1, OFF   ON   0   1, OFF   ON   0   1, OFF   ON   0   1, OFF   ON   0   1, OFF   ON   0   1, OFF   ON   0   1, OFF   ON   0   1, OFF   ON   0   1, OFF   ON   0   1, OFF   ON   0   1, OFF   ON   0   1, OFF   ON   0   1, OFF   ON   0   1, OFF   ON   0   1, OFF   ON   0   1, OFF   ON   0   1, OFF   ON   0   1, OFF   ON   0   1, OFF   ON   0   1</code> <code>[:SENSe]:SPURious:IF:GAIN[:STATe]?</code>
<b>Example</b>	SPUR:IF:GAIN ON,ON SPUR:IF:GAIN?
<b>Preset</b>	OFF, OFF, OFF, OFF, OFF, OFF, OFF, OFF, OFF, OFF, OFF, OFF, OFF, OFF, OFF, OFF, OFF, OFF, OFF
<b>State Saved</b>	Saved in instrument state.
<b>Range</b>	Low Gain (Best for Large Signals) High Gain (Best Noise Level)
<b>Initial S/W Revision</b>	Prior to A.02.00

## Meas Type

Selects either Examine or Full measurement type. This parameter is coupled to the average mode. Therefore, if the examine measurement type is selected, the measurement sets the average mode to exponential. If the full measurement type is selected, the measurement sets the average mode to repeat. The behavior of each measurement type is described in the table below. When averaging is on, trace averaging is used as each active range is measured. Averaging is not used at any other time.

<b>Type</b>	<b>Single</b>	<b>Continuous</b>			
<b>No Spurs Found</b>	<b>Spurs Found</b>	<b>No Spurs Found</b>	<b>Spurs Found</b>		
<b>Examine</b>	All active ranges are measured. On completion the measurement is set to the idle state and the 'No Spurs' happening is displayed.	All active ranges are measured and the spurs found reported. On completion the measurement is set to the idle state and the trace containing the worst spur restored. The spur menu key is enabled. A marker is also added which is set to the frequency of the worst spur.	All active ranges are measured. On completion the SA remains set to last range checked with an active trace and the 'No Spurs' happening is displayed.	All active ranges are measured and the spurs found reported. On completion the SA is set to the range containing the worst spur found and continually sweeps this range. Note that the trace is continually updated but the metrics results aren't updated until restart to keep the initial results as references. Use marker readouts to refer the latest results. The spur menu key is enabled. A marker is also added which is set to the frequency of	

Type	Single	Continuous		
No Spurs Found	Spurs Found	No Spurs Found	Spurs Found	
				the worst spur.
<b>Full</b>	All active ranges are measured. On completion measurement is set to idle state and the 'No Spurs' happening is displayed.	All active ranges are measured and spurs found reported. On completion the measurement is set to the idle state, displaying the trace of the last active range.	Measurement continually cycles through all active ranges.	All active ranges are measured and spurs found reported. On each cycle of the active ranges the spurs found are reset. This ensures any remote queries retrieve the trace data that matches the currently displayed results.

Key Path	Meas Setup
Mode	SA, WCDMA, C2K, WIMAX OFDMA, TD-SCDMA, 1xEV-DO, DVB-T/H, LTE, LTEFDD, LTEATDD
<b>Remote Command</b>	[ :SENSe ] : SPURious : TYPE EXAMine   FULL [ :SENSe ] : SPURious : TYPE ?
<b>Example</b>	SPUR : TYPE FULL SPUR : TYPE ?
Preset	EXAMine
State Saved	Saved in instrument state.
Range	Examine   Full
Initial S/W Revision	Prior to A.02.00
Modified at S/W Revision	A.03.00

## Spur

Displays any spurs found. It is only enabled when the measurement type is set to examine and will turn on upon completion of a measurement. Once the Spur menu key has been enabled, you can view any spur. The measurement sets the analyzer to the range in which the currently selected spur was found. The range settings only changes if the spur selected is in a range which is different from the current range settings. A marker is used to identify the currently selected spur on the trace.

Key Path	Meas Setup
Mode	SA, WCDMA, C2K, WIMAX OFDMA, CDMA1xEVDO, TD-SCDMA, DVB-T/H, LTE, LTEFDD, WLAN, MSR, LTEFDD, LTEATDD
<b>Remote Command</b>	[ :SENSe ] : SPURious : SPUR <integer> [ :SENSe ] : SPURious : SPUR ?
<b>Example</b>	SPUR : SPUR 55

SPUR:SPUR?	
Preset	1
State Saved	No
Min	1
Max	200
Initial S/W Revision	Prior to A.02.00
Modified at S/W Revision	A.03.00

## Spurious Report Mode

Selects the spurious report mode.

- Select Limit Line Test (LIMTest) to report only spurs above the limit line. Any spurs reported will cause the measurement to fail. See Abs Start Limit for more information.
- Select All Spurs (ALL) to report all spurs detected by Peak Threshold and Peak Excursion.
- Select Minimum Margin (MMARgin) to report only the spur with the minimum margin from the limit line. For the spur above the limit, its margin is defined as the negative margin. If there are more than one spurs above the limit, only one spur with the largest negative margin is reported.

Key Path	Meas Setup
Mode	SA, WCDMA, C2K, WIMAX OFDMA, TD-SCDMA, 1xEV-DO, DVB-T/H, LTE, LTETDD, WLAN, MSR, LTEAFDD, LTEATDD
<b>Remote Command</b>	[ :SENSe ] :SPURious:REPT:MODE ALL LIMTest MMARgin [ :SENSe ] :SPURious:REPT:MODE?
<b>Example</b>	SPUR:REPT:MODE LIMIT SPUR:REPT:MODE?
Dependencies	MMARgin is available only when option N9060A-7FP is installed.
Preset	ALL
State Saved	Saved in instrument state.
Range	All Spurs Limit Test Minimum Margin
Initial S/W Revision	Prior to A.02.00
Modified at S/W Revision	A.03.00, A.11.00

## Meas Preset

Restores all measurement parameters to their default values.

Key Path	Meas Setup
Mode	SA, WCDMA, C2K, WIMAX OFDMA, TD-SCDMA, 1xEV-DO, DVB-T/H, LTE, LTETDD, WLAN, MSR, LTEAFDD, LTEATDD

<b>Remote Command</b>	:CONFigure:SPURious
<b>Example</b>	CONF:SPUR
Initial S/W Revision	Prior to A.02.00
Modified at S/W Revision	A.03.00

### Fast Spurious Meas (Remote Command only)

This command is provided as the backward compatibility SCPI command of the Fast Spurious Measurement. Since this command is another representation of Spurious Report Mode, this command is coupled with the command.

When set to ON, only spurs above the limit line are reported. This is the same as Spurious Report Mode "LIMTest".

When set to OFF, all detected spurs are reported. This is the same as Spurious Report Mode "ALL."

<b>Mode</b>	SA, WCDMA, C2K, WIMAX OFDMA, TD-SCDMA, 1xEV-DO, DVB-T/H, WLAN, MSR, LTEAFDD, LTEATDD
<b>Remote Command</b>	[ :SENSe ] :SPURious:FSMeas ON OFF 1 0 [ :SENSe ] :SPURious:FSMeas?
<b>Example</b>	SPUR:FSM ON SPUR:FSM?
<b>Couplings</b>	If SPUR:REPT:MODE is ALL, this parameter is OFF. If SPUR:REPT:MODE is LIMTest, this parameter is ON.
<b>Preset</b>	OFF
<b>State Saved</b>	Saved in instrument state.
Initial S/W Revision	A.04.00

## Mode

See "Mode" on page 318

## Mode Preset

Returns the active mode to a known state.

Mode Preset does the following for the currently active mode:

- Aborts the currently running measurement.
- Brings up the default menu for the mode, with no active function.
- Sets measurement Global settings to their preset values for the active mode only.
- Activates the default measurement.
- Brings up the default menu for the mode.
- Clears the input and output buffers.
- Sets Status Byte to 0.

Mode Preset does not:

- Cause a mode switch
- Affect mode persistent settings
- Affect system settings

See "[How-To Preset](#)" on page 1493 for more information.

<b>Key Path</b>	Front-panel key
<b>Remote Command</b>	:SYSTem:PRESet
<b>Example</b>	:SYST:PRES
<b>Notes</b>	*RST is preferred over :SYST:PRES for remote operation. *RST does a Mode Preset, as done by the :SYST:PRES command, and it sets the measurement mode to Single measurement rather than Continuous for optimal remote control throughput. Clears all pending OPC bits. The Status Byte is set to 0.
<b>Couplings</b>	A Mode Preset aborts the currently running measurement, activates the default measurement, and gets the mode to a consistent state with all of the default couplings set.
<b>Backwards Compatibility Notes</b>	In the X-Series, the legacy "Factory Preset" has been replaced with Mode Preset, which only presets the currently active mode, not the entire instrument. In the X-Series, the way to preset the entire instrument is by using System, Restore System Defaults All, which behaves essentially the same way as restore System Defaults does on ESA and PSA. There is also no "Preset Type" as there is on the PSA. There is a green Mode Preset front-panel key that does a Mode Preset and a white-with-green-letters User Preset front-panel key that does a User Preset. The old PRESet:TYPE command is ignored (without generating an error), and SYST:PRES without a parameter does a Mode Preset, which should cover most backward code compatibility issues. The settings and correction data under the Input/Output front-panel key (examples: Input Z Corr, Ext Amp Gain, etc.) are no longer part of any Mode, so they will not be preset by a Mode Preset. They are preset using Restore Input/Output Defaults, Restore System Defaults All. Note that because User Preset does a Recall State, and all of these settings are saved in State, they ARE recalled when using



	User Preset.
Initial S/W Revision	Prior to A.02.00

## How-To Preset

The table below shows all possible presets, their corresponding SCPI commands and front-panel access (key paths). Instrument settings depend on the current measurement context. Some settings are local to the current measurement, some are global (common) across all the measurements in the current mode, and some are global to all the available modes. In a similar way, restoring the settings to their preset state can be done within the different contexts.

Auto Couple - is a measurement local key. It sets all Auto/Man parameter couplings in the measurement to Auto. Any Auto/Man selection that is local to other measurements in the mode will not be affected.

Meas Preset - is a measurement local key. Meas Preset resets all the variables local to the current measurement except the persistent ones.

Mode Preset - resets all the current mode's measurement local and measurement global variables except the persistent ones.

Restore Mode Defaults - resets ALL the Mode variables (and all the Meas global and Meas local variables), including the persistent ones.

Type Of Preset	SCPI Command	Front Panel Access
Auto Couple	:COUPlE ALL	Auto Couple front-panel key
Meas Preset	:CONFIgure:<Measurement>	Meas Setup Menu
Mode Preset	:SYSTem:PRESet	Mode Preset (green key)
Restore Mode Defaults	:INSTrument:DEFault	Mode Setup Menu
Restore All Mode Defaults	:SYSTem:DEFault MODEs	System Menu; Restore System Default Menu
*RST	*RST	not possible (Mode Preset with Single)
Restore Input/Output Defaults	:SYSTem:DEFault INPut	System Menu; Restore System Default Menu
Restore Power On Defaults	:SYSTem:DEFault PON	System Menu; Restore System Default Menu
Restore Alignment Defaults	:SYSTem:DEFault ALIGn	System Menu; Restore System Default Menu
Restore Miscellaneous Defaults	:SYSTem:DEFault MISC	System Menu; Restore System Default Menu
Restore All System Defaults	:SYSTem:DEFault [ALL] :SYSTem:PRESet:PERSistent	System Menu; Restore System Default Menu
User Preset	:SYSTem:PRESet:USER	User Preset Menu
User Preset All Modes	:SYSTem:PRESet:USER:ALL	User Preset Menu

Power On Mode Preset	:SYSTem:PON:TYPE MODE	System Menu
Power On User Preset	:SYSTem:PON:TYPE USER	System Menu
Power On Last State	:SYSTem:PON:TYPE LAST	System Menu

### Preset Type (Remote Command Only)

As stated in the Backward Compatibility section, to be compatible with ESA/PSA the PRESet:TYPE command will be implemented as a no-op.

<b>Mode</b>	All
<b>Remote Command</b>	:SYSTem:PRESet:TYPE FACTory MODE USER :SYSTem:PRESet:TYPE?
<b>Example</b>	:SYST:PRESet:TYPE FACT
<b>Notes</b>	This command is supported for backward compatibility only. It is a no-op which does not change the behavior of any preset operation.
<b>Preset</b>	This is unaffected by Preset but is set to Mode on a "Restore System Defaults->All"
<b>State Saved</b>	No
<b>Initial S/W Revision</b>	Prior to A.02.00

## Mode Setup

See ["Mode Setup" on page 348](#)

## Peak Search

Performs a peak search and opens the Peak Search menu. The Peak Search functions allow you to define specific search criteria to determine which signals can be considered peaks, excluding unwanted signals from the search.

Places the selected marker on the trace point with the maximum y-axis value for that marker's trace.

<b>Key Path</b>	Front-panel key
<b>Mode</b>	SA, WCDMA, C2K, WIMAX OFDMA, 1xEV-DO, DVB-T/H, LTE, LTE-TDD, WLAN, MSR, LTEAFDD, LTEATDD
<b>Remote Command</b>	:CALCulate:SPURious:MARKer[1]   2   ...   12:MAXimum
<b>Example</b>	CALC:SPUR:MARK2:MAX
<b>Initial S/W Revision</b>	Prior to A.02.00
<b>Modified at S/W Revision</b>	A.03.00

## Next Peak

Moves the selected marker to the peak that has the next highest amplitude less than the current marker value.

<b>Key Path</b>	Peak Search
<b>Mode</b>	SA, WCDMA, C2K, WIMAX OFDMA, TD-SCDMA, 1xEV-DO, DVB-T/H, LTE, LTE-TDD, WLAN, MSR, LTEAFDD, LTEATDD
<b>Remote Command</b>	:CALCulate:SPURious:MARKer[1]   2   ...   12:MAXimum:NEXT
<b>Example</b>	CALC:SPUR:MARK2:MAX:NEXT
<b>Initial S/W Revision</b>	Prior to A.02.00
<b>Modified at S/W Revision</b>	A.03.00

## Next Pk Right

Moves the selected marker to the nearest peak to the right of the current marker which meets all enabled peak criteria.

<b>Key Path</b>	Peak Search
<b>Mode</b>	SA, WCDMA, C2K, WIMAX OFDMA, TD-SCDMA, 1xEV-DO, DVB-T/H, LTE, LTE-TDD, WLAN
<b>Remote Command</b>	:CALCulate:SPURious:MARKer[1]   2   ...   12:MAXimum:RIGHT
<b>Example</b>	CALC:SPUR:MARK2:MAX:RIGH
<b>Initial S/W Revision</b>	Prior to A.02.00
<b>Modified at S/W Revision</b>	A.03.00

## Next Pk Left

Moves the selected marker to the nearest peak to the left of the current marker which meets all enabled peak criteria.

Key Path	Peak Search
Mode	SA, WCDMA, C2K, WIMAX OFDMA, TD-SCDMA, 1xEV-DO, DVB-T/H, LTE, LTETDD, WLAN, MSR, LTEAFDD, LTEATDD
<b>Remote Command</b>	:CALCulate:SPURious:MARKer[1] 2 ... 12:MAXimum:LEFT
<b>Example</b>	CALC:SPUR:MARK2:MAX:LEFT
Initial S/W Revision	Prior to A.02.00
Modified at S/W Revision	A.03.00

## Marker Delta

Performs the same function as the Delta 1-of-N selection key in the Marker menu. This sets the control mode for the selected marker to Delta mode. See the Marker section for the complete description of this function. The key is duplicated here in the Peak Search Menu to allow you to conveniently perform a peak search and change the control of the Marker mode to Delta without having to access two separate menus.

Key Path	Peak Search
Initial S/W Revision	Prior to A.02.00

## Pk-Pk Search

Finds and displays the amplitude and frequency (or time, if in zero span) differences between the highest and lowest y-axis value.

Key Path	Peak Search
Mode	SA, WCDMA, C2K, WIMAX OFDMA, TD-SCDMA, 1xEV-DO, DVB-T/H, LTE, LTETDD, WLAN, MSR, LTEAFDD, LTEATDD
<b>Remote Command</b>	:CALCulate:SPURious:MARKer[1] 2 ... 12:PTPeak
<b>Example</b>	CALC:SPUR:MARK:PTP
Notes	Turns on the Marker $\Delta$
Dependencies	This key is not available (key is grayed-out) when Coupled Markers is on.
Initial S/W Revision	Prior to A.02.00
Modified at S/W Revision	A.03.00

## Min Search

Moves the selected marker to the minimum y-axis value on the current trace.

13 Spurious Emissions Measurement  
Peak Search

<b>Key Path</b>	Peak Search
<b>Mode</b>	SA, WCDMA, C2K, WIMAX OFDMA, TD-SCDMA, 1xEV-DO, DVB-T/H, LTE, LTEFDD, LTEATDD
<b>Remote Command</b>	:CALCulate:SPURious:MARKer[1]   2   ...   12:MINimum
<b>Example</b>	CALC:SPUR:MARK:MIN
<b>Initial S/W Revision</b>	Prior to A.02.00
<b>Modified at S/W Revision</b>	A.03.00

Print

See "Print" on page 358

## Quick Save

The Quick Save front-panel key repeats the most recent save that was performed from the Save menu, with the following exceptions:

- Register saves are not remembered as Saves for the purpose of the Quick Save function
- If the current measurement does not support the last non-register save that was performed, an informational message is generated, “File type not supported for this measurement”

Quick Save repeats the last type of qualified save (that is, a save qualified by the above criteria) in the last save directory by creating a unique filename using the Auto File Naming algorithm described below.

If Quick Save is pressed after startup and before any qualified Save has been performed, the Quick Save function performs a Screen Image save using the current settings for Screen Image saves (current theme, current directory), which then becomes the “last save” for the purpose of subsequent Quick Saves.

The Auto File Naming feature automatically generates a file name for use when saving a file. The filename consists of a prefix and suffix separated by a dot, as is standard for the Windows® file system. A default prefix exists for each of the available file types:

Type	Default Prefix	Menu
State	State_	(Save/Recall)
Trace + State	State_	(Save/Recall)
Screen	Screen_	(Save/Recall)
Amplitude Corrections	Ampcor_	(Import/Export)
Traces	Trace_	(Import/Export)
Limit Lines	LLine_	(Import/Export)
Measurement Result	MeasR_	(Import/Export)
Capture Buffer	CapBuf_	(Import/Export)

A four digit number is appended to the prefix to create a unique file name. The numbering sequence starts at 0000 within each Mode for each file type and updates incrementally to 9999, then wraps to 0000 again. It remembers where it was through a Mode Preset and when leaving and returning to the Mode. It is reset by Restore Misc Defaults and Restore System Defaults and subsequent running of the instrument application. So, for example, the first auto file name generated for State files is State\_0000.state. The next is State\_0001, and so forth.

One of the key features of Auto File Name is that we guarantee that the Auto File Name will never conflict with an existing file. The algorithm looks for the next available number. If it gets to 9999, then it looks for holes. If it find no holes, that is no more numbers are available, it gives an error.

For example, if when we get to State\_0010.state there is already a State\_0010.state file in the current directory, it advances the counter to State\_0011.state to ensure that no conflict will exist (and then it verifies that State\_0011.state also does not exist in the current directory and advances again if it does, and so forth).



If you enter a file name for a given file type, then the prefix becomes the filename you entered instead of the default prefix, followed by an underscore. The last four letters (the suffix) are the 4-digit number.

For example, if you save a measurement results file as “fred.csv”, then the next auto file name chosen for a measurement results save will be fred\_0000.csv.

**NOTE** Although 0000 is used in the example above, the number that is used is actually the current number in the Meas Results sequence, that is, the number that would have been used if you had not entered your own file name.

**NOTE** If the filename you entered ends with \_dddd, where d=any number, making it look just like an auto file name, then the next auto file name picks up where you left off with the suffix being dddd + 1.

Key Path	Front-panel key
Notes	No remote command for this key specifically.
Initial S/W Revision	Prior to A.02.00

## Recall

The Recall menu lets you choose what you want to recall, and where you want to recall it from. Among the types of files you can recall are **States and Traces**. In addition, an Import (Data) option lets you recall a number of data types stored in CSV files (as used by Excel and other spreadsheet programs).

The default paths for Recall are data type dependent and are the same as for the Save key.

Key Path	Front-panel key
Notes	<p>No remote command for this key specifically, but the :MMEM:LOAD command is available for specific file types. An example is :MMEM:LOAD:STATe &lt;filename&gt;.</p> <p>If you try to recall a State file for a mode that is not licensed or not available in the instrument, an error message will occur and the state will not change.</p>
Backwards Compatibility Notes	<p>In legacy analyzers, it was possible to load a state without affecting the trace data, limit lines or correction data. Similarly (since User Preset is actually loading a state), it was possible to do a User Preset without affecting the trace data, limit lines or correction data.</p> <p>In the X-Series, “state” always includes all of this data; so whenever state is loaded, all of the traces, limit lines and corrections are affected. Although this differs from previous behavior, it is desirable behavior, and should not cause adverse issues for users.</p>
Backwards Compatibility Notes	<p>Recall for the X-Series supports backward compatibility in the sense that you can recall a state file from any X-Series model number and any version of X-Series software. This is only possible if part of the recalling process goes through a limiting step after recalling the mode settings, at least for settings that may vary with version number, model number, option and license differences. If you try to recall a state file onto an instrument with less capability than what was available on the instrument during the save, the recall will ignore the state it doesn't support and it will limit the recalled setting to what it allows.</p> <p>Example: if the saved state includes preamp ON, but the recalling instrument does not have a preamp; the preamp is limited to OFF. Conversely, if you save a state without a preamp, the preamp is OFF in the state file. When this saved file is recalled on an instrument with a licensed preamp, the preamp is changed to OFF. Another example is if the saved state has center frequency set to 20 GHz, but the instrument recalling the saved state is a different model and only supports 13.5 GHz. In this case, the center frequency is limited along with any other frequency based settings. Since the center frequency can't be preserved in this case, the recall limiting tries to at least preserve span to keep the measurement setup as intact as possible.</p> <p>It may be appropriate to issue a warning if the state is limited on the recall; warnings do not go out to SCPI so this would only affect the manual user.</p> <p>Note that there is no state file compatibility outside of the X-Series. For example, you cannot recall a state file from ESA or PSA.</p>
Initial S/W Revision	Prior to A.02.00

## State

The Recall State menu lets you choose a register or file from which to recall the state.

The content of a state file includes all of the settings and data required to return the analyzer as closely as possible to the Mode it was in, with the exact settings that were in place, when the save occurred. The Mode settings in each state file include the settings that are affected by Mode Preset, as well as the

additional settings affected by Restore Mode Defaults; all of the Mode’s settings. In addition, all of the settings of the Input/Output system are included, even though they are outside of the Mode’s state, because they are needed to restore the complete setup. Persistent System settings (for example, GPIB address) are not affected by either a Mode Preset or Restore Mode Defaults, nor are they included in a saved State file.

Since each state file is only for one Mode, the settings for other Modes are unaffected when it is loaded. Recall State will cause a mode switch if the state being recalled is not from the current active mode.

After the recall completes, the message "File <filename> recalled" or “Recalled State Register <register number>” is displayed.

For rapid recalls, the State menu lists 16 registers that you can choose from to recall. Pressing a Register key initiates the recall. You can also select a file from which to recall.

The default path for all State Files is:

My Documents\<<mode name>\state

where <mode name> is the parameter used to select the mode with the INST:SEL command (for example, SA for the Spectrum Analyzer).

See "[More Information](#)" on page 1504.

<b>Key Path</b>	Recall
<b>Mode</b>	All
<b>Remote Command</b>	:MMEMory:LOAD:STATe <filename>
<b>Example</b>	:MMEM:LOAD:STAT "myState.state" This recalls the file myState.state on the default path
<b>Example</b>	MMEM:LOAD:STAT "MyStateFile.state" This loads the state file data (on the default file directory path) into the instrument state.
<b>Notes</b>	<p>When you pick a file to recall, the analyzer first verifies that the file is recallable in the current instrument by checking the software version and model number of the instrument. If everything matches, a full recall proceeds by aborting the currently running measurement, clearing any pending operations, and then loading the State from the saved state file. You can open state files from any mode, so recalling a State file switches to the mode that was active when the save occurred. After switching to the mode of the saved state file, mode settings and data (if any for the mode) are loaded with values from the saved file. The saved measurement of the mode becomes the newly active measurement and the data relevant to the measurement (if there is any) is recalled.</p> <p>If there is a mismatch between file version or model number or instrument version or model number, the recall function tries to recall as much as possible and returns a warning message. It may limit settings that differ based on model number, licensing or version number.</p> <p>After recalling the state, the Recall State function does the following:</p> <ul style="list-style-type: none"> <li>• Makes the saved measurement for the mode the active measurement.</li> <li>• Clears the input and output buffers.</li> <li>• Status Byte is set to 0.</li> <li>• Executes a *CLS</li> </ul> <p>If the file specified is empty an error is generated. If the specified file does not exist, another error is generated. If there is a mismatch between the file and the proper file type, an error is generated. If</p>

---

	there is a mismatch between file version or model number or instrument version or model number, a warning is displayed. Then it returns to the State menu and File Open dialog goes away. After the Recall, the analyzer exits the Recall menu and returns to the previous menu.
<b>Backwards Compatibility SCPI</b>	:MMEMory:LOAD:STATe 1,<filename> For backwards compatibility, the above syntax is supported. The "1" is simply ignored.
Initial S/W Revision	Prior to A.02.00

---

### More Information

In measurements that support saving Traces, for example, Swept SA, the Trace data is saved along with the State in the State file. When recalling the State, the Trace data is recalled as well. Traces are recalled exactly as they were stored, including the writing mode and update and display modes. If a Trace was updating and visible when the State was saved, it will come back updating and visible, and its data will be rewritten right away. When you use State to save and recall traces, any trace whose data must be preserved should be placed in View or Blank mode before saving.

The following table describes the Trace Save and Recall possibilities:

You want to recall state and one trace's data, leaving other traces unaffected.	Save Trace+State from 1 trace. Make sure that no other traces are updating (they should all be in View or Blank mode) when the save is performed.	On Recall, specify the trace you want to load the one trace's data into. This trace will load in View. All other traces' data will be unaffected, although their trace mode will be as it was when the state save was performed.
You want to recall all traces	Save Trace+State from ALL traces.	On Recall, all traces will come back in View (or Blank if they were in Blank or Background when saved)
You want all traces to load exactly as they were when saved.	Save State	On recall, all traces' mode and data will be exactly as they were when saved. Any traces that were updating will have their data immediately overwritten.

### From File...

When you press "From File", the analyzer brings up a Windows dialog and a menu entitled "File Open." This menu allows you to navigate to the various fields in the Windows dialog without using a keyboard or mouse. The Tab and Arrow keys can also be used for dialog navigation.



Listed below are the functions of the various fields in the dialog, and the corresponding softkeys:

#### Open

Performs the recall of the specified file. While the recall is being performed, the floppy icon appears briefly in the Meas bar.

#### File/Folder List

Enables you to navigate to the center of the dialog that contains the list of files and folders. Once here you can get information about the file and use the tab keys to navigate to the other fields in the dialog, such as Look In.

#### Look In

The Look In field shows the path from which the file will be recalled and allows you to change the path using the up and down arrow keys to navigate to other paths; the Enter key to open a directory; and the Backspace key to go back one directory. The **Look In field** first uses the last path from the Save As dialog **Save In:** path for that same file type. There is no softkey for directly navigating to the Look In field, but you can use the left tab to get here from the File/Folder List.

User specified paths are remembered when you leave and return to a Mode and are reset back to the default using Restore Mode Defaults.

#### Sort

Accesses a menu that enables you to sort the files within the File Open dialog. Only one sorting type can be selected at a time and the sorting happens immediately. The sorting types are By Date, By Name, By extension, and By Size.

#### Files of Type

This field shows the file suffix for the type of file you have selected to recall. For example, if you navigated here while recalling State, "Mode state (\*.state)" is in the field. If you navigated here while recalling Trace, ""Mode state (\*.trace)" is in the field. If you navigated here while importing a trace data file, "Trace Data (\*.csv)" is in the field. For some file types, there is more than one choice in the dropdown menu, which you can select by using the up and down arrow keys and Enter.

#### Up One Level

This key corresponds to the icon of a folder with the up arrow that is in the tool bar of the dialog. When pressed, it causes the file and folder list to navigate up one level in the directory structure. The Backspace key does the same thing.

#### Cancel

This key corresponds to the Cancel selection in the dialog. It causes the current **Open** request to be cancelled. The ESC key does the same thing.

Key Path	Recall, State
Notes	Brings up the Open dialog for recalling a State Save Type
Initial S/W Revision	Prior to A.02.00

### Edit Register Names

You may enter a custom name on any of the Register keys, to help you remember what you are using that state to save. To do this, press the Edit Register Names key, choose the register whose name you wish to edit, and then enter the desired label using the Alpha Editor or an external PC keyboard.

The maximum number of characters that can be added is 30. In most cases, 30 characters will fit on two lines of the key.

For more information and the SCPI command, see Edit Register Names under the Save, State function.

Key Path	Recall, State
Mode	All
Dependencies	N9060A-7FP or N9060B-2FP license required to edit the register names. When the feature is not licensed, sending the SCPI command generates an error, -221, "Settings conflict;Option not available"
Initial S/W Revision	A.11.00

### Register 1 thru Register 16

Selecting any one of these register keys causes the State of the mode from the specified Register to be recalled. Each of the register keys annotates whether it is empty or at what date and time it was last

modified. In addition, you can use the Edit Register Names key under Save, State to enter custom names for each register.

Registers are shared by all modes, so recalling from any one of the registers will cause a mode switch to the mode that was active when the save to the Register occurred.

Although these 16 registers are the only registers available from the front panel, there are 128 state registers available in the instrument. Registers 17–128 are only available from the SCPI interface, using the \*RCL command.

After the recall completes, the message "Register <register number> recalled" appears in the message bar. If you are in the Spectrum Analyzer Mode, and you are recalling a register that was saved in the Spectrum Analyzer Mode, then after the recall, you will still be in the Recall Register menu. If the Recall causes you to switch modes, then after the Recall, you will be in the Frequency menu.

If a requested register is empty an error is generated.

Key Path	Recall, State
<b>Example</b>	*RCL 1
Range	1–16 from front panel, 1–128 from SCPI
Readback	Date and time with seconds resolution are displayed on the key OR A custom name of up to 30 characters entered using the Save, State, Edit Register Names key OR “(empty)” if no prior save operation has been performed to this register.
Initial S/W Revision	Prior to A.02.00
Modified at S/W Revision	Prior to A.11.00

## Register 1 thru Register 16

Selecting any one of these register keys causes the State of the mode from the specified Register to be recalled. Each of the register keys annotates whether it is empty or at what date and time it was last modified. In addition, you can use the Edit Register Names key under Save, State to enter custom names for each register.

Registers are shared by all modes, so recalling from any one of the registers will cause a mode switch to the mode that was active when the save to the Register occurred.

Although these 16 registers are the only registers available from the front panel, there are 128 state registers available in the instrument. Registers 17–128 are only available from the SCPI interface, using the \*RCL command.

After the recall completes, the message "Register <register number> recalled" appears in the message bar. If you are in the Spectrum Analyzer Mode, and you are recalling a register that was saved in the Spectrum Analyzer Mode, then after the recall, you will still be in the Recall Register menu. If the Recall causes you to switch modes, then after the Recall, you will be in the Frequency menu.

If a requested register is empty an error is generated.

Key Path	Recall, State
Example	*RCL 1
Range	1-16 from front panel, 1-128 from SCPI
Readback	Date and time with seconds resolution are displayed on the key OR A custom name of up to 30 characters entered using the Save, State, Edit Register Names key OR “(empty)” if no prior save operation has been performed to this register.
Initial S/W Revision	Prior to A.02.00
Modified at S/W Revision	Prior to A.11.00

### Trace (+State)

The Recall Trace (+State) menu lets you choose a register or file from which to recall the Trace+State state file.

A saved state contains all of the settings and data required to return the analyzer as closely as possible to the exact setup it had when the save occurred. This includes the Input/Output settings, even though they are outside of the Mode’s state, because they are needed to restore the complete setup. A Trace+State file also includes trace data from one trace or all traces, which will load in View mode when the Trace+State file is recalled. Recall Trace (+State) will also cause a mode switch if the state being recalled is not for the current active mode.

After the recall completes, the message "File <filename> recalled" or “Recalled Trace Register <register number>” is displayed.

For rapid recalls, the Trace (+State) menu lists 5 registers to choose from to recall. Pressing a Register key initiates the recall. You can also select a file from which to recall.

The default path for all State Files including .trace files is:

My Documents\<mode name>\state

where <mode name> is the parameter used to select the mode with the INST:SEL command (for example, SA for the Spectrum Analyzer).

Key Path	Recall
Mode	SA
Remote Command	:MMEMory:LOAD:TRACe TRACE1   TRACE2   TRACE3   TRACE4   TRACE5   TRACE6, <filename>  :MMEMory:LOAD:TRACe:REGister TRACE1   TRACE2   TRACE3   TRACE4   TRACE5   TRACE6, <integer>
Example	MMEM:LOAD:TRAC TRACE2, "MyTraceFile.trace" This loads the trace file data (on the default file directory path) into the specified trace; if it is a "single trace" save file, that trace is loaded to trace 2, and is set to be not updating. :MMEM:LOAD:TRAC:REG TRACE1,2



	restores the trace data in register 2 to Trace 1
Notes	<p>When you perform the recall, the recalling Trace function must first verify the file is recallable in this instrument by checking instrument software version and model number, since it includes State. If everything matches, a full recall proceeds by aborting the currently running measurement, and loading the state from the saved state file to as close as possible to the context in which the save occurred. You can open .trace files from any mode that supports them, so recalling a Trace file switches to the mode that was active when the save occurred. After switching to the mode of the saved state file, mode settings and data (if any for the mode) are loaded with values from the saved file and the saved measurement of the mode becomes the newly active measurement, and the data relevant to the measurement (if there is any) is recalled.</p> <p>Once the state is loaded, the trace data must be loaded. The internal flags are consulted to see which trace to load and the "To Trace" setting to see where to load it. Trace data is always loaded with the specified trace set to View, so that the data is visible and not updating(so as not to erase the recalled data). If the file is an "all trace" file, all traces are loaded with the saved data(to the original trace the data was saved from) and set to View. Traces whose data is not loaded are restored to the update state that existed when they were saved.</p> <p>After the Recall the analyzer exits the Recall menu and returns to the previous menu.</p> <p>Some modes and measurements do not have available all 6 traces. Phase Noise mode command, for example, is: <code>MMEMory:LOAD:TRACe TRACE1 TRACE2 TRACE3,&lt;filename&gt;</code></p> <p>Some modes and measurements have more than 6 traces available. The Realtime SA mode command, for example, is: <code>MMEMory:STORe:TRACe TRACE1   TRACE2   TRACE3   TRACE4   TRACE5   TRACE6   TRACE7   TRACE8   TRACE9   TRACE10   TRACE11   TRACE12   ALL,&lt;filename&gt;</code></p>
Initial S/W Revision	Prior to A.02.00

## To Trace

These menu selections let you choose the Trace where the recalled saved trace will go. Not all modes have the full 6 traces available. The default is the currently selected trace, selected in this menu or in the Trace/Detector, Export Data, Import Data, or Save Trace menus, except if you have chosen All, then it remains chosen until you specifically change it to a single trace.

If the .trace file is an "all trace" file, "To Trace" is ignored and the traces each go back to the trace from which they were saved.

Once selected, the key returns back to the Recall Trace menu and the selected Trace number is annotated on the key. Now you have selected exactly where the trace needs to be recalled.To trigger a recall of the selected Trace, you must select the Open key in the Recall Trace menu.

When you select a trace, it makes that trace the current trace, so it displays on top of all of the other traces.

Key Path	Save, Data, Trace
Mode	SA
Initial S/W Revision	Prior to A.02.00

## Register 1 thru Register 16

Selecting any one of these register keys causes the State of the mode from the specified Register to be recalled. Each of the register keys annotates whether it is empty or at what date and time it was last modified. In addition, you can use the Edit Register Names key under Save, State to enter custom names for each register.

Registers are shared by all modes, so recalling from any one of the registers will cause a mode switch to the mode that was active when the save to the Register occurred.

Although these 16 registers are the only registers available from the front panel, there are 128 state registers available in the instrument. Registers 17–128 are only available from the SCPI interface, using the \*RCL command.

After the recall completes, the message "Register <register number> recalled" appears in the message bar. If you are in the Spectrum Analyzer Mode, and you are recalling a register that was saved in the Spectrum Analyzer Mode, then after the recall, you will still be in the Recall Register menu. If the Recall causes you to switch modes, then after the Recall, you will be in the Frequency menu.

If a requested register is empty an error is generated.

Key Path	Recall, State
<b>Example</b>	*RCL 1
Range	1–16 from front panel, 1–128 from SCPI
Readback	Date and time with seconds resolution are displayed on the key OR A custom name of up to 30 characters entered using the Save, State, Edit Register Names key OR “(empty)” if no prior save operation has been performed to this register.
Initial S/W Revision	Prior to A.02.00
Modified at S/W Revision	Prior to A.11.00

## From File...

When you press “From File”, the analyzer brings up a Windows dialog and a menu entitled “File Open.” This menu allows you to navigate to the various fields in the Windows dialog without using a keyboard or mouse. The Tab and Arrow keys can also be used for dialog navigation.

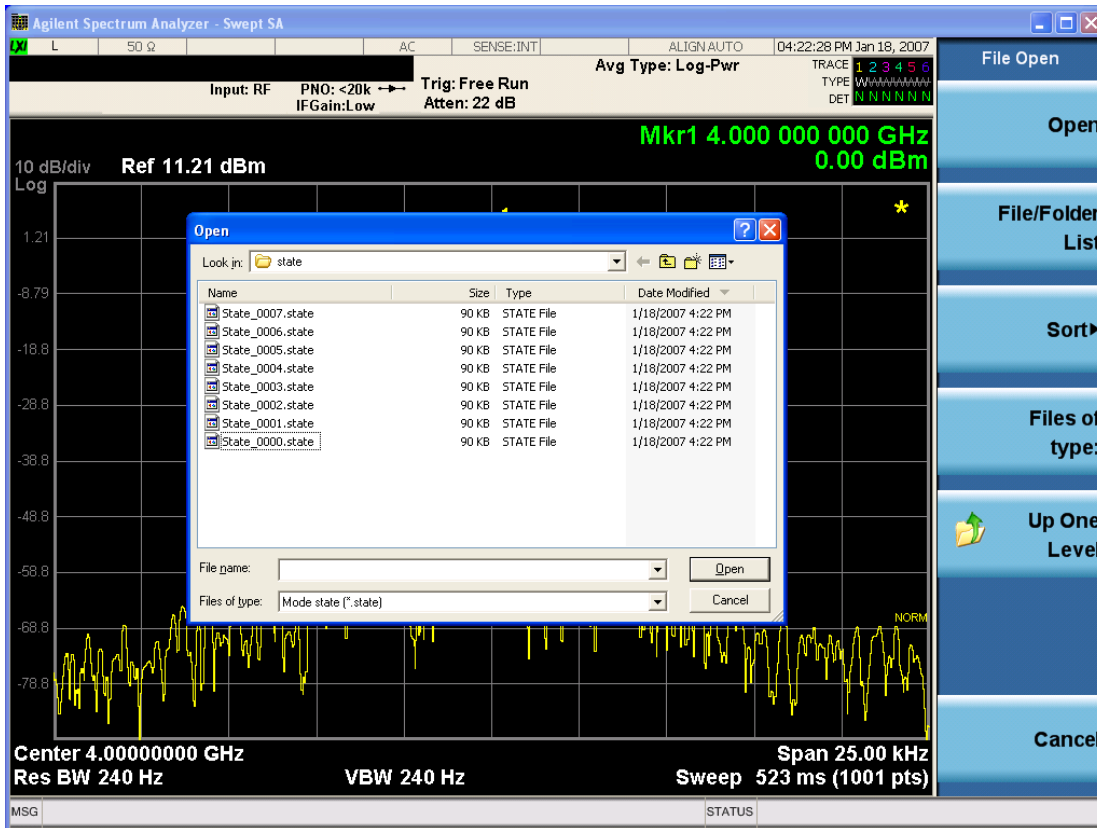

Listed below are the functions of the various fields in the dialog, and the corresponding softkeys:

#### Open

Performs the recall of the specified file. While the recall is being performed, the floppy icon appears briefly in the Meas bar.

#### File/Folder List

Enables you to navigate to the center of the dialog that contains the list of files and folders. Once here you can get information about the file and use the tab keys to navigate to the other fields in the dialog, such as Look In.

#### Look In

The Look In field shows the path from which the file will be recalled and allows you to change the path using the up and down arrow keys to navigate to other paths; the Enter key to open a directory; and the Backspace key to go back one directory. The **Look In field** first uses the last path from the Save As dialog **Save In:** path for that same file type. There is no softkey for directly navigating to the Look In field, but you can use the left tab to get here from the File/Folder List.

User specified paths are remembered when you leave and return to a Mode and are reset back to the default using Restore Mode Defaults.

#### Sort

Accesses a menu that enables you to sort the files within the File Open dialog. Only one sorting type can be selected at a time and the sorting happens immediately. The sorting types are By Date, By Name, By extension, and By Size.

#### Files of Type

This field shows the file suffix for the type of file you have selected to recall. For example, if you navigated here while recalling State, "Mode state (\*.state)" is in the field. If you navigated here while recalling Trace, ""Mode state (\*.trace)" is in the field. If you navigated here while importing a trace data file, "Trace Data (\*.csv)" is in the field. For some file types, there is more than one choice in the dropdown menu, which you can select by using the up and down arrow keys and Enter.

#### Up One Level

This key corresponds to the icon of a folder with the up arrow that is in the tool bar of the dialog. When pressed, it causes the file and folder list to navigate up one level in the directory structure. The Backspace key does the same thing.

#### Cancel

This key corresponds to the Cancel selection in the dialog. It causes the current **Open** request to be cancelled. The ESC key does the same thing.

Key Path	Recall, State
Notes	Brings up the Open dialog for recalling a State Save Type
Initial S/W Revision	Prior to A.02.00

## Data (Import)

Importing a data file loads data that was previously saved from the current measurement or from other measurements and/or modes that produce compatible data files. The Import Menu only contains Data Types that are supported by the current measurement.

Since the commonly exported data files are in .csv format, the data can be edited by the user prior to importing. This allows you to export a data file, manipulate the data in Excel (the most common PC Application for manipulating .csv files) and then import it.

Importing Data loads measurement data from the specified file into the specified or default destination, depending on the data type selected. Selecting an Import Data menu key will not actually cause the importing to occur, since the analyzer still needs to know from where to get the data. Pressing the Open key in this menu brings up the Open dialog and Open menu that provides you with the options from where to recall the data. Once a filename has been selected or entered in the Open menu, the recall occurs as soon as the Open button is pressed.

Key Path	Recall
Mode	All
Notes	The menu is built from whatever data types are available for the mode. Some keys will be missing completely, so the key locations in the sub-menu will vary. No SCPI command directly controls the Data Type that this key controls. The Data Type is included in the MMEM:LOAD commands.

Dependencies	If a file type is not used by a certain measurement, it is grayed out for that measurement. The key for a file type will not show at all if there are no measurements in the Mode that support it.
Preset	Is not affected by Preset or shutdown, but is reset during Restore Mode Defaults
Readback	The data type that is currently selected
Initial S/W Revision	Prior to A.02.00

## Capture Buffer

The captured data is raw data which is not processed.

Key Path	Recall, Data
Mode	<b>CDMA1XEV</b>
Example	M MEM:LOAD:CAPT "MyCaptureData.bin" This loads the file of capture data (on the default file directory path) into the instrument.
Dependencies	In case the capture buffer data is not available from the selected measurement, the key will be grayed out.
Initial S/W Revision	A.11.00

## Open...

When you press "Open", the analyzer brings up a Windows dialog and a menu entitled "**File Open.**" This menu allows you to navigate to the various fields in the Windows dialog without using a keyboard or mouse. The Tab and Arrow keys can also be used for dialog navigation.

See "[From File...](#)" on page 2890 in Recall, State, for a full description of this dialog and menu.

Key Path	Recall, Data
Notes	The key location is mode-dependent and will vary. Brings up Open dialog for recalling a <mode specific> Save Type
Initial S/W Revision	Prior to A.02.00

## Restart

The Restart function restarts the current sweep, or measurement, or set of averaged/held sweeps or measurements. If you are Paused, pressing Restart does a Resume.

The Restart function is accessed in several ways:

- Pressing the Restart key
- Sending the remote command INIT:IMMediate
- Sending the remote command INIT:REStart

See "[More Information](#)" on page 1514

Key Path	Front-panel key
Remote Command	:INITiate[:IMMediate] :INITiate:REStart
Example	:INIT:IMM :INIT:REST
Notes	:INITiate:REStart and :INITiate:IMMediate perform exactly the same function.
Couplings	Resets average/hold count k. For the first sweep overwrites all active (update=on) traces with new current data. For application modes, it resets other parameters as required by the measurement.
Status Bits/OPC dependencies	This is an Overlapped command. The STATus:OPERation register bits 0 through 8 are cleared. The STATus:QUESTionable register bit 9 (INTegrity sum) is cleared. The SWEEPING bit is set. The MEASURING bit is set.
Backwards Compatibility Notes	For Spectrum Analysis mode in ESA and PSA, the Restart hardkey and the INITiate:REStart command restart trace averages (displayed average count reset to 1) for a trace in Clear Write, but did not restart Max Hold and Min Hold.  In the X-Series, the Restart hardkey and the INITiate:REStart command restart not only Trace Average, but MaxHold and MinHold traces as well.  For wireless comms modes in ESA and PSA, the Restart hardkey and the INITiate:REStart command restart every measurement, which includes all traces and numeric results. There is no change to this operation.
Initial S/W Revision	Prior to A.02.00

### More Information

The **Restart** function first aborts the current sweep/measurement as quickly as possible. It then resets the sweep and trigger systems, sets up the measurement and initiates a new data measurement sequence with a new data acquisition (sweep) taken once the trigger condition is met.

If the analyzer is in the process of aligning when **Restart** is executed, the alignment finishes before the restart function is performed.

Even when set for Single operation, multiple sweeps may be taken when Restart is pressed (for example, when averaging/holding is on). Thus when we say that **Restart** "restarts a measurement," we may mean:

- It restarts the current sweep
- It restarts the current measurement
- It restarts the current set of sweeps if any trace is in Trace Average, Max Hold or Min Hold
- It restarts the current set of measurements if Averaging, or Max Hold, or Min Hold is on for the measurement
- depending on the current settings.

With **Average/Hold Number** (in **Meas Setup** menu) set to 1, or Averaging off, or no trace in Trace Average or Hold, a single sweep is equivalent to a single measurement. A single sweep is taken after the trigger condition is met; and the analyzer stops sweeping once that sweep has completed. However, with **Average/Hold Number** >1 and at least one trace set to **Trace Average, Max Hold, or Min Hold (SA Measurement)** or **Averaging on (most other measurements)**, multiple sweeps/data acquisitions are taken for a single measurement. The trigger condition must be met prior to each sweep. The sweep is stopped when the average count  $k$  equals the number  $N$  set for **Average/Hold Number**. A measurement average usually applies to all traces, marker results, and numeric results; but sometimes it only applies to the numeric results.

Once the full set of sweeps has been taken, the analyzer will go to idle state. To take one more sweep without resetting the average count, increment the average count by 1, by pressing the step up key while **Average/Hold Number** is the active function, or sending the remote command `CALC:AVER:TCON UP`.

## Save

The Save menu lets you choose what you want to save and where you want to save it. Among the types of files you can save are **States**, **Traces**, and **Screen Images**. In addition, an Export (Data) option lets you save a number of data types as CSV files for easy import into Excel and other spreadsheet programs.

Key Path	Front-panel key
Mode	All
Notes	No remote command for this key specifically, but the :MMEM:STORe command is available for specific file types. An example is :MMEM:STOR:STATe <filename>.
Initial S/W Revision	Prior to A.02.00

## State

The Save State menu lets you choose a register or file for saving the state.

The content of a state file includes all of the settings and data required to return the analyzer as closely as possible to the Mode it was in, with the exact settings which were in place, when the save occurred. The Mode settings in each state file include the settings that are affected by Mode Preset, as well as the additional settings affected by Restore Mode Defaults; all of the Mode's settings. In addition, all of the settings of the Input/Output system are included, even though they are outside of the Mode's state, because they are needed to restore the complete setup. Persistent System settings (for example, Verbose SCPI) are not affected by either Mode Preset or Restore Mode Defaults, nor are they included in a saved State file.

After the save completes, the message "File <filename> saved" or "State Register <register number> saved" is displayed.

For rapid saving, the State menu lists 16 registers to save to. Pressing a Register key initiates the save. You can also select a file to save to.

The default path for all State Files is:

My Documents\<<mode name>\state

where <mode name> is the parameter used to select the mode with the INST:SEL command (for example, SA for the Spectrum Analyzer).

Key Path	Save
Mode	All
Remote Command	:MMEMory:STORe:STATe <filename>
Example	MMEM:STOR:STATe "MyStateFile.state" This stores the current instrument state data in the file MyStateFile.state in the default directory.
Notes	Both single and double quotes are supported for any filename parameter over remote. After saving to a register, that register's menu key is updated with the date the time, unless a custom label has been entered for that key. After saving to a register, you remain in the Save State menu, so that you can see the Register key



update. After saving to a file, the analyzer automatically returns to the previous menu and any Save As dialog goes away.

<b>Backwards Compatibility SCPI</b>	:MMEMory:STORe:STATe 1,<filename>
Initial S/W Revision	Prior to A.02.00

### To File . . .

When you press “To File”, the analyzer brings up a Windows dialog and a menu entitled “**Save As.**” This menu allows you to navigate to the various fields in the Windows dialog without using a keyboard or mouse. The Tab and Arrow keys can also be used for dialog navigation.

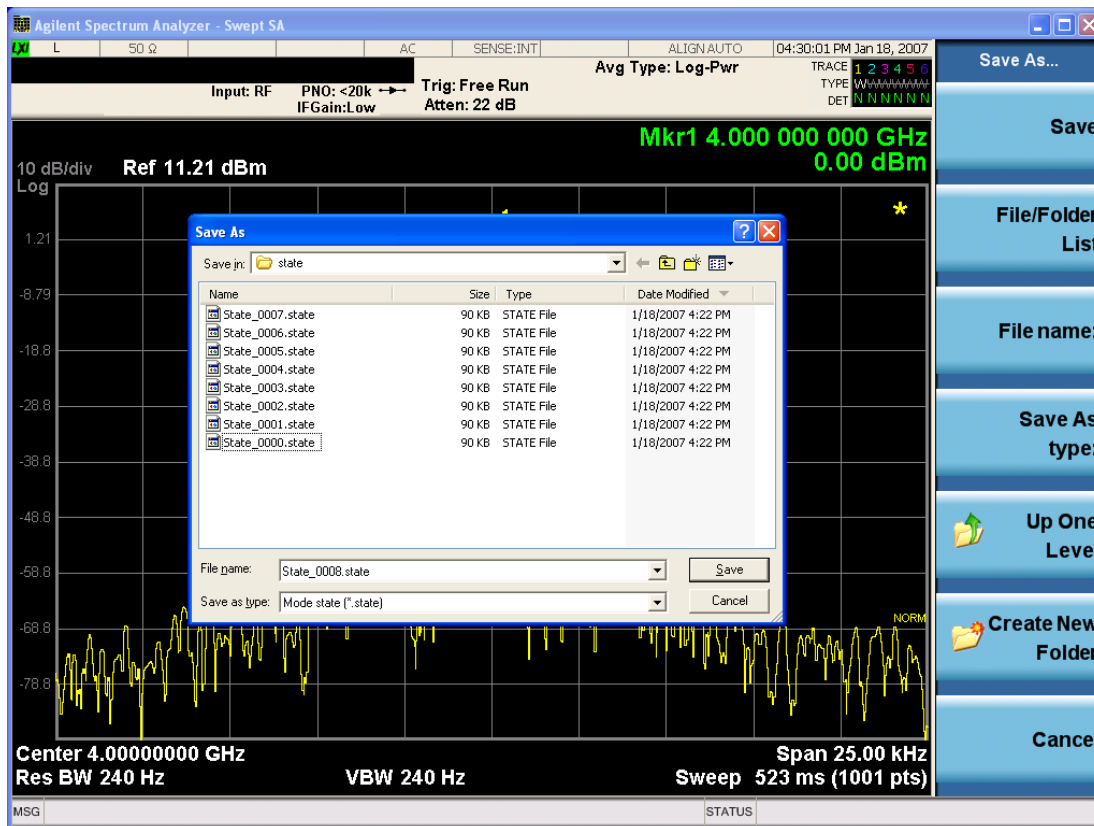

The Listed below

are the functions of the various fields in the dialog, and the corresponding softkeys:

#### Save

Performs the save to the specified file of the selected type. If the file already exists, a dialog will appear that allows you to replace the existing file by selecting OK, or you can Cancel the request. If you select OK, the file will be overwritten. Using the C: drive is strongly discouraged, since it runs the risk of being overwritten during an instrument software upgrade.

While the save is being performed, the floppy icon appears briefly in the Meas bar.

### File/Folder List

Enables you to navigate to the center of the dialog that contains the list of files and folders. Once here you can get information about the file and use the tab keys to navigate to the other fields in the dialog, such as Save In.

### Save In

The Save In field shows the path to which the file will be saved and allows you to change the path using the up and down arrow keys to navigate to other paths; the Enter key to open a directory; and the Backspace key to go back one directory. The **Save In field** defaults to the default path for this type of file and remembers the last path you used to save this type of file. There is no softkey for directly navigating to the Save In field but you can use left tab to get here from the File/Folder List.

User specified paths are remembered when you leave and return to a Mode and are reset back to the default using Restore Mode Defaults.

### File Name

The File Name field is initially loaded with an automatically generated filename specific to the appropriate Save Type. The automatically generated filename is guaranteed not to conflict with any filename currently in the directory. You may replace or modify this filename using the File Name key. See the ["Quick Save " on page 2880](#) documentation for more on the automatic file naming algorithm.

When you press the File Name key the analyzer displays the Alpha Editor. Use the knob to choose the letter to add and the front-panel Enter key to add the letter to the file name. The BK character moves you back and the FW character moves you forward in the filename. The Select key on the front panel generates a space character. When you are done entering the filename press the Done softkey. This returns back to the **File Open** dialog and menu, but does not cause the save to occur.

### Save As Type

This field shows the file suffix for the type of file you have selected to save. For example, if you navigated here while saving State, "Mode state (\*.state)" is in the field. If you navigated here from saving Trace, ""Mode state (\*.trace)" is in the field. If you navigated here while exporting a trace data file, "Trace Data (\*.csv)" is in the field. For some file types, there is more than one choice in the dropdown, which you can select by using the up and down arrow keys and Enter.

### Up One Level

This key corresponds to the icon of a folder with the up arrow that is in the tool bar of the dialog. When pressed, it causes the file and folder list to navigate up one level in the directory structure. The Backspace key does the same thing.

### Create New Folder

This key corresponds to the icon of a folder with the "\*" that is in the tool bar of the dialog. When pressed, a new folder is created in the current directory with the name **New Folder** and you can enter a new folder name using the Alpha Editor.

### Cancel

This key corresponds to the Cancel selection in the dialog. It causes the current **Save As** request to be cancelled. The ESC key does the same thing.

Key Path	Save, State
Mode	All
Notes	Brings up Save As dialog for saving a State Save Type
Initial S/W Revision	Prior to A.02.00

## Edit Register Names

You may enter a custom name on any of the Register keys, to help you remember what you are using that state to save. To do this, press the Edit Register Names key, choose the register whose name you wish to edit, and then enter the desired label using the Alpha Editor or an external PC keyboard.

The maximum number of characters that can be added is 30. In most cases, 30 characters will fit on two lines of the key.

See ["More Information" on page 1519](#)

Key Path	Save, State
Mode	All
<b>Remote Command</b>	:MMEMory:REGister:STATe:LABel <reg number>,"label" :MMEMory:REGister:STATe:LABel? <reg number>
<b>Example</b>	:MMEM:REG:STAT:LAB 1,"my label"
Notes	<reg number> is an integer from 1 to 16. If the SCPI specifies an invalid register number an error message is generated, -222,"Data out of range;Invalid register label number" "label" is a string from 0 to 30 characters in length. If a label exceeds 30 characters, an error message is generated, -150,"String data error;Label clipped to 30 characters" "label" of length 0 erases the custom label and restores the default (time and date) label. E.g.: :MMEM:REG:STAT:LAB 1,""
Dependencies	N9060A-7FP or N9060B-2FP license required to edit the register names. When the feature is not licensed, sending this command generates an error, -221,"Settings conflict;Option not available"
Preset	The names are unaffected by Preset or power cycle but are set to the default label (time and date) on a "Restore System Defaults->Misc"
Initial S/W Revision	A.11.00

## More Information

When you edit one of the register names, the time and date field will be replaced by the custom name.

If you delete all the characters in the custom name, it restores the default (time and date).

The register names are stored within the state files, but they are not part of the instrument state; that is, once you have edited a register name, loading a new state will not change that register name. Another consequence of this is that the names will be persistent through a power cycle. Also, if a named state file is transferred to another analyzer, it will bring its custom name along with it.

If you try to edit the name of an empty register, the analyzer will first save the state to have a file to put the name in. If you load a named state file into an analyzer with older firmware it will ignore the metadata.

The \*SAV and \*RCL commands will not be affected by the custom register names, nor will the MMEM commands.

### Register 1 thru Register 16

Selecting any one of these register menu keys causes the State of the currently active mode to be saved to the specified Register. The registers are provided for rapid saving and recalling, since you do not need to specify a filename or navigate to a file. Each of the register menu keys annotates whether it is empty or at what date and time it was last modified. In addition, you can use the Edit Register Names key to enter custom names for each register.

Although these 16 registers are the only registers available from the front panel, there are 128 state registers available in the instrument. Registers 17–128 are only available from the SCPI interface, using the \*SAV command.

There is one set of 128 state registers in the instrument, not one set for each Mode. When a state is saved, the Mode it was saved from is saved with it; then when it is recalled, the instrument switches to that Mode.

After the save completes, the corresponding register menu key annotation is updated with the date and time and the message "Register <register number> saved" is displayed.

Key Path	Save, State
Mode	All
Example	*SAV 1
Range	1–16 from front panel, 1–128 from SCPI
Readback	Date and time with seconds resolution are displayed on the key OR A custom name of up to 30 characters entered using the Edit Register Names key OR “(empty)” if no prior save operation has been performed to this register.
Initial S/W Revision	Prior to A.02.00
Modified at S/W Revision	A.11.00

### Register 1 thru Register 16

Selecting any one of these register menu keys causes the State of the currently active mode to be saved to the specified Register. The registers are provided for rapid saving and recalling, since you do not need to specify a filename or navigate to a file. Each of the register menu keys annotates whether it is empty or at what date and time it was last modified. In addition, you can use the Edit Register Names key to enter custom names for each register.

Although these 16 registers are the only registers available from the front panel, there are 128 state registers available in the instrument. Registers 17–128 are only available from the SCPI interface, using the \*SAV command.

There is one set of 128 state registers in the instrument, not one set for each Mode. When a state is saved, the Mode it was saved from is saved with it; then when it is recalled, the instrument switches to that Mode.

After the save completes, the corresponding register menu key annotation is updated with the date and time and the message "Register <register number> saved" is displayed.

Key Path	Save, State
Mode	All
Example	*SAV 1
Range	1-16 from front panel, 1-128 from SCPI
Readback	Date and time with seconds resolution are displayed on the key OR A custom name of up to 30 characters entered using the Edit Register Names key OR “(empty)” if no prior save operation has been performed to this register.
Initial S/W Revision	Prior to A.02.00
Modified at S/W Revision	A.11.00

## Data (Export)

Exporting a data file stores data from the current measurement to mass storage files. The Export Menu only contains data types that are supported by the current measurement.

Since the commonly exported data files are in .csv format, the data can be edited by you prior to importing. This allows you to export a data file, manipulate the data in Excel (the most common PC Application for manipulating .csv files) and then import it.

Selecting an Export Data menu key will not actually cause the exporting to occur, since the analyzer still needs to know where you wish to save the data. Pressing the Save As key in this menu brings up the Save As dialog and Save As menu that allows you to specify the destination file and directory. Once a filename has been selected or entered in the Open menu, the export will occur as soon as the Save key is pressed.

Key Path	Save
Mode	All
Notes	The menu is built from whatever data types are available for the mode. So the key locations in the sub menu will vary.  No SCPI command directly controls the Data Type that this key controls. The Data Type is included in the MMEM:STORe commands.
Dependencies	If a file type is not used by a certain measurement, that type is grayed out for that measurement. The key for a file type will not show at all if there are no measurements in the Mode that support it.
Preset	Is not affected by a Preset or shutdown, but is reset during Restore Mode Defaults
Readback	The data type that is currently selected
Initial S/W Revision	Prior to A.02.00

## Measurement Results

Pressing this key selects Meas Results as the data type to be exported.

The Meas Results file contains measurement result sets, plus information describing the current state of the analyzer, as detailed in ["Meas Results File Definition" on page 1522](#) and ["Meas Results File Example" on page 1524](#) below.

Key Path	Save, Data
Remote Command	:MMEMory:STORe:RESults <string>
Example	:MMEM:STOR:RES "MeasR_0000.csv"
Notes	<p>If the save is initiated via SCPI and the file already exists, the file will be overwritten.</p> <p>The SCPI command exports Spurious Emissions measurement results to the file specified as the parameter in the current path. The default path is My Documents\<current mode&gt;\data\spur\results.<="" p=""><p>Using the C: drive is strongly discouraged, since it runs the risk of being overwritten during an instrument software upgrade.</p><p>The SCPI parameter is a quoted string that specifies the filename. Both single and double quotes are supported for any filename parameter over SCPI.</p></current></p>
Dependencies	The current active measurement must be the Spurious Emissions measurement to use this command.
Status Bits/OPC dependencies	Sequential – waits for the previous measurement to complete
Initial S/W Revision	Prior to A.02.00

## Meas Results File Definition

The content of a Meas Results File is defined in this section.

The first lines in the file consist of identification and instrument configuration details, as follows.

- File ID string, which is "MeasResult"
- Measurement ID following Mode ID, which is "SA:SPUR" for example.
- Firmware rev and model number
- Option string
- Abs Start Limit
- Abs Stop Limit
- Abs Stop Limit Mode
- Auto Scaling
- Auto Sweep Time Rules
- Automatic Trigger Time
- Automatic Trigger Time State

- Average Mode
- Average Number
- Average State
- Detector 1
- Detector 2
- Electrical Atten
- Electrical Atten State
- External Array Trigger Delay
- External Array Trigger Delay State
- External Array Trigger Level
- External Array Trigger Slope
- Filter Type
- IF Gain Auto
- IF Gain State
- Internal Preamp
- Internal Preamp Band
- Line Trigger Delay
- Line Trigger Delay State
- Line Trigger Slope
- Meas Type
- Mechanical Atten
- MechanicalAttenStepEnum
- Peak Excursn
- Periodic Timer Period
- Periodic Timer Sync Source
- Periodic Timer Trigger Delay
- Periodic Timer Trigger Delay State
- Pk Threshold
- Points
- Points Mode
- Range State

- Ref Value
- Res BW
- Res BW Mode
- RFBurst Trigger Delay
- RFBurst Trigger Delay State
- RFBurst Trigger Level Abs
- RFBurst Trigger Level Rel
- RFBurst Trigger Level Type
- RFBurst Trigger Slope
- Scale/Div
- Spurious Report Mode
- SpurRangeStartFrequencyArray
- SpurRangeStopFrequencyArray
- Sweep Time
- Sweep Time Mode
- Trigger Holdoff
- Trigger Holdoff State
- TriggerSource
- Video BW
- Video BW Mode

The data above is followed in the file by a line containing “MeasResult1” to “MeasResult42”. This line forms a header for each set of measurement results, which appear in subsequent lines. Each line of Measurement Results consists of 42 comma-separated values, from the MeasResult1 value to the MeasResult42 value.

The MeasResult1 set in the file corresponds to the data returned by MEAS/READ/FETCH:SPURious1; the MeasResult2 set corresponds to the data returned by MEAS/READ/FETCH:SPURious2, and so on.

The exported file is in CSV format, with a .csv extension.

### Meas Results File Example

When imported into Excel, a typical Meas Results file appears as shown in the example below.

NOTE: The following table omits the columns for MeasResult11 to MeasResult42, due to lack of space.

MeasResult	1	2	3	4	5	6	7	8	9	10
SA:SPUR										



A.10.53	N903 0A										
526 ALV ATP B1X B1Y B25 B40 BBA CR3 CRP DCF DDA DP2 DRD EA3 EDP EMC EP1 ERC ESC ESP EXM FSA LFE LNP MAT MPB NFE NUL P26 PFR PNC RTL RTS S40 SB1 SEC SM1 TVT YAS YAV	1										
Abs Start Limit	-50	-50	-50	-50	-50	-50	-50	-50	-50	-50	-50
Abs Stop Limit	-50	-50	-50	-50	-50	-50	-50	-50	-50	-50	-50
Abs Stop Limit Mode	TRUE	TRUE	TRUE	TRUE	TRUE	TRUE	TRUE	TRUE	TRUE	TRUE	TRUE
Auto Scaling	TRUE										
Auto Sweep Time Rules	Norm										
Automatic Trigger Time	0.1										
Automatic Trigger Time State	FALSE										
Average Mode	Exponential										
Average Number	10										
Average State	FALSE										
Detector 1	Peak	Peak	Peak	Peak	Peak	Peak	Peak	Peak	Peak	Peak	Peak
Detector 2	Off	Off	Off	Off	Off	Off	Off	Off	Off	Off	Off
Electrical Atten	0										
Electrical Atten State	FALSE										
External Array Trigger Delay	1.00 E-06	1.00 E-06									
External Array Trigger Delay State	FALSE	FALSE									
External Array Trigger Level	1.2	1.2									
External Array Trigger Slope	Positive	Positive									

Filter Type	Gaussian	Gaussian	Gaussian	Gaussian	Gaussian	Gaussian	Gaussian	Gaussian	Gaussian	Gaussian
IF Gain Auto	FALSE	FALSE	FALSE	FALSE	FALSE	FALSE	FALSE	FALSE	FALSE	FALSE
IF Gain State	FALSE	FALSE	FALSE	FALSE	FALSE	FALSE	FALSE	FALSE	FALSE	FALSE
Internal Preamp	FALSE									
Internal Preamp Band	Low									
Line Trigger Delay	1.00E-06									
Line Trigger Delay State	FALSE									
Line Trigger Slope	Positive									
Meas Type	Examine									
Mechanical Atten	10									
MechanicalAtten StepEnum	S2dB									
Peak Excursn	6	6	6	6	6	6	6	6	6	6
Periodic Timer Period	0.02									
Periodic Timer Sync Source	None									
Periodic Timer Trigger Delay	1.00E-06									
Periodic Timer Trigger Delay State	FALSE									
Pk Threshold	-90	-90	-90	-90	-90	-90	-90	-90	-90	-90
Points	601	601	601	601	601	601	601	601	601	601
Points Mode	FALSE	FALSE	FALSE	FALSE	FALSE	FALSE	FALSE	FALSE	FALSE	FALSE
Range State	TRUE	TRUE	TRUE	TRUE	TRUE	FALSE	FALSE	FALSE	FALSE	FALSE
Ref Value	0									
Res BW	1200000	510000	100000	100000	400000	300000	300000	300000	300000	300000
Res BW Mode	FALSE	FALSE	FALSE	FALSE	FALSE	TRUE	TRUE	TRUE	TRUE	TRUE
RFBurst Trigger Delay	1.00E-06									
RFBurst Trigger Delay State	FALSE									
RFBurst Trigger	-20									

Level Abs										
RFBurst Trigger Level Rel	-6									
RFBurst Trigger Level Type	Absolute									
RFBurst Trigger Slope	Positive									
Scale/Div	10									
Spurious Report Mode	All									
SpurRangeStartFrequencyArray	1.92E+09	1.89E+09	2.1E+09	2.18E+09	8E+08	1.5E+09	1.5E+09	1.5E+09	1.5E+09	1.5E+09
SpurRangeStopFrequencyArray	1.98E+09	1.92E+09	2.1E+09	2.18E+09	1E+09	2.5E+09	2.5E+09	2.5E+09	2.5E+09	2.5E+09
Sweep Time	0.001	0.001	0.0012	0.00396	0.001	0.001	0.001	0.001	0.001	0.001
Sweep Time Mode	TRUE	TRUE	TRUE	TRUE	TRUE	TRUE	TRUE	TRUE	TRUE	TRUE
Trigger Holdoff	0.1									
Trigger Holdoff State	FALSE									
TriggerSource	Free									
Video BW	120000	51000	10000	10000	390000	300000	300000	300000	300000	300000
Video BW Mode	TRUE	TRUE	TRUE	TRUE	TRUE	TRUE	TRUE	TRUE	TRUE	TRUE
MeasResult1	MeasResult2	MeasResult3	MeasResult4	MeasResult5	MeasResult6	MeasResult7	MeasResult8	MeasResult9	MeasResult10	MeasResult11
19	-80.27209	-80.87862	-90.94577	-89.27086	-76.77856	9.91E+37	9.91E+37	9.91E+37	9.91E+37	9.91E+37
1	-78.28497	-80.93996	-91.00485	-90.56063	-76.33968					

### Capture Buffer

Capture Buffer functionality is not available for all measurements. The captured data is raw data which is not processed.

Key Path	Save, Data
Mode	CDMA1XEV

Example	MMEM:STOR:CAPT "MyCaptureData.bin" This stores the capture data in the file MyCaptureData.bin in the default directory.
Dependencies	In case the capture buffer data is not available from the selected measurement, the key will be grayed out.
Initial S/W Revision	A.11.00

### Save As . . .

When you press “Save As”, the analyzer brings up a Windows dialog and a menu entitled “**Save As.**” This menu allows you to navigate to the various fields in the Windows dialog without using a keyboard or mouse. The Tab and Arrow keys can also be used for dialog navigation.

See "[To File . . .](#)" on page 2897 in Save, State for a full description of this dialog and menu.

The default path for saving files is:

For all of the Trace Data Files:

My Documents\<<mode name>\data\traces

For all of the Limit Data Files:

My Documents\<<mode name>\data\limits

For all of the Measurement Results Data Files:

My Documents\<<mode name>\data\<<measurement name>\results

For all of the Capture Buffer Data Files:

My Documents\<<mode name>\data\captureBuffer

Key Path	Save, Data
Mode	All
Notes	The key location is mode-dependent and will vary. Brings up the Save As dialog for saving a <mode specific> Save Type. The save is performed immediately and does not wait until the measurement is complete.
Initial S/W Revision	Prior to A.02.00

### Screen Image

Pressing Screen Image accesses a menu of functions that enable you to specify a format and location for the saved screen image. It brings up a menu that allows you to specify the color scheme of the Screen Image (Themes) or navigate to the Save As dialog to perform the actual save.

Screen Image files contain an exact representation of the analyzer display. They cannot be loaded back onto the analyzer, but they can be loaded into your PC for use in many popular applications.

The image to be saved is actually captured when the Save front panel key is pressed, and kept in temporary storage to be used if you ask for a Screen Image save. When the Screen Image key is pressed, a "thumbnail" of the captured image is displayed, as shown below:

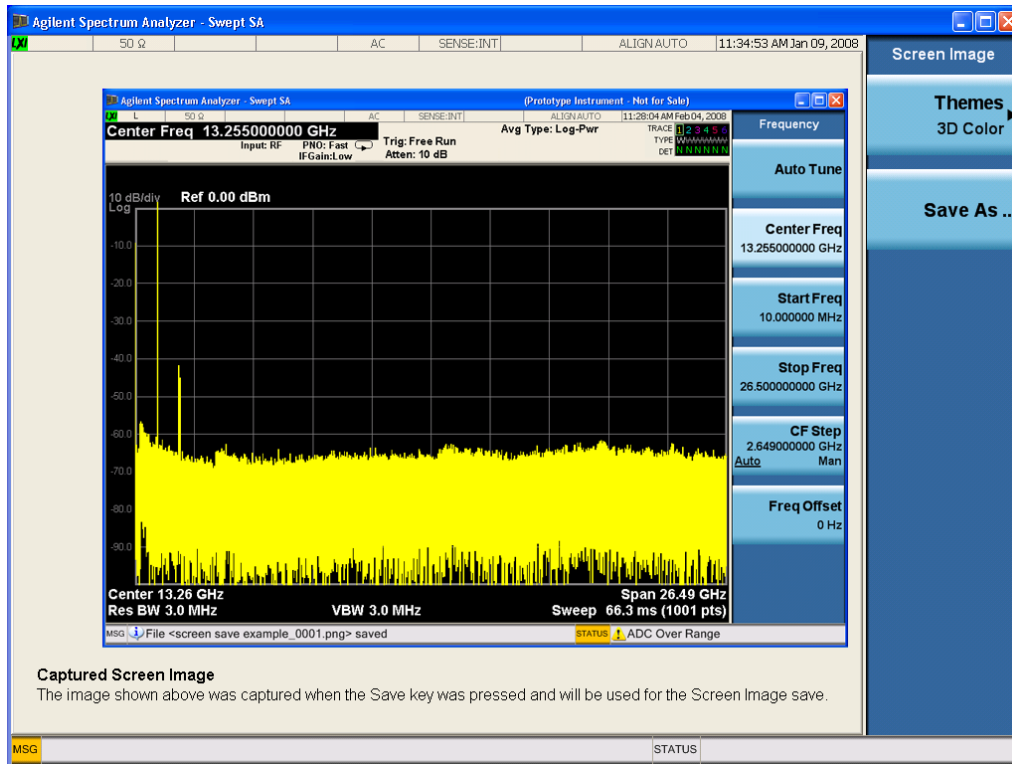

When you continue on into the Save As menu and complete the Screen Image save, the image depicted in the thumbnail is the one that gets saved, showing the menus that were on the screen before going into the Save menu. The save is performed immediately and does not wait until the measurement is complete.

After you have completed the save, the Quick Save front-panel key lets you quickly repeat the last save performed, using an auto-named file, with the current screen data.

**NOTE** For versions previous to A.01.55, if you initiate a screen image save by navigating through the Save menus, the image that is saved will contain the Save menu softkeys, not the menus and the active function that were on the screen when you first pressed the Save front panel key.

Key Path	Save
Mode	All
Remote Command	:MMEMory:STORe:SCReen <filename>
Example	:MMEM:STOR:SCR "myScreen.png" This stores the current screen image in the file MyScreenFile.png in the default directory.
Initial S/W Revision	Prior to A.02.00

## Themes

Accesses a menu of functions that enable you to choose the theme to be used when saving the screen image.

The **Themes** option is the same as the **Themes** option under the **Display** and **Page Setup** dialogs. It allows you to choose between themes to be used when saving the screen image.

<b>Key Path</b>	Save, Screen Image
<b>Remote Command</b>	:MMEMory:STORe:SCReen:THEMe TDColor   TDMonochrome   FCOLor   FMONochrome  :MMEMory:STORe:SCReen:THEMe?
<b>Example</b>	:MMEM:STOR:SCR:THEM TDM
<b>Preset</b>	3D Color; Is not part of Preset, but is reset by Restore Misc Defaults or Restore System Defaults All and survives subsequent running of the modes.
<b>Readback</b>	3D Color   3D Mono   Flat Color   Flat Mono
<b>Backwards Compatibility Notes</b>	In ESA and PSA we offer the choice of "Reverse Bitmap" or "Reverse Metafile" when saving screen images. This is much like the "Flat Color" theme available in X-Series. Also, if you selected Reverse Bitmap AND a black & white screen image, that would be much like "Flat Monochrome". In other words, each of the X-Series themes has a similar screen image type in ESA/PSA. But they are not identical.
<b>Initial S/W Revision</b>	Prior to A.02.00

### 3D Color

Selects a standard color theme with each object filled, shaded and colored as designed.

<b>Key Path</b>	Save, Screen Image, Themes
<b>Example</b>	MMEM:STOR:SCR:THEM TDC
<b>Readback</b>	3D Color
<b>Initial S/W Revision</b>	Prior to A.02.00

### 3D Monochrome

Selects a format that is like 3D color but shades of gray are used instead of colors.

<b>Key Path</b>	Save, Screen Image, Themes
<b>Example</b>	MMEM:STOR:SCR:THEM TDM
<b>Readback</b>	3D Mono
<b>Initial S/W Revision</b>	Prior to A.02.00

### Flat Color

Selects a format that is best when the screen is to be printed on an ink printer.

Key Path	Save, Screen Image, Themes
<b>Example</b>	MMEM:STOR:SCR:THEM FCOL
Readback	Flat Color
Initial S/W Revision	Prior to A.02.00

### Flat Monochrome

Selects a format that is like Flat Color. But only black is used (no colors, not even gray), and no fill.

Key Path	Save, Screen Image, Themes
<b>Example</b>	MMEM:STOR:SCR:THEM FMON
Readback	Flat Mono
Initial S/W Revision	Prior to A.02.00

### Save As...

When you press "Save As", the analyzer brings up a Windows dialog and a menu entitled "**Save As.**" This menu allows you to navigate to the various fields in the Windows dialog without using a keyboard or mouse. The Tab and Arrow keys can also be used for dialog navigation.

See "[To File . . .](#)" on page 2897 in Save, State for a full description of this dialog and menu.

The default path for Screen Images is

My Documents\`<mode name>`\screen.

where `<mode name>` is the parameter used to select the mode with the INST:SEL command (for example, SA for the Spectrum Analyzer).

Key Path	Save, Screen Image
Notes	Brings up Save As dialog for saving a Screen Image Save Type
Initial S/W Revision	Prior to A.02.00

### Mass Storage Catalog (Remote Command Only)

Key path	SCPI Only
<b>Remote Command</b>	:MMEMory:CATalog? [ <code>&lt;directory_name&gt;</code> ]
Notes	<p>The string must be a valid logical path.</p> <p>Queries disk usage information (drive capacity, free space available) and obtains a list of files and directories in a specified directory in the following format:</p> <p><code>&lt;numeric_value&gt;,&lt;numeric_value&gt;,{&lt;file_entry&gt;}</code></p> <p>It returns two numeric parameters and as many strings as there are files and directories. The first</p>

parameter indicates the total amount of storage currently used in bytes. The second parameter indicates the total amount of storage available, also in bytes. The <file\_entry> is a string. Each <file\_entry> indicates the name, type, and size of one file in the directory list:

<file\_name>,<file\_type>,<file\_size>

As the windows file system has an extension that indicates file type, <file\_type> is always empty. <file\_size> provides the size of the file in bytes. For directories, <file\_entry> is surrounded by square brackets and both <file\_type> and <file\_size> are empty

---

Initial S/W Revision      Prior to A.02.00

---

### Mass Storage Change Directory (Remote Command Only)

---

Key path                      SCPI Only

**Remote Command**        :MMEMory:CDIRectory [<directory\_name>]  
                                 :MMEMory:CDIRectory?

**Notes**                      The string must be a valid logical path.  
  
Changes the default directory for a mass memory file system. The <directory\_name> parameter is a string. If no parameter is specified, the directory is set to the \*RST value.  
  
At \*RST, this value is set to the default user data storage area, that is defined as System.Environment.SpecialFolder.Personal.  
  
Query returns full path of the default directory.

---

Initial S/W Revision      Prior to A.02.00

---

### Mass Storage Copy (Remote Command Only)

---

Key path                      SCPI Only

**Remote Command**        :MMEMory:COPY <string>,<string>[,<string>,<string>]

**Notes**                      The string must be a valid logical path.  
  
Copies an existing file to a new file or an existing directory to a new directory.  
  
Two forms of parameters are allowed. The first form has two parameters. In this form, the first parameter specifies the source, and the second parameter specifies the destination.  
  
The second form has four parameters. In this form, the first and third parameters specify the source. The second and fourth parameters specify the directories. The first pair of parameters specifies the source. The second pair specifies the destination. An error is generated if the source doesn't exist or the destination file already exists.  
  
This command will generate an "access denied" error if the destination is a restricted folder (e.g., C:\Windows) and the current user does not have Power User or Administrator privileges.

### Mass Storage Device Copy (Remote Command Only)

This command transfers data to/from a file and a peripheral device.



Key path	SCPI Only
<b>Remote Command</b>	:MMEMory:COpy:DEvice <source_string>,<dest_string>
Notes	<p>The strings must be a valid logical path or a valid device keyword. If the dest_string is a device keyword, the data is copied from the source file to the device. If the source_string is a device keyword, the data is copied to the source file from the device.</p> <p>Valid device keywords are:            SNS (smart noise source)</p> <p>An error is generated if the file or device is not found.</p>

### Mass Storage Delete (Remote Command Only)

Key path	SCPI Only
<b>Remote Command</b>	:MMEMory:DElete <file_name>[,<directory_name>]
Notes	<p>The string must be a valid logical path.</p> <p>Removes a file from the specified directory. The &lt;file_name&gt; parameter specifies the file name to be removed. This command will generate an “access denied” error if the file is in a restricted folder (e.g., C:\Windows) and the current user does not have Power User or Administrator privileges.</p>
Initial S/W Revision	Prior to A.02.00

### Mass Storage Data (Remote Command Only)

Creates a file containing the specified data OR queries the data from an existing file.

Key path	SCPI Only
<b>Remote Command</b>	:MMEMory:DATA <file_name>, <data> :MMEMory:DATA? <file_name>
Notes	<p>The string must be a valid logical path.</p> <p>The command form is MMEMory:DATA &lt;file_name&gt;,&lt;data&gt;. It loads &lt;data&gt; into the file &lt;file_name&gt;. &lt;data&gt; is in 488.2 block format. &lt;file_name&gt; is string data.</p> <p>The query form is MMEMory:DATA? &lt;file_name&gt; with the response being the associated &lt;data&gt; in block format.</p>
Initial S/W Revision	Prior to A.02.00

### Mass Storage Make Directory (Remote Command Only)

Key path	SCPI Only
<b>Remote Command</b>	:MMEMory:MDIRectory <directory_name>
Notes	<p>The string must be a valid logical path.</p> <p>Creates a new directory. The &lt;directory_name&gt; parameter specifies the name to be created.</p>

---

	This command will generate an “access denied” error if the new directory would be in a restricted folder (e.g., C:\Windows) and the current user does not have Power User or Administrator privileges.
Initial S/W Revision	Prior to A.02.00

---

### Mass Storage Move (Remote Command Only)

---

Key path	SCPI Only
<b>Remote Command</b>	:MMEMory:MOVE <string>,<string>[,<string>,<string>]
Notes	<p>The string must be a valid logical path.</p> <p>Moves an existing file to a new file or an existing directory to a new directory.</p> <p>Two forms of parameters are allowed. The first form has two parameters. In this form, the first parameter specifies the source, and the second parameter specifies the destination.</p> <p>The second form has four parameters. In this form, the first and third parameters specify the source. The second and fourth parameters specify the directories. The first pair of parameters specifies the source. The second pair specifies the destination. An error is generated if the source doesn't exist or the destination file already exists.</p> <p>This command will generate an “access denied” error if the destination is a restricted folder (e.g., C:\Windows) and the current user does not have Power User or Administrator privileges.</p>
Initial S/W Revision	Prior to A.02.00

---

### Mass Storage Remove Directory (Remote Command Only)

---

Key path	SCPI Only
<b>Remote Command</b>	:MMEMory:RDIRECTory <directory_name>
Notes	<p>The string must be a valid logical path.</p> <p>Removes a directory. The &lt;directory_name&gt; parameter specifies the directory name to be removed. All files and directories under the specified directory shall also be removed.</p> <p>This command will generate an “access denied” error if the folder is a restricted folder (e.g., C:\Windows) or is in a restricted folder and the current user does not have Power User or Administrator privileges.</p>
Initial S/W Revision	Prior to A.02.00

---

## Single (Single Measurement/Sweep)

Sets the analyzer for Single measurement operation. The single/continuous state is Meas Global, so the setting will affect all the measurements. If you are Paused, pressing Single does a Resume.

See "[More Information](#)" on page 1535

Key Path	Front-panel key
Example	:INIT:CONT OFF
Notes	See Cont key description.
Backwards Compatibility Notes	<p>For Spectrum Analysis mode in ESA and PSA, the Single hardkey and the INITiate:IMM switched from continuous measurement to single measurement and restarted sweeps and averages (displayed average count reset to 1), but did not restart Max Hold and Min Hold. In the X-Series, the Single hardkey and the INITiate:IMM command initiate a sweep/ measurement/ average sequence/hold sequence including MaxHold and MinHold.</p> <p>For Spectrum Analysis mode in ESA and PSA, the Single hardkey restarted the sweep regardless of whether or not you were in an active sweep or sweep sequence. In the X-Series, Restart does this but Single only restarts the sweep or sweep sequence if you are in the idle state.</p> <p>INIT[:IMM] in ESA &amp; PSA Spectrum Analysis Mode does an implied ABORT. In some other PSA Modes, INIT[:IMM] is ignored if not in the idle state. . The X-Series follows the ESA/PSA SA Mode model, which may cause some Modes to have compatibility problems.</p>
Initial S/W Revision	Prior to A.02.00

### More Information

See "[Restart](#)" on page 2894 for details on the INIT:IMMEDIATE (Restart) function.

If you are already in single sweep, the INIT:CONT OFF command has no effect.

If you are already in Single Sweep, then pressing the Single key in the middle of a sweep does not restart the sweep or sequence. Similarly, pressing the Single key does not restart the sweep or sequence if the sweep is not in the idle state (for example, if you are taking a very slow sweep, or the analyzer is waiting for a trigger). Instead, it results in a message. "Already in Single, press Restart to initiate a new sweep or sequence". Even though pressing the Single key in the middle of a sweep does not restart the sweep, sending INIT:IMMEDIATE does reset it.

To take one more sweep without resetting the average count, increment the average count by 1, by pressing the step up key while **Average/Hold Number** is the active function, or sending the remote command CALC:AVER:TCON UP.

## Source

There is no Source control functionality for this measurement. When this key is pressed, the screen either displays a blank menu, or the previously-selected menu remains unchanged.

---

Key Path	Front-panel key
----------	-----------------

---

## Span X Scale

Span X Scale is unavailable in the Spurious Emissions measurement. When pressed, this key displays a blank menu.

---

Key Path	Front-panel key
Initial S/W Revision	Prior to A.02.00

---

## Sweep/Control

Accesses the Sweep/Control menu keys used to set up and control the sweep time and source.

Key Path	Front-panel key
Initial S/W Revision	Prior to A.02.00

### Sweep Setup

Sets the sweep functions that control the sweep state and time.

Key Path	Sweep/Control
Initial S/W Revision	Prior to A.02.00

### Auto Sweep Time Rules

Switches the analyzer between normal and accuracy sweep states. Setting Auto Sweep Time to Accy will result in slower sweep times, usually about three times as long, but better amplitude accuracy for CW signals. The instrument amplitude accuracy specifications only apply when Auto Sweep Time is set to Accy.

Additional amplitude errors which occur when Auto Sweep Time is set to Norm are usually well under 0.1 dB, though this is not guaranteed. Because of the faster sweep times and still low errors, Norm is the preferred setting of Auto Sweep Time. Auto Sweep Time is set to Norm on a Preset or Auto Couple. This means that in the Preset or Auto Coupled state, instrument amplitude accuracy specifications do not apply.

Key Path	Sweep/Control, Sweep Setup
Mode	SA, WCDMA, C2K, WIMAX OFDMA, TD-SCDMA, 1xEV-DO, DVB-T/H, LTE, LTETDD, WLAN, MSR, LTEAFDD, LTEATDD
Remote Command	[ :SENSe ] : SPURious : SWEep : TIME : AUTO : RULes NORMal   ACCuracy [ :SENSe ] : SPURious : SWEep : TIME : AUTO : RULes ?
Example	SPUR:SWE:TIME:AUTO:RUL ACC SPUR:SWE:TIME:AUTO:RUL ?
Notes	In Zero Span, this key is irrelevant and inaccessible (because the whole Sweep Setup menu is grayed out), however, Sweep Setup settings can be changed remotely with no error indication.
Preset	NORMal
State Saved	Saved in instrument state.
Range	Norm Accy
Initial S/W Revision	Prior to A.02.00
Modified at S/W Revision	A.03.00

## Sweep Type

Sets the sweep type of the spurious measurement to either Auto or Swept. When in Auto, the selections of swept type of ranges are governed by the Best Speed Sweep Type Rule, and FFT analysis might be chosen for some ranges if it speeds up the measurement.

Key Path	Sweep/Control, Sweep Setup
Mode	SA, WCDMA, C2K, WIMAX OFDMA, TD-SCDMA, 1xEV-DO, DVB-T/H, LTE, LTETDD, WLAN, MSR, LTEAFDD, LTEATDD
Remote Command	[ :SENSe ] :SPURious [ :RANGe ] :ALL :SWEep :TYPE :AUTO OFF   ON   0   1 [ :SENSe ] :SPURious [ :RANGe ] :ALL :SWEep :TYPE :AUTO?
Example	SPUR:ALL:SWE:TYPE:AUTO 1 SPUR:ALL:SWE:TYPE:AUTO?
Dependencies	This parameter is available only when option N9060A-7FP is installed.
Preset	ON
State Saved	Saved in instrument state.
Range	Auto Swept
Initial S/W Revision	A.11.00

## Pause

Pauses a measurement after the current data acquisition is complete.

When paused, the label on the key changes to Resume. Pressing Resume resumes the measurement at the point it was at when paused.

See "[Pause/Resume](#)" on page 2925 for more information.

Key Path	Sweep/Control
Initial S/W Revision	Prior to A.02.00

## Gate

Accesses a menu that enables you to control the gating function. The Gate functionality is used to view signals best viewed by qualifying them with other events.

Gate setup parameters are the same for all measurements – they do not change as you change measurements. Settings like these are called “Meas Global” and are unaffected by Meas Preset.

Note that Sweep Time autocoupling rules and annotation are changed by Gate being on.

Key Path	Sweep/Control
Scope	Meas Global
Readback	

The state and method of Gate, as [Off, LO] or [On, Video]. Note that for measurements that only support gated LO, the method is nonetheless read back, but always as LO.

Initial S/W Revision      Prior to A.02.00

## Gate On/Off

Turns the gate function on and off.

When the Gate Function is on, the selected Gate Method is used along with the gate settings and the signal at the gate source to control the sweep and video system with the gate signal. Not all measurements allow every type of Gate Methods.

When Gate is on, the annunciation in the measurement bar reflects that it is on and what method is used, as seen in the following "Gate: LO" annunciator graphic.

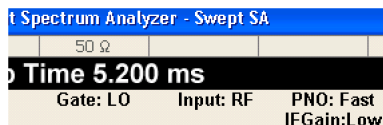

Key Path      Sweep/Control, Gate

Remote Command      [:SENSe]:SWEep:EGATe[:STATe] OFF|ON|0|1  
[:SENSe]:SWEep:EGATe[:STATe] ?

Example      SWE:EGAT ON  
SWE:EGAT?

### Dependencies

The function is unavailable (grayed out) and Off when:

- Gate Method is LO or Video and FFT Sweep Type is manually selected.
- Gate Method is FFT and Swept Sweep Type is manually selected.
- Marker Count is ON.

The following are unavailable whenever Gate is on:

- FFT under Sweep Type when Method=LO or Video or Swept under Sweep Type when Method=FFT
- Marker Count

While Gate is on, the Auto Rules for Sweep Type are modified so that the choice agrees with the Gate Method: i.e., FFT for Method = FFT and Swept for Method = LO or Video.

The Gate softkey and all SCPI under the [:SENSe]:SWEep:EGATe SCPI node are grayed out when Source Mode is Tracking with an external source. This is because the Gate circuitry is used to sync the external source. If the Tracking Source is turned on, the Gate is turned off.

When in the ACP measurement:

- When Meas Method is RBW or FAST, this function is unavailable and the key is grayed out.
- Whenever Gate is on, Meas Method, RBW or FAST is unavailable and keys for those are grayed out.
- When Gate is on, Offset Res BW and Offset Video BW are ignored (if you set these values) and the



	measurement works as if all Offset Res BW and all Offset Video BW are coupled with the Res BW and the Video BW under the BW menu. When Gate is on, the Offset BW key in the Offset/Limit menu is grayed out.
Preset	Off LTETDD: On
State Saved	Saved in instrument state
Range	On Off
<b>Backwards Compatibility SCPI</b>	[:SENSe]:SWEep:TIME:GATE[:STATe] ESA compatibility
Backwards Compatibility Notes	In ESA, Trig Delay (On) and Gate (On) could not be active at the same time.. This dependency does not exist in PSA or in the X-Series.
Initial S/W Revision	Prior to A.02.00

## Gate View On/Off

Turning on Gate View in the Swept SA measurement provides a single-window gate view display..

Turning on Gate View in other measurements shows the split-screen Gate View. In these measurements, when the Gate View is on, the regular view of the current measurement traces and results are reduced vertically to about 70% of the regular height. The Zero Span window, showing the positions of the Gate, is shown between the Measurement Bar and the reduced measurement window. By reducing the height of the measurement window, some of the annotation on the Data Display may not fit and is not shown.

Key Path	Sweep/Control, Gate
<b>Remote Command</b>	[:SENSe]:SWEep:EGATe:VIEW ON OFF 1 0 [:SENSe]:SWEep:EGATe:VIEW?
<b>Example</b>	SWE:EGAT:VIEW ON turns on the gate view.
Dependencies	In the Swept SA measurement: In Gate View, the regular Sweep Time key is grayed out . When pressed, the grayed out key puts up the informational message "Use Gate View Sweep Time in the Gate menu." In the other measurements: When you turn Gate View on, the lower window takes on the current state of the instrument. Upon leaving Gate View, the instrument takes on the state of the lower window. When you turn Gate View on, the upper window Sweep Time is set to the gate view sweep time.
Couplings	These couplings apply to the Swept SA measurement: <ul style="list-style-type: none"> <li>• When Gate View is turned on, the instrument is set to Zero Span.</li> <li>• Gate View automatically turns off whenever a Span other than Zero is selected.</li> <li>• Gate View automatically turns off if you press the Last Span key while in Gate View, and the instrument returns to the Span it was in before entering Gate View (even if that is Zero Span).</li> <li>• When Gate View is turned on, the sweep time used is the gate view sweep time. This is set according to the rules in section <a href="#">"Gate View Setup " on page 2725</a></li> <li>• When Gate View is turned off, Sweep Time is set to the normal Swept SA measurement sweep time.</li> </ul>

- If Gate View is on and Gate is off, then turning on Gate turns off Gate View.

Preset	OFF
State Saved	Saved in instrument state
Range	On Off
Initial S/W Revision	Prior to A.02.00

A sample of the Gate View screen in the Swept SA measurement is shown in the following graphic :

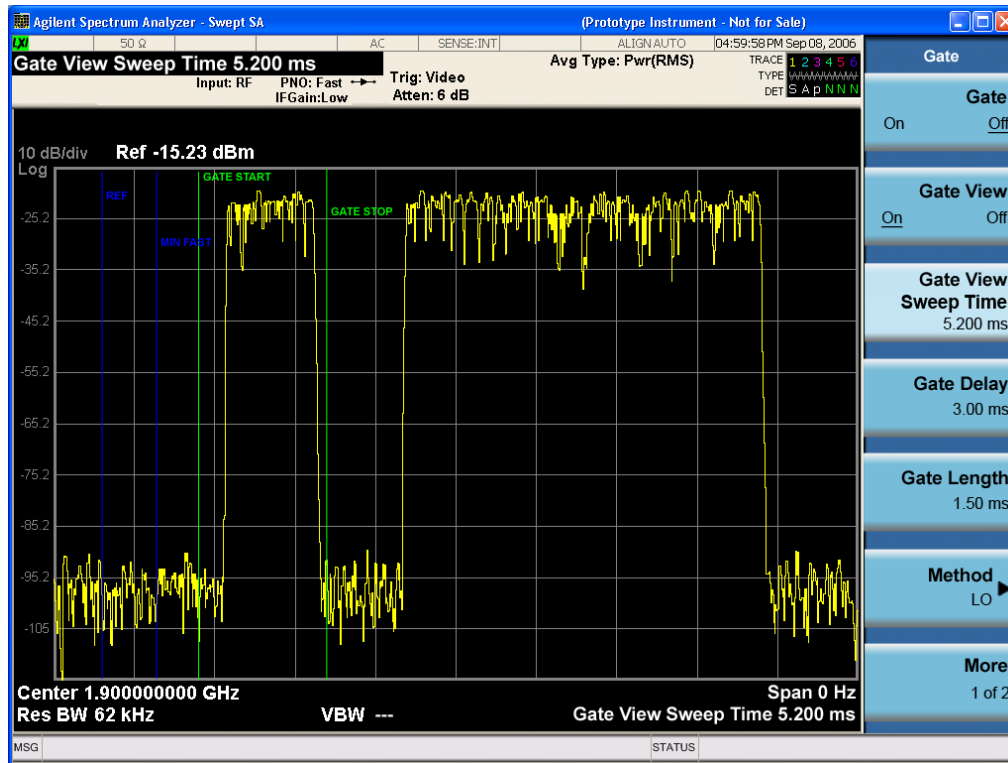

A sample of the Gate View screen in other measurements is shown in the following graphic . This example is for the ACP measurement:

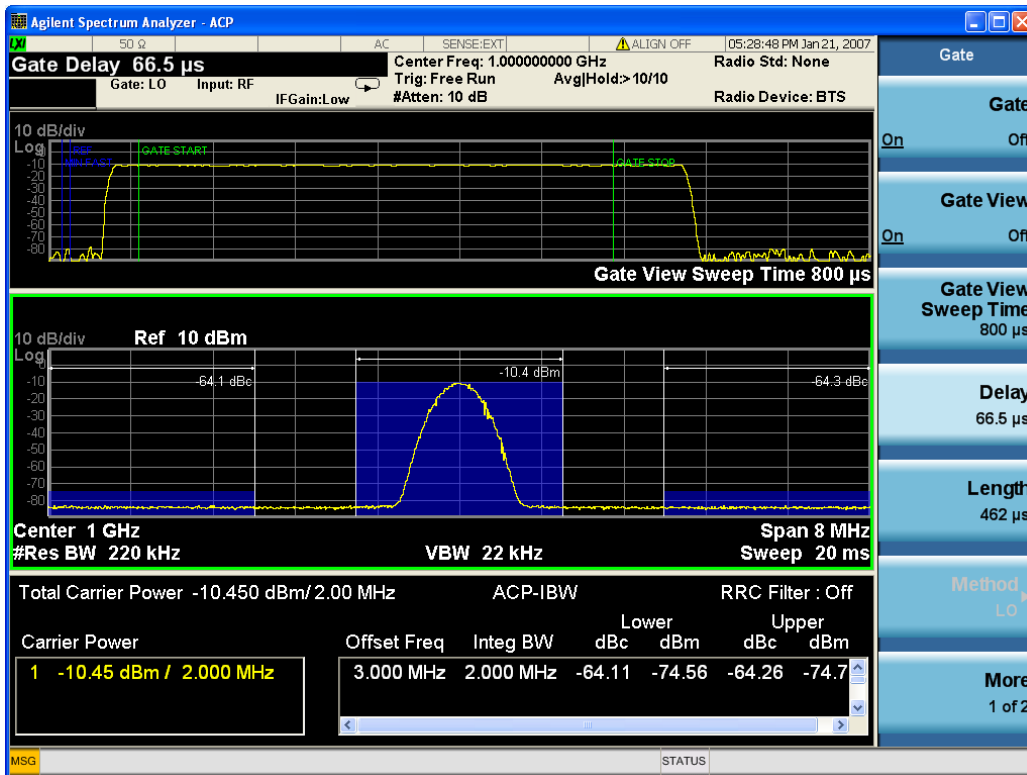

Turning Gate View off returns the analyzer to the Normal measurement view.

In the Swept SA, the normal measurement view is the single-window Swept SA view. When returning to this view, the Swept SA measurement returns to the Span it was in before entering **Gate View** (even if that is Zero Span).

The **Gate View** window is triggered from the Gate Source, with zero trigger delay. Also, when updating the **Gate View** window, the Gate itself must not operate. So it is internally shut off while the gate view window is being updated. For the Swept SA measurement, this means that the Gate is internally shut off whenever the gate view window is displayed. The measurement bar and softkeys continue to show the Trigger source for the main sweep window and give no indication that the Gate is shut off or that the Gate View window is triggered from the Gate Source.

When in **Gate View**, vertical lines are displayed in the Gate View window as follows:

- Green lines are displayed at the gate edges as follows: in Edge Gate, a line is shown for Delay and one for the end of the Gate period, defined by Length. In Level Gate a line is shown only for Delay. You can adjust the position of the green lines by adjusting the gate length and the gate delay. These lines update in the Gate View window as the active function changes, even if the window is not being updated. In Gated LO and Gated Video, these lines are positioned relative to the delay reference line (not relative to 0 time). In Gated FFT, their location is relative to the left edge of the screen.
- A blue line is displayed showing the delay reference, that is, the reference point for the Gate Delay within the Zero Span window. The blue line represents where (in time) the effective location of the gate start would be if the gate were programmed to zero delay.

- The second blue line is labeled "MIN FAST" as shown in the figure above because it represents the minimum Gate Delay for fast Gated LO operation. This line is only displayed in Gated LO. You cannot scroll (knob) or decrement (down key) the Gate Delay to less than that represented by the position of this line, it can only be set below this position manually, although once there it can be moved freely with the knob while below the line.
- A yellow line in the Gated Video case only, is displayed at Blength, where Blength is the display point (bucket) length for the swept trace, which is given by the sweep time for that trace divided by number of Points – 1. So it is referenced to 0 time, not to the delay reference. This line is labeled NEXT PT (it is not shown in the figure above because the figure above is for Gated LO).
- The yellow line represents the edge of a display point (bucket). Normally in Gated Video, the bucket length must be selected so that it exceeds the off time of the burst. There is another way to use the analyzer in Gated Video measurements, and that is to set the bucket width much shorter than the off time of the burst. Then use the Max Hold trace function to fill in "missing" buckets more slowly. This allows you to see some of the patterns of the Gated Video results earlier, though seeing a completely filled-in spectrum later.

## Gate View Setup

Accesses a menu that enables you to setup parameters relevant to the Gate View

Key Path	Sweep/Control, Gate
Scope	Meas Global
Initial S/W Revision	A.10.00

## Gate View Sweep Time

Controls the sweep time in the Gate View window. To provide an optimal view of the gate signal, the analyzer initializes Gate View Sweep Time based on the current settings of Gate Delay and Gate Length.

Key Path	Sweep/Control, Gate, Gate View Setup
Remote Command	[ :SENSe ] :SWEep:EGATe:TIME <time> [ :SENSe ] :SWEep:EGATe:TIME?
Example	SWE:EGAT:TIME 500 ms
Dependencies	Gate View Sweep Time is initialized: <ul style="list-style-type: none"> <li>• On Preset (after initializing delay and length).</li> <li>• Every time the Gate Method is set/changed.</li> </ul> <p>Additionally, in the Swept SA measurement, whenever you do a Preset, or leave Gate View, the analyzer remembers the Gate Delay and Gate Length settings. Then, when returning to Gate View, if the current Gate Delay and/or Gate Length do not match the remembered values Gate View Sweep Time is re-initialized.</p> <ol style="list-style-type: none"> <li>1. Compute the location of the "gate stop" line, which you know is at time <math>t = t_{min} + GateDelay + GateLength</math>.</li> </ol>
Preset	519.3 $\mu$ s

	WiMAX OFDMA: 5 ms GSM/EDGE: 1 ms
State Saved	Saved in instrument state
Max	6000 s
Initial S/W Revision	Prior to A.02.00

### Gate View Start Time

Controls the time at the left edge of the Gate View.

Key Path	Sweep/Control, Gate, Gate View Setup
<b>Remote Command</b>	[ :SENSe ] :SWEep:EGATe:VIEW:STARt <time> [ :SENSe ] :SWEep:EGATe:VIEW:STARt?
<b>Example</b>	SWE:EGAT:VIEW:STAR 10ms
Notes	Units of time are required or no units; otherwise an invalid suffix error message will be generated. See error -131.
Preset	0 ms
State Saved	Saved in instrument state
Min	0
Max	500 ms
Initial S/W Revision	A.10.00

### Gate Delay

Controls the length of time from the time the gate condition goes True until the gate is turned on.

Key Path	Sweep/Control, Gate
<b>Remote Command</b>	[ :SENSe ] :SWEep:EGATe:DELay <time> [ :SENSe ] :SWEep:EGATe:DELay?
<b>Example</b>	SWE:EGAT:DELay 500ms SWE:EGAT:DELay?
Notes	Units of time are required or no units; otherwise an invalid suffix error message will be generated.
Preset	57.7 us WiMAX OFDMA: 71 us GSM/EDGE: 600 us WLAN: 500 us
State Saved	Saved in instrument state

Min	0.0 us
Max	100 s
<b>Backwards Compatibility SCPI</b>	[:SENSe]:SWEep:TIME:GATE:DELay ESA compatibility
Initial S/W Revision	Prior to A.02.00

## Gate Length

Controls the length of time that the gate is on after it opens.

Key Path	Sweep/Control, Gate
<b>Remote Command</b>	[:SENSe]:SWEep:EGATe:LENGth <time> [:SENSe]:SWEep:EGATe:LENGth?
<b>Example</b>	SWE:EGAT:LENG 1 SWE:EGAT:LENG?
Notes	Units of time are required or no units; otherwise an invalid suffix error message will be generated.

### Dependencies

Grayed out when Gate Method is set to FFT in which case the label changes to that shown below.



The key is also grayed out if Gate Control = Level.

Preset	461.6 us WiMAX OFDMA: 50 us GSM/EDGE: 200 us WLAN: 1.54 ms
State Saved	Saved in instrument state
Min	100 ns
Max	5 s
<b>Backwards Compatibility SCPI</b>	[:SENSe]:SWEep:TIME:GATE:LENGth ESA compatibility
Initial S/W Revision	Prior to A.02.00

## Gate Source

The menus under the Gate Source key are the same as those under the Trigger key, with the exception that neither Free Run nor Video are available as Gate Source selections. However, a different SCPI command

is used to select the Gate Source (see table below) because you may independently set the Gate Source and the Trigger Source.

Any changes to the settings in the setup menus under each Gate Source selection key (for example: Trigger Level, Trigger Delay, etc.) also affect the corresponding settings under the Trigger menu keys. The SCPI commands used for these are the same for Trigger and Gate, since there is only one setting which affects both Gate and Trigger. Example: to set the Trigger Level for External 1 you use the command :TRIG:EXT1:LEV regardless of whether you are using External 1 as a Trigger Source or a Gate Source.

Key Path	Sweep/Control, Gate
Remote Command	[ :SENSe ] :SWEep:EGATe:SOURce EXTernal1   EXTernal2   LINE   FRAME   RFBurst  [ :SENSe ] :SWEep:EGATe:SOURce?
Dependencies	In some models, there is no second External input. In these models, the External 2 key is blanked and the EXTernal2 parameter will generate a "Hardware missing; Not available for this model number" error.
Preset	EXTernal 1 GSM/EDGE, MSR: FRAME LTETDD: EXTernal 1When Direction is Downlink, FRAME when Direction is Uplink.
Backwards Compatibility Notes	In ESA, there is a single Gate input port. In PSA, the Gate Source may be taken from one of two specified input ports. In the X-Series, any Trigger Source can be a Gate Source.
Initial S/W Revision	Prior to A.02.00
Modified at S/W Revision	A.03.00, A.14.00

## Line

Pressing this key, when it is not selected, selects the line signal as the trigger. A new sweep/measurement will start synchronized with the next cycle of the line voltage. Pressing this key, when it is already selected, access the line trigger setup menu.

Key Path	Trigger
Example	TRIG:SOUR LINE Swept SA measurement TRIG:<meas>:SOUR LINE Measurements other than Swept SA
Dependencies	Line trigger is not available when operating from a "dc power source", for example, when the instrument is powered from batteries.
State Saved	Saved in instrument state
Status Bits/OPC dependencies	The Status Operation Register bit 5 "Waiting for Trigger" is set at the same time as the Sweeping or Measuring bit is set. It is cleared when the trigger actually occurs (that is, after the trigger event occurs and all the applicable trigger criteria have been met). A corresponding pop-up message ("Waiting for trigger") is generated if no trigger signal appears after approximately 2 sec. This message goes away when a trigger signal appears.
Initial S/W Revision	Prior to A.02.00

### Trig Slope

Controls the trigger polarity. It is set positive to trigger on a rising edge and negative to trigger on a falling edge.

Key Path	Trigger, Line
Remote Command	:TRIGger[:SEquence]:LINE:SLOPe POSitive NEGative :TRIGger[:SEquence]:LINE:SLOPe?
Example	TRIG:LINE:SLOP NEG
Preset	POSitive
State Saved	Saved in instrument state
Backwards Compatibility Notes	The legacy :TRIGger[:SEquence]:SLOPe command affects the slopes for the VID, LINE, EXT1, EXT2, and RFB triggers.
Initial S/W Revision	Prior to A.02.00

### External 1

Pressing this key, when it is not selected, selects an external input signal as the trigger. A new sweep/measurement will start when the external trigger condition is met using the external 1 input connector on the rear panel.

Pressing this key, when it is already selected, accesses the external 1 trigger setup menu.

Key Path	Trigger
Example	TRIG:SOUR EXT1 Swept SA measurement TRIG:<meas>:SOUR EXT1 Measurements other than Swept SA
Dependencies	Grayed out if in use by Point Trigger in the Source Setup menu. Forced to Free Run if already selected and Point Trigger is set to External 1.
State Saved	Saved in instrument state
Status Bits/OPC dependencies	The Status Operation Register bit 5 "Waiting for Trigger" is set at the same time as the Sweeping or Measuring bit is set. It is cleared when the trigger actually occurs (that is, after the trigger event occurs and all the applicable trigger criteria have been met). A corresponding pop-up message ("Waiting for trigger") is generated if no trigger signal appears after approximately 2 sec. This message goes away when a trigger signal appears.
Initial S/W Revision	Prior to A.02.00

### Trigger Level

Sets the value where the external 1 trigger input will trigger a new sweep/measurement.

Key Path	Trigger, External 1
Remote Command	:TRIGger[:SEquence]:EXTernal1:LEVel <level>



	:TRIGger[:SEquence]:EXTernal1:LEVel?
<b>Example</b>	TRIG:EXT1:LEV 0.4 V
<b>Couplings</b>	This same level is used for the Ext1 trigger source in the Trigger menu, for the Ext1 selection in the Periodic Timer sync source (in the Trigger menu and in the Gate Source menu), and also for the Ext1 selection in the Gate Source menu.
<b>Preset</b>	1.2 V
<b>State Saved</b>	Saved in instrument state
<b>Min</b>	-5 V
<b>Max</b>	5 V
<b>Default Unit</b>	V
<b>Backwards Compatibility SCPI</b>	:TRIGger[:SEquence]:EXTernal:LEVel For backward compatibility, the parameter EXTernal is mapped to EXTernal1
<b>Backwards Compatibility SCPI</b>	:TRIGger[:SEquence]:FRAMe:EXTernal1:LEVel
<b>Initial S/W Revision</b>	Prior to A.02.00

### Trig Slope

Controls the trigger polarity. It is set positive to trigger on a rising edge and negative to trigger on a falling edge.

<b>Key Path</b>	Trigger, External 1
<b>Remote Command</b>	:TRIGger[:SEquence]:EXTernal1:SLOPe POSitive NEGative :TRIGger[:SEquence]:EXTernal1:SLOPe?
<b>Example</b>	TRIG:EXT1:SLOP NEG
<b>Couplings</b>	This same slope is used in the Ext1 selection for the trigger source in the Trigger menu and for the period timer sync source (in the Trigger menu and in the Gate Source menu).
<b>Preset</b>	POSitive
<b>State Saved</b>	Saved in instrument state
<b>Backwards Compatibility SCPI</b>	:TRIGger[:SEquence]:EXTernal:SLOPe For backward compatibility, the parameter EXTernal is mapped to EXTernal1
<b>Backwards Compatibility SCPI</b>	:TRIGger[:SEquence]:FRAMe:EXTernal1:SLOPe
<b>Backwards Compatibility Notes</b>	The legacy :TRIGger[:SEquence]:SLOPe command affects the slopes for the VID, LINE, EXT1, EXT2, and RFB triggers.
<b>Initial S/W Revision</b>	Prior to A.02.00

## External 2

Pressing this key, when it is not selected, selects an external input signal as the trigger. A new sweep/measurement will start when the external trigger condition is met using the external 2 input connector. The external trigger 2 input connector is on the rear panel.

Pressing this key, when it is already selected, accesses the external 2 trigger setup menu.

<b>Key Path</b>	Trigger
<b>Example</b>	TRIG:SOUR EXT2 Swept SA measurement TRIG:<meas>:SOUR EXT2 Measurements other than Swept SA
<b>Dependencies</b>	In some models, there is no second External input. In these models, the External 2 key is blanked and the EXTernal2 parameter will generate a "Hardware missing; Not available for this model number" message. Grayed out if in use by Point Trigger in the Source Setup menu. Forced to Free Run if already selected and Point Trigger is set to External 2.
<b>State Saved</b>	Saved in instrument state
<b>Status Bits/OPC dependencies</b>	The Status Operation Register bit 5 "Waiting for Trigger" is set at the same time as the Sweeping or Measuring bit is set. It is cleared when the trigger actually occurs (that is, after the trigger event occurs and all the applicable trigger criteria have been met). A corresponding pop-up message ("Waiting for trigger") is generated if no trigger signal appears after approximately 2 sec. This message goes away when a trigger signal appears.
<b>Initial S/W Revision</b>	Prior to A.02.00
<b>Modified at S/W Revision</b>	A.03.00

## Trigger Level

Sets the value where the external 2 trigger input will trigger a new sweep/measurement.

<b>Key Path</b>	Trigger, External 2
<b>Remote Command</b>	:TRIGger[:SEquence]:EXTernal2:LEVel :TRIGger[:SEquence]:EXTernal2:LEVel?
<b>Example</b>	TRIG:EXT2:LEV 1.1 V
<b>Couplings</b>	This same level is used for the Ext2 trigger source in the Trigger menu, for the Ext2 selection in the Periodic Timer sync source (in the Trigger menu and in the Gate Source menu), and also for the Ext2 selection in the Gate Source menu.
<b>Preset</b>	1.2 V
<b>State Saved</b>	Saved in instrument state
<b>Min</b>	-5 V
<b>Max</b>	5 V
<b>Default Unit</b>	V
<b>Backwards Compatibility SCPI</b>	:TRIGger[:SEquence]:FRAMe:EXTernal2:LEVel
<b>Initial S/W Revision</b>	Prior to A.02.00

### Trig Slope

Controls the trigger polarity. It is set positive to trigger on a rising edge and negative to trigger on a falling edge.

Key Path	Trigger, External 2
Remote Command	:TRIGger[:SEquence]:EXTernal2:SLOPe POSitive NEGative :TRIGger[:SEquence]:EXTernal2:SLOPe?
Example	TRIG:EXT2:SLOP NEG
Couplings	This same slope is used in the Ext2 selection for the trigger source in the Trigger menu and for the period timer sync source (in the Trigger menu and in the Gate Source menu).
Preset	POSitive
State Saved	Saved in instrument state
Backwards Compatibility SCPI	:TRIGger[:SEquence]:FRAMe:EXTernal2:SLOPe
Backwards Compatibility Notes	The legacy :TRIGger[:SEquence]:SLOPe command affects the slopes for the VID, LINE, EXT1, EXT2, and RFB triggers.
Initial S/W Revision	Prior to A.02.00

### RF Burst

Pressing this key, when it is not selected, selects the RF Burst as the trigger. A new sweep/measurement will start when an RF burst envelope signal is identified from the signal at the RF Input connector. Pressing this key, when it is already selected, accesses the RF Burst trigger setup menu.

In some models, a variety of burst trigger circuitry is available, resulting in various available burst trigger bandwidths. The analyzer automatically chooses the appropriate trigger path based on the hardware configuration and other settings of the analyzer.

Key Path	Trigger
Example	TRIG:SOUR RFB      Swept SA measurement TRIG:<meas>:SOUR RFB    Measurements other than Swept SA
State Saved	Saved in instrument state
Status Bits/OPC dependencies	The Status Operation Register bit 5 "Waiting for Trigger" is set at the same time as the Sweeping or Measuring bit is set. It is cleared when the trigger actually occurs (that is, after the trigger event occurs and all the applicable trigger criteria have been met). A corresponding pop-up message ("Waiting for trigger") is generated if no trigger signal appears after approximately 2 sec. This message goes away when a trigger signal appears.
Backwards Compatibility Notes	The legacy command: :TRIGger[:SEquence]:RFBurst:FSElectivity[:STATe] OFF ON 0 1 is not supported in the X-Series, as the hardware to do Frequency Selective burst triggers does not exist in X-Series.

Initial S/W Revision	Prior to A.02.00
Modified at S/W Revision	A.04.00

### Absolute Trigger Level

Sets the absolute trigger level for the RF burst envelope.

When using the External Mixing path, the Absolute Trigger Level is uncalibrated because the factory default was set to accommodate the expected IF levels for the RF path.

Key Path	Trigger, RF Burst
Scope	Meas Global
<b>Remote Command</b>	:TRIGger[:SEquence]:RFBurst:LEVel:ABSolute <ampl> :TRIGger[:SEquence]:RFBurst:LEVel:ABSolute?
<b>Example</b>	TRIG:RFB:LEV:ABS 10 dBm sets the trigger level of the RF burst envelope signal to the absolute level of 10 dBm
Notes	Sending this command does not switch the setting from relative to absolute; to switch it you need to send the :TRIGger[:SEquence]:RFBurst:LEVel:TYPE command, below.  Amplitude Corrections are not taken into account by the Absolute Trigger Level. For example, if you have given yourself effective gain with an amplitude correction factor, the Absolute Trigger will not fire until you have set the trigger level that far below the displayed signal level, rather than simply to the displayed signal level. This is only true for Amplitude Corrections, not External Gain or Ref Level Offset functions.  If mode is Bluetooth, the default value is -50 dBm.
Couplings	This same level is used for the RF Burst trigger source in the Trigger menu, for the RF Burst selection in the Periodic Timer sync source (in the Trigger menu and in the Gate Source menu), and also for the RF Burst selection in the Gate Source menu
Preset	-20 dBm
State Saved	Saved in instrument state
Min	-200 dBm
Max	100 dBm
Default Unit	depends on the current selected Y-Axis unit
<b>Backwards Compatibility SCPI</b>	:TRIGger[:SEquence]:FRAME:RFBurst:LEVel:ABSolute
Initial S/W Revision	Prior to A.02.00
Modified at S/W Revision	A.04.00

Key Path	Trigger, RF Burst
<b>Remote Command</b>	:TRIGger[:SEquence]:RFBurst:LEVel:TYPE ABSolute RELative :TRIGger[:SEquence]:RFBurst:LEVel:TYPE?

<b>Example</b>	TRIG:RFB:LEV:TYPE REL sets the trigger level type of the RF burst trigger to Relative.
Preset	ABSolute
State Saved	Saved in instrument state
Initial S/W Revision	Prior to A.02.00
Modified at S/W Revision	A.04.00

### Relative Trigger Level

Sets the relative trigger level for the RF burst envelope.

In some models, the relative burst trigger function is implemented in hardware. In other models, without the advanced triggering hardware required, the relative burst trigger function is implemented in software in some measurements, and is unavailable in other measurements.

When implemented in software, the relative RF Burst trigger function is implemented as follows:

1. The measurement starts with the absolute RF Burst trigger setting. If it cannot get a trigger with that level, auto trigger fires and the acquisition starts anyway. After the acquisition, the measurement searches for the peak in the acquired waveform and saves it.
2. Now, in the next cycle of the measurement, the measurement determines a new absolute RF Burst level based on the peak value from the first measurement and the Relative RF Burst Trigger Level (always 0 or negative dB) set by the user. The following formula is used:
3. absolute RF Burst level = peak level of the previous acquisition + relative RF Burst level
4. If the new absolute RF Burst level differs from the previous by more than 0.5 dB, the new level is sent to the hardware; otherwise it is not updated (to avoid slowing down the acquisition)

Steps 2 and 3 repeat for subsequent measurements.

<b>Key Path</b>	Trigger, RF Burst
<b>Scope</b>	Meas Global
<b>Remote Command</b>	:TRIGger[:SEquence]:RFBurst:LEVel:RELative <rel_ampl> :TRIGger[:SEquence]:RFBurst:LEVel:RELative?
<b>Example</b>	TRIG:RFB:LEV:REL -10 dB sets the trigger level of the RF burst envelope signal to the relative level of -10 dB
<b>Notes</b>	Sending this command does not switch the setting from absolute to relative; to switch it you need to send the :TRIGger[:SEquence]:RFBurst:LEVel:TYPE command, above.  The relative trigger level is not available in some measurements. In those measurements the RELative parameter, and the :TRIGger[:SEquence]:RFBurst:LEVel:TYPE command (above), will generate an error if sent.
<b>Dependencies</b>	This key is grayed out and Absolute Trigger Level selected if the required hardware is not present in your analyzer and the current measurement does not support Relative triggering.
<b>Preset</b>	-6 dB

	GSM: -25 dB
State Saved	Saved in instrument state
Min	-45 dB
Max	0 dB
Default Unit	dB or dBc
<b>Backwards Compatibility SCPI</b>	:TRIGger[:SEquence]:RFBurst:LEVel
	This legacy command is aliased to :TRIGger[:SEquence]:RFBurst:LEVel:RELative because the PSA had ONLY relative burst triggering
Initial S/W Revision	Prior to A.02.00
Modified at S/W Revision	A.04.00

### Trigger Slope

It is set positive to trigger on a rising edge and negative to trigger on a falling edge.

Key Path	Trigger, RF Burst
<b>Remote Command</b>	:TRIGger[:SEquence]:RFBurst:SLOPe POSitive NEGative :TRIGger[:SEquence]:RFBurst:SLOPe?
<b>Example</b>	TRIG:RFB:SLOP NEG
Couplings	This same slope is used in the RF Burst selection for the trigger source in the Trigger menu and for the period timer sync source (in the Trigger menu and in the Gate Source menu).
Preset	POSitive
State Saved	Saved in instrument state
<b>Backwards Compatibility SCPI</b>	:TRIGger[:SEquence]:FRAMe:RFBurst:SLOPe
Backwards Compatibility Notes	The legacy :TRIGger[:SEquence]:SLOPe command affects the slopes for the VID, LINE, EXT1, EXT2, and RFB triggers.
Initial S/W Revision	Prior to A.02.00

### Periodic Timer (Frame Trigger)

Pressing this key, when it is not selected, selects the internal periodic timer signal as the trigger. Triggering occurrences are set by the **Period** parameter, which is modified by the **Sync Source** and **Offset**. Pressing this key, when it is already selected, accesses the periodic timer trigger setup functions.

If you do not have a sync source selected (it is Off), then the internal timer will not be synchronized with any external timing events.

Key Path	Trigger
<b>Example</b>	TRIG:SOUR FRAM Swept SA measurement TRIG:<meas>:SOUR FRAM Measurements other than Swept SA

State Saved	Saved in instrument state
Readback	[Sync: <value of Sync Source>], for example, [Sync: External 1]
Status Bits/OPC dependencies	The Status Operation Register bit 5 "Waiting for Trigger" is set at the same time as the Sweeping or Measuring bit is set. It is cleared when the trigger actually occurs (that is, after the trigger event occurs and all the applicable trigger criteria have been met). A corresponding pop-up message ("Waiting for trigger") is generated if no trigger signal appears after approximately 2 sec. This message goes away when a trigger signal appears.
Initial S/W Revision	Prior to A.02.00

### Periodic Timer Triggering:

This feature selects the internal periodic timer signal as the trigger. Trigger occurrences are set by the **Periodic Timer** parameter, which is modified by the **Sync Source** and **Offset**.

The figure below shows the action of the periodic timer trigger. Before reviewing the figure, we'll explain some uses for the periodic trigger.

A common application is measuring periodic burst RF signals for which a trigger signal is not easily available. For example, we might be measuring a TDMA radio which bursts every 20 ms. Let's assume that the 20 ms period is very consistent. Let's also assume that we do not have an external trigger source available that is synchronized with the period, and that the signal-to-noise ratio of the signal is not high enough to provide a clean RF burst trigger at all of the analysis frequencies. For example, we might want to measure spurious transmissions at an offset from the carrier that is larger than the bandwidth of the RF burst trigger. In this application, we can set the Periodic Timer to a 20.00 ms period and adjust the offset from that timer to position our trigger just where we want it. If we find that the 20.00 ms is not exactly right, we can adjust the period slightly to minimize the drift between the period timer and the signal to be measured.

A second way to use this feature would be to use **Sync Source** temporarily, instead of **Offset**. In this case, we might tune to the signal in a narrow span and use the RF Burst trigger to synchronize the periodic timer. Then we would turn the sync source off so that it would not miss-trigger. Miss-triggering can occur when we are tuned so far away from the RF burst trigger that it is no longer reliable.

A third example would be to synchronize to a signal that has a reference time element of much longer period than the period of interest. In some CDMA applications, it is useful to look at signals with a short periodicity, by synchronizing that periodicity to the "even-second clock" edge that happens every two seconds. Thus, we could connect the even-second clock trigger to Ext1 and use then Ext1 as the sync source for the periodic timer.

The figure below illustrates this third example. The top trace represents the even-second clock. It causes the periodic timer to synchronize with the leading edge shown. The analyzer trigger occurs at a time delayed by the accumulated offset from the period trigger event. The periodic timer continues to run, and triggers continue to occur, with a periodicity determined by the analyzer time base. The timer output (labeled "late event") will drift away from its ideal time due to imperfect matching between the time base of the signal being measured and the time base of the analyzer, and also because of imperfect setting of the period parameter. But the synchronization is restored on the next even-second clock event. ("Accumulated offset" is described in the in the **Offset** function section.)

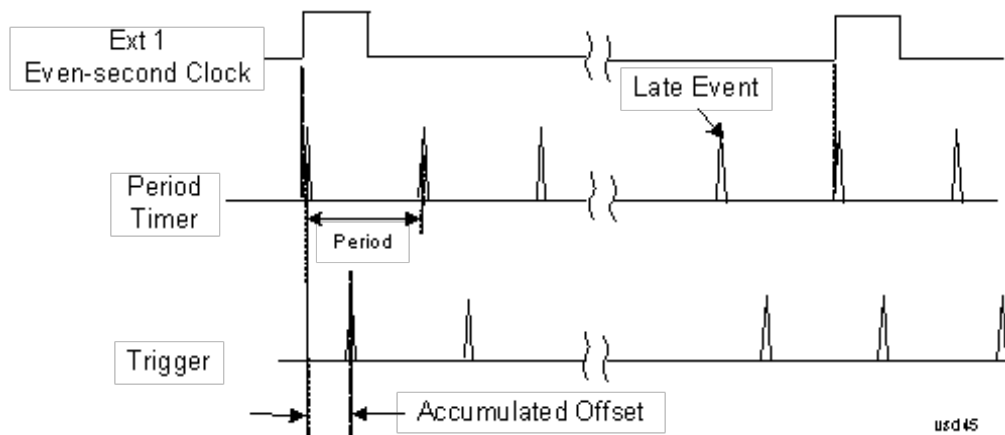

### Period

Sets the period of the internal periodic timer clock. For digital communications signals, this is usually set to the frame period of your current input signal. In the case that sync source is not set to OFF, and the external sync source rate is changed for some reason, the periodic timer is synchronized at the every external synchronization pulse by resetting the internal state of the timer circuit.

Key Path	Trigger, Periodic Timer
Remote Command	:TRIGger[:SEquence]:FRAMe:PERiod <time> :TRIGger[:SEquence]:FRAMe:PERiod?
Example	TRIG:FRAM:PER 100 ms
Dependencies	The invalid data indicator turns on when the period is changed, until the next sweep/measurement completes.
Couplings	The same period is used in the Gate Source selection of the period timer.
Preset	20 ms GSM: 4.615383
State Saved	Saved in instrument state
Min	100.000 ns
Max	559.0000 ms
Default Unit	S
Initial S/W Revision	Prior to A.02.00

### Offset

Adjusts the accumulated offset between the periodic timer events and the trigger event. Adjusting the accumulated offset is different than setting an offset, and requires explanation.

The periodic timer is usually not synchronized with any external events, so the timing of its output events has no absolute meaning. Since the timing relative to external events (RF signals) is important, you need to be able to adjust (offset) it. However, you have no direct way to see when the periodic timer events occur. All that you can see is the trigger timing. When you want to adjust the trigger timing, you will be changing the internal offset between the periodic timer events and the trigger event. Because the absolute value of



that internal offset is unknown, we will just call that the accumulated offset. Whenever the Offset parameter is changed, you are changing that accumulated offset. You can reset the displayed offset using Reset Offset Display. Changing the display does not change the value of the accumulated offset, and you can still make additional changes to accumulated offset.

To avoid ambiguity, we define that an increase in the "offset" parameter, either from the knob or the SCPI adjust command, serves to delay the timing of the trigger event.

Key Path	Trigger, Periodic Timer
Remote Command	:TRIGger[:SEquence]:FRAMe:OFFSet <time> :TRIGger[:SEquence]:FRAMe:OFFSet?
Example	TRIG:FRAM:OFFS 1.2 ms
Notes	<p>The front panel interface (for example, the knob), and this command, adjust the accumulated offset, which is shown on the active function display. However, the actual amount sent to the hardware each time the offset is updated is the delta value, that is, the current accumulated offset value minus the previous accumulated offset value. Note that the accumulated offset value is essentially arbitrary; it represents the accumulated offset from the last time the offset was zeroed (with the Reset Offset Display key).</p> <p>Note that this command does not change the period of the trigger waveform. Note also that Offset is used only when the sync source is set to OFF, otherwise delay is used, see section <a href="#">"Trig Delay" on page 461</a>.</p> <p>An increase in the "offset" parameter, either from the knob or the SCPI adjust command, serves to delay the timing of the trigger event.</p>
Notes	<p>When the SCPI command is sent the value shown on the key (and the Active Function, if this happens to be the active function) is updated with the new value. However, the actual amount sent to the hardware is the delta value, that is, the current accumulated offset value minus the previous accumulated offset value.</p> <p>The SCPI query simply returns the value currently showing on the key.</p>
Dependencies	The invalid data indicator turns on when the offset is changed, until the next sweep/measurement completes.
Couplings	The same offset is used in the Gate Source selection of the period timer.
Preset	0 s
State Saved	Saved in instrument state
Min	-10.000 s
Max	10.000 s
Default Unit	S
Initial S/W Revision	Prior to A.02.00

#### Offset Adjust (Remote Command Only)

This remote command does not work at all like the related front panel keys. This command lets you advance the phase of the frame trigger by the amount you specify.

It does not change the period of the trigger waveform. If the command is sent multiple times, it advances the phase of the frame trigger an additional amount each time it is sent. Negative numbers are permitted.

<b>Remote Command</b>	:TRIGger[:SEquence]:FRAMe:ADJust <time>
<b>Example</b>	TRIG:FRAM:ADJ 1.2 ms
<b>Notes</b>	Note also that Offset is used only when the sync source is set to OFF, otherwise delay is used, see section "Trig Delay" on page 461 An increase in the "offset" parameter, either from the knob or the SCPI adjust command, serves to delay the timing of the trigger event.
<b>Notes</b>	The front panel interface (for example, the knob) and the :TRIG:FRAM:OFFS command adjust the accumulated offset, which is shown on the active function display. However, the actual amount sent to the hardware is the delta value, that is, the current offset value minus the previous offset value. When the SCPI command is sent the value shown on the key (and the Active Function, if this happens to be the active function) is updated by increasing it (or decreasing it if the value sent is negative) by the amount specified in the SCPI command. This is a "command only" SCPI command, with no query.
<b>Dependencies</b>	The invalid data indicator turns on when the offset is changed, until the next sweep/measurement completes.
<b>Couplings</b>	The same offset is used in the Gate Source selection of the period timer.
<b>Preset</b>	0 s
<b>State Saved</b>	Saved in instrument state
<b>Min</b>	-10.000 s
<b>Max</b>	10.000 s
<b>Default Unit</b>	S
<b>Initial S/W Revision</b>	Prior to A.02.00

### Reset Offset Display

Resets the value of the periodic trigger offset display setting to 0.0 seconds. The current displayed trigger location may include an offset value defined with the Offset key. Pressing this key redefines the currently displayed trigger location as the new trigger point that is 0.0 s offset. The Offset key can then be used to add offset relative to this new timing.

<b>Key Path</b>	Trigger, Periodic Timer
<b>Remote Command</b>	:TRIGger[:SEquence]:FRAMe:OFFSet:DISPlay:RESet
<b>Example</b>	TRIG:FRAM:OFFS:DISP:RES
<b>Initial S/W Revision</b>	Prior to A.02.00

### Sync Source

Selects a signal source for you to synchronize your periodic timer trigger to, otherwise you are triggering at some arbitrary location in the frame. Synchronization reduces the precision requirements on the setting of the period.

For convenience you may adjust the level and slope of the selected sync source in a conditional branch setup menu accessed from the Sync Source menu. Note that these settings match those in the **Trigger** and **Gate Source** menus; that is, each trigger source has only one value of level and slope, regardless of which menu it is accessed from.

<b>Key Path</b>	Trigger, Periodic Timer
<b>Remote Command</b>	:TRIGger[:SEquence]:FRAMe:SYNC EXTernal1   EXTernal2   RFBurst   OFF :TRIGger[:SEquence]:FRAMe:SYNC?
<b>Example</b>	TRIG:FRAM:SYNC EXT2
<b>Dependencies</b>	In some models, there is no second External input. In these models, the External 2 key is blanked and the EXTernal2 parameter will generate a "Hardware missing; Not available for this model number" message.
<b>Preset</b>	Off GSM/EDGE, MSR,LTE,LTETDD: RFBurst
<b>State Saved</b>	Saved in instrument state
<b>Readback</b>	The current setting is read back to this key and it is also Readback to the previous Periodic Timer trigger key.
<b>Backwards Compatibility SCPI</b>	:TRIGger[:SEquence]:FRAMe:SYNC EXTernal For backward compatibility, the parameter EXTernal is mapped to EXTernal1
<b>Initial S/W Revision</b>	Prior to A.02.00
<b>Modified at S/W Revision</b>	A.03.00, A.14.00

### Off

Turns off the sync source for your periodic trigger. With the sync source off, the timing will drift unless the signal source frequency is locked to the analyzer frequency reference.

<b>Key Path</b>	Trigger, Periodic Timer, Sync Source
<b>Example</b>	TRIG:FRAM:SYNC OFF
<b>Readback</b>	Off
<b>Initial S/W Revision</b>	Prior to A.02.00

### External 1

Pressing this key, when it is not selected, selects an external input signal as the trigger. A new sweep/measurement will start when the external trigger condition is met using the external 1 input connector on the rear panel.

Pressing this key, when it is already selected, accesses the external 1 trigger setup menu.

<b>Key Path</b>	Trigger
<b>Example</b>	TRIG:SOUR EXT1 Swept SA measurement

	TRIG:<meas>:SOUR EXT1 Measurements other than Swept SA
Dependencies	Grayed out if in use by Point Trigger in the Source Setup menu. Forced to Free Run if already selected and Point Trigger is set to External 1.
State Saved	Saved in instrument state
Status Bits/OPC dependencies	The Status Operation Register bit 5 "Waiting for Trigger" is set at the same time as the Sweeping or Measuring bit is set. It is cleared when the trigger actually occurs (that is, after the trigger event occurs and all the applicable trigger criteria have been met). A corresponding pop-up message ("Waiting for trigger") is generated if no trigger signal appears after approximately 2 sec. This message goes away when a trigger signal appears.
Initial S/W Revision	Prior to A.02.00

### Trigger Level

Sets the value where the external 1 trigger input will trigger a new sweep/measurement.

Key Path	Trigger, External 1
<b>Remote Command</b>	:TRIGger[:SEquence]:EXTernal1:LEVel <level> :TRIGger[:SEquence]:EXTernal1:LEVel?
<b>Example</b>	TRIG:EXT1:LEV 0.4 V
Couplings	This same level is used for the Ext1 trigger source in the Trigger menu, for the Ext1 selection in the Periodic Timer sync source (in the Trigger menu and in the Gate Source menu), and also for the Ext1 selection in the Gate Source menu.
Preset	1.2 V
State Saved	Saved in instrument state
Min	-5 V
Max	5 V
Default Unit	V
<b>Backwards Compatibility SCPI</b>	:TRIGger[:SEquence]:EXTernal:LEVel For backward compatibility, the parameter EXTernal is mapped to EXTernal1
<b>Backwards Compatibility SCPI</b>	:TRIGger[:SEquence]:FRAMe:EXTernal1:LEVel
Initial S/W Revision	Prior to A.02.00

### Trig Slope

Controls the trigger polarity. It is set positive to trigger on a rising edge and negative to trigger on a falling edge.

Key Path	Trigger, External 1
<b>Remote Command</b>	:TRIGger[:SEquence]:EXTernal1:SLOPe POSitive NEGative

	:TRIGger[:SEQuence]:EXTernal1:SLOPe?
<b>Example</b>	TRIG:EXT1:SLOP NEG
Couplings	This same slope is used in the Ext1 selection for the trigger source in the Trigger menu and for the period timer sync source (in the Trigger menu and in the Gate Source menu).
Preset	POSitive
State Saved	Saved in instrument state
<b>Backwards Compatibility SCPI</b>	:TRIGger[:SEQuence]:EXTernal:SLOPe For backward compatibility, the parameter EXTernal is mapped to EXTernal1
<b>Backwards Compatibility SCPI</b>	:TRIGger[:SEQuence]:FRAMe:EXTernal1:SLOPe
Backwards Compatibility Notes	The legacy :TRIGger[:SEQuence]:SLOPe command affects the slopes for the VID, LINE, EXT1, EXT2, and RFB triggers.
Initial S/W Revision	Prior to A.02.00

## External 2

Pressing this key, when it is not selected, selects an external input signal as the trigger. A new sweep/measurement will start when the external trigger condition is met using the external 2 input connector. The external trigger 2 input connector is on the rear panel.

Pressing this key, when it is already selected, accesses the external 2 trigger setup menu.

Key Path	Trigger
<b>Example</b>	TRIG:SOUR EXT2 Swept SA measurement TRIG:<meas>:SOUR EXT2 Measurements other than Swept SA
Dependencies	In some models, there is no second External input. In these models, the External 2 key is blanked and the EXTernal2 parameter will generate a "Hardware missing; Not available for this model number" message. Grayed out if in use by Point Trigger in the Source Setup menu. Forced to Free Run if already selected and Point Trigger is set to External 2.
State Saved	Saved in instrument state
Status Bits/OPC dependencies	The Status Operation Register bit 5 "Waiting for Trigger" is set at the same time as the Sweeping or Measuring bit is set. It is cleared when the trigger actually occurs (that is, after the trigger event occurs and all the applicable trigger criteria have been met). A corresponding pop-up message ("Waiting for trigger") is generated if no trigger signal appears after approximately 2 sec. This message goes away when a trigger signal appears.
Initial S/W Revision	Prior to A.02.00
Modified at S/W Revision	A.03.00

## Trigger Level

Sets the value where the external 2 trigger input will trigger a new sweep/measurement.

Key Path	Trigger, External 2
Remote Command	:TRIGger[:SEquence]:EXTernal2:LEVel :TRIGger[:SEquence]:EXTernal2:LEVel?
Example	TRIG:EXT2:LEV 1.1 V
Couplings	This same level is used for the Ext2 trigger source in the Trigger menu, for the Ext2 selection in the Periodic Timer sync source (in the Trigger menu and in the Gate Source menu), and also for the Ext2 selection in the Gate Source menu.
Preset	1.2 V
State Saved	Saved in instrument state
Min	-5 V
Max	5 V
Default Unit	V
Backwards Compatibility SCPI	:TRIGger[:SEquence]:FRAMe:EXTernal2:LEVel
Initial S/W Revision	Prior to A.02.00

### Trig Slope

Controls the trigger polarity. It is set positive to trigger on a rising edge and negative to trigger on a falling edge.

Key Path	Trigger, External 2
Remote Command	:TRIGger[:SEquence]:EXTernal2:SLOPe POSitive NEGative :TRIGger[:SEquence]:EXTernal2:SLOPe?
Example	TRIG:EXT2:SLOP NEG
Couplings	This same slope is used in the Ext2 selection for the trigger source in the Trigger menu and for the period timer sync source (in the Trigger menu and in the Gate Source menu).
Preset	POSitive
State Saved	Saved in instrument state
Backwards Compatibility SCPI	:TRIGger[:SEquence]:FRAMe:EXTernal2:SLOPe
Backwards Compatibility Notes	The legacy :TRIGger[:SEquence]:SLOPe command affects the slopes for the VID, LINE, EXT1, EXT2, and RFB triggers.
Initial S/W Revision	Prior to A.02.00

### RF Burst

Pressing this key, when it is not selected, selects the RF Burst as the trigger. A new sweep/measurement will start when an RF burst envelope signal is identified from the signal at the RF Input connector. Pressing this key, when it is already selected, accesses the RF Burst trigger setup menu.

In some models, a variety of burst trigger circuitry is available, resulting in various available burst trigger bandwidths. The analyzer automatically chooses the appropriate trigger path based on the hardware configuration and other settings of the analyzer.

Key Path	Trigger
<b>Example</b>	TRIG:SOUR RFB Swept SA measurement TRIG:<meas>:SOUR RFB Measurements other than Swept SA
State Saved	Saved in instrument state
Status Bits/OPC dependencies	The Status Operation Register bit 5 "Waiting for Trigger" is set at the same time as the Sweeping or Measuring bit is set. It is cleared when the trigger actually occurs (that is, after the trigger event occurs and all the applicable trigger criteria have been met). A corresponding pop-up message ("Waiting for trigger") is generated if no trigger signal appears after approximately 2 sec. This message goes away when a trigger signal appears.
Backwards Compatibility Notes	The legacy command: :TRIGger[:SEquence]:RFBurst:FSElectivity[:STATe] OFF ON 0 1 is not supported in the X-Series, as the hardware to do Frequency Selective burst triggers does not exist in X-Series.
Initial S/W Revision	Prior to A.02.00
Modified at S/W Revision	A.04.00

### Absolute Trigger Level

Sets the absolute trigger level for the RF burst envelope.

When using the External Mixing path, the Absolute Trigger Level is uncalibrated because the factory default was set to accommodate the expected IF levels for the RF path.

Key Path	Trigger, RF Burst
Scope	Meas Global
<b>Remote Command</b>	:TRIGger[:SEquence]:RFBurst:LEVel:ABSolute <ampl> :TRIGger[:SEquence]:RFBurst:LEVel:ABSolute?
<b>Example</b>	TRIG:RFB:LEV:ABS 10 dBm sets the trigger level of the RF burst envelope signal to the absolute level of 10 dBm
Notes	Sending this command does not switch the setting from relative to absolute; to switch it you need to send the :TRIGger[:SEquence]:RFBurst:LEVel:TYPE command, below.  Amplitude Corrections are not taken into account by the Absolute Trigger Level. For example, if you have given yourself effective gain with an amplitude correction factor, the Absolute Trigger will not fire until you have set the trigger level that far below the displayed signal level, rather than simply to the displayed signal level. This is only true for Amplitude Corrections, not External Gain or Ref Level Offset functions.  If mode is Bluetooth, the default value is -50 dBm.
Couplings	This same level is used for the RF Burst trigger source in the Trigger menu, for the RF Burst selection in the Periodic Timer sync source (in the Trigger menu and in the Gate Source menu), and also for the

	RF Burst selection in the Gate Source menu
Preset	-20 dBm
State Saved	Saved in instrument state
Min	-200 dBm
Max	100 dBm
Default Unit	depends on the current selected Y-Axis unit
<b>Backwards Compatibility SCPI</b>	:TRIGger[:SEquence]:FRAMe:RFBurst:LEVel:ABSolute
Initial S/W Revision	Prior to A.02.00
Modified at S/W Revision	A.04.00

Key Path	Trigger, RF Burst
<b>Remote Command</b>	:TRIGger[:SEquence]:RFBurst:LEVel:TYPE ABSolute RELative :TRIGger[:SEquence]:RFBurst:LEVel:TYPE?
<b>Example</b>	TRIG:RFB:LEV:TYPE REL sets the trigger level type of the RF burst trigger to Relative.
Preset	ABSolute
State Saved	Saved in instrument state
Initial S/W Revision	Prior to A.02.00
Modified at S/W Revision	A.04.00

### Trigger Slope

It is set positive to trigger on a rising edge and negative to trigger on a falling edge.

Key Path	Trigger, RF Burst
<b>Remote Command</b>	:TRIGger[:SEquence]:RFBurst:SLOPe POSitive NEGative :TRIGger[:SEquence]:RFBurst:SLOPe?
<b>Example</b>	TRIG:RFB:SLOP NEG
Couplings	This same slope is used in the RF Burst selection for the trigger source in the Trigger menu and for the period timer sync source (in the Trigger menu and in the Gate Source menu).
Preset	POSitive
State Saved	Saved in instrument state
<b>Backwards Compatibility SCPI</b>	:TRIGger[:SEquence]:FRAMe:RFBurst:SLOPe
Backwards Compatibility Notes	The legacy :TRIGger[:SEquence]:SLOPe command affects the slopes for the VID, LINE, EXT1, EXT2, and RFB triggers.
Initial S/W Revision	Prior to A.02.00



## Sync Holdoff

Sync Holdoff specifies the duration that the sync source signal must be kept false before the transition to true to be recognized as the sync timing. The periodic timer phase is aligned when the sync source signal becomes true, after the Holdoff time is satisfied.

A holdoff of 2 ms will work with most WiMAX signals, but there may be cases where the burst off duration is less than 1 ms and this value will need to be changed.

Key Path	Trigger, Periodic Timer
<b>Remote Command</b>	:TRIGger[:SEquence]:FRAMe:SYNC:HOLDoff <time> :TRIGger[:SEquence]:FRAMe:SYNC:HOLDoff? :TRIGger[:SEquence]:FRAMe:SYNC:HOLDoff:STATe OFF ON 0 1 :TRIGger[:SEquence]:FRAMe:SYNC:HOLDoff:STATe?
Preset	On, 1.000 ms
State Saved	Saved in instrument state
Min	0 ms
Max	+500 ms
Default Unit	s
Initial S/W Revision	Prior to A.02.00

## Control Edge/Level

Sets the method of controlling the gating function from the gating signal.

### Edge

In Edge triggering, the gate opens (after the Delay) on the selected edge (for example, positive) of the gate signal and closes on the alternate edge (for example, negative).

### Level

In Level triggering, the gate opens (after the Delay) when the gate signal has achieved a certain level and stays open as long as that level is maintained.

Key Path	Sweep/Control, Gate
<b>Remote Command</b>	[:SENSe]:SWEep:EGATe:CONTRol EDGE LEVEl [:SENSe]:SWEep:EGATe:CONTRol?
<b>Example</b>	SWE:EGAT:CONT EDGE
Dependencies	If the Gate Method is FFT the Control key is grayed out and Edge is selected. If the Gate Source is TV, Frame or Line, the Control key is grayed out and Edge is selected.
Preset	EDGE
State Saved	Saved in instrument state
<b>Backwards Compatibility SCPI</b>	[:SENSe]:SWEep:TIME:GATE:TYPE ESA Compatibility
Initial S/W Revision	Prior to A.02.00

## Gate Holdoff

Lets you increase or decrease the wait time after a gate event ends before the analyzer will respond to the next gate signal.

After any Gate event finishes, the analyzer must wait for the sweep system to settle before it can respond to another Gate signal. The analyzer calculates a "wait time," taking into account a number of factors, including RBW and Phase Noise Optimization settings. The goal is to achieve the same accuracy when gated as in ungated operation. The figure below illustrates this concept:

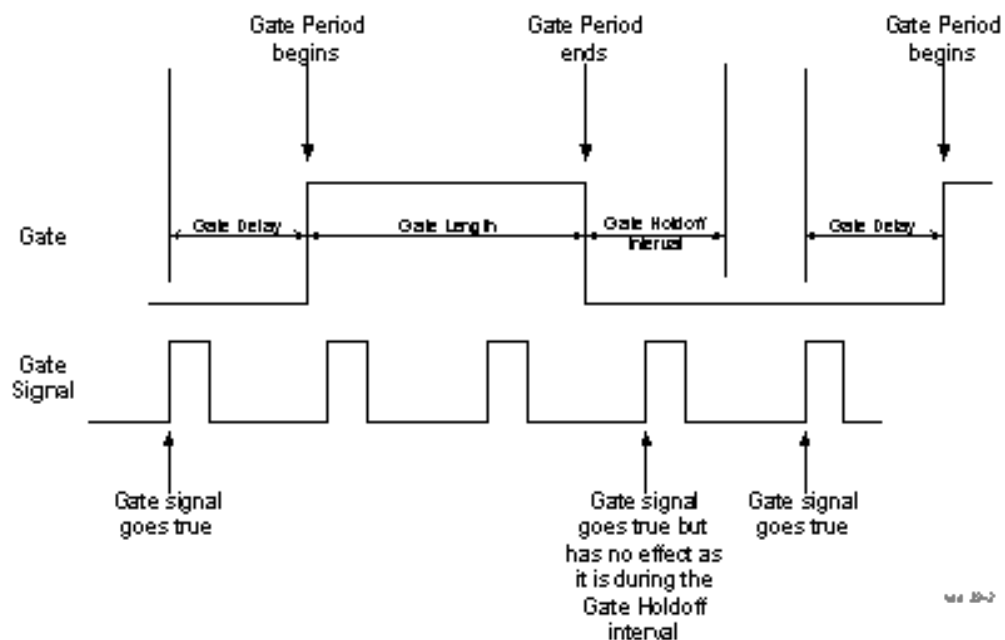

When Gate Holdoff is in Auto, the wait time calculated by the analyzer is used. When Gate Time is in Manual, the user may adjust the wait time, usually decreasing it in order to achieve greater speed, but at the risk of decreasing accuracy.

When the Method key is set to Video or FFT, the Gate Holdoff function has no effect.

In measurements that do not support Auto, the value shown when Auto is selected is “---” and the manually set holdoff is returned to a query.

Key Path	Sweep/Control, Gate
<b>Remote Command</b>	<pre>[ :SENSe]:SWEep:EGATe:HOLDoff &lt;time&gt; [ :SENSe]:SWEep:EGATe:HOLDoff? [ :SENSe]:SWEep:EGATe:HOLDoff:AUTO OFF ON 0 1 [ :SENSe]:SWEep:EGATe:HOLDoff:AUTO?</pre>
<b>Example</b>	<pre>SWE:EGAT:HOLD 0.0002 SWE:EGAT:HOLD? SWE:EGAT:HOLD:AUTO ON</pre>

SWE:EGAT:HOLD:AUTO?	
Couplings	<p>When Gate Holdoff is Auto, the Gate Holdoff key shows the value calculated by the analyzer for the wait time.</p> <p>Pressing the Gate Holdoff key while it is in Auto and not selected, causes the key to become selected and allows the user to adjust the value. If the value is adjusted, the setting changes to Man.</p> <p>Pressing the Gate Holdoff key, while it is in Auto and selected, does not change the value of Gate Holdoff, but causes the setting to change to Man. Now the user can adjust the value.</p> <p>Pressing the key while it is in Man and selected, cause the value to change back to Auto.</p> <p>Pressing the key while it is in Man and not selected, causes the key to become selected and allows the user to adjust the value.</p> <p>When Method is set to Video or FFT, the Gate Holdoff function has no effect.</p>
Preset	<p>Auto</p> <p>Auto/On</p>
State Saved	Saved in instrument state
Min	1 $\mu$ sec
Max	1 sec
Initial S/W Revision	Prior to A.02.00

## Gate Delay Compensation

This function allows you to select an RBW-dependent value by which to adjust the gate delay, to compensate for changes in the delay caused by RBW effects.

You can select between uncompensated operation and two types of compensation, Delay Until RBW Settled and Compensate for RBW Group Delay.

See ["More Information" on page 1568](#)

Key Path	Sweep/Control, Gate
Scope	Meas Global
Remote Command	<pre>[ :SENSe ] :SWEp:EGATe:DELaY:COMPensation:TYPE OFF   SETTled   GDELaY [ :SENSe ] :SWEp:EGATe:DELaY:COMPensation:TYPE?</pre>
Example	<pre>SWE:EGAT:DEL:COMP:TYPE SETT SWE:EGAT:DEL:COMP:TYPE?</pre>
Notes	<p>Although this function is Meas Global, there are some measurements that do not support this function. In those measurements the operation will be Uncompensated. Going into one of those measurements will not change the Meas Global selection; it will simply display the grayed-out menu key with "Uncompensated" showing as the selection. This is a non-forceful grayout, so the SCPI command is still accepted.</p> <p>If Gate Delay Compensation is not supported at all within a particular mode, the key is not displayed, and if the SCPI command is sent while in a measurement within that mode, an "Undefined Header" message is generated.</p> <p>Measurements that do not support this function include:</p>

Swept SA	
Preset	TD-SCDMA mode: Compensate for RBW Group Delay All other modes: Delay Until RBW Settled
State Saved	Saved in instrument state
Range	Uncompensated Delay Until RBW Settled Compensate for RBW Group Delay
Readback text	Uncompensated Settled Group Delay
Initial S/W Revision	Prior to A.02.00
Modified at S/W Revision	A.11.0

### More Information

Selecting Uncompensated means that the actual gate delay is as you sets it.

Selecting Delay Until RBW Settled causes the gate delay to be increased above the user setting by an amount equal to  $3.06/\text{RBW}$ . This compensated delay causes the GATE START and GATE STOP lines on the display to move by the compensation amount, and the actual hardware gate delay to be increased by the same amount. All the other gate lines (for example, MIN FAST) are unaffected. If the RBW subsequently changes, the compensation is readjusted for the new RBW. The value shown on the Gate Delay key does NOT change.

Delay Until RBW Settled allows excellent measurements of gated signals, by allowing the IF to settle following any transient that affects the burst. Excellent measurements also require that the analysis region not extend into the region affected by the falling edge of the burst. Thus, excellent measurements can only be made over a width that declines with narrowing RBWs, which is achieved by decreasing the gate length below the user setting by an amount equal to  $2.53/\text{RBW}$ . Therefore, for general purpose compensation, you will still want to change the gate length with changes in RBW even if the gate delay is compensated. The compensated Gate Length is limited by the analyzer so that it will never go below 10% of the value shown on the Gate Length key, as otherwise the sweep times could get very long. Anytime the Gate Length and RBW values combine in such a way that this limiting takes place, a warning is displayed. For measurements which contain multiple sweeps with different RBW like SEM and SPUR, the smallest RBW is used for this limiting.

Selecting Compensate for RBW Group Delay causes the gate delay to be increased above the user setting by an amount equal to  $1.81/\text{RBW}$ . This compensated delay causes the GATE START, GATE STOP lines on the display to move by the compensation amount, and the actual hardware gate delay to be increased by the same amount. All the other gate lines (for example, MIN FAST) are unaffected. If the RBW subsequently changes, the compensation is readjusted for the new RBW. The value shown on the Gate Delay key does NOT change. Compensate for RBW Group Delay also includes gate length compensation; the gate length itself is adjusted as necessary to attempt to compensate for delay effects imposed by the RBW.

Compensate for RBW Group Delay is similar to Delay Until RBW Settled, but compensates for the group delay of the RBW filter, rather than the filter settling time. As the RBW gets narrow, this can allow the settling tail of the RBW to affect the beginning part of the gated measurement, and allow the beginning of the RBW settling transient to affect the end of the gated measurement. These two effects are symmetric

because the RBW response is symmetric. Because the gate length is not automatically compensated, some users might find this compensation to be more intuitive than compensation for RBW settling.

### Min Fast Position Query (Remote Command Only)

This command queries the position of the MIN FAST line, relative to the delay reference (REF) line. See section "[Gate View On/Off](#)" on page 2722. If this query is sent while not in gate view, the MinFast calculation is performed based on the current values of the appropriate parameters and the result is returned. Knowing this value lets you set an optimal gate delay value for the current measurement setup.

<b>Remote Command</b>	<code>[ :SENSe ] :SWEep:EGATe:MINFast?</code>
<b>Example</b>	<code>SWE:EGAT:MIN?</code>
<b>Initial S/W Revision</b>	Prior to A.02.00

### Gate Preset (Remote Command Only)

Presets the time-gated spectrum analysis capability.

This command sets gate parameter values to the ESA preset values, as follows:

Gate trigger type = edge

Gate polarity = positive

Gate delay = 1 us

Gate length = 1 us

<b>Remote Command</b>	<code>[ :SENSe ] :SWEep:TIME:GATE:PRESet</code> ESA Compatibility
<b>Initial S/W Revision</b>	Prior to A.02.00

### Gate Level (Remote Command Only)

Sets the gate input transition point level for the external TRIGGER inputs on the front and rear panel. This is a legacy command for PSA compatibility. It is simply an alias to the equivalent trigger level command.

<b>Remote Command</b>	<code>[ :SENSe ] :SWEep:EGATe:EXTernal [1]   2:LEVel &lt;voltage&gt;</code> <code>[ :SENSe ] :SWEep:EGATe:EXTernal [1]   2:LEVel?</code>
<b>Notes</b>	This command is simply an alias to <code>:TRIGger[:SEQUence]:EXTernal[1] 2:LEVel</code> For details refer
<b>Initial S/W Revision</b>	Prior to A.02.00

### Gate Polarity (Remote Command Only)

Sets the polarity for the gate signal. This setup is now done using the gate trigger's slope setting.

When Positive (Pos) is selected, a positive-going edge (Edge) or a high voltage (Level) will satisfy the gate condition, after the delay set with the Gate Delay key. When Negative (Neg) is selected, a negative-going edge (Edge) or a low voltage (Level) will satisfy the gate condition after the delay.

<b>Remote Command</b>	<code>[ :SENSe ] :SWEep:EGATe:POLarity NEGative POSitive</code> <code>[ :SENSe ] :SWEep:EGATe:POLarity?</code>
<b>Example</b>	<code>SWE:EGAT:POL NEG</code> <code>SWE:EGAT:POL?</code>
<b>Preset</b>	POSitive
<b>State Saved</b>	Saved in instrument state
<b>Backwards Compatibility SCPI</b>	<code>[ :SENSe ] :SWEep:TIME:GATE:POLarity</code> ESA compatibility
<b>Initial S/W Revision</b>	Prior to A.02.00

<b>Remote Command</b>	<code>[ :SENSe ] :SWEep:TIME:GATE:LEVel HIGH LOW</code> <code>[ :SENSe ] :SWEep:TIME:GATE:LEVel?</code> ESA compatibility
<b>Preset</b>	HIGH
<b>Initial S/W Revision</b>	Prior to A.02.00

## Gate

Accesses a menu that enables you to control the gating function.

The Gate functionality is used to view signals best viewed by qualifying them with other events. See "[Gate](#)" on page 2721 for more details.

<b>Key Path</b>	Sweep/Control
<b>Initial S/W Revision</b>	A.03.00

## System

See "System" on page 359

## Trace/Detector

Trace/Detector is unavailable in the Spurious Emissions measurement. When pressed, this key displays a blank menu.

---

Key Path	Front-panel key
Initial S/W Revision	Prior to A.02.00

---



## Trigger

See ["Trigger" on page 430](#)

### Free Run

See ["Free Run " on page 437](#)

### Video

See ["Video \(IF Envelope\) " on page 438](#)

### Trigger Level

See ["Trigger Level " on page 438](#)

### Trig Slope

See ["Trig Slope " on page 439](#)

### Trig Delay

See ["Trig Delay " on page 440](#)

### Line

See ["Line " on page 2729](#)

### Trig Slope

See ["Trig Slope " on page 2729](#)

### Trig Delay

See ["Trig Delay " on page 442](#)

### External 1

See ["External 1 " on page 2741](#)

### Trigger Level

See ["Trigger Level " on page 2741](#)

### Trig Slope

See ["Trig Slope " on page 2742](#)

### Trig Delay

See ["Trig Delay " on page 445](#)

### External 2

See ["External 2 " on page 2743](#)

### **Trigger Level**

See "[Trigger Level](#) " on page 2743

### **Trig Slope**

See "[Trig Slope](#) " on page 2744

### **Trig Delay**

See "[Trig Delay](#) " on page 447

### **RF Burst**

See "[RF Burst](#) " on page 2744

### **Absolute Trigger**

See "[Absolute Trigger Level](#)" on page 2745

### **Relative Trigger**

See "[Relative Trigger Level](#)" on page 2734

### **Trig Slope**

See "[Trigger Slope](#) " on page 2746

### **Trig Delay**

See "[Trig Delay](#) " on page 451

### **Periodic Timer**

See "[Periodic Timer \(Frame Trigger\)](#) " on page 2736

### **Period**

See "[Period](#) " on page 2737

### **Offset**

See "[Offset](#) " on page 2738

### **Reset Offset Display**

See "[Reset Offset Display](#) " on page 2740

### **Sync Source**

See "[Sync Source](#) " on page 2740

### **Off**

See "[Off](#) " on page 2741

### External 1

See "External 1 " on page 2741

#### Trigger Level

See "Trigger Level " on page 2741

#### Trig Slope

See "Trig Slope " on page 2742

### External 2

See "External 2 " on page 2743

#### Trigger Level

See "Trigger Level " on page 2743

#### Trig Slope

See "Trig Slope " on page 2744

### RF Burst

See "RF Burst " on page 2744

### Absolute Trigger

See "Absolute Trigger Level" on page 2745

#### Trig Slope

See "Trigger Slope " on page 2746

### Trig Delay

See "Trig Delay" on page 461

### Auto/Holdoff

See "Auto/Holdoff " on page 462

### Auto Trig

See "Auto Trig " on page 462

### Trig Holdoff

See "Trig Holdoff " on page 463

## User Preset

Accesses a menu that gives you the following three choices:

- User Preset – recalls a state previously saved using the Save User Preset function.
- User Preset All Modes – presets all of the modes in the analyzer
- Save User Preset– saves the current state for the current mode

Key Path	Front-panel key
Backwards Compatibility Notes	<p>User Preset is actually loading a state, and in legacy analyzers, it was possible to load a state without affecting the trace data, limit lines or correction data. Similarly it was possible to do a User Preset without affecting the trace data, limit lines or correction data.</p> <p>In the X-Series, “state” always includes all of this data; so whenever state is loaded, or User Preset is executed, all of the traces, limit lines and corrections are affected. Although this differs from previous behavior, it is desirable behavior, and should not cause adverse issues for users.</p> <p>On ESA and PSA, User Preset affected the entire instrument’s state. In the X-Series, User Preset only recalls the state for the active mode. There is a User Preset file for each mode. User Preset can never cause a mode switch as it can in legacy analyzers. If you want to recall all modes to their user preset file state, you will need to do a User Preset after mode switching into each mode.</p> <p>User Preset recalls mode state which can now include data like traces; whereas on ESA and PSA, User Preset did not affect data.</p>
Initial S/W Revision	Prior to A.02.00

## User Preset

User Preset sets the state of the currently active mode back to the state that was previously saved for this mode using the Save User Preset menu key or the SCPI command, SYST:PRES:USER:SAV. It not only recalls the Mode Preset settings, but it also recalls all of the mode persistent settings, and the Input/Output system setting that existed at the time Save User Preset was executed.

If a Save User Preset has not been done at any time, User Preset recalls the default user preset file for the currently active mode. The default user preset files are created if, at power-on, a mode detects there is no user preset file. There will never be a scenario when there is no user preset file to restore. For each mode, the default user preset state is the same state that would be saved if a Save User Preset is performed in each mode right after doing a Restore Mode Default and after a Restore Input/Output Defaults.

The User Preset function does the following:

- Aborts the currently running measurement.
- Sets the mode State to the values defined by Save User Preset.
- Makes the saved measurement for the currently running mode the active measurement.
- Brings up the saved menu for the power-on mode.
- Clears the input and output buffers.
- Sets the Status Byte to 0.

Key Path	User Preset
<b>Remote Command</b>	:SYSTem:PRESet:USER
<b>Example</b>	:SYST:PRES:USER:SAVE:SYST:PRES:USER
Notes	:SYST:PRES:USER:SAVE is used to save the current state as the user preset state. Clears all pending OPC bits. The Status Byte is set to 0. Pressing the User Preset front-panel key while already in the User Preset menu will cause the User Preset to get executed
Couplings	A user preset will cause the currently running measurement to be aborted and cause the saved measurement to be active. Recalling a User Preset file has the same issues that recalling a Save State file has. Some settings may need to be limited and therefore re-coupled, since the capabilities of the mode may have changes when the User Preset file was last saved.
Initial S/W Revision	Prior to A.02.00

## User Preset All Modes

Recalls all of the User Preset files for each mode, switches to the power-on mode, and activates the saved measurement from the power-on mode User Preset file.

**NOTE**

When the instrument is secured, all of the user preset files are converted back to their default user preset files.

The User Preset function does the following:

- Aborts the currently running measurement.
- Switches the Mode to the power-on mode.
- Restores the User Preset files for each mode.
- Makes the saved measurement for the power-on mode the active measurement.
- Brings up the saved menu for the power-on mode.
- Clears the input and output buffers.
- Sets the Status Byte to 0.

Key Path	User Preset
<b>Remote Command</b>	:SYSTem:PRESet:USER:ALL
<b>Example</b>	:SYST:PRES:USER:SAVE:SYST:PRES:USER:ALL
Notes	Clears all pending OPC bits. The Status Byte is set to 0. :SYST:PRES:USER:SAVE is used to save the current state as the user preset state.
Couplings	A user preset will cause the currently running measurement to be aborted, cause a mode switch to the power-on mode, and cause the saved measurement to be active in the power-on mode. Recalling a User Preset file has the same issues that recalling a Save State file has. Some settings may need to be limited and therefore re-coupled, since the capabilities of the mode may have changes when the User Preset file was last saved.
Initial S/W Revision	Prior to A.02.00

## Save User Preset

Saves the currently active mode and its State. You can recall this User Preset file by pressing the User Preset menu key or sending the SYST:PRES:USER remote command. This same state is also saved by the Save State function.

Key Path	User Preset
Remote Command	:SYSTem:PRESet:USER:SAVE
Example	:SYST:PRES:USER:SAVE
Notes	:SYST:PRES:SAVE creates the same file as if the user requested a *SAV or a MMEM:STOR:STAT, except User Preset Save does not allow the user to specify the filename or the location of the file.
Initial S/W Revision	Prior to A.02.00

## View/Display

Accesses a menu that includes keys that enables you to control the instrument display.

For details of available views, see [View Selection](#).

For details of remote commands associated with views, see [Range Table Selection \(SCPI only command\)](#).

Key Path	Front-panel key
Initial S/W Revision	Prior to A.02.00

## Display

The Display menu is common to most measurements, and is used for configuring items on the display. Some Display menu settings apply to all the measurements in a mode, and some only to the current measurement. Those under the System Display Settings key apply to all measurements in all modes.

Key Path	Display
Key Path	View/Display
Initial S/W Revision	Prior to A.02.00

## Annotation

Turns on and off various parts of the display annotation. The annotation is divided up into four categories:

1. Meas Bar: This is the measurement bar at the top of the screen. It does not include the settings panel or the Active Function. Turning off the Meas Bar turns off the settings panel and the Active Function. When the Meas Bar is off, the graticule area expands to fill the area formerly occupied by the Meas Bar.
2. Screen Annotation: this is the annotation and annunciation around the graticule, including any annotation on lines (such as the display line, the threshold line, etc.) This does NOT include the marker number or the N dB result. When off, the graticule expands to fill the entire graticule area.
3. Trace annotation: these are the labels on the traces, showing their detector (or their math mode).
4. Active Function annotation: this is the active function display in the meas bar, and all of the active function values displayed on softkeys.

See the figure below. Each type of annotation can be turned on and off individually.

13 Spurious Emissions Measurement  
View/Display

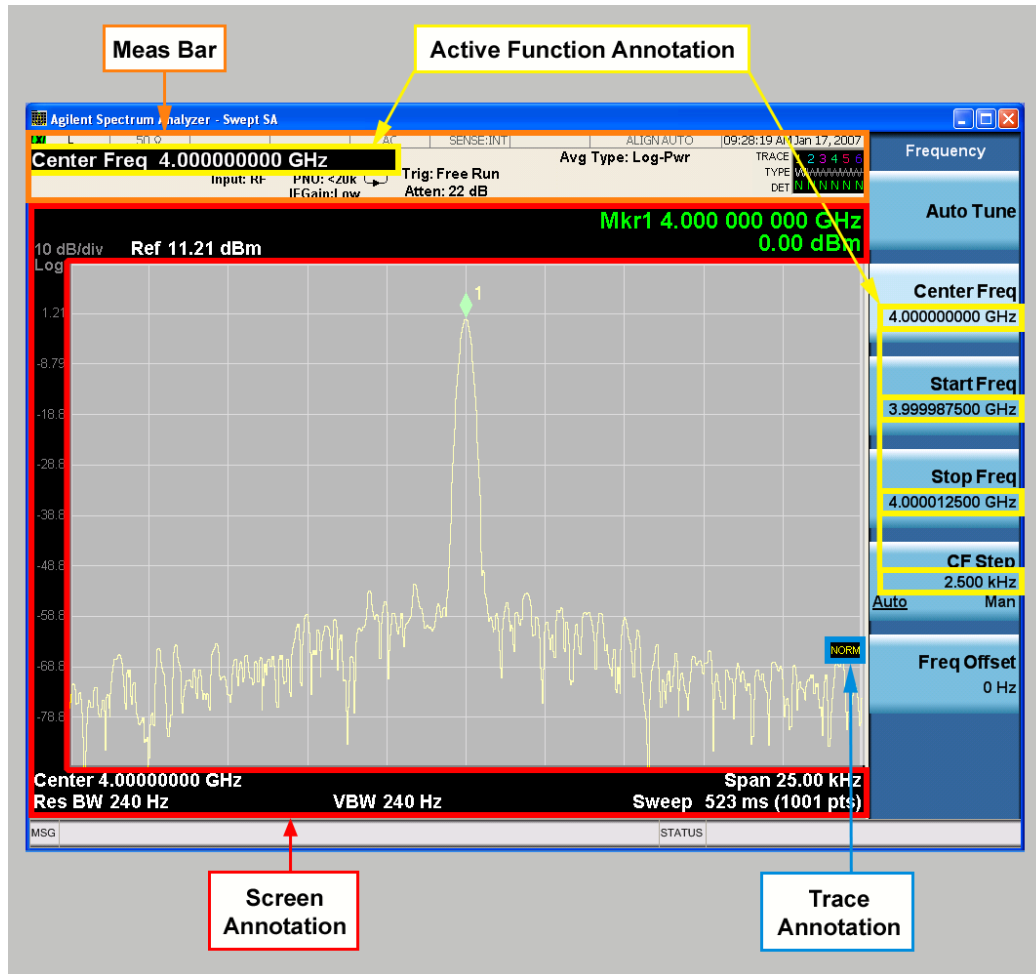

Key Path	View/Display, Display
Initial S/W Revision	Prior to A.02.00

Meas Bar On/Off

This function turns the Measurement Bar on and off, including the settings panel. When off, the graticule area expands to fill the area formerly occupied by the Measurement Bar.

Key Path	View/Display, Display, Annotation
Remote Command	:DISPlay:ANNOtation:MBAR[:STATe] OFF ON 0 1 :DISPlay:ANNOtation:MBAR[:STATe]?
Example	DISP:ANN:MBAR OFF
Dependencies	Grayed out and forced to OFF when System Display Settings, Annotation is set to Off.
Preset	On This should remain Off through a Preset when System DisplaySettings, Annotation is set to Off.
State Saved	Saved in instrument state.
Initial S/W Revision	Prior to A.02.00



## Screen

This controls the display of the annunciation and annotation around the graticule, including any annotation on lines (such as the display line, the threshold line, etc.) and the y-axis annotation. This does NOT include marker annotation (or the N dB result). When off, the graticule expands to fill the entire graticule area, leaving only the 1.5% gap above the graticule as described in the Trace/Detector chapter.

Key Path	View/Display, Display, Annotation
Remote Command	:DISPlay:ANNotation:SCReen[:STATe] OFF ON 0 1 :DISPlay:ANNotation:SCReen[:STATe]?
Example	DISP:ANN:SCR OFF
Dependencies	Grayed-out and forced to OFF when System Display Settings, Annotation is set to Off.
Preset	On This should remain Off through a Preset when System DisplaySettings, Annotation is set to Off
State Saved	Saved in instrument state.
Initial S/W Revision	Prior to A.02.00

## Active Function Values On/Off

Turns on and off the active function display in the Meas Bar, and all of the active function values displayed on the softkeys.

Note that all of the softkeys that have active functions have these numeric values blanked when this function is on. This is a security feature..

13 Spurious Emissions Measurement  
View/Display

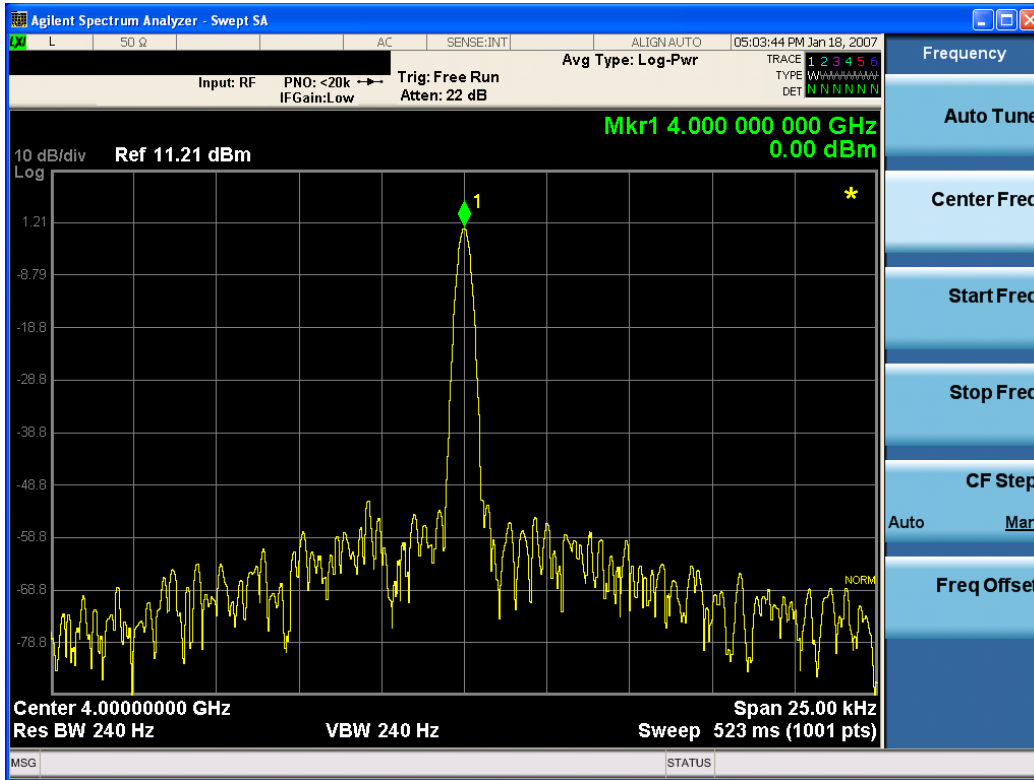

Key Path	View/Display, Display, Annotation
Remote Command	:DISPlay:ACTivefunc[:STATE] ON OFF 1 0 :DISPlay:ACTivefunc[:STATE] ?
Example	DISP:ACT OFF
Dependencies	Grayed out and forced to OFF when System Display Settings, Annotation is set to Off.
Preset	On This should remain Off through a Preset when System DisplaySettings, Annotation is set to Off
State Saved	Saved in instrument state.
Initial S/W Revision	Prior to A.02.00

Title

Displays menu keys that enable you to change or clear a title on your display.

Key Path	View/Display, Display
Initial S/W Revision	Prior to A.02.00

Change Title

Writes a title into the "measurement name" field in the banner, for example, "Swept SA".

Press Change Title to enter a new title through the alpha editor. Press Enter or Return to complete the entry. Press ESC to cancel the entry and preserve your existing title.

The display title will replace the measurement name. It remains for this measurement until you press Change Title again, or you recall a state, or a Preset is performed. A title can also be cleared by pressing Title, Clear Title.

**NOTE**

Notice the inclusion of the <measurement> parameter in the command below. Because each measurement remembers the Display Title, the command must be qualified with the measurement name. For the Swept SA measurement this is not the case; no <measurement> parameter is used when changing the Display Title for the Swept SA measurement.

Key Path	View/Display, Display, Title
Mode	All
<b>Remote Command</b>	:DISPlay:<measurement>:ANNotation:TITLe:DATA <string> :DISPlay:<measurement>:ANNotation:TITLe:DATA?
<b>Example</b>	DISP:ANN:TITL:DATA "This Is My Title" This example is for the Swept SA measurement in the Spectrum Analyzer mode. The SANalyzer <measurement> name is not used. DISP:ACP:ANN:TITL:DATA "This Is My Title" This example is for Measurements other than Swept SA. Both set the title to: This Is My Title
Notes	Pressing this key cancels any active function. When a title is edited the previous title remains intact (it is not cleared) and the cursor goes at the end so that characters can be added or BKSP can be used to go back over previous characters.
Preset	No title (measurement name instead)
State Saved	Saved in instrument state.
Initial S/W Revision	Prior to A.02.00

### Clear Title

Clears a title from the front-panel display. Once cleared, the title cannot be retrieved. After the title is cleared, the current Measurement Name replaces it in the title bar.

Key Path	View/Display, Display, Title
<b>Example</b>	The following commands clear the title and restore the measurement's original title: DISP:ANN:TITL:DATA "" This example is for the Swept SA measurement in the Spectrum Analyzer mode. The SANalyzer <measurement> name is not used. DISP:ACP:ANN:TITL:DATA "" This example is for ACP; in measurements other than Swept SA the measurement name is required.
Notes	Uses the :DISPlay:<measurement>:ANNotation:TITLe:DATA <string> command with an empty string (in the Swept SA, the <measurement> is omitted).
Preset	Performed on Preset.
Initial S/W Revision	Prior to A.02.00

## Graticule

Pressing Graticule turns the display graticule On or Off. It also turns the graticule y-axis annotation on and off.

Key Path	View/Display, Display
Remote Command	:DISPlay:WINDow[1]:TRACe:GRATicule:GRID[:STATe] OFF ON 0 1 :DISPlay:WINDow[1]:TRACe:GRATicule:GRID[:STATe]?
Example	DISP:WIND:TRAC:GRAT:GRID OFF
Notes	The graticule is the set of horizontal and vertical lines that make up the grid/divisions for the x-axis and y-axis.
Preset	On
State Saved	Saved in instrument state
Initial S/W Revision	Prior to A.02.00

## System Display Settings

These settings are "Mode Global" – they affect all modes and measurements and are reset only by Restore Misc Defaults or Restore System Defaults under System.

Key Path	View/Display, Display
Initial S/W Revision	Prior to A.02.00

## Annotation Local Settings

This is a Mode Global override of the meas local annotation settings. When it is All Off, it forces ScreenAnnotation, Meas Bar, Trace, and Active Function Values settings to be OFF for all measurements in all modes. This provides the security based "annotation off" function of previous analyzers; hence it uses the legacy SCPI command.

When it is All Off, the Screen, Meas Bar, Trace, and Active Function Values keys under the Display, Annotation menu are grayed out and forced to Off. When Local Settings is selected, you are able to set the local annotation settings on a measurement by measurement basis.

Key Path	View/Display, Display, System Display Settings
Remote Command	:DISPlay:WINDow[1]:ANNotation[:ALL] OFF ON 0 1 :DISPlay:WINDow[1]:ANNotation[:ALL]?
Example	:DISP:WIND:ANN OFF
Preset	On (Set by Restore Misc Defaults)
State Saved	Not saved in instrument state.
Backwards Compatibility Notes	The WINDow parameter and optional subopcode is included for backwards compatibility but ignored – all windows are equally affected.
Initial S/W Revision	Prior to A.02.00

## Themes

Accesses a menu of functions that enable you to choose the theme to be used when saving the screen image.

The **Themes** option is the same as the **Themes** option under the **Display** and **Page Setup** dialogs. It allows you to choose between themes to be used when saving the screen image.

<b>Key Path</b>	Save, Screen Image
<b>Remote Command</b>	:MMEMory:STORe:SCReem:THEMe TDColor   TDMonochrome   FCOLor   FMONochrome  :MMEMory:STORe:SCReem:THEMe?
<b>Example</b>	:MMEM:STOR:SCR:THEM TDM
<b>Preset</b>	3D Color; Is not part of Preset, but is reset by Restore Misc Defaults or Restore System Defaults All and survives subsequent running of the modes.
<b>Readback</b>	3D Color   3D Mono   Flat Color   Flat Mono
<b>Backwards Compatibility Notes</b>	In ESA and PSA we offer the choice of "Reverse Bitmap" or "Reverse Metafile" when saving screen images. This is much like the "Flat Color" theme available in X-Series. Also, if you selected Reverse Bitmap AND a black & white screen image, that would be much like "Flat Monochrome". In other words, each of the X-Series themes has a similar screen image type in ESA/PSA. But they are not identical.
<b>Initial S/W Revision</b>	Prior to A.02.00

### 3D Color

Selects a standard color theme with each object filled, shaded and colored as designed.

<b>Key Path</b>	Save, Screen Image, Themes
<b>Example</b>	MMEM:STOR:SCR:THEM TDC
<b>Readback</b>	3D Color
<b>Initial S/W Revision</b>	Prior to A.02.00

### 3D Monochrome

Selects a format that is like 3D color but shades of gray are used instead of colors.

<b>Key Path</b>	Save, Screen Image, Themes
<b>Example</b>	MMEM:STOR:SCR:THEM TDM
<b>Readback</b>	3D Mono
<b>Initial S/W Revision</b>	Prior to A.02.00

### Flat Color

Selects a format that is best when the screen is to be printed on an ink printer.

Key Path	Save, Screen Image, Themes
<b>Example</b>	MMEM:STOR:SCR:THEM FCOL
Readback	Flat Color
Initial S/W Revision	Prior to A.02.00

### Flat Monochrome

Selects a format that is like Flat Color. But only black is used (no colors, not even gray), and no fill.

Key Path	Save, Screen Image, Themes
<b>Example</b>	MMEM:STOR:SCR:THEM FMON
Readback	Flat Mono
Initial S/W Revision	Prior to A.02.00

### Backlight

Accesses the display backlight on/off keys. This setting may interact with settings under the Windows "Power" menu.

When the backlight is off, pressing ESC, TAB, SPACE, ENTER, UP, DOWN, LEFT, RIGHT, DEL, BKSP, CTRL, or ALT turns the backlight on without affecting the application. Pressing any other key will turn backlight on and could potentially perform the action as well.

Key Path	View/Display, Display, System Display Settings
<b>Remote Command</b>	:DISPlay:BACKlight ON OFF :DISPlay:BACKlight?
Preset	ON (Set by Restore Misc Defaults)
Initial S/W Revision	Prior to A.02.00

### Backlight Intensity

An active function used to set the backlight intensity. It goes from 0 to 100 where 100 is full on and 0 is off. This value is independent of the values set under the Backlight on/off key.

Key Path	View/Display, Display, System Display Settings
<b>Remote Command</b>	:DISPlay:BACKlight:INTensity <integer> :DISPlay:BACKlight:INTensity?
<b>Example</b>	DISP:BACK:INT 50

Preset	100 (Set by Restore Misc Defaults)
Min	0
Max	100
Initial S/W Revision	Prior to A.02.00

## View Selection

Selects the desired view. The following views are available:

- **"Graph + Metrics" on page 1587** – The lower window displays a list of spurs detected in a measurement cycle. The upper window displays a trace of the range that contains the currently selected spur.
- **"Range Table" on page 1588** – The lower window displays settings of ranges. The upper window displays a trace of the currently selected range.
- **"All Ranges" on page 1591** – The lower window displays a list of spurs detected in a measurement cycle. The upper window displays a merged trace of all the ranges.

Key Path	View/Display
Mode	SA, WCDMA, C2K, 1xEV-DO, WIMAX OFDMA, TD-SCDMA, DVB-T/H, LTE, LTETDD, MSR, LTEAFDD, LTEATDD
Remote Command	:DISPlay:SPURious:VIEW[:SElect] RESult   RANGe   ALL :DISPlay:SPURious:VIEW[:SElect]?
Example	DISP:SPUR:VIEW RANG DISP:SPUR:VIEW?
Notes	You must be in cdma2000 mode, TD-SCDMA mode, W-CDMA mode, DVB-T/H mode, GSM/EDGE mode, LTE mode, LTE TDD mode, LTE-Advanced FDD/TDD mode, MSR or WiMAX mode to use this command. Use INSTRument:SElect to set the mode.
Preset	RESult
State Saved	No
Range	Graph + Metrics   Range Table   All Ranges
Initial S/W Revision	A.10.00
Modified at S/W Revision	A.11.00

## Graph + Metrics

Select Graph + Metrics to view measurement results.

- The lower window displays a list of spurs detected in a measurement cycle. The currently selected spur, which is highlighted, can be changed by the Spur softkey in the Meas Setup menu.
- The upper window displays a trace of the range that contains the currently selected spur.

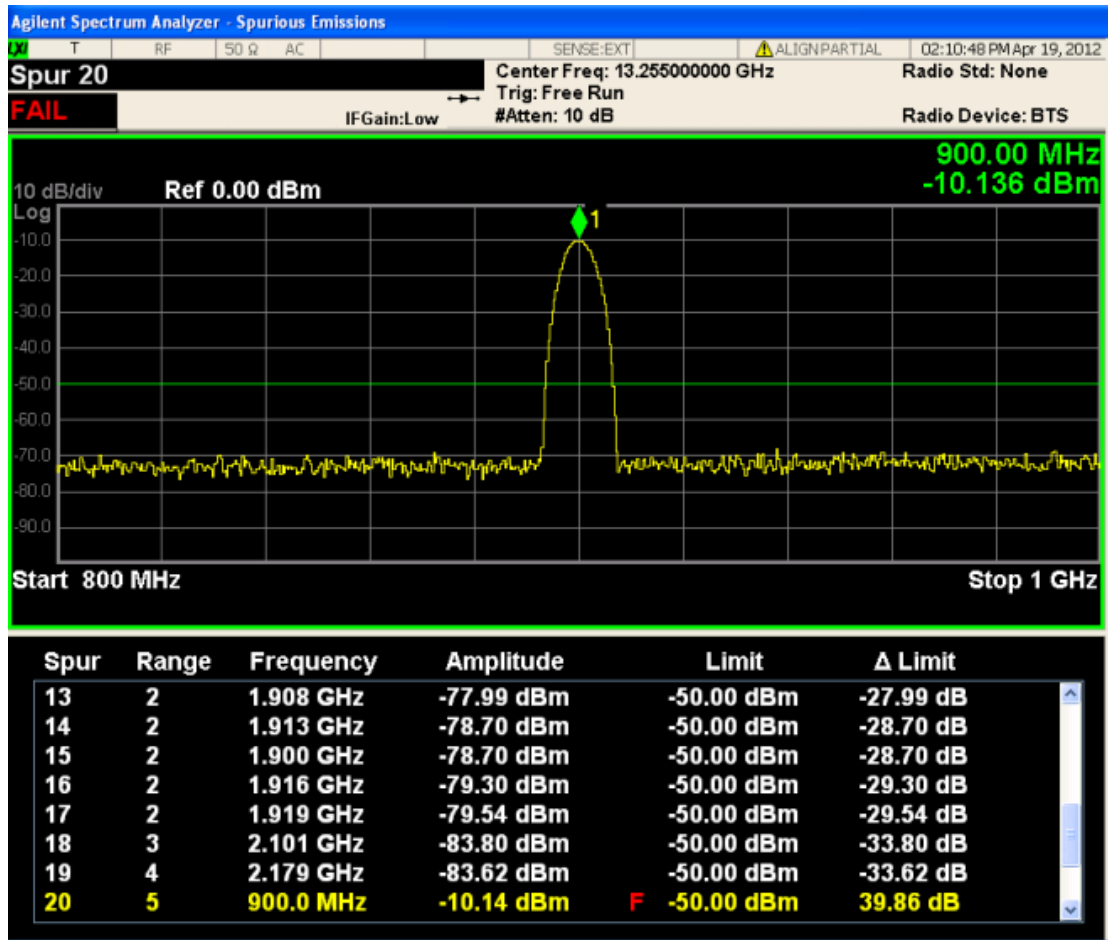

Result	Units	Min	Max
Spur	N/A	0	200
Range	N/A	1	20
Frequency	Hz	Analyzer Min	Analyzer Max
Amplitude	dBm	-150	50
Limit	dBm	-150	50

The spurs listed are within the current value of the Marker Peak Excursion setting of the absolute limit. All of the spurs listed passed. Any spur that has failed the absolute limit will have an 'F' beside it.

### Range Table

Select Range Table to view range settings.

- The upper window displays a trace of the range specified by the Range key under Range Table in Meas Setup.
- The lower window displays the range setting.



All enabled range may not be displayed with the normal window arrangement. Even in that case, the instrument always displays the highlighted line in the table. When you zoom the lower window, all 20 ranges can be displayed.

When the range state is OFF, “---” appears, to indicate the range is inactive.

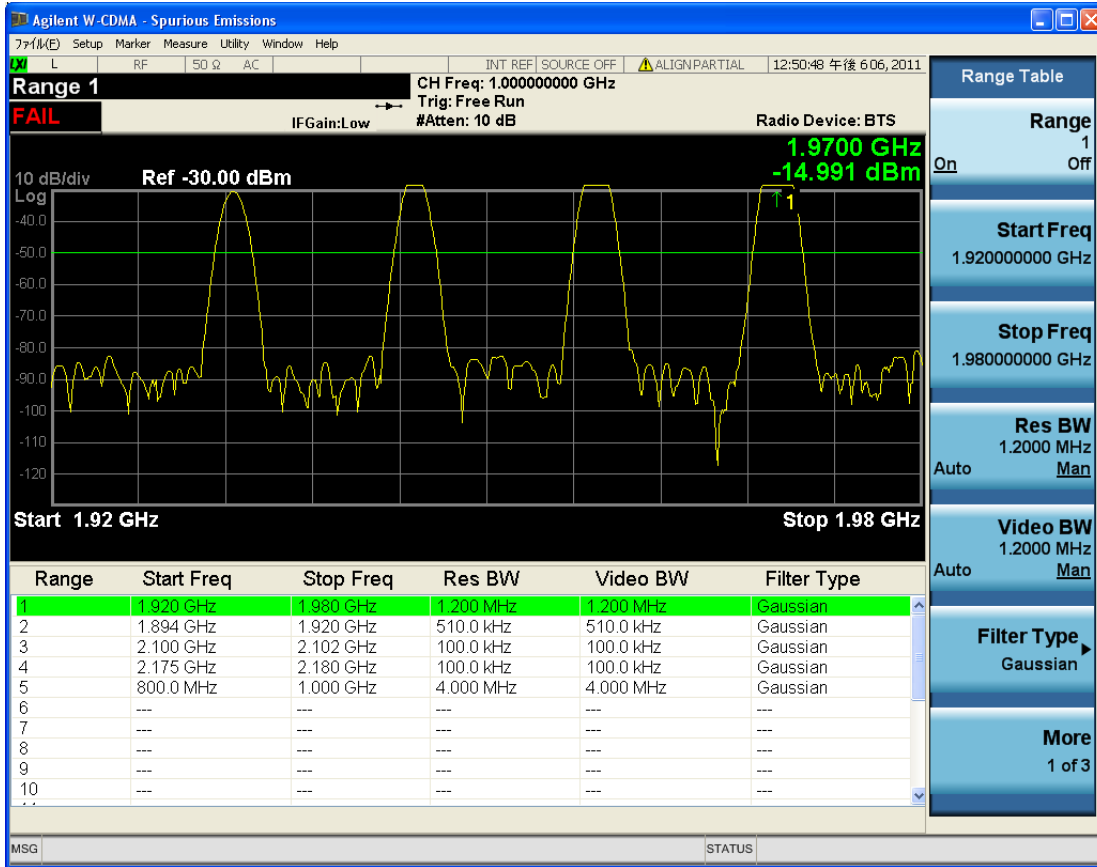

13 Spurious Emissions Measurement  
View/Display

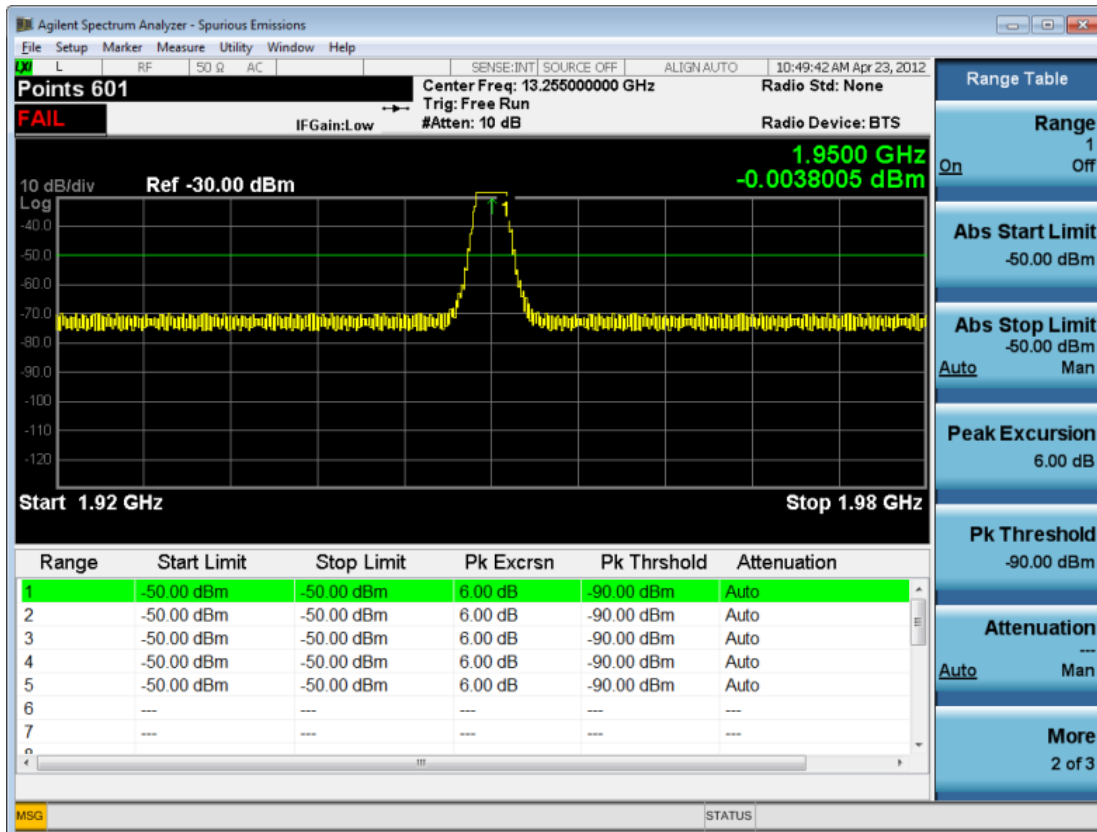

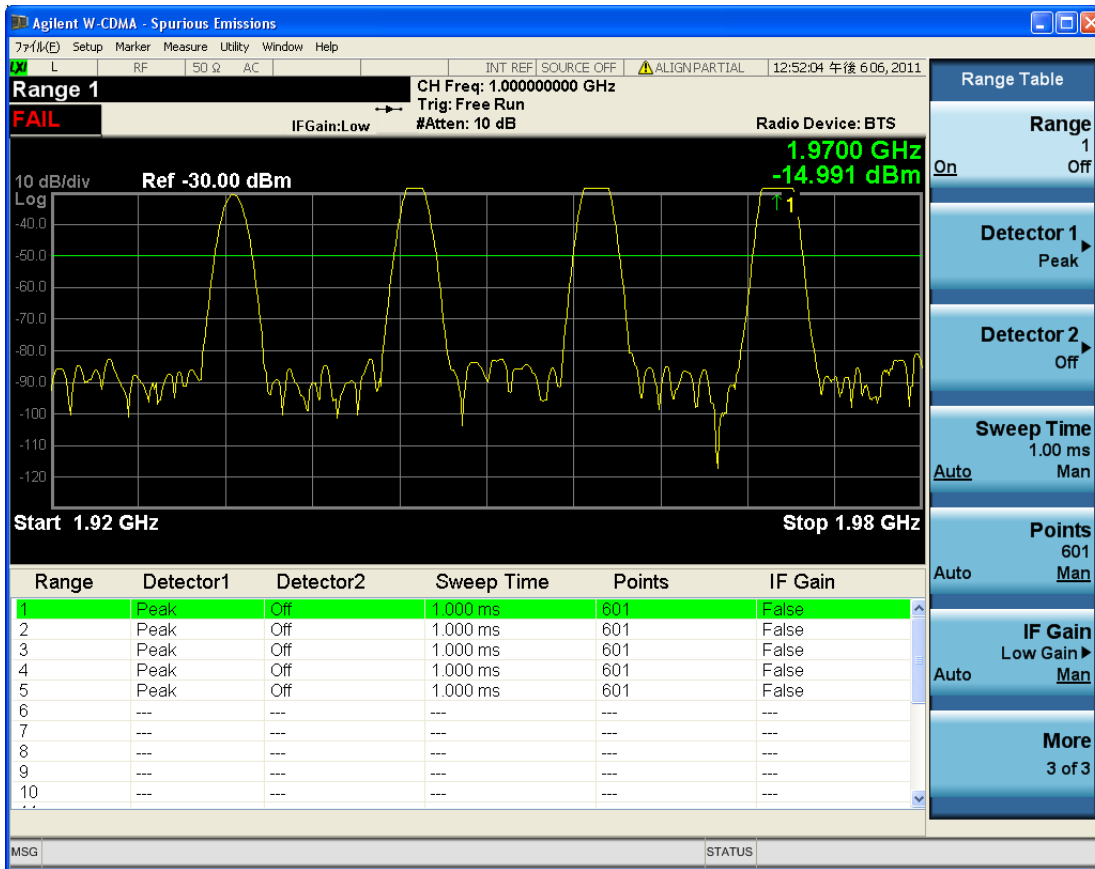

## All Ranges

Select All Ranges to view measurement results for all the ranges.

- The upper window displays a merged trace of all the ranges.
- The lower window displays a list of spurs detected in a measurement cycle. The currently selected spur, which is highlighted, can be changed by the Spur softkey in the Meas Setup menu.

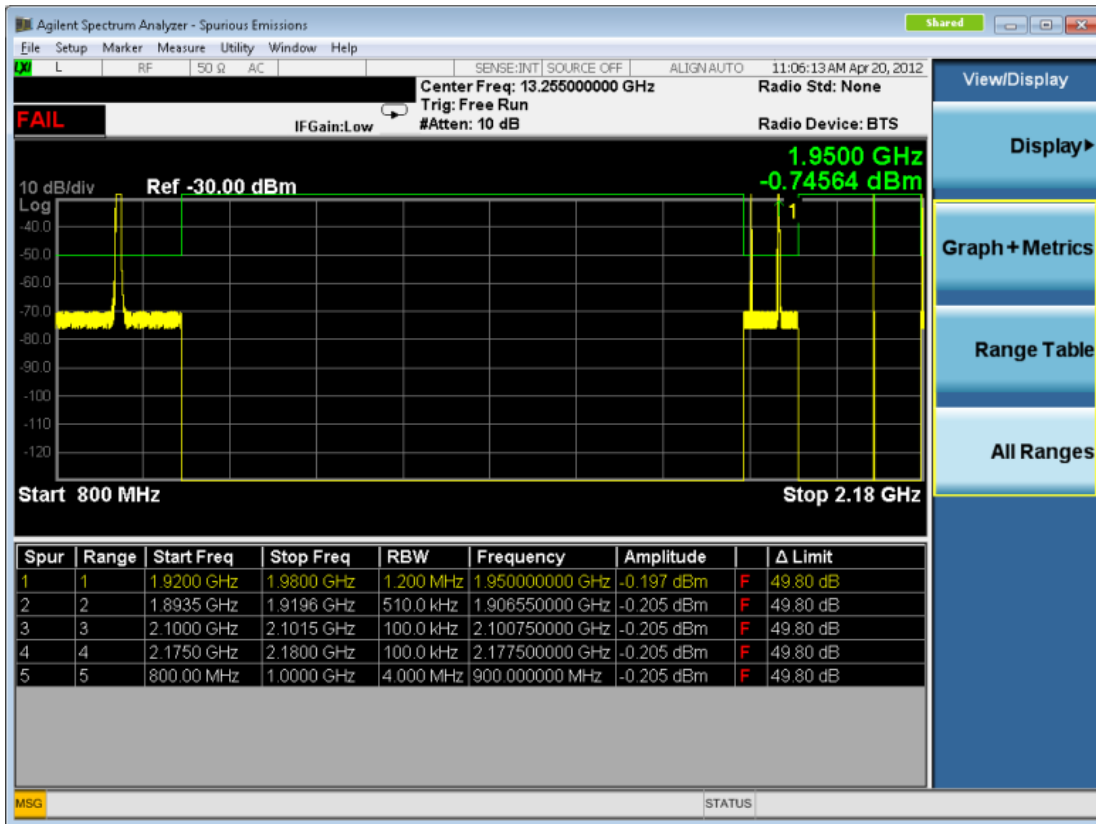

### Range Table Selection (SCPI only command)

Switches contents of Range Table. There are three tables in the Range Table window, corresponding to each page of the Range Table menu. If the Range Table menu is displayed, this command changes the page of the Range Table menu too. Pressing the Range Table softkey always changes the current Range Table to 1.

Key Path	SCPI only
Mode	SA, WCDMA, C2K, 1xEV-DO, WIMAX OFDMA, TD-SCDMA, DVB-T/H, LTE, LTE TDD, WLAN, MSR, LTE FDD, LTE TDD
Remote Command	:DISPlay:SPURious:VIEW:RANGe:TABLE <integer> :DISPlay:SPURious:VIEW:RANGe:TABLE?
Example	DISP:SPUR:VIEW:RANG:TABL 2 DISP:SPUR:VIEW:RANG:TABL?
Notes	You must be in cdma2000 mode, TD-SCDMA mode, W-CDMA mode, DVB-T/H mode, GSM/EDGE mode, LTE mode, LTE TDD mode, WLAN mode, LTE-Advanced FDD/TDD mode, MSR or WiMAX mode to use this command. Use INSTRument:SElect to set the mode.
Preset	1
State Saved	No
Min	1
Max	3
Initial S/W Revision	A.10.00





## 14 Power Stat CCDF Measurement

Many of the digitally modulated signals now look noise-like in the time and frequency domain. This means that statistical measurements of the signals can be a useful characterization. The Power Complementary Cumulative Distribution Function (CCDF) curves characterize the higher level power statistics of a digitally modulated signal. The curves can be useful in determining design parameters for digital communications systems.

For more details, see ["Power Stat CCDF Measurement Description" on page 1599](#).

For measurement results and views, see ["View/Display" on page 1718](#).

This topic contains the following sections:

["Measurement Commands for Power Stat CCDF" on page 1596](#)

["Remote Command Results for Power Stat CCDF" on page 1597](#)

["Power Stat CCDF Measurement Description" on page 1599](#)

## Measurement Commands for Power Stat CCDF

The following commands and queries can be used to retrieve the measurement results:

`:CONFigure:PStatistic`

`:CONFigure:PStatistic:NDEFault`

`:INITiate:PStatistic`

`:FETCh:PStatistic[n]?`

`:READ:PStatistic[n]?`

`:MEASure:PStatistic[n]?`

For more measurement related commands, see the SENSE subsystem, and the section "[Remote Measurement Functions](#)" on page 2848.



## Remote Command Results for Power Stat CCDF

The following table describes the results returned by the FETCh, MEASure, and READ queries listed above, according to the index value n.

n	Results Returned
0	Returns unprocessed I/Q trace data, as a series of trace point values, in volts. The I values are listed first in each pair, using the 0 through even-indexed values. The Q values are the odd-indexed values,
not specified or 1	Returns 10 scalar results: <ol style="list-style-type: none"> <li>1. Average input power (in dBm)</li> <li>2. Probability at the average input power level (in %)</li> <li>3. Power level that has 10% of the power</li> <li>4. Power level that has 1% of the power</li> <li>5. Power level that has 0.1% of the power</li> <li>6. Power level that has 0.01% of the power</li> <li>7. Power level that has 0.001% of the power</li> <li>8. Power level that has 0.0001% of the power</li> <li>9. Peak power (in dB)</li> <li>10.Count</li> </ol>
2	Returns a series of 5001 floating point numbers (in percent) that represent the current measured power stat trace. This is the probability at particular power levels (average power), in the following order: <ol style="list-style-type: none"> <li>1. Probability at 0.0 dB power</li> <li>2. Probability at 0.01 dB power</li> <li>3. Probability at 0.02 dB power</li> <li>...</li> <li>5000. Probability at 49.9 dB power</li> <li>5001. Probability at 50.0 dB power</li> </ol>
3	Returns a series of 5001 floating point numbers (in percent) that represent the Gaussian trace. This is the probability at particular power levels (average power), in the following order: <ol style="list-style-type: none"> <li>1. Probability at 0.0 dB power</li> <li>2. Probability at 0.01 dB power</li> <li>3. Probability at 0.02 dB power</li> <li>...</li> <li>5000. Probability at 49.9 dB power</li> <li>5001. Probability at 50.0 dB power</li> </ol>
4	Returns a series of 5001 floating point numbers (in percent) that represent the user-definable reference trace. This is the probability at particular power levels (average power), in the following order: <ol style="list-style-type: none"> <li>1. Probability at 0.0 dB power</li> <li>2. Probability at 0.01 dB power</li> <li>3. Probability at 0.02 dB power</li> <li>...</li> <li>5000. Probability at 49.9 dB power</li> <li>5001. Probability at 50.0 dB power</li> </ol>



## Power Stat CCDF Measurement Description

The power statistics CCDF measurement can be affected by many factors. For example, modulation filtering, modulation format, combining the multiple signals at different frequencies, number of active codes, and correlation between symbols on different codes with spread spectrum systems will all affect measurement results. These factors are all related to modulation and signal parameters. External factors such as signal compression and expansion by nonlinear components, group delay distortion from filtering, and power control within the observation interval also affect the measurement.

The power measured in power statistics CCDF curves is actually instantaneous envelope power defined by the equation:

$$P = (I^2 + Q^2) / Z_0$$

where I & Q are the quadrature voltage components of the waveform, and  $Z_0$  is the characteristic impedance.

A CCDF curve is defined by how much time the waveform spends at or above a given power level. The percent of time the signal spends at or above the level defines the probability for that particular power level. For capturing a lower probability down to 0.0001%, this measurement is made in the single mode by pressing Single. To make the power statistics CCDF measurement, the instrument uses digital signal processing (DSP) to sample the input signal in the channel bandwidth. The Gaussian distribution line as the band-limited Gaussian noise CCDF reference line, the user-definable reference trace, and the currently measured trace can be displayed on a semi-log graph. If the currently measured trace is above the user reference trace, it means that the higher peak power levels against the average power are included in the input signal.

Key Path	Meas
Initial S/W Revision	Prior to A.02.00

## AMPTD Y Scale

Accesses a menu of functions that enable you to set the vertical scale parameters. The parameter values are measurement independent except all Attenuation values, and the Internal Preamp selection, which are the same across all measurements.

Key Path	Front-panel key
Initial S/W Revision	Prior to A.02.00

### Attenuation

This menu controls the attenuator functions and interactions between the attenuation system components.

There are two attenuator configurations in the X-Series. One is a dual attenuator configuration consisting of a mechanical attenuator and an optional electronic attenuator. The other configuration uses a single attenuator with combined mechanical and electronic sections that controls all the attenuation functions. Different models in the X-Series come with different configurations.

See "[Dual Attenuator Configurations:](#)" on page 1600

See "[Single Attenuator Configuration:](#)" on page 1601

Most Attenuation settings are the same for all measurements – they do not change as you change measurements. Settings like these are called “Meas Global” and are unaffected by Meas Preset.

Key Path	AMPTD Y Scale
Scope	Meas Global
Dependencies	In measurements that support the I/Q inputs, this key is unavailable when I/Q is the selected input, and is replaced by the Range key in that case.
Readback Line	Contains a summary in [ ] brackets of the current total attenuation. See the descriptions of the , " <a href="#">(Mech) Atten</a> " on page 2783, and " <a href="#">Enable Elec Atten</a> " on page 2785 keys for more detail on the contributors to the total attenuation.  Note that when "Pre-Adjust for Min Clip" is on, this value can change at the start of every measurement.
Initial S/W Revision	Prior to A.02.00
Modified at S/W Revision	A.03.00

### Dual Attenuator Configurations:

Configuration 1: Mechanical attenuator + optional electronic attenuator

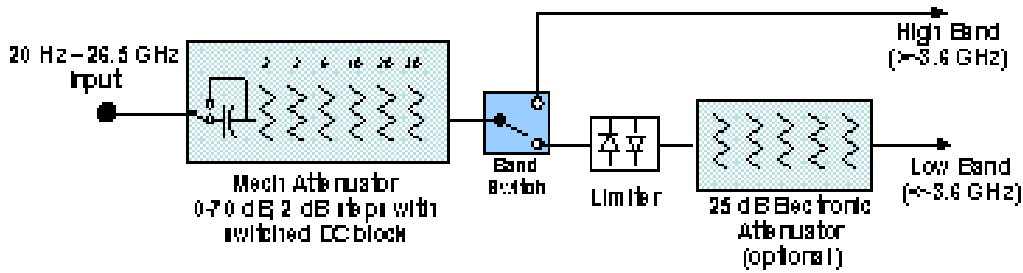

Configuration 2: Mechanical attenuator, no optional electronic attenuator

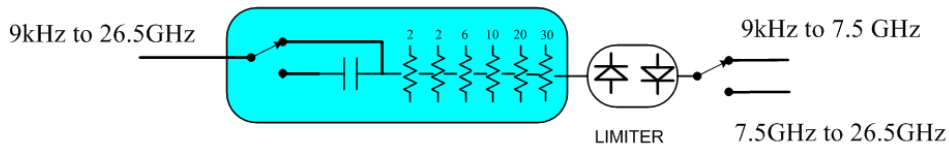

(note that Configuration 2 is not strictly speaking a dual-section attenuator, since there is no electronic section available. However, it behaves exactly like Configuration 1 without the Electronic Attenuator option EA3, therefore for the sake of this document it is grouped into the “Dual Attenuator” configuration)

**Single Attenuator Configuration:**

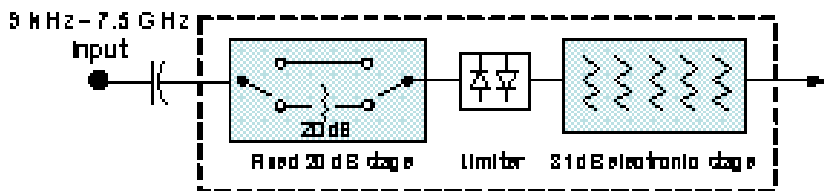

You can tell which attenuator configuration you have by pressing the Attenuation key, which (in most Modes) opens the Attenuation menu. If the first key in the Attenuation menu says Mech Atten you have the dual attenuator configuration. If the first key says Atten you have the single attenuator configuration.

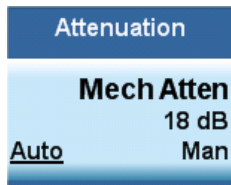

Dual Attenuator

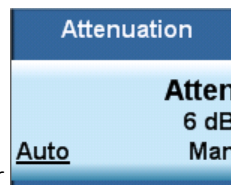

Single Attenuator

In the single attenuator configuration, you control the attenuation with a single control, as the fixed stage has only two states. In the dual attenuator configuration, both stages have significant range so you are given separate control of the mechanical and electronic attenuator stages.

When you have the dual attenuator configuration, you may still have only a single attenuator, because unless option EA3 (the Electronic Attenuator option) is available, and you purchase it, you will have only the mechanical attenuator.

## (Mech) Atten

This key is labeled Mech Atten in dual attenuator models and Atten in single attenuator models. In the dual attenuator configuration, this key only affects the mechanical attenuator.

This key lets you modify the attenuation applied to the RF input signal path. This value is normally auto coupled to the Ref Level, the Internal Preamp Gain, any External Gain that is entered, and the Max Mixer Level, as described in the table below.

See "[Attenuator Configurations and Auto/Man](#)" on page 1603

<b>Key Path</b>	AMPTD Y Scale, Attenuation
<b>Remote Command</b>	<pre>[ :SENSe ] :POWer [ :RF ] :ATTenuation &lt;rel_ampl&gt; [ :SENSe ] :POWer [ :RF ] :ATTenuation? [ :SENSe ] :POWer [ :RF ] :ATTenuation:AUTO OFF ON 0 1 [ :SENSe ] :POWer [ :RF ] :ATTenuation:AUTO?</pre>
<b>Example</b>	<p>POW:ATT 20</p> <p>Dual attenuator configuration: sets the mechanical attenuator to 20 dB</p> <p>Single attenuator mode: sets the main attenuation to 20 dB (see below for definition of “main” attenuation).</p> <p>If the attenuator was in Auto, it sets it to Manual.</p>
<b>Dependencies</b>	<p>Some measurements do not support the Auto setting of (Mech) Atten. In these measurements, the Auto/Man selection is not available, and the Auto/Man line on the key disappears.</p> <p>In dual attenuator configurations, when the electronic attenuator is enabled, the mechanical attenuator has no auto setting and the Auto/Man line on the key disappears. The state of Auto/Man is remembered and restored when the electronic attenuator is once again disabled. This is described in more detail in the "<a href="#">Enable Elec Atten</a>" on page 2785 key description.</p> <p>See "<a href="#">Attenuator Configurations and Auto/Man</a>" on page 1603 for more information on the Auto/Man functionality of Attenuation.</p>
<b>Couplings</b>	<p>When (Mech) Atten is in Auto, it uses the following algorithm to determine a value:</p> <p>If the USB Preamp is connected to USB, use 0 dB.</p> <p>Otherwise, <math>Atten = ReferenceLevel + PreAmpGain + ExternalGain - RefLevelOffset - MaxMixerLevel + IF\ Gain</math>.</p> <p>Limit this value to be between 6 dB and the Max value. No value below 6 dB can ever be chosen by Auto.</p> <p>The resulting value is rounded up to the largest value possible given the attenuation step setting. That is, 50.01 dB would change to 60 dB (for a 10 dB attenuation step).</p> <p>The “IF Gain” term in the equation above is either 0 dB or +10 dB, depending on the settings of FFT IF Gain, Swept IF Gain, max Ref Level and the Auto/Man setting of Mech Atten.</p> <p>In External Mixing and BBIQ, where the Attenuator is not in the signal path, the Attenuator setting changes as described above when (Mech) Atten is in Auto, but no changes are made to the actual attenuator hardware setting until the input is changed back to the RF Input.</p>
<b>Preset</b>	<p>The preset for Mech Attenuation is “Auto.”</p> <p>The Auto value of attenuation is:</p> <p>CXA, EXA, MXA and PXA: 10 dB</p>

State Saved	Saved in instrument state
Min	0 dB The attenuation set by this key cannot be decreased below 6 dB with the knob or step keys. To get to a value below 6 dB it has to be directly entered from the keypad or via SCPI. This protects from adjusting the attenuation to a dangerously small value which can put the instrument at risk of damage to input circuitry. However, if the current mechanical attenuation is below 6 dB it can be increased with the knob and step keys, but not decreased.
Max	CXA N9000A-503/507: 50 dB CXA N9000A-513/526: 70dB EXA: 60 dB MXA and PXA: 70 dB In the single attenuator configuration, the total of ATT and EATT cannot exceed 50 dB, so if the EATT is set to 24 dB first, the main attenuation cannot be greater than 26 dB and will be reduced accordingly; if the main attenuator is set to 40 dB first, EATT cannot be greater than 10 dB.
Initial S/W Revision	Prior to A.02.00
Modified at S/W Revision	A.03.00

### Attenuator Configurations and Auto/Man

As described in the Attenuation key description, there are two distinct attenuator configurations available in the X-Series, the single attenuator and dual attenuator configurations. In dual attenuator configurations, we have the mechanical attenuation and the electronic attenuation, and the current total attenuation is the sum of the electronic + mechanical attenuation. In single attenuator configurations, we refer to the attenuation set using the (Mech) Atten key (or POW:ATT SCPI) as the “main” attenuation; and the attenuation that is set by the SCPI command POW:EATT as the “soft” attenuation (the POW:EATT command is honored even in the single attenuator configuration, for compatibility purposes). Then the current total attenuation is the sum of the main + soft attenuation. See the Elec Atten key description for more on “soft” attenuation.

In the dual attenuator configuration, when the electronic attenuator is enabled, there is no Auto/Man functionality for the mechanical attenuator, and the third line of the key label (the Auto/Man line) disappears:

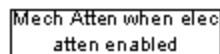
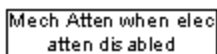
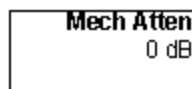
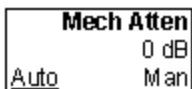

usdB

### Enable Elec Atten

Enables the Electronic Attenuator.

The electronic attenuator offers finer steps than the mechanical attenuator, has no acoustical noise, is faster, and is less subject to wear. These advantages primarily aid in remote operation and are negligible

for front panel use. See ["Using the Electronic Attenuator: Pros and Cons" on page 1605](#) for a detailed discussion of the pros and cons of using the electronic attenuator.

For the single attenuator configuration, for SCPI backwards compatibility, the “soft” attenuation feature replaces the dual attenuator configuration’s electronic attenuator. All the same couplings and limitations apply. See ["Attenuator Configurations and Auto/Man" on page 2785](#)

See ["More Information" on page 1604](#)

<b>Key Path</b>	AMPTD Y Scale, Attenuation
<b>Remote Command</b>	[ :SENSe ] :POWer [ :RF ] :EATTenuation:STATe OFF ON 0 1 [ :SENSe ] :POWer [ :RF ] :EATTenuation:STATe?
<b>Example</b>	POW:EATT:STAT ON
<b>Dependencies</b>	<p>This key only appears in Dual Attenuator models with an Electronic Attenuator installed. It does not appear in models with the Single Attenuator configuration, as in the single attenuator configuration there is no “electronic attenuator” there is only a single integrated attenuator (which has both a mechanical and electronic stage). However, in the single attenuator configuration, EATT SCPI commands are accepted for compatibility with other X-series instruments and set a “soft” attenuation as described in <a href="#">"Attenuator Configurations and Auto/Man" on page 2785</a>.</p> <p>The electronic attenuator (and the “soft” attenuation function provided in single attenuator configurations) is unavailable above 3.6 GHz. Therefore, if the Stop Frequency of the analyzer is &gt; 3.6 GHz then the Enable Elec Atten key will be OFF and grayed out.</p> <p>If the Internal Preamp is on, meaning it is set to Low Band or Full, the electronic attenuator (and the “soft” attenuation function provided in single attenuator configurations) is unavailable. In this case the Enable Elec Atten key will be OFF and grayed out.</p> <p>If either of the above is true, if the SCPI command is sent, an error indicating that the electronic attenuator is unavailable will be sent.</p> <p>If the electronic/soft Attenuator is enabled, then the Stop Freq of the analyzer is limited to 3.6 GHz and the Internal Preamp is unavailable.</p> <p>The SCPI-only “soft” electronic attenuation for the single-attenuator configuration is not available in all measurements; in particular, it is not available in the Swept SA measurement.</p>
<b>Couplings</b>	Enabling and disabling the Electronic Attenuator affects the setting of the Mechanical Attenuator (in dual attenuator configurations). This is described in more detail below this table.
<b>Preset</b>	OFF for Swept SA measurement; ON for all other measurements that support the electronic attenuator
<b>State Saved</b>	Saved in instrument state
<b>Initial S/W Revision</b>	Prior to A.02.00
<b>Modified at S/W Revision</b>	A.03.00

## More Information

### Mechanical Attenuator Transition Rules

When the Electronic Attenuator is enabled, the Mechanical Attenuator transitions to a state that has no Auto function. Below are the rules for transitioning the Mechanical Attenuator. NOTE that the information



below ONLY applies to the dual attenuator configurations, and ONLY when the Electronic Attenuator is installed:

#### **When the Electronic Attenuation is enabled from a disabled state:**

- The Mechanical Attenuator is initialized to 10 dB (this is its optimal performance setting). You can then set it as desired with SCPI, numeric keypad, step keys, or knob, and it behaves as it normally would in manual mode
- The Auto/Man state of (Mech) Atten is saved
- The Auto/Man line on the (Mech) Atten key disappears and the auto rules are disabled
- The Electronic Attenuator is set to 10 dB less than the previous value of the Mechanical Attenuator, within the limitation that it must stay within the range of 0 to 24 dB of attenuation.

#### **Examples in the dual attenuator configuration:**

- Mech Atten at 20 dB. Elec Atten enabled, Mech Atten set to 10 dB, and Elec Atten set to 10 dB. New total attenuation equals the value before Elec Atten enabled.
- Mech Atten at 0 dB. Elec Atten enabled, Mech Atten set to 10 dB, and Elec Atten set to 0 dB. New total attenuation does not equal the value before Elec Atten enabled.
- Mech Atten at 40 dB. Elec Atten enabled, Mech Atten set to 10 dB, and Elec Atten set to 24 dB. New total attenuation does not equal the value before Elec Atten enabled.

#### **When the Electronic Attenuation is disabled from an enabled state:**

- The Elec Atten key is grayed out
- The Auto/Man state of (Mech) Atten is restored
- If now in Auto, (Mech) Atten recouples
- If now in Man, (Mech) Atten is set to the value of total attenuation that existed before the Elec Atten was disabled. The resulting value is rounded up to the smallest value possible given the (Mech) Atten Step setting - (That is, 57 dB changes to 58 dB when (Mech) Atten Step is 2 dB.)

#### **Using the Electronic Attenuator: Pros and Cons**

The electronic attenuator offers finer steps than the mechanical attenuator, has no acoustical noise, is faster, and is less subject to wear.

The “finer steps” advantage of the electronic attenuator is beneficial in optimizing the alignment of the analyzer dynamic range to the signal power in the front panel as well as remote use. Thus, you can achieve improved relative signal measurement accuracy. Compared to a mechanical attenuator with 2 dB steps, the 1 dB resolution of the electronic attenuator only gives better resolution when the odd-decibel steps are used. Those odd-decibel steps are less accurately calibrated than the even-decibel steps, so one tradeoff for this superior relative accuracy is reduced absolute amplitude accuracy.

Another disadvantage of the electronic attenuator is that the spectrum analyzer loses its “Auto” setting, making operation less convenient.

Also, the relationship between the dynamic range specifications (TOI, SHI, compression and noise) and instrument performance are less well-known with the electrical attenuator. With the mechanical

attenuator, TOI, SHI and compression threshold levels increase dB-for-dB with increasing attenuation, and the noise floor does as well. With the electronic attenuator, there is an excess attenuation of about 1 to 3 dB between 0 and 3.6 GHz, making the effective TOI, SHI, and so forth, less well known. Excess attenuation is the actual attenuation relative to stated attenuation. Excess attenuation is accounted for in the analyzer calibration

## Elec Atten

Controls the Electronic Attenuator in dual attenuator configurations. This key does not appear in single attenuator configurations, as the control of both the mechanical and electronic stages of the single attenuator is integrated into the single Atten key.

Key Path	AMPTD Y Scale, Attenuation
Remote Command	[ :SENSe ] :POWer [ :RF ] :EATTenuation <rel_ampl> [ :SENSe ] :POWer [ :RF ] :EATTenuation?
Notes	Electronic Attenuation's specification is defined only when Mechanical Attenuation is 6 dB.
Dependencies	This key only appears in Dual Attenuator models with an Electronic Attenuator installed. It does not appear in models with the Single Attenuator configuration, as in the single attenuator configuration there is no "electronic attenuator" there is only a single integrated attenuator (which has both a mechanical and electronic stage). However, in the single attenuator configuration, EATT SCPI commands are accepted for compatibility with other X-series instruments and set a "soft" attenuation as described in <a href="#">"Attenuator Configurations and Auto/Man" on page 2785</a> . The "soft" attenuation is treated as an addition to the "main" attenuation value set by the Atten softkey or the POW:ATT SCPI command and affects the total attenuation displayed on the Attenuation key and the Meas Bar.  When Enable Elec Atten is off or grayed out, the Elec Atten key is grayed out.
Preset	0 dB
State Saved	Saved in instrument state
Min	0 dB
Max	Dual attenuator configuration: 24 dB Single attenuator configuration: the total of ATT and EATT cannot exceed 50 dB, so if the EATT is set to 24 dB first, the main attenuation cannot be greater than 26 dB and will be reduced accordingly; if the main attenuator is set to 40 dB first, EATT cannot be greater than 10 dB
Initial S/W Revision	Prior to A.02.00
Modified at S/W Revision	A.03.00

## Adjust Atten for Min Clip

Sets the combination of mechanical and electronic attenuation and gain based on the current measured signal level so that clipping will be at a minimum.

This is an "immediate action" function, that is, it executes once, when the key is pressed.

This key is grayed out in measurements that do not support this functionality. The spectrum analyzer measurement, Swept SA, does not support this functionality.

Key Path	AMPTD Y Scale, Attenuation
Remote Command	[ :SENSe ] :POWer [ :RF ] :RANGe:OPTimize IMMEDIATE
Initial S/W Revision	Prior to A.02.00
Modified at S/W Revision	A.03.00

## Pre-Adjust for Min Clip

If this function is on, it does the adjustment described under "[Adjust Atten for Min Clip](#)" on page 2788 each time a measurement restarts. Therefore, in Continuous measurement mode, it only executes before the first measurement.

In dual attenuator models, you can set Elec+Mech Atten, in which case both attenuators participate in the autoranging, or Elec Atten Only, in which case the mechanical attenuator does not participate in the autoranging. This latter case results in less wear on the mechanical attenuator and is usually faster.

This key is grayed out in measurements that do not support this functionality. The spectrum analyzer measurement, Swept SA, does not support this functionality.

Key Path	AMPTD Y Scale, Attenuation
Remote Command	[ :SENSe ] :POWer [ :RF ] :RANGe:OPTimize:ATTenuation OFF   ELECTrical   COMBined  [ :SENSe ] :POWer [ :RF ] :RANGe:OPTimize:ATTenuation?
Notes	The SCPI parameter ELECTrical sets this function to On in single attenuator models. The SCPI parameter COMBined is mapped to ELECTrical in single attenuator models; if you send COMBined, it sets the function to On and returns ELEC to a query.
Dependencies	This key only appears in Dual Attenuator models with an Electronic Attenuator installed. In instruments with Dual Attenuator model, when Enable Elec Atten is off or grayed out, the Pre-Adjust for Min Clip key is grayed out.
Preset	OFF for Swept SA measurement; ON for all other measurements that support Pre-Adjust for Min Clip
State Saved	Saved in instrument state
Range	Dual attenuator models: Off   Elec Atten Only   Mech + Elec Atten Single attenuator models: Off   On
Initial S/W Revision	Prior to A.02.00
Modified at S/W Revision	A.03.00

Remote Command	[ :SENSe ] :POWer [ :RF ] :RANGe:AUTO ON OFF 1 0  [ :SENSe ] :POWer [ :RF ] :RANGe:AUTO?
Notes	ON aliases to "Elec Atten Only" (:POW:RANG:OPT:ATT ELEC)

---

	OFF aliases to "Off" (:POW:RANG:OPT:ATT OFF) The query :POW:RANG:AUTO? returns true if :POW:RANG:OPT:ATT is not "Off"
Initial S/W Revision	Prior to A.02.00

---

## Off

Turns Pre-Adjust for Min Clip off. This is the default setting.

This key is grayed out in measurements that do not support this functionality. The spectrum analyzer measurement, Swept SA, does not support this functionality.

---

Key Path	AMPTD Y Scale, Attenuation, Pre-Adjust for Min Clip
Example	:POW:RANGe:OPT:ATT OFF
Initial S/W Revision	Prior to A.02.00

---

## Elec Atten Only

Selects only the electric attenuator to participate in auto ranging. This offers less wear on the mechanical attenuator and is usually faster.

This key is grayed out in measurements that do not support this functionality. The spectrum analyzer measurement, Swept SA, does not support this functionality.

---

Key Path	AMPTD Y Scale, Attenuation, Pre-Adjust for Min Clip
Example	:POW:RANGe:OPT:ATT ELEC
Initial S/W Revision	Prior to A.02.00

---

## Mech + Elec Atten

In dual attenuator models, this selects both attenuators participate in the autoranging.

This key is grayed out in measurements that do not support this functionality. The spectrum analyzer measurement, Swept SA, does not support this functionality.

---

Key Path	AMPTD Y Scale, Attenuation, Pre-Adjust for Min Clip
Example	:POW:RANGe:OPT:ATT COMB
Initial S/W Revision	Prior to A.02.00

---

## (Mech) Atten Step

This controls the step size used when making adjustments to the input attenuation.

This key is labeled Mech Atten Step in dual attenuator models and Atten Step in single attenuator models. In the dual attenuator configuration, this key only affects the step size of the mechanical attenuator.

Key Path	AMPTD Y Scale, Attenuation
Remote Command	[ :SENSe ] :POWer [ :RF ] :ATTenuation:STEP [ :INCRement ] 10 dB   2 dB [ :SENSe ] :POWer [ :RF ] :ATTenuation:STEP [ :INCRement ] ?
Example	POW:ATT:STEP 2
Notes	Note this feature works like a 1-N choice from the front panel, but it takes a specific value (in dB) when used remotely. The only valid values are 2 and 10.
Dependencies	Blanked in CXA and EXA if option FSA (2 dB steps) is not present. If blanked, attempts to set it via SCPI will yield an error.
Couplings	When the attenuation step size changes, the current mechanical attenuation value is adjusted (if necessary) to be quantized to the new step size. That is, if step is set to 10 dB, mech atten is increased if necessary so it is a multiple of 10 dB
Preset	PXA and MXA: 2 dB EXA and CXA: 10 dB (2 dB with option FSA)
State Saved	Saved in instrument state
Initial S/W Revision	Prior to A.02.00
Modified at S/W Revision	A.03.00

## Presel Center

When this key is pressed, the centering of the preselector filter is adjusted to optimize the amplitude accuracy at the frequency of the selected marker. If the selected marker is not on when Presel Center is pressed, the analyzer will turn on the selected marker, perform a peak search, and then perform centering on the marker's center frequency. If the selected marker is already on and between the start and stop frequencies of the analyzer, the analyzer performs the preselector calibration on that marker's frequency. If the selected marker is already on, but outside the frequency range between Start Freq and Stop Freq, the analyzer will first perform a peak search, and then perform centering on the marker's center frequency.

The value displayed on the Presel Adjust key will change to reflect the new preselector tuning (see Presel Adjust).

A number of considerations should be observed to ensure proper operation. See ["Proper Preselector Operation" on page 1610](#).

Key Path	AMPTD Y Scale
Remote Command	[ :SENSe ] :POWer [ :RF ] :PCENter
Example	POW:PCEN
Notes	Note that the rules outlined above under the key description apply for the remote command as well as the key. The result of the command is dependent on marker position, and so forth. Any message shown by the key press is also shown in response to the remote command.
Dependencies	• Grayed out if the microwave preselector is off. )

---

	<ul style="list-style-type: none"> <li>• If the selected marker's frequency is below Band 1, advisory message 0.5001 is generated and no action is taken.</li> <li>• Grayed out if entirely in Band 0.</li> <li>• Blank in models that do not include a preselector, such as option 503. If the SCPI is sent in these instruments, it is accepted without error, and the query always returns 0.</li> <li>• Grayed out in the Spectrogram View.</li> </ul>
Couplings	<p>The active marker position determines where the centering will be attempted.</p> <p>If the analyzer is in a measurement such as averaging when centering is initiated, the act of centering the preselector will restart averaging but the first average trace will not be taken until the centering is completed.</p>
Status Bits/OPC dependencies	<p>When centering the preselector, *OPC will not return true until the process is complete and a subsequent measurement has completed, nor will results be returned to a READ or MEASure command.</p> <p>The Measuring bit should remain set while this command is operating and should not go false until the subsequent sweep/measurement has completed.</p>
Initial S/W Revision	Prior to A.02.00
Modified at S/W Revision	A.03.00

---

## Proper Preselector Operation

A number of considerations should be observed to ensure proper operation:

1. If the selected marker is off, the analyzer will turn on a marker, perform a peak search, and adjust the preselector using the selected marker's frequency. It uses the "highest peak" peak search method unqualified by threshold or excursion, so that there is no chance of a 'no peak found' error. It continues with that peak, even if it is the peak of just noise. Therefore, for this operation to work properly, there should be a signal on screen in a preselected range for the peak search to find.
2. If the selected marker is already on, the analyzer will attempt the centering at that marker's frequency. There is no preselector for signals below about 3.6 GHz, therefore if the marker is on a signal below 3.6 GHz, no centering will be attempted and an advisory message generated
3. In some models, the preselector can be bypassed. If it is bypassed, no centering will be attempted in that range and a message will be generated.

## Preselector Adjust

Allows you to manually adjust the preselector filter frequency to optimize its response to the signal of interest. This function is only available when **"Presel Center" on page 2791** is available.

For general purpose signal analysis, using Presel Center is recommended. Centering the filter minimizes the impact of long-term preselector drift. Presel Adjust can be used instead to manually optimize the preselector. One application of manual optimization would be to peak the preselector response, which both optimizes the signal-to-noise ratio and minimizes amplitude variations due to small (short-term) preselector drifting.

Key Path	AMPTD Y Scale
Scope	Meas Global
<b>Remote Command</b>	<code>[ :SENSe ] :POWer [ :RF ] :PADJust &lt;freq&gt;</code> <code>[ :SENSe ] :POWer [ :RF ] :PADJust?</code>
<b>Example</b>	POW:PADJ 100KHz POW:PADJ?
Notes	The value on the key reads out to 0.1 MHz resolution.
Dependencies	<ul style="list-style-type: none"> <li>• Grayed out if microwave preselector is off. )</li> <li>• Grayed out if entirely in Band 0.</li> <li>• Blank in models that do not include a preselector, such as option 503. If the SCPI is sent in these instruments, it is accepted without error, and the query always returns 0.</li> <li>• Grayed out in the Spectrogram View.</li> </ul>
Preset	0 MHz
State Saved	The Presel Adjust value set by Presel Center, or by manually adjusting Presel Adjust, is not saved in instrument state, and does not survive a Preset or power cycle.
Min	-500 MHz
Max	500 MHz
Default Unit	Hz
<b>Backwards Compatibility SCPI</b>	<code>[ :SENSe ] :POWer [ :RF ] :MW :PADJust</code> <code>[ :SENSe ] :POWer [ :RF ] :MMW :PADJust</code> PSA had multiple preselectors, but the X-Series has only one. These commands simply alias to <code>[ :SENSe ] :POWer [ :RF ] :PADJust</code>
Initial S/W Revision	Prior to A.02.00
Modified at S/W Revision	A.03.00
<b>Remote Command</b>	<code>[ :SENSe ] :POWer [ :RF ] :PADJust :PRESelector MWAVE   MMWave   EXTernal</code> <code>[ :SENSe ] :POWer [ :RF ] :PADJust :PRESelector?</code>
Notes	PSA had multiple preselectors, and you could select which preselector to adjust. Since the X-Series has only one mm/uW preselector, the preselector selection softkey is no longer available. However, to provide backward compatibility, we accept the legacy remote commands. The command form has no effect, the query always returns MWAVE
Initial S/W Revision	Prior to A.02.00

## μW Path Control

The μW Path Control functions include the μW Preselector Bypass (Option MPB) and Low Noise Path (Option LNP) controls in the High Band path circuits.

When the μW Preselector is bypassed, the user has better flatness, but will be subject to spurs from out of band interfering signals. When the Low Noise Path is enabled, the analyzer automatically switches around certain circuitry in the high frequency bands which can contribute to noise, when it is appropriate based on other analyzer settings.

For most applications, the preset state is Standard Path, which gives the best remote-control throughput, minimizes acoustic noise from switching and minimizes the risk of wear out in the hardware switches. For applications that utilize the wideband IF paths, the preset state is the μW Preselector Bypass path, if option MPB is present. This is because, when using a wideband IF such as the 140 MHz IF, the μW Preselector's bandwidth can be narrower than the available IF bandwidth, causing degraded amplitude flatness and phase linearity, so it is desirable to bypass the preselector in the default case.

Users may choose Low Noise Path Enable. It gives a lower noise floor, especially in the 21–26.5 GHz region, though without improving many measures of dynamic range, and without giving the best possible noise floor. The preamp, if purchased and used, gives better noise floor than does the Low Noise Path, however its compression threshold and third-order intercept are much poorer than that of the non-preamp Low Noise Path. There are some applications, typically for signals around –30 dBm, for which the third-order dynamic range of the standard path is good enough, but the noise floor is not low enough even with 0 dB input attenuation. When the third-order dynamic range of the preamp path is too little and the noise floor of the standard path is too high, the Low Noise Path can provide the best dynamic range.

<b>Key Path</b>	AMPTD Y Scale
<b>Mode</b>	SA, BASIC, PNOISE, VSA , LTE, LTETDD
<b>Scope</b>	Meas Global
<b>Remote Command</b>	[ :SENSe ] :POWer [ :RF ] :MW:PATH STD LNPath MPBypass FULL [ :SENSe ] :POWer [ :RF ] :MW:PATH?
<b>Example</b>	:POW:MW:PATH LNP Enables the Low Noise path
<b>Notes</b>	If a Presel Center is performed, the analyzer will momentarily switch to the Standard Path, regardless of the setting of μW Path Control  The DC Block will always be switched in when the low noise path is switched in, to protect succeeding circuitry from DC. Note that this does not mean “when the low noise path is enabled” but when, based on the Low Noise Path rules, the path is actually switched in. This can happen when the selection is Low Noise Path Enable . In the case where the DC Block is switched in the analyzer is now AC coupled. However, if the user has selected DC coupling, the UI will still behave as though it were DC coupled, including all annunciation, warnings, status bits, and responses to SCPI queries. This is because, based on other settings, the analyzer could switch out the low noise path at any time and hence go back to being DC coupled.  Alignment switching ignores the settings in this menu, and restores them when finished.
<b>Dependencies</b>	Unavailable in BBIQ and External Mixing
<b>Preset</b>	All modes other than IQ Analyzer mode and VXA: STD IQ Analyzer, VXA and WLAN mode: MPB option present and licensed: MPB



	MPB option not present and licensed: STD
State Saved	Save in instrument state
Readback	Value selected in the submenu
Initial S/W Revision	A.04.00
Modified at S/W Revision	A.10.00

## Standard Path

This path gives the best remote-control throughput, minimizes acoustic noise from switching and minimizes the risk of wear in the hardware switches, particularly in remote test scenarios where both low band and high band setups will follow in rapid succession.

In this path, the bypass of the low band/high band switch and microwave preamp is never activated, which can cause some noise degradation but preserves the life of the bypass switch.

Key Path	AMPTD Y Scale, $\mu$ W Path Control
<b>Example</b>	:POW:MW:PATH STD
Readback Text	Standard Path
Initial S/W Revision	A.04.00

## Low Noise Path Enable

You may choose Low Noise Path Enable, which gives a lower noise floor under some circumstances, particularly when operating in the 21–26.5 GHz region. With the Low Noise Path enabled, the low band/high band switch and microwave preamp are bypassed whenever all of the following are true:

- The analyzer is not in the Low Band, meaning:
- the start frequency is above 3.5 GHz and
- the stop frequency is above 3.6 GHz.
- the internal preamp is not installed or (if installed) is set to Off or Low Band

Note that this means that, when any part of a sweep is done in Low Band, the Low Noise Path is not used, whether or not the Low Noise Path Enable is selected in the user interface. Also, if the preamp is turned on, the Low Noise Path is not used, whether or not the Low Noise Path Enable is selected in the user interface. The only time the Low Noise Path is used is when Low Noise Path Enable is selected, the sweep is completely in High Band (> 3.6 GHz) and no preamp is in use.

See "[More Information](#)" on page 1614

Key Path	AMPTD Y Scale, $\mu$ W Path Control
Measurement	Swept SA
<b>Example</b>	:POW:MW:PATH LNP

Notes	<p>For measurements that use IQ acquisition, the low noise path is used when the Center Frequency is in High Band (&gt; 3.6 GHz) and no preamp is in use.</p> <p>In other words, the rules above are modified to use only the center frequency to qualify which path to switch in.</p> <p>This is not the case for FFT's in the Swept SA measurement; they use the same rules as swept measurements.</p>
Dependencies	<p>Key is blanked if current mode does not support it.</p> <p>Key is grayed out if mode supports it but current measurement does not support it.</p> <p>Unless Option LNP is present and licensed, key is blank and if SCPI command sent, error -241, "Hardware missing; Option not installed" is generated.</p>
Readback Text	Low Noise Path Enable
Initial S/W Revision	A.04.00

### More Information

The user should understand that the Low Noise Path, while giving improved DANL, has the disadvantage of decreased TOI performance and decreased gain compression performance relative to the standard path.

The user should also understand that the bypass switch is a mechanical switch and has finite life, so if the Low Noise Path is enabled, it is possible to cause frequent cycling of this switch by frequently changing analyzer settings such that the above conditions hold true only some of the time. A user making tests of this nature should consider opting for the Standard Path, which will never throw the bypass switch, at the expense of some degraded noise performance.

The low noise path is useful for situations where the signal level is so low that the analyzer performance is dominated by noise even with 0 dB attenuation, but still high enough that the preamp option would have excessive third-order intermodulation or compression. The preamp, if purchased and used, gives better noise floor than does the "Low Noise Path." However, its compression threshold and third-order intercept are much poorer than that of the non-preamp path. There are some applications, typically for signals around -30 dBm, for which the third-order dynamic range of the standard path is good enough, but the noise floor is not low enough even with 0 dB input attenuation. When the third-order dynamic range of the preamp path is too little and the noise floor of the standard path is too high, the Low Noise Path can provide the best dynamic range

The graph below illustrates the concept. It shows, in red, the performance of an analyzer at different attenuation settings, both with the preamp on and off, in a measurement that is affected by both analyzer noise and analyzer TOI. The green shows the best available dynamic range, offset by 0.5 dB for clarity. The blue shows how the best available dynamic range improves for moderate signal levels with the low noise path switched in. In this illustration, the preamp improves the noise floor by 15 dB while degrading the third-order intercept by 30 dB, and the low noise path reduces loss by 8 dB. The attenuator step size is 2 dB.

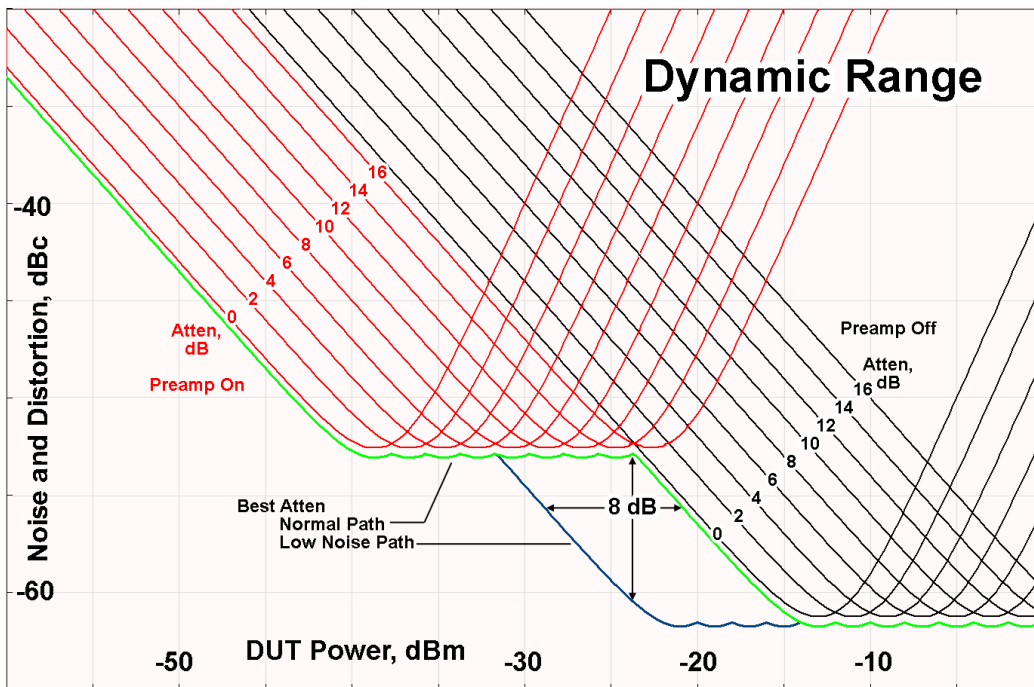

There are other times where selecting the low noise path improves performance, too. Compression-limited measurements such as finding the nulls in a pulsed-RF spectrum can profit from the low noise path in a way similar to the TOI-limited measurement illustrated. Accuracy can be improved when the low noise path allows the optimum attenuation to increase from a small amount like 0, 2 or 4 dB to a larger amount, giving better return loss at the analyzer input. Harmonic measurements, such as second and third harmonic levels, are much improved using the low noise path because of the superiority of that path for harmonic (though not intermodulation) distortion performance.

### μW Preselector Bypass

This key toggles the preselector bypass switch for band 1 and higher. When the microwave preselector is on, the signal path is preselected. When the microwave preselector is off, the signal path is not preselected. The preselected path is the normal path for the analyzer.

The preselector is a tunable bandpass filter which prevents signals away from the frequency of interest from combining in the mixer to generate in-band spurious signals (images). The consequences of using a preselector filter are its limited bandwidth, the amplitude and phase ripple in its passband, and any amplitude and phase instability due to center frequency drift.

Option MPB or pre-selector bypass provides an unpreselected input mixer path for certain X-Series signal analyzers with frequency ranges above 3.6 GHz. This signal path allows a wider bandwidth and less amplitude variability, which is an advantage when doing modulation analysis and broadband signal analysis. The disadvantage is that, without the preselector, image signals will be displayed. Another disadvantage of bypassing the preselector is increased LO emission levels at the front panel input port.

Image responses are separated from the real signal by twice the 1st IF. For IF Paths of 10 MHz and 25 MHz, the 1st IF is 322.5 MHz, so the image response and the real signal will be separated by 645 MHz. The 1st IF will be different for other IF Path settings. When viewing a real signal and its corresponding image response in internal mixing, the image response will be to the left of the real signal.

Also, the image response and the real signal typically have the same amplitude and exhibit the same shape factor.

However, if Option FS1, Fast Sweep Capability, is enabled, the image response in the Swept SA measurement will appear lower in amplitude and have a much wider shape factor compared to the real signal.

<b>Key Path</b>	AMPTD Y Scale, $\mu$ W Path Control
<b>Example</b>	:POW:MW:PATH MPB
<b>Dependencies</b>	Key is blanked if current mode does not support it. Key is grayed out if mode supports it but current measurement does not support it. Key is blank unless Option MPB is present and licensed. If SCPI command sent when MPB not present, error -241, "Hardware missing; Option not installed" is generated.
<b>Readback Text</b>	$\mu$ W Preselector Bypass
<b>Initial S/W Revision</b>	A.04.00

<b>Remote Command</b>	[ :SENSe ] :POWer [ :RF ] :MW:PRESelector [ :STATe ] ON   OFF   0   1 [ :SENSe ] :POWer [ :RF ] :MW:PRESelector [ :STATe ] ?
<b>Example</b>	:POW:MW:PRES OFF Bypasses the microwave preselector
<b>Notes</b>	The ON parameter sets the STD path (:POW:MW:PATH STD) The OFF parameter sets path MPB (:POW:MW:PATH MPB)
<b>Preset</b>	ON

## Internal Preamp

Accesses a menu of keys that control the internal preamps. Turning on the preamp gives a better noise figure, but a poorer TOI to noise floor dynamic range. You can optimize this setting for your particular measurement.

The instrument takes the preamp gain into account as it sweeps. If you sweep outside of the range of the preamp the instrument will also account for that. The displayed result will always reflect the correct gain.

For some measurements, when the preamp is on and any part of the displayed frequency range is below the lowest frequency for which the preamp has specifications, a warning condition message appears in the status line. For example, for a preamp with a 9 kHz lowest specified frequency: "Preamp: Accy unspec'd below 9 kHz".

<b>Key Path</b>	AMPTD Y Scale
<b>Scope</b>	Meas Global
<b>Remote Command</b>	[ :SENSe ] :POWer [ :RF ] :GAIN [ :STATe ] OFF   ON   0   1 [ :SENSe ] :POWer [ :RF ] :GAIN [ :STATe ] ?
<b>Dependencies</b>	Preamp is not available on all hardware platforms. If the preamp is not present or is unlicensed, the

---

	key is not shown. The preamp is not available when the electronic/soft attenuator is enabled.
--	--------------------------------------------------------------------------------------------------

---

Couplings	<p>The act of connecting the U7227A USB Preamplifier to one of the analyzer's USB ports will cause the Internal Preamp to be switched on. When this happens an informational message will be generated: "Internal Preamp turned on for optimal operation with USB Preamp." Note that if the Internal Preamp was already on, there will be no change to the setting, but if it was Off it will be switched On, to Full Range.</p> <p>Note that this same action occurs when the SA mode is selected while the USB Preamp is connected to one of the analyzer's USB ports, if it is the first time that the SA mode has run since powerup, or if the last time the SA mode was running the USB Preamp was NOT connected.</p> <p>Subsequently disconnecting the USB Preamp from USB does not change the Internal Preamp setting nor restore the previous setting.</p>
Preset	OFF
State Saved	Saved in instrument state
Initial S/W Revision	Prior to A.02.00
Modified at S/W Revision	A.14.00

---

Key Path	AMPTD Y Scale, Internal Preamp
Scope	Meas Global
<b>Remote Command</b>	[:SENSe]:POWer[:RF]:GAIN:BAND LOW FULL [:SENSe]:POWer[:RF]:GAIN:BAND?
Dependencies	<p>Preamp is not available on all hardware platforms. If the preamp is not present or is unlicensed, the key is not shown.</p> <p>If a POW:GAIN:BAND FULL command is sent when a low band preamp is available, the preamp band parameter is to LOW instead of FULL, and an "Option not installed" message is generated.</p>
Preset	LOW
State Saved	Saved in instrument state
Initial S/W Revision	Prior to A.02.00

---

## Off

Turns the internal preamp off

Key Path	AMPTD Y Scale, Internal Preamp
<b>Example</b>	:POW:GAIN OFF
Readback	Off
Initial S/W Revision	Prior to A.02.00

---

## Low Band

Sets the internal preamp to use only the low band.

The frequency range of the installed (optional) low-band preamp is displayed in square brackets on the Low Band key label.

Key Path	AMPTD Y Scale, Internal Preamp
<b>Example</b>	:POW:GAIN ON :POW:GAIN:BAND LOW
Readback	Low Band
Initial S/W Revision	Prior to A.02.00

## Full Range

Sets the internal preamp to use its full range. The low band (0–3.6 GHz or 0–3GHz, depending on the model) is supplied by the low band preamp and the frequencies above low band are supplied by the high band preamp.

The frequency range of the installed (optional) preamp is displayed in square brackets on the Full Range key label. If the high band option is not installed the Full Range key does not appear.

Key Path	AMPTD Y Scale, Internal Preamp
<b>Example</b>	:POW:GAIN ON :POW:GAIN:BAND FULL
Readback	Full Range
Initial S/W Revision	Prior to A.02.00

## Range

This key is only available when I/Q is the selected input. It replaces the Attenuation key in that case.

Each input channel (I and Q) has four internal gain ranges. The maximum allowed voltage in each gain range is slightly more than the nominal value, so the break point between ranges is a couple of millivolts higher than the nominal (setting a peak voltage of 0.502 mV will still map to the 0.5 V Peak range).

Gain Setting	Volts RMS	Volts Peak	Volts Peak - Peak	dBm (50Ω)	Break Point
0 dB	0.7071	1.0	2.0	10	n/a
6 dB	0.3536	0.5	1.0	4	0.502 V Peak
12 dB	0.1768	0.25	0.5	-2	0.252 V Peak
18 dB	0.0884	0.125	0.25	-8	0.127 V Peak

Key Path	AMPTD Y Scale
Notes	Visible only when the selected input is I/Q.
State Saved	No
Readback Text	When Range is Auto, "[Auto]" When Range is Man and I & Q are the same, "[<range value>]" When Range is Man and I & Q are different: "[: <I range value> Q: <Q range value>]" See I Range and Q Range for the <range value> enumeration definition.
Initial S/W Revision	Prior to A.02.00

## Range Auto/Man

The Auto setting for Range causes the range to be set based on the Y Scale settings. When Range is "Auto", the I & Q Range are set based on the top of the Y Scale when the Y scale is in dB units (for example, power), or to the max(abs(top), abs(bottom)) when the Y scale reference is not at the top of the screen.

Not all measurements support Range Auto/Man. If Auto is not supported in the current measurement, this key is grayed out and shows "Man" and MAN is returned to a SCPI query, but this does NOT change the Auto/Man setting for Range. When you go to a measurement that supports Auto, it goes back to Auto if it was previously in Auto mode.

Key Path	AMPTD Y Scale, Range
Scope	Meas Global
<b>Remote Command</b>	<code>[:SENSe]:VOLTage:IQ:RANGe:AUTO OFF ON 0 1</code> <code>[:SENSe]:VOLTage:IQ:RANGe:AUTO?</code>
<b>Example</b>	Put the I Range and Q Range in manual. <code>VOLT:IQ:RANG:AUTO OFF</code>
Dependencies	If Auto is not supported, sending the SCPI command will generate an error.
Couplings	When in Auto, both I Range and Q Range are set to the same value, computed as follows: Maximum absolute value is computed for the Y Scale. The top and bottom of the graph are computed based on Ref Value, Scale/Div, and Ref Position. Formula: $Y_{Max} = \max(\text{abs}(\text{top}), \text{abs}(\text{bottom}))$ . The I Range and Q Range are then set to YMax.
Preset	ON
State Saved	Saved in instrument state
Range	Auto   Man
Initial S/W Revision	Prior to A.02.00

<b>Remote Command</b>	<code>[:SENSe]:POWer:IQ:RANGe:AUTO OFF ON 0 1</code> <code>[:SENSe]:POWer:IQ:RANGe:AUTO?</code>
-----------------------	----------------------------------------------------------------------------------------------------

<b>Example</b>	Put the I Range and Q Range in manual. POW:IQ:RANG:AUTO OFF
Notes	The POW:IQ:RANG:AUTO is an alternate form of the VOLT:IQ:RANG:AUTO command. This is to maintain consistency with I Range and Q Range, which support both the POWer and VOLTage forms of the command.
Preset	ON
Range	Auto   Man
Initial S/W Revision	Prior to A.02.00

## I Range

This is the internal gain range for the I channel when Input Path is I Only or I and I/Q, and it is used for both the I and Q channels when the Input Path is I+jQ. See "[I/Q Gain Ranges](#)" on page 2807.

<b>Key Path</b>	AMPTD Y Scale, Range
<b>Remote Command</b>	[ :SENSe ] :VOLTage :IQ [ : I ] :RANGe [ :UPPer ] <voltage> [ :SENSe ] :VOLTage :IQ [ : I ] :RANGe [ :UPPer ] ?
<b>Example</b>	Set the I Range to 0.5 V Peak VOLT:IQ:RANG 0.5 V
Notes	The numeric entries are mapped to the smallest gain range whose break point is greater than or equal to the value, or 1 V Peak if the value is greater than 1 V.
Couplings	When Q Same as I is On, the I Range value will be copied to the Q Range. Changing the value will also set Range = Man.
Preset	1 V Peak
State Saved	Saved in instrument state
Range	1 V Peak   0.5 V Peak   0.25 V Peak   0.125 V Peak
Min	0.125 V
Max	1 V
Initial S/W Revision	Prior to A.02.00

<b>Remote Command</b>	[ :SENSe ] :POWer :IQ [ : I ] :RANGe [ :UPPer ] <ampl> [ :SENSe ] :POWer :IQ [ : I ] :RANGe [ :UPPer ] ?
<b>Example</b>	Set the I Range to 0.5 V Peak when Reference Z is 50Ω, and to 1.0 V Peak when Reference Z is 75Ω. POW:IQ:RANG 4 dBm
Notes	The POWer form of the command is provided for convenience. It maps to the same underlying gain range parameter as the VOLTage form of the command. The Reference Z (not the I channel Input Z) is used to convert the power to peak voltage, which is then used to set the I Range as with the VOLTage form of the command. The power values of the 4



range states (1V Peak, 0.5V Peak, 0.25V Peak, and 0.125V Peak) will vary with Reference Z. Here are some examples:

50Ω: 10, 4, -2, -8  
75Ω: 8.2, 2.2, -3.8, -9.8  
600Ω: -0.8, -6.8, -12.8, -18.9

Preset	10.0 dBm
Range	-20 dBm to 10 dBm
Min	-20 dBm
Max	10 dBm
Initial S/W Revision	Prior to A.02.00

### 1 V Peak

Set the channel gain state to 1 Volt Peak.

Key Path	AMPTD Y Scale, I Range   Q Range
Initial S/W Revision	Prior to A.02.00

### 0.5 V Peak

Set the channel gain state to 0.5 Volt Peak.

Key Path	AMPTD Y Scale, I Range   Q Range
Initial S/W Revision	Prior to A.02.00

### 0.25 V Peak

Set the channel gain state to 0.25 Volt Peak.

Key Path	AMPTD Y Scale, I Range   Q Range
Initial S/W Revision	Prior to A.02.00

### 0.125 V Peak

Set the channel gain state to 0.125 Volt Peak.

Key Path	AMPTD Y Scale, I Range   Q Range
Initial S/W Revision	Prior to A.02.00

## Q Range Value

This is the internal gain range for the Q channel. See "[I/Q Gain Ranges](#)" on page 2807. The Q Range only applies to Input Path Q Only and Ind I/Q. For input I+jQ the I Range determines both I and Q channel range settings.

Key Path	AMPTD Y Scale, Range
Remote Command	<code>[ :SENSe ] :VOLTage:IQ:Q:RANGe[:UPPer] &lt;voltage&gt;</code> <code>[ :SENSe ] :VOLTage:IQ:Q:RANGe[:UPPer] ?</code>
Example	Set the Q Range to 0.5 V Peak <code>VOLT:IQ:Q:RANG 0.5 V</code>
Notes	The numeric entries are mapped to the smallest gain range whose break point is greater than or equal to the value, or 1 V Peak if the value is greater than 1 V. The Q Range is only used for Input Path Q Only and Ind I/Q. For input I+jQ the I Range determines both I and Q channel range settings.
Couplings	When Q Same as I is On, the I Range value will be copied to the Q Range and the range value keys are disabled. Changing the value will also set Range = Man.
Preset	1 V Peak
State Saved	Saved in instrument state
Range	1 V Peak   0.5 V Peak   0.25 V Peak   0.125 V Peak
Min	0.125 V
Max	1 V
Initial S/W Revision	Prior to A.02.00

Remote Command	<code>[ :SENSe ] :POWer:IQ:Q:RANGe[:UPPer] &lt;ampl&gt;</code> <code>[ :SENSe ] :POWer:IQ:Q:RANGe[:UPPer] ?</code>
Example	Will set the Q Range to 0.5 V Peak when Reference Z is 50Ω, and to 1.0 V Peak when Reference Z is 75Ω. <code>POW:IQ:Q:RANG 4 dBm</code>
Notes	The POWER form of the command is provided for convenience. It maps to the same underlying gain range parameter as the VOLTage form of the command. The Reference Z (not the Q channel Input Z) is used to convert the power to peak voltage, which is then used to set the Q Range as with the VOLTage form of the command. The power values of the 4 range states (1V Peak, 0.5V Peak, 0.25V Peak, and 0.125V Peak) will vary with Reference Z. Here are some examples: 50Ω: 10, 4, -2, -8 75Ω: 8.2, 2.2, -3.8, -9.8 600Ω: -0.8, -6.8, -12.8, -18.9
Preset	10.0 dBm
Range	-20 dBm to 10 dBm

Min	-20 dBm
Max	10 dBm
Initial S/W Revision	Prior to A.02.00

### Q Same as I

Many, but not all, usages require the I and Q channels to have an identical setup. To simplify channel setup, the Q Same as I will cause the Q channel range to be mirrored from the I channel. That way you only need to set up one channel (the I channel). The I channel values are copied to the Q channel, so at the time Q Same as I is Off, the I and Q channel setups will be identical.

Key Path	AMPTD Y Scale, Range, Q Range
Remote Command	[ :SENSe ] :VOLTage   POWer : IQ :MIRRed OFF   ON   0   1 [ :SENSe ] :VOLTage   POWer : IQ :MIRRed ?
Example	Turn off the mirroring of I Range to Q Range. VOLT:IQ:MIRR OFF POW:IQ:MIRR OFF
Couplings	When On, the I Range value is mirrored (copied) to the Q Range.
Preset	On
State Saved	Saved in instrument state.
Range	On   Off
Readback Text	"Q Same as I" when On, otherwise none.
Initial S/W Revision	Prior to A.02.00

### 1 V Peak

Set the channel gain state to 1 Volt Peak.

Key Path	AMPTD Y Scale, I Range   Q Range
Initial S/W Revision	Prior to A.02.00

### 0.5 V Peak

Set the channel gain state to 0.5 Volt Peak.

Key Path	AMPTD Y Scale, I Range   Q Range
Initial S/W Revision	Prior to A.02.00

### 0.25 V Peak

Set the channel gain state to 0.25 Volt Peak.

---

Key Path	AMPTD Y Scale, I Range   Q Range
Initial S/W Revision	Prior to A.02.00

---

### 0.125 V Peak

Set the channel gain state to 0.125 Volt Peak.

---

Key Path	AMPTD Y Scale, I Range   Q Range
Initial S/W Revision	Prior to A.02.00

---

### I/Q Gain Ranges

See the following sections:

["1 V Peak" on page 2807](#)

["0.5 V Peak" on page 2807](#)

["0.25 V Peak" on page 2807](#)

["0.125 V Peak" on page 2808](#)

### 1 V Peak

Set the channel gain state to 1 Volt Peak.

---

Key Path	AMPTD Y Scale, I Range   Q Range
Initial S/W Revision	Prior to A.02.00

---

### 0.5 V Peak

Set the channel gain state to 0.5 Volt Peak.

---

Key Path	AMPTD Y Scale, I Range   Q Range
Initial S/W Revision	Prior to A.02.00

---

### 0.25 V Peak

Set the channel gain state to 0.25 Volt Peak.

---

Key Path	AMPTD Y Scale, I Range   Q Range
Initial S/W Revision	Prior to A.02.00

---

### 0.125 V Peak

Set the channel gain state to 0.125 Volt Peak.

Key Path	AMPTD Y Scale, I Range   Q Range
Initial S/W Revision	Prior to A.02.00

### Presel Center

When this key is pressed, the centering of the preselector filter is adjusted to optimize the amplitude accuracy at the frequency of the selected marker.

See AMPTD Y Scale, "[Presel Center](#)" on page 2791 for more information.

This is only available when the selected input is RF.

Key Path	AMPTD Y Scale
Initial S/W Revision	Prior to A.02.00

## Auto Couple

The Auto Couple feature provides a quick and convenient way to automatically couple multiple instrument settings. This helps ensure accurate measurements and optimum dynamic range. When the Auto Couple feature is activated, either from the front panel or remotely, all parameters of the current measurement that have an Auto/Manual mode are set to Auto mode and all measurement settings dependent on (or coupled to) the Auto/Man parameters are automatically adjusted for optimal performance.

However, the Auto Couple key actions are confined to the current measurement only. It does not affect other measurements in the mode, and it does not affect markers, marker functions, or trace or display attributes.

See ["More Information" on page 1626](#)

Key Path	Front-panel key
Remote Command	:COUPle ALL NONE
Example	:COUP ALL
Notes	:COUPle ALL puts all Auto/Man parameters in Auto mode (equivalent to pressing the Auto Couple key). :COUPLE NONE puts all Auto/Man parameters in manual mode. It decouples all the coupled instrument parameters and is not recommended for making measurements.
Initial S/W Revision	Prior to A.02.00

### More Information

There are two types of functions that have Auto/Manual modes.

#### Auto/Man Active Function keys

An Auto/Man toggle key controls the binary state associated with an instrument parameter by toggling between Auto (where the parameter is automatically coupled to the other parameters it is dependent upon) and Man (where the parameter is controlled independent of the other parameters), as well as making the parameter the active function. The current mode is indicated on the softkey with either Auto or Man underlined as illustrated below.

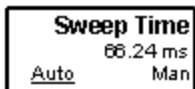

usd07

#### Auto/Man 1-of-N keys

An Auto/Man 1-of-N key allows you to manually pick from a list of parameter values, or place the function in Auto, in which case the value is automatically selected (and indicated) as shown below. If in Auto, Auto is underlined on the calling key. If in manual operation, manual is indicated on the calling key. But the calling key does not actually toggle the function, it simply opens the menu.

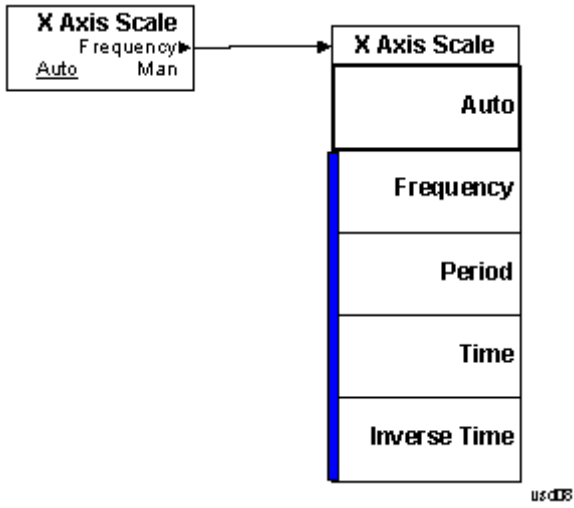

## BW

Opens the BW menu, which contains keys to control the information bandwidth functions of the instrument.

Key Path	Front-panel key
Initial S/W Revision	Prior to A.02.00

### Info BW

Allows you to enter a frequency value to set the channel bandwidth that will be used for data acquisition.

Key Path	BW
Mode	SA, WCDMA, C2K, WIMAXOFDMA, TD-SCDMA, 1xEV-DO, DVB-T/H, DTMB (CTTB), ISDB-T, CMMB, LTE, LTETDD, Digital Cable TV, WLAN, MSR, LTEATDD, LTEAFDD
Remote Command	[ :SENSe ] :PStatistic :BANDwidth <freq> [ :SENSe ] :PStatistic :BANDwidth?
Example	PST:BAND 8 MHz PST:BAND?
Couplings	WiMAX OFDMA: The default value depends on the Radio Standard selection..
Preset	SA, WCDM: 5 MHz C2K:1.5 MHz 1xEV-DO:1.3 MHz WiMAX OFDMA: Hardware Dependent No Option = 10 MHz WB (25 MHz or wider) = 25 MHz TD-SCDMA: 1.3 MHz DVB-T/H, DTMB (CTTB): 8 MHz ISDB-T: 6 MHz CMMB: 8 MHz LTE, LTETDD, LTEATDD, LTEAFDD: 6 MHz Digital Cable TV: 8MHz WLAN: Hardware Dependent No option = 10 MHz Option B25 = 25 MHz Option B40: if Radio Std is 802.11a/b/g/n(20MHz) = 25 MHz if Radio Std is 802.11n(40MHz) = 40 MHz if Radio Std is 802.11ac(20MHz) = 25 MHz if Radio Std is 802.11ac(40MHz) = 40 MHz Option B1X: if Radio Std is 802.11ac(80MHz) = 80 MHz



	<p>Option B1Y:  if Radio Std is 802.11ac(160MHz) = 160 MHz  MSR: same as max value</p>
State Saved	Saved in instrument state.
Min	10.0 kHz
Max	<p>Hardware Dependent:  RF Input:  No Option = 10 MHz  WB (25MHz or wider) = Hardware Option Limit  I/Q Input (for I+jQ):  No Option = 20 MHz  Option B25 = 50 MHz</p>
<b>Backwards Compatibility SCPI</b>	<code>[ :SENSe ] :PStatistic:BWIDth</code>
Initial S/W Revision	Prior to A.02.00
Modified at S/W Revision	A.02.00, A.03.00, A.06.00

## Cont (Continuous Measurement/Sweep)

Sets the analyzer for Continuous measurement operation. The single/continuous state is Meas Global so the setting will affect all measurements. If you are Paused, pressing Cont does a Resume.

<b>Key Path</b>	Front-panel key
<b>Remote Command</b>	:INITiate:CONTinuous OFF ON 0 1 :INITiate:CONTinuous?
<b>Example</b>	:INIT:CONT 0 puts analyzer in Single measurement operation. :INIT:CONT 1 puts analyzer in Continuous measurement operation
<b>Preset</b>	ON (Note that SYST:PRESet sets INIT:CONT to ON but *RST sets INIT:CONT to OFF)
<b>State Saved</b>	Saved in instrument state
<b>Backwards Compatibility Notes</b>	For Spectrum Analysis mode in ESA and PSA, there is no Cont hardkey, instead there is a Sweep Single/Cont key. In these analyzers, switching the Sweep Single/Cont key from Single to Cont restarts averages (displayed average count reset to 1), but does not restart Max Hold and Min Hold. The X-Series has Single and Cont keys in place of the SweepSingleCont key. In the X-Series, if in single measurement, the Cont key (and INIT:CONT ON ) switches to continuous measurement, but never restarts a measurement and never resets a sweep.
<b>Initial S/W Revision</b>	Prior to A.02.00

In Swept SA Measurement (Spectrum Analysis Mode):

The analyzer takes repetitive sweeps, averages, measurements, etc., when in Continuous mode. When the average count reaches the Average/Hold Number the count stops incrementing, but the analyzer keeps sweeping. See the Trace/Detector section for the averaging formula used both before and after the Average/Hold Number is reached. The trigger condition must be met prior to each sweep. The type of trace processing for multiple sweeps, is set under the Trace/Detector key, with choices of Trace Average, Max Hold, or Min Hold.

In Other Measurements/Modes:

With Avg/Hold Num (in the Meas Setup menu) set to Off or set to On with a value of 1, a sweep is taken after the trigger condition is met; and the analyzer continues to take new sweeps after the current sweep has completed and the trigger condition is again met. However, with Avg/Hold Num set to On with a value >1, multiple sweeps (data acquisitions) are taken for the measurement. The trigger condition must be met prior to each sweep. The sweep is not stopped when the average count k equals the number N set for Avg/Hold Num is reached, but the number k stops incrementing. A measurement average usually applies to all traces, marker results, and numeric results. But sometimes it only applies to the numeric results.

If the analyzer is in Single measurement, pressing the Cont key does not change k and does not cause the sweep to be reset; the only action is to put the analyzer into Continuous measurement operation.

If it is already in continuous sweep:

the INIT:CONT 1 command has no effect

the INIT:CONT 0 command will place the analyzer in Single Sweep but will have no effect on the current sequence until  $k = N$ , at which point the current sequence will stop and the instrument will go to the idle state.

14 Power Stat CCDF Measurement  
File

File

See "File" on page 354

## FREQ Channel

Accesses a menu of keys that allow you to control the Frequency and Channel parameters of the instrument.

Some features in the Frequency menu are the same for all measurements – they do not change as you change measurements. Settings like these are called “Meas Global” and are unaffected by Meas Preset. For example, the Center Freq setting is the same for all measurements – it does not change as you change measurements.

Key Path	Front-panel key
Initial S/W Revision	Prior to A.02.00

### Center Freq

Sets the frequency that corresponds to the horizontal center of the graticule (when frequency Scale Type is set to linear). While adjusting the Center Frequency the Span is held constant, which means that both Start Frequency and Stop Frequency will change.

Pressing Center Freq also sets the frequency entry mode to Center/Span. In Center/Span mode, the center frequency and span values are displayed below the graticule, and the default active function in the Frequency menu is Center Freq.

The center frequency setting is the same for all measurements within a mode, that is, it is Meas Global. Some modes are also able to share a Mode Global center frequency value. If this is the case, the Mode will have a Global Settings key in its Mode Setup menu.

The Center Freq function sets (and queries) the Center Frequency for the currently selected input. If your analyzer has multiple inputs, and you select another input, the Center Freq changes to the value for that input. SCPI commands are available to directly set the Center Freq for a specific input.

Center Freq is remembered as you go from input to input. Thus you can set a Center Freq of 10 GHz with the RF Input selected, change to BBIQ and set a Center Freq of 20 MHz, then switch to External Mixing and set a Center Freq of 60 GHz, and when you go back to the RF Input the Center Freq will go back to 10 GHz; back to BBIQ and it is 20 MHz; back to External Mixing and it is 60 GHz.

See ["RF Center Freq" on page 1636](#)

See [Ext Mix Center Freq](#)

See ["I/Q Center Freq" on page 1638](#)

See ["Center Frequency Presets" on page 1634](#)

Key Path	FREQ Channel
Scope	Meas Global
Remote Command	[ :SENSe ] :FREQuency:CENTer <freq> [ :SENSe ] :FREQuency:CENTer?

<b>Example</b>	FREQ:CENT 50 MHz FREQ:CENT UP changes the center frequency to 150 MHz if you use FREQ:CENT:STEP 100 MHz to set the center frequency step size to 100 MHz FREQ:CENT?
<b>Notes</b>	This command sets either the RF or I/Q Center Frequency depending on the selected input. For RF input it is equivalent to FREQ:RF:CENT For I/Q input it is equivalent to FREQ:IQ:CENT Preset and Max values are dependent on Hardware Options (5xx) If no terminator (e.g. MHz) is sent the terminator Hz is used. If a terminator with unit other than Frequency is used, an invalid suffix error message is generated.
<b>Dependencies</b>	The Center Frequency can be limited by Start or Stop Freq limits, if the Span is so large that Start or Stop reach their limit.
<b>Couplings</b>	When operating in “swept span”, any value of the Center Frequency or Span that is within the frequency range of the analyzer is allowed when the value is being set through the front panel numeric key pad or the SCPI command. The other parameter is forced to a different value if needed, to keep the Start and the Stop Frequencies within the analyzer’s frequency range
<b>Preset</b>	Depends on instrument maximum frequency, mode, measurement, and selected input. See <a href="#">"Center Frequency Presets" on page 1634</a> and <a href="#">"RF Center Freq" on page 1636</a> and <a href="#">Ext Mix Center Freq</a> and <a href="#">"I/Q Center Freq" on page 1638</a> .
<b>State Saved</b>	Saved in instrument state
<b>Min</b>	Depends on instrument maximum frequency, mode, measurement, and selected input.. See <a href="#">"Center Frequency Presets" on page 1634</a> and <a href="#">"RF Center Freq" on page 1636</a> and <a href="#">"I/Q Center Freq" on page 1638</a> .
<b>Max</b>	Depends on instrument maximum frequency, mode, measurement, and selected input.. See <a href="#">"Center Frequency Presets" on page 1634</a> and <a href="#">"RF Center Freq" on page 1636</a> and <a href="#">"I/Q Center Freq" on page 1638</a> .
<b>Default Unit</b>	Hz
<b>Status Bits/OPC</b>	Non-overlapped
<b>Dependencies</b>	
<b>Initial S/W Revision</b>	Prior to A.02.00

### Center Frequency Presets

The following table provides the Center Frequency Presets for the Spectrum Analyzer mode, and the Max Freq, for the various frequency options:

Freq Option	CF after Mode Preset	Stop Freq after Mode Preset	Max Freq (can't tune)

			above)
503 (all but N9000A)	1.805 GHz	3.6 GHz	3.7 GHz
503 (N9000A)	1.505 GHz	3.0 GHz	3.08 GHz
507 (all but N9000A)	3.505 GHz	7.0 GHz	7.1 GHz
507 (N9000A)	3.755 GHz	7.5 GHz	7.58 GHz
508 (all but N9038A)	1.805 GHz	3.6 GHz	8.5 GHz
508 (N9038A)	4.205 GHz	8.4 GHz	8.5 GHz
513	6.805 GHz	13.6 GHz	13.8 GHz
526 (all but N9000A and N9038A)	13.255 GHz	26.5 GHz	27.0 GHz
526 (N9000A)	13.255 GHz	26.5 GHz	26.55 GHz
526 (N9038A)	1.805 GHz	3.6 GHz	27.0 GHz
532	16.005 GHz	32.0 GHz	32.5 GHz
543	21.505 GHz	43.0 GHz	TBD
544	22.005 GHz	44.0 GHz	44.5 GHz
550	25.005 GHz	50.0 GHz	51 GHz

Input 2:

Model	CF after Mode Preset	Stop Freq after Mode Preset	Max Freq (can't tune above)
N9000A opt C75	0.7505GHz	1.5 GHz	1.58 GHz
N9038A	505 MHz	1 GHz	1.000025 GHz

Tracking Generator Frequency Limits (N9000A only):

Tracking Generator Option	Min Freq (clips to this freq when turn TG on and	If above this Freq, Stop Freq clipped to this Freq when	Max Freq (can't tune above) while TG

	can't tune below while TG on)	TG turned on	on
T03	9 kHz	3.0 GHz	3.08 GHz
T06	9 kHz	6.0 GHz	6.05 GHz

The following table shows the Center Frequency Presets for modes other than Spectrum Analyzer:

Mode	CF Preset for RF
WCDMA	1 GHz
WIMAXOFDMA,	1 GHz
BASIC	1 GHz
ADEMOD	1 GHz
VSA	1 GHz
TDSCDMA	1 GHz
PNOISE	1 GHz
LTE	1 GHz
LTETDD	1 GHz
MSR	1 GHz
GSM	935.2 MHz
NFIGURE	1.505 GHz

## RF Center Freq

SCPI command for specifying the RF Center Frequency. This command will set the Center Frequency to be used when the RF input is selected, even if the RF input is not the input that is selected at the time the command is sent. Note that the Center Freq function in the Frequency menu on the front panel always applies to the currently selected input.

Scope	Meas Global
<b>Remote Command</b>	<code>[ :SENSe ] :FREQuency:RF:CENTer &lt;freq&gt;</code> <code>[ :SENSe ] :FREQuency:RF:CENTer?</code>
<b>Example</b>	FREQ:RF:CENT 30 MHz
Notes	This command is the same in all modes, but the parameter is Measurement Global. So the value is independent in each mode and common across all the measurements in the mode.
Dependencies	If the electronic/soft attenuator is enabled, any attempt to set Center Frequency such that the Stop Frequency would be >3.6 GHz fails and results in an advisory message. If the equivalent SCPI command is sent, this same message is generated as part of a “-221, Settings conflict” warning. If Source Mode is set to Tracking, and the Max or Min Center Freq is therefore limited by the limits of the source, a warning message is generated, “Data out of range;clipped to source max/min” if these limits are exceeded. Note that for an external source, these limits can be affected by the settings of



	Source Numerator, Source Denominator and Power Sweep.
Preset	See table above
State Saved	Saved in instrument state.
Min	-79.999995 MHz, unless Source Mode is set to Tracking, in which case it is limited by the minimum frequency of the Source
Max	See table above. Basically instrument maximum frequency - 5 Hz. Note that, if the Source Mode is set to Tracking, the effective instrument maximum frequency may be limited by the source maximum frequency.  If the knob or step keys are being used, also depends on the value of the other three interdependent parameters Span, Start Frequency and Stop Frequency
Initial S/W Revision	Prior to A.02.00
Modified at S/W Revision	A.03.00

## Ext Mix Center Freq

SCPI command for specifying the External Mixer Center Frequency. This command will set the Center Frequency to be used when the External Mixer is selected, even if the External Mixer input is not the input which is selected at the time the command is sent. Note that the Center Freq function in the Frequency menu on the front panel always applies to the currently selected input.

Scope	Meas Global
<b>Remote Command</b>	<code>[ :SENSe ] :FREQuency:EMIXer:CENTer &lt;freq&gt;</code> <code>[ :SENSe ] :FREQuency:EMIXer:CENTer?</code>
<b>Example</b>	<code>:FREQ:EMIX:CENT 60 GHz</code> <code>:FREQ:EMIX:CENT?</code>
Notes	This command is the same in all modes, but the parameter is Measurement Global. So the value is independent in each mode and common across all the measurements in the mode.
Couplings	When returning to External Mixing after having been switched to one of the other inputs (e.g., RF), you will come back into the settings that you had when you left External Mixing. So you will come back to the band you were in with the Center Frequency that you had. However, Span is not an input-dependent parameter, therefore you will bring the span over from the other input. Therefore, the analyzer comes back with the span from the previous input, limited as necessary by the current mixer setup.
Preset	When a Mode Preset is performed while in External Mixing, the Start frequency of the current Mode is set to the nominal Min Freq of the lowest harmonic range in the Harmonic Table for the current mixer setup. Similarly, the Stop frequency of the current Mode is set to the nominal Max Freq of the highest harmonic range in the Harmonic Table. The Center Freq thus presets to the point arithmetically equidistant from these two frequencies.  If the current measurement has a limited Span available to it, and cannot achieve the Span shown in the table ( $\text{Span} = \text{Stop Freq} - \text{Start Freq}$ ), the analyzer uses the maximum Span the measurement allows, and still sets the Center Freq to the midpoint of the Start and Stop Freq values in the Harmonic Table.

	<p>When Restore Input/Output Defaults is performed, the mixer presets to the 11970A, whose Start and Stop frequencies are 26.5 and 40 GHz respectively. The center of these two frequencies is 33.25 GHz.</p> <p>Therefore, after a Restore Input/Output Defaults, if you go into External Mixing and do a Mode Preset while in the Spectrum Analyzer Mode, the resulting Center Freq is 33.25 GHz.</p>
State Saved	Saved in instrument state.
Min	The minimum frequency in the currently selected mixer band + 5 Hz
Max	The maximum frequency in the currently selected mixer band – 5 Hz If the knob or step keys are being used, also depends on the value of the other three interdependent parameters Span, Start Frequency and Stop Frequency
Initial S/W Revision	A.08.01

### I/Q Center Freq

SCPI command for specifying the I/Q Center Frequency. This command will set the Center Frequency to be used when the I/Q input is selected, even if the I/Q input is not the input which is selected at the time the command is sent. Note that the Center Freq function in the Frequency menu on the front panel always applies to the currently selected input.

Scope	Meas Global
<b>Remote Command</b>	<pre>[ :SENSe ] :FREQuency:IQ:CENTer &lt;freq&gt;</pre> <pre>[ :SENSe ] :FREQuency:IQ:CENTer?</pre>
<b>Example</b>	FREQ:IQ:CENT: 30 MHz
Notes	This command is the same in all modes, but the parameter is Measurement Global. So the value is independent in each mode and common across all the measurements in the mode.
Preset	0 Hz
State Saved	Saved in instrument state.
Min	-40.049995 MHz
Max	40.049995 MHz
Initial S/W Revision	Prior to A.02.00

### CF Step

Changes the step size for the center frequency and start and stop frequency functions. Once a step size has been selected and the center frequency function is active, the step keys (and the UP|DOWN parameters for Center Frequency from remote commands) change the center frequency by the step-size value. The step size function is useful for finding harmonics and sidebands beyond the current frequency span of the analyzer.

Note that the start and stop frequencies also step by the CF Step value.

Key Path	FREQ Channel
Remote Command	[:SENSe]:FREQuency:CENTer:STEP[:INCRement] <freq> [:SENSe]:FREQuency:CENTer:STEP[:INCRement]? [:SENSe]:FREQuency:CENTer:STEP:AUTO OFF ON 0 1 [:SENSe]:FREQuency:CENTer:STEP:AUTO?
Example	FREQ:CENT:STEP:AUTO ON FREQ:CENT:STEP 500 MHz FREQ:CENT UP increases the current center frequency value by 500 MHz FREQ:CENT:STEP? FREQ:CENT:STEP:AUTO?
Notes	Preset and Max values are depending on Hardware Options (503, 507, 508, 513, 526)
Notes	Preset and Max values are dependent on Hardware Options (5xx)
Dependencies	Freq Offset is not available in External Mixing. In this case the Freq Offset key is grayed out and shows a value of zero. It will once again be available, and show the previously set value, when you return to the RF Input.
Dependencies	Span, RBW, Center frequency If the electronic/soft attenuator is enabled, any attempt to change the value of the center frequency >3.6 GHz by pressing the Up-arrow key, fails and results in an advisory message. If the equivalent SCPI command is sent, this same message is generated as part of a “-221, Settings conflict” warning.
Couplings	When auto-coupled in a non-zero span, the center frequency step size is set to 10% of the span. When auto-coupled in zero span, the center frequency step size is set to the equivalent -3 dB RBW value.
Preset	Auto ADEMOD: 1 MHz ON
State Saved	Saved in instrument state
Min	– (the maximum frequency of the instrument). That is, 27 GHz max freq instrument has a CF step range of +/- 27 GHz. Note that this is the maximum frequency given the current settings of the instrument, so in External Mixing, for example, it is the maximum frequency of the current mixer band.
Max	The maximum frequency of the instrument. That is, 27 GHz max freq instrument has a CF step range of +/- 27 GHz. Note that this is the maximum frequency given the current settings of the instrument, so in External Mixing, for example, it is the maximum frequency of the current mixer band.
Default Unit	Hz
Status Bits/OPC dependencies	non-overlapped
Initial S/W Revision	Prior to A.02.00
Modified at S/W Revision	A.03.00

14 Power Stat CCDF Measurement  
Input/Output

Input/Output

See "[Input/Output](#)" on page 226

## Marker

Accesses a menu that enables you to select, set up and control the markers for the current measurement.

Key Path	Front-panel key
Initial S/W Revision	Prior to A.02.00

## Select Marker

Accesses a menu that allows you to select one of 12 markers for control and function

Key Path	Marker
Initial S/W Revision	Prior to A.02.00

## Marker Type

Sets the marker control mode to Normal, Delta, Fixed or Off.

If the selected marker is Off, pressing Marker sets it to Normal and places it at the center of the screen on the trace determined by the Marker Trace rules. At the same time, Marker X Axis Value appears on the Active Function area.

The Active function for the selected marker's current control mode is the default active function. If the current control mode is Off, there is no active function and the active function is turned off. The active function display is the marker X axis value entered in the active function area, which displays the marker value to its full entered precision.

All interactions and dependencies detailed under the key description are enforced when the remote command is sent.

Key Path	Marker
Mode	SA, WCDMA, C2K, WiMAX OFDMA, TD-SCDMA, 1xEV-DO, DVB-T/H, DTMB (CTTB), ISDB-T, CMMB, LTE, LTE-TDD, Digital Cable TV, WLAN, MSR, LTE-TDD, LTE-FDD
Remote Command	:CALCulate:PStatistic:MARKer[1] 2 ... 12:MODE POSition   DELTA   OFF :CALCulate:PStatistic:MARKer[1] 2 ... 12:MODE?
Example	CALC:PST:MARK:MODE POS CALC:PST:MARK:MODE?
Notes	If the selected marker is Off, pressing Marker sets it to Normal and places it at the center of the screen on the trace determined by the Marker Trace rules. At the same time, Marker X Axis Value appears on the Active Function area.  Default Active Function: the active function for the selected marker's current control mode. If the current control mode is Off, there is no active function and the active function is turned off.  Active Function Display: the marker X axis value entered in the active function area displays the marker value to its full entered precision.

Preset	OFF
State Saved	Saved in instrument state.
Range	Normal Delta Off
Initial S/W Revision	Prior to A.02.00
Modified at S/W Revision	A.02.00, A.03.00

## Properties

Accesses the marker properties menu.

Key Path	Marker
Initial S/W Revision	Prior to A.02.00

## Select Marker

Accesses a menu that allows you to select one of 12 markers for control and function

Key Path	Marker
Initial S/W Revision	Prior to A.02.00

## Relative To

Sets the reference marker that the selected marker will be relative to.

Key Path	Marker, Properties
Mode	SA, WCDMA, C2K, WIMAXOFDMA, TD-SCDMA, 1xEV-DO, DVB-T/H, DTMB (CTTB), ISDB-T, CMMB, LTE, LTETDD, Digital Cable TV, WLAN, MSR, LTEATDD, LTEAFDD
<b>Remote Command</b>	:CALCulate:PStatistic:MARKer[1] 2 ... 12:REFerence <integer> :CALCulate:PStatistic:MARKer[1] 2 ... 12:REFerence?
<b>Example</b>	CALC:PST:MARK:REF 3 CALC:PST:MARK:REF?
Notes	A marker cannot be relative to itself so that choice is grayed out, and if sent from SCPI generates error -221: "Settings conflict; marker cannot be relative to itself." When queried a single value will be returned (the specified marker numbers relative marker).
Preset	2 3 4 5 6 7 8 9 10 11 12 1
State Saved	Saved in instrument state.
Min	1
Max	12
Initial S/W Revision	Prior to A.02.00
Modified at S/W Revision	A.02.00, A.03.00

## Marker Trace

Assigns the specified marker to the designated trace. The trace choices are:

- Measured
- Gaussian
- Reference

Key Path	Marker
Mode	SA, WCDMA, C2K, WIMAXOFDMA, TD-SCDMA, 1xEV-DO, DVB-T/H, DTMB (CTTB), ISDB-T, CMMB, LTE, LTE-TDD, Digital Cable TV, WLAN, MSR, LTE-TDD, LTE-FDD
Remote Command	:CALCulate:PStatistic:MARKer[1] 2 ... 12:TRACe MEASured   GAUSSian   REFerence  :CALCulate:PStatistic:MARKer[1] 2 ... 12:TRACe?
Example	CALC:PST:MARK3:TRAC MEAS CALC:PST:MARK:TRACE?
Preset	MEASured
State Saved	Saved in instrument state.
Range	Measured Gaussian Reference
Initial S/W Revision	Prior to A.02.00
Modified at S/W Revision	A.02.00, A.03.00

## Couple Markers

When this function is on, moving any marker causes an equal X axis movement of every other marker that is not off. By “equal X axis movement” we mean that we preserve the difference between each marker’s X axis value (in the fundamental x-axis units of the trace that marker is on) and the X axis value of the marker being moved (in the same fundamental x-axis units).

Key Path	Marker
Initial S/W Revision	Prior to A.02.00

## All Markers Off

Turns off all markers.

Key Path	Marker, More
Mode	SA, WCDMA, C2K, WIMAXOFDMA, TD-SCDMA, 1xEV-DO, DVB-T/H, DTMB (CTTB), ISDB-T, CMMB, LTE, LTE-TDD, Digital Cable TV, WLAN, MSR, LTE-TDD, LTE-FDD
Remote Command	:CALCulate:PStatistic:MARKer:AOFF

<b>Example</b>	CALC:PST:MARK:AOFF
Initial S/W Revision	Prior to A.02.00
Modified at S/W Revision	A.02.00, A.03.00

### Marker X Axis Value (Remote Command Only)

Sets the marker X Axis value in the current marker X Axis Scale unit. This function has no effect if the control mode is Off, but is the remote command equivalent of entering an X value if the control mode is Normal or Delta.

<b>Mode</b>	SA, WCDMA, C2K, WIMAXOFDMA, TD-SCDMA, 1xEV-DO, DVB-T/H, DTMB (CTTB), ISDB-T, CMMB, LTE, LTE-TDD, Digital Cable TV, WLAN, MSR, LTE-TDD, LTEAFDD
<b>Remote Command</b>	:CALCulate:PStatistic:MARKer[1] 2 ... 12:X <rel_amp> :CALCulate:PStatistic:MARKer[1] 2 ... 12:X?
<b>Example</b>	CALC:PST:MARK3:X 0 CALC:PST:MARK3:X?
<b>Notes</b>	If no suffix is sent, it will use the fundamental units for the current marker X Axis Scale. If a suffix is sent that does not match the current marker X Axis Scale unit, an error "Invalid suffix" will be generated. If the specified marker is Fixed and a Marker Function is on, error -221 "Settings conflict; cannot adjust Fixed marker while Marker Function is on" is generated.  The query returns the marker's absolute X Axis value if the control mode is Normal, or the offset from the marker's reference marker if the control mode is Delta. The query is returned in the fundamental units for the current marker X Axis scale: Hz for Frequency and Inverse Time, seconds for Period and Time. If the marker is Off the response is not a number.
<b>Preset</b>	After a preset, all Markers are turned OFF, so Marker X Axis Value query will return a not a number (NAN).
<b>State Saved</b>	No
<b>Min</b>	-9.9E+37
<b>Max</b>	9.9E+37
Initial S/W Revision	Prior to A.02.00
Modified at S/W Revision	A.02.00, A.03.00

### Marker Y Axis Value (Remote Command Only)

Queries the marker Y Axis value in the current marker Y Axis unit.

<b>Mode</b>	SA, WCDMA, C2K, WIMAXOFDMA, TD-SCDMA, 1xEV-DO, DVB-T/H, DTMB (CTTB), ISDB-T, CMMB, LTE, LTE-TDD, Digital Cable TV, WLAN, MSR, LTE-TDD, LTEAFDD
<b>Remote Command</b>	:CALCulate:PStatistic:MARKer[1] 2 ... 12:Y?
<b>Example</b>	CALC:PST:MARK11:Y?
<b>Notes</b>	The query returns the marker Y-axis result, if the control mode is Normal, or Delta. If the marker is



	Off the response is not a number.
Preset	0
State Saved	No
<b>Backwards Compatibility SCPI</b>	:CALCulate:PSStatistic:MARKer[1] 2 ... 12:FUNCTION:RESult?
Initial S/W Revision	Prior to A.02.00
Modified at S/W Revision	A.02.00, A.03.00

## Marker Function

There are no 'Marker Functions' supported in Power Stat CCDF measurement. The front-panel key displays a blank menu when pressed.

---

Key Path	Front-panel key
Initial S/W Revision	Prior to A.02.00

---

## Marker To

There is no 'Marker To' functionality supported in Power Stat CCDF measurement. The front-panel key displays a blank menu when pressed.

---

Key Path	Front-panel key
Initial S/W Revision	Prior to A.02.00

---

## Meas

The information in this section is common to all measurements. For key and remote command information for a specific measurement, refer to the section that describes the measurement of interest.

Measurements available under the Meas key are specific to the current Mode.

When viewing Help for measurements, note the following:

**NOTE**

Operation for some keys differs between measurements. The information displayed in Help pertains to the current measurement. To see how a key operates in a different measurement, exit Help (press the Cancel Esc key), select the measurement, then reenter Help (press the Help key) and press that key.

---

Key Path	Front-panel key
Initial S/W Revision	Prior to A.02.00

---

### Remote Measurement Functions

This section contains the following topics:

["Measurement Group of Commands" on page 2849](#)

["Current Measurement Query \(Remote Command Only\) " on page 2851](#)

["Limit Test Current Results \(Remote Command Only\)" on page 2851](#)

["Data Query \(Remote Command Only\)" on page 2851](#)

["Calculate/Compress Trace Data Query \(Remote Command Only\)" on page 2852](#)

["Calculate Peaks of Trace Data \(Remote Command Only\)" on page 2857](#)

[Hardware-Accelerated Fast Power Measurement \(Remote Command Only\)](#)

["Format Data: Numeric Data \(Remote Command Only\)" on page 2858](#)

["Format Data: Byte Order \(Remote Command Only\)" on page 2859](#)

---

Initial S/W Revision	Prior to A.02.00
----------------------	------------------

---

## Measurement Group of Commands

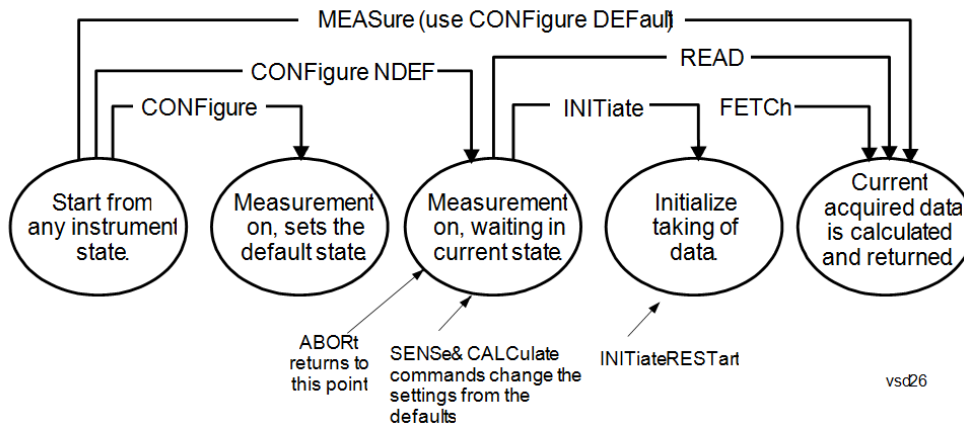

---

### Measure Commands:

:MEASure:<measurement>[n]?

This is a fast single-command way to make a measurement using the factory default instrument settings. These are the settings and units that conform to the Mode Setup settings (e.g. radio standard) that you have currently selected.

- Stops the current measurement (if any) and sets up the instrument for the specified measurement using the factory defaults
- Initiates the data acquisition for the measurement
- Blocks other SCPI communication, waiting until the measurement is complete before returning results.
- If the function does averaging, it is turned on and the number of averages is set to 10.
- After the data is valid it returns the scalar results, or the trace data, for the specified measurement. The type of data returned may be defined by an [n] value that is sent with the command.
- The scalar measurement results will be returned if the optional [n] value is not included, or is set to 1. If the [n] value is set to a value other than 1, the selected trace data results will be returned. See each command for details of what types of scalar results or trace data results are available.
- ASCII is the default format for the data output. (Older versions of Spectrum Analysis and Phase Noise mode measurements only use ASCII.) The binary data formats should be used for handling large blocks of data since they are smaller and faster than the ASCII format. Refer to the FORMat:DATA command for more information.

If you need to change some of the measurement parameters from the factory default settings you can set up the measurement with the CONFIgure command. Use the commands in the SENSe:<measurement> and CALCulate:<measurement> subsystems to change the settings. Then you can use the READ? command to initiate the measurement and query the results.

If you need to repeatedly make a given measurement with settings other than the factory defaults, you can use the commands in the SENSe:<measurement> and CALCulate:<measurement> subsystems to set up the measurement. Then use the READ? command to initiate the measurement and query results.

Measurement settings persist if you initiate a different measurement and then return to a previous one. Use READ:<measurement>? if you want to use those persistent settings. If you want to go back to the default settings, use MEASure:<measurement>?.

---

### Configure Commands:

:CONFIgure:<measurement>

This command stops the current measurement (if any) and sets up the instrument for the specified measurement using

---

---

the factory default instrument settings. It does not initiate the taking of measurement data unless INIT:CONTinuous is ON. If you change any measurement settings after using the CONFigure command, the READ command can be used to initiate a measurement without changing the settings back to their defaults.

In the Swept SA measurement in Spectrum Analyzer mode the CONFigure command also turns the averaging function on and sets the number of averages to 10 for all measurements.

:CONFigure: <measurement>: NDEFault stops the current measurement and changes to the specified measurement. It does not change the settings to the defaults. It does not initiate the taking of measurement data unless INIT:CONTinuous is ON.

The CONFigure? query returns the current measurement name.

The CONFigure:CATalog? query returns a quoted string of all licensed measurement names in the current mode. For example, "SAN, CHP, OBW, ACP, PST, TXP, SPUR, SEM, LIST".

---

#### Fetch Commands:

---

:FETCh:<measurement>[n]?

This command puts selected data from the most recent measurement into the output buffer. Use FETCh if you have already made a good measurement and you want to return several types of data (different [n] values, for example, both scalars and trace data) from a single measurement. FETCh saves you the time of re-making the measurement. You can only FETCh results from the measurement that is currently active, it will not change to a different measurement. An error message is reported if a measurement other than the current one is specified.

If you need to get new measurement data, use the READ command, which is equivalent to an INITiate followed by a FETCh.

The scalar measurement results will be returned if the optional [n] value is not included, or is set to 1. If the [n] value is set to a value other than 1, the selected trace data results will be returned. See each command for details of what types of scalar results or trace data results are available. The binary data formats should be used for handling large blocks of data since they are smaller and transfer faster than the ASCII format. (FORMat:DATA)

FETCh may be used to return results other than those specified with the original READ or MEASure command that you sent.

---

#### INITiate Commands:

---

:INITiate:<measurement>

This command is not available for measurements in all the instrument modes:

- Initiates a trigger cycle for the specified measurement, but does not output any data. You must then use the FETCh<meas> command to return data. If a measurement other than the current one is specified, the instrument will switch to that measurement and then initiate it.
  - For example, suppose you have previously initiated the ACP measurement, but now you are running the channel power measurement. If you send INIT:ACP? it will change from channel power to ACP and will initiate an ACP measurement.
  - Does not change any of the measurement settings. For example, if you have previously started the ACP measurement and you send INIT:ACP? it will initiate a new ACP measurement using the same instrument settings as the last time ACP was run.
  - If your selected measurement is currently active (in the idle state) it triggers the measurement, assuming the trigger conditions are met. Then it completes one trigger cycle. Depending upon the measurement and the number of averages, there may be multiple data acquisitions, with multiple trigger events, for one full trigger cycle. It also holds off additional commands on GPIB until the acquisition is complete.
- 

#### READ Commands:

---

:READ:<measurement>[n]?

- Does not preset the measurement to the factory default settings. For example, if you have previously initiated the ACP
-

---

measurement and you send READ:ACP? it will initiate a new measurement using the same instrument settings.

- Initiates the measurement and puts valid data into the output buffer. If a measurement other than the current one is specified, the instrument will switch to that measurement before it initiates the measurement and returns results.
  - For example, suppose you have previously initiated the ACP measurement, but now you are running the channel power measurement. Then you send READ:ACP? It will change from channel power back to ACP and, using the previous ACP settings, will initiate the measurement and return results.
  - Blocks other SCPI communication, waiting until the measurement is complete before returning the results
  - If the optional [n] value is not included, or is set to 1, the scalar measurement results will be returned. If the [n] value is set to a value other than 1, the selected trace data results will be returned. See each command for details of what types of scalar results or trace data results are available. The binary data formats should be used when handling large blocks of data since they are smaller and faster than the ASCII format. (FORMat:DATA)
- 

---

Initial S/W Revision	Prior to A.02.00
----------------------	------------------

---

### Current Measurement Query (Remote Command Only)

This command returns the name of the measurement that is currently running.

---

<b>Remote Command</b>	:CONFigure?
-----------------------	-------------

<b>Example</b>	CONF?
----------------	-------

Initial S/W Revision	Prior to A.02.00
----------------------	------------------

---

### Limit Test Current Results (Remote Command Only)

Queries the status of the current measurement limit testing. It returns a 0 if the measured results pass when compared with the current limits. It returns a 1 if the measured results fail any limit tests.

---

<b>Remote Command</b>	:CALCulate:CLIMits:FAIL?
-----------------------	--------------------------

<b>Example</b>	CALC:CLIM:FAIL? queries the current measurement to see if it fails the defined limits. Returns a 0 or 1: 0 it passes, 1 it fails.
----------------	--------------------------------------------------------------------------------------------------------------------------------------

Initial S/W Revision	Prior to A.02.00
----------------------	------------------

---

### Data Query (Remote Command Only)

Returns the designated measurement data for the currently selected measurement and subopcode.

n = any valid subopcode for the current measurement. See the measurement command results table for your current measurement, for information about what data is returned for the subopcodes.

This command uses the data setting specified by the FORMat:BORDER and FORMat:DATA commands and can return real or ASCII data. (See the format command descriptions under Input/Output in the Analyzer Setup section.)

<b>Remote Command</b>	:CALCulate:DATA[n]?
<b>Notes</b>	The return trace depends on the measurement. In CALCulate:<meas>:DATA[n], n is any valid subopcode for the current measurement. It returns the same data as the FETCH:<measurement>? query where <measurement> is the current measurement.
<b>Initial S/W Revision</b>	Prior to A.02.00

### Calculate/Compress Trace Data Query (Remote Command Only)

Returns compressed data for the currently selected measurement and sub-opcode [n].

n = any valid sub-opcode for that measurement. See the MEASure:<measurement>? command description of your specific measurement for information on the data that can be returned.

The data is returned in the current Y Axis Unit of the analyzer. The command is used with a sub-opcode <n> (default=1) to specify the trace. With trace queries, it is best if the analyzer is not sweeping during the query. Therefore, it is generally advisable to be in Single Sweep, or Update=Off.

This command is used to compress or decimate a long trace to extract and return only the desired data. A typical example would be to acquire N frames of GSM data and return the mean power of the first burst in each frame. The command can also be used to identify the best curve fit for the data.

<b>Remote Command</b>	:CALCulate:DATA<n>:COMPRESS? BLOCK   CFIT   MAXimum   MINimum   MEAN   DMEan   RMS   RMSCubed   SAMPLE   SDEVIation   PPHase [,<soffset> [,<length>[,<roffset>[,<rlimit>]]]]
<b>Example</b>	To query the mean power of a set of GSM bursts: Supply a signal that is a set of GSM bursts. Select the IQ Waveform measurement (in IQ Analyzer Mode). Set the sweep time to acquire at least one burst. Set the triggers such that acquisition happens at a known position relative to a burst. Then query the mean burst levels using, CALC:DATA2:COMP? MEAN, 24e-6, 526e-6 (These parameter values correspond to GSM signals, where 526e-6 is the length of the burst in the slot and you just want 1 burst.)
<b>Notes</b>	The command supports 5 parameters. Note that the last 4 (<soffset>, <length>, <roffset>, <rlimit>) are optional. But these optional parameters must be entered in the specified order. For example, if you want to specify <length>, then you must also specify <soffset>. See details below for a definition of each of these parameters.  This command uses the data in the format specified by FORMat:DATA, returning either binary or ASCII data.
<b>Initial S/W Revision</b>	Prior to A.02.00

- BLOCK or block data - returns all the data points from the region of the trace data that you specify. For example, it could be used to return the data points of an input signal over several timeslots, excluding the portions of the trace data that you do not want. (This is x,y pairs for trace data and I,Q pairs for complex data.)



- CFIT or curve fit - applies curve fitting routines to the data. <soffset> and <length> are required to define the data that you want. <roffset> is an optional parameter for the desired order of the curve equation. The query will return the following values: the x-offset (in seconds) and the curve coefficients ((order + 1) values).

MIN, MAX, MEAN, DME, RMS, RMSC, SAMP, SDEV and PPH return one data value for each specified region (or <length>) of trace data, for as many regions as possible until you run out of trace data (using <roffset> to specify regions). Or they return the number of regions you specify (using <rlimit>) ignoring any data beyond that.

- MINimum - returns the minimum data point (y value) for the specified region(s) of trace data. For I/Q trace data, the minimum magnitude of the I/Q pairs is returned.
- MAXimum - returns the maximum data point (y value) for the specified region(s) of trace data. For I/Q trace data, the maximum magnitude of the I/Q pairs is returned.
- MEAN - returns a single value that is the arithmetic mean of the data point values (in dB/ dBm) for the specified region(s) of trace data. For I/Q trace data, the mean of the magnitudes of the I/Q pairs is returned. See the following equations.

•

**NOTE**

If the original trace data is in dB, this function returns the arithmetic mean of those log values, not log of the mean power which is a more useful value. The mean of the log is the better measurement technique when measuring CW signals in the presence of noise. The mean of the power, expressed in dB, is useful in power measurements such as Channel Power. To achieve the mean of the power, use the RMS option.

Equation 1

Mean Value of Data Points for Specified Region(s)

$$\text{MEAN} = \frac{1}{n} \sum_{X_i \in \text{region}(s)} X_i$$

where  $X_i$  is a data point value, and  $n$  is the number of data points in the specified region(s).

Equation 2

Mean Value of I/Q Data Pairs for Specified Region(s)

$$\text{MEAN} = \frac{1}{n} \sum_{X_i \in \text{region}(s)} |X_i|$$

where  $|X_i|$  is the magnitude of an I/Q pair, and  $n$  is the number of I/Q pairs in the specified region(s).

- DMEan - returns a single value that is the mean power (in dB/ dBm) of the data point values for the specified region(s) of trace data. See the following equation:

Equation 3

DMEan Value of Data Points for Specified Region(s)

$$\text{DME} = 10 \times \log_{10} \left( \frac{1}{n} \sum_{X_i \in \text{region}(s)} 10^{\frac{X_i}{10}} \right)$$

- RMS - returns a single value that is the average power on a root-mean-squared voltage scale (arithmetic rms) of the data point values for the specified region(s) of trace data. See the following equation.

**NOTE** For I/Q trace data, the rms of the magnitudes of the I/Q pairs is returned. See the following equation. This function is very useful for I/Q trace data. However, if the original trace data is in dB, this function returns the rms of the log values which is not usually needed.

Equation 4

RMS Value of Data Points for Specified Region(s)

$$\text{RMS} = \sqrt{\frac{1}{n} \sum_{X_i \in \text{region}(s)} X_i^2}$$

where  $X_i$  is a data point value, and  $n$  is the number of data points in the specified region(s).

Equation 5

RMS Value of I/Q Data Pairs for Specified Region(s)

$$\text{RMS} = \sqrt{\frac{1}{n} \sum_{X_i \in \text{region}(s)} X_i X_i^*}$$

where  $X_i$  is the complex value representation of an I/Q pair,  $X_i^*$  its conjugate complex number, and  $n$  is the number of I/Q pairs in the specified region(s).

Once you have the rms value for a region of trace data (linear or I/Q), you may want to calculate the mean power. You must convert this rms value (peak volts) to power in dBm:

$$10 \times \log[10 \times (\text{rms value})^2]$$

- SAMPLe - returns the first data value (x,y pair) for the specified region(s) of trace data. For I/Q trace data, the first I/Q pair is returned.
- SDEViation - returns a single value that is the arithmetic standard deviation for the data point values for the specified region(s) of trace data. See the following equation.
- For I/Q trace data, the standard deviation of the magnitudes of the I/Q pairs is returned. See the following equation.

Equation 6

Standard Deviation of Data Point Values for Specified Region(s)

$$\text{SDEV} = \sqrt{\frac{1}{n} \sum_{X_i \in \text{region}(s)} (X_i - \bar{X})^2}$$

where  $X_i$  is a data point value,  $\bar{X}$  is the arithmetic mean of the data point values for the specified region (s), and  $n$  is the number of data points in the specified region(s).

$$\text{SDEV} = \sqrt{\frac{1}{n} \sum_{X_i \in \text{region}(s)} (|X_i| - \bar{X})^2}$$

where  $|X_i|$  is the magnitude of an I/Q pair,  $\bar{X}$  is the mean of the magnitudes for the specified region(s), and  $n$  is the number of data points in the specified region(s).

- PPHase - returns the x,y pairs of both rms power (dBm) and arithmetic mean phase (radian) for every specified region and frequency offset (Hz). The number of pairs is defined by the specified number of regions. This parameter can be used for I/Q vector (n=0) in Waveform (time domain) measurement and all parameters are specified by data point in PPHase.

The rms power of the specified region may be expressed as:

$$\text{Power} = 10 \times \log [10 \times (\text{RMS I/Q value})] + 10.$$

The RMS I/Q value (peak volts) is:

$$\sqrt{\frac{1}{n} \sum_{X_i \in \text{region}} X_i X_i^*}$$

where  $X_i$  is the complex value representation of an I/Q pair,  $X_i^*$  its conjugate complex number, and  $n$  is the number of I/Q pairs in the specified region.

The arithmetic mean phase of the specified region may be expressed as:

$$\frac{1}{n} \sum_{Y_i \in \text{region}} Y_i$$

where  $Y_i$  is the unwrapped phase of I/Q pair with applying frequency correction and  $n$  is the number of I/Q pairs in the specified region.

The frequency correction is made by the frequency offset calculated by the arithmetic mean of every specified region's frequency offset. Each frequency offset is calculated by the least square method against the unwrapped phase of I/Q pair.

Sample Trace Data - Constant Envelope

(See below for explanation of variables.)

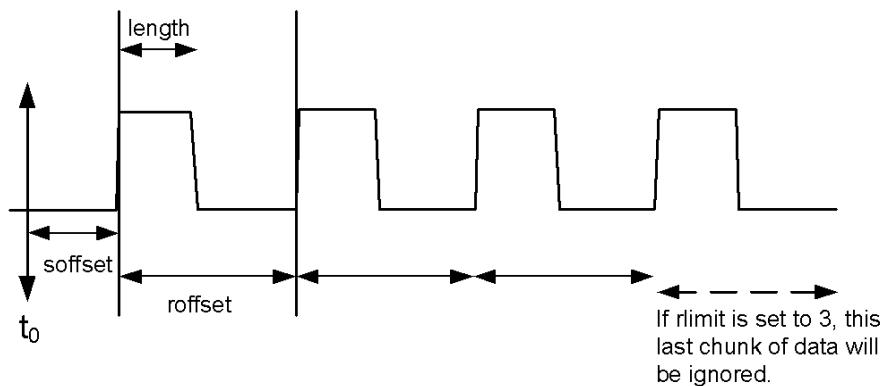

Sample Trace Data - Not Constant Envelope

(See below for explanation of variables.)

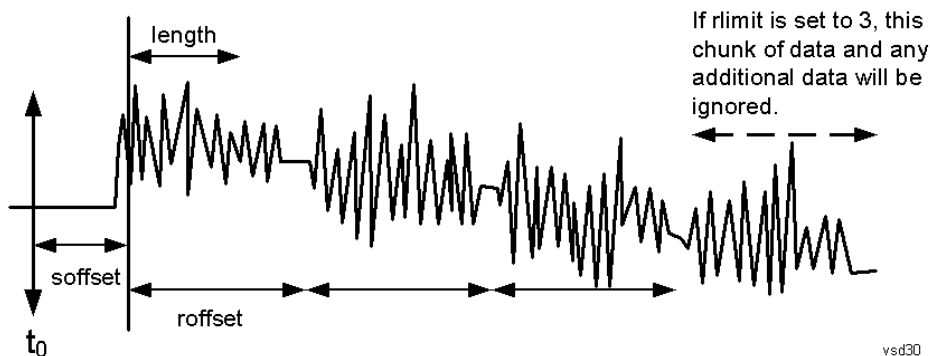

<soffset> - start offset is an optional real number. (It is in seconds for time-domain traces, and is a dimensionless index 0 to Npoints - 1, for frequency-domain traces). It specifies the amount of data at the beginning of the trace that will be ignored before the decimation process starts. It is the time or frequency change from the start of the trace to the point where you want to start using the data. The default value is zero.

<length> - is an optional real number. (It is in seconds for time-domain traces, and is a dimensionless index 0 to Npoints - 1, for frequency-domain traces). It defines how much data will be compressed into one value. This parameter has a default value equal to the current trace length.

<roffset> - repeat offset is an optional real number. (It is in seconds for time-domain traces, and is a dimensionless index 0 to Npoints - 1, for frequency-domain traces). It defines the beginning of the next field of trace elements to be compressed. This is relative to the beginning of the previous field. This parameter has a default value equal to the <length> variable. Note that this parameter is used for a completely different purpose when curve fitting (see CFIT above).

<rlimit> - repeat limit is an optional integer. It specifies the number of data items that you want returned. It will ignore any additional items beyond that number. You can use the Start offset and the Repeat limit to pick out exactly what part of the data you want to use. The default value is all the data.

## Calculate Peaks of Trace Data (Remote Command Only)

Returns a list of all the peaks for the currently selected measurement and sub-opcode [n]. The peaks must meet the requirements of the peak threshold and excursion values.

n = any valid sub-opcode for the current measurement. See the MEASure:<measurement> command description of your specific measurement for information on the data that can be returned.

The command can only be used with specific sub-opcodes with measurement results that are trace data. Both real and complex traces can be searched, but complex traces are converted to magnitude in dBm. In many measurements the sub-opcode n=0, is the raw trace data which cannot be searched for peaks. And Sub-opcode n=1, is often calculated results values which also cannot be searched for peaks.

This command uses the data setting specified by the FORMat:BORDER and FORMat:DATA commands and can return real or ASCII data. If the format is set to INT,32, it returns REAL,32 data.

The command has four types of parameters:

- Threshold (in dBm)
- Excursion (in dB)
- Sorting order (amplitude, frequency, time)
- Optional in some measurements: Display line use (all, > display line, < display line)

<b>Remote Command</b>	<p>For Swept SA measurement:</p> <pre>:CALCulate:DATA[1] 2 ... 6:PEAKs? &lt;threshold&gt;,&lt;excursion&gt;[,AMPLitude   FREQuency   TIME[,ALL   GTDLline   LTDLine]]</pre> <p>For most other measurements:</p> <pre>:CALCulate:DATA[1] 2 ... 6:PEAKs? &lt;threshold&gt;,&lt;excursion&gt;[,AMPLitude   FREQuency   TIME]</pre>
<b>Example</b>	<p>Example for Swept SA measurement in Spectrum Analyzer Mode:</p> <p>CALC:DATA4:PEAK? -40, 10, FREQ, GTDL This will identify the peaks of trace 4 that are above -40 dBm, with excursions of at least 10 dB. The peaks are returned in order of increasing frequency, starting with the lowest frequency. Only the peaks that are above the display line are returned.</p> <p>Query Results 1:</p> <p>With FORMat:DATA REAL, 32 selected, it returns a list of floating-point numbers. The first value in the list is the number of peak points that are in the following list. A peak point consists of two values: a peak amplitude followed by its corresponding frequency (or time).</p> <p>If no peaks are found the peak list will consist of only the number of peaks, (0).</p>
<b>Notes</b>	<p>&lt;n&gt; - is the trace that will be used</p> <p>&lt;threshold&gt; - is the level below which trace data peaks are ignored. Note that the threshold value is required and is always used as a peak criterion. To effectively disable the threshold criterion for this command, provide a substantially low threshold value such as -200 dBm. Also note that the threshold value used in this command is independent of and has no effect on the threshold value stored under the Peak Criteria menu.</p> <p>&lt;excursion&gt; - is the minimum amplitude variation (rise and fall) required for a signal to be identified as peak. Note that the excursion value is required and is always used as a peak criterion. To effectively disable the excursion criterion for this command, provide the minimum value of 0.0 dB. Also note that the excursion value used in this command is independent of and has no effect on the</p>

---

excursion value stored under the Peak Criteria menu.

Values must be provided for threshold and excursion. The sorting and display line parameters are optional (defaults are AMPLitude and ALL).

Note that there is always a Y-axis value for the display line, regardless of whether the display line state is on or off. It is the current Y-axis value of the display line which is used by this command to determine whether a peak should be reported

Sorting order:

AMPLitude - lists the peaks in order of descending amplitude, with the highest peak first (default if optional parameter not sent)

FREQuency - lists the peaks in order of occurrence, left to right across the x-axis.

TIME - lists the peaks in order of occurrence, left to right across the x-axis.

Peaks vs. Display Line:

ALL - lists all of the peaks found (default if optional parameter not sent).

GTDLine (greater than display line) - lists all of the peaks found above the display line.

LTDLine (less than display line) - lists all of the peaks found below the display line.

---

Initial S/W Revision      Prior to A.02.00

---

### Format Data: Numeric Data (Remote Command Only)

This command specifies the format of the trace data input and output. It specifies the formats used for trace data during data transfer across any remote port. It affects only the data format for setting and querying trace data for the :TRACe[:DATA], TRACe[:DATA]?, :CALCulate:DATA[n]? and FETCh:SANalyzer [n]? commands and queries.

---

**Remote Command**      :FORMat [:TRACe] [:DATA] ASCii|INTEger, 32|REAL, 32 |REAL, 64  
:FORMat [:TRACe] [:DATA] ?

---

**Notes**      The query response is:  
ASCii: ASC,8  
REAL,32: REAL,32  
REAL,64: REAL,64  
INTEger,32: INT,32

When the numeric data format is REAL or ASCii, data is output in the current Y Axis unit. When the data format is INTEger, data is output in units of m dBm (.001 dBm).

The INT,32 format returns binary 32-bit integer values in internal units (m dBm), in a definite length block.

---

**Dependencies**      Sending a data format spec with an invalid number (for example, INT,48) generates no error. The analyzer simply uses the default (8 for ASCii, 32 for INTEger, 32 for REAL).

Sending data to the analyzer which does not conform to the current FORMat specified, results in an error. Sending ASCII data when a definite block is expected generates message -161 "Invalid Block Data" and sending a definite block when ASCII data is expected generates message -121 "Invalid Character in Number".

---

**Preset**      ASCii

---

**Backwards Compatibility Notes**      Note that the INT,32 format is only applicable to the command, TRACe:DATA. This preserves backwards compatibility for the Swept SA measurement. For all other commands/queries which honor FORMat:DATA, if INT,32 is sent the analyzer will behave as though it were set to REAL,32.

---

Initial S/W Revision      Prior to A.02.00

---

The specs for each output type follow:

ASCIi - Amplitude values are in ASCII, in the current Y Axis Unit, one ASCII character per digit, values separated by commas, each value in the form:

SX.YYYYYEsZZ

Where:

S = sign (+ or -)

X = one digit to left of decimal point

Y = 5 digits to right of decimal point

E = E, exponent header

s = sign of exponent (+ or -)

ZZ = two digit exponent

REAL,32 - Binary 32-bit real values in the current Y Axis Unit, in a definite length block.

REAL,64 - Binary 64-bit real values in the current Y Axis Unit, in a definite length block.

### Format Data: Byte Order (Remote Command Only)

This command selects the binary data byte order for data transfer and other queries. It controls whether binary data is transferred in normal or swapped mode. This command affects only the byte order for setting and querying trace data for the :TRACe[:DATA], TRACe[:DATA]? , :CALCulate:DATA[n]? and FETCh:SANalyzer[n]? commands and queries.

By definition any command that says it uses FORMat:DATA uses any format supported by FORMat:DATA.

The NORMal order is a byte sequence that begins with the most significant byte (MSB) first, and ends with the least significant byte (LSB) last in the sequence: 1|2|3|4. SWAPPed order is when the byte sequence begins with the LSB first, and ends with the MSB last in the sequence: 4|3|2|1.

<b>Remote Command</b>	:FORMat:BORDER NORMal SWAPPed :FORMat:BORDER?
<b>Preset</b>	NORMal
<b>Initial S/W Revision</b>	Prior to A.02.00

## Meas Setup

Accesses the functions that allow you to change the settings for your measurement requirements.

Key Path	Front-panel key
Initial S/W Revision	Prior to A.02.00

### Counts

Sets the accumulated number of sampling points for data acquisition. The range is 1.000 kpt (k point) to 2.00000 Gpt (G point) with 1 kpt resolution. Counts couples to Meas Cycles. When the value for counts is changed, the Meas Cycles value will be  $(\text{Counts} / \text{SamplingFrequency} * \text{MeasInterval})$ .

Key Path	Meas Setup
Mode	SA, WCDMA, C2K, WIMAXOFDMA, TD-SCDMA, 1xEV-DO, DVB-T/H, DTMB (CTTB), ISDB-T, CMMB, LTE, LTE-TDD, Digital Cable TV, WLAN, MSR, LTE-TDD, LTEAFDD
Remote Command	<code>[ :SENSE ] :PStatistic:COUNTs &lt;integer&gt;</code> <code>[ :SENSE ] :PStatistic:COUNTs?</code>
Example	PST:COUN 5001 PST:COUN?
Couplings	This value is coupled to Meas Cycles. When Counts is changed, the MeasCycles value will be $(\text{Counts} / \text{SamplingFrequency} * \text{MeasInterval})$ . TD-SCDMA: When Counts is changed, the MeasCycles value will be $(\text{Counts} / (\text{Sampling Frequency} * \text{Time duration of measured time slots} / 5 \text{ msec}))$ , Time duration of measured time slots is determined by Analysis Time Slot and Measure Interval.
Preset	10000000
State Saved	Saved in instrument state.
Min	1000
Max	2000000000
Default Unit	Kpt
Initial S/W Revision	Prior to A.02.00
Modified at S/W Revision	A.02.00, A.03.00

### Meas Cycles

Set the number of measurement cycles to calculate power statistic data. This number couples to Counts. The Counts value is  $(\text{MeasCycles} * \text{Sampling Frequency} * \text{MeasInterval})$ .

When the counts value cannot be divided by  $(\text{Sampling Frequency} * \text{MeasInterval})$ , this value is displayed as a decimal fraction.

Key Path	Meas Setup
----------	------------



Mode	SA, WCDMA, C2K, WiMAX OFDMA, TD-SCDMA, 1xEV-DO, DVB-T/H, DTMB (CTTB), ISDB-T, CMMB, LTE, LTE-TDD, Digital Cable TV, WLAN, MSR, LTE-TDD, LTE-AFDD
<b>Remote Command</b>	[ :SENSe ] :PStatistic:SWEep:CYCLes <integer> [ :SENSe ] :PStatistic:SWEep:CYCLes?
<b>Example</b>	PST:SWE:CYCL 1001 PST:SWE:CYCL?
Notes	.
Couplings	The Counts value will be (MeasCycles * Sampling Frequency * MeasInterval). TD-SCDMA: The Counts value will be (MeasCycles * Sampling Frequency * Time duration of measured time slots / 5 msec), Time duration of measured time slots is determined by Analysis Time Slot and Measure Interval.
Preset	Depends on the sampling frequency.
Min	1
Max	Depends on the sampling frequency.
Initial S/W Revision	Prior to A.02.00
Modified at S/W Revision	A.02.00, A.03.00

### Meas Interval (1xEVDO Only)

Sets the value of time to be used as the measurement interval. This value couples to Counts. The Counts value is (MeasCycles \* Sampling Frequency \* MeasInterval).

Key Path	Meas Setup
Mode	1xEV-DO
<b>Remote Command</b>	[ :SENSe ] :PStatistic:SWEep:TIME <time> [ :SENSe ] :PStatistic:SWEep:TIME?
<b>Example</b>	PST:SWE:TIME 2 ms PST:SWE:TIME?
Couplings	The Counts value will be (MeasCycles * Sampling Frequency * MeasInterval).
Preset	182.29 us
State Saved	Saved in instrument state.
Min	1.0 us
Max	10.0 ms
Initial S/W Revision	Prior to A.02.00

### Meas Offset

Sets the value of time to be used as the measurement interval start.

Key Path	Meas Setup
Mode	1xEVDO, LTETDD, LTEATDD
<b>Remote Command</b>	[ :SENSe ] :PStatistic:MEAS:OFFSet <time> [ :SENSe ] :PStatistic:MEAS:OFFSet?
<b>Example</b>	PST:MEAS:OFFS 2 ms PST:MEAS:OFFS?
Preset	325.52 us for CDMA, 1xEVDO; 0.0s for LTETDD, LTEATDD
State Saved	Saved in instrument state.
Min	1.0 us for CDMA, 1xEVDO; 0.0s for LTETDD, LTEATDD
Max	10.0 ms
Initial S/W Revision	Prior to A.02.00

## IF Gain

Sets the IF Gain function to Auto, Low Gain or High Gain. These settings affect sensitivity and IF overloads. This only applies to the RF input. It does not apply to baseband I/Q input.

Key Path	Meas Setup
Dependencies	The IF Gain keys (FFT IF Gain and Swept IF Gain) have no effect when the U7227A USB Preamplifier is connected. This is not annotated or reflected on any softkey; there are no keys grayed out nor any SCPI locked out. The analyzer simply behaves as though both FFT IF Gain and Swept IF Gain are set to Low regardless of the setting on the keys.
Initial S/W Revision	Prior to A.02.00

## IF Gain Auto

Activates the Auto Rules for IF Gain When Auto is active, the IF Gain is set to High Gain under any of the following conditions:

- the input attenuator is set to 0 dB
- the preamp is turned On
- the Max Mixer Level is -20 dBm or lower

For other settings, Auto sets IF Gain to Off.

Key Path	Meas Setup, IF Gain
Mode	SA, WCDMA, C2K, WiMAX OFDMA, TD-SCDMA, 1xEV-DO, DVB-T/H, DTMB (CTTB), ISDB-T, CMMB, LTE, LTETDD, Digital Cable TV, WLAN, MSR, LTEATDD, LTEAFDD
<b>Remote Command</b>	[ :SENSe ] :PStatistic:IF:GAIN:AUTO[:STATE] ON OFF 1 0 [ :SENSe ] :PStatistic:IF:GAIN:AUTO[:STATE]?

<b>Example</b>	PST:IF:GAIN:AUTO ON PST:IF:GAIN:AUTO?
Notes	IF Gain only applies to the RF input. It does not apply to baseband I/Q input.
Couplings	When either the auto attenuation is active (for example, with electrical attenuator), or the optimize mechanical attenuator range is requested, the IF Gain setting is changed using the following rule. The Auto selection sets IF Gain On under any of the following conditions: <ul style="list-style-type: none"> <li>• the input attenuator is set to 0 dB</li> <li>• the preamp is turned on,</li> <li>• the Max Mixer Level is -20 dBm or lower.</li> </ul> For other settings, Auto sets IF Gain to Off.
Preset	OFF
State Saved	Saved in instrument state.
Range	Auto Man
Initial S/W Revision	Prior to A.02.00
Modified at S/W Revision	A.02.00, A.03.00

## IF Gain State

Selects the range of IF gain. On sets the high gain option, which allows for better noise level measurements and Off sets low gain when measuring large signals.

Key Path	Meas Setup, IF Gain
Mode	SA, WCDMA, C2K, WIMAXOFDMA, TD-SCDMA, 1xEV-DO, DVB-T/H, DTMB (CTTB), ISDB-T, CMMB, LTE, LTE-TDD, Digital Cable TV, WLAN, MSR, LTE-TDD, LTE-FDD
<b>Remote Command</b>	[[:SENSe]:PStatistic:IF:GAIN[:STATe] ON OFF 1 0 [:SENSe]:PStatistic:IF:GAIN[:STATe]?
<b>Example</b>	PST:IF:GAIN ON PST:IF:GAIN?
Notes	IF Gain only applies to the RF input. It does not apply to baseband I/Q input. where ON = high gain OFF = low gain
Preset	OFF
State Saved	Saved in instrument state.
Range	Low Gain (Best for Large Signals) High Gain (Best Noise Level)
Readback Text	Low Gain High Gain
Initial S/W Revision	Prior to A.02.00
Modified at S/W Revision	A.02.00, A.03.00

## Meas Preset

Restores all measurement settings to their default values.

Key Path	Meas Setup
Mode	SA, WCDMA, C2K, WIMAXOFDMA, TD-SCDMA, 1xEV-DO, DVB-T/H, DTMB (CTTB), ISDB-T, CMMB, LTE, LTEFDD, Digital Cable TV, WLAN, MSR, LTEATDD, LTEAFDD
Remote Command	:CONFigure:PStatistic
Example	CONF:PST
Notes	You must be in the Spectrum Analysis mode, W-CDMA mode, cdma2000 mode, TD-SCDMA mode, DVB-T/H mode, DTMB (CTTB) mode, ISDB-T mode, CMMB mode, Digital Cable TV mode or WIMAXOFDMA mode to use this command. Use :INSTrument:SElect to set the mode.
Couplings	Selecting Meas Preset will restore all measurement parameters to their default values.
Initial S/W Revision	Prior to A.02.00
Modified at S/W Revision	A.02.00, A.03.00

## Mode

See "Mode" on page 318

## Mode Preset

Returns the active mode to a known state.

Mode Preset does the following for the currently active mode:

- Aborts the currently running measurement.
- Brings up the default menu for the mode, with no active function.
- Sets measurement Global settings to their preset values for the active mode only.
- Activates the default measurement.
- Brings up the default menu for the mode.
- Clears the input and output buffers.
- Sets Status Byte to 0.

Mode Preset does not:

- Cause a mode switch
- Affect mode persistent settings
- Affect system settings

See "[How-To Preset](#)" on page 1667 for more information.

<b>Key Path</b>	Front-panel key
<b>Remote Command</b>	:SYSTem:PRESet
<b>Example</b>	:SYST:PRES
<b>Notes</b>	*RST is preferred over :SYST:PRES for remote operation. *RST does a Mode Preset, as done by the :SYST:PRES command, and it sets the measurement mode to Single measurement rather than Continuous for optimal remote control throughput. Clears all pending OPC bits. The Status Byte is set to 0.
<b>Couplings</b>	A Mode Preset aborts the currently running measurement, activates the default measurement, and gets the mode to a consistent state with all of the default couplings set.
<b>Backwards Compatibility Notes</b>	In the X-Series, the legacy "Factory Preset" has been replaced with Mode Preset, which only presets the currently active mode, not the entire instrument. In the X-Series, the way to preset the entire instrument is by using System, Restore System Defaults All, which behaves essentially the same way as restore System Defaults does on ESA and PSA. There is also no "Preset Type" as there is on the PSA. There is a green Mode Preset front-panel key that does a Mode Preset and a white-with-green-letters User Preset front-panel key that does a User Preset. The old PRESet:TYPE command is ignored (without generating an error), and SYST:PRES without a parameter does a Mode Preset, which should cover most backward code compatibility issues. The settings and correction data under the Input/Output front-panel key (examples: Input Z Corr, Ext Amp Gain, etc.) are no longer part of any Mode, so they will not be preset by a Mode Preset. They are preset using Restore Input/Output Defaults, Restore System Defaults All. Note that because User Preset does a Recall State, and all of these settings are saved in State, they ARE recalled when using

	User Preset.
Initial S/W Revision	Prior to A.02.00

## How-To Preset

The table below shows all possible presets, their corresponding SCPI commands and front-panel access (key paths). Instrument settings depend on the current measurement context. Some settings are local to the current measurement, some are global (common) across all the measurements in the current mode, and some are global to all the available modes. In a similar way, restoring the settings to their preset state can be done within the different contexts.

Auto Couple - is a measurement local key. It sets all Auto/Man parameter couplings in the measurement to Auto. Any Auto/Man selection that is local to other measurements in the mode will not be affected.

Meas Preset - is a measurement local key. Meas Preset resets all the variables local to the current measurement except the persistent ones.

Mode Preset - resets all the current mode's measurement local and measurement global variables except the persistent ones.

Restore Mode Defaults - resets ALL the Mode variables (and all the Meas global and Meas local variables), including the persistent ones.

Type Of Preset	SCPI Command	Front Panel Access
Auto Couple	:COUPlE ALL	Auto Couple front-panel key
Meas Preset	:CONFIgure:<Measurement>	Meas Setup Menu
Mode Preset	:SYSTem:PRESet	Mode Preset (green key)
Restore Mode Defaults	:INSTrument:DEFault	Mode Setup Menu
Restore All Mode Defaults	:SYSTem:DEFault MODEs	System Menu; Restore System Default Menu
*RST	*RST	not possible (Mode Preset with Single)
Restore Input/Output Defaults	:SYSTem:DEFault INPut	System Menu; Restore System Default Menu
Restore Power On Defaults	:SYSTem:DEFault PON	System Menu; Restore System Default Menu
Restore Alignment Defaults	:SYSTem:DEFault ALIGn	System Menu; Restore System Default Menu
Restore Miscellaneous Defaults	:SYSTem:DEFault MISC	System Menu; Restore System Default Menu
Restore All System Defaults	:SYSTem:DEFault [ALL] :SYSTem:PRESet:PERSistent	System Menu; Restore System Default Menu
User Preset	:SYSTem:PRESet:USER	User Preset Menu
User Preset All Modes	:SYSTem:PRESet:USER:ALL	User Preset Menu

Power On Mode Preset	:SYSTem:PON:TYPE MODE	System Menu
Power On User Preset	:SYSTem:PON:TYPE USER	System Menu
Power On Last State	:SYSTem:PON:TYPE LAST	System Menu

### Preset Type (Remote Command Only)

As stated in the Backward Compatibility section, to be compatible with ESA/PSA the PRESet:TYPE command will be implemented as a no-op.

<b>Mode</b>	All
<b>Remote Command</b>	:SYSTem:PRESet:TYPE FACTory MODE USER :SYSTem:PRESet:TYPE?
<b>Example</b>	:SYST:PRESet:TYPE FACT
<b>Notes</b>	This command is supported for backward compatibility only. It is a no-op which does not change the behavior of any preset operation.
<b>Preset</b>	This is unaffected by Preset but is set to Mode on a "Restore System Defaults->All"
<b>State Saved</b>	No
<b>Initial S/W Revision</b>	Prior to A.02.00



## Mode Setup

See ["Mode Setup" on page 348](#)

## Peak Search

There is no 'Peak Search' functionality supported in Power Stat CCDF measurement. The front-panel key displays a blank menu when pressed.

---

Key Path	Front-panel key
Initial S/W Revision	Prior to A.02.00

---

Print

See "Print" on page 358

## Quick Save

The Quick Save front-panel key repeats the most recent save that was performed from the Save menu, with the following exceptions:

- Register saves are not remembered as Saves for the purpose of the Quick Save function
- If the current measurement does not support the last non-register save that was performed, an informational message is generated, “File type not supported for this measurement”

Quick Save repeats the last type of qualified save (that is, a save qualified by the above criteria) in the last save directory by creating a unique filename using the Auto File Naming algorithm described below.

If Quick Save is pressed after startup and before any qualified Save has been performed, the Quick Save function performs a Screen Image save using the current settings for Screen Image saves (current theme, current directory), which then becomes the “last save” for the purpose of subsequent Quick Saves.

The Auto File Naming feature automatically generates a file name for use when saving a file. The filename consists of a prefix and suffix separated by a dot, as is standard for the Windows® file system. A default prefix exists for each of the available file types:

Type	Default Prefix	Menu
State	State_	(Save/Recall)
Trace + State	State_	(Save/Recall)
Screen	Screen_	(Save/Recall)
Amplitude Corrections	Ampcor_	(Import/Export)
Traces	Trace_	(Import/Export)
Limit Lines	LLine_	(Import/Export)
Measurement Result	MeasR_	(Import/Export)
Capture Buffer	CapBuf_	(Import/Export)

A four digit number is appended to the prefix to create a unique file name. The numbering sequence starts at 0000 within each Mode for each file type and updates incrementally to 9999, then wraps to 0000 again. It remembers where it was through a Mode Preset and when leaving and returning to the Mode. It is reset by Restore Misc Defaults and Restore System Defaults and subsequent running of the instrument application. So, for example, the first auto file name generated for State files is State\_0000.state. The next is State\_0001, and so forth.

One of the key features of Auto File Name is that we guarantee that the Auto File Name will never conflict with an existing file. The algorithm looks for the next available number. If it gets to 9999, then it looks for holes. If it find no holes, that is no more numbers are available, it gives an error.

For example, if when we get to State\_0010.state there is already a State\_0010.state file in the current directory, it advances the counter to State\_0011.state to ensure that no conflict will exist (and then it verifies that State\_0011.state also does not exist in the current directory and advances again if it does, and so forth).

If you enter a file name for a given file type, then the prefix becomes the filename you entered instead of the default prefix, followed by an underscore. The last four letters (the suffix) are the 4-digit number.

For example, if you save a measurement results file as “fred.csv”, then the next auto file name chosen for a measurement results save will be fred\_0000.csv.

**NOTE** Although 0000 is used in the example above, the number that is used is actually the current number in the Meas Results sequence, that is, the number that would have been used if you had not entered your own file name.

**NOTE** If the filename you entered ends with \_dddd, where d=any number, making it look just like an auto file name, then the next auto file name picks up where you left off with the suffix being dddd + 1.

Key Path	Front-panel key
Notes	No remote command for this key specifically.
Initial S/W Revision	Prior to A.02.00

## Recall

The Recall menu lets you choose what you want to recall, and where you want to recall it from. Among the types of files you can recall are **States and Traces**. In addition, an Import (Data) option lets you recall a number of data types stored in CSV files (as used by Excel and other spreadsheet programs).

The default paths for Recall are data type dependent and are the same as for the Save key.

Key Path	Front-panel key
Notes	<p>No remote command for this key specifically, but the :MMEM:LOAD command is available for specific file types. An example is :MMEM:LOAD:STATe &lt;filename&gt;.</p> <p>If you try to recall a State file for a mode that is not licensed or not available in the instrument, an error message will occur and the state will not change.</p>
Backwards Compatibility Notes	<p>In legacy analyzers, it was possible to load a state without affecting the trace data, limit lines or correction data. Similarly (since User Preset is actually loading a state), it was possible to do a User Preset without affecting the trace data, limit lines or correction data.</p> <p>In the X-Series, “state” always includes all of this data; so whenever state is loaded, all of the traces, limit lines and corrections are affected. Although this differs from previous behavior, it is desirable behavior, and should not cause adverse issues for users.</p>
Backwards Compatibility Notes	<p>Recall for the X-Series supports backward compatibility in the sense that you can recall a state file from any X-Series model number and any version of X-Series software. This is only possible if part of the recalling process goes through a limiting step after recalling the mode settings, at least for settings that may vary with version number, model number, option and license differences. If you try to recall a state file onto an instrument with less capability than what was available on the instrument during the save, the recall will ignore the state it doesn't support and it will limit the recalled setting to what it allows.</p> <p>Example: if the saved state includes preamp ON, but the recalling instrument does not have a preamp; the preamp is limited to OFF. Conversely, if you save a state without a preamp, the preamp is OFF in the state file. When this saved file is recalled on an instrument with a licensed preamp, the preamp is changed to OFF. Another example is if the saved state has center frequency set to 20 GHz, but the instrument recalling the saved state is a different model and only supports 13.5 GHz. In this case, the center frequency is limited along with any other frequency based settings. Since the center frequency can't be preserved in this case, the recall limiting tries to at least preserve span to keep the measurement setup as intact as possible.</p> <p>It may be appropriate to issue a warning if the state is limited on the recall; warnings do not go out to SCPI so this would only affect the manual user.</p> <p>Note that there is no state file compatibility outside of the X-Series. For example, you cannot recall a state file from ESA or PSA.</p>
Initial S/W Revision	Prior to A.02.00

## State

The Recall State menu lets you choose a register or file from which to recall the state.

The content of a state file includes all of the settings and data required to return the analyzer as closely as possible to the Mode it was in, with the exact settings that were in place, when the save occurred. The Mode settings in each state file include the settings that are affected by Mode Preset, as well as the

additional settings affected by Restore Mode Defaults; all of the Mode’s settings. In addition, all of the settings of the Input/Output system are included, even though they are outside of the Mode’s state, because they are needed to restore the complete setup. Persistent System settings (for example, GPIB address) are not affected by either a Mode Preset or Restore Mode Defaults, nor are they included in a saved State file.

Since each state file is only for one Mode, the settings for other Modes are unaffected when it is loaded. Recall State will cause a mode switch if the state being recalled is not from the current active mode.

After the recall completes, the message "File <filename> recalled" or “Recalled State Register <register number>” is displayed.

For rapid recalls, the State menu lists 16 registers that you can choose from to recall. Pressing a Register key initiates the recall. You can also select a file from which to recall.

The default path for all State Files is:

My Documents\<<mode name>\state

where <mode name> is the parameter used to select the mode with the INST:SEL command (for example, SA for the Spectrum Analyzer).

See "[More Information](#)" on page 1676.

<b>Key Path</b>	Recall
<b>Mode</b>	All
<b>Remote Command</b>	:MMEMory:LOAD:STATe <filename>
<b>Example</b>	:MMEM:LOAD:STAT "myState.state" This recalls the file myState.state on the default path
<b>Example</b>	MMEM:LOAD:STAT "MyStateFile.state" This loads the state file data (on the default file directory path) into the instrument state.
<b>Notes</b>	<p>When you pick a file to recall, the analyzer first verifies that the file is recallable in the current instrument by checking the software version and model number of the instrument. If everything matches, a full recall proceeds by aborting the currently running measurement, clearing any pending operations, and then loading the State from the saved state file. You can open state files from any mode, so recalling a State file switches to the mode that was active when the save occurred. After switching to the mode of the saved state file, mode settings and data (if any for the mode) are loaded with values from the saved file. The saved measurement of the mode becomes the newly active measurement and the data relevant to the measurement (if there is any) is recalled.</p> <p>If there is a mismatch between file version or model number or instrument version or model number, the recall function tries to recall as much as possible and returns a warning message. It may limit settings that differ based on model number, licensing or version number.</p> <p>After recalling the state, the Recall State function does the following:</p> <ul style="list-style-type: none"> <li>• Makes the saved measurement for the mode the active measurement.</li> <li>• Clears the input and output buffers.</li> <li>• Status Byte is set to 0.</li> <li>• Executes a *CLS</li> </ul> <p>If the file specified is empty an error is generated. If the specified file does not exist, another error is generated. If there is a mismatch between the file and the proper file type, an error is generated. If</p>

---

	there is a mismatch between file version or model number or instrument version or model number, a warning is displayed. Then it returns to the State menu and File Open dialog goes away. After the Recall, the analyzer exits the Recall menu and returns to the previous menu.
<b>Backwards Compatibility SCPI</b>	:MMEMory:LOAD:STATe 1,<filename> For backwards compatibility, the above syntax is supported. The "1" is simply ignored.
Initial S/W Revision	Prior to A.02.00

---

## More Information

In measurements that support saving Traces, for example, Swept SA, the Trace data is saved along with the State in the State file. When recalling the State, the Trace data is recalled as well. Traces are recalled exactly as they were stored, including the writing mode and update and display modes. If a Trace was updating and visible when the State was saved, it will come back updating and visible, and its data will be rewritten right away. When you use State to save and recall traces, any trace whose data must be preserved should be placed in View or Blank mode before saving.

The following table describes the Trace Save and Recall possibilities:

You want to recall state and one trace's data, leaving other traces unaffected.	Save Trace+State from 1 trace. Make sure that no other traces are updating (they should all be in View or Blank mode) when the save is performed.	On Recall, specify the trace you want to load the one trace's data into. This trace will load in View. All other traces' data will be unaffected, although their trace mode will be as it was when the state save was performed.
You want to recall all traces	Save Trace+State from ALL traces.	On Recall, all traces will come back in View (or Blank if they were in Blank or Background when saved)
You want all traces to load exactly as they were when saved.	Save State	On recall, all traces' mode and data will be exactly as they were when saved. Any traces that were updating will have their data immediately overwritten.

## From File...

When you press "From File", the analyzer brings up a Windows dialog and a menu entitled "File Open." This menu allows you to navigate to the various fields in the Windows dialog without using a keyboard or mouse. The Tab and Arrow keys can also be used for dialog navigation.



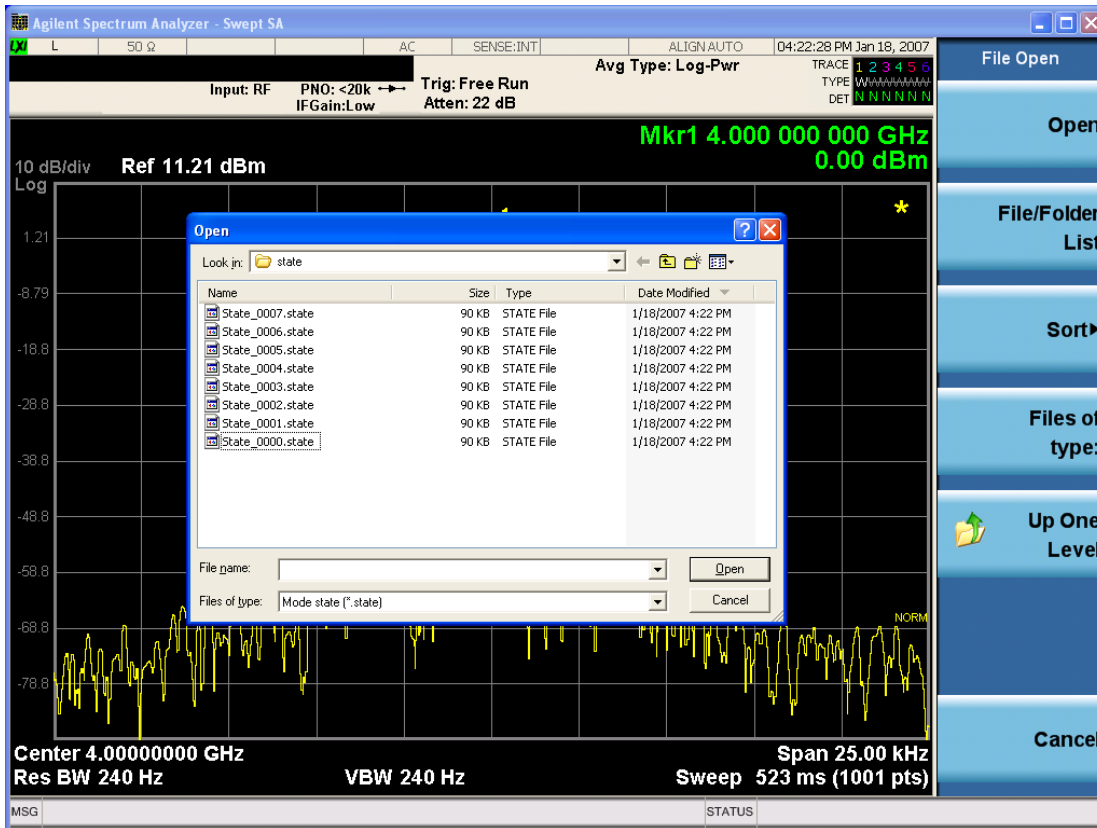

Listed below are the functions of the various fields in the dialog, and the corresponding softkeys:

#### Open

Performs the recall of the specified file. While the recall is being performed, the floppy icon appears briefly in the Meas bar.

#### File/Folder List

Enables you to navigate to the center of the dialog that contains the list of files and folders. Once here you can get information about the file and use the tab keys to navigate to the other fields in the dialog, such as Look In.

#### Look In

The Look In field shows the path from which the file will be recalled and allows you to change the path using the up and down arrow keys to navigate to other paths; the Enter key to open a directory; and the Backspace key to go back one directory. The **Look In field** first uses the last path from the Save As dialog **Save In:** path for that same file type. There is no softkey for directly navigating to the Look In field, but you can use the left tab to get here from the File/Folder List.

User specified paths are remembered when you leave and return to a Mode and are reset back to the default using Restore Mode Defaults.

#### Sort

Accesses a menu that enables you to sort the files within the File Open dialog. Only one sorting type can be selected at a time and the sorting happens immediately. The sorting types are By Date, By Name, By extension, and By Size.

#### Files of Type

This field shows the file suffix for the type of file you have selected to recall. For example, if you navigated here while recalling State, "Mode state (\*.state)" is in the field. If you navigated here while recalling Trace, ""Mode state (\*.trace)" is in the field. If you navigated here while importing a trace data file, "Trace Data (\*.csv)" is in the field. For some file types, there is more than one choice in the dropdown menu, which you can select by using the up and down arrow keys and Enter.

#### Up One Level

This key corresponds to the icon of a folder with the up arrow that is in the tool bar of the dialog. When pressed, it causes the file and folder list to navigate up one level in the directory structure. The Backspace key does the same thing.

#### Cancel

This key corresponds to the Cancel selection in the dialog. It causes the current **Open** request to be cancelled. The ESC key does the same thing.

Key Path	Recall, State
Notes	Brings up the Open dialog for recalling a State Save Type
Initial S/W Revision	Prior to A.02.00

### Edit Register Names

You may enter a custom name on any of the Register keys, to help you remember what you are using that state to save. To do this, press the Edit Register Names key, choose the register whose name you wish to edit, and then enter the desired label using the Alpha Editor or an external PC keyboard.

The maximum number of characters that can be added is 30. In most cases, 30 characters will fit on two lines of the key.

For more information and the SCPI command, see Edit Register Names under the Save, State function.

Key Path	Recall, State
Mode	All
Dependencies	N9060A-7FP or N9060B-2FP license required to edit the register names. When the feature is not licensed, sending the SCPI command generates an error, -221, "Settings conflict;Option not available"
Initial S/W Revision	A.11.00

### Register 1 thru Register 16

Selecting any one of these register keys causes the State of the mode from the specified Register to be recalled. Each of the register keys annotates whether it is empty or at what date and time it was last

modified. In addition, you can use the Edit Register Names key under Save, State to enter custom names for each register.

Registers are shared by all modes, so recalling from any one of the registers will cause a mode switch to the mode that was active when the save to the Register occurred.

Although these 16 registers are the only registers available from the front panel, there are 128 state registers available in the instrument. Registers 17–128 are only available from the SCPI interface, using the \*RCL command.

After the recall completes, the message "Register <register number> recalled" appears in the message bar. If you are in the Spectrum Analyzer Mode, and you are recalling a register that was saved in the Spectrum Analyzer Mode, then after the recall, you will still be in the Recall Register menu. If the Recall causes you to switch modes, then after the Recall, you will be in the Frequency menu.

If a requested register is empty an error is generated.

Key Path	Recall, State
<b>Example</b>	*RCL 1
Range	1–16 from front panel, 1–128 from SCPI
Readback	Date and time with seconds resolution are displayed on the key OR A custom name of up to 30 characters entered using the Save, State, Edit Register Names key OR “(empty)” if no prior save operation has been performed to this register.
Initial S/W Revision	Prior to A.02.00
Modified at S/W Revision	Prior to A.11.00

## Register 1 thru Register 16

Selecting any one of these register keys causes the State of the mode from the specified Register to be recalled. Each of the register keys annotates whether it is empty or at what date and time it was last modified. In addition, you can use the Edit Register Names key under Save, State to enter custom names for each register.

Registers are shared by all modes, so recalling from any one of the registers will cause a mode switch to the mode that was active when the save to the Register occurred.

Although these 16 registers are the only registers available from the front panel, there are 128 state registers available in the instrument. Registers 17–128 are only available from the SCPI interface, using the \*RCL command.

After the recall completes, the message "Register <register number> recalled" appears in the message bar. If you are in the Spectrum Analyzer Mode, and you are recalling a register that was saved in the Spectrum Analyzer Mode, then after the recall, you will still be in the Recall Register menu. If the Recall causes you to switch modes, then after the Recall, you will be in the Frequency menu.

If a requested register is empty an error is generated.

Key Path	Recall, State
Example	*RCL 1
Range	1-16 from front panel, 1-128 from SCPI
Readback	Date and time with seconds resolution are displayed on the key OR A custom name of up to 30 characters entered using the Save, State, Edit Register Names key OR “(empty)” if no prior save operation has been performed to this register.
Initial S/W Revision	Prior to A.02.00
Modified at S/W Revision	Prior to A.11.00

### Trace (+State)

The Recall Trace (+State) menu lets you choose a register or file from which to recall the Trace+State state file.

A saved state contains all of the settings and data required to return the analyzer as closely as possible to the exact setup it had when the save occurred. This includes the Input/Output settings, even though they are outside of the Mode’s state, because they are needed to restore the complete setup. A Trace+State file also includes trace data from one trace or all traces, which will load in View mode when the Trace+State file is recalled. Recall Trace (+State) will also cause a mode switch if the state being recalled is not for the current active mode.

After the recall completes, the message "File <filename> recalled" or “Recalled Trace Register <register number>” is displayed.

For rapid recalls, the Trace (+State) menu lists 5 registers to choose from to recall. Pressing a Register key initiates the recall. You can also select a file from which to recall.

The default path for all State Files including .trace files is:

My Documents\<<mode name>\state

where <mode name> is the parameter used to select the mode with the INST:SEL command (for example, SA for the Spectrum Analyzer).

Key Path	Recall
Mode	SA
Remote Command	:MMEMory:LOAD:TRACe TRACE1   TRACE2   TRACE3   TRACE4   TRACE5   TRACE6, <filename>  :MMEMory:LOAD:TRACe:REGister TRACE1   TRACE2   TRACE3   TRACE4   TRACE5   TRACE6, <integer>
Example	MMEM:LOAD:TRAC TRACE2, "MyTraceFile.trace" This loads the trace file data (on the default file directory path) into the specified trace; if it is a "single trace" save file, that trace is loaded to trace 2, and is set to be not updating. :MMEM:LOAD:TRAC:REG TRACE1,2

	restores the trace data in register 2 to Trace 1
Notes	<p>When you perform the recall, the recalling Trace function must first verify the file is recallable in this instrument by checking instrument software version and model number, since it includes State. If everything matches, a full recall proceeds by aborting the currently running measurement, and loading the state from the saved state file to as close as possible to the context in which the save occurred. You can open .trace files from any mode that supports them, so recalling a Trace file switches to the mode that was active when the save occurred. After switching to the mode of the saved state file, mode settings and data (if any for the mode) are loaded with values from the saved file and the saved measurement of the mode becomes the newly active measurement, and the data relevant to the measurement (if there is any) is recalled.</p> <p>Once the state is loaded, the trace data must be loaded. The internal flags are consulted to see which trace to load and the "To Trace" setting to see where to load it. Trace data is always loaded with the specified trace set to View, so that the data is visible and not updating(so as not to erase the recalled data). If the file is an "all trace" file, all traces are loaded with the saved data(to the original trace the data was saved from) and set to View. Traces whose data is not loaded are restored to the update state that existed when they were saved.</p> <p>After the Recall the analyzer exits the Recall menu and returns to the previous menu.</p> <p>Some modes and measurements do not have available all 6 traces. Phase Noise mode command, for example, is: <code>MMEMory:LOAD:TRACe TRACE1 TRACE2 TRACE3,&lt;filename&gt;</code></p> <p>Some modes and measurements have more than 6 traces available. The Realtime SA mode command, for example, is: <code>MMEMory:STORe:TRACe TRACE1   TRACE2   TRACE3   TRACE4   TRACE5   TRACE6   TRACE7   TRACE8   TRACE9   TRACE10   TRACE11   TRACE12   ALL,&lt;filename&gt;</code></p>
Initial S/W Revision	Prior to A.02.00

## To Trace

These menu selections let you choose the Trace where the recalled saved trace will go. Not all modes have the full 6 traces available. The default is the currently selected trace, selected in this menu or in the Trace/Detector, Export Data, Import Data, or Save Trace menus, except if you have chosen All, then it remains chosen until you specifically change it to a single trace.

If the .trace file is an "all trace" file, "To Trace" is ignored and the traces each go back to the trace from which they were saved.

Once selected, the key returns back to the Recall Trace menu and the selected Trace number is annotated on the key. Now you have selected exactly where the trace needs to be recalled.To trigger a recall of the selected Trace, you must select the Open key in the Recall Trace menu.

When you select a trace, it makes that trace the current trace, so it displays on top of all of the other traces.

Key Path	Save, Data, Trace
Mode	SA
Initial S/W Revision	Prior to A.02.00

## Register 1 thru Register 16

Selecting any one of these register keys causes the State of the mode from the specified Register to be recalled. Each of the register keys annotates whether it is empty or at what date and time it was last modified. In addition, you can use the Edit Register Names key under Save, State to enter custom names for each register.

Registers are shared by all modes, so recalling from any one of the registers will cause a mode switch to the mode that was active when the save to the Register occurred.

Although these 16 registers are the only registers available from the front panel, there are 128 state registers available in the instrument. Registers 17–128 are only available from the SCPI interface, using the \*RCL command.

After the recall completes, the message "Register <register number> recalled" appears in the message bar. If you are in the Spectrum Analyzer Mode, and you are recalling a register that was saved in the Spectrum Analyzer Mode, then after the recall, you will still be in the Recall Register menu. If the Recall causes you to switch modes, then after the Recall, you will be in the Frequency menu.

If a requested register is empty an error is generated.

Key Path	Recall, State
<b>Example</b>	*RCL 1
Range	1–16 from front panel, 1–128 from SCPI
Readback	Date and time with seconds resolution are displayed on the key OR A custom name of up to 30 characters entered using the Save, State, Edit Register Names key OR “(empty)” if no prior save operation has been performed to this register.
Initial S/W Revision	Prior to A.02.00
Modified at S/W Revision	Prior to A.11.00

## From File...

When you press “From File”, the analyzer brings up a Windows dialog and a menu entitled “File Open.” This menu allows you to navigate to the various fields in the Windows dialog without using a keyboard or mouse. The Tab and Arrow keys can also be used for dialog navigation.

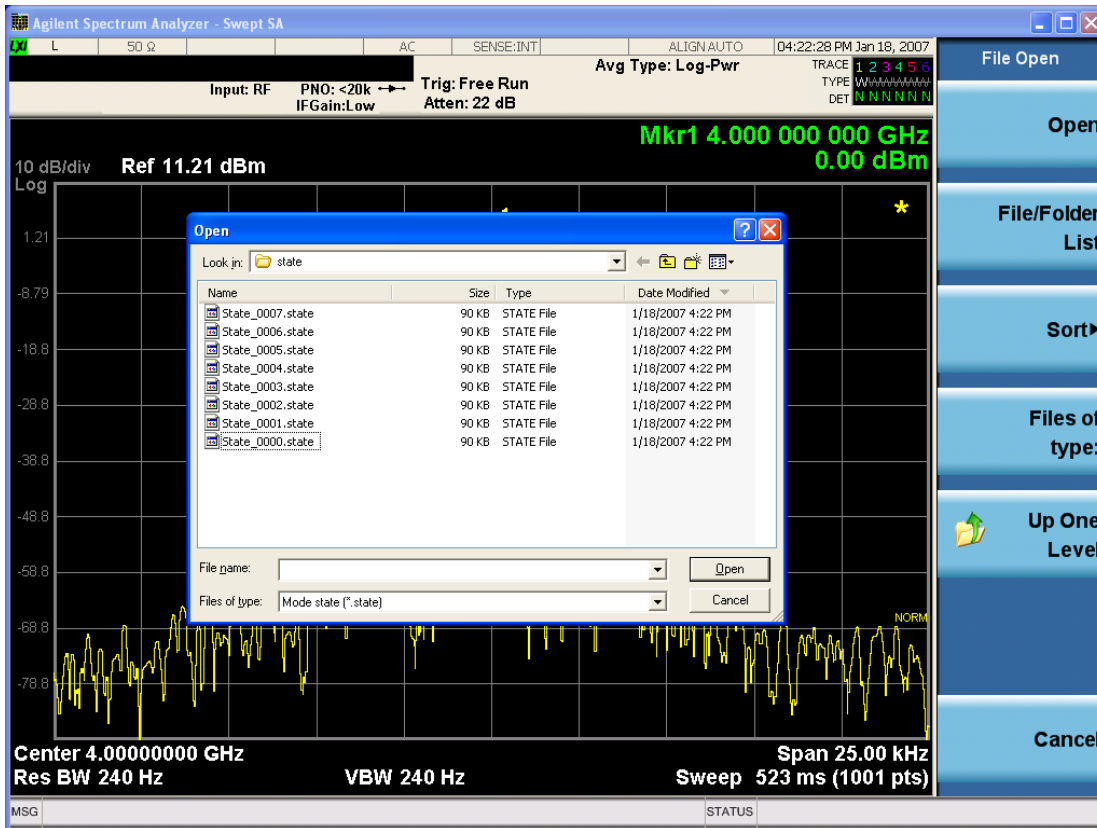

Listed below are the functions of the various fields in the dialog, and the corresponding softkeys:

#### Open

Performs the recall of the specified file. While the recall is being performed, the floppy icon appears briefly in the Meas bar.

#### File/Folder List

Enables you to navigate to the center of the dialog that contains the list of files and folders. Once here you can get information about the file and use the tab keys to navigate to the other fields in the dialog, such as Look In.

#### Look In

The Look In field shows the path from which the file will be recalled and allows you to change the path using the up and down arrow keys to navigate to other paths; the Enter key to open a directory; and the Backspace key to go back one directory. The **Look In field** first uses the last path from the Save As dialog **Save In:** path for that same file type. There is no softkey for directly navigating to the Look In field, but you can use the left tab to get here from the File/Folder List.

User specified paths are remembered when you leave and return to a Mode and are reset back to the default using Restore Mode Defaults.

#### Sort

Accesses a menu that enables you to sort the files within the File Open dialog. Only one sorting type can be selected at a time and the sorting happens immediately. The sorting types are By Date, By Name, By extension, and By Size.

#### Files of Type

This field shows the file suffix for the type of file you have selected to recall. For example, if you navigated here while recalling State, "Mode state (\*.state)" is in the field. If you navigated here while recalling Trace, ""Mode state (\*.trace)" is in the field. If you navigated here while importing a trace data file, "Trace Data (\*.csv)" is in the field. For some file types, there is more than one choice in the dropdown menu, which you can select by using the up and down arrow keys and Enter.

#### Up One Level

This key corresponds to the icon of a folder with the up arrow that is in the tool bar of the dialog. When pressed, it causes the file and folder list to navigate up one level in the directory structure. The Backspace key does the same thing.

#### Cancel

This key corresponds to the Cancel selection in the dialog. It causes the current **Open** request to be cancelled. The ESC key does the same thing.

Key Path	Recall, State
Notes	Brings up the Open dialog for recalling a State Save Type
Initial S/W Revision	Prior to A.02.00

## Data (Import)

Importing a data file loads data that was previously saved from the current measurement or from other measurements and/or modes that produce compatible data files. The Import Menu only contains Data Types that are supported by the current measurement.

Since the commonly exported data files are in .csv format, the data can be edited by the user prior to importing. This allows you to export a data file, manipulate the data in Excel (the most common PC Application for manipulating .csv files) and then import it.

Importing Data loads measurement data from the specified file into the specified or default destination, depending on the data type selected. Selecting an Import Data menu key will not actually cause the importing to occur, since the analyzer still needs to know from where to get the data. Pressing the Open key in this menu brings up the Open dialog and Open menu that provides you with the options from where to recall the data. Once a filename has been selected or entered in the Open menu, the recall occurs as soon as the Open button is pressed.

Key Path	Recall
Mode	All
Notes	The menu is built from whatever data types are available for the mode. Some keys will be missing completely, so the key locations in the sub-menu will vary. No SCPI command directly controls the Data Type that this key controls. The Data Type is included in the MMEM:LOAD commands.



Dependencies	If a file type is not used by a certain measurement, it is grayed out for that measurement. The key for a file type will not show at all if there are no measurements in the Mode that support it.
Preset	Is not affected by Preset or shutdown, but is reset during Restore Mode Defaults
Readback	The data type that is currently selected
Initial S/W Revision	Prior to A.02.00

## Capture Buffer

The captured data is raw data which is not processed.

Key Path	Recall, Data
Mode	<b>CDMA1XEV</b>
Example	MMEM:LOAD:CAPT "MyCaptureData.bin" This loads the file of capture data (on the default file directory path) into the instrument.
Dependencies	In case the capture buffer data is not available from the selected measurement, the key will be grayed out.
Initial S/W Revision	A.11.00

## Open...

When you press "Open", the analyzer brings up a Windows dialog and a menu entitled "**File Open.**" This menu allows you to navigate to the various fields in the Windows dialog without using a keyboard or mouse. The Tab and Arrow keys can also be used for dialog navigation.

See "[From File...](#)" on page 2890 in Recall, State, for a full description of this dialog and menu.

Key Path	Recall, Data
Notes	The key location is mode-dependent and will vary. Brings up Open dialog for recalling a <mode specific> Save Type
Initial S/W Revision	Prior to A.02.00

## Restart

The Restart function restarts the current sweep, or measurement, or set of averaged/held sweeps or measurements. If you are Paused, pressing Restart does a Resume.

The Restart function is accessed in several ways:

- Pressing the Restart key
- Sending the remote command INIT:IMMEDIATE
- Sending the remote command INIT:RESTART

See "[More Information](#)" on page 1686

Key Path	Front-panel key
Remote Command	:INITiate[:IMMEDIATE] :INITiate:RESTART
Example	:INIT:IMM :INIT:REST
Notes	:INITiate:RESTART and :INITiate:IMMEDIATE perform exactly the same function.
Couplings	Resets average/hold count k. For the first sweep overwrites all active (update=on) traces with new current data. For application modes, it resets other parameters as required by the measurement.
Status Bits/OPC dependencies	This is an Overlapped command. The STATus:OPERation register bits 0 through 8 are cleared. The STATus:QUESTionable register bit 9 (INTegrity sum) is cleared. The SWEEPING bit is set. The MEASURING bit is set.
Backwards Compatibility Notes	For Spectrum Analysis mode in ESA and PSA, the Restart hardkey and the INITiate:RESTART command restart trace averages (displayed average count reset to 1) for a trace in Clear Write, but did not restart Max Hold and Min Hold.  In the X-Series, the Restart hardkey and the INITiate:RESTART command restart not only Trace Average, but MaxHold and MinHold traces as well.  For wireless comms modes in ESA and PSA, the Restart hardkey and the INITiate:RESTART command restart every measurement, which includes all traces and numeric results. There is no change to this operation.
Initial S/W Revision	Prior to A.02.00

### More Information

The **Restart** function first aborts the current sweep/measurement as quickly as possible. It then resets the sweep and trigger systems, sets up the measurement and initiates a new data measurement sequence with a new data acquisition (sweep) taken once the trigger condition is met.

If the analyzer is in the process of aligning when **Restart** is executed, the alignment finishes before the restart function is performed.

Even when set for Single operation, multiple sweeps may be taken when Restart is pressed (for example, when averaging/holding is on). Thus when we say that **Restart** "restarts a measurement," we may mean:

- It restarts the current sweep
- It restarts the current measurement
- It restarts the current set of sweeps if any trace is in Trace Average, Max Hold or Min Hold
- It restarts the current set of measurements if Averaging, or Max Hold, or Min Hold is on for the measurement
- depending on the current settings.

With **Average/Hold Number** (in **Meas Setup** menu) set to 1, or Averaging off, or no trace in Trace Average or Hold, a single sweep is equivalent to a single measurement. A single sweep is taken after the trigger condition is met; and the analyzer stops sweeping once that sweep has completed. However, with **Average/Hold Number** >1 and at least one trace set to **Trace Average, Max Hold, or Min Hold (SA Measurement)** or **Averaging on (most other measurements)**, multiple sweeps/data acquisitions are taken for a single measurement. The trigger condition must be met prior to each sweep. The sweep is stopped when the average count  $k$  equals the number  $N$  set for **Average/Hold Number**. A measurement average usually applies to all traces, marker results, and numeric results; but sometimes it only applies to the numeric results.

Once the full set of sweeps has been taken, the analyzer will go to idle state. To take one more sweep without resetting the average count, increment the average count by 1, by pressing the step up key while **Average/Hold Number** is the active function, or sending the remote command `CALC:AVER:TCON UP`.

## Save

The Save menu lets you choose what you want to save and where you want to save it. Among the types of files you can save are **States**, **Traces**, and **Screen Images**. In addition, an Export (Data) option lets you save a number of data types as CSV files for easy import into Excel and other spreadsheet programs.

Key Path	Front-panel key
Mode	All
Notes	No remote command for this key specifically, but the :MMEM:STORe command is available for specific file types. An example is :MMEM:STOR:STATe <filename>.
Initial S/W Revision	Prior to A.02.00

## State

The Save State menu lets you choose a register or file for saving the state.

The content of a state file includes all of the settings and data required to return the analyzer as closely as possible to the Mode it was in, with the exact settings which were in place, when the save occurred. The Mode settings in each state file include the settings that are affected by Mode Preset, as well as the additional settings affected by Restore Mode Defaults; all of the Mode's settings. In addition, all of the settings of the Input/Output system are included, even though they are outside of the Mode's state, because they are needed to restore the complete setup. Persistent System settings (for example, Verbose SCPI) are not affected by either Mode Preset or Restore Mode Defaults, nor are they included in a saved State file.

After the save completes, the message "File <filename> saved" or "State Register <register number> saved" is displayed.

For rapid saving, the State menu lists 16 registers to save to. Pressing a Register key initiates the save. You can also select a file to save to.

The default path for all State Files is:

My Documents\<<mode name>\state

where <mode name> is the parameter used to select the mode with the INST:SEL command (for example, SA for the Spectrum Analyzer).

Key Path	Save
Mode	All
Remote Command	:MMEMory:STORe:STATe <filename>
Example	MMEM:STOR:STATe "MyStateFile.state" This stores the current instrument state data in the file MyStateFile.state in the default directory.
Notes	Both single and double quotes are supported for any filename parameter over remote. After saving to a register, that register's menu key is updated with the date the time, unless a custom label has been entered for that key. After saving to a register, you remain in the Save State menu, so that you can see the Register key

update. After saving to a file, the analyzer automatically returns to the previous menu and any Save As dialog goes away.

<b>Backwards Compatibility SCPI</b>	:MMEMory:STORe:STATe 1,<filename>
Initial S/W Revision	Prior to A.02.00

### To File . . .

When you press “To File”, the analyzer brings up a Windows dialog and a menu entitled “**Save As.**” This menu allows you to navigate to the various fields in the Windows dialog without using a keyboard or mouse. The Tab and Arrow keys can also be used for dialog navigation.

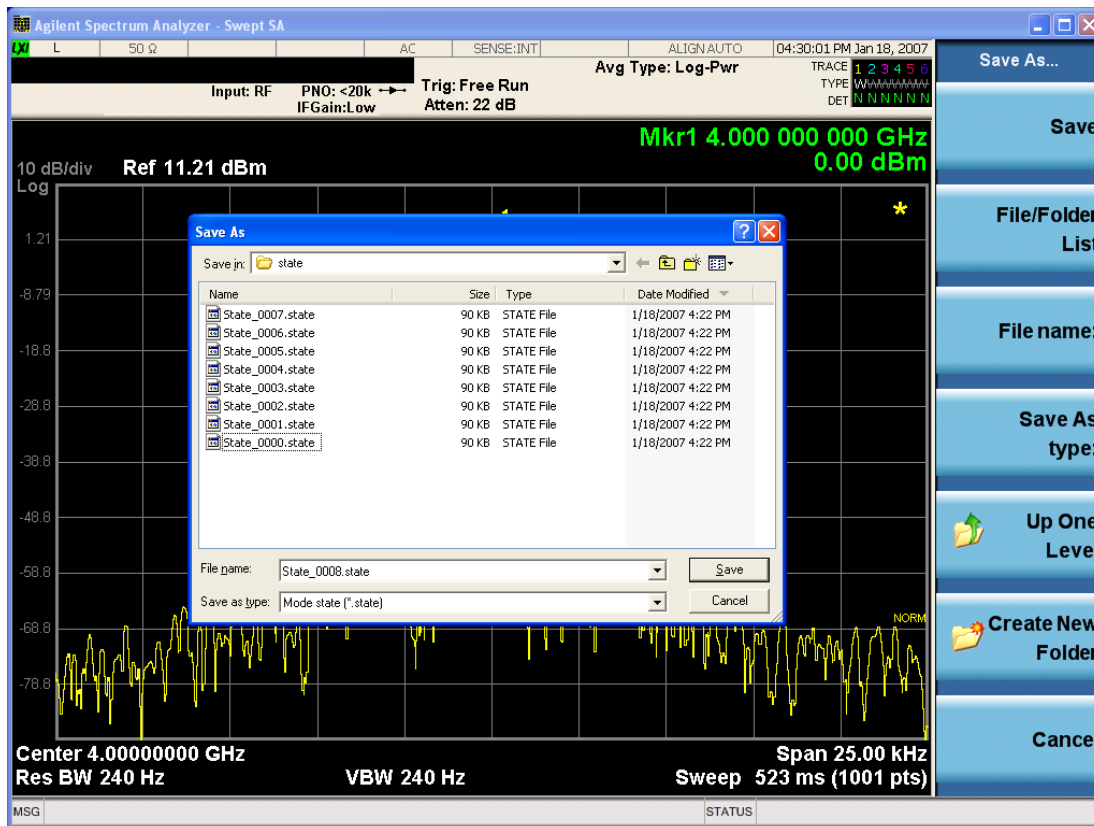

The Listed below

are the functions of the various fields in the dialog, and the corresponding softkeys:

#### Save

Performs the save to the specified file of the selected type. If the file already exists, a dialog will appear that allows you to replace the existing file by selecting OK, or you can Cancel the request. If you select OK, the file will be overwritten. Using the C: drive is strongly discouraged, since it runs the risk of being overwritten during an instrument software upgrade.

While the save is being performed, the floppy icon appears briefly in the Meas bar.

### File/Folder List

Enables you to navigate to the center of the dialog that contains the list of files and folders. Once here you can get information about the file and use the tab keys to navigate to the other fields in the dialog, such as Save In.

### Save In

The Save In field shows the path to which the file will be saved and allows you to change the path using the up and down arrow keys to navigate to other paths; the Enter key to open a directory; and the Backspace key to go back one directory. The **Save In field** defaults to the default path for this type of file and remembers the last path you used to save this type of file. There is no softkey for directly navigating to the Save In field but you can use left tab to get here from the File/Folder List.

User specified paths are remembered when you leave and return to a Mode and are reset back to the default using Restore Mode Defaults.

### File Name

The File Name field is initially loaded with an automatically generated filename specific to the appropriate Save Type. The automatically generated filename is guaranteed not to conflict with any filename currently in the directory. You may replace or modify this filename using the File Name key. See the ["Quick Save " on page 2880](#) documentation for more on the automatic file naming algorithm.

When you press the File Name key the analyzer displays the Alpha Editor. Use the knob to choose the letter to add and the front-panel Enter key to add the letter to the file name. The BK character moves you back and the FW character moves you forward in the filename. The Select key on the front panel generates a space character. When you are done entering the filename press the Done softkey. This returns back to the **File Open** dialog and menu, but does not cause the save to occur.

### Save As Type

This field shows the file suffix for the type of file you have selected to save. For example, if you navigated here while saving State, "Mode state (\*.state)" is in the field. If you navigated here from saving Trace, ""Mode state (\*.trace)" is in the field. If you navigated here while exporting a trace data file, "Trace Data (\*.csv)" is in the field. For some file types, there is more than one choice in the dropdown, which you can select by using the up and down arrow keys and Enter.

### Up One Level

This key corresponds to the icon of a folder with the up arrow that is in the tool bar of the dialog. When pressed, it causes the file and folder list to navigate up one level in the directory structure. The Backspace key does the same thing.

### Create New Folder

This key corresponds to the icon of a folder with the "\*" that is in the tool bar of the dialog. When pressed, a new folder is created in the current directory with the name **New Folder** and you can enter a new folder name using the Alpha Editor.

### Cancel

This key corresponds to the Cancel selection in the dialog. It causes the current **Save As** request to be cancelled. The ESC key does the same thing.

Key Path	Save, State
Mode	All
Notes	Brings up Save As dialog for saving a State Save Type
Initial S/W Revision	Prior to A.02.00

## Edit Register Names

You may enter a custom name on any of the Register keys, to help you remember what you are using that state to save. To do this, press the Edit Register Names key, choose the register whose name you wish to edit, and then enter the desired label using the Alpha Editor or an external PC keyboard.

The maximum number of characters that can be added is 30. In most cases, 30 characters will fit on two lines of the key.

See ["More Information" on page 1691](#)

Key Path	Save, State
Mode	All
<b>Remote Command</b>	:MMEMory:REGister:STATe:LABel <reg number>,"label" :MMEMory:REGister:STATe:LABel? <reg number>
<b>Example</b>	:MMEM:REG:STAT:LAB 1,"my label"
Notes	<reg number> is an integer from 1 to 16. If the SCPI specifies an invalid register number an error message is generated, -222,"Data out of range;Invalid register label number" "label" is a string from 0 to 30 characters in length. If a label exceeds 30 characters, an error message is generated, -150,"String data error;Label clipped to 30 characters" "label" of length 0 erases the custom label and restores the default (time and date) label. E.g.: :MMEM:REG:STAT:LAB 1,""
Dependencies	N9060A-7FP or N9060B-2FP license required to edit the register names. When the feature is not licensed, sending this command generates an error, -221,"Settings conflict;Option not available"
Preset	The names are unaffected by Preset or power cycle but are set to the default label (time and date) on a "Restore System Defaults->Misc"
Initial S/W Revision	A.11.00

## More Information

When you edit one of the register names, the time and date field will be replaced by the custom name.

If you delete all the characters in the custom name, it restores the default (time and date).

The register names are stored within the state files, but they are not part of the instrument state; that is, once you have edited a register name, loading a new state will not change that register name. Another consequence of this is that the names will be persistent through a power cycle. Also, if a named state file is transferred to another analyzer, it will bring its custom name along with it.

If you try to edit the name of an empty register, the analyzer will first save the state to have a file to put the name in. If you load a named state file into an analyzer with older firmware it will ignore the metadata.

The \*SAV and \*RCL commands will not be affected by the custom register names, nor will the MMEM commands.

### Register 1 thru Register 16

Selecting any one of these register menu keys causes the State of the currently active mode to be saved to the specified Register. The registers are provided for rapid saving and recalling, since you do not need to specify a filename or navigate to a file. Each of the register menu keys annotates whether it is empty or at what date and time it was last modified. In addition, you can use the Edit Register Names key to enter custom names for each register.

Although these 16 registers are the only registers available from the front panel, there are 128 state registers available in the instrument. Registers 17–128 are only available from the SCPI interface, using the \*SAV command.

There is one set of 128 state registers in the instrument, not one set for each Mode. When a state is saved, the Mode it was saved from is saved with it; then when it is recalled, the instrument switches to that Mode.

After the save completes, the corresponding register menu key annotation is updated with the date and time and the message "Register <register number> saved" is displayed.

Key Path	Save, State
Mode	All
Example	*SAV 1
Range	1–16 from front panel, 1–128 from SCPI
Readback	Date and time with seconds resolution are displayed on the key OR A custom name of up to 30 characters entered using the Edit Register Names key OR “(empty)” if no prior save operation has been performed to this register.
Initial S/W Revision	Prior to A.02.00
Modified at S/W Revision	A.11.00

### Register 1 thru Register 16

Selecting any one of these register menu keys causes the State of the currently active mode to be saved to the specified Register. The registers are provided for rapid saving and recalling, since you do not need to specify a filename or navigate to a file. Each of the register menu keys annotates whether it is empty or at what date and time it was last modified. In addition, you can use the Edit Register Names key to enter custom names for each register.

Although these 16 registers are the only registers available from the front panel, there are 128 state registers available in the instrument. Registers 17–128 are only available from the SCPI interface, using the \*SAV command.



There is one set of 128 state registers in the instrument, not one set for each Mode. When a state is saved, the Mode it was saved from is saved with it; then when it is recalled, the instrument switches to that Mode.

After the save completes, the corresponding register menu key annotation is updated with the date and time and the message "Register <register number> saved" is displayed.

Key Path	Save, State
Mode	All
Example	*SAV 1
Range	1-16 from front panel, 1-128 from SCPI
Readback	Date and time with seconds resolution are displayed on the key OR A custom name of up to 30 characters entered using the Edit Register Names key OR “(empty)” if no prior save operation has been performed to this register.
Initial S/W Revision	Prior to A.02.00
Modified at S/W Revision	A.11.00

## Data (Export)

Exporting a data file stores data from the current measurement to mass storage files. The Export Menu only contains data types that are supported by the current measurement.

Since the commonly exported data files are in .csv format, the data can be edited by you prior to importing. This allows you to export a data file, manipulate the data in Excel (the most common PC Application for manipulating .csv files) and then import it.

Selecting an Export Data menu key will not actually cause the exporting to occur, since the analyzer still needs to know where you wish to save the data. Pressing the Save As key in this menu brings up the Save As dialog and Save As menu that allows you to specify the destination file and directory. Once a filename has been selected or entered in the Open menu, the export will occur as soon as the Save key is pressed.

Key Path	Save
Mode	All
Notes	The menu is built from whatever data types are available for the mode. So the key locations in the sub menu will vary.  No SCPI command directly controls the Data Type that this key controls. The Data Type is included in the MMEM:STORe commands.
Dependencies	If a file type is not used by a certain measurement, that type is grayed out for that measurement. The key for a file type will not show at all if there are no measurements in the Mode that support it.
Preset	Is not affected by a Preset or shutdown, but is reset during Restore Mode Defaults
Readback	The data type that is currently selected
Initial S/W Revision	Prior to A.02.00

## Measurement Results

Pressing this key selects Meas Results as the data type to be exported.

The Meas Results file contains measurement result sets, plus information describing the current state of the analyzer, as detailed in ["Meas Results File Definition" on page 1694](#) and ["Meas Results File Example" on page 1696](#) below.

Key Path	Save, Data
Remote Command	:MMEMory:STORe:RESults <string>
Example	:MMEM:STOR:RES "MeasR_0000.csv"
Notes	<p>If the save is initiated via SCPI and the file already exists, the file will be overwritten.</p> <p>The SCPI command exports Power Stat CCDF measurement results to the file specified as the parameter in the current path. The default path is My Documents\<current an="" being="" c:="" discouraged,="" drive="" during="" instrument="" is="" it="" mode&gt;\data\pst\results.="" of="" overwritten="" p="" risk="" runs="" since="" software="" strongly="" the="" upgrade.<="" using=""> <p>The SCPI parameter is a quoted string that specifies the filename. Both single and double quotes are supported for any filename parameter over SCPI.</p> </current></p>
Dependencies	The current active measurement must be the Power Stat CCDF measurement to use this command.
Status Bits/OPC dependencies	Sequential – waits for the previous measurement to complete
Initial S/W Revision	Prior to A.02.00

## Meas Results File Definition

The content of a Meas Results File is defined in this section.

The first lines in the file consist of identification and instrument configuration details, as follows.

- File ID string, which is "MeasResult"
- Measurement ID following Mode ID, which is "SA:PST" for example.
- Firmware rev and model number
- Option string
- Automatic Trigger Time
- Automatic Trigger Time State
- CcdfCurrentCounts
- Center Frequency
- Center Frequency Step
- Center Frequency Step State
- Counts
- Electrical Atten

- Electrical Atten State
- External Array Trigger Delay
- External Array Trigger Delay State
- External Array Trigger Level
- External Array Trigger Slope
- Gaussian Line
- IF Gain Auto
- IF Gain State
- Info BW
- Internal Preamp
- Internal Preamp Band
- Line Trigger Delay
- Line Trigger Delay State
- Line Trigger Slope
- Meas Cycles
- MeasInterval
- Mechanical Atten
- MechanicalAttenStepEnum
- Periodic Timer Period
- Periodic Timer Sync Source
- Periodic Timer Trigger Delay
- Periodic Timer Trigger Delay State
- Preselector Adjust
- Ref Trace
- RFBurst Trigger Delay
- RFBurst Trigger Delay State
- RFBurst Trigger Level Abs
- RFBurst Trigger Level Rel
- RFBurst Trigger Level Type
- RFBurst Trigger Slope
- Scale/Div

- Trigger Holdoff
- Trigger Holdoff State
- TriggerSource

The data above is followed in the file by a line containing “MeasResult1” to “MeasResult4”. This line forms a header for each set of measurement results, which appear in subsequent lines. Each line of Measurement Results consists of 4 comma-separated values, from the MeasResult1 value to the MeasResult4 value.

The MeasResult1 set in the file corresponds to the data returned by MEAS|READ|FETCh:PStatistic1; the MeasResult2 set corresponds to the data returned by MEAS|READ|FETCh:PStatistic2, and so on.

The exported file is in CSV format, with a .csv extension.

### Meas Results File Example

When imported into Microsoft Excel, a typical Meas Results CSV file appears as shown in the example below.

MeasResult			
SA:PST			
A.10.53	N9030A		
526 ALV ATP B1X B1Y B25 B40 BBA CR3 CRP DCF DDA DP2 DRD EA3 EDP EMC EP1 ERC ESC ESP EXM FSA LFE LNP MAT MPB NFE NUL P26 PFR PNC RTL RTS S40 SB1 SEC SM1 TVT YAS YAV	1		
Automatic Trigger Time	0.1		
Automatic Trigger Time State	FALSE		
CcdfCurrentCounts	6087500		
Center Frequency	1.33E+10		
Center Frequency Step	5000000		
Center Frequency Step State	TRUE		
Counts	10000000		
Electrical Atten	0		
Electrical Atten State	FALSE		
External Array Trigger Delay	1.00E-06	1.00E-06	
External Array Trigger Delay State	FALSE	FALSE	
External Array Trigger Level	1.2	1.2	
External Array Trigger Slope	Positive	Positive	

Gaussian Line	TRUE		
IF Gain AUto	FALSE		
IF Gain State	FALSE		
Info BW	5000000		
Internal Preamp	FALSE		
Internal Preamp Band	Low		
Line Trigger Delay	1.00E-06		
Line Trigger Delay State	FALSE		
Line Trigger Slope	Positive		
Meas Cycles	1600		
MeasInterval	0.001		
Mechanical Atten	10		
MechanicalAttenStepEnum	S2dB		
Periodic Timer Period	0.02		
Periodic Timer Sync Source	None		
Periodic Timer Trigger Delay	1.00E-06		
Periodic Timer Trigger Delay State	FALSE		
Preselector Adjust	0		
Ref Trace	FALSE		
RFBurst Trigger Delay	1.00E-06		
RFBurst Trigger Delay State	FALSE		
RFBurst Trigger Level Abs	-20		
RFBurst Trigger Level Rel	-6		
RFBurst Trigger Level Type	Absolute		
RFBurst Trigger Slope	Positive		
Scale/Div	2		
Trigger Holdoff	0.1		
Trigger Holdoff State	FALSE		
TriggerSource	Free		
MeasResult1	MeasResult2	MeasResult3	MeasResult4
-73.0651058869747	36.9712197125257	36.7879441171442	
36.9712197125257	36.8850431211499	36.7032368203129	

## Capture Buffer

Capture Buffer functionality is not available for all measurements. The captured data is raw data which is not processed.

Key Path	Save, Data
Mode	CDMA1XEV
Example	MMEM:STOR:CAPT "MyCaptureData.bin" This stores the capture data in the file MyCaptureData.bin in the default directory.
Dependencies	In case the capture buffer data is not available from the selected measurement, the key will be grayed out.
Initial S/W Revision	A.11.00

### Save As . . .

When you press “Save As”, the analyzer brings up a Windows dialog and a menu entitled “**Save As.**” This menu allows you to navigate to the various fields in the Windows dialog without using a keyboard or mouse. The Tab and Arrow keys can also be used for dialog navigation.

See ["To File . . ." on page 2897](#) in Save, State for a full description of this dialog and menu.

The default path for saving files is:

For all of the Trace Data Files:

My Documents\<<mode name>\data\traces

For all of the Limit Data Files:

My Documents\<<mode name>\data\limits

For all of the Measurement Results Data Files:

My Documents\<<mode name>\data\<<measurement name>\results

For all of the Capture Buffer Data Files:

My Documents\<<mode name>\data\captureBuffer

Key Path	Save, Data
Mode	All
Notes	The key location is mode-dependent and will vary. Brings up the Save As dialog for saving a <mode specific> Save Type. The save is performed immediately and does not wait until the measurement is complete.
Initial S/W Revision	Prior to A.02.00

### Screen Image

Pressing Screen Image accesses a menu of functions that enable you to specify a format and location for the saved screen image. It brings up a menu that allows you to specify the color scheme of the Screen Image (Themes) or navigate to the Save As dialog to perform the actual save.

Screen Image files contain an exact representation of the analyzer display. They cannot be loaded back onto the analyzer, but they can be loaded into your PC for use in many popular applications.

The image to be saved is actually captured when the Save front panel key is pressed, and kept in temporary storage to be used if you ask for a Screen Image save. When the Screen Image key is pressed, a "thumbnail" of the captured image is displayed, as shown below:

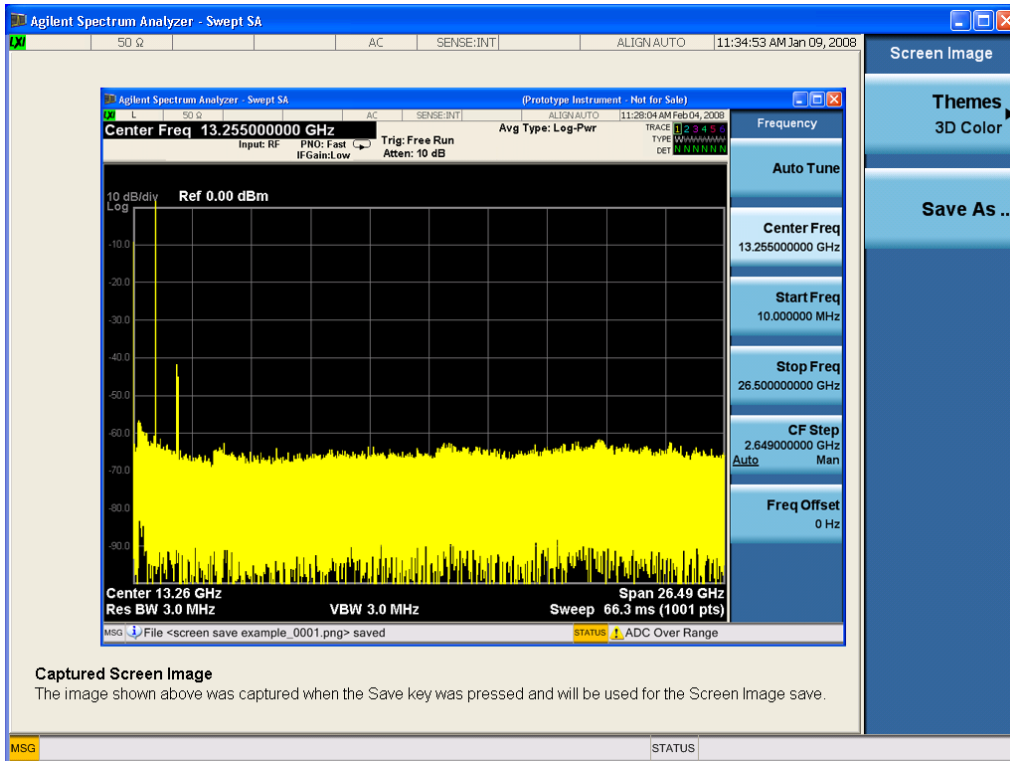

When you continue on into the Save As menu and complete the Screen Image save, the image depicted in the thumbnail is the one that gets saved, showing the menus that were on the screen before going into the Save menus. The save is performed immediately and does not wait until the measurement is complete.

After you have completed the save, the Quick Save front-panel key lets you quickly repeat the last save performed, using an auto-named file, with the current screen data.

**NOTE** For versions previous to A.01.55, if you initiate a screen image save by navigating through the Save menus, the image that is saved will contain the Save menu softkeys, not the menus and the active function that were on the screen when you first pressed the Save front panel key.

Key Path	Save
Mode	All
Remote Command	:MMEMory:STORe:SCReem <filename>
Example	:MMEM:STOR:SCR "myScreen.png" This stores the current screen image in the file MyScreenFile.png in the default directory.
Initial S/W Revision	Prior to A.02.00

## Themes

Accesses a menu of functions that enable you to choose the theme to be used when saving the screen image.

The **Themes** option is the same as the **Themes** option under the **Display** and **Page Setup** dialogs. It allows you to choose between themes to be used when saving the screen image.

<b>Key Path</b>	Save, Screen Image
<b>Remote Command</b>	:MMEMory:STORe:SCReen:THEMe TDColor   TDMonochrome   FCOLor   FMONochrome  :MMEMory:STORe:SCReen:THEMe?
<b>Example</b>	:MMEM:STOR:SCR:THEM TDM
<b>Preset</b>	3D Color; Is not part of Preset, but is reset by Restore Misc Defaults or Restore System Defaults All and survives subsequent running of the modes.
<b>Readback</b>	3D Color   3D Mono   Flat Color   Flat Mono
<b>Backwards Compatibility Notes</b>	In ESA and PSA we offer the choice of "Reverse Bitmap" or "Reverse Metafile" when saving screen images. This is much like the "Flat Color" theme available in X-Series. Also, if you selected Reverse Bitmap AND a black & white screen image, that would be much like "Flat Monochrome". In other words, each of the X-Series themes has a similar screen image type in ESA/PSA. But they are not identical.
<b>Initial S/W Revision</b>	Prior to A.02.00

### 3D Color

Selects a standard color theme with each object filled, shaded and colored as designed.

<b>Key Path</b>	Save, Screen Image, Themes
<b>Example</b>	MMEM:STOR:SCR:THEM TDC
<b>Readback</b>	3D Color
<b>Initial S/W Revision</b>	Prior to A.02.00

### 3D Monochrome

Selects a format that is like 3D color but shades of gray are used instead of colors.

<b>Key Path</b>	Save, Screen Image, Themes
<b>Example</b>	MMEM:STOR:SCR:THEM TDM
<b>Readback</b>	3D Mono
<b>Initial S/W Revision</b>	Prior to A.02.00

### Flat Color

Selects a format that is best when the screen is to be printed on an ink printer.



Key Path	Save, Screen Image, Themes
<b>Example</b>	MMEM:STOR:SCR:THEM FCOL
Readback	Flat Color
Initial S/W Revision	Prior to A.02.00

### Flat Monochrome

Selects a format that is like Flat Color. But only black is used (no colors, not even gray), and no fill.

Key Path	Save, Screen Image, Themes
<b>Example</b>	MMEM:STOR:SCR:THEM FMON
Readback	Flat Mono
Initial S/W Revision	Prior to A.02.00

### Save As...

When you press "Save As", the analyzer brings up a Windows dialog and a menu entitled "**Save As.**" This menu allows you to navigate to the various fields in the Windows dialog without using a keyboard or mouse. The Tab and Arrow keys can also be used for dialog navigation.

See "[To File . . .](#)" on page 2897 in Save, State for a full description of this dialog and menu.

The default path for Screen Images is

My Documents\`<mode name>`\screen.

where `<mode name>` is the parameter used to select the mode with the INST:SEL command (for example, SA for the Spectrum Analyzer).

Key Path	Save, Screen Image
Notes	Brings up Save As dialog for saving a Screen Image Save Type
Initial S/W Revision	Prior to A.02.00

### Mass Storage Catalog (Remote Command Only)

Key path	SCPI Only
<b>Remote Command</b>	:MMEMory:CATalog? [ <code>&lt;directory_name&gt;</code> ]
Notes	<p>The string must be a valid logical path.</p> <p>Queries disk usage information (drive capacity, free space available) and obtains a list of files and directories in a specified directory in the following format:</p> <p><code>&lt;numeric_value&gt;,&lt;numeric_value&gt;,{&lt;file_entry&gt;}</code></p> <p>It returns two numeric parameters and as many strings as there are files and directories. The first</p>

parameter indicates the total amount of storage currently used in bytes. The second parameter indicates the total amount of storage available, also in bytes. The <file\_entry> is a string. Each <file\_entry> indicates the name, type, and size of one file in the directory list:

<file\_name>,<file\_type>,<file\_size>

As the windows file system has an extension that indicates file type, <file\_type> is always empty. <file\_size> provides the size of the file in bytes. For directories, <file\_entry> is surrounded by square brackets and both <file\_type> and <file\_size> are empty

---

Initial S/W Revision      Prior to A.02.00

---

### Mass Storage Change Directory (Remote Command Only)

---

Key path                      SCPI Only

---

**Remote Command**        :MMEMory:CDIRectory [<directory\_name>]  
                                 :MMEMory:CDIRectory?

---

**Notes**                      The string must be a valid logical path.  
  
Changes the default directory for a mass memory file system. The <directory\_name> parameter is a string. If no parameter is specified, the directory is set to the \*RST value.  
  
At \*RST, this value is set to the default user data storage area, that is defined as System.Environment.SpecialFolder.Personal.  
  
Query returns full path of the default directory.

---

Initial S/W Revision      Prior to A.02.00

---

### Mass Storage Copy (Remote Command Only)

---

Key path                      SCPI Only

---

**Remote Command**        :MMEMory:COPY <string>,<string>[,<string>,<string>]

---

**Notes**                      The string must be a valid logical path.  
  
Copies an existing file to a new file or an existing directory to a new directory.  
  
Two forms of parameters are allowed. The first form has two parameters. In this form, the first parameter specifies the source, and the second parameter specifies the destination.  
  
The second form has four parameters. In this form, the first and third parameters specify the source. The second and fourth parameters specify the directories. The first pair of parameters specifies the source. The second pair specifies the destination. An error is generated if the source doesn't exist or the destination file already exists.  
  
This command will generate an "access denied" error if the destination is a restricted folder (e.g., C:\Windows) and the current user does not have Power User or Administrator privileges.

---

### Mass Storage Device Copy (Remote Command Only)

This command transfers data to/from a file and a peripheral device.

Key path	SCPI Only
<b>Remote Command</b>	:MMEMory:COpy:DEvice <source_string>,<dest_string>
Notes	The strings must be a valid logical path or a valid device keyword. If the dest_string is a device keyword, the data is copied from the source file to the device. If the source_string is a device keyword, the data is copied to the source file from the device.  Valid device keywords are: SNS (smart noise source)  An error is generated if the file or device is not found.

### Mass Storage Delete (Remote Command Only)

Key path	SCPI Only
<b>Remote Command</b>	:MMEMory:DElete <file_name>[,<directory_name>]
Notes	The string must be a valid logical path.  Removes a file from the specified directory. The <file_name> parameter specifies the file name to be removed. This command will generate an “access denied” error if the file is in a restricted folder (e.g., C:\Windows) and the current user does not have Power User or Administrator privileges.
Initial S/W Revision	Prior to A.02.00

### Mass Storage Data (Remote Command Only)

Creates a file containing the specified data OR queries the data from an existing file.

Key path	SCPI Only
<b>Remote Command</b>	:MMEMory:DATA <file_name>, <data>  :MMEMory:DATA? <file_name>
Notes	The string must be a valid logical path.  The command form is MMEMory:DATA <file_name>,<data>. It loads <data> into the file <file_name>. <data> is in 488.2 block format. <file_name> is string data.  The query form is MMEMory:DATA? <file_name> with the response being the associated <data> in block format.
Initial S/W Revision	Prior to A.02.00

### Mass Storage Make Directory (Remote Command Only)

Key path	SCPI Only
<b>Remote Command</b>	:MMEMory:MDIRectory <directory_name>
Notes	The string must be a valid logical path.  Creates a new directory. The <directory_name> parameter specifies the name to be created.

---

	This command will generate an “access denied” error if the new directory would be in a restricted folder (e.g., C:\Windows) and the current user does not have Power User or Administrator privileges.
Initial S/W Revision	Prior to A.02.00

---

### Mass Storage Move (Remote Command Only)

---

Key path	SCPI Only
<b>Remote Command</b>	:MMEMory:MOVE <string>,<string>[,<string>,<string>]
Notes	<p>The string must be a valid logical path.</p> <p>Moves an existing file to a new file or an existing directory to a new directory.</p> <p>Two forms of parameters are allowed. The first form has two parameters. In this form, the first parameter specifies the source, and the second parameter specifies the destination.</p> <p>The second form has four parameters. In this form, the first and third parameters specify the source. The second and fourth parameters specify the directories. The first pair of parameters specifies the source. The second pair specifies the destination. An error is generated if the source doesn't exist or the destination file already exists.</p> <p>This command will generate an “access denied” error if the destination is a restricted folder (e.g., C:\Windows) and the current user does not have Power User or Administrator privileges.</p>
Initial S/W Revision	Prior to A.02.00

---

### Mass Storage Remove Directory (Remote Command Only)

---

Key path	SCPI Only
<b>Remote Command</b>	:MMEMory:RDIRECTory <directory_name>
Notes	<p>The string must be a valid logical path.</p> <p>Removes a directory. The &lt;directory_name&gt; parameter specifies the directory name to be removed. All files and directories under the specified directory shall also be removed.</p> <p>This command will generate an “access denied” error if the folder is a restricted folder (e.g., C:\Windows) or is in a restricted folder and the current user does not have Power User or Administrator privileges.</p>
Initial S/W Revision	Prior to A.02.00

---

## Single (Single Measurement/Sweep)

Sets the analyzer for Single measurement operation. The single/continuous state is Meas Global, so the setting will affect all the measurements. If you are Paused, pressing Single does a Resume.

See ["More Information" on page 1705](#)

Key Path	Front-panel key
Example	:INIT:CONT OFF
Notes	See Cont key description.
Backwards Compatibility Notes	<p>For Spectrum Analysis mode in ESA and PSA, the Single hardkey and the INITiate:IMM switched from continuous measurement to single measurement and restarted sweeps and averages (displayed average count reset to 1), but did not restart Max Hold and Min Hold. In the X-Series, the Single hardkey and the INITiate:IMM command initiate a sweep/ measurement/ average sequence/hold sequence including MaxHold and MinHold.</p> <p>For Spectrum Analysis mode in ESA and PSA, the Single hardkey restarted the sweep regardless of whether or not you were in an active sweep or sweep sequence. In the X-Series, Restart does this but Single only restarts the sweep or sweep sequence if you are in the idle state.</p> <p>INIT[:IMM] in ESA &amp; PSA Spectrum Analysis Mode does an implied ABORT. In some other PSA Modes, INIT[:IMM] is ignored if not in the idle state. . The X-Series follows the ESA/PSA SA Mode model, which may cause some Modes to have compatibility problems.</p>
Initial S/W Revision	Prior to A.02.00

### More Information

See ["Restart" on page 2894](#) for details on the INIT:IMMEDIATE (Restart) function.

If you are already in single sweep, the INIT:CONT OFF command has no effect.

If you are already in Single Sweep, then pressing the Single key in the middle of a sweep does not restart the sweep or sequence. Similarly, pressing the Single key does not restart the sweep or sequence if the sweep is not in the idle state (for example, if you are taking a very slow sweep, or the analyzer is waiting for a trigger). Instead, it results in a message. "Already in Single, press Restart to initiate a new sweep or sequence". Even though pressing the Single key in the middle of a sweep does not restart the sweep, sending INIT:IMMEDIATE does reset it.

To take one more sweep without resetting the average count, increment the average count by 1, by pressing the step up key while **Average/Hold Number** is the active function, or sending the remote command CALC:AVER:TCON UP.

## Source

There is no Source control functionality for this measurement. When this key is pressed, the screen either displays a blank menu, or the previously-selected menu remains unchanged.

---

Key Path	Front-panel key
----------	-----------------

---

## Span X Scale

The SPAN X Scale key accesses the menu to set the desired horizontal scale.

Key Path	Front-panel key
Initial S/W Revision	Prior to A.02.00

### Scale/Div

Enables you to enter a time value to change the horizontal scale.

Key Path	Span X Scale
Mode	SA, WCDMA, C2K, WIMAXOFDMA, TD-SCDMA, 1xEV-DO, DVB-T/H, DTMB (CTTB), ISDB-T, CMMB, LTE, LTE-TDD, Digital Cable TV, WLAN, MSR,, LTE-TDD, LTE-FDD
<b>Remote Command</b>	:DISPlay:PStatistic:VIEW[1]:WINDow2:TRACe:X[:SCALe]:PDIVision <rel_ ampl> :DISPlay:PStatistic:VIEW[1]:WINDow2:TRACe:X[:SCALe]:PDIVision?
<b>Example</b>	DISP:PST:VIEW:WIND2:TRAC:X:PDIV 10 DISP:PST:VIEW:WIND2:TRAC:X:PDIV?
Notes	CCDF measurement has the trace display only at Window 2.
Couplings	See Notes
Preset	2.00
State Saved	Saved in instrument state.
Min	0.1
Max	20
<b>Backwards Compatibility SCPI</b>	:DISPlay:PStatistic:XSCale
Initial S/W Revision	Prior to A.02.00
Modified at S/W Revision	A.02.00, A.03.00

## Sweep/Control

Enables you to pause the power statistics CCDF measurement after the current data acquisition is complete. When Paused, the label on the menu key changes to Resume. Press Resume to resume the measurement where it was when it was paused.

---

Key Path	Front-panel key
Initial S/W Revision	Prior to A.02.00

---

### Pause/Resume

Pauses a measurement after the current data acquisition is complete. When Paused, the label on the key changes to Resume. Press Resume to resume the measurement where it was when it was paused. See ["Pause/Resume" on page 2925](#) for details.

---

Key Path	Sweep/Control
Initial S/W Revision	Prior to A.02.00

---



## System

See "System" on page 359

## Trace/Detector

Accesses a menu of functions that enable you to control the storage and manipulation of the reference trace, as well as controls the display of the trace data.

Key Path	Front-panel key
Initial S/W Revision	Prior to A.02.00

### Store Ref Trace

Copies the currently measured curve as the user-definable reference trace. The captured data remains until the other mode is chosen. Pressing this key also refreshes the reference trace.

No query command is available.

Key Path	Trace/Detector
Mode	SA, WCDMA, C2K, WIMAXOFDMA, TD-SCDMA, 1xEV-DO, DVB-T/H, DTMB (CTTB), ISDB-T, CMMB, LTE, LTE-TDD, Digital Cable TV, WLAN, MSR, LTE-TDD, LTE-FDD
<b>Remote Command</b>	:CALCulate:PSTatistic:STORe:REFerence
<b>Example</b>	CALC:PST:STOR:REF
<b>Backwards Compatibility SCPI</b>	[[:SENSE]:PSTatistic:SRTRace
Initial S/W Revision	Prior to A.02.00
Modified at S/W Revision	A.02.00, A.03.00

### Ref Trace

Toggles the reference trace display between On and Off.

Key Path	Trace/Detector
Mode	SA, WCDMA, C2K, WIMAXOFDMA, TD-SCDMA, 1xEV-DO, DVB-T/H, DTMB (CTTB), ISDB-T, CMMB, LTE, LTE-TDD, Digital Cable TV, WLAN, MSR, LTE-TDD, LTE-FDD
<b>Remote Command</b>	:DISPlay:PSTatistic:RTRace[:STATe] OFF ON 0 1 :DISPlay:PSTatistic:RTRace[:STATe]?
<b>Example</b>	DISP:PST:RTR OFF DISP:PST:RTR?
Preset	OFF
State Saved	Saved in instrument state.
Range	On Off
<b>Backwards Compatibility SCPI</b>	[[:SENSE]:PSTatistic:RTRace[:STATe]
Initial S/W Revision	Prior to A.02.00
Modified at S/W Revision	A.02.00, A.03.00, A.04.00

## Gaussian Line

Toggles the Gaussian trace display between On and Off.

<b>Key Path</b>	Trace/Detector
<b>Mode</b>	SA, WCDMA, C2K, WIMAXOFDMA, TD-SCDMA, 1xEV-DO, DVB-T/H, DTMB (CTTB), ISDB-T, CMMB, LTE, LTE-TDD, Digital Cable TV, WLAN, MSR, LTE-TDD, LTE-FDD
<b>Remote Command</b>	:DISPlay:PStatistic:GAUSSian[:STATe] OFF ON 0 1 :DISPlay:PStatistic:GAUSSian[:STATe]?
<b>Example</b>	DISP:PST:GAUS OFF DISP:PST:GAUS?
<b>Preset</b>	ON
<b>State Saved</b>	Saved in instrument state.
<b>Range</b>	On Off
<b>Backwards Compatibility SCPI</b>	[:SENSe]:PStatistic:GAUSSian[:STATe]
<b>Initial S/W Revision</b>	Prior to A.02.00
<b>Modified at S/W Revision</b>	A.02.00, A.03.00, A.04.00

## Trigger

See ["Trigger" on page 430](#)

### Free Run

See ["Free Run " on page 437](#)

### Video

See ["Video \(IF Envelope\) " on page 438](#)

### Trigger Level

See ["Trigger Level " on page 438](#)

### Trig Slope

See ["Trig Slope " on page 439](#)

### Trig Delay

See ["Trig Delay " on page 440](#)

### Line

See ["Line " on page 2729](#)

### Trig Slope

See ["Trig Slope " on page 2729](#)

### Trig Delay

See ["Trig Delay " on page 442](#)

### External 1

See ["External 1 " on page 2741](#)

### Trigger Level

See ["Trigger Level " on page 2741](#)

### Trig Slope

See ["Trig Slope " on page 2742](#)

### Trig Delay

See ["Trig Delay " on page 445](#)

### External 2

See ["External 2 " on page 2743](#)

## Trigger Level

See ["Trigger Level "](#) on page 2743

## Trig Slope

See ["Trig Slope "](#) on page 2744

## Trig Delay

See ["Trig Delay "](#) on page 447

## RF Burst

See ["RF Burst "](#) on page 2744

## Absolute Trigger

See ["Absolute Trigger Level"](#) on page 2745

## Relative Trigger

See ["Relative Trigger Level"](#) on page 2734

## Trig Slope

See ["Trigger Slope "](#) on page 2746

## Trig Delay

See ["Trig Delay "](#) on page 451

## Periodic Timer

See ["Periodic Timer \(Frame Trigger\) "](#) on page 2736

## Period

See ["Period "](#) on page 2737

## Offset

See ["Offset "](#) on page 2738

## Offset Adjust (Remote Command Only)

See ["Offset Adjust \(Remote Command Only\)"](#) on page 2739

## Reset Offset Display

See ["Reset Offset Display "](#) on page 2740

## Sync Source

See ["Sync Source "](#) on page 2740

## Off

See ["Off "](#) on page 2741

## External 1

See ["External 1 "](#) on page 2741

## Trigger Level

See ["Trigger Level "](#) on page 2741

## Trig Slope

See ["Trig Slope "](#) on page 2742

## External 2

See ["External 2 "](#) on page 2743

## Trigger Level

See ["Trigger Level "](#) on page 2743

## Trig Slope

See ["Trig Slope "](#) on page 2744

## RF Burst

See ["RF Burst "](#) on page 2744

## Absolute Trigger

See ["Absolute Trigger Level"](#) on page 2745

## Trig Slope

See ["Trigger Slope "](#) on page 2746

## Trig Delay

See ["Trig Delay"](#) on page 461

## Auto/Holdoff

See ["Auto/Holdoff "](#) on page 462

## Auto Trig

See ["Auto Trig "](#) on page 462

## Trig Holdoff

See ["Trig Holdoff "](#) on page 463

## User Preset

Accesses a menu that gives you the following three choices:

- User Preset – recalls a state previously saved using the Save User Preset function.
- User Preset All Modes – presets all of the modes in the analyzer
- Save User Preset– saves the current state for the current mode

Key Path	Front-panel key
Backwards Compatibility Notes	<p>User Preset is actually loading a state, and in legacy analyzers, it was possible to load a state without affecting the trace data, limit lines or correction data. Similarly it was possible to do a User Preset without affecting the trace data, limit lines or correction data.</p> <p>In the X-Series, “state” always includes all of this data; so whenever state is loaded, or User Preset is executed, all of the traces, limit lines and corrections are affected. Although this differs from previous behavior, it is desirable behavior, and should not cause adverse issues for users.</p> <p>On ESA and PSA, User Preset affected the entire instrument’s state. In the X-Series, User Preset only recalls the state for the active mode. There is a User Preset file for each mode. User Preset can never cause a mode switch as it can in legacy analyzers. If you want to recall all modes to their user preset file state, you will need to do a User Preset after mode switching into each mode.</p> <p>User Preset recalls mode state which can now include data like traces; whereas on ESA and PSA, User Preset did not affect data.</p>
Initial S/W Revision	Prior to A.02.00

## User Preset

User Preset sets the state of the currently active mode back to the state that was previously saved for this mode using the Save User Preset menu key or the SCPI command, SYST:PRES:USER:SAV. It not only recalls the Mode Preset settings, but it also recalls all of the mode persistent settings, and the Input/Output system setting that existed at the time Save User Preset was executed.

If a Save User Preset has not been done at any time, User Preset recalls the default user preset file for the currently active mode. The default user preset files are created if, at power-on, a mode detects there is no user preset file. There will never be a scenario when there is no user preset file to restore. For each mode, the default user preset state is the same state that would be saved if a Save User Preset is performed in each mode right after doing a Restore Mode Default and after a Restore Input/Output Defaults.

The User Preset function does the following:

- Aborts the currently running measurement.
- Sets the mode State to the values defined by Save User Preset.
- Makes the saved measurement for the currently running mode the active measurement.
- Brings up the saved menu for the power-on mode.
- Clears the input and output buffers.
- Sets the Status Byte to 0.

Key Path	User Preset
Remote Command	:SYSTem:PRESet:USER
Example	:SYST:PRES:USER:SAVE:SYST:PRES:USER
Notes	:SYST:PRES:USER:SAVE is used to save the current state as the user preset state. Clears all pending OPC bits. The Status Byte is set to 0. Pressing the User Preset front-panel key while already in the User Preset menu will cause the User Preset to get executed
Couplings	A user preset will cause the currently running measurement to be aborted and cause the saved measurement to be active. Recalling a User Preset file has the same issues that recalling a Save State file has. Some settings may need to be limited and therefore re-coupled, since the capabilities of the mode may have changes when the User Preset file was last saved.
Initial S/W Revision	Prior to A.02.00

### User Preset All Modes

Recalls all of the User Preset files for each mode, switches to the power-on mode, and activates the saved measurement from the power-on mode User Preset file.

**NOTE**

When the instrument is secured, all of the user preset files are converted back to their default user preset files.

The User Preset function does the following:

- Aborts the currently running measurement.
- Switches the Mode to the power-on mode.
- Restores the User Preset files for each mode.
- Makes the saved measurement for the power-on mode the active measurement.
- Brings up the saved menu for the power-on mode.
- Clears the input and output buffers.
- Sets the Status Byte to 0.

Key Path	User Preset
Remote Command	:SYSTem:PRESet:USER:ALL
Example	:SYST:PRES:USER:SAVE:SYST:PRES:USER:ALL
Notes	Clears all pending OPC bits. The Status Byte is set to 0. :SYST:PRES:USER:SAVE is used to save the current state as the user preset state.
Couplings	A user preset will cause the currently running measurement to be aborted, cause a mode switch to the power-on mode, and cause the saved measurement to be active in the power-on mode. Recalling a User Preset file has the same issues that recalling a Save State file has. Some settings may need to be limited and therefore re-coupled, since the capabilities of the mode may have changes when the User Preset file was last saved.
Initial S/W Revision	Prior to A.02.00



## Save User Preset

Saves the currently active mode and its State. You can recall this User Preset file by pressing the User Preset menu key or sending the SYST:PRES:USER remote command. This same state is also saved by the Save State function.

Key Path	User Preset
<b>Remote Command</b>	:SYSTem:PRESet:USER:SAVE
<b>Example</b>	:SYST:PRES:USER:SAVE
Notes	:SYST:PRES:SAVE creates the same file as if the user requested a *SAV or a MMEM:STOR:STAT, except User Preset Save does not allow the user to specify the filename or the location of the file.
Initial S/W Revision	Prior to A.02.00

## View/Display

Accesses a menu of functions that enable you to control the instrument display as well as turn the bar graph On and Off.

The Power Stat CCDF measurement provides a single view. This is common for both Uplink (MS) and Downlink (BTS). The view consists of the following windows:

"Metrics window" on page 1720

"Graph window" on page 1721

"Wave window (TD-SCDMA and LTE TDD only)" on page 1721

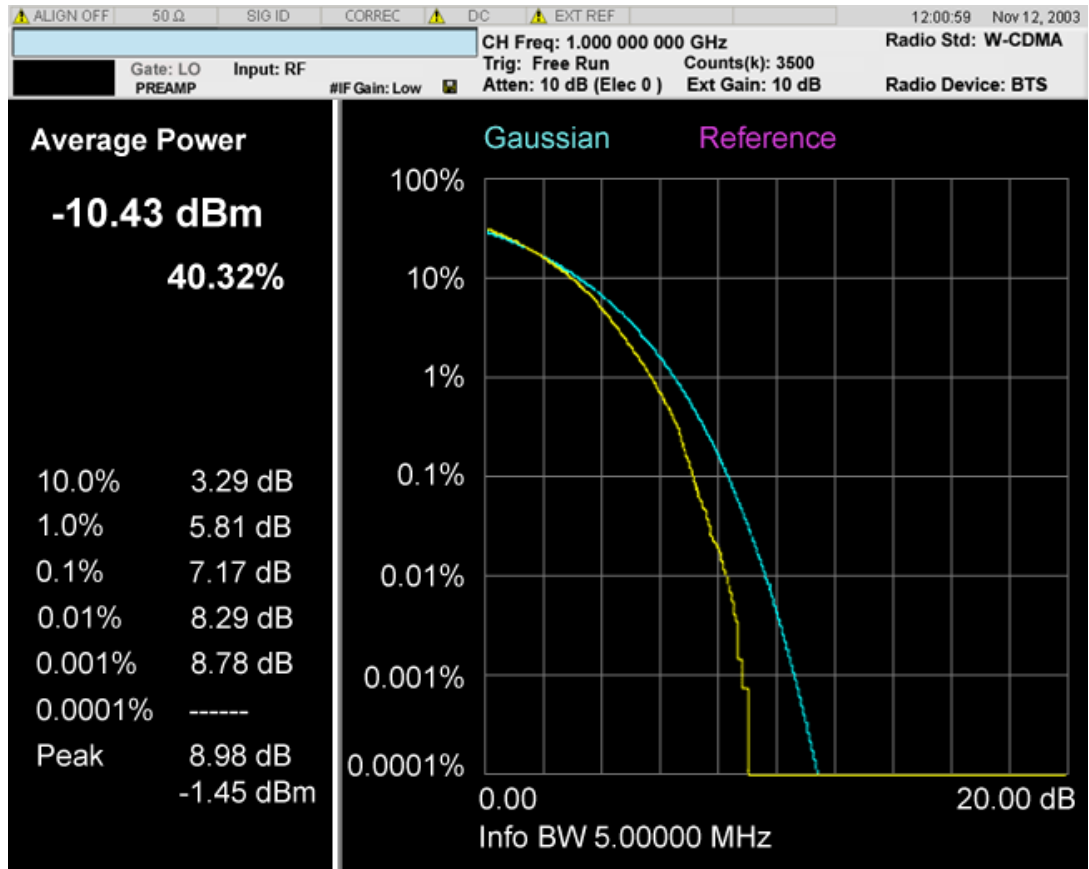

Above: View for Power Stat CCDF Measurement.

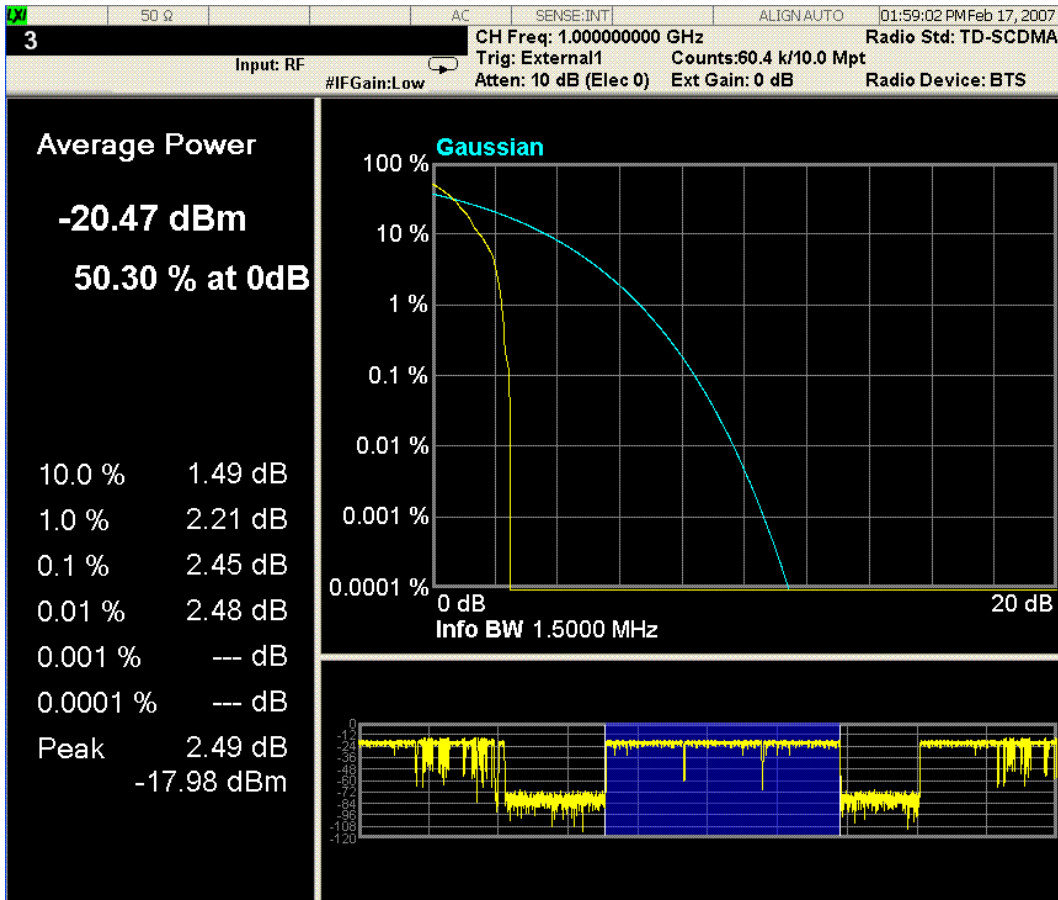

Above: Slot View for Power Stat CCDF Measurement in TD-SCDMA mode.

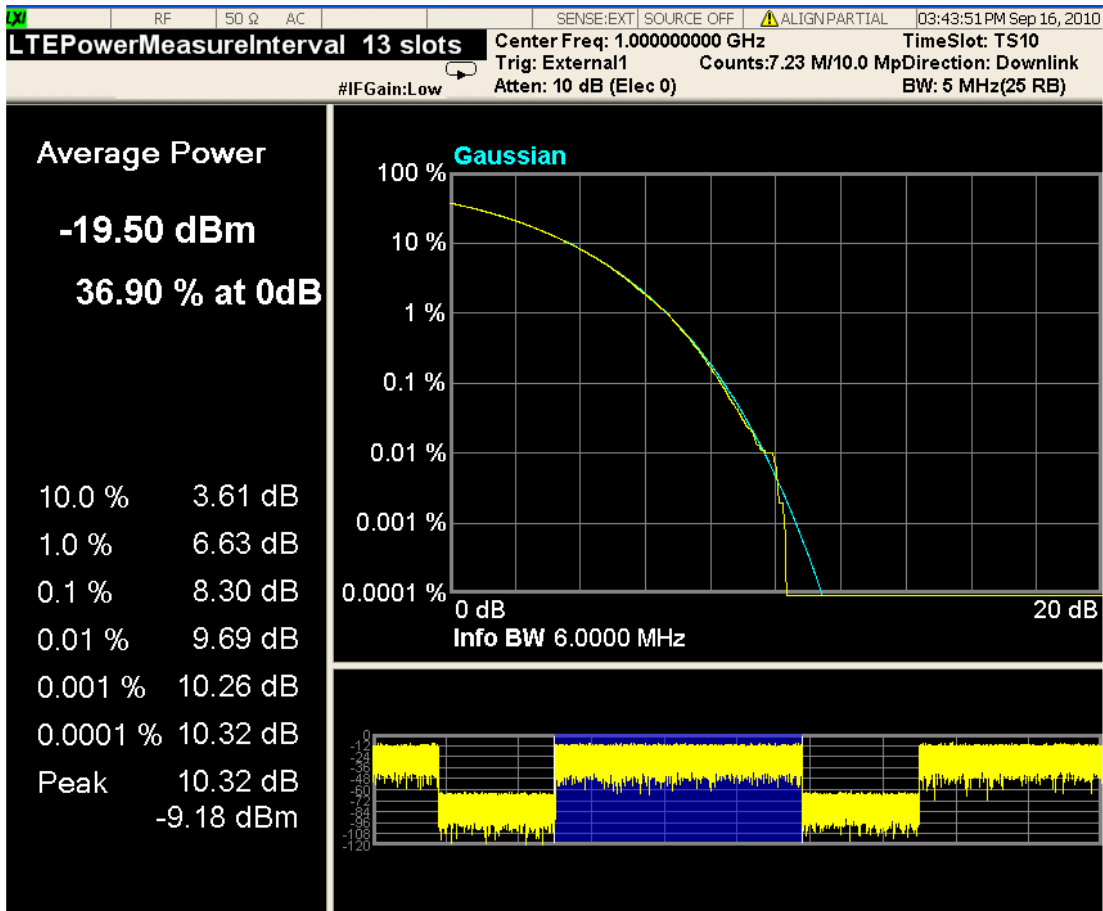

Above: View for Power Stat CCDF Measurement in LTE TDD mode.

### Metrics window

Name	Corresponding Results	Explanation
Average Power [dBm]	n=1 1st Average input power	99.99 dBm
Average Power [%]	n=1 2nd Probability at the average input power level	99.99 %
10.0% [dB]	n=1 3rd Power level that has 10% of the power	99.99 dB
1.0% [dB]	n=1 4th Power level that has 1% of the power	99.99 dB
0.1% [dB]	n=1 5th Power level that has 0.1% of the power	99.99 dB
0.01% [dB]	n=1 6th Power level that has 0.01% of the power	99.99 dB
0.001% [dB]	n=1 7th	99.99 dB

Name	Corresponding Results	Explanation
	Power level that has 0.001% of the power	
0.0001% [dB]	n=1 8th	99.99 dB
	Power level that has 0.0001% of the power	
Peak [dB]	n=1 9th	99.99 dB
	Peak power	
Peak[dBm]	This is not available from SCPI using remote commands.	99.99 dBm

### Graph window

Marker Operation	Yes
Corresponding Trace	<p>Yellow: Series of 5001 floating the current measured power stat trace. (n=2) Initially all markers refer this trace.</p> <p>Light Blue: Series of 5001 floating point numbers (in percent) that represent the Gaussian trace. (n=3)</p> <p>Violet: series of 5001 floating point numbers (in percent) that represent the user-definable reference trace. (n=4)</p> <p>The Gaussian and Reference trace/line can be removed using the functions under the Trace/Detector key</p>

### Wave window (TD-SCDMA and LTE TDD only)

This window is only available under TD-SCDMA mode and LTE TDD mode, and by default this window is closed, it can be turned on or off by using the softkey "Slot View". For more details, refer to the section [Slot View](#).

Marker Operation	No
Corresponding Trace	<p>Yellow: For TD-SCDMA, Waveform of entire TD-SCDMA frame. If measurement range specified by Analysis Time Slot and Measured Time Slot is out of the first frame, the display range extends to two TD-SCDMA frames. For LTETDD, Waveform of 2 continuous LTE type2 frames.</p> <p>Blue: Indicates current measurement range</p>

Key Path	Front-panel key
Initial S/W Revision	Prior to A.02.00

## Display

The Display menu is common to most measurements, and is used for configuring items on the display. Some Display menu settings apply to all the measurements in a mode, and some only to the current measurement. Those under the System Display Settings key apply to all measurements in all modes.

Key Path	Display
Key Path	View/Display
Initial S/W Revision	Prior to A.02.00

## Annotation

Turns on and off various parts of the display annotation. The annotation is divided up into four categories:

1. Meas Bar: This is the measurement bar at the top of the screen. It does not include the settings panel or the Active Function. Turning off the Meas Bar turns off the settings panel and the Active Function. When the Meas Bar is off, the graticule area expands to fill the area formerly occupied by the Meas Bar.
2. Screen Annotation: this is the annotation and annunciation around the graticule, including any annotation on lines (such as the display line, the threshold line, etc.) This does NOT include the marker number or the N dB result. When off, the graticule expands to fill the entire graticule area.
3. Trace annotation: these are the labels on the traces, showing their detector (or their math mode).
4. Active Function annotation: this is the active function display in the meas bar, and all of the active function values displayed on softkeys.

See the figure below. Each type of annotation can be turned on and off individually.

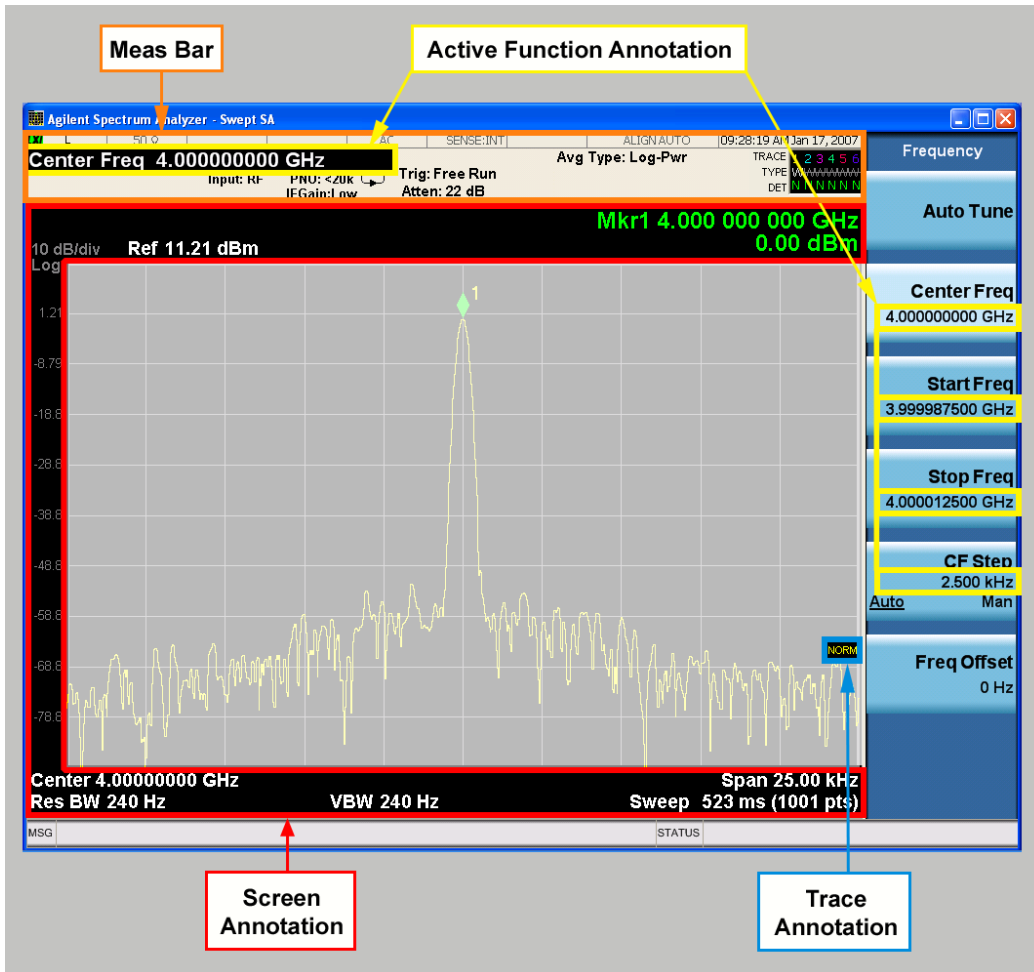

Key Path	View/Display, Display
Initial S/W Revision	Prior to A.02.00

### Meas Bar On/Off

This function turns the Measurement Bar on and off, including the settings panel. When off, the graticule area expands to fill the area formerly occupied by the Measurement Bar.

Key Path	View/Display, Display, Annotation
<b>Remote Command</b>	:DISPlay:ANNotation:MBAR[:STATE] OFF ON 0 1 :DISPlay:ANNotation:MBAR[:STATE]?
<b>Example</b>	DISP:ANN:MBAR OFF
Dependencies	Grayed out and forced to OFF when System Display Settings, Annotation is set to Off.
Preset	On This should remain Off through a Preset when System DisplaySettings, Annotation is set to Off.
State Saved	Saved in instrument state.
Initial S/W Revision	Prior to A.02.00

### Screen

This controls the display of the annunciation and annotation around the graticule, including any annotation on lines (such as the display line, the threshold line, etc.) and the y-axis annotation. This does NOT include marker annotation (or the N dB result). When off, the graticule expands to fill the entire graticule area, leaving only the 1.5% gap above the graticule as described in the Trace/Detector chapter.

<b>Key Path</b>	View/Display, Display, Annotation
<b>Remote Command</b>	:DISPlay:ANNotation:SCReen[:STATe] OFF ON 0 1 :DISPlay:ANNotation:SCReen[:STATe]?
<b>Example</b>	DISP:ANN:SCR OFF
<b>Dependencies</b>	Grayed-out and forced to OFF when System Display Settings, Annotation is set to Off.
<b>Preset</b>	On This should remain Off through a Preset when System DisplaySettings, Annotation is set to Off
<b>State Saved</b>	Saved in instrument state.
<b>Initial S/W Revision</b>	Prior to A.02.00

### Active Function Values On/Off

Turns on and off the active function display in the Meas Bar, and all of the active function values displayed on the softkeys.

Note that all of the softkeys that have active functions have these numeric values blanked when this function is on. This is a security feature..





Key Path	View/Display, Display, Annotation
Remote Command	:DISPlay:ACTivefunc[:STATE] ON OFF 1 0 :DISPlay:ACTivefunc[:STATE]?
Example	DISP:ACT OFF
Dependencies	Grayed out and forced to OFF when System Display Settings, Annotation is set to Off.
Preset	On This should remain Off through a Preset when System DisplaySettings, Annotation is set to Off
State Saved	Saved in instrument state.
Initial S/W Revision	Prior to A.02.00

## Title

Displays menu keys that enable you to change or clear a title on your display.

Key Path	View/Display, Display
Initial S/W Revision	Prior to A.02.00

## Change Title

Writes a title into the "measurement name" field in the banner, for example, "Swept SA".

Press Change Title to enter a new title through the alpha editor. Press Enter or Return to complete the entry. Press ESC to cancel the entry and preserve your existing title.

The display title will replace the measurement name. It remains for this measurement until you press Change Title again, or you recall a state, or a Preset is performed. A title can also be cleared by pressing Title, Clear Title.

**NOTE**

Notice the inclusion of the <measurement> parameter in the command below. Because each measurement remembers the Display Title, the command must be qualified with the measurement name. For the Swept SA measurement this is not the case; no <measurement> parameter is used when changing the Display Title for the Swept SA measurement.

Key Path	View/Display, Display, Title
Mode	All
Remote Command	:DISPlay:<measurement>:ANNotation:TITLe:DATA <string> :DISPlay:<measurement>:ANNotation:TITLe:DATA?
Example	DISP:ANN:TITL:DATA "This Is My Title" This example is for the Swept SA measurement in the Spectrum Analyzer mode. The SANalyzer <measurement> name is not used. DISP:ACP:ANN:TITL:DATA "This Is My Title" This example is for Measurements other than Swept SA. Both set the title to: This Is My Title
Notes	Pressing this key cancels any active function. When a title is edited the previous title remains intact (it is not cleared) and the cursor goes at the end so that characters can be added or BKSP can be used to go back over previous characters.
Preset	No title (measurement name instead)
State Saved	Saved in instrument state.
Initial S/W Revision	Prior to A.02.00

**Clear Title**

Clears a title from the front-panel display. Once cleared, the title cannot be retrieved. After the title is cleared, the current Measurement Name replaces it in the title bar.

Key Path	View/Display, Display, Title
Example	The following commands clear the title and restore the measurement's original title: DISP:ANN:TITL:DATA "" This example is for the Swept SA measurement in the Spectrum Analyzer mode. The SANalyzer <measurement> name is not used. DISP:ACP:ANN:TITL:DATA "" This example is for ACP; in measurements other than Swept SA the measurement name is required.
Notes	Uses the :DISPlay:<measurement>:ANNotation:TITLe:DATA <string> command with an empty string (in the Swept SA, the <measurement> is omitted).
Preset	Performed on Preset.
Initial S/W Revision	Prior to A.02.00

## Graticule

Pressing Graticule turns the display graticule On or Off. It also turns the graticule y-axis annotation on and off.

Key Path	View/Display, Display
Remote Command	:DISPlay:WINDow[1]:TRACe:GRATicule:GRID[:STATe] OFF ON 0 1 :DISPlay:WINDow[1]:TRACe:GRATicule:GRID[:STATe]?
Example	DISP:WIND:TRAC:GRAT:GRID OFF
Notes	The graticule is the set of horizontal and vertical lines that make up the grid/divisions for the x-axis and y-axis.
Preset	On
State Saved	Saved in instrument state
Initial S/W Revision	Prior to A.02.00

## System Display Settings

These settings are "Mode Global" – they affect all modes and measurements and are reset only by Restore Misc Defaults or Restore System Defaults under System.

Key Path	View/Display, Display
Initial S/W Revision	Prior to A.02.00

## Annotation Local Settings

This is a Mode Global override of the meas local annotation settings. When it is All Off, it forces ScreenAnnotation, Meas Bar, Trace, and Active Function Values settings to be OFF for all measurements in all modes. This provides the security based "annotation off" function of previous analyzers; hence it uses the legacy SCPI command.

When it is All Off, the Screen, Meas Bar, Trace, and Active Function Values keys under the Display, Annotation menu are grayed out and forced to Off. When Local Settings is selected, you are able to set the local annotation settings on a measurement by measurement basis.

Key Path	View/Display, Display, System Display Settings
Remote Command	:DISPlay:WINDow[1]:ANNotation[:ALL] OFF ON 0 1 :DISPlay:WINDow[1]:ANNotation[:ALL]?
Example	:DISP:WIND:ANN OFF
Preset	On (Set by Restore Misc Defaults)
State Saved	Not saved in instrument state.
Backwards Compatibility Notes	The WINDow parameter and optional subopcode is included for backwards compatibility but ignored – all windows are equally affected.
Initial S/W Revision	Prior to A.02.00

## Themes

Accesses a menu of functions that enable you to choose the theme to be used when saving the screen image.

The **Themes** option is the same as the **Themes** option under the **Display** and **Page Setup** dialogs. It allows you to choose between themes to be used when saving the screen image.

<b>Key Path</b>	Save, Screen Image
<b>Remote Command</b>	:MMEMory:STORe:SCReen:THEMe TDColor   TDMonochrome   FCOLor   FMONochrome  :MMEMory:STORe:SCReen:THEMe?
<b>Example</b>	:MMEM:STOR:SCR:THEM TDM
<b>Preset</b>	3D Color; Is not part of Preset, but is reset by Restore Misc Defaults or Restore System Defaults All and survives subsequent running of the modes.
<b>Readback</b>	3D Color   3D Mono   Flat Color   Flat Mono
<b>Backwards Compatibility Notes</b>	In ESA and PSA we offer the choice of "Reverse Bitmap" or "Reverse Metafile" when saving screen images. This is much like the "Flat Color" theme available in X-Series. Also, if you selected Reverse Bitmap AND a black & white screen image, that would be much like "Flat Monochrome". In other words, each of the X-Series themes has a similar screen image type in ESA/PSA. But they are not identical.
<b>Initial S/W Revision</b>	Prior to A.02.00

### 3D Color

Selects a standard color theme with each object filled, shaded and colored as designed.

<b>Key Path</b>	Save, Screen Image, Themes
<b>Example</b>	MMEM:STOR:SCR:THEM TDC
<b>Readback</b>	3D Color
<b>Initial S/W Revision</b>	Prior to A.02.00

### 3D Monochrome

Selects a format that is like 3D color but shades of gray are used instead of colors.

<b>Key Path</b>	Save, Screen Image, Themes
<b>Example</b>	MMEM:STOR:SCR:THEM TDM
<b>Readback</b>	3D Mono
<b>Initial S/W Revision</b>	Prior to A.02.00

### Flat Color

Selects a format that is best when the screen is to be printed on an ink printer.

Key Path	Save, Screen Image, Themes
<b>Example</b>	MMEM:STOR:SCR:THEM FCOL
Readback	Flat Color
Initial S/W Revision	Prior to A.02.00

### Flat Monochrome

Selects a format that is like Flat Color. But only black is used (no colors, not even gray), and no fill.

Key Path	Save, Screen Image, Themes
<b>Example</b>	MMEM:STOR:SCR:THEM FMON
Readback	Flat Mono
Initial S/W Revision	Prior to A.02.00

### Backlight

Accesses the display backlight on/off keys. This setting may interact with settings under the Windows "Power" menu.

When the backlight is off, pressing ESC, TAB, SPACE, ENTER, UP, DOWN, LEFT, RIGHT, DEL, BKSP, CTRL, or ALT turns the backlight on without affecting the application. Pressing any other key will turn backlight on and could potentially perform the action as well.

Key Path	View/Display, Display, System Display Settings
<b>Remote Command</b>	:DISPlay:BACKlight ON OFF :DISPlay:BACKlight?
Preset	ON (Set by Restore Misc Defaults)
Initial S/W Revision	Prior to A.02.00

### Backlight Intensity

An active function used to set the backlight intensity. It goes from 0 to 100 where 100 is full on and 0 is off. This value is independent of the values set under the Backlight on/off key.

Key Path	View/Display, Display, System Display Settings
<b>Remote Command</b>	:DISPlay:BACKlight:INTensity <integer> :DISPlay:BACKlight:INTensity?
<b>Example</b>	DISP:BACK:INT 50

14 Power Stat CCDF Measurement  
View/Display

Preset	100 (Set by Restore Misc Defaults)
Min	0
Max	100
Initial S/W Revision	Prior to A.02.00

## 15 Common Functions

### 15 Forward Link Code Domain Measurement

This measures the Code Domain of 1xEV-DO signal.

This topic contains the following sections:

["Measurement Commands for Forward Link Code Domain Measurement" on page 1732](#)

["Remote Command Results for Forward Link Code Domain Measurement" on page 1733](#)

## Measurement Commands for Forward Link Code Domain Measurement

You must be in the 1xEV-DO mode to use these commands. Use `INSTtument:SElect` to set the mode.

**NOTE**

The general functionality of `CONFigure`, `FETCh`, `MEASure`, and `READ` are described at the beginning of this section. See the `SENSe:CDPower` commands for more measurement related commands.

---

```
:CONFigure:CDPower[:BTS]
:CONFigure:CDPower[:BTS]:NDEFault
:INITiate:CDPower[:BTS]
:FETCh:CDPower[:BTS][n]?
:READ:CDPower[:BTS][n]?
:MEASure:CDPower[:BTS][n]?
```

For more measurement related commands, see the section "[Remote Measurement Functions](#)" on page 2848.



## Remote Command Results for Forward Link Code Domain Measurement

Index n	Result Returned
0	Returns unprocessed I/Q trace data, as a series of trace point values, in volts. The I values are listed first in each pair, using the 0 through even-indexed values. The Q values are the odd-indexed values.
1	<p>Returns the following 21 comma-delimited scalar results, in the following order:            These results are measured from one slot specified by Meas Offset (:CALCulate:CDPower:SWEep:OFFSet)</p> <ol style="list-style-type: none"> <li>Total power is a floating point number (in mW or dBm ) of the total RF in current slot.</li> </ol> <p><b>NOTE</b> The following power results are computed by the CDP measurement. The unit used in the computation, either mW or dBm, is determined by the setting of the CALCulate:CDPower:TYPE command. When the selection is ALOG, the unit used is dBm. When the selection is ALINear, the unit used is mW. When the selection is RLOG, the unit used is dB relative to Total Power (above). . When the selection is RLINear, the unit is none.</p> <ol style="list-style-type: none"> <li>Total active power is a floating point number (in dB, mW , dBm or None depending on the measurement type) of the sum of the active powers (NaN when no active channel is detected).</li> <li>Maximum active power is a floating point number (in dB, mW , dBm or None depending on the measurement type) of the maximum average power of the active code (NaN when no active channel is detected in I/Q Combined=On mode. Always NaN in I/Q Combined=Off mode)</li> <li>Average active power is a floating point number (in dB, mW , dBm or None depending on the measurement type) of the average power of all the active traffic channels (NaN when no active channel is detected in I/Q Combined=On mode. Always NaN in I/Q Combined=Off mode).</li> <li>Maximum inactive power is a floating point number (in dB, or dBm depending on the measurement type) of the maximum average power of the inactive traffic channels. (NaN in I/Q Combined=On mode)</li> <li>Average inactive power is a floating point number (in dB, mW , dBm or None depending on the measurement type) of the average power of the inactive traffic channels. (NaN in I/Q Combined=On mode)</li> <li>Number of active channels</li> <li>I channel average active power is a floating point number (in dB, mW , dBm or None depending on the measurement type) of the average power of the active I channels. (NaN when I/Q Combined=Off mode or when no active channel is detected in I/Q Combined=Off mode).</li> <li>I channel maximum inactive power is a floating point number (in dB, mW , dBm or None depending on the measurement type) of the maximum average power of the inactive I channels. (NaN when I/Q Combined=Off mode)</li> <li>Q channel average active power is a floating point number (in dB, mW , dBm or None depending on the measurement type) of the average power of the active Q channels. (NaN when I/Q Combined=Off mode or when no active channel is detected in I/Q Combined=Off mode).</li> <li>Q channel maximum inactive power is a floating point number (in dB, mW , dBm or None depending on the measurement type) of the maximum average power of the inactive Q channels. (NaN when I/Q Combined=Off mode)</li> <li>Preamble Length is an integer number (in chips).</li> <li>Preamble MAC Index is an integer number of MAC index.</li> <li>Minimum Active Power is a floating point number (in dB, mW , dBm or None depending on the measurement type) of the minimum average power of the active code (NaN when no active channel is detected in I/Q Combined=On mode. Always NaN in I/Q Combined=Off mode)</li> </ol>

Index n	Result Returned
	<p>15. I channel maximum active power is a floating point number (in dB, mW , dBm or None depending on the measurement type) of the maximum average power of the active I channels. (NaN when I/Q Combined=On mode)</p> <p>16. I channel minimum active power is a floating point number (in dB, mW , dBm or None depending on the measurement type) of the minimum average power of the active I channels. (NaN when I/Q Combined=On mode)</p> <p>17. Q channel maximum active power is a floating point number (in dB, mW , dBm or None depending on the measurement type) of the maximum average power of the active Q channels. (NaN when I/Q Combined=On mode)</p> <p>18. Q channel minimum active power is a floating point number (in dB, mW , dBm or None depending on the measurement type) of the minimum average power of the active Q channels. (NaN when I/Q Combined=On mode)</p> <p>19. First Slot Number is a floating number of first slot in Capture Interval.</p> <p>20. Data Modulation Scheme is an integer number to represent the modulation scheme for the specified channel and measurement time period. The meaning of the number is : 0 = BPSK    1 = QPSK    2 = 8PSK3 = 16QAM    4 = 64QAM</p> <p>21. Frame Offset is an integer number to represent the Frame Offset value of selected code channel. Frame Offset analysis is done when MAC channel is selected in Subtype2 mode. When Frame Offset analysis is not carried out or Frame Offset is not identified correctly, -999 is returned.</p>
2	<p>Returns a series of floating point numbers (in dB, mW , dBm or None depending on the measurement type) that represents all the code domain powers.</p> <p>When I/Q Combined=On, total is 16 for Data, 32 for Pilot. For MAC channel, total is 64 with Subtype 0/1 and it is 128 with Subtype 2. If the active channel occupies more than the max spreading factor (16 for Data/Preamble, 32 for Pilot, and 64 with Subtype 0/1 or 128 with Subtype 2/3 for MAC) the power is duplicated.</p> <p>These results are calculated from one slot specified by Meas Offset (:CALCulate:CDPower:SWEp:OFFSet)</p> <p>1st number = 1st code power over the slot 2nd number = 2nd code power over the slot ... Nth number = Nth code power over the slot</p> <p>When I/Q Combined=Off, results are returned alternatively. Total is 16 I/Q pairs for Data, 32 for Pilot, and 64 with Subtype 0/1 or 128 with Subtype 2 for MAC. If the active channel occupies more than the max spreading factor (16 for Data/Preamble, 32 for Pilot, and 64 with Subtype 0/1 or 128 with Subtype 2/3 for MAC) the power is duplicated.</p> <p>1st number = 1st in-phase code power over the slot 2nd number = 1st quad-phase code power over the slot ... (2*N-1)th number = Nth in-phase code power over the slot (2*N)th number = Nth quad-phase code power over a slot N = the number of codes.</p>
3	<p>Returns a series of floating point numbers that represents the code domain symbol rate for each of the code powers returned in n=2.</p> <p>These results are calculated from one slot specified by Meas Offset (:CALCulate:CDPower:SWEp:OFFSet)</p>

Index n	Result Returned
	<p>1st number = 1st code symbol rate over the slot  2nd number = 2nd code symbol rate over the slot  ...  Nth number = Nth code symbol rate over the slot  When I/Q Combined=Off, results are returned alternatively.  1st number = 1st in-phase code symbol rate over the slot  2nd number = 1st quad-phase code symbol rate over the slot  ...  (2×N-1)th number = Nth in-phase code symbol rate over the slot  (2×N)th number = Nth quad-phase code symbol rate over a slot  N = the number of codes.</p>
4	<p>Returns a series of floating point numbers that show either active or inactive status for each of the code powers returned in n=2 and 3. If a code is inactive, the value returned is 0.0, otherwise a value &gt;0.0 is returned.  These results are calculated from one slot specified by Meas Offset (:CALCulate:CDPower:SWEEP:OFFSet)  When I/Q Combined=On, I/Q combined results are returned.  1st number = active or inactive flag of the 1st code  ...  Nth number = active or inactive flag of the Nth code  When I/Q Combined=Off, results are returned alternatively.  1st number = 1st in-phase code active flag  2nd number = 1st Quad Phase code active flag  ...  (2×N-1)th number = Nth in-phase code active flag  (2×N)th number = Nth Quad Phase code active flag  N = the number of codes.</p>
5	<p>Returns series of floating point numbers that alternately represent I and Q pairs of the corrected measured trace specified by Meas Interval (:CALCulate:CDPower:SWEEP:TIME) and Meas Offset (:CALCulate:CDPower:SWEEP:OFFSet). The magnitude of each I and Q pair is normalized to 1.0. The first number is the in-phase (I) sample of symbol 0 decision points and the second is the quadrature-phase (Q) sample of symbol 0 decision point. As in the EVM, there are X points per symbol, so that:  1st number is I of the symbol 0 decision point  2nd number is Q of the symbol 0 decision point  3rd number is I of the symbol 1 decision point  4th number is Q of the symbol 1 decision point  ...  (2×N)+1st number is I of the symbol N decision point  (2×N)+2nd number is Q of the symbol N decision point  where N = the number of symbols.</p>
6	<p>Returns series of floating point numbers (in dBm) that represent the trace data of the chip power vs. time which has length of Capture Interval ([:SENSE]:CDPower:CAPTURE:TIME).</p>

Index n	Result Returned
7	Returns series of floating point numbers (in dBm) that represent the trace data of the slot power vs. time which has length of Capture Interval ([:SENSe]:CDPower:CAPTure:TIME)
8	<p>Returns a series of floating point numbers (in dB depending on the measurement type) that represents all the code domain error. These results are calculated from one slot specified by Meas Offset (:CALCulate:CDPower:SWEep:OFFSet)</p> <p>When I/Q Combined=On, total is 16 for Data, 32 for Pilot. For MAC channel, total is 64 with Subtype 0/1 and it is 128 with Subtype 2. If the active channel occupies more than the max spreading factor (16 for Data, 32 for Pilot, and 64 with Subtype 0/1 or 128 with Subtype 2 for MAC) the power is duplicated.</p> <p>1st number = 1st code domain error over the slot  2nd number = 2nd code domain error over the slot  ...  Nth number = Nth code domain error over the slot</p> <p>When I/Q Combined=Off, results are returned alternatively. Total is 16 I/Q pairs for Data, 32 for Pilot, and 64 with Subtype 0/1 or 128 with Subtype 2/3 for MAC. If the active channel occupies more than the max spreading factor (16 for Data, 32 for Pilot, and 64 with Subtype 0/1 or 128 with Subtype 2/3 for MAC) the power is duplicated.</p> <p>1st number = 1st in-phase code domain error over the slot  2nd number = 1st quad-phase code domain error over the slot  ...  (2*N-1)th number = Nth in-phase code domain error over the slot  (2*N)th number = Nth quad-phase code domain error over the slot  N = the number of codes.</p>
9	<p>Code Channel Demod Bits</p> <p>Returns a series of floating point numbers that represents code channel demod bits over the slots specified by Meas Interval (:CALCulate:CDPower:SWEep:TIME) and Meas Offset(:CALCulate:CDPower:SWEep:OFFSet). The return values are determined depending on Packed Mode selection as mentioned in 2.2.5.5</p> <p>Slot boundary of the floating value series are specified by CDP12, code channel demod bits slot start index, and CDP13, code channel demod bits length.</p>
10	<p>Multiplexed Data Demod Bits</p> <p>Returns a series of floating point numbers that represents multiplexed data demod bits over the slots specified by Meas Interval (:CALCulate:CDPower:SWEep:TIME) and Meas Offset(:CALCulate:CDPower:SWEep:OFFSet). The return values are determined depending on Packed Mode (CALCulate:CDPower:PACKed) selection as mentioned in 2.2.5.5</p> <p>Slot boundary of the floating value series are specified by CDP14, multiplexed data channel demod bits slot start index, and CDP15, multiplexed data channel demod bits length.</p>
11	<p>Detected Modulation Scheme of Data Channel</p> <p>Returns a series of floating point numbers that represents detected modulation schemes of data channel over slots specified by Meas Interval (:CALCulate:CDPower:SWEep:TIME) and Meas Offset (:CALCulate:CDPower:SWEep:OFFSet). Value of Nth element represents modulation scheme of Nth slot.</p> <p>The meaning of the number is :</p> <p>1 = QPSK  2 = 8PSK  3 = 16QAM</p>

Index n	Result Returned
	4 = 64QAM
12	Returns a series of floating point numbers that represents start positions of slots of code channel demod bits CDP9. 1st number = start index of 1st slot of CDP9 trace. 2nd number = start index of 2nd slot of CDP9 trace. Number of values returned via this command equals to Meas Interval.
13	Returns a series of floating point numbers that represents length of slots of code channel demod bits CDP9. 1st number = length of 1st slot of CDP9 trace. 2nd number = length of 2nd slot of CDP9 trace. Number of values returned via this command equals to Meas Interval.
14	Returns a series of floating point numbers that represents start positions of slots of multiplexed data demod bits CDP10. 1st number = start index of 1st slot of CDP10 trace. 2nd number = start index of 2nd slot of CDP10 trace. Number of values returned via this command equals to Meas Interval.
15	Returns a series of floating point numbers that represents length of slots of multiplexed data demod bits CDP10. 1st number = length of 1st slot of CDP10 trace. 2nd number = length of 2nd slot of CDP10 trace. Number of values returned via this command equals to Meas Interval.
16	Returns a series of floating point numbers that represents Preamble length of slots. 1st number = preamble length of (Meas Offset + 1)th slot. 2nd number = preamble length of (Meas Offset + 2)th slot.
17	Returns a series of floating point numbers that represents Preamble MAC Index of slots. 1st number = preamble MAC Index of (Meas Offset + 1)th slot. 2nd number = preamble MAC Index of (Meas Offset + 2)th slot.
18	Returns a series of floating point numbers that represents channel type of slots. 1st number = channel type of 1st slot. 2nd number = channel type of 2nd slot. If the selected channel is inactive or type of the selected channel is not being identified correctly, 0.0 is returned. Channel types are defined as below. MAC : Subtype 0/1 1 = RA Channel, 2 = RPC or DRCLock Channel Subtype 2/3 1 = RA Channel 3 = RPC Channel 4 = DRCLock Channel 5 = P-ARQ 6 = H-ARQ

Index n	Result Returned
	7 = L-ARQ
	8 = H or L - ARQ
	DATA :
	Subtype 0/1
	2 = 38.4 kbps Control Channel
	3 = 76.8 kbps Control Channel
	Subtype 2 /3
	1 = 19.2 kbps Control Channel
	2 = 38.4 kbps Control Channel
	3 = 76.8 kbps Control Channel
	4 = Multi-User Packet Channel
	5 = Broadcast
	6 = Forward Traffic Channel

This key invokes the Forward Link Code Domain Power measurement.

See "[More information](#)" on page 1739.

Key Path	Meas
Mode	CDMA1XEV
Initial S/W Revision	Prior to A.02.00

## More information

This measurement consists of five views. They are

- Power Graph and Metrics
- CDP Graph & CDE Graph
- Code Domain (Quad View)
- Demod Bits
- MUX Data Demod Bits

## Amplitude (AMPTD) Y Scale

Access a menu of functions that enable you to set the desired vertical scale parameters for the current measurement. The Metrics, I/Q Symbol Polar Vector, and Demod Bits windows do not support the functions in this menu. A blank menu will be displayed

Key Path	Front-panel key
Initial S/W Revision	Prior to A.02.00

### Attenuation

This menu controls the attenuator functions and interactions between the attenuation system components.

There are two attenuator configurations in the X-Series. One is a dual attenuator configuration consisting of a mechanical attenuator and an optional electronic attenuator. The other configuration uses a single attenuator with combined mechanical and electronic sections that controls all the attenuation functions. Different models in the X-Series come with different configurations.

See ["Dual Attenuator Configurations:" on page 1740](#)

See ["Single Attenuator Configuration:" on page 1741](#)

Most Attenuation settings are the same for all measurements – they do not change as you change measurements. Settings like these are called “Meas Global” and are unaffected by Meas Preset.

Key Path	AMPTD Y Scale
Scope	Meas Global
Dependencies	In measurements that support the I/Q inputs, this key is unavailable when I/Q is the selected input, and is replaced by the Range key in that case.
Readback Line	Contains a summary in [ ] brackets of the current total attenuation. See the descriptions of the , " <a href="#">(Mech) Atten "</a> on page 2783, and " <a href="#">Enable Elec Atten</a> " on page 2785 keys for more detail on the contributors to the total attenuation.  Note that when "Pre-Adjust for Min Clip" is on, this value can change at the start of every measurement.
Initial S/W Revision	Prior to A.02.00
Modified at S/W Revision	A.03.00

### Dual Attenuator Configurations:

Configuration 1: Mechanical attenuator + optional electronic attenuator



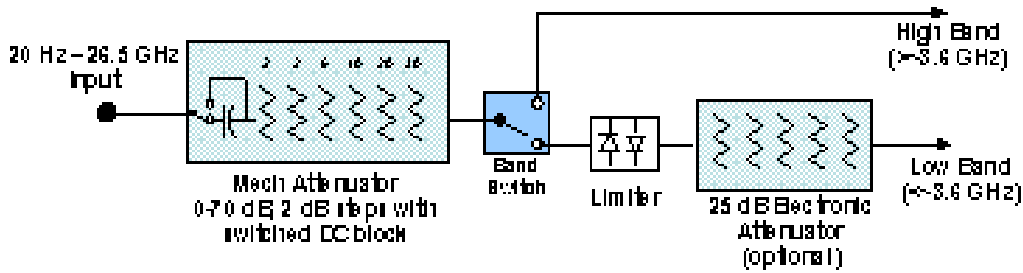

Configuration 2: Mechanical attenuator, no optional electronic attenuator

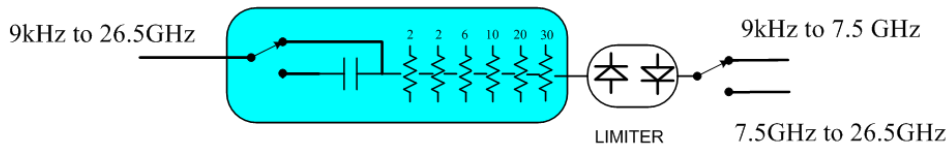

(note that Configuration 2 is not strictly speaking a dual-section attenuator, since there is no electronic section available. However, it behaves exactly like Configuration 1 without the Electronic Attenuator option EA3, therefore for the sake of this document it is grouped into the “Dual Attenuator” configuration)

### Single Attenuator Configuration:

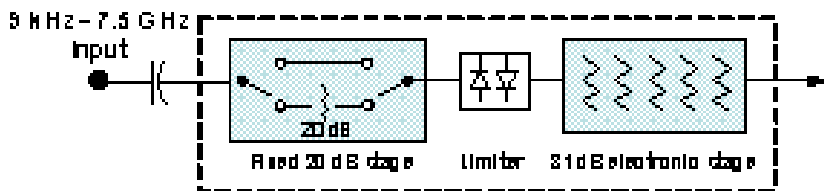

You can tell which attenuator configuration you have by pressing the Attenuation key, which (in most Modes) opens the Attenuation menu. If the first key in the Attenuation menu says Mech Atten you have the dual attenuator configuration. If the first key says Atten you have the single attenuator configuration.

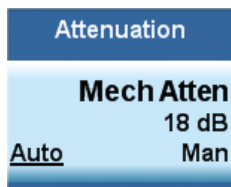

Dual Attenuator

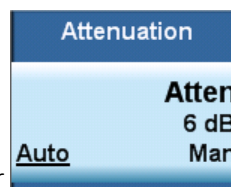

Single Attenuator

In the single attenuator configuration, you control the attenuation with a single control, as the fixed stage has only two states. In the dual attenuator configuration, both stages have significant range so you are given separate control of the mechanical and electronic attenuator stages.

When you have the dual attenuator configuration, you may still have only a single attenuator, because unless option EA3 (the Electronic Attenuator option) is available, and you purchase it, you will have only the mechanical attenuator.

## (Mech) Atten

This key is labeled Mech Atten in dual attenuator models and Atten in single attenuator models. In the dual attenuator configuration, this key only affects the mechanical attenuator.

This key lets you modify the attenuation applied to the RF input signal path. This value is normally auto coupled to the Ref Level, the Internal Preamp Gain, any External Gain that is entered, and the Max Mixer Level, as described in the table below.

See "[Attenuator Configurations and Auto/Man](#)" on page 1743

Key Path	AMPTD Y Scale, Attenuation
Remote Command	<pre>[ :SENSE ] :POWER [ :RF ] :ATTenuation &lt;rel_ampl&gt; [ :SENSE ] :POWER [ :RF ] :ATTenuation? [ :SENSE ] :POWER [ :RF ] :ATTenuation:AUTO OFF ON 0 1 [ :SENSE ] :POWER [ :RF ] :ATTenuation:AUTO?</pre>
Example	<p>POW:ATT 20</p> <p>Dual attenuator configuration: sets the mechanical attenuator to 20 dB</p> <p>Single attenuator mode: sets the main attenuation to 20 dB (see below for definition of “main” attenuation).</p> <p>If the attenuator was in Auto, it sets it to Manual.</p>
Dependencies	<p>Some measurements do not support the Auto setting of (Mech) Atten. In these measurements, the Auto/Man selection is not available, and the Auto/Man line on the key disappears.</p> <p>In dual attenuator configurations, when the electronic attenuator is enabled, the mechanical attenuator has no auto setting and the Auto/Man line on the key disappears. The state of Auto/Man is remembered and restored when the electronic attenuator is once again disabled. This is described in more detail in the "<a href="#">Enable Elec Atten</a>" on page 2785 key description.</p> <p>See "<a href="#">Attenuator Configurations and Auto/Man</a>" on page 1743 for more information on the Auto/Man functionality of Attenuation.</p>
Couplings	<p>When (Mech) Atten is in Auto, it uses the following algorithm to determine a value:</p> <p>If the USB Preamp is connected to USB, use 0 dB.</p> <p>Otherwise, <math>Atten = ReferenceLevel + PreAmpGain + ExternalGain - RefLevelOffset - MaxMixerLevel + IF\ Gain</math>.</p> <p>Limit this value to be between 6 dB and the Max value. No value below 6 dB can ever be chosen by Auto.</p> <p>The resulting value is rounded up to the largest value possible given the attenuation step setting. That is, 50.01 dB would change to 60 dB (for a 10 dB attenuation step).</p> <p>The “IF Gain” term in the equation above is either 0 dB or +10 dB, depending on the settings of FFT IF Gain, Swept IF Gain, max Ref Level and the Auto/Man setting of Mech Atten.</p> <p>In External Mixing and BBIQ, where the Attenuator is not in the signal path, the Attenuator setting changes as described above when (Mech) Atten is in Auto, but no changes are made to the actual attenuator hardware setting until the input is changed back to the RF Input.</p>
Preset	<p>The preset for Mech Attenuation is “Auto.”</p> <p>The Auto value of attenuation is:</p> <p>CXA, EXA, MXA and PXA: 10 dB</p>

State Saved	Saved in instrument state
Min	0 dB The attenuation set by this key cannot be decreased below 6 dB with the knob or step keys. To get to a value below 6 dB it has to be directly entered from the keypad or via SCPI. This protects from adjusting the attenuation to a dangerously small value which can put the instrument at risk of damage to input circuitry. However, if the current mechanical attenuation is below 6 dB it can be increased with the knob and step keys, but not decreased.
Max	CXA N9000A-503/507: 50 dB CXA N9000A-513/526: 70dB EXA: 60 dB MXA and PXA: 70 dB In the single attenuator configuration, the total of ATT and EATT cannot exceed 50 dB, so if the EATT is set to 24 dB first, the main attenuation cannot be greater than 26 dB and will be reduced accordingly; if the main attenuator is set to 40 dB first, EATT cannot be greater than 10 dB.
Initial S/W Revision	Prior to A.02.00
Modified at S/W Revision	A.03.00

### Attenuator Configurations and Auto/Man

As described in the Attenuation key description, there are two distinct attenuator configurations available in the X-Series, the single attenuator and dual attenuator configurations. In dual attenuator configurations, we have the mechanical attenuation and the electronic attenuation, and the current total attenuation is the sum of the electronic + mechanical attenuation. In single attenuator configurations, we refer to the attenuation set using the (Mech) Atten key (or POW:ATT SCPI) as the “main” attenuation; and the attenuation that is set by the SCPI command POW:EATT as the “soft” attenuation (the POW:EATT command is honored even in the single attenuator configuration, for compatibility purposes). Then the current total attenuation is the sum of the main + soft attenuation. See the Elec Atten key description for more on “soft” attenuation.

In the dual attenuator configuration, when the electronic attenuator is enabled, there is no Auto/Man functionality for the mechanical attenuator, and the third line of the key label (the Auto/Man line) disappears:

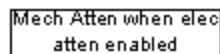
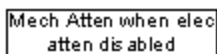
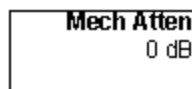
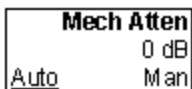

usdB

### Enable Elec Atten

Enables the Electronic Attenuator.

The electronic attenuator offers finer steps than the mechanical attenuator, has no acoustical noise, is faster, and is less subject to wear. These advantages primarily aid in remote operation and are negligible

for front panel use. See ["Using the Electronic Attenuator: Pros and Cons" on page 1745](#) for a detailed discussion of the pros and cons of using the electronic attenuator.

For the single attenuator configuration, for SCPI backwards compatibility, the “soft” attenuation feature replaces the dual attenuator configuration’s electronic attenuator. All the same couplings and limitations apply. See ["Attenuator Configurations and Auto/Man" on page 2785](#)

See ["More Information" on page 1744](#)

<b>Key Path</b>	AMPTD Y Scale, Attenuation
<b>Remote Command</b>	[ :SENSe ] :POWer [ :RF ] :EATTenuation:STATe OFF ON 0 1 [ :SENSe ] :POWer [ :RF ] :EATTenuation:STATe?
<b>Example</b>	POW:EATT:STAT ON
<b>Dependencies</b>	<p>This key only appears in Dual Attenuator models with an Electronic Attenuator installed. It does not appear in models with the Single Attenuator configuration, as in the single attenuator configuration there is no “electronic attenuator” there is only a single integrated attenuator (which has both a mechanical and electronic stage). However, in the single attenuator configuration, EATT SCPI commands are accepted for compatibility with other X-series instruments and set a “soft” attenuation as described in <a href="#">"Attenuator Configurations and Auto/Man" on page 2785</a>.</p> <p>The electronic attenuator (and the “soft” attenuation function provided in single attenuator configurations) is unavailable above 3.6 GHz. Therefore, if the Stop Frequency of the analyzer is &gt; 3.6 GHz then the Enable Elec Atten key will be OFF and grayed out.</p> <p>If the Internal Preamp is on, meaning it is set to Low Band or Full, the electronic attenuator (and the “soft” attenuation function provided in single attenuator configurations) is unavailable. In this case the Enable Elec Atten key will be OFF and grayed out.</p> <p>If either of the above is true, if the SCPI command is sent, an error indicating that the electronic attenuator is unavailable will be sent.</p> <p>If the electronic/soft Attenuator is enabled, then the Stop Freq of the analyzer is limited to 3.6 GHz and the Internal Preamp is unavailable.</p> <p>The SCPI-only “soft” electronic attenuation for the single-attenuator configuration is not available in all measurements; in particular, it is not available in the Swept SA measurement.</p>
<b>Couplings</b>	Enabling and disabling the Electronic Attenuator affects the setting of the Mechanical Attenuator (in dual attenuator configurations). This is described in more detail below this table.
<b>Preset</b>	OFF for Swept SA measurement; ON for all other measurements that support the electronic attenuator
<b>State Saved</b>	Saved in instrument state
<b>Initial S/W Revision</b>	Prior to A.02.00
<b>Modified at S/W Revision</b>	A.03.00

## More Information

### Mechanical Attenuator Transition Rules

When the Electronic Attenuator is enabled, the Mechanical Attenuator transitions to a state that has no Auto function. Below are the rules for transitioning the Mechanical Attenuator. NOTE that the information

below ONLY applies to the dual attenuator configurations, and ONLY when the Electronic Attenuator is installed:

**When the Electronic Attenuation is enabled from a disabled state:**

- The Mechanical Attenuator is initialized to 10 dB (this is its optimal performance setting). You can then set it as desired with SCPI, numeric keypad, step keys, or knob, and it behaves as it normally would in manual mode
- The Auto/Man state of (Mech) Atten is saved
- The Auto/Man line on the (Mech) Atten key disappears and the auto rules are disabled
- The Electronic Attenuator is set to 10 dB less than the previous value of the Mechanical Attenuator, within the limitation that it must stay within the range of 0 to 24 dB of attenuation.

**Examples in the dual attenuator configuration:**

- Mech Atten at 20 dB. Elec Atten enabled, Mech Atten set to 10 dB, and Elec Atten set to 10 dB. New total attenuation equals the value before Elec Atten enabled.
- Mech Atten at 0 dB. Elec Atten enabled, Mech Atten set to 10 dB, and Elec Atten set to 0 dB. New total attenuation does not equal the value before Elec Atten enabled.
- Mech Atten at 40 dB. Elec Atten enabled, Mech Atten set to 10 dB, and Elec Atten set to 24 dB. New total attenuation does not equal the value before Elec Atten enabled.

**When the Electronic Attenuation is disabled from an enabled state:**

- The Elec Atten key is grayed out
- The Auto/Man state of (Mech) Atten is restored
- If now in Auto, (Mech) Atten recouples
- If now in Man, (Mech) Atten is set to the value of total attenuation that existed before the Elec Atten was disabled. The resulting value is rounded up to the smallest value possible given the (Mech) Atten Step setting - (That is, 57 dB changes to 58 dB when (Mech) Atten Step is 2 dB.)

**Using the Electronic Attenuator: Pros and Cons**

The electronic attenuator offers finer steps than the mechanical attenuator, has no acoustical noise, is faster, and is less subject to wear.

The “finer steps” advantage of the electronic attenuator is beneficial in optimizing the alignment of the analyzer dynamic range to the signal power in the front panel as well as remote use. Thus, you can achieve improved relative signal measurement accuracy. Compared to a mechanical attenuator with 2 dB steps, the 1 dB resolution of the electronic attenuator only gives better resolution when the odd-decibel steps are used. Those odd-decibel steps are less accurately calibrated than the even-decibel steps, so one tradeoff for this superior relative accuracy is reduced absolute amplitude accuracy.

Another disadvantage of the electronic attenuator is that the spectrum analyzer loses its “Auto” setting, making operation less convenient.

Also, the relationship between the dynamic range specifications (TOI, SHI, compression and noise) and instrument performance are less well-known with the electrical attenuator. With the mechanical

attenuator, TOI, SHI and compression threshold levels increase dB-for-dB with increasing attenuation, and the noise floor does as well. With the electronic attenuator, there is an excess attenuation of about 1 to 3 dB between 0 and 3.6 GHz, making the effective TOI, SHI, and so forth, less well known. Excess attenuation is the actual attenuation relative to stated attenuation. Excess attenuation is accounted for in the analyzer calibration

## Elec Atten

Controls the Electronic Attenuator in dual attenuator configurations. This key does not appear in single attenuator configurations, as the control of both the mechanical and electronic stages of the single attenuator is integrated into the single Atten key.

Key Path	AMPTD Y Scale, Attenuation
Remote Command	[ :SENSe ] :POWer [ :RF ] :EATTenuation <rel_ampl> [ :SENSe ] :POWer [ :RF ] :EATTenuation?
Notes	Electronic Attenuation's specification is defined only when Mechanical Attenuation is 6 dB.
Dependencies	This key only appears in Dual Attenuator models with an Electronic Attenuator installed. It does not appear in models with the Single Attenuator configuration, as in the single attenuator configuration there is no "electronic attenuator" there is only a single integrated attenuator (which has both a mechanical and electronic stage). However, in the single attenuator configuration, EATT SCPI commands are accepted for compatibility with other X-series instruments and set a "soft" attenuation as described in <a href="#">"Attenuator Configurations and Auto/Man" on page 2785</a> . The "soft" attenuation is treated as an addition to the "main" attenuation value set by the Atten softkey or the POW:ATT SCPI command and affects the total attenuation displayed on the Attenuation key and the Meas Bar.  When Enable Elec Atten is off or grayed out, the Elec Atten key is grayed out.
Preset	0 dB
State Saved	Saved in instrument state
Min	0 dB
Max	Dual attenuator configuration: 24 dB Single attenuator configuration: the total of ATT and EATT cannot exceed 50 dB, so if the EATT is set to 24 dB first, the main attenuation cannot be greater than 26 dB and will be reduced accordingly; if the main attenuator is set to 40 dB first, EATT cannot be greater than 10 dB
Initial S/W Revision	Prior to A.02.00
Modified at S/W Revision	A.03.00

## Adjust Atten for Min Clip

Sets the combination of mechanical and electronic attenuation and gain based on the current measured signal level so that clipping will be at a minimum.

This is an "immediate action" function, that is, it executes once, when the key is pressed.

This key is grayed out in measurements that do not support this functionality. The spectrum analyzer measurement, Swept SA, does not support this functionality.

Key Path	AMPTD Y Scale, Attenuation
Remote Command	<code>[ :SENSe ] :POWer [ :RF ] :RANGe:OPTimize IMMEDIATE</code>
Initial S/W Revision	Prior to A.02.00
Modified at S/W Revision	A.03.00

## Pre-Adjust for Min Clip

If this function is on, it does the adjustment described under "[Adjust Atten for Min Clip](#)" on page 2788 each time a measurement restarts. Therefore, in Continuous measurement mode, it only executes before the first measurement.

In dual attenuator models, you can set Elec+Mech Atten, in which case both attenuators participate in the autoranging, or Elec Atten Only, in which case the mechanical attenuator does not participate in the autoranging. This latter case results in less wear on the mechanical attenuator and is usually faster.

This key is grayed out in measurements that do not support this functionality. The spectrum analyzer measurement, Swept SA, does not support this functionality.

Key Path	AMPTD Y Scale, Attenuation
Remote Command	<code>[ :SENSe ] :POWer [ :RF ] :RANGe:OPTimize:ATTenuation OFF   ELECTrical   COMBined</code>  <code>[ :SENSe ] :POWer [ :RF ] :RANGe:OPTimize:ATTenuation?</code>
Notes	The SCPI parameter ELECTrical sets this function to On in single attenuator models. The SCPI parameter COMBined is mapped to ELECTrical in single attenuator models; if you send COMBined, it sets the function to On and returns ELEC to a query.
Dependencies	This key only appears in Dual Attenuator models with an Electronic Attenuator installed. In instruments with Dual Attenuator model, when Enable Elec Atten is off or grayed out, the Pre-Adjust for Min Clip key is grayed out.
Preset	OFF for Swept SA measurement; ON for all other measurements that support Pre-Adjust for Min Clip
State Saved	Saved in instrument state
Range	Dual attenuator models: Off   Elec Atten Only   Mech + Elec Atten Single attenuator models: Off   On
Initial S/W Revision	Prior to A.02.00
Modified at S/W Revision	A.03.00

Remote Command	<code>[ :SENSe ] :POWer [ :RF ] :RANGe:AUTO ON OFF 1 0</code>  <code>[ :SENSe ] :POWer [ :RF ] :RANGe:AUTO?</code>
Notes	ON aliases to "Elec Atten Only" (:POW:RANG:OPT:ATT ELEC)

---

	OFF aliases to "Off" (:POW:RANG:OPT:ATT OFF) The query :POW:RANG:AUTO? returns true if :POW:RANG:OPT:ATT is not "Off"
Initial S/W Revision	Prior to A.02.00

---

## Off

Turns Pre-Adjust for Min Clip off. This is the default setting.

This key is grayed out in measurements that do not support this functionality. The spectrum analyzer measurement, Swept SA, does not support this functionality.

---

Key Path	AMPTD Y Scale, Attenuation, Pre-Adjust for Min Clip
Example	:POW:RANGe:OPT:ATT OFF
Initial S/W Revision	Prior to A.02.00

---

## Elec Atten Only

Selects only the electric attenuator to participate in auto ranging. This offers less wear on the mechanical attenuator and is usually faster.

This key is grayed out in measurements that do not support this functionality. The spectrum analyzer measurement, Swept SA, does not support this functionality.

---

Key Path	AMPTD Y Scale, Attenuation, Pre-Adjust for Min Clip
Example	:POW:RANGe:OPT:ATT ELEC
Initial S/W Revision	Prior to A.02.00

---

## Mech + Elec Atten

In dual attenuator models, this selects both attenuators participate in the autoranging.

This key is grayed out in measurements that do not support this functionality. The spectrum analyzer measurement, Swept SA, does not support this functionality.

---

Key Path	AMPTD Y Scale, Attenuation, Pre-Adjust for Min Clip
Example	:POW:RANGe:OPT:ATT COMB
Initial S/W Revision	Prior to A.02.00

---

## (Mech) Atten Step

This controls the step size used when making adjustments to the input attenuation.



This key is labeled Mech Atten Step in dual attenuator models and Atten Step in single attenuator models. In the dual attenuator configuration, this key only affects the step size of the mechanical attenuator.

Key Path	AMPTD Y Scale, Attenuation
Remote Command	<code>[ :SENSe ] :POWer [ :RF ] :ATTenuation :STEP [ :INCRement ] 10 dB   2 dB</code> <code>[ :SENSe ] :POWer [ :RF ] :ATTenuation :STEP [ :INCRement ] ?</code>
Example	POW:ATT:STEP 2
Notes	Note this feature works like a 1-N choice from the front panel, but it takes a specific value (in dB) when used remotely. The only valid values are 2 and 10.
Dependencies	Blanked in CXA and EXA if option FSA (2 dB steps) is not present. If blanked, attempts to set it via SCPI will yield an error.
Couplings	When the attenuation step size changes, the current mechanical attenuation value is adjusted (if necessary) to be quantized to the new step size. That is, if step is set to 10 dB, mech atten is increased if necessary so it is a multiple of 10 dB
Preset	PXA and MXA: 2 dB EXA and CXA: 10 dB (2 dB with option FSA)
State Saved	Saved in instrument state
Initial S/W Revision	Prior to A.02.00
Modified at S/W Revision	A.03.00

## Presel Center

When this key is pressed, the centering of the preselector filter is adjusted to optimize the amplitude accuracy at the frequency of the selected marker. If the selected marker is not on when Presel Center is pressed, the analyzer will turn on the selected marker, perform a peak search, and then perform centering on the marker's center frequency. If the selected marker is already on and between the start and stop frequencies of the analyzer, the analyzer performs the preselector calibration on that marker's frequency. If the selected marker is already on, but outside the frequency range between Start Freq and Stop Freq, the analyzer will first perform a peak search, and then perform centering on the marker's center frequency.

The value displayed on the Presel Adjust key will change to reflect the new preselector tuning (see Presel Adjust).

A number of considerations should be observed to ensure proper operation. See ["Proper Preselector Operation" on page 1750](#).

Key Path	AMPTD Y Scale
Remote Command	<code>[ :SENSe ] :POWer [ :RF ] :PCENter</code>
Example	POW:PCEN
Notes	Note that the rules outlined above under the key description apply for the remote command as well as the key. The result of the command is dependent on marker position, and so forth. Any message shown by the key press is also shown in response to the remote command.
Dependencies	• Grayed out if the microwave preselector is off. )

---

	<ul style="list-style-type: none"><li>• If the selected marker's frequency is below Band 1, advisory message 0.5001 is generated and no action is taken.</li><li>• Grayed out if entirely in Band 0.</li><li>• Blank in models that do not include a preselector, such as option 503. If the SCPI is sent in these instruments, it is accepted without error, and the query always returns 0.</li><li>• Grayed out in the Spectrogram View.</li></ul>
Couplings	<p>The active marker position determines where the centering will be attempted.</p> <p>If the analyzer is in a measurement such as averaging when centering is initiated, the act of centering the preselector will restart averaging but the first average trace will not be taken until the centering is completed.</p>
Status Bits/OPC dependencies	<p>When centering the preselector, *OPC will not return true until the process is complete and a subsequent measurement has completed, nor will results be returned to a READ or MEASure command.</p> <p>The Measuring bit should remain set while this command is operating and should not go false until the subsequent sweep/measurement has completed.</p>
Initial S/W Revision	Prior to A.02.00
Modified at S/W Revision	A.03.00

---

## Proper Preselector Operation

A number of considerations should be observed to ensure proper operation:

1. If the selected marker is off, the analyzer will turn on a marker, perform a peak search, and adjust the preselector using the selected marker's frequency. It uses the "highest peak" peak search method unqualified by threshold or excursion, so that there is no chance of a 'no peak found' error. It continues with that peak, even if it is the peak of just noise. Therefore, for this operation to work properly, there should be a signal on screen in a preselected range for the peak search to find.
2. If the selected marker is already on, the analyzer will attempt the centering at that marker's frequency. There is no preselector for signals below about 3.6 GHz, therefore if the marker is on a signal below 3.6 GHz, no centering will be attempted and an advisory message generated
3. In some models, the preselector can be bypassed. If it is bypassed, no centering will be attempted in that range and a message will be generated.

## Preselector Adjust

Allows you to manually adjust the preselector filter frequency to optimize its response to the signal of interest. This function is only available when **"Presel Center" on page 2791** is available.

For general purpose signal analysis, using Presel Center is recommended. Centering the filter minimizes the impact of long-term preselector drift. Presel Adjust can be used instead to manually optimize the preselector. One application of manual optimization would be to peak the preselector response, which both optimizes the signal-to-noise ratio and minimizes amplitude variations due to small (short-term) preselector drifting.

Key Path	AMPTD Y Scale
Scope	Meas Global
<b>Remote Command</b>	<code>[ :SENSe ] :POWer [ :RF ] :PADJust &lt;freq&gt;</code> <code>[ :SENSe ] :POWer [ :RF ] :PADJust?</code>
<b>Example</b>	POW:PADJ 100KHz POW:PADJ?
Notes	The value on the key reads out to 0.1 MHz resolution.
Dependencies	<ul style="list-style-type: none"> <li>• Grayed out if microwave preselector is off. )</li> <li>• Grayed out if entirely in Band 0.</li> <li>• Blank in models that do not include a preselector, such as option 503. If the SCPI is sent in these instruments, it is accepted without error, and the query always returns 0.</li> <li>• Grayed out in the Spectrogram View.</li> </ul>
Preset	0 MHz
State Saved	The Presel Adjust value set by Presel Center, or by manually adjusting Presel Adjust, is not saved in instrument state, and does not survive a Preset or power cycle.
Min	-500 MHz
Max	500 MHz
Default Unit	Hz
<b>Backwards Compatibility SCPI</b>	<code>[ :SENSe ] :POWer [ :RF ] :MW :PADJust</code> <code>[ :SENSe ] :POWer [ :RF ] :MMW :PADJust</code>  PSA had multiple preselectors, but the X-Series has only one. These commands simply alias to <code>[ :SENSe ] :POWer [ :RF ] :PADJust</code>
Initial S/W Revision	Prior to A.02.00
Modified at S/W Revision	A.03.00
<b>Remote Command</b>	<code>[ :SENSe ] :POWer [ :RF ] :PADJust :PRESelector MWAVE   MMWave   EXTernal</code> <code>[ :SENSe ] :POWer [ :RF ] :PADJust :PRESelector?</code>
Notes	PSA had multiple preselectors, and you could select which preselector to adjust. Since the X-Series has only one mm/uW preselector, the preselector selection softkey is no longer available. However, to provide backward compatibility, we accept the legacy remote commands.  The command form has no effect, the query always returns MWAVE
Initial S/W Revision	Prior to A.02.00

## μW Path Control

The μW Path Control functions include the μW Preselector Bypass (Option MPB) and Low Noise Path (Option LNP) controls in the High Band path circuits.

When the μW Preselector is bypassed, the user has better flatness, but will be subject to spurs from out of band interfering signals. When the Low Noise Path is enabled, the analyzer automatically switches around certain circuitry in the high frequency bands which can contribute to noise, when it is appropriate based on other analyzer settings.

For most applications, the preset state is Standard Path, which gives the best remote-control throughput, minimizes acoustic noise from switching and minimizes the risk of wear out in the hardware switches. For applications that utilize the wideband IF paths, the preset state is the μW Preselector Bypass path, if option MPB is present. This is because, when using a wideband IF such as the 140 MHz IF, the μW Preselector's bandwidth can be narrower than the available IF bandwidth, causing degraded amplitude flatness and phase linearity, so it is desirable to bypass the preselector in the default case.

Users may choose Low Noise Path Enable. It gives a lower noise floor, especially in the 21–26.5 GHz region, though without improving many measures of dynamic range, and without giving the best possible noise floor. The preamp, if purchased and used, gives better noise floor than does the Low Noise Path, however its compression threshold and third-order intercept are much poorer than that of the non-preamp Low Noise Path. There are some applications, typically for signals around –30 dBm, for which the third-order dynamic range of the standard path is good enough, but the noise floor is not low enough even with 0 dB input attenuation. When the third-order dynamic range of the preamp path is too little and the noise floor of the standard path is too high, the Low Noise Path can provide the best dynamic range.

<b>Key Path</b>	AMPTD Y Scale
<b>Mode</b>	SA, BASIC, PNOISE, VSA , LTE, LTETDD
<b>Scope</b>	Meas Global
<b>Remote Command</b>	[ :SENSe ] :POWer [ :RF ] :MW:PATH STD LNPath MPBypass FULL [ :SENSe ] :POWer [ :RF ] :MW:PATH?
<b>Example</b>	:POW:MW:PATH LNP Enables the Low Noise path
<b>Notes</b>	If a Presel Center is performed, the analyzer will momentarily switch to the Standard Path, regardless of the setting of μW Path Control  The DC Block will always be switched in when the low noise path is switched in, to protect succeeding circuitry from DC. Note that this does not mean “when the low noise path is enabled” but when, based on the Low Noise Path rules, the path is actually switched in. This can happen when the selection is Low Noise Path Enable . In the case where the DC Block is switched in the analyzer is now AC coupled. However, if the user has selected DC coupling, the UI will still behave as though it were DC coupled, including all annunciation, warnings, status bits, and responses to SCPI queries. This is because, based on other settings, the analyzer could switch out the low noise path at any time and hence go back to being DC coupled.  Alignment switching ignores the settings in this menu, and restores them when finished.
<b>Dependencies</b>	Unavailable in BBIQ and External Mixing
<b>Preset</b>	All modes other than IQ Analyzer mode and VXA: STD IQ Analyzer, VXA and WLAN mode: MPB option present and licensed: MPB

	MPB option not present and licensed: STD
State Saved	Save in instrument state
Readback	Value selected in the submenu
Initial S/W Revision	A.04.00
Modified at S/W Revision	A.10.00

## Standard Path

This path gives the best remote-control throughput, minimizes acoustic noise from switching and minimizes the risk of wear in the hardware switches, particularly in remote test scenarios where both low band and high band setups will follow in rapid succession.

In this path, the bypass of the low band/high band switch and microwave preamp is never activated, which can cause some noise degradation but preserves the life of the bypass switch.

Key Path	AMPTD Y Scale, $\mu$ W Path Control
<b>Example</b>	:POW:MW:PATH STD
Readback Text	Standard Path
Initial S/W Revision	A.04.00

## Low Noise Path Enable

You may choose Low Noise Path Enable, which gives a lower noise floor under some circumstances, particularly when operating in the 21–26.5 GHz region. With the Low Noise Path enabled, the low band/high band switch and microwave preamp are bypassed whenever all of the following are true:

- The analyzer is not in the Low Band, meaning:
- the start frequency is above 3.5 GHz and
- the stop frequency is above 3.6 GHz.
- the internal preamp is not installed or (if installed) is set to Off or Low Band

Note that this means that, when any part of a sweep is done in Low Band, the Low Noise Path is not used, whether or not the Low Noise Path Enable is selected in the user interface. Also, if the preamp is turned on, the Low Noise Path is not used, whether or not the Low Noise Path Enable is selected in the user interface. The only time the Low Noise Path is used is when Low Noise Path Enable is selected, the sweep is completely in High Band (> 3.6 GHz) and no preamp is in use.

See "[More Information](#)" on page 1754

Key Path	AMPTD Y Scale, $\mu$ W Path Control
Measurement	Swept SA
<b>Example</b>	:POW:MW:PATH LNP

Notes	<p>For measurements that use IQ acquisition, the low noise path is used when the Center Frequency is in High Band (&gt; 3.6 GHz) and no preamp is in use.</p> <p>In other words, the rules above are modified to use only the center frequency to qualify which path to switch in.</p> <p>This is not the case for FFT's in the Swept SA measurement; they use the same rules as swept measurements.</p>
Dependencies	<p>Key is blanked if current mode does not support it.</p> <p>Key is grayed out if mode supports it but current measurement does not support it.</p> <p>Unless Option LNP is present and licensed, key is blank and if SCPI command sent, error -241, "Hardware missing; Option not installed" is generated.</p>
Readback Text	Low Noise Path Enable
Initial S/W Revision	A.04.00

## More Information

The user should understand that the Low Noise Path, while giving improved DANL, has the disadvantage of decreased TOI performance and decreased gain compression performance relative to the standard path.

The user should also understand that the bypass switch is a mechanical switch and has finite life, so if the Low Noise Path is enabled, it is possible to cause frequent cycling of this switch by frequently changing analyzer settings such that the above conditions hold true only some of the time. A user making tests of this nature should consider opting for the Standard Path, which will never throw the bypass switch, at the expense of some degraded noise performance.

The low noise path is useful for situations where the signal level is so low that the analyzer performance is dominated by noise even with 0 dB attenuation, but still high enough that the preamp option would have excessive third-order intermodulation or compression. The preamp, if purchased and used, gives better noise floor than does the "Low Noise Path." However, its compression threshold and third-order intercept are much poorer than that of the non-preamp path. There are some applications, typically for signals around -30 dBm, for which the third-order dynamic range of the standard path is good enough, but the noise floor is not low enough even with 0 dB input attenuation. When the third-order dynamic range of the preamp path is too little and the noise floor of the standard path is too high, the Low Noise Path can provide the best dynamic range

The graph below illustrates the concept. It shows, in red, the performance of an analyzer at different attenuation settings, both with the preamp on and off, in a measurement that is affected by both analyzer noise and analyzer TOI. The green shows the best available dynamic range, offset by 0.5 dB for clarity. The blue shows how the best available dynamic range improves for moderate signal levels with the low noise path switched in. In this illustration, the preamp improves the noise floor by 15 dB while degrading the third-order intercept by 30 dB, and the low noise path reduces loss by 8 dB. The attenuator step size is 2 dB.

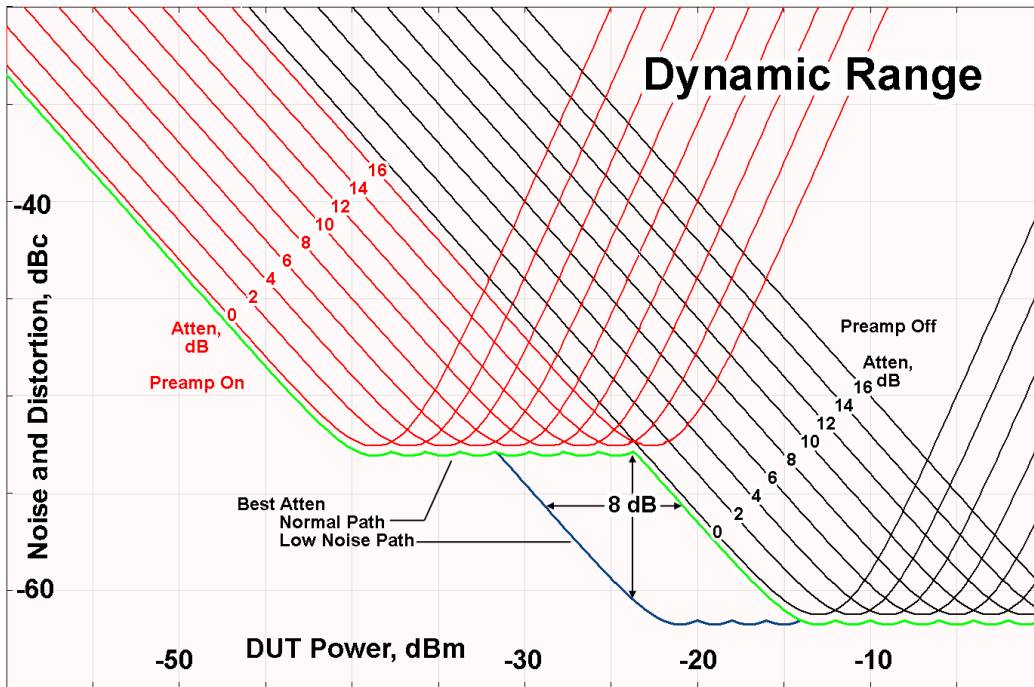

There are other times where selecting the low noise path improves performance, too. Compression-limited measurements such as finding the nulls in a pulsed-RF spectrum can profit from the low noise path in a way similar to the TOI-limited measurement illustrated. Accuracy can be improved when the low noise path allows the optimum attenuation to increase from a small amount like 0, 2 or 4 dB to a larger amount, giving better return loss at the analyzer input. Harmonic measurements, such as second and third harmonic levels, are much improved using the low noise path because of the superiority of that path for harmonic (though not intermodulation) distortion performance.

### μW Preselector Bypass

This key toggles the preselector bypass switch for band 1 and higher. When the microwave preselector is on, the signal path is preselected. When the microwave preselector is off, the signal path is not preselected. The preselected path is the normal path for the analyzer.

The preselector is a tunable bandpass filter which prevents signals away from the frequency of interest from combining in the mixer to generate in-band spurious signals (images). The consequences of using a preselector filter are its limited bandwidth, the amplitude and phase ripple in its passband, and any amplitude and phase instability due to center frequency drift.

Option MPB or pre-selector bypass provides an unpreselected input mixer path for certain X-Series signal analyzers with frequency ranges above 3.6 GHz. This signal path allows a wider bandwidth and less amplitude variability, which is an advantage when doing modulation analysis and broadband signal analysis. The disadvantage is that, without the preselector, image signals will be displayed. Another disadvantage of bypassing the preselector is increased LO emission levels at the front panel input port.

Image responses are separated from the real signal by twice the 1st IF. For IF Paths of 10 MHz and 25 MHz, the 1st IF is 322.5 MHz, so the image response and the real signal will be separated by 645 MHz. The 1st IF will be different for other IF Path settings. When viewing a real signal and its corresponding image response in internal mixing, the image response will be to the left of the real signal.

Also, the image response and the real signal typically have the same amplitude and exhibit the same shape factor.

However, if Option FS1, Fast Sweep Capability, is enabled, the image response in the Swept SA measurement will appear lower in amplitude and have a much wider shape factor compared to the real signal.

<b>Key Path</b>	AMPTD Y Scale, $\mu$ W Path Control
<b>Example</b>	:POW:MW:PATH MPB
<b>Dependencies</b>	Key is blanked if current mode does not support it. Key is grayed out if mode supports it but current measurement does not support it. Key is blank unless Option MPB is present and licensed. If SCPI command sent when MPB not present, error -241, "Hardware missing; Option not installed" is generated.
<b>Readback Text</b>	$\mu$ W Preselector Bypass
<b>Initial S/W Revision</b>	A.04.00

<b>Remote Command</b>	[ :SENSe ] :POWer [ :RF ] :MW:PRESelector [ :STATe ] ON   OFF   0   1 [ :SENSe ] :POWer [ :RF ] :MW:PRESelector [ :STATe ] ?
<b>Example</b>	:POW:MW:PRES OFF Bypasses the microwave preselector
<b>Notes</b>	The ON parameter sets the STD path (:POW:MW:PATH STD) The OFF parameter sets path MPB (:POW:MW:PATH MPB)
<b>Preset</b>	ON

## Internal Preamp

Accesses a menu of keys that control the internal preamps. Turning on the preamp gives a better noise figure, but a poorer TOI to noise floor dynamic range. You can optimize this setting for your particular measurement.

The instrument takes the preamp gain into account as it sweeps. If you sweep outside of the range of the preamp the instrument will also account for that. The displayed result will always reflect the correct gain.

For some measurements, when the preamp is on and any part of the displayed frequency range is below the lowest frequency for which the preamp has specifications, a warning condition message appears in the status line. For example, for a preamp with a 9 kHz lowest specified frequency: "Preamp: Accy unspec'd below 9 kHz".

<b>Key Path</b>	AMPTD Y Scale
<b>Scope</b>	Meas Global
<b>Remote Command</b>	[ :SENSe ] :POWer [ :RF ] :GAIN [ :STATe ] OFF   ON   0   1 [ :SENSe ] :POWer [ :RF ] :GAIN [ :STATe ] ?
<b>Dependencies</b>	Preamp is not available on all hardware platforms. If the preamp is not present or is unlicensed, the



---

	key is not shown. The preamp is not available when the electronic/soft attenuator is enabled.
--	--------------------------------------------------------------------------------------------------

---

Couplings	<p>The act of connecting the U7227A USB Preamplifier to one of the analyzer's USB ports will cause the Internal Preamp to be switched on. When this happens an informational message will be generated: "Internal Preamp turned on for optimal operation with USB Preamp." Note that if the Internal Preamp was already on, there will be no change to the setting, but if it was Off it will be switched On, to Full Range.</p> <p>Note that this same action occurs when the SA mode is selected while the USB Preamp is connected to one of the analyzer's USB ports, if it is the first time that the SA mode has run since powerup, or if the last time the SA mode was running the USB Preamp was NOT connected.</p> <p>Subsequently disconnecting the USB Preamp from USB does not change the Internal Preamp setting nor restore the previous setting.</p>
Preset	OFF
State Saved	Saved in instrument state
Initial S/W Revision	Prior to A.02.00
Modified at S/W Revision	A.14.00

---

Key Path	AMPTD Y Scale, Internal Preamp
Scope	Meas Global
<b>Remote Command</b>	[:SENSe]:POWer[:RF]:GAIN:BAND LOW FULL [:SENSe]:POWer[:RF]:GAIN:BAND?
Dependencies	<p>Preamp is not available on all hardware platforms. If the preamp is not present or is unlicensed, the key is not shown.</p> <p>If a POW:GAIN:BAND FULL command is sent when a low band preamp is available, the preamp band parameter is to LOW instead of FULL, and an "Option not installed" message is generated.</p>
Preset	LOW
State Saved	Saved in instrument state
Initial S/W Revision	Prior to A.02.00

---

## Off

Turns the internal preamp off

---

Key Path	AMPTD Y Scale, Internal Preamp
<b>Example</b>	:POW:GAIN OFF
Readback	Off
Initial S/W Revision	Prior to A.02.00

---

## Low Band

Sets the internal preamp to use only the low band.

The frequency range of the installed (optional) low-band preamp is displayed in square brackets on the Low Band key label.

Key Path	AMPTD Y Scale, Internal Preamp
<b>Example</b>	:POW:GAIN ON :POW:GAIN:BAND LOW
Readback	Low Band
Initial S/W Revision	Prior to A.02.00

## Full Range

Sets the internal preamp to use its full range. The low band (0–3.6 GHz or 0–3GHz, depending on the model) is supplied by the low band preamp and the frequencies above low band are supplied by the high band preamp.

The frequency range of the installed (optional) preamp is displayed in square brackets on the Full Range key label. If the high band option is not installed the Full Range key does not appear.

Key Path	AMPTD Y Scale, Internal Preamp
<b>Example</b>	:POW:GAIN ON :POW:GAIN:BAND FULL
Readback	Full Range
Initial S/W Revision	Prior to A.02.00

## Range

This key is only available when I/Q is the selected input. It replaces the Attenuation key in that case.

Each input channel (I and Q) has four internal gain ranges. The maximum allowed voltage in each gain range is slightly more than the nominal value, so the break point between ranges is a couple of millivolts higher than the nominal (setting a peak voltage of 0.502 mV will still map to the 0.5 V Peak range).

Gain Setting	Volts RMS	Volts Peak	Volts Peak - Peak	dBm (50Ω)	Break Point
0 dB	0.7071	1.0	2.0	10	n/a
6 dB	0.3536	0.5	1.0	4	0.502 V Peak
12 dB	0.1768	0.25	0.5	-2	0.252 V Peak
18 dB	0.0884	0.125	0.25	-8	0.127 V Peak

Key Path	AMPTD Y Scale
Notes	Visible only when the selected input is I/Q.
State Saved	No
Readback Text	When Range is Auto, "[Auto]" When Range is Man and I & Q are the same, "[<range value>]" When Range is Man and I & Q are different: "[: <I range value> Q: <Q range value>]" See I Range and Q Range for the <range value> enumeration definition.
Initial S/W Revision	Prior to A.02.00

## Range Auto/Man

The Auto setting for Range causes the range to be set based on the Y Scale settings. When Range is "Auto", the I & Q Range are set based on the top of the Y Scale when the Y scale is in dB units (for example, power), or to the max(abs(top), abs(bottom)) when the Y scale reference is not at the top of the screen.

Not all measurements support Range Auto/Man. If Auto is not supported in the current measurement, this key is grayed out and shows "Man" and MAN is returned to a SCPI query, but this does NOT change the Auto/Man setting for Range. When you go to a measurement that supports Auto, it goes back to Auto if it was previously in Auto mode.

Key Path	AMPTD Y Scale, Range
Scope	Meas Global
<b>Remote Command</b>	<code>[:SENSe]:VOLTage:IQ:RANGe:AUTO OFF ON 0 1</code> <code>[:SENSe]:VOLTage:IQ:RANGe:AUTO?</code>
<b>Example</b>	Put the I Range and Q Range in manual. <code>VOLT:IQ:RANG:AUTO OFF</code>
Dependencies	If Auto is not supported, sending the SCPI command will generate an error.
Couplings	When in Auto, both I Range and Q Range are set to the same value, computed as follows: Maximum absolute value is computed for the Y Scale. The top and bottom of the graph are computed based on Ref Value, Scale/Div, and Ref Position. Formula: $Y_{Max} = \max(\text{abs}(\text{top}), \text{abs}(\text{bottom}))$ . The I Range and Q Range are then set to YMax.
Preset	ON
State Saved	Saved in instrument state
Range	Auto   Man
Initial S/W Revision	Prior to A.02.00

<b>Remote Command</b>	<code>[:SENSe]:POWer:IQ:RANGe:AUTO OFF ON 0 1</code> <code>[:SENSe]:POWer:IQ:RANGe:AUTO?</code>
-----------------------	----------------------------------------------------------------------------------------------------

<b>Example</b>	Put the I Range and Q Range in manual. POW:IQ:RANG:AUTO OFF
Notes	The POW:IQ:RANG:AUTO is an alternate form of the VOLT:IQ:RANG:AUTO command. This is to maintain consistency with I Range and Q Range, which support both the POWer and VOLTage forms of the command.
Preset	ON
Range	Auto   Man
Initial S/W Revision	Prior to A.02.00

## I Range

This is the internal gain range for the I channel when Input Path is I Only or I and I/Q, and it is used for both the I and Q channels when the Input Path is I+jQ. See "[I/Q Gain Ranges](#)" on page 2807.

<b>Key Path</b>	AMPTD Y Scale, Range
<b>Remote Command</b>	[ :SENSe ] :VOLTage :IQ [ : I ] :RANGe [ :UPPer ] <voltage> [ :SENSe ] :VOLTage :IQ [ : I ] :RANGe [ :UPPer ] ?
<b>Example</b>	Set the I Range to 0.5 V Peak VOLT:IQ:RANG 0.5 V
Notes	The numeric entries are mapped to the smallest gain range whose break point is greater than or equal to the value, or 1 V Peak if the value is greater than 1 V.
Couplings	When Q Same as I is On, the I Range value will be copied to the Q Range. Changing the value will also set Range = Man.
Preset	1 V Peak
State Saved	Saved in instrument state
Range	1 V Peak   0.5 V Peak   0.25 V Peak   0.125 V Peak
Min	0.125 V
Max	1 V
Initial S/W Revision	Prior to A.02.00

<b>Remote Command</b>	[ :SENSe ] :POWer :IQ [ : I ] :RANGe [ :UPPer ] <ampl> [ :SENSe ] :POWer :IQ [ : I ] :RANGe [ :UPPer ] ?
<b>Example</b>	Set the I Range to 0.5 V Peak when Reference Z is 50Ω, and to 1.0 V Peak when Reference Z is 75Ω. POW:IQ:RANG 4 dBm
Notes	The POWer form of the command is provided for convenience. It maps to the same underlying gain range parameter as the VOLTage form of the command. The Reference Z (not the I channel Input Z) is used to convert the power to peak voltage, which is then used to set the I Range as with the VOLTage form of the command. The power values of the 4

range states (1V Peak, 0.5V Peak, 0.25V Peak, and 0.125V Peak) will vary with Reference Z. Here are some examples:

50Ω: 10, 4, -2, -8  
75Ω: 8.2, 2.2, -3.8, -9.8  
600Ω: -0.8, -6.8, -12.8, -18.9

Preset	10.0 dBm
Range	-20 dBm to 10 dBm
Min	-20 dBm
Max	10 dBm
Initial S/W Revision	Prior to A.02.00

### 1 V Peak

Set the channel gain state to 1 Volt Peak.

Key Path	AMPTD Y Scale, I Range   Q Range
Initial S/W Revision	Prior to A.02.00

### 0.5 V Peak

Set the channel gain state to 0.5 Volt Peak.

Key Path	AMPTD Y Scale, I Range   Q Range
Initial S/W Revision	Prior to A.02.00

### 0.25 V Peak

Set the channel gain state to 0.25 Volt Peak.

Key Path	AMPTD Y Scale, I Range   Q Range
Initial S/W Revision	Prior to A.02.00

### 0.125 V Peak

Set the channel gain state to 0.125 Volt Peak.

Key Path	AMPTD Y Scale, I Range   Q Range
Initial S/W Revision	Prior to A.02.00

## Q Range Value

This is the internal gain range for the Q channel. See "[I/Q Gain Ranges](#)" on page 2807. The Q Range only applies to Input Path Q Only and Ind I/Q. For input I+jQ the I Range determines both I and Q channel range settings.

Key Path	AMPTD Y Scale, Range
Remote Command	<code>[ :SENSe ] :VOLTage:IQ:Q:RANGe[:UPPer] &lt;voltage&gt;</code> <code>[ :SENSe ] :VOLTage:IQ:Q:RANGe[:UPPer] ?</code>
Example	Set the Q Range to 0.5 V Peak <code>VOLT:IQ:Q:RANG 0.5 V</code>
Notes	The numeric entries are mapped to the smallest gain range whose break point is greater than or equal to the value, or 1 V Peak if the value is greater than 1 V. The Q Range is only used for Input Path Q Only and Ind I/Q. For input I+jQ the I Range determines both I and Q channel range settings.
Couplings	When Q Same as I is On, the I Range value will be copied to the Q Range and the range value keys are disabled. Changing the value will also set Range = Man.
Preset	1 V Peak
State Saved	Saved in instrument state
Range	1 V Peak   0.5 V Peak   0.25 V Peak   0.125 V Peak
Min	0.125 V
Max	1 V
Initial S/W Revision	Prior to A.02.00

Remote Command	<code>[ :SENSe ] :POWer:IQ:Q:RANGe[:UPPer] &lt;ampl&gt;</code> <code>[ :SENSe ] :POWer:IQ:Q:RANGe[:UPPer] ?</code>
Example	Will set the Q Range to 0.5 V Peak when Reference Z is 50Ω, and to 1.0 V Peak when Reference Z is 75Ω. <code>POW:IQ:Q:RANG 4 dBm</code>
Notes	The POWER form of the command is provided for convenience. It maps to the same underlying gain range parameter as the VOLTage form of the command. The Reference Z (not the Q channel Input Z) is used to convert the power to peak voltage, which is then used to set the Q Range as with the VOLTage form of the command. The power values of the 4 range states (1V Peak, 0.5V Peak, 0.25V Peak, and 0.125V Peak) will vary with Reference Z. Here are some examples: 50Ω: 10, 4, -2, -8 75Ω: 8.2, 2.2, -3.8, -9.8 600Ω: -0.8, -6.8, -12.8, -18.9
Preset	10.0 dBm
Range	-20 dBm to 10 dBm

Min	-20 dBm
Max	10 dBm
Initial S/W Revision	Prior to A.02.00

### Q Same as I

Many, but not all, usages require the I and Q channels to have an identical setup. To simplify channel setup, the Q Same as I will cause the Q channel range to be mirrored from the I channel. That way you only need to set up one channel (the I channel). The I channel values are copied to the Q channel, so at the time Q Same as I is Off, the I and Q channel setups will be identical.

Key Path	AMPTD Y Scale, Range, Q Range
Remote Command	[ :SENSe ] :VOLTage   POWer : IQ : MIRRed OFF   ON   0   1 [ :SENSe ] :VOLTage   POWer : IQ : MIRRed ?
Example	Turn off the mirroring of I Range to Q Range. VOLT:IQ:MIRR OFF POW:IQ:MIRR OFF
Couplings	When On, the I Range value is mirrored (copied) to the Q Range.
Preset	On
State Saved	Saved in instrument state.
Range	On   Off
Readback Text	"Q Same as I" when On, otherwise none.
Initial S/W Revision	Prior to A.02.00

### 1 V Peak

Set the channel gain state to 1 Volt Peak.

Key Path	AMPTD Y Scale, I Range   Q Range
Initial S/W Revision	Prior to A.02.00

### 0.5 V Peak

Set the channel gain state to 0.5 Volt Peak.

Key Path	AMPTD Y Scale, I Range   Q Range
Initial S/W Revision	Prior to A.02.00

### 0.25 V Peak

Set the channel gain state to 0.25 Volt Peak.

---

Key Path	AMPTD Y Scale, I Range   Q Range
Initial S/W Revision	Prior to A.02.00

---

### 0.125 V Peak

Set the channel gain state to 0.125 Volt Peak.

---

Key Path	AMPTD Y Scale, I Range   Q Range
Initial S/W Revision	Prior to A.02.00

---

### I/Q Gain Ranges

See the following sections:

["1 V Peak" on page 2807](#)

["0.5 V Peak" on page 2807](#)

["0.25 V Peak" on page 2807](#)

["0.125 V Peak" on page 2808](#)

### 1 V Peak

Set the channel gain state to 1 Volt Peak.

---

Key Path	AMPTD Y Scale, I Range   Q Range
Initial S/W Revision	Prior to A.02.00

---

### 0.5 V Peak

Set the channel gain state to 0.5 Volt Peak.

---

Key Path	AMPTD Y Scale, I Range   Q Range
Initial S/W Revision	Prior to A.02.00

---

### 0.25 V Peak

Set the channel gain state to 0.25 Volt Peak.

---

Key Path	AMPTD Y Scale, I Range   Q Range
Initial S/W Revision	Prior to A.02.00

---



### 0.125 V Peak

Set the channel gain state to 0.125 Volt Peak.

Key Path	AMPTD Y Scale, I Range   Q Range
Initial S/W Revision	Prior to A.02.00

### Ref Value

Sets the value for the absolute power reference. However, since the Auto Scaling is defaulted to On, this value is automatically determined by the measurement result. When you set a value manually, Auto Scaling automatically changes to Off.

Key Path	AMPTD Y Scale
Initial S/W Revision	Prior to A.02.00

### Y Ref Value (Power Bar Graph & Metrics View, Power Bar Graph window)

Sets the power reference value in the Power Bar Graph window.

Key Path	AMPTD Y Scale
Mode	1xEV-DO
<b>Remote Command</b>	:DISPlay:CDPower[:BTS]:VIEW[1]:WINDow[1]:TRACe:Y[:SCALe]:RLEVel <real> :DISPlay:CDPower[:BTS]:VIEW[1]:WINDow[1]:TRACe:Y[:SCALe]:RLEVel?
<b>Example</b>	DISP:CDP:VIEW:WIND:TRAC:Y:RLEV 0 DISP:CDP:VIEW:WIND:TRAC:Y:RLEV?
Preset	0.00
State Saved	Saved in instrument state.
Min	-250
Max	2000
<b>Backwards Compatibility SCPI</b>	:DISPlay:CDPower:VIEW[1]:WINDow[1]:TRACe:Y[:SCALe]:RLEVel
Initial S/W Revision	Prior to A.02.00

### Y Ref Value (CDP Graph & CDE Graph View, Power Bar Graph window)

Sets the power reference value in the Power Bar Graph window.

Key Path	AMPTD Y Scale
----------	---------------

Mode	1xEV-DO
<b>Remote Command</b>	:DISPlay:CDPower[:BTS]:VIEW2:WINDow[1]:TRACe:Y[:SCALe]:RLEVel <real> :DISPlay:CDPower[:BTS]:VIEW2:WINDow[1]:TRACe:Y[:SCALe]:RLEVel?
<b>Example</b>	DISP:CDP:VIEW2:WIND:TRAC:Y:RLEV 0 DISP:CDP:VIEW2:WIND:TRAC:Y:RLEV?
Preset	0.00
State Saved	Saved in instrument state.
Min	-250
Max	2000
<b>Backwards Compatibility SCPI</b>	:DISPlay:CDPower:VIEW2:WINDow[1]:TRACe:Y[:SCALe]:RLEVel
Initial S/W Revision	Prior to A.02.00

### Y Ref Value (CDP Graph & CDE Graph View, CDE Graph window)

Sets the power reference value in the CDE Graph window.

Key Path	AMPTD Y Scale
Mode	1xEV-DO
<b>Remote Command</b>	:DISPlay:CDPower[:BTS]:VIEW2:WINDow2:TRACe:Y[:SCALe]:RLEVel <real> :DISPlay:CDPower[:BTS]:VIEW2:WINDow2:TRACe:Y[:SCALe]:RLEVel?
<b>Example</b>	DISP:CDP:VIEW2:WIND2:TRAC:Y:RLEV 0 DISP:CDP:VIEW2:WIND2:TRAC:Y:RLEV?
Preset	0.00
State Saved	Saved in instrument state.
Min	-250
Max	2000
<b>Backwards Compatibility SCPI</b>	:DISPlay:CDPower:VIEW2:WINDow2:TRACe:Y[:SCALe]:RLEVel
Initial S/W Revision	Prior to A.02.00

### Y Ref Value (Code Domain (Quad View) View, Power Bar Graph window)

Sets the power reference value in the Power Bar Graph window.

Key Path	AMPTD Y Scale
Mode	1xEV-DO
<b>Remote Command</b>	:DISPlay:CDPower[:BTS]:VIEW3:WINDow[1]:TRACe:Y[:SCALe]:RLEVel <real> :DISPlay:CDPower[:BTS]:VIEW3:WINDow[1]:TRACe:Y[:SCALe]:RLEVel?

<b>Example</b>	DISP:CDP:VIEW3:WIND:TRAC:Y:RLEV 0 DISP:CDP:VIEW3:WIND:TRAC:Y:RLEV?
Preset	0.00
State Saved	Saved in instrument state.
Min	-250
Max	2000
<b>Backwards Compatibility SCPI</b>	:DISPlay:CDPower:VIEW3:WINDow[1]:TRACe:Y[:SCALe]:RLEVel
Initial S/W Revision	Prior to A.02.00

### Y Ref Value (Code Domain (Quad View) View, RMS Code Power/Slot window)

Sets the power reference value in the RMS Code Power/Slot window.

Key Path	AMPTD Y Scale
Mode	1xEV-DO
<b>Remote Command</b>	:DISPlay:CDPower[:BTS]:VIEW3:WINDow2:TRACe:Y[:SCALe]:RLEVel <real> :DISPlay:CDPower[:BTS]:VIEW3:WINDow2:TRACe:Y[:SCALe]:RLEVel?
<b>Example</b>	DISP:CDP:VIEW3:WIND2:TRAC:Y:RLEV 0 DISP:CDP:VIEW3:WIND2:TRAC:Y:RLEV?
Preset	0.00
State Saved	Saved in instrument state.
Min	-250.00
Max	250.00
<b>Backwards Compatibility SCPI</b>	:DISPlay:CDPower:VIEW3:WINDow2:TRACe:Y[:SCALe]:RLEVel
Initial S/W Revision	Prior to A.02.00

### Y Ref Value (Code Domain (Quad View) View, Chip Power window)

Sets the power reference value in the Chip Power window.

Key Path	AMPTD Y Scale
Mode	1xEV-DO
<b>Remote Command</b>	:DISPlay:CDPower[:BTS]:VIEW3:WINDow4:TRACe:Y[:SCALe]:RLEVel <real> :DISPlay:CDPower[:BTS]:VIEW3:WINDow4:TRACe:Y[:SCALe]:RLEVel?
<b>Example</b>	DISP:CDP:VIEW3:WIND4:TRAC:Y:RLEV 0 DISP:CDP:VIEW3:WIND4:TRAC:Y:RLEV?

Preset	0.00
State Saved	Saved in instrument state.
Min	-250.00
Max	250.00
<b>Backwards Compatibility SCPI</b>	:DISPlay:CDPower:VIEW3:WINDow4:TRACe:Y[:SCALe]:RLEVel
Initial S/W Revision	Prior to A.02.00

### Y Ref Value (Demod Bits View, Power Bar Graph window)

Sets the power reference value in the Power Bar Graph window.

Key Path	AMPTD Y Scale
Mode	1xEV-DO
<b>Remote Command</b>	:DISPlay:CDPower[:BTS]:VIEW4:WINDow[1]:TRACe:Y[:SCALe]:RLEVel <real> :DISPlay:CDPower[:BTS]:VIEW4:WINDow[1]:TRACe:Y[:SCALe]:RLEVel?
<b>Example</b>	DISP:CDP:VIEW4:WIND:TRAC:Y:RLEV 0 DISP:CDP:VIEW4:WIND:TRAC:Y:RLEV?
Notes	When meas type is selected Relative Log, the Unit should be dB; When meas type is selected Relative Line, the Unit should be None; When meas type is selected Absolute Log, the Unit should be dBm; When meas type is selected Absolute Linear, the Unit should be mW;
Preset	0.00
State Saved	Saved in instrument state.
Min	-250.00
Max	2000.00
<b>Backwards Compatibility SCPI</b>	:DISPlay:CDPower:VIEW4:WINDow[1]:TRACe:Y[:SCALe]:RLEVel
Initial S/W Revision	Prior to A.02.00

### Y Ref Value (Demod Bits View, RMS Code Power/Slot window)

Sets the power reference value in the RMS Code Power/Slot window.

Key Path	AMPTD Y Scale
Mode	1xEV-DO
<b>Remote Command</b>	:DISPlay:CDPower[:BTS]:VIEW4:WINDow2:TRACe:Y[:SCALe]:RLEVel <real> :DISPlay:CDPower[:BTS]:VIEW4:WINDow2:TRACe:Y[:SCALe]:RLEVel?
<b>Example</b>	DISP:CDP:VIEW4:WIND2:TRAC:Y:RLEV 0

	DISP:CDP:VIEW4:WIND2:TRAC:Y:RLEV?
Preset	0.00
State Saved	Saved in instrument state.
Min	-250.00
Max	250.00
<b>Backwards Compatibility SCPI</b>	:DISPlay:CDPower:VIEW4:WINDow2:TRACe:Y[:SCALE]:RLEVel
Initial S/W Revision	Prior to A.02.00

### Scale/Div

Sets the units per division of vertical scale in the logarithmic display. However, since the Auto Scaling is defaulted to On, this value is automatically determined by the measurement result. When you set a value manually, Auto Scaling automatically changes to Off.

Key Path	AMPTD Y Scale
Initial S/W Revision	Prior to A.02.00

### Y Scale/Div (Power Bar Graph & Metrics View, Power Bar Graph Window)

Sets the vertical scale by changing a power value per division in the Power Bar Graph window of Power Bar Graph & Metrics View.

Key Path	AMPTD Y Scale
Mode	1xEV-DO
<b>Remote Command</b>	:DISPlay:CDPower[:BTS]:VIEW[1]:WINDow[1]:TRACe:Y[:SCALE]:PDIVision <real>  :DISPlay:CDPower[:BTS]:VIEW[1]:WINDow[1]:TRACe:Y[:SCALE]:PDIVision?
<b>Example</b>	DISP:CDP:VIEW:WIND:TRAC:Y:PDIV 10 DISP:CDP:VIEW:WIND:TRAC:Y:PDIV?
Preset	10
State Saved	Saved in instrument state.
Min	0.000001
Max	2000
<b>Backwards Compatibility SCPI</b>	:DISPlay:CDPower:VIEW[1]:WINDow[1]:TRACe:Y[:SCALE]:PDIVision
Initial S/W Revision	Prior to A.02.00

### Y Scale/Div (CDP Graph & CDE Graph View, Power Bar Graph Window)

Sets the vertical scale by changing a power value per division in the Power Bar Graph window of CDP Graph & CDE Graph View.

Key Path	AMPTD Y Scale
Mode	1xEV-DO
<b>Remote Command</b>	:DISPlay:CDPower[:BTS]:VIEW2:WINDow[1]:TRACe:Y[:SCALe]:PDIVision <real> :DISPlay:CDPower[:BTS]:VIEW2:WINDow[1]:TRACe:Y[:SCALe]:PDIVision?
<b>Example</b>	DISP:CDP:VIEW2:WIND:TRAC:Y:PDIV 10 DISP:CDP:VIEW2:WIND:TRAC:Y:PDIV?
Preset	10
State Saved	Saved in instrument state.
Min	0.000001
Max	2000
<b>Backwards Compatibility SCPI</b>	:DISPlay:CDPower:VIEW2:WINDow[1]:TRACe:Y[:SCALe]:PDIVision
Initial S/W Revision	Prior to A.02.00

### Y Scale/Div (CDP Graph & CDE Graph View, CDE Graph Window)

Sets the vertical scale by changing a power value per division in the CDE Graph window of CDP Graph & CDE Graph View.

Key Path	AMPTD Y Scale
Mode	1xEV-DO
<b>Remote Command</b>	:DISPlay:CDPower[:BTS]:VIEW2:WINDow2:TRACe:Y[:SCALe]:PDIVision <real> :DISPlay:CDPower[:BTS]:VIEW2:WINDow2:TRACe:Y[:SCALe]:PDIVision?
<b>Example</b>	DISP:CDP:VIEW2:WIND2:TRAC:Y:PDIV 10 DISP:CDP:VIEW2:WIND2:TRAC:Y:PDIV?
Preset	10
State Saved	Saved in instrument state.
Min	0.000001
Max	2000
<b>Backwards Compatibility SCPI</b>	:DISPlay:CDPower:VIEW2:WINDow2:TRACe:Y[:SCALe]:PDIVision
Initial S/W Revision	Prior to A.02.00

### Y Scale/Div (Code Domain (Quad View) View, Power Bar Graph Window)

Sets the vertical scale by changing a power value per division in the Power Bar Graph window of Code Domain (Quad View) View.

Key Path	AMPTD Y Scale
Mode	1xEV-DO
<b>Remote Command</b>	:DISPlay:CDPower[:BTS]:VIEW3:WINDow[1]:TRACe:Y[:SCALe]:PDIVision <real> :DISPlay:CDPower[:BTS]:VIEW3:WINDow[1]:TRACe:Y[:SCALe]:PDIVision?
<b>Example</b>	DISP:CDP:VIEW3:WIND:TRAC:Y:PDIV 10 DISP:CDP:VIEW3:WIND:TRAC:Y:PDIV?
Preset	10
State Saved	Saved in instrument state.
Min	0.000001
Max	2000
<b>Backwards Compatibility SCPI</b>	:DISPlay:CDPower:VIEW3:WINDow[1]:TRACe:Y[:SCALe]:PDIVision
Initial S/W Revision	Prior to A.02.00

### Y Scale/Div (Code Domain (Quad View) View, RMS Code Power/Slot Window)

Sets the vertical scale by changing a RMS Code Power/Slot value per division in the RMS Code Power/Slot window of Code Domain (Quad View) View.

Key Path	AMPTD Y Scale
Mode	1xEV-DO
<b>Remote Command</b>	:DISPlay:CDPower[:BTS]:VIEW3:WINDow2:TRACe:Y[:SCALe]:PDIVision <real> :DISPlay:CDPower[:BTS]:VIEW3:WINDow2:TRACe:Y[:SCALe]:PDIVision?
<b>Example</b>	DISP:CDP:VIEW3:WIND2:TRAC:Y:PDIV 10 DISP:CDP:VIEW3:WIND2:TRAC:Y:PDIV?
Preset	10
State Saved	Saved in instrument state.
Min	0.10
Max	20.00
<b>Backwards Compatibility SCPI</b>	:DISPlay:CDPower:VIEW3:WINDow2:TRACe:Y[:SCALe]:PDIVision
Initial S/W Revision	Prior to A.02.00

### Y Scale/Div (Code Domain (Quad View) View, Chip Power Window)

Sets the vertical scale by changing a chip power value per division in the Chip Power window of Code Domain (Quad View) View.

Key Path	AMPTD Y Scale
Mode	1xEV-DO
<b>Remote Command</b>	:DISPlay:CDPower[:BTS]:VIEW3:WINDow4:TRACe:Y[:SCALe]:PDIVision <real> :DISPlay:CDPower[:BTS]:VIEW3:WINDow4:TRACe:Y[:SCALe]:PDIVision?
<b>Example</b>	DISP:CDP:VIEW3:WIND4:TRAC:Y:PDIV 10 DISP:CDP:VIEW3:WIND4:TRAC:Y:PDIV?
Preset	10
State Saved	Saved in instrument state.
Min	0.10
Max	20.00
<b>Backwards Compatibility SCPI</b>	:DISPlay:CDPower:VIEW3:WINDow4:TRACe:Y[:SCALe]:PDIVision
Initial S/W Revision	Prior to A.02.00

### Y Scale/Div (Demod Bits View, Power Bar Graph Window)

Sets the vertical scale by changing a power value per division in the Power Bar Graph window of Demod Bits View.

Key Path	AMPTD Y Scale
Mode	1xEV-DO
<b>Remote Command</b>	:DISPlay:CDPower[:BTS]:VIEW4:WINDow[1]:TRACe:Y[:SCALe]:PDIVision <real> :DISPlay:CDPower[:BTS]:VIEW4:WINDow[1]:TRACe:Y[:SCALe]:PDIVision?
<b>Example</b>	DISP:CDP:VIEW3:WIND:TRAC:Y:PDIV 10 DISP:CDP:VIEW3:WIND:TRAC:Y:PDIV?
Preset	10.00
State Saved	Saved in instrument state.
Min	0.000001
Max	2000.00
<b>Backwards Compatibility SCPI</b>	:DISPlay:CDPower:VIEW4:WINDow[1]:TRACe:Y[:SCALe]:PDIVision
Initial S/W Revision	Prior to A.02.00



### Y Scale/Div (Demod Bits View, RMS Code Power/Slot Window)

Sets the vertical scale by changing a RMS Code Power/Slot value per division in the RMS Code Power/Slot window of Demod Bits View.

Key Path	AMPTD Y Scale
Mode	1xEV-DO
<b>Remote Command</b>	:DISPlay:CDPower[:BTS]:VIEW4:WINDow2:TRACe:Y[:SCALe]:PDIVision <real> :DISPlay:CDPower[:BTS]:VIEW4:WINDow2:TRACe:Y[:SCALe]:PDIVision?
<b>Example</b>	DISP:CDP:VIEW3:WIND2:TRAC:Y:PDIV 10 DISP:CDP:VIEW3:WIND2:TRAC:Y:PDIV?
Preset	10
State Saved	Saved in instrument state.
Min	0.10
Max	20.00
<b>Backwards Compatibility SCPI</b>	:DISPlay:CDPower:VIEW4:WINDow2:TRACe:Y[:SCALe]:PDIVision
Initial S/W Revision	Prior to A.02.00

### Y Ref Position

Positions the Y-axis scale reference level at the top, center or bottom of the display. Changing the reference position does not change the reference level value.

Key Path	AMPTD Y Scale
Initial S/W Revision	Prior to A.02.00

### Y Ref Position (Code Domain (Quad View) view, RMS Code Power/Slot window)

Sets the reference position of the Y axis in the RMS Code Power/Slot view of the Code Domain (Quad View) view.

Key Path	AMPTD Y Scale
Mode	1xEV-DO
<b>Remote Command</b>	:DISPlay:CDPower[:BTS]:VIEW3:WINDow2:TRACe:Y[:SCALe]:RPOSition TOP   CENTer   BOTTom :DISPlay:CDPower[:BTS]:VIEW3:WINDow2:TRACe:Y[:SCALe]:RPOSition?
<b>Example</b>	DISP:CDP:VIEW3:WIND2:TRAC:Y:RPOS CENT DISP:CDP:VIEW3:WIND2:TRAC:Y:RPOS?
Preset	TOP
State Saved	Saved in instrument state.

Range	Top Ctr Bot
<b>Backwards Compatibility SCPI</b>	:DISPlay:CDPower:VIEW3:WINDow2:TRACe:Y[:SCALE]:RPOStion
Initial S/W Revision	Prior to A.02.00

### Ref Position (Code Domain (Quad View) view, Chip Power window)

Sets the reference position of the Y axis in the Chip Power view of the Code Domain (Quad View) view.

Key Path	AMPTD Y Scale
Mode	1xEV-DO
<b>Remote Command</b>	:DISPlay:CDPower[:BTS]:VIEW3:WINDow4:TRACe:Y[:SCALE]:RPOStion TOP   CENTer   BOTTom  :DISPlay:CDPower[:BTS]:VIEW3:WINDow4:TRACe:Y[:SCALE]:RPOStion?
<b>Example</b>	DISP:CDP:VIEW3:WIND4:TRAC:Y:RPOS CENT DISP:CDP:VIEW3:WIND4:TRAC:Y:RPOS?
Preset	TOP
State Saved	Saved in instrument state.
Range	Top Ctr Bot
<b>Backwards Compatibility SCPI</b>	:DISPlay:CDPower:VIEW3:WINDow4:TRACe:Y[:SCALE]:RPOStion
Initial S/W Revision	Prior to A.02.00

### Y Ref Position (Demod Bits view, RMS Code Power/Slot window)

Sets the reference position of the Y axis in the RMS Code Power/Slot view of the Demod Bits view.

Key Path	AMPTD Y Scale
Mode	1xEV-DO
<b>Remote Command</b>	:DISPlay:CDPower[:BTS]:VIEW4:WINDow2:TRACe:Y[:SCALE]:RPOStion TOP   CENTer   BOTTom  :DISPlay:CDPower[:BTS]:VIEW4:WINDow2:TRACe:Y[:SCALE]:RPOStion?
<b>Example</b>	DISP:CDP:VIEW4:WIND2:TRAC:Y:RPOS CENT DISP:CDP:VIEW4:WIND2:TRAC:Y:RPOS?
Preset	TOP
State Saved	Saved in instrument state.
Range	Top Ctr Bot
<b>Backwards Compatibility SCPI</b>	:DISPlay:CDPower:VIEW4:WINDow2:TRACe:Y[:SCALE]:RPOStion
Initial S/W Revision	Prior to A.02.00

## Auto Scaling

Toggles the Auto Scaling function between On and Off. When the Restart front panel key or Restart menu key under the Meas Control menu is pressed, this function automatically determines the scale per division and reference values based on the measurement results.

Key Path	AMPTD Y Scale
Initial S/W Revision	Prior to A.02.00

## Y Auto Scaling (Power Bar Graph & Metrics View, Power Bar Graph)

When Auto Scaling is On, and the Restart front panel key is pressed, this function automatically displays the scale per division and reference value results in the View Power Bar Graph of Power Bar Graph & Metrics View.

Key Path	AMPTD Y Scale
Mode	1xEV-DO
<b>Remote Command</b>	:DISPlay:CDPower[:BTS]:VIEW[1]:WINDow[1]:TRACe:Y[:SCALE]:COUPle 0   1   OFF   ON :DISPlay:CDPower[:BTS]:VIEW[1]:WINDow[1]:TRACe:Y[:SCALE]:COUPle?
<b>Example</b>	DISP:CDP:VIEW1:WIND1:TRAC:Y:COUP ON DISP:CDP:VIEW1:WIND1:TRAC:Y:COUP?
Notes	Upon pressing the Restart front-panel key or Restart menu key under the Meas Control menu, the Auto Scaling function automatically determines the scale per division and reference values based on the measurement results if this parameter is set to On. When you set a value to either Scale/Div or Ref Value manually, Auto Scaling automatically changes to Off.
Preset	OFF
State Saved	Saved in instrument state.
Range	Off On 0 1
Initial S/W Revision	Prior to A.02.00

## Y Auto Scaling (CDP Graph & CDE Graph View, Power Bar Graph Window)

When Auto Scaling is On, and the Restart front panel key is pressed, this function automatically displays the scale per division and reference value results in the Power Bar Graph Window of CDP Graph & CDE Graph View

Key Path	AMPTD Y Scale
Mode	1xEV-DO
<b>Remote Command</b>	:DISPlay:CDPower[:BTS]:VIEW2:WINDow[1]:TRACe:Y[:SCALE]:COUPle 0   1   OFF   ON :DISPlay:CDPower[:BTS]:VIEW2:WINDow[1]:TRACe:Y[:SCALE]:COUPle?

<b>Example</b>	DISP:CDP:VIEW3:WIND2:TRAC:Y:COUP ON DISP:CDP:VIEW3:WIND2:TRAC:Y:COUP?
Notes	Upon pressing the Restart front-panel key or Restart menu key under the Meas Control menu, the Auto Scaling function automatically determines the scale per division and reference values based on the measurement results if this parameter is set to On. When you set a value to either Scale/Div or Ref Value manually, Auto Scaling automatically changes to Off.
Preset	OFF
State Saved	Saved in instrument state.
Range	Off On
<b>Backwards Compatibility SCPI</b>	:DISPlay:CDPower:VIEW2:WINDow[1]:TRACe:Y[:SCALE]:COUPle
Initial S/W Revision	Prior to A.02.00

### Y Auto Scaling (CDP Graph & CDE Graph View, CDE Graph Window)

When Auto Scaling is On, and the Restart front panel key is pressed, this function automatically displays the scale per division and reference value results in the CDE Graph Window of CDP Graph & CDE Graph View

Key Path	AMPTD Y Scale
Mode	1xEV-DO
<b>Remote Command</b>	:DISPlay:CDPower[:BTS]:VIEW2:WINDow2:TRACe:Y[:SCALE]:COUPle 0   1   OFF   ON  :DISPlay:CDPower[:BTS]:VIEW2:WINDow2:TRACe:Y[:SCALE]:COUPle?
<b>Example</b>	DISP:CDP:VIEW3:WIND2:TRAC:Y:COUP ON DISP:CDP:VIEW3:WIND2:TRAC:Y:COUP?
Notes	Upon pressing the Restart front-panel key or Restart menu key under the Meas Control menu, the Auto Scaling function automatically determines the scale per division and reference values based on the measurement results if this parameter is set to On. When you set a value to either Scale/Div or Ref Value manually, Auto Scaling automatically changes to Off.
Preset	OFF
State Saved	Saved in instrument state.
Range	Off On
<b>Backwards Compatibility SCPI</b>	:DISPlay:CDPower:VIEW2:WINDow2:TRACe:Y[:SCALE]:COUPle
Initial S/W Revision	Prior to A.02.00

### Y Auto Scaling (Code Domain (Quad View) View, Power Bar Graph Window)

When Auto Scaling is On, and the Restart front panel key is pressed, this function automatically displays the scale per division and reference value results Power Bar Graph Window of Code Domain (Quad View)

View.

Key Path	AMPTD Y Scale
Mode	1xEV-DO
Remote Command	:DISPlay:CDPower[:BTS]:VIEW3:WINDow[1]:TRACe:Y[:SCALE]:COUPle 0   1   OFF   ON :DISPlay:CDPower[:BTS]:VIEW3:WINDow[1]:TRACe:Y[:SCALE]:COUPle?
Example	DISP:CDP:VIEW3:WIND:TRAC:Y:COUP ON DISP:CDP:VIEW3:WIND:TRAC:Y:COUP?
Notes	Upon pressing the Restart front-panel key or Restart menu key under the Meas Control menu, the Auto Scaling function automatically determines the scale per division and reference values based on the measurement results if this parameter is set to On. When you set a value to either Scale/Div or Ref Value manually, Auto Scaling automatically changes to Off.
Preset	OFF
State Saved	Saved in instrument state.
Range	Off On
Initial S/W Revision	Prior to A.02.00

### Y Auto Scaling (Code Domain (Quad View) View, RMS Code Power/Slot Window)

When Auto Scaling is On, and the Restart front panel key is pressed, this function automatically displays the scale per division and reference value results in the RMS Code Power/Slot view of Code Domain (Quad View) View.

Key Path	AMPTD Y Scale
Mode	1xEV-DO
Remote Command	:DISPlay:CDPower[:BTS]:VIEW3:WINDow2:TRACe:Y[:SCALE]:COUPle 0   1   OFF   ON :DISPlay:CDPower[:BTS]:VIEW3:WINDow2:TRACe:Y[:SCALE]:COUPle?
Example	DISP:CDP:VIEW3:WIND2:TRAC:Y:COUP ON DISP:CDP:VIEW3:WIND2:TRAC:Y:COUP?
Notes	Upon pressing the Restart front-panel key or Restart menu key under the Meas Control menu, the Auto Scaling function automatically determines the scale per division and reference values based on the measurement results if this parameter is set to On. When you set a value to either Scale/Div or Ref Value manually, Auto Scaling automatically changes to Off.
Preset	ON
State Saved	Saved in instrument state.
Range	Off On
Backwards Compatibility SCPI	:DISPlay:CDPower:VIEW3:WINDow2:TRACe:Y[:SCALE]:COUPle
Initial S/W Revision	Prior to A.02.00

## Y Auto Scaling (Code Domain (Quad View) View, Chip Power Window)

When Auto Scaling is On, and the Restart front panel key is pressed, this function automatically displays the scale per division and reference value results in the Chip Power view of Code Domain (Quad View) View.

Key Path	AMPTD Y Scale
Mode	1xEV-DO
Remote Command	:DISPlay:CDPower[:BTS]:VIEW3:WINDow4:TRACe:Y[:SCALe]:COUPle 0   1   OFF   ON  :DISPlay:CDPower[:BTS]:VIEW3:WINDow4:TRACe:Y[:SCALe]:COUPle?
Example	DISP:CDP:VIEW3:WIND4:TRAC:Y:COUP ON DISP:CDP:VIEW3:WIND4:TRAC:Y:COUP?
Notes	Upon pressing the Restart front-panel key or Restart menu key under the Meas Control menu, the Auto Scaling function automatically determines the scale per division and reference values based on the measurement results if this parameter is set to On. When you set a value to either Scale/Div or Ref Value manually, Auto Scaling automatically changes to Off.
Preset	ON
State Saved	Saved in instrument state.
Range	Off On
Backwards Compatibility SCPI	:DISPlay:CDPower:VIEW3:WINDow4:TRACe:Y[:SCALe]:COUPle
Initial S/W Revision	Prior to A.02.00

## Y Auto Scaling (Demod Bits View, Power Bar Graph Window)

When Auto Scaling is On, and the Restart front panel key is pressed, this function automatically displays the scale per division and reference value results in Power Bar Graph Window of Demod Bits View.

Key Path	AMPTD Y Scale
Mode	1xEV-DO
Remote Command	:DISPlay:CDPower[:BTS]:VIEW4:WINDow[1]:TRACe:Y[:SCALe]:COUPle 0   1   OFF   ON  :DISPlay:CDPower[:BTS]:VIEW4:WINDow[1]:TRACe:Y[:SCALe]:COUPle?
Example	DISP:CDP:VIEW3:WIND2:TRAC:Y:COUP ON DISP:CDP:VIEW3:WIND2:TRAC:Y:COUP?
Notes	Upon pressing the Restart front-panel key or Restart menu key under the Meas Control menu, the Auto Scaling function automatically determines the scale per division and reference values based on the measurement results if this parameter is set to On. When you set a value to either Scale/Div or Ref Value manually, Auto Scaling automatically changes to Off.
Preset	OFF
State Saved	Saved in instrument state.

Range	Off On
<b>Backwards Compatibility SCPI</b>	:DISPlay:CDPower:VIEW4:WINDow1:TRACe:Y[:SCALe]:COUPle
Initial S/W Revision	Prior to A.02.00

### Y Auto Scaling (Demod Bits View, RMS Code Power/Slot Window)

When Auto Scaling is On, and the Restart front panel key is pressed, this function automatically displays the scale per division and reference value results in the RMS Code Power/Slot view of Demod Bits View.

Key Path	AMPTD Y Scale
Mode	1xEV-DO
<b>Remote Command</b>	:DISPlay:CDPower[:BTS]:VIEW4:WINDow2:TRACe:Y[:SCALe]:COUPle 0   1   OFF   ON  :DISPlay:CDPower[:BTS]:VIEW4:WINDow2:TRACe:Y[:SCALe]:COUPle?
<b>Example</b>	DISP:CDP:VIEW4:WIND2:TRAC:Y:COUP ON DISP:CDP:VIEW4:WIND2:TRAC:Y:COUP?
Notes	Upon pressing the Restart front-panel key or Restart menu key under the Meas Control menu, the Auto Scaling function automatically determines the scale per division and reference values based on the measurement results if this parameter is set to On. When you set a value to either Scale/Div or Ref Value manually, Auto Scaling automatically changes to Off.
Preset	ON
State Saved	Saved in instrument state.
Range	Off On
<b>Backwards Compatibility SCPI</b>	:DISPlay:CDPower:VIEW4:WINDow2:TRACe:Y[:SCALe]:COUPle
Initial S/W Revision	Prior to A.02.00

## Auto Couple

The Auto Couple feature provides a quick and convenient way to automatically couple multiple instrument settings. This helps ensure accurate measurements and optimum dynamic range. When the Auto Couple feature is activated, either from the front panel or remotely, all parameters of the current measurement that have an Auto/Manual mode are set to Auto mode and all measurement settings dependent on (or coupled to) the Auto/Man parameters are automatically adjusted for optimal performance.

However, the Auto Couple key actions are confined to the current measurement only. It does not affect other measurements in the mode, and it does not affect markers, marker functions, or trace or display attributes.

See "[More Information](#)" on page 1780

Key Path	Front-panel key
Remote Command	:COUPLe ALL NONE
Example	:COUP ALL
Notes	:COUPLe ALL puts all Auto/Man parameters in Auto mode (equivalent to pressing the Auto Couple key). :COUPLE NONE puts all Auto/Man parameters in manual mode. It decouples all the coupled instrument parameters and is not recommended for making measurements.
Initial S/W Revision	Prior to A.02.00

### More Information

There are two types of functions that have Auto/Manual modes.

#### Auto/Man Active Function keys

An Auto/Man toggle key controls the binary state associated with an instrument parameter by toggling between Auto (where the parameter is automatically coupled to the other parameters it is dependent upon) and Man (where the parameter is controlled independent of the other parameters), as well as making the parameter the active function. The current mode is indicated on the softkey with either Auto or Man underlined as illustrated below.

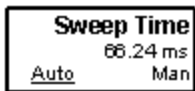

usd07

#### Auto/Man 1-of-N keys

An Auto/Man 1-of-N key allows you to manually pick from a list of parameter values, or place the function in Auto, in which case the value is automatically selected (and indicated) as shown below. If in Auto, Auto is underlined on the calling key. If in manual operation, manual is indicated on the calling key. But the calling key does not actually toggle the function, it simply opens the menu.



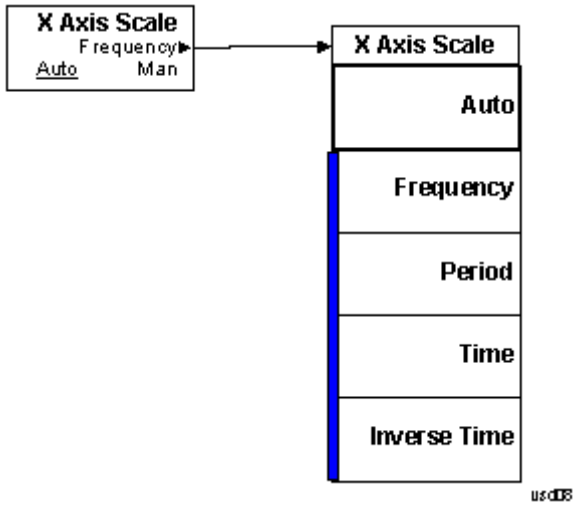

## BW

There is no meas local functionality.

---

Key Path	Front Panel key
Initial S/W Revision	Prior to A.02.00

---

## Cont (Continuous Measurement/Sweep)

Sets the analyzer for Continuous measurement operation. The single/continuous state is Meas Global so the setting will affect all measurements. If you are Paused, pressing Cont does a Resume.

Key Path	Front-panel key
Remote Command	:INITiate:CONTinuous OFF ON 0 1 :INITiate:CONTinuous?
Example	:INIT:CONT 0 puts analyzer in Single measurement operation. :INIT:CONT 1 puts analyzer in Continuous measurement operation
Preset	ON (Note that SYST:PRESet sets INIT:CONT to ON but *RST sets INIT:CONT to OFF)
State Saved	Saved in instrument state
Backwards Compatibility Notes	For Spectrum Analysis mode in ESA and PSA, there is no Cont hardkey, instead there is a Sweep Single/Cont key. In these analyzers, switching the Sweep Single/Cont key from Single to Cont restarts averages (displayed average count reset to 1), but does not restart Max Hold and Min Hold. The X-Series has Single and Cont keys in place of the SweepSingleCont key. In the X-Series, if in single measurement, the Cont key (and INIT:CONT ON ) switches to continuous measurement, but never restarts a measurement and never resets a sweep.
Initial S/W Revision	Prior to A.02.00

In Swept SA Measurement (Spectrum Analysis Mode):

The analyzer takes repetitive sweeps, averages, measurements, etc., when in Continuous mode. When the average count reaches the Average/Hold Number the count stops incrementing, but the analyzer keeps sweeping. See the Trace/Detector section for the averaging formula used both before and after the Average/Hold Number is reached. The trigger condition must be met prior to each sweep. The type of trace processing for multiple sweeps, is set under the Trace/Detector key, with choices of Trace Average, Max Hold, or Min Hold.

In Other Measurements/Modes:

With Avg/Hold Num (in the Meas Setup menu) set to Off or set to On with a value of 1, a sweep is taken after the trigger condition is met; and the analyzer continues to take new sweeps after the current sweep has completed and the trigger condition is again met. However, with Avg/Hold Num set to On with a value >1, multiple sweeps (data acquisitions) are taken for the measurement. The trigger condition must be met prior to each sweep. The sweep is not stopped when the average count k equals the number N set for Avg/Hold Num is reached, but the number k stops incrementing. A measurement average usually applies to all traces, marker results, and numeric results. But sometimes it only applies to the numeric results.

If the analyzer is in Single measurement, pressing the Cont key does not change k and does not cause the sweep to be reset; the only action is to put the analyzer into Continuous measurement operation.

If it is already in continuous sweep:

the INIT:CONT 1 command has no effect

15 Forward Link Code Domain Measurement  
Cont (Continuous Measurement/Sweep)

the INIT:CONT 0 command will place the analyzer in Single Sweep but will have no effect on the current sequence until  $k = N$ , at which point the current sequence will stop and the instrument will go to the idle state.

## File

See ["File" on page 354](#)

## FREQ Channel

Accesses a menu of keys that allow you to control the Frequency and Channel parameters of the instrument.

Some features in the Frequency menu are the same for all measurements – they do not change as you change measurements. Settings like these are called “Meas Global” and are unaffected by Meas Preset. For example, the Center Freq setting is the same for all measurements - it does not change as you change measurements.

<b>Key Path</b>	<b>Front-panel key</b>
<b>Initial S/W Revision</b>	<b>Prior to A.02.00</b>

### Center Freq

Sets the frequency that corresponds to the horizontal center of the graticule (when frequency Scale Type is set to linear). While adjusting the Center Frequency the Span is held constant, which means that both Start Frequency and Stop Frequency will change.

Pressing Center Freq also sets the frequency entry mode to Center/Span. In Center/Span mode, the center frequency and span values are displayed below the graticule, and the default active function in the Frequency menu is Center Freq.

The center frequency setting is the same for all measurements within a mode, that is, it is Meas Global. Some modes are also able to share a Mode Global center frequency value. If this is the case, the Mode will have a Global Settings key in its Mode Setup menu.

The Center Freq function sets (and queries) the Center Frequency for the currently selected input. If your analyzer has multiple inputs, and you select another input, the Center Freq changes to the value for that input. SCPI commands are available to directly set the Center Freq for a specific input.

Center Freq is remembered as you go from input to input. Thus you can set a Center Freq of 10 GHz with the RF Input selected, change to BBIQ and set a Center Freq of 20 MHz, then switch to External Mixing and set a Center Freq of 60 GHz, and when you go back to the RF Input the Center Freq will go back to 10 GHz; back to BBIQ and it is 20 MHz; back to External Mixing and it is 60 GHz.

See ["RF Center Freq" on page 1789](#)

See [Ext Mix Center Freq](#)

See ["I/Q Center Freq" on page 1791](#)

See ["Center Frequency Presets" on page 1787](#)

<b>Key Path</b>	<b>FREQ Channel</b>
<b>Scope</b>	<b>Meas Global</b>
<b>Remote Command</b>	<code>[ :SENSE ] :FREQuency:CENTer &lt;freq&gt;</code> <code>[ :SENSE ] :FREQuency:CENTer?</code>

<b>Example</b>	FREQ:CENT 50 MHz FREQ:CENT UP changes the center frequency to 150 MHz if you use FREQ:CENT:STEP 100 MHz to set the center frequency step size to 100 MHz FREQ:CENT?
<b>Notes</b>	This command sets either the RF or I/Q Center Frequency depending on the selected input. For RF input it is equivalent to FREQ:RF:CENT For I/Q input it is equivalent to FREQ:IQ:CENT Preset and Max values are dependent on Hardware Options (5xx) If no terminator (e.g. MHz) is sent the terminator Hz is used. If a terminator with unit other than Frequency is used, an invalid suffix error message is generated.
<b>Dependencies</b>	The Center Frequency can be limited by Start or Stop Freq limits, if the Span is so large that Start or Stop reach their limit.
<b>Couplings</b>	When operating in “swept span”, any value of the Center Frequency or Span that is within the frequency range of the analyzer is allowed when the value is being set through the front panel numeric key pad or the SCPI command. The other parameter is forced to a different value if needed, to keep the Start and the Stop Frequencies within the analyzer’s frequency range
<b>Preset</b>	Depends on instrument maximum frequency, mode, measurement, and selected input. See <a href="#">"Center Frequency Presets" on page 1787</a> and <a href="#">"RF Center Freq" on page 1789</a> and <a href="#">Ext Mix Center Freq</a> and <a href="#">"I/Q Center Freq" on page 1791</a> .
<b>State Saved</b>	Saved in instrument state
<b>Min</b>	Depends on instrument maximum frequency, mode, measurement, and selected input.. See <a href="#">"Center Frequency Presets" on page 1787</a> and <a href="#">"RF Center Freq" on page 1789</a> and <a href="#">"I/Q Center Freq" on page 1791</a> .
<b>Max</b>	Depends on instrument maximum frequency, mode, measurement, and selected input.. See <a href="#">"Center Frequency Presets" on page 1787</a> and <a href="#">"RF Center Freq" on page 1789</a> and <a href="#">"I/Q Center Freq" on page 1791</a> .
<b>Default Unit</b>	Hz
<b>Status Bits/OPC</b>	Non-overlapped
<b>Dependencies</b>	
<b>Initial S/W Revision</b>	Prior to A.02.00

## Center Frequency Presets

The following table provides the Center Frequency Presets for the Spectrum Analyzer mode, and the Max Freq, for the various frequency options:

Freq Option	CF after Mode Preset	Stop Freq after Mode Preset	Max Freq (can't tune)

15 Forward Link Code Domain Measurement  
FREQ Channel

			above)
503 (all but N9000A)	1.805 GHz	3.6 GHz	3.7 GHz
503 (N9000A)	1.505 GHz	3.0 GHz	3.08 GHz
507 (all but N9000A)	3.505 GHz	7.0 GHz	7.1 GHz
507 (N9000A)	3.755 GHz	7.5 GHz	7.58 GHz
508 (all but N9038A)	1.805 GHz	3.6 GHz	8.5 GHz
508 (N9038A)	4.205 GHz	8.4 GHz	8.5 GHz
513	6.805 GHz	13.6 GHz	13.8 GHz
526 (all but N9000A and N9038A)	13.255 GHz	26.5 GHz	27.0 GHz
526 (N9000A)	13.255 GHz	26.5 GHz	26.55 GHz
526 (N9038A)	1.805 GHz	3.6 GHz	27.0 GHz
532	16.005 GHz	32.0 GHz	32.5 GHz
543	21.505 GHz	43.0 GHz	TBD
544	22.005 GHz	44.0 GHz	44.5 GHz
550	25.005 GHz	50.0 GHz	51 GHz

Input 2:

Model	CF after Mode Preset	Stop Freq after Mode Preset	Max Freq (can't tune above)
N9000A opt C75	0.7505GHz	1.5 GHz	1.58 GHz
N9038A	505 MHz	1 GHz	1.000025 GHz

Tracking Generator Frequency Limits (N9000A only):

Tracking Generator Option	Min Freq (clips to this freq when turn TG on and	If above this Freq, Stop Freq clipped to this Freq when	Max Freq (can't tune above) while TG



	can't tune below while TG on)	TG turned on	on
T03	9 kHz	3.0 GHz	3.08 GHz
T06	9 kHz	6.0 GHz	6.05 GHz

The following table shows the Center Frequency Presets for modes other than Spectrum Analyzer:

Mode	CF Preset for RF
WCDMA	1 GHz
WIMAXOFDMA,	1 GHz
BASIC	1 GHz
ADEMOD	1 GHz
VSA	1 GHz
TDSCDMA	1 GHz
PNOISE	1 GHz
LTE	1 GHz
LTETDD	1 GHz
MSR	1 GHz
GSM	935.2 MHz
NFIGURE	1.505 GHz

## RF Center Freq

SCPI command for specifying the RF Center Frequency. This command will set the Center Frequency to be used when the RF input is selected, even if the RF input is not the input that is selected at the time the command is sent. Note that the Center Freq function in the Frequency menu on the front panel always applies to the currently selected input.

Scope	Meas Global
<b>Remote Command</b>	<code>[ :SENSe ] :FREQuency:RF:CENTer &lt;freq&gt;</code> <code>[ :SENSe ] :FREQuency:RF:CENTer?</code>
<b>Example</b>	FREQ:RF:CENT 30 MHz
Notes	This command is the same in all modes, but the parameter is Measurement Global. So the value is independent in each mode and common across all the measurements in the mode.
Dependencies	If the electronic/soft attenuator is enabled, any attempt to set Center Frequency such that the Stop Frequency would be >3.6 GHz fails and results in an advisory message. If the equivalent SCPI command is sent, this same message is generated as part of a “-221, Settings conflict” warning. If Source Mode is set to Tracking, and the Max or Min Center Freq is therefore limited by the limits of the source, a warning message is generated, “Data out of range;clipped to source max/min” if these limits are exceeded. Note that for an external source, these limits can be affected by the settings of

	Source Numerator, Source Denominator and Power Sweep.
Preset	See table above
State Saved	Saved in instrument state.
Min	-79.999995 MHz, unless Source Mode is set to Tracking, in which case it is limited by the minimum frequency of the Source
Max	See table above. Basically instrument maximum frequency - 5 Hz. Note that, if the Source Mode is set to Tracking, the effective instrument maximum frequency may be limited by the source maximum frequency.  If the knob or step keys are being used, also depends on the value of the other three interdependent parameters Span, Start Frequency and Stop Frequency
Initial S/W Revision	Prior to A.02.00
Modified at S/W Revision	A.03.00

### Ext Mix Center Freq

SCPI command for specifying the External Mixer Center Frequency. This command will set the Center Frequency to be used when the External Mixer is selected, even if the External Mixer input is not the input which is selected at the time the command is sent. Note that the Center Freq function in the Frequency menu on the front panel always applies to the currently selected input.

Scope	Meas Global
Remote Command	<code>[ :SENSe ] :FREQuency:EMIXer:CENTer &lt;freq&gt;</code> <code>[ :SENSe ] :FREQuency:EMIXer:CENTer?</code>
Example	<code>:FREQ:EMIX:CENT 60 GHz</code> <code>:FREQ:EMIX:CENT?</code>
Notes	This command is the same in all modes, but the parameter is Measurement Global. So the value is independent in each mode and common across all the measurements in the mode.
Couplings	When returning to External Mixing after having been switched to one of the other inputs (e.g., RF), you will come back into the settings that you had when you left External Mixing. So you will come back to the band you were in with the Center Frequency that you had. However, Span is not an input-dependent parameter, therefore you will bring the span over from the other input. Therefore, the analyzer comes back with the span from the previous input, limited as necessary by the current mixer setup.
Preset	When a Mode Preset is performed while in External Mixing, the Start frequency of the current Mode is set to the nominal Min Freq of the lowest harmonic range in the Harmonic Table for the current mixer setup. Similarly, the Stop frequency of the current Mode is set to the nominal Max Freq of the highest harmonic range in the Harmonic Table. The Center Freq thus presets to the point arithmetically equidistant from these two frequencies.  If the current measurement has a limited Span available to it, and cannot achieve the Span shown in the table (Span=Stop Freq - Start Freq), the analyzer uses the maximum Span the measurement allows, and still sets the Center Freq to the midpoint of the Start and Stop Freq values in the Harmonic Table.

	When Restore Input/Output Defaults is performed, the mixer presets to the 11970A, whose Start and Stop frequencies are 26.5 and 40 GHz respectively. The center of these two frequencies is 33.25 GHz. Therefore, after a Restore Input/Output Defaults, if you go into External Mixing and do a Mode Preset while in the Spectrum Analyzer Mode, the resulting Center Freq is 33.25 GHz.
State Saved	Saved in instrument state.
Min	The minimum frequency in the currently selected mixer band + 5 Hz
Max	The maximum frequency in the currently selected mixer band – 5 Hz If the knob or step keys are being used, also depends on the value of the other three interdependent parameters Span, Start Frequency and Stop Frequency
Initial S/W Revision	A.08.01

### I/Q Center Freq

SCPI command for specifying the I/Q Center Frequency. This command will set the Center Frequency to be used when the I/Q input is selected, even if the I/Q input is not the input which is selected at the time the command is sent. Note that the Center Freq function in the Frequency menu on the front panel always applies to the currently selected input.

Scope	Meas Global
Remote Command	[ :SENSe ] :FREQuency:IQ:CENTer <freq> [ :SENSe ] :FREQuency:IQ:CENTer?
Example	FREQ:IQ:CENT: 30 MHz
Notes	This command is the same in all modes, but the parameter is Measurement Global. So the value is independent in each mode and common across all the measurements in the mode.
Preset	0 Hz
State Saved	Saved in instrument state.
Min	-40.049995 MHz
Max	40.049995 MHz
Initial S/W Revision	Prior to A.02.00

### CF Step

Changes the step size for the center frequency and start and stop frequency functions. Once a step size has been selected and the center frequency function is active, the step keys (and the UP|DOWN parameters for Center Frequency from remote commands) change the center frequency by the step-size value. The step size function is useful for finding harmonics and sidebands beyond the current frequency span of the analyzer.

Note that the start and stop frequencies also step by the CF Step value.

<b>Key Path</b>	FREQ Channel
<b>Remote Command</b>	[:SENSe]:FREQuency:CENTer:STEP[:INCRement] <freq> [:SENSe]:FREQuency:CENTer:STEP[:INCRement]? [:SENSe]:FREQuency:CENTer:STEP:AUTO OFF ON 0 1 [:SENSe]:FREQuency:CENTer:STEP:AUTO?
<b>Example</b>	FREQ:CENT:STEP:AUTO ON FREQ:CENT:STEP 500 MHz FREQ:CENT UP increases the current center frequency value by 500 MHz FREQ:CENT:STEP? FREQ:CENT:STEP:AUTO?
<b>Notes</b>	Preset and Max values are depending on Hardware Options (503, 507, 508, 513, 526)
<b>Notes</b>	Preset and Max values are dependent on Hardware Options (5xx)
<b>Dependencies</b>	Freq Offset is not available in External Mixing. In this case the Freq Offset key is grayed out and shows a value of zero. It will once again be available, and show the previously set value, when you return to the RF Input.
<b>Dependencies</b>	Span, RBW, Center frequency If the electronic/soft attenuator is enabled, any attempt to change the value of the center frequency >3.6 GHz by pressing the Up-arrow key, fails and results in an advisory message. If the equivalent SCPI command is sent, this same message is generated as part of a “-221, Settings conflict” warning.
<b>Couplings</b>	When auto-coupled in a non-zero span, the center frequency step size is set to 10% of the span. When auto-coupled in zero span, the center frequency step size is set to the equivalent -3 dB RBW value.
<b>Preset</b>	Auto ADEM0D: 1 MHz ON
<b>State Saved</b>	Saved in instrument state
<b>Min</b>	– (the maximum frequency of the instrument). That is, 27 GHz max freq instrument has a CF step range of +/- 27 GHz. Note that this is the maximum frequency given the current settings of the instrument, so in External Mixing, for example, it is the maximum frequency of the current mixer band.
<b>Max</b>	The maximum frequency of the instrument. That is, 27 GHz max freq instrument has a CF step range of +/- 27 GHz. Note that this is the maximum frequency given the current settings of the instrument, so in External Mixing, for example, it is the maximum frequency of the current mixer band.
<b>Default Unit</b>	Hz
<b>Status Bits/OPC dependencies</b>	non-overlapped
<b>Initial S/W Revision</b>	Prior to A.02.00
<b>Modified at S/W Revision</b>	A.03.00

## Input/Output

See ["Input/Output" on page 226](#)

## Marker

Accesses a menu that enables you to select, set up and control the markers for the current measurement.

Contained within this menu is a 1-of-N selection of the control mode (Normal, Delta, Off) for the selected marker.

See the Marker key description under the Marker menu in the Spectrum Analyzer Mode, Swept SA Measurement.

<b>Key Path</b>	<b>Front Panel key</b>
<b>Initial S/W Revision</b>	<b>Prior to A.02.00</b>

### Marker Type

Sets the marker control mode. If the selected marker is Off, pressing Marker sets it to Normal and places it at the center of the screen on the trace determined by the Marker Trace rules. At the same time, reference value of the selected marker appears on the Active Function area.

Active Function Display:

Marker symbol value at I/Q Symbol Polar Vector graph

Marker X-axis value at other graphs

Default Active Function: the active function for the selected marker's current control mode. If the current control mode is Off, there is no active function and the active function is turned off.

The marker X axis value entered in the active function area will display the marker value to its full entered precision.

<b>Key Path</b>	<b>Marker</b>
<b>Mode</b>	<b>1xEV-DO</b>
<b>Remote Command</b>	<code>:CALCulate:CDPower[:BTS]:MARKer[1] 2 ...12:MODE POSITION   DELTA   OFF</code> <code>:CALCulate:CDPower[:BTS]:MARKer[1] 2 ...12:MODE?</code>

**Example**  
CALC:CDP:MARK:MODE POS  
CALC:CDP:MARK:MODE?

**Notes**

If the selected marker is Off, pressing Marker sets it to Normal and places it at the center of the screen on the trace determined by the Marker Trace rules. At the same time, Marker X Axis Value appears on the Active Function area.

Default Active Function: the active function for the selected marker's current control mode. If the current control mode is Off, there is no active function and the active function is turned off.

Active Function Display:

Marker symbol value at I/Q Symbol Polar Vector graph

Marker X-axis value at other graphs

the marker X axis value entered in the active function area will display the marker value to its full entered precision.

	NORMAL is changed to POSition in the new SA.
Preset	OFF
State Saved	Saved in instrument state.
Range	Normal Delta Off
<b>Backwards Compatibility SCPI</b>	:CALCulate:CDPower:MARKer [1]   2   . . . 4:MODE
Initial S/W Revision	Prior to A.02.00

## Properties

Accesses a menu that enables you to select a relative marker and marker trace.

Key Path	Marker
Initial S/W Revision	Prior to A.02.00

## Marker

Accesses a menu that enables you to select, set up and control the markers for the current measurement.

Contained within this menu is a 1-of-N selection of the control mode (Normal, Delta, Off) for the selected marker.

See the Marker key description under the Marker menu in the Spectrum Analyzer Mode, Swept SA Measurement.

Key Path	Front Panel key
Initial S/W Revision	Prior to A.02.00

## Relative TO

Selects the marker the selected marker will be relative to (its reference marker).

Key Path	Marker, Properties
Mode	1xEV-DO
<b>Remote Command</b>	:CALCulate:CDPower[:BTS]:MARKer [1]   2   . . . 12:REFeRence <integer> :CALCulate:CDPower[:BTS]:MARKer [1]   2   . . . 12:REFeRence?
<b>Example</b>	CALC:CDP:MARK:REF 4 CALC:CDP:MARK:REF?
Notes	A marker cannot be relative to itself so that choice is grayed out, and if sent from SCPI generates error -221: "Settings conflict; marker cannot be relative to itself." When queried a single value will be returned (the specified marker numbers relative marker).

	You must be in the Spectrum Analysis mode, 1xEV-DO mode to use this command. Use INSTRUMENT:SElect to set the mode.
Preset	2 3 4 5 6 7 8 9 10 11 12 1
State Saved	Saved in instrument state.
Min	1
Max	12
<b>Backwards Compatibility SCPI</b>	:CALCulate:CDPower:MARKer[1] 2 ...4:REFerence
Initial S/W Revision	Prior to A.02.00

### Marker Trace

Assigns the specified marker to the designated trace.

Key Path	Marker, Properties
Mode	1xEV-DO
<b>Remote Command</b>	:CALCulate:CDPower[:BTS]:MARKer[1] 2 ...12:TRACe CDPower   SPOWer   CPOWer   CDError :CALCulate:CDPower[:BTS]:MARKer[1] 2 ...12:TRACe?
<b>Example</b>	CALC:CDP:MARK:TRACE CDE CALC:CDP:MARK:TRACE?
Preset	CDPower
State Saved	Saved in instrument state.
Range	Code Domain Power Code Domain Error Symbol Power Chip Power
<b>Backwards Compatibility SCPI</b>	:CALCulate:CDPower:MARKer[1] 2 ...4:TRACe
Initial S/W Revision	Prior to A.02.00

### Couple Marker

Toggles the state of the markers to be coupled On or Off. When this function is true, moving any marker causes an equal X Axis movement of every other marker which is not Off. By "equal X Axis movement" we mean that we preserve the difference between each marker's X Axis value (in the fundamental x-axis units of the trace that marker is on) and the X Axis value of the marker being moved (in the same fundamental x-axis units).

See Couple Marker in the "Marker" section for more information.

Key Path	Marker
Mode	1xEV-DO
<b>Remote Command</b>	:CALCulate:CDPower[:BTS]:MARKer:COUple[:STATe] ON OFF 1 0



	:CALCulate:CDPower[:BTS]:MARKer:COUPle[:STATe]?
<b>Example</b>	CALC:CDP:MARK:COUP ON
Preset	OFF
State Saved	Saved in instrument state.
Range	On Off
<b>Backwards Compatibility SCPI</b>	:CALCulate:CDPower:MARKer:COUPle[:STATe]
Initial S/W Revision	Prior to A.02.00

### All Markers Off

Turns off all markers.

Key Path	Marker
Mode	1xEV-DO
<b>Remote Command</b>	:CALCulate:CDPower[:BTS]:MARKer:AOFF
<b>Example</b>	CALC:CDP:MARK:AOFF
<b>Backwards Compatibility SCPI</b>	:CALCulate:CDPower:MARKer:AOFF
Initial S/W Revision	Prior to A.02.00

### Marker Symbol Value (Remote Command only)

Sets the marker Symbol value in the current marker for the I/Q Polar trace. It has no effect if the control mode is Off, but if the control mode is Normal, this is the SCPI equivalent of entering a Symbol value.

This command is valid only when Marker Trace 'POLar'(I/Q Polar)is active. For any other Marker Trace, the command is ignored.

Mode	CDMA1XEV
<b>Remote Command</b>	:CALCulate:CDPower[:BTS]:MARKer[1] 2 ...12:SYMBol <real> :CALCulate:CDPower[:BTS]:MARKer[1] 2 ...12:SYMBol?
<b>Example</b>	CALC:CDP:MARK:SYMB 0 CALC:CDP:MARK:SYMB?
Notes	If no suffix is sent, 'chips' will be used. If a suffix is sent that does not match 'chips', an error "Invalid suffix" will be generated.  The query returns the marker's 'chips' value in the trace if the control mode is Normal The query is returned in 'chips'. If the marker is Off the response is not a number (NAN).  This parameter has different meanings when the marker trace is set to I/Q Polar and others cases. In the case of the I/Q Polar Graph, the X Axis Value is also the measured value, so this parameter is meaningful only when the control mode is set to Normal.

Preset	Start point of the trace in the display window
State Saved	No
Min	-9.9E+37
Max	9.9E+37
Initial S/W Revision	Prior to A.02.00

### Marker X Axis Value (Remote Command only)

Sets the marker X Axis value in the current marker X Axis Scale unit. It has no effect if the control mode is Off, but is the SCPI equivalent of entering an X value if the control mode is Normal or Delta.

Mode	CDMA1XEV
<b>Remote Command</b>	:CALCulate:CDPower[:BTS]:MARKer[1] 2 ...12:X <real> :CALCulate:CDPower[:BTS]:MARKer[1] 2 ...12:X?
<b>Example</b>	CALC:CDP:MARK3:X 0.0 CALC:CDP:MARK3:X?
Notes	The marker X Axis value has no unit suffix. For capture time data trace, the unit is second. The query returns the marker's absolute X Axis value if the control mode is Normal, or the offset from the marker's reference marker if the control mode is Delta. The query is returned without unit suffix.
Preset	After a preset, all Markers are turned OFF, so Marker X Axis Value query will return a not a number (NAN).
State Saved	No
Min	-9.9E+37
Max	9.9E+37
Initial S/W Revision	Prior to A.02.00

### Marker X Axis Position (Remote Command only)

Sets the marker X position in trace points. It has no effect if the control mode is Off, but is the SCPI equivalent of entering a value if the control mode is Normal or Delta - except in trace points rather than X Axis Scale units. The entered value is immediately translated into the current X Axis Scale units for setting the value of the marker.

Mode	CDMA1XEV
<b>Remote Command</b>	:CALCulate:CDPower[:BTS]:MARKer[1] 2 ...12:X:POSition <real> :CALCulate:CDPower[:BTS]:MARKer[1] 2 ...12:X:POSition?
<b>Example</b>	CALC:CDP:MARK10:X:POS 0.0 CALC:CDP:MARK10:X:POS?

Preset	After a preset, all Markers are turned OFF, so Marker X Axis Value query will return a not a number (NAN).
State Saved	No
Min	-9.9E+37
Max	9.9E+37
Initial S/W Revision	Prior to A.02.00

### Marker Y Axis Value (Remote Command only)

Queries the marker Y Axis value in the current marker Y Axis unit.

Mode	CDMA1XEV
<b>Remote Command</b>	:CALCulate:CDPower[:BTS]:MARKer[1] 2 ...12:Y?
<b>Example</b>	CALC:CDP:MARK11:Y?
Preset	Result dependant on markers setup and signal source
State Saved	No
Initial S/W Revision	Prior to A.02.00

### Backward Compatibility SCPI Commands

Sets or queries the state of a marker. Setting a marker which is OFF to state ON or 1 puts it in Normal mode and places it at the center of the screen.

Mode	CDMA1XEV
<b>Remote Command</b>	:CALCulate:CDPower[:BTS]:MARKer[1] 2 ...12:STATe OFF ON 0 1 :CALCulate:CDPower[:BTS]:MARKer[1] 2 ...12:STATe?
<b>Example</b>	CALC:CDP:MARK3:STATe ON CALC:CDP:MARK3:STAT?
Preset	OFF
State Saved	Saved in instrument state.
Range	On Off
<b>Backwards Compatibility SCPI</b>	:CALCulate:CDPower:MARKer[1] 2 ...4:STATe
Initial S/W Revision	Prior to A.02.00

## Marker Fctn

There are no Marker Function operations supported in the Code Domain measurement. The front-panel key will display a blank menu when pressed.

---

Key Path	Front Panel key
Initial S/W Revision	Prior to A.02.00

---

## Marker To

Accesses menu keys that can copy the current marker value into other instrument parameter, for example Despread. If the currently selected marker is not on when the front panel key is pressed, it will be turned on at the center of the screen as a normal type marker.

See the Marker To key description under the Marker menu in the Spectrum Analyzer Mode, Swept SA Measurement.

Key Path	Front Panel key
Initial S/W Revision	Prior to A.02.00

### Mkr -> Despread

Executes post process for selected marker.

Key Path	Marker ->, Mkr->Despread
Mode	1xEV-DO
<b>Remote Command</b>	:CALCulate:CDPower[:BTS]:MARKer[1] 2 ...12[:SET]:DESPread
<b>Example</b>	CALC:CDP:MARK4:SET:DESP
Notes	This function is available only when the marker trace is either 'CDPower' or 'CDError'.
<b>Backwards Compatibility SCPI</b>	:CALCulate:CDPower:MARKer[1] 2 ...4[:SET]:DESPread
Initial S/W Revision	Prior to A.02.00

## Meas

The information in this section is common to all measurements. For key and remote command information for a specific measurement, refer to the section that describes the measurement of interest.

Measurements available under the Meas key are specific to the current Mode.

When viewing Help for measurements, note the following:

**NOTE**

Operation for some keys differs between measurements. The information displayed in Help pertains to the current measurement. To see how a key operates in a different measurement, exit Help (press the Cancel Esc key), select the measurement, then reenter Help (press the Help key) and press that key.

---

Key Path	Front-panel key
Initial S/W Revision	Prior to A.02.00

---

### Remote Measurement Functions

This section contains the following topics:

["Measurement Group of Commands" on page 2849](#)

["Current Measurement Query \(Remote Command Only\)" on page 2851](#)

["Limit Test Current Results \(Remote Command Only\)" on page 2851](#)

["Data Query \(Remote Command Only\)" on page 2851](#)

["Calculate/Compress Trace Data Query \(Remote Command Only\)" on page 2852](#)

["Calculate Peaks of Trace Data \(Remote Command Only\)" on page 2857](#)

[Hardware-Accelerated Fast Power Measurement \(Remote Command Only\)](#)

["Format Data: Numeric Data \(Remote Command Only\)" on page 2858](#)

["Format Data: Byte Order \(Remote Command Only\)" on page 2859](#)

---

Initial S/W Revision	Prior to A.02.00
----------------------	------------------

---

## Measurement Group of Commands

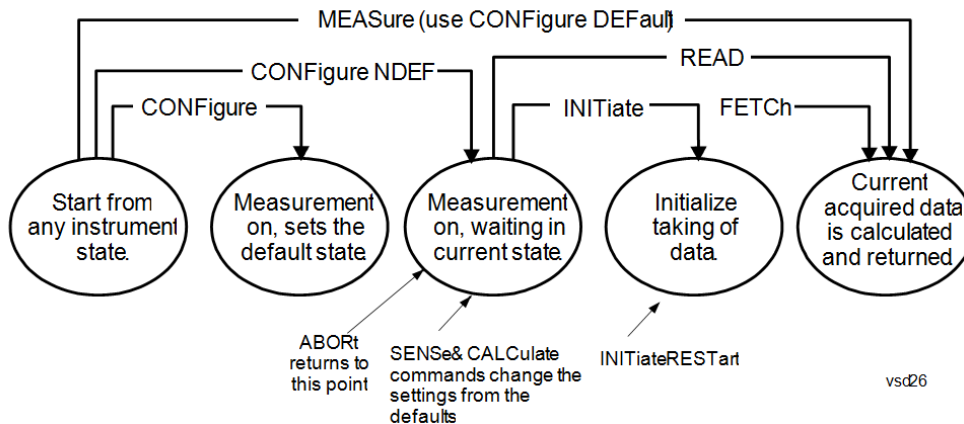

---

### Measure Commands:

:MEASure:<measurement>[n]?

This is a fast single-command way to make a measurement using the factory default instrument settings. These are the settings and units that conform to the Mode Setup settings (e.g. radio standard) that you have currently selected.

- Stops the current measurement (if any) and sets up the instrument for the specified measurement using the factory defaults
- Initiates the data acquisition for the measurement
- Blocks other SCPI communication, waiting until the measurement is complete before returning results.
- If the function does averaging, it is turned on and the number of averages is set to 10.
- After the data is valid it returns the scalar results, or the trace data, for the specified measurement. The type of data returned may be defined by an [n] value that is sent with the command.
- The scalar measurement results will be returned if the optional [n] value is not included, or is set to 1. If the [n] value is set to a value other than 1, the selected trace data results will be returned. See each command for details of what types of scalar results or trace data results are available.
- ASCII is the default format for the data output. (Older versions of Spectrum Analysis and Phase Noise mode measurements only use ASCII.) The binary data formats should be used for handling large blocks of data since they are smaller and faster than the ASCII format. Refer to the FORMat:DATA command for more information.

If you need to change some of the measurement parameters from the factory default settings you can set up the measurement with the CONFIGure command. Use the commands in the SENSe:<measurement> and CALCulate:<measurement> subsystems to change the settings. Then you can use the READ? command to initiate the measurement and query the results.

If you need to repeatedly make a given measurement with settings other than the factory defaults, you can use the commands in the SENSe:<measurement> and CALCulate:<measurement> subsystems to set up the measurement. Then use the READ? command to initiate the measurement and query results.

Measurement settings persist if you initiate a different measurement and then return to a previous one. Use READ:<measurement>? if you want to use those persistent settings. If you want to go back to the default settings, use MEASure:<measurement>?.

---

### Configure Commands:

:CONFigure:<measurement>

This command stops the current measurement (if any) and sets up the instrument for the specified measurement using

---

---

the factory default instrument settings. It does not initiate the taking of measurement data unless INIT:CONTinuous is ON. If you change any measurement settings after using the CONFigure command, the READ command can be used to initiate a measurement without changing the settings back to their defaults.

In the Swept SA measurement in Spectrum Analyzer mode the CONFigure command also turns the averaging function on and sets the number of averages to 10 for all measurements.

:CONFigure: <measurement>: NDEFault stops the current measurement and changes to the specified measurement. It does not change the settings to the defaults. It does not initiate the taking of measurement data unless INIT:CONTinuous is ON.

The CONFigure? query returns the current measurement name.

The CONFigure:CATalog? query returns a quoted string of all licensed measurement names in the current mode. For example, "SAN, CHP, OBW, ACP, PST, TXP, SPUR, SEM, LIST".

---

#### Fetch Commands:

---

:FETCh:<measurement>[n]?

This command puts selected data from the most recent measurement into the output buffer. Use FETCh if you have already made a good measurement and you want to return several types of data (different [n] values, for example, both scalars and trace data) from a single measurement. FETCh saves you the time of re-making the measurement. You can only FETCh results from the measurement that is currently active, it will not change to a different measurement. An error message is reported if a measurement other than the current one is specified.

If you need to get new measurement data, use the READ command, which is equivalent to an INITiate followed by a FETCh.

The scalar measurement results will be returned if the optional [n] value is not included, or is set to 1. If the [n] value is set to a value other than 1, the selected trace data results will be returned. See each command for details of what types of scalar results or trace data results are available. The binary data formats should be used for handling large blocks of data since they are smaller and transfer faster than the ASCII format. (FORMat:DATA)

FETCh may be used to return results other than those specified with the original READ or MEASure command that you sent.

---

#### INITiate Commands:

---

:INITiate:<measurement>

This command is not available for measurements in all the instrument modes:

- Initiates a trigger cycle for the specified measurement, but does not output any data. You must then use the FETCh<meas> command to return data. If a measurement other than the current one is specified, the instrument will switch to that measurement and then initiate it.
  - For example, suppose you have previously initiated the ACP measurement, but now you are running the channel power measurement. If you send INIT:ACP? it will change from channel power to ACP and will initiate an ACP measurement.
  - Does not change any of the measurement settings. For example, if you have previously started the ACP measurement and you send INIT:ACP? it will initiate a new ACP measurement using the same instrument settings as the last time ACP was run.
  - If your selected measurement is currently active (in the idle state) it triggers the measurement, assuming the trigger conditions are met. Then it completes one trigger cycle. Depending upon the measurement and the number of averages, there may be multiple data acquisitions, with multiple trigger events, for one full trigger cycle. It also holds off additional commands on GPIB until the acquisition is complete.
- 

#### READ Commands:

---

:READ:<measurement>[n]?

- Does not preset the measurement to the factory default settings. For example, if you have previously initiated the ACP
-



---

measurement and you send READ:ACP? it will initiate a new measurement using the same instrument settings.

- Initiates the measurement and puts valid data into the output buffer. If a measurement other than the current one is specified, the instrument will switch to that measurement before it initiates the measurement and returns results.
  - For example, suppose you have previously initiated the ACP measurement, but now you are running the channel power measurement. Then you send READ:ACP? It will change from channel power back to ACP and, using the previous ACP settings, will initiate the measurement and return results.
  - Blocks other SCPI communication, waiting until the measurement is complete before returning the results
  - If the optional [n] value is not included, or is set to 1, the scalar measurement results will be returned. If the [n] value is set to a value other than 1, the selected trace data results will be returned. See each command for details of what types of scalar results or trace data results are available. The binary data formats should be used when handling large blocks of data since they are smaller and faster than the ASCII format. (FORMat:DATA)
- 

---

Initial S/W Revision	Prior to A.02.00
----------------------	------------------

---

### Current Measurement Query (Remote Command Only)

This command returns the name of the measurement that is currently running.

---

<b>Remote Command</b>	:CONFigure?
-----------------------	-------------

<b>Example</b>	CONF?
----------------	-------

Initial S/W Revision	Prior to A.02.00
----------------------	------------------

---

### Limit Test Current Results (Remote Command Only)

Queries the status of the current measurement limit testing. It returns a 0 if the measured results pass when compared with the current limits. It returns a 1 if the measured results fail any limit tests.

---

<b>Remote Command</b>	:CALCulate:CLIMits:FAIL?
-----------------------	--------------------------

<b>Example</b>	CALC:CLIM:FAIL? queries the current measurement to see if it fails the defined limits. Returns a 0 or 1: 0 it passes, 1 it fails.
----------------	--------------------------------------------------------------------------------------------------------------------------------------

Initial S/W Revision	Prior to A.02.00
----------------------	------------------

---

### Data Query (Remote Command Only)

Returns the designated measurement data for the currently selected measurement and subopcode.

n = any valid subopcode for the current measurement. See the measurement command results table for your current measurement, for information about what data is returned for the subopcodes.

This command uses the data setting specified by the FORMat:BORDER and FORMat:DATA commands and can return real or ASCII data. (See the format command descriptions under Input/Output in the Analyzer Setup section.)

<b>Remote Command</b>	:CALCulate:DATA[n]?
<b>Notes</b>	The return trace depends on the measurement. In CALCulate:<meas>:DATA[n], n is any valid subopcode for the current measurement. It returns the same data as the FETCH:<measurement>? query where <measurement> is the current measurement.
<b>Initial S/W Revision</b>	Prior to A.02.00

### Calculate/Compress Trace Data Query (Remote Command Only)

Returns compressed data for the currently selected measurement and sub-opcode [n].

n = any valid sub-opcode for that measurement. See the MEASure:<measurement>? command description of your specific measurement for information on the data that can be returned.

The data is returned in the current Y Axis Unit of the analyzer. The command is used with a sub-opcode <n> (default=1) to specify the trace. With trace queries, it is best if the analyzer is not sweeping during the query. Therefore, it is generally advisable to be in Single Sweep, or Update=Off.

This command is used to compress or decimate a long trace to extract and return only the desired data. A typical example would be to acquire N frames of GSM data and return the mean power of the first burst in each frame. The command can also be used to identify the best curve fit for the data.

<b>Remote Command</b>	:CALCulate:DATA<n>:COMPRESS? BLOCK   CFIT   MAXimum   MINimum   MEAN   DMEan   RMS   RMSCubed   SAMPLE   SDEVIation   PPHase [,<soffset> [,<length>[,<roffset>[,<rlimit>]]]]
<b>Example</b>	To query the mean power of a set of GSM bursts: Supply a signal that is a set of GSM bursts. Select the IQ Waveform measurement (in IQ Analyzer Mode). Set the sweep time to acquire at least one burst. Set the triggers such that acquisition happens at a known position relative to a burst. Then query the mean burst levels using, CALC:DATA2:COMP? MEAN, 24e-6, 526e-6 (These parameter values correspond to GSM signals, where 526e-6 is the length of the burst in the slot and you just want 1 burst.)
<b>Notes</b>	The command supports 5 parameters. Note that the last 4 (<soffset>, <length>, <roffset>, <rlimit>) are optional. But these optional parameters must be entered in the specified order. For example, if you want to specify <length>, then you must also specify <soffset>. See details below for a definition of each of these parameters.  This command uses the data in the format specified by FORMat:DATA, returning either binary or ASCII data.
<b>Initial S/W Revision</b>	Prior to A.02.00

- BLOCK or block data - returns all the data points from the region of the trace data that you specify. For example, it could be used to return the data points of an input signal over several timeslots, excluding the portions of the trace data that you do not want. (This is x,y pairs for trace data and I,Q pairs for complex data.)

- CFIT or curve fit - applies curve fitting routines to the data. <soffset> and <length> are required to define the data that you want. <roffset> is an optional parameter for the desired order of the curve equation. The query will return the following values: the x-offset (in seconds) and the curve coefficients ((order + 1) values).

MIN, MAX, MEAN, DME, RMS, RMSC, SAMP, SDEV and PPH return one data value for each specified region (or <length>) of trace data, for as many regions as possible until you run out of trace data (using <roffset> to specify regions). Or they return the number of regions you specify (using <rlimit>) ignoring any data beyond that.

- MINimum - returns the minimum data point (y value) for the specified region(s) of trace data. For I/Q trace data, the minimum magnitude of the I/Q pairs is returned.
- MAXimum - returns the maximum data point (y value) for the specified region(s) of trace data. For I/Q trace data, the maximum magnitude of the I/Q pairs is returned.
- MEAN - returns a single value that is the arithmetic mean of the data point values (in dB/ dBm) for the specified region(s) of trace data. For I/Q trace data, the mean of the magnitudes of the I/Q pairs is returned. See the following equations.

- 

**NOTE**

If the original trace data is in dB, this function returns the arithmetic mean of those log values, not log of the mean power which is a more useful value. The mean of the log is the better measurement technique when measuring CW signals in the presence of noise. The mean of the power, expressed in dB, is useful in power measurements such as Channel Power. To achieve the mean of the power, use the RMS option.

Equation 1

Mean Value of Data Points for Specified Region(s)

$$\text{MEAN} = \frac{1}{n} \sum_{X_i \in \text{region}(s)} X_i$$

where  $X_i$  is a data point value, and  $n$  is the number of data points in the specified region(s).

Equation 2

Mean Value of I/Q Data Pairs for Specified Region(s)

$$\text{MEAN} = \frac{1}{n} \sum_{X_i \in \text{region}(s)} |X_i|$$

where  $|X_i|$  is the magnitude of an I/Q pair, and  $n$  is the number of I/Q pairs in the specified region(s).

- DMEan - returns a single value that is the mean power (in dB/ dBm) of the data point values for the specified region(s) of trace data. See the following equation:

Equation 3

DMEan Value of Data Points for Specified Region(s)

$$\text{DME} = 10 \times \log_{10} \left( \frac{1}{n} \sum_{X_i \in \text{region}(s)} 10^{\frac{X_i}{10}} \right)$$

- RMS - returns a single value that is the average power on a root-mean-squared voltage scale (arithmetic rms) of the data point values for the specified region(s) of trace data. See the following equation.

**NOTE**

For I/Q trace data, the rms of the magnitudes of the I/Q pairs is returned. See the following equation. This function is very useful for I/Q trace data. However, if the original trace data is in dB, this function returns the rms of the log values which is not usually needed.

Equation 4

RMS Value of Data Points for Specified Region(s)

$$\text{RMS} = \sqrt{\frac{1}{n} \sum_{X_i \in \text{region}(s)} X_i^2}$$

where  $X_i$  is a data point value, and  $n$  is the number of data points in the specified region(s).

Equation 5

RMS Value of I/Q Data Pairs for Specified Region(s)

$$\text{RMS} = \sqrt{\frac{1}{n} \sum_{X_i \in \text{region}(s)} X_i X_i^*}$$

where  $X_i$  is the complex value representation of an I/Q pair,  $X_i^*$  its conjugate complex number, and  $n$  is the number of I/Q pairs in the specified region(s).

Once you have the rms value for a region of trace data (linear or I/Q), you may want to calculate the mean power. You must convert this rms value (peak volts) to power in dBm:

$$10 \times \log[10 \times (\text{rms value})^2]$$

- SAMPlE - returns the first data value (x,y pair) for the specified region(s) of trace data. For I/Q trace data, the first I/Q pair is returned.
- SDEVIation - returns a single value that is the arithmetic standard deviation for the data point values for the specified region(s) of trace data. See the following equation.
- For I/Q trace data, the standard deviation of the magnitudes of the I/Q pairs is returned. See the following equation.

Equation 6

Standard Deviation of Data Point Values for Specified Region(s)

$$\text{SDEV} = \sqrt{\frac{1}{n} \sum_{X_i \in \text{region}(s)} (X_i - \bar{X})^2}$$

where  $X_i$  is a data point value,  $\bar{X}$  is the arithmetic mean of the data point values for the specified region (s), and  $n$  is the number of data points in the specified region(s).

$$\text{SDEV} = \sqrt{\frac{1}{n} \sum_{X_i \in \text{region}(s)} (|X_i| - \bar{X})^2}$$

where  $|X_i|$  is the magnitude of an I/Q pair,  $\bar{X}$  is the mean of the magnitudes for the specified region(s), and  $n$  is the number of data points in the specified region(s).

- PPHase - returns the x,y pairs of both rms power (dBm) and arithmetic mean phase (radian) for every specified region and frequency offset (Hz). The number of pairs is defined by the specified number of regions. This parameter can be used for I/Q vector ( $n=0$ ) in Waveform (time domain) measurement and all parameters are specified by data point in PPHase.

The rms power of the specified region may be expressed as:

$$\text{Power} = 10 \times \log [10 \times (\text{RMS I/Q value})] + 10.$$

The RMS I/Q value (peak volts) is:

$$\sqrt{\frac{1}{n} \sum_{X_i \in \text{region}} X_i X_i^*}$$

where  $X_i$  is the complex value representation of an I/Q pair,  $X_i^*$  its conjugate complex number, and  $n$  is the number of I/Q pairs in the specified region.

The arithmetic mean phase of the specified region may be expressed as:

$$\frac{1}{n} \sum_{Y_i \in \text{region}} Y_i$$

where  $Y_i$  is the unwrapped phase of I/Q pair with applying frequency correction and  $n$  is the number of I/Q pairs in the specified region.

The frequency correction is made by the frequency offset calculated by the arithmetic mean of every specified region's frequency offset. Each frequency offset is calculated by the least square method against the unwrapped phase of I/Q pair.

Sample Trace Data - Constant Envelope

(See below for explanation of variables.)

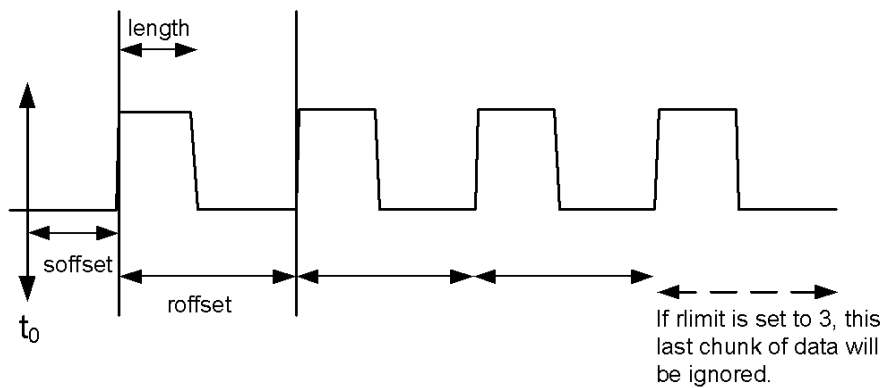

Sample Trace Data - Not Constant Envelope

(See below for explanation of variables.)

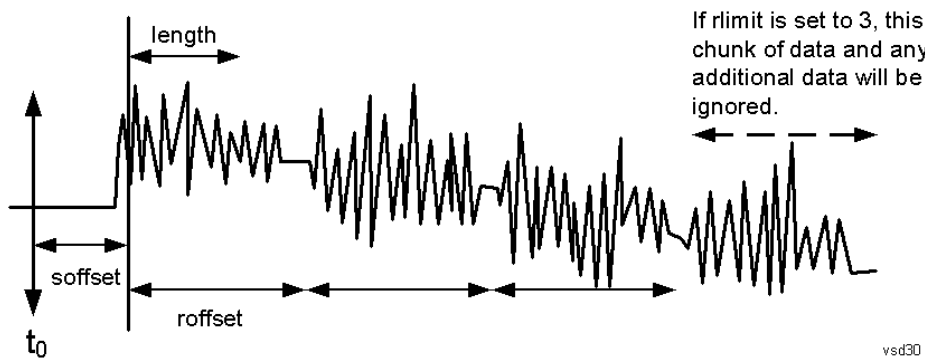

<soffset> - start offset is an optional real number. (It is in seconds for time-domain traces, and is a dimensionless index 0 to Npoints - 1, for frequency-domain traces). It specifies the amount of data at the beginning of the trace that will be ignored before the decimation process starts. It is the time or frequency change from the start of the trace to the point where you want to start using the data. The default value is zero.

<length> - is an optional real number. (It is in seconds for time-domain traces, and is a dimensionless index 0 to Npoints - 1, for frequency-domain traces). It defines how much data will be compressed into one value. This parameter has a default value equal to the current trace length.

<roffset> - repeat offset is an optional real number. (It is in seconds for time-domain traces, and is a dimensionless index 0 to Npoints - 1, for frequency-domain traces). It defines the beginning of the next field of trace elements to be compressed. This is relative to the beginning of the previous field. This parameter has a default value equal to the <length> variable. Note that this parameter is used for a completely different purpose when curve fitting (see CFIT above).

<rlimit> - repeat limit is an optional integer. It specifies the number of data items that you want returned. It will ignore any additional items beyond that number. You can use the Start offset and the Repeat limit to pick out exactly what part of the data you want to use. The default value is all the data.

## Calculate Peaks of Trace Data (Remote Command Only)

Returns a list of all the peaks for the currently selected measurement and sub-opcode [n]. The peaks must meet the requirements of the peak threshold and excursion values.

n = any valid sub-opcode for the current measurement. See the MEASure:<measurement> command description of your specific measurement for information on the data that can be returned.

The command can only be used with specific sub-opcodes with measurement results that are trace data. Both real and complex traces can be searched, but complex traces are converted to magnitude in dBm. In many measurements the sub-opcode n=0, is the raw trace data which cannot be searched for peaks. And Sub-opcode n=1, is often calculated results values which also cannot be searched for peaks.

This command uses the data setting specified by the FORMat:BORDER and FORMat:DATA commands and can return real or ASCII data. If the format is set to INT,32, it returns REAL,32 data.

The command has four types of parameters:

- Threshold (in dBm)
- Excursion (in dB)
- Sorting order (amplitude, frequency, time)
- Optional in some measurements: Display line use (all, > display line, < display line)

---

<b>Remote Command</b>	<p>For Swept SA measurement:</p> <pre>:CALCulate:DATA[1] 2 ... 6:PEAKs? &lt;threshold&gt;,&lt;excursion&gt;[,AMPLitude   FREQuency   TIME[,ALL   GTDLline   LTDLine]]</pre> <p>For most other measurements:</p> <pre>:CALCulate:DATA[1] 2 ... 6:PEAKs? &lt;threshold&gt;,&lt;excursion&gt;[,AMPLitude   FREQuency   TIME]</pre>
-----------------------	---------------------------------------------------------------------------------------------------------------------------------------------------------------------------------------------------------------------------------------------------------------------------------------------------------------------------------

---

<b>Example</b>	<p>Example for Swept SA measurement in Spectrum Analyzer Mode:</p> <p>CALC:DATA4:PEAK? -40, 10, FREQ, GTDL This will identify the peaks of trace 4 that are above -40 dBm, with excursions of at least 10 dB. The peaks are returned in order of increasing frequency, starting with the lowest frequency. Only the peaks that are above the display line are returned.</p> <p>Query Results 1:</p> <p>With FORMat:DATA REAL, 32 selected, it returns a list of floating-point numbers. The first value in the list is the number of peak points that are in the following list. A peak point consists of two values: a peak amplitude followed by its corresponding frequency (or time).</p> <p>If no peaks are found the peak list will consist of only the number of peaks, (0).</p>
----------------	-----------------------------------------------------------------------------------------------------------------------------------------------------------------------------------------------------------------------------------------------------------------------------------------------------------------------------------------------------------------------------------------------------------------------------------------------------------------------------------------------------------------------------------------------------------------------------------------------------------------------------------------------------------------------------------------------------------------------------------------------------------------------------------------

---

<b>Notes</b>	<p>&lt;n&gt; - is the trace that will be used</p> <p>&lt;threshold&gt; - is the level below which trace data peaks are ignored. Note that the threshold value is required and is always used as a peak criterion. To effectively disable the threshold criterion for this command, provide a substantially low threshold value such as -200 dBm. Also note that the threshold value used in this command is independent of and has no effect on the threshold value stored under the Peak Criteria menu.</p> <p>&lt;excursion&gt; - is the minimum amplitude variation (rise and fall) required for a signal to be identified as peak. Note that the excursion value is required and is always used as a peak criterion. To effectively disable the excursion criterion for this command, provide the minimum value of 0.0 dB. Also note that the excursion value used in this command is independent of and has no effect on the</p>
--------------	---------------------------------------------------------------------------------------------------------------------------------------------------------------------------------------------------------------------------------------------------------------------------------------------------------------------------------------------------------------------------------------------------------------------------------------------------------------------------------------------------------------------------------------------------------------------------------------------------------------------------------------------------------------------------------------------------------------------------------------------------------------------------------------------------------------------------------------------------------------------------------------------------------------------------------------

---

---

excursion value stored under the Peak Criteria menu.

Values must be provided for threshold and excursion. The sorting and display line parameters are optional (defaults are AMPLitude and ALL).

Note that there is always a Y-axis value for the display line, regardless of whether the display line state is on or off. It is the current Y-axis value of the display line which is used by this command to determine whether a peak should be reported

Sorting order:

AMPLitude - lists the peaks in order of descending amplitude, with the highest peak first (default if optional parameter not sent)

FREQuency - lists the peaks in order of occurrence, left to right across the x-axis.

TIME - lists the peaks in order of occurrence, left to right across the x-axis.

Peaks vs. Display Line:

ALL - lists all of the peaks found (default if optional parameter not sent).

GTDLine (greater than display line) - lists all of the peaks found above the display line.

LTDLine (less than display line) - lists all of the peaks found below the display line.

---

Initial S/W Revision      Prior to A.02.00

---

### Format Data: Numeric Data (Remote Command Only)

This command specifies the format of the trace data input and output. It specifies the formats used for trace data during data transfer across any remote port. It affects only the data format for setting and querying trace data for the :TRACe[:DATA], TRACe[:DATA]?, :CALCulate:DATA[n]? and FETCh:SANalyzer [n]? commands and queries.

---

**Remote Command**      :FORMat [:TRACe] [:DATA] ASCii|INTEger, 32|REAL, 32 |REAL, 64  
:FORMat [:TRACe] [:DATA] ?

---

**Notes**      The query response is:  
ASCii: ASC,8  
REAL,32: REAL,32  
REAL,64: REAL,64  
INTEger,32: INT,32

When the numeric data format is REAL or ASCii, data is output in the current Y Axis unit. When the data format is INTEger, data is output in units of m dBm (.001 dBm).

The INT,32 format returns binary 32-bit integer values in internal units (m dBm), in a definite length block.

---

**Dependencies**      Sending a data format spec with an invalid number (for example, INT,48) generates no error. The analyzer simply uses the default (8 for ASCii, 32 for INTEger, 32 for REAL).

Sending data to the analyzer which does not conform to the current FORMat specified, results in an error. Sending ASCII data when a definite block is expected generates message -161 "Invalid Block Data" and sending a definite block when ASCII data is expected generates message -121 "Invalid Character in Number".

---

**Preset**      ASCii

---

**Backwards Compatibility Notes**      Note that the INT,32 format is only applicable to the command, TRACe:DATA. This preserves backwards compatibility for the Swept SA measurement. For all other commands/queries which honor FORMat:DATA, if INT,32 is sent the analyzer will behave as though it were set to REAL,32.

---

Initial S/W Revision      Prior to A.02.00

---



The specs for each output type follow:

ASCIi - Amplitude values are in ASCII, in the current Y Axis Unit, one ASCII character per digit, values separated by commas, each value in the form:

SX.YYYYYEsZZ

Where:

S = sign (+ or -)

X = one digit to left of decimal point

Y = 5 digits to right of decimal point

E = E, exponent header

s = sign of exponent (+ or -)

ZZ = two digit exponent

REAL,32 - Binary 32-bit real values in the current Y Axis Unit, in a definite length block.

REAL,64 - Binary 64-bit real values in the current Y Axis Unit, in a definite length block.

### Format Data: Byte Order (Remote Command Only)

This command selects the binary data byte order for data transfer and other queries. It controls whether binary data is transferred in normal or swapped mode. This command affects only the byte order for setting and querying trace data for the :TRACe[:DATA], TRACe[:DATA]? , :CALCulate:DATA[n]? and FETCh:SANalyzer[n]? commands and queries.

By definition any command that says it uses FORMat:DATA uses any format supported by FORMat:DATA.

The NORMal order is a byte sequence that begins with the most significant byte (MSB) first, and ends with the least significant byte (LSB) last in the sequence: 1|2|3|4. SWAPPed order is when the byte sequence begins with the LSB first, and ends with the MSB last in the sequence: 4|3|2|1.

<b>Remote Command</b>	:FORMat:BORDER NORMal SWAPPed :FORMat:BORDER?
<b>Preset</b>	NORMal
<b>Initial S/W Revision</b>	Prior to A.02.00

## Meas Setup

Displays the setup menu for the currently selected measurement.

Key Path	Front-panel key
Initial S/W Revision	Prior to A.02.00

### Meas Type

Sets the code domain power computation type to the following selection.

- Relative Log (unit: dB)
- Relative Linear (no unit)
- Absolute Log (unit: dBm)
- Absolute Linear (unit: mW)

All the related result window traces must be aligned with the Meas Type selection: e.g. CDP has to be shown in “mW” when “Absolute Linear” is selected. If “Rel Linear” is selected, no unit is applied.

Key Path	Meas Setup
Mode	1xEV-DO
Remote Command	:CALCulate:CDPower[:BTS]:TYPE RLOG RLINear ALOG ALINear :CALCulate:CDPower[:BTS]:TYPE?
Example	CALC:CDP:TYPE ALOG CALC:CDP:TYPE?
Notes	'REL' and 'ABS' are the old selection type and need to support to keep backwards compatibility. If 'REL' is selected, it means 'RLOG'. If 'ABS' is selected, it means 'ALOG'.
Preset	RLOG
State Saved	Saved in instrument state.
Range	Relative Log   Relative Linear   Absolute Log   Absolute Linear
Readback Text	Relative Log   Relative Linear   Absolute Log   Absolute Linear
Backwards Compatibility SCPI	CALCulate:CDPower:TYPE
Initial S/W Revision	Prior to A.02.00

### Channel Type

Selects channel type from Pilot, MAC, Data and Preamble. Code domain power, channel IQ constellation and demod bits of selected channel are calculated. Since Preamble length is variable from 0 to 1024, it often happens that no preamble is included in a specified slot. When preamble is not time-multiplexed into specified slot, all code domain power results are set to NaN.

Key Path	Meas Setup
Mode	1xEV-DO
<b>Remote Command</b>	:CALCulate:CDPower[:BTS]:CHANnel:TYPE PIlot   MAC   DATA   PReamble :CALCulate:CDPower[:BTS]:CHANnel:TYPE?
<b>Example</b>	:CALC:CDP:CHAN:TYPE MAC :CALC:CDP:CHAN:TYPE?
Preset	PIlot
State Saved	Saved in instrument state.
Range	Pilot   MAC   Data   Preamble
<b>Backwards Compatibility SCPI</b>	:CALCulate:CDPower:CHANnel:TYPE
Initial S/W Revision	Prior to A.02.00

## Walsh Code Number

Sets the Walsh code number whose channel analysis is carried out. The upper range changes depending on channel type and subtype selection.

Key Path	Meas Setup
Mode	1xEV-DO
<b>Remote Command</b>	CALCulate:CDPower[:BTS]:WCODe[:NUMBer] <integer> CALCulate:CDPower[:BTS]:WCODe[:NUMBer]?
<b>Example</b>	:CALC:CDP:WCOD 8 :CALC:CDP:WCOD?
Notes	Range and Min/Max of this command depends on selected physical layer subtype and channel type. If need to do SCPI test in the case of Subtype2 by SCPI tree tool, add the test manually.
Couplings	Max is dependent on Channel Type and Subtype.
Preset	0
State Saved	Saved in instrument state.
Range	Subtype 0/1 0 to 31 for Pilot. 0 to 63 for MAC 0 to 15 for Data 0 to 31 for Preamble Subtype 2 0 to 31 for Pilot. 0 to 127 for MAC 0 to 15 for Data 0 to 63 for Preamble

	Subtype 3 0 to 31 for Pilot. 0 to 127 for MAC 0 to 15 for Data 0 to 127 for Preamble
Min	0
Max	127
<b>Backwards Compatibility SCPI</b>	CALCulate:CDPower:WCODE[:NUMBER]
Initial S/W Revision	Prior to A.02.00

### I/Q Branch

Selects branch between I and Q for demod bits and RMS Code Power/Slot. But when channel type is Data, this selection change RMS Code Power/Slot only.

Key Path	Meas Setup
Mode	1xEV-DO
<b>Remote Command</b>	:CALCulate:CDPower[:BTS]:AXIS IPH QPH :CALCulate:CDPower[:BTS]:AXIS?
<b>Example</b>	:CALC:CDP:AXIS QPH :CALC:CDP:AXIS?
Preset	IPH
State Saved	Saved in instrument state.
Range	I   Q
<b>Backwards Compatibility SCPI</b>	:CALCulate:CDPower:AXIS
Initial S/W Revision	Prior to A.02.00

### Meas Interval

Sets the length of measurement interval in slots. This interval is effective only for demod bits result. Code Domain Power and Code Domain Error results are always calculated from an interval of a slot which is specified by Meas Offset.

Key Path	Meas Setup
Mode	1xEV-DO
<b>Remote Command</b>	:CALCulate:CDPower[:BTS]:SWEep:TIME <real> :CALCulate:CDPower[:BTS]:SWEep:TIME?
<b>Example</b>	:CALC:CDP:SWE:TIME 8.5

	:CALC:CDP:SWE:TIME?
Notes	If summation of Meas Interval and Meas Offset exceeds Capture Interval after changing Meas Interval (or Meas Offset), then Meas Offset (or Meas Interval) decreases accordingly to keep the summation. Meas interval is effective only for demod bits result. Code Domain Power results are always calculated from an interval of a slot which is specified by Meas Offset.
Couplings	Max value is dependent on [:SENSE]:CDPower[:BTS]:CAPTURE:TIME and CALCulate:CDPower[:BTS]:SWEep:OFFSet.
Preset	16.0
State Saved	Saved in instrument state.
Min	1.0
Max	32.0
<b>Backwards Compatibility SCPI</b>	:CALCulate:CDPower:SWEep:TIME
Initial S/W Revision	Prior to A.02.00

## Meas Offset

Sets the timing offset of measurement interval in slots.

Key Path	Meas Setup
Mode	1xEV-DO
<b>Remote Command</b>	:CALCulate:CDPower[:BTS]:SWEep:OFFSet <real> :CALCulate:CDPower[:BTS]:SWEep:OFFSet?
<b>Example</b>	:CALC:CDP:SWE:OFFS 10 :CALC:CDP:SWE:OFFS?
Notes	If summation of Meas Interval and Meas Offset exceeds Capture Interval after changing Meas Interval (or Meas Offset), then Meas Offset (or Meas Interval) decreases accordingly to keep the summation. Meas interval is effective only for demod bits result. Code Domain Power results are always calculated from an interval of a slot which is specified by Meas Offset.
Couplings	Max value is dependent [:SENSE]:CDPower[:BTS]:CAPTURE:TIME and CALCulate:CDPower[:BTS]:SWEep:TIME
Preset	0.0
State Saved	Saved in instrument state.
Min	0.0
Max	31.0
<b>Backwards Compatibility SCPI</b>	:CALCulate:CDPower:SWEep:OFFSet
Initial S/W Revision	Prior to A.02.00

## PN Offset

Sets offset index of pilot PN sequence. Pilot of 1xEV-DO forward link shall be identified by an offset index in the range from 0 through 511. This offset index specifies offset or lag of pilot PN sequence in units of 64 chips. This parameter takes PN offset index and the measurement uses this value to generate pilot reference.

<b>Key Path</b>	Meas Setup, More1 of 3
<b>Mode</b>	1xEV-DO
<b>Remote Command</b>	[ :SENSe ] :CDPower [ :BTS ] :PNOffset <integer> [ :SENSe ] :CDPower [ :BTS ] :PNOffset?
<b>Example</b>	:CDP:PNOF 32 :CDP:PNOF?
<b>Preset</b>	0
<b>State Saved</b>	Saved in instrument state.
<b>Min</b>	0
<b>Max</b>	511
<b>Backwards Compatibility SCPI</b>	[ :SENSe ] :CDPower :PNOffset
<b>Initial S/W Revision</b>	Prior to A.02.00

## Sync Start Slot

Before the first slot to start the measurement is depend on trigger timing or capture timing if trigger is set to Free Run.

This is a BAF key. Boolean parameter determines whether to enable synchronization start slot number specification. Sync Start Slot value is an absolute slot number in frame. When this mode is ON, first slot of result interval, which is equal to Capture Interval setting, becomes a slot of specified number.

If users use some kind of trigger, the first slot number is determined by trigger timing. The user can specify the synchronization start slot number by setting Sync Start Slot on. For example Sync start slot number is set to 5, the analysis starts from slot number 5.0. If Sync Start Slot detection mode is set to Off, keep backward compatibility and the measurement is done from trigger timing or capture timing.

<b>Key Path</b>	Meas Setup, More 1 of 3
<b>Mode</b>	1xEV-DO
<b>Remote Command</b>	[ :SENSe ] :CDPower [ :BTS ] :SSLot:NUMBer <integer> [ :SENSe ] :CDPower [ :BTS ] :SSLot:NUMBer? [ :SENSe ] :CDPower [ :BTS ] :SSLot [ :STATe ] OFF   ON   0   1 [ :SENSe ] :CDPower [ :BTS ] :SSLot [ :STATe ] ?
<b>Example</b>	:CDP:SSL:NUMB 5 :CDP:SSL ON

Notes	Turn first slot number detection mode on or off.
Preset	0 OFF
State Saved	Saved in instrument state.
Range	0 to 15
Min	0
Max	15
<b>Backwards Compatibility SCPI</b>	[ :SENSe ] :CDPower :SSLot :NUMBer
Initial S/W Revision	Prior to A.02.00

## MAC Position

Selects MAC channel position from half slot 1, half slot 2, or Full Slot. If half slot 1 is selected, only the MAC channel in first half slot will be analyzed, if half slot 2 is selected, only the second half slot will be analyzed, if over all is select, two half slot will be composite analyzed.

In Subtype 0/1/2, two part of MAC channel are the same, so we can select “Over all”, analyzed two part at the same time. In Subtype 3, when Mac Index greater than 128, two part of MAC are difference, so we had better analyze two half slot respectively.

Key Path	Meas Setup
Mode	1xEV-DO
<b>Remote Command</b>	[ :SENSe ] :CDPower [ :BTS ] :MACPosition SH1   SH2   FULL [ :SENSe ] :CDPower [ :BTS ] :MACPosition?
<b>Example</b>	:SENS:CDP:MACP SH1 :SENS:CDP:MACP?
Preset	FULL
State Saved	Saved in instrument state.
Range	SH1   SH2   FULL
Initial S/W Revision	Prior to A.02.00

## Data Channel Attributes

Allows you to adjust the Data Channel Attributes.

Key Path	Meas Setup, More
Initial S/W Revision	Prior to A.02.00

## Data Mod Scheme

Selects data channel modulation scheme from QPSK, 8PSK, 16QAM, 64QAM and Auto. The selection can be classified into 2 groups, i.e. Auto and the others. When Auto is selected, the measurement automatically identifies modulation schemes of data channels of measured slots. This detection is done on slot-by-slot basis and signals with slots of various data packet types can be analyzed with appropriate modulation schemes. When one of QPSK, 8PSK, 16QAM and 64QAM is selected, the analysis of data channel is carried out with the selected modulation scheme over Meas Interval. 64QAM mod scheme is added for the purpose of supporting some minimum (critical) sets of the new Rev.B requirement, in other subtype, this key will be grayed.

<b>Key Path</b>	Meas Setup, More, Data Channel Attribute
<b>Mode</b>	1xEV-DO
<b>Remote Command</b>	:CALCulate:CDPower[:BTS]:TYPE:DATA QPSK OPSK QAM  QAM64 AUTO :CALCulate:CDPower[:BTS]:TYPE:DATA?
<b>Example</b>	:CALC:CDP:TYPE:DATA QPSK :CALC:CDP:TYPE:DATA?
<b>Notes</b>	This key is inactive when channel type is NOT DATA.
<b>Preset</b>	AUTO
<b>State Saved</b>	Saved in instrument state.
<b>Range</b>	QPSK   8PSK   16QAM   64QAM   Auto
<b>Backwards Compatibility SCPI</b>	:CALCulate:CDPower:TYPE:DATA
<b>Initial S/W Revision</b>	Prior to A.02.00

## Preamble Length

This is a BAF key. Boolean parameter selects Auto or Manual mode of Preamble analysis. When Auto mode selected, the measurement identifies length of preamble time-multiplexed into Data channel on slot-by-slot basis and proceeds code domain & demod bit analysis using this information. When Manual mode is selected, the measurement uses fixed preamble length given by the user over Meas Interval.

<b>Key Path</b>	Meas Setup, More, Data Channel Attribute
<b>Mode</b>	1xEV-DO
<b>Remote Command</b>	[:SENSe]:CDPower[:BTS]:PREamble:LENGth <integer> [:SENSe]:CDPower[:BTS]:PREamble:LENGth? [:SENSe]:CDPower[:BTS]:PREamble:LENGth:AUTO OFF ON 0 1 [:SENSe]:CDPower[:BTS]:PREamble:LENGth:AUTO?
<b>Example</b>	:CDP:PRE:LENG 128 :CDP:PRE:LENG? :CDP:PRE:LENG:AUTO ON :CDP:PRE:LENG:AUTO?



Notes	This parameter only takes values of valid preamble length. i.e. 0, 64, 128, 256, 512 and 1024. If non valid preamble length is entered, it clips to a valid value. The Preamble Length State will turn preamble length detection mode on or off
Preset	0 ON
State Saved	Saved in instrument state.
Range	0 to 1024
Min	0
Max	1024
Initial S/W Revision	Prior to A.02.00

## Active Data Channel

When set to Auto, the active channel ID detection is automatically made for the data channel measurement. When set to Predefined, the predefined active channel detection is used for the data channel measurement, i.e. all code channels of data channel are set Active.

Key Path	Meas Setup, More, Data Channel Attribute
Mode	1xEV-DO
<b>Remote Command</b>	[ :SENSe ] :CDPower [ :BTS ] :ACode AUTO   PREDEFINED [ :SENSe ] :CDPower [ :BTS ] :ACode?
<b>Example</b>	:CDP:ACOD PRED :CDP:ACOD?
Notes	This key is inactive when channel type is NOT DATA.
Preset	AUTO
State Saved	Saved in instrument state.
Range	Auto   Predef
<b>Backwards Compatibility SCPI</b>	[ :SENSe ] :CDPower :ACode
Initial S/W Revision	Prior to A.02.00

## Capture Interval

Sets the data capture length in slots that will be used in the acquisition.

Key Path	Meas Setup, More 1 of 3
Mode	1xEV-DO
<b>Remote Command</b>	[ :SENSe ] :CDPower [ :BTS ] :CAPTURE:TIME <integer> [ :SENSe ] :CDPower [ :BTS ] :CAPTURE:TIME?

<b>Example</b>	CDP:CAPT:TIME 12 CDP:CAPT:TIME?
Couplings	If Capture interval changed, The maximum value of Measurement interval equal to the capture interval, and the maximum value of measurement offset equal to capture interval -1.
Preset	16
State Saved	Saved in instrument state.
Range	1 to 32
Min	1
Max	32
<b>Backwards Compatibility SCPI</b>	[ :SENSe ] :CDPower :CAPTure :TIME
Initial S/W Revision	Prior to A.02.00

### Demod Bits Tri-State

Toggles Demod Bits Tri-State on and off. When ON, symbols on inactive channel are show as “X” on display.

When Off, symbols on inactive channel are show as normal. And for active channel it can be ignored

Key Path	Meas Setup, More, More
Mode	1xEV-DO
<b>Remote Command</b>	:CALCulate:CDPower[:BTS]:DBITs:TSTate ON OFF 0 1 :CALCulate:CDPower[:BTS]:DBITs:TSTate?
<b>Example</b>	CALC:CDP:DBIT:TST OFF CALC:CDP:DBIT:TST?
Preset	ON
State Saved	Saved in instrument state.
Range	On   Off
<b>Backwards Compatibility SCPI</b>	:CALCulate:CDPower:DBITs:TSTate
Initial S/W Revision	Prior to A.02.00

### Spectrum

Sets a spectrum either to Normal or Inverted for the demodulation related measurements. If set to INVert, the upper and lower spectrums are swapped.

Invert: This function conjugates the spectrum, which is equivalent to taking the negative of the quadrature component in demodulation. The correct setting (Normal or Invert) depends on whether the signal at the input of the instrument has a high or low side mix.

Key Path	Meas Setup, More 1 of 3, More 2of 3
Mode	1xEV-DO
<b>Remote Command</b>	<code>[ :SENSe ] :CDPower [ :BTS ] :SPECtrum NORMal   INVert</code> <code>[ :SENSe ] :CDPower [ :BTS ] :SPECtrum?</code>
<b>Example</b>	CDP:SPEC INV CDP:SPEC?
Preset	NORMal
State Saved	Saved in instrument state.
Range	Normal   Invert
<b>Backwards Compatibility SCPI</b>	<code>[ :SENSe ] :CDPower :SPECtrum</code>
Initial S/W Revision	Prior to A.02.00

## Meas Preset

Restores all the measurement parameters to their default values.

Key Path	Meas Setup, More 1 of 3, More 2of 3
Mode	1xEV-DO
<b>Remote Command</b>	<code>:CONFigure:CDPower</code>
<b>Example</b>	CONF:CDP
Couplings	Selecting Meas Preset will restore all measurement parameters to their default values.
Initial S/W Revision	Prior to A.02.00

## Advanced

Accesses a menu of functions that enable you to set up more specific parameters for the measurement.

Key Path	Meas Setup
Initial S/W Revision	Prior to A.02.00

## Active Set Threshold

Sets the threshold value for the active channel detection. And user can select the active channel identification function between Auto and Man. If set to Auto, the active channels are determined automatically by the internal algorithm. If it set to Man, the active channel identification is determined by a user definable threshold ranging from 0.00 to -100.0 dB.

Key Path	Meas Setup, More, More, Advanced
----------	----------------------------------

Mode	1xEV-DO
<b>Remote Command</b>	:CALCulate:CDPower[:BTS]:ASET:THReshold <real> :CALCulate:CDPower[:BTS]:ASET:THReshold? :CALCulate:CDPower[:BTS]:ASET:THReshold:AUTO OFF ON 0 1 :CALCulate:CDPower[:BTS]:ASET:THReshold:AUTO?
<b>Example</b>	:CALC:CDP:ASET:THR -20 :CALC:CDP:ASET:THR:AUTO OFF :CALC:CDP:ASET:THR:AUTO?
Notes	The Active Set Threshold Mode will turn the automatic mode On or Off for the active channel identification function. OFF – The active channel identification for each code channel is determined by a value set by CALCulate:CDPower[:BTS]:ASET:THReshold. ON – The internal algorithm determines the active channels automatically.
Preset	0.0 ON
State Saved	Saved in instrument state.
Range	-100 to 0.0
Min	-100
Max	0
<b>Backwards Compatibility SCPI</b>	:CALCulate:CDPower:ASET:THReshold
Initial S/W Revision	Prior to A.02.00

## Filter Alpha

Selects one of 4 complementary filters. These complementary filters are designed to have raised cosine frequency responses of slightly different roll off factors, Alpha, conjunction with a TX filter defined in the standard. The smaller the Filter Alpha is, the better the adjacent power rejection performance becomes. Default of this parameter is 0.15.

Key Path	Meas Setup, More, More, Advanced
Mode	1xEV-DO
<b>Remote Command</b>	[:SENSe]:CDPower[:BTS]:ALPHA <real> [:SENSe]:CDPower[:BTS]:ALPHA?
<b>Example</b>	CDP:ALPH 0.05 CDP:ALPH?
Preset	0.15
State Saved	Saved in instrument state.
Range	0.05 to 0.20

Min	0.05
Max	0.20
<b>Backwards Compatibility SCPI</b>	[ :SENSe ] :CDPower :ALPHA
Initial S/W Revision	Prior to A.02.00

## Chip Rate

Changes the Chip Rate

Key Path	Meas Setup, More 1 of 3, More 2of 3, Advanced
Mode	1xEV-DO
<b>Remote Command</b>	[ :SENSe ] :CDPower [ :BTS ] :CRATe <freq> [ :SENSe ] :CDPower [ :BTS ] :CRATe?
<b>Example</b>	CDP:CRAT 1.22 MHz CDP:CRAT?
Preset	1.2288 MHz
State Saved	Saved in instrument state.
Range	1.10592 MHz to 1.35168 MHz
Min	1.10592 MHz
Max	1.35168 MHz
<b>Backwards Compatibility SCPI</b>	[ :SENSe ] :CDPower :CRATe
Initial S/W Revision	Prior to A.02.00

## IF Gain

Enables you to control an internally switched IF amplifier with approximately 10 dB of gain. When it can be turned on without an overload, the dynamic range is always better with the amplifier on than off. The IF Gain key can be used to set the IF Gain function to Auto, or to On (the extra 10 dB) or Off. These settings affect sensitivity and IF overloads.

Key Path	Meas Setup, More 1 of 3, More 2of 3, Advanced
Initial S/W Revision	Prior to A.02.00

## IF Gain Auto

Activates the auto rules for IF Gain.

Key Path	Meas Setup, More 1 of 3, More 2of 3, Advanced, IF Gain
Mode	1xEV-DO
<b>Remote Command</b>	[ :SENSe ] :CDPower [ :BTS ] : IF : GAIN : AUTO [ : STATE ] OFF   ON   0   1 [ :SENSe ] :CDPower [ :BTS ] : IF : GAIN : AUTO [ : STATE ] ?
<b>Example</b>	CDP:IF:GAIN:AUTO ON CDP:IF:GAIN:AUTO?
Couplings	When either the auto attenuation works (for example, with electrical attenuator), or the optimize mechanical attenuator range is requested, the IF Gain setting is changed as following rule. 'auto' sets IF Gain 'High Gain' under any of the following conditions: the input attenuator is set to 0 dB, the preamp is turned on, or the Max Mixer Level is -20 dBm or lower. For other settings, auto sets IF Gain to 'Low Gain'.
Preset	OFF
State Saved	Saved in instrument state.
Range	Off On
<b>Backwards Compatibility SCPI</b>	[ :SENSe ] :CDPower : IF : GAIN : AUTO [ : STATE ]
Initial S/W Revision	Prior to A.02.00

### IF Gain State

Selects the range of IF Gain.

Key Path	Meas Setup, More 1 of 3, More 2of 3, Advanced, IF Gain
Mode	1xEV-DO
<b>Remote Command</b>	[ :SENSe ] :CDPower [ :BTS ] : IF : GAIN [ : STATE ] OFF   ON   0   1 [ :SENSe ] :CDPower [ :BTS ] : IF : GAIN [ : STATE ] ?
<b>Example</b>	CDP:IF:GAIN ON CDP:IF:GAIN:AUTO?
Notes	Where ON = high gain OFF = low gain
Couplings	When either the auto attenuation works (for example, with electrical attenuator), or the optimize mechanical attenuator range is requested, the IF Gain setting is changed as following rule. 'auto' sets IF Gain 'High Gain' under any of the following conditions: the input attenuator is set to 0 dB, the preamp is turned on, or the Max Mixer Level is -20 dBm or lower. For other settings, auto sets IF Gain to 'Low Gain'.
Preset	OFF
State Saved	Saved in instrument state.
Range	Low Gain (Best for Large Signals) High Gain (Best Noise Level)
Readback Text	Low Gain   High Gain
<b>Backwards</b>	[ :SENSe ] :CDPower : IF : GAIN [ : STATE ]

---

**Compatibility SCPI**

Initial S/W Revision      Prior to A.02.00

---

**Packed Mode (SCPI command only)**

Allows you to select the packed mode for Demod bits in SCPI result of READ:CDP12.

This function makes the demod bits per symbol to pack into one floating value following the detected modulation format. User knows which format is detected on the selected channel using the return value of READ|FETCH:CDP11.

Packed Mode OFF:

The demod bits are returned in binary values, 0 and 1. Bits of off-symbols are represented by -1 when Demod Bit Tri-State is ON.

Packed Mode 1 (PKM1):

The demod bits per symbol plus one mask bit are packed into one floating value. This mask bit is used to indicate whether the channel is active or not. When the code channel is identified as inactive, the mask bit is set to 1. When active, it is set to 0 and resulting packed demod bits values become same as PKM1. The mask bit is always 0 when Demod Bit Tri-State is OFF.

For example, if the detected modulation format is QPSK, the returning demod bits with non-packed mode (default) are following.

- 0.0, 1.0, 1.0, 0.0, 0.0, 1.0, 1.0, 1.0,.....

QPSK is 2 bits per symbols modulation. Therefore with packed mode 1 (PKM1), by 2 bits are packed into one floating value.

- 1.0, 2.0, 1.0, 3.0, .....

When the channel is inactive and Packed Mode 1 is selected with Demod Bit Tri-State ON, two bits and one mask bit are packed into one floating value.

- 5.0, 6.0, 1.0, 7.0, .....

Packed mode is only for SCPI commands. Setting to packed mode does not make any changes to the results on MUI. It only controls the result format of READ(MEAS|FETch|CONF):CDP9 and CDP10.

---

<b>Mode</b>	CDMA1XEV
<b>Remote Command</b>	CALCulate:CDPower[:BTS]:PACKed OFF PKM1 CALCulate:CDPower[:BTS]:PACKed?
<b>Example</b>	CALC:CDP:PACK PKM1 CALC:CDP:PACK?
<b>Preset</b>	OFF
<b>State Saved</b>	Saved in instrument state.
<b>Backwards Compatibility SCPI</b>	CALCulate:CDPower:PACKed
<b>Initial S/W Revision</b>	Prior to A.02.00

---





## Mode

See "Mode" on page 318

## Mode Preset

Returns the active mode to a known state.

Mode Preset does the following for the currently active mode:

- Aborts the currently running measurement.
- Brings up the default menu for the mode, with no active function.
- Sets measurement Global settings to their preset values for the active mode only.
- Activates the default measurement.
- Brings up the default menu for the mode.
- Clears the input and output buffers.
- Sets Status Byte to 0.

Mode Preset does not:

- Cause a mode switch
- Affect mode persistent settings
- Affect system settings

See "[How-To Preset](#)" on page 1831 for more information.

<b>Key Path</b>	Front-panel key
<b>Remote Command</b>	:SYSTem:PRESet
<b>Example</b>	:SYST:PRES
<b>Notes</b>	*RST is preferred over :SYST:PRES for remote operation. *RST does a Mode Preset, as done by the :SYST:PRES command, and it sets the measurement mode to Single measurement rather than Continuous for optimal remote control throughput. Clears all pending OPC bits. The Status Byte is set to 0.
<b>Couplings</b>	A Mode Preset aborts the currently running measurement, activates the default measurement, and gets the mode to a consistent state with all of the default couplings set.
<b>Backwards Compatibility Notes</b>	In the X-Series, the legacy "Factory Preset" has been replaced with Mode Preset, which only presets the currently active mode, not the entire instrument. In the X-Series, the way to preset the entire instrument is by using System, Restore System Defaults All, which behaves essentially the same way as restore System Defaults does on ESA and PSA. There is also no "Preset Type" as there is on the PSA. There is a green Mode Preset front-panel key that does a Mode Preset and a white-with-green-letters User Preset front-panel key that does a User Preset. The old PRESet:TYPE command is ignored (without generating an error), and SYST:PRES without a parameter does a Mode Preset, which should cover most backward code compatibility issues. The settings and correction data under the Input/Output front-panel key (examples: Input Z Corr, Ext Amp Gain, etc.) are no longer part of any Mode, so they will not be preset by a Mode Preset. They are preset using Restore Input/Output Defaults, Restore System Defaults All. Note that because User Preset does a Recall State, and all of these settings are saved in State, they ARE recalled when using

	User Preset.
Initial S/W Revision	Prior to A.02.00

## How-To Preset

The table below shows all possible presets, their corresponding SCPI commands and front-panel access (key paths). Instrument settings depend on the current measurement context. Some settings are local to the current measurement, some are global (common) across all the measurements in the current mode, and some are global to all the available modes. In a similar way, restoring the settings to their preset state can be done within the different contexts.

Auto Couple - is a measurement local key. It sets all Auto/Man parameter couplings in the measurement to Auto. Any Auto/Man selection that is local to other measurements in the mode will not be affected.

Meas Preset - is a measurement local key. Meas Preset resets all the variables local to the current measurement except the persistent ones.

Mode Preset - resets all the current mode's measurement local and measurement global variables except the persistent ones.

Restore Mode Defaults - resets ALL the Mode variables (and all the Meas global and Meas local variables), including the persistent ones.

Type Of Preset	SCPI Command	Front Panel Access
Auto Couple	:COUPlE ALL	Auto Couple front-panel key
Meas Preset	:CONFIgure:<Measurement>	Meas Setup Menu
Mode Preset	:SYSTem:PRESet	Mode Preset (green key)
Restore Mode Defaults	:INSTrument:DEFault	Mode Setup Menu
Restore All Mode Defaults	:SYSTem:DEFault MODEs	System Menu; Restore System Default Menu
*RST	*RST	not possible (Mode Preset with Single)
Restore Input/Output Defaults	:SYSTem:DEFault INPut	System Menu; Restore System Default Menu
Restore Power On Defaults	:SYSTem:DEFault PON	System Menu; Restore System Default Menu
Restore Alignment Defaults	:SYSTem:DEFault ALIGn	System Menu; Restore System Default Menu
Restore Miscellaneous Defaults	:SYSTem:DEFault MISC	System Menu; Restore System Default Menu
Restore All System Defaults	:SYSTem:DEFault [ALL] :SYSTem:PRESet:PERSistent	System Menu; Restore System Default Menu
User Preset	:SYSTem:PRESet:USER	User Preset Menu
User Preset All Modes	:SYSTem:PRESet:USER:ALL	User Preset Menu

Power On Mode Preset	:SYSTem:PON:TYPE MODE	System Menu
Power On User Preset	:SYSTem:PON:TYPE USER	System Menu
Power On Last State	:SYSTem:PON:TYPE LAST	System Menu

### Preset Type (Remote Command Only)

As stated in the Backward Compatibility section, to be compatible with ESA/PSA the PRESet:TYPE command will be implemented as a no-op.

<b>Mode</b>	All
<b>Remote Command</b>	:SYSTem:PRESet:TYPE FACTory MODE USER :SYSTem:PRESet:TYPE?
<b>Example</b>	:SYST:PRESet:TYPE FACT
<b>Notes</b>	This command is supported for backward compatibility only. It is a no-op which does not change the behavior of any preset operation.
<b>Preset</b>	This is unaffected by Preset but is set to Mode on a "Restore System Defaults->All"
<b>State Saved</b>	No
<b>Initial S/W Revision</b>	Prior to A.02.00

## Mode Setup

See ["Mode Setup" on page 348](#)

## Peak Search

Accesses a menu that enables you to control the peak search function and places a marker on the trace point with highest peak.

See the Peak Search key description under the Peak Search menu in the Spectrum Analyzer Mode, Swept SA Measurement.

Key Path	Front panel key
Mode	1xEV-DO
<b>Remote Command</b>	:CALCulate:CDPower[:BTS]:MARKer[1] 2 ...12:MAXimum
<b>Example</b>	CALC:CDP:MARK2:MAX
<b>Backwards Compatibility SCPI</b>	:CALCulate:CDPower:MARKer[1] 2 ...4:MAXimum
Initial S/W Revision	Prior to A.02.00

## Next Peak

Moves the selected marker to the peak that has the next highest amplitude less than the marker's current value.

Key Path	Peak Search
Mode	1xEV-DO
<b>Remote Command</b>	:CALCulate:CDPower[:BTS]:MARKer[1] 2 ...12:MAXimum:NEXT
<b>Example</b>	CALC:CDP:MARK2:MAX:NEXT
<b>Backwards Compatibility SCPI</b>	:CALCulate:CDPower:MARKer[1] 2 ...4:MAXimum:NEXT
Initial S/W Revision	Prior to A.02.00

## Next Pk Right

Moves the selected marker to the nearest peak right of the current marker which meets all enabled peak criteria.

Key Path	Peak Search
Mode	1xEV-DO
<b>Remote Command</b>	:CALCulate:CDPower[:BTS]:MARKer[1] 2 ...12:MAXimum:RIGHT
<b>Example</b>	CALC:CDP:MARK2:MAX:RIGH
<b>Backwards Compatibility SCPI</b>	:CALCulate:CDPower:MARKer[1] 2 ...4:MAXimum:RIGHT
Initial S/W Revision	Prior to A.02.00

## Next Pk Left

Moves the selected marker to the nearest peak left of the current marker which meets all enabled peak criteria.

Key Path	Peak Search
Mode	1xEV-DO
<b>Remote Command</b>	:CALCulate:CDPower[:BTS]:MARKer[1] 2 ...12:MAXimum:LEFT
<b>Example</b>	CALC:CDP:MARK2:MAX:LEFT
<b>Backwards Compatibility SCPI</b>	:CALCulate:CDPower:MARKer[1] 2 ...4:MAXimum:LEFT
Initial S/W Revision	Prior to A.02.00

## Marker Delta

Performs the same function as the Delta 1-of-N selection key in the Marker menu. Basically this sets the control mode for the selected marker to Delta mode. See the Marker chapter for the complete description of this function. The key is duplicated here in the Peak Search Menu to allow the user to conveniently perform a peak search and change the marker's control mode to Delta without having to access two separate menus.

Key Path	Peak Search
Initial S/W Revision	Prior to A.02.00

## Pk-Pk Search

Finds and displays the amplitude and frequency (or time, if in zero span) differences between the highest and lowest y-axis value.

Key Path	Peak Search
Mode	1xEV-DO
<b>Remote Command</b>	:CALCulate:CDPower[:BTS]:MARKer[1] 2 ...12:PTPeak
<b>Example</b>	CALC:CDP:MARK:PTP
Notes	Turns on the Marker $\Delta$
Couplings	This key is not available (key is grayed out) when Coupled Markers is on.
<b>Backwards Compatibility SCPI</b>	:CALCulate:CDPower:MARKer[1] 2 ...4:PTPeak
Initial S/W Revision	Prior to A.02.00

## Min Search

Moves the selected marker to the minimum y-axis value on the current trace.

15 Forward Link Code Domain Measurement  
Peak Search

Key Path	Peak Search
Mode	1xEV-DO
<b>Remote Command</b>	:CALCulate:CDPower[:BTS]:MARKer[1] 2 ...12:MINimum
<b>Example</b>	CALC:CDP:MARK:MIN
<b>Backwards Compatibility SCPI</b>	:CALCulate:CDPower:MARKer[1] 2 ...4:MINimum
Initial S/W Revision	Prior to A.02.00



Print

See ["Print" on page 358](#)

## Quick Save

The Quick Save front-panel key repeats the most recent save that was performed from the Save menu, with the following exceptions:

- Register saves are not remembered as Saves for the purpose of the Quick Save function
- If the current measurement does not support the last non-register save that was performed, an informational message is generated, “File type not supported for this measurement”

Quick Save repeats the last type of qualified save (that is, a save qualified by the above criteria) in the last save directory by creating a unique filename using the Auto File Naming algorithm described below.

If Quick Save is pressed after startup and before any qualified Save has been performed, the Quick Save function performs a Screen Image save using the current settings for Screen Image saves (current theme, current directory), which then becomes the “last save” for the purpose of subsequent Quick Saves.

The Auto File Naming feature automatically generates a file name for use when saving a file. The filename consists of a prefix and suffix separated by a dot, as is standard for the Windows® file system. A default prefix exists for each of the available file types:

Type	Default Prefix	Menu
State	State_	(Save/Recall)
Trace + State	State_	(Save/Recall)
Screen	Screen_	(Save/Recall)
Amplitude Corrections	Ampcor_	(Import/Export)
Traces	Trace_	(Import/Export)
Limit Lines	LLine_	(Import/Export)
Measurement Result	MeasR_	(Import/Export)
Capture Buffer	CapBuf_	(Import/Export)

A four digit number is appended to the prefix to create a unique file name. The numbering sequence starts at 0000 within each Mode for each file type and updates incrementally to 9999, then wraps to 0000 again. It remembers where it was through a Mode Preset and when leaving and returning to the Mode. It is reset by Restore Misc Defaults and Restore System Defaults and subsequent running of the instrument application. So, for example, the first auto file name generated for State files is State\_0000.state. The next is State\_0001, and so forth.

One of the key features of Auto File Name is that we guarantee that the Auto File Name will never conflict with an existing file. The algorithm looks for the next available number. If it gets to 9999, then it looks for holes. If it find no holes, that is no more numbers are available, it gives an error.

For example, if when we get to State\_0010.state there is already a State\_0010.state file in the current directory, it advances the counter to State\_0011.state to ensure that no conflict will exist (and then it verifies that State\_0011.state also does not exist in the current directory and advances again if it does, and so forth).

If you enter a file name for a given file type, then the prefix becomes the filename you entered instead of the default prefix, followed by an underscore. The last four letters (the suffix) are the 4-digit number.

For example, if you save a measurement results file as “fred.csv”, then the next auto file name chosen for a measurement results save will be fred\_0000.csv.

**NOTE** Although 0000 is used in the example above, the number that is used is actually the current number in the Meas Results sequence, that is, the number that would have been used if you had not entered your own file name.

**NOTE** If the filename you entered ends with \_dddd, where d=any number, making it look just like an auto file name, then the next auto file name picks up where you left off with the suffix being dddd + 1.

Key Path	Front-panel key
Notes	No remote command for this key specifically.
Initial S/W Revision	Prior to A.02.00

## Recall

The Recall menu lets you choose what you want to recall, and where you want to recall it from. Among the types of files you can recall are **States and Traces**. In addition, an Import (Data) option lets you recall a number of data types stored in CSV files (as used by Excel and other spreadsheet programs).

The default paths for Recall are data type dependent and are the same as for the Save key.

Key Path	Front-panel key
Notes	<p>No remote command for this key specifically, but the :MMEM:LOAD command is available for specific file types. An example is :MMEM:LOAD:STATe &lt;filename&gt;.</p> <p>If you try to recall a State file for a mode that is not licensed or not available in the instrument, an error message will occur and the state will not change.</p>
Backwards Compatibility Notes	<p>In legacy analyzers, it was possible to load a state without affecting the trace data, limit lines or correction data. Similarly (since User Preset is actually loading a state), it was possible to do a User Preset without affecting the trace data, limit lines or correction data.</p> <p>In the X-Series, “state” always includes all of this data; so whenever state is loaded, all of the traces, limit lines and corrections are affected. Although this differs from previous behavior, it is desirable behavior, and should not cause adverse issues for users.</p>
Backwards Compatibility Notes	<p>Recall for the X-Series supports backward compatibility in the sense that you can recall a state file from any X-Series model number and any version of X-Series software. This is only possible if part of the recalling process goes through a limiting step after recalling the mode settings, at least for settings that may vary with version number, model number, option and license differences. If you try to recall a state file onto an instrument with less capability than what was available on the instrument during the save, the recall will ignore the state it doesn't support and it will limit the recalled setting to what it allows.</p> <p>Example: if the saved state includes preamp ON, but the recalling instrument does not have a preamp; the preamp is limited to OFF. Conversely, if you save a state without a preamp, the preamp is OFF in the state file. When this saved file is recalled on an instrument with a licensed preamp, the preamp is changed to OFF. Another example is if the saved state has center frequency set to 20 GHz, but the instrument recalling the saved state is a different model and only supports 13.5 GHz. In this case, the center frequency is limited along with any other frequency based settings. Since the center frequency can't be preserved in this case, the recall limiting tries to at least preserve span to keep the measurement setup as intact as possible.</p> <p>It may be appropriate to issue a warning if the state is limited on the recall; warnings do not go out to SCPI so this would only affect the manual user.</p> <p>Note that there is no state file compatibility outside of the X-Series. For example, you cannot recall a state file from ESA or PSA.</p>
Initial S/W Revision	Prior to A.02.00

## State

The Recall State menu lets you choose a register or file from which to recall the state.

The content of a state file includes all of the settings and data required to return the analyzer as closely as possible to the Mode it was in, with the exact settings that were in place, when the save occurred. The Mode settings in each state file include the settings that are affected by Mode Preset, as well as the

additional settings affected by Restore Mode Defaults; all of the Mode’s settings. In addition, all of the settings of the Input/Output system are included, even though they are outside of the Mode’s state, because they are needed to restore the complete setup. Persistent System settings (for example, GPIB address) are not affected by either a Mode Preset or Restore Mode Defaults, nor are they included in a saved State file.

Since each state file is only for one Mode, the settings for other Modes are unaffected when it is loaded. Recall State will cause a mode switch if the state being recalled is not from the current active mode.

After the recall completes, the message "File <filename> recalled" or “Recalled State Register <register number>” is displayed.

For rapid recalls, the State menu lists 16 registers that you can choose from to recall. Pressing a Register key initiates the recall. You can also select a file from which to recall.

The default path for all State Files is:

My Documents\<<mode name>\state

where <mode name> is the parameter used to select the mode with the INST:SEL command (for example, SA for the Spectrum Analyzer).

See "[More Information](#)" on page 1842.

<b>Key Path</b>	Recall
<b>Mode</b>	All
<b>Remote Command</b>	:MMEMory:LOAD:STATe <filename>
<b>Example</b>	:MMEM:LOAD:STAT "myState.state" This recalls the file myState.state on the default path
<b>Example</b>	MMEM:LOAD:STAT "MyStateFile.state" This loads the state file data (on the default file directory path) into the instrument state.
<b>Notes</b>	<p>When you pick a file to recall, the analyzer first verifies that the file is recallable in the current instrument by checking the software version and model number of the instrument. If everything matches, a full recall proceeds by aborting the currently running measurement, clearing any pending operations, and then loading the State from the saved state file. You can open state files from any mode, so recalling a State file switches to the mode that was active when the save occurred. After switching to the mode of the saved state file, mode settings and data (if any for the mode) are loaded with values from the saved file. The saved measurement of the mode becomes the newly active measurement and the data relevant to the measurement (if there is any) is recalled.</p> <p>If there is a mismatch between file version or model number or instrument version or model number, the recall function tries to recall as much as possible and returns a warning message. It may limit settings that differ based on model number, licensing or version number.</p> <p>After recalling the state, the Recall State function does the following:</p> <ul style="list-style-type: none"> <li>• Makes the saved measurement for the mode the active measurement.</li> <li>• Clears the input and output buffers.</li> <li>• Status Byte is set to 0.</li> <li>• Executes a *CLS</li> </ul> <p>If the file specified is empty an error is generated. If the specified file does not exist, another error is generated. If there is a mismatch between the file and the proper file type, an error is generated. If</p>

	there is a mismatch between file version or model number or instrument version or model number, a warning is displayed. Then it returns to the State menu and File Open dialog goes away. After the Recall, the analyzer exits the Recall menu and returns to the previous menu.
<b>Backwards Compatibility SCPI</b>	:MMEMory:LOAD:STATe 1,<filename> For backwards compatibility, the above syntax is supported. The "1" is simply ignored.
Initial S/W Revision	Prior to A.02.00

## More Information

In measurements that support saving Traces, for example, Swept SA, the Trace data is saved along with the State in the State file. When recalling the State, the Trace data is recalled as well. Traces are recalled exactly as they were stored, including the writing mode and update and display modes. If a Trace was updating and visible when the State was saved, it will come back updating and visible, and its data will be rewritten right away. When you use State to save and recall traces, any trace whose data must be preserved should be placed in View or Blank mode before saving.

The following table describes the Trace Save and Recall possibilities:

You want to recall state and one trace's data, leaving other traces unaffected.	Save Trace+State from 1 trace. Make sure that no other traces are updating (they should all be in View or Blank mode) when the save is performed.	On Recall, specify the trace you want to load the one trace's data into. This trace will load in View. All other traces' data will be unaffected, although their trace mode will be as it was when the state save was performed.
You want to recall all traces	Save Trace+State from ALL traces.	On Recall, all traces will come back in View (or Blank if they were in Blank or Background when saved)
You want all traces to load exactly as they were when saved.	Save State	On recall, all traces' mode and data will be exactly as they were when saved. Any traces that were updating will have their data immediately overwritten.

## From File...

When you press "From File", the analyzer brings up a Windows dialog and a menu entitled "File Open." This menu allows you to navigate to the various fields in the Windows dialog without using a keyboard or mouse. The Tab and Arrow keys can also be used for dialog navigation.

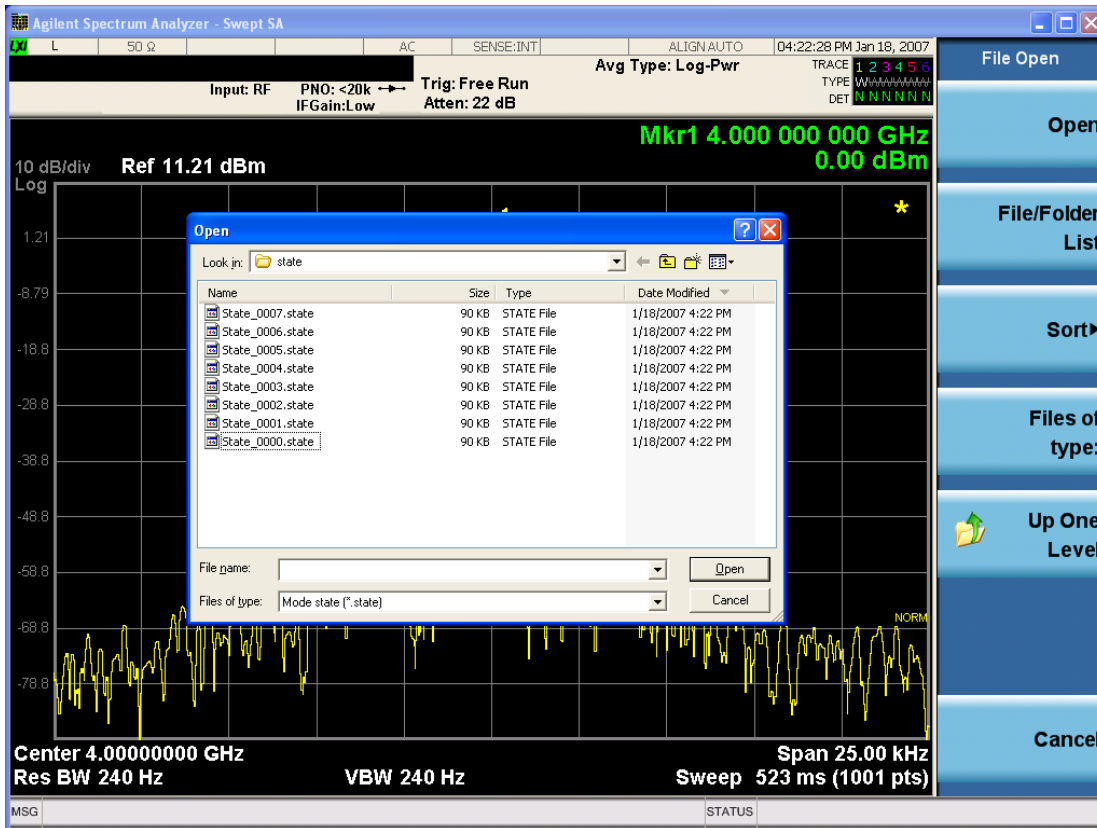

Listed below are the functions of the various fields in the dialog, and the corresponding softkeys:

#### Open

Performs the recall of the specified file. While the recall is being performed, the floppy icon appears briefly in the Meas bar.

#### File/Folder List

Enables you to navigate to the center of the dialog that contains the list of files and folders. Once here you can get information about the file and use the tab keys to navigate to the other fields in the dialog, such as Look In.

#### Look In

The Look In field shows the path from which the file will be recalled and allows you to change the path using the up and down arrow keys to navigate to other paths; the Enter key to open a directory; and the Backspace key to go back one directory. The **Look In field** first uses the last path from the Save As dialog **Save In:** path for that same file type. There is no softkey for directly navigating to the Look In field, but you can use the left tab to get here from the File/Folder List.

User specified paths are remembered when you leave and return to a Mode and are reset back to the default using Restore Mode Defaults.

#### Sort

Accesses a menu that enables you to sort the files within the File Open dialog. Only one sorting type can be selected at a time and the sorting happens immediately. The sorting types are By Date, By Name, By extension, and By Size.

#### Files of Type

This field shows the file suffix for the type of file you have selected to recall. For example, if you navigated here while recalling State, "Mode state (\*.state)" is in the field. If you navigated here while recalling Trace, ""Mode state (\*.trace)" is in the field. If you navigated here while importing a trace data file, "Trace Data (\*.csv)" is in the field. For some file types, there is more than one choice in the dropdown menu, which you can select by using the up and down arrow keys and Enter.

#### Up One Level

This key corresponds to the icon of a folder with the up arrow that is in the tool bar of the dialog. When pressed, it causes the file and folder list to navigate up one level in the directory structure. The Backspace key does the same thing.

#### Cancel

This key corresponds to the Cancel selection in the dialog. It causes the current **Open** request to be cancelled. The ESC key does the same thing.

Key Path	Recall, State
Notes	Brings up the Open dialog for recalling a State Save Type
Initial S/W Revision	Prior to A.02.00

### Edit Register Names

You may enter a custom name on any of the Register keys, to help you remember what you are using that state to save. To do this, press the Edit Register Names key, choose the register whose name you wish to edit, and then enter the desired label using the Alpha Editor or an external PC keyboard.

The maximum number of characters that can be added is 30. In most cases, 30 characters will fit on two lines of the key.

For more information and the SCPI command, see Edit Register Names under the Save, State function.

Key Path	Recall, State
Mode	All
Dependencies	N9060A-7FP or N9060B-2FP license required to edit the register names. When the feature is not licensed, sending the SCPI command generates an error, -221, "Settings conflict;Option not available"
Initial S/W Revision	A.11.00

### Register 1 thru Register 16

Selecting any one of these register keys causes the State of the mode from the specified Register to be recalled. Each of the register keys annotates whether it is empty or at what date and time it was last



modified. In addition, you can use the Edit Register Names key under Save, State to enter custom names for each register.

Registers are shared by all modes, so recalling from any one of the registers will cause a mode switch to the mode that was active when the save to the Register occurred.

Although these 16 registers are the only registers available from the front panel, there are 128 state registers available in the instrument. Registers 17–128 are only available from the SCPI interface, using the \*RCL command.

After the recall completes, the message "Register <register number> recalled" appears in the message bar. If you are in the Spectrum Analyzer Mode, and you are recalling a register that was saved in the Spectrum Analyzer Mode, then after the recall, you will still be in the Recall Register menu. If the Recall causes you to switch modes, then after the Recall, you will be in the Frequency menu.

If a requested register is empty an error is generated.

Key Path	Recall, State
<b>Example</b>	*RCL 1
Range	1–16 from front panel, 1–128 from SCPI
Readback	Date and time with seconds resolution are displayed on the key OR A custom name of up to 30 characters entered using the Save, State, Edit Register Names key OR “(empty)” if no prior save operation has been performed to this register.
Initial S/W Revision	Prior to A.02.00
Modified at S/W Revision	Prior to A.11.00

## Register 1 thru Register 16

Selecting any one of these register keys causes the State of the mode from the specified Register to be recalled. Each of the register keys annotates whether it is empty or at what date and time it was last modified. In addition, you can use the Edit Register Names key under Save, State to enter custom names for each register.

Registers are shared by all modes, so recalling from any one of the registers will cause a mode switch to the mode that was active when the save to the Register occurred.

Although these 16 registers are the only registers available from the front panel, there are 128 state registers available in the instrument. Registers 17–128 are only available from the SCPI interface, using the \*RCL command.

After the recall completes, the message "Register <register number> recalled" appears in the message bar. If you are in the Spectrum Analyzer Mode, and you are recalling a register that was saved in the Spectrum Analyzer Mode, then after the recall, you will still be in the Recall Register menu. If the Recall causes you to switch modes, then after the Recall, you will be in the Frequency menu.

If a requested register is empty an error is generated.

Key Path	Recall, State
Example	*RCL 1
Range	1-16 from front panel, 1-128 from SCPI
Readback	Date and time with seconds resolution are displayed on the key OR A custom name of up to 30 characters entered using the Save, State, Edit Register Names key OR “(empty)” if no prior save operation has been performed to this register.
Initial S/W Revision	Prior to A.02.00
Modified at S/W Revision	Prior to A.11.00

### Trace (+State)

The Recall Trace (+State) menu lets you choose a register or file from which to recall the Trace+State state file.

A saved state contains all of the settings and data required to return the analyzer as closely as possible to the exact setup it had when the save occurred. This includes the Input/Output settings, even though they are outside of the Mode’s state, because they are needed to restore the complete setup. A Trace+State file also includes trace data from one trace or all traces, which will load in View mode when the Trace+State file is recalled. Recall Trace (+State) will also cause a mode switch if the state being recalled is not for the current active mode.

After the recall completes, the message "File <filename> recalled" or “Recalled Trace Register <register number>” is displayed.

For rapid recalls, the Trace (+State) menu lists 5 registers to choose from to recall. Pressing a Register key initiates the recall. You can also select a file from which to recall.

The default path for all State Files including .trace files is:

My Documents\<mode name>\state

where <mode name> is the parameter used to select the mode with the INST:SEL command (for example, SA for the Spectrum Analyzer).

Key Path	Recall
Mode	SA
Remote Command	:MMEMory:LOAD:TRACe TRACE1   TRACE2   TRACE3   TRACE4   TRACE5   TRACE6, <filename>  :MMEMory:LOAD:TRACe:REGister TRACE1   TRACE2   TRACE3   TRACE4   TRACE5   TRACE6, <integer>
Example	MMEM:LOAD:TRAC TRACE2, "MyTraceFile.trace" This loads the trace file data (on the default file directory path) into the specified trace; if it is a "single trace" save file, that trace is loaded to trace 2, and is set to be not updating. :MMEM:LOAD:TRAC:REG TRACE1,2

	restores the trace data in register 2 to Trace 1
Notes	<p>When you perform the recall, the recalling Trace function must first verify the file is recallable in this instrument by checking instrument software version and model number, since it includes State. If everything matches, a full recall proceeds by aborting the currently running measurement, and loading the state from the saved state file to as close as possible to the context in which the save occurred. You can open .trace files from any mode that supports them, so recalling a Trace file switches to the mode that was active when the save occurred. After switching to the mode of the saved state file, mode settings and data (if any for the mode) are loaded with values from the saved file and the saved measurement of the mode becomes the newly active measurement, and the data relevant to the measurement (if there is any) is recalled.</p> <p>Once the state is loaded, the trace data must be loaded. The internal flags are consulted to see which trace to load and the "To Trace" setting to see where to load it. Trace data is always loaded with the specified trace set to View, so that the data is visible and not updating (so as not to erase the recalled data). If the file is an "all trace" file, all traces are loaded with the saved data (to the original trace the data was saved from) and set to View. Traces whose data is not loaded are restored to the update state that existed when they were saved.</p> <p>After the Recall the analyzer exits the Recall menu and returns to the previous menu.</p> <p>Some modes and measurements do not have available all 6 traces. Phase Noise mode command, for example, is: <code>MMEMory:LOAD:TRACe TRACE1 TRACE2 TRACE3,&lt;filename&gt;</code></p> <p>Some modes and measurements have more than 6 traces available. The Realtime SA mode command, for example, is: <code>MMEMory:STORe:TRACe TRACE1   TRACE2   TRACE3   TRACE4   TRACE5   TRACE6   TRACE7   TRACE8   TRACE9   TRACE10   TRACE11   TRACE12   ALL,&lt;filename&gt;</code></p>
Initial S/W Revision	Prior to A.02.00

## To Trace

These menu selections let you choose the Trace where the recalled saved trace will go. Not all modes have the full 6 traces available. The default is the currently selected trace, selected in this menu or in the Trace/Detector, Export Data, Import Data, or Save Trace menus, except if you have chosen All, then it remains chosen until you specifically change it to a single trace.

If the .trace file is an "all trace" file, "To Trace" is ignored and the traces each go back to the trace from which they were saved.

Once selected, the key returns back to the Recall Trace menu and the selected Trace number is annotated on the key. Now you have selected exactly where the trace needs to be recalled. To trigger a recall of the selected Trace, you must select the Open key in the Recall Trace menu.

When you select a trace, it makes that trace the current trace, so it displays on top of all of the other traces.

Key Path	Save, Data, Trace
Mode	SA
Initial S/W Revision	Prior to A.02.00

## Register 1 thru Register 16

Selecting any one of these register keys causes the State of the mode from the specified Register to be recalled. Each of the register keys annotates whether it is empty or at what date and time it was last modified. In addition, you can use the Edit Register Names key under Save, State to enter custom names for each register.

Registers are shared by all modes, so recalling from any one of the registers will cause a mode switch to the mode that was active when the save to the Register occurred.

Although these 16 registers are the only registers available from the front panel, there are 128 state registers available in the instrument. Registers 17–128 are only available from the SCPI interface, using the \*RCL command.

After the recall completes, the message "Register <register number> recalled" appears in the message bar. If you are in the Spectrum Analyzer Mode, and you are recalling a register that was saved in the Spectrum Analyzer Mode, then after the recall, you will still be in the Recall Register menu. If the Recall causes you to switch modes, then after the Recall, you will be in the Frequency menu.

If a requested register is empty an error is generated.

Key Path	Recall, State
<b>Example</b>	*RCL 1
Range	1–16 from front panel, 1–128 from SCPI
Readback	Date and time with seconds resolution are displayed on the key OR A custom name of up to 30 characters entered using the Save, State, Edit Register Names key OR “(empty)” if no prior save operation has been performed to this register.
Initial S/W Revision	Prior to A.02.00
Modified at S/W Revision	Prior to A.11.00

## From File...

When you press “From File”, the analyzer brings up a Windows dialog and a menu entitled “File Open.” This menu allows you to navigate to the various fields in the Windows dialog without using a keyboard or mouse. The Tab and Arrow keys can also be used for dialog navigation.



Listed below are the functions of the various fields in the dialog, and the corresponding softkeys:

#### Open

Performs the recall of the specified file. While the recall is being performed, the floppy icon appears briefly in the Meas bar.

#### File/Folder List

Enables you to navigate to the center of the dialog that contains the list of files and folders. Once here you can get information about the file and use the tab keys to navigate to the other fields in the dialog, such as Look In.

#### Look In

The Look In field shows the path from which the file will be recalled and allows you to change the path using the up and down arrow keys to navigate to other paths; the Enter key to open a directory; and the Backspace key to go back one directory. The **Look In field** first uses the last path from the Save As dialog **Save In:** path for that same file type. There is no softkey for directly navigating to the Look In field, but you can use the left tab to get here from the File/Folder List.

User specified paths are remembered when you leave and return to a Mode and are reset back to the default using Restore Mode Defaults.

#### Sort

Accesses a menu that enables you to sort the files within the File Open dialog. Only one sorting type can be selected at a time and the sorting happens immediately. The sorting types are By Date, By Name, By extension, and By Size.

#### Files of Type

This field shows the file suffix for the type of file you have selected to recall. For example, if you navigated here while recalling State, "Mode state (\*.state)" is in the field. If you navigated here while recalling Trace, ""Mode state (\*.trace)" is in the field. If you navigated here while importing a trace data file, "Trace Data (\*.csv)" is in the field. For some file types, there is more than one choice in the dropdown menu, which you can select by using the up and down arrow keys and Enter.

#### Up One Level

This key corresponds to the icon of a folder with the up arrow that is in the tool bar of the dialog. When pressed, it causes the file and folder list to navigate up one level in the directory structure. The Backspace key does the same thing.

#### Cancel

This key corresponds to the Cancel selection in the dialog. It causes the current **Open** request to be cancelled. The ESC key does the same thing.

Key Path	Recall, State
Notes	Brings up the Open dialog for recalling a State Save Type
Initial S/W Revision	Prior to A.02.00

## Data (Import)

Importing a data file loads data that was previously saved from the current measurement or from other measurements and/or modes that produce compatible data files. The Import Menu only contains Data Types that are supported by the current measurement.

Since the commonly exported data files are in .csv format, the data can be edited by the user prior to importing. This allows you to export a data file, manipulate the data in Excel (the most common PC Application for manipulating .csv files) and then import it.

Importing Data loads measurement data from the specified file into the specified or default destination, depending on the data type selected. Selecting an Import Data menu key will not actually cause the importing to occur, since the analyzer still needs to know from where to get the data. Pressing the Open key in this menu brings up the Open dialog and Open menu that provides you with the options from where to recall the data. Once a filename has been selected or entered in the Open menu, the recall occurs as soon as the Open button is pressed.

Key Path	Recall
Mode	All
Notes	The menu is built from whatever data types are available for the mode. Some keys will be missing completely, so the key locations in the sub-menu will vary. No SCPI command directly controls the Data Type that this key controls. The Data Type is included in the MMEM:LOAD commands.

Dependencies	If a file type is not used by a certain measurement, it is grayed out for that measurement. The key for a file type will not show at all if there are no measurements in the Mode that support it.
Preset	Is not affected by Preset or shutdown, but is reset during Restore Mode Defaults
Readback	The data type that is currently selected
Initial S/W Revision	Prior to A.02.00

## Capture Buffer

The captured data is raw data which is not processed.

Key Path	Recall, Data
Mode	<b>CDMA1XEV</b>
Example	MMEM:LOAD:CAPT "MyCaptureData.bin" This loads the file of capture data (on the default file directory path) into the instrument.
Dependencies	In case the capture buffer data is not available from the selected measurement, the key will be grayed out.
Initial S/W Revision	A.11.00

## Open...

When you press "Open", the analyzer brings up a Windows dialog and a menu entitled "**File Open.**" This menu allows you to navigate to the various fields in the Windows dialog without using a keyboard or mouse. The Tab and Arrow keys can also be used for dialog navigation.

See "[From File...](#)" on page 2890 in Recall, State, for a full description of this dialog and menu.

Key Path	Recall, Data
Notes	The key location is mode-dependent and will vary. Brings up Open dialog for recalling a <mode specific> Save Type
Initial S/W Revision	Prior to A.02.00

## Restart

The Restart function restarts the current sweep, or measurement, or set of averaged/held sweeps or measurements. If you are Paused, pressing Restart does a Resume.

The Restart function is accessed in several ways:

- Pressing the Restart key
- Sending the remote command INIT:IMMEDIATE
- Sending the remote command INIT:RESTART

See "[More Information](#)" on page 1852

Key Path	Front-panel key
Remote Command	:INITiate[:IMMEDIATE] :INITiate:RESTART
Example	:INIT:IMM :INIT:REST
Notes	:INITiate:RESTART and :INITiate:IMMEDIATE perform exactly the same function.
Couplings	Resets average/hold count k. For the first sweep overwrites all active (update=on) traces with new current data. For application modes, it resets other parameters as required by the measurement.
Status Bits/OPC dependencies	This is an Overlapped command. The STATus:OPERation register bits 0 through 8 are cleared. The STATus:QUESTionable register bit 9 (INTegrity sum) is cleared. The SWEEPING bit is set. The MEASURING bit is set.
Backwards Compatibility Notes	For Spectrum Analysis mode in ESA and PSA, the Restart hardkey and the INITiate:RESTART command restart trace averages (displayed average count reset to 1) for a trace in Clear Write, but did not restart Max Hold and Min Hold.  In the X-Series, the Restart hardkey and the INITiate:RESTART command restart not only Trace Average, but MaxHold and MinHold traces as well.  For wireless comms modes in ESA and PSA, the Restart hardkey and the INITiate:RESTART command restart every measurement, which includes all traces and numeric results. There is no change to this operation.
Initial S/W Revision	Prior to A.02.00

### More Information

The **Restart** function first aborts the current sweep/measurement as quickly as possible. It then resets the sweep and trigger systems, sets up the measurement and initiates a new data measurement sequence with a new data acquisition (sweep) taken once the trigger condition is met.

If the analyzer is in the process of aligning when **Restart** is executed, the alignment finishes before the restart function is performed.



Even when set for Single operation, multiple sweeps may be taken when Restart is pressed (for example, when averaging/holding is on). Thus when we say that **Restart** "restarts a measurement," we may mean:

- It restarts the current sweep
- It restarts the current measurement
- It restarts the current set of sweeps if any trace is in Trace Average, Max Hold or Min Hold
- It restarts the current set of measurements if Averaging, or Max Hold, or Min Hold is on for the measurement
- depending on the current settings.

With **Average/Hold Number** (in **Meas Setup** menu) set to 1, or Averaging off, or no trace in Trace Average or Hold, a single sweep is equivalent to a single measurement. A single sweep is taken after the trigger condition is met; and the analyzer stops sweeping once that sweep has completed. However, with **Average/Hold Number** >1 and at least one trace set to **Trace Average, Max Hold, or Min Hold (SA Measurement)** or **Averaging on (most other measurements)**, multiple sweeps/data acquisitions are taken for a single measurement. The trigger condition must be met prior to each sweep. The sweep is stopped when the average count  $k$  equals the number  $N$  set for **Average/Hold Number**. A measurement average usually applies to all traces, marker results, and numeric results; but sometimes it only applies to the numeric results.

Once the full set of sweeps has been taken, the analyzer will go to idle state. To take one more sweep without resetting the average count, increment the average count by 1, by pressing the step up key while **Average/Hold Number** is the active function, or sending the remote command `CALC:AVER:TCON UP`.

## Save

The Save menu lets you choose what you want to save and where you want to save it. Among the types of files you can save are **States**, **Traces**, and **Screen Images**. In addition, an Export (Data) option lets you save a number of data types as CSV files for easy import into Excel and other spreadsheet programs.

Key Path	Front-panel key
Mode	All
Notes	No remote command for this key specifically, but the :MMEM:STOR:STATe command is available for specific file types. An example is :MMEM:STOR:STATe <filename>.
Initial S/W Revision	Prior to A.02.00

## State

The Save State menu lets you choose a register or file for saving the state.

The content of a state file includes all of the settings and data required to return the analyzer as closely as possible to the Mode it was in, with the exact settings which were in place, when the save occurred. The Mode settings in each state file include the settings that are affected by Mode Preset, as well as the additional settings affected by Restore Mode Defaults; all of the Mode's settings. In addition, all of the settings of the Input/Output system are included, even though they are outside of the Mode's state, because they are needed to restore the complete setup. Persistent System settings (for example, Verbose SCPI) are not affected by either Mode Preset or Restore Mode Defaults, nor are they included in a saved State file.

After the save completes, the message "File <filename> saved" or "State Register <register number> saved" is displayed.

For rapid saving, the State menu lists 16 registers to save to. Pressing a Register key initiates the save. You can also select a file to save to.

The default path for all State Files is:

My Documents\<<mode name>\state

where <mode name> is the parameter used to select the mode with the INST:SEL command (for example, SA for the Spectrum Analyzer).

Key Path	Save
Mode	All
Remote Command	:MMEMory:STORe:STATe <filename>
Example	MMEM:STOR:STATe "MyStateFile.state" This stores the current instrument state data in the file MyStateFile.state in the default directory.
Notes	Both single and double quotes are supported for any filename parameter over remote. After saving to a register, that register's menu key is updated with the date the time, unless a custom label has been entered for that key. After saving to a register, you remain in the Save State menu, so that you can see the Register key

update. After saving to a file, the analyzer automatically returns to the previous menu and any Save As dialog goes away.

<b>Backwards Compatibility SCPI</b>	:MMEMoRY:STORe:STATe 1,<filename>
Initial S/W Revision	Prior to A.02.00

### To File . . .

When you press “To File”, the analyzer brings up a Windows dialog and a menu entitled “**Save As.**” This menu allows you to navigate to the various fields in the Windows dialog without using a keyboard or mouse. The Tab and Arrow keys can also be used for dialog navigation.

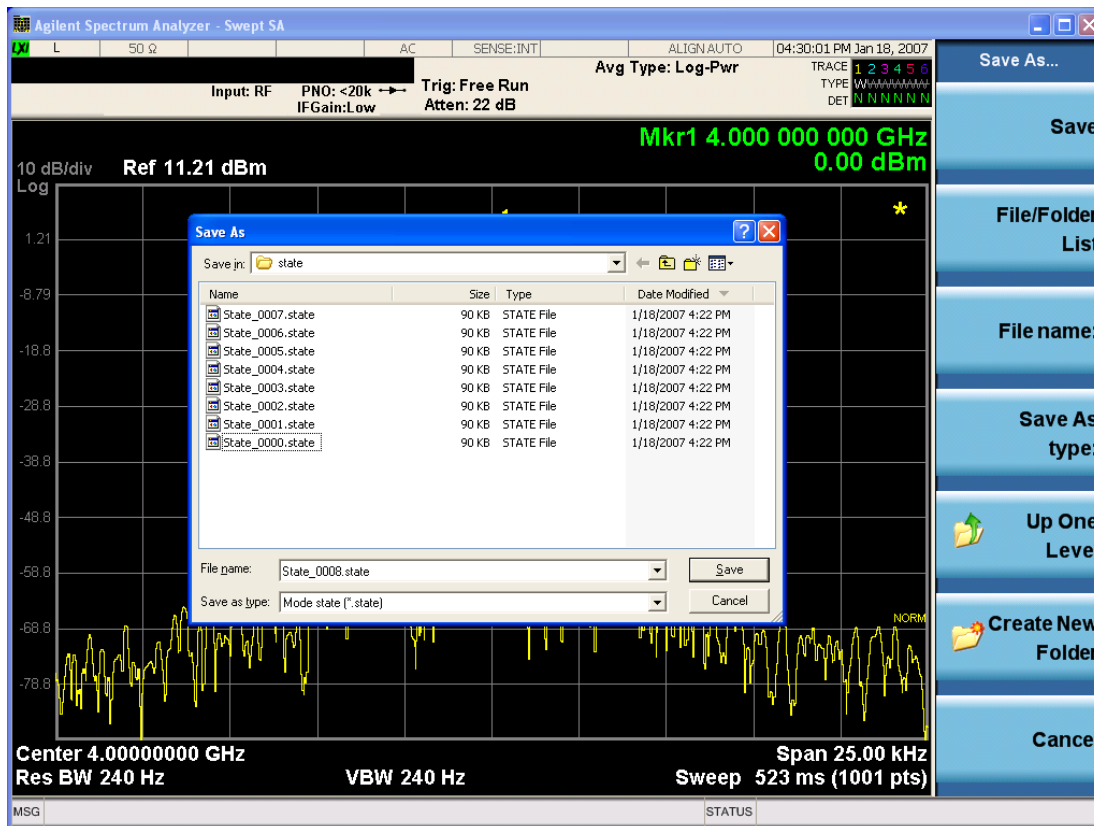

The Listed below

are the functions of the various fields in the dialog, and the corresponding softkeys:

#### Save

Performs the save to the specified file of the selected type. If the file already exists, a dialog will appear that allows you to replace the existing file by selecting OK, or you can Cancel the request. If you select OK, the file will be overwritten. Using the C: drive is strongly discouraged, since it runs the risk of being overwritten during an instrument software upgrade.

While the save is being performed, the floppy icon appears briefly in the Meas bar.

### File/Folder List

Enables you to navigate to the center of the dialog that contains the list of files and folders. Once here you can get information about the file and use the tab keys to navigate to the other fields in the dialog, such as Save In.

### Save In

The Save In field shows the path to which the file will be saved and allows you to change the path using the up and down arrow keys to navigate to other paths; the Enter key to open a directory; and the Backspace key to go back one directory. The **Save In field** defaults to the default path for this type of file and remembers the last path you used to save this type of file. There is no softkey for directly navigating to the Save In field but you can use left tab to get here from the File/Folder List.

User specified paths are remembered when you leave and return to a Mode and are reset back to the default using Restore Mode Defaults.

### File Name

The File Name field is initially loaded with an automatically generated filename specific to the appropriate Save Type. The automatically generated filename is guaranteed not to conflict with any filename currently in the directory. You may replace or modify this filename using the File Name key. See the ["Quick Save " on page 2880](#) documentation for more on the automatic file naming algorithm.

When you press the File Name key the analyzer displays the Alpha Editor. Use the knob to choose the letter to add and the front-panel Enter key to add the letter to the file name. The BK character moves you back and the FW character moves you forward in the filename. The Select key on the front panel generates a space character. When you are done entering the filename press the Done softkey. This returns back to the **File Open** dialog and menu, but does not cause the save to occur.

### Save As Type

This field shows the file suffix for the type of file you have selected to save. For example, if you navigated here while saving State, "Mode state (\*.state)" is in the field. If you navigated here from saving Trace, ""Mode state (\*.trace)" is in the field. If you navigated here while exporting a trace data file, "Trace Data (\*.csv)" is in the field. For some file types, there is more than one choice in the dropdown, which you can select by using the up and down arrow keys and Enter.

### Up One Level

This key corresponds to the icon of a folder with the up arrow that is in the tool bar of the dialog. When pressed, it causes the file and folder list to navigate up one level in the directory structure. The Backspace key does the same thing.

### Create New Folder

This key corresponds to the icon of a folder with the "\*" that is in the tool bar of the dialog. When pressed, a new folder is created in the current directory with the name **New Folder** and you can enter a new folder name using the Alpha Editor.

### Cancel

This key corresponds to the Cancel selection in the dialog. It causes the current **Save As** request to be cancelled. The ESC key does the same thing.

Key Path	Save, State
Mode	All
Notes	Brings up Save As dialog for saving a State Save Type
Initial S/W Revision	Prior to A.02.00

## Edit Register Names

You may enter a custom name on any of the Register keys, to help you remember what you are using that state to save. To do this, press the Edit Register Names key, choose the register whose name you wish to edit, and then enter the desired label using the Alpha Editor or an external PC keyboard.

The maximum number of characters that can be added is 30. In most cases, 30 characters will fit on two lines of the key.

See ["More Information" on page 1857](#)

Key Path	Save, State
Mode	All
<b>Remote Command</b>	:MMEMory:REGister:STATe:LABel <reg number>,"label" :MMEMory:REGister:STATe:LABel? <reg number>
<b>Example</b>	:MMEM:REG:STAT:LAB 1,"my label"
Notes	<reg number> is an integer from 1 to 16. If the SCPI specifies an invalid register number an error message is generated, -222,"Data out of range;Invalid register label number" "label" is a string from 0 to 30 characters in length. If a label exceeds 30 characters, an error message is generated, -150,"String data error;Label clipped to 30 characters" "label" of length 0 erases the custom label and restores the default (time and date) label. E.g.: :MMEM:REG:STAT:LAB 1,""
Dependencies	N9060A-7FP or N9060B-2FP license required to edit the register names. When the feature is not licensed, sending this command generates an error, -221,"Settings conflict;Option not available"
Preset	The names are unaffected by Preset or power cycle but are set to the default label (time and date) on a "Restore System Defaults->Misc"
Initial S/W Revision	A.11.00

## More Information

When you edit one of the register names, the time and date field will be replaced by the custom name.

If you delete all the characters in the custom name, it restores the default (time and date).

The register names are stored within the state files, but they are not part of the instrument state; that is, once you have edited a register name, loading a new state will not change that register name. Another consequence of this is that the names will be persistent through a power cycle. Also, if a named state file is transferred to another analyzer, it will bring its custom name along with it.

If you try to edit the name of an empty register, the analyzer will first save the state to have a file to put the name in. If you load a named state file into an analyzer with older firmware it will ignore the metadata.

The \*SAV and \*RCL commands will not be affected by the custom register names, nor will the MMEM commands.

### Register 1 thru Register 16

Selecting any one of these register menu keys causes the State of the currently active mode to be saved to the specified Register. The registers are provided for rapid saving and recalling, since you do not need to specify a filename or navigate to a file. Each of the register menu keys annotates whether it is empty or at what date and time it was last modified. In addition, you can use the Edit Register Names key to enter custom names for each register.

Although these 16 registers are the only registers available from the front panel, there are 128 state registers available in the instrument. Registers 17–128 are only available from the SCPI interface, using the \*SAV command.

There is one set of 128 state registers in the instrument, not one set for each Mode. When a state is saved, the Mode it was saved from is saved with it; then when it is recalled, the instrument switches to that Mode.

After the save completes, the corresponding register menu key annotation is updated with the date and time and the message "Register <register number> saved" is displayed.

Key Path	Save, State
Mode	All
Example	*SAV 1
Range	1–16 from front panel, 1–128 from SCPI
Readback	Date and time with seconds resolution are displayed on the key OR A custom name of up to 30 characters entered using the Edit Register Names key OR “(empty)” if no prior save operation has been performed to this register.
Initial S/W Revision	Prior to A.02.00
Modified at S/W Revision	A.11.00

### Register 1 thru Register 16

Selecting any one of these register menu keys causes the State of the currently active mode to be saved to the specified Register. The registers are provided for rapid saving and recalling, since you do not need to specify a filename or navigate to a file. Each of the register menu keys annotates whether it is empty or at what date and time it was last modified. In addition, you can use the Edit Register Names key to enter custom names for each register.

Although these 16 registers are the only registers available from the front panel, there are 128 state registers available in the instrument. Registers 17–128 are only available from the SCPI interface, using the \*SAV command.

There is one set of 128 state registers in the instrument, not one set for each Mode. When a state is saved, the Mode it was saved from is saved with it; then when it is recalled, the instrument switches to that Mode.

After the save completes, the corresponding register menu key annotation is updated with the date and time and the message "Register <register number> saved" is displayed.

Key Path	Save, State
Mode	All
Example	*SAV 1
Range	1–16 from front panel, 1–128 from SCPI
Readback	Date and time with seconds resolution are displayed on the key OR A custom name of up to 30 characters entered using the Edit Register Names key OR “(empty)” if no prior save operation has been performed to this register.
Initial S/W Revision	Prior to A.02.00
Modified at S/W Revision	A.11.00

## Data (Export)

Exporting a data file stores data from the current measurement to mass storage files. The Export Menu only contains data types that are supported by the current measurement.

Since the commonly exported data files are in .csv format, the data can be edited by you prior to importing. This allows you to export a data file, manipulate the data in Excel (the most common PC Application for manipulating .csv files) and then import it.

Selecting an Export Data menu key will not actually cause the exporting to occur, since the analyzer still needs to know where you wish to save the data. Pressing the Save As key in this menu brings up the Save As dialog and Save As menu that allows you to specify the destination file and directory. Once a filename has been selected or entered in the Open menu, the export will occur as soon as the Save key is pressed.

Key Path	Save
Mode	All
Notes	The menu is built from whatever data types are available for the mode. So the key locations in the sub menu will vary.  No SCPI command directly controls the Data Type that this key controls. The Data Type is included in the MMEM:STORe commands.
Dependencies	If a file type is not used by a certain measurement, that type is grayed out for that measurement. The key for a file type will not show at all if there are no measurements in the Mode that support it.
Preset	Is not affected by a Preset or shutdown, but is reset during Restore Mode Defaults
Readback	The data type that is currently selected
Initial S/W Revision	Prior to A.02.00

## Measurement Results

Pressing this key selects Meas Results as the data type to be exported. Pressing the key a second time brings up the Meas Results menu, which allows you to select which **Meas Result** to save. In the Swept SA measurement, there are three types of Measurement Results files: Peak Table, Marker Table and Spectrogram.

See "[Meas Results File Contents](#)" on page 1860.

See "[Marker Table](#)" on page 1860.

See "[Peak Table](#)" on page 1863.

See "[Spectrogram](#)" on page 1866

<b>Remote Command</b>	:MMEMory:STORe:RESults:MTABle PTABle SPEctrogram <filename>
<b>Example</b>	:MMEM:STOR:RES:MTAB "myResults.csv" Saves the results from the current marker table to the file myResults.csv in the current path. :MMEM:STOR:RES:PTAB "myResults.csv" Saves the results from the current peak table to the file myResults.csv in the current path. :MMEM:STOR:RES:SPEC "myResults.csv" Saves the results from the current Spectrogram display to the file myResults.csv in the current path. The default path is My Documents\SA\data\SAN\results
<b>Notes</b>	If the save is initiated via SCPI, and the file already exists, the file will be overwritten. Using the C: drive is strongly discouraged, since it runs the risk of being overwritten during an instrument software upgrade. Both single and double quotes are supported for any filename parameter over SCPI.
<b>Dependencies</b>	If a save of Marker Table results is requested and the Marker Table is not on, no file is saved and a message is generated If a save of Peak Table results is requested and the Peak Table is not on, no file is saved and a message is generated If a save of Spectrogram results is requested and the Spectrogram is not on, no file is saved and a message is generated. The Spectrogram choice only appears if option EDP is licensed.
<b>Preset</b>	Not part of Preset, but is reset to Peak Table by Restore Mode Defaults. Survives a shutdown.
<b>Initial S/W Revision</b>	Prior to A.02.00

## Meas Results File Contents

All files are .csv files. The following section details the data in each file type.

### Marker Table

This section discusses the Marker Table Meas Results file format.

Imagine that, at the point where a Marker Table Meas Result is requested, the following screen is showing:



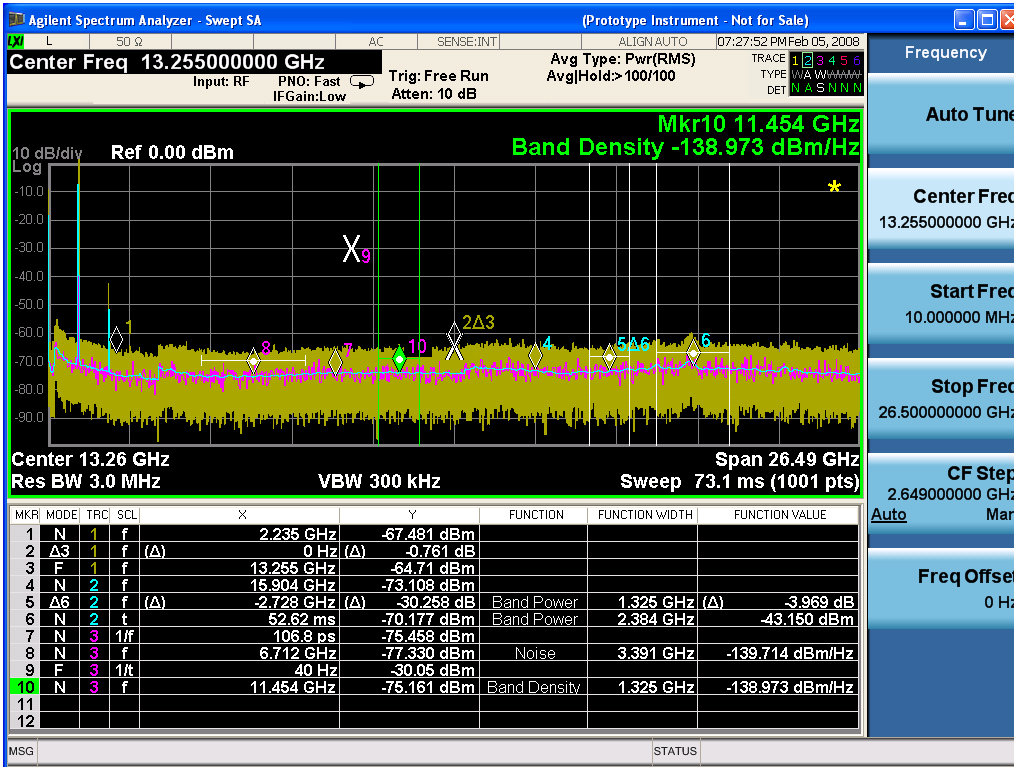

Then the Meas Results file, when opened, would show the following data:

MeasurementR	
result	
Swept SA	
A.01.40_R0017	N9020A
526 B25 PFR	1
P26 EA3	
Result Type	Marker Table
Ref Level	0
Number of Points	1001
Sweep Time	0.0662666 67
Start Frequency	10000000
Stop Frequency	26500000 000
Average Count	0
Average Type	LogPower (Video)
RBW	3000000

RBW Filter	Gaussian
RBW Filter BW	3dB
VBW	3000000
Sweep Type	Swept
X Axis Scale	Lin
PreAmp State	Off
PreAmp Band	Low
Trigger Source	Free
Trigger Level	1.2
Trigger Slope	Positive
Trigger Delay	1.00E-06
Phase Noise Optimization	Fast
Swept If Gain	Low
FFT If Gain	Autorange
RF Coupling	AC
FFT Width	411900
Ext Ref	10000000
Input	RF
RF Calibrator	Off
Attenuation	10
Ref Level Offset	0
External Gain	0
X Axis Units	Hz
Y Axis Units	dBm

DATA									
MKR	MODE	TRC	SCL	X	Y	FUNCTION	FUNCTION WIDTH	FUNCTION VALUE	FUNCTION UNIT
1	Normal	1	Frequency	2.2350E+09	-67.481	Off	0.0000E+00	0	None
2	Delta3	1	Frequency	0.0000E+00	-0.761	Off	0.0000E+00	0	None
3	Fixed	1	Frequency	1.3255E+10	-64.71	Off	0.0000E+00	0	None
4	Normal	2	Frequency	1.5904E+10	-73.1	Off	0.0000E+00	0	None

08									
5	Delta7	2	Frequency	- 2.7280E+ 09	- 30.2 58	Band Power	1.3250E+ 06	-3.969	dB
6	Normal	2	Time	5.2620E- 02	- 70.1 77	Band Power	2.3840E+ 06	-43.15	dBm
7	Normal	3	Period	1.0680E- 10	- 75.4 58	Off	0.0000E+ 00	0	None
8	Normal	3	Frequency	6.7120E+ 09	- 77.3 3	Noise	3.3910E+ 06	- 139.71 4	dBm/Hz
9	Fixed	3	Inverse Time	4.0000E+ 01	- 30.0 5	Off	0.0000E+ 00	0	None
10	Normal	3	Frequency	1.1454E+ 10	- 75.1 61	Band Density	1.3250E+ 06	- 138.97 3	dBm/Hz
11	Off	1	Frequency	0.0000E+ 00	0	Off	0.0000E+ 00	0	None
12	Off	1	Frequency	0.0000E+ 00	0	Off	0.0000E+ 00	0	None

The numbers appear in the file exactly as they appear onscreen. If it says 11.454 GHz onscreen, then in the file it is 11.454E+09.

The metadata header is very similar to the metadata used in the trace data .csv files. See Trace File Contents. The only new information concerns the 1-of-N fields in the marker table itself.

### Peak Table

This section discusses the Peak Table Meas Results file format.

Imagine that, at the point where a Marker Table Meas Result is requested, the following screen is showing:

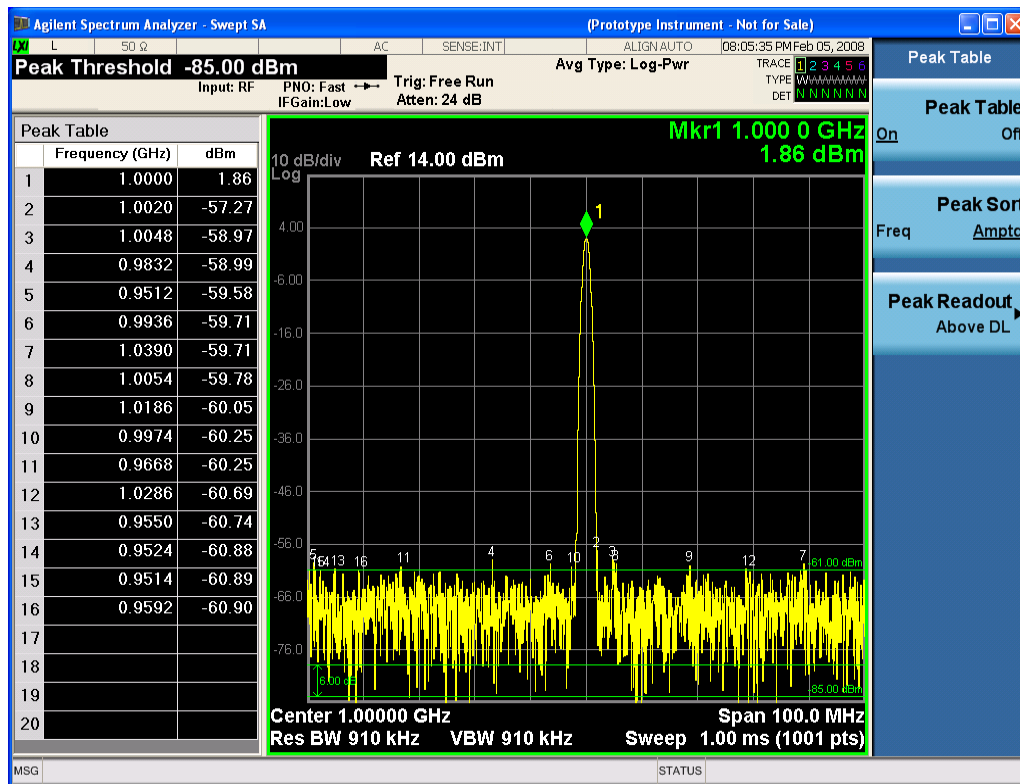

Then the Meas Results file, when opened, would show the header data (the same as for the Marker Table except that the Result Type is Peak Table) ending with a few fields of specific interest to Peak Table users:

- Peak Threshold
- Peak Threshold State (On|Off)
- Peak Excursion
- Peak Excursion State (On|Off)
- Display Line
- Peak Readout (All|AboveDL|BelowDL)
- Peak Sort (Freq|Amptd)

These fields are then followed by the data for the Peak Table itself.

Note that the label for the Frequency column changes to Time in 0 span.

Here is what the table for the above display looks like:

MeasurementResult	
Swept SA	
A.01.40_R0017	N9020A
526 B25 PFR P26 EA3	1

Result Type	Peak Table
Ref Level	0
Number of Points	1001
Sweep Time	0.066266667
Start Frequency	10000000
Stop Frequency	26500000000
Average Count	0
Average Type	LogPower(Video)
RBW	3000000
RBW Filter	Gaussian
RBW Filter BW	3dB
VBW	3000000
Sweep Type	Swept
X Axis Scale	Lin
PreAmp State	Off
PreAmp Band	Low
Trigger Source	Free
Trigger Level	1.2
Trigger Slope	Positive
Trigger Delay	1.00E-06
Phase Noise Optimization	Fast
Swept If Gain	Low
FFT If Gain	Autorange
RF Coupling	AC
FFT Width	411900
Ext Ref	10000000
Input	RF
RF Calibrator	Off
Attenuation	10
Ref Level Offset	0
External Gain	0
X Axis Units	Hz
Y Axis Units	dBm
Peak Threshold	-85
Peak Threshold State	On
Peak Excursion	6
Peak Excursion State	On

Display Line	-61	
Peak Readout	AboveDL	
Peak Sort	Amptd	
DATA		
Peak	Frequency	Amplitude
1	1.0000E+06	1.86
2	1.0020E+06	-57.27
3	1.0048E+06	-58.97
4	9.8320E+05	-58.99
5	9.5120E+05	-59.58
6	9.9360E+05	-59.71
7	1.0390E+06	-59.71
8	1.0054E+06	-59.78
9	1.1086E+06	-60.05
10	9.9740E+05	-60.25
11	9.6680E+05	-60.25
12	1.0286E+06	-60.69
13	9.5500E+05	-60.74
14	9.5240E+05	-60.88
15	9.5140E+05	-60.89
16	9.5920E+05	-60.90
17		
18		
19		
20		

### Spectrogram

This section discusses the Spectrogram Results file format. The Spectrogram choice only appears if option EDP is licensed.

The Spectrogram results are the same as a Trace data export, except that instead of having just one trace's data, all 300 traces appear one after the other.

Each trace has its own data mark; the data for Spectrogram Trace 0 follows the row marked DATA, the data for Spectrogram Trace 1 follows the row marked DATA1, for Spectrogram Trace 2 follows the row marked DATA2, and so on.

Each DATA row has a timestamp in the second column (as of firmware revision A.11.01). So, for example, if Trace 0 had a relative start time of 1729.523 sec, then the first DATA row would look like this:

DATA,1729.523

And if Trace 13 had a relative start time of 100.45 sec, then the fourteenth data row would look like:

DATA13,100.453

To find the absolute time for the relative timestamps of each trace, the last row before the first DATA row gives the absolute start time of the Spectrogram, in the form YYYYMMDDHHMMSS

So, for example, if the absolute start time is 13:23:45:678 on January 30, 2012, this row would look like:

Start Time,20120130132345678

**NOTE** The resolution of the absolute time stored is 1 ms, which matches up with the fact that the fastest sweep time is also 1 ms. However, there is no specification for the absolute accuracy of the clock in the analyzer, nor is there any facility provided to allow the user to set this time to any particular degree of accuracy.

Traces that have not yet been filled in the Spectrogram display are empty; there is no DATA header for them. The file ends after the last non-empty trace.

Imagine that, at the point where a Spectrogram Meas Result is requested, the following screen is showing:

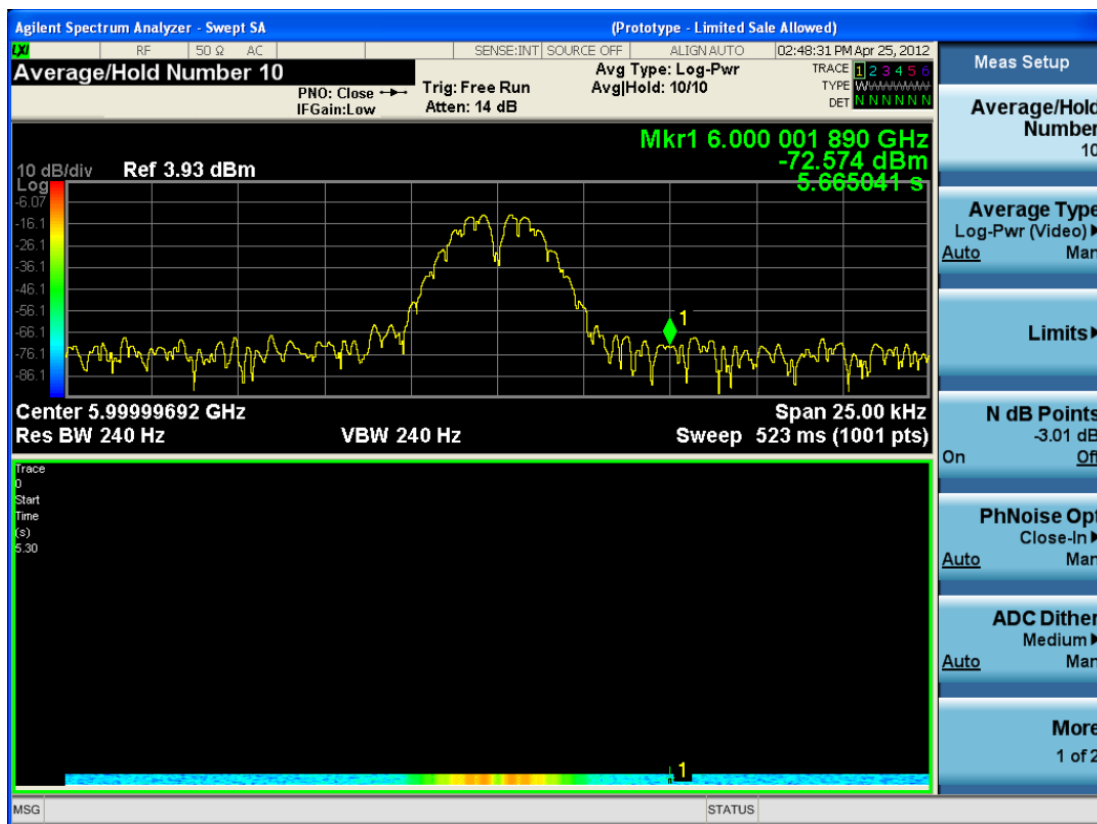

For the purpose of this example, we have set the Average/Hold Number to 10, thus we have only traces 0 thru 10. The Spectrogram was started at 02:28:08:700 pm on April 25, 2012 (that is, 700 ms after 2:28:08 pm), although the screen dump itself shows a different time, as it was taken ten minutes after the

Spectrogram data. Trace 0 is showing a start time of 5.30 seconds, meaning 5.3 seconds after the Spectrogram started (trace 10 has a start time of 0, as it was the first trace taken but has now rolled up into the tenth trace slot).

The Meas Results file, when opened, shows the header data and ten traces of trace data. Below is an extract from the result file for the above display. Note the start time of 20120425142808700 showing in the last row before the first DATA row, and the relative time of 5.299231048 showing in the first DATA row:

<b>Result Type</b>	<b>Spectrogram</b>
MeasResult	
Swept SA	
A.11.00.01	N9020A
503 508 513 526 ALL ALV B1C B1X B25 B2X B40 BAB BBA CR3 CRP DP2 DRD EA3 EDP EMC EP1 ERC ESC ESP EXM FSA HBA K03 LFE MPB P03 P08 P13 P26 PFR RTL RTS S40 SB1 SEC SM1 UK6 YAS YAV	1
Segment	0
Number of Points	1001
Sweep Time	0.523333333
Start Frequency	5999984415
Stop Frequency	6000009415
Average Count	0
Average Type	LogPower(Video)
RBW	240
RBW Filter	Gaussian
RBW Filter BW	3dB
VBW	240
Sweep Type	Swept
X Axis Scale	Lin
PreAmp State	Off
PreAmp Band	Low
Trigger Source	Free
Trigger Level	1.2
Trigger Slope	Positive
Trigger Delay	0
Phase Noise Optimization	Wide
Swept If Gain	Low
FFT If Gain	Autorange
RF Coupling	AC



Result Type	Spectrogram
FFT Width	411900
Ext Ref	10000000
Input	RF
RF Calibrator	Off
Attenuation	14
Ref Level Offset	0
External Gain	0
Trace Type	Clearwrite
Detector	Normal
Trace Math	Off
Trace Math Oper1	Trace5
Trace Math Oper2	Trace6
Trace Math Offset	0
Trace Name	Trace1
X Axis Units	Hz
Y Axis Units	dBm
Start Time	20120425142808700
DATA	5.299231048
5999984415	-76.34749519
5999984440	-77.28097006
5999984465	-75.32317869
5999984490	-73.64417681
5999984515	-72.67154604

- o
- o
- o

6000009315	-77.94423277
6000009340	-79.51829697
6000009365	-78.46108961
6000009390	-78.46108957
6000009415	-76.59570596
DATA2	4.708697055
5999984415	-80.98197882
5999984440	-80.98197879

5999984465	-75.83142132
5999984490	-74.02712079
5999984515	-73.57213005

- 
- 
- 

6000009315	-75.9183103
6000009340	-79.53787488
6000009365	-78.82602191
6000009390	-78.82602188
6000009415	-76.37486709
DATA10	0
5999984415	-75.56751112
5999984440	-75.76485645
5999984465	-76.67718717
5999984490	-78.79238489
5999984515	-83.72680212

- 
- 
- 

6000009315	-71.3942461
6000009340	-72.28308332
6000009365	-73.92684489
6000009390	-75.45548832
6000009415	-75.17904815

### Capture Buffer

Capture Buffer functionality is not available for all measurements. The captured data is raw data which is not processed.

Key Path	Save, Data
----------	------------

Mode	CDMA1XEV
Example	MMEM:STOR:CAPT "MyCaptureData.bin" This stores the capture data in the file MyCaptureData.bin in the default directory.
Dependencies	In case the capture buffer data is not available from the selected measurement, the key will be grayed out.
Initial S/W Revision	A.11.00

## Save As . . .

When you press “Save As”, the analyzer brings up a Windows dialog and a menu entitled “**Save As.**” This menu allows you to navigate to the various fields in the Windows dialog without using a keyboard or mouse. The Tab and Arrow keys can also be used for dialog navigation.

See "[To File . . .](#)" on page 2897 in Save, State for a full description of this dialog and menu.

The default path for saving files is:

For all of the Trace Data Files:

My Documents\`<mode name>`\data\traces

For all of the Limit Data Files:

My Documents\`<mode name>`\data\limits

For all of the Measurement Results Data Files:

My Documents\`<mode name>`\data\`<measurement name>`\results

For all of the Capture Buffer Data Files:

My Documents\`<mode name>`\data\captureBuffer

Key Path	Save, Data
Mode	All
Notes	The key location is mode-dependent and will vary. Brings up the Save As dialog for saving a <code>&lt;mode specific&gt;</code> Save Type. The save is performed immediately and does not wait until the measurement is complete.
Initial S/W Revision	Prior to A.02.00

## Screen Image

Pressing Screen Image accesses a menu of functions that enable you to specify a format and location for the saved screen image. It brings up a menu that allows you to specify the color scheme of the Screen Image (Themes) or navigate to the Save As dialog to perform the actual save.

Screen Image files contain an exact representation of the analyzer display. They cannot be loaded back onto the analyzer, but they can be loaded into your PC for use in many popular applications.

The image to be saved is actually captured when the Save front panel key is pressed, and kept in temporary storage to be used if you ask for a Screen Image save. When the Screen Image key is pressed, a "thumbnail" of the captured image is displayed, as shown below:

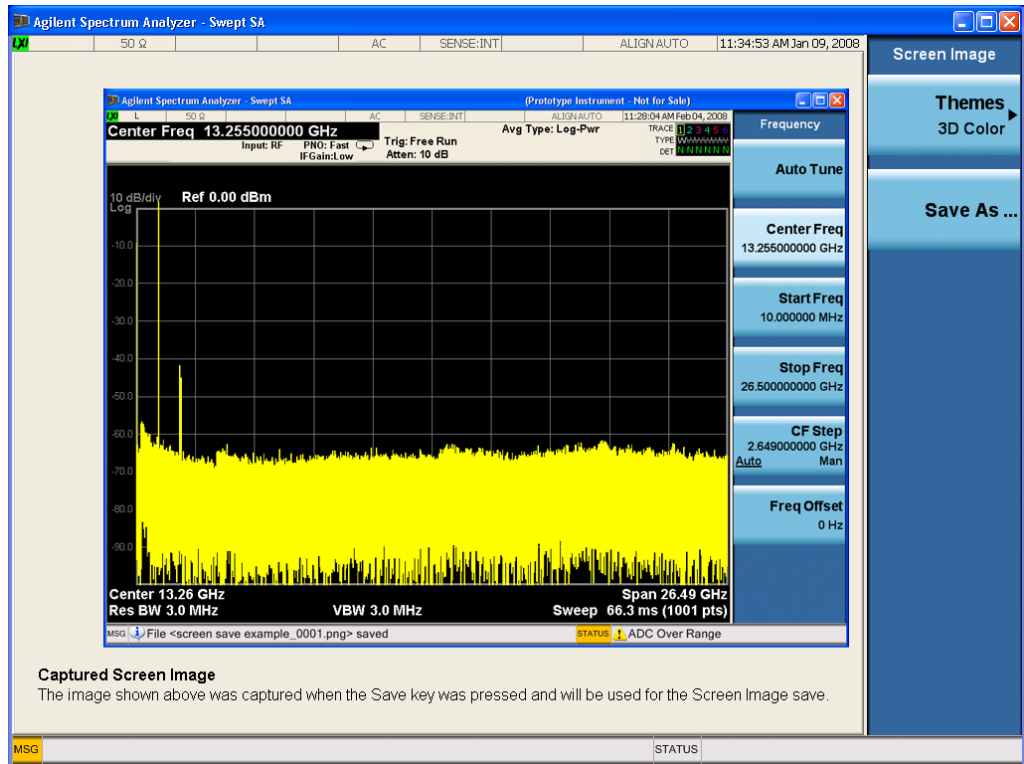

When you continue on into the Save As menu and complete the Screen Image save, the image depicted in the thumbnail is the one that gets saved, showing the menus that were on the screen before going into the Save menus. The save is performed immediately and does not wait until the measurement is complete.

After you have completed the save, the Quick Save front-panel key lets you quickly repeat the last save performed, using an auto-named file, with the current screen data.

**NOTE**

For versions previous to A.01.55, if you initiate a screen image save by navigating through the Save menus, the image that is saved will contain the Save menu softkeys, not the menus and the active function that were on the screen when you first pressed the Save front panel key.

Key Path	Save
Mode	All
Remote Command	:MMEMory:STORe:SCReen <filename>
Example	:MMEM:STOR:SCR "myScreen.png" This stores the current screen image in the file MyScreenFile.png in the default directory.
Initial S/W Revision	Prior to A.02.00

## Themes

Accesses a menu of functions that enable you to choose the theme to be used when saving the screen image.

The **Themes** option is the same as the **Themes** option under the **Display** and **Page Setup** dialogs. It allows you to choose between themes to be used when saving the screen image.

<b>Key Path</b>	Save, Screen Image
<b>Remote Command</b>	:MMEMory:STORe:SCReen:THEMe TDColor   TDMonochrome   FCOlor   FMONochrome  :MMEMory:STORe:SCReen:THEMe?
<b>Example</b>	:MMEM:STOR:SCR:THEM TDM
<b>Preset</b>	3D Color; Is not part of Preset, but is reset by Restore Misc Defaults or Restore System Defaults All and survives subsequent running of the modes.
<b>Readback</b>	3D Color   3D Mono   Flat Color   Flat Mono
<b>Backwards Compatibility Notes</b>	In ESA and PSA we offer the choice of "Reverse Bitmap" or "Reverse Metafile" when saving screen images. This is much like the "Flat Color" theme available in X-Series. Also, if you selected Reverse Bitmap AND a black & white screen image, that would be much like "Flat Monochrome". In other words, each of the X-Series themes has a similar screen image type in ESA/PSA. But they are not identical.
<b>Initial S/W Revision</b>	Prior to A.02.00

### 3D Color

Selects a standard color theme with each object filled, shaded and colored as designed.

<b>Key Path</b>	Save, Screen Image, Themes
<b>Example</b>	MMEM:STOR:SCR:THEM TDC
<b>Readback</b>	3D Color
<b>Initial S/W Revision</b>	Prior to A.02.00

### 3D Monochrome

Selects a format that is like 3D color but shades of gray are used instead of colors.

<b>Key Path</b>	Save, Screen Image, Themes
<b>Example</b>	MMEM:STOR:SCR:THEM TDM
<b>Readback</b>	3D Mono
<b>Initial S/W Revision</b>	Prior to A.02.00

### Flat Color

Selects a format that is best when the screen is to be printed on an ink printer.

Key Path	Save, Screen Image, Themes
<b>Example</b>	MMEM:STOR:SCR:THEM FCOL
Readback	Flat Color
Initial S/W Revision	Prior to A.02.00

### Flat Monochrome

Selects a format that is like Flat Color. But only black is used (no colors, not even gray), and no fill.

Key Path	Save, Screen Image, Themes
<b>Example</b>	MMEM:STOR:SCR:THEM FMON
Readback	Flat Mono
Initial S/W Revision	Prior to A.02.00

### Save As...

When you press “Save As”, the analyzer brings up a Windows dialog and a menu entitled “**Save As.**” This menu allows you to navigate to the various fields in the Windows dialog without using a keyboard or mouse. The Tab and Arrow keys can also be used for dialog navigation.

See "[To File . . .](#)" on page 2897 in Save, State for a full description of this dialog and menu.

The default path for Screen Images is

My Documents\`<mode name>`\screen.

where `<mode name>` is the parameter used to select the mode with the INST:SEL command (for example, SA for the Spectrum Analyzer).

Key Path	Save, Screen Image
Notes	Brings up Save As dialog for saving a Screen Image Save Type
Initial S/W Revision	Prior to A.02.00

### Mass Storage Catalog (Remote Command Only)

Key path	SCPI Only
<b>Remote Command</b>	:MMEMory:CATalog? [ <code>&lt;directory_name&gt;</code> ]
Notes	The string must be a valid logical path. Queries disk usage information (drive capacity, free space available) and obtains a list of files and directories in a specified directory in the following format: <code>&lt;numeric_value&gt;,&lt;numeric_value&gt;,{&lt;file_entry&gt;}</code> It returns two numeric parameters and as many strings as there are files and directories. The first

parameter indicates the total amount of storage currently used in bytes. The second parameter indicates the total amount of storage available, also in bytes. The <file\_entry> is a string. Each <file\_entry> indicates the name, type, and size of one file in the directory list:

<file\_name>,<file\_type>,<file\_size>

As the windows file system has an extension that indicates file type, <file\_type> is always empty. <file\_size> provides the size of the file in bytes. For directories, <file\_entry> is surrounded by square brackets and both <file\_type> and <file\_size> are empty

---

Initial S/W Revision      Prior to A.02.00

---

## Mass Storage Change Directory (Remote Command Only)

---

Key path                      SCPI Only

**Remote Command**        :MMEMory:CDIRectory [<directory\_name>]  
                                  :MMEMory:CDIRectory?

**Notes**                      The string must be a valid logical path.  
  
Changes the default directory for a mass memory file system. The <directory\_name> parameter is a string. If no parameter is specified, the directory is set to the \*RST value.  
At \*RST, this value is set to the default user data storage area, that is defined as System.Environment.SpecialFolder.Personal.  
Query returns full path of the default directory.

---

Initial S/W Revision      Prior to A.02.00

---

## Mass Storage Copy (Remote Command Only)

---

Key path                      SCPI Only

**Remote Command**        :MMEMory:COPY <string>,<string> [,<string>,<string>]

**Notes**                      The string must be a valid logical path.  
  
Copies an existing file to a new file or an existing directory to a new directory.  
Two forms of parameters are allowed. The first form has two parameters. In this form, the first parameter specifies the source, and the second parameter specifies the destination.  
The second form has four parameters. In this form, the first and third parameters specify the source. The second and fourth parameters specify the directories. The first pair of parameters specifies the source. The second pair specifies the destination. An error is generated if the source doesn't exist or the destination file already exists.  
  
This command will generate an "access denied" error if the destination is a restricted folder (e.g., C:\Windows) and the current user does not have Power User or Administrator privileges.

## Mass Storage Device Copy (Remote Command Only)

This command transfers data to/from a file and a peripheral device.

---

Key path	SCPI Only
<b>Remote Command</b>	:MMEMory:COpy:DEvice <source_string>,<dest_string>
Notes	The strings must be a valid logical path or a valid device keyword. If the dest_string is a device keyword, the data is copied from the source file to the device. If the source_string is a device keyword, the data is copied to the source file from the device.  Valid device keywords are: SNS (smart noise source)  An error is generated if the file or device is not found.

---

### Mass Storage Delete (Remote Command Only)

---

Key path	SCPI Only
<b>Remote Command</b>	:MMEMory:DELeTe <file_name>[,<directory_name>]
Notes	The string must be a valid logical path.  Removes a file from the specified directory. The <file_name> parameter specifies the file name to be removed. This command will generate an "access denied" error if the file is in a restricted folder (e.g., C:\Windows) and the current user does not have Power User or Administrator privileges.
Initial S/W Revision	Prior to A.02.00

---

### Mass Storage Data (Remote Command Only)

Creates a file containing the specified data OR queries the data from an existing file.

---

Key path	SCPI Only
<b>Remote Command</b>	:MMEMory:DATA <file_name>, <data> :MMEMory:DATA? <file_name>
Notes	The string must be a valid logical path.  The command form is MMEMory:DATA <file_name>,<data>. It loads <data> into the file <file_name>. <data> is in 488.2 block format. <file_name> is string data.  The query form is MMEMory:DATA? <file_name> with the response being the associated <data> in block format.
Initial S/W Revision	Prior to A.02.00

---

### Mass Storage Make Directory (Remote Command Only)

---

Key path	SCPI Only
<b>Remote Command</b>	:MMEMory:MDIRectory <directory_name>
Notes	The string must be a valid logical path.  Creates a new directory. The <directory_name> parameter specifies the name to be created.

---



	This command will generate an “access denied” error if the new directory would be in a restricted folder (e.g., C:\Windows) and the current user does not have Power User or Administrator privileges.
Initial S/W Revision	Prior to A.02.00

### Mass Storage Move (Remote Command Only)

Key path	SCPI Only
<b>Remote Command</b>	:MMEMory:MOVE <string>,<string>[,<string>,<string>]
Notes	<p>The string must be a valid logical path.</p> <p>Moves an existing file to a new file or an existing directory to a new directory.</p> <p>Two forms of parameters are allowed. The first form has two parameters. In this form, the first parameter specifies the source, and the second parameter specifies the destination.</p> <p>The second form has four parameters. In this form, the first and third parameters specify the source. The second and fourth parameters specify the directories. The first pair of parameters specifies the source. The second pair specifies the destination. An error is generated if the source doesn't exist or the destination file already exists.</p> <p>This command will generate an “access denied” error if the destination is a restricted folder (e.g., C:\Windows) and the current user does not have Power User or Administrator privileges.</p>
Initial S/W Revision	Prior to A.02.00

### Mass Storage Remove Directory (Remote Command Only)

Key path	SCPI Only
<b>Remote Command</b>	:MMEMory:RDIRECTory <directory_name>
Notes	<p>The string must be a valid logical path.</p> <p>Removes a directory. The &lt;directory_name&gt; parameter specifies the directory name to be removed. All files and directories under the specified directory shall also be removed.</p> <p>This command will generate an “access denied” error if the folder is a restricted folder (e.g., C:\Windows) or is in a restricted folder and the current user does not have Power User or Administrator privileges.</p>
Initial S/W Revision	Prior to A.02.00

## Single (Single Measurement/Sweep)

Sets the analyzer for Single measurement operation. The single/continuous state is Meas Global, so the setting will affect all the measurements. If you are Paused, pressing Single does a Resume.

See ["More Information" on page 1878](#)

Key Path	Front-panel key
Example	:INIT:CONT OFF
Notes	See Cont key description.
Backwards Compatibility Notes	<p>For Spectrum Analysis mode in ESA and PSA, the Single hardkey and the INITiate:IMM switched from continuous measurement to single measurement and restarted sweeps and averages (displayed average count reset to 1), but did not restart Max Hold and Min Hold. In the X-Series, the Single hardkey and the INITiate:IMM command initiate a sweep/ measurement/ average sequence/hold sequence including MaxHold and MinHold.</p> <p>For Spectrum Analysis mode in ESA and PSA, the Single hardkey restarted the sweep regardless of whether or not you were in an active sweep or sweep sequence. In the X-Series, Restart does this but Single only restarts the sweep or sweep sequence if you are in the idle state.</p> <p>INIT[:IMM] in ESA &amp; PSA Spectrum Analysis Mode does an implied ABORT. In some other PSA Modes, INIT[:IMM] is ignored if not in the idle state. . The X-Series follows the ESA/PSA SA Mode model, which may cause some Modes to have compatibility problems.</p>
Initial S/W Revision	Prior to A.02.00

### More Information

See ["Restart" on page 2894](#) for details on the INIT:IMMEDIATE (Restart) function.

If you are already in single sweep, the INIT:CONT OFF command has no effect.

If you are already in Single Sweep, then pressing the Single key in the middle of a sweep does not restart the sweep or sequence. Similarly, pressing the Single key does not restart the sweep or sequence if the sweep is not in the idle state (for example, if you are taking a very slow sweep, or the analyzer is waiting for a trigger). Instead, it results in a message. "Already in Single, press Restart to initiate a new sweep or sequence". Even though pressing the Single key in the middle of a sweep does not restart the sweep, sending INIT:IMMEDIATE does reset it.

To take one more sweep without resetting the average count, increment the average count by 1, by pressing the step up key while **Average/Hold Number** is the active function, or sending the remote command CALC:AVER:TCON UP.

## Source

There is no meas local functionality.

Key Path	Front Panel key
Initial S/W Revision	Prior to A.02.00

## SPAN X Scale

Accesses a menu of functions that enable you to set the desired horizontal scale parameters.

Key Path	Front Panel key
Initial S/W Revision	Prior to A.02.00

### X Ref Value

Controls the reference value of the X scale of the current measurement. The operation of this key differs by measurement, as follows:

- "X Ref Value (Code Domain (Quad View) View, RMS Code Power/Slot window)" on page 1880
- "X Ref Value (Code Domain (Quad View) View, Chip Power window)" on page 1881
- "X Ref Value (Demod Bits View, RMS Code Power/Slot window)" on page 1881

Key Path	Span X Scale
Initial S/W Revision	Prior to A.02.00

### X Ref Value (Code Domain (Quad View) View, RMS Code Power/Slot window)

Sets the RMS Code Power/Slot reference value on the horizontal axis in the RMS Code Power/Slot window of the Code Domain (Quad View) view.

Key Path	Span X Scale
Mode	1xEV-DO
<b>Remote Command</b>	:DISPlay:CDPower[:BTS]:VIEW3:WINDow2:TRACe:X[:SCALe]:RLEVel <real> :DISPlay:CDPower[:BTS]:VIEW3:WINDow2:TRACe:X[:SCALe]:RLEVel?
<b>Example</b>	DISP:CDP:VIEW3:WIND2:TRAC:X:RLEV 0 DISP:CDP:VIEW3:WIND2:TRAC:X:RLEV?
Notes	If the Auto Scaling is set to On, this value is automatically determined by the measurement result. When you set this value manually, Auto Scaling automatically changes to Off. Target window to control depends on the SubOpCode.
Preset	0.000
State Saved	Saved in instrument state.
Min	-100
Max	100
<b>Backwards Compatibility SCPI</b>	:DISPlay:CDPower:VIEW3:WINDow2:TRACe:X[:SCALe]:RLEVel
Initial S/W Revision	Prior to A.02.00

### X Ref Value (Code Domain (Quad View) View, Chip Power window)

Sets the chip power reference value on the horizontal axis in the RMS Code Power/Slot window of the Code Domain (Quad View) view.

Key Path	Span X Scale
Mode	1xEV-DO
<b>Remote Command</b>	:DISPlay:CDPower[:BTS]:VIEW3:WINDow4:TRACe:X[:SCALE]:RLEVel <real> :DISPlay:CDPower[:BTS]:VIEW3:WINDow4:TRACe:X[:SCALE]:RLEVel?
<b>Example</b>	DISP:CDP:VIEW3:WIND4:TRAC:X:RLEV 0 DISP:CDP:VIEW3:WIND4:TRAC:X:RLEV?
Notes	If the Auto Scaling is set to On, this value is automatically determined by the measurement result. When you set this value manually, Auto Scaling automatically changes to Off. Target window to control depends on the SubOpCode.
Preset	0.000
State Saved	Saved in instrument state.
Min	-100000
Max	100000
<b>Backwards Compatibility SCPI</b>	:DISPlay:CDPower:VIEW3:WINDow4:TRACe:X[:SCALE]:RLEVel
Initial S/W Revision	Prior to A.02.00

### X Ref Value (Demod Bits View, RMS Code Power/Slot window)

Sets the RMS Code Power/Slot reference value on the horizontal axis in the RMS Code Power/Slot window of the Code Domain (Quad View) view.

Key Path	Span X Scale
Mode	1xEV-DO
<b>Remote Command</b>	:DISPlay:CDPower[:BTS]:VIEW4:WINDow2:TRACe:X[:SCALE]:RLEVel <real> :DISPlay:CDPower[:BTS]:VIEW4:WINDow2:TRACe:X[:SCALE]:RLEVel?
<b>Example</b>	DISP:CDP:VIEW3:WIND2:TRAC:X:RLEV 0 DISP:CDP:VIEW3:WIND2:TRAC:X:RLEV?
Notes	If the Auto Scaling is set to On, this value is automatically determined by the measurement result. When you set this value manually, Auto Scaling automatically changes to Off. Target window to control depends on the SubOpCode.
Preset	0.000
State Saved	Saved in instrument state.
Min	-100
Max	100
<b>Backwards</b>	:DISPlay:CDPower:VIEW4:WINDow2:TRACe:X[:SCALE]:RLEVel

---

### Compatibility SCPI

Initial S/W Revision	Prior to A.02.00
----------------------	------------------

---

### X Scale/Div

Sets the horizontal scale by changing a value per division. The operation of this key differs by measurement, as follows:

- "X Scale/Div (Code Domain (Quad View) View, RMS Code Power/Slot Window)" on page 1882
- "X Scale/Div (Code Domain (Quad View) View, Chip Power Window)" on page 1883
- "X Scale/Div (Demod Bits View, RMS Code Power/Slot Window)" on page 1883

Key Path	Span X Scale
----------	--------------

Initial S/W Revision	Prior to A.02.00
----------------------	------------------

---

### X Scale/Div (Code Domain (Quad View) View, RMS Code Power/Slot Window)

Sets the horizontal scale by changing a RMS Code Power/Slot value per division in the RMS Code Power/Slot window of Code Domain (Quad View) View.

Key Path	Span X Scale
----------	--------------

Mode	1xEV-DO
------	---------

<b>Remote Command</b>	:DISPlay:CDPower[:BTS]:VIEW3:WINDow2:TRACe:X[:SCALE]:PDIVision <real> :DISPlay:CDPower[:BTS]:VIEW3:WINDow2:TRACe:X[:SCALE]:PDIVision?
-----------------------	------------------------------------------------------------------------------------------------------------------------------------------

<b>Example</b>	DISP:CDP:VIEW3:WIND2:TRAC:X:PDIV 10 DISP:CDP:VIEW3:WIND2:TRAC:X:PDIV?
----------------	--------------------------------------------------------------------------

<b>Notes</b>	If the Auto Scaling is set to On, this value is automatically determined by the measurement result. When you set this value manually, Auto Scaling automatically changes to Off. Target window to control depends on the SubOpCode.
--------------	----------------------------------------------------------------------------------------------------------------------------------------------------------------------------------------------------------------------------------------

Preset	0.5000
--------	--------

State Saved	Saved in instrument state.
-------------	----------------------------

Min	0.1
-----	-----

Max	100
-----	-----

<b>Backwards Compatibility SCPI</b>	:DISPlay:CDPower:VIEW3:WINDow2:TRACe:X[:SCALE]:PDIVision
-------------------------------------	----------------------------------------------------------

Initial S/W Revision	Prior to A.02.00
----------------------	------------------

---

### X Scale/Div (Code Domain (Quad View) View, Chip Power Window)

Sets the horizontal scale by changing a chip power value per division in the Chip Power window of Code Domain (Quad View) View.

Key Path	Span X Scale
Mode	1xEV-DO
<b>Remote Command</b>	:DISPlay:CDPower[:BTS]:VIEW3:WINDow4:TRACe:X[:SCALe]:PDIVision <real> :DISPlay:CDPower[:BTS]:VIEW3:WINDow4:TRACe:X[:SCALe]:PDIVision?
<b>Example</b>	DISP:CDP:VIEW3:WIND4:TRAC:X:PDIV 10 DISP:CDP:VIEW3:WIND4:TRAC:X:PDIV?
Notes	If the Auto Scaling is set to On, this value is automatically determined by the measurement result. When you set this value manually, Auto Scaling automatically changes to Off. Target window to control depends on the SubOpCode.
Preset	1024
State Saved	Saved in instrument state.
Min	1.000
Max	100000
<b>Backwards Compatibility SCPI</b>	:DISPlay:CDPower:VIEW3:WINDow4:TRACe:X[:SCALe]:PDIVision
Initial S/W Revision	Prior to A.02.00

### X Scale/Div (Demod Bits View, RMS Code Power/Slot Window)

Sets the horizontal scale by changing a RMS Code Power/Slot value per division in the RMS Code Power/Slot window of Demod Bits View.

Key Path	Span X Scale
Mode	1xEV-DO
<b>Remote Command</b>	:DISPlay:CDPower[:BTS]:VIEW4:WINDow2:TRACe:X[:SCALe]:PDIVision <real> :DISPlay:CDPower[:BTS]:VIEW4:WINDow2:TRACe:X[:SCALe]:PDIVision?
<b>Example</b>	DISP:CDP:VIEW3:WIND2:TRAC:X:PDIV 10 DISP:CDP:VIEW3:WIND2:TRAC:X:PDIV?
Notes	If the Auto Scaling is set to On, this value is automatically determined by the measurement result. When you set this value manually, Auto Scaling automatically changes to Off. Target window to control depends on the SubOpCode.
Preset	0.5000
State Saved	Saved in instrument state.
Min	0.1
Max	100
<b>Backwards</b>	:DISPlay:CDPower:VIEW4:WINDow2:TRACe:X[:SCALe]:PDIVision

<b>Compatibility SCPI</b>	
Initial S/W Revision	Prior to A.02.00

### X Ref Position

Sets the reference position of the X axis on the display. The reference position can be set to Left, Ctr (Center) or Right. Operation of this key differs by measurement, as follows:

- "Ref Position (Code Domain (Quad View) view, RMS Code Power/Slot window)" on page 1884
- "Ref Position (Code Domain (Quad View) view, Chip Power window)" on page 1884
- "Ref Position (Demod Bits view, RMS Code Power/Slot window)" on page 1885

Key Path	Span X Scale
Initial S/W Revision	Prior to A.02.00

### Ref Position (Code Domain (Quad View) view, RMS Code Power/Slot window)

Sets the reference position of the X axis in the RMS Code Power/Slot view of the Code Domain (Quad View) view.

Key Path	Span X Scale
Mode	1xEV-DO
<b>Remote Command</b>	:DISPlay:CDPower[:BTS]:VIEW3:WINDow2:TRACe:X[:SCALE]:RPOStion LEFT   CENTer   RIGHT  :DISPlay:CDPower[:BTS]:VIEW3:WINDow2:TRACe:X[:SCALE]:RPOStion?
<b>Example</b>	DISP:CDP:VIEW3:WIND2:TRAC:X:RPOS RIGH DISP:CDP:VIEW3:WIND2:TRAC:X:RPOS?
Preset	LEFT
State Saved	Saved in instrument state.
Range	Left Ctr Right
<b>Backwards Compatibility SCPI</b>	:DISPlay:CDPower:VIEW3:WINDow2:TRACe:X[:SCALE]:RPOStion
Initial S/W Revision	Prior to A.02.00

### Ref Position (Code Domain (Quad View) view, Chip Power window)

Sets the reference position of the X axis in the Chip Power view of the Code Domain (Quad View) view.

Key Path	Span X Scale
----------	--------------



Mode	1xEV-DO
<b>Remote Command</b>	:DISPlay:CDPower[:BTS]:VIEW3:WINDow4:TRACe:X[:SCALe]:RPOSition LEFT   CENTER   RIGHT  :DISPlay:CDPower[:BTS]:VIEW3:WINDow4:TRACe:X[:SCALe]:RPOSition?
<b>Example</b>	DISP:CDP:VIEW3:WIND4:TRAC:X:RPOS RIGH DISP:CDP:VIEW3:WIND4:TRAC:X:RPOS?
Preset	LEFT
State Saved	Saved in instrument state.
Range	Left Ctr Right
<b>Backwards Compatibility SCPI</b>	:DISPlay:CDPower:VIEW3:WINDow4:TRACe:X[:SCALe]:RPOSition
Initial S/W Revision	Prior to A.02.00

### Ref Position (Demod Bits view, RMS Code Power/Slot window)

Sets the reference position of the X axis in the RMS Code Power/Slot view of the Demod Bits view.

Key Path	Span X Scale
Mode	1xEV-DO
<b>Remote Command</b>	:DISPlay:CDPower[:BTS]:VIEW4:WINDow2:TRACe:X[:SCALe]:RPOSition LEFT   CENTER   RIGHT  :DISPlay:CDPower[:BTS]:VIEW4:WINDow2:TRACe:X[:SCALe]:RPOSition?
<b>Example</b>	DISP:CDP:VIEW4:WIND2:TRAC:X:RPOS RIGH DISP:CDP:VIEW4:WIND2:TRAC:X:RPOS?
Preset	LEFT
State Saved	Saved in instrument state.
Range	Left Ctr Right
<b>Backwards Compatibility SCPI</b>	:DISPlay:CDPower:VIEW4:WINDow2:TRACe:X[:SCALe]:RPOSition
Initial S/W Revision	Prior to A.02.00

### Auto Scaling

Determines the scale per division and reference value for the X axis based on the current measurement results.

Key Path	Span X Scale
Initial S/W Revision	Prior to A.02.00

### Auto Scaling (Code Domain (Quad View) View, RMS Code Power/Slot Window)

When Auto Scaling is On, and the Restart front panel key is pressed, this function automatically displays the scale per division and reference value results in the RMS Code Power/Slot view of Code Domain (Quad View) View.

Key Path	Span X Scale
Mode	1xEV-DO
Remote Command	:DISPlay:CDPower[:BTS]:VIEW3:WINDow2:TRACe:X[:SCALE]:COUPle 0   1   OFF   ON  :DISPlay:CDPower[:BTS]:VIEW3:WINDow2:TRACe:X[:SCALE]:COUPle?
Example	DISP:CDP:VIEW3:WIND2:TRAC:X:COUP ON DISP:CDP:VIEW3:WIND2:TRAC:X:COUP?
Notes	Upon pressing the Restart front-panel key or Restart menu key under the Meas Control menu, the Auto Scaling function automatically determines the scale per division and reference values based on the measurement results if this parameter is set to On. When you set a value to either Scale/Div or Ref Value manually, Auto Scaling automatically changes to Off.
Preset	ON
State Saved	Saved in instrument state.
Range	Off On
Backwards Compatibility SCPI	:DISPlay:CDPower:VIEW3:WINDow2:TRACe:X[:SCALE]:COUPle
Initial S/W Revision	Prior to A.02.00

### Auto Scaling (Code Domain (Quad View) View Chip Power Window)

When Auto Scaling is On, and the Restart front panel key is pressed, this function automatically displays the scale per division and reference value results in the Chip Power view of Code Domain (Quad View) View.

Key Path	Span X Scale
Mode	1xEV-DO
Remote Command	:DISPlay:CDPower[:BTS]:VIEW3:WINDow4:TRACe:X[:SCALE]:COUPle 0   1   OFF   ON  :DISPlay:CDPower[:BTS]:VIEW3:WINDow4:TRACe:X[:SCALE]:COUPle?
Example	DISP:CDP:VIEW3:WIND4:TRAC:X:COUP ON DISP:CDP:VIEW3:WIND4:TRAC:X:COUP?
Notes	Upon pressing the Restart front-panel key or Restart menu key under the Meas Control menu, the Auto Scaling function automatically determines the scale per division and reference values based on the measurement results if this parameter is set to On. When you set a value to either Scale/Div or Ref Value manually, Auto Scaling automatically changes to Off.
Preset	ON
State Saved	Saved in instrument state.

Range	Off On
<b>Backwards Compatibility SCPI</b>	:DISPlay:CDPower:VIEW3:WINDow4:TRACe:X[:SCALe]:COUPle
Initial S/W Revision	Prior to A.02.00

### Auto Scaling (Demod Bits View, RMS Code Power/Slot Window)

When Auto Scaling is On, and the Restart front panel key is pressed, this function automatically displays the scale per division and reference value results in the RMS Code Power/Slot view of Demod Bits View.

Key Path	Span X Scale
Mode	1xEV-DO
<b>Remote Command</b>	:DISPlay:CDPower[:BTS]:VIEW4:WINDow2:TRACe:X[:SCALe]:COUPle 0   1   OFF   ON  :DISPlay:CDPower[:BTS]:VIEW4:WINDow2:TRACe:X[:SCALe]:COUPle?
<b>Example</b>	DISP:CDP:VIEW4:WIND2:TRAC:X:COUP ON DISP:CDP:VIEW4:WIND2:TRAC:X:COUP?
Notes	Upon pressing the Restart front-panel key or Restart menu key under the Meas Control menu, the Auto Scaling function automatically determines the scale per division and reference values based on the measurement results if this parameter is set to On. When you set a value to either Scale/Div or Ref Value manually, Auto Scaling automatically changes to Off.
Preset	ON
State Saved	Saved in instrument state.
Range	Off On
<b>Backwards Compatibility SCPI</b>	:DISPlay:CDPower:VIEW4:WINDow2:TRACe:X[:SCALe]:COUPle
Initial S/W Revision	Prior to A.02.00

## Sweep/Control

Accesses a menu that allows you to select parameters that affect the sweep of the displayed measurement signal.

Only the Pause/Resume key is available.

Key Path	Front panel key
Initial S/W Revision	Prior to A.02.00

## Pause/Resume

This key allows you to pause or resume the measurement of the displayed signal.

See "[Pause/Resume](#)" on page 2925 function.

Key Path	Sweep/Control
Initial S/W Revision	Prior to A.02.00

## System

See "System" on page 359

## Trace/Detector

There is no meas local functionality.

See Trace/Detector.

---

Key Path	Front Panel key
Initial S/W Revision	Prior to A.02.00

---

## Trigger

See ["Trigger" on page 430](#)

### Free Run

See ["Free Run " on page 437](#)

### Video

See ["Video \(IF Envelope\) " on page 438](#)

### Trigger Level

See ["Trigger Level " on page 438](#)

### Trig Slope

See ["Trig Slope " on page 439](#)

### Trig Delay

See ["Trig Delay " on page 440](#)

### Line

See ["Line " on page 2729](#)

### Trig Slope

See ["Trig Slope " on page 2729](#)

### Trig Delay

See ["Trig Delay " on page 442](#)

### External 1

See ["External 1 " on page 2741](#)

### Trigger Level

See ["Trigger Level " on page 2741](#)

### Trig Slope

See ["Trig Slope " on page 2742](#)

### Trig Delay

See ["Trig Delay " on page 445](#)

### External 2

See ["External 2 " on page 2743](#)

### **Trigger Level**

See ["Trigger Level "](#) on page 2743

### **Trig Slope**

See ["Trig Slope "](#) on page 2744

### **Trig Delay**

See ["Trig Delay "](#) on page 447

### **RF Burst**

See ["RF Burst "](#) on page 2744

### **Absolute Trigger**

See ["Absolute Trigger Level"](#) on page 2745

### **Relative Trigger**

See ["Relative Trigger Level"](#) on page 2734

### **Trig Slope**

See ["Trigger Slope "](#) on page 2746

### **Trig Delay**

See ["Trig Delay "](#) on page 451

### **Periodic Timer**

See ["Periodic Timer \(Frame Trigger\) "](#) on page 2736

### **Period**

See ["Period "](#) on page 2737

### **Offset**

See ["Offset "](#) on page 2738

### **Offset Adjust (Remote Command Only)**

See ["Offset Adjust \(Remote Command Only\)"](#) on page 2739

### **Reset Offset Display**

See ["Reset Offset Display "](#) on page 2740

### **Sync Source**

See ["Sync Source "](#) on page 2740



## Off

See ["Off "](#) on page 2741

## External 1

See ["External 1 "](#) on page 2741

## Trigger Level

See ["Trigger Level "](#) on page 2741

## Trig Slope

See ["Trig Slope "](#) on page 2742

## External 2

See ["External 2 "](#) on page 2743

## Trigger Level

See ["Trigger Level "](#) on page 2743

## Trig Slope

See ["Trig Slope "](#) on page 2744

## RF Burst

See ["RF Burst "](#) on page 2744

## Absolute Trigger

See ["Absolute Trigger Level"](#) on page 2745

## Trig Slope

See ["Trigger Slope "](#) on page 2746

## Trig Delay

See ["Trig Delay"](#) on page 461

## Auto/Holdoff

See ["Auto/Holdoff "](#) on page 462

## Auto Trig

See ["Auto Trig "](#) on page 462

## Trig Holdoff

See ["Trig Holdoff "](#) on page 463

## Holdoff Type

See [\\_\\_](#) on page X

## User Preset

Accesses a menu that gives you the following three choices:

- User Preset – recalls a state previously saved using the Save User Preset function.
- User Preset All Modes – presets all of the modes in the analyzer
- Save User Preset– saves the current state for the current mode

Key Path	Front-panel key
Backwards Compatibility Notes	<p>User Preset is actually loading a state, and in legacy analyzers, it was possible to load a state without affecting the trace data, limit lines or correction data. Similarly it was possible to do a User Preset without affecting the trace data, limit lines or correction data.</p> <p>In the X-Series, “state” always includes all of this data; so whenever state is loaded, or User Preset is executed, all of the traces, limit lines and corrections are affected. Although this differs from previous behavior, it is desirable behavior, and should not cause adverse issues for users.</p> <p>On ESA and PSA, User Preset affected the entire instrument’s state. In the X-Series, User Preset only recalls the state for the active mode. There is a User Preset file for each mode. User Preset can never cause a mode switch as it can in legacy analyzers. If you want to recall all modes to their user preset file state, you will need to do a User Preset after mode switching into each mode.</p> <p>User Preset recalls mode state which can now include data like traces; whereas on ESA and PSA, User Preset did not affect data.</p>
Initial S/W Revision	Prior to A.02.00

## User Preset

User Preset sets the state of the currently active mode back to the state that was previously saved for this mode using the Save User Preset menu key or the SCPI command, SYST:PRES:USER:SAV. It not only recalls the Mode Preset settings, but it also recalls all of the mode persistent settings, and the Input/Output system setting that existed at the time Save User Preset was executed.

If a Save User Preset has not been done at any time, User Preset recalls the default user preset file for the currently active mode. The default user preset files are created if, at power-on, a mode detects there is no user preset file. There will never be a scenario when there is no user preset file to restore. For each mode, the default user preset state is the same state that would be saved if a Save User Preset is performed in each mode right after doing a Restore Mode Default and after a Restore Input/Output Defaults.

The User Preset function does the following:

- Aborts the currently running measurement.
- Sets the mode State to the values defined by Save User Preset.
- Makes the saved measurement for the currently running mode the active measurement.
- Brings up the saved menu for the power-on mode.
- Clears the input and output buffers.
- Sets the Status Byte to 0.

Key Path	User Preset
<b>Remote Command</b>	:SYSTem:PRESet:USER
<b>Example</b>	:SYST:PRES:USER:SAVE:SYST:PRES:USER
Notes	:SYST:PRES:USER:SAVE is used to save the current state as the user preset state. Clears all pending OPC bits. The Status Byte is set to 0. Pressing the User Preset front-panel key while already in the User Preset menu will cause the User Preset to get executed
Couplings	A user preset will cause the currently running measurement to be aborted and cause the saved measurement to be active. Recalling a User Preset file has the same issues that recalling a Save State file has. Some settings may need to be limited and therefore re-coupled, since the capabilities of the mode may have changes when the User Preset file was last saved.
Initial S/W Revision	Prior to A.02.00

## User Preset All Modes

Recalls all of the User Preset files for each mode, switches to the power-on mode, and activates the saved measurement from the power-on mode User Preset file.

**NOTE**

When the instrument is secured, all of the user preset files are converted back to their default user preset files.

The User Preset function does the following:

- Aborts the currently running measurement.
- Switches the Mode to the power-on mode.
- Restores the User Preset files for each mode.
- Makes the saved measurement for the power-on mode the active measurement.
- Brings up the saved menu for the power-on mode.
- Clears the input and output buffers.
- Sets the Status Byte to 0.

Key Path	User Preset
<b>Remote Command</b>	:SYSTem:PRESet:USER:ALL
<b>Example</b>	:SYST:PRES:USER:SAVE:SYST:PRES:USER:ALL
Notes	Clears all pending OPC bits. The Status Byte is set to 0. :SYST:PRES:USER:SAVE is used to save the current state as the user preset state.
Couplings	A user preset will cause the currently running measurement to be aborted, cause a mode switch to the power-on mode, and cause the saved measurement to be active in the power-on mode. Recalling a User Preset file has the same issues that recalling a Save State file has. Some settings may need to be limited and therefore re-coupled, since the capabilities of the mode may have changes when the User Preset file was last saved.
Initial S/W Revision	Prior to A.02.00

## Save User Preset

Saves the currently active mode and its State. You can recall this User Preset file by pressing the User Preset menu key or sending the SYST:PRES:USER remote command. This same state is also saved by the Save State function.

Key Path	User Preset
Remote Command	:SYSTem:PRESet:USER:SAVE
Example	:SYST:PRES:USER:SAVE
Notes	:SYST:PRES:SAVE creates the same file as if the user requested a *SAV or a MMEM:STOR:STAT, except User Preset Save does not allow the user to specify the filename or the location of the file.
Initial S/W Revision	Prior to A.02.00

## View/Display

Accesses a menu of functions that enable you to control the instrument display.

See the section Front Panel Key for more information.

Selects the desired measurement view from the following selections:

- PGraph – (Power Graph & Metrics) provides a combination view of the code domain power graph and the summary data.
- CDPErr – (Power Graph & CDE Graph) provides a combination view of the code domain power graph and the code domain error.
- CDQView – (Code Domain Quad View) provides a combination view for the code domain power chip power, I/Q symbol polar vector and the RMS Code Power/Slot.
- DBITs – (Demod Bits) provides a combination view of the graphs for the code domain power and chip power, and the I/Q demodulated bit stream data for slots selected by the measurement interval and measurement offset.
- MDDBITs – (Multiplexed Data Demod Bits) provides a combination view of the graphs for the code domain power and chip power, and the multiplexed data bit stream for slots selected by the measurement interval and measurement offset.

For remote commands, see ["View Selection by Name" on page 1897](#) and ["View Selection by number \(Remote Command only\)" on page 1898](#).

### View Selection by Name

See also ["View Selection by number \(Remote Command only\)" on page 1898](#).

Key Path	View/Display
Mode	1xEV-DO
Remote Command	:DISPlay:CDPower[:BTS]:VIEW[:SElect] PGraph   CDPErr   CDQView   DBITs   MDDBITs :DISPlay:CDPower[:BTS]:VIEW[:SElect]?
Example	DISP:CDP:VIEW PGR DISP:CDP:VIEW?
Notes	You must be in the 1xEV-DO mode to use this command. Use INSTRument:SElect to set the mode.
Preset	PGraph
State Saved	Saved in instrument state.
Range	Power Graph & Metrics CDP Graph & CDE Graph  Code Domain (Quad View) Demod Bits Mux Demod
Backwards Compatibility SCPI	:DISPlay:CDPower:VIEW[:SElect]
Initial S/W Revision	Prior to A.02.00

## View Selection by number (Remote Command only)

Displays the numeric values of the measurement results. This function is available by SCPI command only.

Mode	CDMA1XEV
<b>Remote Command</b>	:DISPlay:CDPower[:BTS]:VIEW:NSElect <integer> :DISPlay:CDPower[:BTS]:VIEW:NSElect?
<b>Example</b>	DISP:CDP:VIEW:NSEL 2 DISP:CDP:VIEW:NSEL?
Notes	You must be in the 1XEV-DO mode to use this command. Use INSTRument:SElect to set the mode. The relation between selection number and View: 1: Power Graph & Metrics 2:CDP Graph & CDE Graph 3: Code Domain (Quad View) 4: Demod Bits 5: Mux Demod
Preset	1
State Saved	Saved in instrument state.
Min	1
Max	5
<b>Backwards Compatibility SCPI</b>	:DISPlay:CDPower:VIEW:NSElect
Initial S/W Revision	Prior to A.02.00

## Display

The Display menu is common to most measurements, and is used for configuring items on the display. Some Display menu settings apply to all the measurements in a mode, and some only to the current measurement. Those under the System Display Settings key apply to all measurements in all modes.

Key Path	Display
Key Path	View/Display
Initial S/W Revision	Prior to A.02.00

## Annotation

Turns on and off various parts of the display annotation. The annotation is divided up into four categories:

1. Meas Bar: This is the measurement bar at the top of the screen. It does not include the settings panel or the Active Function. Turning off the Meas Bar turns off the settings panel and the Active Function. When the Meas Bar is off, the graticule area expands to fill the area formerly occupied by the Meas Bar.

2. Screen Annotation: this is the annotation and annunciation around the graticule, including any annotation on lines (such as the display line, the threshold line, etc.) This does NOT include the marker number or the N dB result. When off, the graticule expands to fill the entire graticule area.
  3. Trace annotation: these are the labels on the traces, showing their detector (or their math mode).
  4. Active Function annotation: this is the active function display in the meas bar, and all of the active function values displayed on softkeys.
- See the figure below. Each type of annotation can be turned on and off individually.

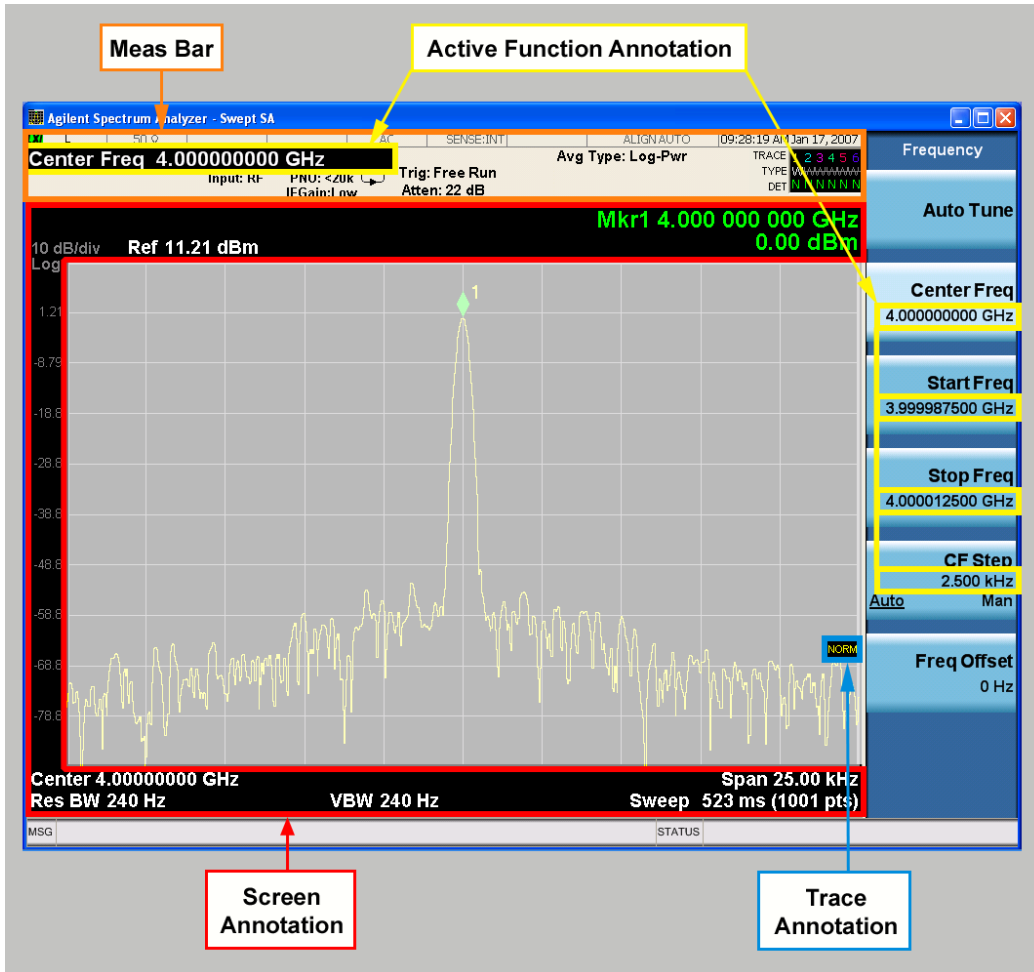

Key Path	View/Display, Display
Initial S/W Revision	Prior to A.02.00

### Meas Bar On/Off

This function turns the Measurement Bar on and off, including the settings panel. When off, the graticule area expands to fill the area formerly occupied by the Measurement Bar.

Key Path	View/Display, Display, Annotation
Remote Command	:DISPlay:ANNotation:MBAR[:STATe] OFF ON 0 1 :DISPlay:ANNotation:MBAR[:STATe]?
Example	DISP:ANN:MBAR OFF
Dependencies	Grayed out and forced to OFF when System Display Settings, Annotation is set to Off.
Preset	On This should remain Off through a Preset when System DisplaySettings, Annotation is set to Off.
State Saved	Saved in instrument state.
Initial S/W Revision	Prior to A.02.00

### Screen

This controls the display of the annunciation and annotation around the graticule, including any annotation on lines (such as the display line, the threshold line, etc.) and the y-axis annotation. This does NOT include marker annotation (or the N dB result). When off, the graticule expands to fill the entire graticule area, leaving only the 1.5% gap above the graticule as described in the Trace/Detector chapter.

Key Path	View/Display, Display, Annotation
Remote Command	:DISPlay:ANNotation:SCReen[:STATe] OFF ON 0 1 :DISPlay:ANNotation:SCReen[:STATe]?
Example	DISP:ANN:SCR OFF
Dependencies	Grayed-out and forced to OFF when System Display Settings, Annotation is set to Off.
Preset	On This should remain Off through a Preset when System DisplaySettings, Annotation is set to Off
State Saved	Saved in instrument state.
Initial S/W Revision	Prior to A.02.00

### Active Function Values On/Off

Turns on and off the active function display in the Meas Bar, and all of the active function values displayed on the softkeys.

Note that all of the softkeys that have active functions have these numeric values blanked when this function is on. This is a security feature..





Key Path	View/Display, Display, Annotation
Remote Command	:DISPlay:ACTivefunc[:STATE] ON OFF 1 0 :DISPlay:ACTivefunc[:STATE]?
Example	DISP:ACT OFF
Dependencies	Grayed out and forced to OFF when System Display Settings, Annotation is set to Off.
Preset	On This should remain Off through a Preset when System DisplaySettings, Annotation is set to Off
State Saved	Saved in instrument state.
Initial S/W Revision	Prior to A.02.00

## Title

Displays menu keys that enable you to change or clear a title on your display.

Key Path	View/Display, Display
Initial S/W Revision	Prior to A.02.00

## Change Title

Writes a title into the "measurement name" field in the banner, for example, "Swept SA".

Press Change Title to enter a new title through the alpha editor. Press Enter or Return to complete the entry. Press ESC to cancel the entry and preserve your existing title.

The display title will replace the measurement name. It remains for this measurement until you press Change Title again, or you recall a state, or a Preset is performed. A title can also be cleared by pressing Title, Clear Title.

**NOTE**

Notice the inclusion of the <measurement> parameter in the command below. Because each measurement remembers the Display Title, the command must be qualified with the measurement name. For the Swept SA measurement this is not the case; no <measurement> parameter is used when changing the Display Title for the Swept SA measurement.

Key Path	View/Display, Display, Title
Mode	All
Remote Command	:DISPlay:<measurement>:ANNotation:TITLe:DATA <string> :DISPlay:<measurement>:ANNotation:TITLe:DATA?
Example	DISP:ANN:TITL:DATA "This Is My Title" This example is for the Swept SA measurement in the Spectrum Analyzer mode. The SANalyzer <measurement> name is not used. DISP:ACP:ANN:TITL:DATA "This Is My Title" This example is for Measurements other than Swept SA. Both set the title to: This Is My Title
Notes	Pressing this key cancels any active function. When a title is edited the previous title remains intact (it is not cleared) and the cursor goes at the end so that characters can be added or BKSP can be used to go back over previous characters.
Preset	No title (measurement name instead)
State Saved	Saved in instrument state.
Initial S/W Revision	Prior to A.02.00

**Clear Title**

Clears a title from the front-panel display. Once cleared, the title cannot be retrieved. After the title is cleared, the current Measurement Name replaces it in the title bar.

Key Path	View/Display, Display, Title
Example	The following commands clear the title and restore the measurement's original title: DISP:ANN:TITL:DATA "" This example is for the Swept SA measurement in the Spectrum Analyzer mode. The SANalyzer <measurement> name is not used. DISP:ACP:ANN:TITL:DATA "" This example is for ACP; in measurements other than Swept SA the measurement name is required.
Notes	Uses the :DISPlay:<measurement>:ANNotation:TITLe:DATA <string> command with an empty string (in the Swept SA, the <measurement> is omitted).
Preset	Performed on Preset.
Initial S/W Revision	Prior to A.02.00

## Graticule

Pressing Graticule turns the display graticule On or Off. It also turns the graticule y-axis annotation on and off.

Key Path	View/Display, Display
<b>Remote Command</b>	:DISPlay:WINDow[1]:TRACe:GRATicule:GRID[:STATe] OFF ON 0 1 :DISPlay:WINDow[1]:TRACe:GRATicule:GRID[:STATe]?
<b>Example</b>	DISP:WIND:TRAC:GRAT:GRID OFF
Notes	The graticule is the set of horizontal and vertical lines that make up the grid/divisions for the x-axis and y-axis.
Preset	On
State Saved	Saved in instrument state
Initial S/W Revision	Prior to A.02.00

## System Display Settings

These settings are "Mode Global" – they affect all modes and measurements and are reset only by Restore Misc Defaults or Restore System Defaults under System.

Key Path	View/Display, Display
Initial S/W Revision	Prior to A.02.00

## Annotation Local Settings

This is a Mode Global override of the meas local annotation settings. When it is All Off, it forces ScreenAnnotation, Meas Bar, Trace, and Active Function Values settings to be OFF for all measurements in all modes. This provides the security based "annotation off" function of previous analyzers; hence it uses the legacy SCPI command.

When it is All Off, the Screen, Meas Bar, Trace, and Active Function Values keys under the Display, Annotation menu are grayed out and forced to Off. When Local Settings is selected, you are able to set the local annotation settings on a measurement by measurement basis.

Key Path	View/Display, Display, System Display Settings
<b>Remote Command</b>	:DISPlay:WINDow[1]:ANNOtation[:ALL] OFF ON 0 1 :DISPlay:WINDow[1]:ANNOtation[:ALL]?
<b>Example</b>	:DISP:WIND:ANN OFF
Preset	On (Set by Restore Misc Defaults)
State Saved	Not saved in instrument state.
Backwards Compatibility Notes	The WINDow parameter and optional subopcode is included for backwards compatibility but ignored – all windows are equally affected.
Initial S/W Revision	Prior to A.02.00

## Themes

Accesses a menu of functions that enable you to choose the theme to be used when saving the screen image.

The **Themes** option is the same as the **Themes** option under the **Display** and **Page Setup** dialogs. It allows you to choose between themes to be used when saving the screen image.

<b>Key Path</b>	Save, Screen Image
<b>Remote Command</b>	:MMEMory:STORe:SCReen:THEMe TDColor   TDMonochrome   FCOLor   FMONochrome  :MMEMory:STORe:SCReen:THEMe?
<b>Example</b>	:MMEM:STOR:SCR:THEM TDM
<b>Preset</b>	3D Color; Is not part of Preset, but is reset by Restore Misc Defaults or Restore System Defaults All and survives subsequent running of the modes.
<b>Readback</b>	3D Color   3D Mono   Flat Color   Flat Mono
<b>Backwards Compatibility Notes</b>	In ESA and PSA we offer the choice of "Reverse Bitmap" or "Reverse Metafile" when saving screen images. This is much like the "Flat Color" theme available in X-Series. Also, if you selected Reverse Bitmap AND a black & white screen image, that would be much like "Flat Monochrome". In other words, each of the X-Series themes has a similar screen image type in ESA/PSA. But they are not identical.
<b>Initial S/W Revision</b>	Prior to A.02.00

### 3D Color

Selects a standard color theme with each object filled, shaded and colored as designed.

<b>Key Path</b>	Save, Screen Image, Themes
<b>Example</b>	MMEM:STOR:SCR:THEM TDC
<b>Readback</b>	3D Color
<b>Initial S/W Revision</b>	Prior to A.02.00

### 3D Monochrome

Selects a format that is like 3D color but shades of gray are used instead of colors.

<b>Key Path</b>	Save, Screen Image, Themes
<b>Example</b>	MMEM:STOR:SCR:THEM TDM
<b>Readback</b>	3D Mono
<b>Initial S/W Revision</b>	Prior to A.02.00

### Flat Color

Selects a format that is best when the screen is to be printed on an ink printer.

Key Path	Save, Screen Image, Themes
<b>Example</b>	MMEM:STOR:SCR:THEM FCOL
Readback	Flat Color
Initial S/W Revision	Prior to A.02.00

### Flat Monochrome

Selects a format that is like Flat Color. But only black is used (no colors, not even gray), and no fill.

Key Path	Save, Screen Image, Themes
<b>Example</b>	MMEM:STOR:SCR:THEM FMON
Readback	Flat Mono
Initial S/W Revision	Prior to A.02.00

### Backlight

Accesses the display backlight on/off keys. This setting may interact with settings under the Windows "Power" menu.

When the backlight is off, pressing ESC, TAB, SPACE, ENTER, UP, DOWN, LEFT, RIGHT, DEL, BKSP, CTRL, or ALT turns the backlight on without affecting the application. Pressing any other key will turn backlight on and could potentially perform the action as well.

Key Path	View/Display, Display, System Display Settings
<b>Remote Command</b>	:DISPlay:BACKlight ON OFF :DISPlay:BACKlight?
Preset	ON (Set by Restore Misc Defaults)
Initial S/W Revision	Prior to A.02.00

### Backlight Intensity

An active function used to set the backlight intensity. It goes from 0 to 100 where 100 is full on and 0 is off. This value is independent of the values set under the Backlight on/off key.

Key Path	View/Display, Display, System Display Settings
<b>Remote Command</b>	:DISPlay:BACKlight:INTensity <integer> :DISPlay:BACKlight:INTensity?
<b>Example</b>	DISP:BACK:INT 50

Preset	100 (Set by Restore Misc Defaults)
Min	0
Max	100
Initial S/W Revision	Prior to A.02.00

### Power Graph & Metrics

Provides a combination view of the code domain power graph and the summary data.

This view shows code domain power and its numeric results. There are two windows:

- "Power Bar Graph window" on page 1907 (upper)
- "Metrics window" on page 1907 (lower)

The figure below shows Power Graph & Metrics view when setting IQ Combined Off.

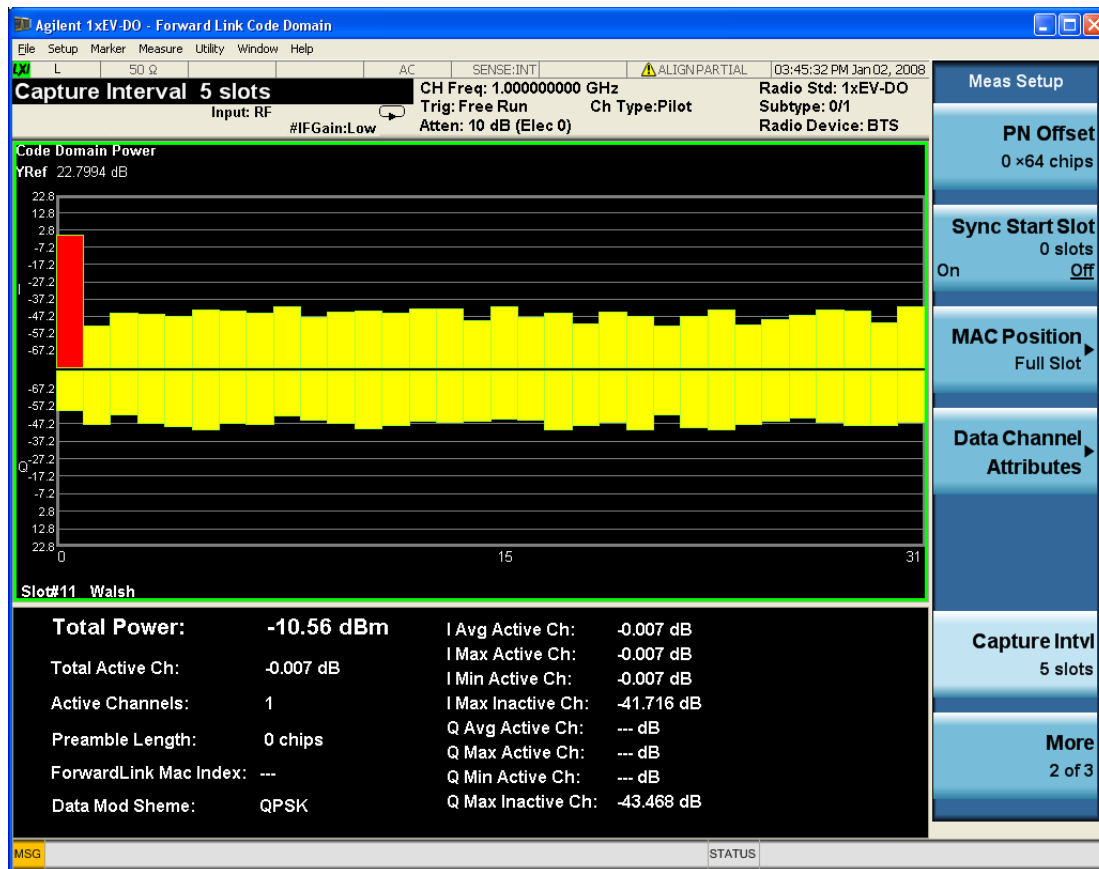

The figure below shows Power Graph & Metrics view when setting IQ Combined On.

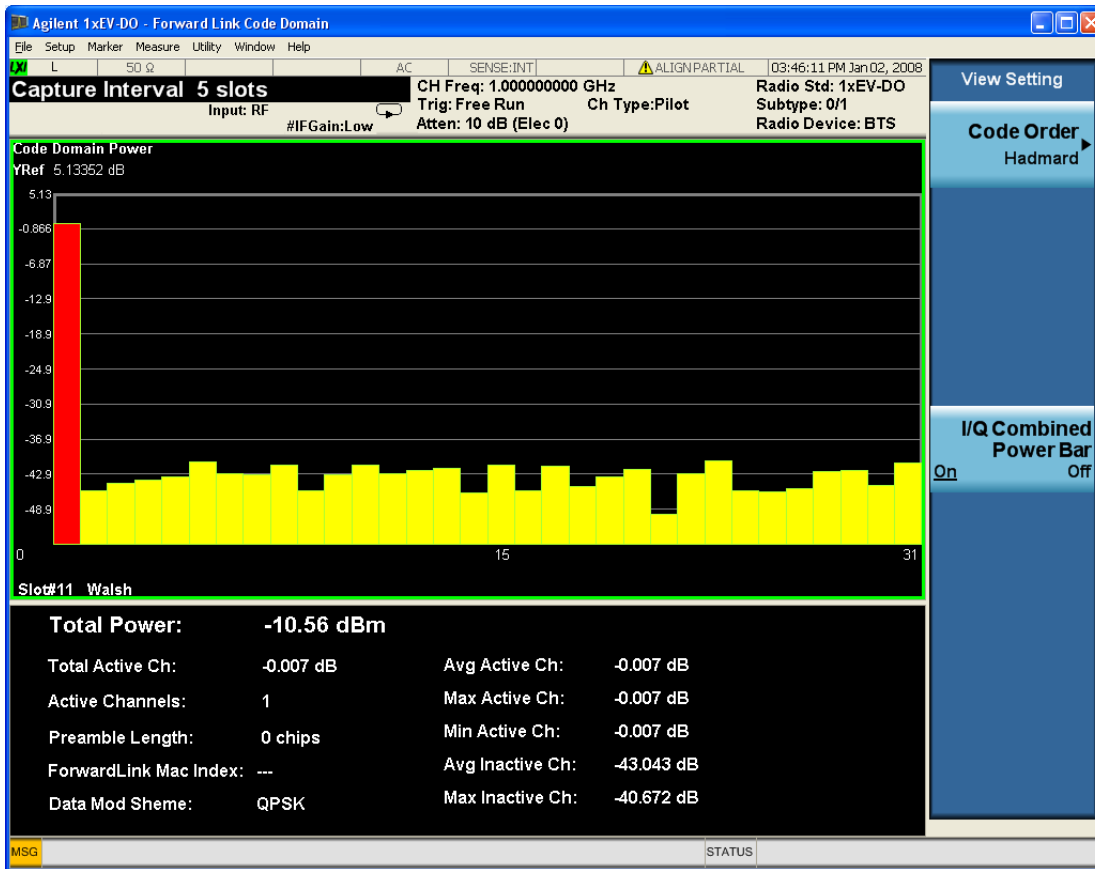

### Power Bar Graph window

Show code domain power.

Marker Operation	Yes
Corresponding Trace	CDPower (n=2)

This trace is of the slot specified by the Meas Offset. (Not averaged through meas interval.)

### Metrics window

Table 4.1 Metrics Window IQ Combined Off

Name	Corresponding Results	Display Format
Total Power	n=1 1st Total Power	-99.99 dBm mW
Total Active Ch	n=1 2nd Total active power	-999.999 dB dBm mW None
I Avg Active Ch	n=1 8th I channel Average active code power	-999.999 dB dBm mW None

Name	Corresponding Results	Display Format
I Max Inactive Ch	n=1 9th I channel Max inactive code power	-999.999 dB dBm mW None
Q Avg Active Ch	n=1 10th Q channel Average active code power	-999.999 dB dBm mW None
Q Max Inactive Ch	n=1 11th Q channel Max inactive code power	-999.999 dB dBm mW None
Active Channels	n=1 7th Number of active channels.	-999
Preamble Length	n=1 12th Preamble length in chips.	-999
Preamble MAC Index	n=1 13th MAC Index of preamble.	-999
Data Mod Scheme	n=1 20th Data Modulation Scheme	QPSK 8PSK 16QAM 64QAM

Table 4.2 Metrics Window IQ Combined On

Name	Corresponding Results	Display Format
Total Power	n=1 1st Total Power	-99.99 dBm mW
Total Active Ch	n=1 2nd Total active power	-999.999 dB dBm mW None
Active Channels	n=1 7th Number of active channels.	-999
Max Active Ch	n=1 3rd IQ combined Max active code power	-999.999 dB dBm mW None
Avg Active Ch	n=1 4th IQ combined Avg active code power	-999.999 dB dBm mW None
Max Inactive Ch	n=1 5th IQ combined Max inactive code power	-999.999 dB dBm mW None
Avg Inactive Ch	n=1 6th IQ combined Avg inactive code power	-999.999 dB dBm mW None
Preamble Length	n=1 12th Preamble length in chips.	-999
Preamble MAC Index	n=1 13th MAC Index of preamble.	-999



Name	Corresponding Results	Display Format
Data Mod Scheme	n=1 20th Data Modulation Scheme	QPSK 8PSK 16QAM 64QAM

These scalar results are of the slot specified by the Meas Offset. (Not averaged through meas interval.)  
Unit is switched by Meas Type key.

<b>Example</b>	DISP:CDP:VIEW PGR DISP:CDP:VIEW?
Initial S/W Revision	Prior to A.02.00

## Code Order

Sets the Walsh code order, Hadamard or Bit Reverse.

Key Path	View/Display, Power Graph & Metrics
Mode	1xEV-DO
<b>Remote Command</b>	:CALCulate:CDPower[:BTS]:WCODE:ORDER HADamard BREVerse :CALCulate:CDPower[:BTS]:WCODE:ORDER?
<b>Example</b>	:CALC:CDP:WCOD:ORD BREV :CALC:CDP:WCOD:ORD?
Notes	This key appears when Code Domain Power window is active.
Preset	HADamard
State Saved	Saved in instrument state.
Range	Hadamard   Bit Reverse
<b>Backwards Compatibility SCPI</b>	:CALCulate:CDPower:WCODE:ORDER
Initial S/W Revision	Prior to A.02.00

## I/Q Combined Power Bar

Allows you to toggle the I/Q combined power display function between On and Off. If set to On, the I and Q power bars are consolidated on the upper side of the horizontal axis. If set to Off, the I and Q power bars are shown on the upper side and the lower side of the horizontal axis, respectively.

The following figure shows Code Domain Power when I/Q Combined Power Bar is set to ON.

15 Forward Link Code Domain Measurement  
View/Display

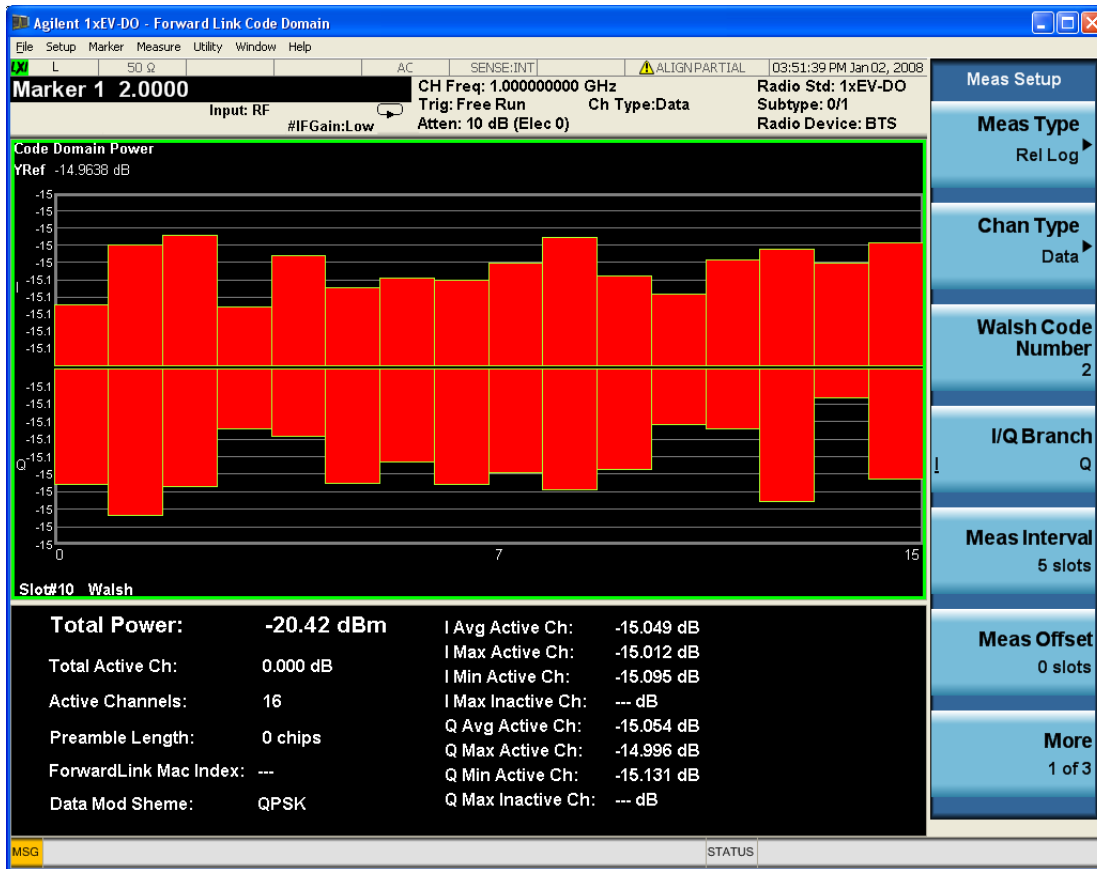

The following figure shows Code Domain Power when I/Q Combined Power Bar is set to OFF.

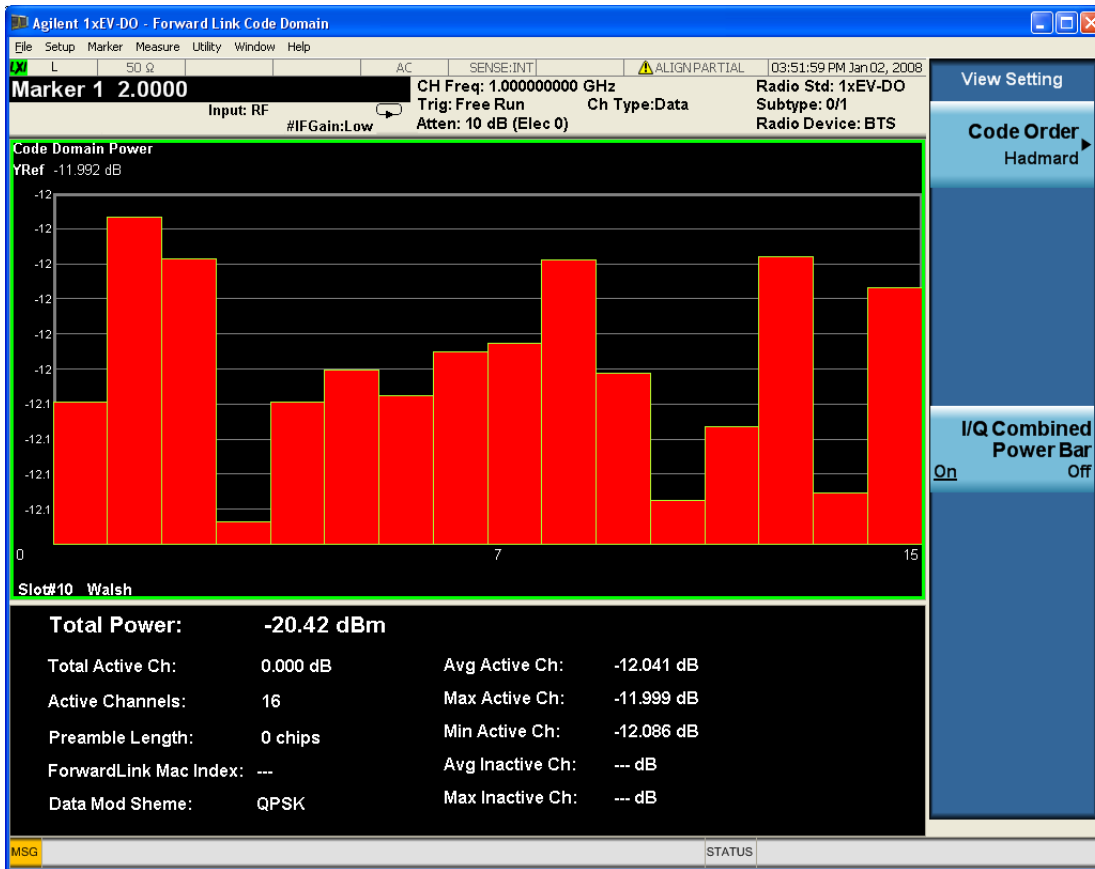

Key Path	View/Display, Power Graph & Metrics
Mode	1xEV-DO
Remote Command	:CALCulate:CDPower[:BTS]:IQ:COMBined[:STATe] 0 1 OFF ON :CALCulate:CDPower[:BTS]:IQ:COMBined[:STATe]?
Example	:CALC:CDP:IQ:COMB ON :CALC:CDP:IQ:COMB?
Notes	You must be in the 1xEV-DO mode to use this command. Use INSTRument:SElect to set the mode.
Preset	OFF
State Saved	Saved in instrument state.
Range	On   Off
Backwards Compatibility SCPI	:CALCulate:CDPower:IQ:COMBined[:STATe]
Initial S/W Revision	Prior to A.02.00

### CDP Graph & CDE Graph

Provides a combination view of the code domain power graph and the code domain error.

There are two windows:

- "Power Bar Graph window" on page 1913 (upper)
- "Code Domain Error Graph window" on page 1913 (lower)

The two windows of Power Bar Graph and CDE graph are coupled in terms of:

- X/Y Scaling
- Composite Symbol Boundary, Display Symbol Rate

The following figure shows CDP Graph & CDE Graph view when IQ Combined is set to Off.

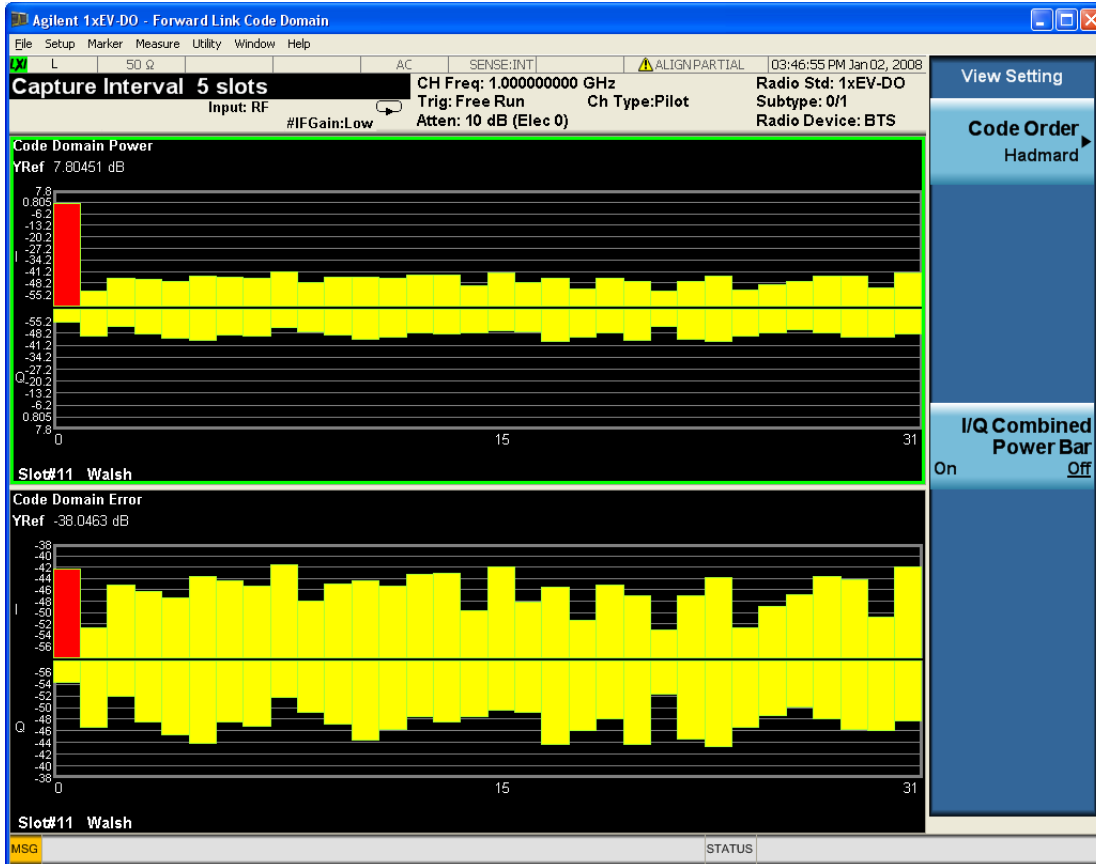

The following figure shows CDP Graph & CDE Graph view when IQ Combined is set to On.

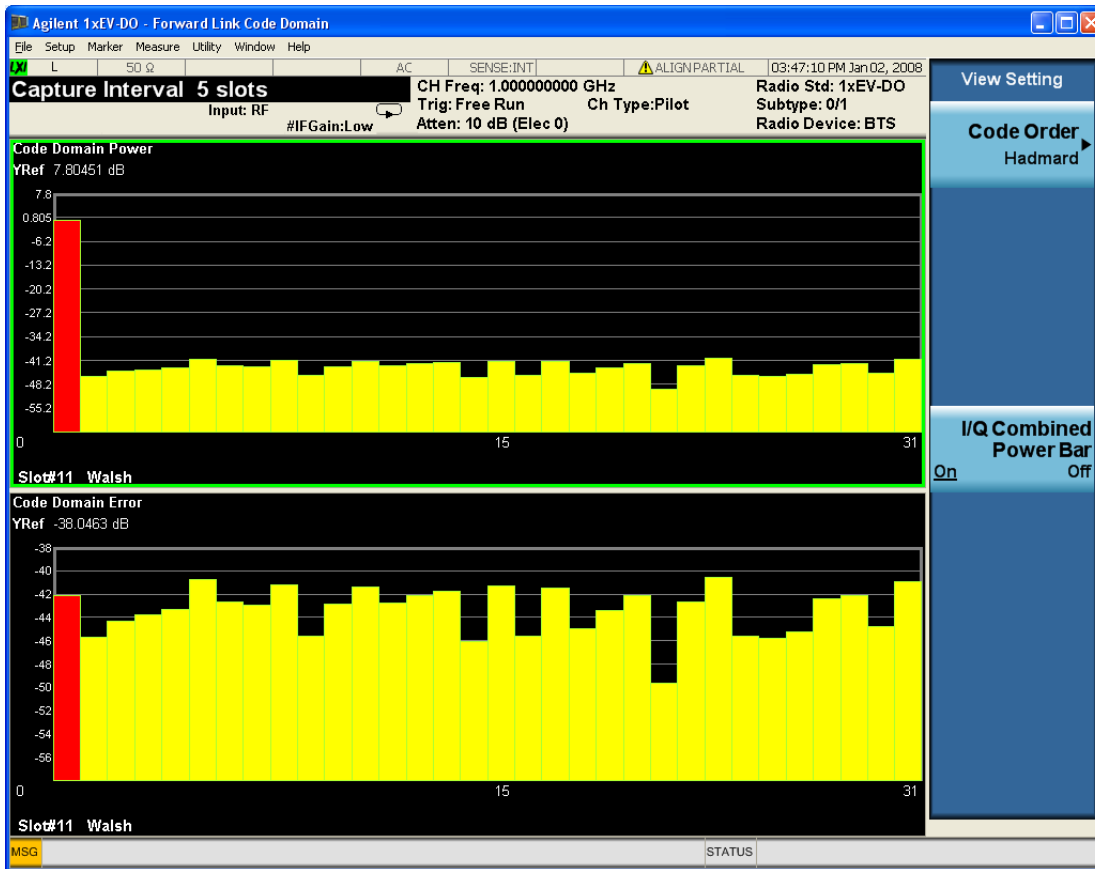

### Power Bar Graph window

Shows code domain power.

Marker Operation	Yes
Corresponding Trace	CDPower (n=2)

This trace is of the slot specified by the Meas Offset. (Not averaged through meas interval.)

### Code Domain Error Graph window

Shows code domain error.

Marker Operation	Yes
Corresponding Trace	CDError (n=8)

This trace is of the slot specified by the Meas Offset. (Not averaged through meas interval.)

<b>Example</b>	DISP:CDP:VIEW CDPE DISP:CDP:VIEW?
Initial S/W Revision	Prior to A.02.00

## Code Order

Sets the Walsh code order, Hadamard or Bit Reverse.

Key Path	View/Display,Power Graph &Metrics
Mode	1xEV-DO
Remote Command	:CALCulate:CDPower[:BTS]:WCode:ORder HADamard BREVerse :CALCulate:CDPower[:BTS]:WCode:ORder?
Example	:CALC:CDP:WCOD:ORD BREV :CALC:CDP:WCOD:ORD?
Notes	This key appears when Code Domain Power window is active.
Preset	HADamard
State Saved	Saved in instrument state.
Range	Hadamard   Bit Reverse
Backwards Compatibility SCPI	:CALCulate:CDPower:WCode:ORder
Initial S/W Revision	Prior to A.02.00

## I/Q Combined Power Bar

Allows you to toggle the I/Q combined power display function between On and Off. If set to On, the I and Q power bars are consolidated on the upper side of the horizontal axis. If set to Off, the I and Q power bars are shown on the upper side and the lower side of the horizontal axis, respectively.

The following figure shows Code Domain Power when I/Q Combined Power Bar is set to ON.

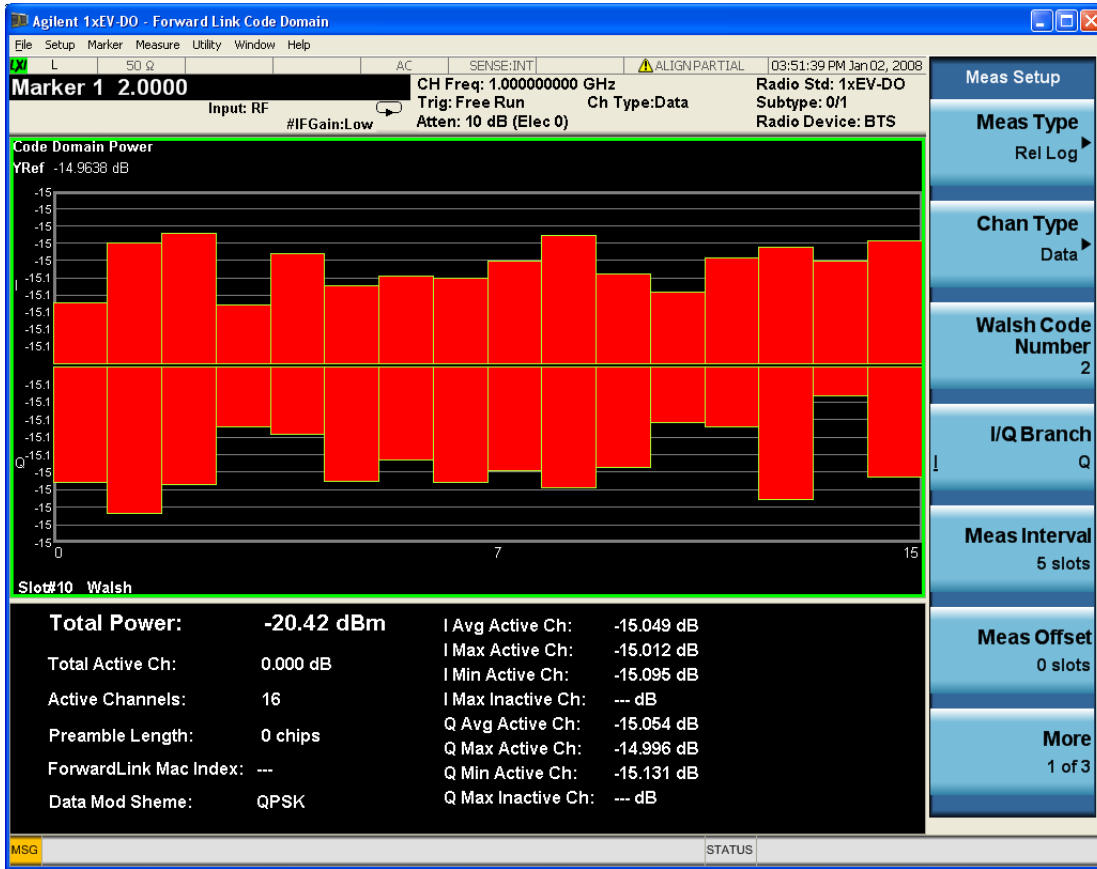

The following figure shows Code Domain Power when I/Q Combined Power Bar is set to OFF.

15 Forward Link Code Domain Measurement  
View/Display

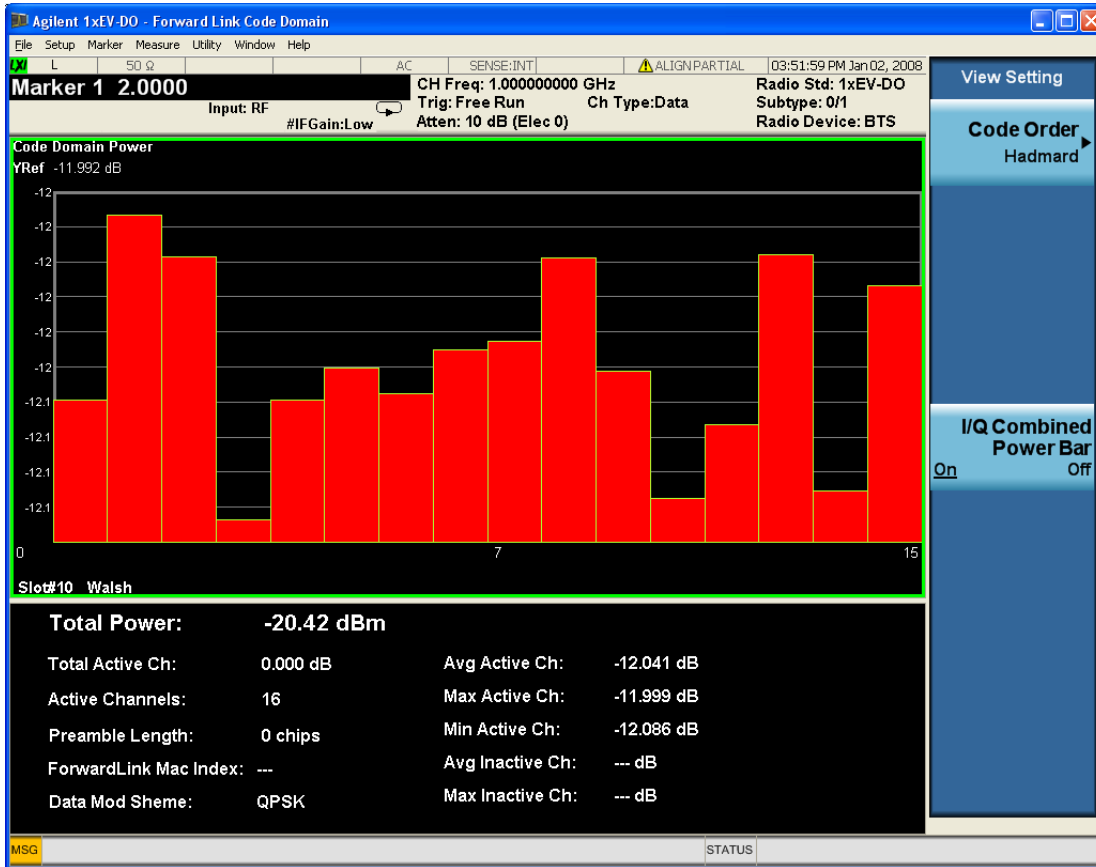

Key Path	View/Display, Power Graph & Metrics
Mode	1xEV-DO
Remote Command	:CALCulate:CDPower[:BTS]:IQ:COMBined[:STATE] 0 1 OFF ON :CALCulate:CDPower[:BTS]:IQ:COMBined[:STATE] ?
Example	:CALC:CDP:IQ:COMB ON :CALC:CDP:IQ:COMB?
Notes	You must be in the 1xEV-DO mode to use this command. Use INSTRUMENT:SElect to set the mode.
Preset	OFF
State Saved	Saved in instrument state.
Range	On   Off
Backwards Compatibility SCPI	:CALCulate:CDPower:IQ:COMBined[:STATE]
Initial S/W Revision	Prior to A.02.00

Code Domain (Quad View)

There four windows:

- "Power Bar Graph window" on page 1917 (upper-left)



- "I/Q Symbol Polar Vector window" on page 1917 (lower-left)
- "RMS Code Power/Slot window" on page 1918 (upper-right)
- "Chip Power window" on page 1918 (lower- right)

The following figure shows Code Domain (Quad View) View.

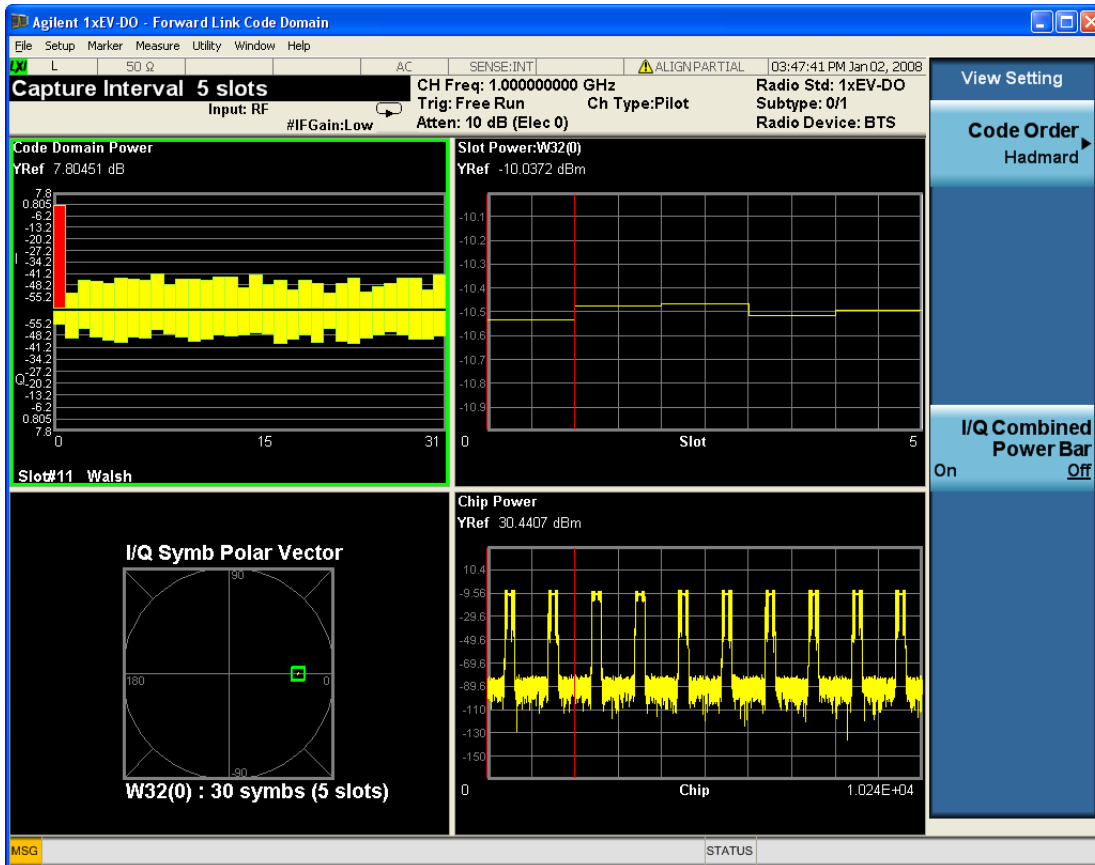

### Power Bar Graph window

This trace is of the slot specified by the Meas Offset. (Not averaged through meas interval.)

Marker Operation	Yes
Corresponding Trace	CDPower (n=2)

### I/Q Symbol Polar Vector window

This trace is of the slots specified by the Meas Offset and Meas Interval.

Marker Operation	Yes
Corresponding Trace	(n=5)

### RMS Code Power/Slot window

This trace is of the slots specified by the Meas Offset and Meas Interval.

Marker Operation	Yes
Corresponding Trace	(n=7)

### Chip Power window

This trace is of all captured slots.

Marker Operation	Yes
Corresponding Trace	(n=6)

<b>Example</b>	DISP:CDP:VIEW CDQV DISP:CDP:VIEW?
Initial S/W Revision	Prior to A.02.00

### Code Order

Sets the Walsh code order, Hadamard or Bit Reverse.

Key Path	View/Display,Power Graph &Metrics
Mode	1xEV-DO
<b>Remote Command</b>	:CALCulate:CDPower[:BTS]:WCOde:ORDer HADamard BREVerse :CALCulate:CDPower[:BTS]:WCOde:ORDer?
<b>Example</b>	:CALC:CDP:WCOD:ORD BREV :CALC:CDP:WCOD:ORD?
Notes	This key appears when Code Domain Power window is active.
Preset	HADamard
State Saved	Saved in instrument state.
Range	Hadamard   Bit Reverse
<b>Backwards Compatibility SCPI</b>	:CALCulate:CDPower:WCOde:ORDer
Initial S/W Revision	Prior to A.02.00

### I/Q Combined Power Bar

Allows you to toggle the I/Q combined power display function between On and Off. If set to On, the I and Q power bars are consolidated on the upper side of the horizontal axis. If set to Off, the I and Q power bars

are shown on the upper side and the lower side of the horizontal axis, respectively.

The following figure shows Code Domain Power when I/Q Combined Power Bar is set to ON.

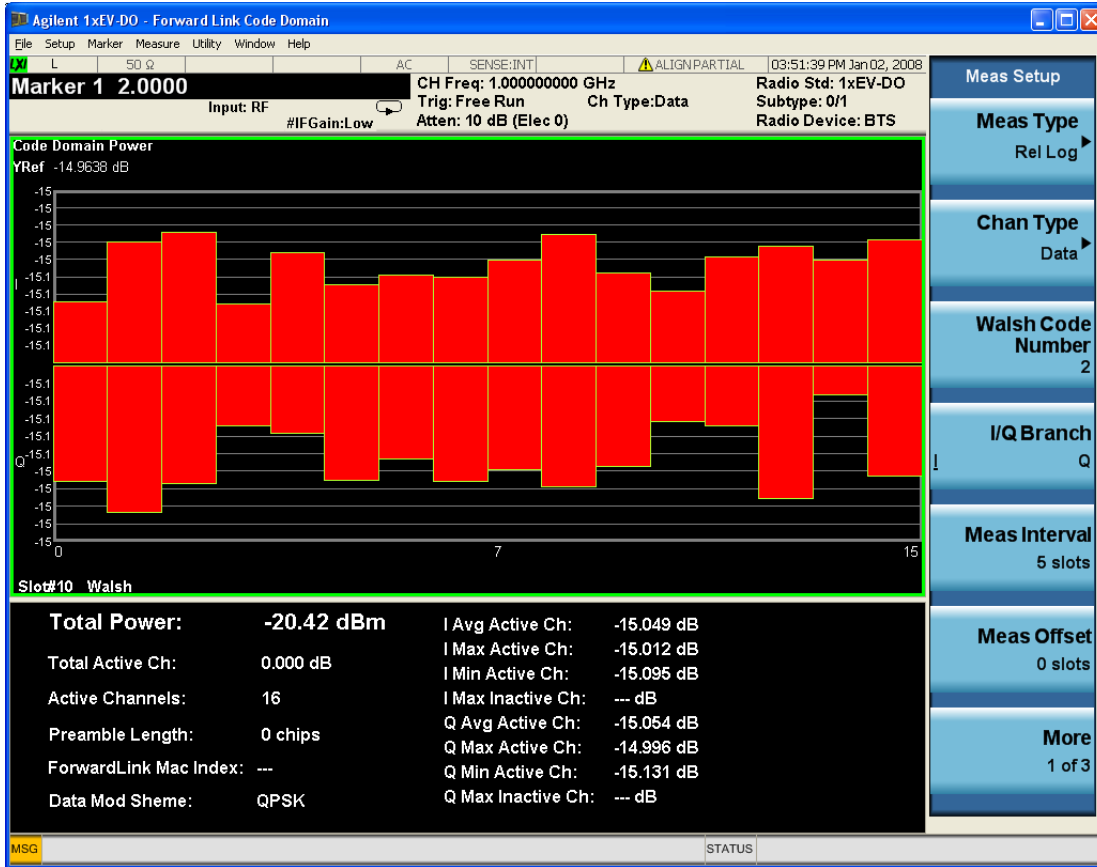

The following figure shows Code Domain Power when I/Q Combined Power Bar is set to OFF.

15 Forward Link Code Domain Measurement  
View/Display

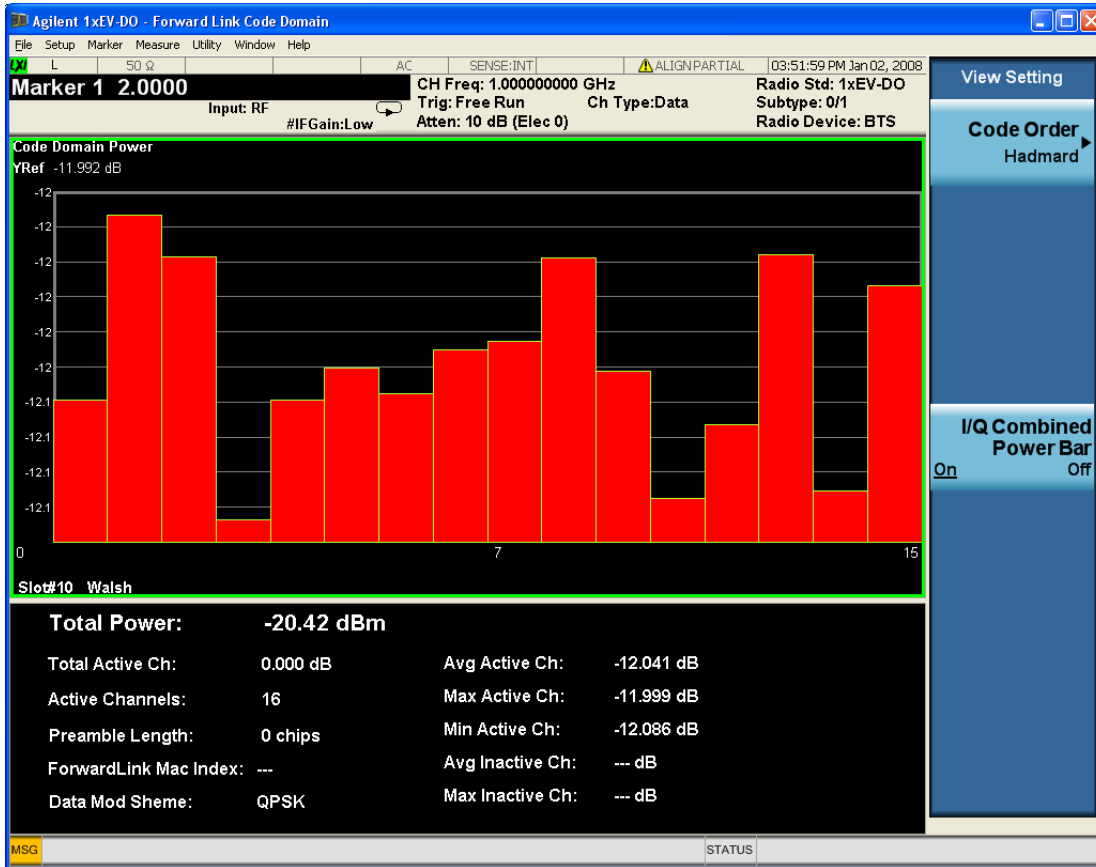

Key Path	View/Display, Power Graph & Metrics
Mode	1xEV-DO
Remote Command	:CALCulate:CDPower[:BTS]:IQ:COMBined[:STATE] 0 1 OFF ON :CALCulate:CDPower[:BTS]:IQ:COMBined[:STATE]?
Example	:CALC:CDP:IQ:COMB ON :CALC:CDP:IQ:COMB?
Notes	You must be in the 1xEV-DO mode to use this command. Use INSTRUMENT:SELECT to set the mode.
Preset	OFF
State Saved	Saved in instrument state.
Range	On   Off
Backwards Compatibility SCPI	:CALCulate:CDPower:IQ:COMBined[:STATE]
Initial S/W Revision	Prior to A.02.00

Demod Bits window

Provides a combination view of the graphs for the code domain power and chip power, and the I/Q demodulated bit stream data for slots selected by the measurement interval and measurement offset.

There are three windows:

- "Power Bar Graph window" on page 1924 (upper-left)
- "RMS Code Power/Slot window" on page 1924 (upper-right)
- "Demod Bits window" on page 1924 (lower)

## Pilot Channel

The following figure shows Demod Bits display of Pilot in Binary, Code Number = 3 and IQ Branch is Q.

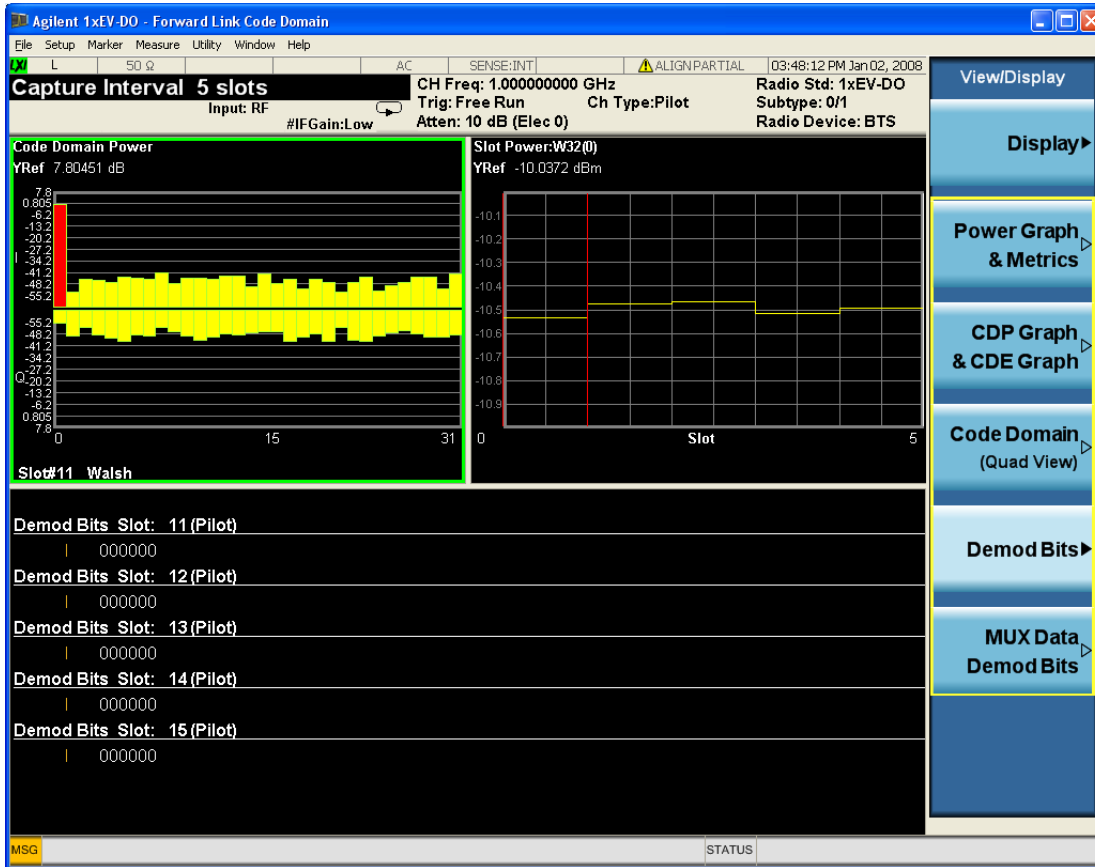

Demod Bits display of Pilot in Binary when Tri state mode is on. Code Number = 0 and IQ Branch is Q.

## MAC Channel

The following figure shows Demod Bits display of MAC in Binary mode, Subtype 0/1, Code Number = 3 and IQ Branch is Q.

# 15 Forward Link Code Domain Measurement View/Display

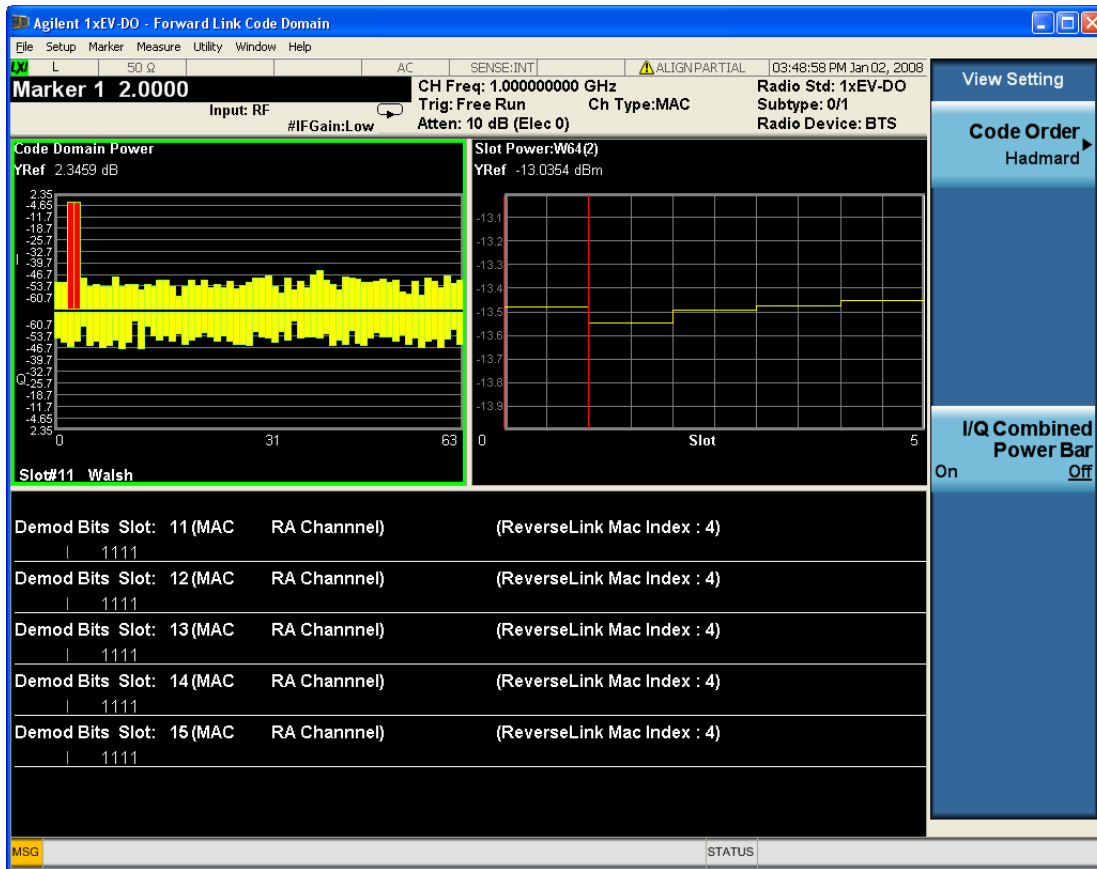

## Data Channel

The following figure shows Demod Bits display of Data in Binary mode.

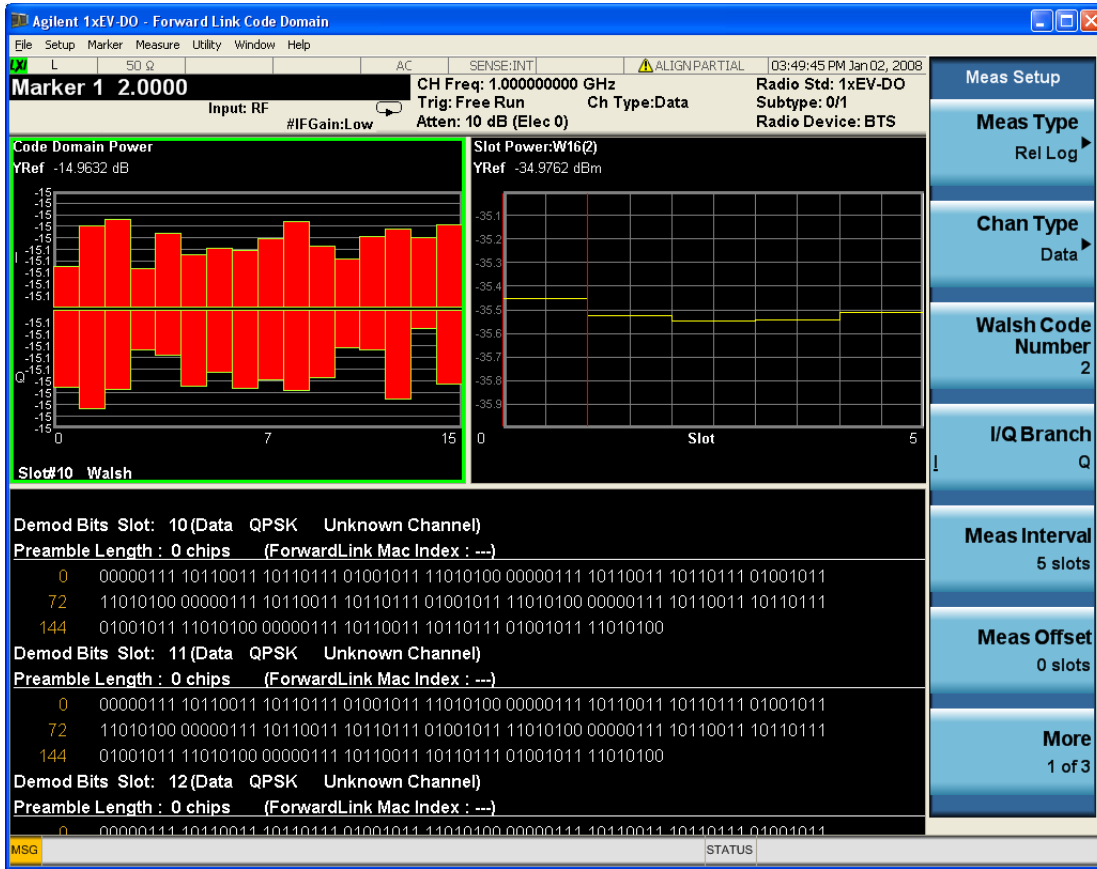

### Preamble Channel

The following figure shows Demod Bits display of Preamble in Binary mode.

## 15 Forward Link Code Domain Measurement View/Display

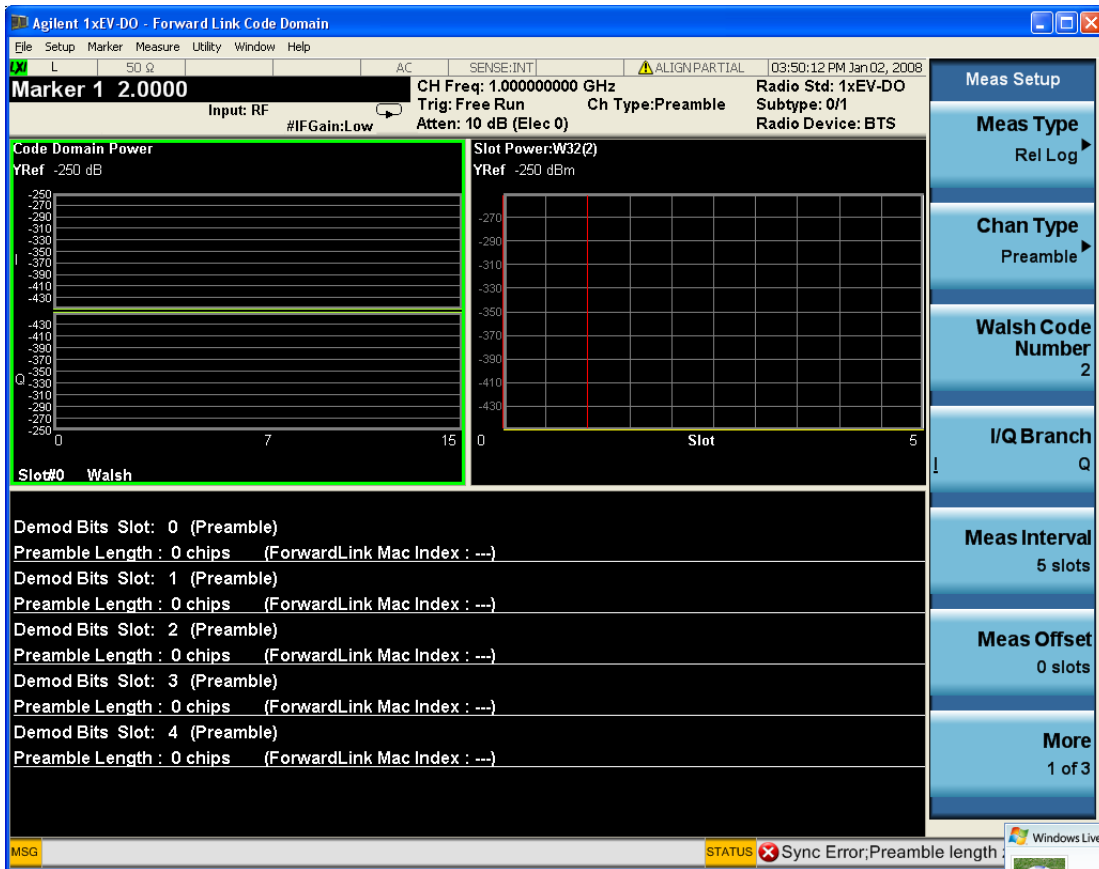

### Power Bar Graph window

This trace is of the slot specified by the Meas Offset. (Not averaged through meas interval.)

Marker Operation	Yes
Corresponding Trace	CDPower (n=2)

### RMS Code Power/Slot window

This trace is of the slots specified by the Meas Offset and Meas Interval.

Marker Operation	Yes
Corresponding Trace	(n=7)

### Demod Bits window

This trace is of the slots specified by the Meas Offset and Meas Interval.

Marker Operation	Yes
Corresponding Trace	(n=6)



If the Demod Bits window is active in the Demod Bits view (window), the View/Display key accesses the menu to allow the following controls to read the bit stream measurement results:

- Prev Page - Returns one page back to the previous page of the measurement results.
- Next Page - Moves one page forward to the next page of the measurement results.
- Scroll Up - Moves one line upward from the current page of the measurement results by each pressing.
- Scroll Down - Moves one line downward from the current page of the measurement results by each pressing.
- First Page - Moves from the current page to the first page of the measurement results.
- Last Page - Moves from the current page to the last page of the measurement results.
- Demod Bits Format - Changes the measured demod bits representation as binary or hexadecimal format.

<b>Example</b>	DISP:CDP:VIEW DBIT DISP:CDP:VIEW?
Initial S/W Revision	Prior to A.02.00

## Code Order

Sets the Walsh code order, Hadamard or Bit Reverse.

Key Path	View/Display, Power Graph & Metrics
Mode	1xEV-DO
<b>Remote Command</b>	:CALCulate:CDPower[:BTS]:WCODE:ORDER HADamard BREVerse :CALCulate:CDPower[:BTS]:WCODE:ORDER?
<b>Example</b>	:CALC:CDP:WCOD:ORD BREV :CALC:CDP:WCOD:ORD?
Notes	This key appears when Code Domain Power window is active.
Preset	HADamard
State Saved	Saved in instrument state.
Range	Hadamard   Bit Reverse
<b>Backwards Compatibility SCPI</b>	:CALCulate:CDPower:WCODE:ORDER
Initial S/W Revision	Prior to A.02.00

### I/Q Combined Power Bar

Allows you to toggle the I/Q combined power display function between On and Off. If set to On, the I and Q power bars are consolidated on the upper side of the horizontal axis. If set to Off, the I and Q power bars are shown on the upper side and the lower side of the horizontal axis, respectively.

The following figure shows Code Domain Power when I/Q Combined Power Bar is set to ON.

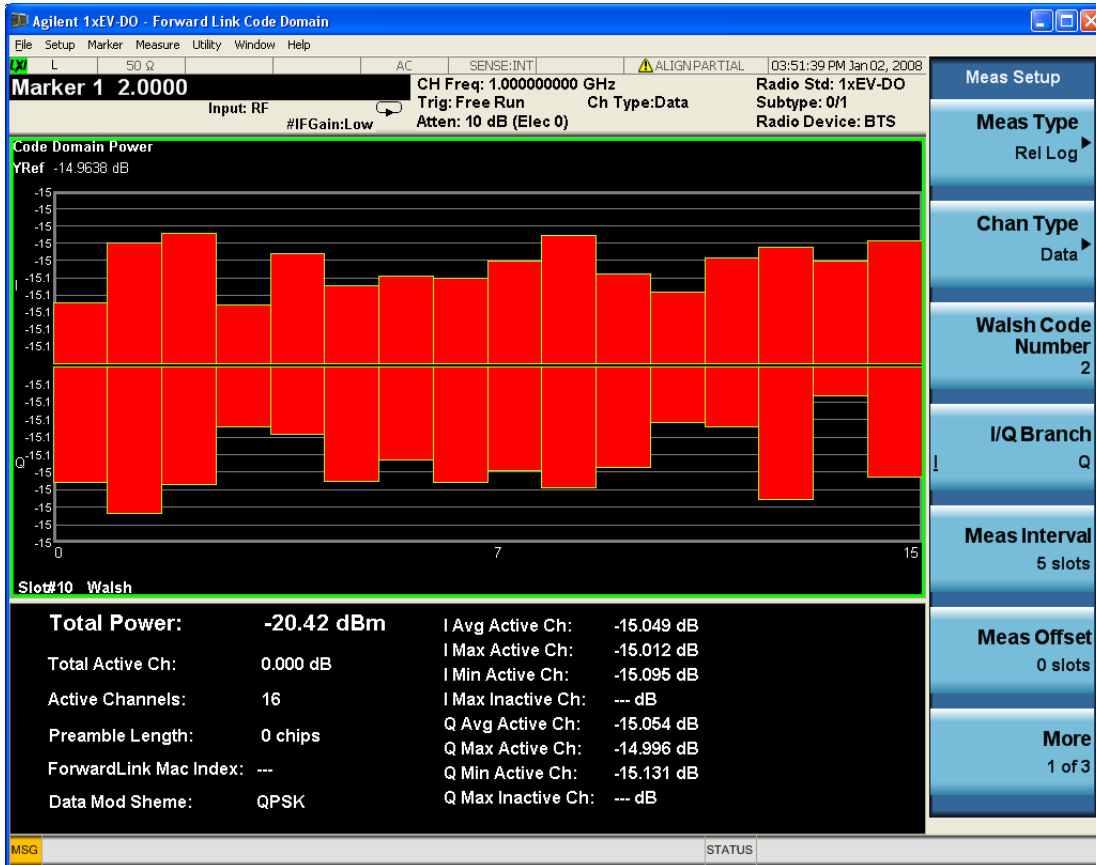

The following figure shows Code Domain Power when I/Q Combined Power Bar is set to OFF.

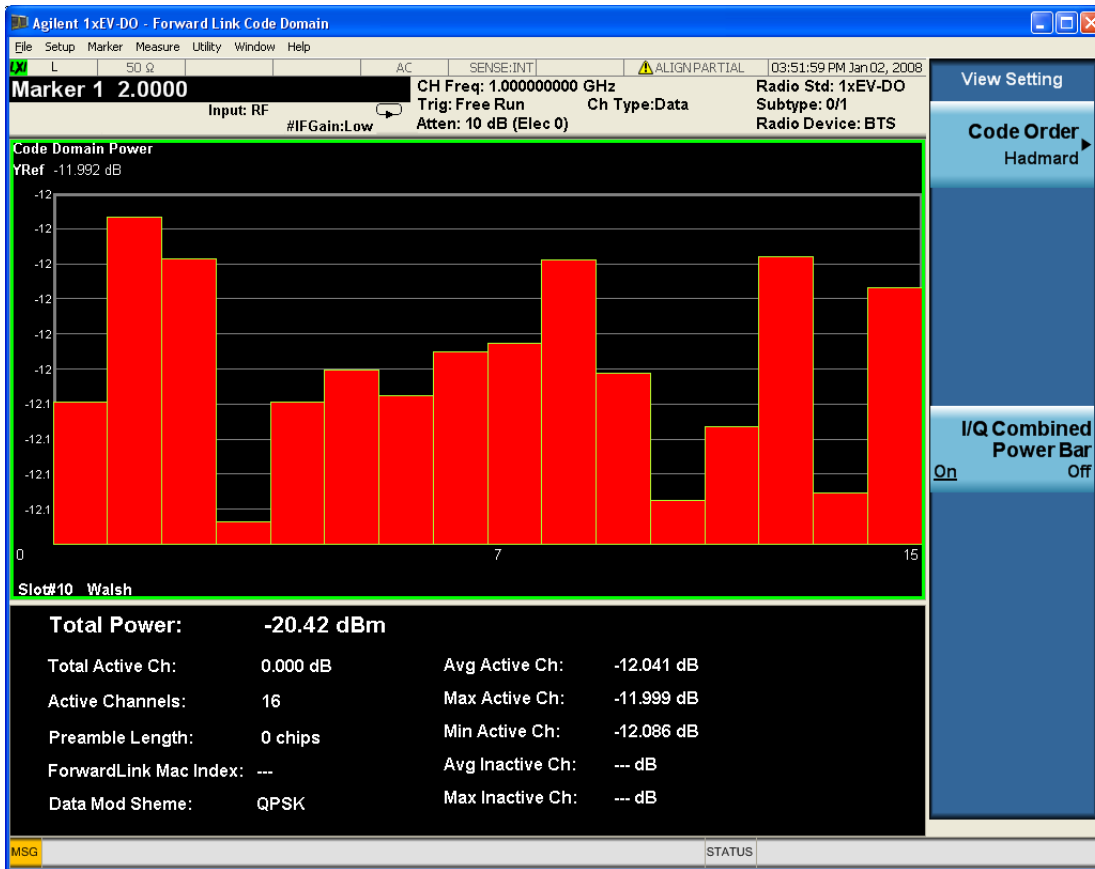

Key Path	View/Display, Power Graph & Metrics
Mode	1xEV-DO
Remote Command	:CALCulate:CDPower[:BTS]:IQ:COMBined[:STATE] 0 1 OFF ON :CALCulate:CDPower[:BTS]:IQ:COMBined[:STATE]?
Example	:CALC:CDP:IQ:COMB ON :CALC:CDP:IQ:COMB?
Notes	You must be in the 1xEV-DO mode to use this command. Use INSTRument:SElect to set the mode.
Preset	OFF
State Saved	Saved in instrument state.
Range	On   Off
Backwards Compatibility SCPI	:CALCulate:CDPower:IQ:COMBined[:STATE]
Initial S/W Revision	Prior to A.02.00

### Multiplexed Data Demod Bits view

This view has one window: "Multiplexed Data Demod Bits window" on page 1928.

The following figure shows Demod Bits display of Multiplexed Data in Hex mode.

15 Forward Link Code Domain Measurement  
View/Display

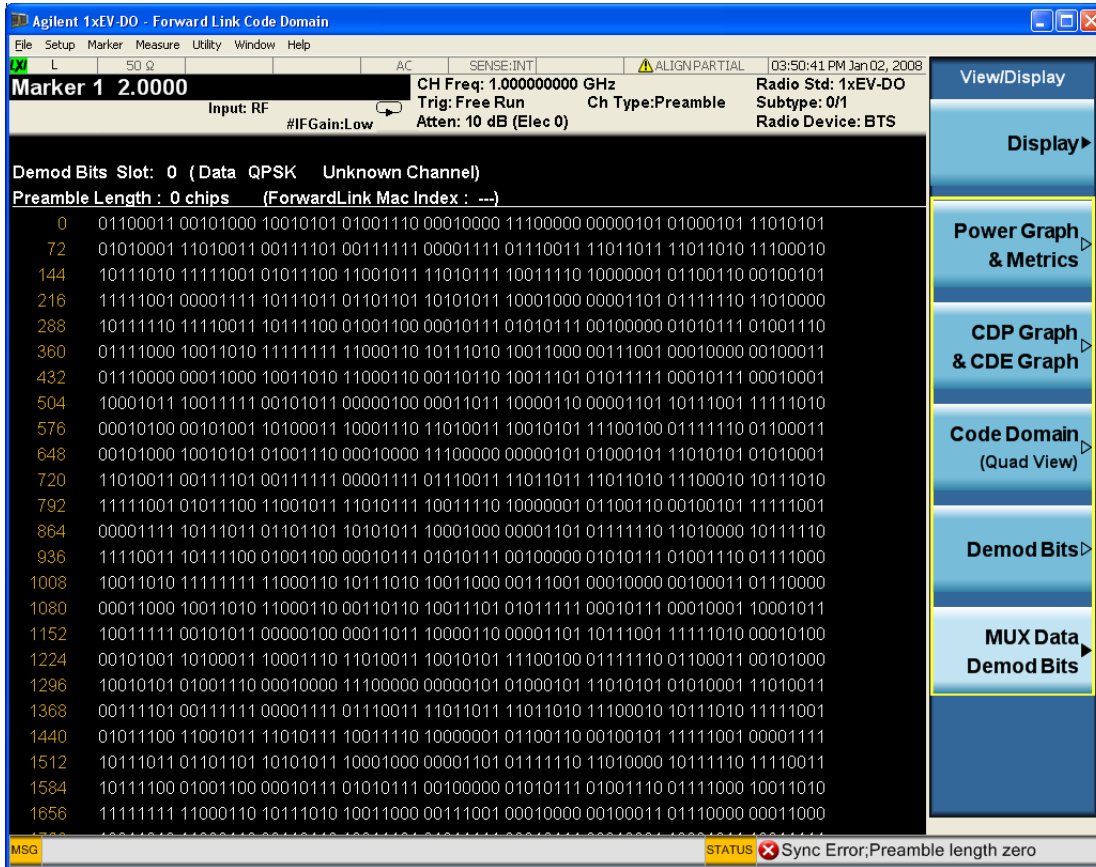

Multiplexed Data Demod Bits window

This trace is of the slots specified by the Meas Offset and Meas Interval.

Marker Operation	Yes
Corresponding Trace	(n=10)

<b>Example</b>	DISP:CDP:VIEW MDDB DISP:CDP:VIEW?
Initial S/W Revision	Prior to A.02.00

Prev Page

Returns the current page back to the previous page of the measurement results.

Key Path	View/Display, Demod Bits/Mux Data Demod Bits
Mode	1xEV-DO
Notes	The Demod Bits window must be the focused window.
Initial S/W Revision	Prior to A.02.00

## Next Page

Moves the current page forward to the next page of the measurement results.

Key Path	View/Display, Demod Bits/Mux Data Demod Bits
Mode	1xEV-DO
Notes	The Demod Bits window must be the focused window.
Initial S/W Revision	Prior to A.02.00

## Scroll Up

Moves one line upward from the current page of the measurement results by each pressing.

Key Path	View/Display, Demod Bits/Mux Data Demod Bits
Mode	1xEV-DO
Notes	The Demod Bits window must be the focused window.
Initial S/W Revision	Prior to A.02.00

## Scroll Down

Moves one line downward from the current page of the measurement results by each press.

Key Path	View/Display, Demod Bits/Mux Data Demod Bits
Mode	1xEV-DO
Notes	The Demod Bits window must be the focused window.
Initial S/W Revision	Prior to A.02.00

## First Page

Moves from the current page to the first page of the measurement results.

Key Path	View/Display, Demod Bits/Mux Data Demod Bits
Mode	1xEV-DO
Notes	The Demod Bits window must be the focused window.
Initial S/W Revision	Prior to A.02.00

## Last Page

Moves from the current page to the last page of the measurement results.

Key Path	View/Display, Demod Bits/Mux Data Demod Bits
Mode	1xEV-DO
Notes	The Demod Bits window must be the focused window.
Initial S/W Revision	Prior to A.02.00

## Demod Bit Format

The Demod Bits view changes its representation as the above settings change.

- Binary: The symbol data bit format is binary and each character represents a binary digit.
- Hex: 4 Bit map to 1 Hex Symbol.

The number to the left of each row indicates the symbol of the first symbol in the row.

Key Path	View/Display, Demod Bits/Mux Data Demod Bits
Mode	1xEV-DO
<b>Remote Command</b>	:CALCulate:CDPower[:BTS]:DBIT:FORMat BIN HEX :CALCulate:CDPower[:BTS]:DBIT:FORMat?
<b>Example</b>	:CALC:CDP: DBIT: FORM BIN :CALC:CDP: DBIT: FORM?
Preset	BIN
State Saved	Saved in instrument state.
Range	BIN HEX
Initial S/W Revision	Prior to A.02.00

## 16 Reverse Link Code Domain

This key invokes the Reverse Link Code Domain Power measurement.

Key Path	Measure
Initial S/W Revision	Prior to A.02.00

## Amplitude (AMPTD) Y Scale

Accesses a menu of functions that enable you to set the desired vertical scale parameters for the current measurement. The Metrics, I/Q Symbol Polar Vector, and Demod Bits windows do not support the functions in this menu. A blank menu will be displayed.

Key Path	Front-panel key
Initial S/W Revision	Prior to A.02.00

### Y Ref Value (Power Bar Graph & Metrics View, Power Bar Graph window)

Sets the power reference value in the Power Bar Graph window.

Key Path	AMPTD Y Scale
Mode	1xEV-DO
<b>Remote Command</b>	:DISPlay:CDPower:MS:VIEW[1]:WINDow[1]:TRACe:Y[:SCALE]:RLEVel <real> :DISPlay:CDPower:MS:VIEW[1]:WINDow[1]:TRACe:Y[:SCALE]:RLEVel?
<b>Example</b>	DISP:CDP:MS:VIEW:WIND:TRAC:Y:RLEV 0 DISP:CDP:MS:VIEW:WIND:TRAC:Y:RLEV?
Preset	0.00
State Saved	Saved in instrument state.
Min	-250.00
Max	250.00
<b>Backwards Compatibility SCPI</b>	:DISPlay:TCDPower:VIEW[1]:WINDow[1]:TRACe:Y[:SCALE]:RLEVel
Initial S/W Revision	Prior to A.02.00

## Attenuation

This menu controls the attenuator functions and interactions between the attenuation system components.

There are two attenuator configurations in the X-Series. One is a dual attenuator configuration consisting of a mechanical attenuator and an optional electronic attenuator. The other configuration uses a single attenuator with combined mechanical and electronic sections that controls all the attenuation functions. Different models in the X-Series come with different configurations.

See ["Dual Attenuator Configurations:" on page 1933](#)

See ["Single Attenuator Configuration:" on page 1933](#)

Most Attenuation settings are the same for all measurements – they do not change as you change measurements. Settings like these are called “Meas Global” and are unaffected by Meas Preset.



Key Path	AMPTD Y Scale
Scope	Meas Global
Dependencies	In measurements that support the I/Q inputs, this key is unavailable when I/Q is the selected input, and is replaced by the Range key in that case.
Readback Line	Contains a summary in [ ] brackets of the current total attenuation. See the descriptions of the , " <a href="#">(Mech) Atten</a> " on page 2783, and " <a href="#">Enable Elec Atten</a> " on page 2785 keys for more detail on the contributors to the total attenuation.  Note that when "Pre-Adjust for Min Clip" is on, this value can change at the start of every measurement.
Initial S/W Revision	Prior to A.02.00
Modified at S/W Revision	A.03.00

### Dual Attenuator Configurations:

Configuration 1: Mechanical attenuator + optional electronic attenuator

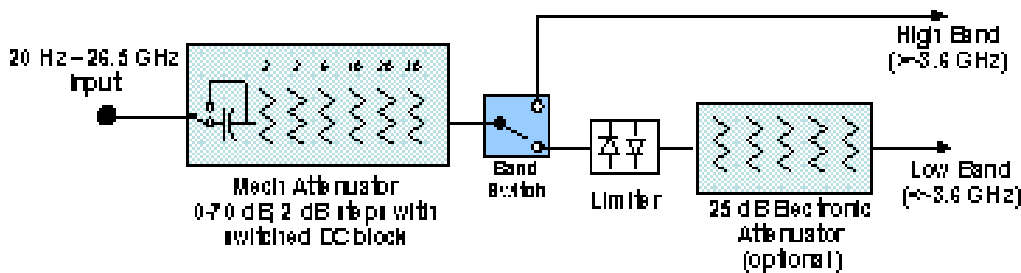

Configuration 2: Mechanical attenuator, no optional electronic attenuator

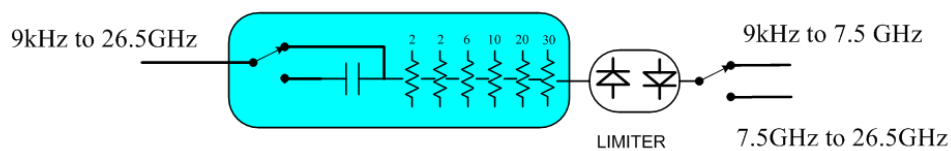

(note that Configuration 2 is not strictly speaking a dual-section attenuator, since there is no electronic section available. However, it behaves exactly like Configuration 1 without the Electronic Attenuator option EA3, therefore for the sake of this document it is grouped into the "Dual Attenuator" configuration)

### Single Attenuator Configuration:

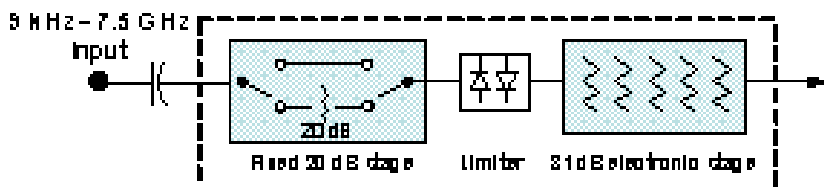

You can tell which attenuator configuration you have by pressing the Attenuation key, which (in most Modes) opens the Attenuation menu. If the first key in the Attenuation menu says Mech Atten you have the dual attenuator configuration. If the first key says Atten you have the single attenuator configuration.

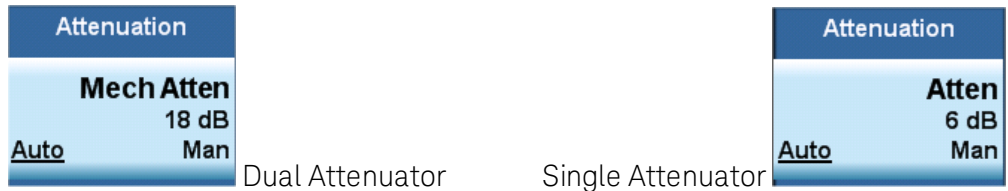

In the single attenuator configuration, you control the attenuation with a single control, as the fixed stage has only two states. In the dual attenuator configuration, both stages have significant range so you are given separate control of the mechanical and electronic attenuator stages.

When you have the dual attenuator configuration, you may still have only a single attenuator, because unless option EA3 (the Electronic Attenuator option) is available, and you purchase it, you will have only the mechanical attenuator.

### (Mech) Atten

This key is labeled Mech Atten in dual attenuator models and Atten in single attenuator models. In the dual attenuator configuration, this key only affects the mechanical attenuator.

This key lets you modify the attenuation applied to the RF input signal path. This value is normally auto coupled to the Ref Level, the Internal Preamp Gain, any External Gain that is entered, and the Max Mixer Level, as described in the table below.

See "[Attenuator Configurations and Auto/Man](#)" on page 1935

Key Path	AMPTD Y Scale, Attenuation
<b>Remote Command</b>	<pre>[ :SENSe] :POWer [:RF] :ATTenuation &lt;rel_ampl&gt; [ :SENSe] :POWer [:RF] :ATTenuation? [ :SENSe] :POWer [:RF] :ATTenuation:AUTO OFF ON 0 1 [ :SENSe] :POWer [:RF] :ATTenuation:AUTO?</pre>
<b>Example</b>	<p>POW:ATT 20</p> <p>Dual attenuator configuration: sets the mechanical attenuator to 20 dB</p> <p>Single attenuator mode: sets the main attenuation to 20 dB (see below for definition of "main" attenuation).</p> <p>If the attenuator was in Auto, it sets it to Manual.</p>
<b>Dependencies</b>	<p>Some measurements do not support the Auto setting of (Mech) Atten. In these measurements, the Auto/Man selection is not available, and the Auto/Man line on the key disappears.</p> <p>In dual attenuator configurations, when the electronic attenuator is enabled, the mechanical attenuator has no auto setting and the Auto/Man line on the key disappears. The state of Auto/Man is remembered and restored when the electronic attenuator is once again disabled. This is described in more detail in the "<a href="#">Enable Elec Atten</a>" on page 2785 key description.</p> <p>See "<a href="#">Attenuator Configurations and Auto/Man</a>" on page 1935 for more information on the Auto/Man functionality of Attenuation.</p>
<b>Couplings</b>	

---

	<p>When (Mech) Atten is in Auto, it uses the following algorithm to determine a value:          If the USB Preamp is connected to USB, use 0 dB.          Otherwise, Atten = ReferenceLevel + PreAmpGain + ExternalGain – RefLevelOffset - MaxMixerLevel + IF Gain.          Limit this value to be between 6 dB and the Max value. No value below 6 dB can ever be chosen by Auto.          The resulting value is rounded up to the largest value possible given the attenuation step setting. That is, 50.01 dB would change to 60 dB (for a 10 dB attenuation step).          The “IF Gain” term in the equation above is either 0 dB or +10 dB, depending on the settings of FFT IF Gain, Swept IF Gain, max Ref Level and the Auto/Man setting of Mech Atten.          In External Mixing and BBIQ, where the Attenuator is not in the signal path, the Attenuator setting changes as described above when (Mech) Atten is in Auto, but no changes are made to the actual attenuator hardware setting until the input is changed back to the RF Input.</p>
Preset	<p>The preset for Mech Attenuation is “Auto.”          The Auto value of attenuation is:          CXA, EXA, MXA and PXA: 10 dB</p>
State Saved	<p>Saved in instrument state</p>
Min	<p>0 dB          The attenuation set by this key cannot be decreased below 6 dB with the knob or step keys. To get to a value below 6 dB it has to be directly entered from the keypad or via SCPI. This protects from adjusting the attenuation to a dangerously small value which can put the instrument at risk of damage to input circuitry. However, if the current mechanical attenuation is below 6 dB it can be increased with the knob and step keys, but not decreased.</p>
Max	<p>CXA N9000A–503/507: 50 dB          CXA N9000A–513/526: 70dB          EXA: 60 dB          MXA and PXA: 70 dB          In the single attenuator configuration, the total of ATT and EATT cannot exceed 50 dB, so if the EATT is set to 24 dB first, the main attenuation cannot be greater than 26 dB and will be reduced accordingly; if the main attenuator is set to 40 dB first, EATT cannot be greater than 10 dB.</p>
Initial S/W Revision	<p>Prior to A.02.00</p>
Modified at S/W Revision	<p>A.03.00</p>

---

### Attenuator Configurations and Auto/Man

As described in the Attenuation key description, there are two distinct attenuator configurations available in the X-Series, the single attenuator and dual attenuator configurations. In dual attenuator configurations, we have the mechanical attenuation and the electronic attenuation, and the current total attenuation is the sum of the electronic + mechanical attenuation. In single attenuator configurations, we refer to the attenuation set using the (Mech) Atten key (or POW:ATT SCPI) as the “main” attenuation; and the attenuation that is set by the SCPI command POW:EATT as the “soft” attenuation (the POW:EATT command is honored even in the single attenuator configuration, for compatibility purposes). Then the

current total attenuation is the sum of the main + soft attenuation. See the Elec Atten key description for more on “soft” attenuation.

In the dual attenuator configuration, when the electronic attenuator is enabled, there is no Auto/Man functionality for the mechanical attenuator, and the third line of the key label (the Auto/Man line) disappears:

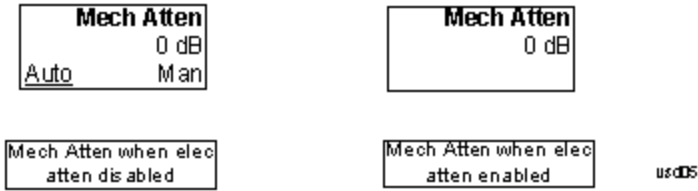

### Enable Elec Atten

Enables the Electronic Attenuator.

The electronic attenuator offers finer steps than the mechanical attenuator, has no acoustical noise, is faster, and is less subject to wear. These advantages primarily aid in remote operation and are negligible for front panel use. See ["Using the Electronic Attenuator: Pros and Cons" on page 1938](#) for a detailed discussion of the pros and cons of using the electronic attenuator.

For the single attenuator configuration, for SCPI backwards compatibility, the “soft” attenuation feature replaces the dual attenuator configuration’s electronic attenuator. All the same couplings and limitations apply. See ["Attenuator Configurations and Auto/Man" on page 2785](#)

See ["More Information" on page 1937](#)

<b>Key Path</b>	AMPTD Y Scale, Attenuation
<b>Remote Command</b>	[ :SENSE ] :POWER [ :RF ] :EATTenuation :STATe OFF   ON   0   1 [ :SENSE ] :POWER [ :RF ] :EATTenuation :STATe ?
<b>Example</b>	POW:EATT:STAT ON
<b>Dependencies</b>	<p>This key only appears in Dual Attenuator models with an Electronic Attenuator installed. It does not appear in models with the Single Attenuator configuration, as in the single attenuator configuration there is no “electronic attenuator” there is only a single integrated attenuator (which has both a mechanical and electronic stage). However, in the single attenuator configuration, EATT SCPI commands are accepted for compatibility with other X-series instruments and set a “soft” attenuation as described in <a href="#">"Attenuator Configurations and Auto/Man" on page 2785</a>.</p> <p>The electronic attenuator (and the “soft” attenuation function provided in single attenuator configurations) is unavailable above 3.6 GHz. Therefore, if the Stop Frequency of the analyzer is &gt; 3.6 GHz then the Enable Elec Atten key will be OFF and grayed out.</p> <p>If the Internal Preamp is on, meaning it is set to Low Band or Full, the electronic attenuator (and the “soft” attenuation function provided in single attenuator configurations) is unavailable. In this case the Enable Elec Atten key will be OFF and grayed out.</p> <p>If either of the above is true, if the SCPI command is sent, an error indicating that the electronic attenuator is unavailable will be sent.</p> <p>If the electronic/soft Attenuator is enabled, then the Stop Freq of the analyzer is limited to 3.6 GHz and the Internal Preamp is unavailable.</p> <p>The SCPI-only “soft” electronic attenuation for the single-attenuator configuration is not available in</p>

	all measurements; in particular, it is not available in the Swept SA measurement.
Couplings	Enabling and disabling the Electronic Attenuator affects the setting of the Mechanical Attenuator (in dual attenuator configurations). This is described in more detail below this table.
Preset	OFF for Swept SA measurement; ON for all other measurements that support the electronic attenuator
State Saved	Saved in instrument state
Initial S/W Revision	Prior to A.02.00
Modified at S/W Revision	A.03.00

## More Information

### Mechanical Attenuator Transition Rules

When the Electronic Attenuator is enabled, the Mechanical Attenuator transitions to a state that has no Auto function. Below are the rules for transitioning the Mechanical Attenuator. NOTE that the information below ONLY applies to the dual attenuator configurations, and ONLY when the Electronic Attenuator is installed:

#### When the Electronic Attenuation is enabled from a disabled state:

- The Mechanical Attenuator is initialized to 10 dB (this is its optimal performance setting). You can then set it as desired with SCPI, numeric keypad, step keys, or knob, and it behaves as it normally would in manual mode
- The Auto/Man state of (Mech) Atten is saved
- The Auto/Man line on the (Mech) Atten key disappears and the auto rules are disabled
- The Electronic Attenuator is set to 10 dB less than the previous value of the Mechanical Attenuator, within the limitation that it must stay within the range of 0 to 24 dB of attenuation.

#### Examples in the dual attenuator configuration:

- Mech Atten at 20 dB. Elec Atten enabled, Mech Atten set to 10 dB, and Elec Atten set to 10 dB. New total attenuation equals the value before Elec Atten enabled.
- Mech Atten at 0 dB. Elec Atten enabled, Mech Atten set to 10 dB, and Elec Atten set to 0 dB. New total attenuation does not equal the value before Elec Atten enabled.
- Mech Atten at 40 dB. Elec Atten enabled, Mech Atten set to 10 dB, and Elec Atten set to 24 dB. New total attenuation does not equal the value before Elec Atten enabled.

#### When the Electronic Attenuation is disabled from an enabled state:

- The Elec Atten key is grayed out
- The Auto/Man state of (Mech) Atten is restored
- If now in Auto, (Mech) Atten recouples

- If now in Man, (Mech) Atten is set to the value of total attenuation that existed before the Elec Atten was disabled. The resulting value is rounded up to the smallest value possible given the (Mech) Atten Step setting - (That is, 57 dB changes to 58 dB when (Mech) Atten Step is 2 dB.)

### Using the Electronic Attenuator: Pros and Cons

The electronic attenuator offers finer steps than the mechanical attenuator, has no acoustical noise, is faster, and is less subject to wear.

The “finer steps” advantage of the electronic attenuator is beneficial in optimizing the alignment of the analyzer dynamic range to the signal power in the front panel as well as remote use. Thus, you can achieve improved relative signal measurement accuracy. Compared to a mechanical attenuator with 2 dB steps, the 1 dB resolution of the electronic attenuator only gives better resolution when the odd-decibel steps are used. Those odd-decibel steps are less accurately calibrated than the even-decibel steps, so one tradeoff for this superior relative accuracy is reduced absolute amplitude accuracy.

Another disadvantage of the electronic attenuator is that the spectrum analyzer loses its “Auto” setting, making operation less convenient.

Also, the relationship between the dynamic range specifications (TOI, SHI, compression and noise) and instrument performance are less well-known with the electrical attenuator. With the mechanical attenuator, TOI, SHI and compression threshold levels increase dB-for-dB with increasing attenuation, and the noise floor does as well. With the electronic attenuator, there is an excess attenuation of about 1 to 3 dB between 0 and 3.6 GHz, making the effective TOI, SHI, and so forth, less well known. Excess attenuation is the actual attenuation relative to stated attenuation. Excess attenuation is accounted for in the analyzer calibration

### Elec Atten

Controls the Electronic Attenuator in dual attenuator configurations. This key does not appear in single attenuator configurations, as the control of both the mechanical and electronic stages of the single attenuator is integrated into the single Atten key.

Key Path	AMPTD Y Scale, Attenuation
Remote Command	<code>[ :SENSe ] :POWer [ :RF ] :EATTenuation &lt;rel_amp1&gt;</code> <code>[ :SENSe ] :POWer [ :RF ] :EATTenuation?</code>
Notes	Electronic Attenuation's specification is defined only when Mechanical Attenuation is 6 dB.
Dependencies	This key only appears in Dual Attenuator models with an Electronic Attenuator installed. It does not appear in models with the Single Attenuator configuration, as in the single attenuator configuration there is no “electronic attenuator” there is only a single integrated attenuator (which has both a mechanical and electronic stage). However, in the single attenuator configuration, EATT SCPI commands are accepted for compatibility with other X-series instruments and set a “soft” attenuation as described in <a href="#">"Attenuator Configurations and Auto/Man" on page 2785</a> . The “soft” attenuation is treated as an addition to the “main” attenuation value set by the Atten softkey or the POW:ATT SCPI command and affects the total attenuation displayed on the Attenuation key and the Meas Bar.  When Enable Elec Atten is off or grayed out, the Elec Atten key is grayed out.
Preset	0 dB
State Saved	Saved in instrument state

Min	0 dB
Max	Dual attenuator configuration: 24 dB Single attenuator configuration: the total of ATT and EATT cannot exceed 50 dB, so if the EATT is set to 24 dB first, the main attenuation cannot be greater than 26 dB and will be reduced accordingly; if the main attenuator is set to 40 dB first, EATT cannot be greater than 10 dB
Initial S/W Revision	Prior to A.02.00
Modified at S/W Revision	A.03.00

### Adjust Atten for Min Clip

Sets the combination of mechanical and electronic attenuation and gain based on the current measured signal level so that clipping will be at a minimum.

This is an "immediate action" function, that is, it executes once, when the key is pressed.

This key is grayed out in measurements that do not support this functionality. The spectrum analyzer measurement, Swept SA, does not support this functionality.

Key Path	AMPTD Y Scale, Attenuation
Remote Command	<code>[ :SENSe ] :POWer [ :RF ] :RANGe:OPTimize IMMEDIATE</code>
Initial S/W Revision	Prior to A.02.00
Modified at S/W Revision	A.03.00

### Pre-Adjust for Min Clip

If this function is on, it does the adjustment described under "[Adjust Atten for Min Clip](#)" on page 2788 each time a measurement restarts. Therefore, in Continuous measurement mode, it only executes before the first measurement.

In dual attenuator models, you can set Elec+Mech Atten, in which case both attenuators participate in the autoranging, or Elec Atten Only, in which case the mechanical attenuator does not participate in the autoranging. This latter case results in less wear on the mechanical attenuator and is usually faster.

This key is grayed out in measurements that do not support this functionality. The spectrum analyzer measurement, Swept SA, does not support this functionality.

Key Path	AMPTD Y Scale, Attenuation
Remote Command	<code>[ :SENSe ] :POWer [ :RF ] :RANGe:OPTimize:ATTenuation OFF   ELECTrical   COMBined</code>  <code>[ :SENSe ] :POWer [ :RF ] :RANGe:OPTimize:ATTenuation?</code>
Notes	The SCPI parameter ELECTrical sets this function to On in single attenuator models. The SCPI parameter COMBined is mapped to ELECTrical in single attenuator models; if you send COMBined, it sets the function to On and returns ELEC to a query.
Dependencies	This key only appears in Dual Attenuator models with an Electronic Attenuator installed.

	In instruments with Dual Attenuator model, when Enable Elec Atten is off or grayed out, the Pre-Adjust for Min Clip key is grayed out.
Preset	OFF for Swept SA measurement; ON for all other measurements that support Pre-Adjust for Min Clip
State Saved	Saved in instrument state
Range	Dual attenuator models: Off   Elec Atten Only   Mech + Elec Atten Single attenuator models: Off   On
Initial S/W Revision	Prior to A.02.00
Modified at S/W Revision	A.03.00

<b>Remote Command</b>	<code>[ :SENSe ] :POWer [ :RF ] :RANGe :AUTO ON OFF 1 0</code> <code>[ :SENSe ] :POWer [ :RF ] :RANGe :AUTO?</code>
Notes	ON aliases to "Elec Atten Only" (:POW:RANG:OPT:ATT ELEC) OFF aliases to "Off" (:POW:RANG:OPT:ATT OFF) The query :POW:RANG:AUTO? returns true if :POW:RANG:OPT:ATT is not "Off"
Initial S/W Revision	Prior to A.02.00

## Off

Turns Pre-Adjust for Min Clip off. This is the default setting.

This key is grayed out in measurements that do not support this functionality. The spectrum analyzer measurement, Swept SA, does not support this functionality.

Key Path	AMPTD Y Scale, Attenuation, Pre-Adjust for Min Clip
Example	:POW:RANG:OPT:ATT OFF
Initial S/W Revision	Prior to A.02.00

## Elec Atten Only

Selects only the electric attenuator to participate in auto ranging. This offers less wear on the mechanical attenuator and is usually faster.

This key is grayed out in measurements that do not support this functionality. The spectrum analyzer measurement, Swept SA, does not support this functionality.

Key Path	AMPTD Y Scale, Attenuation, Pre-Adjust for Min Clip
Example	:POW:RANG:OPT:ATT ELEC
Initial S/W Revision	Prior to A.02.00



## Mech + Elec Atten

In dual attenuator models, this selects both attenuators participate in the autoranging.

This key is grayed out in measurements that do not support this functionality. The spectrum analyzer measurement, Swept SA, does not support this functionality.

Key Path	AMPTD Y Scale, Attenuation, Pre-Adjust for Min Clip
Example	:POW:RANGe:OPT:ATT COMB
Initial S/W Revision	Prior to A.02.00

## (Mech) Atten Step

This controls the step size used when making adjustments to the input attenuation.

This key is labeled Mech Atten Step in dual attenuator models and Atten Step in single attenuator models. In the dual attenuator configuration, this key only affects the step size of the mechanical attenuator.

Key Path	AMPTD Y Scale, Attenuation
<b>Remote Command</b>	<code>[ :SENSe ] :POWer [ :RF ] :ATTenuation :STEP [ :INCRement ] 10 dB   2 dB</code> <code>[ :SENSe ] :POWer [ :RF ] :ATTenuation :STEP [ :INCRement ] ?</code>
<b>Example</b>	POW:ATT:STEP 2
Notes	Note this feature works like a 1-N choice from the front panel, but it takes a specific value (in dB) when used remotely. The only valid values are 2 and 10.
Dependencies	Blanked in CXA and EXA if option FSA (2 dB steps) is not present. If blanked, attempts to set it via SCPI will yield an error.
Couplings	When the attenuation step size changes, the current mechanical attenuation value is adjusted (if necessary) to be quantized to the new step size. That is, if step is set to 10 dB, mech atten is increased if necessary so it is a multiple of 10 dB
Preset	PXA and MXA: 2 dB EXA and CXA: 10 dB (2 dB with option FSA)
State Saved	Saved in instrument state
Initial S/W Revision	Prior to A.02.00
Modified at S/W Revision	A.03.00

## Y Scale/Div (Power Bar Graph & Metrics View, Power Bar Graph Window)

Sets the vertical scale by changing a power value per division in the Power Bar Graph window of Power Bar Graph & Metrics View.

Key Path	AMPTD Y Scale
----------	---------------

Mode	1xEV-DO
<b>Remote Command</b>	:DISPlay:CDPower:MS:VIEW[1]:WINDow[1]:TRACe:Y[:SCALE]:PDIVision <real> :DISPlay:CDPower:MS:VIEW[1]:WINDow[1]:TRACe:Y[:SCALE]:PDIVision?
<b>Example</b>	DISP:CDP:MS:VIEW:WIND:TRAC:Y:PDIV 10 DISP:CDP:MS:VIEW:WIND:TRAC:Y:PDIV?
Preset	10.0
State Saved	Saved in instrument state.
Min	0.10
Max	20.00
<b>Backwards Compatibility SCPI</b>	:DISPlay:TCDPower:VIEW[1]:WINDow[1]:TRACe:Y[:SCALE]:PDIVision
Initial S/W Revision	Prior to A.02.00

## Presel Center

When this key is pressed, the centering of the preselector filter is adjusted to optimize the amplitude accuracy at the frequency of the selected marker. If the selected marker is not on when Presel Center is pressed, the analyzer will turn on the selected marker, perform a peak search, and then perform centering on the marker's center frequency. If the selected marker is already on and between the start and stop frequencies of the analyzer, the analyzer performs the preselector calibration on that marker's frequency. If the selected marker is already on, but outside the frequency range between Start Freq and Stop Freq, the analyzer will first perform a peak search, and then perform centering on the marker's center frequency.

The value displayed on the Presel Adjust key will change to reflect the new preselector tuning (see Presel Adjust).

A number of considerations should be observed to ensure proper operation. See ["Proper Preselector Operation" on page 1943](#).

Key Path	AMPTD Y Scale
<b>Remote Command</b>	[:SENSe]:POWer[:RF]:PCENter
<b>Example</b>	POW:PCEN
Notes	Note that the rules outlined above under the key description apply for the remote command as well as the key. The result of the command is dependent on marker position, and so forth. Any message shown by the key press is also shown in response to the remote command.
Dependencies	<ul style="list-style-type: none"> <li>• Grayed out if the microwave preselector is off. )</li> <li>• If the selected marker's frequency is below Band 1, advisory message 0.5001 is generated and no action is taken.</li> <li>• Grayed out if entirely in Band 0.</li> <li>• Blank in models that do not include a preselector, such as option 503. If the SCPI is sent in these instruments, it is accepted without error, and the query always returns 0.</li> <li>• Grayed out in the Spectrogram View.</li> </ul>

Couplings	The active marker position determines where the centering will be attempted. If the analyzer is in a measurement such as averaging when centering is initiated, the act of centering the preselector will restart averaging but the first average trace will not be taken until the centering is completed.
Status Bits/OPC dependencies	When centering the preselector, *OPC will not return true until the process is complete and a subsequent measurement has completed, nor will results be returned to a READ or MEASure command. The Measuring bit should remain set while this command is operating and should not go false until the subsequent sweep/measurement has completed.
Initial S/W Revision	Prior to A.02.00
Modified at S/W Revision	A.03.00

## Proper Preselector Operation

A number of considerations should be observed to ensure proper operation:

1. If the selected marker is off, the analyzer will turn on a marker, perform a peak search, and adjust the preselector using the selected marker's frequency. It uses the "highest peak" peak search method unqualified by threshold or excursion, so that there is no chance of a 'no peak found' error. It continues with that peak, even if it is the peak of just noise. Therefore, for this operation to work properly, there should be a signal on screen in a preselected range for the peak search to find.
2. If the selected marker is already on, the analyzer will attempt the centering at that marker's frequency. There is no preselector for signals below about 3.6 GHz, therefore if the marker is on a signal below 3.6 GHz, no centering will be attempted and an advisory message generated
3. In some models, the preselector can be bypassed. If it is bypassed, no centering will be attempted in that range and a message will be generated.

## Preselector Adjust

Allows you to manually adjust the preselector filter frequency to optimize its response to the signal of interest. This function is only available when "[Presel Center](#)" on page 2791 is available.

For general purpose signal analysis, using Presel Center is recommended. Centering the filter minimizes the impact of long-term preselector drift. Presel Adjust can be used instead to manually optimize the preselector. One application of manual optimization would be to peak the preselector response, which both optimizes the signal-to-noise ratio and minimizes amplitude variations due to small (short-term) preselector drifting.

Key Path	AMPTD Y Scale
Scope	Meas Global
Remote Command	[ :SENSe ] :POWer [ :RF ] :PADJust <freq> [ :SENSe ] :POWer [ :RF ] :PADJust?
Example	POW:PADJ 100KHz

	POW:PADJ?
Notes	The value on the key reads out to 0.1 MHz resolution.
Dependencies	<ul style="list-style-type: none"> <li>• Grayed out if microwave preselector is off. )</li> <li>• Grayed out if entirely in Band 0.</li> <li>• Blank in models that do not include a preselector, such as option 503. If the SCPI is sent in these instruments, it is accepted without error, and the query always returns 0.</li> <li>• Grayed out in the Spectrogram View.</li> </ul>
Preset	0 MHz
State Saved	The Presel Adjust value set by Presel Center, or by manually adjusting Presel Adjust, is not saved in instrument state, and does not survive a Preset or power cycle.
Min	-500 MHz
Max	500 MHz
Default Unit	Hz
<b>Backwards Compatibility SCPI</b>	<pre>[ :SENSe ] :POWer [ :RF ] :MW :PADJust</pre> <pre>[ :SENSe ] :POWer [ :RF ] :MMW :PADJust</pre> <p>PSA had multiple preselectors, but the X-Series has only one. These commands simply alias to [ :SENSe ] :POWer [ :RF ] :PADJust</p>
Initial S/W Revision	Prior to A.02.00
Modified at S/W Revision	A.03.00

<b>Remote Command</b>	<pre>[ :SENSe ] :POWer [ :RF ] :PADJust :PRESelector MWAVE   MMWave   EXTERNAL</pre> <pre>[ :SENSe ] :POWer [ :RF ] :PADJust :PRESelector?</pre>
Notes	<p>PSA had multiple preselectors, and you could select which preselector to adjust. Since the X-Series has only one mm/uW preselector, the preselector selection softkey is no longer available. However, to provide backward compatibility, we accept the legacy remote commands.</p> <p>The command form has no effect, the query always returns MWAVE</p>
Initial S/W Revision	Prior to A.02.00

## μW Path Control

The μW Path Control functions include the μW Preselector Bypass (Option MPB) and Low Noise Path (Option LNP) controls in the High Band path circuits.

When the μW Preselector is bypassed, the user has better flatness, but will be subject to spurs from out of band interfering signals. When the Low Noise Path is enabled, the analyzer automatically switches around certain circuitry in the high frequency bands which can contribute to noise, when it is appropriate based on other analyzer settings.

For most applications, the preset state is Standard Path, which gives the best remote-control throughput, minimizes acoustic noise from switching and minimizes the risk of wear out in the hardware switches. For applications that utilize the wideband IF paths, the preset state is the  $\mu$ W Preselector Bypass path, if option MPB is present. This is because, when using a wideband IF such as the 140 MHz IF, the  $\mu$ W Preselector's bandwidth can be narrower than the available IF bandwidth, causing degraded amplitude flatness and phase linearity, so it is desirable to bypass the preselector in the default case.

Users may choose Low Noise Path Enable. It gives a lower noise floor, especially in the 21–26.5 GHz region, though without improving many measures of dynamic range, and without giving the best possible noise floor. The preamp, if purchased and used, gives better noise floor than does the Low Noise Path, however its compression threshold and third-order intercept are much poorer than that of the non-preamp Low Noise Path. There are some applications, typically for signals around –30 dBm, for which the third-order dynamic range of the standard path is good enough, but the noise floor is not low enough even with 0 dB input attenuation. When the third-order dynamic range of the preamp path is too little and the noise floor of the standard path is too high, the Low Noise Path can provide the best dynamic range.

<b>Key Path</b>	AMPTD Y Scale
<b>Mode</b>	SA, BASIC, PNOISE, VSA , LTE, LTETDD
<b>Scope</b>	Meas Global
<b>Remote Command</b>	[ :SENSe] :POWer [ :RF] :MW:PATH STD LNPath MPBypass FULL [ :SENSe] :POWer [ :RF] :MW:PATH?
<b>Example</b>	:POW:MW:PATH LNP Enables the Low Noise path
<b>Notes</b>	If a Presel Center is performed, the analyzer will momentarily switch to the Standard Path, regardless of the setting of $\mu$ W Path Control  The DC Block will always be switched in when the low noise path is switched in, to protect succeeding circuitry from DC. Note that this does not mean “when the low noise path is enabled” but when, based on the Low Noise Path rules, the path is actually switched in. This can happen when the selection is Low Noise Path Enable . In the case where the DC Block is switched in the analyzer is now AC coupled. However, if the user has selected DC coupling, the UI will still behave as though it were DC coupled, including all annunciation, warnings, status bits, and responses to SCPI queries. This is because, based on other settings, the analyzer could switch out the low noise path at any time and hence go back to being DC coupled.  Alignment switching ignores the settings in this menu, and restores them when finished.
<b>Dependencies</b>	Unavailable in BBIQ and External Mixing
<b>Preset</b>	All modes other than IQ Analyzer mode and VXA: STD IQ Analyzer, VXA and WLAN mode: MPB option present and licensed: MPB MPB option not present and licensed: STD
<b>State Saved</b>	Save in instrument state
<b>Readback</b>	Value selected in the submenu
<b>Initial S/W Revision</b>	A.04.00
<b>Modified at S/W Revision</b>	A.10.00

## Standard Path

This path gives the best remote-control throughput, minimizes acoustic noise from switching and minimizes the risk of wear in the hardware switches, particularly in remote test scenarios where both low band and high band setups will follow in rapid succession.

In this path, the bypass of the low band/high band switch and microwave preamp is never activated, which can cause some noise degradation but preserves the life of the bypass switch.

Key Path	AMPTD Y Scale, $\mu$ W Path Control
<b>Example</b>	:POW:MW:PATH STD
Readback Text	Standard Path
Initial S/W Revision	A.04.00

## Low Noise Path Enable

You may choose Low Noise Path Enable, which gives a lower noise floor under some circumstances, particularly when operating in the 21–26.5 GHz region. With the Low Noise Path enabled, the low band/high band switch and microwave preamp are bypassed whenever all of the following are true:

- The analyzer is not in the Low Band, meaning:
- the start frequency is above 3.5 GHz and
- the stop frequency is above 3.6 GHz.
- the internal preamp is not installed or (if installed) is set to Off or Low Band

Note that this means that, when any part of a sweep is done in Low Band, the Low Noise Path is not used, whether or not the Low Noise Path Enable is selected in the user interface. Also, if the preamp is turned on, the Low Noise Path is not used, whether or not the Low Noise Path Enable is selected in the user interface. The only time the Low Noise Path is used is when Low Noise Path Enable is selected, the sweep is completely in High Band (> 3.6 GHz) and no preamp is in use.

See "[More Information](#)" on page 1947

Key Path	AMPTD Y Scale, $\mu$ W Path Control
Measurement	Swept SA
<b>Example</b>	:POW:MW:PATH LNP
Notes	For measurements that use IQ acquisition, the low noise path is used when the Center Frequency is in High Band (> 3.6 GHz) and no preamp is in use. In other words, the rules above are modified to use only the center frequency to qualify which path to switch in. This is not the case for FFT's in the Swept SA measurement; they use the same rules as swept measurements.
Dependencies	Key is blanked if current mode does not support it. Key is grayed out if mode supports it but current measurement does not support it. Unless Option LNP is present and licensed, key is blank and if SCPI command sent, error -241,

	"Hardware missing; Option not installed" is generated.
Readback Text	Low Noise Path Enable
Initial S/W Revision	A.04.00

### More Information

The user should understand that the Low Noise Path, while giving improved DANL, has the disadvantage of decreased TOI performance and decreased gain compression performance relative to the standard path.

The user should also understand that the bypass switch is a mechanical switch and has finite life, so if the Low Noise Path is enabled, it is possible to cause frequent cycling of this switch by frequently changing analyzer settings such that the above conditions hold true only some of the time. A user making tests of this nature should consider opting for the Standard Path, which will never throw the bypass switch, at the expense of some degraded noise performance.

The low noise path is useful for situations where the signal level is so low that the analyzer performance is dominated by noise even with 0 dB attenuation, but still high enough that the preamp option would have excessive third-order intermodulation or compression. The preamp, if purchased and used, gives better noise floor than does the "Low Noise Path." However, its compression threshold and third-order intercept are much poorer than that of the non-preamp path. There are some applications, typically for signals around -30 dBm, for which the third-order dynamic range of the standard path is good enough, but the noise floor is not low enough even with 0 dB input attenuation. When the third-order dynamic range of the preamp path is too little and the noise floor of the standard path is too high, the Low Noise Path can provide the best dynamic range

The graph below illustrates the concept. It shows, in red, the performance of an analyzer at different attenuation settings, both with the preamp on and off, in a measurement that is affected by both analyzer noise and analyzer TOI. The green shows the best available dynamic range, offset by 0.5 dB for clarity. The blue shows how the best available dynamic range improves for moderate signal levels with the low noise path switched in. In this illustration, the preamp improves the noise floor by 15 dB while degrading the third-order intercept by 30 dB, and the low noise path reduces loss by 8 dB. The attenuator step size is 2 dB.

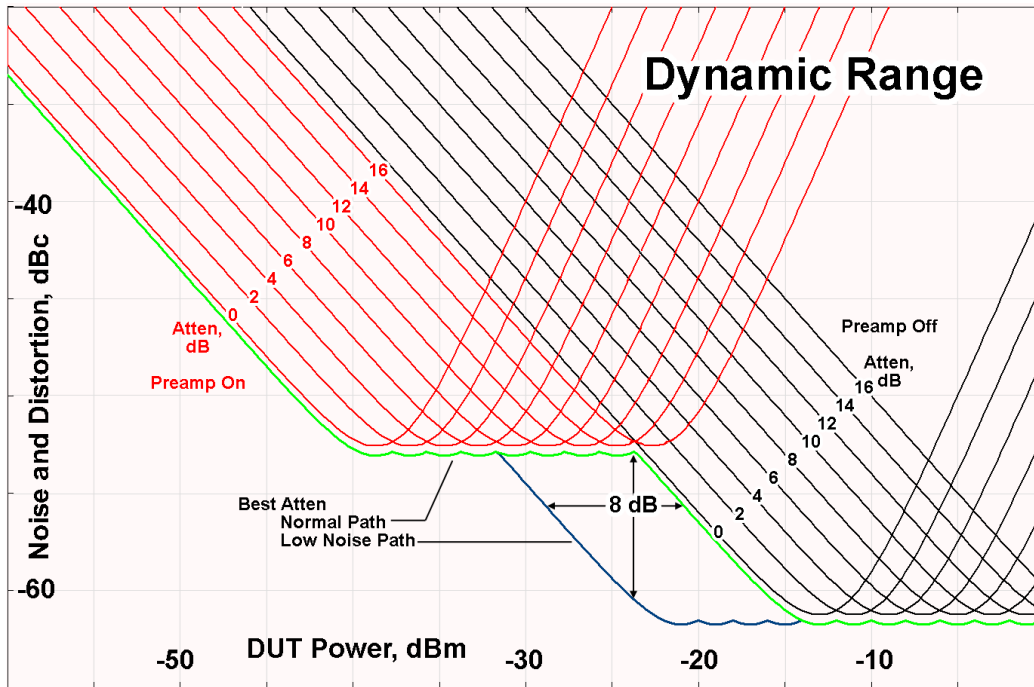

There are other times where selecting the low noise path improves performance, too. Compression-limited measurements such as finding the nulls in a pulsed-RF spectrum can profit from the low noise path in a way similar to the TOI-limited measurement illustrated. Accuracy can be improved when the low noise path allows the optimum attenuation to increase from a small amount like 0, 2 or 4 dB to a larger amount, giving better return loss at the analyzer input. Harmonic measurements, such as second and third harmonic levels, are much improved using the low noise path because of the superiority of that path for harmonic (though not intermodulation) distortion performance.

### μW Preselector Bypass

This key toggles the preselector bypass switch for band 1 and higher. When the microwave preselector is on, the signal path is preselected. When the microwave preselector is off, the signal path is not preselected. The preselected path is the normal path for the analyzer.

The preselector is a tunable bandpass filter which prevents signals away from the frequency of interest from combining in the mixer to generate in-band spurious signals (images). The consequences of using a preselector filter are its limited bandwidth, the amplitude and phase ripple in its passband, and any amplitude and phase instability due to center frequency drift.

Option MPB or pre-selector bypass provides an unpreselected input mixer path for certain X-Series signal analyzers with frequency ranges above 3.6 GHz. This signal path allows a wider bandwidth and less amplitude variability, which is an advantage when doing modulation analysis and broadband signal analysis. The disadvantage is that, without the preselector, image signals will be displayed. Another disadvantage of bypassing the preselector is increased LO emission levels at the front panel input port.

Image responses are separated from the real signal by twice the 1st IF. For IF Paths of 10 MHz and 25 MHz, the 1st IF is 322.5 MHz, so the image response and the real signal will be separated by 645 MHz. The 1st IF will be different for other IF Path settings. When viewing a real signal and its corresponding image response in internal mixing, the image response will be to the left of the real signal.



Also, the image response and the real signal typically have the same amplitude and exhibit the same shape factor.

However, if Option FS1, Fast Sweep Capability, is enabled, the image response in the Swept SA measurement will appear lower in amplitude and have a much wider shape factor compared to the real signal.

Key Path	AMPTD Y Scale, $\mu$ W Path Control
<b>Example</b>	:POW:MW:PATH MPB
Dependencies	Key is blanked if current mode does not support it. Key is grayed out if mode supports it but current measurement does not support it. Key is blank unless Option MPB is present and licensed. If SCPI command sent when MPB not present, error -241, "Hardware missing; Option not installed" is generated.
Readback Text	$\mu$ W Preselector Bypass
Initial S/W Revision	A.04.00

<b>Remote Command</b>	[ :SENSe ] :POWer [ :RF ] :MW:PRESelector [ :STATe ] ON OFF 0 1 [ :SENSe ] :POWer [ :RF ] :MW:PRESelector [ :STATe ] ?
<b>Example</b>	:POW:MW:PRES OFF Bypasses the microwave preselector
Notes	The ON parameter sets the STD path (:POW:MW:PATH STD) The OFF parameter sets path MPB (:POW:MW:PATH MPB)
Preset	ON

## Internal Preamp

Accesses a menu of keys that control the internal preamps. Turning on the preamp gives a better noise figure, but a poorer TOI to noise floor dynamic range. You can optimize this setting for your particular measurement.

The instrument takes the preamp gain into account as it sweeps. If you sweep outside of the range of the preamp the instrument will also account for that. The displayed result will always reflect the correct gain.

For some measurements, when the preamp is on and any part of the displayed frequency range is below the lowest frequency for which the preamp has specifications, a warning condition message appears in the status line. For example ,for a preamp with a 9 kHz lowest specified frequency: "Preamp: Accy unspec'd below 9 kHz".

Key Path	AMPTD Y Scale
Scope	Meas Global
<b>Remote Command</b>	[ :SENSe ] :POWer [ :RF ] :GAIN [ :STATe ] OFF ON 0 1 [ :SENSe ] :POWer [ :RF ] :GAIN [ :STATe ] ?
Dependencies	Preamp is not available on all hardware platforms. If the preamp is not present or is unlicensed, the

---

	key is not shown. The preamp is not available when the electronic/soft attenuator is enabled.
--	--------------------------------------------------------------------------------------------------

---

Couplings	The act of connecting the U7227A USB Preamplifier to one of the analyzer's USB ports will cause the Internal Preamp to be switched on. When this happens an informational message will be generated: "Internal Preamp turned on for optimal operation with USB Preamp." Note that if the Internal Preamp was already on, there will be no change to the setting, but if it was Off it will be switched On, to Full Range.  Note that this same action occurs when the SA mode is selected while the USB Preamp is connected to one of the analyzer's USB ports, if it is the first time that the SA mode has run since powerup, or if the last time the SA mode was running the USB Preamp was NOT connected.  Subsequently disconnecting the USB Preamp from USB does not change the Internal Preamp setting nor restore the previous setting.
Preset	OFF
State Saved	Saved in instrument state
Initial S/W Revision	Prior to A.02.00
Modified at S/W Revision	A.14.00

---

Key Path	AMPTD Y Scale, Internal Preamp
Scope	Meas Global
<b>Remote Command</b>	[ :SENSe ] : POWer [ :RF ] : GAIN : BAND LOW   FULL [ :SENSe ] : POWer [ :RF ] : GAIN : BAND ?
Dependencies	Preamp is not available on all hardware platforms. If the preamp is not present or is unlicensed, the key is not shown.  If a POW:GAIN:BAND FULL command is sent when a low band preamp is available, the preamp band parameter is to LOW instead of FULL, and an "Option not installed" message is generated.
Preset	LOW
State Saved	Saved in instrument state
Initial S/W Revision	Prior to A.02.00

---

## Off

Turns the internal preamp off

---

Key Path	AMPTD Y Scale, Internal Preamp
<b>Example</b>	:POW:GAIN OFF
Readback	Off
Initial S/W Revision	Prior to A.02.00

---

## Low Band

Sets the internal preamp to use only the low band.

The frequency range of the installed (optional) low-band preamp is displayed in square brackets on the Low Band key label.

Key Path	AMPTD Y Scale, Internal Preamp
<b>Example</b>	:POW:GAIN ON :POW:GAIN:BAND LOW
Readback	Low Band
Initial S/W Revision	Prior to A.02.00

## Full Range

Sets the internal preamp to use its full range. The low band (0–3.6 GHz or 0–3GHz, depending on the model) is supplied by the low band preamp and the frequencies above low band are supplied by the high band preamp.

The frequency range of the installed (optional) preamp is displayed in square brackets on the Full Range key label. If the high band option is not installed the Full Range key does not appear.

Key Path	AMPTD Y Scale, Internal Preamp
<b>Example</b>	:POW:GAIN ON :POW:GAIN:BAND FULL
Readback	Full Range
Initial S/W Revision	Prior to A.02.00

## Range

This key is only available when I/Q is the selected input. It replaces the Attenuation key in that case.

Each input channel (I and Q) has four internal gain ranges. The maximum allowed voltage in each gain range is slightly more than the nominal value, so the break point between ranges is a couple of millivolts higher than the nominal (setting a peak voltage of 0.502 mV will still map to the 0.5 V Peak range).

Gain Setting	Volts RMS	Volts Peak	Volts Peak - Peak	dBm (50Ω)	Break Point
0 dB	0.7071	1.0	2.0	10	n/a
6 dB	0.3536	0.5	1.0	4	0.502 V Peak
12 dB	0.1768	0.25	0.5	-2	0.252 V Peak
18 dB	0.0884	0.125	0.25	-8	0.127 V Peak

Key Path	AMPTD Y Scale
Notes	Visible only when the selected input is I/Q.
State Saved	No
Readback Text	When Range is Auto, "[Auto]" When Range is Man and I & Q are the same, "<range value>" When Range is Man and I & Q are different: "[: <I range value> Q: <Q range value>]" See I Range and Q Range for the <range value> enumeration definition.
Initial S/W Revision	Prior to A.02.00

## Range Auto/Man

The Auto setting for Range causes the range to be set based on the Y Scale settings. When Range is "Auto", the I & Q Range are set based on the top of the Y Scale when the Y scale is in dB units (for example, power), or to the max(abs(top), abs(bottom)) when the Y scale reference is not at the top of the screen.

Not all measurements support Range Auto/Man. If Auto is not supported in the current measurement, this key is grayed out and shows "Man" and MAN is returned to a SCPI query, but this does NOT change the Auto/Man setting for Range. When you go to a measurement that supports Auto, it goes back to Auto if it was previously in Auto mode.

Key Path	AMPTD Y Scale, Range
Scope	Meas Global
Remote Command	[ :SENSe ] :VOLTage:IQ:RANGe:AUTO OFF ON 0 1 [ :SENSe ] :VOLTage:IQ:RANGe:AUTO?
Example	Put the I Range and Q Range in manual. VOLT:IQ:RANG:AUTO OFF
Dependencies	If Auto is not supported, sending the SCPI command will generate an error.
Couplings	When in Auto, both I Range and Q Range are set to the same value, computed as follows: Maximum absolute value is computed for the Y Scale. The top and bottom of the graph are computed based on Ref Value, Scale/Div, and Ref Position. Formula: YMax = max(abs(top), abs(bottom)). The I Range and Q Range are then set to YMax.
Preset	ON
State Saved	Saved in instrument state
Range	Auto   Man
Initial S/W Revision	Prior to A.02.00

Remote Command	[ :SENSe ] :POWer:IQ:RANGe:AUTO OFF ON 0 1 [ :SENSe ] :POWer:IQ:RANGe:AUTO?
----------------	--------------------------------------------------------------------------------

<b>Example</b>	Put the I Range and Q Range in manual. POW:IQ:RANG:AUTO OFF
Notes	The POW:IQ:RANG:AUTO is an alternate form of the VOLT:IQ:RANG:AUTO command. This is to maintain consistency with I Range and Q Range, which support both the POWER and VOLTage forms of the command.
Preset	ON
Range	Auto   Man
Initial S/W Revision	Prior to A.02.00

## I Range

This is the internal gain range for the I channel when Input Path is I Only or I and I/Q, and it is used for both the I and Q channels when the Input Path is I+jQ. See "[I/Q Gain Ranges](#)" on page 2807.

<b>Key Path</b>	AMPTD Y Scale, Range
<b>Remote Command</b>	[ :SENSe ] :VOLTage :IQ [ :I ] :RANGe [ :UPPer ] <voltage> [ :SENSe ] :VOLTage :IQ [ :I ] :RANGe [ :UPPer ] ?
<b>Example</b>	Set the I Range to 0.5 V Peak VOLT:IQ:RANG 0.5 V
Notes	The numeric entries are mapped to the smallest gain range whose break point is greater than or equal to the value, or 1 V Peak if the value is greater than 1 V.
Couplings	When Q Same as I is On, the I Range value will be copied to the Q Range. Changing the value will also set Range = Man.
Preset	1 V Peak
State Saved	Saved in instrument state
Range	1 V Peak   0.5 V Peak   0.25 V Peak   0.125 V Peak
Min	0.125 V
Max	1 V
Initial S/W Revision	Prior to A.02.00

<b>Remote Command</b>	[ :SENSe ] :POWer :IQ [ :I ] :RANGe [ :UPPer ] <ampl> [ :SENSe ] :POWer :IQ [ :I ] :RANGe [ :UPPer ] ?
<b>Example</b>	Set the I Range to 0.5 V Peak when Reference Z is 50Ω, and to 1.0 V Peak when Reference Z is 75Ω. POW:IQ:RANG 4 dBm
Notes	The POWER form of the command is provided for convenience. It maps to the same underlying gain range parameter as the VOLTage form of the command. The Reference Z (not the I channel Input Z) is used to convert the power to peak voltage, which is then used to set the I Range as with the VOLTage form of the command. The power values of the 4

range states (1V Peak, 0.5V Peak, 0.25V Peak, and 0.125V Peak) will vary with Reference Z. Here are some examples:

50Ω: 10, 4, -2, -8

75Ω: 8.2, 2.2, -3.8, -9.8

600Ω: -0.8, -6.8, -12.8, -18.9

Preset	10.0 dBm
Range	-20 dBm to 10 dBm
Min	-20 dBm
Max	10 dBm
Initial S/W Revision	Prior to A.02.00

### 1 V Peak

Set the channel gain state to 1 Volt Peak.

Key Path	AMPTD Y Scale, I Range   Q Range
Initial S/W Revision	Prior to A.02.00

### 0.5 V Peak

Set the channel gain state to 0.5 Volt Peak.

Key Path	AMPTD Y Scale, I Range   Q Range
Initial S/W Revision	Prior to A.02.00

### 0.25 V Peak

Set the channel gain state to 0.25 Volt Peak.

Key Path	AMPTD Y Scale, I Range   Q Range
Initial S/W Revision	Prior to A.02.00

### 0.125 V Peak

Set the channel gain state to 0.125 Volt Peak.

Key Path	AMPTD Y Scale, I Range   Q Range
Initial S/W Revision	Prior to A.02.00

## Q Range Value

This is the internal gain range for the Q channel. See "[I/Q Gain Ranges](#)" on page 2807. The Q Range only applies to Input Path Q Only and Ind I/Q. For input I+jQ the I Range determines both I and Q channel range settings.

Key Path	AMPTD Y Scale, Range
Remote Command	[ :SENSe ] :VOLTage:IQ:Q:RANGe[:UPPer] <voltage> [ :SENSe ] :VOLTage:IQ:Q:RANGe[:UPPer] ?
Example	Set the Q Range to 0.5 V Peak VOLT:IQ:Q:RANG 0.5 V
Notes	The numeric entries are mapped to the smallest gain range whose break point is greater than or equal to the value, or 1 V Peak if the value is greater than 1 V. The Q Range is only used for Input Path Q Only and Ind I/Q. For input I+jQ the I Range determines both I and Q channel range settings.
Couplings	When Q Same as I is On, the I Range value will be copied to the Q Range and the range value keys are disabled. Changing the value will also set Range = Man.
Preset	1 V Peak
State Saved	Saved in instrument state
Range	1 V Peak   0.5 V Peak   0.25 V Peak   0.125 V Peak
Min	0.125 V
Max	1 V
Initial S/W Revision	Prior to A.02.00

Remote Command	[ :SENSe ] :POWer:IQ:Q:RANGe[:UPPer] <ampl> [ :SENSe ] :POWer:IQ:Q:RANGe[:UPPer] ?
Example	Will set the Q Range to 0.5 V Peak when Reference Z is 50Ω, and to 1.0 V Peak when Reference Z is 75Ω. POW:IQ:Q:RANG 4 dBm
Notes	The POWER form of the command is provided for convenience. It maps to the same underlying gain range parameter as the VOLTage form of the command. The Reference Z (not the Q channel Input Z) is used to convert the power to peak voltage, which is then used to set the Q Range as with the VOLTage form of the command. The power values of the 4 range states (1V Peak, 0.5V Peak, 0.25V Peak, and 0.125V Peak) will vary with Reference Z. Here are some examples: 50Ω: 10, 4, -2, -8 75Ω: 8.2, 2.2, -3.8, -9.8 600Ω: -0.8, -6.8, -12.8, -18.9
Preset	10.0 dBm
Range	-20 dBm to 10 dBm

Min	-20 dBm
Max	10 dBm
Initial S/W Revision	Prior to A.02.00

### Q Same as I

Many, but not all, usages require the I and Q channels to have an identical setup. To simplify channel setup, the Q Same as I will cause the Q channel range to be mirrored from the I channel. That way you only need to set up one channel (the I channel). The I channel values are copied to the Q channel, so at the time Q Same as I is Off, the I and Q channel setups will be identical.

Key Path	AMPTD Y Scale, Range, Q Range
Remote Command	[ :SENSe ] :VOLTage   PWEr : IQ : MIRRored OFF   ON   0   1 [ :SENSe ] :VOLTage   PWEr : IQ : MIRRored ?
Example	Turn off the mirroring of I Range to Q Range. VOLT:IQ:MIRR OFF POW:IQ:MIRR OFF
Couplings	When On, the I Range value is mirrored (copied) to the Q Range.
Preset	On
State Saved	Saved in instrument state.
Range	On   Off
Readback Text	"Q Same as I" when On, otherwise none.
Initial S/W Revision	Prior to A.02.00

### 1 V Peak

Set the channel gain state to 1 Volt Peak.

Key Path	AMPTD Y Scale, I Range   Q Range
Initial S/W Revision	Prior to A.02.00

### 0.5 V Peak

Set the channel gain state to 0.5 Volt Peak.

Key Path	AMPTD Y Scale, I Range   Q Range
Initial S/W Revision	Prior to A.02.00



### 0.25 V Peak

Set the channel gain state to 0.25 Volt Peak.

Key Path	AMPTD Y Scale, I Range   Q Range
Initial S/W Revision	Prior to A.02.00

### 0.125 V Peak

Set the channel gain state to 0.125 Volt Peak.

Key Path	AMPTD Y Scale, I Range   Q Range
Initial S/W Revision	Prior to A.02.00

### I/Q Gain Ranges

See the following sections:

["1 V Peak" on page 2807](#)

["0.5 V Peak" on page 2807](#)

["0.25 V Peak" on page 2807](#)

["0.125 V Peak" on page 2808](#)

### 1 V Peak

Set the channel gain state to 1 Volt Peak.

Key Path	AMPTD Y Scale, I Range   Q Range
Initial S/W Revision	Prior to A.02.00

### 0.5 V Peak

Set the channel gain state to 0.5 Volt Peak.

Key Path	AMPTD Y Scale, I Range   Q Range
Initial S/W Revision	Prior to A.02.00

### 0.25 V Peak

Set the channel gain state to 0.25 Volt Peak.

Key Path	AMPTD Y Scale, I Range   Q Range
Initial S/W Revision	Prior to A.02.00

### 0.125 V Peak

Set the channel gain state to 0.125 Volt Peak.

Key Path	AMPTD Y Scale, I Range   Q Range
Initial S/W Revision	Prior to A.02.00

## Auto Couple

The Auto Couple feature provides a quick and convenient way to automatically couple multiple instrument settings. This helps ensure accurate measurements and optimum dynamic range. When the Auto Couple feature is activated, either from the front panel or remotely, all parameters of the current measurement that have an Auto/Manual mode are set to Auto mode and all measurement settings dependent on (or coupled to) the Auto/Man parameters are automatically adjusted for optimal performance.

However, the Auto Couple key actions are confined to the current measurement only. It does not affect other measurements in the mode, and it does not affect markers, marker functions, or trace or display attributes.

See "[More Information](#)" on page 1959

Key Path	Front-panel key
Remote Command	:COUPle ALL NONE
Example	:COUP ALL
Notes	:COUPle ALL puts all Auto/Man parameters in Auto mode (equivalent to pressing the Auto Couple key). :COUPLE NONE puts all Auto/Man parameters in manual mode. It decouples all the coupled instrument parameters and is not recommended for making measurements.
Initial S/W Revision	Prior to A.02.00

### More Information

There are two types of functions that have Auto/Manual modes.

#### Auto/Man Active Function keys

An Auto/Man toggle key controls the binary state associated with an instrument parameter by toggling between Auto (where the parameter is automatically coupled to the other parameters it is dependent upon) and Man (where the parameter is controlled independent of the other parameters), as well as making the parameter the active function. The current mode is indicated on the softkey with either Auto or Man underlined as illustrated below.



#### Auto/Man 1-of-N keys

An Auto/Man 1-of-N key allows you to manually pick from a list of parameter values, or place the function in Auto, in which case the value is automatically selected (and indicated) as shown below. If in Auto, Auto is underlined on the calling key. If in manual operation, manual is indicated on the calling key. But the calling key does not actually toggle the function, it simply opens the menu.

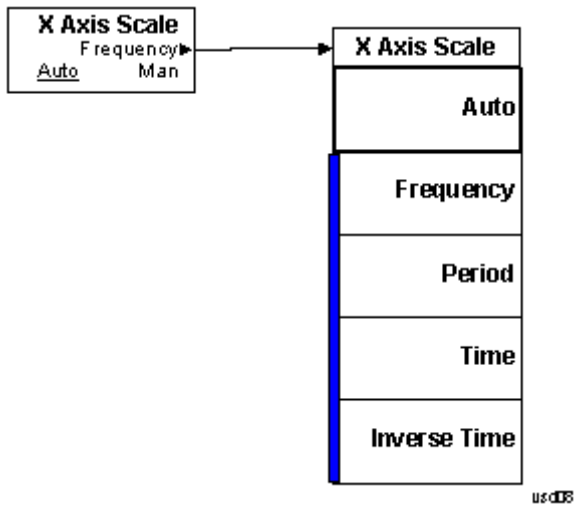

## BW

There is no meas local functionality.

See Front Panel Key for more information.

---

Key Path	Front-panel key
Initial S/W Revision	Prior to A.02.00

---

## Cont (Continuous Measurement/Sweep)

Sets the analyzer for Continuous measurement operation. The single/continuous state is Meas Global so the setting will affect all measurements. If you are Paused, pressing Cont does a Resume.

<b>Key Path</b>	Front-panel key
<b>Remote Command</b>	:INITiate:CONTinuous OFF ON 0 1 :INITiate:CONTinuous?
<b>Example</b>	:INIT:CONT 0 puts analyzer in Single measurement operation. :INIT:CONT 1 puts analyzer in Continuous measurement operation
<b>Preset</b>	ON (Note that SYST:PRESet sets INIT:CONT to ON but *RST sets INIT:CONT to OFF)
<b>State Saved</b>	Saved in instrument state
<b>Backwards Compatibility Notes</b>	For Spectrum Analysis mode in ESA and PSA, there is no Cont hardkey, instead there is a Sweep Single/Cont key. In these analyzers, switching the Sweep Single/Cont key from Single to Cont restarts averages (displayed average count reset to 1), but does not restart Max Hold and Min Hold. The X-Series has Single and Cont keys in place of the SweepSingleCont key. In the X-Series, if in single measurement, the Cont key (and INIT:CONT ON ) switches to continuous measurement, but never restarts a measurement and never resets a sweep.
<b>Initial S/W Revision</b>	Prior to A.02.00

In Swept SA Measurement (Spectrum Analysis Mode):

The analyzer takes repetitive sweeps, averages, measurements, etc., when in Continuous mode. When the average count reaches the Average/Hold Number the count stops incrementing, but the analyzer keeps sweeping. See the Trace/Detector section for the averaging formula used both before and after the Average/Hold Number is reached. The trigger condition must be met prior to each sweep. The type of trace processing for multiple sweeps, is set under the Trace/Detector key, with choices of Trace Average, Max Hold, or Min Hold.

In Other Measurements/Modes:

With Avg/Hold Num (in the Meas Setup menu) set to Off or set to On with a value of 1, a sweep is taken after the trigger condition is met; and the analyzer continues to take new sweeps after the current sweep has completed and the trigger condition is again met. However, with Avg/Hold Num set to On with a value >1, multiple sweeps (data acquisitions) are taken for the measurement. The trigger condition must be met prior to each sweep. The sweep is not stopped when the average count k equals the number N set for Avg/Hold Num is reached, but the number k stops incrementing. A measurement average usually applies to all traces, marker results, and numeric results. But sometimes it only applies to the numeric results.

If the analyzer is in Single measurement, pressing the Cont key does not change k and does not cause the sweep to be reset; the only action is to put the analyzer into Continuous measurement operation.

If it is already in continuous sweep:

the INIT:CONT 1 command has no effect

the INIT:CONT 0 command will place the analyzer in Single Sweep but will have no effect on the current sequence until  $k = N$ , at which point the current sequence will stop and the instrument will go to the idle state.

16 Reverse Link Code Domain  
File

File

See ["File" on page 354](#)



## FREQ Channel

Accesses a menu of keys that allow you to control the Frequency and Channel parameters of the instrument.

Some features in the Frequency menu are the same for all measurements – they do not change as you change measurements. Settings like these are called “Meas Global” and are unaffected by Meas Preset. For example, the Center Freq setting is the same for all measurements – it does not change as you change measurements.

<b>Key Path</b>	Front-panel key
<b>Initial S/W Revision</b>	Prior to A.02.00

### Center Freq

Sets the frequency that corresponds to the horizontal center of the graticule (when frequency Scale Type is set to linear). While adjusting the Center Frequency the Span is held constant, which means that both Start Frequency and Stop Frequency will change.

Pressing Center Freq also sets the frequency entry mode to Center/Span. In Center/Span mode, the center frequency and span values are displayed below the graticule, and the default active function in the Frequency menu is Center Freq.

The center frequency setting is the same for all measurements within a mode, that is, it is Meas Global. Some modes are also able to share a Mode Global center frequency value. If this is the case, the Mode will have a Global Settings key in its Mode Setup menu.

The Center Freq function sets (and queries) the Center Frequency for the currently selected input. If your analyzer has multiple inputs, and you select another input, the Center Freq changes to the value for that input. SCPI commands are available to directly set the Center Freq for a specific input.

Center Freq is remembered as you go from input to input. Thus you can set a Center Freq of 10 GHz with the RF Input selected, change to BBIQ and set a Center Freq of 20 MHz, then switch to External Mixing and set a Center Freq of 60 GHz, and when you go back to the RF Input the Center Freq will go back to 10 GHz; back to BBIQ and it is 20 MHz; back to External Mixing and it is 60 GHz.

See ["RF Center Freq" on page 1968](#)

See [Ext Mix Center Freq](#)

See ["I/Q Center Freq" on page 1970](#)

See ["Center Frequency Presets" on page 1966](#)

<b>Key Path</b>	FREQ Channel
<b>Scope</b>	Meas Global
<b>Remote Command</b>	[ :SENSe ] :FREQuency:CENTer <freq> [ :SENSe ] :FREQuency:CENTer?

<b>Example</b>	FREQ:CENT 50 MHz FREQ:CENT UP changes the center frequency to 150 MHz if you use FREQ:CENT:STEP 100 MHz to set the center frequency step size to 100 MHz FREQ:CENT?
<b>Notes</b>	This command sets either the RF or I/Q Center Frequency depending on the selected input. For RF input it is equivalent to FREQ:RF:CENT For I/Q input it is equivalent to FREQ:IQ:CENT Preset and Max values are dependent on Hardware Options (5xx) If no terminator (e.g. MHz) is sent the terminator Hz is used. If a terminator with unit other than Frequency is used, an invalid suffix error message is generated.
<b>Dependencies</b>	The Center Frequency can be limited by Start or Stop Freq limits, if the Span is so large that Start or Stop reach their limit.
<b>Couplings</b>	When operating in “swept span”, any value of the Center Frequency or Span that is within the frequency range of the analyzer is allowed when the value is being set through the front panel numeric key pad or the SCPI command. The other parameter is forced to a different value if needed, to keep the Start and the Stop Frequencies within the analyzer’s frequency range
<b>Preset</b>	Depends on instrument maximum frequency, mode, measurement, and selected input. See <a href="#">"Center Frequency Presets" on page 1966</a> and <a href="#">"RF Center Freq" on page 1968</a> and <a href="#">Ext Mix Center Freq</a> and <a href="#">"I/Q Center Freq" on page 1970</a> .
<b>State Saved</b>	Saved in instrument state
<b>Min</b>	Depends on instrument maximum frequency, mode, measurement, and selected input.. See <a href="#">"Center Frequency Presets" on page 1966</a> and <a href="#">"RF Center Freq" on page 1968</a> and <a href="#">"I/Q Center Freq" on page 1970</a> .
<b>Max</b>	Depends on instrument maximum frequency, mode, measurement, and selected input.. See <a href="#">"Center Frequency Presets" on page 1966</a> and <a href="#">"RF Center Freq" on page 1968</a> and <a href="#">"I/Q Center Freq" on page 1970</a> .
<b>Default Unit</b>	Hz
<b>Status Bits/OPC</b>	Non-overlapped
<b>Dependencies</b>	
<b>Initial S/W Revision</b>	Prior to A.02.00

## Center Frequency Presets

The following table provides the Center Frequency Presets for the Spectrum Analyzer mode, and the Max Freq, for the various frequency options:

Freq Option	CF after Mode Preset	Stop Freq after Mode Preset	Max Freq (can't tune)

			above)
503 (all but N9000A)	1.805 GHz	3.6 GHz	3.7 GHz
503 (N9000A)	1.505 GHz	3.0 GHz	3.08 GHz
507 (all but N9000A)	3.505 GHz	7.0 GHz	7.1 GHz
507 (N9000A)	3.755 GHz	7.5 GHz	7.58 GHz
508 (all but N9038A)	1.805 GHz	3.6 GHz	8.5 GHz
508 (N9038A)	4.205 GHz	8.4 GHz	8.5 GHz
513	6.805 GHz	13.6 GHz	13.8 GHz
526 (all but N9000A and N9038A)	13.255 GHz	26.5 GHz	27.0 GHz
526 (N9000A)	13.255 GHz	26.5 GHz	26.55 GHz
526 (N9038A)	1.805 GHz	3.6 GHz	27.0 GHz
532	16.005 GHz	32.0 GHz	32.5 GHz
543	21.505 GHz	43.0 GHz	TBD
544	22.005 GHz	44.0 GHz	44.5 GHz
550	25.005 GHz	50.0 GHz	51 GHz

Input 2:

Model	CF after Mode Preset	Stop Freq after Mode Preset	Max Freq (can't tune above)
N9000A opt C75	0.7505GHz	1.5 GHz	1.58 GHz
N9038A	505 MHz	1 GHz	1.000025 GHz

Tracking Generator Frequency Limits (N9000A only):

Tracking Generator Option	Min Freq (clips to this freq when turn TG on and	If above this Freq, Stop Freq clipped to this Freq when	Max Freq (can't tune above) while TG

	can't tune below while TG on)	TG turned on	on
T03	9 kHz	3.0 GHz	3.08 GHz
T06	9 kHz	6.0 GHz	6.05 GHz

The following table shows the Center Frequency Presets for modes other than Spectrum Analyzer:

Mode	CF Preset for RF
WCDMA	1 GHz
WIMAXOFDMA,	1 GHz
BASIC	1 GHz
ADEMOD	1 GHz
VSA	1 GHz
TDSCDMA	1 GHz
PNOISE	1 GHz
LTE	1 GHz
LTETDD	1 GHz
MSR	1 GHz
GSM	935.2 MHz
NFIGURE	1.505 GHz

## RF Center Freq

SCPI command for specifying the RF Center Frequency. This command will set the Center Frequency to be used when the RF input is selected, even if the RF input is not the input that is selected at the time the command is sent. Note that the Center Freq function in the Frequency menu on the front panel always applies to the currently selected input.

Scope	Meas Global
<b>Remote Command</b>	[ :SENSe ] :FREQuency:RF:CENTer <freq> [ :SENSe ] :FREQuency:RF:CENTer?
<b>Example</b>	FREQ:RF:CENT 30 MHz
Notes	This command is the same in all modes, but the parameter is Measurement Global. So the value is independent in each mode and common across all the measurements in the mode.
Dependencies	If the electronic/soft attenuator is enabled, any attempt to set Center Frequency such that the Stop Frequency would be >3.6 GHz fails and results in an advisory message. If the equivalent SCPI command is sent, this same message is generated as part of a “-221, Settings conflict” warning. If Source Mode is set to Tracking, and the Max or Min Center Freq is therefore limited by the limits of the source, a warning message is generated, “Data out of range;clipped to source max/min” if these limits are exceeded. Note that for an external source, these limits can be affected by the settings of

	Source Numerator, Source Denominator and Power Sweep.
Preset	See table above
State Saved	Saved in instrument state.
Min	-79.999995 MHz, unless Source Mode is set to Tracking, in which case it is limited by the minimum frequency of the Source
Max	See table above. Basically instrument maximum frequency - 5 Hz. Note that, if the Source Mode is set to Tracking, the effective instrument maximum frequency may be limited by the source maximum frequency.  If the knob or step keys are being used, also depends on the value of the other three interdependent parameters Span, Start Frequency and Stop Frequency
Initial S/W Revision	Prior to A.02.00
Modified at S/W Revision	A.03.00

## Ext Mix Center Freq

SCPI command for specifying the External Mixer Center Frequency. This command will set the Center Frequency to be used when the External Mixer is selected, even if the External Mixer input is not the input which is selected at the time the command is sent. Note that the Center Freq function in the Frequency menu on the front panel always applies to the currently selected input.

Scope	Meas Global
<b>Remote Command</b>	<code>[ :SENSe ] :FREQuency:EMIXer:CENTer &lt;freq&gt;</code> <code>[ :SENSe ] :FREQuency:EMIXer:CENTer?</code>
<b>Example</b>	<code>:FREQ:EMIX:CENT 60 GHz</code> <code>:FREQ:EMIX:CENT?</code>
Notes	This command is the same in all modes, but the parameter is Measurement Global. So the value is independent in each mode and common across all the measurements in the mode.
Couplings	When returning to External Mixing after having been switched to one of the other inputs (e.g., RF), you will come back into the settings that you had when you left External Mixing. So you will come back to the band you were in with the Center Frequency that you had. However, Span is not an input-dependent parameter, therefore you will bring the span over from the other input. Therefore, the analyzer comes back with the span from the previous input, limited as necessary by the current mixer setup.
Preset	When a Mode Preset is performed while in External Mixing, the Start frequency of the current Mode is set to the nominal Min Freq of the lowest harmonic range in the Harmonic Table for the current mixer setup. Similarly, the Stop frequency of the current Mode is set to the nominal Max Freq of the highest harmonic range in the Harmonic Table. The Center Freq thus presets to the point arithmetically equidistant from these two frequencies.  If the current measurement has a limited Span available to it, and cannot achieve the Span shown in the table (Span=Stop Freq - Start Freq), the analyzer uses the maximum Span the measurement allows, and still sets the Center Freq to the midpoint of the Start and Stop Freq values in the Harmonic Table.

	<p>When Restore Input/Output Defaults is performed, the mixer presets to the 11970A, whose Start and Stop frequencies are 26.5 and 40 GHz respectively. The center of these two frequencies is 33.25 GHz.</p> <p>Therefore, after a Restore Input/Output Defaults, if you go into External Mixing and do a Mode Preset while in the Spectrum Analyzer Mode, the resulting Center Freq is 33.25 GHz.</p>
State Saved	Saved in instrument state.
Min	The minimum frequency in the currently selected mixer band + 5 Hz
Max	The maximum frequency in the currently selected mixer band – 5 Hz If the knob or step keys are being used, also depends on the value of the other three interdependent parameters Span, Start Frequency and Stop Frequency
Initial S/W Revision	A.08.01

### I/Q Center Freq

SCPI command for specifying the I/Q Center Frequency. This command will set the Center Frequency to be used when the I/Q input is selected, even if the I/Q input is not the input which is selected at the time the command is sent. Note that the Center Freq function in the Frequency menu on the front panel always applies to the currently selected input.

Scope	Meas Global
<b>Remote Command</b>	<pre>[ :SENSe ] :FREQuency:IQ:CENTer &lt;freq&gt;</pre> <pre>[ :SENSe ] :FREQuency:IQ:CENTer?</pre>
<b>Example</b>	FREQ:IQ:CENT: 30 MHz
Notes	This command is the same in all modes, but the parameter is Measurement Global. So the value is independent in each mode and common across all the measurements in the mode.
Preset	0 Hz
State Saved	Saved in instrument state.
Min	-40.049995 MHz
Max	40.049995 MHz
Initial S/W Revision	Prior to A.02.00

### CF Step

Changes the step size for the center frequency and start and stop frequency functions. Once a step size has been selected and the center frequency function is active, the step keys (and the UP|DOWN parameters for Center Frequency from remote commands) change the center frequency by the step-size value. The step size function is useful for finding harmonics and sidebands beyond the current frequency span of the analyzer.

Note that the start and stop frequencies also step by the CF Step value.

Key Path	FREQ Channel
Remote Command	[:SENSe]:FREQuency:CENTer:STEP[:INCRement] <freq> [:SENSe]:FREQuency:CENTer:STEP[:INCRement]? [:SENSe]:FREQuency:CENTer:STEP:AUTO OFF ON 0 1 [:SENSe]:FREQuency:CENTer:STEP:AUTO?
Example	FREQ:CENT:STEP:AUTO ON FREQ:CENT:STEP 500 MHz FREQ:CENT UP increases the current center frequency value by 500 MHz FREQ:CENT:STEP? FREQ:CENT:STEP:AUTO?
Notes	Preset and Max values are depending on Hardware Options (503, 507, 508, 513, 526)
Notes	Preset and Max values are dependent on Hardware Options (5xx)
Dependencies	Freq Offset is not available in External Mixing. In this case the Freq Offset key is grayed out and shows a value of zero. It will once again be available, and show the previously set value, when you return to the RF Input.
Dependencies	Span, RBW, Center frequency If the electronic/soft attenuator is enabled, any attempt to change the value of the center frequency >3.6 GHz by pressing the Up-arrow key, fails and results in an advisory message. If the equivalent SCPI command is sent, this same message is generated as part of a “-221, Settings conflict” warning.
Couplings	When auto-coupled in a non-zero span, the center frequency step size is set to 10% of the span. When auto-coupled in zero span, the center frequency step size is set to the equivalent -3 dB RBW value.
Preset	Auto ADEMOD: 1 MHz ON
State Saved	Saved in instrument state
Min	– (the maximum frequency of the instrument). That is, 27 GHz max freq instrument has a CF step range of +/- 27 GHz. Note that this is the maximum frequency given the current settings of the instrument, so in External Mixing, for example, it is the maximum frequency of the current mixer band.
Max	The maximum frequency of the instrument. That is, 27 GHz max freq instrument has a CF step range of +/- 27 GHz. Note that this is the maximum frequency given the current settings of the instrument, so in External Mixing, for example, it is the maximum frequency of the current mixer band.
Default Unit	Hz
Status Bits/OPC dependencies	non-overlapped
Initial S/W Revision	Prior to A.02.00
Modified at S/W Revision	A.03.00

16 Reverse Link Code Domain  
Input/Output

## Input/Output

See "[Input/Output](#)" on page 226



## Marker

Accesses a menu that enables you to select, set up and control the markers for the current measurement.

Contained within this menu is a 1-of-N selection of the control mode (Normal, Delta, Off) for the selected marker.

For more information, see the Marker key description under the Marker menu in the Spectrum Analyzer Mode, Swept SA Measurement.

<b>Key Path</b>	<b>Front-panel key</b>
Initial S/W Revision	Prior to A.02.00

### Marker Type

Sets the marker control mode. If the selected marker is Off, pressing Marker sets it to Normal and places it at the centre of the screen on the trace determined by the Marker Trace rules. At the same time, reference value of the selected marker appears on the Active Function area.

Active Function Display:

Marker symbol value at I/Q Symbol Polar Vector graph

Marker X-axis value at other graphs

Default Active Function: the active function for the selected marker's current control mode. If the current control mode is Off, there is no active function and the active function is turned off.

The marker X axis value entered in the active function area will display the marker value to its full entered precision.

<b>Key Path</b>	<b>Marker</b>
<b>Mode</b>	<b>1xEV-DO</b>
<b>Remote Command</b>	:CALCulate:CDPower:MS:MARKer[1] 2 ...12:MODE POSition   DELTa   OFF :CALCulate:CDPower:MS:MARKer[1] 2 ...12:MODE?
<b>Example</b>	CALC:CDP:MS:MARK:MODE POS CALC:CDP:MS:MARK:MODE?
<b>Notes</b>	If the selected marker is Off, pressing Marker sets it to Normal and places it at the center of the screen on the trace determined by the Marker Trace rules. At the same time, Marker X Axis Value appears on the Active Function area.  Default Active Function: the active function for the selected marker's current control mode. If the current control mode is Off, there is no active function and the active function is turned off.  Active Function Display: Marker symbol value at I/Q Symbol Polar Vector graph Marker X-axis value at other graphs  The marker X axis value entered in the active function area will display the marker value to its full entered precision.

Preset	OFF
State Saved	Saved in instrument state.
Range	Normal Delta Off
<b>Backwards Compatibility SCPI</b>	:CALCulate:TCDPower:MARKer[1] 2 ...4:MODE
Initial S/W Revision	Prior to A.02.00

## Properties

Accesses a menu that enables you to select a relative marker and marker trace.

Key Path	Marker
Initial S/W Revision	Prior to A.02.00

## Marker

Accesses a menu that enables you to select, set up and control the markers for the current measurement.

Contained within this menu is a 1-of-N selection of the control mode (Normal, Delta, Off) for the selected marker.

For more information, see the Marker key description under the Marker menu in the Spectrum Analyzer Mode, Swept SA Measurement.

Key Path	Front-panel key
Initial S/W Revision	Prior to A.02.00

## Relative TO

Selects the marker the selected marker will be relative to (its reference marker).

Key Path	Marker, Properties
Mode	1xEV-DO
<b>Remote Command</b>	:CALCulate:CDPower:MS:MARKer[1] 2 ...12:REFerence <integer> :CALCulate:CDPower:MS:MARKer[1] 2 ...12:REFerence?
<b>Example</b>	CALC:CDP:MS:MARK:REF 4 CALC:CDP:MS:MARK:REF?
<b>Notes</b>	When queried a single value will be returned (the specified marker numbers relative marker). A marker cannot be relative to itself so that choice is grayed out, and if sent from SCPI generates error -221: "Settings conflict; marker cannot be relative to itself."

	You must be in the Spectrum Analysis mode, 1xEV-DO mode to use this command. Use INSTRUMENT:SElect to set the mode.
Preset	2 3 4 5 6 7 8 9 10 11 12 1
State Saved	Saved in instrument state.
Min	1
Max	12
<b>Backwards Compatibility SCPI</b>	:CALCulate:TCDPower:MARKer[1] 2 ...4:REference
Initial S/W Revision	Prior to A.02.00

## Marker Trace

Assigns the specified marker to the designated trace.

Key Path	Marker, Properties
Mode	1xEV-DO
<b>Remote Command</b>	:CALCulate:CDPower:MS:MARKer[1] 2 ...12:TRACe CDPower   CDError   SPOwer   CPOwer   EVM   MERRor   PERRor   POLar :CALCulate:CDPower:MS:MARKer[1] 2 ...12:TRACe?
<b>Example</b>	CALC:CDP:MS:MARK:TRACE CDE CALC:CDP:MS:MARK:TRACE?
Preset	CDPower
State Saved	Saved in instrument state.
Range	Code Domain Power   Code Domain Error   Symbol Power   Chip Power   EVM   Phase Error   Mag Error
<b>Backwards Compatibility SCPI</b>	:CALCulate:TCDPower:MARKer[1] 2 ...4:TRACe
Initial S/W Revision	Prior to A.02.00

## Couple Marker

Toggles the state of the markers to be coupled On or Off. When this function is true, moving any marker causes an equal X Axis movement of every other marker which is not Off. By "equal X Axis movement" we mean that we preserve the difference between each marker's X Axis value (in the fundamental x-axis units of the trace that marker is on) and the X Axis value of the marker being moved (in the same fundamental x-axis units).

See Couple Marker in the "Marker" section for more information.

Key Path	Marker
Mode	1xEV-DO

<b>Remote Command</b>	:CALCulate:CDPower:MS:MARKer:COUPle[:STATe] ON OFF 1 0 :CALCulate:CDPower:MS:MARKer:COUPle[:STATe]?
<b>Example</b>	CALC:CDP:MS:MARK:COUP ON
Preset	OFF
State Saved	Saved in instrument state.
Range	On Off
<b>Backwards Compatibility SCPI</b>	:CALCulate:TCDPower:MARKer:COUPle[:STATe]
Initial S/W Revision	Prior to A.02.00

### All Markers Off

Turns off all markers.

Key Path	Marker
Mode	1xEV-DO
<b>Remote Command</b>	:CALCulate:CDPower:MS:MARKer:AOFF
<b>Example</b>	CALC:CDP:MS:MARK:AOFF
<b>Backwards Compatibility SCPI</b>	:CALCulate:TCDPower:MARKer:AOFF
Initial S/W Revision	Prior to A.02.00

## Marker Fctn

There are no Marker Function operations supported in the Reverse Link Code Domain measurement. The front-panel key will display a blank menu when pressed.

---

Key Path	Front-panel key
Initial S/W Revision	Prior to A.02.00

---

## Marker To

Accesses menu keys that can copy the current marker value into other parameters, for example Despread. If the currently selected marker is not on when the front-panel key is pressed, it will be turned on at the center of the screen as a normal type marker. See the Marker To key description under Marker.

Key Path	Front-panel key
Initial S/W Revision	Prior to A.02.00

### Mkr -> Despread

Executes post process for selected marker.

Key Path	Marker ->, Mkr->Despread
Mode	1xEV-DO
Remote Command	:CALCulate:CDPower:MS:MARKer[1] 2 ...12[:SET]:DESPread
Example	CALC:CDP:MS:MARK4:SET:DESP
Notes	This function is available only when the marker trace is either 'CDPower' or 'CDError'.
Backwards Compatibility SCPI	:CALCulate:TCDPower:MARKer[1] 2 ...4[:SET]:DESPread
Initial S/W Revision	Prior to A.02.00

## Meas

The information in this section is common to all measurements. For key and remote command information for a specific measurement, refer to the section that describes the measurement of interest.

Measurements available under the Meas key are specific to the current Mode.

When viewing Help for measurements, note the following:

**NOTE**

Operation for some keys differs between measurements. The information displayed in Help pertains to the current measurement. To see how a key operates in a different measurement, exit Help (press the Cancel Esc key), select the measurement, then reenter Help (press the Help key) and press that key.

---

Key Path	Front-panel key
Initial S/W Revision	Prior to A.02.00

---

### Remote Measurement Functions

This section contains the following topics:

"Measurement Group of Commands" on page 2849

"Current Measurement Query (Remote Command Only)" on page 2851

"Limit Test Current Results (Remote Command Only)" on page 2851

"Data Query (Remote Command Only)" on page 2851

"Calculate/Compress Trace Data Query (Remote Command Only)" on page 2852

"Calculate Peaks of Trace Data (Remote Command Only)" on page 2857

Hardware-Accelerated Fast Power Measurement (Remote Command Only)

"Format Data: Numeric Data (Remote Command Only)" on page 2858

"Format Data: Byte Order (Remote Command Only)" on page 2859

---

Initial S/W Revision	Prior to A.02.00
----------------------	------------------

---

## Measurement Group of Commands

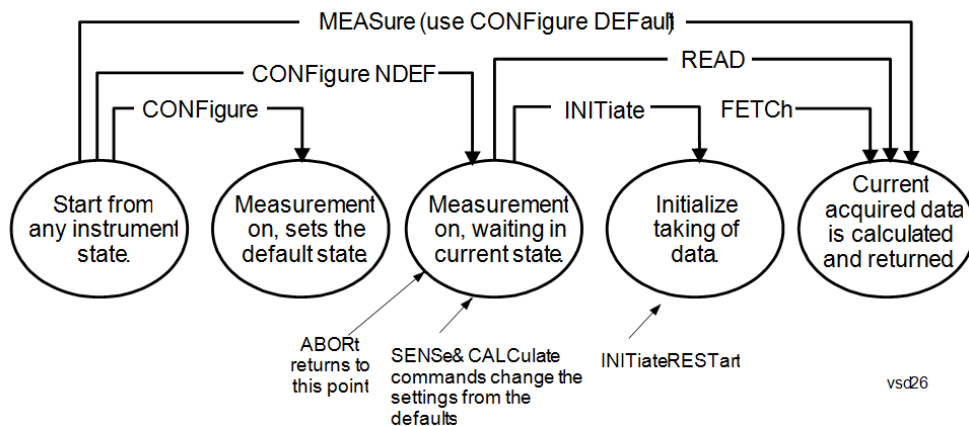

---

### Measure Commands:

:MEASure:<measurement>[n]?

This is a fast single-command way to make a measurement using the factory default instrument settings. These are the settings and units that conform to the Mode Setup settings (e.g. radio standard) that you have currently selected.

- Stops the current measurement (if any) and sets up the instrument for the specified measurement using the factory defaults
- Initiates the data acquisition for the measurement
- Blocks other SCPI communication, waiting until the measurement is complete before returning results.
- If the function does averaging, it is turned on and the number of averages is set to 10.
- After the data is valid it returns the scalar results, or the trace data, for the specified measurement. The type of data returned may be defined by an [n] value that is sent with the command.
- The scalar measurement results will be returned if the optional [n] value is not included, or is set to 1. If the [n] value is set to a value other than 1, the selected trace data results will be returned. See each command for details of what types of scalar results or trace data results are available.
- ASCII is the default format for the data output. (Older versions of Spectrum Analysis and Phase Noise mode measurements only use ASCII.) The binary data formats should be used for handling large blocks of data since they are smaller and faster than the ASCII format. Refer to the FORMat:DATA command for more information.

If you need to change some of the measurement parameters from the factory default settings you can set up the measurement with the CONFIgure command. Use the commands in the SENSE:<measurement> and CALCulate:<measurement> subsystems to change the settings. Then you can use the READ? command to initiate the measurement and query the results.

If you need to repeatedly make a given measurement with settings other than the factory defaults, you can use the commands in the SENSE:<measurement> and CALCulate:<measurement> subsystems to set up the measurement. Then use the READ? command to initiate the measurement and query results.

Measurement settings persist if you initiate a different measurement and then return to a previous one. Use READ:<measurement>? if you want to use those persistent settings. If you want to go back to the default settings, use MEASure:<measurement>?.

---

### Configure Commands:

:CONFIgure:<measurement>

This command stops the current measurement (if any) and sets up the instrument for the specified measurement using

---



---

the factory default instrument settings. It does not initiate the taking of measurement data unless INIT:CONTInuous is ON. If you change any measurement settings after using the CONFigure command, the READ command can be used to initiate a measurement without changing the settings back to their defaults.

In the Swept SA measurement in Spectrum Analyzer mode the CONFigure command also turns the averaging function on and sets the number of averages to 10 for all measurements.

:CONFigure: <measurement>: NDEFault stops the current measurement and changes to the specified measurement. It does not change the settings to the defaults. It does not initiate the taking of measurement data unless INIT:CONTInuous is ON.

The CONFigure? query returns the current measurement name.

The CONFigure:CATalog? query returns a quoted string of all licensed measurement names in the current mode. For example, "SAN, CHP, OBW, ACP, PST, TXP, SPUR, SEM, LIST".

---

#### Fetch Commands:

:FETCh:<measurement>[n]?

This command puts selected data from the most recent measurement into the output buffer. Use FETCh if you have already made a good measurement and you want to return several types of data (different [n] values, for example, both scalars and trace data) from a single measurement. FETCh saves you the time of re-making the measurement. You can only FETCh results from the measurement that is currently active, it will not change to a different measurement. An error message is reported if a measurement other than the current one is specified.

If you need to get new measurement data, use the READ command, which is equivalent to an INITiate followed by a FETCh.

The scalar measurement results will be returned if the optional [n] value is not included, or is set to 1. If the [n] value is set to a value other than 1, the selected trace data results will be returned. See each command for details of what types of scalar results or trace data results are available. The binary data formats should be used for handling large blocks of data since they are smaller and transfer faster than the ASCII format. (FORMat:DATA)

FETCh may be used to return results other than those specified with the original READ or MEASure command that you sent.

---

#### INITiate Commands:

:INITiate:<measurement>

This command is not available for measurements in all the instrument modes:

- Initiates a trigger cycle for the specified measurement, but does not output any data. You must then use the FETCh<meas> command to return data. If a measurement other than the current one is specified, the instrument will switch to that measurement and then initiate it.
- For example, suppose you have previously initiated the ACP measurement, but now you are running the channel power measurement. If you send INIT:ACP? it will change from channel power to ACP and will initiate an ACP measurement.
- Does not change any of the measurement settings. For example, if you have previously started the ACP measurement and you send INIT:ACP? it will initiate a new ACP measurement using the same instrument settings as the last time ACP was run.
- If your selected measurement is currently active (in the idle state) it triggers the measurement, assuming the trigger conditions are met. Then it completes one trigger cycle. Depending upon the measurement and the number of averages, there may be multiple data acquisitions, with multiple trigger events, for one full trigger cycle. It also holds off additional commands on GPIB until the acquisition is complete.

---

#### READ Commands:

:READ:<measurement>[n]?

- Does not preset the measurement to the factory default settings. For example, if you have previously initiated the ACP
-

---

measurement and you send READ:ACP? it will initiate a new measurement using the same instrument settings.

- Initiates the measurement and puts valid data into the output buffer. If a measurement other than the current one is specified, the instrument will switch to that measurement before it initiates the measurement and returns results.
  - For example, suppose you have previously initiated the ACP measurement, but now you are running the channel power measurement. Then you send READ:ACP? It will change from channel power back to ACP and, using the previous ACP settings, will initiate the measurement and return results.
  - Blocks other SCPI communication, waiting until the measurement is complete before returning the results
  - If the optional [n] value is not included, or is set to 1, the scalar measurement results will be returned. If the [n] value is set to a value other than 1, the selected trace data results will be returned. See each command for details of what types of scalar results or trace data results are available. The binary data formats should be used when handling large blocks of data since they are smaller and faster than the ASCII format. (FORMat:DATA)
- 

---

Initial S/W Revision	Prior to A.02.00
----------------------	------------------

---

### Current Measurement Query (Remote Command Only)

This command returns the name of the measurement that is currently running.

---

<b>Remote Command</b>	:CONFigure?
-----------------------	-------------

---

<b>Example</b>	CONF?
----------------	-------

---

Initial S/W Revision	Prior to A.02.00
----------------------	------------------

---

### Limit Test Current Results (Remote Command Only)

Queries the status of the current measurement limit testing. It returns a 0 if the measured results pass when compared with the current limits. It returns a 1 if the measured results fail any limit tests.

---

<b>Remote Command</b>	:CALCulate:CLIMits:FAIL?
-----------------------	--------------------------

---

<b>Example</b>	CALC:CLIM:FAIL? queries the current measurement to see if it fails the defined limits. Returns a 0 or 1: 0 it passes, 1 it fails.
----------------	--------------------------------------------------------------------------------------------------------------------------------------

---

Initial S/W Revision	Prior to A.02.00
----------------------	------------------

---

### Data Query (Remote Command Only)

Returns the designated measurement data for the currently selected measurement and subopcode.

n = any valid subopcode for the current measurement. See the measurement command results table for your current measurement, for information about what data is returned for the subopcodes.

This command uses the data setting specified by the FORMat:BOReDer and FORMat:DATA commands and can return real or ASCII data. (See the format command descriptions under Input/Output in the Analyzer Setup section.)

<b>Remote Command</b>	:CALCulate:DATA[n]?
<b>Notes</b>	The return trace depends on the measurement. In CALCulate:<meas>:DATA[n], n is any valid subopcode for the current measurement. It returns the same data as the FETCH:<measurement>? query where <measurement> is the current measurement.
<b>Initial S/W Revision</b>	Prior to A.02.00

## Calculate/Compress Trace Data Query (Remote Command Only)

Returns compressed data for the currently selected measurement and sub-opcode [n].

n = any valid sub-opcode for that measurement. See the MEASure:<measurement>? command description of your specific measurement for information on the data that can be returned.

The data is returned in the current Y Axis Unit of the analyzer. The command is used with a sub-opcode <n> (default=1) to specify the trace. With trace queries, it is best if the analyzer is not sweeping during the query. Therefore, it is generally advisable to be in Single Sweep, or Update=Off.

This command is used to compress or decimate a long trace to extract and return only the desired data. A typical example would be to acquire N frames of GSM data and return the mean power of the first burst in each frame. The command can also be used to identify the best curve fit for the data.

<b>Remote Command</b>	:CALCulate:DATA<n>:COMPRESS? BLOCK   CFIT   MAXimum   MINimum   MEAN   DMEan   RMS   RMSCubed   SAMPLE   SDEVIation   PPHase [,<soffset> [,<length>[,<roffset>[,<rlimit>]]]]
<b>Example</b>	To query the mean power of a set of GSM bursts: Supply a signal that is a set of GSM bursts. Select the IQ Waveform measurement (in IQ Analyzer Mode). Set the sweep time to acquire at least one burst. Set the triggers such that acquisition happens at a known position relative to a burst. Then query the mean burst levels using, CALC:DATA2:COMP? MEAN, 24e-6, 526e-6 (These parameter values correspond to GSM signals, where 526e-6 is the length of the burst in the slot and you just want 1 burst.)
<b>Notes</b>	The command supports 5 parameters. Note that the last 4 (<soffset>, <length>, <roffset>, <rlimit>) are optional. But these optional parameters must be entered in the specified order. For example, if you want to specify <length>, then you must also specify <soffset>. See details below for a definition of each of these parameters.  This command uses the data in the format specified by FORMat:DATA, returning either binary or ASCII data.
<b>Initial S/W Revision</b>	Prior to A.02.00

- BLOCK or block data - returns all the data points from the region of the trace data that you specify. For example, it could be used to return the data points of an input signal over several timeslots, excluding the portions of the trace data that you do not want. (This is x,y pairs for trace data and I,Q pairs for complex data.)

- CFIT or curve fit - applies curve fitting routines to the data. <soffset> and <length> are required to define the data that you want. <roffset> is an optional parameter for the desired order of the curve equation. The query will return the following values: the x-offset (in seconds) and the curve coefficients ((order + 1) values).

MIN, MAX, MEAN, DME, RMS, RMSC, SAMP, SDEV and PPH return one data value for each specified region (or <length>) of trace data, for as many regions as possible until you run out of trace data (using <roffset> to specify regions). Or they return the number of regions you specify (using <rlimit>) ignoring any data beyond that.

- MINimum - returns the minimum data point (y value) for the specified region(s) of trace data. For I/Q trace data, the minimum magnitude of the I/Q pairs is returned.
- MAXimum - returns the maximum data point (y value) for the specified region(s) of trace data. For I/Q trace data, the maximum magnitude of the I/Q pairs is returned.
- MEAN - returns a single value that is the arithmetic mean of the data point values (in dB/ dBm) for the specified region(s) of trace data. For I/Q trace data, the mean of the magnitudes of the I/Q pairs is returned. See the following equations.

**NOTE** If the original trace data is in dB, this function returns the arithmetic mean of those log values, not log of the mean power which is a more useful value. The mean of the log is the better measurement technique when measuring CW signals in the presence of noise. The mean of the power, expressed in dB, is useful in power measurements such as Channel Power. To achieve the mean of the power, use the RMS option.

Equation 1

Mean Value of Data Points for Specified Region(s)

$$MEAN = \frac{1}{n} \sum_{X_i \in \text{region}(s)} X_i$$

where  $X_i$  is a data point value, and  $n$  is the number of data points in the specified region(s).

Equation 2

Mean Value of I/Q Data Pairs for Specified Region(s)

$$MEAN = \frac{1}{n} \sum_{X_i \in \text{region}(s)} |X_i|$$

where  $|X_i|$  is the magnitude of an I/Q pair, and  $n$  is the number of I/Q pairs in the specified region(s).

- DMEan - returns a single value that is the mean power (in dB/ dBm) of the data point values for the specified region(s) of trace data. See the following equation:

Equation 3

DMEan Value of Data Points for Specified Region(s)

$$\text{DME} = 10 \times \log_{10} \left( \frac{1}{n} \sum_{X_i \in \text{region}(s)} 10^{\frac{X_i}{10}} \right)$$

- RMS - returns a single value that is the average power on a root-mean-squared voltage scale (arithmetic rms) of the data point values for the specified region(s) of trace data. See the following equation.

**NOTE**

For I/Q trace data, the rms of the magnitudes of the I/Q pairs is returned. See the following equation. This function is very useful for I/Q trace data. However, if the original trace data is in dB, this function returns the rms of the log values which is not usually needed.

Equation 4

RMS Value of Data Points for Specified Region(s)

$$\text{RMS} = \sqrt{\frac{1}{n} \sum_{X_i \in \text{region}(s)} X_i^2}$$

where  $X_i$  is a data point value, and  $n$  is the number of data points in the specified region(s).

Equation 5

RMS Value of I/Q Data Pairs for Specified Region(s)

$$\text{RMS} = \sqrt{\frac{1}{n} \sum_{X_i \in \text{region}(s)} X_i X_i^*}$$

where  $X_i$  is the complex value representation of an I/Q pair,  $X_i^*$  its conjugate complex number, and  $n$  is the number of I/Q pairs in the specified region(s).

Once you have the rms value for a region of trace data (linear or I/Q), you may want to calculate the mean power. You must convert this rms value (peak volts) to power in dBm:

$$10 \times \log[10 \times (\text{rms value})^2]$$

- SAMPLe - returns the first data value (x,y pair) for the specified region(s) of trace data. For I/Q trace data, the first I/Q pair is returned.
- SDEVIation - returns a single value that is the arithmetic standard deviation for the data point values for the specified region(s) of trace data. See the following equation.
- For I/Q trace data, the standard deviation of the magnitudes of the I/Q pairs is returned. See the following equation.

Equation 6

Standard Deviation of Data Point Values for Specified Region(s)

$$\text{SDEV} = \sqrt{\frac{1}{n} \sum_{X_i \in \text{region}(s)} (X_i - \bar{X})^2}$$

where  $X_i$  is a data point value,  $\bar{X}$  is the arithmetic mean of the data point values for the specified region (s), and  $n$  is the number of data points in the specified region(s).

$$\text{SDEV} = \sqrt{\frac{1}{n} \sum_{X_i \in \text{region}(s)} (|X_i| - \bar{X})^2}$$

where  $|X_i|$  is the magnitude of an I/Q pair,  $\bar{X}$  is the mean of the magnitudes for the specified region(s), and  $n$  is the number of data points in the specified region(s).

- PPHase - returns the x,y pairs of both rms power (dBm) and arithmetic mean phase (radian) for every specified region and frequency offset (Hz). The number of pairs is defined by the specified number of regions. This parameter can be used for I/Q vector ( $n=0$ ) in Waveform (time domain) measurement and all parameters are specified by data point in PPHase.

The rms power of the specified region may be expressed as:

$$\text{Power} = 10 \times \log [10 \times (\text{RMS I/Q value})] + 10.$$

The RMS I/Q value (peak volts) is:

$$\sqrt{\frac{1}{n} \sum_{X_i \in \text{region}} X_i X_i^*}$$

where  $X_i$  is the complex value representation of an I/Q pair,  $X_i^*$  its conjugate complex number, and  $n$  is the number of I/Q pairs in the specified region.

The arithmetic mean phase of the specified region may be expressed as:

$$\frac{1}{n} \sum_{Y_i \in \text{region}} Y_i$$

where  $Y_i$  is the unwrapped phase of I/Q pair with applying frequency correction and  $n$  is the number of I/Q pairs in the specified region.

The frequency correction is made by the frequency offset calculated by the arithmetic mean of every specified region's frequency offset. Each frequency offset is calculated by the least square method against the unwrapped phase of I/Q pair.

Sample Trace Data - Constant Envelope

(See below for explanation of variables.)

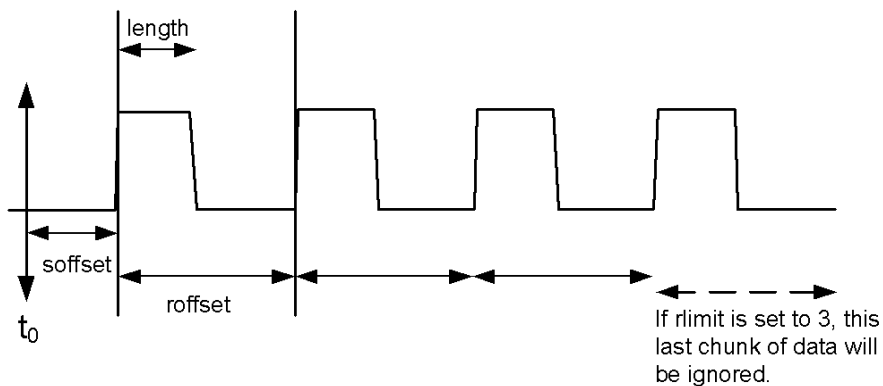

### Sample Trace Data - Not Constant Envelope

(See below for explanation of variables.)

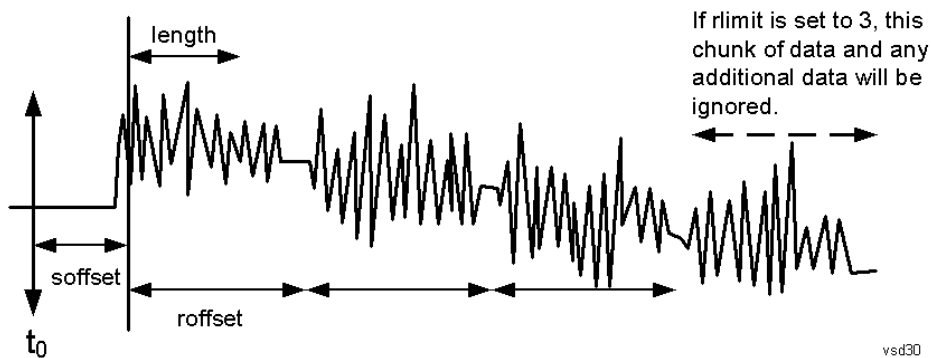

<soffset> - start offset is an optional real number. (It is in seconds for time-domain traces, and is a dimensionless index 0 to Npoints - 1, for frequency-domain traces). It specifies the amount of data at the beginning of the trace that will be ignored before the decimation process starts. It is the time or frequency change from the start of the trace to the point where you want to start using the data. The default value is zero.

<length> - is an optional real number. (It is in seconds for time-domain traces, and is a dimensionless index 0 to Npoints - 1, for frequency-domain traces). It defines how much data will be compressed into one value. This parameter has a default value equal to the current trace length.

<roffset> - repeat offset is an optional real number. (It is in seconds for time-domain traces, and is a dimensionless index 0 to Npoints - 1, for frequency-domain traces). It defines the beginning of the next field of trace elements to be compressed. This is relative to the beginning of the previous field. This parameter has a default value equal to the <length> variable. Note that this parameter is used for a completely different purpose when curve fitting (see CFIT above).

<rlimit> - repeat limit is an optional integer. It specifies the number of data items that you want returned. It will ignore any additional items beyond that number. You can use the Start offset and the Repeat limit to pick out exactly what part of the data you want to use. The default value is all the data.

## Calculate Peaks of Trace Data (Remote Command Only)

Returns a list of all the peaks for the currently selected measurement and sub-opcode [n]. The peaks must meet the requirements of the peak threshold and excursion values.

n = any valid sub-opcode for the current measurement. See the MEASure:<measurement> command description of your specific measurement for information on the data that can be returned.

The command can only be used with specific sub-opcodes with measurement results that are trace data. Both real and complex traces can be searched, but complex traces are converted to magnitude in dBm. In many measurements the sub-opcode n=0, is the raw trace data which cannot be searched for peaks. And Sub-opcode n=1, is often calculated results values which also cannot be searched for peaks.

This command uses the data setting specified by the FORMat:BORDER and FORMat:DATA commands and can return real or ASCII data. If the format is set to INT,32, it returns REAL,32 data.

The command has four types of parameters:

- Threshold (in dBm)
- Excursion (in dB)
- Sorting order (amplitude, frequency, time)
- Optional in some measurements: Display line use (all, > display line, < display line)

---

<b>Remote Command</b>	<p>For Swept SA measurement:</p> <pre>:CALCulate:DATA[1] 2 ... 6:PEAKs? &lt;threshold&gt;,&lt;excursion&gt;[,AMPLitude   FREQuency   TIME[,ALL   GTDLine   LTDLine]]</pre> <p>For most other measurements:</p> <pre>:CALCulate:DATA[1] 2 ... 6:PEAKs? &lt;threshold&gt;,&lt;excursion&gt;[,AMPLitude   FREQuency   TIME]</pre>
-----------------------	--------------------------------------------------------------------------------------------------------------------------------------------------------------------------------------------------------------------------------------------------------------------------------------------------------------------------------

---

<b>Example</b>	<p>Example for Swept SA measurement in Spectrum Analyzer Mode:</p> <p>CALC:DATA4:PEAK? -40, 10, FREQ, GTDL This will identify the peaks of trace 4 that are above -40 dBm, with excursions of at least 10 dB. The peaks are returned in order of increasing frequency, starting with the lowest frequency. Only the peaks that are above the display line are returned.</p> <p>Query Results 1:</p> <p>With FORMat:DATA REAL, 32 selected, it returns a list of floating-point numbers. The first value in the list is the number of peak points that are in the following list. A peak point consists of two values: a peak amplitude followed by its corresponding frequency (or time).</p> <p>If no peaks are found the peak list will consist of only the number of peaks, (0).</p>
----------------	-----------------------------------------------------------------------------------------------------------------------------------------------------------------------------------------------------------------------------------------------------------------------------------------------------------------------------------------------------------------------------------------------------------------------------------------------------------------------------------------------------------------------------------------------------------------------------------------------------------------------------------------------------------------------------------------------------------------------------------------------------------------------------------------

---

<b>Notes</b>	<p>&lt;n&gt; - is the trace that will be used</p> <p>&lt;threshold&gt; - is the level below which trace data peaks are ignored. Note that the threshold value is required and is always used as a peak criterion. To effectively disable the threshold criterion for this command, provide a substantially low threshold value such as -200 dBm. Also note that the threshold value used in this command is independent of and has no effect on the threshold value stored under the Peak Criteria menu.</p> <p>&lt;excursion&gt; - is the minimum amplitude variation (rise and fall) required for a signal to be identified as peak. Note that the excursion value is required and is always used as a peak criterion. To effectively disable the excursion criterion for this command, provide the minimum value of 0.0 dB. Also note that the excursion value used in this command is independent of and has no effect on the</p>
--------------	---------------------------------------------------------------------------------------------------------------------------------------------------------------------------------------------------------------------------------------------------------------------------------------------------------------------------------------------------------------------------------------------------------------------------------------------------------------------------------------------------------------------------------------------------------------------------------------------------------------------------------------------------------------------------------------------------------------------------------------------------------------------------------------------------------------------------------------------------------------------------------------------------------------------------------------

---



excursion value stored under the Peak Criteria menu.

Values must be provided for threshold and excursion. The sorting and display line parameters are optional (defaults are AMPLitude and ALL).

Note that there is always a Y-axis value for the display line, regardless of whether the display line state is on or off. It is the current Y-axis value of the display line which is used by this command to determine whether a peak should be reported

Sorting order:

AMPLitude - lists the peaks in order of descending amplitude, with the highest peak first (default if optional parameter not sent)

FREQUency - lists the peaks in order of occurrence, left to right across the x-axis.

TIME - lists the peaks in order of occurrence, left to right across the x-axis.

Peaks vs. Display Line:

ALL - lists all of the peaks found (default if optional parameter not sent).

GTDLine (greater than display line) - lists all of the peaks found above the display line.

LTDLine (less than display line) - lists all of the peaks found below the display line.

---

Initial S/W Revision      Prior to A.02.00

---

### Format Data: Numeric Data (Remote Command Only)

This command specifies the format of the trace data input and output. It specifies the formats used for trace data during data transfer across any remote port. It affects only the data format for setting and querying trace data for the :TRACe[:DATA], TRACe[:DATA]?, :CALCulate:DATA[n]? and FETCh:SANalyzer [n]? commands and queries.

---

**Remote Command**      :FORMat[:TRACe] [:DATA] ASCii|INTeger, 32|REAL, 32 |REAL, 64  
:FORMat[:TRACe] [:DATA] ?

---

**Notes**      The query response is:  
ASCii: ASC,8  
REAL,32: REAL,32  
REAL,64: REAL,64  
INTeger,32: INT,32

When the numeric data format is REAL or ASCii, data is output in the current Y Axis unit. When the data format is INTeger, data is output in units of m dBm (.001 dBm).

The INT,32 format returns binary 32-bit integer values in internal units (m dBm), in a definite length block.

---

**Dependencies**      Sending a data format spec with an invalid number (for example, INT,48) generates no error. The analyzer simply uses the default (8 for ASCii, 32 for INTeger, 32 for REAL).

Sending data to the analyzer which does not conform to the current FORMat specified, results in an error. Sending ASCII data when a definite block is expected generates message -161 "Invalid Block Data" and sending a definite block when ASCII data is expected generates message -121 "Invalid Character in Number".

---

**Preset**      ASCii

---

**Backwards Compatibility Notes**      Note that the INT,32 format is only applicable to the command, TRACe:DATA. This preserves backwards compatibility for the Swept SA measurement. For all other commands/queries which honor FORMat:DATA, if INT,32 is sent the analyzer will behave as though it were set to REAL,32.

---

Initial S/W Revision      Prior to A.02.00

---

The specs for each output type follow:

AScii - Amplitude values are in ASCII, in the current Y Axis Unit, one ASCII character per digit, values separated by commas, each value in the form:

SX.YYYYYEsZZ

Where:

S = sign (+ or -)

X = one digit to left of decimal point

Y = 5 digits to right of decimal point

E = E, exponent header

s = sign of exponent (+ or -)

ZZ = two digit exponent

REAL,32 - Binary 32-bit real values in the current Y Axis Unit, in a definite length block.

REAL,64 - Binary 64-bit real values in the current Y Axis Unit, in a definite length block.

### Format Data: Byte Order (Remote Command Only)

This command selects the binary data byte order for data transfer and other queries. It controls whether binary data is transferred in normal or swapped mode. This command affects only the byte order for setting and querying trace data for the :TRACe[:DATA], TRACe[:DATA]? , :CALCulate:DATA[n]? and FETCh:SANalyzer[n]? commands and queries.

By definition any command that says it uses FORMat:DATA uses any format supported by FORMat:DATA.

The NORMal order is a byte sequence that begins with the most significant byte (MSB) first, and ends with the least significant byte (LSB) last in the sequence: 1|2|3|4. SWAPped order is when the byte sequence begins with the LSB first, and ends with the MSB last in the sequence: 4|3|2|1.

---

<b>Remote Command</b>	:FORMat:BORDER NORMal   SWAPped :FORMat:BORDER?
-----------------------	----------------------------------------------------

---

<b>Preset</b>	NORMal
---------------	--------

---

<b>Initial S/W Revision</b>	Prior to A.02.00
-----------------------------	------------------

---

## Meas Setup

Displays the setup menu for the currently selected measurement.

Key Path	Front-panel key
Initial S/W Revision	Prior to A.02.00

## Meas Type

Sets the code domain power computation type to either the absolute power or the relative value to the mean power.

Key Path	Meas Setup
Mode	1xEV-DO
<b>Remote Command</b>	:CALCulate:CDPower:MS:TYPE Relative ABSolute :CALCulate:CDPower:MS:TYPE?
<b>Example</b>	CALC:CDP:MS:TYPE ABS CALC:CDP:MS:TYPE?
Preset	RElative
State Saved	Saved in instrument state.
Range	Abs   Rel
<b>Backwards Compatibility SCPI</b>	CALCulate:TCDPower:TYPE
Initial S/W Revision	Prior to A.02.00

## Walsh Code Length

Sets the Walsh code length to either 4, 8, or 16 for Subtype 0/1. If Physical layer subtype is set to Subtype 2, the setting values shall be 2, 4, 8, 16 or 32. The parameter automatically sets the maximum value for Walsh Code Number when appropriate.

Key Path	Meas Setup
Mode	1xEV-DO
<b>Remote Command</b>	:CALCulate:CDPower:MS:WCODe:LENGth <integer> :CALCulate:CDPower:MS:WCODe:LENGth?
<b>Example</b>	:CALC:CDP:MS:WCOD:LENG 8 :CALC:CDP:MS:WCOD:LENG?
Notes	Range and Min/Max of this command depends on selected physical layer subtype. When Subtype 0/1 selected, the range is 4, 8,16. When Subtype 2 selected, the range is 2, 4, 8, 16, 32

Couplings	Maximum value of Walsh Code Number is smaller than this value.
Preset	16
State Saved	Saved in instrument state.
Range	2 4 8 16 32
<b>Backwards Compatibility SCPI</b>	:CALCulate:TCDPower:WCODE:LENGth
Initial S/W Revision	Prior to A.02.00

## Walsh Code Number

Sets the Walsh code number. The upper range is automatically set the maximum value for Walsh Code Length. Therefore there is difference between Subtype 0/1 and Subtype 2.

Key Path	Meas Setup
Mode	1xEV-DO
<b>Remote Command</b>	:CALCulate:CDPower:MS:WCODE[:NUMBER] <integer> :CALCulate:CDPower:MS:WCODE[:NUMBER]?
<b>Example</b>	:CALC:CDP:MS:WCOD 8 :CALC:CDP:MS:WCOD?
Notes	Range and Min/Max of this command depends on selected physical layer subtype. If need to do SCPI test in the case of Subtype2 by SCPI tree tool, add the test manually.
Couplings	Max is dependent on Walsh Code Length.
Preset	0
State Saved	Saved in instrument state.
Range	0 to 1, when :CALCulate:CDPower:MS:WCODE:LENGth = 2 and Subtype 2 0 to 3, when :CALCulate:CDPower:MS:WCODE:LENGth = 4 0 to 7, when :CALCulate:CDPower:MS:WCODE:LENGth = 8 0 to 15, when :CALCulate:CDPower:MS:WCODE:LENGth = 16 0 to 31, when :CALCulate:CDPower:MS:WCODE:LENGth = 32 and Subtype 2
Min	0
Max	15
<b>Backwards Compatibility SCPI</b>	CALCulate:TCDPower:WCODE[:NUMBER]
Initial S/W Revision	Prior to A.02.00

## I/Q Branch

Allows you to toggle the selection of the branch signals between I, Q, and IQC (I/Q Combined) for demodulation axis. When the user specifies “I” or “Q”, then both I/Q measured trace and reference points are projected on the I or Q axis, respectively. When the user specifies “IQC”, the I/Q projection is skipped.

Therefore, when the user measures a BPSK signal this parameter must be set to either “I” or “Q”. When the user measures QPSK or 8PSK signals, this parameter should be set to “IQC”. This parameter is effective for symbol analysis, but is not effective for modulation type detection or code power calculation. It is especially useful for the analysis of Subtype 2 channels because most Data channels are I/Q combined.

<b>Key Path</b>	<b>Meas Setup</b>
Mode	1xEV-DO
<b>Remote Command</b>	:CALCulate:CDPower:MS:AXIS IPH QPH IQCCombined :CALCulate:CDPower:MS:AXIS?
<b>Example</b>	:CALC:CDP:MS:AXIS QPH
Preset	IPH
State Saved	Saved in instrument state.
Range	I Q IQC
<b>Backwards Compatibility SCPI</b>	:CALCulate:TCDPower:AXIS
Initial S/W Revision	Prior to A.02.00

## Sync Type

Controls the function to choice the sync type of Reverse Link signal. There are two type for choosing, Pilot Channel and Aux-Pilot Channel.

Pilot Channel: Sync the Reverse Link signal by Pilot Channel

Aux-Pilot Channel: Sync the Reverse Link signal by Aux-Pilot Channel

<b>Key Path</b>	<b>Meas Setup, More 1 of 3 1</b>
Mode	1xEV-DO
<b>Remote Command</b>	[ :SENSe ] :CDPower:MS:SYNC PILOt APILOt [ :SENSe ] :CDPower:MS:SYNC?
<b>Example</b>	:SENSe:CDPower:MS:SYNC PILOt :SENSe:CDPower:MS:SYNC?
Preset	PILOt
State Saved	Saved in instrument state.
Range	PILOt   APILOt
<b>Backwards Compatibility SCPI</b>	[ :SENSe ] :TCDPower:SYNC
Initial S/W Revision	Prior to A.02.00

## Meas Offset

Sets the timing offset of measurement interval in slots.

Key Path	Meas Setup
Mode	1xEV-DO
<b>Remote Command</b>	:CALCulate:CDPower:MS:SWEep:OFFSet <real> :CALCulate:CDPower:MS:SWEep:OFFSet?
<b>Example</b>	:CALC:CDP:MS:SWE:OFFS 10 :CALC:CDP:MS:SWE:OFFS?
Notes	If summation of Meas Interval and Meas Offset exceeds Capture Interval after changing Meas Interval (or Meas Offset), then Meas Offset (or Meas Interval) decreases accordingly to keep the summation. Meas interval is effective only for demod bits result. Code Domain Power results are always calculated from an interval of a slot which is specified by Meas Offset.
Couplings	Max value is dependent [:SENSe]:CDPower:MS:CAPture:TIME and :CALCulate:CDPower:MS:SWEep:TIME
Preset	0.0
State Saved	Saved in instrument state.
Min	0.0
Max	31.5
<b>Backwards Compatibility SCPI</b>	:CALCulate:TCDPower:SWEep:OFFSet
Initial S/W Revision	Prior to A.02.00

## I Long Code Mask

Sets the Long Code Mask value for I axis.

Key Path	Meas Setup, More
Mode	1xEV-DO
<b>Remote Command</b>	[:SENSe]:CDPower:MS:SYNC:ILCMask <integer> [:SENSe]:CDPower:MS:SYNC:ILCMask?
<b>Example</b>	:CDP:MS:SYNC:ILCM 1 :CDP:MS:SYNC:ILCM?
Preset	0000000000
State Saved	Saved in instrument state.
Range	0000000000 to 4398046511103
Min	0000000000
Max	4398046511103
<b>Backwards Compatibility SCPI</b>	[:SENSe]:TCDPower:SYNC:ILCMask
Initial S/W Revision	Prior to A.02.00

## Q Long Code Mask

Sets the Long Code Mask value for Q axis.

Key Path	Meas Setup, More 1 of 3
Mode	1xEV-DO
<b>Remote Command</b>	<code>[ :SENSe ] :CDPower:MS:SYNC:QLCMask &lt;integer&gt;</code> <code>[ :SENSe ] :CDPower:MS:SYNC:QLCMask?</code>
<b>Example</b>	<code>:CDP:MS:SYNC:QLCM 1</code> <code>:CDP:MS:SYNC:QLCM?</code>
Preset	00000000000
State Saved	Saved in instrument state.
Range	00000000000 to 4398046511103
Min	00000000000
Max	4398046511103
<b>Backwards Compatibility SCPI</b>	<code>[ :SENSe ] :TCDPower:SYNC:QLCMask</code>
Initial S/W Revision	Prior to A.02.00

## Active Code Channel

Controls the function to identify which code channels are active.

Auto (Auto Active Channel Detection) means system determines Active Channel(s) automatically. Due to algorithm limitation, when the power level is not stable, Auto won't work well.

Predefined means that user specifies which code channel is active manually.

Combination means the code channel selected by Predefine Active Channel is always regarded as Active and moreover Auto Active Channel detection is performed. If Auto finds other active channels, they are also regarded as Active.

Key Path	Meas setup, More 1 of 3
Mode	1xEV-DO
<b>Remote Command</b>	<code>[ :SENSe ] :CDPower:MS:ACode AUTO COMBination PREDefined</code> <code>[ :SENSe ] :CDPower:MS:ACode?</code>
<b>Example</b>	<code>:CDP:MS:ACOD COMB</code> <code>:CDP:MS:ACOD?</code>
Preset	AUTO
State Saved	Saved in instrument state.
Range	Auto   Combination   Predefined
<b>Backwards Compatibility SCPI</b>	<code>[ :SENSe ] :TCDPower:ACode</code>
Initial S/W Revision	Prior to A.02.00

## Predefined Active Chan

Each channel (Pilot, DRC, RRI, ACK/DSC, Aux-Pilot or Data) can be set Active (On) or Inactive (Off). If Active Code Channel is set to Auto, each selection menu is grayed out. The specified active channels are different due to subtype 0/1 or subtype 2.

Subtype 0/1:

- Pilot/RRI channel – Allows you to set the pilot channel and RRI channel activation on W16(0) I phase.
- DRC channel – Allows you to set the DRC channel activation on W16(8) Q phase.
- ACK channel – Allows you to set the ACK channel activation on W8(4) I phase.
- Data channel – Allows you to set the Data channel activation on W4(2) Q phase.

Subtype 2 or Subtype 3(Basic Mux):

- Pilot channel – Allows you to set the pilot channel activation on W16(0) I phase.
- DRC channel – Allows you to set the DRC channel activation on W16(8) Q phase.
- RRI channel – Allows you to set the RRI channel activation on W16(4) I phase.
- ACK/DSC channel – Allows you to set the ACK channel and DSC channel activation on W32(12) I phase.
- Auxiliary Pilot channel – Allows you to set the Auxiliary Pilot channel activation on W32(28) I phase.
- Data channel – Allows you to set the Data channel activation. The location of Data channel is decided by modulation format. B4 is W4(2) Q phase. Q4 is W4(2). Q2 is W2(1). Q4Q2 is W4(2) and W2(1) with QPSK modulation. E4E2 is W4(2) and W2(1) with 8PSK modulation.

Key Path	Meas Setup, Active Code Channel
Initial S/W Revision	Prior to A.02.00

## Pilot/RRI Channel

Allows you to toggle the pilot channel and RRI channel W16(0) I phase activation between On and Off.

Key Path	Meas Setup, More 1 of 3, Active Code Channel,Predefined Active Chan
Mode	1xEV-DO
Remote Command	[ :SENSe ] :CDPower:MS:ACode:PILot OFF ON 0 1 [ :SENSe ] :CDPower:MS:ACode:PILot?
Example	:CDP:MS:ACOD:PIL ON :CDP:MS:ACOD:PIL?
Notes	This setting is valid with Active Code Chan is set to Combination or Predefined and the physical layer subtype is set to 0/1/2/3.
Preset	ON



State Saved	Saved in instrument state.
Range	On   Off
<b>Backwards Compatibility SCPI</b>	[ :SENSe ] :TCDPower :ACODE :PILot
Initial S/W Revision	Prior to A.02.00

### DRC Channel Definition [Common for Subtype 0/1 and Subtype 2/3]

Allows you to toggle the DRC channel W16(8) Q phase activation between On and Off.

Key Path	Meas Setup, More 1 of 3, Active Code Chan,Predefined Active Chan
Mode	1xEV-DO
<b>Remote Command</b>	[ :SENSe ] :CDPower :MS :ACODE :DRC OFF   ON   0   1 [ :SENSe ] :CDPower :MS :ACODE :DRC ?
<b>Example</b>	:CDP:MS:ACOD:DRC ON :CDP:MS:ACOD:DRC ?
Notes	This setting is valid with Active Code Chan is set to Combination or Predefined.
Preset	ON
State Saved	Saved in instrument state.
Range	On   Off
<b>Backwards Compatibility SCPI</b>	[ :SENSe ] :TCDPower :ACODE :DRC
Initial S/W Revision	Prior to A.02.00

### ACK Channel Definition [Subtype 0/1 only]

Allows you to toggle the ACK channel W8(4) I phase activation between On and Off.

Key Path	Meas Setup, More 1 of 3, Active Code Chan,Predefined Active Chan
Mode	1xEV-DO
<b>Remote Command</b>	[ :SENSe ] :CDPower :MS :ACODE :ACK OFF   ON   0   1 [ :SENSe ] :CDPower :MS :ACODE :ACK ?
<b>Example</b>	:CDP:MS:ACOD:ACK ON :CDP:MS:ACOD:ACK ?
Notes	This setting is valid with Active Code Chan is set to Combination or Predefined and the physical layer subtype is set to 0/1.
Preset	ON
State Saved	Saved in instrument state.
Range	On   Off

<b>Backwards Compatibility SCPI</b>	<code>[ :SENSe ] :TCDPower:ACODE:ACK</code>
Initial S/W Revision	Prior to A.02.00

### Data Channel Definition [Subtype 0/1 only]

Allows you to toggle the Data channel W4(2) Q phase activation between On and Off.

Key Path	Meas Setup, More 1 of 3, Active Code Chan, Predefined Active Chan
Mode	1xEV-DO
<b>Remote Command</b>	<code>[ :SENSe ] :CDPower:MS:ACODE:DATA OFF ON 0 1</code> <code>[ :SENSe ] :CDPower:MS:ACODE:DATA?</code>
<b>Example</b>	<code>:CDP:MS:ACOD:DATA ON</code> <code>:CDP:MS:ACOD:DATA?</code>
Notes	This setting is valid with Active Code Chan is set to Combination or Predefined and the physical layer subtype is set to 0/1.
Preset	ON
State Saved	Saved in instrument state.
Range	On   Off
<b>Backwards Compatibility SCPI</b>	<code>[ :SENSe ] :TCDPower:ACODE:DATA</code>
Initial S/W Revision	Prior to A.02.00

### Sync Start Slot

For the measurement to begin at the first slot, the instrument must depend on trigger timing, or capture timing if the trigger is set to Free Run. If the user employs a trigger, the first slot number measured is determined by the trigger timing. Alternatively, you can specify the synchronization starting slot number. For example, if the Sync start slot number is set to 5, the analysis starts from slot number 5.0. If Sync Start Slot detection mode is set to Off, the measurement is synchronized based on trigger timing or capture timing.

Key Path	Meas Setup, More 1 of 3
Mode	1xEV-DO
<b>Remote Command</b>	<code>[ :SENSe ] :CDPower:MS:SSlot:NUMBer &lt;integer&gt;</code> <code>[ :SENSe ] :CDPower:MS:SSlot:NUMBer?</code> <code>[ :SENSe ] :CDPower:MS:SSlot[:STATe] OFF ON 0 1</code> <code>[ :SENSe ] :CDPower:MS:SSlot[:STATe]?</code> <code>[ :SENSe ] :CDPower:MS:SSlot[:STATe] OFF ON 0 1</code> <code>[ :SENSe ] :CDPower:MS:SSlot[:STATe]?</code>

<b>Example</b>	:CDP:MS:SSL:NUMB 5 :CDP:MS:SSL ON :CDP:MS:SSL?
Notes	The parameter can turn first slot number detection mode on or off.
Preset	0 OFF
State Saved	Saved in instrument state.
Range	0 to 15
Min	0
Max	15
<b>Backwards Compatibility SCPI</b>	[ :SENSe ] :TCDPower :SSLot :NUMBer
Initial S/W Revision	Prior to A.02.00

## Capture Interval

Sets the data capture length in slots that will be used in the acquisition.

Key Path	Meas Setup, More 1 of 3
Mode	1xEV-DO
<b>Remote Command</b>	[ :SENSe ] :CDPower:MS:CAPTure:TIME <integer> [ :SENSe ] :CDPower:MS:CAPTure:TIME?
<b>Example</b>	CDP:MS:CAPT:TIME 12 CDP:MS:CAPT:TIME?
Couplings	If Capture interval changed, The maximum value of Measurement interval equal to the capture interval, and the maximum value of measurement offset equal to capture interval -1.
Preset	16
State Saved	Saved in instrument state.
Range	1 to 32
Min	1
Max	32
<b>Backwards Compatibility SCPI</b>	[ :SENSe ] :TCDPower :CAPTure :TIME
Initial S/W Revision	Prior to A.02.00

## Spectrum

Sets a spectrum either to Normal or Inverted for the demodulation related measurements. If set to INVert, the upper and lower spectrums are swapped.

Invert: This function conjugates the spectrum, which is equivalent to taking the negative of the quadrature component in demodulation. The correct setting (Normal or Invert) depends on whether the signal at the input of the instrument has a high or low side mix.

Key Path	Meas Setup, More
Mode	1xEV-DO
Remote Command	[ :SENSe ] :CDPower:MS:SPECTrum NORMal   INVert [ :SENSe ] :CDPower:MS:SPECTrum?
Example	CDP:MS:SPEC INV CDP:MS:SPEC?
Preset	NORMal
State Saved	Saved in instrument state.
Range	Normal   Invert
Backwards Compatibility SCPI	[ :SENSe ] :TCDPower:SPECTrum
Initial S/W Revision	Prior to A.02.00

### Meas Preset

This key allows users to restore all the measurement settings to their defaults.

This will set the measure setup parameters for the currently selected measurement only, to the factory defaults.

Key Path	Meas Setup More 1 of 3, More 2of 3
Mode	1xEV-DO
Remote Command	:CONFigure:CDPower
Example	:CONFigure:CDPower:MS
Couplings	Selecting measurement preset will restore all measurement parameters to their default values for the current measurement.
Initial S/W Revision	Prior to A.02.00

### Advanced

Accesses a menu of functions that enable you to set up more specific parameters for the measurement.

Key Path	Meas Setup
Initial S/W Revision	Prior to A.02.00

## Symbol EVM Compensation

Accesses a menu of functions that enable you to set Frequency Compensation and Phase Compensation On or Off for the measurement.

Key Path	Meas Setup, Advanced
Initial S/W Revision	Prior to A.02.00

## Frequency Compensation

Allows you to toggle the setting of the frequency compensation to calculate the symbol EVM.

Key Path	Meas Setup, More 1 of 3, More 2of 3, Advanced, Symbol EVM Compensation
Mode	1xEVDO
<b>Remote Command</b>	:CALCulate:CDPower:MS:SEVM:FCOMpen ON OFF 0 1 :CALCulate:CDPower:MS:SEVM:FCOMpen?
<b>Example</b>	:CALC:CDP:MS:SEVM:FCOM OFF
Preset	On
State Saved	Saved in instrument state.
Range	On   Off
<b>Backwards Compatibility SCPI</b>	:CALCulate:TCDPower:SEVM:FCOMpen
Initial S/W Revision	Prior to A.02.00

## Active Set Threshold

Sets the threshold value for the active channel detection. And user can select the active channel identification function between Auto and Man. If set to Auto, the active channels are determined automatically by the internal algorithm. If it set to Man, the active channel identification is determined by a user definable threshold ranging from 0.00 to -100.0 dB.

Key Path	Meas Setup, More 1 of 3, More 2of 3, Advanced
Mode	1xEVDO
<b>Remote Command</b>	:CALCulate:CDPower:MS:ASET:THReshold <real> :CALCulate:CDPower:MS:ASET:THReshold? :CALCulate:CDPower:MS:ASET:THReshold:AUTO OFF ON 0 1 :CALCulate:CDPower:MS:ASET:THReshold:AUTO?
<b>Example</b>	:CALC:CDP:MS:ASET:THR -20 :CALC:CDP:MS:ASET:THR:AUTO OFF
Notes	Turn the automatic mode On or Off, for the active channel identification function. OFF - The active channel identification for each code channel is determined by a value set by

	CALCulate:CDPower:[MS]:ASET:THReshold. ON – The internal algorithm determines the active channels automatically.
Preset	0.0 ON
State Saved	Saved in instrument state.
Range	-100 to 0.0
Min	-100
Max	0
<b>Backwards Compatibility SCPI</b>	:CALCulate:TCDPower:ASET:THReshold
Initial S/W Revision	Prior to A.02.00

### Freq Error Tol Range (Frequency Error Tolerance Range)

Frequency error tolerance range is specified:

- Narrow
- Normal
- Wide

See "[More Information about Frequency Error Tolerance Range](#)" on page 2002.

Key Path	Meas Setup, More 1 of 3, More 2 of 3, Advanced
Mode	1xEVDO
<b>Remote Command</b>	[ :SENSe ] :CDPower:MS:FERRor:TRANge NARRow   NORMal   WIDE [ :SENSe ] :CDPower:MS:FERRor:TRANge?
<b>Example</b>	:CDP:MS:FERR:TRAN NARR
Preset	NORMal
State Saved	Saved in instrument state.
Range	Narrow   Normal   Wide
<b>Backwards Compatibility SCPI</b>	[ :SENSe ] :TCDPower:FERRor:TRANge
Initial S/W Revision	Prior to A.02.00

### More Information about Frequency Error Tolerance Range

Wide' provides a wider, or more loose, range of frequency error tolerance. To correctly demodulate signals of higher complexity, a more stringent frequency tolerance is required. For example, when composite channels are modulated on the same signal, the modulation is more complex, and frequency error is critical to correct synchronization and demodulation, use Narrow. When demodulating less demanding

signals, set to Normal or Wide. The Normal parameter setting allows a higher measurement speed than Wide.

## Chip Rate

Changes the Chip Rate as desired frequency.

Key Path	Meas Setup, More 1 of 3, More 2 of 3, Advanced
Mode	1xEVDO
<b>Remote Command</b>	[ :SENSe ] :CDPower:MS:CRATe <freq> [ :SENSe ] :CDPower:MS:CRATe?
<b>Example</b>	CDP:MS:CRAT 1.22 MHz
Preset	1.2288 MHz
State Saved	Saved in instrument state.
Range	1.10592 MHz to 1.35168 MHz
Min	1.10592 MHz
Max	1.35168 MHz
<b>Backwards Compatibility SCPI</b>	[ :SENSe ] :TCDPower:CRATe
Initial S/W Revision	Prior to A.02.00

## Filter Alpha

Selects one of 4 complementary filters. These complementary filters are designed to have raised cosine frequency responses of slightly different roll off factors, Alpha, conjunction with a TX filter defined in the standard. The smaller the Filter Alpha is, the better the adjacent power rejection performance becomes. Default of this parameter is 0.15.

Key Path	Meas Setup, More, More, Advanced
Mode	1xEVDO
<b>Remote Command</b>	[ :SENSe ] :CDPower:MS:ALPHa <real> [ :SENSe ] :CDPower:MS:ALPHa?
<b>Example</b>	CDP:MS:ALPH 0.05
Preset	0.15
State Saved	Saved in instrument state.
Range	0.05 to 0.20
Min	0.05
Max	0.20
Initial S/W Revision	Prior to A.02.00

## IF Gain

Enables you to control an internally switched IF amplifier with approximately 10 dB of gain. When it can be turned on without an overload, the dynamic range is always better with the amplifier on than off. The IF Gain key can be used to set the IF Gain function to Auto, or to On (the extra 10 dB) or Off. These settings affect sensitivity and IF overloads.

Key Path	Meas Setup, Advanced
Initial S/W Revision	Prior to A.02.00

### IF Gain Auto

Activate the auto rules for IF Gain.

Key Path	Meas Setup, More 1 of 3, More 2of 3, Advanced, IF Gain
Mode	1xEVDO
<b>Remote Command</b>	<code>[ :SENSe ] :CDPower:MS:IF:GAIN:AUTO [ :STATe ] OFF   ON   1</code> <code>[ :SENSe ] :CDPower:MS:IF:GAIN:AUTO [ :STATe ] ?</code>
<b>Example</b>	CDP:MS:IF:GAIN:AUTO ON
Couplings	When either the auto attenuation works (for example, with electrical attenuator), or the optimize mechanical attenuator range is requested, the IF Gain setting is changed as following rule. 'auto' sets IF Gain 'High Gain' under any of the following conditions: the input attenuator is set to 0 dB, the preamp is turned on, or the Max Mixer Level is -20 dBm or lower. For other settings, auto sets IF Gain to 'Low Gain'.
Preset	OFF
State Saved	Saved in instrument state.
Range	Off On
<b>Backwards Compatibility SCPI</b>	<code>[ :SENSe ] :TCDPower:IF:GAIN:AUTO [ :STATe ]</code>
Initial S/W Revision	Prior to A.02.00

### IF Gain State

Selects the range of IF Gain.

Key Path	Meas Setup, More 1 of 3, More 2of 3, Advanced, IF Gain
Mode	1xEVDO
<b>Remote Command</b>	<code>[ :SENSe ] :CDPower:MS:IF:GAIN [ :STATe ] OFF   ON   0   1</code> <code>[ :SENSe ] :CDPower:MS:IF:GAIN [ :STATe ] ?</code>
<b>Example</b>	CDP:MS:IF:GAIN:AUTO ON
Notes	Where ON = high gain OFF = low gain



Couplings	When either the auto attenuation works (for example, with electrical attenuator), or the optimize mechanical attenuator range is requested, the IF Gain setting is changed as following rule.  'auto' sets IF Gain 'High Gain' under any of the following conditions: the input attenuator is set to 0 dB, the preamp is turned on, or the Max Mixer Level is -20 dBm or lower. For other settings, auto sets IF Gain to 'Low Gain'.
Preset	OFF
State Saved	Saved in instrument state.
Range	Low Gain (Best for Large Signals) High Gain (Best Noise Level)
Readback Text	Low Gain   High Gain
<b>Backwards Compatibility SCPI</b>	[ :SENSe ] :TCDPower :IF :GAIN [ :STATe ]
Initial S/W Revision	Prior to A.02.00

16 Reverse Link Code Domain  
Mode

Mode

See "[Mode](#)" on page 318

## Mode Preset

Returns the active mode to a known state.

Mode Preset does the following for the currently active mode:

- Aborts the currently running measurement.
- Brings up the default menu for the mode, with no active function.
- Sets measurement Global settings to their preset values for the active mode only.
- Activates the default measurement.
- Brings up the default menu for the mode.
- Clears the input and output buffers.
- Sets Status Byte to 0.

Mode Preset does not:

- Cause a mode switch
- Affect mode persistent settings
- Affect system settings

See "[How-To Preset](#)" on page 2008 for more information.

Key Path	Front-panel key
<b>Remote Command</b>	:SYSTem:PRESet
<b>Example</b>	:SYST:PRES
Notes	*RST is preferred over :SYST:PRES for remote operation. *RST does a Mode Preset, as done by the :SYST:PRES command, and it sets the measurement mode to Single measurement rather than Continuous for optimal remote control throughput. Clears all pending OPC bits. The Status Byte is set to 0.
Couplings	A Mode Preset aborts the currently running measurement, activates the default measurement, and gets the mode to a consistent state with all of the default couplings set.
Backwards Compatibility Notes	In the X-Series, the legacy "Factory Preset" has been replaced with Mode Preset, which only presets the currently active mode, not the entire instrument. In the X-Series, the way to preset the entire instrument is by using System, Restore System Defaults All, which behaves essentially the same way as restore System Defaults does on ESA and PSA. There is also no "Preset Type" as there is on the PSA. There is a green Mode Preset front-panel key that does a Mode Preset and a white-with-green-letters User Preset front-panel key that does a User Preset. The old PRESet:TYPE command is ignored (without generating an error), and SYST:PRES without a parameter does a Mode Preset, which should cover most backward code compatibility issues. The settings and correction data under the Input/Output front-panel key (examples: Input Z Corr, Ext Amp Gain, etc.) are no longer part of any Mode, so they will not be preset by a Mode Preset. They are preset using Restore Input/Output Defaults, Restore System Defaults All. Note that because User Preset does a Recall State, and all of these settings are saved in State, they ARE recalled when using

	User Preset.
Initial S/W Revision	Prior to A.02.00

## How-To Preset

The table below shows all possible presets, their corresponding SCPI commands and front-panel access (key paths). Instrument settings depend on the current measurement context. Some settings are local to the current measurement, some are global (common) across all the measurements in the current mode, and some are global to all the available modes. In a similar way, restoring the settings to their preset state can be done within the different contexts.

Auto Couple - is a measurement local key. It sets all Auto/Man parameter couplings in the measurement to Auto. Any Auto/Man selection that is local to other measurements in the mode will not be affected.

Meas Preset - is a measurement local key. Meas Preset resets all the variables local to the current measurement except the persistent ones.

Mode Preset - resets all the current mode's measurement local and measurement global variables except the persistent ones.

Restore Mode Defaults - resets ALL the Mode variables (and all the Meas global and Meas local variables), including the persistent ones.

Type Of Preset	SCPI Command	Front Panel Access
Auto Couple	:COUPle ALL	Auto Couple front-panel key
Meas Preset	:CONFigure:<Measurement>	Meas Setup Menu
Mode Preset	:SYSTem:PRESet	Mode Preset (green key)
Restore Mode Defaults	:INSTrument:DEFault	Mode Setup Menu
Restore All Mode Defaults	:SYSTem:DEFault MODes	System Menu; Restore System Default Menu
*RST	*RST	not possible (Mode Preset with Single)
Restore Input/Output Defaults	:SYSTem:DEFault INPUt	System Menu; Restore System Default Menu
Restore Power On Defaults	:SYSTem:DEFault PON	System Menu; Restore System Default Menu
Restore Alignment Defaults	:SYSTem:DEFault ALIGN	System Menu; Restore System Default Menu
Restore Miscellaneous Defaults	:SYSTem:DEFault MISC	System Menu; Restore System Default Menu
Restore All System Defaults	:SYSTem:DEFault [ALL] :SYSTem:PRESet:PERsistent	System Menu; Restore System Default Menu
User Preset	:SYSTem:PRESet:USER	User Preset Menu
User Preset All Modes	:SYSTem:PRESet:USER:ALL	User Preset Menu

Power On Mode Preset	:SYSTem:PON:TYPE MODE	System Menu
Power On User Preset	:SYSTem:PON:TYPE USER	System Menu
Power On Last State	:SYSTem:PON:TYPE LAST	System Menu

### Preset Type (Remote Command Only)

As stated in the Backward Compatibility section, to be compatible with ESA/PSA the PRESet:TYPE command will be implemented as a no-op.

Mode	All
<b>Remote Command</b>	:SYSTem:PRESet:TYPE FACTory MODE USER :SYSTem:PRESet:TYPE?
<b>Example</b>	:SYST:PRE:TYPE FACT
Notes	This command is supported for backward compatibility only. It is a no-op which does not change the behavior of any preset operation.
Preset	This is unaffected by Preset but is set to Mode on a "Restore System Defaults->All"
State Saved	No
Initial S/W Revision	Prior to A.02.00

16 Reverse Link Code Domain  
Mode Setup

## Mode Setup

See "[Mode Setup](#)" on page 348

## Peak Search

Accesses a menu that enables you to control the peak search function and places a marker on the trace point with highest peak.

See Peak Search under the Peak Search menu in the Spectrum Analyzer Mode, Swept SA Measurement.

Places the selected marker on the trace point with the maximum y-axis value for that marker's trace.

Key Path	Front-panel key
Mode	1xEV-DO
<b>Remote Command</b>	:CALCulate:CDPower:MS:MARKer[1] 2 ...12:MAXimum
<b>Example</b>	CALC:CDP:MS:MARK2:MAX
<b>Backwards Compatibility SCPI</b>	:CALCulate:TCDPower:MARKer[1] 2 ...4:MAXimum
Initial S/W Revision	Prior to A.02.00

## Next Peak

Moves the selected marker to the peak that has the next highest amplitude less than the marker's current value.

Key Path	Peak Search
Mode	1xEV-DO
<b>Remote Command</b>	:CALCulate:CDPower:MS:MARKer[1] 2 ...12:MAXimum:NEXT
<b>Example</b>	CALC:CDP:MS:MARK2:MAX:NEXT
<b>Backwards Compatibility SCPI</b>	:CALCulate:TCDPower:MARKer[1] 2 ...4:MAXimum:NEXT
Initial S/W Revision	Prior to A.02.00

## Next Pk Right

Moves the selected marker to the nearest peak right of the current marker which meets all enabled peak criteria.

Key Path	Peak Search
Mode	1xEV-DO
<b>Remote Command</b>	:CALCulate:CDPower:MS:MARKer[1] 2 ...12:MAXimum:RIGHT
<b>Example</b>	CALC:CDP:MS:MARK2:MAX:RIGH
<b>Backwards Compatibility SCPI</b>	:CALCulate:TCDPower:MARKer[1] 2 ...4:MAXimum:RIGHT
Initial S/W Revision	Prior to A.02.00

## Next Pk Left

Moves the selected marker to the nearest peak left of the current marker which meets all enabled peak criteria.

Key Path	Peak Search
Mode	1xEV-DO
Remote Command	:CALCulate:CDPower:MS:MARKer[1] 2 ...12:MAXimum:LEFT
Example	CALC:CDP:MS:MARK2:MAX:LEFT
Backwards Compatibility SCPI	:CALCulate:TCDPower:MARKer[1] 2 ...4:MAXimum:LEFT
Initial S/W Revision	Prior to A.02.00

## Marker Delta

Performs the same function as the Delta 1-of-N selection key in the Marker menu. Basically this sets the control mode for the selected marker to Delta mode. See the Marker chapter for the complete description of this function. The key is duplicated here in the Peak Search Menu to allow the user to conveniently perform a peak search and change the marker's control mode to Delta without having to access two separate menus.

Key Path	Peak Search
Initial S/W Revision	Prior to A.02.00

## Pk-Pk Search

Finds and displays the amplitude and frequency (or time, if in zero span) differences between the highest and lowest y-axis value.

Key Path	Peak Search
Mode	1xEV-DO
Remote Command	:CALCulate:CDPower:MS:MARKer[1] 2 ...12:PTPeak
Example	CALC:CDP:MS:MARK:PTP
Notes	Turns on the Marker $\Delta$
Couplings	This key is not available (key is grayed out) when Coupled Markers is on.
Backwards Compatibility SCPI	:CALCulate:TCDPower:MARKer[1] 2 ...4:PTPeak
Initial S/W Revision	Prior to A.02.00



## Min Search

Moves the selected marker to the minimum y-axis value on the current trace.

Key Path	Peak Search
Mode	1xEV-DO
<b>Remote Command</b>	:CALCulate:CDPower:MS:MARKer[1] 2 ...12:MINimum
<b>Example</b>	CALC:CDP:MS:MARK:MIN
<b>Backwards Compatibility SCPI</b>	:CALCulate:TCDPower:MARKer[1] 2 ...4:MINimum
Initial S/W Revision	Prior to A.02.00

16 Reverse Link Code Domain  
Print

Print

See ["Print" on page 358](#)

## Quick Save

The Quick Save front-panel key repeats the most recent save that was performed from the Save menu, with the following exceptions:

- Register saves are not remembered as Saves for the purpose of the Quick Save function
- If the current measurement does not support the last non-register save that was performed, an informational message is generated, “File type not supported for this measurement”

Quick Save repeats the last type of qualified save (that is, a save qualified by the above criteria) in the last save directory by creating a unique filename using the Auto File Naming algorithm described below.

If Quick Save is pressed after startup and before any qualified Save has been performed, the Quick Save function performs a Screen Image save using the current settings for Screen Image saves (current theme, current directory), which then becomes the “last save” for the purpose of subsequent Quick Saves.

The Auto File Naming feature automatically generates a file name for use when saving a file. The filename consists of a prefix and suffix separated by a dot, as is standard for the Windows® file system. A default prefix exists for each of the available file types:

Type	Default Prefix	Menu
State	State_	(Save/Recall)
Trace + State	State_	(Save/Recall)
Screen	Screen_	(Save/Recall)
Amplitude Corrections	Ampcor_	(Import/Export)
Traces	Trace_	(Import/Export)
Limit Lines	LLine_	(Import/Export)
Measurement Result	MeasR_	(Import/Export)
Capture Buffer	CapBuf_	(Import/Export)

A four digit number is appended to the prefix to create a unique file name. The numbering sequence starts at 0000 within each Mode for each file type and updates incrementally to 9999, then wraps to 0000 again. It remembers where it was through a Mode Preset and when leaving and returning to the Mode. It is reset by Restore Misc Defaults and Restore System Defaults and subsequent running of the instrument application. So, for example, the first auto file name generated for State files is State\_0000.state. The next is State\_0001, and so forth.

One of the key features of Auto File Name is that we guarantee that the Auto File Name will never conflict with an existing file. The algorithm looks for the next available number. If it gets to 9999, then it looks for holes. If it find no holes, that is no more numbers are available, it gives an error.

For example, if when we get to State\_0010.state there is already a State\_0010.state file in the current directory, it advances the counter to State\_0011.state to ensure that no conflict will exist (and then it verifies that State\_0011.state also does not exist in the current directory and advances again if it does, and so forth).

If you enter a file name for a given file type, then the prefix becomes the filename you entered instead of the default prefix, followed by an underscore. The last four letters (the suffix) are the 4-digit number.

For example, if you save a measurement results file as “fred.csv”, then the next auto file name chosen for a measurement results save will be fred\_0000.csv.

**NOTE**

Although 0000 is used in the example above, the number that is used is actually the current number in the Meas Results sequence, that is, the number that would have been used if you had not entered your own file name.

---

**NOTE**

If the filename you entered ends with \_dddd, where d=any number, making it look just like an auto file name, then the next auto file name picks up where you left off with the suffix being dddd + 1.

---

Key Path	Front-panel key
Notes	No remote command for this key specifically.
Initial S/W Revision	Prior to A.02.00

## Recall

The Recall menu lets you choose what you want to recall, and where you want to recall it from. Among the types of files you can recall are **States and Traces**. In addition, an Import (Data) option lets you recall a number of data types stored in CSV files (as used by Excel and other spreadsheet programs).

The default paths for Recall are data type dependent and are the same as for the Save key.

Key Path	Front-panel key
Notes	<p>No remote command for this key specifically, but the :MMEM:LOAD command is available for specific file types. An example is :MMEM:LOAD:STATe &lt;filename&gt;.</p> <p>If you try to recall a State file for a mode that is not licensed or not available in the instrument, an error message will occur and the state will not change.</p>
Backwards Compatibility Notes	<p>In legacy analyzers, it was possible to load a state without affecting the trace data, limit lines or correction data. Similarly (since User Preset is actually loading a state), it was possible to do a User Preset without affecting the trace data, limit lines or correction data.</p> <p>In the X-Series, "state" always includes all of this data; so whenever state is loaded, all of the traces, limit lines and corrections are affected. Although this differs from previous behavior, it is desirable behavior, and should not cause adverse issues for users.</p>
Backwards Compatibility Notes	<p>Recall for the X-Series supports backward compatibility in the sense that you can recall a state file from any X-Series model number and any version of X-Series software. This is only possible if part of the recalling process goes through a limiting step after recalling the mode settings, at least for settings that may vary with version number, model number, option and license differences. If you try to recall a state file onto an instrument with less capability than what was available on the instrument during the save, the recall will ignore the state it doesn't support and it will limit the recalled setting to what it allows.</p> <p>Example: if the saved state includes preamp ON, but the recalling instrument does not have a preamp; the preamp is limited to OFF. Conversely, if you save a state without a preamp, the preamp is OFF in the state file. When this saved file is recalled on an instrument with a licensed preamp, the preamp is changed to OFF. Another example is if the saved state has center frequency set to 20 GHz, but the instrument recalling the saved state is a different model and only supports 13.5 GHz. In this case, the center frequency is limited along with any other frequency based settings. Since the center frequency can't be preserved in this case, the recall limiting tries to at least preserve span to keep the measurement setup as intact as possible.</p> <p>It may be appropriate to issue a warning if the state is limited on the recall; warnings do not go out to SCPI so this would only affect the manual user.</p> <p>Note that there is no state file compatibility outside of the X-Series. For example, you cannot recall a state file from ESA or PSA.</p>
Initial S/W Revision	Prior to A.02.00

## State

The Recall State menu lets you choose a register or file from which to recall the state.

The content of a state file includes all of the settings and data required to return the analyzer as closely as possible to the Mode it was in, with the exact settings that were in place, when the save occurred. The Mode settings in each state file include the settings that are affected by Mode Preset, as well as the

additional settings affected by Restore Mode Defaults; all of the Mode's settings. In addition, all of the settings of the Input/Output system are included, even though they are outside of the Mode's state, because they are needed to restore the complete setup. Persistent System settings (for example, GPIB address) are not affected by either a Mode Preset or Restore Mode Defaults, nor are they included in a saved State file.

Since each state file is only for one Mode, the settings for other Modes are unaffected when it is loaded. Recall State will cause a mode switch if the state being recalled is not from the current active mode.

After the recall completes, the message "File <filename> recalled" or "Recalled State Register <register number>" is displayed.

For rapid recalls, the State menu lists 16 registers that you can choose from to recall. Pressing a Register key initiates the recall. You can also select a file from which to recall.

The default path for all State Files is:

My Documents\<<mode name>\state

where <mode name> is the parameter used to select the mode with the INST:SEL command (for example, SA for the Spectrum Analyzer).

See ["More Information" on page 2019](#).

<b>Key Path</b>	Recall
<b>Mode</b>	All
<b>Remote Command</b>	:MMEMory:LOAD:STATe <filename>
<b>Example</b>	:MMEM:LOAD:STAT "myState.state" This recalls the file myState.state on the default path
<b>Example</b>	MMEM:LOAD:STAT "MyStateFile.state" This loads the state file data (on the default file directory path) into the instrument state.
<b>Notes</b>	<p>When you pick a file to recall, the analyzer first verifies that the file is recallable in the current instrument by checking the software version and model number of the instrument. If everything matches, a full recall proceeds by aborting the currently running measurement, clearing any pending operations, and then loading the State from the saved state file. You can open state files from any mode, so recalling a State file switches to the mode that was active when the save occurred. After switching to the mode of the saved state file, mode settings and data (if any for the mode) are loaded with values from the saved file. The saved measurement of the mode becomes the newly active measurement and the data relevant to the measurement (if there is any) is recalled.</p> <p>If there is a mismatch between file version or model number or instrument version or model number, the recall function tries to recall as much as possible and returns a warning message. It may limit settings that differ based on model number, licensing or version number.</p> <p>After recalling the state, the Recall State function does the following:</p> <ul style="list-style-type: none"> <li>• Makes the saved measurement for the mode the active measurement.</li> <li>• Clears the input and output buffers.</li> <li>• Status Byte is set to 0.</li> <li>• Executes a *CLS</li> </ul> <p>If the file specified is empty an error is generated. If the specified file does not exist, another error is generated. If there is a mismatch between the file and the proper file type, an error is generated. If</p>

	there is a mismatch between file version or model number or instrument version or model number, a warning is displayed. Then it returns to the State menu and File Open dialog goes away. After the Recall, the analyzer exits the Recall menu and returns to the previous menu.
<b>Backwards Compatibility SCPI</b>	:MMEMory:LOAD:STATe 1,<filename> For backwards compatibility, the above syntax is supported. The "1" is simply ignored.
Initial S/W Revision	Prior to A.02.00

## More Information

In measurements that support saving Traces, for example, Swept SA, the Trace data is saved along with the State in the State file. When recalling the State, the Trace data is recalled as well. Traces are recalled exactly as they were stored, including the writing mode and update and display modes. If a Trace was updating and visible when the State was saved, it will come back updating and visible, and its data will be rewritten right away. When you use State to save and recall traces, any trace whose data must be preserved should be placed in View or Blank mode before saving.

The following table describes the Trace Save and Recall possibilities:

You want to recall state and one trace's data, leaving other traces unaffected.	Save Trace+State from 1 trace. Make sure that no other traces are updating (they should all be in View or Blank mode) when the save is performed.	On Recall, specify the trace you want to load the one trace's data into. This trace will load in View. All other traces' data will be unaffected, although their trace mode will be as it was when the state save was performed.
You want to recall all traces	Save Trace+State from ALL traces.	On Recall, all traces will come back in View (or Blank if they were in Blank or Background when saved)
You want all traces to load exactly as they were when saved.	Save State	On recall, all traces' mode and data will be exactly as they were when saved. Any traces that were updating will have their data immediately overwritten.

## From File...

When you press "From File", the analyzer brings up a Windows dialog and a menu entitled "File Open." This menu allows you to navigate to the various fields in the Windows dialog without using a keyboard or mouse. The Tab and Arrow keys can also be used for dialog navigation.

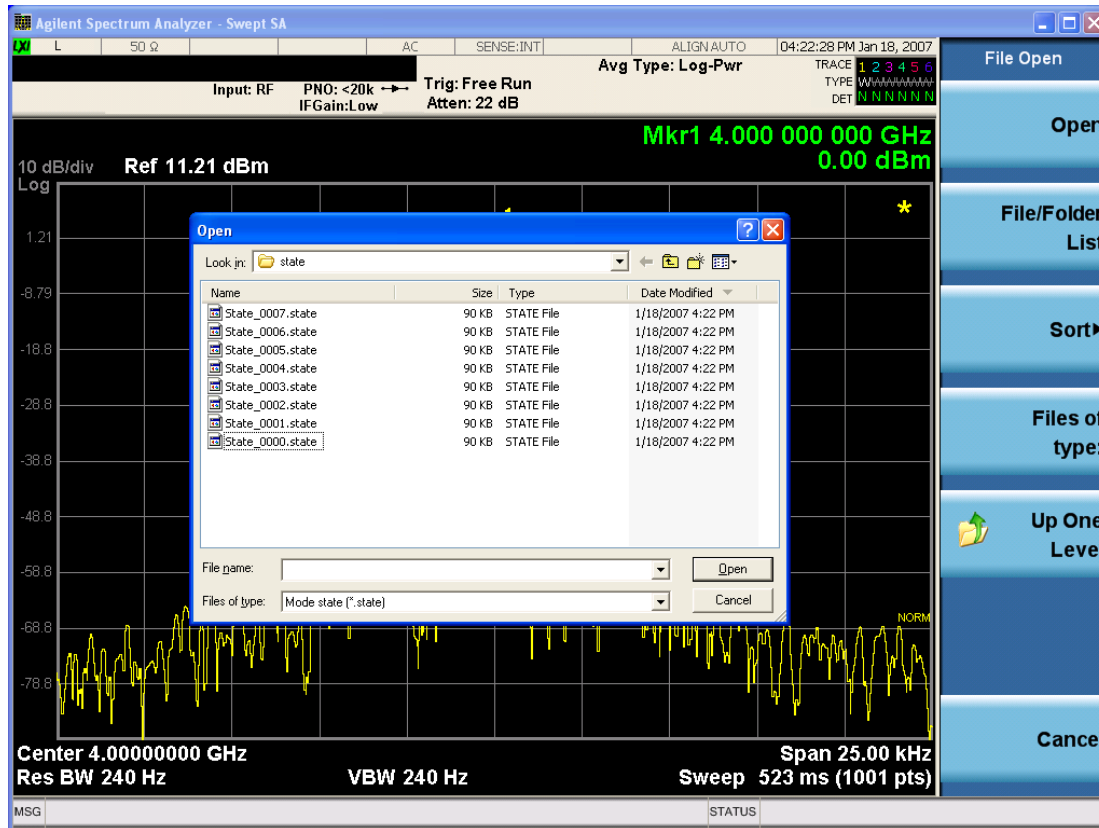

Listed below are the functions of the various fields in the dialog, and the corresponding softkeys:

### Open

Performs the recall of the specified file. While the recall is being performed, the floppy icon appears briefly in the Meas bar.

### File/Folder List

Enables you to navigate to the center of the dialog that contains the list of files and folders. Once here you can get information about the file and use the tab keys to navigate to the other fields in the dialog, such as Look In.

### Look In

The Look In field shows the path from which the file will be recalled and allows you to change the path using the up and down arrow keys to navigate to other paths; the Enter key to open a directory; and the Backspace key to go back one directory. The **Look In field** first uses the last path from the Save As dialog **Save In:** path for that same file type. There is no softkey for directly navigating to the Look In field, but you can use the left tab to get here from the File/Folder List.

User specified paths are remembered when you leave and return to a Mode and are reset back to the default using Restore Mode Defaults.

### Sort



Accesses a menu that enables you to sort the files within the File Open dialog. Only one sorting type can be selected at a time and the sorting happens immediately. The sorting types are By Date, By Name, By extension, and By Size.

#### Files of Type

This field shows the file suffix for the type of file you have selected to recall. For example, if you navigated here while recalling State, "Mode state (\*.state)" is in the field. If you navigated here while recalling Trace, ""Mode state (\*.trace)" is in the field. If you navigated here while importing a trace data file, "Trace Data (\*.csv)" is in the field. For some file types, there is more than one choice in the dropdown menu, which you can select by using the up and down arrow keys and Enter.

#### Up One Level

This key corresponds to the icon of a folder with the up arrow that is in the tool bar of the dialog. When pressed, it causes the file and folder list to navigate up one level in the directory structure. The Backspace key does the same thing.

#### Cancel

This key corresponds to the Cancel selection in the dialog. It causes the current **Open** request to be cancelled. The ESC key does the same thing.

Key Path	Recall, State
Notes	Brings up the Open dialog for recalling a State Save Type
Initial S/W Revision	Prior to A.02.00

### Edit Register Names

You may enter a custom name on any of the Register keys, to help you remember what you are using that state to save. To do this, press the Edit Register Names key, choose the register whose name you wish to edit, and then enter the desired label using the Alpha Editor or an external PC keyboard.

The maximum number of characters that can be added is 30. In most cases, 30 characters will fit on two lines of the key.

For more information and the SCPI command, see Edit Register Names under the Save, State function.

Key Path	Recall, State
Mode	All
Dependencies	N9060A-7FP or N9060B-2FP license required to edit the register names. When the feature is not licensed, sending the SCPI command generates an error, -221, "Settings conflict;Option not available"
Initial S/W Revision	A.11.00

### Register 1 thru Register 16

Selecting any one of these register keys causes the State of the mode from the specified Register to be recalled. Each of the register keys annotates whether it is empty or at what date and time it was last

modified. In addition, you can use the Edit Register Names key under Save, State to enter custom names for each register.

Registers are shared by all modes, so recalling from any one of the registers will cause a mode switch to the mode that was active when the save to the Register occurred.

Although these 16 registers are the only registers available from the front panel, there are 128 state registers available in the instrument. Registers 17–128 are only available from the SCPI interface, using the \*RCL command.

After the recall completes, the message "Register <register number> recalled" appears in the message bar. If you are in the Spectrum Analyzer Mode, and you are recalling a register that was saved in the Spectrum Analyzer Mode, then after the recall, you will still be in the Recall Register menu. If the Recall causes you to switch modes, then after the Recall, you will be in the Frequency menu.

If a requested register is empty an error is generated.

<b>Key Path</b>	Recall, State
<b>Example</b>	*RCL 1
<b>Range</b>	1–16 from front panel, 1–128 from SCPI
<b>Readback</b>	Date and time with seconds resolution are displayed on the key OR A custom name of up to 30 characters entered using the Save, State, Edit Register Names key OR “(empty)” if no prior save operation has been performed to this register.
<b>Initial S/W Revision</b>	Prior to A.02.00
<b>Modified at S/W Revision</b>	Prior to A.11.00

## Register 1 thru Register 16

Selecting any one of these register keys causes the State of the mode from the specified Register to be recalled. Each of the register keys annotates whether it is empty or at what date and time it was last modified. In addition, you can use the Edit Register Names key under Save, State to enter custom names for each register.

Registers are shared by all modes, so recalling from any one of the registers will cause a mode switch to the mode that was active when the save to the Register occurred.

Although these 16 registers are the only registers available from the front panel, there are 128 state registers available in the instrument. Registers 17–128 are only available from the SCPI interface, using the \*RCL command.

After the recall completes, the message "Register <register number> recalled" appears in the message bar. If you are in the Spectrum Analyzer Mode, and you are recalling a register that was saved in the Spectrum Analyzer Mode, then after the recall, you will still be in the Recall Register menu. If the Recall causes you to switch modes, then after the Recall, you will be in the Frequency menu.

If a requested register is empty an error is generated.

Key Path	Recall, State
<b>Example</b>	*RCL 1
Range	1-16 from front panel, 1-128 from SCPI
Readback	Date and time with seconds resolution are displayed on the key OR A custom name of up to 30 characters entered using the Save, State,Edit Register Names key OR “(empty)” if no prior save operation has been performed to this register.
Initial S/W Revision	Prior to A.02.00
Modified at S/W Revision	Prior to A.11.00

## Trace (+State)

The Recall Trace (+State) menu lets you choose a register or file from which to recall the Trace+State state file.

A saved state contains all of the settings and data required to return the analyzer as closely as possible to the exact setup it had when the save occurred. This includes the Input/Output settings, even though they are outside of the Mode’s state, because they are needed to restore the complete setup. A Trace+State file also includes trace data from one trace or all traces, which will load in View mode when the Trace+State file is recalled. Recall Trace (+State) will also cause a mode switch if the state being recalled is not for the current active mode.

After the recall completes, the message "File <filename> recalled" or “Recalled Trace Register <register number>” is displayed.

For rapid recalls, the Trace (+State) menu lists 5 registers to choose from to recall. Pressing a Register key initiates the recall. You can also select a file from which to recall.

The default path for all State Files including .trace files is:

My Documents\<>mode name>\state

where <mode name> is the parameter used to select the mode with the INST:SEL command (for example, SA for the Spectrum Analyzer).

Key Path	Recall
Mode	SA
<b>Remote Command</b>	:MMEMory:LOAD:TRACe TRACE1   TRACE2   TRACE3   TRACE4   TRACE5   TRACE6,<filename>  :MMEMory:LOAD:TRACe:REGister TRACE1   TRACE2   TRACE3   TRACE4   TRACE5   TRACE6,<integer>
<b>Example</b>	MMEM:LOAD:TRAC TRACE2, "MyTraceFile.trace" This loads the trace file data (on the default file directory path) into the specified trace; if it is a "single trace" save file, that trace is loaded to trace 2, and is set to be not updating. :MMEM:LOAD:TRAC:REG TRACE1,2

	restores the trace data in register 2 to Trace 1
Notes	<p>When you perform the recall, the recalling Trace function must first verify the file is recallable in this instrument by checking instrument software version and model number, since it includes State. If everything matches, a full recall proceeds by aborting the currently running measurement, and loading the state from the saved state file to as close as possible to the context in which the save occurred. You can open .trace files from any mode that supports them, so recalling a Trace file switches to the mode that was active when the save occurred. After switching to the mode of the saved state file, mode settings and data (if any for the mode) are loaded with values from the saved file and the saved measurement of the mode becomes the newly active measurement, and the data relevant to the measurement (if there is any) is recalled.</p> <p>Once the state is loaded, the trace data must be loaded. The internal flags are consulted to see which trace to load and the "To Trace" setting to see where to load it. Trace data is always loaded with the specified trace set to View, so that the data is visible and not updating(so as not to erase the recalled data). If the file is an "all trace" file, all traces are loaded with the saved data(to the original trace the data was saved from) and set to View. Traces whose data is not loaded are restored to the update state that existed when they were saved.</p> <p>After the Recall the analyzer exits the Recall menu and returns to the previous menu.</p> <p>Some modes and measurements do not have available all 6 traces. Phase Noise mode command, for example, is: <code>MMEMory:LOAD:TRACe TRACE1 TRACE2 TRACE3,&lt;filename&gt;</code></p> <p>Some modes and measurements have more than 6 traces available. The Realtime SA mode command, for example, is: <code>MMEMory:STORe:TRACe TRACE1   TRACE2   TRACE3   TRACE4   TRACE5   TRACE6   TRACE7   TRACE8   TRACE9   TRACE10   TRACE11   TRACE12   ALL,&lt;filename&gt;</code></p>
Initial S/W Revision	Prior to A.02.00

## To Trace

These menu selections let you choose the Trace where the recalled saved trace will go. Not all modes have the full 6 traces available. The default is the currently selected trace, selected in this menu or in the Trace/Detector, Export Data, Import Data, or Save Trace menus, except if you have chosen All, then it remains chosen until you specifically change it to a single trace.

If the .trace file is an "all trace" file, "To Trace" is ignored and the traces each go back to the trace from which they were saved.

Once selected, the key returns back to the Recall Trace menu and the selected Trace number is annotated on the key. Now you have selected exactly where the trace needs to be recalled.To trigger a recall of the selected Trace, you must select the Open key in the Recall Trace menu.

When you select a trace, it makes that trace the current trace, so it displays on top of all of the other traces.

Key Path	Save, Data, Trace
Mode	SA
Initial S/W Revision	Prior to A.02.00

## Register 1 thru Register 16

Selecting any one of these register keys causes the State of the mode from the specified Register to be recalled. Each of the register keys annotates whether it is empty or at what date and time it was last modified. In addition, you can use the Edit Register Names key under Save, State to enter custom names for each register.

Registers are shared by all modes, so recalling from any one of the registers will cause a mode switch to the mode that was active when the save to the Register occurred.

Although these 16 registers are the only registers available from the front panel, there are 128 state registers available in the instrument. Registers 17–128 are only available from the SCPI interface, using the \*RCL command.

After the recall completes, the message "Register <register number> recalled" appears in the message bar. If you are in the Spectrum Analyzer Mode, and you are recalling a register that was saved in the Spectrum Analyzer Mode, then after the recall, you will still be in the Recall Register menu. If the Recall causes you to switch modes, then after the Recall, you will be in the Frequency menu.

If a requested register is empty an error is generated.

Key Path	Recall, State
<b>Example</b>	*RCL 1
Range	1–16 from front panel, 1–128 from SCPI
Readback	Date and time with seconds resolution are displayed on the key OR A custom name of up to 30 characters entered using the Save, State, Edit Register Names key OR “(empty)” if no prior save operation has been performed to this register.
Initial S/W Revision	Prior to A.02.00
Modified at S/W Revision	Prior to A.11.00

## From File...

When you press “From File”, the analyzer brings up a Windows dialog and a menu entitled “File Open.” This menu allows you to navigate to the various fields in the Windows dialog without using a keyboard or mouse. The Tab and Arrow keys can also be used for dialog navigation.

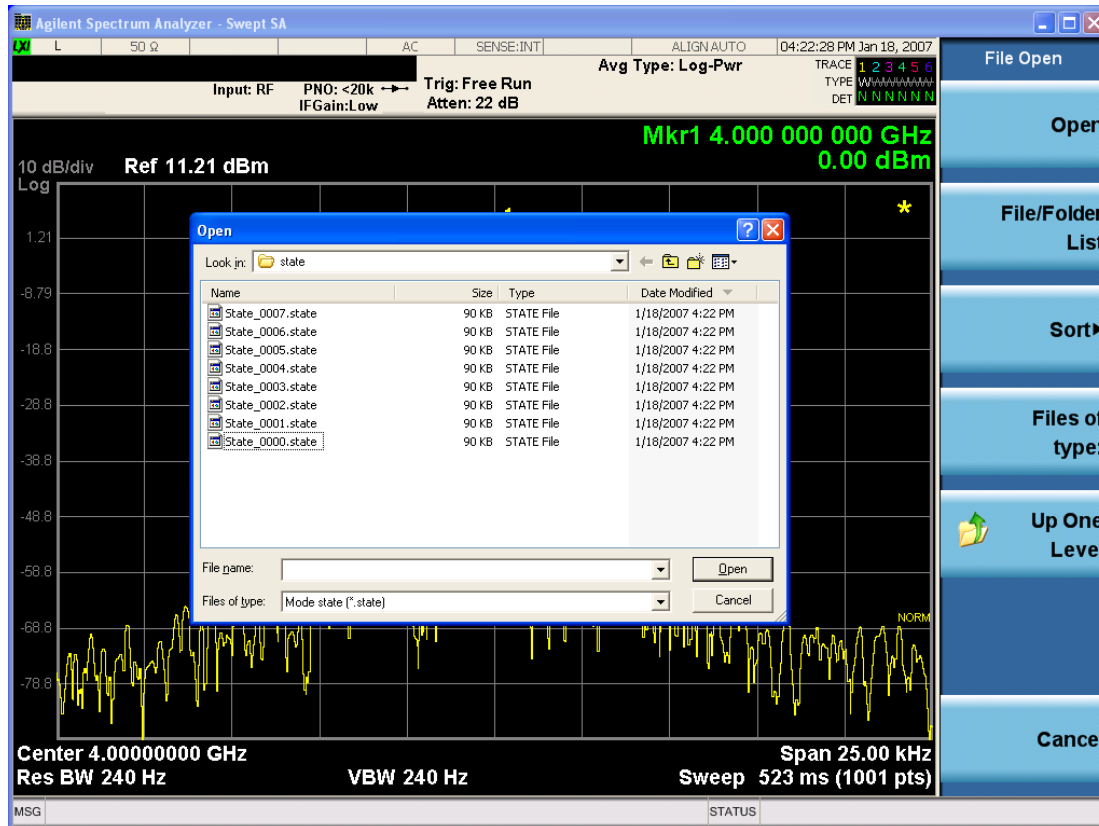

Listed below are the functions of the various fields in the dialog, and the corresponding softkeys:

### Open

Performs the recall of the specified file. While the recall is being performed, the floppy icon appears briefly in the Meas bar.

### File/Folder List

Enables you to navigate to the center of the dialog that contains the list of files and folders. Once here you can get information about the file and use the tab keys to navigate to the other fields in the dialog, such as Look In.

### Look In

The Look In field shows the path from which the file will be recalled and allows you to change the path using the up and down arrow keys to navigate to other paths; the Enter key to open a directory; and the Backspace key to go back one directory. The **Look In field** first uses the last path from the Save As dialog **Save In:** path for that same file type. There is no softkey for directly navigating to the Look In field, but you can use the left tab to get here from the File/Folder List.

User specified paths are remembered when you leave and return to a Mode and are reset back to the default using Restore Mode Defaults.

### Sort

Accesses a menu that enables you to sort the files within the File Open dialog. Only one sorting type can be selected at a time and the sorting happens immediately. The sorting types are By Date, By Name, By extension, and By Size.

#### Files of Type

This field shows the file suffix for the type of file you have selected to recall. For example, if you navigated here while recalling State, "Mode state (\*.state)" is in the field. If you navigated here while recalling Trace, ""Mode state (\*.trace)" is in the field. If you navigated here while importing a trace data file, "Trace Data (\*.csv)" is in the field. For some file types, there is more than one choice in the dropdown menu, which you can select by using the up and down arrow keys and Enter.

#### Up One Level

This key corresponds to the icon of a folder with the up arrow that is in the tool bar of the dialog. When pressed, it causes the file and folder list to navigate up one level in the directory structure. The Backspace key does the same thing.

#### Cancel

This key corresponds to the Cancel selection in the dialog. It causes the current **Open** request to be cancelled. The ESC key does the same thing.

Key Path	Recall, State
Notes	Brings up the Open dialog for recalling a State Save Type
Initial S/W Revision	Prior to A.02.00

### Data (Import)

Importing a data file loads data that was previously saved from the current measurement or from other measurements and/or modes that produce compatible data files. The Import Menu only contains Data Types that are supported by the current measurement.

Since the commonly exported data files are in .csv format, the data can be edited by the user prior to importing. This allows you to export a data file, manipulate the data in Excel (the most common PC Application for manipulating .csv files) and then import it.

Importing Data loads measurement data from the specified file into the specified or default destination, depending on the data type selected. Selecting an Import Data menu key will not actually cause the importing to occur, since the analyzer still needs to know from where to get the data. Pressing the Open key in this menu brings up the Open dialog and Open menu that provides you with the options from where to recall the data. Once a filename has been selected or entered in the Open menu, the recall occurs as soon as the Open button is pressed.

Key Path	Recall
Mode	All
Notes	The menu is built from whatever data types are available for the mode. Some keys will be missing completely, so the key locations in the sub-menu will vary.  No SCPI command directly controls the Data Type that this key controls. The Data Type is included in the MMEM:LOAD commands.

Dependencies	If a file type is not used by a certain measurement, it is grayed out for that measurement. The key for a file type will not show at all if there are no measurements in the Mode that support it.
Preset	Is not affected by Preset or shutdown, but is reset during Restore Mode Defaults
Readback	The data type that is currently selected
Initial S/W Revision	Prior to A.02.00

## Capture Buffer

The captured data is raw data which is not processed.

Key Path	Recall, Data
Mode	<b>CDMA1XEV</b>
Example	MMEM:LOAD:CAPT "MyCaptureData.bin" This loads the file of capture data (on the default file directory path) into the instrument.
Dependencies	In case the capture buffer data is not available from the selected measurement, the key will be grayed out.
Initial S/W Revision	A.11.00

## Open...

When you press "Open", the analyzer brings up a Windows dialog and a menu entitled "**File Open.**" This menu allows you to navigate to the various fields in the Windows dialog without using a keyboard or mouse. The Tab and Arrow keys can also be used for dialog navigation.

See "[From File...](#)" on page 2890 in Recall, State, for a full description of this dialog and menu.

Key Path	Recall, Data
Notes	The key location is mode-dependent and will vary. Brings up Open dialog for recalling a <mode specific> Save Type
Initial S/W Revision	Prior to A.02.00



## Restart

The Restart function restarts the current sweep, or measurement, or set of averaged/held sweeps or measurements. If you are Paused, pressing Restart does a Resume.

The Restart function is accessed in several ways:

- Pressing the Restart key
- Sending the remote command INIT:IMMEDIATE
- Sending the remote command INIT:RESTART

See "[More Information](#)" on page 2029

Key Path	Front-panel key
Remote Command	:INITiate[:IMMEDIATE] :INITiate:RESTART
Example	:INIT:IMM :INIT:REST
Notes	:INITiate:RESTART and :INITiate:IMMEDIATE perform exactly the same function.
Couplings	Resets average/hold count k. For the first sweep overwrites all active (update=on) traces with new current data. For application modes, it resets other parameters as required by the measurement.
Status Bits/OPC dependencies	This is an Overlapped command. The STATUS:OPERation register bits 0 through 8 are cleared. The STATUS:QUESTIONable register bit 9 (INTEgrity sum) is cleared. The SWEEPING bit is set. The MEASURING bit is set.
Backwards Compatibility Notes	For Spectrum Analysis mode in ESA and PSA, the Restart hardkey and the INITiate:RESTART command restart trace averages (displayed average count reset to 1) for a trace in Clear Write, but did not restart Max Hold and Min Hold. In the X-Series, the Restart hardkey and the INITiate:RESTART command restart not only Trace Average, but MaxHold and MinHold traces as well. For wireless comms modes in ESA and PSA, the Restart hardkey and the INITiate:RESTART command restart every measurement, which includes all traces and numeric results. There is no change to this operation.
Initial S/W Revision	Prior to A.02.00

### More Information

The **Restart** function first aborts the current sweep/measurement as quickly as possible. It then resets the sweep and trigger systems, sets up the measurement and initiates a new data measurement sequence with a new data acquisition (sweep) taken once the trigger condition is met.

If the analyzer is in the process of aligning when **Restart** is executed, the alignment finishes before the restart function is performed.

Even when set for Single operation, multiple sweeps may be taken when Restart is pressed (for example, when averaging/holding is on). Thus when we say that **Restart** "restarts a measurement," we may mean:

- It restarts the current sweep
- It restarts the current measurement
- It restarts the current set of sweeps if any trace is in Trace Average, Max Hold or Min Hold
- It restarts the current set of measurements if Averaging, or Max Hold, or Min Hold is on for the measurement
- depending on the current settings.

With **Average/Hold Number** (in **Meas Setup** menu) set to 1, or Averaging off, or no trace in Trace Average or Hold, a single sweep is equivalent to a single measurement. A single sweep is taken after the trigger condition is met; and the analyzer stops sweeping once that sweep has completed. However, with **Average/Hold Number** >1 and at least one trace set to **Trace Average, Max Hold, or Min Hold (SA Measurement)** or **Averaging on (most other measurements)**, multiple sweeps/data acquisitions are taken for a single measurement. The trigger condition must be met prior to each sweep. The sweep is stopped when the average count  $k$  equals the number  $N$  set for **Average/Hold Number**. A measurement average usually applies to all traces, marker results, and numeric results; but sometimes it only applies to the numeric results.

Once the full set of sweeps has been taken, the analyzer will go to idle state. To take one more sweep without resetting the average count, increment the average count by 1, by pressing the step up key while **Average/Hold Number** is the active function, or sending the remote command CALC:AVER:TCON UP.

## Save

The Save menu lets you choose what you want to save and where you want to save it. Among the types of files you can save are **States**, **Traces**, and **Screen Images**. In addition, an Export (Data) option lets you save a number of data types as CSV files for easy import into Excel and other spreadsheet programs.

Key Path	Front-panel key
Mode	All
Notes	No remote command for this key specifically, but the :MMEM:STORe command is available for specific file types. An example is :MMEM:STOR:STATe <filename>.
Initial S/W Revision	Prior to A.02.00

## State

The Save State menu lets you choose a register or file for saving the state.

The content of a state file includes all of the settings and data required to return the analyzer as closely as possible to the Mode it was in, with the exact settings which were in place, when the save occurred. The Mode settings in each state file include the settings that are affected by Mode Preset, as well as the additional settings affected by Restore Mode Defaults; all of the Mode's settings. In addition, all of the settings of the Input/Output system are included, even though they are outside of the Mode's state, because they are needed to restore the complete setup. Persistent System settings (for example, Verbose SCPI) are not affected by either Mode Preset or Restore Mode Defaults, nor are they included in a saved State file.

After the save completes, the message "File <filename> saved" or "State Register <register number> saved" is displayed.

For rapid saving, the State menu lists 16 registers to save to. Pressing a Register key initiates the save. You can also select a file to save to.

The default path for all State Files is:

My Documents\<>mode name>\state

where <mode name> is the parameter used to select the mode with the INST:SEL command (for example, SA for the Spectrum Analyzer).

Key Path	Save
Mode	All
Remote Command	:MMEMory:STORe:STATe <filename>
Example	MMEM:STOR:STATe "MyStateFile.state" This stores the current instrument state data in the file MyStateFile.state in the default directory.
Notes	Both single and double quotes are supported for any filename parameter over remote. After saving to a register, that register's menu key is updated with the date the time, unless a custom label has been entered for that key. After saving to a register, you remain in the Save State menu, so that you can see the Register key

update. After saving to a file, the analyzer automatically returns to the previous menu and any Save As dialog goes away.

**Backwards Compatibility SCPI** :MMEMory:STORe:STATe 1,<filename>

For backwards compatibility, the above syntax is supported. The "1" is simply ignored. The command is sequential.

Initial S/W Revision Prior to A.02.00

### To File . . .

When you press “To File”, the analyzer brings up a Windows dialog and a menu entitled “Save As.” This menu allows you to navigate to the various fields in the Windows dialog without using a keyboard or mouse. The Tab and Arrow keys can also be used for dialog navigation.

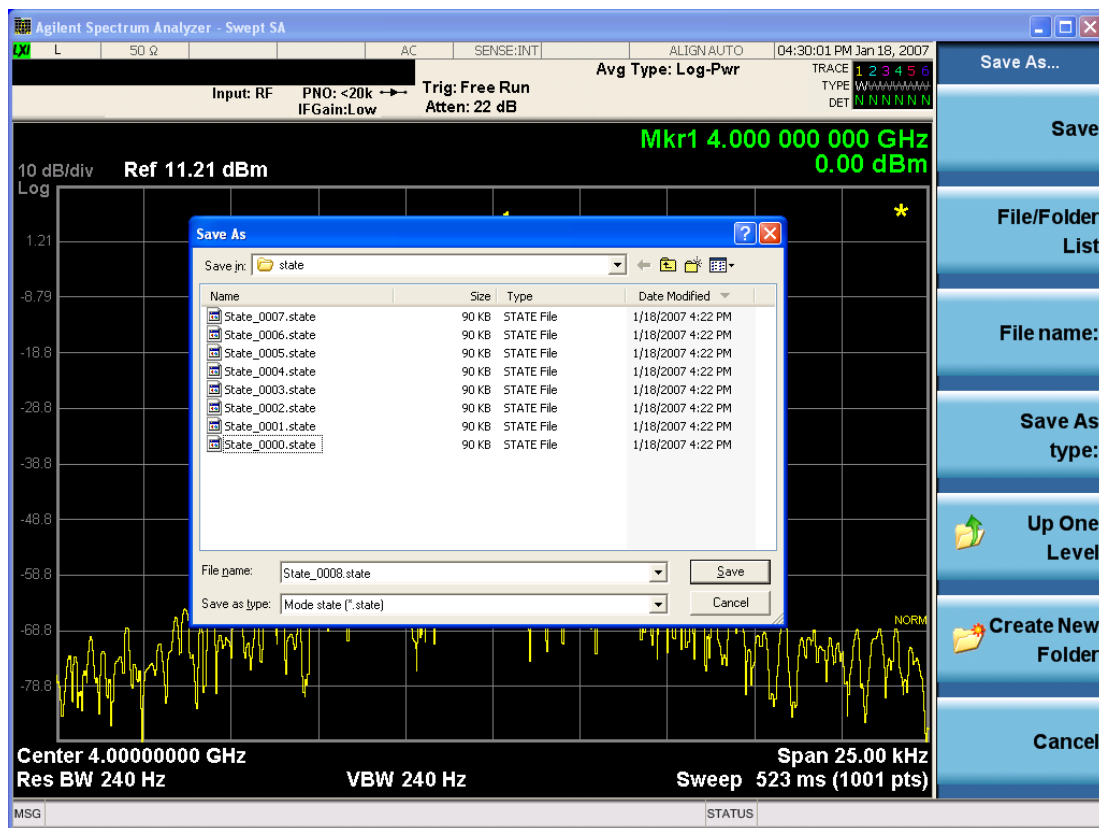

The Listed below

are the functions of the various fields in the dialog, and the corresponding softkeys:

### Save

Performs the save to the specified file of the selected type. If the file already exists, a dialog will appear that allows you to replace the existing file by selecting OK, or you can Cancel the request. If you select OK, the file will be overwritten. Using the C: drive is strongly discouraged, since it runs the risk of being overwritten during an instrument software upgrade.

While the save is being performed, the floppy icon appears briefly in the Meas bar.

## File/Folder List

Enables you to navigate to the center of the dialog that contains the list of files and folders. Once here you can get information about the file and use the tab keys to navigate to the other fields in the dialog, such as Save In.

## Save In

The Save In field shows the path to which the file will be saved and allows you to change the path using the up and down arrow keys to navigate to other paths; the Enter key to open a directory; and the Backspace key to go back one directory. The **Save In field** defaults to the default path for this type of file and remembers the last path you used to save this type of file. There is no softkey for directly navigating to the Save In field but you can use left tab to get here from the File/Folder List.

User specified paths are remembered when you leave and return to a Mode and are reset back to the default using Restore Mode Defaults.

## File Name

The File Name field is initially loaded with an automatically generated filename specific to the appropriate Save Type. The automatically generated filename is guaranteed not to conflict with any filename currently in the directory. You may replace or modify this filename using the File Name key. See the ["Quick Save " on page 2880](#) documentation for more on the automatic file naming algorithm.

When you press the File Name key the analyzer displays the Alpha Editor. Use the knob to choose the letter to add and the front-panel Enter key to add the letter to the file name. The BK character moves you back and the FW character moves you forward in the filename. The Select key on the front panel generates a space character. When you are done entering the filename press the Done softkey. This returns back to the **File Open** dialog and menu, but does not cause the save to occur.

## Save As Type

This field shows the file suffix for the type of file you have selected to save. For example, if you navigated here while saving State, "Mode state (\*.state)" is in the field. If you navigated here from saving Trace, ""Mode state (\*.trace)" is in the field. If you navigated here while exporting a trace data file, "Trace Data (\*.csv)" is in the field. For some file types, there is more than one choice in the dropdown, which you can select by using the up and down arrow keys and Enter.

## Up One Level

This key corresponds to the icon of a folder with the up arrow that is in the tool bar of the dialog. When pressed, it causes the file and folder list to navigate up one level in the directory structure. The Backspace key does the same thing.

## Create New Folder

This key corresponds to the icon of a folder with the "\*" that is in the tool bar of the dialog. When pressed, a new folder is created in the current directory with the name **New Folder** and you can enter a new folder name using the Alpha Editor.

## Cancel

This key corresponds to the Cancel selection in the dialog. It causes the current **Save As** request to be cancelled. The ESC key does the same thing.

Key Path	Save, State
Mode	All
Notes	Brings up Save As dialog for saving a State Save Type
Initial S/W Revision	Prior to A.02.00

## Edit Register Names

You may enter a custom name on any of the Register keys, to help you remember what you are using that state to save. To do this, press the Edit Register Names key, choose the register whose name you wish to edit, and then enter the desired label using the Alpha Editor or an external PC keyboard.

The maximum number of characters that can be added is 30. In most cases, 30 characters will fit on two lines of the key.

See ["More Information" on page 2034](#)

Key Path	Save, State
Mode	All
<b>Remote Command</b>	:MMEMory:REGister:STATe:LABel <reg number>,"label" :MMEMory:REGister:STATe:LABel? <reg number>
<b>Example</b>	:MMEM:REG:STAT:LAB 1,"my label"
Notes	<reg number> is an integer from 1 to 16. If the SCPI specifies an invalid register number an error message is generated, -222,"Data out of range;Invalid register label number" "label" is a string from 0 to 30 characters in length. If a label exceeds 30 characters, an error message is generated, -150,"String data error;Label clipped to 30 characters" "label" of length 0 erases the custom label and restores the default (time and date) label. E.g.: :MMEM:REG:STAT:LAB 1,""
Dependencies	N9060A-7FP or N9060B-2FP license required to edit the register names. When the feature is not licensed, sending this command generates an error, -221,"Settings conflict;Option not available"
Preset	The names are unaffected by Preset or power cycle but are set to the default label (time and date) on a "Restore System Defaults->Misc"
Initial S/W Revision	A.11.00

## More Information

When you edit one of the register names, the time and date field will be replaced by the custom name.

If you delete all the characters in the custom name, it restores the default (time and date).

The register names are stored within the state files, but they are not part of the instrument state; that is, once you have edited a register name, loading a new state will not change that register name. Another consequence of this is that the names will be persistent through a power cycle. Also, if a named state file is transferred to another analyzer, it will bring its custom name along with it.

If you try to edit the name of an empty register, the analyzer will first save the state to have a file to put the name in. If you load a named state file into an analyzer with older firmware it will ignore the metadata.

The \*SAV and \*RCL commands will not be affected by the custom register names, nor will the MMEM commands.

### Register 1 thru Register 16

Selecting any one of these register menu keys causes the State of the currently active mode to be saved to the specified Register. The registers are provided for rapid saving and recalling, since you do not need to specify a filename or navigate to a file. Each of the register menu keys annotates whether it is empty or at what date and time it was last modified. In addition, you can use the Edit Register Names key to enter custom names for each register.

Although these 16 registers are the only registers available from the front panel, there are 128 state registers available in the instrument. Registers 17–128 are only available from the SCPI interface, using the \*SAV command.

There is one set of 128 state registers in the instrument, not one set for each Mode. When a state is saved, the Mode it was saved from is saved with it; then when it is recalled, the instrument switches to that Mode.

After the save completes, the corresponding register menu key annotation is updated with the date and time and the message "Register <register number> saved" is displayed.

Key Path	Save, State
Mode	All
<b>Example</b>	*SAV 1
Range	1–16 from front panel, 1–128 from SCPI
Readback	Date and time with seconds resolution are displayed on the key OR A custom name of up to 30 characters entered using the Edit Register Names key OR “(empty)” if no prior save operation has been performed to this register.
Initial S/W Revision	Prior to A.02.00
Modified at S/W Revision	A.11.00

### Register 1 thru Register 16

Selecting any one of these register menu keys causes the State of the currently active mode to be saved to the specified Register. The registers are provided for rapid saving and recalling, since you do not need to specify a filename or navigate to a file. Each of the register menu keys annotates whether it is empty or at what date and time it was last modified. In addition, you can use the Edit Register Names key to enter custom names for each register.

Although these 16 registers are the only registers available from the front panel, there are 128 state registers available in the instrument. Registers 17–128 are only available from the SCPI interface, using the \*SAV command.

There is one set of 128 state registers in the instrument, not one set for each Mode. When a state is saved, the Mode it was saved from is saved with it; then when it is recalled, the instrument switches to that Mode.

After the save completes, the corresponding register menu key annotation is updated with the date and time and the message "Register <register number> saved" is displayed.

Key Path	Save, State
Mode	All
Example	*SAV 1
Range	1-16 from front panel, 1-128 from SCPI
Readback	Date and time with seconds resolution are displayed on the key OR A custom name of up to 30 characters entered using the Edit Register Names key OR “(empty)” if no prior save operation has been performed to this register.
Initial S/W Revision	Prior to A.02.00
Modified at S/W Revision	A.11.00

## Data (Export)

Exporting a data file stores data from the current measurement to mass storage files. The Export Menu only contains data types that are supported by the current measurement.

Since the commonly exported data files are in .csv format, the data can be edited by you prior to importing. This allows you to export a data file, manipulate the data in Excel (the most common PC Application for manipulating .csv files) and then import it.

Selecting an Export Data menu key will not actually cause the exporting to occur, since the analyzer still needs to know where you wish to save the data. Pressing the Save As key in this menu brings up the Save As dialog and Save As menu that allows you to specify the destination file and directory. Once a filename has been selected or entered in the Open menu, the export will occur as soon as the Save key is pressed.

Key Path	Save
Mode	All
Notes	The menu is built from whatever data types are available for the mode. So the key locations in the sub menu will vary.  No SCPI command directly controls the Data Type that this key controls. The Data Type is included in the MMEM:STORe commands.
Dependencies	If a file type is not used by a certain measurement, that type is grayed out for that measurement. The key for a file type will not show at all if there are no measurements in the Mode that support it.
Preset	Is not affected by a Preset or shutdown, but is reset during Restore Mode Defaults
Readback	The data type that is currently selected
Initial S/W Revision	Prior to A.02.00



## Measurement Results

Pressing this key selects Meas Results as the data type to be exported. Pressing the key a second time brings up the Meas Results menu, which allows you to select which **Meas Result** to save. In the Swept SA measurement, there are three types of Measurement Results files: Peak Table, Marker Table and Spectrogram.

See "[Meas Results File Contents](#)" on page 2037.

See "[Marker Table](#)" on page 2037.

See "[Peak Table](#)" on page 2040.

See "[Spectrogram](#)" on page 2043

<b>Remote Command</b>	:MMEMory:STORe:RESults:MTABle PTABle SPEctrogram <filename>
<b>Example</b>	:MMEM:STOR:RES:MTAB "myResults.csv" Saves the results from the current marker table to the file myResults.csv in the current path. :MMEM:STOR:RES:PTAB "myResults.csv" Saves the results from the current peak table to the file myResults.csv in the current path. :MMEM:STOR:RES:SPEC "myResults.csv" Saves the results from the current Spectrogram display to the file myResults.csv in the current path. The default path is My Documents\SA\data\SAN\results
<b>Notes</b>	If the save is initiated via SCPI, and the file already exists, the file will be overwritten. Using the C: drive is strongly discouraged, since it runs the risk of being overwritten during an instrument software upgrade. Both single and double quotes are supported for any filename parameter over SCPI.
<b>Dependencies</b>	If a save of Marker Table results is requested and the Marker Table is not on, no file is saved and a message is generated If a save of Peak Table results is requested and the Peak Table is not on, no file is saved and a message is generated If a save of Spectrogram results is requested and the Spectrogram is not on, no file is saved and a message is generated. The Spectrogram choice only appears if option EDP is licensed.
<b>Preset</b>	Not part of Preset, but is reset to Peak Table by Restore Mode Defaults. Survives a shutdown.
<b>Initial S/W Revision</b>	Prior to A.02.00

## Meas Results File Contents

All files are .csv files. The following section details the data in each file type.

### Marker Table

This section discusses the Marker Table Meas Results file format.

Imagine that, at the point where a Marker Table Meas Result is requested, the following screen is showing:

16 Reverse Link Code Domain  
Save

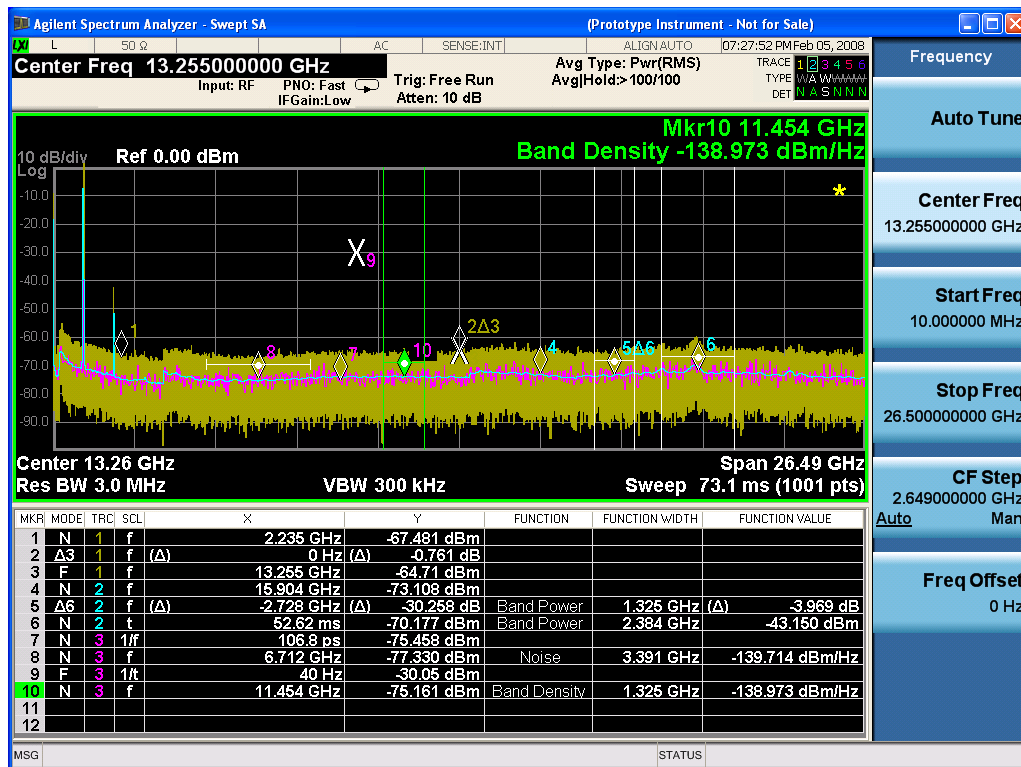

Then the Meas Results file, when opened, would show the following data:

MeasurementResult	
Swept SA	
A.01.40_R0017	N9020A
526 B25 PFR	1
P26 EA3	
Result Type	Marker Table
Ref Level	0
Number of Points	1001
Sweep Time	0.0662666 67
Start Frequency	10000000
Stop Frequency	26500000 000
Average Count	0
Average Type	LogPower (Video)
RBW	3000000

RBW Filter	Gaussian
RBW Filter BW	3dB
VBW	3000000
Sweep Type	Swept
X Axis Scale	Lin
PreAmp State	Off
PreAmp Band	Low
Trigger Source	Free
Trigger Level	1.2
Trigger Slope	Positive
Trigger Delay	1.00E-06
Phase Noise Optimization	Fast
Swept If Gain	Low
FFT If Gain	Autorange
RF Coupling	AC
FFT Width	411900
Ext Ref	10000000
Input	RF
RF Calibrator	Off
Attenuation	10
Ref Level Offset	0
External Gain	0
X Axis Units	Hz
Y Axis Units	dBm

DATA									
MKR	MODE	TR C	SCL	X	Y	FUNCTI ON	FUNCTIO N WIDTH	FUNCTI ON VALUE	FUNCTI ON UNIT
1	Normal	1	Freque ncy	2.2350E+09	- 67.481	Off	0.0000E+00	0	None
2	Delta3	1	Freque ncy	0.0000E+00	- 0.761	Off	0.0000E+00	0	None
3	Fixed	1	Freque ncy	1.3255E+10	- 64.71	Off	0.0000E+00	0	None
4	Normal	2	Freque ncy	1.5904E+10	- 73.1	Off	0.0000E+00	0	None

08									
5	Delta7	2	Frequency	-2.7280E+09	-30.258	Band Power	1.3250E+06	-3.969	dB
6	Normal	2	Time	5.2620E-02	-70.177	Band Power	2.3840E+06	-43.15	dBm
7	Normal	3	Period	1.0680E-10	-75.458	Off	0.0000E+00	0	None
8	Normal	3	Frequency	6.7120E+09	-77.33	Noise	3.3910E+06	-139.714	dBm/Hz
9	Fixed	3	Inverse Time	4.0000E+01	-30.05	Off	0.0000E+00	0	None
10	Normal	3	Frequency	1.1454E+10	-75.161	Band Density	1.3250E+06	-138.973	dBm/Hz
11	Off	1	Frequency	0.0000E+00	0	Off	0.0000E+00	0	None
12	Off	1	Frequency	0.0000E+00	0	Off	0.0000E+00	0	None

The numbers appear in the file exactly as they appear onscreen. If it says 11.454 GHz onscreen, then in the file it is 11.454E+09.

The metadata header is very similar to the metadata used in the trace data .csv files. See Trace File Contents. The only new information concerns the 1-of-N fields in the marker table itself.

### Peak Table

This section discusses the Peak Table Meas Results file format.

Imagine that, at the point where a Marker Table Meas Result is requested, the following screen is showing:

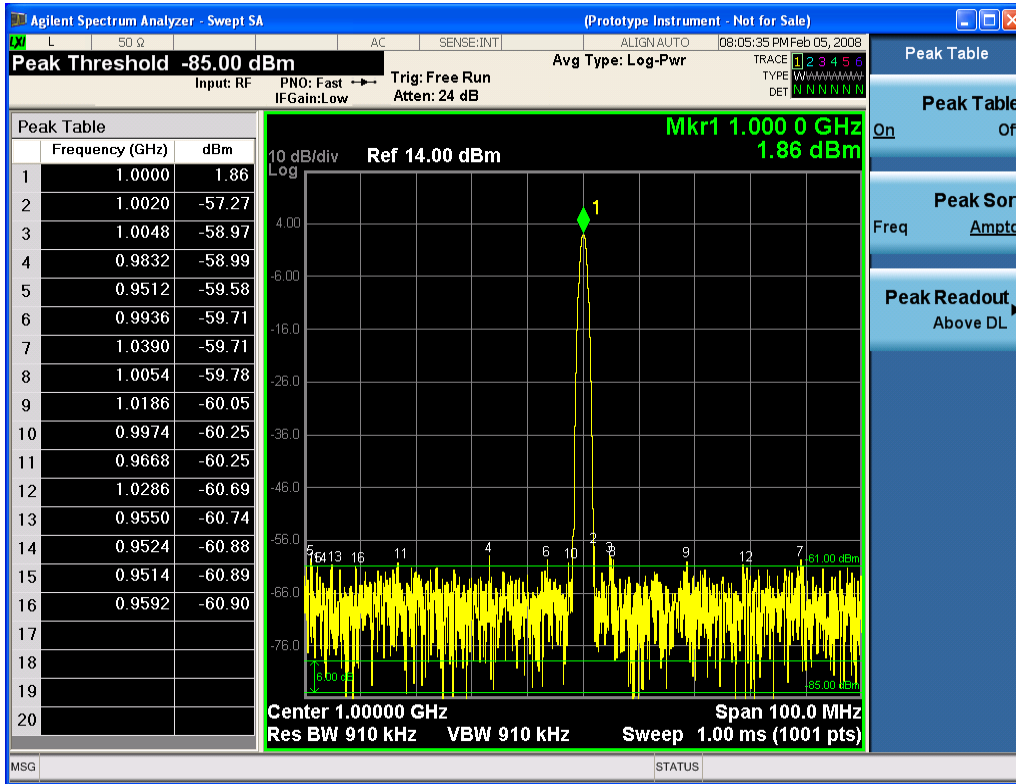

Then the Meas Results file, when opened, would show the header data (the same as for the Marker Table except that the Result Type is Peak Table) ending with a few fields of specific interest to Peak Table users:

- Peak Threshold
- Peak Threshold State (On|Off)
- Peak Excursion
- Peak Excursion State (On|Off)
- Display Line
- Peak Readout (All|AboveDL|BelowDL)
- Peak Sort (Freq|Amptd)

These fields are then followed by the data for the Peak Table itself.

Note that the label for the Frequency column changes to Time in 0 span.

Here is what the table for the above display looks like:

MeasurementResult	
Swept SA	
A.01.40_R0017	N9020A
526 B25 PFR P26 EA3	1

Result Type	Peak Table
Ref Level	0
Number of Points	1001
Sweep Time	0.066266667
Start Frequency	10000000
Stop Frequency	26500000000
Average Count	0
Average Type	LogPower(Video)
RBW	3000000
RBW Filter	Gaussian
RBW Filter BW	3dB
VBW	3000000
Sweep Type	Swept
X Axis Scale	Lin
PreAmp State	Off
PreAmp Band	Low
Trigger Source	Free
Trigger Level	1.2
Trigger Slope	Positive
Trigger Delay	1.00E-06
Phase Noise Optimization	Fast
Swept If Gain	Low
FFT If Gain	Autorange
RF Coupling	AC
FFT Width	411900
Ext Ref	10000000
Input	RF
RF Calibrator	Off
Attenuation	10
Ref Level Offset	0
External Gain	0
X Axis Units	Hz
Y Axis Units	dBm
Peak Threshold	-85
Peak Threshold State	On
Peak Excursion	6
Peak Excursion State	On

Display Line	-61	
Peak Readout	AboveDL	
Peak Sort	Amptd	
DATA		
Peak	Frequency	Amplitude
1	1.0000E+06	1.86
2	1.0020E+06	-57.27
3	1.0048E+06	-58.97
4	9.8320E+05	-58.99
5	9.5120E+05	-59.58
6	9.9360E+05	-59.71
7	1.0390E+06	-59.71
8	1.0054E+06	-59.78
9	1.1086E+06	-60.05
10	9.9740E+05	-60.25
11	9.6680E+05	-60.25
12	1.0286E+06	-60.69
13	9.5500E+05	-60.74
14	9.5240E+05	-60.88
15	9.5140E+05	-60.89
16	9.5920E+05	-60.90
17		
18		
19		
20		

## Spectrogram

This section discusses the Spectrogram Results file format. The Spectrogram choice only appears if option EDP is licensed.

The Spectrogram results are the same as a Trace data export, except that instead of having just one trace's data, all 300 traces appear one after the other.

.

Each trace has its own data mark; the data for Spectrogram Trace 0 follows the row marked DATA, the data for Spectrogram Trace 1 follows the row marked DATA1, for Spectrogram Trace 2 follows the row marked DATA2, and so on.

Each DATA row has a timestamp in the second column (as of firmware revision A.11.01). So, for example, if Trace 0 had a relative start time of 1729.523 sec, then the first DATA row would look like this:

DATA,1729.523

And if Trace 13 had a relative start time of 100.45 sec, then the fourteenth data row would look like:

DATA13,100.453

To find the absolute time for the relative timestamps of each trace, the last row before the first DATA row gives the absolute start time of the Spectrogram, in the form YYYYMMDDHHMMSS

So, for example, if the absolute start time is 13:23:45:678 on January 30, 2012, this row would look like:

Start Time,20120130132345678

**NOTE**

The resolution of the absolute time stored is 1 ms, which matches up with the fact that the fastest sweep time is also 1 ms. However, there is no specification for the absolute accuracy of the clock in the analyzer, nor is there any facility provided to allow the user to set this time to any particular degree of accuracy.

Traces that have not yet been filled in the Spectrogram display are empty; there is no DATA header for them. The file ends after the last non-empty trace.

Imagine that, at the point where a Spectrogram Meas Result is requested, the following screen is showing:

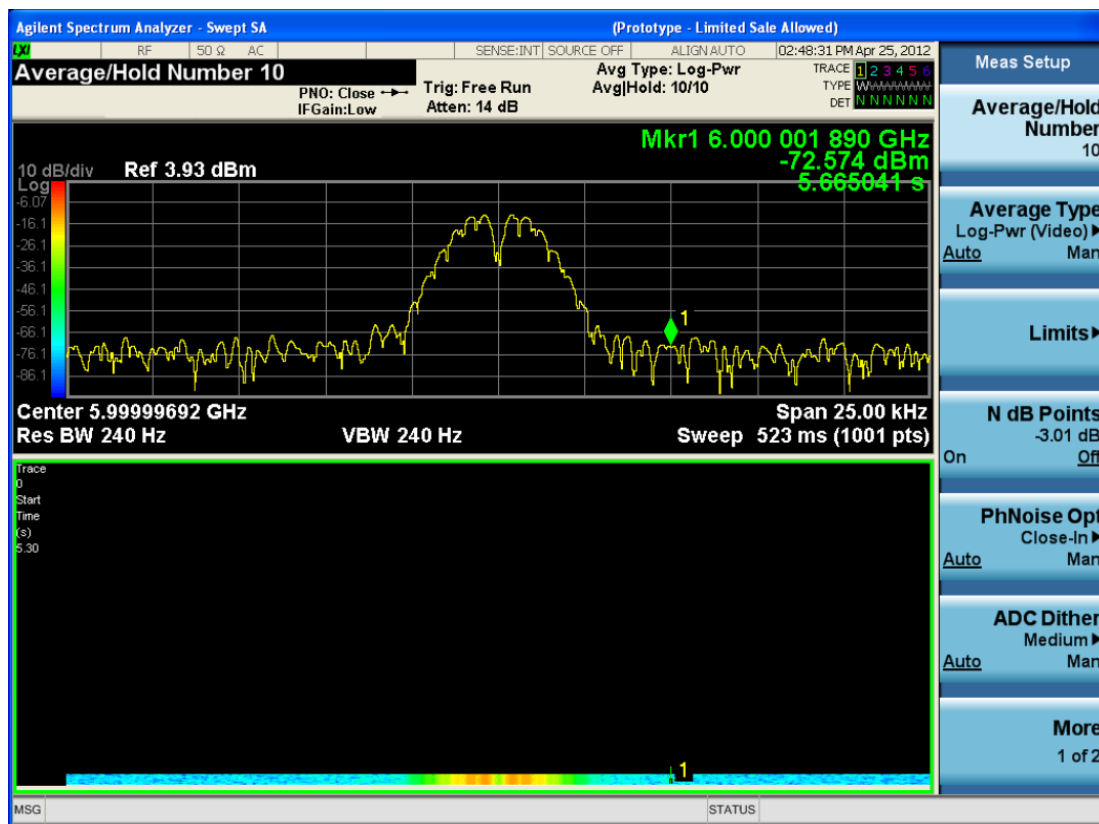

For the purpose of this example, we have set the Average/Hold Number to 10, thus we have only traces 0 thru 10. The Spectrogram was started at 02:28:08:700 pm on April 25, 2012 (that is, 700 ms after 2:28:08 pm), although the screen dump itself shows a different time, as it was taken ten minutes after the



Spectrogram data. Trace 0 is showing a start time of 5.30 seconds, meaning 5.3 seconds after the Spectrogram started (trace 10 has a start time of 0, as it was the first trace taken but has now rolled up into the tenth trace slot).

The Meas Results file, when opened, shows the header data and ten traces of trace data. Below is an extract from the result file for the above display. Note the start time of 20120425142808700 showing in the last row before the first DATA row, and the relative time of 5.299231048 showing in the first DATA row:

<b>Result Type</b>	<b>Spectrogram</b>
MeasResult	
Swept SA	
A.11.00.01	N9020A
503 508 513 526 ALL ALV B1C B1X B25 B2X B40 BAB BBA CR3 CRP DP2 DRD EA3 EDP EMC EP1 ERC ESC ESP EXM FSA HBA K03 LFE MPB P03 P08 P13 P26 PFR RTL RTS S40 SB1 SEC SM1 UK6 YAS YAV	1
Segment	0
Number of Points	1001
Sweep Time	0.523333333
Start Frequency	5999984415
Stop Frequency	6000009415
Average Count	0
Average Type	LogPower(Video)
RBW	240
RBW Filter	Gaussian
RBW Filter BW	3dB
VBW	240
Sweep Type	Swept
X Axis Scale	Lin
PreAmp State	Off
PreAmp Band	Low
Trigger Source	Free
Trigger Level	1.2
Trigger Slope	Positive
Trigger Delay	0
Phase Noise Optimization	Wide
Swept If Gain	Low
FFT If Gain	Autorange
RF Coupling	AC

Result Type	Spectrogram
FFT Width	411900
Ext Ref	10000000
Input	RF
RF Calibrator	Off
Attenuation	14
Ref Level Offset	0
External Gain	0
Trace Type	Clearwrite
Detector	Normal
Trace Math	Off
Trace Math Oper1	Trace5
Trace Math Oper2	Trace6
Trace Math Offset	0
Trace Name	Trace1
X Axis Units	Hz
Y Axis Units	dBm
Start Time	20120425142808700
DATA	5.299231048
5999984415	-76.34749519
5999984440	-77.28097006
5999984465	-75.32317869
5999984490	-73.64417681
5999984515	-72.67154604

- o
- o
- o

6000009315	-77.94423277
6000009340	-79.51829697
6000009365	-78.46108961
6000009390	-78.46108957
6000009415	-76.59570596
DATA2	4.708697055
5999984415	-80.98197882
5999984440	-80.98197879

5999984465	-75.83142132
5999984490	-74.02712079
5999984515	-73.57213005

- 
- 
- 

6000009315	-75.9183103
6000009340	-79.53787488
6000009365	-78.82602191
6000009390	-78.82602188
6000009415	-76.37486709
DATA10	0
5999984415	-75.56751112
5999984440	-75.76485645
5999984465	-76.67718717
5999984490	-78.79238489
5999984515	-83.72680212

- 
- 
- 

6000009315	-71.3942461
6000009340	-72.28308332
6000009365	-73.92684489
6000009390	-75.45548832
6000009415	-75.17904815

### Capture Buffer

Capture Buffer functionality is not available for all measurements. The captured data is raw data which is not processed.

Key Path	Save, Data
----------	------------

Mode	CDMA1XEV
Example	MMEM:STOR:CAPT "MyCaptureData.bin" This stores the capture data in the file MyCaptureData.bin in the default directory.
Dependencies	In case the capture buffer data is not available from the selected measurement, the key will be grayed out.
Initial S/W Revision	A.11.00

## Save As . . .

When you press "Save As", the analyzer brings up a Windows dialog and a menu entitled "**Save As.**" This menu allows you to navigate to the various fields in the Windows dialog without using a keyboard or mouse. The Tab and Arrow keys can also be used for dialog navigation.

See "[To File . . .](#)" on page 2897 in Save, State for a full description of this dialog and menu.

The default path for saving files is:

For all of the Trace Data Files:

My Documents\<<mode name>\data\traces

For all of the Limit Data Files:

My Documents\<<mode name>\data\limits

For all of the Measurement Results Data Files:

My Documents\<<mode name>\data\<<measurement name>\results

For all of the Capture Buffer Data Files:

My Documents\<<mode name>\data\captureBuffer

Key Path	Save, Data
Mode	All
Notes	The key location is mode-dependent and will vary. Brings up the Save As dialog for saving a <mode specific> Save Type. The save is performed immediately and does not wait until the measurement is complete.
Initial S/W Revision	Prior to A.02.00

## Screen Image

Pressing Screen Image accesses a menu of functions that enable you to specify a format and location for the saved screen image. It brings up a menu that allows you to specify the color scheme of the Screen Image (Themes) or navigate to the Save As dialog to perform the actual save.

Screen Image files contain an exact representation of the analyzer display. They cannot be loaded back onto the analyzer, but they can be loaded into your PC for use in many popular applications.

The image to be saved is actually captured when the Save front panel key is pressed, and kept in temporary storage to be used if you ask for a Screen Image save. When the Screen Image key is pressed, a "thumbnail" of the captured image is displayed, as shown below:

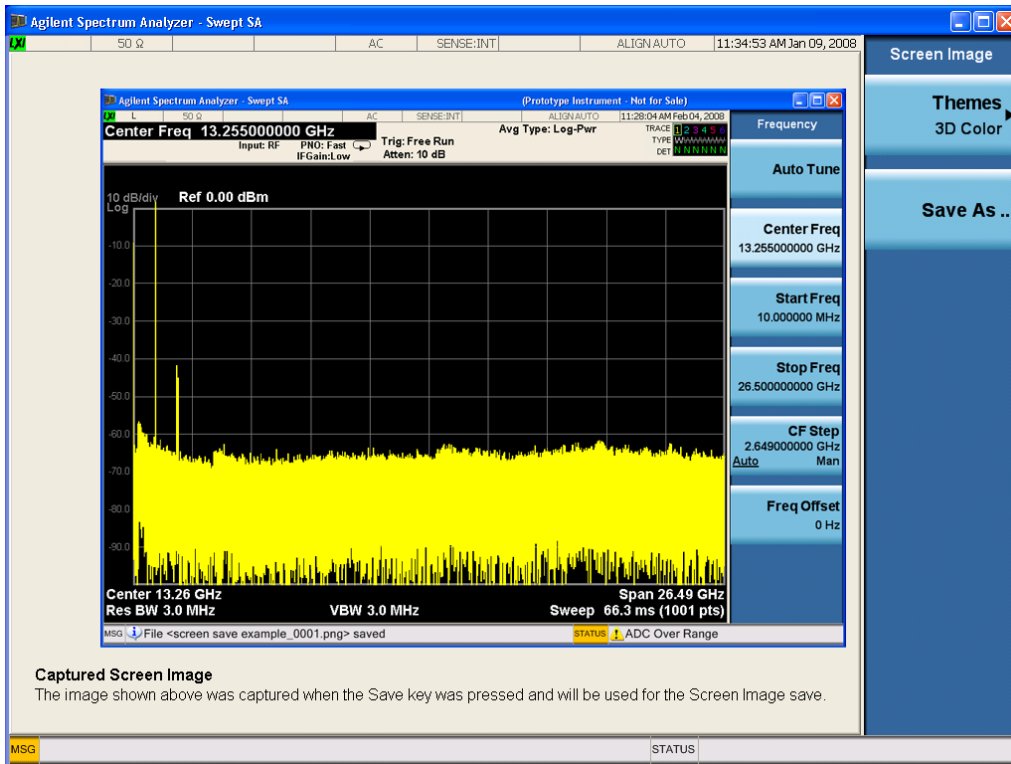

When you continue on into the Save As menu and complete the Screen Image save, the image depicted in the thumbnail is the one that gets saved, showing the menus that were on the screen before going into the Save menu. The save is performed immediately and does not wait until the measurement is complete.

After you have completed the save, the Quick Save front-panel key lets you quickly repeat the last save performed, using an auto-named file, with the current screen data.

**NOTE** For versions previous to A.01.55, if you initiate a screen image save by navigating through the Save menus, the image that is saved will contain the Save menu softkeys, not the menus and the active function that were on the screen when you first pressed the Save front panel key.

Key Path	Save
Mode	All
Remote Command	:MMEMory:STORe:SCReen <filename>
Example	:MMEM:STOR:SCR "myScreen.png" This stores the current screen image in the file MyScreenFile.png in the default directory.
Initial S/W Revision	Prior to A.02.00

## Themes

Accesses a menu of functions that enable you to choose the theme to be used when saving the screen image.

The **Themes** option is the same as the **Themes** option under the **Display** and **Page Setup** dialogs. It allows you to choose between themes to be used when saving the screen image.

Key Path	Save, Screen Image
Remote Command	:MMEMory:STORe:SCReen:THEMe TDColor   TDMonochrome   FCOLor   FMONochrome  :MMEMory:STORe:SCReen:THEMe?
Example	:MMEM:STOR:SCR:THEM TDM
Preset	3D Color; Is not part of Preset, but is reset by Restore Misc Defaults or Restore System Defaults All and survives subsequent running of the modes.
Readback	3D Color   3D Mono   Flat Color   Flat Mono
Backwards Compatibility Notes	In ESA and PSA we offer the choice of "Reverse Bitmap" or "Reverse Metafile" when saving screen images. This is much like the "Flat Color" theme available in X-Series. Also, if you selected Reverse Bitmap AND a black & white screen image, that would be much like "Flat Monochrome". In other words, each of the X-Series themes has a similar screen image type in ESA/PSA. But they are not identical.
Initial S/W Revision	Prior to A.02.00

### 3D Color

Selects a standard color theme with each object filled, shaded and colored as designed.

Key Path	Save, Screen Image, Themes
Example	MMEM:STOR:SCR:THEM TDC
Readback	3D Color
Initial S/W Revision	Prior to A.02.00

### 3D Monochrome

Selects a format that is like 3D color but shades of gray are used instead of colors.

Key Path	Save, Screen Image, Themes
Example	MMEM:STOR:SCR:THEM TDM
Readback	3D Mono
Initial S/W Revision	Prior to A.02.00

### Flat Color

Selects a format that is best when the screen is to be printed on an ink printer.

Key Path	Save, Screen Image, Themes
<b>Example</b>	MMEM:STOR:SCR:THEM FCOL
Readback	Flat Color
Initial S/W Revision	Prior to A.02.00

## Flat Monochrome

Selects a format that is like Flat Color. But only black is used (no colors, not even gray), and no fill.

Key Path	Save, Screen Image, Themes
<b>Example</b>	MMEM:STOR:SCR:THEM FMON
Readback	Flat Mono
Initial S/W Revision	Prior to A.02.00

## Save As...

When you press "Save As", the analyzer brings up a Windows dialog and a menu entitled "**Save As.**" This menu allows you to navigate to the various fields in the Windows dialog without using a keyboard or mouse. The Tab and Arrow keys can also be used for dialog navigation.

See "[To File . . .](#)" on page 2897 in Save, State for a full description of this dialog and menu.

The default path for Screen Images is

My Documents\`<mode name>`\screen.

where `<mode name>` is the parameter used to select the mode with the INST:SEL command (for example, SA for the Spectrum Analyzer).

Key Path	Save, Screen Image
Notes	Brings up Save As dialog for saving a Screen Image Save Type
Initial S/W Revision	Prior to A.02.00

## Mass Storage Catalog (Remote Command Only)

Key path	SCPI Only
<b>Remote Command</b>	:MMEMory:CATalog? [ <code>&lt;directory_name&gt;</code> ]
Notes	<p>The string must be a valid logical path.</p> <p>Queries disk usage information (drive capacity, free space available) and obtains a list of files and directories in a specified directory in the following format:</p> <p><code>&lt;numeric_value&gt;,&lt;numeric_value&gt;,{&lt;file_entry&gt;}</code></p> <p>It returns two numeric parameters and as many strings as there are files and directories. The first</p>

---

parameter indicates the total amount of storage currently used in bytes. The second parameter indicates the total amount of storage available, also in bytes. The <file\_entry> is a string. Each <file\_entry> indicates the name, type, and size of one file in the directory list:

<file\_name>,<file\_type>,<file\_size>

As the windows file system has an extension that indicates file type, <file\_type> is always empty. <file\_size> provides the size of the file in bytes. For directories, <file\_entry> is surrounded by square brackets and both <file\_type> and <file\_size> are empty

---

Initial S/W Revision      Prior to A.02.00

---

## Mass Storage Change Directory (Remote Command Only)

---

Key path                      SCPI Only

**Remote Command**        :MMEMory:CDIRectory [<directory\_name>]  
                              :MMEMory:CDIRectory?

**Notes**                      The string must be a valid logical path.  
  
Changes the default directory for a mass memory file system. The <directory\_name> parameter is a string. If no parameter is specified, the directory is set to the \*RST value.  
  
At \*RST, this value is set to the default user data storage area, that is defined as System.Environment.SpecialFolder.Personal.  
  
Query returns full path of the default directory.

---

Initial S/W Revision      Prior to A.02.00

---

## Mass Storage Copy (Remote Command Only)

---

Key path                      SCPI Only

**Remote Command**        :MMEMory:COPY <string>,<string>[,<string>,<string>]

**Notes**                      The string must be a valid logical path.  
  
Copies an existing file to a new file or an existing directory to a new directory.  
  
Two forms of parameters are allowed. The first form has two parameters. In this form, the first parameter specifies the source, and the second parameter specifies the destination.  
  
The second form has four parameters. In this form, the first and third parameters specify the source. The second and fourth parameters specify the directories. The first pair of parameters specifies the source. The second pair specifies the destination. An error is generated if the source doesn't exist or the destination file already exists.  
  
This command will generate an "access denied" error if the destination is a restricted folder (e.g., C:\Windows) and the current user does not have Power User or Administrator privileges.

---

## Mass Storage Device Copy (Remote Command Only)

This command transfers data to/from a file and a peripheral device.



Key path	SCPI Only
<b>Remote Command</b>	:MMEMory:COpy:DEvice <source_string>,<dest_string>
Notes	The strings must be a valid logical path or a valid device keyword. If the dest_string is a device keyword, the data is copied from the source file to the device. If the source_string is a device keyword, the data is copied to the source file from the device.  Valid device keywords are: SNS (smart noise source)  An error is generated if the file or device is not found.

### Mass Storage Delete (Remote Command Only)

Key path	SCPI Only
<b>Remote Command</b>	:MMEMory:DElete <file_name>[,<directory_name>]
Notes	The string must be a valid logical path.  Removes a file from the specified directory. The <file_name> parameter specifies the file name to be removed. This command will generate an “access denied” error if the file is in a restricted folder (e.g., C:\Windows) and the current user does not have Power User or Administrator privileges.
Initial S/W Revision	Prior to A.02.00

### Mass Storage Data (Remote Command Only)

Creates a file containing the specified data OR queries the data from an existing file.

Key path	SCPI Only
<b>Remote Command</b>	:MMEMory:DATA <file_name>,<data> :MMEMory:DATA? <file_name>
Notes	The string must be a valid logical path.  The command form is MMEMory:DATA <file_name>,<data>. It loads <data> into the file <file_name>. <data> is in 488.2 block format. <file_name> is string data.  The query form is MMEMory:DATA? <file_name> with the response being the associated <data> in block format.
Initial S/W Revision	Prior to A.02.00

### Mass Storage Make Directory (Remote Command Only)

Key path	SCPI Only
<b>Remote Command</b>	:MMEMory:MDIRectory <directory_name>
Notes	The string must be a valid logical path.  Creates a new directory. The <directory_name> parameter specifies the name to be created.

---

	This command will generate an “access denied” error if the new directory would be in a restricted folder (e.g., C:\Windows) and the current user does not have Power User or Administrator privileges.
Initial S/W Revision	Prior to A.02.00

---

### Mass Storage Move (Remote Command Only)

---

Key path	SCPI Only
<b>Remote Command</b>	:MMEMory:MOVE <string>,<string>[,<string>,<string>]
Notes	<p>The string must be a valid logical path.</p> <p>Moves an existing file to a new file or an existing directory to a new directory.</p> <p>Two forms of parameters are allowed. The first form has two parameters. In this form, the first parameter specifies the source, and the second parameter specifies the destination.</p> <p>The second form has four parameters. In this form, the first and third parameters specify the source. The second and fourth parameters specify the directories. The first pair of parameters specifies the source. The second pair specifies the destination. An error is generated if the source doesn't exist or the destination file already exists.</p> <p>This command will generate an “access denied” error if the destination is a restricted folder (e.g., C:\Windows) and the current user does not have Power User or Administrator privileges.</p>
Initial S/W Revision	Prior to A.02.00

---

### Mass Storage Remove Directory (Remote Command Only)

---

Key path	SCPI Only
<b>Remote Command</b>	:MMEMory:RDIRECTory <directory_name>
Notes	<p>The string must be a valid logical path.</p> <p>Removes a directory. The &lt;directory_name&gt; parameter specifies the directory name to be removed. All files and directories under the specified directory shall also be removed.</p> <p>This command will generate an “access denied” error if the folder is a restricted folder (e.g., C:\Windows) or is in a restricted folder and the current user does not have Power User or Administrator privileges.</p>
Initial S/W Revision	Prior to A.02.00

---

## Single (Single Measurement/Sweep)

Sets the analyzer for Single measurement operation. The single/continuous state is Meas Global, so the setting will affect all the measurements. If you are Paused, pressing Single does a Resume.

See "[More Information](#)" on page 2055

Key Path	Front-panel key
Example	:INIT:CONT OFF
Notes	See Cont key description.
Backwards Compatibility Notes	<p>For Spectrum Analysis mode in ESA and PSA, the Single hardkey and the INITiate:IMM switched from continuous measurement to single measurement and restarted sweeps and averages (displayed average count reset to 1), but did not restart Max Hold and Min Hold. In the X-Series, the Single hardkey and the INITiate:IMM command initiate a sweep/ measurement/ average sequence/hold sequence including MaxHold and MinHold.</p> <p>For Spectrum Analysis mode in ESA and PSA, the Single hardkey restarted the sweep regardless of whether or not you were in an active sweep or sweep sequence. In the X-Series, Restart does this but Single only restarts the sweep or sweep sequence if you are in the idle state.</p> <p>INIT[:IMM] in ESA &amp; PSA Spectrum Analysis Mode does an implied ABORT. In some other PSA Modes, INIT[:IMM] is ignored if not in the idle state. . The X-Series follows the ESA/PSA SA Mode model, which may cause some Modes to have compatibility problems.</p>
Initial S/W Revision	Prior to A.02.00

### More Information

See "[Restart](#)" on page 2894 for details on the INIT:IMMEDIATE (Restart) function.

If you are already in single sweep, the INIT:CONT OFF command has no effect.

If you are already in Single Sweep, then pressing the Single key in the middle of a sweep does not restart the sweep or sequence. Similarly, pressing the Single key does not restart the sweep or sequence if the sweep is not in the idle state (for example, if you are taking a very slow sweep, or the analyzer is waiting for a trigger). Instead, it results in a message. "Already in Single, press Restart to initiate a new sweep or sequence". Even though pressing the Single key in the middle of a sweep does not restart the sweep, sending INIT:IMMEDIATE does reset it.

To take one more sweep without resetting the average count, increment the average count by 1, by pressing the step up key while **Average/Hold Number** is the active function, or sending the remote command CALC:AVER:TCON UP.

## Source

Operation of this key is identical across all measurements. For details about this key, see ["Source" on page 2921](#).

---

Key Path	Front-panel key
Initial S/W Revision	Prior to A.02.00

---

## Span X Scale

Accesses a menu of functions that enable you to set the desired horizontal scale parameters.

The SPAN X Scale for Power Bar Graph and CDE Graph functions are coupled to each other.

Key Path	Front-panel key
Initial S/W Revision	Prior to A.02.00

### X Ref Value (I/Q Error (Quad View) view, Magnitude Error window)

Sets the reference value on the horizontal axis in the Magnitude Error window of the I/Q Error (Quad View) view.

Key Path	Span X Scale
Mode	1xEV-DO
<b>Remote Command</b>	:DISPlay:CDPower:MS:VIEW3:WINDow[1]:TRACe:X[:SCALE]:RLEVel <real> :DISPlay:CDPower:MS:VIEW3:WINDow[1]:TRACe:X[:SCALE]:RLEVel?
<b>Example</b>	DISP:CDP:MS:VIEW3:WIND:TRAC:X:RLEV 0 DISP:CDP:MS:VIEW3:WIND:TRAC:X:RLEV?
Notes	If the Auto Scaling is set to On, this value is automatically determined by the measurement result. When you set this value manually, Auto Scaling automatically changes to Off. Target window to control depends on the SubOpCode.
Preset	0.0
State Saved	Saved in instrument state.
Min	0.0
Max	5000000
<b>Backwards Compatibility SCPI</b>	:DISPlay:TCDPower:VIEW3:WINDow[1]:TRACe:X[:SCALE]:RLEVel
Initial S/W Revision	Prior to A.02.00

### X Scale/Div (I/Q Error (Quad) View, Magnitude Error Window)

Sets the horizontal scale by changing a value per division in the Magnitude Error window of I/Q Error (Quad) View.

Key Path	Span X Scale
Mode	1xEV-DO
<b>Remote Command</b>	:DISPlay:CDPower:MS:VIEW3:WINDow[1]:TRACe:X[:SCALE]:PDIVision <real> :DISPlay:CDPower:MS:VIEW3:WINDow[1]:TRACe:X[:SCALE]:PDIVision?
<b>Example</b>	DISP:CDP:MS:VIEW3:WIND:TRAC:X:PDIV 10

	DISP:CDP:MS:VIEW3:WIND:TRAC:X:PDIV?
Notes	If the Auto Scaling is set to On, this value is automatically determined by the measurement result. When you set this value manually, Auto Scaling automatically changes to Off. Target window to control depends on the SubOpCode.
Preset	6.0
State Saved	Saved in instrument state.
Min	0.10
Max	500000
<b>Backwards Compatibility SCPI</b>	:DISPlay:TCDPower:VIEW3:WINDow[1]:TRACe:X[:SCALe]:PDIVision
Initial S/W Revision	Prior to A.02.00

### X Ref Position (I/Q Error (Quad) view, Phase Error window)

Sets the reference position of the X axis in the Phase Error window of the I/Q Error view.

Key Path	Span X Scale
Mode	1xEV-DO
<b>Remote Command</b>	:DISPlay:CDPower:MS:VIEW3:WINDow2:TRACe:X[:SCALe]:RPOSition LEFT   CENTER   RIGHT  :DISPlay:CDPower:MS:VIEW3:WINDow2:TRACe:X[:SCALe]:RPOSition?
<b>Example</b>	DISP:CDP:MS:VIEW3:WIND2:TRAC:X:RPOS RIGH DISP:CDP:MS:VIEW3:WIND2:TRAC:X:RPOS?
Preset	LEFT
State Saved	Saved in instrument state.
Range	Left Ctr Right
<b>Backwards Compatibility SCPI</b>	:DISPlay:TCDPower:VIEW3:WINDow2:TRACe:X[:SCALe]:RPOSition
Initial S/W Revision	Prior to A.02.00

### Auto Scaling (I/Q Error (Quad View) View, Phase Error window)

When Auto Scaling is On, and the Restart front-panel key is pressed, this function automatically displays the scale per division and reference value results in the Phase Error view of I/Q Error (Quad View) View.

Key Path	Span X Scale
Mode	1xEV-DO
<b>Remote Command</b>	:DISPlay:CDPower:MS:VIEW3:WINDow2:TRACe:X[:SCALe]:COUPlE 0   1   OFF   ON  :DISPlay:CDPower:MS:VIEW3:WINDow2:TRACe:X[:SCALe]:COUPlE?

<b>Example</b>	DISP:CDP:MS:VIEW3:WIND2:TRAC:X:COUP ON DISP:CDP:MS:VIEW3:WIND2:TRAC:X:COUP?
Notes	Upon pressing the Restart front-panel key or Restart menu key under the Meas Control menu, the Auto Scaling function automatically determines the scale per division and reference values based on the measurement results if this parameter is set to On. When you set a value to either Scale/Div or Ref Value manually, Auto Scaling automatically changes to Off.
Preset	ON
State Saved	Saved in instrument state.
Range	Off On
<b>Backwards Compatibility SCPI</b>	:DISPlay:TCDPower:VIEW3:WINDow2:TRACe:X[:SCALE]:COUPle
Initial S/W Revision	Prior to A.02.00

## Sweep/Control

Accesses a menu that allows you to select parameters that affect the sweep of the displayed measurement signal.

Only the Pause/Resume key is available.

Key Path	Front panel key
Initial S/W Revision	Prior to A.02.00

## Pause/Resume

This key allows you to pause or resume the measurement of the displayed signal.

See "[Pause/Resume](#)" on page 2925 function.

Key Path	Sweep/Control
Initial S/W Revision	Prior to A.02.00



## System

See "System" on page 359

## Trace/Detector

There is no meas local functionality. See Trace/Detector.

---

Key Path	Front-panel key
Initial S/W Revision	Prior to A.02.00

---

## Trigger

See ["Trigger" on page 430](#)

### Free Run

See ["Free Run " on page 437](#)

### Video

See ["Video \(IF Envelope\) " on page 438](#)

### Trigger Level

See ["Trigger Level " on page 438](#)

### Trig Slope

See ["Trig Slope " on page 439](#)

### Trig Delay

See ["Trig Delay " on page 440](#)

### Line

See ["Line " on page 2729](#)

### Trig Slope

See ["Trig Slope " on page 2729](#)

### Trig Delay

See ["Trig Delay " on page 442](#)

### External 1

See ["External 1 " on page 2741](#)

### Trigger Level

See ["Trigger Level " on page 2741](#)

### Trig Slope

See ["Trig Slope " on page 2742](#)

### Trig Delay

See ["Trig Delay " on page 445](#)

### External 2

See ["External 2 " on page 2743](#)

16 Reverse Link Code Domain  
Trigger

### **Trigger Level**

See ["Trigger Level "](#) on page 2743

### **Trig Slope**

See ["Trig Slope "](#) on page 2744

### **Trig Delay**

See ["Trig Delay "](#) on page 447

### **RF Burst**

See ["RF Burst "](#) on page 2744

### **Absolute Trigger**

See ["Absolute Trigger Level"](#) on page 2745

### **Relative Trigger**

See ["Relative Trigger Level"](#) on page 2734

### **Trig Slope**

See ["Trigger Slope "](#) on page 2746

### **Trig Delay**

See ["Trig Delay "](#) on page 451

### **Periodic Timer**

See ["Periodic Timer \(Frame Trigger\) "](#) on page 2736

### **Period**

See ["Period "](#) on page 2737

### **Offset**

See ["Offset "](#) on page 2738

### **Offset Adjust (Remote Command Only)**

See ["Offset Adjust \(Remote Command Only\)"](#) on page 2739

### **Reset Offset Display**

See ["Reset Offset Display "](#) on page 2740

### **Sync Source**

See ["Sync Source "](#) on page 2740

## Off

See "Off " on page 2741

## External 1

See "External 1 " on page 2741

## Trigger Level

See "Trigger Level " on page 2741

## Trig Slope

See "Trig Slope " on page 2742

## External 2

See "External 2 " on page 2743

## Trigger Level

See "Trigger Level " on page 2743

## Trig Slope

See "Trig Slope " on page 2744

## RF Burst

See "RF Burst " on page 2744

## Absolute Trigger

See "Absolute Trigger Level" on page 2745

## Trig Slope

See "Trigger Slope " on page 2746

## Trig Delay

See "Trig Delay" on page 461

## Auto/Holdoff

See "Auto/Holdoff " on page 462

## Auto Trig

See "Auto Trig " on page 462

## Trig Holdoff

See "Trig Holdoff " on page 463

## Holdoff Type

See \_\_\_ on page X

## User Preset

Accesses a menu that gives you the following three choices:

- User Preset – recalls a state previously saved using the Save User Preset function.
- User Preset All Modes – presets all of the modes in the analyzer
- Save User Preset– saves the current state for the current mode

Key Path	Front-panel key
Backwards Compatibility Notes	<p>User Preset is actually loading a state, and in legacy analyzers, it was possible to load a state without affecting the trace data, limit lines or correction data. Similarly it was possible to do a User Preset without affecting the trace data, limit lines or correction data.</p> <p>In the X-Series, “state” always includes all of this data; so whenever state is loaded, or User Preset is executed, all of the traces, limit lines and corrections are affected. Although this differs from previous behavior, it is desirable behavior, and should not cause adverse issues for users.</p> <p>On ESA and PSA, User Preset affected the entire instrument’s state. In the X-Series, User Preset only recalls the state for the active mode. There is a User Preset file for each mode. User Preset can never cause a mode switch as it can in legacy analyzers. If you want to recall all modes to their user preset file state, you will need to do a User Preset after mode switching into each mode.</p> <p>User Preset recalls mode state which can now include data like traces; whereas on ESA and PSA, User Preset did not affect data.</p>
Initial S/W Revision	Prior to A.02.00

## User Preset

User Preset sets the state of the currently active mode back to the state that was previously saved for this mode using the Save User Preset menu key or the SCPI command, SYST:PRES:USER:SAV. It not only recalls the Mode Preset settings, but it also recalls all of the mode persistent settings, and the Input/Output system setting that existed at the time Save User Preset was executed.

If a Save User Preset has not been done at any time, User Preset recalls the default user preset file for the currently active mode. The default user preset files are created if, at power-on, a mode detects there is no user preset file. There will never be a scenario when there is no user preset file to restore. For each mode, the default user preset state is the same state that would be saved if a Save User Preset is performed in each mode right after doing a Restore Mode Default and after a Restore Input/Output Defaults.

The User Preset function does the following:

- Aborts the currently running measurement.
- Sets the mode State to the values defined by Save User Preset.
- Makes the saved measurement for the currently running mode the active measurement.
- Brings up the saved menu for the power-on mode.
- Clears the input and output buffers.
- Sets the Status Byte to 0.

Key Path	User Preset
<b>Remote Command</b>	:SYSTem:PRESet:USER
<b>Example</b>	:SYST:PRES:USER:SAVE:SYST:PRES:USER
Notes	:SYST:PRES:USER:SAVE is used to save the current state as the user preset state. Clears all pending OPC bits. The Status Byte is set to 0. Pressing the User Preset front-panel key while already in the User Preset menu will cause the User Preset to get executed
Couplings	A user preset will cause the currently running measurement to be aborted and cause the saved measurement to be active. Recalling a User Preset file has the same issues that recalling a Save State file has. Some settings may need to be limited and therefore re-coupled, since the capabilities of the mode may have changes when the User Preset file was last saved.
Initial S/W Revision	Prior to A.02.00

## User Preset All Modes

Recalls all of the User Preset files for each mode, switches to the power-on mode, and activates the saved measurement from the power-on mode User Preset file.

**NOTE**

When the instrument is secured, all of the user preset files are converted back to their default user preset files.

The User Preset function does the following:

- Aborts the currently running measurement.
- Switches the Mode to the power-on mode.
- Restores the User Preset files for each mode.
- Makes the saved measurement for the power-on mode the active measurement.
- Brings up the saved menu for the power-on mode.
- Clears the input and output buffers.
- Sets the Status Byte to 0.

Key Path	User Preset
<b>Remote Command</b>	:SYSTem:PRESet:USER:ALL
<b>Example</b>	:SYST:PRES:USER:SAVE:SYST:PRES:USER:ALL
Notes	Clears all pending OPC bits. The Status Byte is set to 0. :SYST:PRES:USER:SAVE is used to save the current state as the user preset state.
Couplings	A user preset will cause the currently running measurement to be aborted, cause a mode switch to the power-on mode, and cause the saved measurement to be active in the power-on mode. Recalling a User Preset file has the same issues that recalling a Save State file has. Some settings may need to be limited and therefore re-coupled, since the capabilities of the mode may have changes when the User Preset file was last saved.
Initial S/W Revision	Prior to A.02.00

## Save User Preset

Saves the currently active mode and its State. You can recall this User Preset file by pressing the User Preset menu key or sending the SYST:PRES:USER remote command. This same state is also saved by the Save State function.

Key Path	User Preset
Remote Command	:SYSTem:PRESet:USER:SAVE
Example	:SYST:PRES:USER:SAVE
Notes	:SYST:PRES:SAVE creates the same file as if the user requested a *SAV or a MMEM:STOR:STAT, except User Preset Save does not allow the user to specify the filename or the location of the file.
Initial S/W Revision	Prior to A.02.00



## View/Display

Accesses a menu of functions that enable you to control the instrument display.

See the section Front Panel Key for more information.

Key Path	Front-panel key
Initial S/W Revision	Prior to A.02.00

### View Selection by Name

Key Path	View/Display
Mode	1xEV-DO
<b>Remote Command</b>	:DISPlay:CDPower:MS:VIEW[:SElect] PGRaph   CDPError   SEVM   QUAD   DBITs :DISPlay:CDPower:MS:VIEW[:SElect]?
<b>Example</b>	DISP:CDP:MS:VIEW PGR DISP:CDP:MS:VIEW?
Notes	You must be in the 1xEV-DO mode to use this command. Use INSTRument:SElect to set the mode.
Preset	PGRaph
State Saved	Saved in instrument state.
Range	Power Graph & Metrics   CDP Graph & CDE Graph   I/Q Error (Quad View)   Code Domain (Quad View)   Demod Bits
<b>Backwards Compatibility SCPI</b>	:DISPlay:TCDPower:VIEW[:SElect]
Initial S/W Revision	Prior to A.02.00

### View Selection by number (Remote Command only)

Displays the numeric values of the measurement results. This function is available by SCPI command only.

Mode	1xEV-DO
<b>Remote Command</b>	:DISPlay:CDPower:MS:VIEW:NSElect <integer> :DISPlay:CDPower:MS:VIEW:NSElect?
<b>Example</b>	DISP:CDP:MS:VIEW:NSEL 2 DISP:CDP:MS:VIEW:NSEL?
Notes	You must be in the 1XEVD-DO mode to use this command. Use INSTRument:SElect to set the mode.
Preset	1
State Saved	Saved in instrument state.
Min	1

Max	5
<b>Backwards Compatibility SCPI</b>	:DISPlay:TCDPower:VIEW:NSElect
Initial S/W Revision	Prior to A.02.00

## Display

The Display menu is common to most measurements, and is used for configuring items on the display. Some Display menu settings apply to all the measurements in a mode, and some only to the current measurement. Those under the System Display Settings key apply to all measurements in all modes.

Key Path	Display
Key Path	View/Display
Initial S/W Revision	Prior to A.02.00

## Annotation

Turns on and off various parts of the display annotation. The annotation is divided up into four categories:

1. Meas Bar: This is the measurement bar at the top of the screen. It does not include the settings panel or the Active Function. Turning off the Meas Bar turns off the settings panel and the Active Function. When the Meas Bar is off, the graticule area expands to fill the area formerly occupied by the Meas Bar.
2. Screen Annotation: this is the annotation and annunciation around the graticule, including any annotation on lines (such as the display line, the threshold line, etc.) This does NOT include the marker number or the N dB result. When off, the graticule expands to fill the entire graticule area.
3. Trace annotation: these are the labels on the traces, showing their detector (or their math mode).
4. Active Function annotation: this is the active function display in the meas bar, and all of the active function values displayed on softkeys.

See the figure below. Each type of annotation can be turned on and off individually.

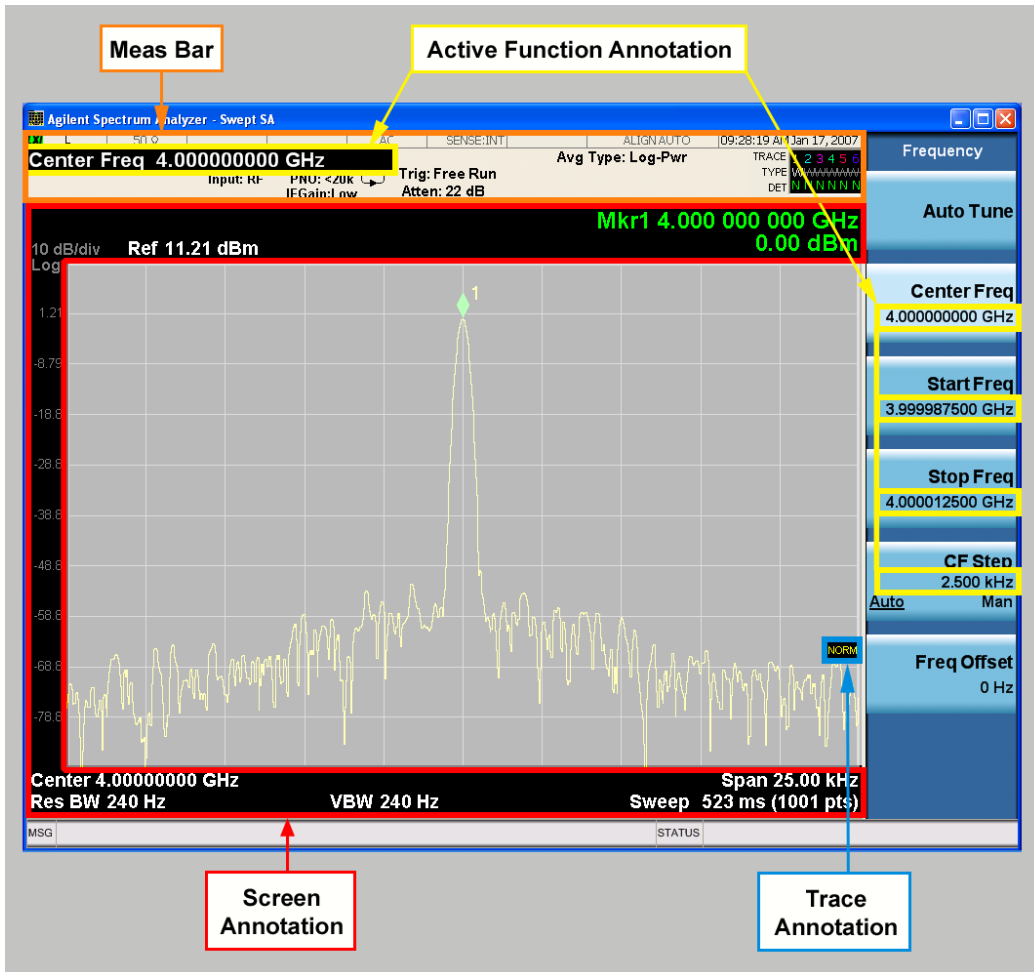

Key Path	View/Display, Display
Initial S/W Revision	Prior to A.02.00

### Meas Bar On/Off

This function turns the Measurement Bar on and off, including the settings panel. When off, the graticule area expands to fill the area formerly occupied by the Measurement Bar.

Key Path	View/Display, Display, Annotation
Remote Command	:DISPlay:ANNotation:MBAR[:STATE] OFF ON 0 1 :DISPlay:ANNotation:MBAR[:STATE]?
Example	DISP:ANN:MBAR OFF
Dependencies	Grayed out and forced to OFF when System Display Settings, Annotation is set to Off.
Preset	On This should remain Off through a Preset when System DisplaySettings, Annotation is set to Off.
State Saved	Saved in instrument state.
Initial S/W Revision	Prior to A.02.00

### Screen

This controls the display of the annunciation and annotation around the graticule, including any annotation on lines (such as the display line, the threshold line, etc.) and the y-axis annotation. This does NOT include marker annotation (or the N dB result). When off, the graticule expands to fill the entire graticule area, leaving only the 1.5% gap above the graticule as described in the Trace/Detector chapter.

<b>Key Path</b>	View/Display, Display, Annotation
<b>Remote Command</b>	:DISPlay:ANNotation:SCReen[:STATe] OFF ON 0 1 :DISPlay:ANNotation:SCReen[:STATe]?
<b>Example</b>	DISP:ANN:SCR OFF
<b>Dependencies</b>	Grayed-out and forced to OFF when System Display Settings, Annotation is set to Off.
<b>Preset</b>	On This should remain Off through a Preset when System DisplaySettings, Annotation is set to Off
<b>State Saved</b>	Saved in instrument state.
<b>Initial S/W Revision</b>	Prior to A.02.00

### Active Function Values On/Off

Turns on and off the active function display in the Meas Bar, and all of the active function values displayed on the softkeys.

Note that all of the softkeys that have active functions have these numeric values blanked when this function is on. This is a security feature..

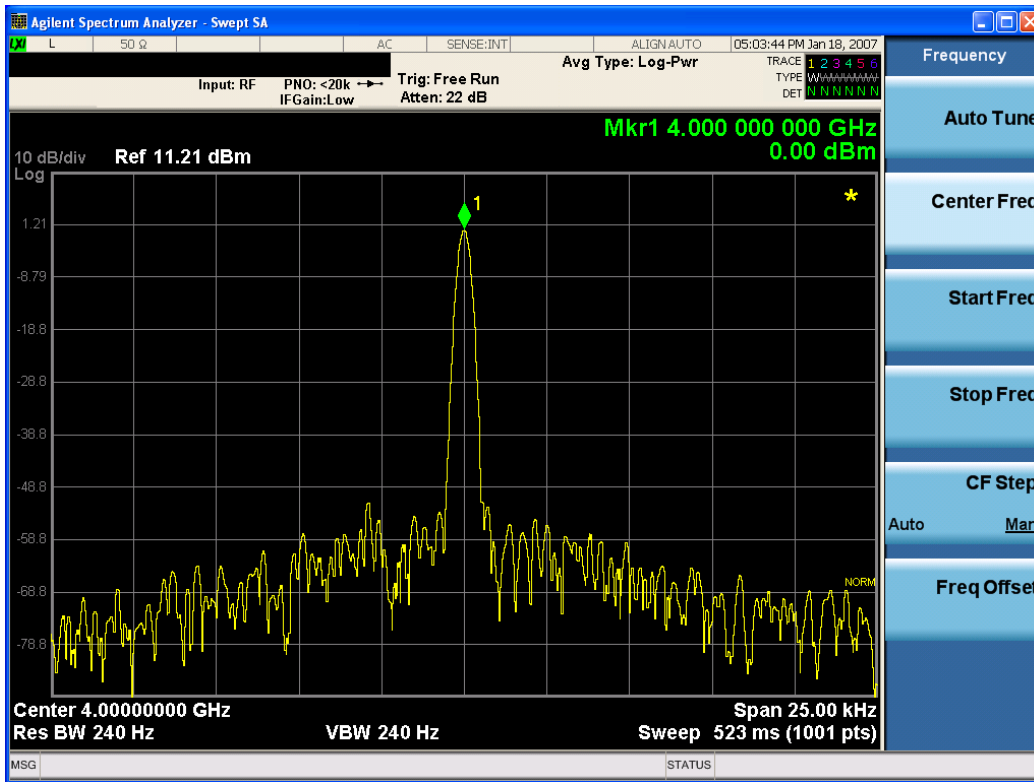

Key Path	View/Display, Display, Annotation
Remote Command	:DISPlay:ACTivefunc[:STATE] ON OFF 1 0 :DISPlay:ACTivefunc[:STATE]?
Example	DISP:ACT OFF
Dependencies	Grayed out and forced to OFF when System Display Settings, Annotation is set to Off.
Preset	On This should remain Off through a Preset when System DisplaySettings, Annotation is set to Off
State Saved	Saved in instrument state.
Initial S/W Revision	Prior to A.02.00

## Title

Displays menu keys that enable you to change or clear a title on your display.

Key Path	View/Display, Display
Initial S/W Revision	Prior to A.02.00

## Change Title

Writes a title into the "measurement name" field in the banner, for example, "Swept SA".

Press Change Title to enter a new title through the alpha editor. Press Enter or Return to complete the entry. Press ESC to cancel the entry and preserve your existing title.

The display title will replace the measurement name. It remains for this measurement until you press Change Title again, or you recall a state, or a Preset is performed. A title can also be cleared by pressing Title, Clear Title.

**NOTE**

Notice the inclusion of the <measurement> parameter in the command below. Because each measurement remembers the Display Title, the command must be qualified with the measurement name. For the Swept SA measurement this is not the case; no <measurement> parameter is used when changing the Display Title for the Swept SA measurement.

Key Path	View/Display, Display, Title
Mode	All
Remote Command	:DISPlay:<measurement>:ANNotation:TITLe:DATA <string> :DISPlay:<measurement>:ANNotation:TITLe:DATA?
Example	DISP:ANN:TITL:DATA "This Is My Title" This example is for the Swept SA measurement in the Spectrum Analyzer mode. The SANalyzer <measurement> name is not used. DISP:ACP:ANN:TITL:DATA "This Is My Title" This example is for Measurements other than Swept SA. Both set the title to: This Is My Title
Notes	Pressing this key cancels any active function. When a title is edited the previous title remains intact (it is not cleared) and the cursor goes at the end so that characters can be added or BKSP can be used to go back over previous characters.
Preset	No title (measurement name instead)
State Saved	Saved in instrument state.
Initial S/W Revision	Prior to A.02.00

**Clear Title**

Clears a title from the front-panel display. Once cleared, the title cannot be retrieved. After the title is cleared, the current Measurement Name replaces it in the title bar.

Key Path	View/Display, Display, Title
Example	The following commands clear the title and restore the measurement's original title: DISP:ANN:TITL:DATA "" This example is for the Swept SA measurement in the Spectrum Analyzer mode. The SANalyzer <measurement> name is not used. DISP:ACP:ANN:TITL:DATA "" This example is for ACP; in measurements other than Swept SA the measurement name is required.
Notes	Uses the :DISPlay:<measurement>:ANNotation:TITLe:DATA <string> command with an empty string (in the Swept SA, the <measurement> is omitted).
Preset	Performed on Preset.
Initial S/W Revision	Prior to A.02.00

## Graticule

Pressing Graticule turns the display graticule On or Off. It also turns the graticule y-axis annotation on and off.

Key Path	View/Display, Display
<b>Remote Command</b>	:DISPlay:WINDow[1]:TRACe:GRATicule:GRID[:STATe] OFF ON 0 1 :DISPlay:WINDow[1]:TRACe:GRATicule:GRID[:STATe]?
<b>Example</b>	DISP:WIND:TRAC:GRAT:GRID OFF
Notes	The graticule is the set of horizontal and vertical lines that make up the grid/divisions for the x-axis and y-axis.
Preset	On
State Saved	Saved in instrument state
Initial S/W Revision	Prior to A.02.00

## System Display Settings

These settings are "Mode Global" – they affect all modes and measurements and are reset only by Restore Misc Defaults or Restore System Defaults under System.

Key Path	View/Display, Display
Initial S/W Revision	Prior to A.02.00

## Annotation Local Settings

This is a Mode Global override of the meas local annotation settings. When it is All Off, it forces ScreenAnnotation, Meas Bar, Trace, and Active Function Values settings to be OFF for all measurements in all modes. This provides the security based "annotation off" function of previous analyzers; hence it uses the legacy SCPI command.

When it is All Off, the Screen, Meas Bar, Trace, and Active Function Values keys under the Display, Annotation menu are grayed out and forced to Off. When Local Settings is selected, you are able to set the local annotation settings on a measurement by measurement basis.

Key Path	View/Display, Display, System Display Settings
<b>Remote Command</b>	:DISPlay:WINDow[1]:ANNOtation[:ALL] OFF ON 0 1 :DISPlay:WINDow[1]:ANNOtation[:ALL]?
<b>Example</b>	:DISP:WIND:ANN OFF
Preset	On (Set by Restore Misc Defaults)
State Saved	Not saved in instrument state.
Backwards Compatibility Notes	The WINDow parameter and optional subopcode is included for backwards compatibility but ignored – all windows are equally affected.
Initial S/W Revision	Prior to A.02.00

## Themes

Accesses a menu of functions that enable you to choose the theme to be used when saving the screen image.

The **Themes** option is the same as the **Themes** option under the **Display** and **Page Setup** dialogs. It allows you to choose between themes to be used when saving the screen image.

<b>Key Path</b>	Save, Screen Image
<b>Remote Command</b>	:MMEMory:STORe:SCReen:THEMe TDColor   TDMonochrome   FCOLor   FMONochrome  :MMEMory:STORe:SCReen:THEMe?
<b>Example</b>	:MMEM:STOR:SCR:THEM TDM
<b>Preset</b>	3D Color; Is not part of Preset, but is reset by Restore Misc Defaults or Restore System Defaults All and survives subsequent running of the modes.
<b>Readback</b>	3D Color   3D Mono   Flat Color   Flat Mono
<b>Backwards Compatibility Notes</b>	In ESA and PSA we offer the choice of "Reverse Bitmap" or "Reverse Metafile" when saving screen images. This is much like the "Flat Color" theme available in X-Series. Also, if you selected Reverse Bitmap AND a black & white screen image, that would be much like "Flat Monochrome". In other words, each of the X-Series themes has a similar screen image type in ESA/PSA. But they are not identical.
<b>Initial S/W Revision</b>	Prior to A.02.00

### 3D Color

Selects a standard color theme with each object filled, shaded and colored as designed.

<b>Key Path</b>	Save, Screen Image, Themes
<b>Example</b>	MMEM:STOR:SCR:THEM TDC
<b>Readback</b>	3D Color
<b>Initial S/W Revision</b>	Prior to A.02.00

### 3D Monochrome

Selects a format that is like 3D color but shades of gray are used instead of colors.

<b>Key Path</b>	Save, Screen Image, Themes
<b>Example</b>	MMEM:STOR:SCR:THEM TDM
<b>Readback</b>	3D Mono
<b>Initial S/W Revision</b>	Prior to A.02.00



### Flat Color

Selects a format that is best when the screen is to be printed on an ink printer.

Key Path	Save, Screen Image, Themes
<b>Example</b>	MMEM:STOR:SCR:THEM FCOL
Readback	Flat Color
Initial S/W Revision	Prior to A.02.00

### Flat Monochrome

Selects a format that is like Flat Color. But only black is used (no colors, not even gray), and no fill.

Key Path	Save, Screen Image, Themes
<b>Example</b>	MMEM:STOR:SCR:THEM FMON
Readback	Flat Mono
Initial S/W Revision	Prior to A.02.00

### Backlight

Accesses the display backlight on/off keys. This setting may interact with settings under the Windows "Power" menu.

When the backlight is off, pressing ESC, TAB, SPACE, ENTER, UP, DOWN, LEFT, RIGHT, DEL, BKSP, CTRL, or ALT turns the backlight on without affecting the application. Pressing any other key will turn backlight on and could potentially perform the action as well.

Key Path	View/Display, Display, System Display Settings
<b>Remote Command</b>	:DISPlay:BACKlight ON OFF :DISPlay:BACKlight?
Preset	ON (Set by Restore Misc Defaults)
Initial S/W Revision	Prior to A.02.00

### Backlight Intensity

An active function used to set the backlight intensity. It goes from 0 to 100 where 100 is full on and 0 is off. This value is independent of the values set under the Backlight on/off key.

Key Path	View/Display, Display, System Display Settings
<b>Remote Command</b>	:DISPlay:BACKlight:INTensity <integer> :DISPlay:BACKlight:INTensity?
<b>Example</b>	DISP:BACK:INT 50

Preset	100 (Set by Restore Misc Defaults)
Min	0
Max	100
Initial S/W Revision	Prior to A.02.00

### Power Graph & Metrics

Provides a combination view of the code domain power graph and the summary data.

This view shows code domain power and its numeric results. There are two windows:

- "Power Bar Graph window" on page 2079 (upper)
- "Metrics window" on page 2079 (lower)

The figure below shows Power Graph & Metrics View when setting IQ Combined Off.

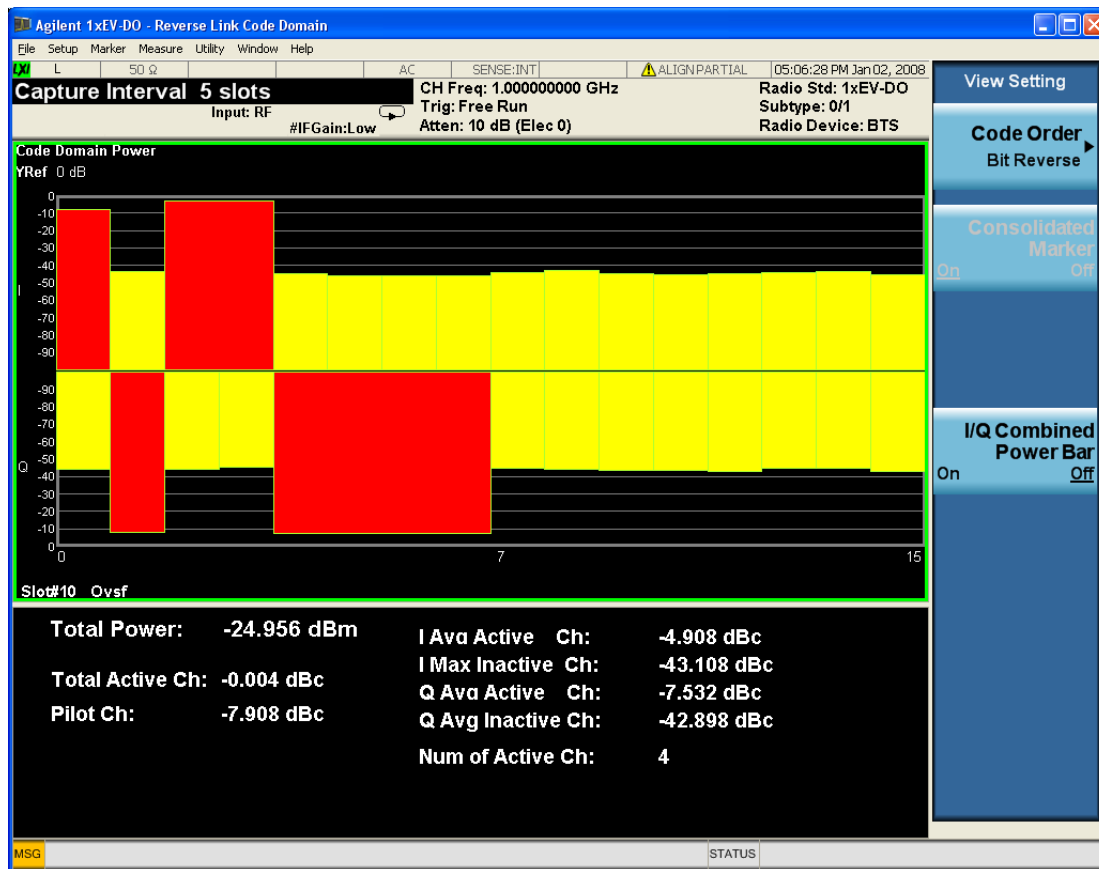

The figure below shows Power Graph & Metrics View when setting IQ Combined On.

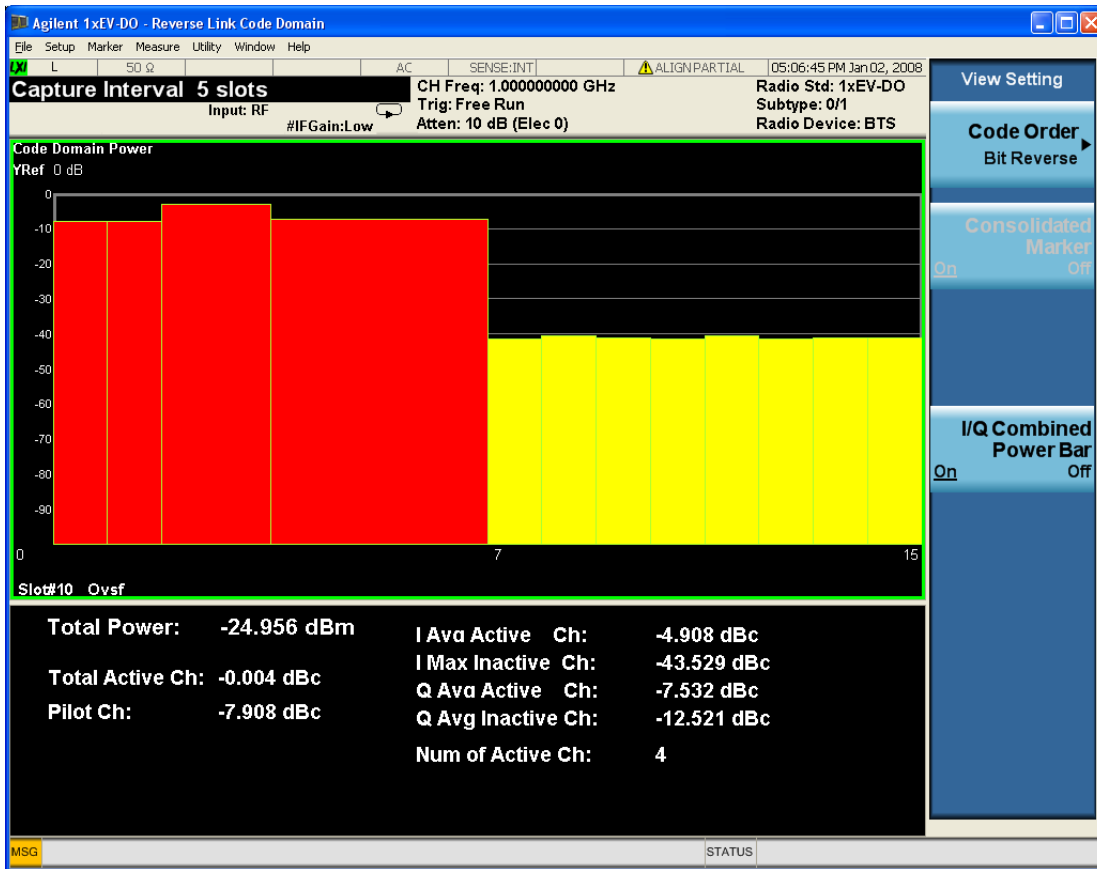

### Power Bar Graph window

Show code domain power.

Marker Operation	Yes
Corresponding Trace	CDPower (n=2)

This trace is of the slot specified by the Meas Offset. (Not averaged through meas interval.)

### Metrics window

Name	Corresponding Results	Display Format
Total Power	n=1 9th Total Power	-99.99 dBm
Total Active Ch	n=1 7th Total active power	-999.999 dB/dBm
Pilot	n=1 8th Pilot power	-99.999 dB/dBm
I Avg Active Ch	n=1 15th	-999.999 dB/dBm

Name	Corresponding Results	Display Format
	I channel Average active code power	
I Max Inactive Ch	n=1 16th I channel Max inactive code power	-999.999 dB/dBm
Q Avg Active Ch	n=1 17th Q channel Average active code power	-99.999 dB/dBm
Q Max Inactive Ch	n=1 18th Q channel Max inactive code power	-99.999 dB/dBm

These scalar results are of the slot specified by the Meas Offset. (Not averaged through meas interval.)  
Unit is switched by Meas Type key.

<b>Example</b>	DISP:CDP:MS:VIEW PGR DISP:CDP:MS:VIEW?
Initial S/W Revision	Prior to A.02.00

## Code Order

Sets the Walsh code order, Hadamard or Bit Reverse.

Key Path	View/Display,Power Graph &Metrics
Mode	1xEV-DO
<b>Remote Command</b>	:CALCulate:CDPower[:BTS]:WCode:ORder HADamard BREVerse :CALCulate:CDPower[:BTS]:WCode:ORder?
<b>Example</b>	:CALC:CDP:WCOD:ORD BREV :CALC:CDP:WCOD:ORD?
Notes	This key appears when Code Domain Power window is active.
Preset	HADamard
State Saved	Saved in instrument state.
Range	Hadamard   Bit Reverse
<b>Backwards Compatibility SCPI</b>	:CALCulate:CDPower:WCode:ORder
Initial S/W Revision	Prior to A.02.00

## Consolidated Marker

Toggles the consolidated marker function between On and Off.

Key Path	View/Display, Code Domain Power, Consolidated Marker
Mode	1xEVDO
<b>Remote Command</b>	:DISPlay:CDPower:MS:MARKer:CONSolidated ON OFF 1 0 :DISPlay:CDPower:MS:MARKer:CONSolidated?
<b>Example</b>	:DISPlay:CDPower:MS:MARKer:CONSolidated ON :DISPlay:CDPower:MS:MARKer:CONSolidated?
Notes	This soft key is displayed only when the CDP window is selected. This key is grayed out when the Code Order Bit Reverse key is selected. If set to On, the corresponding Walsh code channel power will be marked in the different color upon placing the marker at the consolidated Walsh code channel power. You must be in the 1xEVDO mode to use this command. Use INSTRument:SElect to set the mode.
Preset	ON
State Saved	Saved in instrument state.
Range	Off On
<b>Backwards Compatibility SCPI</b>	:DISPlay:TCDPower:MARKer:CONSolidated
Initial S/W Revision	Prior to A.02.00

## I/Q Combined Power Bar

Allows you to toggle the I/Q combined power display function between On and Off. If set to On, the I and Q power bars are consolidated on the upper side of the horizontal axis. If set to Off, the I and Q power bars are shown on the upper side and the lower side of the horizontal axis, respectively.

Code Domain Power when I/Q Combined Power Bar is set to OFF.

Key Path	View/Display, Power Graph & Metrics
Mode	1xEV-DO
<b>Remote Command</b>	:CALCulate:CDPower:MS:IQ:COMBined[:STATe] 0 1 OFF ON :CALCulate:CDPower:MS:IQ:COMBined[:STATe]?
<b>Example</b>	:CALC:CDP:MS:IQ:COMB ON :CALC:CDP:MS:IQ:COMB?
Notes	You must be in the 1xEV-DO mode to use this command. Use INSTRument:SElect to set the mode.
Preset	OFF
State Saved	Saved in instrument state.
Range	On   Off
<b>Backwards Compatibility SCPI</b>	:CALCulate:TCDPower:IQ:COMBined[:STATe]
Initial S/W Revision	Prior to A.02.00

### CDP Graph & CDE Graph

Provides a combination view of the code domain power graph and the code domain error.

There are two windows:

- "Code Domain Power Bar Graph window" on page 2083 (upper)
- "Code Domain Error Bar Graph window" on page 2083 (lower)

The two windows of Power Bar Graph and CDE graph are coupled in terms of:

- X/Y Scaling
- Composite Symbol Boundary, Display Symbol Rate

The figure below shows CDP Graph and CDE Graph View when setting IQ Combined Off.

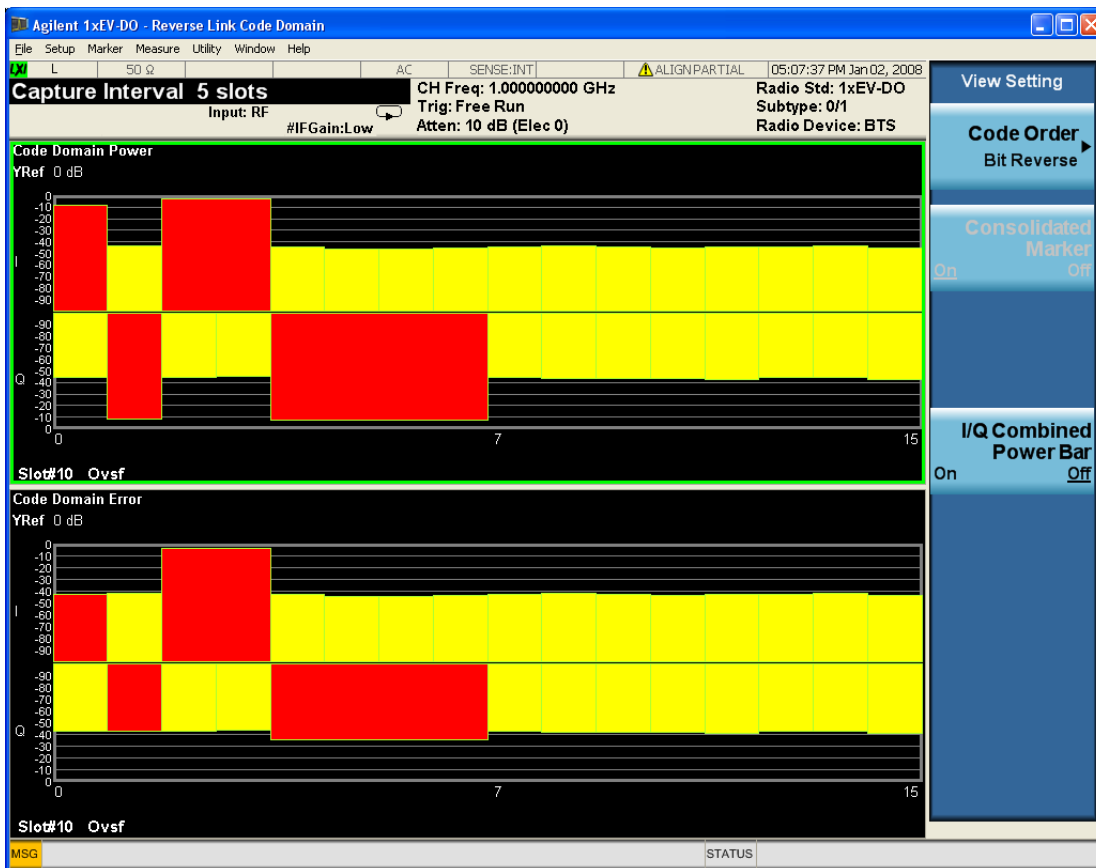

The figure below shows CDP Graph and CDE Graph View when setting IQ Combined On.

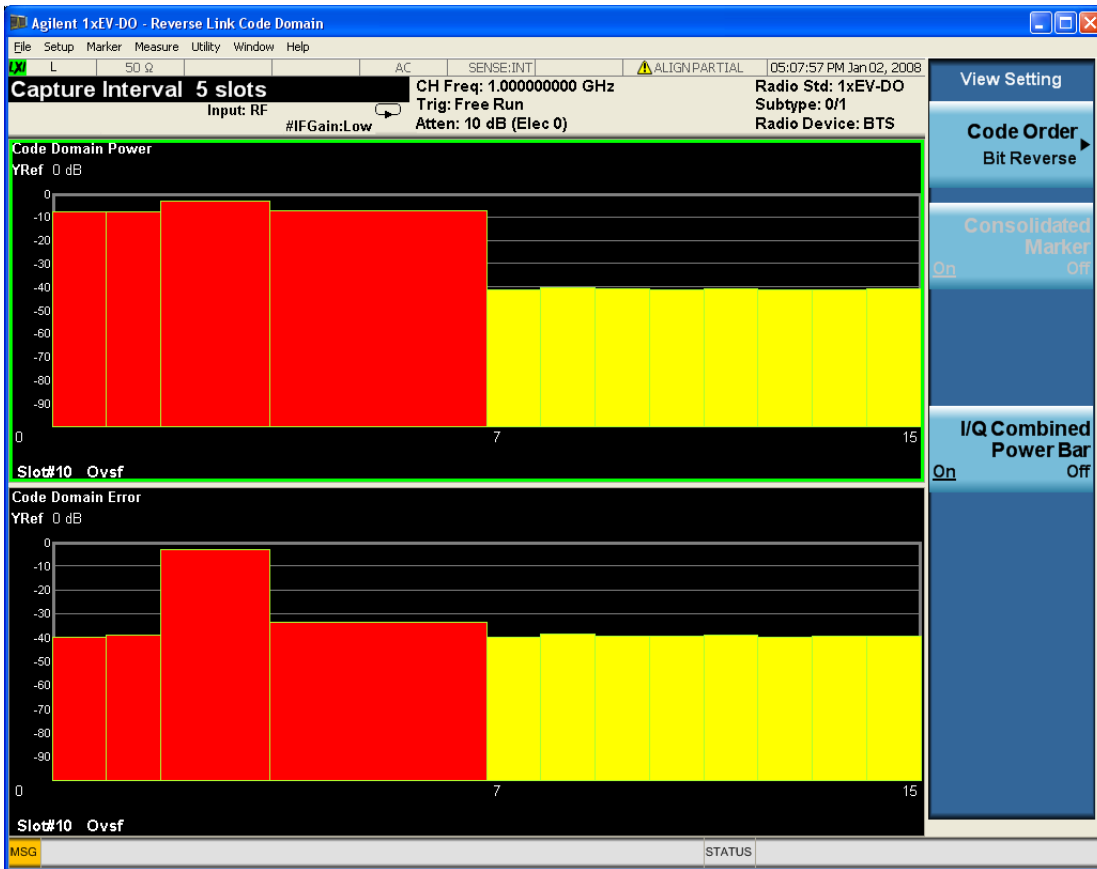

### Code Domain Power Bar Graph window

Show code domain power.

Marker Operation	Yes
Corresponding Trace	CDPower (n=2)

This trace is of the slot specified by the Meas Offset. (Not averaged through meas interval.)

### Code Domain Error Bar Graph window

Show code domain error.

Marker Operation	Yes
Corresponding Trace	CDError (n=8)

This trace is of the slot specified by the Meas Offset. (Not averaged through meas interval.)

<b>Example</b>	DISP:CDP:MS:VIEW CDPE DISP:CDP:MS:VIEW?
Initial S/W Revision	Prior to A.02.00

## Code Order

Sets the Walsh code order, Hadamard or Bit Reverse.

Key Path	View/Display, Power Graph & Metrics
Mode	1xEV-DO
<b>Remote Command</b>	:CALCulate:CDPower[:BTS]:WCOde:ORDer HADamard BREVerse :CALCulate:CDPower[:BTS]:WCOde:ORDer?
<b>Example</b>	:CALC:CDP:WCOD:ORD BREV :CALC:CDP:WCOD:ORD?
Notes	This key appears when Code Domain Power window is active.
Preset	HADamard
State Saved	Saved in instrument state.
Range	Hadamard   Bit Reverse
<b>Backwards Compatibility SCPI</b>	:CALCulate:CDPower:WCOde:ORDer
Initial S/W Revision	Prior to A.02.00

## Consolidated Marker

Toggles the consolidated marker function between On and Off.

Key Path	View/Display, Code Domain Power, Consolidated Marker
Mode	1xEVDO
<b>Remote Command</b>	:DISPlay:CDPower:MS:MARKer:CONSolidated ON OFF 1 0 :DISPlay:CDPower:MS:MARKer:CONSolidated?
<b>Example</b>	:DISPlay:CDPower:MS:MARKer:CONSolidated ON :DISPlay:CDPower:MS:MARKer:CONSolidated?
Notes	This soft key is displayed only when the CDP window is selected. This key is grayed out when the Code Order Bit Reverse key is selected. If set to On, the corresponding Walsh code channel power will be marked in the different color upon placing the marker at the consolidated Walsh code channel power. You must be in the 1xEVDO mode to use this command. Use INSTRument:SElect to set the mode.
Preset	ON
State Saved	Saved in instrument state.
Range	Off On
<b>Backwards Compatibility SCPI</b>	:DISPlay:TCDPower:MARKer:CONSolidated
Initial S/W Revision	Prior to A.02.00



## I/Q Combined Power Bar

Allows you to toggle the I/Q combined power display function between On and Off. If set to On, the I and Q power bars are consolidated on the upper side of the horizontal axis. If set to Off, the I and Q power bars are shown on the upper side and the lower side of the horizontal axis, respectively.

Code Domain Power when I/Q Combined Power Bar is set to OFF.

Key Path	View/Display, Power Graph & Metrics
Mode	1xEV-DO
Remote Command	:CALCulate:CDPower:MS:IQ:COMBined[:STATe] 0 1 OFF ON :CALCulate:CDPower:MS:IQ:COMBined[:STATe]?
Example	:CALC:CDP:MS:IQ:COMB ON :CALC:CDP:MS:IQ:COMB?
Notes	You must be in the 1xEV-DO mode to use this command. Use INSTRument:SElect to set the mode.
Preset	OFF
State Saved	Saved in instrument state.
Range	On   Off
Backwards Compatibility SCPI	:CALCulate:TCDPower:IQ:COMBined[:STATe]
Initial S/W Revision	Prior to A.02.00

## I/Q Error (Quad View) - Symbol EVM

Provides a combination view of magnitude error, phase error, Symbol EVM, and the summary data.

There are four windows:

- "Magnitude Error window" on page 2086 (upper left)
- "Phase Error window" on page 2086 (upper right)
- "Symbol EVM window" on page 2086 (lower left)
- "Metrics window" on page 2087 (lower right)

The Metrics window is exactly same as one in Code Domain (Quad View) view.

Result metrics window indicates the modulation scheme ("BPSK", "QPSK" or "8PSK") that was used in the measurement. If "Active Code Chan" setting is "Auto" or "Combination", the result is auto-detected one. If the setting is "Predefined", the result is the same as the specified one. The result of modulation scheme shows with data channel analysis when "Physical Layer subtype" is set to 2.

The figure below shows I/Q Error (Quad View) View.

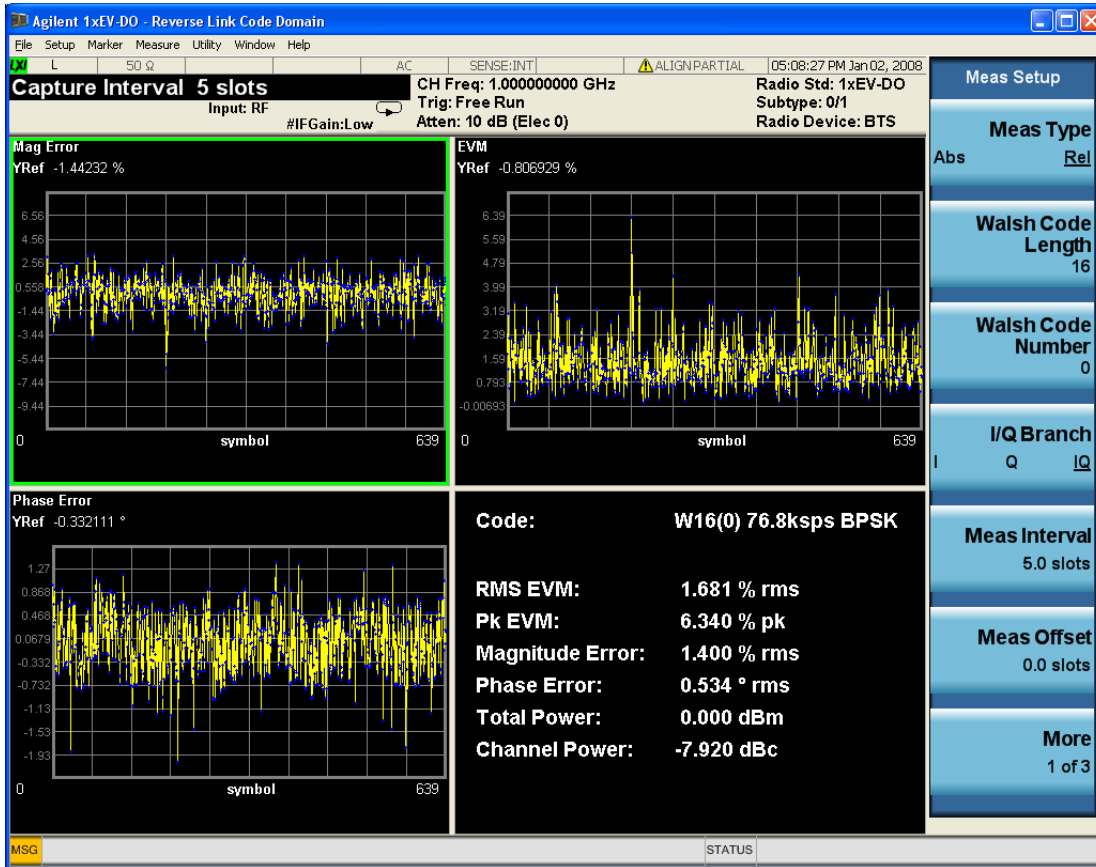

### Magnitude Error window

Marker Operation	Yes
Corresponding Trace	MERRor (n=6)

### Phase Error window

Marker Operation	Yes
Corresponding Trace	PERRor (n=7)

### Symbol EVM window

Marker Operation	Yes
Corresponding Trace	EVM (n=5)

## Metrics window

Name	Corresponding Results	Display Format
Code Number	NA	WX(Y) N ksps Mod Format X: Walsh Code length (2 .. 32) 2: 614.4ksps ... 32:38.4ksps Y: Walsh code number (0 .. X-1) N: 38.4,76.8, 153.6 ..., 614.4 ksps Mod Format: the detected modulation format with data channel analysis and Subtype 2 only. (BPSK, QPSK, 8PSK)
RMS EVM	n=1 1st RMS symbol EVM	99.99 % rms
Pk EVM	n=1 2nd Peak symbol EVM	99.99 % pk
Magnitude Error	n=1 3rd Symbol magnitude error	99.99 % rms
Phase Error	n=1 4th Symbol phase error	99.99 °rms
Total Power	n=1 5th Total power	-99.99 dBm
Channel Power	n=1 6th Channel Power	-99.99 dB/dBm

Unit is switched by Meas Type key.

<b>Example</b>	DISP:CDP:MS:VIEW SEVM DISP:CDP:MS:VIEW?
----------------	--------------------------------------------

Initial S/W Revision	Prior to A.02.00
----------------------	------------------

## Code Domain (Quad View)

Provides a combination view for the code domain power symbol power, I/Q symbol polar vector and the summary data.

There four windows:

- "Power Bar Graph window" on page 2088 (upper-left)
- "Symbol/Chip Power vs Time window" on page 2088 (upper right)
- "I/Q Symbol Polar Vector window" on page 2088 (lower-left)
- "Metrics window" on page 2089 (lower- right)

The figure below shows Code Domain (Quad View) View.

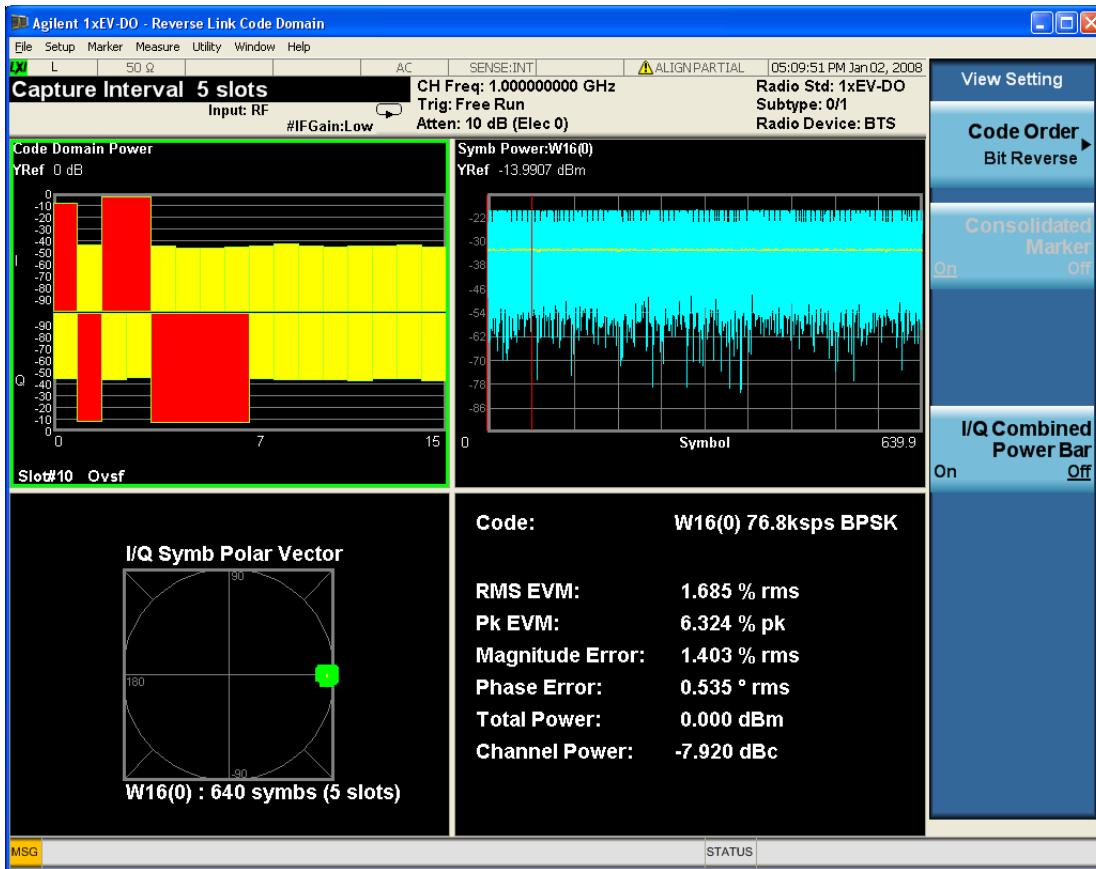

### Power Bar Graph window

This trace is of the slot specified by the Meas Offset. (Not averaged through meas interval.)

Marker Operation	Yes
Corresponding Trace	CDPower (n=2)

### Symbol/Chip Power vs Time window

Marker Operation	Yes
Corresponding Trace	SPOWer (n=9), CPOWer (n=10)

### I/Q Symbol Polar Vector window

This trace is of the slots specified by the Meas Offset and Meas Interval.

Marker Operation	
Corresponding Trace	(n=5)

## Metrics window

Name	Corresponding Results	Display Format
Code Number	NA	WX(Y) N ksp Mod Format X: Walsh Code length (2 .. 32) 2: 614.4ksp ... 32:38.4ksp Y: Walsh code number (0 .. X-1) N: 38.4,76.8, 153.6 ..., 614.4 ksp Mod Format: the detected modulation format with data channel analysis and Subtype2 only. (BPSK, QPSK, 8PSK)
RMS EVM	n=1 1st RMS symbol EVM	99.99 % rms
Pk EVM	n=1 2nd Peak symbol EVM	99.99 % pk
Magnitude Error	n=1 3rd Symbol magnitude error	99.99 % rms
Phase Error	n=1 4th Symbol phase error	99.99 °rms
Total Power	n=1 5th Total power	-99.99 dBm
Channel Power	n=1 6th Channel Power	-99.99 dB/dBm

Unit is switched by Meas Type key.

<b>Example</b>	DISP:CDP:MS:VIEW QUAD DISP:CDP:MS:VIEW?
Initial S/W Revision	Prior to A.02.00

## Code Order

Sets the Walsh code order, Hadamard or Bit Reverse.

Key Path	View/Display,Power Graph &Metrics
Mode	1xEV-DO
<b>Remote Command</b>	:CALCulate:CDPower[:BTS]:WCOde:ORDer HADamard BREVerse :CALCulate:CDPower[:BTS]:WCOde:ORDer?
<b>Example</b>	:CALC:CDP:WCOD:ORD BREV

	:CALC:CDP:WCOD:ORD?
Notes	This key appears when Code Domain Power window is active.
Preset	HADamard
State Saved	Saved in instrument state.
Range	Hadamard   Bit Reverse
<b>Backwards Compatibility SCPI</b>	:CALCulate:CDPower:WCODe:ORDer
Initial S/W Revision	Prior to A.02.00

### Consolidated Marker

Toggles the consolidated marker function between On and Off.

Key Path	View/Display, Code Domain Power, Consolidated Marker
Mode	1xEVDO
<b>Remote Command</b>	:DISPlay:CDPower:MS:MARKer:CONSolidated ON OFF 1 0 :DISPlay:CDPower:MS:MARKer:CONSolidated?
<b>Example</b>	:DISPlay:CDPower:MS:MARKer:CONSolidated ON :DISPlay:CDPower:MS:MARKer:CONSolidated?
Notes	This soft key is displayed only when the CDP window is selected. This key is grayed out when the Code Order Bit Reverse key is selected. If set to On, the corresponding Walsh code channel power will be marked in the different color upon placing the marker at the consolidated Walsh code channel power. You must be in the 1xEVDO mode to use this command. Use INSTRument:SElect to set the mode.
Preset	ON
State Saved	Saved in instrument state.
Range	Off On
<b>Backwards Compatibility SCPI</b>	:DISPlay:TCDPower:MARKer:CONSolidated
Initial S/W Revision	Prior to A.02.00

### I/Q Combined Power Bar

Allows you to toggle the I/Q combined power display function between On and Off. If set to On, the I and Q power bars are consolidated on the upper side of the horizontal axis. If set to Off, the I and Q power bars are shown on the upper side and the lower side of the horizontal axis, respectively.

Code Domain Power when I/Q Combined Power Bar is set to OFF.

Key Path	View/Display, Power Graph & Metrics
----------	-------------------------------------

Mode	1xEV-DO
<b>Remote Command</b>	:CALCulate:CDPower:MS:IQ:COMBined[:STATe] 0 1 OFF ON :CALCulate:CDPower:MS:IQ:COMBined[:STATe]?
<b>Example</b>	:CALC:CDP:MS:IQ:COMB ON :CALC:CDP:MS:IQ:COMB?
Notes	You must be in the 1xEV-DO mode to use this command. Use INSTRument:SElect to set the mode.
Preset	OFF
State Saved	Saved in instrument state.
Range	On   Off
<b>Backwards Compatibility SCPI</b>	:CALCulate:TCDPower:IQ:COMBined[:STATe]
Initial S/W Revision	Prior to A.02.00

## Demod Bits

Provides a combination view of the graphs for the code domain power and chip power, and the I/Q demodulated bit stream data for slots selected by the measurement interval and measurement offset.

There are three windows:

- "Power Bar Graph window" on page 2098 (upper-left)
- "Symbol/Chip Power window" on page 2098 (upper-right)
- "Demod Bits window" on page 2098 (lower)

And in Subtype 2, the number of symbols for data channel is over 2 code symbols. Therefore the prefix changes when the data channel with Q2, E4 and E2 modulation format.

- Q2 modulation format

16 Reverse Link Code Domain  
View/Display

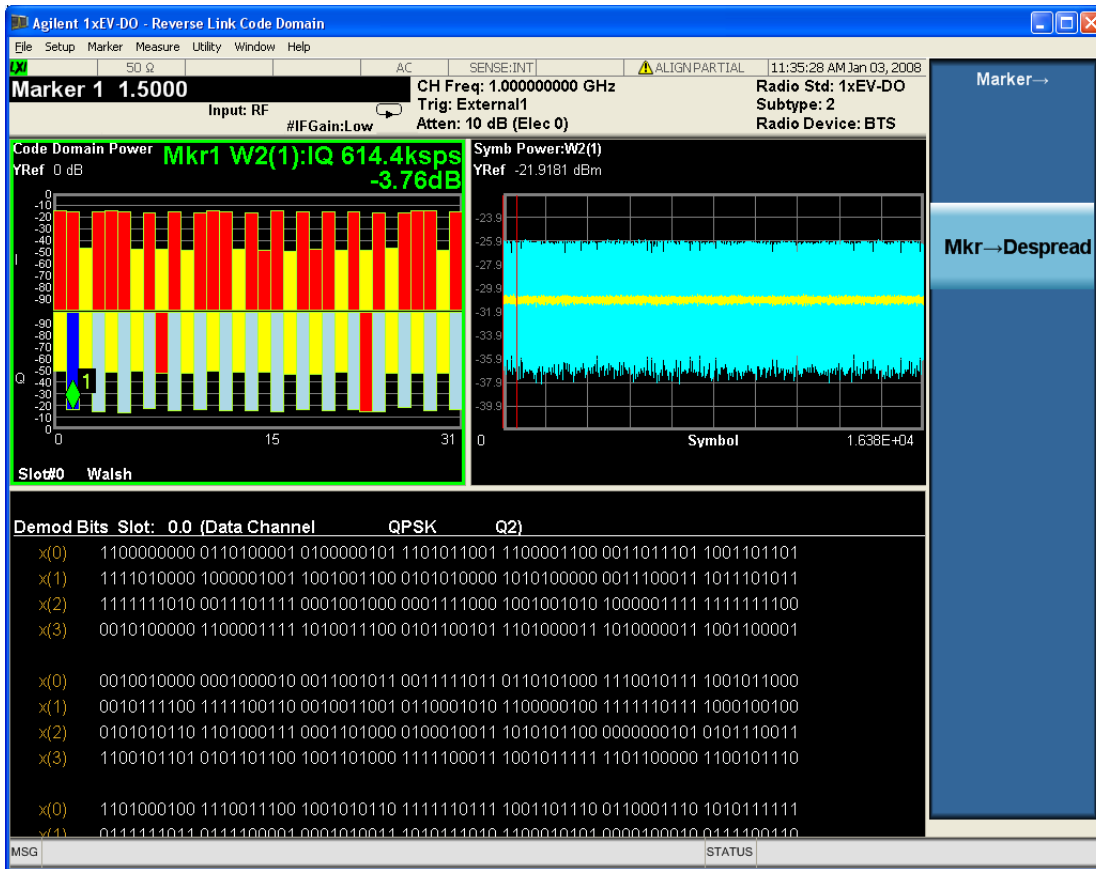

- E4 modulation format



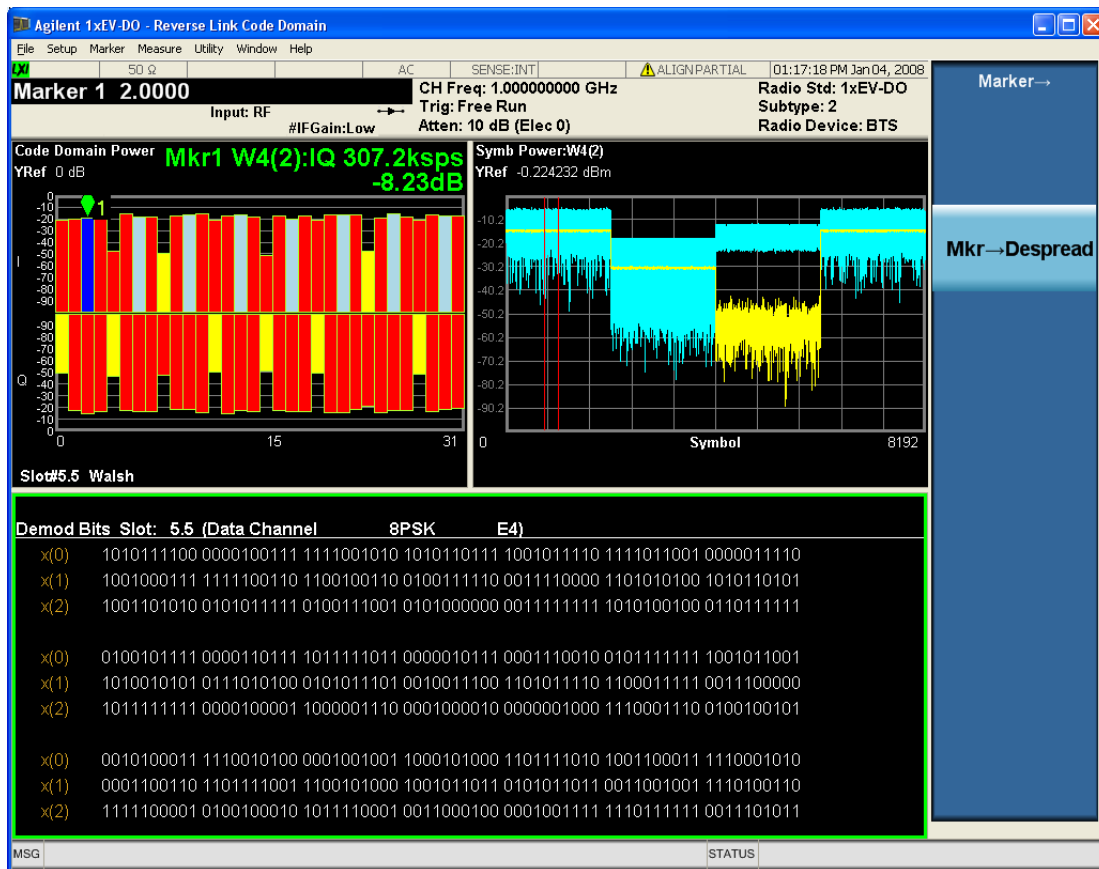

- E2 modulation format

16 Reverse Link Code Domain  
View/Display

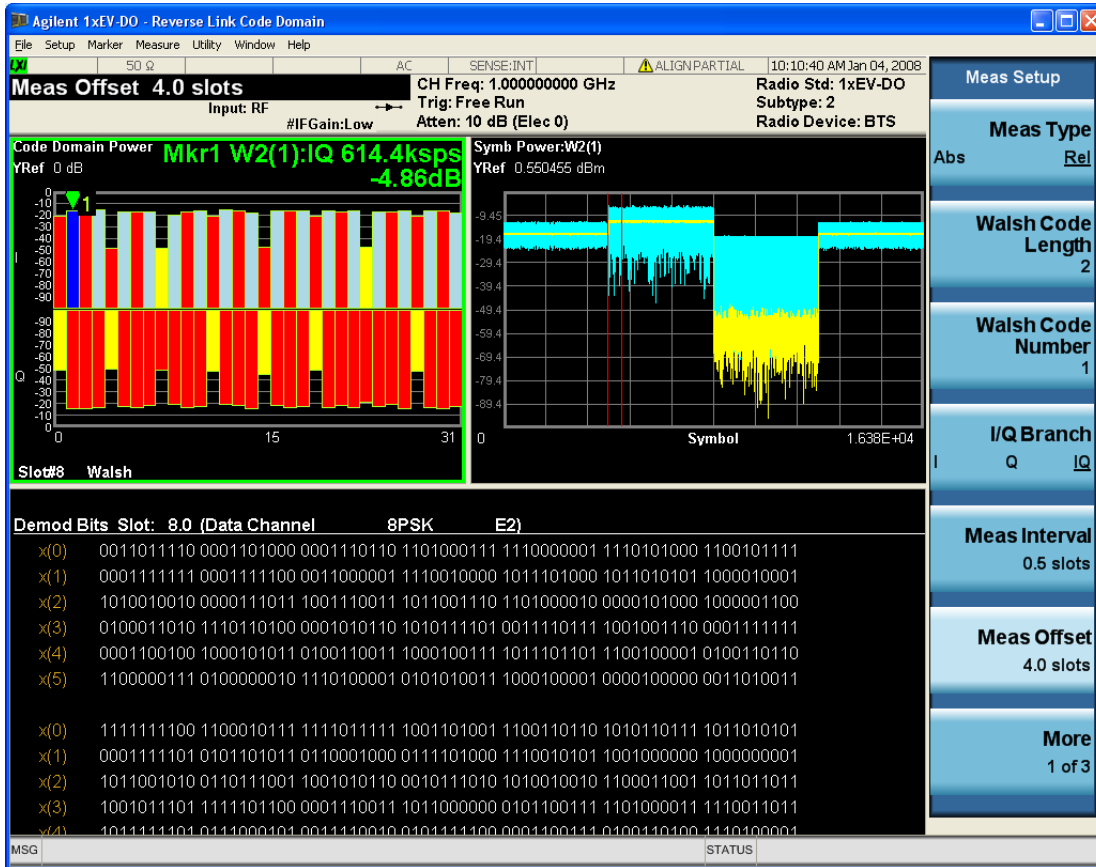

The modulation scheme can dynamically change in sub-frame boundary since 1xEV-DO reverse link support AMC (Adaptive Modulation and Coding). Therefore, correctly to demodulate AMC channel, it needs to detect the modulation scheme slot-by-slot. To support AMC, it returns Demod bits according to the modulation scheme dynamically changed. As a result, the bits data of different 'bit-per-symbols' could be mixed slot-by-slot.

The following figure is the demod bit window when the different modulation scheme is mixed. User knows the modulation scheme changed at Slot 15.5 and at Slot 0.

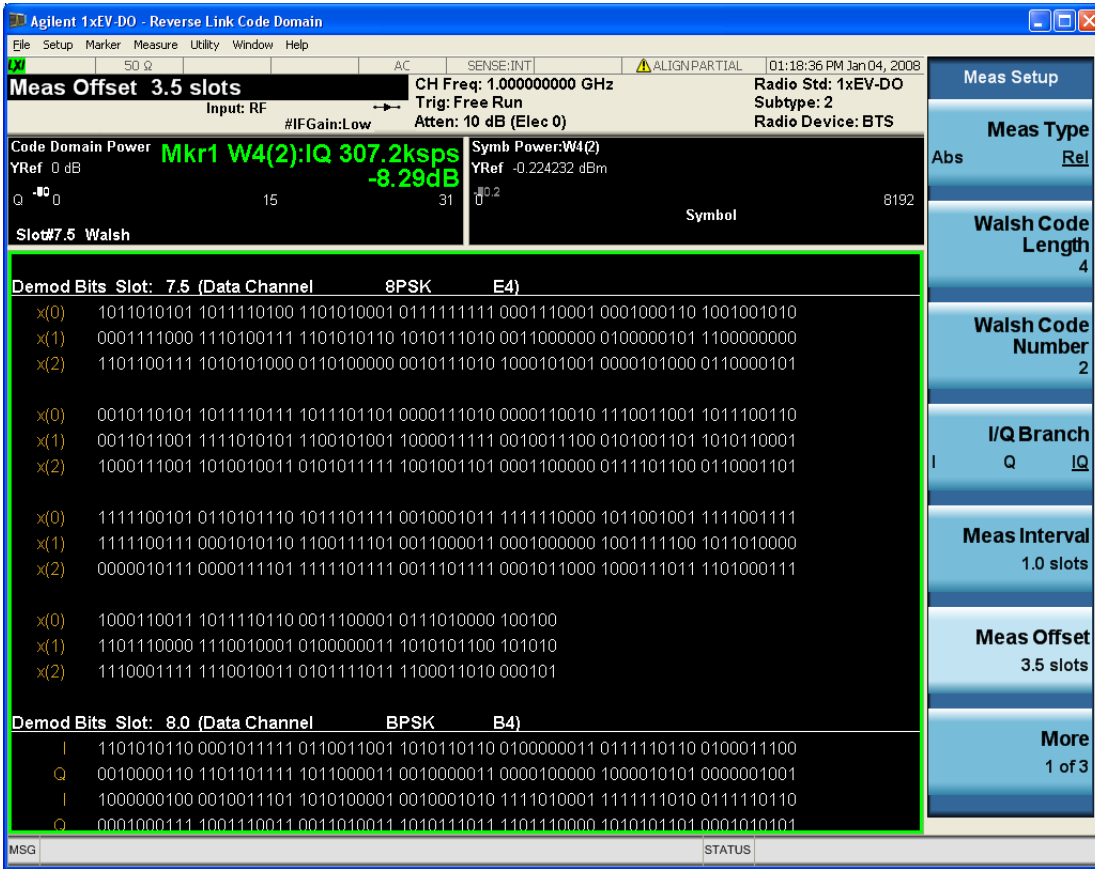

-DTX (Discontinuous Transmission) support

ACK channel code domain power repeats ON and OFF every half slot. This kind of transmission is called “DTX (Discontinuous Transmission)”. ON slot and OFF slot can detect automatically and the demod bit changes by following detected power. The demod bit with DTX represents “X” and distinguished from active part bit (0.0 and 1.0).

16 Reverse Link Code Domain  
View/Display

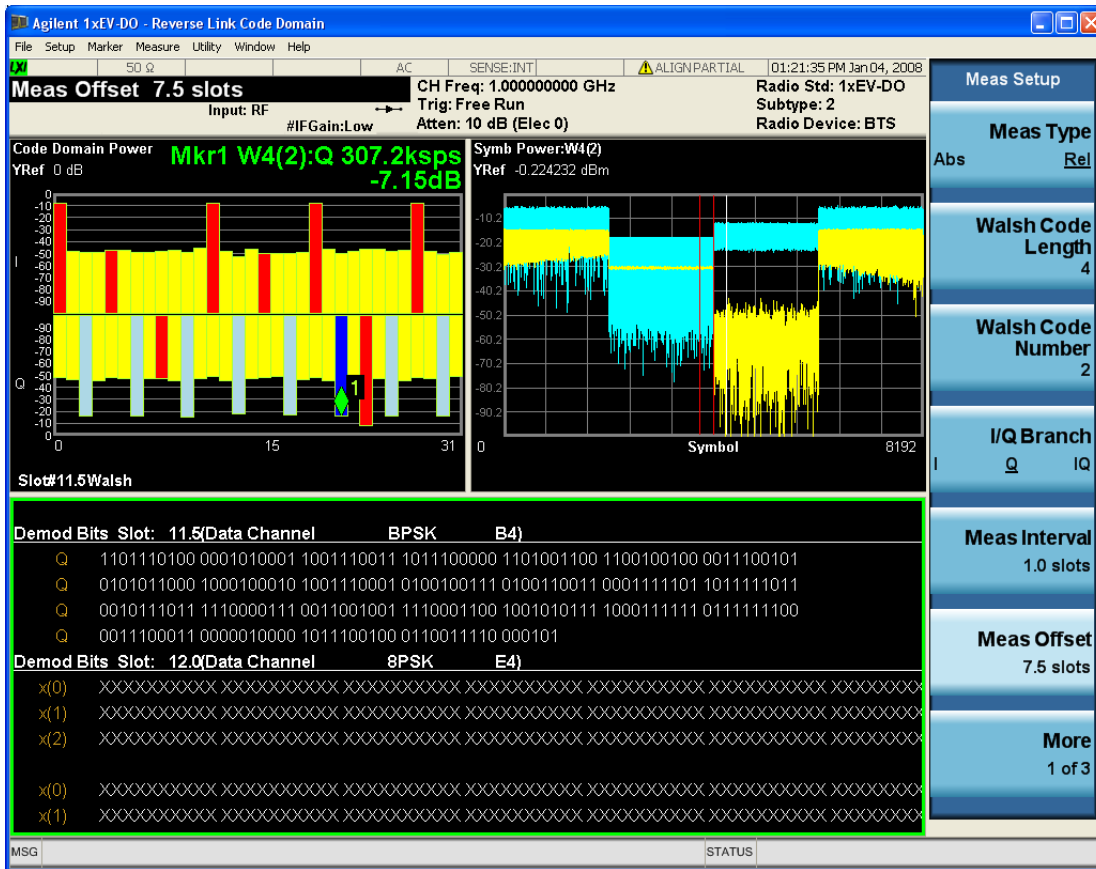

Changes in demod bit window with “I/Q Branch” key

1xEV-DO Reverse link Code domain measurement has “IQC” (I/Q Combined) parameter within “I/Q Branch” key. When “IQC” is selected, the representation of Demod bits window changes.

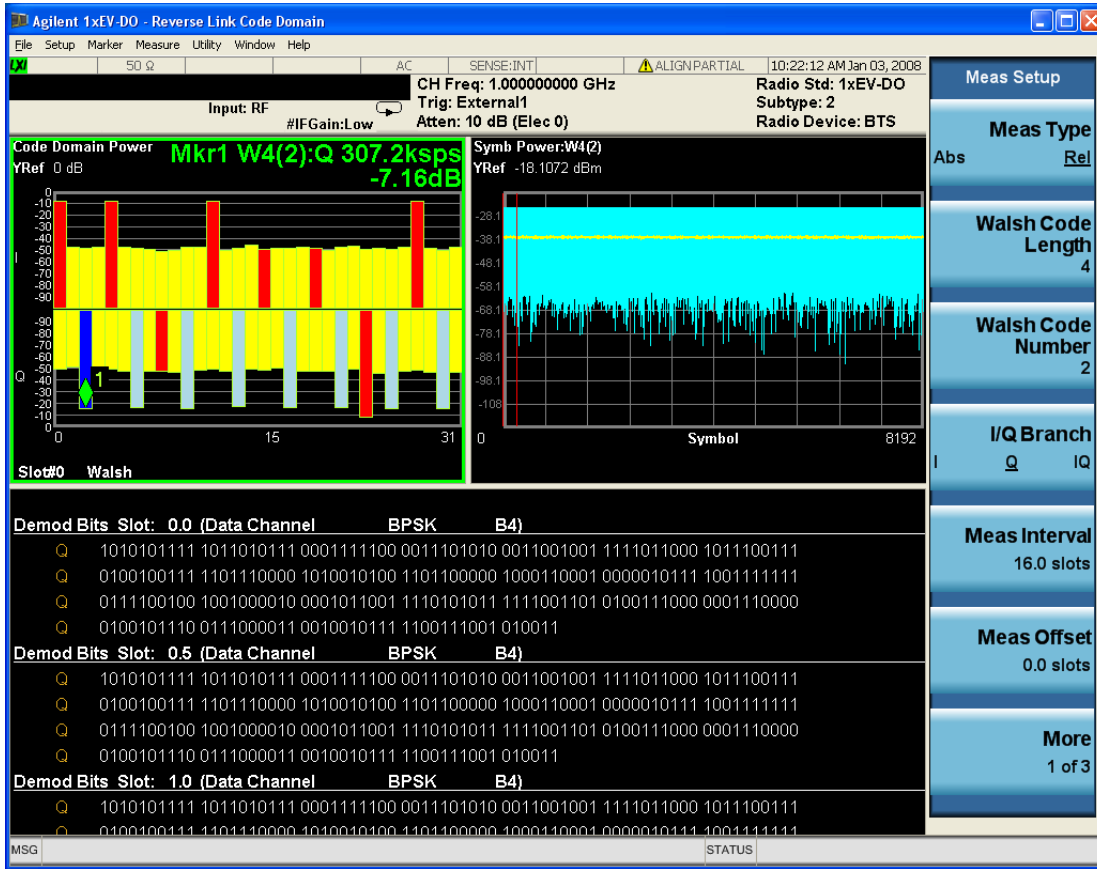

Branch changes between Q branch and IQC (IQ combined) branch

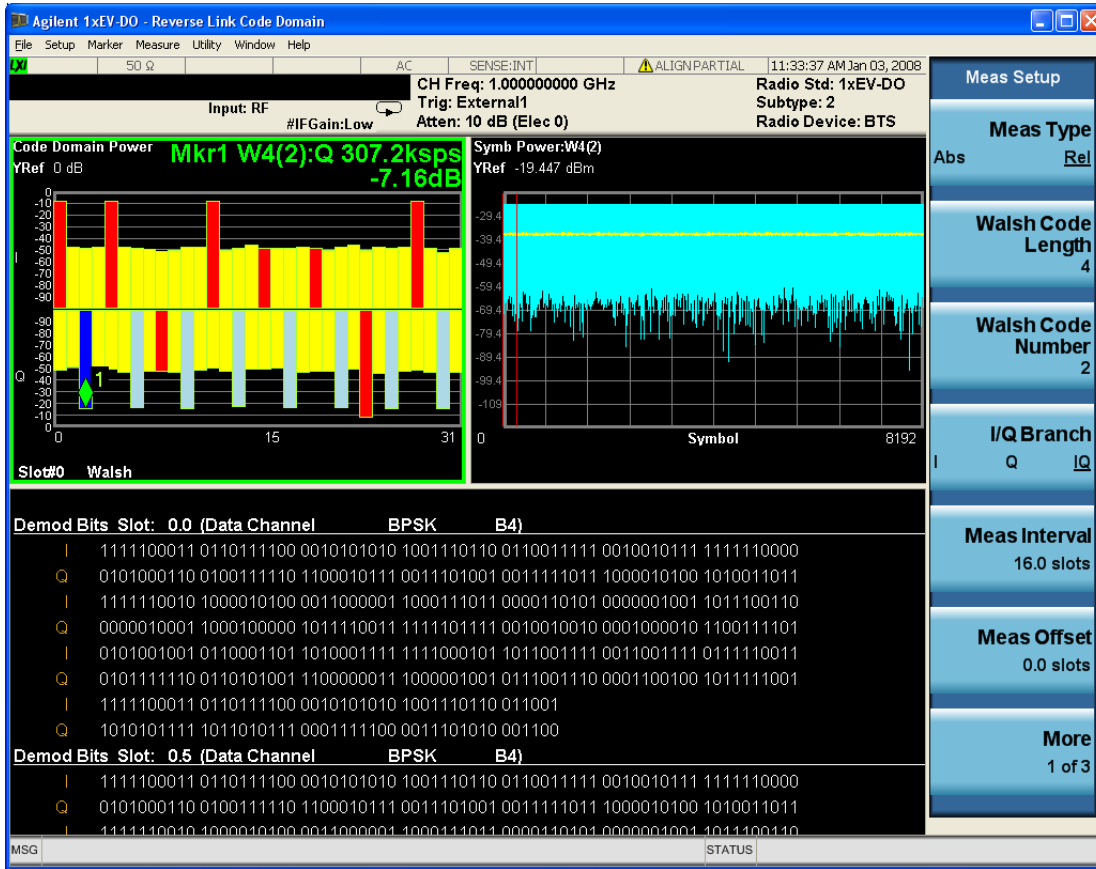

### Power Bar Graph window

This trace is of the slot specified by the Meas Offset. (Not averaged through meas interval.)

Marker Operation	Yes
Corresponding Trace	CDPower (n=2)

### Symbol/Chip Power window

This trace is of the slots specified by the Meas Offset and Meas Interval.

Marker Operation	Yes
Corresponding Trace	SPOWer (n=9), CPOWer (n=10)

### Demod Bits window

This trace is of the slots specified by the Meas Offset and Meas Interval.

Marker Operation	
Corresponding Trace	(n=11)

If the Demod Bits window is active in the Demod Bits view (window), the View/Display key accesses the menu to allow the following controls to read the bit stream measurement results:

- Prev Page - Returns one page back to the previous page of the measurement results.
- Next Page - Moves one page forward to the next page of the measurement results.
- Scroll Up - Moves one line upward from the current page of the measurement results by each pressing.
- Scroll Down - Moves one line downward from the current page of the measurement results by each pressing.
- First Page - Moves from the current page to the first page of the measurement results.
- Last Page - Moves from the current page to the last page of the measurement results.

<b>Example</b>	DISP:CDP:MS:VIEW DBIT DISP:CDP:MS:VIEW?
Initial S/W Revision	Prior to A.02.00

## Code Order

Sets the Walsh code order, Hadamard or Bit Reverse.

<b>Key Path</b>	View/Display, Power Graph & Metrics
<b>Mode</b>	1xEV-DO
<b>Remote Command</b>	:CALCulate:CDPower[:BTS]:WCODe:ORDer HADamard BREVerse :CALCulate:CDPower[:BTS]:WCODe:ORDer?
<b>Example</b>	:CALC:CDP:WCOD:ORD BREV :CALC:CDP:WCOD:ORD?
<b>Notes</b>	This key appears when Code Domain Power window is active.
<b>Preset</b>	HADamard
<b>State Saved</b>	Saved in instrument state.
<b>Range</b>	Hadamard   Bit Reverse
<b>Backwards Compatibility SCPI</b>	:CALCulate:CDPower:WCODe:ORDer
Initial S/W Revision	Prior to A.02.00

## Consolidated Marker

Toggles the consolidated marker function between On and Off.

<b>Key Path</b>	View/Display, Code Domain Power, Consolidated Marker
<b>Mode</b>	1xEVDO

<b>Remote Command</b>	:DISPlay:CDPower:MS:MARKer:CONSolidated ON OFF 1 0 :DISPlay:CDPower:MS:MARKer:CONSolidated?
<b>Example</b>	:DISPlay:CDPower:MS:MARKer:CONSolidated ON :DISPlay:CDPower:MS:MARKer:CONSolidated?
<b>Notes</b>	This soft key is displayed only when the CDP window is selected. This key is grayed out when the Code Order Bit Reverse key is selected. If set to On, the corresponding Walsh code channel power will be marked in the different color upon placing the marker at the consolidated Walsh code channel power. You must be in the 1xEVDO mode to use this command. Use INSTRument:SElect to set the mode.
<b>Preset</b>	ON
<b>State Saved</b>	Saved in instrument state.
<b>Range</b>	Off On
<b>Backwards Compatibility SCPI</b>	:DISPlay:TCDPower:MARKer:CONSolidated
<b>Initial S/W Revision</b>	Prior to A.02.00

## I/Q Combined Power Bar

Allows you to toggle the I/Q combined power display function between On and Off. If set to On, the I and Q power bars are consolidated on the upper side of the horizontal axis. If set to Off, the I and Q power bars are shown on the upper side and the lower side of the horizontal axis, respectively.

Code Domain Power when I/Q Combined Power Bar is set to OFF.

<b>Key Path</b>	View/Display, Power Graph & Metrics
<b>Mode</b>	1xEV-DO
<b>Remote Command</b>	:CALCulate:CDPower:MS:IQ:COMBined[:STATe] 0 1 OFF ON :CALCulate:CDPower:MS:IQ:COMBined[:STATe]?
<b>Example</b>	:CALC:CDP:MS:IQ:COMB ON :CALC:CDP:MS:IQ:COMB?
<b>Notes</b>	You must be in the 1xEV-DO mode to use this command. Use INSTRument:SElect to set the mode.
<b>Preset</b>	OFF
<b>State Saved</b>	Saved in instrument state.
<b>Range</b>	On   Off
<b>Backwards Compatibility SCPI</b>	:CALCulate:TCDPower:IQ:COMBined[:STATe]
<b>Initial S/W Revision</b>	Prior to A.02.00



## 17 Forward Link Modulation Accuracy

This key invokes the Forward Link Modulation Accuracy measurement.

Key Path	Measure
Initial S/W Revision	Prior to A.02.00

## Amplitude (AMPTD) Y Scale

The AMPLITUDE Y Scale key accesses the menu to set the desired vertical scale and associated settings. It specifies AMPLITUDE Y Scale setting when EVM, Magnitude Error, Phase Error, Code Domain Power, I/Q waveform or Chip Power is active.

Key Path	Front-panel key
Initial S/W Revision	Prior to A.02.00

### Attenuation

This menu controls the attenuator functions and interactions between the attenuation system components.

There are two attenuator configurations in the X-Series. One is a dual attenuator configuration consisting of a mechanical attenuator and an optional electronic attenuator. The other configuration uses a single attenuator with combined mechanical and electronic sections that controls all the attenuation functions. Different models in the X-Series come with different configurations.

See "[Dual Attenuator Configurations:](#)" on page 2102

See "[Single Attenuator Configuration:](#)" on page 2103

Most Attenuation settings are the same for all measurements – they do not change as you change measurements. Settings like these are called “Meas Global” and are unaffected by Meas Preset.

Key Path	AMPTD Y Scale
Scope	Meas Global
Dependencies	In measurements that support the I/Q inputs, this key is unavailable when I/Q is the selected input, and is replaced by the Range key in that case.
Readback Line	Contains a summary in [ ] brackets of the current total attenuation. See the descriptions of the , " <a href="#">(Mech) Atten</a> " on page 2783, and " <a href="#">Enable Elec Atten</a> " on page 2785 keys for more detail on the contributors to the total attenuation.  Note that when "Pre-Adjust for Min Clip" is on, this value can change at the start of every measurement.
Initial S/W Revision	Prior to A.02.00
Modified at S/W Revision	A.03.00

### Dual Attenuator Configurations:

Configuration 1: Mechanical attenuator + optional electronic attenuator

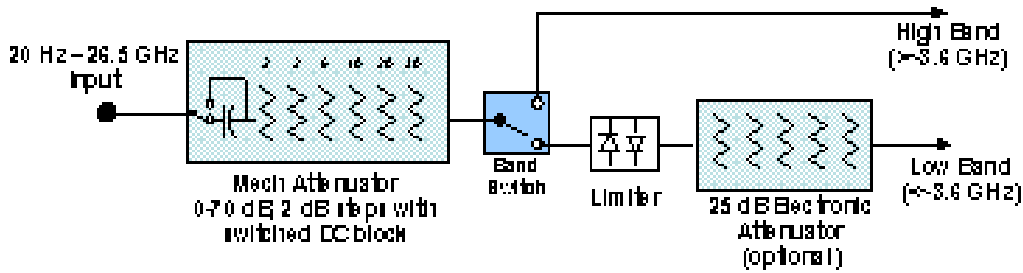

Configuration 2: Mechanical attenuator, no optional electronic attenuator

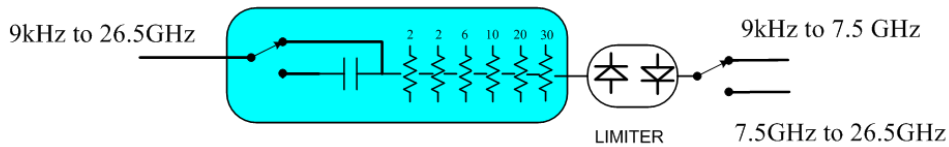

(note that Configuration 2 is not strictly speaking a dual-section attenuator, since there is no electronic section available. However, it behaves exactly like Configuration 1 without the Electronic Attenuator option EA3, therefore for the sake of this document it is grouped into the “Dual Attenuator” configuration)

**Single Attenuator Configuration:**

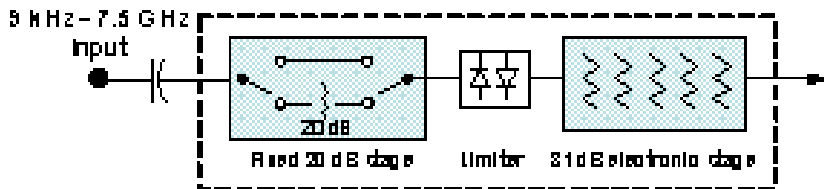

You can tell which attenuator configuration you have by pressing the Attenuation key, which (in most Modes) opens the Attenuation menu. If the first key in the Attenuation menu says Mech Atten you have the dual attenuator configuration. If the first key says Atten you have the single attenuator configuration.

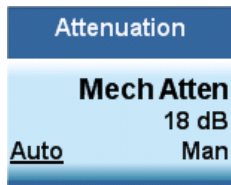

Dual Attenuator

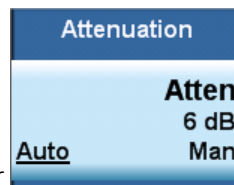

Single Attenuator

In the single attenuator configuration, you control the attenuation with a single control, as the fixed stage has only two states. In the dual attenuator configuration, both stages have significant range so you are given separate control of the mechanical and electronic attenuator stages.

When you have the dual attenuator configuration, you may still have only a single attenuator, because unless option EA3 (the Electronic Attenuator option) is available, and you purchase it, you will have only the mechanical attenuator.

## (Mech) Atten

This key is labeled Mech Atten in dual attenuator models and Atten in single attenuator models. In the dual attenuator configuration, this key only affects the mechanical attenuator.

This key lets you modify the attenuation applied to the RF input signal path. This value is normally auto coupled to the Ref Level, the Internal Preamp Gain, any External Gain that is entered, and the Max Mixer Level, as described in the table below.

See "[Attenuator Configurations and Auto/Man](#)" on page 2105

Key Path	AMPTD Y Scale, Attenuation
Remote Command	<pre>[ :SENSE ] :POWER [ :RF ] :ATTenuation &lt;rel_ampl&gt; [ :SENSE ] :POWER [ :RF ] :ATTenuation? [ :SENSE ] :POWER [ :RF ] :ATTenuation:AUTO OFF ON 0 1 [ :SENSE ] :POWER [ :RF ] :ATTenuation:AUTO?</pre>
Example	<p>POW:ATT 20</p> <p>Dual attenuator configuration: sets the mechanical attenuator to 20 dB</p> <p>Single attenuator mode: sets the main attenuation to 20 dB (see below for definition of “main” attenuation).</p> <p>If the attenuator was in Auto, it sets it to Manual.</p>
Dependencies	<p>Some measurements do not support the Auto setting of (Mech) Atten. In these measurements, the Auto/Man selection is not available, and the Auto/Man line on the key disappears.</p> <p>In dual attenuator configurations, when the electronic attenuator is enabled, the mechanical attenuator has no auto setting and the Auto/Man line on the key disappears. The state of Auto/Man is remembered and restored when the electronic attenuator is once again disabled. This is described in more detail in the "<a href="#">Enable Elec Atten</a>" on page 2785 key description.</p> <p>See "<a href="#">Attenuator Configurations and Auto/Man</a>" on page 2105 for more information on the Auto/Man functionality of Attenuation.</p>
Couplings	<p>When (Mech) Atten is in Auto, it uses the following algorithm to determine a value:</p> <p>If the USB Preamp is connected to USB, use 0 dB.</p> <p>Otherwise, <math>Atten = ReferenceLevel + PreAmpGain + ExternalGain - RefLevelOffset - MaxMixerLevel + IF\ Gain</math>.</p> <p>Limit this value to be between 6 dB and the Max value. No value below 6 dB can ever be chosen by Auto.</p> <p>The resulting value is rounded up to the largest value possible given the attenuation step setting. That is, 50.01 dB would change to 60 dB (for a 10 dB attenuation step).</p> <p>The “IF Gain” term in the equation above is either 0 dB or +10 dB, depending on the settings of FFT IF Gain, Swept IF Gain, max Ref Level and the Auto/Man setting of Mech Atten.</p> <p>In External Mixing and BBIQ, where the Attenuator is not in the signal path, the Attenuator setting changes as described above when (Mech) Atten is in Auto, but no changes are made to the actual attenuator hardware setting until the input is changed back to the RF Input.</p>
Preset	<p>The preset for Mech Attenuation is “Auto.”</p> <p>The Auto value of attenuation is:</p> <p>CXA, EXA, MXA and PXA: 10 dB</p>

State Saved	Saved in instrument state
Min	0 dB The attenuation set by this key cannot be decreased below 6 dB with the knob or step keys. To get to a value below 6 dB it has to be directly entered from the keypad or via SCPI. This protects from adjusting the attenuation to a dangerously small value which can put the instrument at risk of damage to input circuitry. However, if the current mechanical attenuation is below 6 dB it can be increased with the knob and step keys, but not decreased.
Max	CXA N9000A-503/507: 50 dB CXA N9000A-513/526: 70dB EXA: 60 dB MXA and PXA: 70 dB In the single attenuator configuration, the total of ATT and EATT cannot exceed 50 dB, so if the EATT is set to 24 dB first, the main attenuation cannot be greater than 26 dB and will be reduced accordingly; if the main attenuator is set to 40 dB first, EATT cannot be greater than 10 dB.
Initial S/W Revision	Prior to A.02.00
Modified at S/W Revision	A.03.00

### Attenuator Configurations and Auto/Man

As described in the Attenuation key description, there are two distinct attenuator configurations available in the X-Series, the single attenuator and dual attenuator configurations. In dual attenuator configurations, we have the mechanical attenuation and the electronic attenuation, and the current total attenuation is the sum of the electronic + mechanical attenuation. In single attenuator configurations, we refer to the attenuation set using the (Mech) Atten key (or POW:ATT SCPI) as the “main” attenuation; and the attenuation that is set by the SCPI command POW:EATT as the “soft” attenuation (the POW:EATT command is honored even in the single attenuator configuration, for compatibility purposes). Then the current total attenuation is the sum of the main + soft attenuation. See the Elec Atten key description for more on “soft” attenuation.

In the dual attenuator configuration, when the electronic attenuator is enabled, there is no Auto/Man functionality for the mechanical attenuator, and the third line of the key label (the Auto/Man line) disappears:

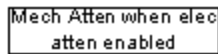
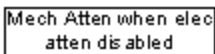
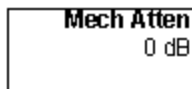
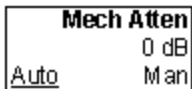

usdB

### Enable Elec Atten

Enables the Electronic Attenuator.

The electronic attenuator offers finer steps than the mechanical attenuator, has no acoustical noise, is faster, and is less subject to wear. These advantages primarily aid in remote operation and are negligible

for front panel use. See ["Using the Electronic Attenuator: Pros and Cons" on page 2107](#) for a detailed discussion of the pros and cons of using the electronic attenuator.

For the single attenuator configuration, for SCPI backwards compatibility, the “soft” attenuation feature replaces the dual attenuator configuration’s electronic attenuator. All the same couplings and limitations apply. See ["Attenuator Configurations and Auto/Man" on page 2785](#)

See ["More Information" on page 2106](#)

<b>Key Path</b>	AMPTD Y Scale, Attenuation
<b>Remote Command</b>	[ :SENSe ] :POWer [ :RF ] :EATTenuation:STATe OFF ON 0 1 [ :SENSe ] :POWer [ :RF ] :EATTenuation:STATe?
<b>Example</b>	POW:EATT:STAT ON
<b>Dependencies</b>	<p>This key only appears in Dual Attenuator models with an Electronic Attenuator installed. It does not appear in models with the Single Attenuator configuration, as in the single attenuator configuration there is no “electronic attenuator” there is only a single integrated attenuator (which has both a mechanical and electronic stage). However, in the single attenuator configuration, EATT SCPI commands are accepted for compatibility with other X-series instruments and set a “soft” attenuation as described in <a href="#">"Attenuator Configurations and Auto/Man" on page 2785</a>.</p> <p>The electronic attenuator (and the “soft” attenuation function provided in single attenuator configurations) is unavailable above 3.6 GHz. Therefore, if the Stop Frequency of the analyzer is &gt; 3.6 GHz then the Enable Elec Atten key will be OFF and grayed out.</p> <p>If the Internal Preamp is on, meaning it is set to Low Band or Full, the electronic attenuator (and the “soft” attenuation function provided in single attenuator configurations) is unavailable. In this case the Enable Elec Atten key will be OFF and grayed out.</p> <p>If either of the above is true, if the SCPI command is sent, an error indicating that the electronic attenuator is unavailable will be sent.</p> <p>If the electronic/soft Attenuator is enabled, then the Stop Freq of the analyzer is limited to 3.6 GHz and the Internal Preamp is unavailable.</p> <p>The SCPI-only “soft” electronic attenuation for the single-attenuator configuration is not available in all measurements; in particular, it is not available in the Swept SA measurement.</p>
<b>Couplings</b>	Enabling and disabling the Electronic Attenuator affects the setting of the Mechanical Attenuator (in dual attenuator configurations). This is described in more detail below this table.
<b>Preset</b>	OFF for Swept SA measurement; ON for all other measurements that support the electronic attenuator
<b>State Saved</b>	Saved in instrument state
<b>Initial S/W Revision</b>	Prior to A.02.00
<b>Modified at S/W Revision</b>	A.03.00

## More Information

### Mechanical Attenuator Transition Rules

When the Electronic Attenuator is enabled, the Mechanical Attenuator transitions to a state that has no Auto function. Below are the rules for transitioning the Mechanical Attenuator. NOTE that the information

below ONLY applies to the dual attenuator configurations, and ONLY when the Electronic Attenuator is installed:

**When the Electronic Attenuation is enabled from a disabled state:**

- The Mechanical Attenuator is initialized to 10 dB (this is its optimal performance setting). You can then set it as desired with SCPI, numeric keypad, step keys, or knob, and it behaves as it normally would in manual mode
- The Auto/Man state of (Mech) Atten is saved
- The Auto/Man line on the (Mech) Atten key disappears and the auto rules are disabled
- The Electronic Attenuator is set to 10 dB less than the previous value of the Mechanical Attenuator, within the limitation that it must stay within the range of 0 to 24 dB of attenuation.

**Examples in the dual attenuator configuration:**

- Mech Atten at 20 dB. Elec Atten enabled, Mech Atten set to 10 dB, and Elec Atten set to 10 dB. New total attenuation equals the value before Elec Atten enabled.
- Mech Atten at 0 dB. Elec Atten enabled, Mech Atten set to 10 dB, and Elec Atten set to 0 dB. New total attenuation does not equal the value before Elec Atten enabled.
- Mech Atten at 40 dB. Elec Atten enabled, Mech Atten set to 10 dB, and Elec Atten set to 24 dB. New total attenuation does not equal the value before Elec Atten enabled.

**When the Electronic Attenuation is disabled from an enabled state:**

- The Elec Atten key is grayed out
- The Auto/Man state of (Mech) Atten is restored
- If now in Auto, (Mech) Atten recouples
- If now in Man, (Mech) Atten is set to the value of total attenuation that existed before the Elec Atten was disabled. The resulting value is rounded up to the smallest value possible given the (Mech) Atten Step setting - (That is, 57 dB changes to 58 dB when (Mech) Atten Step is 2 dB.)

**Using the Electronic Attenuator: Pros and Cons**

The electronic attenuator offers finer steps than the mechanical attenuator, has no acoustical noise, is faster, and is less subject to wear.

The “finer steps” advantage of the electronic attenuator is beneficial in optimizing the alignment of the analyzer dynamic range to the signal power in the front panel as well as remote use. Thus, you can achieve improved relative signal measurement accuracy. Compared to a mechanical attenuator with 2 dB steps, the 1 dB resolution of the electronic attenuator only gives better resolution when the odd-decibel steps are used. Those odd-decibel steps are less accurately calibrated than the even-decibel steps, so one tradeoff for this superior relative accuracy is reduced absolute amplitude accuracy.

Another disadvantage of the electronic attenuator is that the spectrum analyzer loses its “Auto” setting, making operation less convenient.

Also, the relationship between the dynamic range specifications (TOI, SHI, compression and noise) and instrument performance are less well-known with the electrical attenuator. With the mechanical

attenuator, TOI, SHI and compression threshold levels increase dB-for-dB with increasing attenuation, and the noise floor does as well. With the electronic attenuator, there is an excess attenuation of about 1 to 3 dB between 0 and 3.6 GHz, making the effective TOI, SHI, and so forth, less well known. Excess attenuation is the actual attenuation relative to stated attenuation. Excess attenuation is accounted for in the analyzer calibration

## Elec Atten

Controls the Electronic Attenuator in dual attenuator configurations. This key does not appear in single attenuator configurations, as the control of both the mechanical and electronic stages of the single attenuator is integrated into the single Atten key.

Key Path	AMPTD Y Scale, Attenuation
Remote Command	[ :SENSe ] :POWer [ :RF ] :EATTenuation <rel_ampl> [ :SENSe ] :POWer [ :RF ] :EATTenuation?
Notes	Electronic Attenuation's specification is defined only when Mechanical Attenuation is 6 dB.
Dependencies	This key only appears in Dual Attenuator models with an Electronic Attenuator installed. It does not appear in models with the Single Attenuator configuration, as in the single attenuator configuration there is no "electronic attenuator" there is only a single integrated attenuator (which has both a mechanical and electronic stage). However, in the single attenuator configuration, EATT SCPI commands are accepted for compatibility with other X-series instruments and set a "soft" attenuation as described in <a href="#">"Attenuator Configurations and Auto/Man" on page 2785</a> . The "soft" attenuation is treated as an addition to the "main" attenuation value set by the Atten softkey or the POW:ATT SCPI command and affects the total attenuation displayed on the Attenuation key and the Meas Bar.  When Enable Elec Atten is off or grayed out, the Elec Atten key is grayed out.
Preset	0 dB
State Saved	Saved in instrument state
Min	0 dB
Max	Dual attenuator configuration: 24 dB Single attenuator configuration: the total of ATT and EATT cannot exceed 50 dB, so if the EATT is set to 24 dB first, the main attenuation cannot be greater than 26 dB and will be reduced accordingly; if the main attenuator is set to 40 dB first, EATT cannot be greater than 10 dB
Initial S/W Revision	Prior to A.02.00
Modified at S/W Revision	A.03.00

## Adjust Atten for Min Clip

Sets the combination of mechanical and electronic attenuation and gain based on the current measured signal level so that clipping will be at a minimum.

This is an "immediate action" function, that is, it executes once, when the key is pressed.

This key is grayed out in measurements that do not support this functionality. The spectrum analyzer measurement, Swept SA, does not support this functionality.



Key Path	AMPTD Y Scale, Attenuation
<b>Remote Command</b>	<code>[ :SENSe ] :POWer [ :RF ] :RANGe:OPTimize IMMEDIATE</code>
Initial S/W Revision	Prior to A.02.00
Modified at S/W Revision	A.03.00

## Pre-Adjust for Min Clip

If this function is on, it does the adjustment described under "[Adjust Atten for Min Clip](#)" on page 2788 each time a measurement restarts. Therefore, in Continuous measurement mode, it only executes before the first measurement.

In dual attenuator models, you can set Elec+Mech Atten, in which case both attenuators participate in the autoranging, or Elec Atten Only, in which case the mechanical attenuator does not participate in the autoranging. This latter case results in less wear on the mechanical attenuator and is usually faster.

This key is grayed out in measurements that do not support this functionality. The spectrum analyzer measurement, Swept SA, does not support this functionality.

Key Path	AMPTD Y Scale, Attenuation
<b>Remote Command</b>	<code>[ :SENSe ] :POWer [ :RF ] :RANGe:OPTimize:ATTenuation OFF   ELECTrical   COMBined</code>  <code>[ :SENSe ] :POWer [ :RF ] :RANGe:OPTimize:ATTenuation?</code>
Notes	The SCPI parameter ELECTrical sets this function to On in single attenuator models. The SCPI parameter COMBined is mapped to ELECTrical in single attenuator models; if you send COMBined, it sets the function to On and returns ELEC to a query.
Dependencies	This key only appears in Dual Attenuator models with an Electronic Attenuator installed. In instruments with Dual Attenuator model, when Enable Elec Atten is off or grayed out, the Pre-Adjust for Min Clip key is grayed out.
Preset	OFF for Swept SA measurement; ON for all other measurements that support Pre-Adjust for Min Clip
State Saved	Saved in instrument state
Range	Dual attenuator models: Off   Elec Atten Only   Mech + Elec Atten Single attenuator models: Off   On
Initial S/W Revision	Prior to A.02.00
Modified at S/W Revision	A.03.00

<b>Remote Command</b>	<code>[ :SENSe ] :POWer [ :RF ] :RANGe:AUTO ON OFF 1 0</code>  <code>[ :SENSe ] :POWer [ :RF ] :RANGe:AUTO?</code>
Notes	ON aliases to "Elec Atten Only" (:POW:RANG:OPT:ATT ELEC)

---

	OFF aliases to "Off" (:POW:RANG:OPT:ATT OFF) The query :POW:RANG:AUTO? returns true if :POW:RANG:OPT:ATT is not "Off"
Initial S/W Revision	Prior to A.02.00

---

## Off

Turns Pre-Adjust for Min Clip off. This is the default setting.

This key is grayed out in measurements that do not support this functionality. The spectrum analyzer measurement, Swept SA, does not support this functionality.

---

Key Path	AMPTD Y Scale, Attenuation, Pre-Adjust for Min Clip
Example	:POW:RANGe:OPT:ATT OFF
Initial S/W Revision	Prior to A.02.00

---

## Elec Atten Only

Selects only the electric attenuator to participate in auto ranging. This offers less wear on the mechanical attenuator and is usually faster.

This key is grayed out in measurements that do not support this functionality. The spectrum analyzer measurement, Swept SA, does not support this functionality.

---

Key Path	AMPTD Y Scale, Attenuation, Pre-Adjust for Min Clip
Example	:POW:RANGe:OPT:ATT ELEC
Initial S/W Revision	Prior to A.02.00

---

## Mech + Elec Atten

In dual attenuator models, this selects both attenuators participate in the autoranging.

This key is grayed out in measurements that do not support this functionality. The spectrum analyzer measurement, Swept SA, does not support this functionality.

---

Key Path	AMPTD Y Scale, Attenuation, Pre-Adjust for Min Clip
Example	:POW:RANGe:OPT:ATT COMB
Initial S/W Revision	Prior to A.02.00

---

## (Mech) Atten Step

This controls the step size used when making adjustments to the input attenuation.

This key is labeled Mech Atten Step in dual attenuator models and Atten Step in single attenuator models. In the dual attenuator configuration, this key only affects the step size of the mechanical attenuator.

Key Path	AMPTD Y Scale, Attenuation
Remote Command	[ :SENSe ] :POWer [ :RF ] :ATTenuation:STEP [ :INCRement ] 10 dB   2 dB [ :SENSe ] :POWer [ :RF ] :ATTenuation:STEP [ :INCRement ] ?
Example	POW:ATT:STEP 2
Notes	Note this feature works like a 1-N choice from the front panel, but it takes a specific value (in dB) when used remotely. The only valid values are 2 and 10.
Dependencies	Blanked in CXA and EXA if option FSA (2 dB steps) is not present. If blanked, attempts to set it via SCPI will yield an error.
Couplings	When the attenuation step size changes, the current mechanical attenuation value is adjusted (if necessary) to be quantized to the new step size. That is, if step is set to 10 dB, mech atten is increased if necessary so it is a multiple of 10 dB
Preset	PXA and MXA: 2 dB EXA and CXA: 10 dB (2 dB with option FSA)
State Saved	Saved in instrument state
Initial S/W Revision	Prior to A.02.00
Modified at S/W Revision	A.03.00

### Presel Center

This soft key is disabled in this measurement.

Key Path	AMPTD Y Scale
Initial S/W Revision	Prior to A.02.00

### Presel Adjust

This soft key is disabled in this measurement.

Key Path	AMPTD Y Scale
Initial S/W Revision	Prior to A.02.00

### $\mu$ W Path Control

The  $\mu$ W Path Control functions include the  $\mu$ W Preselector Bypass (Option MPB) and Low Noise Path (Option LNP) controls in the High Band path circuits.

When the  $\mu$ W Preselector is bypassed, the user has better flatness, but will be subject to spurs from out of band interfering signals. When the Low Noise Path is enabled, the analyzer automatically switches around

certain circuitry in the high frequency bands which can contribute to noise, when it is appropriate based on other analyzer settings.

For most applications, the preset state is Standard Path, which gives the best remote-control throughput, minimizes acoustic noise from switching and minimizes the risk of wear out in the hardware switches. For applications that utilize the wideband IF paths, the preset state is the  $\mu$ W Preselector Bypass path, if option MPB is present. This is because, when using a wideband IF such as the 140 MHz IF, the  $\mu$ W Preselector's bandwidth can be narrower than the available IF bandwidth, causing degraded amplitude flatness and phase linearity, so it is desirable to bypass the preselector in the default case.

Users may choose Low Noise Path Enable. It gives a lower noise floor, especially in the 21–26.5 GHz region, though without improving many measures of dynamic range, and without giving the best possible noise floor. The preamp, if purchased and used, gives better noise floor than does the Low Noise Path, however its compression threshold and third-order intercept are much poorer than that of the non-preamp Low Noise Path. There are some applications, typically for signals around –30 dBm, for which the third-order dynamic range of the standard path is good enough, but the noise floor is not low enough even with 0 dB input attenuation. When the third-order dynamic range of the preamp path is too little and the noise floor of the standard path is too high, the Low Noise Path can provide the best dynamic range.

<b>Key Path</b>	AMPTD Y Scale
<b>Mode</b>	SA, BASIC, PNOISE, VSA , LTE, LTETDD
<b>Scope</b>	Meas Global
<b>Remote Command</b>	[ :SENSe ] :POWer [ :RF ] :MW:PATH STD LNPath MPBypass FULL [ :SENSe ] :POWer [ :RF ] :MW:PATH?
<b>Example</b>	:POW:MW:PATH LNP Enables the Low Noise path
<b>Notes</b>	If a Presel Center is performed, the analyzer will momentarily switch to the Standard Path, regardless of the setting of $\mu$ W Path Control  The DC Block will always be switched in when the low noise path is switched in, to protect succeeding circuitry from DC. Note that this does not mean “when the low noise path is enabled” but when, based on the Low Noise Path rules, the path is actually switched in. This can happen when the selection is Low Noise Path Enable . In the case where the DC Block is switched in the analyzer is now AC coupled. However, if the user has selected DC coupling, the UI will still behave as though it were DC coupled, including all annunciation, warnings, status bits, and responses to SCPI queries. This is because, based on other settings, the analyzer could switch out the low noise path at any time and hence go back to being DC coupled.  Alignment switching ignores the settings in this menu, and restores them when finished.
<b>Dependencies</b>	Unavailable in BBIQ and External Mixing
<b>Preset</b>	All modes other than IQ Analyzer mode and VXA: STD IQ Analyzer, VXA and WLAN mode: MPB option present and licensed: MPB MPB option not present and licensed: STD
<b>State Saved</b>	Save in instrument state
<b>Readback</b>	Value selected in the submenu
<b>Initial S/W Revision</b>	A.04.00
<b>Modified at S/W Revision</b>	A.10.00

## Standard Path

This path gives the best remote-control throughput, minimizes acoustic noise from switching and minimizes the risk of wear in the hardware switches, particularly in remote test scenarios where both low band and high band setups will follow in rapid succession.

In this path, the bypass of the low band/high band switch and microwave preamp is never activated, which can cause some noise degradation but preserves the life of the bypass switch.

Key Path	AMPTD Y Scale, $\mu$ W Path Control
<b>Example</b>	:POW:MW:PATH STD
Readback Text	Standard Path
Initial S/W Revision	A.04.00

## Low Noise Path Enable

You may choose Low Noise Path Enable, which gives a lower noise floor under some circumstances, particularly when operating in the 21–26.5 GHz region. With the Low Noise Path enabled, the low band/high band switch and microwave preamp are bypassed whenever all of the following are true:

- The analyzer is not in the Low Band, meaning:
- the start frequency is above 3.5 GHz and
- the stop frequency is above 3.6 GHz.
- the internal preamp is not installed or (if installed) is set to Off or Low Band

Note that this means that, when any part of a sweep is done in Low Band, the Low Noise Path is not used, whether or not the Low Noise Path Enable is selected in the user interface. Also, if the preamp is turned on, the Low Noise Path is not used, whether or not the Low Noise Path Enable is selected in the user interface. The only time the Low Noise Path is used is when Low Noise Path Enable is selected, the sweep is completely in High Band (> 3.6 GHz) and no preamp is in use.

See "[More Information](#)" on page 2114

Key Path	AMPTD Y Scale, $\mu$ W Path Control
Measurement	Swept SA
<b>Example</b>	:POW:MW:PATH LNP
Notes	For measurements that use IQ acquisition, the low noise path is used when the Center Frequency is in High Band (> 3.6 GHz) and no preamp is in use. In other words, the rules above are modified to use only the center frequency to qualify which path to switch in. This is not the case for FFT's in the Swept SA measurement; they use the same rules as swept measurements.
Dependencies	Key is blanked if current mode does not support it. Key is grayed out if mode supports it but current measurement does not support it. Unless Option LNP is present and licensed, key is blank and if SCPI command sent, error -241,

---

	"Hardware missing; Option not installed" is generated.
Readback Text	Low Noise Path Enable
Initial S/W Revision	A.04.00

---

### More Information

The user should understand that the Low Noise Path, while giving improved DANL, has the disadvantage of decreased TOI performance and decreased gain compression performance relative to the standard path.

The user should also understand that the bypass switch is a mechanical switch and has finite life, so if the Low Noise Path is enabled, it is possible to cause frequent cycling of this switch by frequently changing analyzer settings such that the above conditions hold true only some of the time. A user making tests of this nature should consider opting for the Standard Path, which will never throw the bypass switch, at the expense of some degraded noise performance.

The low noise path is useful for situations where the signal level is so low that the analyzer performance is dominated by noise even with 0 dB attenuation, but still high enough that the preamp option would have excessive third-order intermodulation or compression. The preamp, if purchased and used, gives better noise floor than does the "Low Noise Path." However, its compression threshold and third-order intercept are much poorer than that of the non-preamp path. There are some applications, typically for signals around -30 dBm, for which the third-order dynamic range of the standard path is good enough, but the noise floor is not low enough even with 0 dB input attenuation. When the third-order dynamic range of the preamp path is too little and the noise floor of the standard path is too high, the Low Noise Path can provide the best dynamic range

The graph below illustrates the concept. It shows, in red, the performance of an analyzer at different attenuation settings, both with the preamp on and off, in a measurement that is affected by both analyzer noise and analyzer TOI. The green shows the best available dynamic range, offset by 0.5 dB for clarity. The blue shows how the best available dynamic range improves for moderate signal levels with the low noise path switched in. In this illustration, the preamp improves the noise floor by 15 dB while degrading the third-order intercept by 30 dB, and the low noise path reduces loss by 8 dB. The attenuator step size is 2 dB.

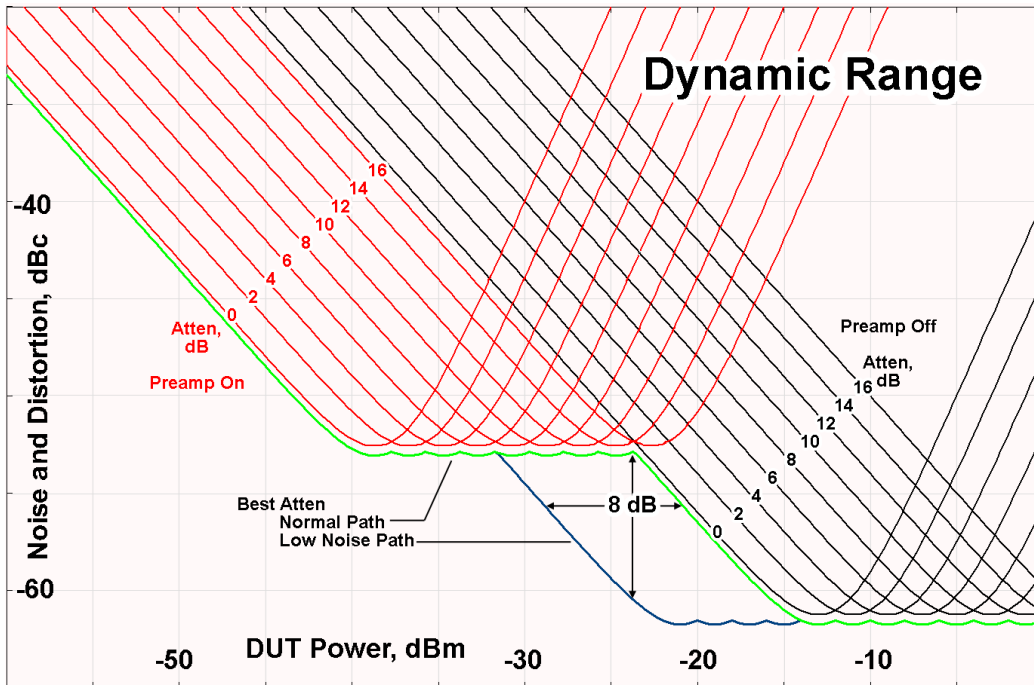

There are other times where selecting the low noise path improves performance, too. Compression-limited measurements such as finding the nulls in a pulsed-RF spectrum can profit from the low noise path in a way similar to the TOI-limited measurement illustrated. Accuracy can be improved when the low noise path allows the optimum attenuation to increase from a small amount like 0, 2 or 4 dB to a larger amount, giving better return loss at the analyzer input. Harmonic measurements, such as second and third harmonic levels, are much improved using the low noise path because of the superiority of that path for harmonic (though not intermodulation) distortion performance.

### μW Preselector Bypass

This key toggles the preselector bypass switch for band 1 and higher. When the microwave preselector is on, the signal path is preselected. When the microwave preselector is off, the signal path is not preselected. The preselected path is the normal path for the analyzer.

The preselector is a tunable bandpass filter which prevents signals away from the frequency of interest from combining in the mixer to generate in-band spurious signals (images). The consequences of using a preselector filter are its limited bandwidth, the amplitude and phase ripple in its passband, and any amplitude and phase instability due to center frequency drift.

Option MPB or pre-selector bypass provides an unpreselected input mixer path for certain X-Series signal analyzers with frequency ranges above 3.6 GHz. This signal path allows a wider bandwidth and less amplitude variability, which is an advantage when doing modulation analysis and broadband signal analysis. The disadvantage is that, without the preselector, image signals will be displayed. Another disadvantage of bypassing the preselector is increased LO emission levels at the front panel input port.

Image responses are separated from the real signal by twice the 1st IF. For IF Paths of 10 MHz and 25 MHz, the 1st IF is 322.5 MHz, so the image response and the real signal will be separated by 645 MHz. The 1st IF will be different for other IF Path settings. When viewing a real signal and its corresponding image response in internal mixing, the image response will be to the left of the real signal.

Also, the image response and the real signal typically have the same amplitude and exhibit the same shape factor.

However, if Option FS1, Fast Sweep Capability, is enabled, the image response in the Swept SA measurement will appear lower in amplitude and have a much wider shape factor compared to the real signal.

<b>Key Path</b>	AMPTD Y Scale, $\mu$ W Path Control
<b>Example</b>	:POW:MW:PATH MPB
<b>Dependencies</b>	Key is blanked if current mode does not support it. Key is grayed out if mode supports it but current measurement does not support it. Key is blank unless Option MPB is present and licensed. If SCPI command sent when MPB not present, error -241, "Hardware missing; Option not installed" is generated.
<b>Readback Text</b>	$\mu$ W Preselector Bypass
<b>Initial S/W Revision</b>	A.04.00

<b>Remote Command</b>	[ :SENSe ] :POWer [ :RF ] :MW:PRESelector [ :STATe ] ON   OFF   0   1 [ :SENSe ] :POWer [ :RF ] :MW:PRESelector [ :STATe ] ?
<b>Example</b>	:POW:MW:PRES OFF Bypasses the microwave preselector
<b>Notes</b>	The ON parameter sets the STD path (:POW:MW:PATH STD) The OFF parameter sets path MPB (:POW:MW:PATH MPB)
<b>Preset</b>	ON

## Internal Preamp

Accesses a menu of keys that control the internal preamps. Turning on the preamp gives a better noise figure, but a poorer TOI to noise floor dynamic range. You can optimize this setting for your particular measurement.

The instrument takes the preamp gain into account as it sweeps. If you sweep outside of the range of the preamp the instrument will also account for that. The displayed result will always reflect the correct gain.

For some measurements, when the preamp is on and any part of the displayed frequency range is below the lowest frequency for which the preamp has specifications, a warning condition message appears in the status line. For example, for a preamp with a 9 kHz lowest specified frequency: "Preamp: Accy unspec'd below 9 kHz".

<b>Key Path</b>	AMPTD Y Scale
<b>Scope</b>	Meas Global
<b>Remote Command</b>	[ :SENSe ] :POWer [ :RF ] :GAIN [ :STATe ] OFF   ON   0   1 [ :SENSe ] :POWer [ :RF ] :GAIN [ :STATe ] ?
<b>Dependencies</b>	Preamp is not available on all hardware platforms. If the preamp is not present or is unlicensed, the



---

	key is not shown. The preamp is not available when the electronic/soft attenuator is enabled.
--	--------------------------------------------------------------------------------------------------

---

Couplings	<p>The act of connecting the U7227A USB Preamplifier to one of the analyzer's USB ports will cause the Internal Preamp to be switched on. When this happens an informational message will be generated: "Internal Preamp turned on for optimal operation with USB Preamp." Note that if the Internal Preamp was already on, there will be no change to the setting, but if it was Off it will be switched On, to Full Range.</p> <p>Note that this same action occurs when the SA mode is selected while the USB Preamp is connected to one of the analyzer's USB ports, if it is the first time that the SA mode has run since powerup, or if the last time the SA mode was running the USB Preamp was NOT connected.</p> <p>Subsequently disconnecting the USB Preamp from USB does not change the Internal Preamp setting nor restore the previous setting.</p>
Preset	OFF
State Saved	Saved in instrument state
Initial S/W Revision	Prior to A.02.00
Modified at S/W Revision	A.14.00

---

Key Path	AMPTD Y Scale, Internal Preamp
Scope	Meas Global
<b>Remote Command</b>	[:SENSe]:POWer[:RF]:GAIN:BAND LOW FULL [:SENSe]:POWer[:RF]:GAIN:BAND?
Dependencies	<p>Preamp is not available on all hardware platforms. If the preamp is not present or is unlicensed, the key is not shown.</p> <p>If a POW:GAIN:BAND FULL command is sent when a low band preamp is available, the preamp band parameter is to LOW instead of FULL, and an "Option not installed" message is generated.</p>
Preset	LOW
State Saved	Saved in instrument state
Initial S/W Revision	Prior to A.02.00

---

## Off

Turns the internal preamp off

---

Key Path	AMPTD Y Scale, Internal Preamp
<b>Example</b>	:POW:GAIN OFF
Readback	Off
Initial S/W Revision	Prior to A.02.00

---

## Low Band

Sets the internal preamp to use only the low band.

The frequency range of the installed (optional) low-band preamp is displayed in square brackets on the Low Band key label.

Key Path	AMPTD Y Scale, Internal Preamp
<b>Example</b>	:POW:GAIN ON :POW:GAIN:BAND LOW
Readback	Low Band
Initial S/W Revision	Prior to A.02.00

## Full Range

Sets the internal preamp to use its full range. The low band (0–3.6 GHz or 0–3GHz, depending on the model) is supplied by the low band preamp and the frequencies above low band are supplied by the high band preamp.

The frequency range of the installed (optional) preamp is displayed in square brackets on the Full Range key label. If the high band option is not installed the Full Range key does not appear.

Key Path	AMPTD Y Scale, Internal Preamp
<b>Example</b>	:POW:GAIN ON :POW:GAIN:BAND FULL
Readback	Full Range
Initial S/W Revision	Prior to A.02.00

## Range

This key is only available when I/Q is the selected input. It replaces the Attenuation key in that case.

Each input channel (I and Q) has four internal gain ranges. The maximum allowed voltage in each gain range is slightly more than the nominal value, so the break point between ranges is a couple of millivolts higher than the nominal (setting a peak voltage of 0.502 mV will still map to the 0.5 V Peak range).

Gain Setting	Volts RMS	Volts Peak	Volts Peak - Peak	dBm (50Ω)	Break Point
0 dB	0.7071	1.0	2.0	10	n/a
6 dB	0.3536	0.5	1.0	4	0.502 V Peak
12 dB	0.1768	0.25	0.5	-2	0.252 V Peak
18 dB	0.0884	0.125	0.25	-8	0.127 V Peak

Key Path	AMPTD Y Scale
Notes	Visible only when the selected input is I/Q.
State Saved	No
Readback Text	When Range is Auto, "[Auto]" When Range is Man and I & Q are the same, "[<range value>]" When Range is Man and I & Q are different: "[: <I range value> Q: <Q range value>]" See I Range and Q Range for the <range value> enumeration definition.
Initial S/W Revision	Prior to A.02.00

## Range Auto/Man

The Auto setting for Range causes the range to be set based on the Y Scale settings. When Range is "Auto", the I & Q Range are set based on the top of the Y Scale when the Y scale is in dB units (for example, power), or to the max(abs(top), abs(bottom)) when the Y scale reference is not at the top of the screen.

Not all measurements support Range Auto/Man. If Auto is not supported in the current measurement, this key is grayed out and shows "Man" and MAN is returned to a SCPI query, but this does NOT change the Auto/Man setting for Range. When you go to a measurement that supports Auto, it goes back to Auto if it was previously in Auto mode.

Key Path	AMPTD Y Scale, Range
Scope	Meas Global
<b>Remote Command</b>	<code>[:SENSe]:VOLTage:IQ:RANGe:AUTO OFF ON 0 1</code> <code>[:SENSe]:VOLTage:IQ:RANGe:AUTO?</code>
<b>Example</b>	Put the I Range and Q Range in manual. <code>VOLT:IQ:RANG:AUTO OFF</code>
Dependencies	If Auto is not supported, sending the SCPI command will generate an error.
Couplings	When in Auto, both I Range and Q Range are set to the same value, computed as follows: Maximum absolute value is computed for the Y Scale. The top and bottom of the graph are computed based on Ref Value, Scale/Div, and Ref Position. Formula: $Y_{Max} = \max(\text{abs}(\text{top}), \text{abs}(\text{bottom}))$ . The I Range and Q Range are then set to YMax.
Preset	ON
State Saved	Saved in instrument state
Range	Auto   Man
Initial S/W Revision	Prior to A.02.00

<b>Remote Command</b>	<code>[:SENSe]:POWer:IQ:RANGe:AUTO OFF ON 0 1</code> <code>[:SENSe]:POWer:IQ:RANGe:AUTO?</code>
-----------------------	----------------------------------------------------------------------------------------------------

<b>Example</b>	Put the I Range and Q Range in manual. POW:IQ:RANG:AUTO OFF
Notes	The POW:IQ:RANG:AUTO is an alternate form of the VOLT:IQ:RANG:AUTO command. This is to maintain consistency with I Range and Q Range, which support both the POWer and VOLTage forms of the command.
Preset	ON
Range	Auto   Man
Initial S/W Revision	Prior to A.02.00

## I Range

This is the internal gain range for the I channel when Input Path is I Only or I and I/Q, and it is used for both the I and Q channels when the Input Path is I+jQ. See "[I/Q Gain Ranges](#)" on page 2807.

<b>Key Path</b>	AMPTD Y Scale, Range
<b>Remote Command</b>	[ :SENSe ] :VOLTage :IQ [ : I ] :RANGe [ :UPPer ] <voltage> [ :SENSe ] :VOLTage :IQ [ : I ] :RANGe [ :UPPer ] ?
<b>Example</b>	Set the I Range to 0.5 V Peak VOLT:IQ:RANG 0.5 V
Notes	The numeric entries are mapped to the smallest gain range whose break point is greater than or equal to the value, or 1 V Peak if the value is greater than 1 V.
Couplings	When Q Same as I is On, the I Range value will be copied to the Q Range. Changing the value will also set Range = Man.
Preset	1 V Peak
State Saved	Saved in instrument state
Range	1 V Peak   0.5 V Peak   0.25 V Peak   0.125 V Peak
Min	0.125 V
Max	1 V
Initial S/W Revision	Prior to A.02.00

<b>Remote Command</b>	[ :SENSe ] :POWer :IQ [ : I ] :RANGe [ :UPPer ] <ampl> [ :SENSe ] :POWer :IQ [ : I ] :RANGe [ :UPPer ] ?
<b>Example</b>	Set the I Range to 0.5 V Peak when Reference Z is 50Ω, and to 1.0 V Peak when Reference Z is 75Ω. POW:IQ:RANG 4 dBm
Notes	The POWer form of the command is provided for convenience. It maps to the same underlying gain range parameter as the VOLTage form of the command. The Reference Z (not the I channel Input Z) is used to convert the power to peak voltage, which is then used to set the I Range as with the VOLTage form of the command. The power values of the 4

range states (1V Peak, 0.5V Peak, 0.25V Peak, and 0.125V Peak) will vary with Reference Z. Here are some examples:

50Ω: 10, 4, -2, -8  
75Ω: 8.2, 2.2, -3.8, -9.8  
600Ω: -0.8, -6.8, -12.8, -18.9

Preset	10.0 dBm
Range	-20 dBm to 10 dBm
Min	-20 dBm
Max	10 dBm
Initial S/W Revision	Prior to A.02.00

### 1 V Peak

Set the channel gain state to 1 Volt Peak.

Key Path	AMPTD Y Scale, I Range   Q Range
Initial S/W Revision	Prior to A.02.00

### 0.5 V Peak

Set the channel gain state to 0.5 Volt Peak.

Key Path	AMPTD Y Scale, I Range   Q Range
Initial S/W Revision	Prior to A.02.00

### 0.25 V Peak

Set the channel gain state to 0.25 Volt Peak.

Key Path	AMPTD Y Scale, I Range   Q Range
Initial S/W Revision	Prior to A.02.00

### 0.125 V Peak

Set the channel gain state to 0.125 Volt Peak.

Key Path	AMPTD Y Scale, I Range   Q Range
Initial S/W Revision	Prior to A.02.00

## Q Range Value

This is the internal gain range for the Q channel. See "[I/Q Gain Ranges](#)" on page 2807. The Q Range only applies to Input Path Q Only and Ind I/Q. For input I+jQ the I Range determines both I and Q channel range settings.

Key Path	AMPTD Y Scale, Range
Remote Command	<code>[ :SENSe ] :VOLTage:IQ:Q:RANGe[:UPPer] &lt;voltage&gt;</code> <code>[ :SENSe ] :VOLTage:IQ:Q:RANGe[:UPPer] ?</code>
Example	Set the Q Range to 0.5 V Peak <code>VOLT:IQ:Q:RANG 0.5 V</code>
Notes	The numeric entries are mapped to the smallest gain range whose break point is greater than or equal to the value, or 1 V Peak if the value is greater than 1 V. The Q Range is only used for Input Path Q Only and Ind I/Q. For input I+jQ the I Range determines both I and Q channel range settings.
Couplings	When Q Same as I is On, the I Range value will be copied to the Q Range and the range value keys are disabled. Changing the value will also set Range = Man.
Preset	1 V Peak
State Saved	Saved in instrument state
Range	1 V Peak   0.5 V Peak   0.25 V Peak   0.125 V Peak
Min	0.125 V
Max	1 V
Initial S/W Revision	Prior to A.02.00

Remote Command	<code>[ :SENSe ] :POWer:IQ:Q:RANGe[:UPPer] &lt;ampl&gt;</code> <code>[ :SENSe ] :POWer:IQ:Q:RANGe[:UPPer] ?</code>
Example	Will set the Q Range to 0.5 V Peak when Reference Z is 50Ω, and to 1.0 V Peak when Reference Z is 75Ω. <code>POW:IQ:Q:RANG 4 dBm</code>
Notes	The POWER form of the command is provided for convenience. It maps to the same underlying gain range parameter as the VOLTage form of the command. The Reference Z (not the Q channel Input Z) is used to convert the power to peak voltage, which is then used to set the Q Range as with the VOLTage form of the command. The power values of the 4 range states (1V Peak, 0.5V Peak, 0.25V Peak, and 0.125V Peak) will vary with Reference Z. Here are some examples: 50Ω: 10, 4, -2, -8 75Ω: 8.2, 2.2, -3.8, -9.8 600Ω: -0.8, -6.8, -12.8, -18.9
Preset	10.0 dBm
Range	-20 dBm to 10 dBm

Min	-20 dBm
Max	10 dBm
Initial S/W Revision	Prior to A.02.00

### Q Same as I

Many, but not all, usages require the I and Q channels to have an identical setup. To simplify channel setup, the Q Same as I will cause the Q channel range to be mirrored from the I channel. That way you only need to set up one channel (the I channel). The I channel values are copied to the Q channel, so at the time Q Same as I is Off, the I and Q channel setups will be identical.

Key Path	AMPTD Y Scale, Range, Q Range
Remote Command	[ :SENSe ] :VOLTage   POWer : IQ : MIRRed OFF   ON   0   1 [ :SENSe ] :VOLTage   POWer : IQ : MIRRed ?
Example	Turn off the mirroring of I Range to Q Range. VOLT:IQ:MIRR OFF POW:IQ:MIRR OFF
Couplings	When On, the I Range value is mirrored (copied) to the Q Range.
Preset	On
State Saved	Saved in instrument state.
Range	On   Off
Readback Text	"Q Same as I" when On, otherwise none.
Initial S/W Revision	Prior to A.02.00

### 1 V Peak

Set the channel gain state to 1 Volt Peak.

Key Path	AMPTD Y Scale, I Range   Q Range
Initial S/W Revision	Prior to A.02.00

### 0.5 V Peak

Set the channel gain state to 0.5 Volt Peak.

Key Path	AMPTD Y Scale, I Range   Q Range
Initial S/W Revision	Prior to A.02.00

### 0.25 V Peak

Set the channel gain state to 0.25 Volt Peak.

---

Key Path	AMPTD Y Scale, I Range   Q Range
Initial S/W Revision	Prior to A.02.00

---

### 0.125 V Peak

Set the channel gain state to 0.125 Volt Peak.

---

Key Path	AMPTD Y Scale, I Range   Q Range
Initial S/W Revision	Prior to A.02.00

---

### I/Q Gain Ranges

See the following sections:

["1 V Peak" on page 2807](#)

["0.5 V Peak" on page 2807](#)

["0.25 V Peak" on page 2807](#)

["0.125 V Peak" on page 2808](#)

### 1 V Peak

Set the channel gain state to 1 Volt Peak.

---

Key Path	AMPTD Y Scale, I Range   Q Range
Initial S/W Revision	Prior to A.02.00

---

### 0.5 V Peak

Set the channel gain state to 0.5 Volt Peak.

---

Key Path	AMPTD Y Scale, I Range   Q Range
Initial S/W Revision	Prior to A.02.00

---

### 0.25 V Peak

Set the channel gain state to 0.25 Volt Peak.

---

Key Path	AMPTD Y Scale, I Range   Q Range
Initial S/W Revision	Prior to A.02.00

---



### 0.125 V Peak

Set the channel gain state to 0.125 Volt Peak.

Key Path	AMPTD Y Scale, I Range   Q Range
Initial S/W Revision	Prior to A.02.00

## Auto Couple

The Auto Couple feature provides a quick and convenient way to automatically couple multiple instrument settings. This helps ensure accurate measurements and optimum dynamic range. When the Auto Couple feature is activated, either from the front panel or remotely, all parameters of the current measurement that have an Auto/Manual mode are set to Auto mode and all measurement settings dependent on (or coupled to) the Auto/Man parameters are automatically adjusted for optimal performance.

However, the Auto Couple key actions are confined to the current measurement only. It does not affect other measurements in the mode, and it does not affect markers, marker functions, or trace or display attributes.

See "[More Information](#)" on page 2126

Key Path	Front-panel key
Remote Command	:COUPle ALL NONE
Example	:COUP ALL
Notes	:COUPle ALL puts all Auto/Man parameters in Auto mode (equivalent to pressing the Auto Couple key). :COUPLE NONE puts all Auto/Man parameters in manual mode. It decouples all the coupled instrument parameters and is not recommended for making measurements.
Initial S/W Revision	Prior to A.02.00

### More Information

There are two types of functions that have Auto/Manual modes.

#### Auto/Man Active Function keys

An Auto/Man toggle key controls the binary state associated with an instrument parameter by toggling between Auto (where the parameter is automatically coupled to the other parameters it is dependent upon) and Man (where the parameter is controlled independent of the other parameters), as well as making the parameter the active function. The current mode is indicated on the softkey with either Auto or Man underlined as illustrated below.



#### Auto/Man 1-of-N keys

An Auto/Man 1-of-N key allows you to manually pick from a list of parameter values, or place the function in Auto, in which case the value is automatically selected (and indicated) as shown below. If in Auto, Auto is underlined on the calling key. If in manual operation, manual is indicated on the calling key. But the calling key does not actually toggle the function, it simply opens the menu.

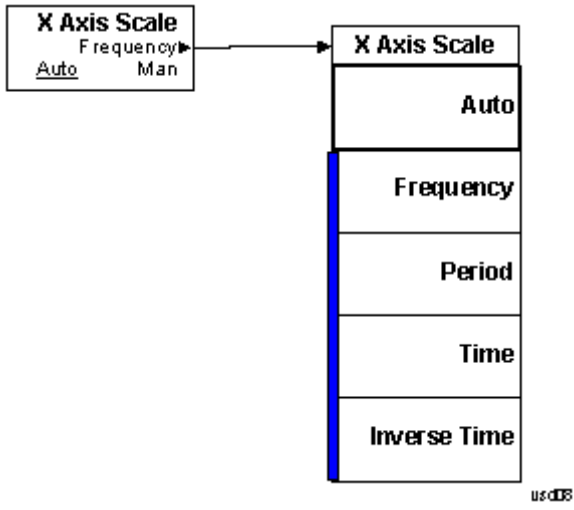

## BW

There is no BW functionality supported in the Modulation Accuracy measurement. The front-panel key will display a blank menu when key pressed.

---

Key Path	Front panel key
Initial S/W Revision	Prior to A.02.00

---

## Cont (Continuous Measurement/Sweep)

Sets the analyzer for Continuous measurement operation. The single/continuous state is Meas Global so the setting will affect all measurements. If you are Paused, pressing Cont does a Resume.

Key Path	Front-panel key
Remote Command	:INITiate:CONTinuous OFF ON 0 1 :INITiate:CONTinuous?
Example	:INIT:CONT 0 puts analyzer in Single measurement operation. :INIT:CONT 1 puts analyzer in Continuous measurement operation
Preset	ON (Note that SYST:PRESet sets INIT:CONT to ON but *RST sets INIT:CONT to OFF)
State Saved	Saved in instrument state
Backwards Compatibility Notes	For Spectrum Analysis mode in ESA and PSA, there is no Cont hardkey, instead there is a Sweep Single/Cont key. In these analyzers, switching the Sweep Single/Cont key from Single to Cont restarts averages (displayed average count reset to 1), but does not restart Max Hold and Min Hold. The X-Series has Single and Cont keys in place of the SweepSingleCont key. In the X-Series, if in single measurement, the Cont key (and INIT:CONT ON ) switches to continuous measurement, but never restarts a measurement and never resets a sweep.
Initial S/W Revision	Prior to A.02.00

In Swept SA Measurement (Spectrum Analysis Mode):

The analyzer takes repetitive sweeps, averages, measurements, etc., when in Continuous mode. When the average count reaches the Average/Hold Number the count stops incrementing, but the analyzer keeps sweeping. See the Trace/Detector section for the averaging formula used both before and after the Average/Hold Number is reached. The trigger condition must be met prior to each sweep. The type of trace processing for multiple sweeps, is set under the Trace/Detector key, with choices of Trace Average, Max Hold, or Min Hold.

In Other Measurements/Modes:

With Avg/Hold Num (in the Meas Setup menu) set to Off or set to On with a value of 1, a sweep is taken after the trigger condition is met; and the analyzer continues to take new sweeps after the current sweep has completed and the trigger condition is again met. However, with Avg/Hold Num set to On with a value >1, multiple sweeps (data acquisitions) are taken for the measurement. The trigger condition must be met prior to each sweep. The sweep is not stopped when the average count k equals the number N set for Avg/Hold Num is reached, but the number k stops incrementing. A measurement average usually applies to all traces, marker results, and numeric results. But sometimes it only applies to the numeric results.

If the analyzer is in Single measurement, pressing the Cont key does not change k and does not cause the sweep to be reset; the only action is to put the analyzer into Continuous measurement operation.

If it is already in continuous sweep:

the INIT:CONT 1 command has no effect

17 Forward Link Modulation Accuracy  
Cont (Continuous Measurement/Sweep)

the INIT:CONT 0 command will place the analyzer in Single Sweep but will have no effect on the current sequence until  $k = N$ , at which point the current sequence will stop and the instrument will go to the idle state.

File

See "File" on page 354

## FREQ Channel

Accesses a menu of keys that allow you to control the Frequency and Channel parameters of the instrument.

Some features in the Frequency menu are the same for all measurements – they do not change as you change measurements. Settings like these are called “Meas Global” and are unaffected by Meas Preset. For example, the Center Freq setting is the same for all measurements - it does not change as you change measurements.

<b>Key Path</b>	<b>Front-panel key</b>
<b>Initial S/W Revision</b>	<b>Prior to A.02.00</b>

### Center Freq

Sets the frequency that corresponds to the horizontal center of the graticule (when frequency Scale Type is set to linear). While adjusting the Center Frequency the Span is held constant, which means that both Start Frequency and Stop Frequency will change.

Pressing Center Freq also sets the frequency entry mode to Center/Span. In Center/Span mode, the center frequency and span values are displayed below the graticule, and the default active function in the Frequency menu is Center Freq.

The center frequency setting is the same for all measurements within a mode, that is, it is Meas Global. Some modes are also able to share a Mode Global center frequency value. If this is the case, the Mode will have a Global Settings key in its Mode Setup menu.

The Center Freq function sets (and queries) the Center Frequency for the currently selected input. If your analyzer has multiple inputs, and you select another input, the Center Freq changes to the value for that input. SCPI commands are available to directly set the Center Freq for a specific input.

Center Freq is remembered as you go from input to input. Thus you can set a Center Freq of 10 GHz with the RF Input selected, change to BBIQ and set a Center Freq of 20 MHz, then switch to External Mixing and set a Center Freq of 60 GHz, and when you go back to the RF Input the Center Freq will go back to 10 GHz; back to BBIQ and it is 20 MHz; back to External Mixing and it is 60 GHz.

See ["RF Center Freq" on page 2135](#)

See [Ext Mix Center Freq](#)

See ["I/Q Center Freq" on page 2137](#)

See ["Center Frequency Presets" on page 2133](#)

<b>Key Path</b>	<b>FREQ Channel</b>
<b>Scope</b>	<b>Meas Global</b>
<b>Remote Command</b>	<code>[ :SENSe ] :FREQuency:CENTer &lt;freq&gt;</code> <code>[ :SENSe ] :FREQuency:CENTer?</code>



<b>Example</b>	FREQ:CENT 50 MHz FREQ:CENT UP changes the center frequency to 150 MHz if you use FREQ:CENT:STEP 100 MHz to set the center frequency step size to 100 MHz FREQ:CENT?
<b>Notes</b>	This command sets either the RF or I/Q Center Frequency depending on the selected input. For RF input it is equivalent to FREQ:RF:CENT For I/Q input it is equivalent to FREQ:IQ:CENT Preset and Max values are dependent on Hardware Options (5xx) If no terminator (e.g. MHz) is sent the terminator Hz is used. If a terminator with unit other than Frequency is used, an invalid suffix error message is generated.
<b>Dependencies</b>	The Center Frequency can be limited by Start or Stop Freq limits, if the Span is so large that Start or Stop reach their limit.
<b>Couplings</b>	When operating in “swept span”, any value of the Center Frequency or Span that is within the frequency range of the analyzer is allowed when the value is being set through the front panel numeric key pad or the SCPI command. The other parameter is forced to a different value if needed, to keep the Start and the Stop Frequencies within the analyzer’s frequency range
<b>Preset</b>	Depends on instrument maximum frequency, mode, measurement, and selected input. See <a href="#">"Center Frequency Presets" on page 2133</a> and <a href="#">"RF Center Freq" on page 2135</a> and <a href="#">Ext Mix Center Freq</a> and <a href="#">"I/Q Center Freq" on page 2137</a> .
<b>State Saved</b>	Saved in instrument state
<b>Min</b>	Depends on instrument maximum frequency, mode, measurement, and selected input.. See <a href="#">"Center Frequency Presets" on page 2133</a> and <a href="#">"RF Center Freq" on page 2135</a> and <a href="#">"I/Q Center Freq" on page 2137</a> .
<b>Max</b>	Depends on instrument maximum frequency, mode, measurement, and selected input.. See <a href="#">"Center Frequency Presets" on page 2133</a> and <a href="#">"RF Center Freq" on page 2135</a> and <a href="#">"I/Q Center Freq" on page 2137</a> .
<b>Default Unit</b>	Hz
<b>Status Bits/OPC</b>	Non-overlapped
<b>Dependencies</b>	
<b>Initial S/W Revision</b>	Prior to A.02.00

## Center Frequency Presets

The following table provides the Center Frequency Presets for the Spectrum Analyzer mode, and the Max Freq, for the various frequency options:

Freq Option	CF after Mode Preset	Stop Freq after Mode Preset	Max Freq (can't tune)

17 Forward Link Modulation Accuracy  
 FREQ Channel

			above)
503 (all but N9000A)	1.805 GHz	3.6 GHz	3.7 GHz
503 (N9000A)	1.505 GHz	3.0 GHz	3.08 GHz
507 (all but N9000A)	3.505 GHz	7.0 GHz	7.1 GHz
507 (N9000A)	3.755 GHz	7.5 GHz	7.58 GHz
508 (all but N9038A)	1.805 GHz	3.6 GHz	8.5 GHz
508 (N9038A)	4.205 GHz	8.4 GHz	8.5 GHz
513	6.805 GHz	13.6 GHz	13.8 GHz
526 (all but N9000A and N9038A)	13.255 GHz	26.5 GHz	27.0 GHz
526 (N9000A)	13.255 GHz	26.5 GHz	26.55 GHz
526 (N9038A)	1.805 GHz	3.6 GHz	27.0 GHz
532	16.005 GHz	32.0 GHz	32.5 GHz
543	21.505 GHz	43.0 GHz	TBD
544	22.005 GHz	44.0 GHz	44.5 GHz
550	25.005 GHz	50.0 GHz	51 GHz

Input 2:

Model	CF after Mode Preset	Stop Freq after Mode Preset	Max Freq (can't tune above)
N9000A opt C75	0.7505GHz	1.5 GHz	1.58 GHz
N9038A	505 MHz	1 GHz	1.000025 GHz

Tracking Generator Frequency Limits (N9000A only):

Tracking Generator Option	Min Freq (clips to this freq when turn TG on and	If above this Freq, Stop Freq clipped to this Freq when	Max Freq (can't tune above) while TG

	can't tune below while TG on)	TG turned on	on
T03	9 kHz	3.0 GHz	3.08 GHz
T06	9 kHz	6.0 GHz	6.05 GHz

The following table shows the Center Frequency Presets for modes other than Spectrum Analyzer:

Mode	CF Preset for RF
WCDMA	1 GHz
WIMAXOFDMA,	1 GHz
BASIC	1 GHz
ADEMOD	1 GHz
VSA	1 GHz
TDSCDMA	1 GHz
PNOISE	1 GHz
LTE	1 GHz
LTETDD	1 GHz
MSR	1 GHz
GSM	935.2 MHz
NFIGURE	1.505 GHz

## RF Center Freq

SCPI command for specifying the RF Center Frequency. This command will set the Center Frequency to be used when the RF input is selected, even if the RF input is not the input that is selected at the time the command is sent. Note that the Center Freq function in the Frequency menu on the front panel always applies to the currently selected input.

Scope	Meas Global
<b>Remote Command</b>	<code>[ :SENSe ] :FREQuency:RF:CENTer &lt;freq&gt;</code> <code>[ :SENSe ] :FREQuency:RF:CENTer?</code>
<b>Example</b>	FREQ:RF:CENT 30 MHz
Notes	This command is the same in all modes, but the parameter is Measurement Global. So the value is independent in each mode and common across all the measurements in the mode.
Dependencies	If the electronic/soft attenuator is enabled, any attempt to set Center Frequency such that the Stop Frequency would be >3.6 GHz fails and results in an advisory message. If the equivalent SCPI command is sent, this same message is generated as part of a “-221, Settings conflict” warning. If Source Mode is set to Tracking, and the Max or Min Center Freq is therefore limited by the limits of the source, a warning message is generated, “Data out of range;clipped to source max/min” if these limits are exceeded. Note that for an external source, these limits can be affected by the settings of

	Source Numerator, Source Denominator and Power Sweep.
Preset	See table above
State Saved	Saved in instrument state.
Min	-79.999995 MHz, unless Source Mode is set to Tracking, in which case it is limited by the minimum frequency of the Source
Max	See table above. Basically instrument maximum frequency – 5 Hz. Note that, if the Source Mode is set to Tracking, the effective instrument maximum frequency may be limited by the source maximum frequency.  If the knob or step keys are being used, also depends on the value of the other three interdependent parameters Span, Start Frequency and Stop Frequency
Initial S/W Revision	Prior to A.02.00
Modified at S/W Revision	A.03.00

### Ext Mix Center Freq

SCPI command for specifying the External Mixer Center Frequency. This command will set the Center Frequency to be used when the External Mixer is selected, even if the External Mixer input is not the input which is selected at the time the command is sent. Note that the Center Freq function in the Frequency menu on the front panel always applies to the currently selected input.

Scope	Meas Global
Remote Command	<code>[ :SENSe ] :FREQuency:EMIXer:CENTer &lt;freq&gt;</code> <code>[ :SENSe ] :FREQuency:EMIXer:CENTer?</code>
Example	<code>:FREQ:EMIX:CENT 60 GHz</code> <code>:FREQ:EMIX:CENT?</code>
Notes	This command is the same in all modes, but the parameter is Measurement Global. So the value is independent in each mode and common across all the measurements in the mode.
Couplings	When returning to External Mixing after having been switched to one of the other inputs (e.g., RF), you will come back into the settings that you had when you left External Mixing. So you will come back to the band you were in with the Center Frequency that you had. However, Span is not an input-dependent parameter, therefore you will bring the span over from the other input. Therefore, the analyzer comes back with the span from the previous input, limited as necessary by the current mixer setup.
Preset	When a Mode Preset is performed while in External Mixing, the Start frequency of the current Mode is set to the nominal Min Freq of the lowest harmonic range in the Harmonic Table for the current mixer setup. Similarly, the Stop frequency of the current Mode is set to the nominal Max Freq of the highest harmonic range in the Harmonic Table. The Center Freq thus presets to the point arithmetically equidistant from these two frequencies.  If the current measurement has a limited Span available to it, and cannot achieve the Span shown in the table (Span=Stop Freq – Start Freq), the analyzer uses the maximum Span the measurement allows, and still sets the Center Freq to the midpoint of the Start and Stop Freq values in the Harmonic Table.

	When Restore Input/Output Defaults is performed, the mixer presets to the 11970A, whose Start and Stop frequencies are 26.5 and 40 GHz respectively. The center of these two frequencies is 33.25 GHz. Therefore, after a Restore Input/Output Defaults, if you go into External Mixing and do a Mode Preset while in the Spectrum Analyzer Mode, the resulting Center Freq is 33.25 GHz.
State Saved	Saved in instrument state.
Min	The minimum frequency in the currently selected mixer band + 5 Hz
Max	The maximum frequency in the currently selected mixer band – 5 Hz If the knob or step keys are being used, also depends on the value of the other three interdependent parameters Span, Start Frequency and Stop Frequency
Initial S/W Revision	A.08.01

### I/Q Center Freq

SCPI command for specifying the I/Q Center Frequency. This command will set the Center Frequency to be used when the I/Q input is selected, even if the I/Q input is not the input which is selected at the time the command is sent. Note that the Center Freq function in the Frequency menu on the front panel always applies to the currently selected input.

Scope	Meas Global
<b>Remote Command</b>	<code>[ :SENSe ] :FREQuency:IQ:CENTer &lt;freq&gt;</code> <code>[ :SENSe ] :FREQuency:IQ:CENTer?</code>
<b>Example</b>	FREQ:IQ:CENT: 30 MHz
Notes	This command is the same in all modes, but the parameter is Measurement Global. So the value is independent in each mode and common across all the measurements in the mode.
Preset	0 Hz
State Saved	Saved in instrument state.
Min	-40.049995 MHz
Max	40.049995 MHz
Initial S/W Revision	Prior to A.02.00

### CF Step

Changes the step size for the center frequency and start and stop frequency functions. Once a step size has been selected and the center frequency function is active, the step keys (and the UP|DOWN parameters for Center Frequency from remote commands) change the center frequency by the step-size value. The step size function is useful for finding harmonics and sidebands beyond the current frequency span of the analyzer.

Note that the start and stop frequencies also step by the CF Step value.

Key Path	FREQ Channel
Remote Command	<pre>[ :SENSe] :FREQuency:CENTer:STEP[:INCRement] &lt;freq&gt; [ :SENSe] :FREQuency:CENTer:STEP[:INCRement] ? [ :SENSe] :FREQuency:CENTer:STEP:AUTO OFF ON 0 1 [ :SENSe] :FREQuency:CENTer:STEP:AUTO?</pre>
Example	<pre>FREQ:CENt:STEP:AUTO ON FREQ:CENt:STEP 500 MHz FREQ:CENt UP increases the current center frequency value by 500 MHz FREQ:CENt:STEP? FREQ:CENt:STEP:AUTO?</pre>
Notes	Preset and Max values are depending on Hardware Options (503, 507, 508, 513, 526)
Notes	Preset and Max values are dependent on Hardware Options (5xx)
Dependencies	Freq Offset is not available in External Mixing. In this case the Freq Offset key is grayed out and shows a value of zero. It will once again be available, and show the previously set value, when you return to the RF Input.
Dependencies	Span, RBW, Center frequency If the electronic/soft attenuator is enabled, any attempt to change the value of the center frequency >3.6 GHz by pressing the Up-arrow key, fails and results in an advisory message. If the equivalent SCPI command is sent, this same message is generated as part of a “-221, Settings conflict” warning.
Couplings	When auto-coupled in a non-zero span, the center frequency step size is set to 10% of the span. When auto-coupled in zero span, the center frequency step size is set to the equivalent -3 dB RBW value.
Preset	Auto ADEM0D: 1 MHz ON
State Saved	Saved in instrument state
Min	– (the maximum frequency of the instrument). That is, 27 GHz max freq instrument has a CF step range of +/- 27 GHz. Note that this is the maximum frequency given the current settings of the instrument, so in External Mixing, for example, it is the maximum frequency of the current mixer band.
Max	The maximum frequency of the instrument. That is, 27 GHz max freq instrument has a CF step range of +/- 27 GHz. Note that this is the maximum frequency given the current settings of the instrument, so in External Mixing, for example, it is the maximum frequency of the current mixer band.
Default Unit	Hz
Status Bits/OPC dependencies	non-overlapped
Initial S/W Revision	Prior to A.02.00
Modified at S/W Revision	A.03.00

## Input/Output

See ["Input/Output" on page 226](#)

## Marker

Accesses a menu that enables you to select, set up and control the markers for the current measurement. See the "Marker Functions" section for more information

Key Path	Front Panel Key
Initial S/W Revision	Prior to A.02.00

### Select Marker

Accesses a menu that enables you to select, set up and control the markers for the current measurement.

Key Path	Marker, Properties
Initial S/W Revision	Prior to A.02.00

### Marker Type

Sets the marker control mode. If the selected marker is Off, pressing Marker sets it to Normal and places it at the center of the screen on the trace determined by the Marker Trace rules. At the same time, reference value of the selected marker appears on the Active Function area.

Active Function Display:

Marker chip value at I/Q Chip Polar Vector graph

Marker X-axis value at other graphs

Default Active Function: the active function for the selected marker's current control mode. If the current control mode is Off, there is no active function and the active function is turned off.

The marker X axis value entered in the active function area will display the marker value to its full entered precision.

Key Path	Marker
Mode	1xEV-DO
<b>Remote Command</b>	:CALCulate:RHO[:BTS]:MARKer[1] 2 ...12:MODE POSition   DELTa   =OFF :CALCulate:RHO[:BTS]:MARKer[1] 2 ...12:MODE?
<b>Example</b>	CALC:RHO:MARK:MODE POS CALC:RHO:MARK:MODE?
Preset	OFF
State Saved	Saved in instrument state.
Range	Normal Delta Off
Initial S/W Revision	Prior to A.02.00



## Properties

Accesses a menu that enables you to select a relative marker and marker trace.

Key Path	Marker
Initial S/W Revision	Prior to A.02.00

## Select Marker

Accesses a menu that enables you to select, set up and control the markers for the current measurement.

Key Path	Marker, Properties
Initial S/W Revision	Prior to A.02.00

## Relative To

Selects the marker the selected marker will be relative to (its reference marker).

Key Path	Marker, Properties
Mode	1xEVDO
<b>Remote Command</b>	:CALCulate:RHO[:BTS]:MARKer[1] 2 ...12:REFerence <integer> :CALCulate:RHO[:BTS]:MARKer[1] 2 ...12:REFerence?
<b>Example</b>	CALC:RHO:MARK:REF 4 CALC:RHO:MARK:REF?
Notes	A marker cannot be relative to itself so that choice is grayed out, and if sent from SCPI generates error -221: "Settings conflict; marker cannot be relative to itself."
Preset	2 3 4 5 6 7 8 9 10 11 12 1
State Saved	Saved in instrument state.
Min	1
Max	12
Initial S/W Revision	Prior to A.02.00

## Marker Trace

Assigns the specified marker to the designated trace.

Key Path	Marker, Properties
Mode	1xEVDO
<b>Remote Command</b>	:CALCulate:RHO[:BTS]:MARKer[1] 2 ...12:TRACe EVM   MERRor   PERRor   IQ   CHIP   CDPower   POLar :CALCulate:RHO[:BTS]:MARKer[1] 2 ...12:TRACe?

<b>Example</b>	CALC:RHO:MARK:TRACE PERR CALC:RHO:MARK:TRACE?
Preset	EVM
State Saved	Saved in instrument state.
Range	EVM   Phase Error   Mag Error   I/Q Waveform   Chip Power   Code Domain Power   I/Q Polar
Initial S/W Revision	Prior to A.02.00

## Couple Marker

Toggles the state of the markers to be coupled On or Off. When this function is true, moving any marker causes an equal X Axis movement of every other marker which is not Off. By “equal X Axis movement” we mean that we preserve the difference between each marker’s X Axis value (in the fundamental x-axis units of the trace that marker is on) and the X Axis value of the marker being moved (in the same fundamental x-axis units).

See Couple Marker in the "Marker" section for more information.

<b>Key Path</b>	Marker
Mode	1xEVDO
<b>Remote Command</b>	:CALCulate:RHO[:BTS]:MARKer:COUple[:STATe] ON OFF 1 0 :CALCulate:RHO[:BTS]:MARKer:COUple[:STATe]?
<b>Example</b>	CALC:RHO:MARK:COUP ON
Preset	OFF
State Saved	Saved in instrument state.
Range	On Off
Initial S/W Revision	Prior to A.02.00

## All Markers Off

Turns off all markers.

<b>Key Path</b>	Marker
Mode	1xEVDO
<b>Remote Command</b>	:CALCulate:RHO[:BTS]:MARKer:AOFF
<b>Example</b>	CALC:RHO:MARK:AOFF
<b>Backwards Compatibility SCPI</b>	:CALCulate:RHO:MARKer:AOFF
Initial S/W Revision	Prior to A.02.00

## Marker Fctn

There are no Marker Function operations supported in the Modulation Accuracy measurement. The front-panel key will display a blank menu when pressed.

---

Key Path	Front panel key
Initial S/W Revision	Prior to A.02.00

---

## Marker To

There are no Marker To operations supported in the Mod Accuracy measurement. The front-panel key will display a blank menu when pressed.

---

Key Path	Front panel key
Initial S/W Revision	Prior to A.02.00

---

## Meas

The information in this section is common to all measurements. For key and remote command information for a specific measurement, refer to the section that describes the measurement of interest.

Measurements available under the Meas key are specific to the current Mode.

When viewing Help for measurements, note the following:

**NOTE**

Operation for some keys differs between measurements. The information displayed in Help pertains to the current measurement. To see how a key operates in a different measurement, exit Help (press the Cancel Esc key), select the measurement, then reenter Help (press the Help key) and press that key.

---

Key Path	Front-panel key
Initial S/W Revision	Prior to A.02.00

---

### Remote Measurement Functions

This section contains the following topics:

"Measurement Group of Commands" on page 2849

"Current Measurement Query (Remote Command Only)" on page 2851

"Limit Test Current Results (Remote Command Only)" on page 2851

"Data Query (Remote Command Only)" on page 2851

"Calculate/Compress Trace Data Query (Remote Command Only)" on page 2852

"Calculate Peaks of Trace Data (Remote Command Only)" on page 2857

Hardware-Accelerated Fast Power Measurement (Remote Command Only)

"Format Data: Numeric Data (Remote Command Only)" on page 2858

"Format Data: Byte Order (Remote Command Only)" on page 2859

---

Initial S/W Revision	Prior to A.02.00
----------------------	------------------

---

## Measurement Group of Commands

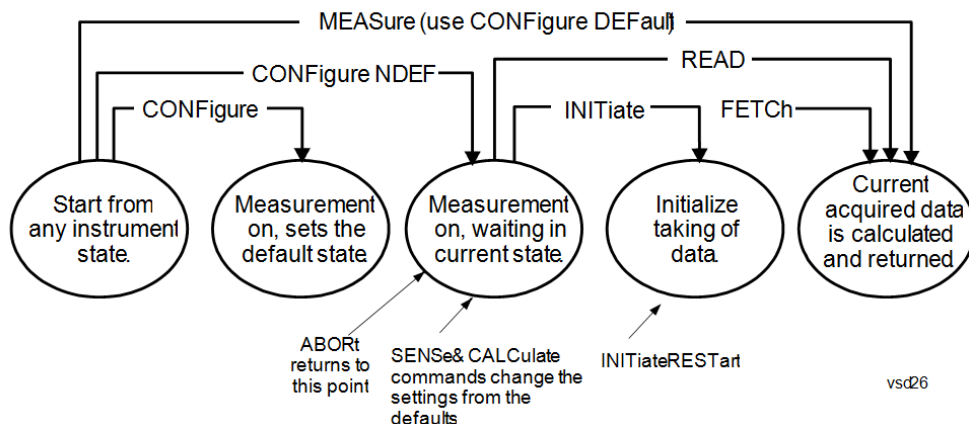

---

### Measure Commands:

:MEASure:<measurement>[n]?

This is a fast single-command way to make a measurement using the factory default instrument settings. These are the settings and units that conform to the Mode Setup settings (e.g. radio standard) that you have currently selected.

- Stops the current measurement (if any) and sets up the instrument for the specified measurement using the factory defaults
- Initiates the data acquisition for the measurement
- Blocks other SCPI communication, waiting until the measurement is complete before returning results.
- If the function does averaging, it is turned on and the number of averages is set to 10.
- After the data is valid it returns the scalar results, or the trace data, for the specified measurement. The type of data returned may be defined by an [n] value that is sent with the command.
- The scalar measurement results will be returned if the optional [n] value is not included, or is set to 1. If the [n] value is set to a value other than 1, the selected trace data results will be returned. See each command for details of what types of scalar results or trace data results are available.
- ASCII is the default format for the data output. (Older versions of Spectrum Analysis and Phase Noise mode measurements only use ASCII.) The binary data formats should be used for handling large blocks of data since they are smaller and faster than the ASCII format. Refer to the FORMat:DATA command for more information.

If you need to change some of the measurement parameters from the factory default settings you can set up the measurement with the CONFIgure command. Use the commands in the SENSe:<measurement> and CALCulate:<measurement> subsystems to change the settings. Then you can use the READ? command to initiate the measurement and query the results.

If you need to repeatedly make a given measurement with settings other than the factory defaults, you can use the commands in the SENSe:<measurement> and CALCulate:<measurement> subsystems to set up the measurement. Then use the READ? command to initiate the measurement and query results.

Measurement settings persist if you initiate a different measurement and then return to a previous one. Use READ:<measurement>? if you want to use those persistent settings. If you want to go back to the default settings, use MEASure:<measurement>?.

---

### Configure Commands:

:CONFIgure:<measurement>

This command stops the current measurement (if any) and sets up the instrument for the specified measurement using

---

---

the factory default instrument settings. It does not initiate the taking of measurement data unless INIT:CONTInuous is ON. If you change any measurement settings after using the CONFigure command, the READ command can be used to initiate a measurement without changing the settings back to their defaults.

In the Swept SA measurement in Spectrum Analyzer mode the CONFigure command also turns the averaging function on and sets the number of averages to 10 for all measurements.

:CONFigure: <measurement>: NDEFault stops the current measurement and changes to the specified measurement. It does not change the settings to the defaults. It does not initiate the taking of measurement data unless INIT:CONTInuous is ON.

The CONFigure? query returns the current measurement name.

The CONFigure:CATalog? query returns a quoted string of all licensed measurement names in the current mode. For example, "SAN, CHP, OBW, ACP, PST, TXP, SPUR, SEM, LIST".

---

#### Fetch Commands:

:FETCh:<measurement>[n]?

This command puts selected data from the most recent measurement into the output buffer. Use FETCh if you have already made a good measurement and you want to return several types of data (different [n] values, for example, both scalars and trace data) from a single measurement. FETCh saves you the time of re-making the measurement. You can only FETCh results from the measurement that is currently active, it will not change to a different measurement. An error message is reported if a measurement other than the current one is specified.

If you need to get new measurement data, use the READ command, which is equivalent to an INITiate followed by a FETCh.

The scalar measurement results will be returned if the optional [n] value is not included, or is set to 1. If the [n] value is set to a value other than 1, the selected trace data results will be returned. See each command for details of what types of scalar results or trace data results are available. The binary data formats should be used for handling large blocks of data since they are smaller and transfer faster than the ASCII format. (FORMat:DATA)

FETCh may be used to return results other than those specified with the original READ or MEASure command that you sent.

---

#### INITiate Commands:

:INITiate:<measurement>

This command is not available for measurements in all the instrument modes:

- Initiates a trigger cycle for the specified measurement, but does not output any data. You must then use the FETCh<meas> command to return data. If a measurement other than the current one is specified, the instrument will switch to that measurement and then initiate it.
- For example, suppose you have previously initiated the ACP measurement, but now you are running the channel power measurement. If you send INIT:ACP? it will change from channel power to ACP and will initiate an ACP measurement.
- Does not change any of the measurement settings. For example, if you have previously started the ACP measurement and you send INIT:ACP? it will initiate a new ACP measurement using the same instrument settings as the last time ACP was run.
- If your selected measurement is currently active (in the idle state) it triggers the measurement, assuming the trigger conditions are met. Then it completes one trigger cycle. Depending upon the measurement and the number of averages, there may be multiple data acquisitions, with multiple trigger events, for one full trigger cycle. It also holds off additional commands on GPIB until the acquisition is complete.

---

#### READ Commands:

:READ:<measurement>[n]?

- Does not preset the measurement to the factory default settings. For example, if you have previously initiated the ACP
-

---

measurement and you send READ:ACP? it will initiate a new measurement using the same instrument settings.

- Initiates the measurement and puts valid data into the output buffer. If a measurement other than the current one is specified, the instrument will switch to that measurement before it initiates the measurement and returns results.
  - For example, suppose you have previously initiated the ACP measurement, but now you are running the channel power measurement. Then you send READ:ACP? It will change from channel power back to ACP and, using the previous ACP settings, will initiate the measurement and return results.
  - Blocks other SCPI communication, waiting until the measurement is complete before returning the results
  - If the optional [n] value is not included, or is set to 1, the scalar measurement results will be returned. If the [n] value is set to a value other than 1, the selected trace data results will be returned. See each command for details of what types of scalar results or trace data results are available. The binary data formats should be used when handling large blocks of data since they are smaller and faster than the ASCII format. (FORMat:DATA)
- 

---

Initial S/W Revision	Prior to A.02.00
----------------------	------------------

---

### Current Measurement Query (Remote Command Only)

This command returns the name of the measurement that is currently running.

---

<b>Remote Command</b>	:CONFigure?
-----------------------	-------------

<b>Example</b>	CONF?
----------------	-------

Initial S/W Revision	Prior to A.02.00
----------------------	------------------

---

### Limit Test Current Results (Remote Command Only)

Queries the status of the current measurement limit testing. It returns a 0 if the measured results pass when compared with the current limits. It returns a 1 if the measured results fail any limit tests.

---

<b>Remote Command</b>	:CALCulate:CLIMits:FAIL?
-----------------------	--------------------------

<b>Example</b>	CALC:CLIM:FAIL? queries the current measurement to see if it fails the defined limits. Returns a 0 or 1: 0 it passes, 1 it fails.
----------------	--------------------------------------------------------------------------------------------------------------------------------------

Initial S/W Revision	Prior to A.02.00
----------------------	------------------

---

### Data Query (Remote Command Only)

Returns the designated measurement data for the currently selected measurement and subopcode.

n = any valid subopcode for the current measurement. See the measurement command results table for your current measurement, for information about what data is returned for the subopcodes.

This command uses the data setting specified by the FORMat:BORDER and FORMat:DATA commands and can return real or ASCII data. (See the format command descriptions under Input/Output in the Analyzer Setup section.)



<b>Remote Command</b>	:CALCulate:DATA[n]?
<b>Notes</b>	The return trace depends on the measurement. In CALCulate:<meas>:DATA[n], n is any valid subopcode for the current measurement. It returns the same data as the FETCH:<measurement>? query where <measurement> is the current measurement.
<b>Initial S/W Revision</b>	Prior to A.02.00

### Calculate/Compress Trace Data Query (Remote Command Only)

Returns compressed data for the currently selected measurement and sub-opcode [n].

n = any valid sub-opcode for that measurement. See the MEASure:<measurement>? command description of your specific measurement for information on the data that can be returned.

The data is returned in the current Y Axis Unit of the analyzer. The command is used with a sub-opcode <n> (default=1) to specify the trace. With trace queries, it is best if the analyzer is not sweeping during the query. Therefore, it is generally advisable to be in Single Sweep, or Update=Off.

This command is used to compress or decimate a long trace to extract and return only the desired data. A typical example would be to acquire N frames of GSM data and return the mean power of the first burst in each frame. The command can also be used to identify the best curve fit for the data.

<b>Remote Command</b>	:CALCulate:DATA<n>:COMPress? BLOCk   CFIT   MAXimum   MINimum   MEAN   DMEan   RMS   RMSCubed   SAMPlE   SDEVIation   PPHase [,<soffset> [,<length>[,<roffset>[,<rlimit>]]]]
<b>Example</b>	To query the mean power of a set of GSM bursts: Supply a signal that is a set of GSM bursts. Select the IQ Waveform measurement (in IQ Analyzer Mode). Set the sweep time to acquire at least one burst. Set the triggers such that acquisition happens at a known position relative to a burst. Then query the mean burst levels using, CALC:DATA2:COMP? MEAN, 24e-6, 526e-6 (These parameter values correspond to GSM signals, where 526e-6 is the length of the burst in the slot and you just want 1 burst.)
<b>Notes</b>	The command supports 5 parameters. Note that the last 4 (<soffset>, <length>, <roffset>, <rlimit>) are optional. But these optional parameters must be entered in the specified order. For example, if you want to specify <length>, then you must also specify <soffset>. See details below for a definition of each of these parameters.  This command uses the data in the format specified by FORMat:DATA, returning either binary or ASCII data.
<b>Initial S/W Revision</b>	Prior to A.02.00

- BLOCk or block data - returns all the data points from the region of the trace data that you specify. For example, it could be used to return the data points of an input signal over several timeslots, excluding the portions of the trace data that you do not want. (This is x,y pairs for trace data and I,Q pairs for complex data.)

- CFIT or curve fit - applies curve fitting routines to the data. <soffset> and <length> are required to define the data that you want. <roffset> is an optional parameter for the desired order of the curve equation. The query will return the following values: the x-offset (in seconds) and the curve coefficients ((order + 1) values).

MIN, MAX, MEAN, DME, RMS, RMSC, SAMP, SDEV and PPH return one data value for each specified region (or <length>) of trace data, for as many regions as possible until you run out of trace data (using <roffset> to specify regions). Or they return the number of regions you specify (using <rlimit>) ignoring any data beyond that.

- MINimum - returns the minimum data point (y value) for the specified region(s) of trace data. For I/Q trace data, the minimum magnitude of the I/Q pairs is returned.
- MAXimum - returns the maximum data point (y value) for the specified region(s) of trace data. For I/Q trace data, the maximum magnitude of the I/Q pairs is returned.
- MEAN - returns a single value that is the arithmetic mean of the data point values (in dB/ dBm) for the specified region(s) of trace data. For I/Q trace data, the mean of the magnitudes of the I/Q pairs is returned. See the following equations.

•

**NOTE** If the original trace data is in dB, this function returns the arithmetic mean of those log values, not log of the mean power which is a more useful value. The mean of the log is the better measurement technique when measuring CW signals in the presence of noise. The mean of the power, expressed in dB, is useful in power measurements such as Channel Power. To achieve the mean of the power, use the RMS option.

Equation 1

Mean Value of Data Points for Specified Region(s)

$$\text{MEAN} = \frac{1}{n} \sum_{X_i \in \text{region}(s)} X_i$$

where  $X_i$  is a data point value, and  $n$  is the number of data points in the specified region(s).

Equation 2

Mean Value of I/Q Data Pairs for Specified Region(s)

$$\text{MEAN} = \frac{1}{n} \sum_{X_i \in \text{region}(s)} |X_i|$$

where  $|X_i|$  is the magnitude of an I/Q pair, and  $n$  is the number of I/Q pairs in the specified region(s).

- DMEan - returns a single value that is the mean power (in dB/ dBm) of the data point values for the specified region(s) of trace data. See the following equation:

Equation 3

DMEan Value of Data Points for Specified Region(s)

$$\text{DME} = 10 \times \log_{10} \left( \frac{1}{n} \sum_{X_i \in \text{region}(s)} 10^{\frac{X_i}{10}} \right)$$

- RMS - returns a single value that is the average power on a root-mean-squared voltage scale (arithmetic rms) of the data point values for the specified region(s) of trace data. See the following equation.

**NOTE**

For I/Q trace data, the rms of the magnitudes of the I/Q pairs is returned. See the following equation. This function is very useful for I/Q trace data. However, if the original trace data is in dB, this function returns the rms of the log values which is not usually needed.

Equation 4

RMS Value of Data Points for Specified Region(s)

$$\text{RMS} = \sqrt{\frac{1}{n} \sum_{X_i \in \text{region}(s)} X_i^2}$$

where  $X_i$  is a data point value, and  $n$  is the number of data points in the specified region(s).

Equation 5

RMS Value of I/Q Data Pairs for Specified Region(s)

$$\text{RMS} = \sqrt{\frac{1}{n} \sum_{X_i \in \text{region}(s)} X_i X_i^*}$$

where  $X_i$  is the complex value representation of an I/Q pair,  $X_i^*$  its conjugate complex number, and  $n$  is the number of I/Q pairs in the specified region(s).

Once you have the rms value for a region of trace data (linear or I/Q), you may want to calculate the mean power. You must convert this rms value (peak volts) to power in dBm:

$$10 \times \log[10 \times (\text{rms value})^2]$$

- SAMPLe - returns the first data value (x,y pair) for the specified region(s) of trace data. For I/Q trace data, the first I/Q pair is returned.
- SDEViation - returns a single value that is the arithmetic standard deviation for the data point values for the specified region(s) of trace data. See the following equation.
- For I/Q trace data, the standard deviation of the magnitudes of the I/Q pairs is returned. See the following equation.

Equation 6

Standard Deviation of Data Point Values for Specified Region(s)

$$\text{SDEV} = \sqrt{\frac{1}{n} \sum_{X_i \in \text{region}(s)} (X_i - \bar{X})^2}$$

where  $X_i$  is a data point value,  $\bar{X}$  is the arithmetic mean of the data point values for the specified region (s), and  $n$  is the number of data points in the specified region(s).

$$\text{SDEV} = \sqrt{\frac{1}{n} \sum_{X_i \in \text{region}(s)} (|X_i| - \bar{X})^2}$$

where  $|X_i|$  is the magnitude of an I/Q pair,  $\bar{X}$  is the mean of the magnitudes for the specified region(s), and  $n$  is the number of data points in the specified region(s).

- PPHase - returns the x,y pairs of both rms power (dBm) and arithmetic mean phase (radian) for every specified region and frequency offset (Hz). The number of pairs is defined by the specified number of regions. This parameter can be used for I/Q vector ( $n=0$ ) in Waveform (time domain) measurement and all parameters are specified by data point in PPHase.

The rms power of the specified region may be expressed as:

$$\text{Power} = 10 \times \log [10 \times (\text{RMS I/Q value})] + 10.$$

The RMS I/Q value (peak volts) is:

$$\sqrt{\frac{1}{n} \sum_{X_i \in \text{region}} X_i X_i^*}$$

where  $X_i$  is the complex value representation of an I/Q pair,  $X_i^*$  its conjugate complex number, and  $n$  is the number of I/Q pairs in the specified region.

The arithmetic mean phase of the specified region may be expressed as:

$$\frac{1}{n} \sum_{Y_i \in \text{region}} Y_i$$

where  $Y_i$  is the unwrapped phase of I/Q pair with applying frequency correction and  $n$  is the number of I/Q pairs in the specified region.

The frequency correction is made by the frequency offset calculated by the arithmetic mean of every specified region's frequency offset. Each frequency offset is calculated by the least square method against the unwrapped phase of I/Q pair.

Sample Trace Data - Constant Envelope

(See below for explanation of variables.)

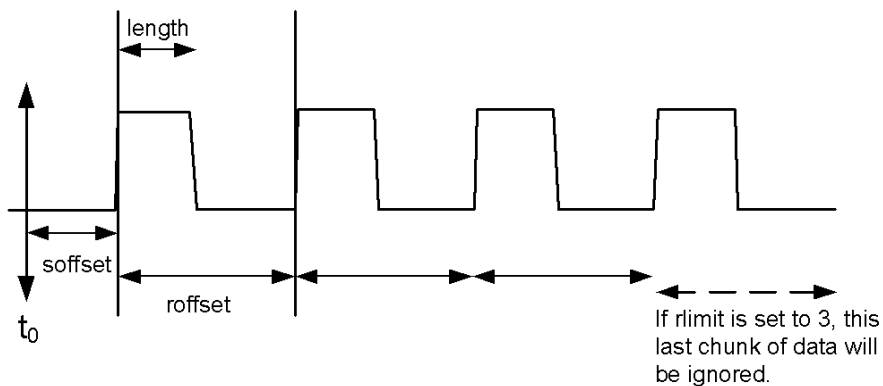

### Sample Trace Data - Not Constant Envelope

(See below for explanation of variables.)



<soffset> - start offset is an optional real number. (It is in seconds for time-domain traces, and is a dimensionless index 0 to Npoints - 1, for frequency-domain traces). It specifies the amount of data at the beginning of the trace that will be ignored before the decimation process starts. It is the time or frequency change from the start of the trace to the point where you want to start using the data. The default value is zero.

<length> - is an optional real number. (It is in seconds for time-domain traces, and is a dimensionless index 0 to Npoints - 1, for frequency-domain traces). It defines how much data will be compressed into one value. This parameter has a default value equal to the current trace length.

<roffset> - repeat offset is an optional real number. (It is in seconds for time-domain traces, and is a dimensionless index 0 to Npoints - 1, for frequency-domain traces). It defines the beginning of the next field of trace elements to be compressed. This is relative to the beginning of the previous field. This parameter has a default value equal to the <length> variable. Note that this parameter is used for a completely different purpose when curve fitting (see CFIT above).

<rlimit> - repeat limit is an optional integer. It specifies the number of data items that you want returned. It will ignore any additional items beyond that number. You can use the Start offset and the Repeat limit to pick out exactly what part of the data you want to use. The default value is all the data.

## Calculate Peaks of Trace Data (Remote Command Only)

Returns a list of all the peaks for the currently selected measurement and sub-opcode [n]. The peaks must meet the requirements of the peak threshold and excursion values.

n = any valid sub-opcode for the current measurement. See the MEASure:<measurement> command description of your specific measurement for information on the data that can be returned.

The command can only be used with specific sub-opcodes with measurement results that are trace data. Both real and complex traces can be searched, but complex traces are converted to magnitude in dBm. In many measurements the sub-opcode n=0, is the raw trace data which cannot be searched for peaks. And Sub-opcode n=1, is often calculated results values which also cannot be searched for peaks.

This command uses the data setting specified by the FORMat:BORDER and FORMat:DATA commands and can return real or ASCII data. If the format is set to INT,32, it returns REAL,32 data.

The command has four types of parameters:

- Threshold (in dBm)
- Excursion (in dB)
- Sorting order (amplitude, frequency, time)
- Optional in some measurements: Display line use (all, > display line, < display line)

---

<b>Remote Command</b>	<p>For Swept SA measurement:</p> <pre>:CALCulate:DATA[1] 2 ... 6:PEAKs? &lt;threshold&gt;,&lt;excursion&gt;[,AMPLitude   FREQuency   TIME[,ALL   GTDLine   LTDLine]]</pre> <p>For most other measurements:</p> <pre>:CALCulate:DATA[1] 2 ... 6:PEAKs? &lt;threshold&gt;,&lt;excursion&gt;[,AMPLitude   FREQuency   TIME]</pre>
-----------------------	--------------------------------------------------------------------------------------------------------------------------------------------------------------------------------------------------------------------------------------------------------------------------------------------------------------------------------

---

<b>Example</b>	<p>Example for Swept SA measurement in Spectrum Analyzer Mode:</p> <p>CALC:DATA4:PEAK? -40, 10, FREQ, GTDL This will identify the peaks of trace 4 that are above -40 dBm, with excursions of at least 10 dB. The peaks are returned in order of increasing frequency, starting with the lowest frequency. Only the peaks that are above the display line are returned.</p> <p>Query Results 1:</p> <p>With FORMat:DATA REAL, 32 selected, it returns a list of floating-point numbers. The first value in the list is the number of peak points that are in the following list. A peak point consists of two values: a peak amplitude followed by its corresponding frequency (or time).</p> <p>If no peaks are found the peak list will consist of only the number of peaks, (0).</p>
----------------	-----------------------------------------------------------------------------------------------------------------------------------------------------------------------------------------------------------------------------------------------------------------------------------------------------------------------------------------------------------------------------------------------------------------------------------------------------------------------------------------------------------------------------------------------------------------------------------------------------------------------------------------------------------------------------------------------------------------------------------------------------------------------------------------

---

<b>Notes</b>	<p>&lt;n&gt; - is the trace that will be used</p> <p>&lt;threshold&gt; - is the level below which trace data peaks are ignored. Note that the threshold value is required and is always used as a peak criterion. To effectively disable the threshold criterion for this command, provide a substantially low threshold value such as -200 dBm. Also note that the threshold value used in this command is independent of and has no effect on the threshold value stored under the Peak Criteria menu.</p> <p>&lt;excursion&gt; - is the minimum amplitude variation (rise and fall) required for a signal to be identified as peak. Note that the excursion value is required and is always used as a peak criterion. To effectively disable the excursion criterion for this command, provide the minimum value of 0.0 dB. Also note that the excursion value used in this command is independent of and has no effect on the</p>
--------------	---------------------------------------------------------------------------------------------------------------------------------------------------------------------------------------------------------------------------------------------------------------------------------------------------------------------------------------------------------------------------------------------------------------------------------------------------------------------------------------------------------------------------------------------------------------------------------------------------------------------------------------------------------------------------------------------------------------------------------------------------------------------------------------------------------------------------------------------------------------------------------------------------------------------------------------

---

excursion value stored under the Peak Criteria menu.

Values must be provided for threshold and excursion. The sorting and display line parameters are optional (defaults are AMPLitude and ALL).

Note that there is always a Y-axis value for the display line, regardless of whether the display line state is on or off. It is the current Y-axis value of the display line which is used by this command to determine whether a peak should be reported

Sorting order:

AMPLitude - lists the peaks in order of descending amplitude, with the highest peak first (default if optional parameter not sent)

FREQUency - lists the peaks in order of occurrence, left to right across the x-axis.

TIME - lists the peaks in order of occurrence, left to right across the x-axis.

Peaks vs. Display Line:

ALL - lists all of the peaks found (default if optional parameter not sent).

GTDLine (greater than display line) - lists all of the peaks found above the display line.

LTDLine (less than display line) - lists all of the peaks found below the display line.

---

Initial S/W Revision      Prior to A.02.00

---

### Format Data: Numeric Data (Remote Command Only)

This command specifies the format of the trace data input and output. It specifies the formats used for trace data during data transfer across any remote port. It affects only the data format for setting and querying trace data for the :TRACe[:DATA], TRACe[:DATA]?, :CALCulate:DATA[n]? and FETCh:SANalyzer [n]? commands and queries.

<b>Remote Command</b>	:FORMat[:TRACe][:DATA] ASCii INTeger,32 REAL,32  REAL,64 :FORMat[:TRACe][:DATA]?
Notes	<p>The query response is:</p> <p>ASCii: ASC,8</p> <p>REAL,32: REAL,32</p> <p>REAL,64: REAL,64</p> <p>INTeger,32: INT,32</p> <p>When the numeric data format is REAL or ASCii, data is output in the current Y Axis unit. When the data format is INTeger, data is output in units of m dBm (.001 dBm).</p> <p>The INT,32 format returns binary 32-bit integer values in internal units (m dBm), in a definite length block.</p>
Dependencies	<p>Sending a data format spec with an invalid number (for example, INT,48) generates no error. The analyzer simply uses the default (8 for ASCii, 32 for INTeger, 32 for REAL).</p> <p>Sending data to the analyzer which does not conform to the current FORMat specified, results in an error. Sending ASCII data when a definite block is expected generates message -161 "Invalid Block Data" and sending a definite block when ASCII data is expected generates message -121 "Invalid Character in Number".</p>
Preset	ASCii
Backwards Compatibility Notes	Note that the INT,32 format is only applicable to the command, TRACe:DATA. This preserves backwards compatibility for the Swept SA measurement. For all other commands/queries which honor FORMat:DATA, if INT,32 is sent the analyzer will behave as though it were set to REAL,32.
Initial S/W Revision	Prior to A.02.00

The specs for each output type follow:

AScii - Amplitude values are in ASCII, in the current Y Axis Unit, one ASCII character per digit, values separated by commas, each value in the form:

SX.YYYYYEsZZ

Where:

S = sign (+ or -)

X = one digit to left of decimal point

Y = 5 digits to right of decimal point

E = E, exponent header

s = sign of exponent (+ or -)

ZZ = two digit exponent

REAL,32 - Binary 32-bit real values in the current Y Axis Unit, in a definite length block.

REAL,64 - Binary 64-bit real values in the current Y Axis Unit, in a definite length block.

### Format Data: Byte Order (Remote Command Only)

This command selects the binary data byte order for data transfer and other queries. It controls whether binary data is transferred in normal or swapped mode. This command affects only the byte order for setting and querying trace data for the :TRACe[:DATA], TRACe[:DATA]? , :CALCulate:DATA[n]? and FETCh:SANalyzer[n]? commands and queries.

By definition any command that says it uses FORMat:DATA uses any format supported by FORMat:DATA.

The NORMal order is a byte sequence that begins with the most significant byte (MSB) first, and ends with the least significant byte (LSB) last in the sequence: 1|2|3|4. SWAPped order is when the byte sequence begins with the LSB first, and ends with the MSB last in the sequence: 4|3|2|1.

---

<b>Remote Command</b>	:FORMat:BORDER NORMal   SWAPped
-----------------------	---------------------------------

	:FORMat:BORDER?
--	-----------------

---

<b>Preset</b>	NORMal
---------------	--------

---

<b>Initial S/W Revision</b>	Prior to A.02.00
-----------------------------	------------------

---



## Meas Setup

Displays the setup menu for the currently selected measurement.

Key Path	Front panel key
Initial S/W Revision	Prior to A.02.00

### Avg/Hold Num

This is a BAF key which toggles Average State and sets Average Number.

Key Path	Meas Setup
Mode	1xEVDO
<b>Remote Command</b>	[:SENSe]:RHO[:BTS]:AVERage:COUNT <integer> [:SENSe]:RHO[:BTS]:AVERage:COUNT? [:SENSe]:RHO[:BTS]:AVERage[:STATe] OFF ON 0 1 [:SENSe]:RHO[:BTS]:AVERage[:STATe]?
<b>Example</b>	:RHO:AVER:COUN 5 RHO:AVER OFF
Notes	Turn average mode on or off.
Couplings	Sets maximum of other rhos.
Preset	10 ON
State Saved	Saved in instrument state.
Range	1 to 10000
Min	1
Max	10000
<b>Backwards Compatibility SCPI</b>	[:SENSe]:RHO:AVERage:COUNT
Initial S/W Revision	Prior to A.02.00

### Avg Mode

Selects the type of termination control used for the averaging function. This determines the averaging action after the specified number of data acquisitions (average count) is reached.

KEYExponential averaging	When Measure is set at Cont, data acquisitions will continue indefinitely.
SCPIEXPponential	After N averages, exponential averaging is used with a weighting factor of N (the displayed average count stops at N). Exponential averaging weights new data more than old data, which allows tracking of slow-changing signals.

KEYRepeat averaging SCPIRepeat	When Measure is set at Cont, data acquisitions will continue indefinitely. After N averages is reached, all previous result data is cleared and the average count is set back to 1. This is equivalent to being in Measure Single and pressing the Restart key when the Single measurement finishes.
-----------------------------------	------------------------------------------------------------------------------------------------------------------------------------------------------------------------------------------------------------------------------------------------------------------------------------------------------

Key Path	Meas Setup
Mode	1xEVDO
<b>Remote Command</b>	[ :SENSe ] :RHO [ :BTS ] :AVERAge:TCONtrol EXPonential   REPEAT [ :SENSe ] :RHO [ :BTS ] :AVERAge:TCONtrol ?
<b>Example</b>	:RHO:AVER:TCON EXP
Preset	EXP
State Saved	Saved in instrument state.
Range	Exp   Repeat
<b>Backwards Compatibility SCPI</b>	[ :SENSe ] :RHO :AVERAge :TCONtrol
Initial S/W Revision	Prior to A.02.00

## Meas Slot Type

Selects slot type of measurement from Active and Idle. When Active (Idle) is selected, slots of active (idle) are picked up for waveform quality measurement and idle (active) slots are ignored. When Idle is selected, results of Data, Preamble and Overall are not calculated.

Key Path	Meas Setup
Mode	1xEVDO
<b>Remote Command</b>	[ :SENSe ] :RHO [ :BTS ] :SLOT:TYPE ACTive   IDLE [ :SENSe ] :RHO [ :BTS ] :SLOT:TYPE ?
<b>Example</b>	RHO:SLOT:TYPE IDLE
Preset	ACTIVE
State Saved	Saved in instrument state.
Range	Active   Idle
<b>Backwards Compatibility SCPI</b>	[ :SENSe ] :RHO :SLOT :TYPE
Initial S/W Revision	Prior to A.02.00

## Capture Interval

Sets the data capture length in slot.

Key Path	Meas Setup
Mode	1xEVDO
<b>Remote Command</b>	<code>[ :SENSe ] :RHO [ :BTS ] :CAPTure:TIME &lt;integer&gt;</code> <code>[ :SENSe ] :RHO [ :BTS ] :CAPTure:TIME?</code>
<b>Example</b>	RHO:CAPT:TIME 12
Preset	1
State Saved	Saved in instrument state.
Range	1 to 16
Min	1
Max	16
<b>Backwards Compatibility SCPI</b>	<code>[ :SENSe ] :RHO:CAPTure:TIME</code>
Initial S/W Revision	Prior to A.02.00

## Meas Offset

Sets the offset of measurement interval in slots.

Key Path	Meas Setup
Mode	1xEVDO
<b>Remote Command</b>	<code>:CALCulate:RHO [ :BTS ] :SWEep:OFFSet &lt;integer&gt;</code> <code>:CALCulate:RHO [ :BTS ] :SWEep:OFFSet?</code>
<b>Example</b>	:CALC:RHO:SWE:OFFS 10
Notes	Max is Capture Interval -1.
Couplings	Max value is dependent on Capture Interval ( <code>[ :SENSe ] :RHO:CAPTure:TIME.</code> )
Preset	0.0
State Saved	Saved in instrument state.
Range	0 to 15
Min	0.0
Max	15.0
<b>Backwards Compatibility SCPI</b>	<code>:CALCulate:RHO:SWEep:OFFSet</code>
Initial S/W Revision	Prior to A.02.00

## PN Offset

Sets offset index of pilot PN sequence. Pilot of 1xEV-DO forward link shall be identified by an offset index in the range from 0 through 511. This offset index specifies offset or lag of pilot PN sequence in units of 64

chips. This parameter takes PN offset index and the measurement uses this value to generate pilot reference.

Key Path	Meas Setup, More 1 of 3
Mode	1xEVDO
Remote Command	[ :SENSe ] :RHO [ :BTS ] :PNOffset <integer> [ :SENSe ] :RHO [ :BTS ] :PNOffset?
Example	:RHO:PNOF 32
Preset	0
State Saved	Saved in instrument state.
Min	0
Max	511
Backwards Compatibility SCPI	[ :SENSe ] :RHO :PNOffset
Initial S/W Revision	Prior to A.02.00

### Sync Start Slot

Before the first slot to start the measurement is depend on trigger timing or capture timing if trigger is set to Free Run.

This is a BAF key. Boolean parameter determines whether to enable synchronization start slot number specification. Sync Start Slot value is an absolute slot number in frame. When this mode is ON, first slot of result interval, which is equal to Capture Interval setting, becomes a slot of specified number.

If users use some kind of trigger, the first slot number is determined by trigger timing.

In Castagna-II, User can specify the synchronization start slot number. If Sync start slot number is set to 5, the analysis starts from slot number 5.0. If Sync Start Slot detection mode is set to Off, keep backward compatibility and the measurement is done from trigger timing or capture timing.

Key Path	Meas Setup, More 1 of 3
Mode	1xEVDO
Remote Command	[ :SENSe ] :RHO [ :BTS ] :SSLot:NUMBer <integer> [ :SENSe ] :RHO [ :BTS ] :SSLot:NUMBer? [ :SENSe ] :RHO [ :BTS ] :SSLot [ :STATe ] OFF ON 0 1 [ :SENSe ] :RHO [ :BTS ] :SSLot [ :STATe ] ?
Example	:RHO:SSL:NUMB 5 :RHO:SSL ON
Notes	Turn first slot number detection mode on or off.
Preset	0 OFF

State Saved	Saved in instrument state.
Range	0 to 15
Min	0
Max	15
<b>Backwards Compatibility SCPI</b>	<code>[ :SENSe ] :RHO :SSLot :NUMBER</code>
Initial S/W Revision	Prior to A.02.00

## Meas Type

Sets the code domain power computation type to the following selection.

- Relative Log (unit: dB)
- Relative Linear (no unit)
- Absolute Log (unit: dBm)
- Absolute Linear (unit: mW)

All the related result window traces must be aligned with the Meas Type selection: e.g. CDP has to be shown in “mW” when “Absolute Linear” is selected. If “Rel Linear” is selected, no unit is applied.

Key Path	Meas Setup, More 1 of 3
Mode	1xEVDO
<b>Remote Command</b>	<code>[ :SENSe ] :RHO [ :BTS ] :POWer :TYPE RLOG   RLINear   ALOG   ALINear</code> <code>[ :SENSe ] :RHO [ :BTS ] :POWer :TYPE ?</code>
<b>Example</b>	<code>:SENS:RHO:POW:TYPE ALOG</code>
Notes	The old selection type in PSA only supports ‘RLOG and ‘RLIN’
Preset	RLOG
State Saved	Saved in instrument state.
Range	Relative Log   Relative Linear   Absolute Log   Absolute Linear
Readback Text	Relative Log   Relative Linear   Absolute Log   Absolute Linear
<b>Backwards Compatibility SCPI</b>	<code>[ :SENSe ] :RHO :POWer :TYPE</code>
Initial S/W Revision	Prior to A.02.00

## Data Channel Attributes

Sets the parameters for Data Channel Attributes.

Key Path	Front panel key
Initial S/W Revision	Prior to A.02.00

## Data Mod Scheme

Selects data channel modulation scheme from QPSK, 8PSK, 16QAM, 64QAM and Auto. The selection can be classified into 2 groups, i.e. Auto and the others. When Auto is selected, the measurement automatically identifies modulation schemes of data channels of measured slots. This detection is done on slot-by-slot basis and signals with slots of various data packet types can be analyzed with appropriate modulation schemes. When one of QPSK, 8PSK, 16QAM and 64QAM is selected, the analysis of data channel is carried out with the selected modulation scheme over Meas Interval. 64QAM mod scheme is added for the purpose of supporting some minimum (critical) sets of the new Rev.B requirement.

Key Path	Meas Setup, More 1 of 3, Data Channel Attribute
Mode	1xEVDO
Remote Command	:CALCulate:RHO[:BTS]:CHANnel:TYPE:DATA QPSK   OPSK   QAM   QAM64   AUTO :CALCulate:RHO[:BTS]:CHANnel:TYPE:DATA?
Example	:CALC:RHO:CHANnel:TYPE:DATA QPSK
Notes	QAM64 is inactive when the subtype is not 3.
Preset	AUTO
State Saved	Saved in instrument state.
Range	QPSK   8PSK   16QAM   64QAM   Auto
Backwards Compatibility SCPI	:CALCulate:RHO:CHANnel:TYPE:DATA
Initial S/W Revision	Prior to A.02.00

## Preamble Length

This is a BAF key. Boolean parameter selects Auto or Manual mode of Preamble analysis. When Auto mode selected, the measurement identifies length of preamble time-multiplexed into Data channel on slot-by-slot basis and proceeds code domain & demod bit analysis using this information. When Manual mode is selected, the measurement uses fixed preamble length given by the user over Meas Interval.

Key Path	Meas Setup, More 1 of 3, Data Channel Attribute
Mode	1xEVDO
Remote Command	[:SENSe]:RHO[:BTS]:PREamble:LENGth <integer> [:SENSe]:RHO[:BTS]:PREamble:LENGth? [:SENSe]:RHO[:BTS]:PREamble:LENGth:AUTO OFF ON 0 1 [:SENSe]:RHO[:BTS]:PREamble:LENGth:AUTO?
Example	:RHO:PRE:LENG 128 :RHO:PRE:LENG:AUTO ON
Notes	This parameter only takes values of valid preamble length. i.e. 0, 64, 128, 256, 512 and 1024. If non valid preamble length is entered, it clips to a valid value.
Preset	0

	ON
State Saved	Saved in instrument state.
Range	0 to 1024
Min	0
Max	1024
<b>Backwards Compatibility SCPI</b>	<code>[ :SENSe ] :RHO:PREamble:LENGth</code>
Initial S/W Revision	Prior to A.02.00

## Active Data Channel

When set to Auto, the active channel ID detection is automatically made for the data channel measurement. When set to Predefined, the predefined active channel detection is used for the data channel measurement, i.e. all code channels of data channel are set Active.

Key Path	Meas Setup, More 1 of 3, Data Channel Attribute
Mode	1xEVDO
<b>Remote Command</b>	<code>[ :SENSe ] :RHO[:BTS]:ACODE AUTO PREDefined</code> <code>[ :SENSe ] :RHO[:BTS]:ACODE?</code>
<b>Example</b>	<code>:RHO:ACOD PRED</code>
Preset	AUTO
State Saved	Saved in instrument state.
Range	Auto   Predef
<b>Backwards Compatibility SCPI</b>	<code>[ :SENSe ] :RHO:ACODE</code>
Initial S/W Revision	Prior to A.02.00

## MAC Position

Selects MAC channel to be analyzed. If Half Slot 1 is selected, only the MAC channel in first half slot will be analyzed, if Half Slot 2 is selected, only the second half slot will be analyzed, if Full Slot is select, two half slot will be composately analyzed.

In Subtype 0/1/2, since two parts of MAC channel are the same, we can select “Full Slot” to analyze two parts at the same time. In Subtype 3, when Mac Index greater than 128, two parts of MAC are different, so we’d better analyze two half slots respectively.

Key Path	Meas Setup, More 1 of 3
Mode	1xEV-DO
<b>Remote Command</b>	<code>[ :SENSe ] :RHO[:BTS]:MACPosition HS1 HS2 FULL</code> <code>[ :SENSe ] :RHO[:BTS]:MACPosition?</code>

<b>Example</b>	:SENS:RHO:MACP HS1 :SENS:RHO:MACP?
Preset	FULL
State Saved	Saved in instrument state.
Range	HS1 HS2 FULL
Initial S/W Revision	Prior to A.02.00

## Limits

Sets limits for metrics results.

Key Path	Meas Setup
Initial S/W Revision	Prior to A.02.00

## Limit Preset

Selects one of preset limit sets and set the limit values to limit parameters.

The standard of 1xEV-DO, C.S0032-A, requires different performance limits for rho Pilot and rho Data depending on slot type and BTS type respectively. Rho pilot shall be

$$\rho_{Pilot} > \begin{cases} 0.970 & \text{(Active)} \\ 0.954 & \text{(Idle)} \end{cases}$$

Rho Data shall be greater than 0.985 if  $|\Delta f| > 750$  kHz, where  $\Delta f$  is the frequency difference between the center frequency and the closest band or block edge. Otherwise rho data shall be greater than 0.970.

Limit preset is provided so that the user can easily set appropriate limit values defined in the standard.

Table 0-2 Values of Limit Preset

Rho Pilot		0.970	0.970	0.954	0.954
Rho MAC		0.912	0.912	0.912	0.912
Rho Data		0.985	0.970	0.985	0.970
Rho Overall		0.900	0.900	0.900	0.900
Rho Preamble		0.900	0.900	0.900	0.900
Frequency Error		0.05ppm	0.05ppm	0.05ppm	0.05ppm
Pilot Offset		10.0 us	10.0 us	10.0 us	10.0 us
Max MAC	Subtype	0.0021	0.0021	0.0021	0.0021
Inactive Power	0/1				
	Subtype	0.0011	0.0011	0.0011	0.0011
	2/3				



Max Data Active Power	0.035	0.035	0.035	0.035
Min Data Active Power	0.02785	0.02785	0.02785	0.02785
RMS EVM	50.0 %	50.0 %	50.0 %	50.0 %
Pk EVM	200.0 %	200.0 %	200.0 %	200.0 %
Timing	50.0 ns	50.0 ns	50.0 ns	50.0 ns
Phase	0.05 rad	0.05 rad	0.05 rad	0.05 rad

<b>Key Path</b>	Meas Setup, More1 of 3, Limits
<b>Mode</b>	1xEVDO
<b>Remote Command</b>	:CALCulate:RHO[:BTS]:LIMit:PRESet ASEVere ANORmal SEVere INORmal :CALCulate:RHO[:BTS]:LIMit:PRESet?
<b>Example</b>	CALC:RHO:LIM:PRES ISEV
<b>State Saved</b>	No
<b>Range</b>	Active Severe   Active Normal   Idle Severe   Idle Normal
<b>Backwards Compatibility SCPI</b>	:CALCulate:RHO:LIMit:PRESet
<b>Initial S/W Revision</b>	Prior to A.02.00

## Rho Pilot Limit

Sets rho pilot limit.

<b>Key Path</b>	Meas Setup, More1 of 3, Limits
<b>Mode</b>	1xEVDO
<b>Remote Command</b>	:CALCulate:RHO[:BTS]:LIMit:RHO:PILot <real> :CALCulate:RHO[:BTS]:LIMit:RHO:PILot?
<b>Example</b>	:CALC:RHO:LIM:RHO:PIL 0.950
<b>Preset</b>	0.970
<b>State Saved</b>	Saved in instrument state.
<b>Min</b>	0.0
<b>Max</b>	1.0
<b>Backwards Compatibility SCPI</b>	:CALCulate:RHO:LIMit:RHO:PILot
<b>Initial S/W Revision</b>	Prior to A.02.00

## Rho MAC Limit

Sets rho MAC limit.

Key Path	Meas Setup, More1 of 3, Limits
Mode	1xEVDO
<b>Remote Command</b>	:CALCulate:RHO[:BTS]:LIMit:RHO:MAC <real> :CALCulate:RHO[:BTS]:LIMit:RHO:MAC?
<b>Example</b>	:CALC:RHO:LIM:RHO:MAC 0.920
Preset	0.912
State Saved	Saved in instrument state.
Min	0.0
Max	1.0
<b>Backwards Compatibility SCPI</b>	:CALCulate:RHO:LIMit:RHO:MAC
Initial S/W Revision	Prior to A.02.00

## Rho Data Limit

Sets rho MAC limit.

Key Path	Meas Setup, More1 of 3, Limits
Mode	1xEVDO
<b>Remote Command</b>	:CALCulate:RHO[:BTS]:LIMit:RHO:DATA <real> :CALCulate:RHO[:BTS]:LIMit:RHO:DATA?
<b>Example</b>	:CALC:RHO:LIM:RHO:DATA 0.930
Preset	0.985
State Saved	Saved in instrument state.
Min	0.0
Max	1.0
<b>Backwards Compatibility SCPI</b>	:CALCulate:RHO:LIMit:RHO:DATA
Initial S/W Revision	Prior to A.02.00

## Frequency Error Limit

Sets relative frequency error limit in ppm. Frequency error fails unless it is smaller than both Absolute Frequency Error and Relative Frequency Error limits.

Key Path	Meas Setup, More1 of 3, Limits
Mode	1xEVDO

<b>Remote Command</b>	:CALCulate:RHO[:BTS]:LIMit:FREQuency <real> :CALCulate:RHO[:BTS]:LIMit:FREQuency?
<b>Example</b>	:CALC:RHO:LIM:FREQ 0.5
Preset	0.05 ppm
State Saved	Saved in instrument state.
Min	0
Max	1.0
<b>Backwards Compatibility SCPI</b>	:CALCulate:RHO:LIMit:FREQuency
Initial S/W Revision	Prior to A.02.00

### Pilot Offset Limit

Sets pilot offset limit in sec.

Key Path	Meas Setup, More1 of 3, Limits
Mode	1xEVDO
<b>Remote Command</b>	:CALCulate:RHO[:BTS]:LIMit:POFFset <real> :CALCulate:RHO[:BTS]:LIMit:POFFset?
<b>Example</b>	:CALC:RHO:LIM:POFF 1us
Preset	10 us
State Saved	Saved in instrument state.
Min	0 us
Max	100.0 us
<b>Backwards Compatibility SCPI</b>	:CALCulate:RHO:LIMit:POFFset
Initial S/W Revision	Prior to A.02.00

### Max MAC Inactive Power Limit

Sets max MAC inactive power limit.

Key Path	Meas Setup, More1 of 3, Limits, More 1 of 3
Mode	1xEVDO
<b>Remote Command</b>	:CALCulate:RHO[:BTS]:LIMit:MAC:INActive[:UPPer] <real> :CALCulate:RHO[:BTS]:LIMit:MAC:INActive[:UPPer]?
<b>Example</b>	:CALC:RHO:LIM:MAC:INAC -20
Preset	-27.00 dBc

State Saved	Saved in instrument state.
Min	-100.00 dBc
Max	0.0 dBc
<b>Backwards Compatibility SCPI</b>	:CALCulate:RHO:LIMit:MAC:INActive[:UPPer]
Initial S/W Revision	Prior to A.02.00

### Max Data Active Power Limit

Sets max Data active power limit.

Key Path	Meas Setup, More1 of 3, Limits, More 1 of 3
Mode	1xEVDO
<b>Remote Command</b>	:CALCulate:RHO[:BTS]:LIMit:DATA[:ACTive][:UPPer] <real> :CALCulate:RHO[:BTS]:LIMit:DATA[:ACTive][:UPPer]?
<b>Example</b>	:CALC:RHO:LIM:DATA -20
Preset	-14.56 dBc
State Saved	Saved in instrument state.
Min	-100.00 dBc
Max	0.0 dBc
<b>Backwards Compatibility SCPI</b>	:CALCulate:RHO:LIMit:DATA[:ACTive][:UPPer]
Initial S/W Revision	Prior to A.02.00

### Min Data Active Power Limit

Sets min Data active power limit.

Key Path	Meas Setup, More1 of 3, Limits, More 1 of 3
Mode	1xEVDO
<b>Remote Command</b>	:CALCulate:RHO[:BTS]:LIMit:DATA[:ACTive]:LOWer <real> :CALCulate:RHO[:BTS]:LIMit:DATA[:ACTive]:LOWer?
<b>Example</b>	:CALC:RHO:LIM:DATA:UPPer -20
Notes	Max is Max Data Active Power Limit value (:CALCulate:RHO:LIMit:DATA[:ACTive][:UPPer])
Preset	-15.55 dBc
State Saved	Saved in instrument state.
Min	-100.00 dBc
Max	0.0 dBc
<b>Backwards</b>	:CALCulate:RHO:LIMit:DATA[:ACTive]:LOWer

---

### Compatibility SCPI

Initial S/W Revision	Prior to A.02.00
----------------------	------------------

---

### Rho Overall Limit

Sets rho overall limit.

Key Path	Meas Setup, More1 of 3, Limits, More 1 of 3
Mode	1xEVDO
<b>Remote Command</b>	:CALCulate:RHO[:BTS]:LIMit:RHO:ALL <real> :CALCulate:RHO[:BTS]:LIMit:RHO:ALL?
<b>Example</b>	:CALC:RHO:LIM:RHO:ALL 0.950
Preset	0.500
State Saved	Saved in instrument state.
Min	0.0
Max	1.0
<b>Backwards Compatibility SCPI</b>	:CALCulate:RHO:LIMit:RHO:ALL
Initial S/W Revision	Prior to A.02.00

### Rho Preamble Limit

Sets rho preamble limit.

Key Path	Meas Setup, More1 of 3, Limits, More 1 of 3
Mode	1xEVDO
<b>Remote Command</b>	:CALCulate:RHO[:BTS]:LIMit:RHO:PREamble <real> :CALCulate:RHO[:BTS]:LIMit:RHO:PREamble?
<b>Example</b>	:CALC:RHO:LIM:RHO:PRE 0.950
Preset	0.500
State Saved	Saved in instrument state.
Min	0.0
Max	1.0
<b>Backwards Compatibility SCPI</b>	:CALCulate:RHO:LIMit:RHO:PREamble
Initial S/W Revision	Prior to A.02.00

## RMS EVM Limit

Sets RMS EVM limit.

Key Path	Meas Setup, More1 of 3, Limits, More 1 of 3, More 2 of 3
Mode	1xEVDO
<b>Remote Command</b>	:CALCulate:RHO[:BTS]:LIMit:RMS <real> :CALCulate:RHO[:BTS]:LIMit:RMS?
<b>Example</b>	:CALC:RHO:LIM:RMS 11.5
Preset	50.0 %
State Saved	Saved in instrument state.
Min	0.0 %
Max	100.0 %
<b>Backwards Compatibility SCPI</b>	:CALCulate:RHO:LIMit:RMS
Initial S/W Revision	Prior to A.02.00

## Peak EVM Limit

Sets Peak EVM limit.

Key Path	Meas Setup, More1 of 3, Limits, More 1 of 3, More 2 of 3,
Mode	1xEVDO
<b>Remote Command</b>	:CALCulate:RHO[:BTS]:LIMit:PEAK <real> :CALCulate:RHO[:BTS]:LIMit:PEAK?
<b>Example</b>	:CALC:RHO:LIM:PEAK 11.5
Preset	200.0 %
State Saved	Saved in instrument state.
Min	0.0 %
Max	500.0 %
<b>Backwards Compatibility SCPI</b>	:CALCulate:RHO:LIMit:PEAK
Initial S/W Revision	Prior to A.02.00

## Timing Limit

Sets Timing limit.

Key Path	Meas Setup, More1 of 3, Limits, More 1 of 3, More 2 of 3
Mode	1xEVDO

<b>Remote Command</b>	:CALCulate:RHO[:BTS]:LIMit:TIMing <second> :CALCulate:RHO[:BTS]:LIMit:TIMing?
<b>Example</b>	:CALC:RHO:LIM:TIM 0.05us
Preset	50.0 ns
State Saved	Saved in instrument state.
Min	0.0 s
Max	0.5 us
<b>Backwards Compatibility SCPI</b>	:CALCulate:RHO:LIMit:TIMing
Initial S/W Revision	Prior to A.02.00

## Phase Limit

Sets Phase limit.

Key Path	Meas Setup, More1 of 3, Limits, More 1 of 3, More 2 of 3
Mode	1xEVDO
<b>Remote Command</b>	:CALCulate:RHO[:BTS]:LIMit:PHASe <real> :CALCulate:RHO[:BTS]:LIMit:PHASe?
<b>Example</b>	:CALC:RHO:LIM:PHAS 0.05
Preset	0.05 rad
State Saved	Saved in instrument state.
Min	0.0 rad
Max	3.0 rad
<b>Backwards Compatibility SCPI</b>	:CALCulate:RHO:LIMit:PHASe
Initial S/W Revision	Prior to A.02.00

## Spectrum

Sets a spectrum either to Normal or Inverted for the demodulation related measurements. If set to INVert, the upper and lower spectrums are swapped.

Invert: This function conjugates the spectrum, which is equivalent to taking the negative of the quadrature component in demodulation. The correct setting (Normal or Invert) depends on whether the signal at the input of the instrument has a high or low side mix.

Key Path	Meas Setup, More 1 of 3, More 2 of 3
Mode	1xEVDO
<b>Remote Command</b>	[:SENSe]:RHO[:BTS]:SPECTrum NORMal INVert

	<code>[ :SENSe ] :RHO [ :BTS ] :SPEctrum?</code>
<b>Example</b>	RHO:SPEC INV
Preset	NORMal
State Saved	Saved in instrument state.
Range	Normal   Invert
<b>Backwards Compatibility SCPI</b>	<code>[ :SENSe ] :RHO :SPEctrum</code>
Initial S/W Revision	Prior to A.02.00

## Advanced

Accesses a menu of functions that enable you to set up more specific parameters for the measurement.

Key Path	Meas Setup
Initial S/W Revision	Prior to A.02.00

## EVM Result I/Q Offset

Selects whether to exclude I/Q origin offset from EVM calculation.

Key Path	Meas Setup, More 1 of 3, More 2 of 3, Advanced
Mode	1xEVDO
<b>Remote Command</b>	<code>:CALCulate:RHO[:BTS]:IQOffset:INCLude OFF ON 0 1</code> <code>:CALCulate:RHO[:BTS]:IQOffset:INCLude?</code>
<b>Example</b>	<code>:CALC:RHO:IQOF:INCL OFF</code>
Notes	Std and Exclude on soft key correspond to ON and OFF of SCPI respectively.
Preset	ON
State Saved	Saved in instrument state.
Range	Std   Exclude
<b>Backwards Compatibility SCPI</b>	<code>:CALCulate:RHO:IQOffset:INCLude</code>
Initial S/W Revision	Prior to A.02.00

## Result Preamble

Selects whether or not Preamble is included for Rho Data calculation.

Key Path	Meas Setup, More 1 of 3, More 2 of 3, Advanced
Mode	1xEVDO



<b>Remote Command</b>	<code>[ :SENSe ] :RHO [ :BTS ] :PREamble:STATe OFF ON 0 1</code> <code>[ :SENSe ] :RHO [ :BTS ] :PREamble:STATe?</code>
<b>Example</b>	RHO:PRE:STAT OFF
Notes	Incl and Excl on soft key correspond to ON and OFF of SCPI respectively.
Preset	ON
State Saved	Saved in instrument state.
Range	Incl   Excl
<b>Backwards Compatibility SCPI</b>	<code>[ :SENSe ] :RHO:PREamble:STATe</code>
Initial S/W Revision	Prior to A.02.00

## Filter Alpha

Selects one of 4 complementary filters. These complementary filters are designed to have raised cosine frequency responses of slightly different roll off factors, Alpha, conjunction with a TX filter defined in the standard. The smaller the Filter Alpha is, the better the adjacent power rejection performance becomes. Default of this parameter is 0.15.

Key Path	Meas Setup, More 1 of 3, More 2 of 3, Advanced
Mode	1xEVDO
<b>Remote Command</b>	<code>[ :SENSe ] :RHO [ :BTS ] :ALPHa &lt;real&gt;</code> <code>[ :SENSe ] :RHO [ :BTS ] :ALPHa?</code>
<b>Example</b>	RHO:ALPH 0.05
Preset	0.15
State Saved	Saved in instrument state.
Range	0.05 to 0.20
Min	0.05
Max	0.20
<b>Backwards Compatibility SCPI</b>	<code>[ :SENSe ] :RHO:ALPHa</code>
Initial S/W Revision	Prior to A.02.00

## Chip Rate

Changes the Chip Rate.

Key Path	Meas Setup, More 1 of 3, More 2 of 3, Advanced
Mode	1xEVDO
<b>Remote Command</b>	<code>[ :SENSe ] :RHO [ :BTS ] :CRATe &lt;freq&gt;</code>

	<code>[ :SENSe ] :RHO [ :BTS ] :CRATe?</code>
<b>Example</b>	RHO:CRAT 1.22 MHz
Preset	1.2288 MHz
State Saved	Saved in instrument state.
Range	1.10592 MHz to 1.35168 MHz
Min	1.10592 MHz
Max	1.35168 MHz
<b>Backwards Compatibility SCPI</b>	<code>[ :SENSe ] :RHO :CRATe</code>
Initial S/W Revision	Prior to A.02.00

## Rho Overall

Selects whether to calculate Rho Overall1/2 results. When Off, Overall results are not calculated.

Key Path	Meas Setup, More 1 of 3, More 2 of 3, Advanced
Mode	1xEVDO
<b>Remote Command</b>	<code>[ :SENSe ] :RHO [ :BTS ] :ALL [ :STATe ] OFF ON 0 1</code> <code>[ :SENSe ] :RHO [ :BTS ] :ALL [ :STATe ] ?</code>
<b>Example</b>	RHO:ALL ON
Preset	OFF
State Saved	Saved in instrument state.
Range	On   Off
<b>Backwards Compatibility SCPI</b>	<code>[ :SENSe ] :RHO :ALL [ :STATe ]</code>
Initial S/W Revision	Prior to A.02.00

## IF Gain

Enables you to control an internally switched IF amplifier with approximately 10 dB of gain. When it can be turned on without an overload, the dynamic range is always better with the amplifier on than off. The IF Gain key can be used to set the IF Gain function to Auto, or to On (the extra 10 dB) or Off. These settings affect sensitivity and IF overloads.

Key Path	Meas Setup, Advanced
Initial S/W Revision	Prior to A.02.00

## IF Gain Auto

Activates the auto rules for IF Gain.

Key Path	Meas Setup, More 1 of 3, More 2of 3, Advanced, IF Gain
Mode	1xEVDO
<b>Remote Command</b>	[ :SENSe ] :RHO [ :BTS ] :IF:GAIN:AUTO [ :STATe ] OFF ON  0  1 [ :SENSe ] :RHO [ :BTS ] :IF:GAIN:AUTO [ :STATe ] ?
<b>Example</b>	RHO:IF:GAIN:AUTO ON
Couplings	When either the auto attenuation works (for example, with electrical attenuator), or the optimize mechanical attenuator range is requested, the IF Gain setting is changed as following rule. 'auto' sets IF Gain 'High Gain' under any of the following conditions: the input attenuator is set to 0 dB, the preamp is turned on, or the Max Mixer Level is -20 dBm or lower. For other settings, auto sets IF Gain to 'Low Gain'.
Preset	OFF
State Saved	Saved in instrument state.
Range	Off On
<b>Backwards Compatibility SCPI</b>	[ :SENSe ] :RHO :IF:GAIN:AUTO [ :STATe ]
Initial S/W Revision	Prior to A.02.00

## IF Gain State

Selects the range of IF Gain.

Key Path	Meas Setup, More 1 of 3, More 2of 3, Advanced, IF Gain
Mode	1xEVDO
<b>Remote Command</b>	[ :SENSe ] :RHO [ :BTS ] :IF:GAIN [ :STATe ] OFF ON  0 1 [ :SENSe ] :RHO [ :BTS ] :IF:GAIN [ :STATe ] ?
<b>Example</b>	RHO:IF:GAIN:AUTO ON
Couplings	When either the auto attenuation works (for example, with electrical attenuator), or the optimize mechanical attenuator range is requested, the IF Gain setting is changed as following rule. 'auto' sets IF Gain 'High Gain' under any of the following conditions: the input attenuator is set to 0 dB, the preamp is turned on, or the Max Mixer Level is -20 dBm or lower. For other settings, auto sets IF Gain to 'Low Gain'.
Preset	OFF
State Saved	Saved in instrument state.
Range	Low Gain (Best for Large Signals) High Gain (Best Noise Level)
Readback Text	Low Gain   High Gain
<b>Backwards Compatibility SCPI</b>	[ :SENSe ] :RHO :IF:GAIN [ :STATe ]
Initial S/W Revision	Prior to A.02.00

## Multi Channel Estimator

Allows you to toggle the multi channel estimator function between On and Off.

- On : The individual code channels are aligned to the pilot channel to improve the phase error (whether each code phase is aligned or not). This takes a longer time.
- Off : The phase information is computed from one coded signal only. (The phase of each code channel needs to be aligned to the pilot channel.)

Key Path	Meas Setup, More 1 of 3, More 2 of 3, Advanced, More 1 of 2
Mode	1xEVDO
Remote Command	[ :SENSe ] :RHO [ :BTS ] :MCEstimator OFF ON 0 1 [ :SENSe ] :RHO [ :BTS ] :MCEstimator?
Example	RHO:MCES ON
Preset	OFF
State Saved	Saved in instrument state.
Range	On   Off
Backwards Compatibility SCPI	[ :SENSe ] :RHO:MCEstimator
Initial S/W Revision	Prior to A.02.00

## Timing Estimation

Allows you to select timing estimation function between channel-by-channel and global.

- Channel-by-Channel - The individual code channels are estimated as each timing. This takes a longer time.
- Global : The individual code channels are estimated as global timing.

Key Path	Meas Setup, More 1 of 3, More 2 of 3, Advanced, More1 of 2
Mode	1xEVDO
Remote Command	[ :SENSe ] :RHO [ :BTS ] :MCEstimator:TIMing CHANnel GLOBal [ :SENSe ] :RHO [ :BTS ] :MCEstimator:TIMing?
Example	RHO:MCES:TIM CHAN
Preset	GLOBal
State Saved	Saved in instrument state.
Range	CHANnel   GLOBal
Backwards Compatibility SCPI	[ :SENSe ] :RHO:MCEstimator:TIMing
Initial S/W Revision	Prior to A.02.00

## Active Set Threshold

Sets the threshold value for the active channel detection. And user can select the active channel identification function between Auto and Man. If set to Auto, the active channels are determined automatically by the internal algorithm. If it set to Man, the active channel identification is determined by a user definable threshold ranging from 0.00 to -100.0 dB.

Key Path	Meas Setup, More 1 of 3, More 2 of 3, Advanced, More 1 of 2
Mode	1xEVDO
Remote Command	:CALCulate:RHO[:BTS]:ASET:THReshold <real> :CALCulate:RHO[:BTS]:ASET:THReshold? :CALCulate:RHO[:BTS]:ASET:THReshold:AUTO OFF ON 0 1 :CALCulate:RHO[:BTS]:ASET:THReshold:AUTO?
Example	:CALC:RHO:ASET:THR -20 :CALC:RHO:ASET:THR:AUTO OFF
Notes	Turn the automatic mode On or Off, for the active channel identification function. OFF - The active channel identification for each code channel is determined by a value set by CALCulate:RHO:ASET:THReshold. ON - The internal algorithm determines the active channels automatically.
Preset	0.0 ON
State Saved	Saved in instrument state.
Range	-100 to 0.0
Min	-100
Max	0
Backwards Compatibility SCPI	:CALCulate:RHO:ASET:THReshold
Initial S/W Revision	Prior to A.02.00

## Idle Slot Threshold

Sets the threshold value for the Idle Slot detection. A slot is identified as Idle when power ratio of average power over Data channel in the slot to average power over Pilot and MAC channels in the slot is smaller than the value specified by this parameter.

Key Path	Meas Setup, More 1 of 3, More 2 of 3, Advanced, More 1 of 2
Mode	1xEVDO
Remote Command	[:SENSe]:RHO[:BTS]:ISLot:THReshold <real> [:SENSe]:RHO[:BTS]:ISLot:THReshold?
Example	:SENS:RHO:ISL:THR -20
Preset	-7.0

State Saved	Saved in instrument state.
Range	-100 to 0.0
Min	-100
Max	0
<b>Backwards Compatibility SCPI</b>	<code>[:SENSe]:RHO:ISLot:THReshold</code>
Initial S/W Revision	Prior to A.02.00

## Meas Preset

This key allows you to restore all the measurement settings to their defaults.

This will set the measure setup parameters for the currently selected measurement only, to the factory defaults.

Key Path	Meas Setup
Mode	1xEVDO
<b>Remote Command</b>	<code>:CONFigure:RHO[:BTS]</code>
<b>Example</b>	<code>:CONFigure:RHO</code>
Couplings	Selecting measurement preset will restore all measurement parameters to their default values for the current measurement.
Initial S/W Revision	Prior to A.02.00

Mode

See "Mode" on page 318

## Mode Preset

Returns the active mode to a known state.

Mode Preset does the following for the currently active mode:

- Aborts the currently running measurement.
- Brings up the default menu for the mode, with no active function.
- Sets measurement Global settings to their preset values for the active mode only.
- Activates the default measurement.
- Brings up the default menu for the mode.
- Clears the input and output buffers.
- Sets Status Byte to 0.

Mode Preset does not:

- Cause a mode switch
- Affect mode persistent settings
- Affect system settings

See "[How-To Preset](#)" on page 2181 for more information.

Key Path	Front-panel key
Remote Command	:SYSTem:PRESet
Example	:SYST:PRES
Notes	*RST is preferred over :SYST:PRES for remote operation. *RST does a Mode Preset, as done by the :SYST:PRES command, and it sets the measurement mode to Single measurement rather than Continuous for optimal remote control throughput. Clears all pending OPC bits. The Status Byte is set to 0.
Couplings	A Mode Preset aborts the currently running measurement, activates the default measurement, and gets the mode to a consistent state with all of the default couplings set.
Backwards Compatibility Notes	In the X-Series, the legacy "Factory Preset" has been replaced with Mode Preset, which only presets the currently active mode, not the entire instrument. In the X-Series, the way to preset the entire instrument is by using System, Restore System Defaults All, which behaves essentially the same way as restore System Defaults does on ESA and PSA. There is also no "Preset Type" as there is on the PSA. There is a green Mode Preset front-panel key that does a Mode Preset and a white-with-green-letters User Preset front-panel key that does a User Preset. The old PRESet:TYPE command is ignored (without generating an error), and SYST:PRES without a parameter does a Mode Preset, which should cover most backward code compatibility issues. The settings and correction data under the Input/Output front-panel key (examples: Input Z Corr, Ext Amp Gain, etc.) are no longer part of any Mode, so they will not be preset by a Mode Preset. They are preset using Restore Input/Output Defaults, Restore System Defaults All. Note that because User Preset does a Recall State, and all of these settings are saved in State, they ARE recalled when using



	User Preset.
Initial S/W Revision	Prior to A.02.00

## How-To Preset

The table below shows all possible presets, their corresponding SCPI commands and front-panel access (key paths). Instrument settings depend on the current measurement context. Some settings are local to the current measurement, some are global (common) across all the measurements in the current mode, and some are global to all the available modes. In a similar way, restoring the settings to their preset state can be done within the different contexts.

Auto Couple - is a measurement local key. It sets all Auto/Man parameter couplings in the measurement to Auto. Any Auto/Man selection that is local to other measurements in the mode will not be affected.

Meas Preset - is a measurement local key. Meas Preset resets all the variables local to the current measurement except the persistent ones.

Mode Preset - resets all the current mode's measurement local and measurement global variables except the persistent ones.

Restore Mode Defaults - resets ALL the Mode variables (and all the Meas global and Meas local variables), including the persistent ones.

Type Of Preset	SCPI Command	Front Panel Access
Auto Couple	:COUPlE ALL	Auto Couple front-panel key
Meas Preset	:CONFIgure:<Measurement>	Meas Setup Menu
Mode Preset	:SYSTem:PRESet	Mode Preset (green key)
Restore Mode Defaults	:INSTrument:DEFault	Mode Setup Menu
Restore All Mode Defaults	:SYSTem:DEFault MODEs	System Menu; Restore System Default Menu
*RST	*RST	not possible (Mode Preset with Single)
Restore Input/Output Defaults	:SYSTem:DEFault INPut	System Menu; Restore System Default Menu
Restore Power On Defaults	:SYSTem:DEFault PON	System Menu; Restore System Default Menu
Restore Alignment Defaults	:SYSTem:DEFault ALIGn	System Menu; Restore System Default Menu
Restore Miscellaneous Defaults	:SYSTem:DEFault MISC	System Menu; Restore System Default Menu
Restore All System Defaults	:SYSTem:DEFault [ALL] :SYSTem:PRESet:PERSistent	System Menu; Restore System Default Menu
User Preset	:SYSTem:PRESet:USER	User Preset Menu
User Preset All Modes	:SYSTem:PRESet:USER:ALL	User Preset Menu

Power On Mode Preset	:SYSTem:PON:TYPE MODE	System Menu
Power On User Preset	:SYSTem:PON:TYPE USER	System Menu
Power On Last State	:SYSTem:PON:TYPE LAST	System Menu

### Preset Type (Remote Command Only)

As stated in the Backward Compatibility section, to be compatible with ESA/PSA the PRESet:TYPE command will be implemented as a no-op.

<b>Mode</b>	All
<b>Remote Command</b>	:SYSTem:PRESet:TYPE FACTory MODE USER :SYSTem:PRESet:TYPE?
<b>Example</b>	:SYST:PRESet:TYPE FACT
<b>Notes</b>	This command is supported for backward compatibility only. It is a no-op which does not change the behavior of any preset operation.
<b>Preset</b>	This is unaffected by Preset but is set to Mode on a "Restore System Defaults->All"
<b>State Saved</b>	No
<b>Initial S/W Revision</b>	Prior to A.02.00

## Mode Setup

See ["Mode Setup" on page 348](#)

## Peak Search

Accesses a menu that enables you to control the peak search function and places a marker on the trace point with highest peak.

See the Peak Search key description under the Peak Search menu in the Spectrum Analyzer Mode, Swept SA Measurement.

Key Path	Front Panel Key
Initial S/W Revision	Prior to A.02.00

Key Path	Front panel key
Mode	1xEVDO
<b>Remote Command</b>	:CALCulate:RHO[:BTS]:MARKer[1] 2 ...12:MAXimum
<b>Example</b>	CALC:RHO:MARK2:MAX
Initial S/W Revision	Prior to A.02.00

## Next Peak

Moves the selected marker to the peak that has the next highest amplitude less than the marker's current value.

Key Path	Peak Search
Mode	1xEVDO
<b>Remote Command</b>	:CALCulate:RHO[:BTS]:MARKer[1] 2 ...12:MAXimum:NEXT
<b>Example</b>	CALC:RHO:MARK2:MAX:NEXT
Initial S/W Revision	Prior to A.02.00

## Next Pk Right

Moves the selected marker to the nearest peak right of the current marker which meets all enabled peak criteria.

Key Path	Peak Search
Mode	1xEVDO
<b>Remote Command</b>	:CALCulate:RHO[:BTS]:MARKer[1] 2 ...12:MAXimum:RIGHT
<b>Example</b>	CALC:RHO:MARK2:MAX:RIGH
Initial S/W Revision	Prior to A.02.00

## Next Pk Left

Moves the selected marker to the nearest peak left of the current marker which meets all enabled peak criteria.

Key Path	Peak Search
Mode	1xEVDO
<b>Remote Command</b>	:CALCulate:RHO[:BTS]:MARKer[1] 2 ...12:MAXimum:LEFT
<b>Example</b>	CALC:RHO:MARK2:MAX:LEFT
Initial S/W Revision	Prior to A.02.00

## Marker Delta

Performs the same function as the Delta 1-of-N selection key in the Marker menu. Basically this sets the control mode for the selected marker to Delta mode. See the Marker chapter for the complete description of this function. The key is duplicated here in the Peak Search Menu to allow the user to conveniently perform a peak search and change the marker's control mode to Delta without having to access two separate menus.

Key Path	Peak Search
Initial S/W Revision	Prior to A.02.00

## Pk-Pk Search

Finds and displays the amplitude and frequency (or time, if in zero span) differences between the highest and lowest y-axis value.

Key Path	Peak Search
Mode	1xEVDO
<b>Remote Command</b>	:CALCulate:RHO[:BTS]:MARKer[1] 2 ...12:PTPeak
<b>Example</b>	CALC:RHO:MARK:PTP
Notes	Turns on the Marker $\Delta$
Couplings	This key is not available (key is grayed out) when Coupled Markers is on.
Initial S/W Revision	Prior to A.02.00

## Min Search

Moves the selected marker to the minimum y-axis value on the current trace.

Key Path	Peak Search
Mode	1xEVDO

17 Forward Link Modulation Accuracy  
Peak Search

---

<b>Remote Command</b>	:CALCulate:RHO[:BTS]:MARKer[1] 2 ...12:MINimum
<b>Example</b>	CALC:RHO:MARK:MIN
<b>Initial S/W Revision</b>	Prior to A.02.00

---

Print

See "Print" on page 358

## Quick Save

The Quick Save front-panel key repeats the most recent save that was performed from the Save menu, with the following exceptions:

- Register saves are not remembered as Saves for the purpose of the Quick Save function
- If the current measurement does not support the last non-register save that was performed, an informational message is generated, “File type not supported for this measurement”

Quick Save repeats the last type of qualified save (that is, a save qualified by the above criteria) in the last save directory by creating a unique filename using the Auto File Naming algorithm described below.

If Quick Save is pressed after startup and before any qualified Save has been performed, the Quick Save function performs a Screen Image save using the current settings for Screen Image saves (current theme, current directory), which then becomes the “last save” for the purpose of subsequent Quick Saves.

The Auto File Naming feature automatically generates a file name for use when saving a file. The filename consists of a prefix and suffix separated by a dot, as is standard for the Windows® file system. A default prefix exists for each of the available file types:

Type	Default Prefix	Menu
State	State_	(Save/Recall)
Trace + State	State_	(Save/Recall)
Screen	Screen_	(Save/Recall)
Amplitude Corrections	Ampcor_	(Import/Export)
Traces	Trace_	(Import/Export)
Limit Lines	LLine_	(Import/Export)
Measurement Result	MeasR_	(Import/Export)
Capture Buffer	CapBuf_	(Import/Export)

A four digit number is appended to the prefix to create a unique file name. The numbering sequence starts at 0000 within each Mode for each file type and updates incrementally to 9999, then wraps to 0000 again. It remembers where it was through a Mode Preset and when leaving and returning to the Mode. It is reset by Restore Misc Defaults and Restore System Defaults and subsequent running of the instrument application. So, for example, the first auto file name generated for State files is State\_0000.state. The next is State\_0001, and so forth.

One of the key features of Auto File Name is that we guarantee that the Auto File Name will never conflict with an existing file. The algorithm looks for the next available number. If it gets to 9999, then it looks for holes. If it find no holes, that is no more numbers are available, it gives an error.

For example, if when we get to State\_0010.state there is already a State\_0010.state file in the current directory, it advances the counter to State\_0011.state to ensure that no conflict will exist (and then it verifies that State\_0011.state also does not exist in the current directory and advances again if it does, and so forth).



If you enter a file name for a given file type, then the prefix becomes the filename you entered instead of the default prefix, followed by an underscore. The last four letters (the suffix) are the 4-digit number.

For example, if you save a measurement results file as “fred.csv”, then the next auto file name chosen for a measurement results save will be fred\_0000.csv.

**NOTE** Although 0000 is used in the example above, the number that is used is actually the current number in the Meas Results sequence, that is, the number that would have been used if you had not entered your own file name.

**NOTE** If the filename you entered ends with \_dddd, where d=any number, making it look just like an auto file name, then the next auto file name picks up where you left off with the suffix being dddd + 1.

Key Path	Front-panel key
Notes	No remote command for this key specifically.
Initial S/W Revision	Prior to A.02.00

## Recall

The Recall menu lets you choose what you want to recall, and where you want to recall it from. Among the types of files you can recall are **States and Traces**. In addition, an Import (Data) option lets you recall a number of data types stored in CSV files (as used by Excel and other spreadsheet programs).

The default paths for Recall are data type dependent and are the same as for the Save key.

Key Path	Front-panel key
Notes	<p>No remote command for this key specifically, but the :MMEM:LOAD command is available for specific file types. An example is :MMEM:LOAD:STATe &lt;filename&gt;.</p> <p>If you try to recall a State file for a mode that is not licensed or not available in the instrument, an error message will occur and the state will not change.</p>
Backwards Compatibility Notes	<p>In legacy analyzers, it was possible to load a state without affecting the trace data, limit lines or correction data. Similarly (since User Preset is actually loading a state), it was possible to do a User Preset without affecting the trace data, limit lines or correction data.</p> <p>In the X-Series, “state” always includes all of this data; so whenever state is loaded, all of the traces, limit lines and corrections are affected. Although this differs from previous behavior, it is desirable behavior, and should not cause adverse issues for users.</p>
Backwards Compatibility Notes	<p>Recall for the X-Series supports backward compatibility in the sense that you can recall a state file from any X-Series model number and any version of X-Series software. This is only possible if part of the recalling process goes through a limiting step after recalling the mode settings, at least for settings that may vary with version number, model number, option and license differences. If you try to recall a state file onto an instrument with less capability than what was available on the instrument during the save, the recall will ignore the state it doesn't support and it will limit the recalled setting to what it allows.</p> <p>Example: if the saved state includes preamp ON, but the recalling instrument does not have a preamp; the preamp is limited to OFF. Conversely, if you save a state without a preamp, the preamp is OFF in the state file. When this saved file is recalled on an instrument with a licensed preamp, the preamp is changed to OFF. Another example is if the saved state has center frequency set to 20 GHz, but the instrument recalling the saved state is a different model and only supports 13.5 GHz. In this case, the center frequency is limited along with any other frequency based settings. Since the center frequency can't be preserved in this case, the recall limiting tries to at least preserve span to keep the measurement setup as intact as possible.</p> <p>It may be appropriate to issue a warning if the state is limited on the recall; warnings do not go out to SCPI so this would only affect the manual user.</p> <p>Note that there is no state file compatibility outside of the X-Series. For example, you cannot recall a state file from ESA or PSA.</p>
Initial S/W Revision	Prior to A.02.00

## State

The Recall State menu lets you choose a register or file from which to recall the state.

The content of a state file includes all of the settings and data required to return the analyzer as closely as possible to the Mode it was in, with the exact settings that were in place, when the save occurred. The Mode settings in each state file include the settings that are affected by Mode Preset, as well as the

additional settings affected by Restore Mode Defaults; all of the Mode’s settings. In addition, all of the settings of the Input/Output system are included, even though they are outside of the Mode’s state, because they are needed to restore the complete setup. Persistent System settings (for example, GPIB address) are not affected by either a Mode Preset or Restore Mode Defaults, nor are they included in a saved State file.

Since each state file is only for one Mode, the settings for other Modes are unaffected when it is loaded. Recall State will cause a mode switch if the state being recalled is not from the current active mode.

After the recall completes, the message "File <filename> recalled" or “Recalled State Register <register number>” is displayed.

For rapid recalls, the State menu lists 16 registers that you can choose from to recall. Pressing a Register key initiates the recall. You can also select a file from which to recall.

The default path for all State Files is:

My Documents\<<mode name>\state

where <mode name> is the parameter used to select the mode with the INST:SEL command (for example, SA for the Spectrum Analyzer).

See "[More Information](#)" on page 2192.

<b>Key Path</b>	Recall
<b>Mode</b>	All
<b>Remote Command</b>	:MMEMory:LOAD:STATe <filename>
<b>Example</b>	:MMEM:LOAD:STAT "myState.state" This recalls the file myState.state on the default path
<b>Example</b>	MMEM:LOAD:STAT "MyStateFile.state" This loads the state file data (on the default file directory path) into the instrument state.
<b>Notes</b>	<p>When you pick a file to recall, the analyzer first verifies that the file is recallable in the current instrument by checking the software version and model number of the instrument. If everything matches, a full recall proceeds by aborting the currently running measurement, clearing any pending operations, and then loading the State from the saved state file. You can open state files from any mode, so recalling a State file switches to the mode that was active when the save occurred. After switching to the mode of the saved state file, mode settings and data (if any for the mode) are loaded with values from the saved file. The saved measurement of the mode becomes the newly active measurement and the data relevant to the measurement (if there is any) is recalled.</p> <p>If there is a mismatch between file version or model number or instrument version or model number, the recall function tries to recall as much as possible and returns a warning message. It may limit settings that differ based on model number, licensing or version number.</p> <p>After recalling the state, the Recall State function does the following:</p> <ul style="list-style-type: none"> <li>• Makes the saved measurement for the mode the active measurement.</li> <li>• Clears the input and output buffers.</li> <li>• Status Byte is set to 0.</li> <li>• Executes a *CLS</li> </ul> <p>If the file specified is empty an error is generated. If the specified file does not exist, another error is generated. If there is a mismatch between the file and the proper file type, an error is generated. If</p>

---

	there is a mismatch between file version or model number or instrument version or model number, a warning is displayed. Then it returns to the State menu and File Open dialog goes away. After the Recall, the analyzer exits the Recall menu and returns to the previous menu.
<b>Backwards Compatibility SCPI</b>	:MMEMory:LOAD:STATe 1,<filename> For backwards compatibility, the above syntax is supported. The "1" is simply ignored.
Initial S/W Revision	Prior to A.02.00

---

## More Information

In measurements that support saving Traces, for example, Swept SA, the Trace data is saved along with the State in the State file. When recalling the State, the Trace data is recalled as well. Traces are recalled exactly as they were stored, including the writing mode and update and display modes. If a Trace was updating and visible when the State was saved, it will come back updating and visible, and its data will be rewritten right away. When you use State to save and recall traces, any trace whose data must be preserved should be placed in View or Blank mode before saving.

The following table describes the Trace Save and Recall possibilities:

You want to recall state and one trace's data, leaving other traces unaffected.	Save Trace+State from 1 trace. Make sure that no other traces are updating (they should all be in View or Blank mode) when the save is performed.	On Recall, specify the trace you want to load the one trace's data into. This trace will load in View. All other traces' data will be unaffected, although their trace mode will be as it was when the state save was performed.
You want to recall all traces	Save Trace+State from ALL traces.	On Recall, all traces will come back in View (or Blank if they were in Blank or Background when saved)
You want all traces to load exactly as they were when saved.	Save State	On recall, all traces' mode and data will be exactly as they were when saved. Any traces that were updating will have their data immediately overwritten.

## From File...

When you press "From File", the analyzer brings up a Windows dialog and a menu entitled "File Open." This menu allows you to navigate to the various fields in the Windows dialog without using a keyboard or mouse. The Tab and Arrow keys can also be used for dialog navigation.



Listed below are the functions of the various fields in the dialog, and the corresponding softkeys:

#### Open

Performs the recall of the specified file. While the recall is being performed, the floppy icon appears briefly in the Meas bar.

#### File/Folder List

Enables you to navigate to the center of the dialog that contains the list of files and folders. Once here you can get information about the file and use the tab keys to navigate to the other fields in the dialog, such as Look In.

#### Look In

The Look In field shows the path from which the file will be recalled and allows you to change the path using the up and down arrow keys to navigate to other paths; the Enter key to open a directory; and the Backspace key to go back one directory. The **Look In field** first uses the last path from the Save As dialog **Save In:** path for that same file type. There is no softkey for directly navigating to the Look In field, but you can use the left tab to get here from the File/Folder List.

User specified paths are remembered when you leave and return to a Mode and are reset back to the default using Restore Mode Defaults.

#### Sort

Accesses a menu that enables you to sort the files within the File Open dialog. Only one sorting type can be selected at a time and the sorting happens immediately. The sorting types are By Date, By Name, By extension, and By Size.

#### Files of Type

This field shows the file suffix for the type of file you have selected to recall. For example, if you navigated here while recalling State, "Mode state (\*.state)" is in the field. If you navigated here while recalling Trace, ""Mode state (\*.trace)" is in the field. If you navigated here while importing a trace data file, "Trace Data (\*.csv)" is in the field. For some file types, there is more than one choice in the dropdown menu, which you can select by using the up and down arrow keys and Enter.

#### Up One Level

This key corresponds to the icon of a folder with the up arrow that is in the tool bar of the dialog. When pressed, it causes the file and folder list to navigate up one level in the directory structure. The Backspace key does the same thing.

#### Cancel

This key corresponds to the Cancel selection in the dialog. It causes the current **Open** request to be cancelled. The ESC key does the same thing.

Key Path	Recall, State
Notes	Brings up the Open dialog for recalling a State Save Type
Initial S/W Revision	Prior to A.02.00

### Edit Register Names

You may enter a custom name on any of the Register keys, to help you remember what you are using that state to save. To do this, press the Edit Register Names key, choose the register whose name you wish to edit, and then enter the desired label using the Alpha Editor or an external PC keyboard.

The maximum number of characters that can be added is 30. In most cases, 30 characters will fit on two lines of the key.

For more information and the SCPI command, see Edit Register Names under the Save, State function.

Key Path	Recall, State
Mode	All
Dependencies	N9060A-7FP or N9060B-2FP license required to edit the register names. When the feature is not licensed, sending the SCPI command generates an error, -221, "Settings conflict;Option not available"
Initial S/W Revision	A.11.00

### Register 1 thru Register 16

Selecting any one of these register keys causes the State of the mode from the specified Register to be recalled. Each of the register keys annotates whether it is empty or at what date and time it was last

modified. In addition, you can use the Edit Register Names key under Save, State to enter custom names for each register.

Registers are shared by all modes, so recalling from any one of the registers will cause a mode switch to the mode that was active when the save to the Register occurred.

Although these 16 registers are the only registers available from the front panel, there are 128 state registers available in the instrument. Registers 17–128 are only available from the SCPI interface, using the \*RCL command.

After the recall completes, the message "Register <register number> recalled" appears in the message bar. If you are in the Spectrum Analyzer Mode, and you are recalling a register that was saved in the Spectrum Analyzer Mode, then after the recall, you will still be in the Recall Register menu. If the Recall causes you to switch modes, then after the Recall, you will be in the Frequency menu.

If a requested register is empty an error is generated.

Key Path	Recall, State
<b>Example</b>	*RCL 1
Range	1–16 from front panel, 1–128 from SCPI
Readback	Date and time with seconds resolution are displayed on the key OR A custom name of up to 30 characters entered using the Save, State, Edit Register Names key OR “(empty)” if no prior save operation has been performed to this register.
Initial S/W Revision	Prior to A.02.00
Modified at S/W Revision	Prior to A.11.00

## Register 1 thru Register 16

Selecting any one of these register keys causes the State of the mode from the specified Register to be recalled. Each of the register keys annotates whether it is empty or at what date and time it was last modified. In addition, you can use the Edit Register Names key under Save, State to enter custom names for each register.

Registers are shared by all modes, so recalling from any one of the registers will cause a mode switch to the mode that was active when the save to the Register occurred.

Although these 16 registers are the only registers available from the front panel, there are 128 state registers available in the instrument. Registers 17–128 are only available from the SCPI interface, using the \*RCL command.

After the recall completes, the message "Register <register number> recalled" appears in the message bar. If you are in the Spectrum Analyzer Mode, and you are recalling a register that was saved in the Spectrum Analyzer Mode, then after the recall, you will still be in the Recall Register menu. If the Recall causes you to switch modes, then after the Recall, you will be in the Frequency menu.

If a requested register is empty an error is generated.

Key Path	Recall, State
<b>Example</b>	*RCL 1
Range	1-16 from front panel, 1-128 from SCPI
Readback	Date and time with seconds resolution are displayed on the key OR A custom name of up to 30 characters entered using the Save, State,Edit Register Names key OR “(empty)” if no prior save operation has been performed to this register.
Initial S/W Revision	Prior to A.02.00
Modified at S/W Revision	Prior to A.11.00

### Trace (+State)

The Recall Trace (+State) menu lets you choose a register or file from which to recall the Trace+State state file.

A saved state contains all of the settings and data required to return the analyzer as closely as possible to the exact setup it had when the save occurred. This includes the Input/Output settings, even though they are outside of the Mode’s state, because they are needed to restore the complete setup. A Trace+State file also includes trace data from one trace or all traces, which will load in View mode when the Trace+State file is recalled. Recall Trace (+State) will also cause a mode switch if the state being recalled is not for the current active mode.

After the recall completes, the message "File <filename> recalled" or “Recalled Trace Register <register number>” is displayed.

For rapid recalls, the Trace (+State) menu lists 5 registers to choose from to recall. Pressing a Register key initiates the recall. You can also select a file from which to recall.

The default path for all State Files including .trace files is:

My Documents\<mode name>\state

where <mode name> is the parameter used to select the mode with the INST:SEL command (for example, SA for the Spectrum Analyzer).

Key Path	Recall
Mode	SA
<b>Remote Command</b>	:MMEMory:LOAD:TRACe TRACE1   TRACE2   TRACE3   TRACE4   TRACE5   TRACE6,<filename>  :MMEMory:LOAD:TRACe:REGister TRACE1   TRACE2   TRACE3   TRACE4   TRACE5   TRACE6,<integer>
<b>Example</b>	MMEM:LOAD:TRAC TRACE2, "MyTraceFile.trace" This loads the trace file data (on the default file directory path) into the specified trace; if it is a "single trace" save file, that trace is loaded to trace 2, and is set to be not updating. :MMEM:LOAD:TRAC:REG TRACE1,2



	restores the trace data in register 2 to Trace 1
Notes	<p>When you perform the recall, the recalling Trace function must first verify the file is recallable in this instrument by checking instrument software version and model number, since it includes State. If everything matches, a full recall proceeds by aborting the currently running measurement, and loading the state from the saved state file to as close as possible to the context in which the save occurred. You can open .trace files from any mode that supports them, so recalling a Trace file switches to the mode that was active when the save occurred. After switching to the mode of the saved state file, mode settings and data (if any for the mode) are loaded with values from the saved file and the saved measurement of the mode becomes the newly active measurement, and the data relevant to the measurement (if there is any) is recalled.</p> <p>Once the state is loaded, the trace data must be loaded. The internal flags are consulted to see which trace to load and the "To Trace" setting to see where to load it. Trace data is always loaded with the specified trace set to View, so that the data is visible and not updating(so as not to erase the recalled data). If the file is an "all trace" file, all traces are loaded with the saved data(to the original trace the data was saved from) and set to View. Traces whose data is not loaded are restored to the update state that existed when they were saved.</p> <p>After the Recall the analyzer exits the Recall menu and returns to the previous menu.</p> <p>Some modes and measurements do not have available all 6 traces. Phase Noise mode command, for example, is: <code>MMEMory:LOAD:TRACe TRACE1 TRACE2 TRACE3,&lt;filename&gt;</code></p> <p>Some modes and measurements have more than 6 traces available. The Realtime SA mode command, for example, is: <code>MMEMory:STORe:TRACe TRACE1   TRACE2   TRACE3   TRACE4   TRACE5   TRACE6   TRACE7   TRACE8   TRACE9   TRACE10   TRACE11   TRACE12   ALL,&lt;filename&gt;</code></p>
Initial S/W Revision	Prior to A.02.00

## To Trace

These menu selections let you choose the Trace where the recalled saved trace will go. Not all modes have the full 6 traces available. The default is the currently selected trace, selected in this menu or in the Trace/Detector, Export Data, Import Data, or Save Trace menus, except if you have chosen All, then it remains chosen until you specifically change it to a single trace.

If the .trace file is an "all trace" file, "To Trace" is ignored and the traces each go back to the trace from which they were saved.

Once selected, the key returns back to the Recall Trace menu and the selected Trace number is annotated on the key. Now you have selected exactly where the trace needs to be recalled.To trigger a recall of the selected Trace, you must select the Open key in the Recall Trace menu.

When you select a trace, it makes that trace the current trace, so it displays on top of all of the other traces.

Key Path	Save, Data, Trace
Mode	SA
Initial S/W Revision	Prior to A.02.00

## Register 1 thru Register 16

Selecting any one of these register keys causes the State of the mode from the specified Register to be recalled. Each of the register keys annotates whether it is empty or at what date and time it was last modified. In addition, you can use the Edit Register Names key under Save, State to enter custom names for each register.

Registers are shared by all modes, so recalling from any one of the registers will cause a mode switch to the mode that was active when the save to the Register occurred.

Although these 16 registers are the only registers available from the front panel, there are 128 state registers available in the instrument. Registers 17–128 are only available from the SCPI interface, using the \*RCL command.

After the recall completes, the message "Register <register number> recalled" appears in the message bar. If you are in the Spectrum Analyzer Mode, and you are recalling a register that was saved in the Spectrum Analyzer Mode, then after the recall, you will still be in the Recall Register menu. If the Recall causes you to switch modes, then after the Recall, you will be in the Frequency menu.

If a requested register is empty an error is generated.

Key Path	Recall, State
<b>Example</b>	*RCL 1
Range	1–16 from front panel, 1–128 from SCPI
Readback	Date and time with seconds resolution are displayed on the key OR A custom name of up to 30 characters entered using the Save, State, Edit Register Names key OR “(empty)” if no prior save operation has been performed to this register.
Initial S/W Revision	Prior to A.02.00
Modified at S/W Revision	Prior to A.11.00

## From File...

When you press “From File”, the analyzer brings up a Windows dialog and a menu entitled “File Open.” This menu allows you to navigate to the various fields in the Windows dialog without using a keyboard or mouse. The Tab and Arrow keys can also be used for dialog navigation.

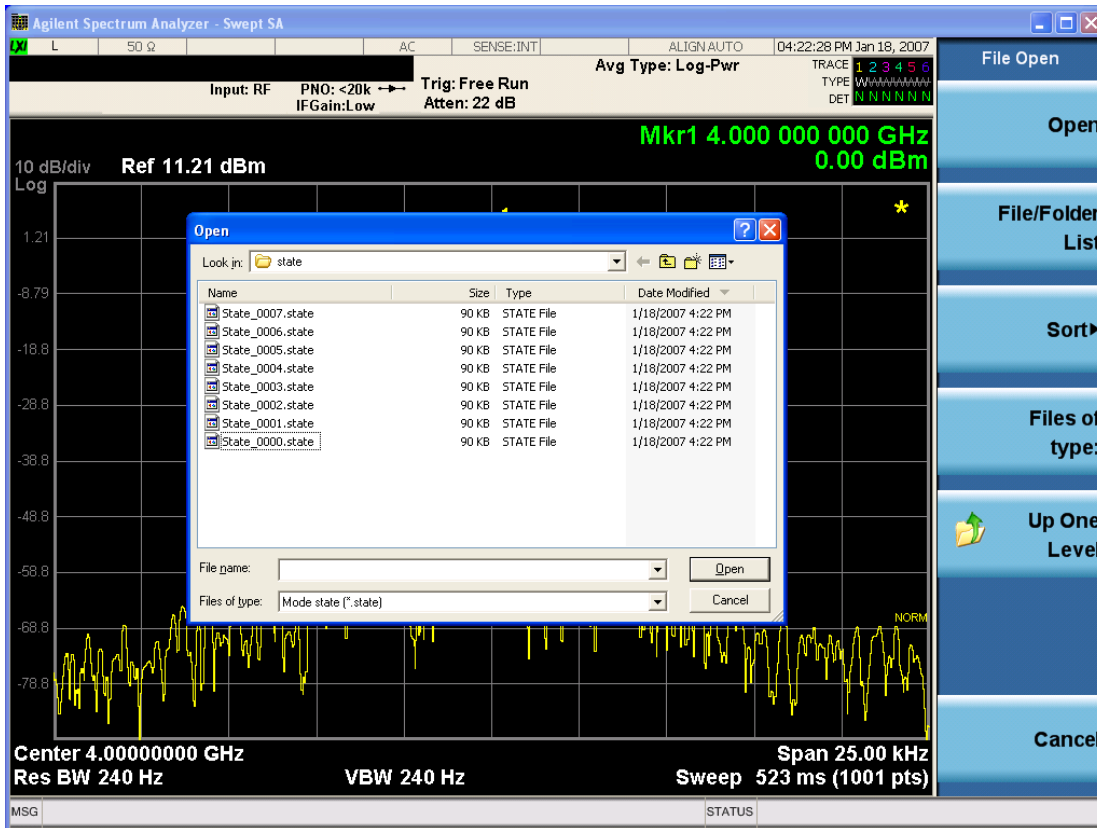

Listed below are the functions of the various fields in the dialog, and the corresponding softkeys:

#### Open

Performs the recall of the specified file. While the recall is being performed, the floppy icon appears briefly in the Meas bar.

#### File/Folder List

Enables you to navigate to the center of the dialog that contains the list of files and folders. Once here you can get information about the file and use the tab keys to navigate to the other fields in the dialog, such as Look In.

#### Look In

The Look In field shows the path from which the file will be recalled and allows you to change the path using the up and down arrow keys to navigate to other paths; the Enter key to open a directory; and the Backspace key to go back one directory. The **Look In field** first uses the last path from the Save As dialog **Save In:** path for that same file type. There is no softkey for directly navigating to the Look In field, but you can use the left tab to get here from the File/Folder List.

User specified paths are remembered when you leave and return to a Mode and are reset back to the default using Restore Mode Defaults.

#### Sort

Accesses a menu that enables you to sort the files within the File Open dialog. Only one sorting type can be selected at a time and the sorting happens immediately. The sorting types are By Date, By Name, By extension, and By Size.

#### Files of Type

This field shows the file suffix for the type of file you have selected to recall. For example, if you navigated here while recalling State, "Mode state (\*.state)" is in the field. If you navigated here while recalling Trace, ""Mode state (\*.trace)" is in the field. If you navigated here while importing a trace data file, "Trace Data (\*.csv)" is in the field. For some file types, there is more than one choice in the dropdown menu, which you can select by using the up and down arrow keys and Enter.

#### Up One Level

This key corresponds to the icon of a folder with the up arrow that is in the tool bar of the dialog. When pressed, it causes the file and folder list to navigate up one level in the directory structure. The Backspace key does the same thing.

#### Cancel

This key corresponds to the Cancel selection in the dialog. It causes the current **Open** request to be cancelled. The ESC key does the same thing.

Key Path	Recall, State
Notes	Brings up the Open dialog for recalling a State Save Type
Initial S/W Revision	Prior to A.02.00

## Data (Import)

Importing a data file loads data that was previously saved from the current measurement or from other measurements and/or modes that produce compatible data files. The Import Menu only contains Data Types that are supported by the current measurement.

Since the commonly exported data files are in .csv format, the data can be edited by the user prior to importing. This allows you to export a data file, manipulate the data in Excel (the most common PC Application for manipulating .csv files) and then import it.

Importing Data loads measurement data from the specified file into the specified or default destination, depending on the data type selected. Selecting an Import Data menu key will not actually cause the importing to occur, since the analyzer still needs to know from where to get the data. Pressing the Open key in this menu brings up the Open dialog and Open menu that provides you with the options from where to recall the data. Once a filename has been selected or entered in the Open menu, the recall occurs as soon as the Open button is pressed.

Key Path	Recall
Mode	All
Notes	The menu is built from whatever data types are available for the mode. Some keys will be missing completely, so the key locations in the sub-menu will vary. No SCPI command directly controls the Data Type that this key controls. The Data Type is included in the MMEM:LOAD commands.

Dependencies	If a file type is not used by a certain measurement, it is grayed out for that measurement. The key for a file type will not show at all if there are no measurements in the Mode that support it.
Preset	Is not affected by Preset or shutdown, but is reset during Restore Mode Defaults
Readback	The data type that is currently selected
Initial S/W Revision	Prior to A.02.00

## Capture Buffer

The captured data is raw data which is not processed.

Key Path	Recall, Data
Mode	<b>CDMA1XEV</b>
Example	MMEM:LOAD:CAPT "MyCaptureData.bin" This loads the file of capture data (on the default file directory path) into the instrument.
Dependencies	In case the capture buffer data is not available from the selected measurement, the key will be grayed out.
Initial S/W Revision	A.11.00

## Open...

When you press "Open", the analyzer brings up a Windows dialog and a menu entitled "**File Open.**" This menu allows you to navigate to the various fields in the Windows dialog without using a keyboard or mouse. The Tab and Arrow keys can also be used for dialog navigation.

See "[From File...](#)" on page 2890 in Recall, State, for a full description of this dialog and menu.

Key Path	Recall, Data
Notes	The key location is mode-dependent and will vary. Brings up Open dialog for recalling a <mode specific> Save Type
Initial S/W Revision	Prior to A.02.00

## Restart

The Restart function restarts the current sweep, or measurement, or set of averaged/held sweeps or measurements. If you are Paused, pressing Restart does a Resume.

The Restart function is accessed in several ways:

- Pressing the Restart key
- Sending the remote command INIT:IMMEDIATE
- Sending the remote command INIT:RESTART

See "[More Information](#)" on page 2202

Key Path	Front-panel key
Remote Command	:INITiate[:IMMEDIATE] :INITiate:RESTART
Example	:INIT:IMM :INIT:REST
Notes	:INITiate:RESTART and :INITiate:IMMEDIATE perform exactly the same function.
Couplings	Resets average/hold count k. For the first sweep overwrites all active (update=on) traces with new current data. For application modes, it resets other parameters as required by the measurement.
Status Bits/OPC dependencies	This is an Overlapped command. The STATus:OPERation register bits 0 through 8 are cleared. The STATus:QUESTionable register bit 9 (INTegrity sum) is cleared. The SWEEPING bit is set. The MEASURING bit is set.
Backwards Compatibility Notes	For Spectrum Analysis mode in ESA and PSA, the Restart hardkey and the INITiate:RESTART command restart trace averages (displayed average count reset to 1) for a trace in Clear Write, but did not restart Max Hold and Min Hold.  In the X-Series, the Restart hardkey and the INITiate:RESTART command restart not only Trace Average, but MaxHold and MinHold traces as well.  For wireless comms modes in ESA and PSA, the Restart hardkey and the INITiate:RESTART command restart every measurement, which includes all traces and numeric results. There is no change to this operation.
Initial S/W Revision	Prior to A.02.00

### More Information

The **Restart** function first aborts the current sweep/measurement as quickly as possible. It then resets the sweep and trigger systems, sets up the measurement and initiates a new data measurement sequence with a new data acquisition (sweep) taken once the trigger condition is met.

If the analyzer is in the process of aligning when **Restart** is executed, the alignment finishes before the restart function is performed.

Even when set for Single operation, multiple sweeps may be taken when Restart is pressed (for example, when averaging/holding is on). Thus when we say that **Restart** "restarts a measurement," we may mean:

- It restarts the current sweep
- It restarts the current measurement
- It restarts the current set of sweeps if any trace is in Trace Average, Max Hold or Min Hold
- It restarts the current set of measurements if Averaging, or Max Hold, or Min Hold is on for the measurement
- depending on the current settings.

With **Average/Hold Number** (in **Meas Setup** menu) set to 1, or Averaging off, or no trace in Trace Average or Hold, a single sweep is equivalent to a single measurement. A single sweep is taken after the trigger condition is met; and the analyzer stops sweeping once that sweep has completed. However, with **Average/Hold Number** >1 and at least one trace set to **Trace Average, Max Hold, or Min Hold (SA Measurement)** or **Averaging on (most other measurements)**, multiple sweeps/data acquisitions are taken for a single measurement. The trigger condition must be met prior to each sweep. The sweep is stopped when the average count  $k$  equals the number  $N$  set for **Average/Hold Number**. A measurement average usually applies to all traces, marker results, and numeric results; but sometimes it only applies to the numeric results.

Once the full set of sweeps has been taken, the analyzer will go to idle state. To take one more sweep without resetting the average count, increment the average count by 1, by pressing the step up key while **Average/Hold Number** is the active function, or sending the remote command `CALC:AVER:TCON UP`.

## Save

The Save menu lets you choose what you want to save and where you want to save it. Among the types of files you can save are **States**, **Traces**, and **Screen Images**. In addition, an Export (Data) option lets you save a number of data types as CSV files for easy import into Excel and other spreadsheet programs.

Key Path	Front-panel key
Mode	All
Notes	No remote command for this key specifically, but the :MMEM:STOR:STATe <filename> command is available for specific file types. An example is :MMEM:STOR:STATe <filename>.
Initial S/W Revision	Prior to A.02.00

## State

The Save State menu lets you choose a register or file for saving the state.

The content of a state file includes all of the settings and data required to return the analyzer as closely as possible to the Mode it was in, with the exact settings which were in place, when the save occurred. The Mode settings in each state file include the settings that are affected by Mode Preset, as well as the additional settings affected by Restore Mode Defaults; all of the Mode's settings. In addition, all of the settings of the Input/Output system are included, even though they are outside of the Mode's state, because they are needed to restore the complete setup. Persistent System settings (for example, Verbose SCPI) are not affected by either Mode Preset or Restore Mode Defaults, nor are they included in a saved State file.

After the save completes, the message "File <filename> saved" or "State Register <register number> saved" is displayed.

For rapid saving, the State menu lists 16 registers to save to. Pressing a Register key initiates the save. You can also select a file to save to.

The default path for all State Files is:

My Documents\<<mode name>\state

where <mode name> is the parameter used to select the mode with the INST:SEL command (for example, SA for the Spectrum Analyzer).

Key Path	Save
Mode	All
Remote Command	:MMEMory:STORe:STATe <filename>
Example	MMEM:STOR:STATe "MyStateFile.state" This stores the current instrument state data in the file MyStateFile.state in the default directory.
Notes	Both single and double quotes are supported for any filename parameter over remote. After saving to a register, that register's menu key is updated with the date the time, unless a custom label has been entered for that key. After saving to a register, you remain in the Save State menu, so that you can see the Register key



update. After saving to a file, the analyzer automatically returns to the previous menu and any Save As dialog goes away.

<b>Backwards Compatibility SCPI</b>	:MMEMoRY:STORe:STATe 1,<filename>
Initial S/W Revision	Prior to A.02.00

### To File . . .

When you press “To File”, the analyzer brings up a Windows dialog and a menu entitled “**Save As.**” This menu allows you to navigate to the various fields in the Windows dialog without using a keyboard or mouse. The Tab and Arrow keys can also be used for dialog navigation.

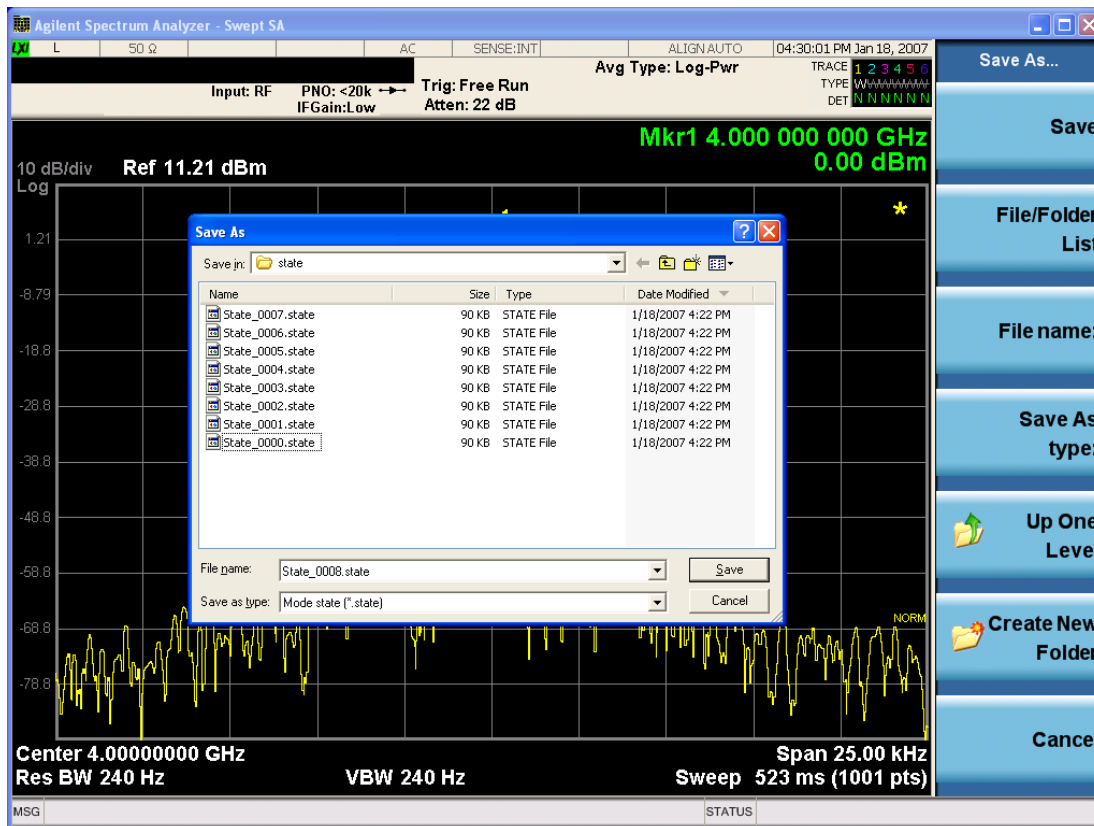

The Listed below

are the functions of the various fields in the dialog, and the corresponding softkeys:

#### Save

Performs the save to the specified file of the selected type. If the file already exists, a dialog will appear that allows you to replace the existing file by selecting OK, or you can Cancel the request. If you select OK, the file will be overwritten. Using the C: drive is strongly discouraged, since it runs the risk of being overwritten during an instrument software upgrade.

While the save is being performed, the floppy icon appears briefly in the Meas bar.

### File/Folder List

Enables you to navigate to the center of the dialog that contains the list of files and folders. Once here you can get information about the file and use the tab keys to navigate to the other fields in the dialog, such as Save In.

### Save In

The Save In field shows the path to which the file will be saved and allows you to change the path using the up and down arrow keys to navigate to other paths; the Enter key to open a directory; and the Backspace key to go back one directory. The **Save In field** defaults to the default path for this type of file and remembers the last path you used to save this type of file. There is no softkey for directly navigating to the Save In field but you can use left tab to get here from the File/Folder List.

User specified paths are remembered when you leave and return to a Mode and are reset back to the default using Restore Mode Defaults.

### File Name

The File Name field is initially loaded with an automatically generated filename specific to the appropriate Save Type. The automatically generated filename is guaranteed not to conflict with any filename currently in the directory. You may replace or modify this filename using the File Name key. See the ["Quick Save " on page 2880](#) documentation for more on the automatic file naming algorithm.

When you press the File Name key the analyzer displays the Alpha Editor. Use the knob to choose the letter to add and the front-panel Enter key to add the letter to the file name. The BK character moves you back and the FW character moves you forward in the filename. The Select key on the front panel generates a space character. When you are done entering the filename press the Done softkey. This returns back to the **File Open** dialog and menu, but does not cause the save to occur.

### Save As Type

This field shows the file suffix for the type of file you have selected to save. For example, if you navigated here while saving State, "Mode state (\*.state)" is in the field. If you navigated here from saving Trace, ""Mode state (\*.trace)" is in the field. If you navigated here while exporting a trace data file, "Trace Data (\*.csv)" is in the field. For some file types, there is more than one choice in the dropdown, which you can select by using the up and down arrow keys and Enter.

### Up One Level

This key corresponds to the icon of a folder with the up arrow that is in the tool bar of the dialog. When pressed, it causes the file and folder list to navigate up one level in the directory structure. The Backspace key does the same thing.

### Create New Folder

This key corresponds to the icon of a folder with the "\*" that is in the tool bar of the dialog. When pressed, a new folder is created in the current directory with the name **New Folder** and you can enter a new folder name using the Alpha Editor.

### Cancel

This key corresponds to the Cancel selection in the dialog. It causes the current **Save As** request to be cancelled. The ESC key does the same thing.

Key Path	Save, State
Mode	All
Notes	Brings up Save As dialog for saving a State Save Type
Initial S/W Revision	Prior to A.02.00

## Edit Register Names

You may enter a custom name on any of the Register keys, to help you remember what you are using that state to save. To do this, press the Edit Register Names key, choose the register whose name you wish to edit, and then enter the desired label using the Alpha Editor or an external PC keyboard.

The maximum number of characters that can be added is 30. In most cases, 30 characters will fit on two lines of the key.

See ["More Information" on page 2207](#)

Key Path	Save, State
Mode	All
<b>Remote Command</b>	:MMEMory:REGister:STATe:LABel <reg number>,"label" :MMEMory:REGister:STATe:LABel? <reg number>
<b>Example</b>	:MMEM:REG:STAT:LAB 1,"my label"
Notes	<reg number> is an integer from 1 to 16. If the SCPI specifies an invalid register number an error message is generated, -222,"Data out of range;Invalid register label number" "label" is a string from 0 to 30 characters in length. If a label exceeds 30 characters, an error message is generated, -150,"String data error;Label clipped to 30 characters" "label" of length 0 erases the custom label and restores the default (time and date) label. E.g.: :MMEM:REG:STAT:LAB 1,""
Dependencies	N9060A-7FP or N9060B-2FP license required to edit the register names. When the feature is not licensed, sending this command generates an error, -221,"Settings conflict;Option not available"
Preset	The names are unaffected by Preset or power cycle but are set to the default label (time and date) on a "Restore System Defaults->Misc"
Initial S/W Revision	A.11.00

## More Information

When you edit one of the register names, the time and date field will be replaced by the custom name.

If you delete all the characters in the custom name, it restores the default (time and date).

The register names are stored within the state files, but they are not part of the instrument state; that is, once you have edited a register name, loading a new state will not change that register name. Another consequence of this is that the names will be persistent through a power cycle. Also, if a named state file is transferred to another analyzer, it will bring its custom name along with it.

If you try to edit the name of an empty register, the analyzer will first save the state to have a file to put the name in. If you load a named state file into an analyzer with older firmware it will ignore the metadata.

The \*SAV and \*RCL commands will not be affected by the custom register names, nor will the MMEM commands.

### Register 1 thru Register 16

Selecting any one of these register menu keys causes the State of the currently active mode to be saved to the specified Register. The registers are provided for rapid saving and recalling, since you do not need to specify a filename or navigate to a file. Each of the register menu keys annotates whether it is empty or at what date and time it was last modified. In addition, you can use the Edit Register Names key to enter custom names for each register.

Although these 16 registers are the only registers available from the front panel, there are 128 state registers available in the instrument. Registers 17–128 are only available from the SCPI interface, using the \*SAV command.

There is one set of 128 state registers in the instrument, not one set for each Mode. When a state is saved, the Mode it was saved from is saved with it; then when it is recalled, the instrument switches to that Mode.

After the save completes, the corresponding register menu key annotation is updated with the date and time and the message "Register <register number> saved" is displayed.

Key Path	Save, State
Mode	All
Example	*SAV 1
Range	1–16 from front panel, 1–128 from SCPI
Readback	Date and time with seconds resolution are displayed on the key OR A custom name of up to 30 characters entered using the Edit Register Names key OR “(empty)” if no prior save operation has been performed to this register.
Initial S/W Revision	Prior to A.02.00
Modified at S/W Revision	A.11.00

### Register 1 thru Register 16

Selecting any one of these register menu keys causes the State of the currently active mode to be saved to the specified Register. The registers are provided for rapid saving and recalling, since you do not need to specify a filename or navigate to a file. Each of the register menu keys annotates whether it is empty or at what date and time it was last modified. In addition, you can use the Edit Register Names key to enter custom names for each register.

Although these 16 registers are the only registers available from the front panel, there are 128 state registers available in the instrument. Registers 17–128 are only available from the SCPI interface, using the \*SAV command.

There is one set of 128 state registers in the instrument, not one set for each Mode. When a state is saved, the Mode it was saved from is saved with it; then when it is recalled, the instrument switches to that Mode.

After the save completes, the corresponding register menu key annotation is updated with the date and time and the message "Register <register number> saved" is displayed.

Key Path	Save, State
Mode	All
Example	*SAV 1
Range	1-16 from front panel, 1-128 from SCPI
Readback	Date and time with seconds resolution are displayed on the key OR A custom name of up to 30 characters entered using the Edit Register Names key OR "(empty)" if no prior save operation has been performed to this register.
Initial S/W Revision	Prior to A.02.00
Modified at S/W Revision	A.11.00

## Data (Export)

Exporting a data file stores data from the current measurement to mass storage files. The Export Menu only contains data types that are supported by the current measurement.

Since the commonly exported data files are in .csv format, the data can be edited by you prior to importing. This allows you to export a data file, manipulate the data in Excel (the most common PC Application for manipulating .csv files) and then import it.

Selecting an Export Data menu key will not actually cause the exporting to occur, since the analyzer still needs to know where you wish to save the data. Pressing the Save As key in this menu brings up the Save As dialog and Save As menu that allows you to specify the destination file and directory. Once a filename has been selected or entered in the Open menu, the export will occur as soon as the Save key is pressed.

Key Path	Save
Mode	All
Notes	The menu is built from whatever data types are available for the mode. So the key locations in the sub menu will vary.  No SCPI command directly controls the Data Type that this key controls. The Data Type is included in the MMEM:STORe commands.
Dependencies	If a file type is not used by a certain measurement, that type is grayed out for that measurement. The key for a file type will not show at all if there are no measurements in the Mode that support it.
Preset	Is not affected by a Preset or shutdown, but is reset during Restore Mode Defaults
Readback	The data type that is currently selected
Initial S/W Revision	Prior to A.02.00

## Measurement Results

Pressing this key selects Meas Results as the data type to be exported. Pressing the key a second time brings up the Meas Results menu, which allows you to select which **Meas Result** to save. In the Swept SA measurement, there are three types of Measurement Results files: Peak Table, Marker Table and Spectrogram.

See "[Meas Results File Contents](#)" on page 2210.

See "[Marker Table](#)" on page 2210.

See "[Peak Table](#)" on page 2213.

See "[Spectrogram](#)" on page 2216

<b>Remote Command</b>	:MMEMory:STORe:RESults:MTABle PTABle SPEctrogram <filename>
<b>Example</b>	:MMEM:STOR:RES:MTAB "myResults.csv" Saves the results from the current marker table to the file myResults.csv in the current path. :MMEM:STOR:RES:PTAB "myResults.csv" Saves the results from the current peak table to the file myResults.csv in the current path. :MMEM:STOR:RES:SPEC "myResults.csv" Saves the results from the current Spectrogram display to the file myResults.csv in the current path. The default path is My Documents\SA\data\SAN\results
<b>Notes</b>	If the save is initiated via SCPI, and the file already exists, the file will be overwritten. Using the C: drive is strongly discouraged, since it runs the risk of being overwritten during an instrument software upgrade. Both single and double quotes are supported for any filename parameter over SCPI.
<b>Dependencies</b>	If a save of Marker Table results is requested and the Marker Table is not on, no file is saved and a message is generated If a save of Peak Table results is requested and the Peak Table is not on, no file is saved and a message is generated If a save of Spectrogram results is requested and the Spectrogram is not on, no file is saved and a message is generated. The Spectrogram choice only appears if option EDP is licensed.
<b>Preset</b>	Not part of Preset, but is reset to Peak Table by Restore Mode Defaults. Survives a shutdown.
<b>Initial S/W Revision</b>	Prior to A.02.00

## Meas Results File Contents

All files are .csv files. The following section details the data in each file type.

### Marker Table

This section discusses the Marker Table Meas Results file format.

Imagine that, at the point where a Marker Table Meas Result is requested, the following screen is showing:

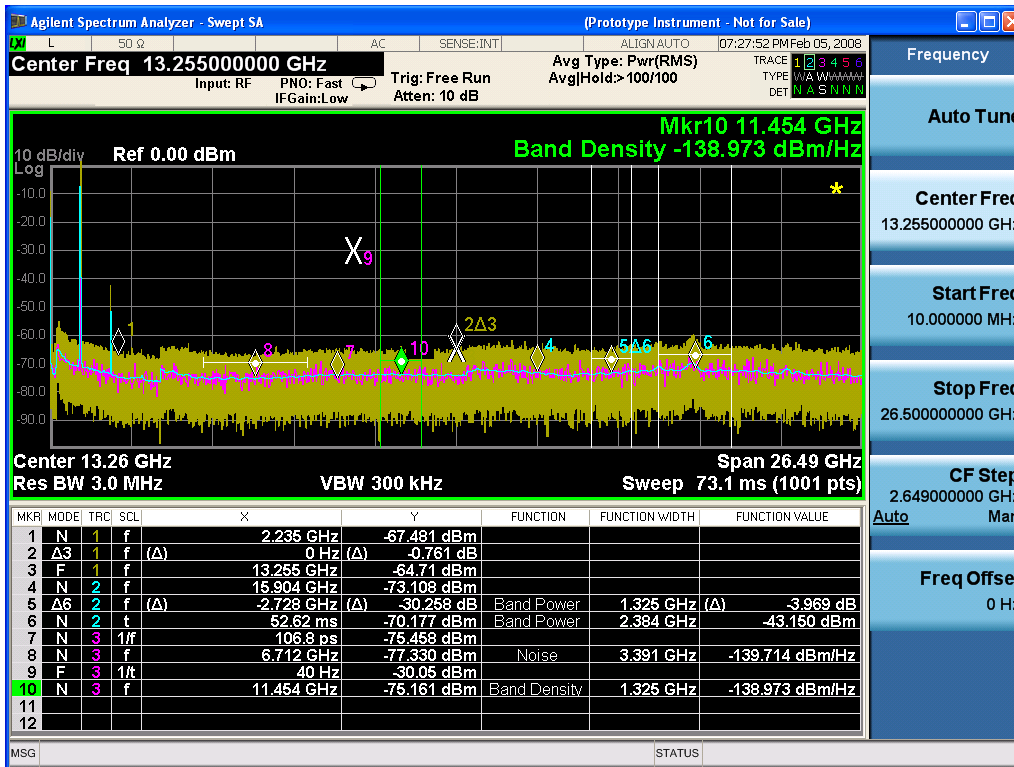

Then the Meas Results file, when opened, would show the following data:

MeasurementR	
result	
Swept SA	
A.01.40_R0017	N9020A
526 B25 PFR	1
P26 EA3	
Result Type	Marker Table
Ref Level	0
Number of Points	1001
Sweep Time	0.0662666 67
Start Frequency	10000000
Stop Frequency	26500000 000
Average Count	0
Average Type	LogPower (Video)
RBW	3000000

Save

RBW Filter	Gaussian
RBW Filter BW	3dB
VBW	3000000
Sweep Type	Swept
X Axis Scale	Lin
PreAmp State	Off
PreAmp Band	Low
Trigger Source	Free
Trigger Level	1.2
Trigger Slope	Positive
Trigger Delay	1.00E-06
Phase Noise Optimization	Fast
Swept If Gain	Low
FFT If Gain	Autorange
RF Coupling	AC
FFT Width	411900
Ext Ref	10000000
Input	RF
RF Calibrator	Off
Attenuation	10
Ref Level Offset	0
External Gain	0
X Axis Units	Hz
Y Axis Units	dBm

## DATA

MKR	MODE	TR C	SCL	X	Y	FUNCTI ON	FUNCTIO N WIDTH	FUNCTI ON VALUE	FUNCTI ON UNIT
1	Normal	1	Freque ncy	2.2350E+ 09	- 67.4 81	Off	0.0000E+ 00	0	None
2	Delta3	1	Freque ncy	0.0000E+ 00	- 0.76 1	Off	0.0000E+ 00	0	None
3	Fixed	1	Freque ncy	1.3255E+ 10	- 64.7 1	Off	0.0000E+ 00	0	None
4	Normal	2	Freque ncy	1.5904E+ 10	- 73.1	Off	0.0000E+ 00	0	None



08									
5	Delta7	2	Freque ncy	- 2.7280E+ 09	- 30.2 58	Band Power	1.3250E+ 06	-3.969	dB
6	Normal	2	Time	5.2620E- 02	- 70.1 77	Band Power	2.3840E+ 06	-43.15	dBm
7	Normal	3	Period	1.0680E- 10	- 75.4 58	Off	0.0000E+ 00	0	None
8	Normal	3	Freque ncy	6.7120E+ 09	- 77.3 3	Noise	3.3910E+ 06	- 139.71 4	dBm/Hz
9	Fixed	3	Inverse Time	4.0000E+ 01	- 30.0 5	Off	0.0000E+ 00	0	None
10	Normal	3	Freque ncy	1.1454E+ 10	- 75.1 61	Band Density	1.3250E+ 06	- 138.97 3	dBm/Hz
11	Off	1	Freque ncy	0.0000E+ 00	0	Off	0.0000E+ 00	0	None
12	Off	1	Freque ncy	0.0000E+ 00	0	Off	0.0000E+ 00	0	None

The numbers appear in the file exactly as they appear onscreen. If it says 11.454 GHz onscreen, then in the file it is 11.454E+09.

The metadata header is very similar to the metadata used in the trace data .csv files. See Trace File Contents. The only new information concerns the 1-of-N fields in the marker table itself.

### Peak Table

This section discusses the Peak Table Meas Results file format.

Imagine that, at the point where a Marker Table Meas Result is requested, the following screen is showing:

17 Forward Link Modulation Accuracy  
Save

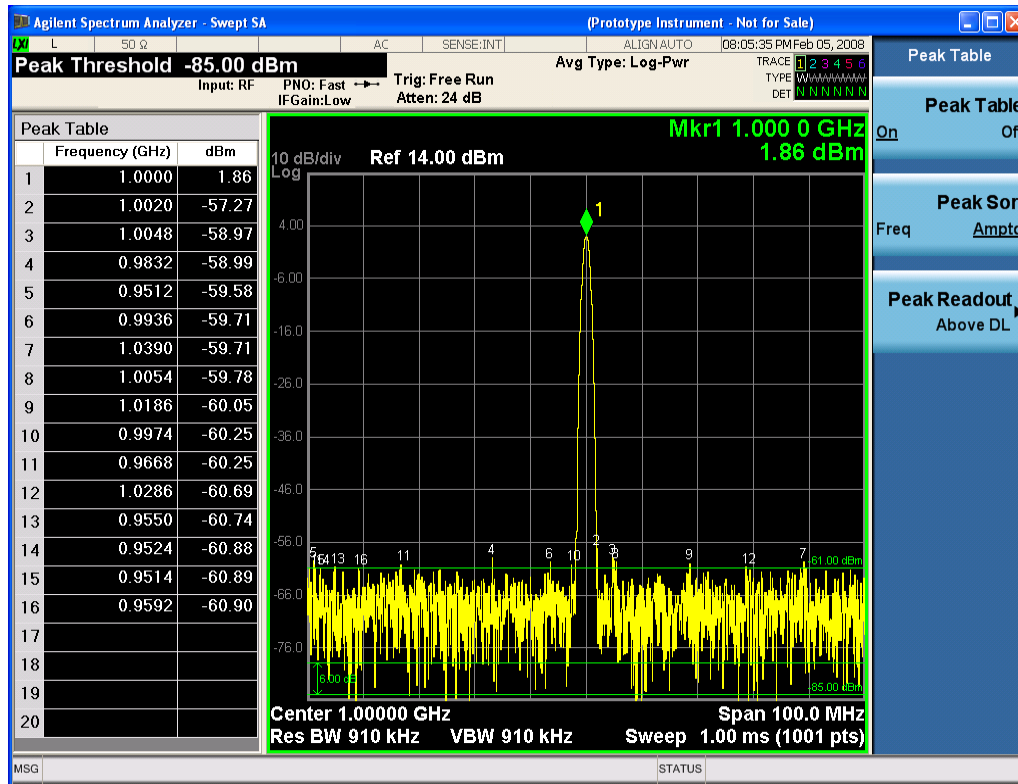

Then the Meas Results file, when opened, would show the header data (the same as for the Marker Table except that the Result Type is Peak Table) ending with a few fields of specific interest to Peak Table users:

- Peak Threshold
- Peak Threshold State (On|Off)
- Peak Excursion
- Peak Excursion State (On|Off)
- Display Line
- Peak Readout (All|AboveDL|BelowDL)
- Peak Sort (Freq|Amptd)

These fields are then followed by the data for the Peak Table itself.

Note that the label for the Frequency column changes to Time in 0 span.

Here is what the table for the above display looks like:

MeasurementResult	
Swept SA	
A.01.40_R0017	N9020A
526 B25 PFR P26 EA3	1

Result Type	Peak Table
Ref Level	0
Number of Points	1001
Sweep Time	0.066266667
Start Frequency	10000000
Stop Frequency	26500000000
Average Count	0
Average Type	LogPower(Video)
RBW	3000000
RBW Filter	Gaussian
RBW Filter BW	3dB
VBW	3000000
Sweep Type	Swept
X Axis Scale	Lin
PreAmp State	Off
PreAmp Band	Low
Trigger Source	Free
Trigger Level	1.2
Trigger Slope	Positive
Trigger Delay	1.00E-06
Phase Noise Optimization	Fast
Swept If Gain	Low
FFT If Gain	Autorange
RF Coupling	AC
FFT Width	411900
Ext Ref	10000000
Input	RF
RF Calibrator	Off
Attenuation	10
Ref Level Offset	0
External Gain	0
X Axis Units	Hz
Y Axis Units	dBm
Peak Threshold	-85
Peak Threshold State	On
Peak Excursion	6
Peak Excursion State	On

Display Line	-61	
Peak Readout	AboveDL	
Peak Sort	Amptd	
DATA		
Peak	Frequency	Amplitude
1	1.0000E+06	1.86
2	1.0020E+06	-57.27
3	1.0048E+06	-58.97
4	9.8320E+05	-58.99
5	9.5120E+05	-59.58
6	9.9360E+05	-59.71
7	1.0390E+06	-59.71
8	1.0054E+06	-59.78
9	1.1086E+06	-60.05
10	9.9740E+05	-60.25
11	9.6680E+05	-60.25
12	1.0286E+06	-60.69
13	9.5500E+05	-60.74
14	9.5240E+05	-60.88
15	9.5140E+05	-60.89
16	9.5920E+05	-60.90
17		
18		
19		
20		

### Spectrogram

This section discusses the Spectrogram Results file format. The Spectrogram choice only appears if option EDP is licensed.

The Spectrogram results are the same as a Trace data export, except that instead of having just one trace's data, all 300 traces appear one after the other.

Each trace has its own data mark; the data for Spectrogram Trace 0 follows the row marked DATA, the data for Spectrogram Trace 1 follows the row marked DATA1, for Spectrogram Trace 2 follows the row marked DATA2, and so on.

Each DATA row has a timestamp in the second column (as of firmware revision A.11.01). So, for example, if Trace 0 had a relative start time of 1729.523 sec, then the first DATA row would look like this:

DATA,1729.523

And if Trace 13 had a relative start time of 100.45 sec, then the fourteenth data row would look like:

DATA13,100.453

To find the absolute time for the relative timestamps of each trace, the last row before the first DATA row gives the absolute start time of the Spectrogram, in the form YYYYMMDDHHMMSS

So, for example, if the absolute start time is 13:23:45:678 on January 30, 2012, this row would look like:

Start Time,20120130132345678

**NOTE** The resolution of the absolute time stored is 1 ms, which matches up with the fact that the fastest sweep time is also 1 ms. However, there is no specification for the absolute accuracy of the clock in the analyzer, nor is there any facility provided to allow the user to set this time to any particular degree of accuracy.

Traces that have not yet been filled in the Spectrogram display are empty; there is no DATA header for them. The file ends after the last non-empty trace.

Imagine that, at the point where a Spectrogram Meas Result is requested, the following screen is showing:

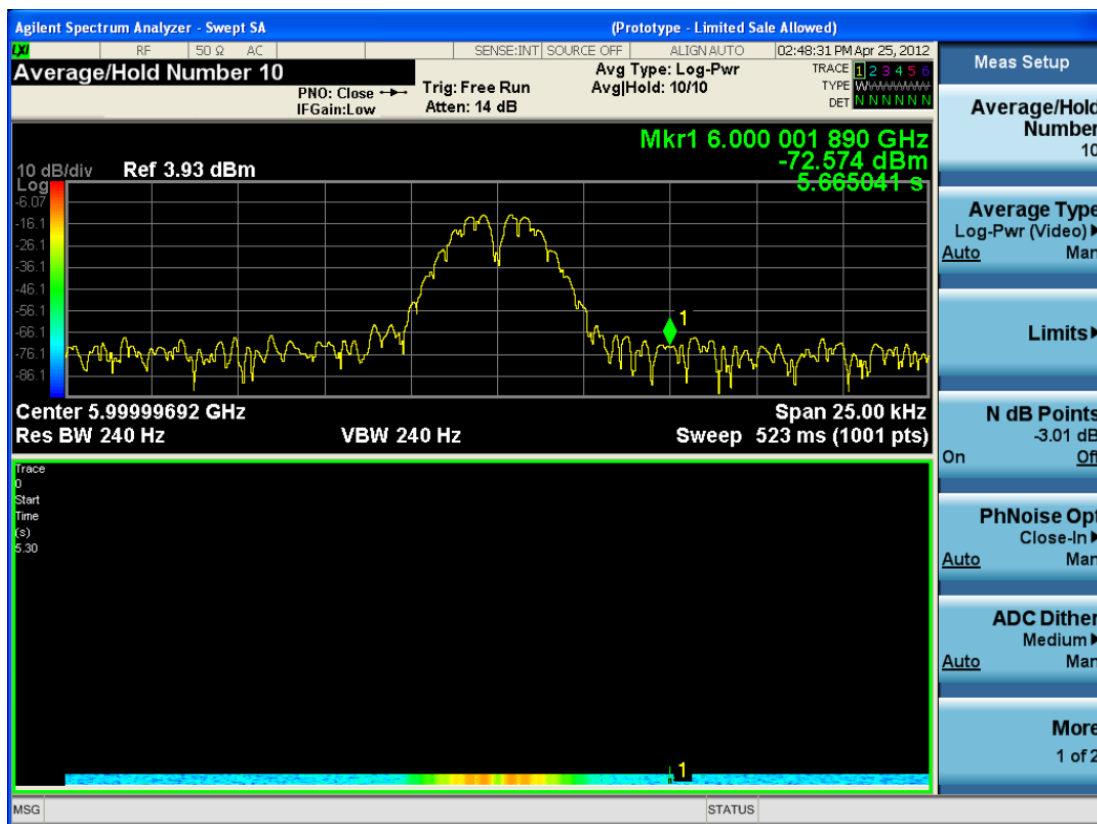

For the purpose of this example, we have set the Average/Hold Number to 10, thus we have only traces 0 thru 10. The Spectrogram was started at 02:28:08:700 pm on April 25, 2012 (that is, 700 ms after 2:28:08 pm), although the screen dump itself shows a different time, as it was taken ten minutes after the

Spectrogram data. Trace 0 is showing a start time of 5.30 seconds, meaning 5.3 seconds after the Spectrogram started (trace 10 has a start time of 0, as it was the first trace taken but has now rolled up into the tenth trace slot).

The Meas Results file, when opened, shows the header data and ten traces of trace data. Below is an extract from the result file for the above display. Note the start time of 20120425142808700 showing in the last row before the first DATA row, and the relative time of 5.299231048 showing in the first DATA row:

<b>Result Type</b>	<b>Spectrogram</b>
MeasResult	
Swept SA	
A.11.00.01	N9020A
503 508 513 526 ALL ALV B1C B1X B25 B2X B40 BAB BBA CR3 CRP DP2 DRD EA3 EDP EMC EP1 ERC ESC ESP EXM FSA HBA K03 LFE MPB P03 P08 P13 P26 PFR RTL RTS S40 SB1 SEC SM1 UK6 YAS YAV	1
Segment	0
Number of Points	1001
Sweep Time	0.523333333
Start Frequency	5999984415
Stop Frequency	6000009415
Average Count	0
Average Type	LogPower(Video)
RBW	240
RBW Filter	Gaussian
RBW Filter BW	3dB
VBW	240
Sweep Type	Swept
X Axis Scale	Lin
PreAmp State	Off
PreAmp Band	Low
Trigger Source	Free
Trigger Level	1.2
Trigger Slope	Positive
Trigger Delay	0
Phase Noise Optimization	Wide
Swept If Gain	Low
FFT If Gain	Autorange
RF Coupling	AC

Result Type	Spectrogram
FFT Width	411900
Ext Ref	10000000
Input	RF
RF Calibrator	Off
Attenuation	14
Ref Level Offset	0
External Gain	0
Trace Type	Clearwrite
Detector	Normal
Trace Math	Off
Trace Math Oper1	Trace5
Trace Math Oper2	Trace6
Trace Math Offset	0
Trace Name	Trace1
X Axis Units	Hz
Y Axis Units	dBm
Start Time	20120425142808700
DATA	5.299231048
5999984415	-76.34749519
5999984440	-77.28097006
5999984465	-75.32317869
5999984490	-73.64417681
5999984515	-72.67154604

- o
- o
- o

6000009315	-77.94423277
6000009340	-79.51829697
6000009365	-78.46108961
6000009390	-78.46108957
6000009415	-76.59570596
DATA2	4.708697055
5999984415	-80.98197882
5999984440	-80.98197879

5999984465	-75.83142132
5999984490	-74.02712079
5999984515	-73.57213005

O

O

O

6000009315	-75.9183103
6000009340	-79.53787488
6000009365	-78.82602191
6000009390	-78.82602188
6000009415	-76.37486709
DATA10	0
5999984415	-75.56751112
5999984440	-75.76485645
5999984465	-76.67718717
5999984490	-78.79238489
5999984515	-83.72680212

O

O

O

6000009315	-71.3942461
6000009340	-72.28308332
6000009365	-73.92684489
6000009390	-75.45548832
6000009415	-75.17904815

## Capture Buffer

Capture Buffer functionality is not available for all measurements. The captured data is raw data which is not processed.

Key Path	Save, Data
----------	------------



Mode	CDMA1XEV
Example	MMEM:STOR:CAPT "MyCaptureData.bin" This stores the capture data in the file MyCaptureData.bin in the default directory.
Dependencies	In case the capture buffer data is not available from the selected measurement, the key will be grayed out.
Initial S/W Revision	A.11.00

## Save As . . .

When you press “Save As”, the analyzer brings up a Windows dialog and a menu entitled “**Save As.**” This menu allows you to navigate to the various fields in the Windows dialog without using a keyboard or mouse. The Tab and Arrow keys can also be used for dialog navigation.

See "[To File . . .](#)" on page 2897 in Save, State for a full description of this dialog and menu.

The default path for saving files is:

For all of the Trace Data Files:

My Documents\`<mode name>`\data\traces

For all of the Limit Data Files:

My Documents\`<mode name>`\data\limits

For all of the Measurement Results Data Files:

My Documents\`<mode name>`\data\`<measurement name>`\results

For all of the Capture Buffer Data Files:

My Documents\`<mode name>`\data\captureBuffer

Key Path	Save, Data
Mode	All
Notes	The key location is mode-dependent and will vary. Brings up the Save As dialog for saving a <code>&lt;mode specific&gt;</code> Save Type. The save is performed immediately and does not wait until the measurement is complete.
Initial S/W Revision	Prior to A.02.00

## Screen Image

Pressing Screen Image accesses a menu of functions that enable you to specify a format and location for the saved screen image. It brings up a menu that allows you to specify the color scheme of the Screen Image (Themes) or navigate to the Save As dialog to perform the actual save.

Screen Image files contain an exact representation of the analyzer display. They cannot be loaded back onto the analyzer, but they can be loaded into your PC for use in many popular applications.

The image to be saved is actually captured when the Save front panel key is pressed, and kept in temporary storage to be used if you ask for a Screen Image save. When the Screen Image key is pressed, a "thumbnail" of the captured image is displayed, as shown below:

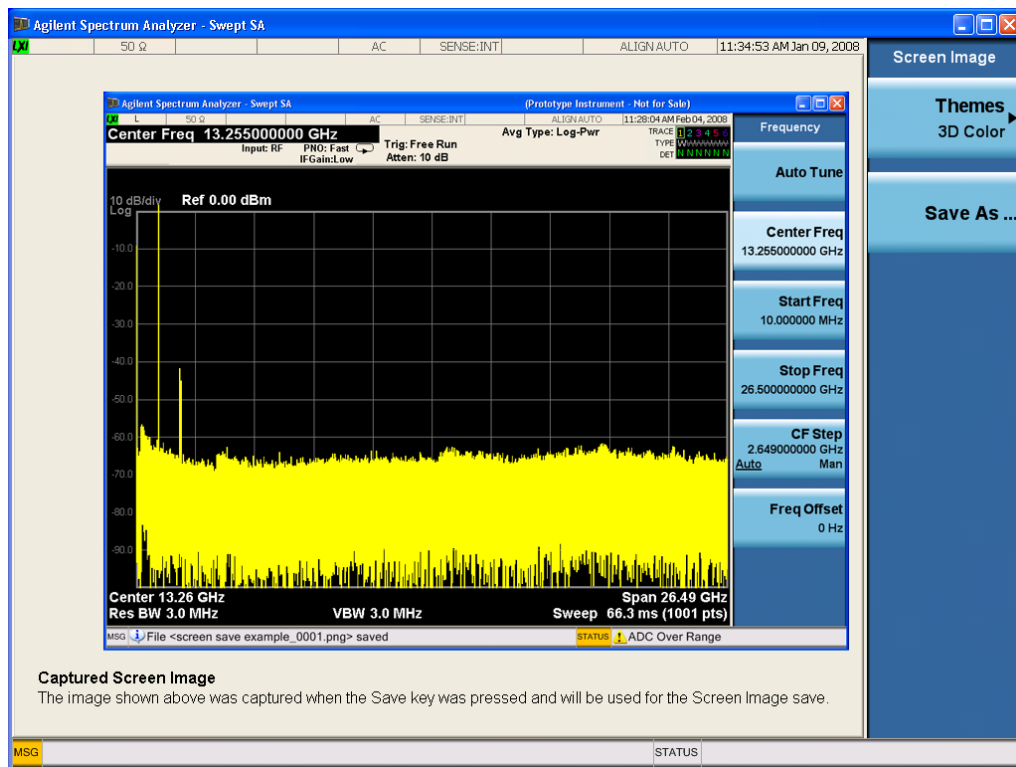

When you continue on into the Save As menu and complete the Screen Image save, the image depicted in the thumbnail is the one that gets saved, showing the menus that were on the screen before going into the Save menus. The save is performed immediately and does not wait until the measurement is complete.

After you have completed the save, the Quick Save front-panel key lets you quickly repeat the last save performed, using an auto-named file, with the current screen data.

**NOTE**

For versions previous to A.01.55, if you initiate a screen image save by navigating through the Save menus, the image that is saved will contain the Save menu softkeys, not the menus and the active function that were on the screen when you first pressed the Save front panel key.

Key Path	Save
Mode	All
Remote Command	:MMEMory:STORe:SCReen <filename>
Example	:MMEM:STOR:SCR "myScreen.png" This stores the current screen image in the file MyScreenFile.png in the default directory.
Initial S/W Revision	Prior to A.02.00

## Themes

Accesses a menu of functions that enable you to choose the theme to be used when saving the screen image.

The **Themes** option is the same as the **Themes** option under the **Display** and **Page Setup** dialogs. It allows you to choose between themes to be used when saving the screen image.

<b>Key Path</b>	Save, Screen Image
<b>Remote Command</b>	:MMEMory:STORe:SCReen:THEME TDCOLOR   TDMonochrome   FCOLOR   FMONochrome  :MMEMory:STORe:SCReen:THEME?
<b>Example</b>	:MMEM:STOR:SCR:THEM TDM
<b>Preset</b>	3D Color; Is not part of Preset, but is reset by Restore Misc Defaults or Restore System Defaults All and survives subsequent running of the modes.
<b>Readback</b>	3D Color   3D Mono   Flat Color   Flat Mono
<b>Backwards Compatibility Notes</b>	In ESA and PSA we offer the choice of "Reverse Bitmap" or "Reverse Metafile" when saving screen images. This is much like the "Flat Color" theme available in X-Series. Also, if you selected Reverse Bitmap AND a black & white screen image, that would be much like "Flat Monochrome". In other words, each of the X-Series themes has a similar screen image type in ESA/PSA. But they are not identical.
<b>Initial S/W Revision</b>	Prior to A.02.00

## 3D Color

Selects a standard color theme with each object filled, shaded and colored as designed.

<b>Key Path</b>	Save, Screen Image, Themes
<b>Example</b>	MMEM:STOR:SCR:THEM TDC
<b>Readback</b>	3D Color
<b>Initial S/W Revision</b>	Prior to A.02.00

## 3D Monochrome

Selects a format that is like 3D color but shades of gray are used instead of colors.

<b>Key Path</b>	Save, Screen Image, Themes
<b>Example</b>	MMEM:STOR:SCR:THEM TDM
<b>Readback</b>	3D Mono
<b>Initial S/W Revision</b>	Prior to A.02.00

## Flat Color

Selects a format that is best when the screen is to be printed on an ink printer.

Key Path	Save, Screen Image, Themes
<b>Example</b>	MMEM:STOR:SCR:THEM FCOL
Readback	Flat Color
Initial S/W Revision	Prior to A.02.00

### Flat Monochrome

Selects a format that is like Flat Color. But only black is used (no colors, not even gray), and no fill.

Key Path	Save, Screen Image, Themes
<b>Example</b>	MMEM:STOR:SCR:THEM FMON
Readback	Flat Mono
Initial S/W Revision	Prior to A.02.00

### Save As...

When you press “Save As”, the analyzer brings up a Windows dialog and a menu entitled “**Save As.**” This menu allows you to navigate to the various fields in the Windows dialog without using a keyboard or mouse. The Tab and Arrow keys can also be used for dialog navigation.

See "[To File . . .](#)" on page 2897 in Save, State for a full description of this dialog and menu.

The default path for Screen Images is

My Documents\`<mode name>`\screen.

where `<mode name>` is the parameter used to select the mode with the INST:SEL command (for example, SA for the Spectrum Analyzer).

Key Path	Save, Screen Image
Notes	Brings up Save As dialog for saving a Screen Image Save Type
Initial S/W Revision	Prior to A.02.00

### Mass Storage Catalog (Remote Command Only)

Key path	SCPI Only
<b>Remote Command</b>	:MMEMory:CATalog? [ <code>&lt;directory_name&gt;</code> ]
Notes	The string must be a valid logical path. Queries disk usage information (drive capacity, free space available) and obtains a list of files and directories in a specified directory in the following format: <code>&lt;numeric_value&gt;,&lt;numeric_value&gt;,{&lt;file_entry&gt;}</code> It returns two numeric parameters and as many strings as there are files and directories. The first

parameter indicates the total amount of storage currently used in bytes. The second parameter indicates the total amount of storage available, also in bytes. The <file\_entry> is a string. Each <file\_entry> indicates the name, type, and size of one file in the directory list:

<file\_name>,<file\_type>,<file\_size>

As the windows file system has an extension that indicates file type, <file\_type> is always empty. <file\_size> provides the size of the file in bytes. For directories, <file\_entry> is surrounded by square brackets and both <file\_type> and <file\_size> are empty

---

Initial S/W Revision      Prior to A.02.00

---

### Mass Storage Change Directory (Remote Command Only)

---

Key path                      SCPI Only

**Remote Command**        :MMEMory:CDIRectory [<directory\_name>]  
                                  :MMEMory:CDIRectory?

**Notes**                      The string must be a valid logical path.  
  
Changes the default directory for a mass memory file system. The <directory\_name> parameter is a string. If no parameter is specified, the directory is set to the \*RST value.  
At \*RST, this value is set to the default user data storage area, that is defined as System.Environment.SpecialFolder.Personal.  
Query returns full path of the default directory.

---

Initial S/W Revision      Prior to A.02.00

---

### Mass Storage Copy (Remote Command Only)

---

Key path                      SCPI Only

**Remote Command**        :MMEMory:COPY <string>,<string> [,<string>,<string>]

**Notes**                      The string must be a valid logical path.  
  
Copies an existing file to a new file or an existing directory to a new directory.  
Two forms of parameters are allowed. The first form has two parameters. In this form, the first parameter specifies the source, and the second parameter specifies the destination.  
The second form has four parameters. In this form, the first and third parameters specify the source. The second and fourth parameters specify the directories. The first pair of parameters specifies the source. The second pair specifies the destination. An error is generated if the source doesn't exist or the destination file already exists.  
  
This command will generate an "access denied" error if the destination is a restricted folder (e.g., C:\Windows) and the current user does not have Power User or Administrator privileges.

### Mass Storage Device Copy (Remote Command Only)

This command transfers data to/from a file and a peripheral device.

---

Key path	SCPI Only
<b>Remote Command</b>	:MMEMory:COpy:DEvice <source_string>,<dest_string>
Notes	The strings must be a valid logical path or a valid device keyword. If the dest_string is a device keyword, the data is copied from the source file to the device. If the source_string is a device keyword, the data is copied to the source file from the device.  Valid device keywords are: SNS (smart noise source)  An error is generated if the file or device is not found.

---

### Mass Storage Delete (Remote Command Only)

---

Key path	SCPI Only
<b>Remote Command</b>	:MMEMory:DElete <file_name>[,<directory_name>]
Notes	The string must be a valid logical path.  Removes a file from the specified directory. The <file_name> parameter specifies the file name to be removed. This command will generate an "access denied" error if the file is in a restricted folder (e.g., C:\Windows) and the current user does not have Power User or Administrator privileges.
Initial S/W Revision	Prior to A.02.00

---

### Mass Storage Data (Remote Command Only)

Creates a file containing the specified data OR queries the data from an existing file.

---

Key path	SCPI Only
<b>Remote Command</b>	:MMEMory:DATA <file_name>, <data> :MMEMory:DATA? <file_name>
Notes	The string must be a valid logical path.  The command form is MMEMory:DATA <file_name>,<data>. It loads <data> into the file <file_name>. <data> is in 488.2 block format. <file_name> is string data.  The query form is MMEMory:DATA? <file_name> with the response being the associated <data> in block format.
Initial S/W Revision	Prior to A.02.00

---

### Mass Storage Make Directory (Remote Command Only)

---

Key path	SCPI Only
<b>Remote Command</b>	:MMEMory:MDIRectory <directory_name>
Notes	The string must be a valid logical path.  Creates a new directory. The <directory_name> parameter specifies the name to be created.

---

	This command will generate an “access denied” error if the new directory would be in a restricted folder (e.g., C:\Windows) and the current user does not have Power User or Administrator privileges.
Initial S/W Revision	Prior to A.02.00

### Mass Storage Move (Remote Command Only)

Key path	SCPI Only
<b>Remote Command</b>	:MMEMory:MOVE <string>,<string>[,<string>,<string>]
Notes	<p>The string must be a valid logical path.</p> <p>Moves an existing file to a new file or an existing directory to a new directory.</p> <p>Two forms of parameters are allowed. The first form has two parameters. In this form, the first parameter specifies the source, and the second parameter specifies the destination.</p> <p>The second form has four parameters. In this form, the first and third parameters specify the source. The second and fourth parameters specify the directories. The first pair of parameters specifies the source. The second pair specifies the destination. An error is generated if the source doesn't exist or the destination file already exists.</p> <p>This command will generate an “access denied” error if the destination is a restricted folder (e.g., C:\Windows) and the current user does not have Power User or Administrator privileges.</p>
Initial S/W Revision	Prior to A.02.00

### Mass Storage Remove Directory (Remote Command Only)

Key path	SCPI Only
<b>Remote Command</b>	:MMEMory:RDIRECTory <directory_name>
Notes	<p>The string must be a valid logical path.</p> <p>Removes a directory. The &lt;directory_name&gt; parameter specifies the directory name to be removed. All files and directories under the specified directory shall also be removed.</p> <p>This command will generate an “access denied” error if the folder is a restricted folder (e.g., C:\Windows) or is in a restricted folder and the current user does not have Power User or Administrator privileges.</p>
Initial S/W Revision	Prior to A.02.00

## Single (Single Measurement/Sweep)

Sets the analyzer for Single measurement operation. The single/continuous state is Meas Global, so the setting will affect all the measurements. If you are Paused, pressing Single does a Resume.

See "[More Information](#)" on page 2228

Key Path	Front-panel key
Example	:INIT:CONT OFF
Notes	See Cont key description.
Backwards Compatibility Notes	<p>For Spectrum Analysis mode in ESA and PSA, the Single hardkey and the INITiate:IMM switched from continuous measurement to single measurement and restarted sweeps and averages (displayed average count reset to 1), but did not restart Max Hold and Min Hold. In the X-Series, the Single hardkey and the INITiate:IMM command initiate a sweep/ measurement/ average sequence/hold sequence including MaxHold and MinHold.</p> <p>For Spectrum Analysis mode in ESA and PSA, the Single hardkey restarted the sweep regardless of whether or not you were in an active sweep or sweep sequence. In the X-Series, Restart does this but Single only restarts the sweep or sweep sequence if you are in the idle state.</p> <p>INIT[:IMM] in ESA &amp; PSA Spectrum Analysis Mode does an implied ABORT. In some other PSA Modes, INIT[:IMM] is ignored if not in the idle state. . The X-Series follows the ESA/PSA SA Mode model, which may cause some Modes to have compatibility problems.</p>
Initial S/W Revision	Prior to A.02.00

### More Information

See "[Restart](#)" on page 2894 for details on the INIT:IMMEDIATE (Restart) function.

If you are already in single sweep, the INIT:CONT OFF command has no effect.

If you are already in Single Sweep, then pressing the Single key in the middle of a sweep does not restart the sweep or sequence. Similarly, pressing the Single key does not restart the sweep or sequence if the sweep is not in the idle state (for example, if you are taking a very slow sweep, or the analyzer is waiting for a trigger). Instead, it results in a message. "Already in Single, press Restart to initiate a new sweep or sequence". Even though pressing the Single key in the middle of a sweep does not restart the sweep, sending INIT:IMMEDIATE does reset it.

To take one more sweep without resetting the average count, increment the average count by 1, by pressing the step up key while **Average/Hold Number** is the active function, or sending the remote command CALC:AVER:TCON UP.



## Source

There is no Source functionality supported in the Modulation Accuracy measurement. The front-panel key will display a blank menu when key pressed.

---

Key Path	Front panel key
Initial S/W Revision	Prior to A.02.00

---

## SPAN X Scale

Accesses a menu of functions that enable you to set the desired horizontal scale parameters.

Key Path	Front panel key
Initial S/W Revision	Prior to A.02.00

## Sweep/Control

Accesses a menu that allows you to select parameters that affect the sweep of the displayed measurement signal.

Only the Pause/Resume key is available.

Key Path	Front panel key
Initial S/W Revision	Prior to A.02.00

## Pause/Resume

This key allows you to pause or resume the measurement of the displayed signal.

See "[Pause/Resume](#)" on page 2925 function.

Key Path	Sweep/Control
Initial S/W Revision	Prior to A.02.00

17 Forward Link Modulation Accuracy  
System

## System

See "[System](#)" on page 359

## Trace/Detector

There is no Trace/Detector functionality supported in the Modulation Accuracy measurement. The front-panel key will display a blank menu when key pressed.

---

Key Path	Front panel key
Initial S/W Revision	Prior to A.02.00

---

## Trigger

See ["Trigger" on page 430](#)

### Free Run

See ["Free Run " on page 437](#)

### Video

See ["Video \(IF Envelope\) " on page 438](#)

### Trigger Level

See ["Trigger Level " on page 438](#)

### Trig Slope

See ["Trig Slope " on page 439](#)

### Trig Delay

See ["Trig Delay " on page 440](#)

### Line

See ["Line " on page 2729](#)

### Trig Slope

See ["Trig Slope " on page 2729](#)

### Trig Delay

See ["Trig Delay " on page 442](#)

### External 1

See ["External 1 " on page 2741](#)

### Trigger Level

See ["Trigger Level " on page 2741](#)

### Trig Slope

See ["Trig Slope " on page 2742](#)

### Trig Delay

See ["Trig Delay " on page 445](#)

### External 2

See ["External 2 " on page 2743](#)

## Trigger Level

See ["Trigger Level "](#) on page 2743

## Trig Slope

See ["Trig Slope "](#) on page 2744

## Trig Delay

See ["Trig Delay "](#) on page 447

## RF Burst

See ["RF Burst "](#) on page 2744

## Absolute Trigger

See ["Absolute Trigger Level"](#) on page 2745

## Relative Trigger

See ["Relative Trigger Level"](#) on page 2734

## Trig Slope

See ["Trigger Slope "](#) on page 2746

## Trig Delay

See ["Trig Delay "](#) on page 451

## Periodic Timer

See ["Periodic Timer \(Frame Trigger\) "](#) on page 2736

## Period

See ["Period "](#) on page 2737

## Offset

See ["Offset "](#) on page 2738

## Offset Adjust (Remote Command Only)

See ["Offset Adjust \(Remote Command Only\)"](#) on page 2739

## Reset Offset Display

See ["Reset Offset Display "](#) on page 2740

## Sync Source

See ["Sync Source "](#) on page 2740

## Off

See ["Off "](#) on page 2741

## External 1

See ["External 1 "](#) on page 2741

## Trigger Level

See ["Trigger Level "](#) on page 2741

## Trig Slope

See ["Trig Slope "](#) on page 2742

## External 2

See ["External 2 "](#) on page 2743

## Trigger Level

See ["Trigger Level "](#) on page 2743

## Trig Slope

See ["Trig Slope "](#) on page 2744

## RF Burst

See ["RF Burst "](#) on page 2744

## Absolute Trigger

See ["Absolute Trigger Level"](#) on page 2745

## Trig Slope

See ["Trigger Slope "](#) on page 2746

## Trig Delay

See ["Trig Delay"](#) on page 461

## Auto/Holdoff

See ["Auto/Holdoff "](#) on page 462

## Auto Trig

See ["Auto Trig "](#) on page 462

## Trig Holdoff

See ["Trig Holdoff "](#) on page 463

## Holdoff Type

See [\\_\\_](#) on page X



## User Preset

Accesses a menu that gives you the following three choices:

- User Preset – recalls a state previously saved using the Save User Preset function.
- User Preset All Modes – presets all of the modes in the analyzer
- Save User Preset– saves the current state for the current mode

Key Path	Front-panel key
Backwards Compatibility Notes	<p>User Preset is actually loading a state, and in legacy analyzers, it was possible to load a state without affecting the trace data, limit lines or correction data. Similarly it was possible to do a User Preset without affecting the trace data, limit lines or correction data.</p> <p>In the X-Series, “state” always includes all of this data; so whenever state is loaded, or User Preset is executed, all of the traces, limit lines and corrections are affected. Although this differs from previous behavior, it is desirable behavior, and should not cause adverse issues for users.</p> <p>On ESA and PSA, User Preset affected the entire instrument’s state. In the X-Series, User Preset only recalls the state for the active mode. There is a User Preset file for each mode. User Preset can never cause a mode switch as it can in legacy analyzers. If you want to recall all modes to their user preset file state, you will need to do a User Preset after mode switching into each mode.</p> <p>User Preset recalls mode state which can now include data like traces; whereas on ESA and PSA, User Preset did not affect data.</p>
Initial S/W Revision	Prior to A.02.00

## User Preset

User Preset sets the state of the currently active mode back to the state that was previously saved for this mode using the Save User Preset menu key or the SCPI command, SYST:PRES:USER:SAV. It not only recalls the Mode Preset settings, but it also recalls all of the mode persistent settings, and the Input/Output system setting that existed at the time Save User Preset was executed.

If a Save User Preset has not been done at any time, User Preset recalls the default user preset file for the currently active mode. The default user preset files are created if, at power-on, a mode detects there is no user preset file. There will never be a scenario when there is no user preset file to restore. For each mode, the default user preset state is the same state that would be saved if a Save User Preset is performed in each mode right after doing a Restore Mode Default and after a Restore Input/Output Defaults.

The User Preset function does the following:

- Aborts the currently running measurement.
- Sets the mode State to the values defined by Save User Preset.
- Makes the saved measurement for the currently running mode the active measurement.
- Brings up the saved menu for the power-on mode.
- Clears the input and output buffers.
- Sets the Status Byte to 0.

Key Path	User Preset
Remote Command	:SYSTem:PRESet:USER
Example	:SYST:PRES:USER:SAVE:SYST:PRES:USER
Notes	:SYST:PRES:USER:SAVE is used to save the current state as the user preset state. Clears all pending OPC bits. The Status Byte is set to 0. Pressing the User Preset front-panel key while already in the User Preset menu will cause the User Preset to get executed
Couplings	A user preset will cause the currently running measurement to be aborted and cause the saved measurement to be active. Recalling a User Preset file has the same issues that recalling a Save State file has. Some settings may need to be limited and therefore re-coupled, since the capabilities of the mode may have changes when the User Preset file was last saved.
Initial S/W Revision	Prior to A.02.00

### User Preset All Modes

Recalls all of the User Preset files for each mode, switches to the power-on mode, and activates the saved measurement from the power-on mode User Preset file.

**NOTE**

When the instrument is secured, all of the user preset files are converted back to their default user preset files.

The User Preset function does the following:

- Aborts the currently running measurement.
- Switches the Mode to the power-on mode.
- Restores the User Preset files for each mode.
- Makes the saved measurement for the power-on mode the active measurement.
- Brings up the saved menu for the power-on mode.
- Clears the input and output buffers.
- Sets the Status Byte to 0.

Key Path	User Preset
Remote Command	:SYSTem:PRESet:USER:ALL
Example	:SYST:PRES:USER:SAVE:SYST:PRES:USER:ALL
Notes	Clears all pending OPC bits. The Status Byte is set to 0. :SYST:PRES:USER:SAVE is used to save the current state as the user preset state.
Couplings	A user preset will cause the currently running measurement to be aborted, cause a mode switch to the power-on mode, and cause the saved measurement to be active in the power-on mode. Recalling a User Preset file has the same issues that recalling a Save State file has. Some settings may need to be limited and therefore re-coupled, since the capabilities of the mode may have changes when the User Preset file was last saved.
Initial S/W Revision	Prior to A.02.00

## Save User Preset

Saves the currently active mode and its State. You can recall this User Preset file by pressing the User Preset menu key or sending the SYST:PRES:USER remote command. This same state is also saved by the Save State function.

Key Path	User Preset
<b>Remote Command</b>	:SYSTem:PRESet:USER:SAVE
<b>Example</b>	:SYST:PRES:USER:SAVE
Notes	:SYST:PRES:SAVE creates the same file as if the user requested a *SAV or a MMEM:STOR:STAT, except User Preset Save does not allow the user to specify the filename or the location of the file.
Initial S/W Revision	Prior to A.02.00

## View/Display

Accesses a menu of functions that enable you to control the instrument display.

This measurement consists of seven views. They are

NO.	View	NO. of Windows	Window No.	Window
1	VIEW[1] I/Q Measured Polar Graph	Dual (Horizontal)	WINDow[1]	Result Metrics
			WINDow2	I/Q Measured Polar Graph
2	VIEW2 Results Metrics(One-Slot)	Single	WINDow[1]	Numeric Results Summary for one slot
3	VIEW3 Channel Peak/Avg Metrics	Single	WINDow[1]	Numeric Results Summary
4	VIEW4 Summary Peak/Avg Metrics	Single	WINDow[1]	Numeric Results Summary
5	VIEW5 I/Q Error	Quad	WINDow[1]	Magnitude Error
			WINDow2	Phase Error
			WINDow3	EVM
			WINDow4	Result Metrics
6	VIEW6 I/Q Measured (Quad View)	Quad	WINDow[1]	I/Q Waveform
			WINDow2	Chip Power
			WINDow3	I/Q Measured Polar Graph
			WINDow4	Numeric Result
7	VIEW7 Code Domain Power	Dual (Vertical)	WINDow[1]	Code Domain Power
			WINDow2	Code Domain Power Summary

The default view is I/Q Measured Polar Graph (left/right).

Key Path	Front panel key
Initial S/W Revision	Prior to A.02.00

### View Selection

Selects the desired measurement view from the following selections:

- POLar – (I/Q Measured Polar Graph) provides a combination view of I/Q measured polar vector graph and the summary data.

- TABLE – (Result Metrics (One-Slot)) provides a summary table of one-slot results of selected channel. Slot whose results are displayed on this view is specified by Meas Offset.
- CPATable – (Channel Peak/Avg Metrics) provides a table of average and peak hold results of selected channel.
- SPATable – (Summary Peak/Avg Metrics) provides a summary table of average and peak hold of some important results of all channels.
- ERRor – (I/Q Error (Quad View)) provides a combination view of a magnitude error, phase error, EVM graphs and one-slot result summary of selected channel.
- QUAD – (I/Q Measured (Quad View)) provides a combination of IQ waveform plot, chip power graph and IQ measured polar vector graph.
- CDPower – (Code Domain Power) provides a combination view of the code domain power graph and the summary table of code domain channel.

Key Path	View/Display
Mode	1xEVDO
Remote Command	:DISPlay:RHO[:BTS]:VIEW[:SElect] POLar   TABLE   ERRor   QUAD   CDPower   CPATable   SPATable :DISPlay:RHO[:BTS]:VIEW[:SElect]?
Example	:DISP:RHO:VIEW TABLE
Preset	POLar
State Saved	Saved in instrument state.
Range	I/Q Measured Polar Graph   Result Metrics   I/Q Error (Quad View)   I/Q Measured (Quad View)   Code Domain Power   Channel Peak/Avg Metrics   Summary Peak/Avg Metrics
Backwards Compatibility SCPI	:DISPlay:RHO:VIEW[:SElect]
Initial S/W Revision	Prior to A.02.00

### View Selection by number (SCPI Remote Command only)

Displays the numeric values of the measurement results. This function is available by SCPI command only.

Mode	1xEVDO
Remote Command	:DISPlay:RHO[:BTS]:VIEW:NSElect <integer> :DISPlay:RHO[:BTS]:VIEW:NSElect?
Example	:DISP:RHO:VIEW:NSEL 2 :DISP:RHO:VIEW:NSEL?
Preset	1
State Saved	Saved in instrument state.
Min	1
Max	7

---

<b>Backwards Compatibility SCPI</b>	<b>:DISPlay:RHO:VIEW:NSElect</b>
Initial S/W Revision	Prior to A.02.00

---

## Display

The Display menu is common to most measurements, and is used for configuring items on the display. Some Display menu settings apply to all the measurements in a mode, and some only to the current measurement. Those under the System Display Settings key apply to all measurements in all modes.

---

Key Path	Display
Key Path	View/Display
Initial S/W Revision	Prior to A.02.00

---

## Annotation

Turns on and off various parts of the display annotation. The annotation is divided up into four categories:

1. Meas Bar: This is the measurement bar at the top of the screen. It does not include the settings panel or the Active Function. Turning off the Meas Bar turns off the settings panel and the Active Function. When the Meas Bar is off, the graticule area expands to fill the area formerly occupied by the Meas Bar.
2. Screen Annotation: this is the annotation and annunciation around the graticule, including any annotation on lines (such as the display line, the threshold line, etc.) This does NOT include the marker number or the N dB result. When off, the graticule expands to fill the entire graticule area.
3. Trace annotation: these are the labels on the traces, showing their detector (or their math mode).
4. Active Function annotation: this is the active function display in the meas bar, and all of the active function values displayed on softkeys.

See the figure below. Each type of annotation can be turned on and off individually.

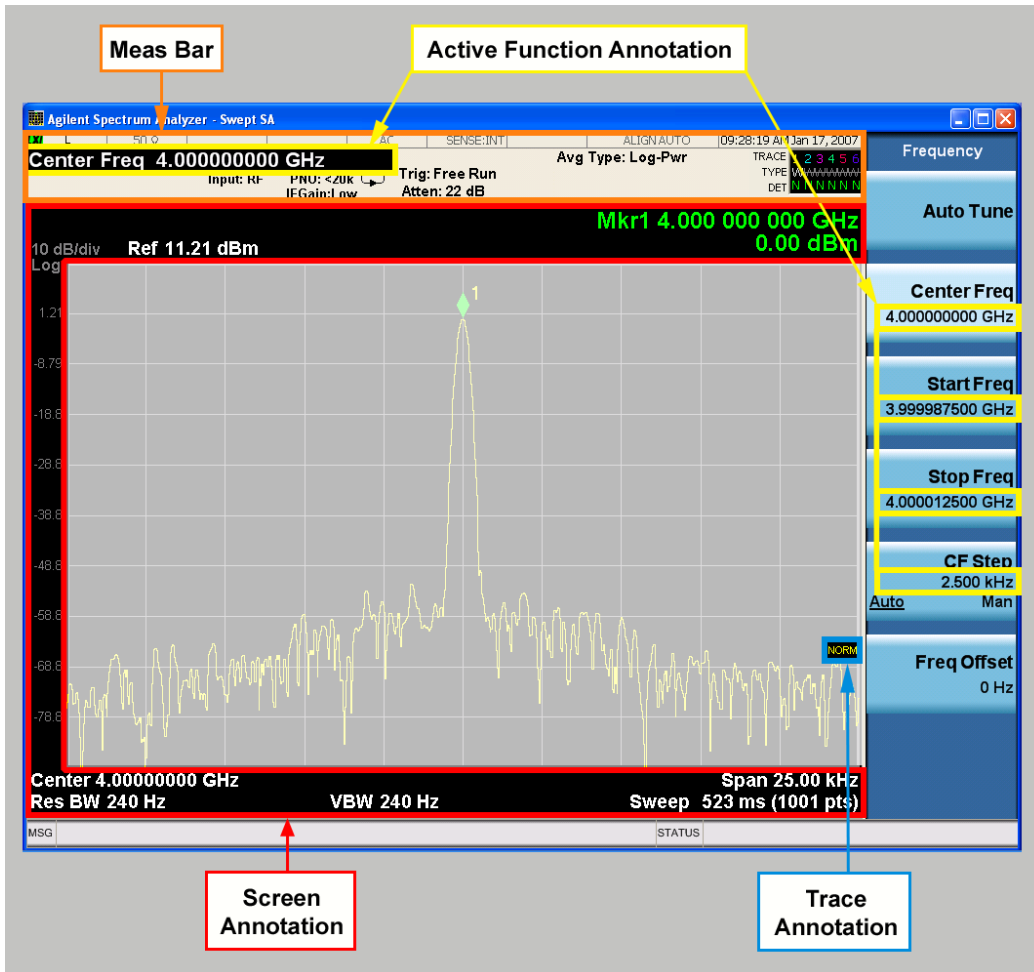

Key Path	View/Display, Display
Initial S/W Revision	Prior to A.02.00

### Meas Bar On/Off

This function turns the Measurement Bar on and off, including the settings panel. When off, the graticule area expands to fill the area formerly occupied by the Measurement Bar.

Key Path	View/Display, Display, Annotation
Remote Command	:DISPlay:ANNotation:MBAR[:STATE] OFF ON 0 1 :DISPlay:ANNotation:MBAR[:STATE]?
Example	DISP:ANN:MBAR OFF
Dependencies	Grayed out and forced to OFF when System Display Settings, Annotation is set to Off.
Preset	On This should remain Off through a Preset when System DisplaySettings, Annotation is set to Off.
State Saved	Saved in instrument state.
Initial S/W Revision	Prior to A.02.00

## Screen

This controls the display of the annunciation and annotation around the graticule, including any annotation on lines (such as the display line, the threshold line, etc.) and the y-axis annotation. This does NOT include marker annotation (or the N dB result). When off, the graticule expands to fill the entire graticule area, leaving only the 1.5% gap above the graticule as described in the Trace/Detector chapter.

<b>Key Path</b>	View/Display, Display, Annotation
<b>Remote Command</b>	:DISPlay:ANNotation:SCReen[:STATe] OFF ON 0 1 :DISPlay:ANNotation:SCReen[:STATe]?
<b>Example</b>	DISP:ANN:SCR OFF
<b>Dependencies</b>	Grayed-out and forced to OFF when System Display Settings, Annotation is set to Off.
<b>Preset</b>	On This should remain Off through a Preset when System DisplaySettings, Annotation is set to Off
<b>State Saved</b>	Saved in instrument state.
<b>Initial S/W Revision</b>	Prior to A.02.00

## Active Function Values On/Off

Turns on and off the active function display in the Meas Bar, and all of the active function values displayed on the softkeys.

Note that all of the softkeys that have active functions have these numeric values blanked when this function is on. This is a security feature..





Key Path	View/Display, Display, Annotation
Remote Command	:DISPlay:ACTivefunc[:STATE] ON OFF 1 0 :DISPlay:ACTivefunc[:STATE]?
Example	DISP:ACT OFF
Dependencies	Grayed out and forced to OFF when System Display Settings, Annotation is set to Off.
Preset	On This should remain Off through a Preset when System DisplaySettings, Annotation is set to Off
State Saved	Saved in instrument state.
Initial S/W Revision	Prior to A.02.00

## Title

Displays menu keys that enable you to change or clear a title on your display.

Key Path	View/Display, Display
Initial S/W Revision	Prior to A.02.00

## Change Title

Writes a title into the "measurement name" field in the banner, for example, "Swept SA".

Press Change Title to enter a new title through the alpha editor. Press Enter or Return to complete the entry. Press ESC to cancel the entry and preserve your existing title.

The display title will replace the measurement name. It remains for this measurement until you press Change Title again, or you recall a state, or a Preset is performed. A title can also be cleared by pressing Title, Clear Title.

**NOTE**

Notice the inclusion of the <measurement> parameter in the command below. Because each measurement remembers the Display Title, the command must be qualified with the measurement name. For the Swept SA measurement this is not the case; no <measurement> parameter is used when changing the Display Title for the Swept SA measurement.

Key Path	View/Display, Display, Title
Mode	All
Remote Command	:DISPlay:<measurement>:ANNotation:TITLe:DATA <string> :DISPlay:<measurement>:ANNotation:TITLe:DATA?
Example	DISP:ANN:TITL:DATA "This Is My Title" This example is for the Swept SA measurement in the Spectrum Analyzer mode. The SANalyzer <measurement> name is not used. DISP:ACP:ANN:TITL:DATA "This Is My Title" This example is for Measurements other than Swept SA. Both set the title to: This Is My Title
Notes	Pressing this key cancels any active function. When a title is edited the previous title remains intact (it is not cleared) and the cursor goes at the end so that characters can be added or BKSP can be used to go back over previous characters.
Preset	No title (measurement name instead)
State Saved	Saved in instrument state.
Initial S/W Revision	Prior to A.02.00

**Clear Title**

Clears a title from the front-panel display. Once cleared, the title cannot be retrieved. After the title is cleared, the current Measurement Name replaces it in the title bar.

Key Path	View/Display, Display, Title
Example	The following commands clear the title and restore the measurement's original title: DISP:ANN:TITL:DATA "" This example is for the Swept SA measurement in the Spectrum Analyzer mode. The SANalyzer <measurement> name is not used. DISP:ACP:ANN:TITL:DATA "" This example is for ACP; in measurements other than Swept SA the measurement name is required.
Notes	Uses the :DISPlay:<measurement>:ANNotation:TITLe:DATA <string> command with an empty string (in the Swept SA, the <measurement> is omitted).
Preset	Performed on Preset.
Initial S/W Revision	Prior to A.02.00

## Graticule

Pressing Graticule turns the display graticule On or Off. It also turns the graticule y-axis annotation on and off.

Key Path	View/Display, Display
Remote Command	:DISPlay:WINDow[1]:TRACe:GRATicule:GRID[:STATe] OFF ON 0 1 :DISPlay:WINDow[1]:TRACe:GRATicule:GRID[:STATe]?
Example	DISP:WIND:TRAC:GRAT:GRID OFF
Notes	The graticule is the set of horizontal and vertical lines that make up the grid/divisions for the x-axis and y-axis.
Preset	On
State Saved	Saved in instrument state
Initial S/W Revision	Prior to A.02.00

## System Display Settings

These settings are "Mode Global" – they affect all modes and measurements and are reset only by Restore Misc Defaults or Restore System Defaults under System.

Key Path	View/Display, Display
Initial S/W Revision	Prior to A.02.00

## Annotation Local Settings

This is a Mode Global override of the meas local annotation settings. When it is All Off, it forces ScreenAnnotation, Meas Bar, Trace, and Active Function Values settings to be OFF for all measurements in all modes. This provides the security based "annotation off" function of previous analyzers; hence it uses the legacy SCPI command.

When it is All Off, the Screen, Meas Bar, Trace, and Active Function Values keys under the Display, Annotation menu are grayed out and forced to Off. When Local Settings is selected, you are able to set the local annotation settings on a measurement by measurement basis.

Key Path	View/Display, Display, System Display Settings
Remote Command	:DISPlay:WINDow[1]:ANNOtation[:ALL] OFF ON 0 1 :DISPlay:WINDow[1]:ANNOtation[:ALL]?
Example	:DISP:WIND:ANN OFF
Preset	On (Set by Restore Misc Defaults)
State Saved	Not saved in instrument state.
Backwards Compatibility Notes	The WINDow parameter and optional subopcode is included for backwards compatibility but ignored – all windows are equally affected.
Initial S/W Revision	Prior to A.02.00

## Themes

Accesses a menu of functions that enable you to choose the theme to be used when saving the screen image.

The **Themes** option is the same as the **Themes** option under the **Display** and **Page Setup** dialogs. It allows you to choose between themes to be used when saving the screen image.

<b>Key Path</b>	Save, Screen Image
<b>Remote Command</b>	:MMEMory:STORe:SCReen:THEMe TDColor   TDMonochrome   FCOLor   FMONochrome  :MMEMory:STORe:SCReen:THEMe?
<b>Example</b>	:MMEM:STOR:SCR:THEM TDM
<b>Preset</b>	3D Color; Is not part of Preset, but is reset by Restore Misc Defaults or Restore System Defaults All and survives subsequent running of the modes.
<b>Readback</b>	3D Color   3D Mono   Flat Color   Flat Mono
<b>Backwards Compatibility Notes</b>	In ESA and PSA we offer the choice of "Reverse Bitmap" or "Reverse Metafile" when saving screen images. This is much like the "Flat Color" theme available in X-Series. Also, if you selected Reverse Bitmap AND a black & white screen image, that would be much like "Flat Monochrome". In other words, each of the X-Series themes has a similar screen image type in ESA/PSA. But they are not identical.
<b>Initial S/W Revision</b>	Prior to A.02.00

### 3D Color

Selects a standard color theme with each object filled, shaded and colored as designed.

<b>Key Path</b>	Save, Screen Image, Themes
<b>Example</b>	MMEM:STOR:SCR:THEM TDC
<b>Readback</b>	3D Color
<b>Initial S/W Revision</b>	Prior to A.02.00

### 3D Monochrome

Selects a format that is like 3D color but shades of gray are used instead of colors.

<b>Key Path</b>	Save, Screen Image, Themes
<b>Example</b>	MMEM:STOR:SCR:THEM TDM
<b>Readback</b>	3D Mono
<b>Initial S/W Revision</b>	Prior to A.02.00

### Flat Color

Selects a format that is best when the screen is to be printed on an ink printer.

Key Path	Save, Screen Image, Themes
<b>Example</b>	MMEM:STOR:SCR:THEM FCOL
Readback	Flat Color
Initial S/W Revision	Prior to A.02.00

### Flat Monochrome

Selects a format that is like Flat Color. But only black is used (no colors, not even gray), and no fill.

Key Path	Save, Screen Image, Themes
<b>Example</b>	MMEM:STOR:SCR:THEM FMON
Readback	Flat Mono
Initial S/W Revision	Prior to A.02.00

### Backlight

Accesses the display backlight on/off keys. This setting may interact with settings under the Windows "Power" menu.

When the backlight is off, pressing ESC, TAB, SPACE, ENTER, UP, DOWN, LEFT, RIGHT, DEL, BKSP, CTRL, or ALT turns the backlight on without affecting the application. Pressing any other key will turn backlight on and could potentially perform the action as well.

Key Path	View/Display, Display, System Display Settings
<b>Remote Command</b>	:DISPlay:BACKlight ON OFF :DISPlay:BACKlight?
Preset	ON (Set by Restore Misc Defaults)
Initial S/W Revision	Prior to A.02.00

### Backlight Intensity

An active function used to set the backlight intensity. It goes from 0 to 100 where 100 is full on and 0 is off. This value is independent of the values set under the Backlight on/off key.

Key Path	View/Display, Display, System Display Settings
<b>Remote Command</b>	:DISPlay:BACKlight:INTensity <integer> :DISPlay:BACKlight:INTensity?
<b>Example</b>	DISP:BACK:INT 50

Preset	100 (Set by Restore Misc Defaults)
Min	0
Max	100
Initial S/W Revision	Prior to A.02.00

## Display Channel Type

Selects channel type to display. This setting affects all the results except for those in Summary Avg/Peak Metrics view.

Key Path	Display
Mode	1xEVDO
<b>Remote Command</b>	:DISPlay:RHO[:BTS]:CHANnel:TYPE PILOt   MAC   DATA   PREAmble   ALL1   ALL2 :DISPlay:RHO[:BTS]:CHANnel:TYPE?
<b>Example</b>	:DISP:RHO:CHAN:TYPE MAC
Preset	PILot
State Saved	Saved in instrument state.
Range	Pilot   MAC   Data   Preamble   Overall1   Overall2
<b>Backwards Compatibility SCPI</b>	:DISPlay:RHO:CHANnel:TYPE
Initial S/W Revision	Prior to A.02.00

## I/Q Measured Polar Graph

Provides a combination view of I/Q measured polar vector graph and the summary data.

Key Path	View/Display
<b>Example</b>	:DISP:RHO:VIEW POL :DISP:RHO:VIEW?
Initial S/W Revision	Prior to A.02.00

This view shows I/Q Polar graph and its numeric results. There are two windows:

- I/Q Measured Polar Vector window (right)
- Metrics window (left)

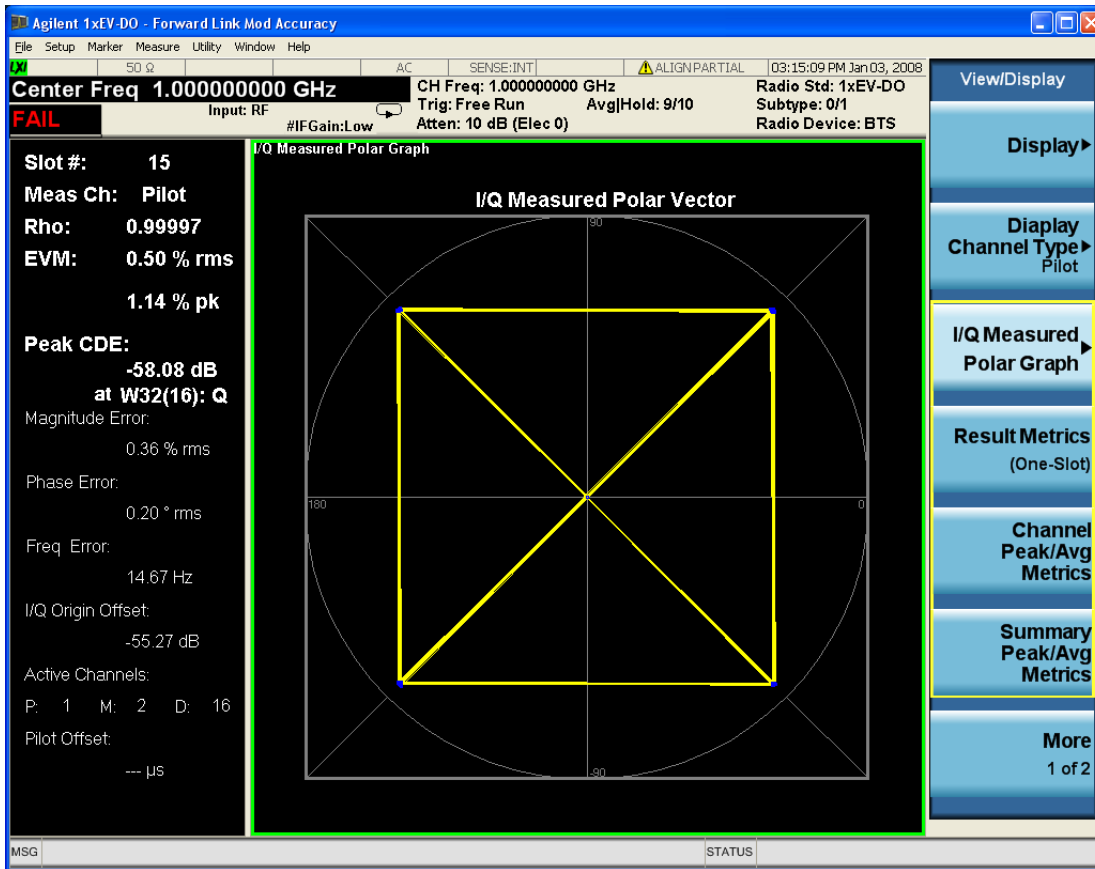

Figure 0-2 I/Q Measured Polar Vector View

### I/Q Measured Polar Vector window

This window provides composite IQ polar vector.

Marker Operation	Yes
Corresponding Trace	Corrected measured IQ trace(n=5)

### Metrics window

All results displayed on this window except for Pilot Offset are calculated from interval of one slot specified by Meas Offset.

Table 0-3 Results in the metrics window of I/Q Measured Polar Graph view with Pilot

Name	Corresponding Results	Display Format
Slot Num	n=1 32nd	00
Rho	n=54 7th , Rho	0.00000

EVM	n=54 1st , RMS EVM	-99.99 % rms
Peak EVM	n=54 2nd, Peak EVM	-99.99 % pk
Pk CDE	n=54 10th , Peak CDE n=54 11th	-99.99 dB at W32(Y):Phase Y: Walsh code number (0 .. 31) Phase: I or Q
Magnitude Error	n=54 3rd , RMS Magnitude Error	-99.99 % rms
Phase Error	n=54 4th , RMS Phase Error	-99.99 ° rms
Freq Error	n=54 6th , Frequency Error	-999.99 Hz
I/Q Origin Offset	n=54 5th , I/Q Origin Offset	-999.99 dB
Active Channels	n=54 8th , Pilot Active Channels n=55 8th , MAC Active Channels n=56 8th , Data Active Channels	P:00 M:00 D:00
Pilot Offset	n=54 9th , Pilot Offset	-99.99 us

Table 0-4 Results in the metrics window of I/Q Measured Polar Graph view with MAC

Slot Num	n=1 32nd	00
Rho	n=55 7nd , Rho	0.00000
EVM	n=55 1st , RMS EVM	-99.99 % rms
Peak EVM	n=55 2nd, Peak EVM	-99.99 % pk
Pk CDE	n=55 10th , Peak CDE n=55 11th	Subtype 0/1 -99.99 dB at W32(Y):Phase Y: Walsh code number (0 .. 31) Phase: I or Q Subtype 2, Subtype 3 -99.99 dB at W64(Y):Phase Y: Walsh code number (0 .. 63) Phase: I or Q
Magnitude Error	n=55 3rd , RMS Magnitude Error	-99.99 % rms
Phase Error	n=55 4th , RMS Phase Error	-99.99 ° rms
Freq Error	n=55 6th , Frequency Error	-999.99 Hz
I/Q Origin Offset	n=55 5th , I/Q Origin Offset	-999.99 dB
Active Channels	n=54 8th , Pilot Active Channels n=55 8th , MAC Active Channels n=56 8th , Data Active Channels	P:00 M:00 D:00
Pilot Offset	n=55 9th , Pilot Offset	-99.99 us

Table 0-5 Results in the metrics window of I/Q Measured Polar Graph view with Data



Name	Corresponding Results	Display Format
Slot Num	n=1 32nd	00
Rho	n=56 7th , Rho	0.00000
EVM	n=56 1st , RMS EVM	-99.99 % rms
Peak EVM	n=56 2nd, Peak EVM	-99.99 % pk
Pk CDE	n=56 10th , Peak CDE n=56 11th	-99.99 dB at W16(Y):Phase Y: Walsh code number (0 .. 15) Phase: I or Q
Magnitude Error	n=56 3rd , RMS Magnitude Error	-99.99 % rms
Phase Error	n=56 4th , RMS Phase Error	-99.99 ° rms
Freq Error	n=56 6th , Frequency Error	-999.99 Hz
I/Q Origin Offset	n=56 5th , I/Q Origin Offset	-999.99 dB
Active Channels	n=54 8th , Pilot Active Channels n=55 8th , MAC Active Channels n=56 8th , Data Active Channels	P:00 M:00 D:00
Pilot Offset	n=56 9th , Pilot Offset	-99.99 us

Table 5–6 Results in the metrics window of I/Q Measured Polar Graph view with Preamble

Slot Num	n=1 32nd	00
Rho	n=57 7th , Rho	0.00000
EVM	n=57 1st , RMS EVM	-99.99 % rms
Peak EVM	n=57 2nd, Peak EVM	-99.99 % pk
Pk CDE	n=57 9th , Peak CDE n=57 10th	Subtype 0/1 -99.99 dB at W32(Y):Phase Y: Walsh code number (0 .. 31) Phase: I or Q
		Subtype 2 -99.99 dB at W64(Y):Phase Y: Walsh code number (0 .. 63) Phase: I or Q
		Subtype 3 -99.99 dB at W128(Y):Phase Y: Walsh code number (0 .. 127) Phase: I or Q
Magnitude Error	n=57 3rd , RMS Magnitude Error	-99.99 % rms
Phase Error	n=57 4th , RMS Phase Error	-99.99 ° rms

Freq Error	n=57 6th , Frequency Error	-999.99 Hz
I/Q Origin Offset	n=57 5th , I/Q Origin Offset	-999.99 dB
Pilot Offset	n=57 8th , Pilot Offset	-99.99 us

Table 0-7 Results in the metrics window of I/Q Measured Polar Graph view with Overall-1

Name	Corresponding Results	Display Format
Slot Num	n=1 32nd	00
Rho	n=58 7th , Rho	0.00000
EVM	n=58 1st , RMS EVM	-99.99 % rms
Peak EVM	n=58 2nd, Peak EVM	-99.99 % pk
Magnitude Error	n=58 3rd , RMS Magnitude Error	-99.99 % rms
Phase Error	n=58 4th , RMS Phase Error	-99.99 ° rms
Freq Error	n=58 6th , Frequency Error	-999.99 Hz
I/Q Origin Offset	n=58 5th , I/Q Origin Offset	-999.99 dB
Active Channels	n=58 8th , Pilot Active Channels n=58 9th , MAC Active Channels n=58 10th , Data Active Channels	P:00 M:00 D:00
Pilot Offset	n=58 11th , Pilot Offset	-99.99 us

Table 0-8 Results in the metrics window of I/Q Measured Polar Graph view with Overall-2

Name	Corresponding Results	Display Format
Slot Num	n=1 32nd	00
Rho	n=59 7th , Rho	0.00000
EVM	n=59 1st , RMS EVM	-99.99 % rms
Peak EVM	n=59 2nd, Peak EVM	-99.99 % pk
Magnitude Error	n=59 3rd , RMS Magnitude Error	-99.99 % rms
Phase Error	n=59 4th , RMS Phase Error	-99.99 ° rms
Freq Error	n=59 6th , Frequency Error	-999.99 Hz
I/Q Origin Offset	n=59 5th , I/Q Origin Offset	-999.99 dB
Active Channels	n=59 8th , Pilot Active Channels n=59 9th , MAC Active Channels n=59 10th , Data Active Channels	P:00 M:00 D:00
Pilot Offset	n=59 11th , Pilot Offset	-99.99 us

## I/Q Polar Vector/Constellation

Sets IQ Polar graph display mode from Vector & Constellation, Vector and Constellation. This key appears when I/Q Polar Graph window is active.

VCONStIn – Vector & Constellation

VECTor – Vector

CONStIn – Constellation

Key Path	View/Display – I/Q Measured Polar Graph, I/Q Polar
Mode	1xEVDO
<b>Remote Command</b>	:DISPlay:RHO[:BTS]:IQPTtype VCONStIn VECTor CONStIn :DISPlay:RHO[:BTS]:IQPTtype?
<b>Example</b>	:DISP:RHO:IQPT VCON
Preset	VCONStIn
State Saved	Saved in instrument state.
Range	Vec & ConstIn   Vector   Constellation
Initial S/W Revision	Prior to A.02.00

## Chip Offset

Sets display trace length in IQ Polar Graph in chips.

Key Path	View/Display – I/Q Measured Polar Graph, Chip Offset
Mode	1xEVDO
<b>Remote Command</b>	:DISPlay:RHO[:BTS]:OFFSet <integer> :DISPlay:RHO[:BTS]:OFFSet?
<b>Example</b>	:DISPlay:RHO:OFFS 10
Notes	Maximum varies so that (Chip Offset + I/Q Chips) does not exceed 2048 chip.
Couplings	When (Chip Offset + I/Q Chips) exceeds 2048, Chip Offset is changed to keep it 2048.
Preset	0
State Saved	Saved in instrument state.
Range	0 to 2047
Min	0
Max	2047
Initial S/W Revision	Prior to A.02.00

## I/Q Chips

Sets display trace length in IQ Polar Graph in chips.

Key Path	View/Display – I/Q Measured Polar Graph, I/Q Chips
Mode	1xEVDO
<b>Remote Command</b>	:DISPlay:RHO[:BTS]:IQCHips <integer> :DISPlay:RHO[:BTS]:IQCHips?
<b>Example</b>	:DISPlay:RHO:IQCH 2000
Couplings	When (Chip Offset + I/Q Chips) exceeds 2048, Chip Offset is changed to keep it 2048.
Preset	2048
State Saved	Saved in instrument state.
Range	1 to 2048
Min	1
Max	2048
Initial S/W Revision	Prior to A.02.00

### +45° Rotation

Allows you to toggle the 45 Degree Rotation of the trace on IQ Polar Graph. When On, the trace plotted on IQ Polar Graph is rotated by +45 degree. This setting affects display of the trace but not trace returned from RUI.

Key Path	View/Display – I/Q Measured Polar Graph, +45 Rotation
Mode	1xEVDO
<b>Remote Command</b>	:DISPlay:RHO[:BTS]:ROTQpi[:STATe] 0 1 OFF ON :DISPlay:RHO[:BTS]:ROTQpi[:STATe]?
<b>Example</b>	:DISPlay:RHO:ROTQ ON
Preset	OFF
State Saved	Saved in instrument state.
Range	On   Off
Initial S/W Revision	Prior to A.02.00

### Full Vector(Background)

Allows you to toggle the Full Vector display. Full Vector is a trace plotted on IQ Polar graph using the same IQ data plotted on the graph. Full trace data is always drew with gray line behind the normal plot which is drawn with yellow line and/or blue dots. Full Vector provides the user an intuitive sense of relative magnitude of plotted IQ measured data which is specified by I/Q Chips and Chip Offset.

Key Path	View/Display – I/Q Measured Polar Graph, Full Vector
Mode	1xEVDO
<b>Remote Command</b>	:DISPlay:RHO[:BTS]:FVEctor[:STATe] 0 1 OFF ON

	:DISPlay:RHO[:BTS]:FVEctor[:STATE]?
<b>Example</b>	:DISPlay:RHO:FVEC ON
Preset	OFF
State Saved	Saved in instrument state.
Range	On   Off
Initial S/W Revision	Prior to A.02.00

## Interpolation

This key specifies whether the input I/Q data should be interpolated.

Key Path	View/Display – I/Q Measured Polar Graph, Interpolation
Mode	1xEVDO
<b>Remote Command</b>	:DISPlay:RHO[:BTS]:INterpolate OFF ON 0 1 :DISPlay:RHO[:BTS]:INterpolate?
<b>Example</b>	:DISP:RHO:INT ON
Preset	OFF
State Saved	Saved in instrument state.
Range	On   Off
Initial S/W Revision	Prior to A.02.00

## Chip Descrambling

Allows you to toggle the chip descrambling between On and Off. When On, descrambled IQ measured trace is displayed.

Key Path	View/Display – I/Q Measured Polar Graph, Chip Descrambling
Mode	1xEVDO
<b>Remote Command</b>	:DISPlay:RHO[:BTS]:CDEScramble[:STATE] 0 1 OFF ON :DISPlay:RHO[:BTS]:CDEScramble[:STATE]?
<b>Example</b>	:DISPlay:RHO:CDES ON
Preset	OFF
State Saved	Saved in instrument state.
Range	On   Off
Initial S/W Revision	Prior to A.02.00

### Result Metrics (One-Slot)

Provides a summary table of one-slot results of selected channel. Slot whose results are displayed on this view is specified by Meas Offset.

Key Path	View/Display
Example	:DISP:RHO:VIEW TABL :DISP:RHO:VIEW?
Initial S/W Revision	Prior to A.02.00

This is a view of result metrics table. All results displayed on this window except for Pilot Offset are calculated from interval of one slot specified by Meas Offset. Displaying results are determined by Display Channel Type.



Figure 0-6 Result Metrics (One-Slot) View

Table 0-9 Results in the metrics window of Result Metrics view with Pilot

Name	Corresponding Results	Display Format
Slot Num	n=1 32nd	00

Rho	n=54 7th , Rho	0.00000
EVM	n=54 1st , RMS EVM	-99.99 % rms
Peak EVM	n=54 2nd, Peak EVM	-99.99 % pk
Pk CDE	n=54 10th , Peak CDE n=54 11th	-99.99 dB at W32(Y):Phase Y: Walsh code number (0 .. 31) Phase: I or Q
Magnitude Error	n=54 3rd , RMS Magnitude Error	-99.99 % rms
Phase Error	n=54 4th , RMS Phase Error	-99.99 ° rms
Freq Error	n=54 6th , Frequency Error	-999.99 Hz
I/Q Origin Offset	n=54 5th , I/Q Origin Offset	-999.99 dB
Active Channels	n=54 8th , Pilot Active Channels n=55 8th , MAC Active Channels n=56 8th , Data Active Channels	P:00 M:00 D:00
Pilot Offset	n=54 9th , Pilot Offset	-99.99 us

Table 0-10 Results in the metrics window of Result Metrics view with MAC

Slot Num	n=1 32nd	00
Rho	n=55 7nd , Rho	0.00000
EVM	n=55 1st , RMS EVM	-99.99 % rms
Peak EVM	n=55 2nd, Peak EVM	-99.99 % pk
Pk CDE	n=55 10th , Peak CDE n=55 11th	Subtype 0/1 -99.99 dB at W64(Y):Phase Y: Walsh code number (0 .. 63) Phase: I or Q Subtype 2, -99.99 dB at W128(Y):Phase Subtype 3 Y: Walsh code number (0 .. 127) Phase: I or Q
Magnitude Error	n=55 3rd , RMS Magnitude Error	-99.99 % rms
Phase Error	n=55 4th , RMS Phase Error	-99.99 ° rms
Freq Error	n=55 6th , Frequency Error	-999.99 Hz
I/Q Origin Offset	n=55 5th , I/Q Origin Offset	-999.99 dB
Active Channels	n=54 8th , Pilot Active Channels n=55 8th , MAC Active Channels n=56 8th , Data Active Channels	P:00 M:00 D:00

Pilot Offset	n=55 9th , Pilot Offset	-99.99 us	
Max MAC Inactive Ch	n=55 12th , Max Inactive Code Domain Power	Subtype 0/1	-99.99 dB at W64(Y):Phase Y: Walsh code number (0 .. 63) Phase: I or Q
	n=55 13th , Max Inactive Code Domain Power Channel Number	Subtype 2, Subtype 3	-99.99 dB at W128(Y):Phase Y: Walsh code number (0 .. 127) Phase: I or Q

Table 0-11 Results in the metrics window of Result Metrics view with Data

Name	Corresponding Results	Display Format
Slot Num	n=1 32nd	00
Rho	n=56 7th , Rho	0.00000
EVM	n=56 1st , RMS EVM	-99.99 % rms
Peak EVM	n=56 2nd, Peak EVM	-99.99 % pk
Pk CDE	n=56 10th , Peak CDE n=56 11th	-99.99 dB at W16(Y):Phase Y: Walsh code number (0 .. 15) Phase: I or Q
Magnitude Error	n=56 3rd , RMS Magnitude Error	-99.99 % rms
Phase Error	n=56 4th , RMS Phase Error	-99.99 ° rms
Freq Error	n=56 6th , Frequency Error	-999.99 Hz
I/Q Origin Offset	n=56 5th , I/Q Origin Offset	-999.99 dB
Active Channels	n=54 8th , Pilot Active Channels n=55 8th , MAC Active Channels n=56 8th , Data Active Channels	P:00 M:00 D:00
Pilot Offset	n=56 9th , Pilot Offset	-99.99 us
Max Data Active Ch	n=56 12th , Max Active Code Domain Power n=56 13th , Max Active Code Domain Power Channel Number	-99.99 dB at W16(Y):Phase Y: Walsh code number (0 .. 15) Phase: I or Q
Min Data Active Ch	n=56 14th , Min Active Code Domain Power n=56 15th , Min Active Code Domain Power Channel Number	-99.99 dB at W16(Y):Phase



	Y: Walsh code number (0 .. 15)
	Phase: I or Q

Table 0-12 Results in the metrics window of Result Metrics view with Preamble

Slot Num	n=1 32nd	00	
Rho	n=57 7th , Rho	0.00000	
EVM	n=57 1st , RMS EVM	-99.99 % rms	
Peak EVM	n=57 2nd, Peak EVM	-99.99 % pk	
Pk CDE	n=57 9th , Peak CDE n=57 10th	Subtype 0/1	-99.99 dB at W32(Y):Phase Y: Walsh code number (0 .. 31) Phase: I or Q
		Subtype 2	-99.99 dB at W64(Y):Phase Y: Walsh code number (0 .. 63) Phase: I or Q
		Subtype 3	-99.99 dB at W128(Y):Phase Y: Walsh code number (0 .. 127) Phase: I or Q
Magnitude Error	n=57 3rd , RMS Magnitude Error	-99.99 % rms	
Phase Error	n=57 4th , RMS Phase Error	-99.99 ° rms	
Freq Error	n=57 6th , Frequency Error	-999.99 Hz	
I/Q Origin Offset	n=57 5th , I/Q Origin Offset	-999.99 dB	
Pilot Offset	n=57 8th , Pilot Offset	-99.99 us	
Preamble Length	n=57 11th , Preamble Length	-999 chips	
Preamble MAC Index	n=57 12th , Preamble MAC Index	-999	

Table 0-13 Results in the metrics window of Result Metrics view with Overall-1

Slot Num	n=1 32nd	00
Rho	n=58 7th , Rho	0.00000
EVM	n=58 1st , RMS EVM	-99.99 % rms
Peak EVM	n=58 2nd, Peak EVM	-99.99 % pk
Magnitude Error	n=58 3rd , RMS Magnitude Error	-99.99 % rms
Phase Error	n=58 4th , RMS Phase Error	-99.99 ° rms

Freq Error	n=58 6th , Frequency Error	-999.99 Hz
I/Q Origin Offset	n=58 5th , I/Q Origin Offset	-999.99 dB
Active Channels	n=58 8th , Pilot Active Channels n=58 9th , MAC Active Channels n=58 10th , Data Active Channels	P:00 M:00 D:00
Pilot Offset	n=58 11th , Pilot Offset	-99.99 us
Max MAC Inactive Ch	n=58 12th , Max Inactive Code Domain Power n=58 13th , Max Inactive Code Domain Power Channel Number	Subtype 0/1 -99.99 dB at W64(Y):Phase Y: Walsh code number (0 .. 63) Phase: I or Q
		Subtype 2, Subtype 3 -99.99 dB at W128(Y):Phase Y: Walsh code number (0 .. 127) Phase: I or Q
Max Data Active Ch	n=58 14th , Max Active Code Domain Power n=58 15th , Max Active Code Domain Power Channel Number	-99.99 dB at W16(Y):Phase Y: Walsh code number (0 .. 15) Phase: I or Q
Min Data Active Ch	n=58 16th , Min Active Code Domain Power n=58 17th , Min Active Code Domain Power Channel Number	-99.99 dB at W16(Y):Phase Y: Walsh code number (0 .. 15) Phase: I or Q
Preamble Length	n=58 18th , Preamble Length	-999 chips
Preamble MAC Index	n=58 19th , Preamble MAC Index	-999

Table 0-14 Results in the metrics window of Result Metrics view with Overall-2

Slot Num	n=1 32nd	00
Rho	n=58 7th , Rho	0.00000
EVM	n=58 1st , RMS EVM	-99.99 % rms
Peak EVM	n=58 2nd, Peak EVM	-99.99 % pk
Magnitude Error	n=58 3rd , RMS Magnitude Error	-99.99 % rms
Phase Error	n=58 4th , RMS Phase Error	-99.99 ° rms
Freq Error	n=58 6th , Frequency Error	-999.99 Hz
I/Q Origin Offset	n=58 5th , I/Q Origin Offset	-999.99 dB
Active Channels	n=58 8th , Pilot Active Channels	P:00 M:00 D:00

	n=58 9th , MAC Active Channels n=58 10th , Data Active Channels		
Pilot Offset	n=58 11th , Pilot Offset	-99.99 us	
Max MAC Inactive Ch	n=58 12th , Max Inactive Code Domain Power n=58 13th , Max Inactive Code Domain Power Channel Number	Subtype 0/1	-99.99 dB at W64(Y):Phase Y: Walsh code number (0 .. 63) Phase: I or Q
		Subtype 2, Subtype 3	-99.99 dB at W128(Y):Phase Y: Walsh code number (0 .. 127) Phase: I or Q
Max Data Active Ch	n=58 14th , Max Active Code Domain Power n=58 15th , Max Active Code Domain Power Channel Number	-99.99 dB at W16(Y):Phase Y: Walsh code number (0 .. 15) Phase: I or Q	
Min Data Active Ch	n=58 16h , Min Active Code Domain Power n=58 17th , Min Active Code Domain Power Channel Number	-99.99 dB at W16(Y):Phase Y: Walsh code number (0 .. 15) Phase: I or Q	
Preamble Length	n=58 18th , Preamble Length	-999 chips	
Preamble MAC Index	n=58 19th , Preamble MAC Index	-999	

### Channel Peak/Avg Metrics

Provides a table of average and peak hold results of selected channel.

Key Path	View/Display
<b>Example</b>	:DISP:RHO:VIEW CPAT :DISP:RHO:VIEW?
Initial S/W Revision	Prior to A.02.00

This is a view of result metrics table. All results displayed on this widow are calculated from interval of slots specified by Average Number. Displaying results are determined by Display Channel Type.

17 Forward Link Modulation Accuracy  
View/Display

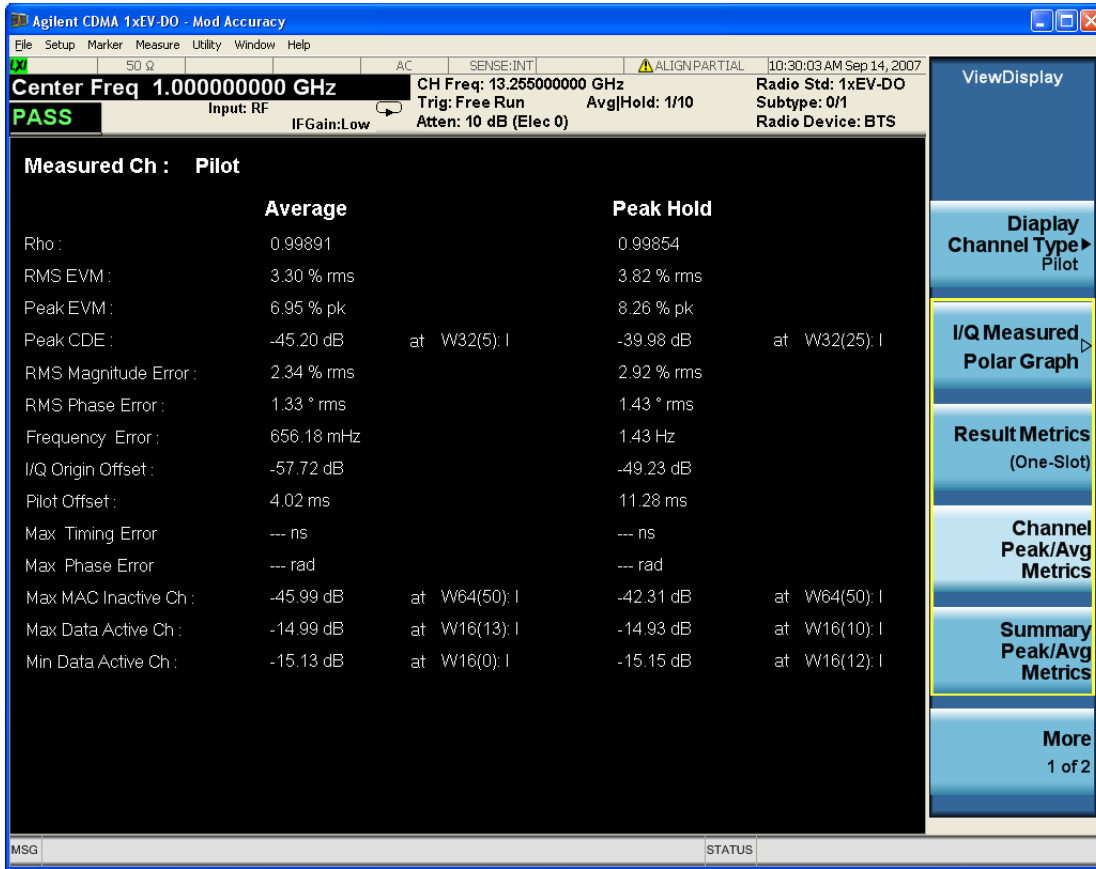

Figure 0-7 Channel Peak/Avg Metrics View

Table 0-35 Results in Channel Peak/Avg Metrics view with Pilot

Name	Corresponding Results	Display Format
Rho (Avg)	n=42 7th , Rho	0.00000
Rho (Peak Hold)	n=48 7th , Rho	0.00000
EVM (Avg)	n=42 1st , RMS EVM	-99.99 % rms
EVM (Peak Hold)	n=48 1st , RMS EVM	-99.99 % rms
Peak EVM (Avg)	n=42 2nd, Peak EVM	-99.99 % pk
Peak EVM (Peak Hold)	n=48 2nd, Peak EVM	-99.99 % pk
Pk CDE (Avg)	n=42 8th , Peak CDE n=42 9th	-99.99 dB at W32(Y):Phase Y: Walsh code number (0 .. 31) Phase: I or Q
Pk CDE (Peak Hold)	n=48 10th , Peak CDE n=48 11th	-99.99 dB at W32(Y):Phase Y: Walsh code number (0 .. 31)

		Phase: I or Q
Magnitude Error (Avg)	n=42 3rd , RMS Magnitude Error	-99.99 % rms
Magnitude Error (Peak Hold)	n=48 3rd , RMS Magnitude Error	-99.99 % rms
Phase Error (Avg)	n=42 4th , RMS Phase Error	-99.99 ° rms
Phase Error (Peak Hold)	n=48 4th , RMS Phase Error	-99.99 ° rms
Freq Error (Avg)	n=42 6th , Frequency Error	-999.99 Hz
Freq Error (Peak Hold)	n=48 6th , Frequency Error	-999.99 Hz
I/Q Origin Offset (Avg)	n=42 5th , I/Q Origin Offset	-999.99 dB
I/Q Origin Offset (Peak Hold)	n=48 5th , I/Q Origin Offset	-999.99 dB
Pilot Offset (Avg)	n=42 7th , Pilot Offset	-99.99 us
Pilot Offset (Peak Hold)	n=48 7th , Pilot Offset	-99.99 us

Table 0-46 Results in Channel Peak/Avg Metrics view with MAC

Rho (Avg)	n=43 7th , Rho	0.00000
Rho (Peak Hold)	n=49 7th , Rho	0.00000
EVM (Avg)	n=43 1st , RMS EVM	-99.99 % rms
EVM (Peak Hold)	n=49 1st , RMS EVM	-99.99 % rms
Peak EVM (Avg)	n=43 2nd, Peak EVM	-99.99 % pk
Peak EVM (Peak Hold)	n=49 2nd, Peak EVM	-99.99 % pk
Pk CDE (Avg)	n=43 8th , Peak CDE n=41 9th	Subtype 0/1 -99.99 dB at W64(Y):Phase Y: Walsh code number (0 .. 63) Phase: I or Q
		Subtype 2, -99.99 dB at W128(Y):Phase Y: Walsh code number (0 .. 127)
		Subtype 3 -99.99 dB at W128(Y):Phase Y: Walsh code number (0 .. 127)
Pk CDE (Peak Hold)	n=49 8th , Peak CDE n=49 9th	Subtype 0/1 -99.99 dB at W64(Y):Phase Y: Walsh code number (0 .. 63) Phase: I or Q
		Subtype 2, -99.99 dB at W128(Y):Phase Y: Walsh code number (0 .. 127)
		Subtype 3 -99.99 dB at W128(Y):Phase Y: Walsh code number (0 .. 127)

Magnitude Error (Avg)	n=43 3rd , RMS Magnitude Error		-99.99 % rms
Magnitude Error (Peak Hold)	n=49 3rd , RMS Magnitude Error		-99.99 % rms
Phase Error (Avg)	n=43 4th , RMS Phase Error		-99.99 ° rms
Phase Error (Peak Hold)	n=49 4th , RMS Phase Error		-99.99 ° rms
Freq Error (Avg)	n=43 6th , Frequency Error		-999.99 Hz
Freq Error (Peak Hold)	n=49 6th , Frequency Error		-999.99 Hz
I/Q Origin Offset (Avg)	n=43 5th , I/Q Origin Offset		-999.99 dB
I/Q Origin Offset (Peak Hold)	n=49 5th , I/Q Origin Offset		-999.99 dB
Max Timing Error (Avg)	n=43 12th , Max Timing Error		-99.99 us
Max Timing Error (Peak Hold)	n=49 12th , Max Timing Error		-99.99 us
Max Phase Error (Avg)	n=43 13th , Max Phase Error		-99.99 deg
Max Phase Error (Peak Hold)	n=49 13th , Max Phase Error		-99.99 deg
Max MAC Inactive Ch (Avg)	n=43 10th , Max Inactive Code Domain Power n=43 11th , Max Inactive Code Domain Power Channel Number	Subtype 0/1	-99.99 dB at W64(Y):Phase Y: Walsh code number (0 .. 63) Phase: I or Q
		Subtype 2, Subtype 3	-99.99 dB at W128(Y):Phase Y: Walsh code number (0 .. 127) Phase: I or Q
Max MAC Inactive Ch (Peak Hold)	n=43 10th , Max Inactive Code Domain Power n=43 11th , Max Inactive Code Domain Power Channel Number	Subtype 0/1	-99.99 dB at W64(Y):Phase Y: Walsh code number (0 .. 63) Phase: I or Q
		Subtype 2, Subtype 3	-99.99 dB at W128(Y):Phase Y: Walsh code number (0 .. 127) Phase: I or Q

Table 0-57 Results in Channel Peak/Avg Metrics view with Data

Name	Corresponding Results	Display Format
------	-----------------------	----------------

Rho (Avg)	n=44 7th , Rho	0.00000
Rho (Peak)	n=50 7th , Rho	0.00000
EVM (Avg)	n=44 1st , RMS EVM	-99.99 % rms
EVM (Peak)	n=50 1st , RMS EVM	-99.99 % rms
Peak EVM (Avg)	n=44 2nd, Peak EVM	-99.99 % pk
Peak EVM (Peak)	n=50 2nd, Peak EVM	-99.99 % pk
Pk CDE (Avg)	n=44 8th , Peak CDE n=50 9th	-99.99 dB at W16(Y):Phase Y: Walsh code number (0 .. 15) Phase: I or Q
Pk CDE (Peak)	n=44 8th , Peak CDE n=50 9th	-99.99 dB at W16(Y):Phase Y: Walsh code number (0 .. 15) Phase: I or Q
Magnitude Error (Avg)	n=44 3rd , RMS Magnitude Error	-99.99 % rms
Magnitude Error (Peak)	n=50 3rd , RMS Magnitude Error	-99.99 % rms
Phase Error (Avg)	n=44 4th , RMS Phase Error	-99.99 ° rms
Phase Error (Peak)	n=50 4th , RMS Phase Error	-99.99 ° rms
Freq Error (Avg)	n=44 6th , Frequency Error	-999.99 Hz
Freq Error (Peak)	n=50 6th , Frequency Error	-999.99 Hz
I/Q Origin Offset (Avg)	n=44 5th , I/Q Origin Offset	-999.99 dB
I/Q Origin Offset (Peak)	n=50 5th , I/Q Origin Offset	-999.99 dB
Max Timing Error (Avg)	n=44 14th , Max Timing Error	-99.99 us
Max Timing Error (Peak Hold)	n=50 14th , Max Timing Error	-99.99 us
Max Phase Error (Avg)	n=44 15th , Max Phase Error	-99.99 deg
Max Phase Error (Peak Hold)	n=50 15th , Max Phase Error	-99.99 deg
Max Data Active Ch (Avg)	n=44 10th , Max Active Code Domain Power n=44 11th , Max Active Code Domain Power Channel Number	-99.99 dB at W16(Y):Phase Y: Walsh code number (0 .. 15) Phase: I or Q
Max Data Active Ch (Peak)	n=50 10th , Max Active Code Domain Power n=50 11th , Max Active Code Domain Power Channel Number	-99.99 dB at W16(Y):Phase Y: Walsh code number (0 .. 15) Phase: I or Q

Min Data Active Ch (Avg)	n=44 12th , Max Active Code Domain Power n=44 13th , Max Active Code Domain Power Channel Number	-99.99 dB at W16(Y):Phase Y: Walsh code number (0 .. 15) Phase: I or Q
Min Data Active Ch (Peak)	n=50 12th , Max Active Code Domain Power n=50 13th , Max Active Code Domain Power Channel Number	-99.99 dB at W16(Y):Phase Y: Walsh code number (0 .. 15) Phase: I or Q

Table 0-68 Results in Channel Peak/Avg Metrics view with Preamble

Rho (Avg)	n=45 7th , Rho	0.00000	
Rho (Peak)	n=51 7th , Rho	0.00000	
EVM (Avg)	n=45 1st , RMS EVM	-99.99 % rms	
EVM (Peak)	n=51 1st , RMS EVM	-99.99 % rms	
Peak EVM (Avg)	n=45 2nd, Peak EVM	-99.99 % pk	
Peak EVM (Peak)	n=51 2nd, Peak EVM	-99.99 % pk	
Pk CDE (Avg)	n=45 8th , Peak CDE n=45 9th	Subtype 0/1	-99.99 dB at W32(Y):Phase Y: Walsh code number (0 .. 31) Phase: I or Q
		Subtype 2	-99.99 dB at W64(Y):Phase Y: Walsh code number (0 .. 63) Phase: I or Q
		Subtype 3	-99.99 dB at W128(Y):Phase Y: Walsh code number (0 .. 127) Phase: I or Q
Pk CDE (Peak)	n=51 8th , Peak CDE n=51 9th	Subtype 0/1	-99.99 dB at W32(Y):Phase Y: Walsh code number (0 .. 31) Phase: I or Q
		Subtype 2	-99.99 dB at W64(Y):Phase Y: Walsh code number (0 .. 63) Phase: I or Q



		Subtype 3	-99.99 dB at W128(Y):Phase Y: Walsh code number (0 .. 127) Phase: I or Q
Magnitude Error (Avg)	n=45 3rd , RMS Magnitude Error		-99.99 % rms
Magnitude Error (Peak)	n=51 3rd , RMS Magnitude Error		-99.99 % rms
Phase Error (Avg)	n=45 4th , RMS Phase Error		-99.99 ° rms
Phase Error (Peak)	n=51 4th , RMS Phase Error		-99.99 ° rms
Freq Error (Avg)	n=45 6th , Frequency Error		-999.99 Hz
Freq Error (Peak)	n=51 6th , Frequency Error		-999.99 Hz
I/Q Origin Offset (Avg)	n=45 5th , I/Q Origin Offset		-999.99 dB
I/Q Origin Offset (Peak)	n=51 5th , I/Q Origin Offset		-999.99 dB

Table 0-79 Results in Channel Peak/Avg Metrics view with Overall-1

Name	Corresponding Results	Display Format
Rho (Avg)	n=46 7th , Rho	0.00000
Rho (Peak)	n=52 7th , Rho	0.00000
EVM (Avg)	n=46 1st , RMS EVM	-99.99 % rms
EVM (Peak)	n=52 1st , RMS EVM	-99.99 % rms
Peak EVM (Avg)	n=46 2nd, Peak EVM	-99.99 % pk
Peak EVM (Peak)	n=52 2nd, Peak EVM	-99.99 % pk
Magnitude Error (Avg)	n=46 3rd , RMS Magnitude Error	-99.99 % rms
Magnitude Error (Peak)	n=52 3rd , RMS Magnitude Error	-99.99 % rms
Phase Error (Avg)	n=46 4th , RMS Phase Error	-99.99 ° rms
Phase Error (Peak)	n=52 4th , RMS Phase Error	-99.99 ° rms
Freq Error (Avg)	n=46 6th , Frequency Error	-999.99 Hz
Freq Error (Peak)	n=52 6th , Frequency Error	-999.99 Hz
I/Q Origin Offset (Avg)	n=46 5th , I/Q Origin Offset	-999.99 dB
I/Q Origin Offset (Peak)	n=52 5th , I/Q Origin Offset	-999.99 dB
Pilot Offset (Avg)	n=46 9th , Pilot Offset	-99.99 us
Pilot Offset (Peak)	n=52 9th , Pilot Offset	-99.99 us

Table 0-20 Results in Channel Peak/Avg Metrics view with Overall-2

Name	Corresponding Results	Display Format
Rho (Avg)	n=47 7th , Rho	0.00000

Rho (Peak)	n=53 7th , Rho	0.00000
EVM (Avg)	n=47 1st , RMS EVM	-99.99 % rms
EVM (Peak)	n=53 1st , RMS EVM	-99.99 % rms
Peak EVM (Avg)	n=47 2nd , Peak EVM	-99.99 % pk
Peak EVM (Peak)	n=53 2nd , Peak EVM	-99.99 % pk
Magnitude Error (Avg)	n=47 3rd , RMS Magnitude Error	-99.99 % rms
Magnitude Error (Peak)	n=53 3rd , RMS Magnitude Error	-99.99 % rms
Phase Error (Avg)	n=47 4th , RMS Phase Error	-99.99 ° rms
Phase Error (Peak)	n=53 4th , RMS Phase Error	-99.99 ° rms
Freq Error (Avg)	n=47 6th , Frequency Error	-999.99 Hz
Freq Error (Peak)	n=53 6th , Frequency Error	-999.99 Hz
I/Q Origin Offset (Avg)	n=47 5th , I/Q Origin Offset	-999.99 dB
I/Q Origin Offset (Peak)	n=53 5th , I/Q Origin Offset	-999.99 dB
Pilot Offset (Avg)	n=47 9th , Pilot Offset	-99.99 us
Pilot Offset (Peak)	n=53 9th , Pilot Offset	-99.99 us

### Summary Peak/Avg Metrics

Provides a summary table of average and peak hold of some important results of all channels.

Key Path	View/Display
<b>Example</b>	:DISP:RHO:VIEW SPAT :DISP:RHO:VIEW?
Initial S/W Revision	Prior to A.02.00

This view provides a summary table of average and peak hold of some important results of all channels.



Figure 0-8 Figure Summary Peak/Avg Metrics View

Table 0-21 Results in Summary Peak/Avg Metrics view

Rho Pilot (Avg)	n=40 1st , Rho	0.00000
Rho Pilot (Peak Hold)	n=41 1st , Rho	0.00000
Rho MAC (Avg)	n=40 2nd , Rho	0.00000
Rho MAC (Peak Hold)	n=41 2nd , Rho	0.00000
Rho Data (Avg)	n=40 3rd , Rho	0.00000
Rho Data (Peak Hold)	n=41 3rd , Rho	0.00000
Rho Overall-1 (Avg)	n=40 5th , Rho	0.00000
Rho Overall-1 (Peak Hold)	n=41 5th , Rho	0.00000
Rho Overall-2 (Avg)	n=40 6th , Rho	0.00000
Rho Overall-2 (Peak Hold)	n=41 6th , Rho	0.00000
Freq Error (Avg)	n=40 7th , Frequency Error.	0.00 Hz
Freq Error (Peak Hold)	n=41 7th , Frequency Error.	0.00 Hz
Pilot Offset (Avg)	n=40 8th , Pilot Offset	0.00 us
Pilot Offset (Peak Hold)	n=41 8th , Pilot Offset	0.00 us
Max MAC Inactive Ch (Avg)	n=40 9th , Max Inactive CDP	Subtype 0.00 dBc

	n=40 10th , Max Inactive CDP Channel Number	0/1	at W64(Y):Phase Y: Walsh code number (0 .. 63) Phase: I or Q
		Subtype 2	0.00 dBc
		Subtype 3	at W128(Y):Phase Y: Walsh code number (0 .. 127) Phase: I or Q
Max MAC Inactive Ch (Peak Hold)	n=41 9th , Max Inactive CDP n=41 10th , Max Inactive CDP Channel Number	Subtype 0/1	0.00 dBc at W64(Y):Phase Y: Walsh code number (0 .. 63) Phase: I or Q
		Subtype 2	0.00 dBc
		Subtype 3	at W128(Y):Phase Y: Walsh code number (0 .. 127) Phase: I or Q
Max Data Active Ch (Avg)	n=40 11th , Max Active CDP n=40 12th , Max Active CDP Channel Number		-99.99 dB at W16(Y):Phase Y: Walsh code number (0 .. 15) Phase: I or Q
Max Data Active Ch (Peak Hold)	n=41 11th , Max Active CDP n=41 12th , Max Active CDP Channel Number		-99.99 dB at W16(Y):Phase Y: Walsh code number (0 .. 15) Phase: I or Q
Min Data Active Ch (Avg)	n=40 13th , Max Active CDP n=40 14th , Max Active CDP Channel Number		-99.99 dB at W16(Y):Phase Y: Walsh code number (0 .. 15) Phase: I or Q
Min Data Active Ch (Peak Hold)	n=41 13th , Max Active CDP n=41 14th , Max Active CDP Channel Number		-99.99 dB at W16(Y):Phase Y: Walsh code number (0 .. 15) Phase: I or Q

### I/Q Error (Quad View)

Provides a combination view of a magnitude error, phase error, EVM graphs and one-slot result summary of selected channel.

Key Path	View/Display
Example	:DISP:RHO:VIEW ERR :DISP:RHO:VIEW?
Initial S/W Revision	Prior to A.02.00

There are four windows:

- Magnitude Error window (upper left)
- Phase Error window (upper right)
- EVM window (lower left)
- Metrics window (lower right)

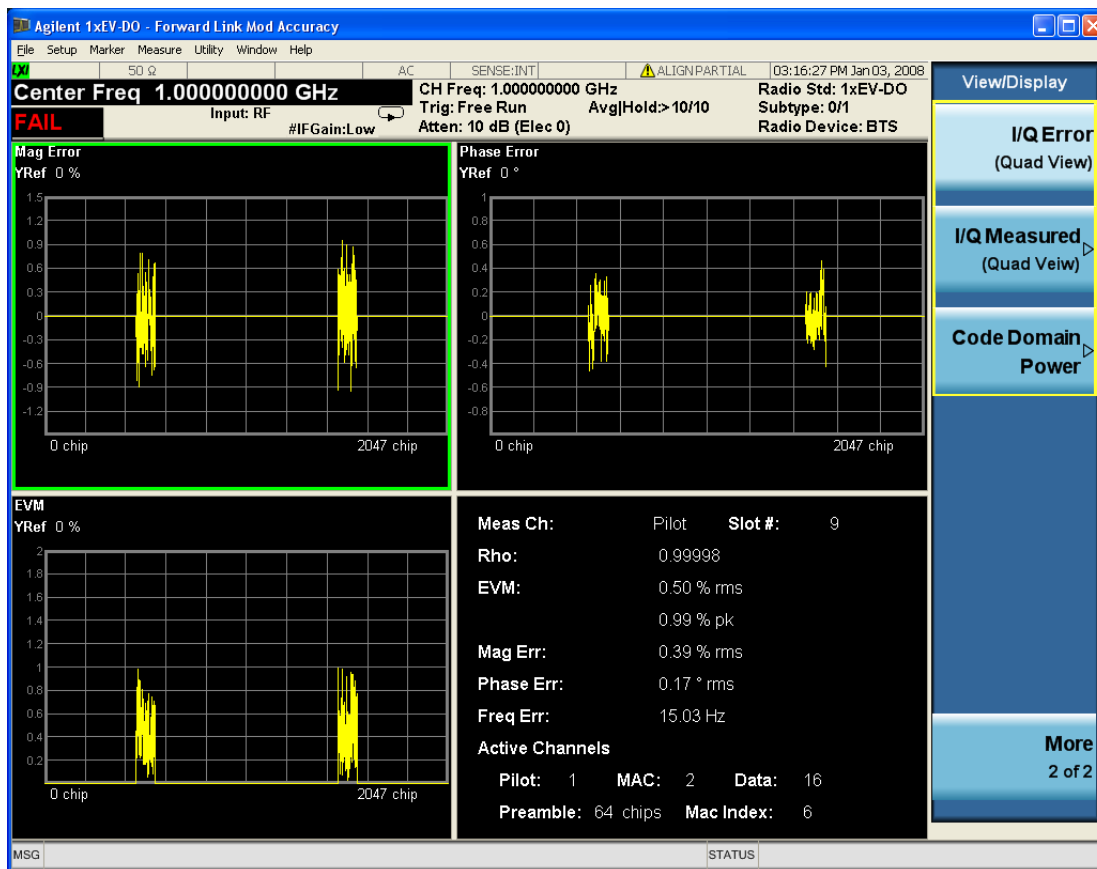

Figure 0-9 I/Q Error (Quad View) View

### Magnitude Error window

Marker Operation	Yes
Corresponding Trace	Magnitude error trace(n=3)

### Phase Error window

Marker Operation	Yes
Corresponding Trace	Phase error trace(n=4)

### EVM Window

Marker Operation	Yes
Corresponding Trace	EVM trace (n=2)

### Metrics Window

All results displayed on this window are calculated from interval of one slot specified by Meas Offset.

Table 0-22 Results in Metrics window of IQ Error view (Pilot)

Name	Corresponding Results	Display Format
Slot Num	n=1 32nd	00
Rho	n=54 7th , Rho	0.00000
EVM	n=54 1st , RMS EVM	0.00 % rms
Peak EVM	n=54 2nd , Peak EVM	0.00 % pk
Magnitude Error	n=54 3rd , RMS Magnitude Error	0.00 % rms
Phase Error	n=54 4th , RMS Phase Error	0.00 ° rms
Freq Error	n=54 6th , Frequency Error.	0.00 Hz
Active Channels	n=54 8th , Active Channels	P:0 M:- D:-

Table 0-23 Results in Metrics window of IQ Error view (MAC)

Name	Corresponding Results	Display Format
Slot Num	n=1 32nd	00
Rho	n=55 7th , Rho	0.00000
EVM	n=55 1st , RMS EVM	0.00 % rms
Peak EVM	n=55 2nd , Peak EVM	0.00 % pk
Magnitude Error	n=55 3rd , RMS Magnitude Error	0.00 % rms
Phase Error	n=55 4th , RMS Phase Error	0.00 ° rms
Freq Error	n=55 6th , Frequency Error.	0.00 Hz
Active Channels	n=55 8th , Active Channels	P:- M:0 D:-

Table 0-24 Results in Metrics window of IQ Error view (Data)

Name	Corresponding Results	Display Format
Slot Num	n=1 32nd	00
Rho	n=56 7th , Rho	0.00000
EVM	n=56 1st , RMS EVM	0.00 % rms
Peak EVM	n=56 2nd , Peak EVM	0.00 % pk
Magnitude Error	n=56 3rd , RMS Magnitude Error	0.00 % rms
Phase Error	n=56 4th , RMS Phase Error	0.00 ° rms
Freq Error	n=56 6th , Frequency Error.	0.00 Hz
Active Channels	n=56 8th , Active Channels	P:- M:- D:0

Table 0-25 Results in Metrics window of IQ Error view (Preamble)

Name	Corresponding Results	Display Format
Slot Num	n=1 32nd	00
Rho	n=57 7th , Rho	0.00000
EVM	n=57 1st , RMS EVM	0.00 % rms
Peak EVM	n=57 2nd , Peak EVM	0.00 % pk
Magnitude Error	n=57 3rd , RMS Magnitude Error	0.00 % rms
Phase Error	n=57 4th , RMS Phase Error	0.00 ° rms
Freq Error	n=57 6th , Frequency Error.	0.00 Hz
Preamble Length	n=57 11th , Preamble Length	0 chips
Preamble MAC Index	n=57 12th , Preamble MAC Index	0

Table 0-26 Results in Metrics window of IQ Error view (Overall-1)

Name	Corresponding Results	Display Format
Slot Num	n=1 32nd	00
Rho	n=58 7th , Rho	0.00000
EVM	n=58 1st , RMS EVM	0.00 % rms
Peak EVM	n=58 2nd , Peak EVM	0.00 % pk
Magnitude Error	n=58 3rd , RMS Magnitude Error	0.00 % rms
Phase Error	n=58 4th , RMS Phase Error	0.00 ° rms
Freq Error	n=58 6th , Frequency Error.	0.00 Hz
I/Q Origin Offset	n=58 5th , I/Q Origin Offset	0.00 dB
Active Channels	n=58 8th , Pilot Active Channels n=58 9th , MAC Active Channels	P:0 M:0 D:0

	n=58 10th , Data Active Channels	
Preamble Length	n=58 18th , Preamble Length	0 chips
Preamble MAC Index	n=58 19th , Preamble MAC Index	0

Table 0-87 Results in Metrics window of IQ Error view (Overall-2)

Name	Corresponding Results	Display Format
Slot Num	n=1 32nd	00
Rho	n=59 7th , Rho	0.00000
EVM	n=59 1st , RMS EVM	0.00 % rms
Peak EVM	n=59 2nd , Peak EVM	0.00 % pk
Magnitude Error	n=59 3rd , RMS Magnitude Error	0.00 % rms
Phase Error	n=59 4th , RMS Phase Error	0.00 ° rms
Freq Error	n=59 6th , Frequency Error.	0.00 Hz
Active Channels	n=59 8th , Pilot Active Channels n=59 9th , MAC Active Channels n=59 10th , Data Active Channels	P:0 M:0 D:0
Preamble Length	n=59 18th , Preamble Length	0 chips
Preamble MAC Index	n=59 19th , Preamble MAC Index	0

### I/Q Measured(Quad Veiw)

Provides a combination of IQ waveform plot, chip power graph and IQ measured polar vector graph.

Key Path	View/Display
<b>Example</b>	:DISP:RHO:VIEW QUAD :DISP:RHO:VIEW?
Initial S/W Revision	Prior to A.02.00

There are four windows:

- IQ Waveform (upper left)
- Chip Power vs Time (upper right)
- Measured IQ Polar Graph (lower left)
- Metrics window (lower right)



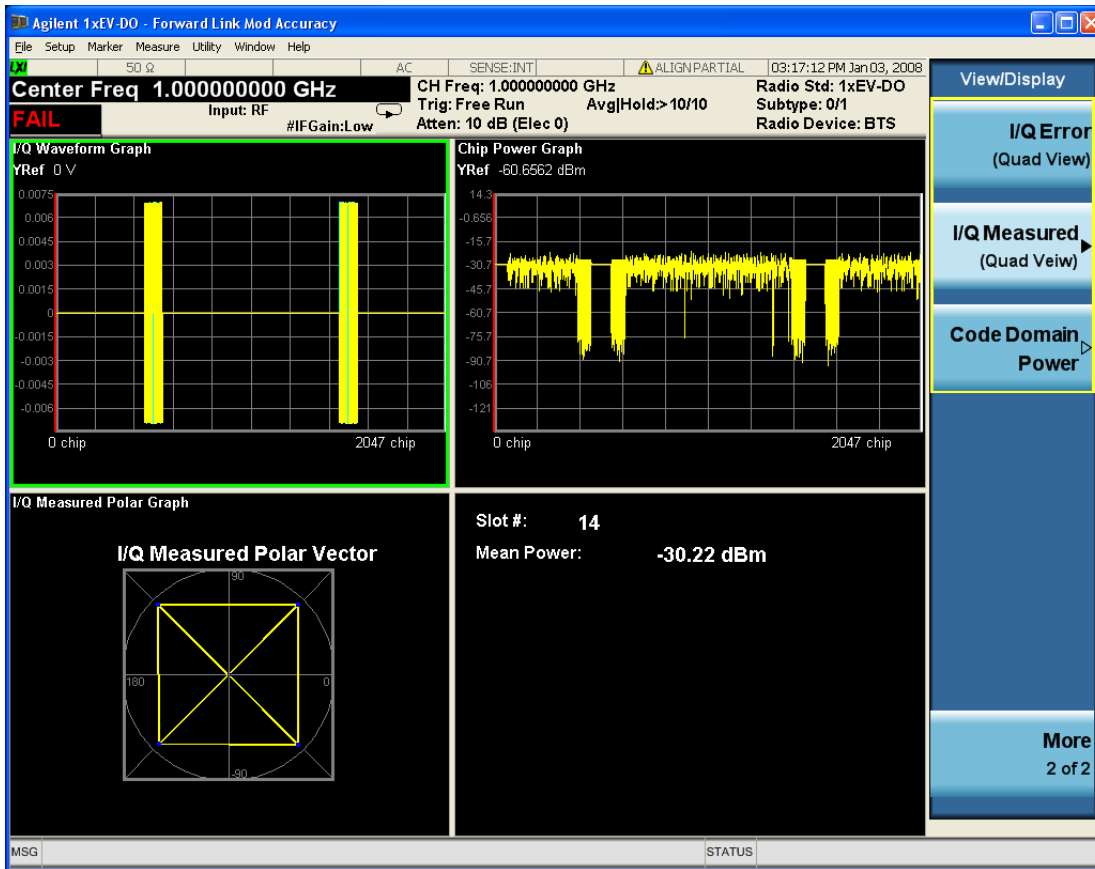

Figure 0-10 I/Q Measured(Quad View) View

### IQ Waveform window

IQ waveform graph is a plot of Corrected Measured IQ data.

Marker Operation	Yes
Corresponding Trace	Descrambled IQ trace(n=14)

### Chip Power window

Marker Operation	Yes
Corresponding Trace	Chip Power trace.

### Measured IQ Polar Graph Window

Marker Operation	Yes
Corresponding Trace	Corrected measured IQ trace(n=5)

## Numeric Results Window

Name	Corresponding Results	Display Format
Slot Num	n=1 32nd	00
Mean Power	null	0.00 dBm

## I/Q Polar Vector/Constellation

Sets IQ Polar graph display mode from Vector & Constellation, Vector and Constellation. This key appears when I/Q Polar Graph window is active.

VCONstIn – Vector & Constellation

VECTor – Vector

CONStIn – Constellation

Key Path	View/Display – I/Q Measured Polar Graph, I/Q Polar
Mode	1xEVDO
<b>Remote Command</b>	:DISPlay:RHO[:BTS]:IQPTtype VCONstIn VECTor CONStIn :DISPlay:RHO[:BTS]:IQPTtype?
<b>Example</b>	:DISP:RHO:IQPT VCON
Preset	VCONstIn
State Saved	Saved in instrument state.
Range	Vec & ConstIn   Vector   Constellation
Initial S/W Revision	Prior to A.02.00

## Chip Offset

Sets display trace length in IQ Polar Graph in chips.

Key Path	View/Display – I/Q Measured Polar Graph, Chip Offset
Mode	1xEVDO
<b>Remote Command</b>	:DISPlay:RHO[:BTS]:OFFSet <integer> :DISPlay:RHO[:BTS]:OFFSet?
<b>Example</b>	:DISPlay:RHO:OFFS 10
Notes	Maximum varies so that (Chip Offset + I/Q Chips) does not exceed 2048 chip.
Couplings	When (Chip Offset + I/Q Chips) exceeds 2048, Chip Offset is changed to keep it 2048.
Preset	0
State Saved	Saved in instrument state.
Range	0 to 2047

Min	0
Max	2047
Initial S/W Revision	Prior to A.02.00

## I/Q Chips

Sets display trace length in IQ Polar Graph in chips.

Key Path	View/Display – I/Q Measured Polar Graph, I/Q Chips
Mode	1xEVDO
<b>Remote Command</b>	:DISPlay:RHO[:BTS]:IQChips <integer> :DISPlay:RHO[:BTS]:IQChips?
<b>Example</b>	:DISPlay:RHO:IQCH 2000
Couplings	When (Chip Offset + I/Q Chips) exceeds 2048, Chip Offset is changed to keep it 2048.
Preset	2048
State Saved	Saved in instrument state.
Range	1 to 2048
Min	1
Max	2048
Initial S/W Revision	Prior to A.02.00

## +45° Rotation

Allows you to toggle the 45 Degree Rotation of the trace on IQ Polar Graph. When On, the trace plotted on IQ Polar Graph is rotated by +45 degree. This setting affects display of the trace but not trace returned from RUI.

Key Path	View/Display – I/Q Measured Polar Graph, +45 Rotation
Mode	1xEVDO
<b>Remote Command</b>	:DISPlay:RHO[:BTS]:ROTQpi[:STATe] 0 1 OFF ON :DISPlay:RHO[:BTS]:ROTQpi[:STATe]?
<b>Example</b>	:DISPlay:RHO:ROTQ ON
Preset	OFF
State Saved	Saved in instrument state.
Range	On   Off
Initial S/W Revision	Prior to A.02.00

## Full Vector(Background)

Allows you to toggle the Full Vector display. Full Vector is a trace plotted on IQ Polar graph using the same IQ data plotted on the graph. Full trace data is always drawn with gray line behind the normal plot which is drawn with yellow line and/or blue dots. Full Vector provides the user an intuitive sense of relative magnitude of plotted IQ measured data which is specified by I/Q Chips and Chip Offset.

Key Path	View/Display – I/Q Measured Polar Graph, Full Vector
Mode	1xEVDO
Remote Command	:DISPlay:RHO[:BTS]:FVEctor[:STATe] 0 1 OFF ON :DISPlay:RHO[:BTS]:FVEctor[:STATe]?
Example	:DISPlay:RHO:FVEC ON
Preset	OFF
State Saved	Saved in instrument state.
Range	On   Off
Initial S/W Revision	Prior to A.02.00

## Interpolation

This key specifies whether the input I/Q data should be interpolated.

Key Path	View/Display – I/Q Measured Polar Graph, Interpolation
Mode	1xEVDO
Remote Command	:DISPlay:RHO[:BTS]:INTErpolate OFF ON 0 1 :DISPlay:RHO[:BTS]:INTErpolate?
Example	:DISP:RHO:INT ON
Preset	OFF
State Saved	Saved in instrument state.
Range	On   Off
Initial S/W Revision	Prior to A.02.00

## Chip Descrambling

Allows you to toggle the chip descrambling between On and Off. When On, descrambled IQ measured trace is displayed.

Key Path	View/Display – I/Q Measured Polar Graph, Chip Descrambling
Mode	1xEVDO
Remote Command	:DISPlay:RHO[:BTS]:CDEScramble[:STATe] 0 1 OFF ON :DISPlay:RHO[:BTS]:CDEScramble[:STATe]?

<b>Example</b>	:DISPlay:RHO:CDES ON
Preset	OFF
State Saved	Saved in instrument state.
Range	On   Off
Initial S/W Revision	Prior to A.02.00

## Code Domain Power

Provides a combination view of the code domain power graph and the summary table of code domain channel.

Key Path	View/Display
<b>Example</b>	:DISP:RHO:VIEW CDP :DISP:RHO:VIEW?
Initial S/W Revision	Prior to A.02.00

There are two windows:

- Code Domain Power Graph window (upper)
- Metrics window (lower)

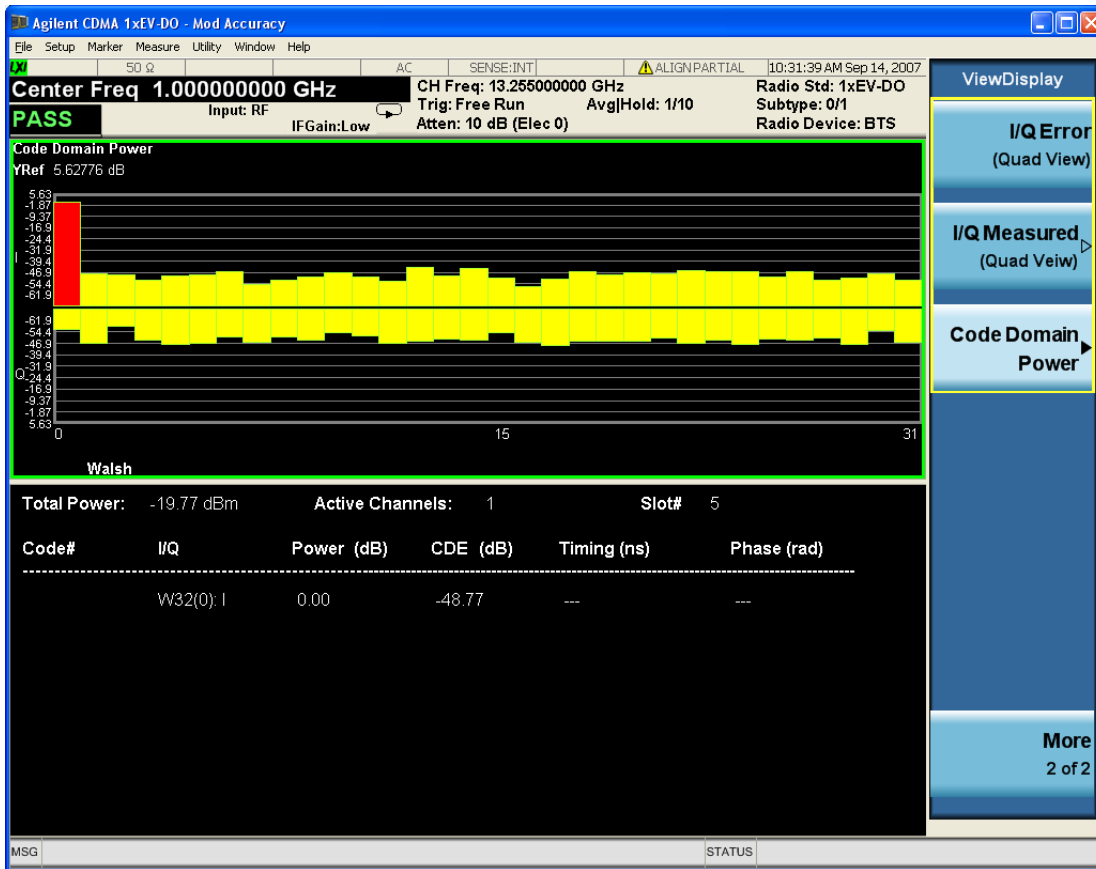

Figure 0-11 Code Domain Power View

### Code Domain Power Graph window

Marker Operation	Yes
Corresponding Trace	Code domain power trace n=20 when Display Channel Type is Pilot, n=26 when Display Channel Type is MAC n=32 when Display Channel Type is Data n=38 when Display Channel Type is Preamble

### Metrics window

Active channels and their CDP, CDE, phase and timing are listed in this view.

Marker Operation	No
Corresponding Trace	Active channel scalar results: n=21 when Display Channel Type is Pilot, n=27 when Display Channel Type is MAC n=33 when Display Channel Type is Data n=39 when Display Channel Type is Preamble

## Code Order

Sets the Walsh code order, Hadamard or Bit Reverse.

Key Path	View/Display, Code Domain Power, Code Order
Mode	1xEVDO
<b>Remote Command</b>	:CALCulate:RHO[:BTS]:WCODe:ORDer BREVerse HADamard :CALCulate:RHO[:BTS]:WCODe:ORDer?
<b>Example</b>	:CALC:RHO:WCOD:ORD BREV
Notes	This key appears when Code Domain Power window is active.
Preset	HADamard
State Saved	Saved in instrument state.
Range	Hadamard   Bit Reverse
<b>Backwards Compatibility SCPI</b>	:CALCulate:RHO:WCODe:ORDer
Initial S/W Revision	Prior to A.02.00

## I/Q Combined Power Bar

Allows you to toggle the I/Q combined power display function between On and Off. If set to On, the I and Q power bars are consolidated on the upper side of the horizontal axis. If set to Off, the I and Q power bars are shown on the upper side and the lower side of the horizontal axis, respectively.

Key Path	View/Display, Code Domain Power, I/Q Combined Power Bar
Mode	1xEVDO
<b>Remote Command</b>	:CALCulate:RHO[:BTS]:IQ:COMBined[:STATe] OFF ON 0 1 :CALCulate:RHO[:BTS]:IQ:COMBined[:STATe]?
<b>Example</b>	:CALC:RHO:IQ:COMB ON
Preset	OFF
State Saved	Saved in instrument state.
Range	On   Off
<b>Backwards Compatibility SCPI</b>	:CALCulate:RHO:IQ:COMBined[:STATe]
Initial S/W Revision	Prior to A.02.00





## 18 Reverse Link Modulation Accuracy

This key invokes the Reverse Link Modulation Accuracy measurement.

Key Path	Measure
Initial S/W Revision	Prior to A.02.00

## Amplitude (AMPTD) Y Scale

Access a menu of functions that enable you to set the desired vertical scale parameters for the current measurement. The Metrics, I/Q Symbol Polar Vector, and Demod Bits windows do not support the functions in this menu. A blank menu will be displayed

Key Path	Front Panel key
Initial S/W Revision	Prior to A.02.00

### Attenuation

This menu controls the attenuator functions and interactions between the attenuation system components.

There are two attenuator configurations in the X-Series. One is a dual attenuator configuration consisting of a mechanical attenuator and an optional electronic attenuator. The other configuration uses a single attenuator with combined mechanical and electronic sections that controls all the attenuation functions. Different models in the X-Series come with different configurations.

See "[Dual Attenuator Configurations:](#)" on page 2286

See "[Single Attenuator Configuration:](#)" on page 2287

Most Attenuation settings are the same for all measurements – they do not change as you change measurements. Settings like these are called “Meas Global” and are unaffected by Meas Preset.

Key Path	AMPTD Y Scale
Scope	Meas Global
Dependencies	In measurements that support the I/Q inputs, this key is unavailable when I/Q is the selected input, and is replaced by the Range key in that case.
Readback Line	Contains a summary in [ ] brackets of the current total attenuation. See the descriptions of the , " <a href="#">(Mech) Atten</a> " on page 2783, and " <a href="#">Enable Elec Atten</a> " on page 2785 keys for more detail on the contributors to the total attenuation.  Note that when "Pre-Adjust for Min Clip" is on, this value can change at the start of every measurement.
Initial S/W Revision	Prior to A.02.00
Modified at S/W Revision	A.03.00

### Dual Attenuator Configurations:

Configuration 1: Mechanical attenuator + optional electronic attenuator

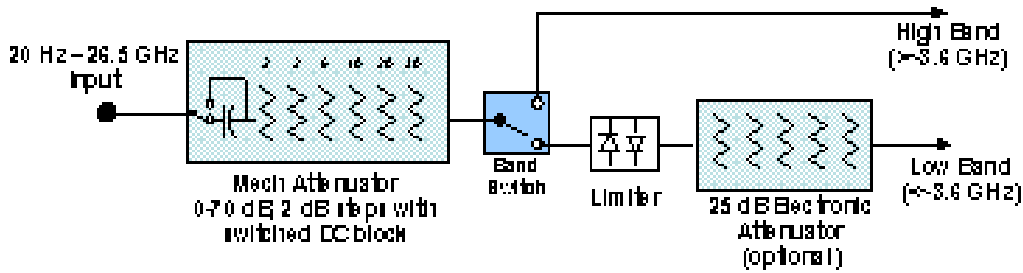

Configuration 2: Mechanical attenuator, no optional electronic attenuator

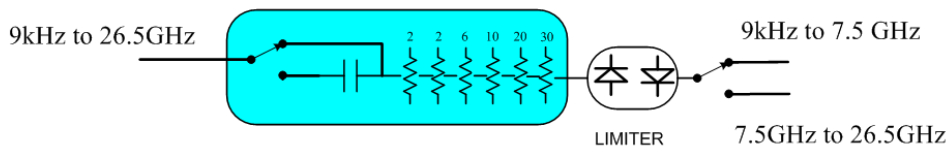

(note that Configuration 2 is not strictly speaking a dual-section attenuator, since there is no electronic section available. However, it behaves exactly like Configuration 1 without the Electronic Attenuator option EA3, therefore for the sake of this document it is grouped into the “Dual Attenuator” configuration)

**Single Attenuator Configuration:**

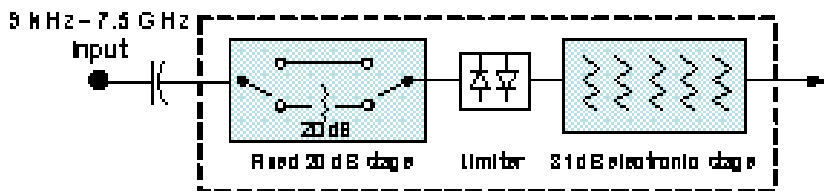

You can tell which attenuator configuration you have by pressing the Attenuation key, which (in most Modes) opens the Attenuation menu. If the first key in the Attenuation menu says Mech Atten you have the dual attenuator configuration. If the first key says Atten you have the single attenuator configuration.

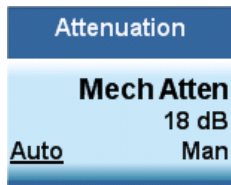

Dual Attenuator

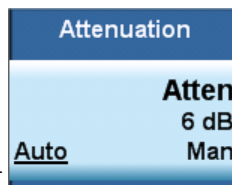

Single Attenuator

In the single attenuator configuration, you control the attenuation with a single control, as the fixed stage has only two states. In the dual attenuator configuration, both stages have significant range so you are given separate control of the mechanical and electronic attenuator stages.

When you have the dual attenuator configuration, you may still have only a single attenuator, because unless option EA3 (the Electronic Attenuator option) is available, and you purchase it, you will have only the mechanical attenuator.

## (Mech) Atten

This key is labeled Mech Atten in dual attenuator models and Atten in single attenuator models. In the dual attenuator configuration, this key only affects the mechanical attenuator.

This key lets you modify the attenuation applied to the RF input signal path. This value is normally auto coupled to the Ref Level, the Internal Preamp Gain, any External Gain that is entered, and the Max Mixer Level, as described in the table below.

See "[Attenuator Configurations and Auto/Man](#)" on page 2289

<b>Key Path</b>	AMPTD Y Scale, Attenuation
<b>Remote Command</b>	<pre>[ :SENSe] :POWer [:RF] :ATTenuation &lt;rel_ampl&gt; [ :SENSe] :POWer [:RF] :ATTenuation? [ :SENSe] :POWer [:RF] :ATTenuation:AUTO OFF ON 0 1 [ :SENSe] :POWer [:RF] :ATTenuation:AUTO?</pre>
<b>Example</b>	<p>POW:ATT 20</p> <p>Dual attenuator configuration: sets the mechanical attenuator to 20 dB</p> <p>Single attenuator mode: sets the main attenuation to 20 dB (see below for definition of “main” attenuation).</p> <p>If the attenuator was in Auto, it sets it to Manual.</p>
<b>Dependencies</b>	<p>Some measurements do not support the Auto setting of (Mech) Atten. In these measurements, the Auto/Man selection is not available, and the Auto/Man line on the key disappears.</p> <p>In dual attenuator configurations, when the electronic attenuator is enabled, the mechanical attenuator has no auto setting and the Auto/Man line on the key disappears. The state of Auto/Man is remembered and restored when the electronic attenuator is once again disabled. This is described in more detail in the "<a href="#">Enable Elec Atten</a>" on page 2785 key description.</p> <p>See "<a href="#">Attenuator Configurations and Auto/Man</a>" on page 2289 for more information on the Auto/Man functionality of Attenuation.</p>
<b>Couplings</b>	<p>When (Mech) Atten is in Auto, it uses the following algorithm to determine a value:</p> <p>If the USB Preamp is connected to USB, use 0 dB.</p> <p>Otherwise, <math>Atten = ReferenceLevel + PreAmpGain + ExternalGain - RefLevelOffset - MaxMixerLevel + IF\ Gain</math>.</p> <p>Limit this value to be between 6 dB and the Max value. No value below 6 dB can ever be chosen by Auto.</p> <p>The resulting value is rounded up to the largest value possible given the attenuation step setting. That is, 50.01 dB would change to 60 dB (for a 10 dB attenuation step).</p> <p>The “IF Gain” term in the equation above is either 0 dB or +10 dB, depending on the settings of FFT IF Gain, Swept IF Gain, max Ref Level and the Auto/Man setting of Mech Atten.</p> <p>In External Mixing and BBIQ, where the Attenuator is not in the signal path, the Attenuator setting changes as described above when (Mech) Atten is in Auto, but no changes are made to the actual attenuator hardware setting until the input is changed back to the RF Input.</p>
<b>Preset</b>	<p>The preset for Mech Attenuation is “Auto.”</p> <p>The Auto value of attenuation is:</p> <p>CXA, EXA, MXA and PXA: 10 dB</p>

State Saved	Saved in instrument state
Min	0 dB The attenuation set by this key cannot be decreased below 6 dB with the knob or step keys. To get to a value below 6 dB it has to be directly entered from the keypad or via SCPI. This protects from adjusting the attenuation to a dangerously small value which can put the instrument at risk of damage to input circuitry. However, if the current mechanical attenuation is below 6 dB it can be increased with the knob and step keys, but not decreased.
Max	CXA N9000A-503/507: 50 dB CXA N9000A-513/526: 70dB EXA: 60 dB MXA and PXA: 70 dB In the single attenuator configuration, the total of ATT and EATT cannot exceed 50 dB, so if the EATT is set to 24 dB first, the main attenuation cannot be greater than 26 dB and will be reduced accordingly; if the main attenuator is set to 40 dB first, EATT cannot be greater than 10 dB.
Initial S/W Revision	Prior to A.02.00
Modified at S/W Revision	A.03.00

### Attenuator Configurations and Auto/Man

As described in the Attenuation key description, there are two distinct attenuator configurations available in the X-Series, the single attenuator and dual attenuator configurations. In dual attenuator configurations, we have the mechanical attenuation and the electronic attenuation, and the current total attenuation is the sum of the electronic + mechanical attenuation. In single attenuator configurations, we refer to the attenuation set using the (Mech) Atten key (or POW:ATT SCPI) as the “main” attenuation; and the attenuation that is set by the SCPI command POW:EATT as the “soft” attenuation (the POW:EATT command is honored even in the single attenuator configuration, for compatibility purposes). Then the current total attenuation is the sum of the main + soft attenuation. See the Elec Atten key description for more on “soft” attenuation.

In the dual attenuator configuration, when the electronic attenuator is enabled, there is no Auto/Man functionality for the mechanical attenuator, and the third line of the key label (the Auto/Man line) disappears:

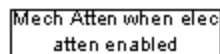
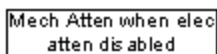
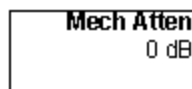
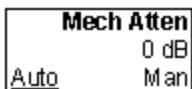

usdB

### Enable Elec Atten

Enables the Electronic Attenuator.

The electronic attenuator offers finer steps than the mechanical attenuator, has no acoustical noise, is faster, and is less subject to wear. These advantages primarily aid in remote operation and are negligible

for front panel use. See ["Using the Electronic Attenuator: Pros and Cons" on page 2291](#) for a detailed discussion of the pros and cons of using the electronic attenuator.

For the single attenuator configuration, for SCPI backwards compatibility, the “soft” attenuation feature replaces the dual attenuator configuration’s electronic attenuator. All the same couplings and limitations apply. See ["Attenuator Configurations and Auto/Man" on page 2785](#)

See ["More Information" on page 2290](#)

<b>Key Path</b>	AMPTD Y Scale, Attenuation
<b>Remote Command</b>	[ :SENSe ] :POWer [ :RF ] :EATTenuation:STATe OFF ON 0 1 [ :SENSe ] :POWer [ :RF ] :EATTenuation:STATe?
<b>Example</b>	POW:EATT:STAT ON
<b>Dependencies</b>	<p>This key only appears in Dual Attenuator models with an Electronic Attenuator installed. It does not appear in models with the Single Attenuator configuration, as in the single attenuator configuration there is no “electronic attenuator” there is only a single integrated attenuator (which has both a mechanical and electronic stage). However, in the single attenuator configuration, EATT SCPI commands are accepted for compatibility with other X-series instruments and set a “soft” attenuation as described in <a href="#">"Attenuator Configurations and Auto/Man" on page 2785</a>.</p> <p>The electronic attenuator (and the “soft” attenuation function provided in single attenuator configurations) is unavailable above 3.6 GHz. Therefore, if the Stop Frequency of the analyzer is &gt; 3.6 GHz then the Enable Elec Atten key will be OFF and grayed out.</p> <p>If the Internal Preamp is on, meaning it is set to Low Band or Full, the electronic attenuator (and the “soft” attenuation function provided in single attenuator configurations) is unavailable. In this case the Enable Elec Atten key will be OFF and grayed out.</p> <p>If either of the above is true, if the SCPI command is sent, an error indicating that the electronic attenuator is unavailable will be sent.</p> <p>If the electronic/soft Attenuator is enabled, then the Stop Freq of the analyzer is limited to 3.6 GHz and the Internal Preamp is unavailable.</p> <p>The SCPI-only “soft” electronic attenuation for the single-attenuator configuration is not available in all measurements; in particular, it is not available in the Swept SA measurement.</p>
<b>Couplings</b>	Enabling and disabling the Electronic Attenuator affects the setting of the Mechanical Attenuator (in dual attenuator configurations). This is described in more detail below this table.
<b>Preset</b>	OFF for Swept SA measurement; ON for all other measurements that support the electronic attenuator
<b>State Saved</b>	Saved in instrument state
<b>Initial S/W Revision</b>	Prior to A.02.00
<b>Modified at S/W Revision</b>	A.03.00

## More Information

### Mechanical Attenuator Transition Rules

When the Electronic Attenuator is enabled, the Mechanical Attenuator transitions to a state that has no Auto function. Below are the rules for transitioning the Mechanical Attenuator. NOTE that the information

below ONLY applies to the dual attenuator configurations, and ONLY when the Electronic Attenuator is installed:

**When the Electronic Attenuation is enabled from a disabled state:**

- The Mechanical Attenuator is initialized to 10 dB (this is its optimal performance setting). You can then set it as desired with SCPI, numeric keypad, step keys, or knob, and it behaves as it normally would in manual mode
- The Auto/Man state of (Mech) Atten is saved
- The Auto/Man line on the (Mech) Atten key disappears and the auto rules are disabled
- The Electronic Attenuator is set to 10 dB less than the previous value of the Mechanical Attenuator, within the limitation that it must stay within the range of 0 to 24 dB of attenuation.

**Examples in the dual attenuator configuration:**

- Mech Atten at 20 dB. Elec Atten enabled, Mech Atten set to 10 dB, and Elec Atten set to 10 dB. New total attenuation equals the value before Elec Atten enabled.
- Mech Atten at 0 dB. Elec Atten enabled, Mech Atten set to 10 dB, and Elec Atten set to 0 dB. New total attenuation does not equal the value before Elec Atten enabled.
- Mech Atten at 40 dB. Elec Atten enabled, Mech Atten set to 10 dB, and Elec Atten set to 24 dB. New total attenuation does not equal the value before Elec Atten enabled.

**When the Electronic Attenuation is disabled from an enabled state:**

- The Elec Atten key is grayed out
- The Auto/Man state of (Mech) Atten is restored
- If now in Auto, (Mech) Atten recouples
- If now in Man, (Mech) Atten is set to the value of total attenuation that existed before the Elec Atten was disabled. The resulting value is rounded up to the smallest value possible given the (Mech) Atten Step setting - (That is, 57 dB changes to 58 dB when (Mech) Atten Step is 2 dB.)

**Using the Electronic Attenuator: Pros and Cons**

The electronic attenuator offers finer steps than the mechanical attenuator, has no acoustical noise, is faster, and is less subject to wear.

The “finer steps” advantage of the electronic attenuator is beneficial in optimizing the alignment of the analyzer dynamic range to the signal power in the front panel as well as remote use. Thus, you can achieve improved relative signal measurement accuracy. Compared to a mechanical attenuator with 2 dB steps, the 1 dB resolution of the electronic attenuator only gives better resolution when the odd-decibel steps are used. Those odd-decibel steps are less accurately calibrated than the even-decibel steps, so one tradeoff for this superior relative accuracy is reduced absolute amplitude accuracy.

Another disadvantage of the electronic attenuator is that the spectrum analyzer loses its “Auto” setting, making operation less convenient.

Also, the relationship between the dynamic range specifications (TOI, SHI, compression and noise) and instrument performance are less well-known with the electrical attenuator. With the mechanical

attenuator, TOI, SHI and compression threshold levels increase dB-for-dB with increasing attenuation, and the noise floor does as well. With the electronic attenuator, there is an excess attenuation of about 1 to 3 dB between 0 and 3.6 GHz, making the effective TOI, SHI, and so forth, less well known. Excess attenuation is the actual attenuation relative to stated attenuation. Excess attenuation is accounted for in the analyzer calibration

## Elec Atten

Controls the Electronic Attenuator in dual attenuator configurations. This key does not appear in single attenuator configurations, as the control of both the mechanical and electronic stages of the single attenuator is integrated into the single Atten key.

Key Path	AMPTD Y Scale, Attenuation
Remote Command	[ :SENSe ] :POWer [ :RF ] :EATTenuation <rel_ampl> [ :SENSe ] :POWer [ :RF ] :EATTenuation?
Notes	Electronic Attenuation's specification is defined only when Mechanical Attenuation is 6 dB.
Dependencies	This key only appears in Dual Attenuator models with an Electronic Attenuator installed. It does not appear in models with the Single Attenuator configuration, as in the single attenuator configuration there is no "electronic attenuator" there is only a single integrated attenuator (which has both a mechanical and electronic stage). However, in the single attenuator configuration, EATT SCPI commands are accepted for compatibility with other X-series instruments and set a "soft" attenuation as described in <a href="#">"Attenuator Configurations and Auto/Man" on page 2785</a> . The "soft" attenuation is treated as an addition to the "main" attenuation value set by the Atten softkey or the POW:ATT SCPI command and affects the total attenuation displayed on the Attenuation key and the Meas Bar.  When Enable Elec Atten is off or grayed out, the Elec Atten key is grayed out.
Preset	0 dB
State Saved	Saved in instrument state
Min	0 dB
Max	Dual attenuator configuration: 24 dB Single attenuator configuration: the total of ATT and EATT cannot exceed 50 dB, so if the EATT is set to 24 dB first, the main attenuation cannot be greater than 26 dB and will be reduced accordingly; if the main attenuator is set to 40 dB first, EATT cannot be greater than 10 dB
Initial S/W Revision	Prior to A.02.00
Modified at S/W Revision	A.03.00

## Adjust Atten for Min Clip

Sets the combination of mechanical and electronic attenuation and gain based on the current measured signal level so that clipping will be at a minimum.

This is an "immediate action" function, that is, it executes once, when the key is pressed.

This key is grayed out in measurements that do not support this functionality. The spectrum analyzer measurement, Swept SA, does not support this functionality.



Key Path	AMPTD Y Scale, Attenuation
Remote Command	[ :SENSe ] :POWer [ :RF ] :RANGe:OPTimize IMMEDIATE
Initial S/W Revision	Prior to A.02.00
Modified at S/W Revision	A.03.00

## Pre-Adjust for Min Clip

If this function is on, it does the adjustment described under "[Adjust Atten for Min Clip](#)" on page 2788 each time a measurement restarts. Therefore, in Continuous measurement mode, it only executes before the first measurement.

In dual attenuator models, you can set Elec+Mech Atten, in which case both attenuators participate in the autoranging, or Elec Atten Only, in which case the mechanical attenuator does not participate in the autoranging. This latter case results in less wear on the mechanical attenuator and is usually faster.

This key is grayed out in measurements that do not support this functionality. The spectrum analyzer measurement, Swept SA, does not support this functionality.

Key Path	AMPTD Y Scale, Attenuation
Remote Command	[ :SENSe ] :POWer [ :RF ] :RANGe:OPTimize:ATTenuation OFF   ELECTrical   COMBined  [ :SENSe ] :POWer [ :RF ] :RANGe:OPTimize:ATTenuation?
Notes	The SCPI parameter ELECTrical sets this function to On in single attenuator models. The SCPI parameter COMBined is mapped to ELECTrical in single attenuator models; if you send COMBined, it sets the function to On and returns ELEC to a query.
Dependencies	This key only appears in Dual Attenuator models with an Electronic Attenuator installed. In instruments with Dual Attenuator model, when Enable Elec Atten is off or grayed out, the Pre-Adjust for Min Clip key is grayed out.
Preset	OFF for Swept SA measurement; ON for all other measurements that support Pre-Adjust for Min Clip
State Saved	Saved in instrument state
Range	Dual attenuator models: Off   Elec Atten Only   Mech + Elec Atten Single attenuator models: Off   On
Initial S/W Revision	Prior to A.02.00
Modified at S/W Revision	A.03.00

Remote Command	[ :SENSe ] :POWer [ :RF ] :RANGe:AUTO ON OFF 1 0  [ :SENSe ] :POWer [ :RF ] :RANGe:AUTO?
Notes	ON aliases to "Elec Atten Only" (:POW:RANG:OPT:ATT ELEC)

---

	OFF aliases to "Off" (:POW:RANG:OPT:ATT OFF) The query :POW:RANG:AUTO? returns true if :POW:RANG:OPT:ATT is not "Off"
Initial S/W Revision	Prior to A.02.00

---

## Off

Turns Pre-Adjust for Min Clip off. This is the default setting.

This key is grayed out in measurements that do not support this functionality. The spectrum analyzer measurement, Swept SA, does not support this functionality.

---

Key Path	AMPTD Y Scale, Attenuation, Pre-Adjust for Min Clip
Example	:POW:RANGe:OPT:ATT OFF
Initial S/W Revision	Prior to A.02.00

---

## Elec Atten Only

Selects only the electric attenuator to participate in auto ranging. This offers less wear on the mechanical attenuator and is usually faster.

This key is grayed out in measurements that do not support this functionality. The spectrum analyzer measurement, Swept SA, does not support this functionality.

---

Key Path	AMPTD Y Scale, Attenuation, Pre-Adjust for Min Clip
Example	:POW:RANGe:OPT:ATT ELEC
Initial S/W Revision	Prior to A.02.00

---

## Mech + Elec Atten

In dual attenuator models, this selects both attenuators participate in the autoranging.

This key is grayed out in measurements that do not support this functionality. The spectrum analyzer measurement, Swept SA, does not support this functionality.

---

Key Path	AMPTD Y Scale, Attenuation, Pre-Adjust for Min Clip
Example	:POW:RANGe:OPT:ATT COMB
Initial S/W Revision	Prior to A.02.00

---

## (Mech) Atten Step

This controls the step size used when making adjustments to the input attenuation.

This key is labeled Mech Atten Step in dual attenuator models and Atten Step in single attenuator models. In the dual attenuator configuration, this key only affects the step size of the mechanical attenuator.

Key Path	AMPTD Y Scale, Attenuation
Remote Command	<code>[ :SENSe ] :POWer [ :RF ] :ATTenuation:STEP [ :INCRement ] 10 dB   2 dB</code> <code>[ :SENSe ] :POWer [ :RF ] :ATTenuation:STEP [ :INCRement ] ?</code>
Example	POW:ATT:STEP 2
Notes	Note this feature works like a 1-N choice from the front panel, but it takes a specific value (in dB) when used remotely. The only valid values are 2 and 10.
Dependencies	Blanked in CXA and EXA if option FSA (2 dB steps) is not present. If blanked, attempts to set it via SCPI will yield an error.
Couplings	When the attenuation step size changes, the current mechanical attenuation value is adjusted (if necessary) to be quantized to the new step size. That is, if step is set to 10 dB, mech atten is increased if necessary so it is a multiple of 10 dB
Preset	PXA and MXA: 2 dB EXA and CXA: 10 dB (2 dB with option FSA)
State Saved	Saved in instrument state
Initial S/W Revision	Prior to A.02.00
Modified at S/W Revision	A.03.00

## IF Gain

Enables you to control an internally switched IF amplifier with approximately 10 dB of gain. When it can be turned on without an overload, the dynamic range is always better with the amplifier on than off. The IF Gain key can be used to set the IF Gain function to Auto, or to On (the extra 10 dB) or Off. These settings affect sensitivity and IF overloads.

Key Path	Meas Setup, Advanced
Initial S/W Revision	Prior to A.02.00

## Presel Adjust

This soft key is disabled in this measurement.

Key Path	AMPTD Y Scale
Initial S/W Revision	Prior to A.02.00

## $\mu$ W Path Control

The  $\mu$ W Path Control functions include the  $\mu$ W Preselector Bypass (Option MPB) and Low Noise Path (Option LNP) controls in the High Band path circuits.

When the  $\mu$ W Preselector is bypassed, the user has better flatness, but will be subject to spurs from out of band interfering signals. When the Low Noise Path is enabled, the analyzer automatically switches around certain circuitry in the high frequency bands which can contribute to noise, when it is appropriate based on other analyzer settings.

For most applications, the preset state is Standard Path, which gives the best remote-control throughput, minimizes acoustic noise from switching and minimizes the risk of wear out in the hardware switches. For applications that utilize the wideband IF paths, the preset state is the  $\mu$ W Preselector Bypass path, if option MPB is present. This is because, when using a wideband IF such as the 140 MHz IF, the  $\mu$ W Preselector's bandwidth can be narrower than the available IF bandwidth, causing degraded amplitude flatness and phase linearity, so it is desirable to bypass the preselector in the default case.

Users may choose Low Noise Path Enable. It gives a lower noise floor, especially in the 21–26.5 GHz region, though without improving many measures of dynamic range, and without giving the best possible noise floor. The preamp, if purchased and used, gives better noise floor than does the Low Noise Path, however its compression threshold and third-order intercept are much poorer than that of the non-preamp Low Noise Path. There are some applications, typically for signals around –30 dBm, for which the third-order dynamic range of the standard path is good enough, but the noise floor is not low enough even with 0 dB input attenuation. When the third-order dynamic range of the preamp path is too little and the noise floor of the standard path is too high, the Low Noise Path can provide the best dynamic range.

<b>Key Path</b>	AMPTD Y Scale
<b>Mode</b>	SA, BASIC, PNOISE, VSA , LTE, LTETDD
<b>Scope</b>	Meas Global
<b>Remote Command</b>	[ :SENSe ] :POWer [ :RF ] :MW:PATH STD LNPath MPBypass FULL [ :SENSe ] :POWer [ :RF ] :MW:PATH?
<b>Example</b>	:POW:MW:PATH LNP Enables the Low Noise path
<b>Notes</b>	If a Presel Center is performed, the analyzer will momentarily switch to the Standard Path, regardless of the setting of $\mu$ W Path Control  The DC Block will always be switched in when the low noise path is switched in, to protect succeeding circuitry from DC. Note that this does not mean “when the low noise path is enabled” but when, based on the Low Noise Path rules, the path is actually switched in. This can happen when the selection is Low Noise Path Enable . In the case where the DC Block is switched in the analyzer is now AC coupled. However, if the user has selected DC coupling, the UI will still behave as though it were DC coupled, including all annunciation, warnings, status bits, and responses to SCPI queries. This is because, based on other settings, the analyzer could switch out the low noise path at any time and hence go back to being DC coupled.  Alignment switching ignores the settings in this menu, and restores them when finished.
<b>Dependencies</b>	Unavailable in BBIQ and External Mixing
<b>Preset</b>	All modes other than IQ Analyzer mode and VXA: STD IQ Analyzer, VXA and WLAN mode: MPB option present and licensed: MPB MPB option not present and licensed: STD
<b>State Saved</b>	Save in instrument state
<b>Readback</b>	Value selected in the submenu
<b>Initial S/W Revision</b>	A.04.00
<b>Modified at S/W Revision</b>	A.10.00

## Standard Path

This path gives the best remote-control throughput, minimizes acoustic noise from switching and minimizes the risk of wear in the hardware switches, particularly in remote test scenarios where both low band and high band setups will follow in rapid succession.

In this path, the bypass of the low band/high band switch and microwave preamp is never activated, which can cause some noise degradation but preserves the life of the bypass switch.

Key Path	AMPTD Y Scale, $\mu$ W Path Control
<b>Example</b>	:POW:MW:PATH STD
Readback Text	Standard Path
Initial S/W Revision	A.04.00

## Low Noise Path Enable

You may choose Low Noise Path Enable, which gives a lower noise floor under some circumstances, particularly when operating in the 21–26.5 GHz region. With the Low Noise Path enabled, the low band/high band switch and microwave preamp are bypassed whenever all of the following are true:

- The analyzer is not in the Low Band, meaning:
- the start frequency is above 3.5 GHz and
- the stop frequency is above 3.6 GHz.
- the internal preamp is not installed or (if installed) is set to Off or Low Band

Note that this means that, when any part of a sweep is done in Low Band, the Low Noise Path is not used, whether or not the Low Noise Path Enable is selected in the user interface. Also, if the preamp is turned on, the Low Noise Path is not used, whether or not the Low Noise Path Enable is selected in the user interface. The only time the Low Noise Path is used is when Low Noise Path Enable is selected, the sweep is completely in High Band (> 3.6 GHz) and no preamp is in use.

See "[More Information](#)" on page 2298

Key Path	AMPTD Y Scale, $\mu$ W Path Control
Measurement	Swept SA
<b>Example</b>	:POW:MW:PATH LNP
Notes	<p>For measurements that use IQ acquisition, the low noise path is used when the Center Frequency is in High Band (&gt; 3.6 GHz) and no preamp is in use.</p> <p>In other words, the rules above are modified to use only the center frequency to qualify which path to switch in.</p> <p>This is not the case for FFT's in the Swept SA measurement; they use the same rules as swept measurements.</p>
Dependencies	Key is blanked if current mode does not support it.

---

	Key is grayed out if mode supports it but current measurement does not support it. Unless Option LNP is present and licensed, key is blank and if SCPI command sent, error -241, "Hardware missing; Option not installed" is generated.
Readback Text	Low Noise Path Enable
Initial S/W Revision	A.04.00

---

## More Information

The user should understand that the Low Noise Path, while giving improved DANL, has the disadvantage of decreased TOI performance and decreased gain compression performance relative to the standard path.

The user should also understand that the bypass switch is a mechanical switch and has finite life, so if the Low Noise Path is enabled, it is possible to cause frequent cycling of this switch by frequently changing analyzer settings such that the above conditions hold true only some of the time. A user making tests of this nature should consider opting for the Standard Path, which will never throw the bypass switch, at the expense of some degraded noise performance.

The low noise path is useful for situations where the signal level is so low that the analyzer performance is dominated by noise even with 0 dB attenuation, but still high enough that the preamp option would have excessive third-order intermodulation or compression. The preamp, if purchased and used, gives better noise floor than does the "Low Noise Path." However, its compression threshold and third-order intercept are much poorer than that of the non-preamp path. There are some applications, typically for signals around -30 dBm, for which the third-order dynamic range of the standard path is good enough, but the noise floor is not low enough even with 0 dB input attenuation. When the third-order dynamic range of the preamp path is too little and the noise floor of the standard path is too high, the Low Noise Path can provide the best dynamic range

The graph below illustrates the concept. It shows, in red, the performance of an analyzer at different attenuation settings, both with the preamp on and off, in a measurement that is affected by both analyzer noise and analyzer TOI. The green shows the best available dynamic range, offset by 0.5 dB for clarity. The blue shows how the best available dynamic range improves for moderate signal levels with the low noise path switched in. In this illustration, the preamp improves the noise floor by 15 dB while degrading the third-order intercept by 30 dB, and the low noise path reduces loss by 8 dB. The attenuator step size is 2 dB.

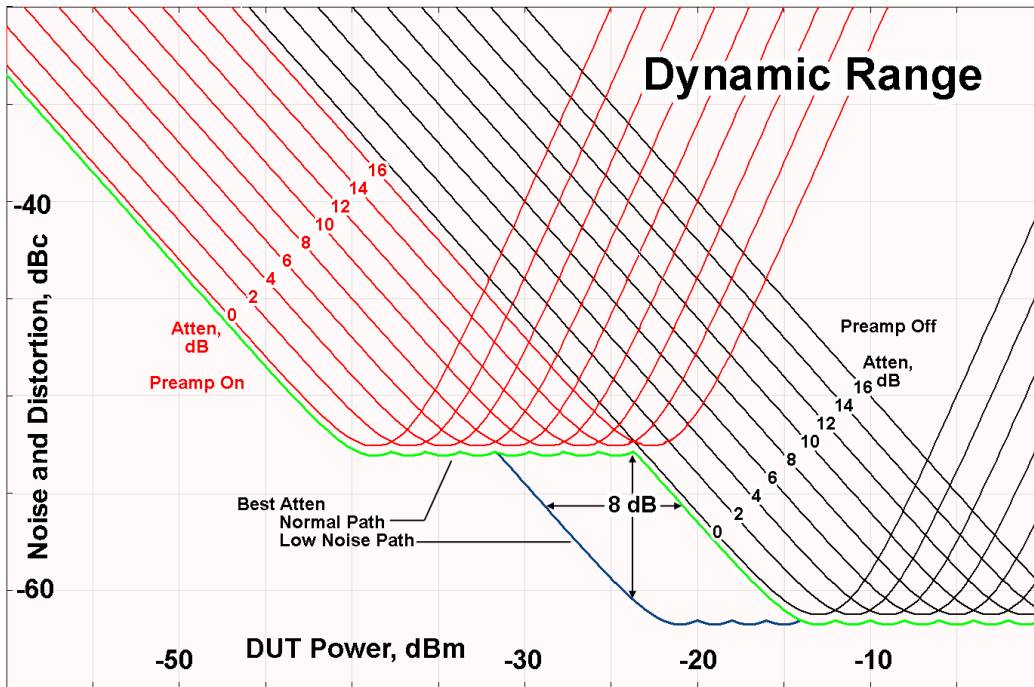

There are other times where selecting the low noise path improves performance, too. Compression-limited measurements such as finding the nulls in a pulsed-RF spectrum can profit from the low noise path in a way similar to the TOI-limited measurement illustrated. Accuracy can be improved when the low noise path allows the optimum attenuation to increase from a small amount like 0, 2 or 4 dB to a larger amount, giving better return loss at the analyzer input. Harmonic measurements, such as second and third harmonic levels, are much improved using the low noise path because of the superiority of that path for harmonic (though not intermodulation) distortion performance.

### μW Preselector Bypass

This key toggles the preselector bypass switch for band 1 and higher. When the microwave preselector is on, the signal path is preselected. When the microwave preselector is off, the signal path is not preselected. The preselected path is the normal path for the analyzer.

The preselector is a tunable bandpass filter which prevents signals away from the frequency of interest from combining in the mixer to generate in-band spurious signals (images). The consequences of using a preselector filter are its limited bandwidth, the amplitude and phase ripple in its passband, and any amplitude and phase instability due to center frequency drift.

Option MPB or pre-selector bypass provides an unpreselected input mixer path for certain X-Series signal analyzers with frequency ranges above 3.6 GHz. This signal path allows a wider bandwidth and less amplitude variability, which is an advantage when doing modulation analysis and broadband signal analysis. The disadvantage is that, without the preselector, image signals will be displayed. Another disadvantage of bypassing the preselector is increased LO emission levels at the front panel input port.

Image responses are separated from the real signal by twice the 1st IF. For IF Paths of 10 MHz and 25 MHz, the 1st IF is 322.5 MHz, so the image response and the real signal will be separated by 645 MHz. The 1st IF will be different for other IF Path settings. When viewing a real signal and its corresponding image response in internal mixing, the image response will be to the left of the real signal.

Also, the image response and the real signal typically have the same amplitude and exhibit the same shape factor.

However, if Option FS1, Fast Sweep Capability, is enabled, the image response in the Swept SA measurement will appear lower in amplitude and have a much wider shape factor compared to the real signal.

<b>Key Path</b>	AMPTD Y Scale, $\mu$ W Path Control
<b>Example</b>	:POW:MW:PATH MPB
<b>Dependencies</b>	Key is blanked if current mode does not support it. Key is grayed out if mode supports it but current measurement does not support it. Key is blank unless Option MPB is present and licensed. If SCPI command sent when MPB not present, error -241, "Hardware missing; Option not installed" is generated.
<b>Readback Text</b>	$\mu$ W Preselector Bypass
<b>Initial S/W Revision</b>	A.04.00

<b>Remote Command</b>	[ :SENSe ] :POWer [ :RF ] :MW:PRESelector [ :STATe ] ON   OFF   0   1 [ :SENSe ] :POWer [ :RF ] :MW:PRESelector [ :STATe ] ?
<b>Example</b>	:POW:MW:PRES OFF Bypasses the microwave preselector
<b>Notes</b>	The ON parameter sets the STD path (:POW:MW:PATH STD) The OFF parameter sets path MPB (:POW:MW:PATH MPB)
<b>Preset</b>	ON

## Internal Preamp

Accesses a menu of keys that control the internal preamps. Turning on the preamp gives a better noise figure, but a poorer TOI to noise floor dynamic range. You can optimize this setting for your particular measurement.

The instrument takes the preamp gain into account as it sweeps. If you sweep outside of the range of the preamp the instrument will also account for that. The displayed result will always reflect the correct gain.

For some measurements, when the preamp is on and any part of the displayed frequency range is below the lowest frequency for which the preamp has specifications, a warning condition message appears in the status line. For example, for a preamp with a 9 kHz lowest specified frequency: "Preamp: Accy unspec'd below 9 kHz".

<b>Key Path</b>	AMPTD Y Scale
<b>Scope</b>	Meas Global
<b>Remote Command</b>	[ :SENSe ] :POWer [ :RF ] :GAIN [ :STATe ] OFF   ON   0   1 [ :SENSe ] :POWer [ :RF ] :GAIN [ :STATe ] ?
<b>Dependencies</b>	Preamp is not available on all hardware platforms. If the preamp is not present or is unlicensed, the



key is not shown.  
The preamp is not available when the electronic/soft attenuator is enabled.

Couplings	<p>The act of connecting the U7227A USB Preamplifier to one of the analyzer's USB ports will cause the Internal Preamp to be switched on. When this happens an informational message will be generated: "Internal Preamp turned on for optimal operation with USB Preamp." Note that if the Internal Preamp was already on, there will be no change to the setting, but if it was Off it will be switched On, to Full Range.</p> <p>Note that this same action occurs when the SA mode is selected while the USB Preamp is connected to one of the analyzer's USB ports, if it is the first time that the SA mode has run since powerup, or if the last time the SA mode was running the USB Preamp was NOT connected.</p> <p>Subsequently disconnecting the USB Preamp from USB does not change the Internal Preamp setting nor restore the previous setting.</p>
Preset	OFF
State Saved	Saved in instrument state
Initial S/W Revision	Prior to A.02.00
Modified at S/W Revision	A.14.00

Key Path	AMPTD Y Scale, Internal Preamp
Scope	Meas Global
<b>Remote Command</b>	<pre>[ :SENSe ] :POWer [ :RF ] :GAIN :BAND LOW   FULL [ :SENSe ] :POWer [ :RF ] :GAIN :BAND ?</pre>
Dependencies	<p>Preamp is not available on all hardware platforms. If the preamp is not present or is unlicensed, the key is not shown.</p> <p>If a POW:GAIN:BAND FULL command is sent when a low band preamp is available, the preamp band parameter is to LOW instead of FULL, and an "Option not installed" message is generated.</p>
Preset	LOW
State Saved	Saved in instrument state
Initial S/W Revision	Prior to A.02.00

## Off

Turns the internal preamp off

Key Path	AMPTD Y Scale, Internal Preamp
<b>Example</b>	:POW:GAIN OFF
Readback	Off
Initial S/W Revision	Prior to A.02.00

## Low Band

Sets the internal preamp to use only the low band.

The frequency range of the installed (optional) low-band preamp is displayed in square brackets on the Low Band key label.

Key Path	AMPTD Y Scale, Internal Preamp
<b>Example</b>	:POW:GAIN ON :POW:GAIN:BAND LOW
Readback	Low Band
Initial S/W Revision	Prior to A.02.00

## Full Range

Sets the internal preamp to use its full range. The low band (0–3.6 GHz or 0–3GHz, depending on the model) is supplied by the low band preamp and the frequencies above low band are supplied by the high band preamp.

The frequency range of the installed (optional) preamp is displayed in square brackets on the Full Range key label. If the high band option is not installed the Full Range key does not appear.

Key Path	AMPTD Y Scale, Internal Preamp
<b>Example</b>	:POW:GAIN ON :POW:GAIN:BAND FULL
Readback	Full Range
Initial S/W Revision	Prior to A.02.00

## Range

This key is only available when I/Q is the selected input. It replaces the Attenuation key in that case.

Each input channel (I and Q) has four internal gain ranges. The maximum allowed voltage in each gain range is slightly more than the nominal value, so the break point between ranges is a couple of millivolts higher than the nominal (setting a peak voltage of 0.502 mV will still map to the 0.5 V Peak range).

Gain Setting	Volts RMS	Volts Peak	Volts Peak - Peak	dBm (50Ω)	Break Point
0 dB	0.7071	1.0	2.0	10	n/a
6 dB	0.3536	0.5	1.0	4	0.502 V Peak
12 dB	0.1768	0.25	0.5	-2	0.252 V Peak
18 dB	0.0884	0.125	0.25	-8	0.127 V Peak

Key Path	AMPTD Y Scale
Notes	Visible only when the selected input is I/Q.
State Saved	No
Readback Text	When Range is Auto, "[Auto]" When Range is Man and I & Q are the same, "[<range value>]" When Range is Man and I & Q are different: "[: <I range value> Q: <Q range value>]" See I Range and Q Range for the <range value> enumeration definition.
Initial S/W Revision	Prior to A.02.00

## Range Auto/Man

The Auto setting for Range causes the range to be set based on the Y Scale settings. When Range is "Auto", the I & Q Range are set based on the top of the Y Scale when the Y scale is in dB units (for example, power), or to the max(abs(top), abs(bottom)) when the Y scale reference is not at the top of the screen.

Not all measurements support Range Auto/Man. If Auto is not supported in the current measurement, this key is grayed out and shows "Man" and MAN is returned to a SCPI query, but this does NOT change the Auto/Man setting for Range. When you go to a measurement that supports Auto, it goes back to Auto if it was previously in Auto mode.

Key Path	AMPTD Y Scale, Range
Scope	Meas Global
<b>Remote Command</b>	<code>[:SENSe]:VOLTage:IQ:RANGe:AUTO OFF ON 0 1</code> <code>[:SENSe]:VOLTage:IQ:RANGe:AUTO?</code>
<b>Example</b>	Put the I Range and Q Range in manual. <code>VOLT:IQ:RANG:AUTO OFF</code>
Dependencies	If Auto is not supported, sending the SCPI command will generate an error.
Couplings	When in Auto, both I Range and Q Range are set to the same value, computed as follows: Maximum absolute value is computed for the Y Scale. The top and bottom of the graph are computed based on Ref Value, Scale/Div, and Ref Position. Formula: $Y_{Max} = \max(\text{abs}(\text{top}), \text{abs}(\text{bottom}))$ . The I Range and Q Range are then set to YMax.
Preset	ON
State Saved	Saved in instrument state
Range	Auto   Man
Initial S/W Revision	Prior to A.02.00

<b>Remote Command</b>	<code>[:SENSe]:POWer:IQ:RANGe:AUTO OFF ON 0 1</code> <code>[:SENSe]:POWer:IQ:RANGe:AUTO?</code>
-----------------------	----------------------------------------------------------------------------------------------------

<b>Example</b>	Put the I Range and Q Range in manual. POW:IQ:RANG:AUTO OFF
Notes	The POW:IQ:RANG:AUTO is an alternate form of the VOLT:IQ:RANG:AUTO command. This is to maintain consistency with I Range and Q Range, which support both the POWer and VOLTage forms of the command.
Preset	ON
Range	Auto   Man
Initial S/W Revision	Prior to A.02.00

## I Range

This is the internal gain range for the I channel when Input Path is I Only or I and I/Q, and it is used for both the I and Q channels when the Input Path is I+jQ. See "[I/Q Gain Ranges](#)" on page 2807.

<b>Key Path</b>	AMPTD Y Scale, Range
<b>Remote Command</b>	[ :SENSe ] :VOLTage :IQ [ : I ] :RANGe [ :UPPer ] <voltage> [ :SENSe ] :VOLTage :IQ [ : I ] :RANGe [ :UPPer ] ?
<b>Example</b>	Set the I Range to 0.5 V Peak VOLT:IQ:RANG 0.5 V
Notes	The numeric entries are mapped to the smallest gain range whose break point is greater than or equal to the value, or 1 V Peak if the value is greater than 1 V.
Couplings	When Q Same as I is On, the I Range value will be copied to the Q Range. Changing the value will also set Range = Man.
Preset	1 V Peak
State Saved	Saved in instrument state
Range	1 V Peak   0.5 V Peak   0.25 V Peak   0.125 V Peak
Min	0.125 V
Max	1 V
Initial S/W Revision	Prior to A.02.00

<b>Remote Command</b>	[ :SENSe ] :POWer :IQ [ : I ] :RANGe [ :UPPer ] <ampl> [ :SENSe ] :POWer :IQ [ : I ] :RANGe [ :UPPer ] ?
<b>Example</b>	Set the I Range to 0.5 V Peak when Reference Z is 50Ω, and to 1.0 V Peak when Reference Z is 75Ω. POW:IQ:RANG 4 dBm
Notes	The POWer form of the command is provided for convenience. It maps to the same underlying gain range parameter as the VOLTage form of the command. The Reference Z (not the I channel Input Z) is used to convert the power to peak voltage, which is then used to set the I Range as with the VOLTage form of the command. The power values of the 4

range states (1V Peak, 0.5V Peak, 0.25V Peak, and 0.125V Peak) will vary with Reference Z. Here are some examples:

50Ω: 10, 4, -2, -8  
75Ω: 8.2, 2.2, -3.8, -9.8  
600Ω: -0.8, -6.8, -12.8, -18.9

Preset	10.0 dBm
Range	-20 dBm to 10 dBm
Min	-20 dBm
Max	10 dBm
Initial S/W Revision	Prior to A.02.00

### 1 V Peak

Set the channel gain state to 1 Volt Peak.

Key Path	AMPTD Y Scale, I Range   Q Range
Initial S/W Revision	Prior to A.02.00

### 0.5 V Peak

Set the channel gain state to 0.5 Volt Peak.

Key Path	AMPTD Y Scale, I Range   Q Range
Initial S/W Revision	Prior to A.02.00

### 0.25 V Peak

Set the channel gain state to 0.25 Volt Peak.

Key Path	AMPTD Y Scale, I Range   Q Range
Initial S/W Revision	Prior to A.02.00

### 0.125 V Peak

Set the channel gain state to 0.125 Volt Peak.

Key Path	AMPTD Y Scale, I Range   Q Range
Initial S/W Revision	Prior to A.02.00

## Q Range Value

This is the internal gain range for the Q channel. See "[I/Q Gain Ranges](#)" on page 2807. The Q Range only applies to Input Path Q Only and Ind I/Q. For input I+jQ the I Range determines both I and Q channel range settings.

Key Path	AMPTD Y Scale, Range
Remote Command	<code>[ :SENSe ] :VOLTage:IQ:Q:RANGe[:UPPer] &lt;voltage&gt;</code> <code>[ :SENSe ] :VOLTage:IQ:Q:RANGe[:UPPer] ?</code>
Example	Set the Q Range to 0.5 V Peak <code>VOLT:IQ:Q:RANG 0.5 V</code>
Notes	The numeric entries are mapped to the smallest gain range whose break point is greater than or equal to the value, or 1 V Peak if the value is greater than 1 V. The Q Range is only used for Input Path Q Only and Ind I/Q. For input I+jQ the I Range determines both I and Q channel range settings.
Couplings	When Q Same as I is On, the I Range value will be copied to the Q Range and the range value keys are disabled. Changing the value will also set Range = Man.
Preset	1 V Peak
State Saved	Saved in instrument state
Range	1 V Peak   0.5 V Peak   0.25 V Peak   0.125 V Peak
Min	0.125 V
Max	1 V
Initial S/W Revision	Prior to A.02.00

Remote Command	<code>[ :SENSe ] :POWer:IQ:Q:RANGe[:UPPer] &lt;ampl&gt;</code> <code>[ :SENSe ] :POWer:IQ:Q:RANGe[:UPPer] ?</code>
Example	Will set the Q Range to 0.5 V Peak when Reference Z is 50Ω, and to 1.0 V Peak when Reference Z is 75Ω. <code>POW:IQ:Q:RANG 4 dBm</code>
Notes	The POWER form of the command is provided for convenience. It maps to the same underlying gain range parameter as the VOLTage form of the command. The Reference Z (not the Q channel Input Z) is used to convert the power to peak voltage, which is then used to set the Q Range as with the VOLTage form of the command. The power values of the 4 range states (1V Peak, 0.5V Peak, 0.25V Peak, and 0.125V Peak) will vary with Reference Z. Here are some examples: 50Ω: 10, 4, -2, -8 75Ω: 8.2, 2.2, -3.8, -9.8 600Ω: -0.8, -6.8, -12.8, -18.9
Preset	10.0 dBm
Range	-20 dBm to 10 dBm

Min	-20 dBm
Max	10 dBm
Initial S/W Revision	Prior to A.02.00

### Q Same as I

Many, but not all, usages require the I and Q channels to have an identical setup. To simplify channel setup, the Q Same as I will cause the Q channel range to be mirrored from the I channel. That way you only need to set up one channel (the I channel). The I channel values are copied to the Q channel, so at the time Q Same as I is Off, the I and Q channel setups will be identical.

Key Path	AMPTD Y Scale, Range, Q Range
Remote Command	[ :SENSe] :VOLTage POWer:IQ:MIRRored OFF ON 0 1 [ :SENSe] :VOLTage POWer:IQ:MIRRored?
Example	Turn off the mirroring of I Range to Q Range. VOLT:IQ:MIRR OFF POW:IQ:MIRR OFF
Couplings	When On, the I Range value is mirrored (copied) to the Q Range.
Preset	On
State Saved	Saved in instrument state.
Range	On   Off
Readback Text	"Q Same as I" when On, otherwise none.
Initial S/W Revision	Prior to A.02.00

### 1 V Peak

Set the channel gain state to 1 Volt Peak.

Key Path	AMPTD Y Scale, I Range   Q Range
Initial S/W Revision	Prior to A.02.00

### 0.5 V Peak

Set the channel gain state to 0.5 Volt Peak.

Key Path	AMPTD Y Scale, I Range   Q Range
Initial S/W Revision	Prior to A.02.00

### 0.25 V Peak

Set the channel gain state to 0.25 Volt Peak.

---

Key Path	AMPTD Y Scale, I Range   Q Range
Initial S/W Revision	Prior to A.02.00

---

### 0.125 V Peak

Set the channel gain state to 0.125 Volt Peak.

---

Key Path	AMPTD Y Scale, I Range   Q Range
Initial S/W Revision	Prior to A.02.00

---

### I/Q Gain Ranges

See the following sections:

["1 V Peak" on page 2807](#)

["0.5 V Peak" on page 2807](#)

["0.25 V Peak" on page 2807](#)

["0.125 V Peak" on page 2808](#)

### 1 V Peak

Set the channel gain state to 1 Volt Peak.

---

Key Path	AMPTD Y Scale, I Range   Q Range
Initial S/W Revision	Prior to A.02.00

---

### 0.5 V Peak

Set the channel gain state to 0.5 Volt Peak.

---

Key Path	AMPTD Y Scale, I Range   Q Range
Initial S/W Revision	Prior to A.02.00

---

### 0.25 V Peak

Set the channel gain state to 0.25 Volt Peak.

---

Key Path	AMPTD Y Scale, I Range   Q Range
Initial S/W Revision	Prior to A.02.00

---



### 0.125 V Peak

Set the channel gain state to 0.125 Volt Peak.

Key Path	AMPTD Y Scale, I Range   Q Range
Initial S/W Revision	Prior to A.02.00

## Auto Couple

The Auto Couple feature provides a quick and convenient way to automatically couple multiple instrument settings. This helps ensure accurate measurements and optimum dynamic range. When the Auto Couple feature is activated, either from the front panel or remotely, all parameters of the current measurement that have an Auto/Manual mode are set to Auto mode and all measurement settings dependent on (or coupled to) the Auto/Man parameters are automatically adjusted for optimal performance.

However, the Auto Couple key actions are confined to the current measurement only. It does not affect other measurements in the mode, and it does not affect markers, marker functions, or trace or display attributes.

See "[More Information](#)" on page 2310

Key Path	Front-panel key
Remote Command	:COUPLe ALL NONE
Example	:COUP ALL
Notes	:COUPLe ALL puts all Auto/Man parameters in Auto mode (equivalent to pressing the Auto Couple key). :COUPLE NONE puts all Auto/Man parameters in manual mode. It decouples all the coupled instrument parameters and is not recommended for making measurements.
Initial S/W Revision	Prior to A.02.00

### More Information

There are two types of functions that have Auto/Manual modes.

#### Auto/Man Active Function keys

An Auto/Man toggle key controls the binary state associated with an instrument parameter by toggling between Auto (where the parameter is automatically coupled to the other parameters it is dependent upon) and Man (where the parameter is controlled independent of the other parameters), as well as making the parameter the active function. The current mode is indicated on the softkey with either Auto or Man underlined as illustrated below.



#### Auto/Man 1-of-N keys

An Auto/Man 1-of-N key allows you to manually pick from a list of parameter values, or place the function in Auto, in which case the value is automatically selected (and indicated) as shown below. If in Auto, Auto is underlined on the calling key. If in manual operation, manual is indicated on the calling key. But the calling key does not actually toggle the function, it simply opens the menu.

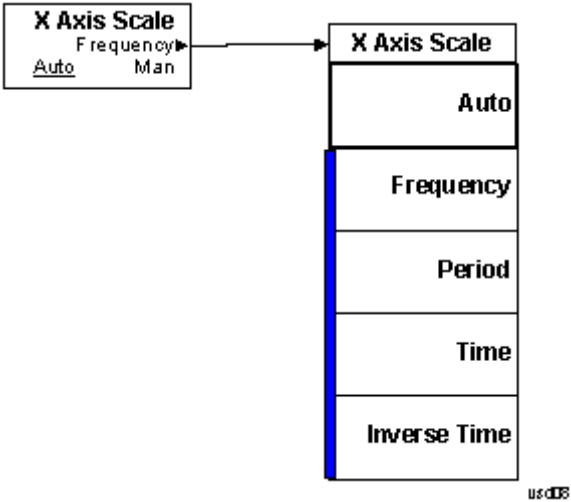

## BW

There is no BW functionality supported in the Modulation Accuracy measurement. The front-panel key will display a blank menu when key pressed.

---

Key Path	Front Panel key
Initial S/W Revision	Prior to A.02.00

---

## Cont (Continuous Measurement/Sweep)

Sets the analyzer for Continuous measurement operation. The single/continuous state is Meas Global so the setting will affect all measurements. If you are Paused, pressing Cont does a Resume.

Key Path	Front-panel key
Remote Command	:INITiate:CONTinuous OFF ON 0 1 :INITiate:CONTinuous?
Example	:INIT:CONT 0 puts analyzer in Single measurement operation. :INIT:CONT 1 puts analyzer in Continuous measurement operation
Preset	ON (Note that SYST:PRESet sets INIT:CONT to ON but *RST sets INIT:CONT to OFF)
State Saved	Saved in instrument state
Backwards Compatibility Notes	For Spectrum Analysis mode in ESA and PSA, there is no Cont hardkey, instead there is a Sweep Single/Cont key. In these analyzers, switching the Sweep Single/Cont key from Single to Cont restarts averages (displayed average count reset to 1), but does not restart Max Hold and Min Hold. The X-Series has Single and Cont keys in place of the SweepSingleCont key. In the X-Series, if in single measurement, the Cont key (and INIT:CONT ON ) switches to continuous measurement, but never restarts a measurement and never resets a sweep.
Initial S/W Revision	Prior to A.02.00

In Swept SA Measurement (Spectrum Analysis Mode):

The analyzer takes repetitive sweeps, averages, measurements, etc., when in Continuous mode. When the average count reaches the Average/Hold Number the count stops incrementing, but the analyzer keeps sweeping. See the Trace/Detector section for the averaging formula used both before and after the Average/Hold Number is reached. The trigger condition must be met prior to each sweep. The type of trace processing for multiple sweeps, is set under the Trace/Detector key, with choices of Trace Average, Max Hold, or Min Hold.

In Other Measurements/Modes:

With Avg/Hold Num (in the Meas Setup menu) set to Off or set to On with a value of 1, a sweep is taken after the trigger condition is met; and the analyzer continues to take new sweeps after the current sweep has completed and the trigger condition is again met. However, with Avg/Hold Num set to On with a value >1, multiple sweeps (data acquisitions) are taken for the measurement. The trigger condition must be met prior to each sweep. The sweep is not stopped when the average count k equals the number N set for Avg/Hold Num is reached, but the number k stops incrementing. A measurement average usually applies to all traces, marker results, and numeric results. But sometimes it only applies to the numeric results.

If the analyzer is in Single measurement, pressing the Cont key does not change k and does not cause the sweep to be reset; the only action is to put the analyzer into Continuous measurement operation.

If it is already in continuous sweep:

the INIT:CONT 1 command has no effect

18 Reverse Link Modulation Accuracy  
Cont (Continuous Measurement/Sweep)

the INIT:CONT 0 command will place the analyzer in Single Sweep but will have no effect on the current sequence until  $k = N$ , at which point the current sequence will stop and the instrument will go to the idle state.

File

See "File" on page 354

## FREQ Channel

Accesses a menu of keys that allow you to control the Frequency and Channel parameters of the instrument.

Some features in the Frequency menu are the same for all measurements – they do not change as you change measurements. Settings like these are called “Meas Global” and are unaffected by Meas Preset. For example, the Center Freq setting is the same for all measurements - it does not change as you change measurements.

<b>Key Path</b>	<b>Front-panel key</b>
<b>Initial S/W Revision</b>	<b>Prior to A.02.00</b>

### Center Freq

Sets the frequency that corresponds to the horizontal center of the graticule (when frequency Scale Type is set to linear). While adjusting the Center Frequency the Span is held constant, which means that both Start Frequency and Stop Frequency will change.

Pressing Center Freq also sets the frequency entry mode to Center/Span. In Center/Span mode, the center frequency and span values are displayed below the graticule, and the default active function in the Frequency menu is Center Freq.

The center frequency setting is the same for all measurements within a mode, that is, it is Meas Global. Some modes are also able to share a Mode Global center frequency value. If this is the case, the Mode will have a Global Settings key in its Mode Setup menu.

The Center Freq function sets (and queries) the Center Frequency for the currently selected input. If your analyzer has multiple inputs, and you select another input, the Center Freq changes to the value for that input. SCPI commands are available to directly set the Center Freq for a specific input.

Center Freq is remembered as you go from input to input. Thus you can set a Center Freq of 10 GHz with the RF Input selected, change to BBIQ and set a Center Freq of 20 MHz, then switch to External Mixing and set a Center Freq of 60 GHz, and when you go back to the RF Input the Center Freq will go back to 10 GHz; back to BBIQ and it is 20 MHz; back to External Mixing and it is 60 GHz.

See ["RF Center Freq" on page 2319](#)

See [Ext Mix Center Freq](#)

See ["I/Q Center Freq" on page 2321](#)

See ["Center Frequency Presets" on page 2317](#)

<b>Key Path</b>	<b>FREQ Channel</b>
<b>Scope</b>	<b>Meas Global</b>
<b>Remote Command</b>	<code>[ :SENSe ] :FREQuency:CENTer &lt;freq&gt;</code> <code>[ :SENSe ] :FREQuency:CENTer?</code>



<b>Example</b>	FREQ:CENT 50 MHz FREQ:CENT UP changes the center frequency to 150 MHz if you use FREQ:CENT:STEP 100 MHz to set the center frequency step size to 100 MHz FREQ:CENT?
<b>Notes</b>	This command sets either the RF or I/Q Center Frequency depending on the selected input. For RF input it is equivalent to FREQ:RF:CENT For I/Q input it is equivalent to FREQ:IQ:CENT Preset and Max values are dependent on Hardware Options (5xx) If no terminator (e.g. MHz) is sent the terminator Hz is used. If a terminator with unit other than Frequency is used, an invalid suffix error message is generated.
<b>Dependencies</b>	The Center Frequency can be limited by Start or Stop Freq limits, if the Span is so large that Start or Stop reach their limit.
<b>Couplings</b>	When operating in “swept span”, any value of the Center Frequency or Span that is within the frequency range of the analyzer is allowed when the value is being set through the front panel numeric key pad or the SCPI command. The other parameter is forced to a different value if needed, to keep the Start and the Stop Frequencies within the analyzer’s frequency range
<b>Preset</b>	Depends on instrument maximum frequency, mode, measurement, and selected input. See <a href="#">"Center Frequency Presets" on page 2317</a> and <a href="#">"RF Center Freq" on page 2319</a> and <a href="#">Ext Mix Center Freq</a> and <a href="#">"I/Q Center Freq" on page 2321</a> .
<b>State Saved</b>	Saved in instrument state
<b>Min</b>	Depends on instrument maximum frequency, mode, measurement, and selected input.. See <a href="#">"Center Frequency Presets" on page 2317</a> and <a href="#">"RF Center Freq" on page 2319</a> and <a href="#">"I/Q Center Freq" on page 2321</a> .
<b>Max</b>	Depends on instrument maximum frequency, mode, measurement, and selected input.. See <a href="#">"Center Frequency Presets" on page 2317</a> and <a href="#">"RF Center Freq" on page 2319</a> and <a href="#">"I/Q Center Freq" on page 2321</a> .
<b>Default Unit</b>	Hz
<b>Status Bits/OPC</b>	Non-overlapped
<b>Dependencies</b>	
<b>Initial S/W Revision</b>	Prior to A.02.00

## Center Frequency Presets

The following table provides the Center Frequency Presets for the Spectrum Analyzer mode, and the Max Freq, for the various frequency options:

Freq Option	CF after Mode Preset	Stop Freq after Mode Preset	Max Freq (can't tune)

18 Reverse Link Modulation Accuracy  
 FREQ Channel

			above)
503 (all but N9000A)	1.805 GHz	3.6 GHz	3.7 GHz
503 (N9000A)	1.505 GHz	3.0 GHz	3.08 GHz
507 (all but N9000A)	3.505 GHz	7.0 GHz	7.1 GHz
507 (N9000A)	3.755 GHz	7.5 GHz	7.58 GHz
508 (all but N9038A)	1.805 GHz	3.6 GHz	8.5 GHz
508 (N9038A)	4.205 GHz	8.4 GHz	8.5 GHz
513	6.805 GHz	13.6 GHz	13.8 GHz
526 (all but N9000A and N9038A)	13.255 GHz	26.5 GHz	27.0 GHz
526 (N9000A)	13.255 GHz	26.5 GHz	26.55 GHz
526 (N9038A)	1.805 GHz	3.6 GHz	27.0 GHz
532	16.005 GHz	32.0 GHz	32.5 GHz
543	21.505 GHz	43.0 GHz	TBD
544	22.005 GHz	44.0 GHz	44.5 GHz
550	25.005 GHz	50.0 GHz	51 GHz

Input 2:

Model	CF after Mode Preset	Stop Freq after Mode Preset	Max Freq (can't tune above)
N9000A opt C75	0.7505GHz	1.5 GHz	1.58 GHz
N9038A	505 MHz	1 GHz	1.000025 GHz

Tracking Generator Frequency Limits (N9000A only):

Tracking Generator Option	Min Freq (clips to this freq when turn TG on and	If above this Freq, Stop Freq clipped to this Freq when	Max Freq (can't tune above) while TG

	can't tune below while TG on)	TG turned on	on
T03	9 kHz	3.0 GHz	3.08 GHz
T06	9 kHz	6.0 GHz	6.05 GHz

The following table shows the Center Frequency Presets for modes other than Spectrum Analyzer:

Mode	CF Preset for RF
WCDMA	1 GHz
WIMAXOFDMA,	1 GHz
BASIC	1 GHz
ADEMOD	1 GHz
VSA	1 GHz
TDSCDMA	1 GHz
PNOISE	1 GHz
LTE	1 GHz
LTETDD	1 GHz
MSR	1 GHz
GSM	935.2 MHz
NFIGURE	1.505 GHz

## RF Center Freq

SCPI command for specifying the RF Center Frequency. This command will set the Center Frequency to be used when the RF input is selected, even if the RF input is not the input that is selected at the time the command is sent. Note that the Center Freq function in the Frequency menu on the front panel always applies to the currently selected input.

Scope	Meas Global
<b>Remote Command</b>	<code>[ :SENSe ] :FREQuency:RF:CENTer &lt;freq&gt;</code> <code>[ :SENSe ] :FREQuency:RF:CENTer?</code>
<b>Example</b>	FREQ:RF:CENT 30 MHz
Notes	This command is the same in all modes, but the parameter is Measurement Global. So the value is independent in each mode and common across all the measurements in the mode.
Dependencies	If the electronic/soft attenuator is enabled, any attempt to set Center Frequency such that the Stop Frequency would be >3.6 GHz fails and results in an advisory message. If the equivalent SCPI command is sent, this same message is generated as part of a “-221, Settings conflict” warning. If Source Mode is set to Tracking, and the Max or Min Center Freq is therefore limited by the limits of the source, a warning message is generated, “Data out of range;clipped to source max/min” if these limits are exceeded. Note that for an external source, these limits can be affected by the settings of

	Source Numerator, Source Denominator and Power Sweep.
Preset	See table above
State Saved	Saved in instrument state.
Min	-79.999995 MHz, unless Source Mode is set to Tracking, in which case it is limited by the minimum frequency of the Source
Max	See table above. Basically instrument maximum frequency - 5 Hz. Note that, if the Source Mode is set to Tracking, the effective instrument maximum frequency may be limited by the source maximum frequency.  If the knob or step keys are being used, also depends on the value of the other three interdependent parameters Span, Start Frequency and Stop Frequency
Initial S/W Revision	Prior to A.02.00
Modified at S/W Revision	A.03.00

### Ext Mix Center Freq

SCPI command for specifying the External Mixer Center Frequency. This command will set the Center Frequency to be used when the External Mixer is selected, even if the External Mixer input is not the input which is selected at the time the command is sent. Note that the Center Freq function in the Frequency menu on the front panel always applies to the currently selected input.

Scope	Meas Global
Remote Command	<code>[ :SENSe ] :FREQuency:EMIXer:CENTer &lt;freq&gt;</code> <code>[ :SENSe ] :FREQuency:EMIXer:CENTer?</code>
Example	<code>:FREQ:EMIX:CENT 60 GHz</code> <code>:FREQ:EMIX:CENT?</code>
Notes	This command is the same in all modes, but the parameter is Measurement Global. So the value is independent in each mode and common across all the measurements in the mode.
Couplings	When returning to External Mixing after having been switched to one of the other inputs (e.g., RF), you will come back into the settings that you had when you left External Mixing. So you will come back to the band you were in with the Center Frequency that you had. However, Span is not an input-dependent parameter, therefore you will bring the span over from the other input. Therefore, the analyzer comes back with the span from the previous input, limited as necessary by the current mixer setup.
Preset	When a Mode Preset is performed while in External Mixing, the Start frequency of the current Mode is set to the nominal Min Freq of the lowest harmonic range in the Harmonic Table for the current mixer setup. Similarly, the Stop frequency of the current Mode is set to the nominal Max Freq of the highest harmonic range in the Harmonic Table. The Center Freq thus presets to the point arithmetically equidistant from these two frequencies.  If the current measurement has a limited Span available to it, and cannot achieve the Span shown in the table (Span=Stop Freq - Start Freq), the analyzer uses the maximum Span the measurement allows, and still sets the Center Freq to the midpoint of the Start and Stop Freq values in the Harmonic Table.

	When Restore Input/Output Defaults is performed, the mixer presets to the 11970A, whose Start and Stop frequencies are 26.5 and 40 GHz respectively. The center of these two frequencies is 33.25 GHz. Therefore, after a Restore Input/Output Defaults, if you go into External Mixing and do a Mode Preset while in the Spectrum Analyzer Mode, the resulting Center Freq is 33.25 GHz.
State Saved	Saved in instrument state.
Min	The minimum frequency in the currently selected mixer band + 5 Hz
Max	The maximum frequency in the currently selected mixer band – 5 Hz If the knob or step keys are being used, also depends on the value of the other three interdependent parameters Span, Start Frequency and Stop Frequency
Initial S/W Revision	A.08.01

### I/Q Center Freq

SCPI command for specifying the I/Q Center Frequency. This command will set the Center Frequency to be used when the I/Q input is selected, even if the I/Q input is not the input which is selected at the time the command is sent. Note that the Center Freq function in the Frequency menu on the front panel always applies to the currently selected input.

Scope	Meas Global
<b>Remote Command</b>	<code>[ :SENSe ] :FREQuency:IQ:CENTer &lt;freq&gt;</code> <code>[ :SENSe ] :FREQuency:IQ:CENTer?</code>
<b>Example</b>	FREQ:IQ:CENT: 30 MHz
Notes	This command is the same in all modes, but the parameter is Measurement Global. So the value is independent in each mode and common across all the measurements in the mode.
Preset	0 Hz
State Saved	Saved in instrument state.
Min	-40.049995 MHz
Max	40.049995 MHz
Initial S/W Revision	Prior to A.02.00

### CF Step

Changes the step size for the center frequency and start and stop frequency functions. Once a step size has been selected and the center frequency function is active, the step keys (and the UP|DOWN parameters for Center Frequency from remote commands) change the center frequency by the step-size value. The step size function is useful for finding harmonics and sidebands beyond the current frequency span of the analyzer.

Note that the start and stop frequencies also step by the CF Step value.

Key Path	FREQ Channel
Remote Command	<pre>[ :SENSe] :FREQuency:CENTer:STEP[:INCRement] &lt;freq&gt; [ :SENSe] :FREQuency:CENTer:STEP[:INCRement] ? [ :SENSe] :FREQuency:CENTer:STEP:AUTO OFF ON 0 1 [ :SENSe] :FREQuency:CENTer:STEP:AUTO?</pre>
Example	<pre>FREQ:CENt:STEP:AUTO ON FREQ:CENt:STEP 500 MHz FREQ:CENt UP increases the current center frequency value by 500 MHz FREQ:CENt:STEP? FREQ:CENt:STEP:AUTO?</pre>
Notes	Preset and Max values are depending on Hardware Options (503, 507, 508, 513, 526)
Notes	Preset and Max values are dependent on Hardware Options (5xx)
Dependencies	Freq Offset is not available in External Mixing. In this case the Freq Offset key is grayed out and shows a value of zero. It will once again be available, and show the previously set value, when you return to the RF Input.
Dependencies	Span, RBW, Center frequency If the electronic/soft attenuator is enabled, any attempt to change the value of the center frequency >3.6 GHz by pressing the Up-arrow key, fails and results in an advisory message. If the equivalent SCPI command is sent, this same message is generated as part of a “-221, Settings conflict” warning.
Couplings	When auto-coupled in a non-zero span, the center frequency step size is set to 10% of the span. When auto-coupled in zero span, the center frequency step size is set to the equivalent -3 dB RBW value.
Preset	Auto ADEM0D: 1 MHz ON
State Saved	Saved in instrument state
Min	– (the maximum frequency of the instrument). That is, 27 GHz max freq instrument has a CF step range of +/- 27 GHz. Note that this is the maximum frequency given the current settings of the instrument, so in External Mixing, for example, it is the maximum frequency of the current mixer band.
Max	The maximum frequency of the instrument. That is, 27 GHz max freq instrument has a CF step range of +/- 27 GHz. Note that this is the maximum frequency given the current settings of the instrument, so in External Mixing, for example, it is the maximum frequency of the current mixer band.
Default Unit	Hz
Status Bits/OPC dependencies	non-overlapped
Initial S/W Revision	Prior to A.02.00
Modified at S/W Revision	A.03.00

## Input/Output

See ["Input/Output" on page 226](#)

## Marker

Accesses a menu that enables you to select, set up and control the markers for the current measurement.

Contained within this menu is a 1-of-N selection of the control mode (Normal, Delta, Off) for the selected marker.

Key Path	Front Panel key
Initial S/W Revision	Prior to A.02.00

### Select Marker

Accesses a menu that enables you to select, set up and control the markers for the current measurement.

Key Path	Marker, Properties
Initial S/W Revision	Prior to A.02.00

### Marker Type

Sets the marker control mode. If the selected marker is Off, pressing Marker sets it to Normal and places it at the center of the screen on the trace determined by the Marker Trace rules. At the same time, reference value of the selected marker appears on the Active Function area.

Active Function Display:

Marker symbol value at I/Q Symbol Polar Vector graph

Marker X-axis value at other graphs

Default Active Function: the active function for the selected marker's current control mode. If the current control mode is Off, there is no active function and the active function is turned off.

The marker X axis value entered in the active function area will display the marker value to its full entered precision.

Key Path	Marker
Mode	1xEVDO
Remote Command	:CALCulate:RHO:MS:MARKer[1] 2 ...12:MODE POSITION DELTA OFF :CALCulate:RHO:MS:MARKer[1] 2 ...12:MODE?
Example	CALC:RHO:MS:MARK:MODE POS CALC:RHO:MS:MARK:MODE?
Notes	If the selected marker is Off, pressing Marker sets it to Normal and places it at the center of the screen on the trace determined by the Marker Trace rules. At the same time, Marker X Axis Value appears on the Active Function area.  Default Active Function: the active function for the selected marker's current control mode. If the current control mode is Off, there is no active function and the active function is turned off.



	Active Function Display: Marker symbol value at I/Q Symbol Polar Vector graph Marker X-axis value at other graphs the marker X axis value entered in the active function area will display the marker value to its full entered precision.
Preset	OFF
State Saved	Saved in instrument state.
Range	Normal Delta =Off
Initial S/W Revision	Prior to A.02.00

## Properties

Accesses a menu that enables you to select a relative marker and marker trace.

Key Path	Marker
Initial S/W Revision	Prior to A.02.00

## Select Marker

Accesses a menu that enables you to select, set up and control the markers for the current measurement.

Key Path	Marker, Properties
Initial S/W Revision	Prior to A.02.00

## Relative TO

Selects the marker the selected marker will be relative to (its reference marker).

Key Path	Marker, Properties
Mode	1xEVDO
<b>Remote Command</b>	:CALCulate:RHO:MS:MARKer[1] 2 ...12:REFerence <integer> :CALCulate:RHO:MS:MARKer[1] 2 ...12:REFerence?
<b>Example</b>	CALC:RHO:MS:MARK:REF 4 CALC:RHO:MS:MARK:REF?
Notes	When queried a single value will be returned (the specified marker numbers relative marker). A marker cannot be relative to itself so that choice is grayed out, and if sent from SCPI generates error -221: "Settings conflict; marker cannot be relative to itself."
Preset	2 3 4 5 6 7 8 9 10 11 12 1

State Saved	Saved in instrument state.
Min	1
Max	12
Initial S/W Revision	Prior to A.02.00

## Marker Trace

Assigns the specified marker to the designated trace.

Key Path	Marker, Properties
Mode	1xEVDO
Remote Command	:CALCulate:RHO:MS:MARKer[1] 2 ...12:TRACe EVM   MERRor   PERRor   CDPower   POLar  :CALCulate:RHO:MS:MARKer[1] 2 ...12:TRACe?
Example	CALC:RHO:MS:MARK:TRACE CDP CALC:RHO:MS:MARK:TRACE?
Preset	EVM
State Saved	Saved in instrument state.
Range	EVM   Phase Error   Mag Error   Code Domain Power   Polar
Backwards Compatibility SCPI	:CALCulate:TRHO:MARKer[1] 2 ...4:TRACe
Initial S/W Revision	Prior to A.02.00

## Couple Marker

Toggles the state of the markers to be coupled On or Off. When this function is true, moving any marker causes an equal X Axis movement of every other marker which is not Off. By “equal X Axis movement” we mean that we preserve the difference between each marker’s X Axis value (in the fundamental x-axis units of the trace that marker is on) and the X Axis value of the marker being moved (in the same fundamental x-axis units).

Key Path	Marker
Mode	1xEVDO
Remote Command	:CALCulate:RHO:MS:MARKer:COUPlE[:STATe] ON OFF 1 0 :CALCulate:RHO:MS:MARKer:COUPlE[:STATe]?
Example	CALC:RHO:MS:MARK:COUP ON
Preset	OFF
State Saved	Saved in instrument state.
Range	On Off
Initial S/W Revision	Prior to A.02.00

## All Markers Off

Turns off all markers.

Key Path	Marker
Mode	1xEVDO
<b>Remote Command</b>	:CALCulate:RHO:MS:MARKer:AOff
<b>Example</b>	CALC:RHO:MS:MARK:AOff
<b>Backwards Compatibility SCPI</b>	:CALCulate:TRHO:MARKer:AOff
Initial S/W Revision	Prior to A.02.00

## Marker Fctn

There are no Marker Function operations supported in the Modulation Accuracy measurement. The front-panel key will display a blank menu when pressed.

---

Key Path	Front Panel key
Initial S/W Revision	Prior to A.02.00

---

## Marker To

There are no Marker To operations supported in the Mod Accuracy measurement. The front-panel key will display a blank menu when pressed.

---

Key Path	Front Panel key
Initial S/W Revision	Prior to A.02.00

---

## Meas

The information in this section is common to all measurements. For key and remote command information for a specific measurement, refer to the section that describes the measurement of interest.

Measurements available under the Meas key are specific to the current Mode.

When viewing Help for measurements, note the following:

**NOTE**

Operation for some keys differs between measurements. The information displayed in Help pertains to the current measurement. To see how a key operates in a different measurement, exit Help (press the Cancel Esc key), select the measurement, then reenter Help (press the Help key) and press that key.

---

Key Path	Front-panel key
Initial S/W Revision	Prior to A.02.00

---

### Remote Measurement Functions

This section contains the following topics:

["Measurement Group of Commands" on page 2849](#)

["Current Measurement Query \(Remote Command Only\) " on page 2851](#)

["Limit Test Current Results \(Remote Command Only\)" on page 2851](#)

["Data Query \(Remote Command Only\)" on page 2851](#)

["Calculate/Compress Trace Data Query \(Remote Command Only\)" on page 2852](#)

["Calculate Peaks of Trace Data \(Remote Command Only\)" on page 2857](#)

[Hardware-Accelerated Fast Power Measurement \(Remote Command Only\)](#)

["Format Data: Numeric Data \(Remote Command Only\)" on page 2858](#)

["Format Data: Byte Order \(Remote Command Only\)" on page 2859](#)

---

Initial S/W Revision	Prior to A.02.00
----------------------	------------------

---

## Measurement Group of Commands

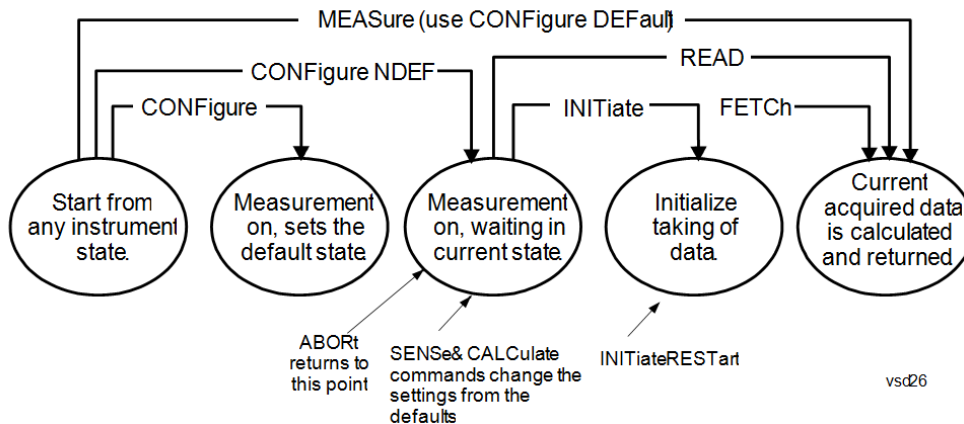

---

### Measure Commands:

:MEASure:<measurement>[n]?

This is a fast single-command way to make a measurement using the factory default instrument settings. These are the settings and units that conform to the Mode Setup settings (e.g. radio standard) that you have currently selected.

- Stops the current measurement (if any) and sets up the instrument for the specified measurement using the factory defaults
- Initiates the data acquisition for the measurement
- Blocks other SCPI communication, waiting until the measurement is complete before returning results.
- If the function does averaging, it is turned on and the number of averages is set to 10.
- After the data is valid it returns the scalar results, or the trace data, for the specified measurement. The type of data returned may be defined by an [n] value that is sent with the command.
- The scalar measurement results will be returned if the optional [n] value is not included, or is set to 1. If the [n] value is set to a value other than 1, the selected trace data results will be returned. See each command for details of what types of scalar results or trace data results are available.
- ASCII is the default format for the data output. (Older versions of Spectrum Analysis and Phase Noise mode measurements only use ASCII.) The binary data formats should be used for handling large blocks of data since they are smaller and faster than the ASCII format. Refer to the FORMat:DATA command for more information.

If you need to change some of the measurement parameters from the factory default settings you can set up the measurement with the CONFIGure command. Use the commands in the SENSe:<measurement> and CALCulate:<measurement> subsystems to change the settings. Then you can use the READ? command to initiate the measurement and query the results.

If you need to repeatedly make a given measurement with settings other than the factory defaults, you can use the commands in the SENSe:<measurement> and CALCulate:<measurement> subsystems to set up the measurement. Then use the READ? command to initiate the measurement and query results.

Measurement settings persist if you initiate a different measurement and then return to a previous one. Use READ:<measurement>? if you want to use those persistent settings. If you want to go back to the default settings, use MEASure:<measurement>?.

---

### Configure Commands:

:CONFigure:<measurement>

This command stops the current measurement (if any) and sets up the instrument for the specified measurement using

---

---

the factory default instrument settings. It does not initiate the taking of measurement data unless INIT:CONTinuous is ON. If you change any measurement settings after using the CONFigure command, the READ command can be used to initiate a measurement without changing the settings back to their defaults.

In the Swept SA measurement in Spectrum Analyzer mode the CONFigure command also turns the averaging function on and sets the number of averages to 10 for all measurements.

:CONFigure: <measurement>: NDEFault stops the current measurement and changes to the specified measurement. It does not change the settings to the defaults. It does not initiate the taking of measurement data unless INIT:CONTinuous is ON.

The CONFigure? query returns the current measurement name.

The CONFigure:CATalog? query returns a quoted string of all licensed measurement names in the current mode. For example, "SAN, CHP, OBW, ACP, PST, TXP, SPUR, SEM, LIST".

---

#### Fetch Commands:

---

:FETCh:<measurement>[n]?

This command puts selected data from the most recent measurement into the output buffer. Use FETCh if you have already made a good measurement and you want to return several types of data (different [n] values, for example, both scalars and trace data) from a single measurement. FETCh saves you the time of re-making the measurement. You can only FETCh results from the measurement that is currently active, it will not change to a different measurement. An error message is reported if a measurement other than the current one is specified.

If you need to get new measurement data, use the READ command, which is equivalent to an INITiate followed by a FETCh.

The scalar measurement results will be returned if the optional [n] value is not included, or is set to 1. If the [n] value is set to a value other than 1, the selected trace data results will be returned. See each command for details of what types of scalar results or trace data results are available. The binary data formats should be used for handling large blocks of data since they are smaller and transfer faster than the ASCII format. (FORMat:DATA)

FETCh may be used to return results other than those specified with the original READ or MEASure command that you sent.

---

#### INITiate Commands:

---

:INITiate:<measurement>

This command is not available for measurements in all the instrument modes:

- Initiates a trigger cycle for the specified measurement, but does not output any data. You must then use the FETCh<meas> command to return data. If a measurement other than the current one is specified, the instrument will switch to that measurement and then initiate it.
  - For example, suppose you have previously initiated the ACP measurement, but now you are running the channel power measurement. If you send INIT:ACP? it will change from channel power to ACP and will initiate an ACP measurement.
  - Does not change any of the measurement settings. For example, if you have previously started the ACP measurement and you send INIT:ACP? it will initiate a new ACP measurement using the same instrument settings as the last time ACP was run.
  - If your selected measurement is currently active (in the idle state) it triggers the measurement, assuming the trigger conditions are met. Then it completes one trigger cycle. Depending upon the measurement and the number of averages, there may be multiple data acquisitions, with multiple trigger events, for one full trigger cycle. It also holds off additional commands on GPIB until the acquisition is complete.
- 

#### READ Commands:

---

:READ:<measurement>[n]?

- Does not preset the measurement to the factory default settings. For example, if you have previously initiated the ACP
-



---

measurement and you send READ:ACP? it will initiate a new measurement using the same instrument settings.

- Initiates the measurement and puts valid data into the output buffer. If a measurement other than the current one is specified, the instrument will switch to that measurement before it initiates the measurement and returns results.
  - For example, suppose you have previously initiated the ACP measurement, but now you are running the channel power measurement. Then you send READ:ACP? It will change from channel power back to ACP and, using the previous ACP settings, will initiate the measurement and return results.
  - Blocks other SCPI communication, waiting until the measurement is complete before returning the results
  - If the optional [n] value is not included, or is set to 1, the scalar measurement results will be returned. If the [n] value is set to a value other than 1, the selected trace data results will be returned. See each command for details of what types of scalar results or trace data results are available. The binary data formats should be used when handling large blocks of data since they are smaller and faster than the ASCII format. (FORMat:DATA)
- 

---

Initial S/W Revision	Prior to A.02.00
----------------------	------------------

---

### Current Measurement Query (Remote Command Only)

This command returns the name of the measurement that is currently running.

---

<b>Remote Command</b>	:CONFigure?
-----------------------	-------------

<b>Example</b>	CONF?
----------------	-------

Initial S/W Revision	Prior to A.02.00
----------------------	------------------

---

### Limit Test Current Results (Remote Command Only)

Queries the status of the current measurement limit testing. It returns a 0 if the measured results pass when compared with the current limits. It returns a 1 if the measured results fail any limit tests.

---

<b>Remote Command</b>	:CALCulate:CLIMits:FAIL?
-----------------------	--------------------------

<b>Example</b>	CALC:CLIM:FAIL? queries the current measurement to see if it fails the defined limits. Returns a 0 or 1: 0 it passes, 1 it fails.
----------------	--------------------------------------------------------------------------------------------------------------------------------------

Initial S/W Revision	Prior to A.02.00
----------------------	------------------

---

### Data Query (Remote Command Only)

Returns the designated measurement data for the currently selected measurement and subopcode.

n = any valid subopcode for the current measurement. See the measurement command results table for your current measurement, for information about what data is returned for the subopcodes.

This command uses the data setting specified by the FORMat:BORDER and FORMat:DATA commands and can return real or ASCII data. (See the format command descriptions under Input/Output in the Analyzer Setup section.)

<b>Remote Command</b>	:CALCulate:DATA[n]?
<b>Notes</b>	The return trace depends on the measurement. In CALCulate:<meas>:DATA[n], n is any valid subopcode for the current measurement. It returns the same data as the FETCH:<measurement>? query where <measurement> is the current measurement.
<b>Initial S/W Revision</b>	Prior to A.02.00

### Calculate/Compress Trace Data Query (Remote Command Only)

Returns compressed data for the currently selected measurement and sub-opcode [n].

n = any valid sub-opcode for that measurement. See the MEASure:<measurement>? command description of your specific measurement for information on the data that can be returned.

The data is returned in the current Y Axis Unit of the analyzer. The command is used with a sub-opcode <n> (default=1) to specify the trace. With trace queries, it is best if the analyzer is not sweeping during the query. Therefore, it is generally advisable to be in Single Sweep, or Update=Off.

This command is used to compress or decimate a long trace to extract and return only the desired data. A typical example would be to acquire N frames of GSM data and return the mean power of the first burst in each frame. The command can also be used to identify the best curve fit for the data.

<b>Remote Command</b>	:CALCulate:DATA<n>:COMPRESS? BLOCK   CFIT   MAXimum   MINimum   MEAN   DMEan   RMS   RMSCubed   SAMPLE   SDEViation   PPHase [,<soffset> [,<length>[,<roffset>[,<rlimit>]]]]
<b>Example</b>	To query the mean power of a set of GSM bursts: Supply a signal that is a set of GSM bursts. Select the IQ Waveform measurement (in IQ Analyzer Mode). Set the sweep time to acquire at least one burst. Set the triggers such that acquisition happens at a known position relative to a burst. Then query the mean burst levels using, CALC:DATA2:COMP? MEAN, 24e-6, 526e-6 (These parameter values correspond to GSM signals, where 526e-6 is the length of the burst in the slot and you just want 1 burst.)
<b>Notes</b>	The command supports 5 parameters. Note that the last 4 (<soffset>, <length>, <roffset>, <rlimit>) are optional. But these optional parameters must be entered in the specified order. For example, if you want to specify <length>, then you must also specify <soffset>. See details below for a definition of each of these parameters.  This command uses the data in the format specified by FORMat:DATA, returning either binary or ASCII data.
<b>Initial S/W Revision</b>	Prior to A.02.00

- BLOCK or block data - returns all the data points from the region of the trace data that you specify. For example, it could be used to return the data points of an input signal over several timeslots, excluding the portions of the trace data that you do not want. (This is x,y pairs for trace data and I,Q pairs for complex data.)

- CFIT or curve fit - applies curve fitting routines to the data. <soffset> and <length> are required to define the data that you want. <roffset> is an optional parameter for the desired order of the curve equation. The query will return the following values: the x-offset (in seconds) and the curve coefficients ((order + 1) values).

MIN, MAX, MEAN, DME, RMS, RMSC, SAMP, SDEV and PPH return one data value for each specified region (or <length>) of trace data, for as many regions as possible until you run out of trace data (using <roffset> to specify regions). Or they return the number of regions you specify (using <rlimit>) ignoring any data beyond that.

- MINimum - returns the minimum data point (y value) for the specified region(s) of trace data. For I/Q trace data, the minimum magnitude of the I/Q pairs is returned.
- MAXimum - returns the maximum data point (y value) for the specified region(s) of trace data. For I/Q trace data, the maximum magnitude of the I/Q pairs is returned.
- MEAN - returns a single value that is the arithmetic mean of the data point values (in dB/ dBm) for the specified region(s) of trace data. For I/Q trace data, the mean of the magnitudes of the I/Q pairs is returned. See the following equations.

- 

**NOTE**

If the original trace data is in dB, this function returns the arithmetic mean of those log values, not log of the mean power which is a more useful value. The mean of the log is the better measurement technique when measuring CW signals in the presence of noise. The mean of the power, expressed in dB, is useful in power measurements such as Channel Power. To achieve the mean of the power, use the RMS option.

Equation 1

Mean Value of Data Points for Specified Region(s)

$$\text{MEAN} = \frac{1}{n} \sum_{X_i \in \text{region}(s)} X_i$$

where  $X_i$  is a data point value, and  $n$  is the number of data points in the specified region(s).

Equation 2

Mean Value of I/Q Data Pairs for Specified Region(s)

$$\text{MEAN} = \frac{1}{n} \sum_{X_i \in \text{region}(s)} |X_i|$$

where  $|X_i|$  is the magnitude of an I/Q pair, and  $n$  is the number of I/Q pairs in the specified region(s).

- DMEan - returns a single value that is the mean power (in dB/ dBm) of the data point values for the specified region(s) of trace data. See the following equation:

Equation 3

DMEan Value of Data Points for Specified Region(s)

$$\text{DME} = 10 \times \log_{10} \left( \frac{1}{n} \sum_{X_i \in \text{region}(s)} 10^{\frac{X_i}{10}} \right)$$

- RMS - returns a single value that is the average power on a root-mean-squared voltage scale (arithmetic rms) of the data point values for the specified region(s) of trace data. See the following equation.

**NOTE** For I/Q trace data, the rms of the magnitudes of the I/Q pairs is returned. See the following equation. This function is very useful for I/Q trace data. However, if the original trace data is in dB, this function returns the rms of the log values which is not usually needed.

Equation 4

RMS Value of Data Points for Specified Region(s)

$$\text{RMS} = \sqrt{\frac{1}{n} \sum_{X_i \in \text{region}(s)} X_i^2}$$

where  $X_i$  is a data point value, and  $n$  is the number of data points in the specified region(s).

Equation 5

RMS Value of I/Q Data Pairs for Specified Region(s)

$$\text{RMS} = \sqrt{\frac{1}{n} \sum_{X_i \in \text{region}(s)} X_i X_i^*}$$

where  $X_i$  is the complex value representation of an I/Q pair,  $X_i^*$  its conjugate complex number, and  $n$  is the number of I/Q pairs in the specified region(s).

Once you have the rms value for a region of trace data (linear or I/Q), you may want to calculate the mean power. You must convert this rms value (peak volts) to power in dBm:

$$10 \times \log[10 \times (\text{rms value})^2]$$

- SAMPlE - returns the first data value (x,y pair) for the specified region(s) of trace data. For I/Q trace data, the first I/Q pair is returned.
- SDEViation - returns a single value that is the arithmetic standard deviation for the data point values for the specified region(s) of trace data. See the following equation.
- For I/Q trace data, the standard deviation of the magnitudes of the I/Q pairs is returned. See the following equation.

Equation 6

Standard Deviation of Data Point Values for Specified Region(s)

$$\text{SDEV} = \sqrt{\frac{1}{n} \sum_{X_i \in \text{region}(s)} (X_i - \bar{X})^2}$$

where  $X_i$  is a data point value,  $\bar{X}$  is the arithmetic mean of the data point values for the specified region (s), and  $n$  is the number of data points in the specified region(s).

$$\text{SDEV} = \sqrt{\frac{1}{n} \sum_{X_i \in \text{region}(s)} (|X_i| - \bar{X})^2}$$

where  $|X_i|$  is the magnitude of an I/Q pair,  $\bar{X}$  is the mean of the magnitudes for the specified region(s), and  $n$  is the number of data points in the specified region(s).

- PPHase - returns the x,y pairs of both rms power (dBm) and arithmetic mean phase (radian) for every specified region and frequency offset (Hz). The number of pairs is defined by the specified number of regions. This parameter can be used for I/Q vector ( $n=0$ ) in Waveform (time domain) measurement and all parameters are specified by data point in PPHase.

The rms power of the specified region may be expressed as:

$$\text{Power} = 10 \times \log [10 \times (\text{RMS I/Q value})] + 10.$$

The RMS I/Q value (peak volts) is:

$$\sqrt{\frac{1}{n} \sum_{X_i \in \text{region}} X_i X_i^*}$$

where  $X_i$  is the complex value representation of an I/Q pair,  $X_i^*$  its conjugate complex number, and  $n$  is the number of I/Q pairs in the specified region.

The arithmetic mean phase of the specified region may be expressed as:

$$\frac{1}{n} \sum_{Y_i \in \text{region}} Y_i$$

where  $Y_i$  is the unwrapped phase of I/Q pair with applying frequency correction and  $n$  is the number of I/Q pairs in the specified region.

The frequency correction is made by the frequency offset calculated by the arithmetic mean of every specified region's frequency offset. Each frequency offset is calculated by the least square method against the unwrapped phase of I/Q pair.

Sample Trace Data - Constant Envelope

(See below for explanation of variables.)

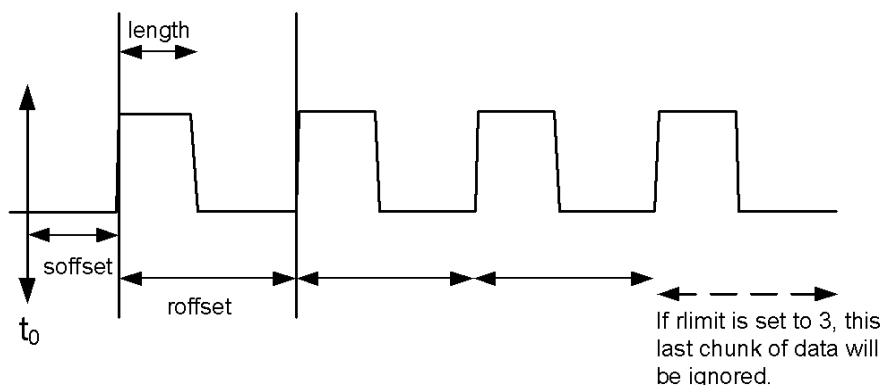

Sample Trace Data - Not Constant Envelope

(See below for explanation of variables.)

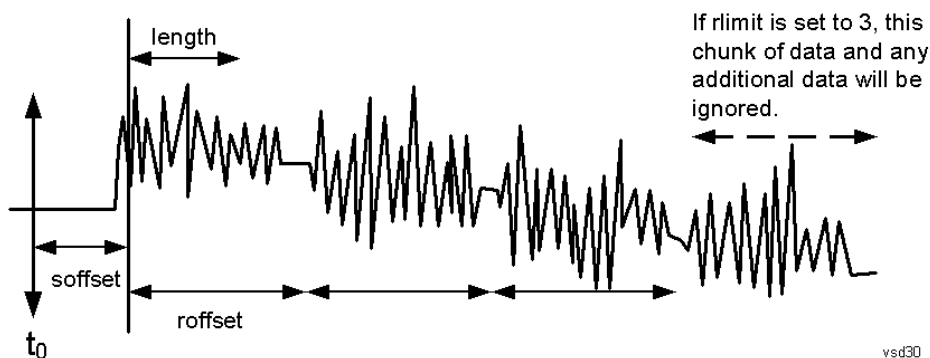

<soffset> - start offset is an optional real number. (It is in seconds for time-domain traces, and is a dimensionless index 0 to Npoints - 1, for frequency-domain traces). It specifies the amount of data at the beginning of the trace that will be ignored before the decimation process starts. It is the time or frequency change from the start of the trace to the point where you want to start using the data. The default value is zero.

<length> - is an optional real number. (It is in seconds for time-domain traces, and is a dimensionless index 0 to Npoints - 1, for frequency-domain traces). It defines how much data will be compressed into one value. This parameter has a default value equal to the current trace length.

<roffset> - repeat offset is an optional real number. (It is in seconds for time-domain traces, and is a dimensionless index 0 to Npoints - 1, for frequency-domain traces). It defines the beginning of the next field of trace elements to be compressed. This is relative to the beginning of the previous field. This parameter has a default value equal to the <length> variable. Note that this parameter is used for a completely different purpose when curve fitting (see CFIT above).

<rlimit> - repeat limit is an optional integer. It specifies the number of data items that you want returned. It will ignore any additional items beyond that number. You can use the Start offset and the Repeat limit to pick out exactly what part of the data you want to use. The default value is all the data.

## Calculate Peaks of Trace Data (Remote Command Only)

Returns a list of all the peaks for the currently selected measurement and sub-opcode [n]. The peaks must meet the requirements of the peak threshold and excursion values.

n = any valid sub-opcode for the current measurement. See the MEASure:<measurement> command description of your specific measurement for information on the data that can be returned.

The command can only be used with specific sub-opcodes with measurement results that are trace data. Both real and complex traces can be searched, but complex traces are converted to magnitude in dBm. In many measurements the sub-opcode n=0, is the raw trace data which cannot be searched for peaks. And Sub-opcode n=1, is often calculated results values which also cannot be searched for peaks.

This command uses the data setting specified by the FORMat:BORDER and FORMat:DATA commands and can return real or ASCII data. If the format is set to INT,32, it returns REAL,32 data.

The command has four types of parameters:

- Threshold (in dBm)
- Excursion (in dB)
- Sorting order (amplitude, frequency, time)
- Optional in some measurements: Display line use (all, > display line, < display line)

<b>Remote Command</b>	<p>For Swept SA measurement:</p> <pre>:CALCulate:DATA[1] 2 ... 6:PEAKs? &lt;threshold&gt;,&lt;excursion&gt;[,AMPLitude   FREQuency   TIME[,ALL   GTDLline   LTDLine]]</pre> <p>For most other measurements:</p> <pre>:CALCulate:DATA[1] 2 ... 6:PEAKs? &lt;threshold&gt;,&lt;excursion&gt;[,AMPLitude   FREQuency   TIME]</pre>
-----------------------	---------------------------------------------------------------------------------------------------------------------------------------------------------------------------------------------------------------------------------------------------------------------------------------------------------------------------------

<b>Example</b>	<p>Example for Swept SA measurement in Spectrum Analyzer Mode:</p> <p>CALC:DATA4:PEAK? -40, 10, FREQ, GTDL This will identify the peaks of trace 4 that are above -40 dBm, with excursions of at least 10 dB. The peaks are returned in order of increasing frequency, starting with the lowest frequency. Only the peaks that are above the display line are returned.</p> <p>Query Results 1:</p> <p>With FORMat:DATA REAL, 32 selected, it returns a list of floating-point numbers. The first value in the list is the number of peak points that are in the following list. A peak point consists of two values: a peak amplitude followed by its corresponding frequency (or time).</p> <p>If no peaks are found the peak list will consist of only the number of peaks, (0).</p>
----------------	-----------------------------------------------------------------------------------------------------------------------------------------------------------------------------------------------------------------------------------------------------------------------------------------------------------------------------------------------------------------------------------------------------------------------------------------------------------------------------------------------------------------------------------------------------------------------------------------------------------------------------------------------------------------------------------------------------------------------------------------------------------------------------------------

<b>Notes</b>	<p>&lt;n&gt; - is the trace that will be used</p> <p>&lt;threshold&gt; - is the level below which trace data peaks are ignored. Note that the threshold value is required and is always used as a peak criterion. To effectively disable the threshold criterion for this command, provide a substantially low threshold value such as -200 dBm. Also note that the threshold value used in this command is independent of and has no effect on the threshold value stored under the Peak Criteria menu.</p> <p>&lt;excursion&gt; - is the minimum amplitude variation (rise and fall) required for a signal to be identified as peak. Note that the excursion value is required and is always used as a peak criterion. To effectively disable the excursion criterion for this command, provide the minimum value of 0.0 dB. Also note that the excursion value used in this command is independent of and has no effect on the</p>
--------------	---------------------------------------------------------------------------------------------------------------------------------------------------------------------------------------------------------------------------------------------------------------------------------------------------------------------------------------------------------------------------------------------------------------------------------------------------------------------------------------------------------------------------------------------------------------------------------------------------------------------------------------------------------------------------------------------------------------------------------------------------------------------------------------------------------------------------------------------------------------------------------------------------------------------------------------

---

excursion value stored under the Peak Criteria menu.

Values must be provided for threshold and excursion. The sorting and display line parameters are optional (defaults are AMPLitude and ALL).

Note that there is always a Y-axis value for the display line, regardless of whether the display line state is on or off. It is the current Y-axis value of the display line which is used by this command to determine whether a peak should be reported

Sorting order:

AMPLitude - lists the peaks in order of descending amplitude, with the highest peak first (default if optional parameter not sent)

FREQuency - lists the peaks in order of occurrence, left to right across the x-axis.

TIME - lists the peaks in order of occurrence, left to right across the x-axis.

Peaks vs. Display Line:

ALL - lists all of the peaks found (default if optional parameter not sent).

GTDLine (greater than display line) - lists all of the peaks found above the display line.

LTDLine (less than display line) - lists all of the peaks found below the display line.

---

Initial S/W Revision      Prior to A.02.00

---

### Format Data: Numeric Data (Remote Command Only)

This command specifies the format of the trace data input and output. It specifies the formats used for trace data during data transfer across any remote port. It affects only the data format for setting and querying trace data for the :TRACe[:DATA], TRACe[:DATA]?, :CALCulate:DATA[n]? and FETCh:SANalyzer [n]? commands and queries.

---

**Remote Command**      :FORMat [:TRACe] [:DATA] ASCii|INTeger,32|REAL,32 |REAL,64  
:FORMat [:TRACe] [:DATA] ?

---

**Notes**      The query response is:  
ASCii: ASC,8  
REAL,32: REAL,32  
REAL,64: REAL,64  
INTeger,32: INT,32

When the numeric data format is REAL or ASCii, data is output in the current Y Axis unit. When the data format is INTeger, data is output in units of m dBm (.001 dBm).

The INT,32 format returns binary 32-bit integer values in internal units (m dBm), in a definite length block.

---

**Dependencies**      Sending a data format spec with an invalid number (for example, INT,48) generates no error. The analyzer simply uses the default (8 for ASCii, 32 for INTeger, 32 for REAL).

Sending data to the analyzer which does not conform to the current FORMat specified, results in an error. Sending ASCII data when a definite block is expected generates message -161 "Invalid Block Data" and sending a definite block when ASCII data is expected generates message -121 "Invalid Character in Number".

---

**Preset**      ASCii

---

**Backwards Compatibility Notes**      Note that the INT,32 format is only applicable to the command, TRACe:DATA. This preserves backwards compatibility for the Swept SA measurement. For all other commands/queries which honor FORMat:DATA, if INT,32 is sent the analyzer will behave as though it were set to REAL,32.

---

Initial S/W Revision      Prior to A.02.00

---



The specs for each output type follow:

ASCIi - Amplitude values are in ASCII, in the current Y Axis Unit, one ASCII character per digit, values separated by commas, each value in the form:

SX.YYYYYEsZZ

Where:

S = sign (+ or -)

X = one digit to left of decimal point

Y = 5 digits to right of decimal point

E = E, exponent header

s = sign of exponent (+ or -)

ZZ = two digit exponent

REAL,32 - Binary 32-bit real values in the current Y Axis Unit, in a definite length block.

REAL,64 - Binary 64-bit real values in the current Y Axis Unit, in a definite length block.

### Format Data: Byte Order (Remote Command Only)

This command selects the binary data byte order for data transfer and other queries. It controls whether binary data is transferred in normal or swapped mode. This command affects only the byte order for setting and querying trace data for the :TRACe[:DATA], TRACe[:DATA]? , :CALCulate:DATA[n]? and FETCh:SANalyzer[n]? commands and queries.

By definition any command that says it uses FORMat:DATA uses any format supported by FORMat:DATA.

The NORMal order is a byte sequence that begins with the most significant byte (MSB) first, and ends with the least significant byte (LSB) last in the sequence: 1|2|3|4. SWAPPed order is when the byte sequence begins with the LSB first, and ends with the MSB last in the sequence: 4|3|2|1.

<b>Remote Command</b>	:FORMat:BORDER NORMal SWAPPed :FORMat:BORDER?
<b>Preset</b>	NORMal
<b>Initial S/W Revision</b>	Prior to A.02.00

## Meas Setup

Displays the setup menu for the currently selected measurement.

Key Path	Front panel key
Initial S/W Revision	Prior to A.02.00

### Avg/Hold Number

Sets the number of data acquisitions that will be averaged. After the specified number of average counts, the averaging mode (terminal control) setting determines the averaging action.

Key Path	Meas Setup
Mode	1xEVDO
<b>Remote Command</b>	[:SENSe]:RHO:MS:AVERAge:COUNT <integer> [:SENSe]:RHO:MS:AVERAge:COUNT? [:SENSe]:RHO:MS:AVERAge[:STATe] OFF ON 0 1 [:SENSe]:RHO:MS:AVERAge[:STATe]?
<b>Example</b>	:RHO:MS:AVER:COUN 15 :RHO:MS:AVER OFF
Notes	Turn averaging on or off.
Preset	10 ON
State Saved	Saved in instrument state.
Range	1 to 10000
Min	1
Max	10000
<b>Backwards Compatibility SCPI</b>	[:SENSe]:TRHO:AVERAge:COUNT
Initial S/W Revision	Prior to A.02.00

### Avg Mode

Selects the type of termination control used for the averaging function. This determines the averaging action after the specified number of data acquisitions (average count) is reached.

KEYExponential averaging	When Measure is set at Cont, data acquisitions will continue indefinitely.
SCPIEXPonential	After N averages, exponential averaging is used with a weighting factor of N (the displayed average count stops at N). Exponential averaging weights new data more than old data, which allows tracking of slow-changing signals.

KEYRepeat averaging SCPIREPEAT	When Measure is set at Cont, data acquisitions will continue indefinitely. After N averages is reached, all previous result data is cleared and the average count is set back to 1. This is equivalent to being in Measure Single and pressing the Restart key when the Single measurement finishes.
-----------------------------------	------------------------------------------------------------------------------------------------------------------------------------------------------------------------------------------------------------------------------------------------------------------------------------------------------

Key Path	Meas Setup
Mode	1xEVDO
<b>Remote Command</b>	[ :SENSe ] :RHO:MS:AVERAge:TCONtrol EXPonential REPEAT [ :SENSe ] :RHO:MS:AVERAge:TCONtrol?
<b>Example</b>	:RHO:MS:AVER:TCON EXP
Preset	EXP
State Saved	Saved in instrument state.
Range	Exp   Repeat
<b>Backwards Compatibility SCPI</b>	[ :SENSe ] :TRHO:AVERAge:TCONtrol
Initial S/W Revision	Prior to A.02.00

## Avg Slots

Selects the averaging slots within capture length. In Mod Accuracy measurement, Capture length is 1 slot. This setting can switch the results in Peak/Avg Metrics view. The result in I/Q Measured Polar Graph view, I/Q Error view and Code Domain Power view is a snapshot with selected slots by Meas Offset. If Meas Offset is set to 0, the user can see the result with first half slot in these views.

Key Path	Meas Setup
Mode	1xEVDO
<b>Remote Command</b>	[ :SENSe ] :RHO:MS:AVERAge:SLOT HS1   HS2   FS [ :SENSe ] :RHO:MS:AVERAge:SLOT?
<b>Example</b>	:RHO:MS:AVER:SLOT FS
Preset	HS1
State Saved	Saved in instrument state.
Range	1st Half Slot   2nd Half Slot   full slot
<b>Backwards Compatibility SCPI</b>	[ :SENSe ] :TRHO:AVERAge:SLOT
Initial S/W Revision	Prior to A.02.00

### Peak/Avg Metrics

Provides a table of magnitude error, phase error, EVM, and the modulation accuracy summary data such as rho, peak and rms EVM, peak Modulation Accuracy (Rho) error, magnitude error, phase error, and so forth in a text window, in terms of averaged and detected peak/maximum value in the average cycle.

- Average : The value averaged in average cycle
- Peak Hold : The value detected and hold as Peak/Maximum in average cycle

In this view, “F” shows failure to setting limit.

<b>Example</b>	:DISP:RHO:MS:VIEW TABL
Initial S/W Revision	Prior to A.02.00



Figure 0-2 Peak/Avg Metrics View(Subtype0/1)

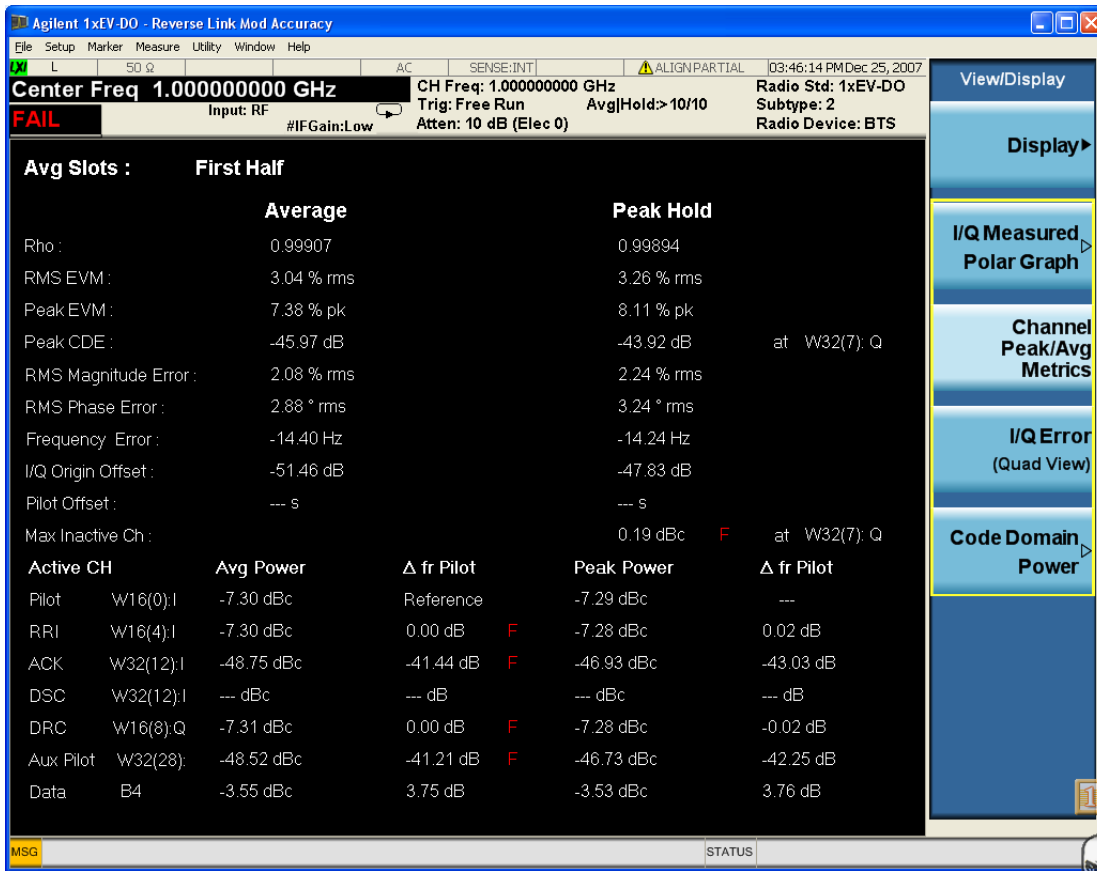

Figure 0-3 Peak/Avg Metrics View(Subtype2/3)

Parameter Name	Corresponding Results	Display Format
Rho	n=1 7th and n=9 7th (Average) n=10 7th (Peak Hold) rho	9.99999
RMS EVM	n=1 1st and n=9 1st (Average) n=10 1st (Peak Hold) EVM over the entire measurement area	99.99 %
Peak EVM	n=9 2nd (Average) n=1 2nd and n=10 2nd (Peak Hold) Peak EVM in the measurement area	99.99 %
Peak CDE	n=9 8th (Average) n=1 8th and n=10 8th (Peak Hold) Peak Code Domain Error relative to the mean power	99.99 dB
Pk CDE (Ch No.)	n=1 9th and n=10 9th The channel number in which the peak code domain error is detected.	WX(Y):Phase X: Walsh Code length (2 .. 32) 2: 614.4ksps ... 32:38.4ksps

		Y: Walsh code number (0 .. X-1) Phase: I or Q
RMS Magnitude Error	n=1 3rd and n=9 3rd (Average) n=10 3rd (Peak Hold) Magnitude error over the entire measurement area	99.99 % rms
RMS Phase Error	n=1 4th and n=9 4th (Average) n=10 4th (Peak Hold) Phase error over the entire measurement area	99.99 °rms
Freq Error	n=1 6th and n=9 6th (Average) n=10 6th (Peak Hold) Frequency error in the measured signal	99.99 Hz
I/Q Origin Offset	n=1 5th and n=9 5th (Average) n=10 5th (Peak Hold) I and Q error (magnitude squared) offset from the origin	99.99 dB
Pilot Offset	n=1 11th and n=9 11th (Average) n=10 11th (Peak Hold) Pilot phase timing from the acquisition trigger point.	9999.99 us
Max Inactive Ch (dB)	n=1 12th and n=10 12th Max Inactive Code Domain power	99.99 dBc
Pilot & RRI Power (Subtype 0/1)	n=9 29th (Average) n=10 29th (Peak Hold) Pilot Power	99.99 dB
Pilot Power (Subtype 2/3)	n=9 13th (Average) n=10 13th (Peak Hold) Pilot Power	99.99 dB
RRI Channel Power	n=9 14th (Average) n=10 14th (Peak Hold) RRI Channel Power	99.99 dB
$\Delta$ RRI/Pilot (Subtype 0/1)	n=1 13th and n=9 15th (Average) n=10 15th (Peak Hold) RRI ch relative power to Pilot Ch	99.99 dB
RRI Channel Relative Power to Pilot (Subtype 2/3)	n=1 13th and n=9 15th (Average) n=10 15th (Peak Hold) RRI ch relative power to Pilot Ch	99.99 dB
ACK Channel Power	n=9 18th (Average) n=10 18th (Peak Hold) ACK Channel Power	99.99 dB

ACK Channel Relative Power to Pilot	n=1 14th and n=9 19th (Average) n=10 19th (Peak Hold) ACK ch relative power to Pilot Ch	99.99 dB
DSC Channel Power	n=9 30th (Average) n=10 30th (Peak Hold) DSC Channel Power	99.99 dB
DSC Channel Relative Power to Pilot	n=1 22nd and n=9 31st (Average) n=10 31st (Peak Hold) DSC ch relative power to Pilot Ch	99.99 dB
DRC Channel Power	n=9 16th (Average) n=10 16th (Peak Hold) DRC Channel Power	99.99 dB
DRC Channel Relative Power to Pilot	n=1 15th and n=9 17th (Average) n=10 17th (Peak Hold) DRC ch relative power to Pilot Ch	99.99 dB
Data Channel Power (W4 (2))	n=9 20th (Average) n=10 20th (Peak Hold) DataChannel Power on W4(2)	99.99 dB
Data Channel Relative Power (W4(2))to Pilot	n=1 16th and n=9 21st (Average) n=10 21st (Peak Hold) Data ch relative power on W4(2) to Pilot Ch	99.99 dB
Data Channel Power (W2 (1))	n=9 20th (Average) n=10 20th (Peak Hold) Data Channel Power on W2(1)	99.99 dB
Data Channel Relative Power (W2(1))to Pilot	n=1 16th and n=9 21st (Average) n=10 21st (Peak Hold) Data ch relative power on W2(1)to Pilot Ch	99.99 dB
Auxiliary Pilot Channel Power	n=9 26th (Average) n=10 26th (Peak Hold) Auxiliary Pilot Channel Power	99.99 dB
Auxiliary Pilot Channel Relative Power to Pilot	n=1 19th and n=9 27th (Average) n=10 27th (Peak Hold) Auxiliary Pilot ch relative power to Pilot Ch	99.99 dB

### RMS EVM (Composite) [Subtype 0/1]

Sets the limit for composite RMS EVM measurement result with Subtype 0/1.

Key Path	Meas Setup, Limits
----------	--------------------

Mode	1xEVDO
<b>Remote Command</b>	:CALCulate:RHO:MS:LIMit:RMS[:SUB0] <real> :CALCulate:RHO:MS:LIMit:RMS[:SUB0]?
<b>Example</b>	:CALC:RHO:MS:LIM:RMS 25
Preset	50
State Saved	Saved in instrument state.
Range	0 to 100
Min	0.0
Max	100
<b>Backwards Compatibility SCPI</b>	:CALCulate:TRHO:LIMit:RMS[:SUB0]
Initial S/W Revision	Prior to A.02.00

### Peak EVM (Composite) [Subtype 0/1]

Sets the limit for composite peak EVM measurement result with Subtype 0/1

Key Path	Meas Setup, Limits
Mode	1xEVDO
<b>Remote Command</b>	:CALCulate:RHO:MS:LIMit:PEAK[:SUB0] <real> :CALCulate:RHO:MS:LIMit:PEAK[:SUB0]?
<b>Example</b>	:CALC:RHO:MS:LIM:PEAK 125
Preset	100
State Saved	Saved in instrument state.
Range	0 to 200
Min	0.0
Max	200
<b>Backwards Compatibility SCPI</b>	:CALCulate:TRHO:LIMit:PEAK[:SUB0]
Initial S/W Revision	Prior to A.02.00

### Rho (Composite) [Subtype 0/1]

Sets the limit for composite Rho measurement result with Subtype 0/1.

Key Path	Meas Setup, Limits
Mode	1xEVDO
<b>Remote Command</b>	:CALCulate:RHO:MS:LIMit:RHO[:SUB0] <real> :CALCulate:RHO:MS:LIMit:RHO[:SUB0]?



<b>Example</b>	:CALC:RHO:MS:LIM:RHO 0.955
Preset	0.94400
State Saved	Saved in instrument state.
Range	0 to 1
Min	0
Max	1
<b>Backwards Compatibility SCPI</b>	:CALCulate:TRHO:LIMit:RHO[:SUB0]
Initial S/W Revision	Prior to A.02.00

### Peak Code Domain Error [Subtype 0/1]

Sets the Peak Code Domain Error limit in dB with Subtype 0/1.

Key Path	Meas Setup, Limits
Mode	1xEVDO
<b>Remote Command</b>	:CALCulate:RHO:MS:LIMit:CDERror[:SUB0] <real> :CALCulate:RHO:MS:LIMit:CDERror[:SUB0]?
<b>Example</b>	:CALC:RHO:MS:LIM:CDER -20
Preset	0.0
State Saved	Saved in instrument state.
Range	-100 to 0
Min	-100
Max	0
<b>Backwards Compatibility SCPI</b>	:CALCulate:TRHO:LIMit:CDERror[:SUB0]
Initial S/W Revision	Prior to A.02.00

### Frequency Error [Subtype 0/1]

Sets the Frequency Error limit with Subtype 0/1.

Key Path	Meas Setup, Limits
Mode	1xEVDO
<b>Remote Command</b>	:CALCulate:RHO:MS:LIMit:FERRor[:SUB0] <real> :CALCulate:RHO:MS:LIMit:FERRor[:SUB0]?
<b>Example</b>	:CALC:RHO:MS:LIM:FERR 500
Preset	300

State Saved	Saved in instrument state.
Range	0 Hz to 10kHz
Min	0
Max	10000
<b>Backwards Compatibility SCPI</b>	:CALCulate:TRHO:LIMit:FERRor[:SUB0]
Initial S/W Revision	Prior to A.02.00

### Pilot Offset [Subtype 0/1]

Sets the limit for pilot offset time from the trigger timing with Subtype 0/1.

Key Path	Meas Setup, Limits
Mode	1xEVDO
<b>Remote Command</b>	:CALCulate:RHO:MS:LIMit:POFFset[:SUB0] <real> :CALCulate:RHO:MS:LIMit:POFFset[:SUB0]?
<b>Example</b>	:CALC:RHO:MS:LIM:POFF 0.2us
Preset	1 us
State Saved	Saved in instrument state.
Range	0 to 100.0 ms
Min	0
Max	0.1
<b>Backwards Compatibility SCPI</b>	:CALCulate:TRHO:LIMit:POFFset[:SUB0]
Initial S/W Revision	Prior to A.02.00

### Inactive CDP [Subtype 0/1]

Sets the limit for inactive channel code domain power measurement result with Subtype 0/1.

Key Path	Meas Setup, Limits, More 1 of 2
Mode	1xEVDO
<b>Remote Command</b>	:CALCulate:RHO:MS:LIMit:ICDPower[:SUB0] <real> :CALCulate:RHO:MS:LIMit:ICDPower[:SUB0]?
<b>Example</b>	:CALC:RHO:MS:LIM:ICDP -30
Preset	-23
State Saved	Saved in instrument state.
Range	-100 to 0

Min	-100
Max	0
<b>Backwards Compatibility SCPI</b>	:CALCulate:TRHO:LIMit:ICDPower[:SUB0]
Initial S/W Revision	Prior to A.02.00

### RRI/Pilot Power Tolerance [Subtype 0/1]

Sets the tolerance for RRI (reverse rate indicator) and pilot power ratio measurement result for Subtype 0/1.

Key Path	Meas Setup, Limits, More 1 of 2
Mode	1xEVDO
<b>Remote Command</b>	:CALCulate:RHO:MS:LIMit:RRI[:SUB0] <real> :CALCulate:RHO:MS:LIMit:RRI[:SUB0]?
<b>Example</b>	:CALC:RHO:MS:LIM:RRI 0.35
Preset	0.25
State Saved	Saved in instrument state.
Range	0 dB to 3.00 dB
Min	0
Max	3.00
<b>Backwards Compatibility SCPI</b>	:CALCulate:TRHO:LIMit:RRI[:SUB0]
Initial S/W Revision	Prior to A.02.00

### Active CDP Tolerance [Subtype 0/1]

Sets the tolerance for each active code domain power level with its channel gain defined by DRC Chan Gain, ACK Chan Gain, or Data Chan Gain, respectively for Subtype 0/1. The range is 0.00 to 3.00 dB.

Key Path	Meas Setup, Limits, More 1 of 2
Mode	1xEVDO
<b>Remote Command</b>	:CALCulate:RHO:MS:LIMit:ACDPower[:SUB0] <real> :CALCulate:RHO:MS:LIMit:ACDPower[:SUB0]?
<b>Example</b>	:CALC:RHO:MS:LIM:ACDP 0.35
Preset	0.25
State Saved	Saved in instrument state.
Range	0 dB to 3.00 dB
Min	0

Max	3.00
<b>Backwards Compatibility SCPI</b>	:CALCulate:TRHO:LIMit:ACDPower[:SUB0]
Initial S/W Revision	Prior to A.02.00

### DRC Channel Gain [Subtype 0/1]

Sets the power gain level of the DRC (data rate control) channel relative to the pilot channel power level for Subtype 0/1.

Key Path	Meas Setup, Limits, More 1 of 2
Mode	1xEVDO
<b>Remote Command</b>	:CALCulate:RHO:MS:LIMit:DRC:GAIN[:SUB0] <real> :CALCulate:RHO:MS:LIMit:DRC:GAIN[:SUB0]?
<b>Example</b>	:CALC:RHO:MS:LIM:DRC:GAIN 4.2
Preset	3 dB
State Saved	Saved in instrument state.
Range	-10 dB to 10 dB
Min	-10
Max	10
<b>Backwards Compatibility SCPI</b>	:CALCulate:TRHO:LIMit:DRC:GAIN[:SUB0]
Initial S/W Revision	Prior to A.02.00

### ACK Channel Gain [Subtype 0/1]

Setsthe power gain level of the ACK (acknowledge) channel relative to the pilot channel power level for Subtype 0/1. The range is -10.00 to 10.00 dB.

Key Path	Meas Setup, Limits, More 1 of 2
Mode	1xEVDO
<b>Remote Command</b>	:CALCulate:RHO:MS:LIMit:ACK:GAIN[:SUB0] <real> :CALCulate:RHO:MS:LIMit:ACK:GAIN[:SUB0]?
<b>Example</b>	:CALC:RHO:MS:LIM:ACK:GAIN 4.2
Preset	3
State Saved	Saved in instrument state.
Range	-10 dB to 10 dB
Min	-10
Max	10

<b>Backwards Compatibility SCPI</b>	:CALCulate:TRHO:LIMit:ACK:GAIN[:SUB0]
Initial S/W Revision	Prior to A.02.00

### Data Channel Gain [Subtype 0/1]

Sets the power gain level of the data channel relative to the pilot channel power level for Subtype 0/1. The range is 0 to 20.00 dB.

Key Path	Meas Setup, Limits, More 1 of 2
Mode	1xEVDO
<b>Remote Command</b>	:CALCulate:RHO:MS:LIMit:DATA:GAIN[:SUB0] <real> :CALCulate:RHO:MS:LIMit:DATA:GAIN[:SUB0]?
<b>Example</b>	:CALC:RHO:MS:LIM:DATA:GAIN 4.2
Preset	3.75
State Saved	Saved in instrument state.
Range	0 dB to 20 dB
Min	0
Max	20
<b>Backwards Compatibility SCPI</b>	:CALCulate:TRHO:LIMit:DATA:GAIN[:SUB0]
Initial S/W Revision	Prior to A.02.00

### Meas Offset

Sets the number of offset slots to make a symbol power measurement.

Key Path	Meas Setup
Mode	1xEVDO
<b>Remote Command</b>	:CALCulate:RHO:MS:SWEep:OFFSet <integer> :CALCulate:RHO:MS:SWEep:OFFSet?
<b>Example</b>	:CALC:RHO:MS:SWE:OFFS 0.5
Preset	0.0
State Saved	Saved in instrument state.
Range	0.0 to 0.5
Min	0.0
Max	0.5
<b>Backwards Compatibility SCPI</b>	:CALCulate:TRHO:SWEep:OFFSet
Initial S/W Revision	Prior to A.02.00

## Sync Type

Select the sync type, pilot or auxiliary pilot.

Key Path	Meas Setup, more 1 of 3
Mode	1xEVDO
Remote Command	[ :SENSe ] :RHO:MS:SYNC PILOt   APILOt [ :SENSe ] :RHO:MS:SYNC?
Example	:RHO:MS:SYNC APIL
Notes	It is active when subtype is 2.
Preset	PILOt
State Saved	Saved in instrument state.
Range	Pilot   Aux Pilot
Initial S/W Revision	Prior to A.02.00

## I Long Code Mask

Sets the Long Code Mask value for I axis.

Key Path	Meas Setup, More 1 of 3
Mode	1xEVDO
Remote Command	[ :SENSe ] :RHO:MS:SYNC:ILCMask <long_integer> [ :SENSe ] :RHO:MS:SYNC:ILCMask?
Example	:RHO:MS:SYNC:ILCM 1
Preset	0000000000
State Saved	Saved in instrument state.
Range	0000000000 to 4398046511103
Min	0000000000
Max	4398046511103
Backwards Compatibility SCPI	[ :SENSe ] :TRHO:SYNC:ILCMask
Initial S/W Revision	Prior to A.02.00

## Q Long Code Mask

Sets the Long Code Mask value for Q axis.

Key Path	Meas Setup, More 1 of 3
----------	-------------------------

Mode	1xEVDO
<b>Remote Command</b>	[ :SENSe ] :RHO:MS:SYNC:QLCMask <long_integer> [ :SENSe ] :RHO:MS:SYNC:QLCMask?
<b>Example</b>	:RHO:MS:SYNC:QLCM 1
Preset	00000000000
State Saved	Saved in instrument state.
Range	00000000000 to 4398046511103
Min	00000000000
Max	4398046511103
<b>Backwards Compatibility SCPI</b>	[ :SENSe ] :TRHO:SYNC:QLCMask
Initial S/W Revision	Prior to A.02.00

## Active Code Chan

This menu controls the function to identify which code channels are active:

Auto (Auto Active Channel Detection) - allows the instrument to determine Active Channels automatically. Due to algorithm limitation, when the power level is unstable, Auto performance may be unstable, as well.

Predefined - the user specifies which code channels are active manually.

Combination - the code channel selected by Predefined Active Channel is always regarded as Active and Auto Active Channel detection is performed. If Auto finds other active channels, they are also regarded as Active.

Key Path	Meas setup, more 1 of 3
Mode	1xEVDO
<b>Remote Command</b>	[ :SENSe ] :RHO:MS:ACODE AUTO COMBination PREDefined [ :SENSe ] :RHO:MS:ACODE?
<b>Example</b>	:RHO:MS:ACOD COMB
Preset	AUTO
State Saved	Saved in instrument state.
Range	Auto   Combination   Predefined
<b>Backwards Compatibility SCPI</b>	[ :SENSe ] :TRHO:ACODE
Initial S/W Revision	Prior to A.02.00

## Predefined Active Channel

Predefined Active Chan: Each channel (Pilot, DRC, RRI, ACK/DSC, Aux-Pilot or Data) can be set Active (On) or Inactive (Off). If Active Code Channel is set to Auto, each selection menu is greyed out. The specified

active channels are different due to subtype 0/1 or subtype 2.

Subtype 0/1:

- Pilot/RRI channel – Sets the pilot channel and RRI channel activation on W16(0) I phase.
- DRC channel – Sets the DRC channel activation on W16(8) Q phase.
- ACK channel – Sets the ACK channel activation on W8(4) I phase.
- Data channel – Sets the Data channel activation on W4(2) Q phase.

Subtype 2, and subtype3(NoFeedback Mux mode):

- Pilot channel – Sets the pilot channel activation on W16(0) I phase.
- DRC channel – Sets the DRC channel activation on W16(8) Q phase.
- RRI channel – Sets the RRI channel activation on W16(4) I phase.
- ACK/DSC channel – Sets the ACK channel and DSC channel activation on W32(12) I phase.
- Auxiliary Pilot channel – Sets the Auxiliary Pilot channel activation on W32(28) I phase.
- Data channel – Sets the Data channel activation. The location of Data channel is decided by modulation format. B4 is W4(2) Q phase. Q4 is W4(2). Q2 is W2(1). Q4Q2 is W4(2) and W2(1) with QPSK modulation. E4E2 is W4(2) and W2(1) with 8PSK modulation.

Key Path	Meas Setup, Active Code Chan
Initial S/W Revision	Prior to A.02.00

### Pilot/RRI Channel [Common for Subtype 0/1 , Subtype 2 and Subtype3(NFM)]

Key Path	Meas Setup, more 1 of 3, Active Code Chan, Predefined Active Chan
Mode	1xEVDO
Remote Command	[ :SENSe ] :RHO:MS:ACODE:PILot OFF ON 0 1 [ :SENSe ] :RHO:MS:ACODE:PILot?
Example	:RHO:MS:ACOD:PIL ON
Notes	This setting is valid with Active Code Chan is set to Combination or Predefined. In Subtype 2 and 3, Pilot channel and RRI channel are NOT time-multiplexed and these channels are assigned on different walsh code space. Therefore this key's label is different between Subtype 2/3 and Subtype 0/1. But SCPI command is same because this command was already used in Subtype 0/1.
Preset	ON
State Saved	Saved in instrument state.
Range	On   Off
Backwards Compatibility SCPI	[ :SENSe ] :TRHO:ACODE:PILot
Initial S/W Revision	Prior to A.02.00



### DRC Channel Definition [Common for Subtype 0/1 , Subtype 2 and Subtype3(NFM)]

Key Path	Meas Setup, more 1 of 3, Active Code Chan, Predefined Active Chan
Mode	1xEVDO
<b>Remote Command</b>	[ :SENSe ] :RHO:MS:ACODE:DRC OFF ON 0 1 [ :SENSe ] :RHO:MS:ACODE:DRC?
<b>Example</b>	:RHO:MS:ACOD:DRC ON
Notes	This setting is valid with Active Code Chan is set to Combination or Predefined.
Preset	ON
State Saved	Saved in instrument state.
Range	On   Off
<b>Backwards Compatibility SCPI</b>	[ :SENSe ] :TRHO:ACODE:DRC
Initial S/W Revision	Prior to A.02.00

### ACK Channel Definition [Subtype 0/1 only]

Key Path	Meas Setup, more 1 of 3, Active Code Chan, Predefined Active Chan
Mode	1xEVDO
<b>Remote Command</b>	[ :SENSe ] :RHO:MS:ACODE:ACK OFF ON 0 1 [ :SENSe ] :RHO:MS:ACODE:ACK?
<b>Example</b>	:RHO:MS:ACOD:ACK ON
Notes	This setting is valid with Active Code Chan is set to Combination or Predefined.
Preset	ON
State Saved	Saved in instrument state.
Range	On   Off
<b>Backwards Compatibility SCPI</b>	[ :SENSe ] :TRHO:ACODE:ACK
Initial S/W Revision	Prior to A.02.00

### Data Channel Definition [Subtype 0/1 only]

Key Path	Meas Setup, more 1 of 3, Active Code Chan, Predefined Active Chan
Mode	1xEVDO
<b>Remote Command</b>	[ :SENSe ] :RHO:MS:ACODE:DATA OFF ON 0 1 [ :SENSe ] :RHO:MS:ACODE:DATA?
<b>Example</b>	:RHO:MS:ACOD:DATA ON

Notes	This setting is valid with Active Code Chan is set to Combination or Predefined.
Preset	ON
State Saved	Saved in instrument state.
Range	On   Off
<b>Backwards Compatibility SCPI</b>	[ :SENSe ] :TRHO:ACODE:DATA
Initial S/W Revision	Prior to A.02.00

## Sync Start Slot

Before the first slot to start the measurement is depend on trigger timing or capture timing if trigger is set to Free Run.

This is a BAF key. Boolean parameter determines whether to enable synchronization start slot number specification. Sync Start Slot value is an absolute slot number in frame. When this mode is ON, first slot of result interval, which is equal to Capture Interval setting, becomes a slot of specified number.

If users use some kind of trigger, the first slot number is determined by trigger timing. The user can specify the synchronization start slot number by setting Sync Start Slot on. For example Sync start slot number is set to 5, the analysis starts from slot number 5.0. If Sync Start Slot detection mode is set to Off, keep backward compatibility and the measurement is done from trigger timing or capture timing.

Key Path	Meas Setup, More 1 of 3
Mode	1xEVDO
<b>Remote Command</b>	[ :SENSe ] :RHO:MS:SSLot:NUMBer <integer> [ :SENSe ] :RHO:MS:SSLot:NUMBer? [ :SENSe ] :RHO:MS:SSLot [ :STATe ] OFF   ON   0   1 [ :SENSe ] :RHO:MS:SSLot [ :STATe ] ?
<b>Example</b>	:RHO:MS:SSL:NUMB 5 :RHO:MS:SSL ON
Notes	Turn first slot number detection mode on or off.
Preset	0 OFF
State Saved	Saved in instrument state.
Range	0 to 15
Min	0
Max	15
<b>Backwards Compatibility SCPI</b>	[ :SENSe ] :TRHO:SSLot:NUMBer
Initial S/W Revision	Prior to A.02.00

## Capture Interval

Modulation Accuracy measure with 1 slot. So this softkey gives the information of capture length only and don't accept more than 1 slot setting.

Key Path	Meas Setup
Mode	1xEVDO
Notes	NO SCPI
Initial S/W Revision	Prior to A.02.00

## Spectrum

Set a spectrum either to Normal or Inverted for the demodulation related measurements. If set to INVert, the upper and lower spectrums are swapped.

Invert: This function conjugates the spectrum, which is equivalent to taking the negative of the quadrature component in demodulation. The correct setting (Normal or Invert) depends on whether the signal at the input of the instrument has a high or low side mix.

Key Path	Meas Setup, More 1 of 3, More 2 of 3
Mode	1xEVDO
<b>Remote Command</b>	[ :SENSe ] :RHO:MS:SPECTrum NORMal   INVert [ :SENSe ] :RHO:MS:SPECTrum?
<b>Example</b>	:RHO:MS:SPEC INV
Preset	NORMal
State Saved	Saved in instrument state.
Range	Normal   Invert
<b>Backwards Compatibility SCPI</b>	[ :SENSe ] :TRHO:SPECTrum
Initial S/W Revision	Prior to A.02.00

## Advanced

Accesses a menu of functions that enable you to set up more specific parameters for the measurement.

Key Path	Meas Setup
Initial S/W Revision	Prior to A.02.00

## EVM Result I/Q Offset

Allows you to toggle the I/Q origin offset function between Std (standard) and Exclude.

- Std : The measurement results for EVM, Rho, and Modulation Accuracy (Rho) error takes into account the I/Q origin offset.
- Exclude : The measurement results for EVM, Rho, and Modulation Accuracy (Rho) error do not take into account the I/Q origin offset, and the message “EVM excludes I/Q Offset” is displayed in the lower right-hand graph display area.

Key Path	Meas Setup, More 1 of 3, More 2 of 3, Advanced
Mode	1xEVDO
Remote Command	:CALCulate:RHO:MS:IQOffset:INCLude OFF ON 0 1 :CALCulate:RHO:MS:IQOffset:INCLude?
Example	:CALC:RHO:MS:IQOF:INCL OFF
Preset	ON
State Saved	Saved in instrument state.
Range	Std   Exclude
Backwards Compatibility SCPI	:CALCulate:TRHO:IQOffset:INCLude
Initial S/W Revision	Prior to A.02.00

## Active Set Threshold

Sets the threshold value for the active channel detection. And user can select the active channel identification function between Auto and Man. If set to Auto, the active channels are determined automatically by the internal algorithm. If it set to Man, the active channel identification is determined by a user definable threshold ranging from 0.00 to -100.0 dB.

Key Path	Meas Setup, More 1 of 3, More 2 of 3, Advanced
Mode	1xEVDO
Remote Command	:CALCulate:RHO:MS:ASET:THReshold <real> :CALCulate:RHO:MS:ASET:THReshold? :CALCulate:RHO:MS:ASET:THReshold:AUTO OFF ON 0 1 :CALCulate:RHO:MS:ASET:THReshold:AUTO?
Example	:CALC:RHO:MS:ASET:THR -20 :CALC:RHO:MS:ASET:THR:AUTO OFF
Notes	Turn the automatic mode On or Off, for the active channel identification function. OFF - The active channel identification for each code channel is determined by a value set by CALCulate:RHO:MS:ASET:THReshold. ON - The internal algorithm determines the active channels automatically.
Preset	0.0 ON
State Saved	Saved in instrument state.

Range	-100 to 0.0
Min	-100
Max	0
<b>Backwards Compatibility SCPI</b>	:CALCulate:TRHO:ASET:THReshold
Initial S/W Revision	Prior to A.02.00

## Chip Rate

Changes the Chip Rate

Key Path	Meas Setup, More 1 of 3, More 2 of 3, Advanced
Mode	1xEVDO
<b>Remote Command</b>	[ :SENSe ] :RHO:MS:CRATe <freq> [ :SENSe ] :RHO:MS:CRATe?
<b>Example</b>	:RHO:MS:CRAT 1.22 MHz
Preset	1.2288 MHz
State Saved	Saved in instrument state.
Range	1.10592 MHz to 1.35168 MHz
Min	1.10592 MHz
Max	1.35168 MHz
<b>Backwards Compatibility SCPI</b>	[ :SENSe ] :TRHO:CRATe
Initial S/W Revision	Prior to A.02.00

## Filter Alpha

Selects one of 4 complementary filters. These complementary filters are designed to have raised cosine frequency responses of slightly different roll off factors, Alpha, conjunction with a TX filter defined in the standard. The smaller the Filter Alpha is, the better the adjacent power rejection performance becomes. Default of this parameter is 0.15.

Key Path	Meas Setup, More 1 of 3, More 2 of 3, Advanced
Mode	1xEVDO
<b>Remote Command</b>	[ :SENSe ] :RHO:MS:ALPHa <real> [ :SENSe ] :RHO:MS:ALPHa?
<b>Example</b>	:RHO:MS:ALPH 0.05
Preset	0.15
State Saved	Saved in instrument state.

Range	0.05 to 0.20
Min	0.05
Max	0.20
<b>Backwards Compatibility SCPI</b>	[ :SENSe ] :TRHO:ALPHA
Initial S/W Revision	Prior to A.02.00

## IF Gain

Enable you to control an internally switched IF amplifier with approximately 10 dB of gain. When it can be turned on without an overload, the dynamic range is always better with the amplifier on than off. The IF Gain key can be used to set the IF Gain function to Auto, or to On (the extra 10 dB) or Off. These settings affect sensitivity and IF overloads.

Key Path	Meas Setup, More 1 of 3, More 2of 3, Advanced
Initial S/W Revision	Prior to A.02.00

## IF Gain Auto

Activates the auto rules for IF Gain.

Key Path	Meas Setup, More 1 of 3, More 2of 3, Advanced, IF Gain
Mode	1xEVDO
<b>Remote Command</b>	[ :SENSe ] :RHO:MS:IF:GAIN:AUTO [ :STATe ] OFF   ON   0   1 [ :SENSe ] :RHO:MS:IF:GAIN:AUTO [ :STATe ] ?
<b>Example</b>	:RHO:MS:IF:GAIN:AUTO ON
Couplings	When either the auto attenuation works (for example, with electrical attenuator), or the optimize mechanical attenuator range is requested, the IF Gain setting is changed as following rule. 'auto' sets IF Gain 'High Gain' under any of the following conditions: the input attenuator is set to 0 dB, the preamp is turned on, or the Max Mixer Level is -20 dBm or lower. For other settings, auto sets IF Gain to 'Low Gain'.
Preset	OFF
State Saved	Saved in instrument state.
Range	Off On
<b>Backwards Compatibility SCPI</b>	[ :SENSe ] :TRHO:IF:GAIN:AUTO [ :STATe ]
Initial S/W Revision	Prior to A.02.00

## IF Gain State

Selects the range of IF Gain.

Key Path	Meas Setup, More 1 of 3, More 2of 3, Advanced, IF Gain
Mode	1xEVDO
<b>Remote Command</b>	<code>[ :SENSe ] :RHO:MS:IF:GAIN [ :STATe ] OFF   ON   0   1</code> <code>[ :SENSe ] :RHO:MS:IF:GAIN [ :STATe ] ?</code>
<b>Example</b>	<code>:RHO:MS:IF:GAIN:AUTO ON</code>
Notes	Where ON = high gain OFF = low gain
Couplings	When either the auto attenuation works (for example, with electrical attenuator), or the optimize mechanical attenuator range is requested, the IF Gain setting is changed as following rule. 'auto' sets IF Gain 'High Gain' under any of the following conditions: the input attenuator is set to 0 dB, the preamp is turned on, or the Max Mixer Level is -20 dBm or lower. For other settings, auto sets IF Gain to 'Low Gain'.
Preset	OFF
State Saved	Saved in instrument state.
Range	Low Gain (Best for Large Signals) High Gain (Best Noise Level)
Readback Text	Low Gain   High Gain
<b>Backwards Compatibility SCPI</b>	<code>[ :SENSe ] :TRHO:IF:GAIN [ :STATe ]</code>
Initial S/W Revision	Prior to A.02.00

## Multi Channel Estimator

Allows you to toggle the multi channel estimator function between On and Off.

- On: The individual code channels are aligned to the pilot channel to improve the phase error (whether each code phase is aligned or not). This takes longer to accomplish.
- Off: The phase information is computed from one coded signal only. (The phase of each code channel needs to be aligned to the pilot channel.)

Key Path	Meas Setup, More 1 of 3, More 2 of 3, Advanced, More 1 of 2
Mode	1xEVDO
<b>Remote Command</b>	<code>[ :SENSe ] :RHO:MS:MCEstimator OFF   ON   0   1</code> <code>[ :SENSe ] :RHO:MS:MCEstimator ?</code>
<b>Example</b>	<code>:RHO:MS:MCES ON</code>
Preset	OFF
State Saved	Saved in instrument state.
Range	On   Off
<b>Backwards Compatibility SCPI</b>	<code>[ :SENSe ] :TRHO:MCEstimator</code>
Initial S/W Revision	Prior to A.02.00

## Timing Estimation

Selects timing estimation function between channel-by-channel and global.

- Channel-by-Channel: The individual code channels are estimated as each timing. This takes a longer time.
- Global: The individual code channels are estimated as global timing.

Key Path	Meas Setup, More 1 of 3, More 2 of 3, Advanced, More 1 of 2
Mode	1xEVDO
Remote Command	[ :SENSe ] :RHO:MS:MCEstimator:TIMing CHANnel   GLOBal [ :SENSe ] :RHO:MS:MCEstimator:TIMing?
Example	:RHO:MS:MCES:TIM CHAN
Preset	GLOBal
State Saved	Saved in instrument state.
Range	CHANnel   GLOBal
Backwards Compatibility SCPI	[ :SENSe ] :TRHO:MCEstimator:TIMing
Initial S/W Revision	Prior to A.02.00

## Freq Error Tolerance Range

Frequency error tolerance range is specified:

- Narrow
- Normal
- Wide

‘Wide’ provides the wide range of the frequency error tolerance. But the more complex signal to demodulate correctly, the less frequency tolerance range is required. For example, composite number of channels is modulated on the test signal, the modulation is complex, and frequency error is very critical to demodulate correctly. Therefore, In such a case, to demodulate complex signal, it needs to set ‘Narrow’. “Wide” parameter makes improvement for the frequency error tolerance range and “Narrow” parameter does the sensitivity for synchronization. Therefore the measurement speed is trade off these functionalities. “Normal” parameter focuses the measurement speed. The default is “Normal”. User selects the suitable parameter depending on the using signal condition.

Key Path	Meas Setup, More 1 of 3, More 2 of 3, Advanced, More 1 of 2
Mode	1xEVDO
Remote Command	[ :SENSe ] :RHO:MS:FERRor:TRANge NARRow   NORMal   WIDE [ :SENSe ] :RHO:MS:FERRor:TRANge?



<b>Example</b>	:RHO:MS:FERR:TRAN NARR
Preset	NORMal
State Saved	Saved in instrument state.
Range	Narrow   Normal   Wide
<b>Backwards Compatibility SCPI</b>	[ :SENSe ] :TRHO:FERRor:TRANge
Initial S/W Revision	Prior to A.02.00

## Meas Preset

This key allows users to restore all the measurement settings to their defaults.

This will set the measure setup parameters for the currently selected measurement only, to the factory defaults.

Key Path	Meas Setup
Mode	1xEVDO
<b>Remote Command</b>	:CONFigure:RHO:MS
<b>Example</b>	:CONFigure:RHO:MS
Couplings	Selecting measurement preset will restore all measurement parameters to their default values for the current measurement.
<b>Backwards Compatibility SCPI</b>	:CONFigure:TRHO
Initial S/W Revision	Prior to A.02.00

18 Reverse Link Modulation Accuracy  
Mode

Mode

See "[Mode](#)" on page 318

## Mode Preset

Returns the active mode to a known state.

Mode Preset does the following for the currently active mode:

- Aborts the currently running measurement.
- Brings up the default menu for the mode, with no active function.
- Sets measurement Global settings to their preset values for the active mode only.
- Activates the default measurement.
- Brings up the default menu for the mode.
- Clears the input and output buffers.
- Sets Status Byte to 0.

Mode Preset does not:

- Cause a mode switch
- Affect mode persistent settings
- Affect system settings

See "[How-To Preset](#)" on page 2368 for more information.

Key Path	Front-panel key
<b>Remote Command</b>	:SYSTem:PRESet
<b>Example</b>	:SYST:PRES
Notes	*RST is preferred over :SYST:PRES for remote operation. *RST does a Mode Preset, as done by the :SYST:PRES command, and it sets the measurement mode to Single measurement rather than Continuous for optimal remote control throughput. Clears all pending OPC bits. The Status Byte is set to 0.
Couplings	A Mode Preset aborts the currently running measurement, activates the default measurement, and gets the mode to a consistent state with all of the default couplings set.
Backwards Compatibility Notes	In the X-Series, the legacy "Factory Preset" has been replaced with Mode Preset, which only presets the currently active mode, not the entire instrument. In the X-Series, the way to preset the entire instrument is by using System, Restore System Defaults All, which behaves essentially the same way as restore System Defaults does on ESA and PSA. There is also no "Preset Type" as there is on the PSA. There is a green Mode Preset front-panel key that does a Mode Preset and a white-with-green-letters User Preset front-panel key that does a User Preset. The old PRESet:TYPE command is ignored (without generating an error), and SYST:PRES without a parameter does a Mode Preset, which should cover most backward code compatibility issues. The settings and correction data under the Input/Output front-panel key (examples: Input Z Corr, Ext Amp Gain, etc.) are no longer part of any Mode, so they will not be preset by a Mode Preset. They are preset using Restore Input/Output Defaults, Restore System Defaults All. Note that because User Preset does a Recall State, and all of these settings are saved in State, they ARE recalled when using

	User Preset.
Initial S/W Revision	Prior to A.02.00

## How-To Preset

The table below shows all possible presets, their corresponding SCPI commands and front-panel access (key paths). Instrument settings depend on the current measurement context. Some settings are local to the current measurement, some are global (common) across all the measurements in the current mode, and some are global to all the available modes. In a similar way, restoring the settings to their preset state can be done within the different contexts.

Auto Couple - is a measurement local key. It sets all Auto/Man parameter couplings in the measurement to Auto. Any Auto/Man selection that is local to other measurements in the mode will not be affected.

Meas Preset - is a measurement local key. Meas Preset resets all the variables local to the current measurement except the persistent ones.

Mode Preset - resets all the current mode's measurement local and measurement global variables except the persistent ones.

Restore Mode Defaults - resets ALL the Mode variables (and all the Meas global and Meas local variables), including the persistent ones.

Type Of Preset	SCPI Command	Front Panel Access
Auto Couple	:COUPle ALL	Auto Couple front-panel key
Meas Preset	:CONFigure:<Measurement>	Meas Setup Menu
Mode Preset	:SYSTem:PRESet	Mode Preset (green key)
Restore Mode Defaults	:INSTrument:DEFault	Mode Setup Menu
Restore All Mode Defaults	:SYSTem:DEFault MODes	System Menu; Restore System Default Menu
*RST	*RST	not possible (Mode Preset with Single)
Restore Input/Output Defaults	:SYSTem:DEFault INPUt	System Menu; Restore System Default Menu
Restore Power On Defaults	:SYSTem:DEFault PON	System Menu; Restore System Default Menu
Restore Alignment Defaults	:SYSTem:DEFault ALIGN	System Menu; Restore System Default Menu
Restore Miscellaneous Defaults	:SYSTem:DEFault MISC	System Menu; Restore System Default Menu
Restore All System Defaults	:SYSTem:DEFault [ALL] :SYSTem:PRESet:PERsistent	System Menu; Restore System Default Menu
User Preset	:SYSTem:PRESet:USER	User Preset Menu
User Preset All Modes	:SYSTem:PRESet:USER:ALL	User Preset Menu

Power On Mode Preset	:SYSTem:PON:TYPE MODE	System Menu
Power On User Preset	:SYSTem:PON:TYPE USER	System Menu
Power On Last State	:SYSTem:PON:TYPE LAST	System Menu

### Preset Type (Remote Command Only)

As stated in the Backward Compatibility section, to be compatible with ESA/PSA the PRESet:TYPE command will be implemented as a no-op.

Mode	All
<b>Remote Command</b>	:SYSTem:PRESet:TYPE FACTory MODE USER :SYSTem:PRESet:TYPE?
<b>Example</b>	:SYST:PRESet:TYPE FACT
Notes	This command is supported for backward compatibility only. It is a no-op which does not change the behavior of any preset operation.
Preset	This is unaffected by Preset but is set to Mode on a “Restore System Defaults->All”
State Saved	No
Initial S/W Revision	Prior to A.02.00

18 Reverse Link Modulation Accuracy  
Mode Setup

## Mode Setup

See "[Mode Setup](#)" on page 348

## Peak Search

Accesses a menu that enables you to control the peak search function and places a marker on the trace point with highest peak.

Places the selected marker on the trace point with the maximum y-axis value for that marker's trace.

Key Path	Front panel key
Mode	1XEVD0
<b>Remote Command</b>	:CALCulate:RHO:MS:MARKer[1] 2 ...12:MAXimum
<b>Example</b>	CALC:RHO:MS:MARK2:MAX
<b>Backwards Compatibility SCPI</b>	:CALCulate:TRHO:MARKer[1] 2 ...4:MAXimum
Initial S/W Revision	Prior to A.02.00

## Next Peak

Moves the selected marker to the peak that has the next highest amplitude less than the marker's current value.

Key Path	Peak Search
Mode	1xEVD0
<b>Remote Command</b>	:CALCulate:RHO:MS:MARKer[1] 2 ...12:MAXimum:NEXT
<b>Example</b>	CALC:RHO:MS:MARK2:MAX:NEXT
<b>Backwards Compatibility SCPI</b>	:CALCulate:TRHO:MARKer[1] 2 ...4:MAXimum:NEXT
Initial S/W Revision	Prior to A.02.00

## Next Pk Right

Moves the selected marker to the nearest peak right of the current marker which meets all enabled peak criteria.

Key Path	Peak Search
Mode	1xEVD0
<b>Remote Command</b>	:CALCulate:RHO:MS:MARKer[1] 2 ...12:MAXimum:RIGHT
<b>Example</b>	CALC:RHO:MS:MARK2:MAX:RIGH
<b>Backwards Compatibility SCPI</b>	:CALCulate:TRHO:MARKer[1] 2 ...4:MAXimum:RIGHT
Initial S/W Revision	Prior to A.02.00

## Next Pk Left

Moves the selected marker to the nearest peak left of the current marker which meets all enabled peak criteria.

Key Path	Peak Search
Mode	1XEVD0
<b>Remote Command</b>	:CALCulate:RHO:MS:MARKer[1] 2 ...12:MAXimum:LEFT
<b>Example</b>	CALC:RHO:MS:MARK2:MAX:LEFT
<b>Backwards Compatibility SCPI</b>	:CALCulate:TRHO:MARKer[1] 2 ...4:MAXimum:LEFT
Initial S/W Revision	Prior to A.02.00

## Marker Delta

Performs the same function as the Delta 1-of-N selection key in the Marker menu. Basically this sets the control mode for the selected marker to Delta mode. See the Marker chapter for the complete description of this function. The key is duplicated here in the Peak Search Menu to allow the user to conveniently perform a peak search and change the marker's control mode to Delta without having to access two separate menus.

Key Path	Peak Search
Initial S/W Revision	Prior to A.02.00

## Pk-Pk Search

Finds and displays the amplitude and frequency (or time, if in zero span) differences between the highest and lowest y-axis value.

Key Path	Peak Search
Mode	1xEVD0
<b>Remote Command</b>	:CALCulate:RHO:MS:MARKer[1] 2 ...12:PTPeak
<b>Example</b>	CALC:RHO:MS:MARK:PTP
Notes	Turns on the Marker $\Delta$
Couplings	This key is not available (key is grayed out) when Coupled Markers is on.
<b>Backwards Compatibility SCPI</b>	:CALCulate:TRHO:MARKer[1] 2 ...4:PTPeak
Initial S/W Revision	Prior to A.02.00

## Min Search

Moves the selected marker to the minimum y-axis value on the current trace.



Key Path	Peak Search
Mode	1xEVDO
<b>Remote Command</b>	:CALCulate:RHO:MS:MARKer[1] 2 ...12:MINimum
<b>Example</b>	CALC:RHO:MS:MARK:MIN
<b>Backwards Compatibility SCPI</b>	:CALCulate:TRHO:MARKer[1] 2 ...4:MINimum
Initial S/W Revision	Prior to A.02.00

18 Reverse Link Modulation Accuracy  
Print

Print

See "[Print](#)" on page 358

## Quick Save

The Quick Save front-panel key repeats the most recent save that was performed from the Save menu, with the following exceptions:

- Register saves are not remembered as Saves for the purpose of the Quick Save function
- If the current measurement does not support the last non-register save that was performed, an informational message is generated, “File type not supported for this measurement”

Quick Save repeats the last type of qualified save (that is, a save qualified by the above criteria) in the last save directory by creating a unique filename using the Auto File Naming algorithm described below.

If Quick Save is pressed after startup and before any qualified Save has been performed, the Quick Save function performs a Screen Image save using the current settings for Screen Image saves (current theme, current directory), which then becomes the “last save” for the purpose of subsequent Quick Saves.

The Auto File Naming feature automatically generates a file name for use when saving a file. The filename consists of a prefix and suffix separated by a dot, as is standard for the Windows® file system. A default prefix exists for each of the available file types:

Type	Default Prefix	Menu
State	State_	(Save/Recall)
Trace + State	State_	(Save/Recall)
Screen	Screen_	(Save/Recall)
Amplitude Corrections	Ampcor_	(Import/Export)
Traces	Trace_	(Import/Export)
Limit Lines	LLine_	(Import/Export)
Measurement Result	MeasR_	(Import/Export)
Capture Buffer	CapBuf_	(Import/Export)

A four digit number is appended to the prefix to create a unique file name. The numbering sequence starts at 0000 within each Mode for each file type and updates incrementally to 9999, then wraps to 0000 again. It remembers where it was through a Mode Preset and when leaving and returning to the Mode. It is reset by Restore Misc Defaults and Restore System Defaults and subsequent running of the instrument application. So, for example, the first auto file name generated for State files is State\_0000.state. The next is State\_0001, and so forth.

One of the key features of Auto File Name is that we guarantee that the Auto File Name will never conflict with an existing file. The algorithm looks for the next available number. If it gets to 9999, then it looks for holes. If it find no holes, that is no more numbers are available, it gives an error.

For example, if when we get to State\_0010.state there is already a State\_0010.state file in the current directory, it advances the counter to State\_0011.state to ensure that no conflict will exist (and then it verifies that State\_0011.state also does not exist in the current directory and advances again if it does, and so forth).

If you enter a file name for a given file type, then the prefix becomes the filename you entered instead of the default prefix, followed by an underscore. The last four letters (the suffix) are the 4-digit number.

For example, if you save a measurement results file as “fred.csv”, then the next auto file name chosen for a measurement results save will be fred\_0000.csv.

**NOTE**

Although 0000 is used in the example above, the number that is used is actually the current number in the Meas Results sequence, that is, the number that would have been used if you had not entered your own file name.

---

**NOTE**

If the filename you entered ends with \_dddd, where d=any number, making it look just like an auto file name, then the next auto file name picks up where you left off with the suffix being dddd + 1.

---

Key Path	Front-panel key
Notes	No remote command for this key specifically.
Initial S/W Revision	Prior to A.02.00

## Recall

The Recall menu lets you choose what you want to recall, and where you want to recall it from. Among the types of files you can recall are **States and Traces**. In addition, an Import (Data) option lets you recall a number of data types stored in CSV files (as used by Excel and other spreadsheet programs).

The default paths for Recall are data type dependent and are the same as for the Save key.

Key Path	Front-panel key
Notes	<p>No remote command for this key specifically, but the :MMEM:LOAD command is available for specific file types. An example is :MMEM:LOAD:STATe &lt;filename&gt;.</p> <p>If you try to recall a State file for a mode that is not licensed or not available in the instrument, an error message will occur and the state will not change.</p>
Backwards Compatibility Notes	<p>In legacy analyzers, it was possible to load a state without affecting the trace data, limit lines or correction data. Similarly (since User Preset is actually loading a state), it was possible to do a User Preset without affecting the trace data, limit lines or correction data.</p> <p>In the X-Series, “state” always includes all of this data; so whenever state is loaded, all of the traces, limit lines and corrections are affected. Although this differs from previous behavior, it is desirable behavior, and should not cause adverse issues for users.</p>
Backwards Compatibility Notes	<p>Recall for the X-Series supports backward compatibility in the sense that you can recall a state file from any X-Series model number and any version of X-Series software. This is only possible if part of the recalling process goes through a limiting step after recalling the mode settings, at least for settings that may vary with version number, model number, option and license differences. If you try to recall a state file onto an instrument with less capability than what was available on the instrument during the save, the recall will ignore the state it doesn't support and it will limit the recalled setting to what it allows.</p> <p>Example: if the saved state includes preamp ON, but the recalling instrument does not have a preamp; the preamp is limited to OFF. Conversely, if you save a state without a preamp, the preamp is OFF in the state file. When this saved file is recalled on an instrument with a licensed preamp, the preamp is changed to OFF. Another example is if the saved state has center frequency set to 20 GHz, but the instrument recalling the saved state is a different model and only supports 13.5 GHz. In this case, the center frequency is limited along with any other frequency based settings. Since the center frequency can't be preserved in this case, the recall limiting tries to at least preserve span to keep the measurement setup as intact as possible.</p> <p>It may be appropriate to issue a warning if the state is limited on the recall; warnings do not go out to SCPI so this would only affect the manual user.</p> <p>Note that there is no state file compatibility outside of the X-Series. For example, you cannot recall a state file from ESA or PSA.</p>
Initial S/W Revision	Prior to A.02.00

## State

The Recall State menu lets you choose a register or file from which to recall the state.

The content of a state file includes all of the settings and data required to return the analyzer as closely as possible to the Mode it was in, with the exact settings that were in place, when the save occurred. The Mode settings in each state file include the settings that are affected by Mode Preset, as well as the

additional settings affected by Restore Mode Defaults; all of the Mode's settings. In addition, all of the settings of the Input/Output system are included, even though they are outside of the Mode's state, because they are needed to restore the complete setup. Persistent System settings (for example, GPIB address) are not affected by either a Mode Preset or Restore Mode Defaults, nor are they included in a saved State file.

Since each state file is only for one Mode, the settings for other Modes are unaffected when it is loaded. Recall State will cause a mode switch if the state being recalled is not from the current active mode.

After the recall completes, the message "File <filename> recalled" or "Recalled State Register <register number>" is displayed.

For rapid recalls, the State menu lists 16 registers that you can choose from to recall. Pressing a Register key initiates the recall. You can also select a file from which to recall.

The default path for all State Files is:

My Documents\<mode name>\state

where <mode name> is the parameter used to select the mode with the INST:SEL command (for example, SA for the Spectrum Analyzer).

See ["More Information" on page 2379](#).

<b>Key Path</b>	Recall
<b>Mode</b>	All
<b>Remote Command</b>	:MMEMory:LOAD:STATe <filename>
<b>Example</b>	:MMEM:LOAD:STAT "myState.state" This recalls the file myState.state on the default path
<b>Example</b>	MMEM:LOAD:STAT "MyStateFile.state" This loads the state file data (on the default file directory path) into the instrument state.
<b>Notes</b>	<p>When you pick a file to recall, the analyzer first verifies that the file is recallable in the current instrument by checking the software version and model number of the instrument. If everything matches, a full recall proceeds by aborting the currently running measurement, clearing any pending operations, and then loading the State from the saved state file. You can open state files from any mode, so recalling a State file switches to the mode that was active when the save occurred. After switching to the mode of the saved state file, mode settings and data (if any for the mode) are loaded with values from the saved file. The saved measurement of the mode becomes the newly active measurement and the data relevant to the measurement (if there is any) is recalled.</p> <p>If there is a mismatch between file version or model number or instrument version or model number, the recall function tries to recall as much as possible and returns a warning message. It may limit settings that differ based on model number, licensing or version number.</p> <p>After recalling the state, the Recall State function does the following:</p> <ul style="list-style-type: none"> <li>• Makes the saved measurement for the mode the active measurement.</li> <li>• Clears the input and output buffers.</li> <li>• Status Byte is set to 0.</li> <li>• Executes a *CLS</li> </ul> <p>If the file specified is empty an error is generated. If the specified file does not exist, another error is generated. If there is a mismatch between the file and the proper file type, an error is generated. If</p>

	there is a mismatch between file version or model number or instrument version or model number, a warning is displayed. Then it returns to the State menu and File Open dialog goes away. After the Recall, the analyzer exits the Recall menu and returns to the previous menu.
<b>Backwards Compatibility SCPI</b>	:MMEMory:LOAD:STATe 1,<filename> For backwards compatibility, the above syntax is supported. The "1" is simply ignored.
Initial S/W Revision	Prior to A.02.00

## More Information

In measurements that support saving Traces, for example, Swept SA, the Trace data is saved along with the State in the State file. When recalling the State, the Trace data is recalled as well. Traces are recalled exactly as they were stored, including the writing mode and update and display modes. If a Trace was updating and visible when the State was saved, it will come back updating and visible, and its data will be rewritten right away. When you use State to save and recall traces, any trace whose data must be preserved should be placed in View or Blank mode before saving.

The following table describes the Trace Save and Recall possibilities:

You want to recall state and one trace's data, leaving other traces unaffected.	Save Trace+State from 1 trace. Make sure that no other traces are updating (they should all be in View or Blank mode) when the save is performed.	On Recall, specify the trace you want to load the one trace's data into. This trace will load in View. All other traces' data will be unaffected, although their trace mode will be as it was when the state save was performed.
You want to recall all traces	Save Trace+State from ALL traces.	On Recall, all traces will come back in View (or Blank if they were in Blank or Background when saved)
You want all traces to load exactly as they were when saved.	Save State	On recall, all traces' mode and data will be exactly as they were when saved. Any traces that were updating will have their data immediately overwritten.

## From File...

When you press "From File", the analyzer brings up a Windows dialog and a menu entitled "File Open." This menu allows you to navigate to the various fields in the Windows dialog without using a keyboard or mouse. The Tab and Arrow keys can also be used for dialog navigation.

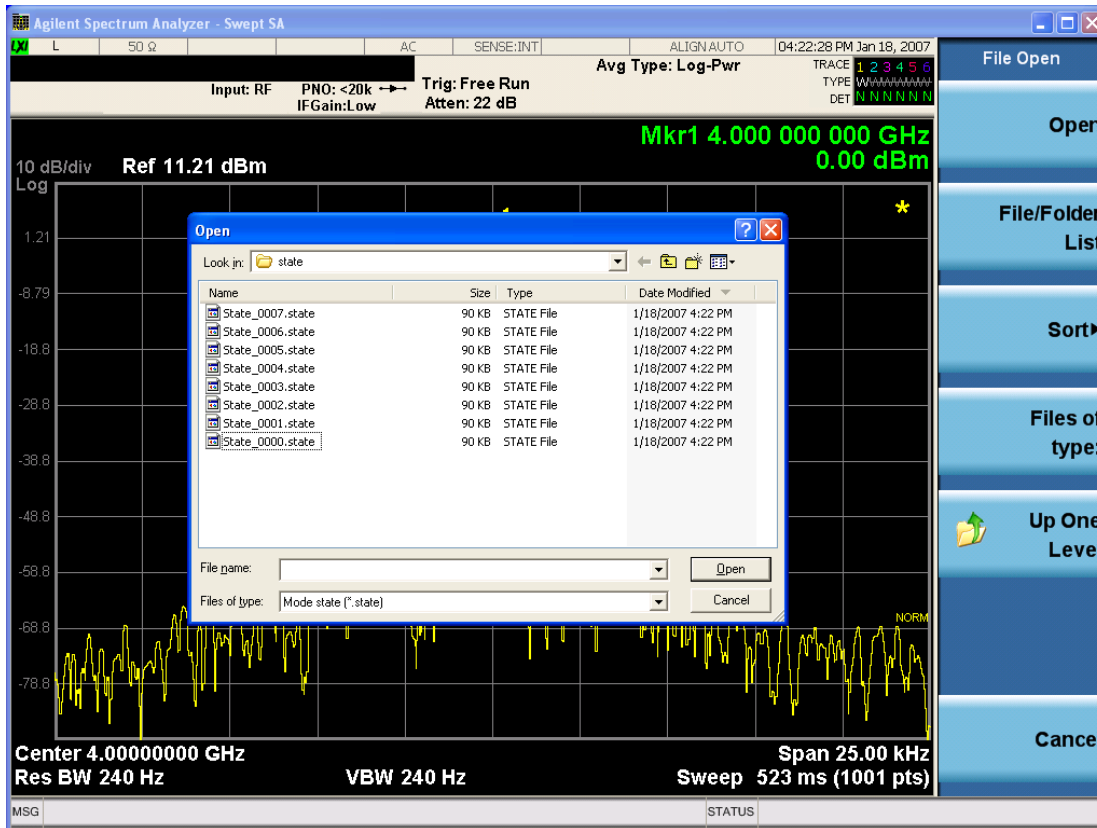

Listed below are the functions of the various fields in the dialog, and the corresponding softkeys:

#### Open

Performs the recall of the specified file. While the recall is being performed, the floppy icon appears briefly in the Meas bar.

#### File/Folder List

Enables you to navigate to the center of the dialog that contains the list of files and folders. Once here you can get information about the file and use the tab keys to navigate to the other fields in the dialog, such as Look In.

#### Look In

The Look In field shows the path from which the file will be recalled and allows you to change the path using the up and down arrow keys to navigate to other paths; the Enter key to open a directory; and the Backspace key to go back one directory. The **Look In field** first uses the last path from the Save As dialog **Save In:** path for that same file type. There is no softkey for directly navigating to the Look In field, but you can use the left tab to get here from the File/Folder List.

User specified paths are remembered when you leave and return to a Mode and are reset back to the default using Restore Mode Defaults.

#### Sort



Accesses a menu that enables you to sort the files within the File Open dialog. Only one sorting type can be selected at a time and the sorting happens immediately. The sorting types are By Date, By Name, By extension, and By Size.

#### Files of Type

This field shows the file suffix for the type of file you have selected to recall. For example, if you navigated here while recalling State, "Mode state (\*.state)" is in the field. If you navigated here while recalling Trace, ""Mode state (\*.trace)" is in the field. If you navigated here while importing a trace data file, "Trace Data (\*.csv)" is in the field. For some file types, there is more than one choice in the dropdown menu, which you can select by using the up and down arrow keys and Enter.

#### Up One Level

This key corresponds to the icon of a folder with the up arrow that is in the tool bar of the dialog. When pressed, it causes the file and folder list to navigate up one level in the directory structure. The Backspace key does the same thing.

#### Cancel

This key corresponds to the Cancel selection in the dialog. It causes the current **Open** request to be cancelled. The ESC key does the same thing.

Key Path	Recall, State
Notes	Brings up the Open dialog for recalling a State Save Type
Initial S/W Revision	Prior to A.02.00

### Edit Register Names

You may enter a custom name on any of the Register keys, to help you remember what you are using that state to save. To do this, press the Edit Register Names key, choose the register whose name you wish to edit, and then enter the desired label using the Alpha Editor or an external PC keyboard.

The maximum number of characters that can be added is 30. In most cases, 30 characters will fit on two lines of the key.

For more information and the SCPI command, see Edit Register Names under the Save, State function.

Key Path	Recall, State
Mode	All
Dependencies	N9060A-7FP or N9060B-2FP license required to edit the register names. When the feature is not licensed, sending the SCPI command generates an error, -221, "Settings conflict;Option not available"
Initial S/W Revision	A.11.00

### Register 1 thru Register 16

Selecting any one of these register keys causes the State of the mode from the specified Register to be recalled. Each of the register keys annotates whether it is empty or at what date and time it was last

modified. In addition, you can use the Edit Register Names key under Save, State to enter custom names for each register.

Registers are shared by all modes, so recalling from any one of the registers will cause a mode switch to the mode that was active when the save to the Register occurred.

Although these 16 registers are the only registers available from the front panel, there are 128 state registers available in the instrument. Registers 17–128 are only available from the SCPI interface, using the \*RCL command.

After the recall completes, the message "Register <register number> recalled" appears in the message bar. If you are in the Spectrum Analyzer Mode, and you are recalling a register that was saved in the Spectrum Analyzer Mode, then after the recall, you will still be in the Recall Register menu. If the Recall causes you to switch modes, then after the Recall, you will be in the Frequency menu.

If a requested register is empty an error is generated.

<b>Key Path</b>	Recall, State
<b>Example</b>	*RCL 1
<b>Range</b>	1–16 from front panel, 1–128 from SCPI
<b>Readback</b>	Date and time with seconds resolution are displayed on the key OR A custom name of up to 30 characters entered using the Save, State, Edit Register Names key OR “(empty)” if no prior save operation has been performed to this register.
<b>Initial S/W Revision</b>	Prior to A.02.00
<b>Modified at S/W Revision</b>	Prior to A.11.00

## Register 1 thru Register 16

Selecting any one of these register keys causes the State of the mode from the specified Register to be recalled. Each of the register keys annotates whether it is empty or at what date and time it was last modified. In addition, you can use the Edit Register Names key under Save, State to enter custom names for each register.

Registers are shared by all modes, so recalling from any one of the registers will cause a mode switch to the mode that was active when the save to the Register occurred.

Although these 16 registers are the only registers available from the front panel, there are 128 state registers available in the instrument. Registers 17–128 are only available from the SCPI interface, using the \*RCL command.

After the recall completes, the message "Register <register number> recalled" appears in the message bar. If you are in the Spectrum Analyzer Mode, and you are recalling a register that was saved in the Spectrum Analyzer Mode, then after the recall, you will still be in the Recall Register menu. If the Recall causes you to switch modes, then after the Recall, you will be in the Frequency menu.

If a requested register is empty an error is generated.

Key Path	Recall, State
<b>Example</b>	*RCL 1
Range	1-16 from front panel, 1-128 from SCPI
Readback	Date and time with seconds resolution are displayed on the key OR A custom name of up to 30 characters entered using the Save, State,Edit Register Names key OR “(empty)” if no prior save operation has been performed to this register.
Initial S/W Revision	Prior to A.02.00
Modified at S/W Revision	Prior to A.11.00

### Trace (+State)

The Recall Trace (+State) menu lets you choose a register or file from which to recall the Trace+State state file.

A saved state contains all of the settings and data required to return the analyzer as closely as possible to the exact setup it had when the save occurred. This includes the Input/Output settings, even though they are outside of the Mode’s state, because they are needed to restore the complete setup. A Trace+State file also includes trace data from one trace or all traces, which will load in View mode when the Trace+State file is recalled. Recall Trace (+State) will also cause a mode switch if the state being recalled is not for the current active mode.

After the recall completes, the message "File <filename> recalled" or “Recalled Trace Register <register number>” is displayed.

For rapid recalls, the Trace (+State) menu lists 5 registers to choose from to recall. Pressing a Register key initiates the recall. You can also select a file from which to recall.

The default path for all State Files including .trace files is:

My Documents\<mode name>\state

where <mode name> is the parameter used to select the mode with the INST:SEL command (for example, SA for the Spectrum Analyzer).

Key Path	Recall
Mode	SA
<b>Remote Command</b>	:MMEMory:LOAD:TRACe TRACE1   TRACE2   TRACE3   TRACE4   TRACE5   TRACE6,<filename>  :MMEMory:LOAD:TRACe:REGister TRACE1   TRACE2   TRACE3   TRACE4   TRACE5   TRACE6,<integer>
<b>Example</b>	MMEM:LOAD:TRAC TRACE2, "MyTraceFile.trace" This loads the trace file data (on the default file directory path) into the specified trace; if it is a "single trace" save file, that trace is loaded to trace 2, and is set to be not updating. :MMEM:LOAD:TRAC:REG TRACE1,2

	restores the trace data in register 2 to Trace 1
Notes	<p>When you perform the recall, the recalling Trace function must first verify the file is recallable in this instrument by checking instrument software version and model number, since it includes State. If everything matches, a full recall proceeds by aborting the currently running measurement, and loading the state from the saved state file to as close as possible to the context in which the save occurred. You can open .trace files from any mode that supports them, so recalling a Trace file switches to the mode that was active when the save occurred. After switching to the mode of the saved state file, mode settings and data (if any for the mode) are loaded with values from the saved file and the saved measurement of the mode becomes the newly active measurement, and the data relevant to the measurement (if there is any) is recalled.</p> <p>Once the state is loaded, the trace data must be loaded. The internal flags are consulted to see which trace to load and the "To Trace" setting to see where to load it. Trace data is always loaded with the specified trace set to View, so that the data is visible and not updating(so as not to erase the recalled data). If the file is an "all trace" file, all traces are loaded with the saved data(to the original trace the data was saved from) and set to View. Traces whose data is not loaded are restored to the update state that existed when they were saved.</p> <p>After the Recall the analyzer exits the Recall menu and returns to the previous menu.</p> <p>Some modes and measurements do not have available all 6 traces. Phase Noise mode command, for example, is: <code>MMEMOry:LOAD:TRACe TRACE1 TRACE2 TRACE3,&lt;filename&gt;</code></p> <p>Some modes and measurements have more than 6 traces available. The Realtime SA mode command, for example, is: <code>MMEMOry:STORe:TRACe TRACE1   TRACE2   TRACE3   TRACE4   TRACE5   TRACE6   TRACE7   TRACE8   TRACE9   TRACE10   TRACE11   TRACE12   ALL,&lt;filename&gt;</code></p>
Initial S/W Revision	Prior to A.02.00

## To Trace

These menu selections let you choose the Trace where the recalled saved trace will go. Not all modes have the full 6 traces available. The default is the currently selected trace, selected in this menu or in the Trace/Detector, Export Data, Import Data, or Save Trace menus, except if you have chosen All, then it remains chosen until you specifically change it to a single trace.

If the .trace file is an "all trace" file, "To Trace" is ignored and the traces each go back to the trace from which they were saved.

Once selected, the key returns back to the Recall Trace menu and the selected Trace number is annotated on the key. Now you have selected exactly where the trace needs to be recalled.To trigger a recall of the selected Trace, you must select the Open key in the Recall Trace menu.

When you select a trace, it makes that trace the current trace, so it displays on top of all of the other traces.

Key Path	Save, Data, Trace
Mode	SA
Initial S/W Revision	Prior to A.02.00

## Register 1 thru Register 16

Selecting any one of these register keys causes the State of the mode from the specified Register to be recalled. Each of the register keys annotates whether it is empty or at what date and time it was last modified. In addition, you can use the Edit Register Names key under Save, State to enter custom names for each register.

Registers are shared by all modes, so recalling from any one of the registers will cause a mode switch to the mode that was active when the save to the Register occurred.

Although these 16 registers are the only registers available from the front panel, there are 128 state registers available in the instrument. Registers 17–128 are only available from the SCPI interface, using the \*RCL command.

After the recall completes, the message "Register <register number> recalled" appears in the message bar. If you are in the Spectrum Analyzer Mode, and you are recalling a register that was saved in the Spectrum Analyzer Mode, then after the recall, you will still be in the Recall Register menu. If the Recall causes you to switch modes, then after the Recall, you will be in the Frequency menu.

If a requested register is empty an error is generated.

Key Path	Recall, State
<b>Example</b>	*RCL 1
Range	1–16 from front panel, 1–128 from SCPI
Readback	Date and time with seconds resolution are displayed on the key OR A custom name of up to 30 characters entered using the Save, State, Edit Register Names key OR “(empty)” if no prior save operation has been performed to this register.
Initial S/W Revision	Prior to A.02.00
Modified at S/W Revision	Prior to A.11.00

## From File...

When you press “From File”, the analyzer brings up a Windows dialog and a menu entitled “File Open.” This menu allows you to navigate to the various fields in the Windows dialog without using a keyboard or mouse. The Tab and Arrow keys can also be used for dialog navigation.

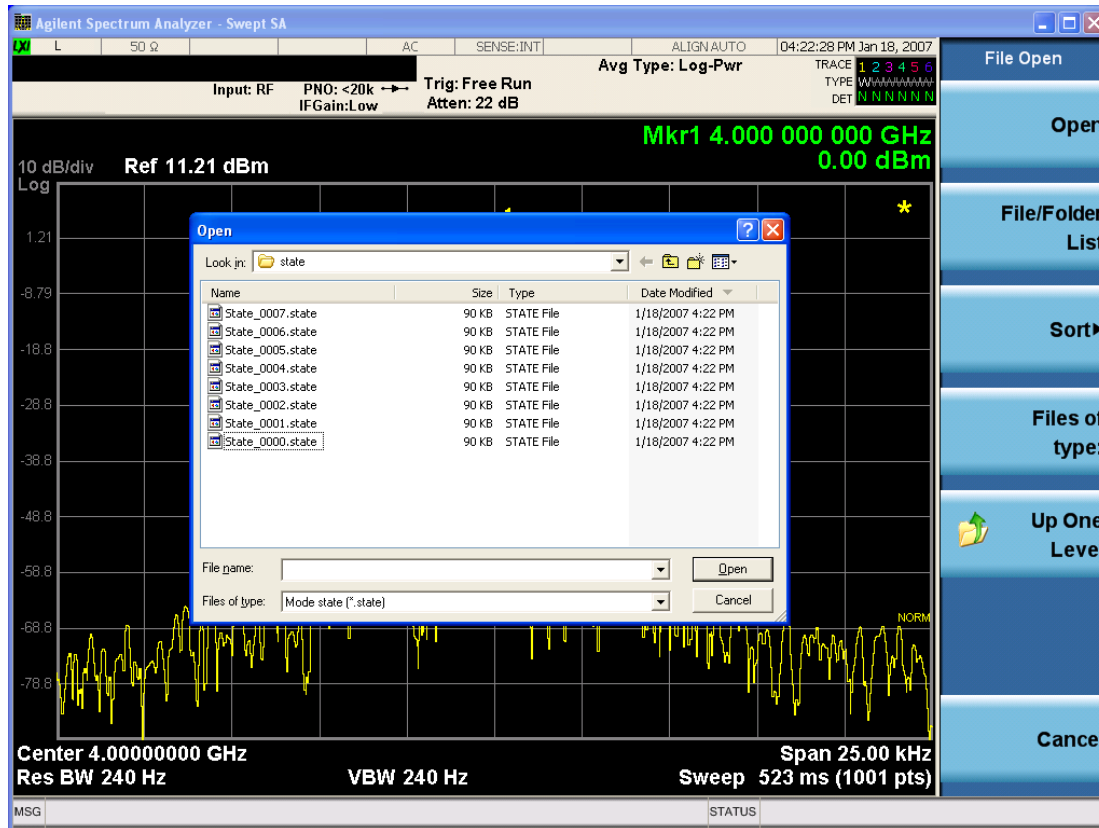

Listed below are the functions of the various fields in the dialog, and the corresponding softkeys:

### Open

Performs the recall of the specified file. While the recall is being performed, the floppy icon appears briefly in the Meas bar.

### File/Folder List

Enables you to navigate to the center of the dialog that contains the list of files and folders. Once here you can get information about the file and use the tab keys to navigate to the other fields in the dialog, such as Look In.

### Look In

The Look In field shows the path from which the file will be recalled and allows you to change the path using the up and down arrow keys to navigate to other paths; the Enter key to open a directory; and the Backspace key to go back one directory. The **Look In field** first uses the last path from the Save As dialog **Save In:** path for that same file type. There is no softkey for directly navigating to the Look In field, but you can use the left tab to get here from the File/Folder List.

User specified paths are remembered when you leave and return to a Mode and are reset back to the default using Restore Mode Defaults.

### Sort

Accesses a menu that enables you to sort the files within the File Open dialog. Only one sorting type can be selected at a time and the sorting happens immediately. The sorting types are By Date, By Name, By extension, and By Size.

#### Files of Type

This field shows the file suffix for the type of file you have selected to recall. For example, if you navigated here while recalling State, "Mode state (\*.state)" is in the field. If you navigated here while recalling Trace, ""Mode state (\*.trace)" is in the field. If you navigated here while importing a trace data file, "Trace Data (\*.csv)" is in the field. For some file types, there is more than one choice in the dropdown menu, which you can select by using the up and down arrow keys and Enter.

#### Up One Level

This key corresponds to the icon of a folder with the up arrow that is in the tool bar of the dialog. When pressed, it causes the file and folder list to navigate up one level in the directory structure. The Backspace key does the same thing.

#### Cancel

This key corresponds to the Cancel selection in the dialog. It causes the current **Open** request to be cancelled. The ESC key does the same thing.

Key Path	Recall, State
Notes	Brings up the Open dialog for recalling a State Save Type
Initial S/W Revision	Prior to A.02.00

### Data (Import)

Importing a data file loads data that was previously saved from the current measurement or from other measurements and/or modes that produce compatible data files. The Import Menu only contains Data Types that are supported by the current measurement.

Since the commonly exported data files are in .csv format, the data can be edited by the user prior to importing. This allows you to export a data file, manipulate the data in Excel (the most common PC Application for manipulating .csv files) and then import it.

Importing Data loads measurement data from the specified file into the specified or default destination, depending on the data type selected. Selecting an Import Data menu key will not actually cause the importing to occur, since the analyzer still needs to know from where to get the data. Pressing the Open key in this menu brings up the Open dialog and Open menu that provides you with the options from where to recall the data. Once a filename has been selected or entered in the Open menu, the recall occurs as soon as the Open button is pressed.

Key Path	Recall
Mode	All
Notes	The menu is built from whatever data types are available for the mode. Some keys will be missing completely, so the key locations in the sub-menu will vary. No SCPI command directly controls the Data Type that this key controls. The Data Type is included in the MMEM:LOAD commands.

Dependencies	If a file type is not used by a certain measurement, it is grayed out for that measurement. The key for a file type will not show at all if there are no measurements in the Mode that support it.
Preset	Is not affected by Preset or shutdown, but is reset during Restore Mode Defaults
Readback	The data type that is currently selected
Initial S/W Revision	Prior to A.02.00

## Capture Buffer

The captured data is raw data which is not processed.

Key Path	Recall, Data
Mode	<b>CDMA1XEV</b>
Example	MMEM:LOAD:CAPT "MyCaptureData.bin" This loads the file of capture data (on the default file directory path) into the instrument.
Dependencies	In case the capture buffer data is not available from the selected measurement, the key will be grayed out.
Initial S/W Revision	A.11.00

## Open...

When you press "Open", the analyzer brings up a Windows dialog and a menu entitled "**File Open.**" This menu allows you to navigate to the various fields in the Windows dialog without using a keyboard or mouse. The Tab and Arrow keys can also be used for dialog navigation.

See "[From File...](#)" on page 2890 in Recall, State, for a full description of this dialog and menu.

Key Path	Recall, Data
Notes	The key location is mode-dependent and will vary. Brings up Open dialog for recalling a <mode specific> Save Type
Initial S/W Revision	Prior to A.02.00



## Restart

The Restart function restarts the current sweep, or measurement, or set of averaged/held sweeps or measurements. If you are Paused, pressing Restart does a Resume.

The Restart function is accessed in several ways:

- Pressing the Restart key
- Sending the remote command INIT:IMMEDIATE
- Sending the remote command INIT:RESTART

See "[More Information](#)" on page 2389

Key Path	Front-panel key
Remote Command	:INITiate[:IMMEDIATE] :INITiate:RESTART
Example	:INIT:IMM :INIT:REST
Notes	:INITiate:RESTART and :INITiate:IMMEDIATE perform exactly the same function.
Couplings	Resets average/hold count k. For the first sweep overwrites all active (update=on) traces with new current data. For application modes, it resets other parameters as required by the measurement.
Status Bits/OPC dependencies	This is an Overlapped command. The STATUS:OPERation register bits 0 through 8 are cleared. The STATUS:QUESTIONable register bit 9 (INTEgrity sum) is cleared. The SWEEPING bit is set. The MEASURING bit is set.
Backwards Compatibility Notes	For Spectrum Analysis mode in ESA and PSA, the Restart hardkey and the INITiate:RESTART command restart trace averages (displayed average count reset to 1) for a trace in Clear Write, but did not restart Max Hold and Min Hold. In the X-Series, the Restart hardkey and the INITiate:RESTART command restart not only Trace Average, but MaxHold and MinHold traces as well. For wireless comms modes in ESA and PSA, the Restart hardkey and the INITiate:RESTART command restart every measurement, which includes all traces and numeric results. There is no change to this operation.
Initial S/W Revision	Prior to A.02.00

### More Information

The **Restart** function first aborts the current sweep/measurement as quickly as possible. It then resets the sweep and trigger systems, sets up the measurement and initiates a new data measurement sequence with a new data acquisition (sweep) taken once the trigger condition is met.

If the analyzer is in the process of aligning when **Restart** is executed, the alignment finishes before the restart function is performed.

Even when set for Single operation, multiple sweeps may be taken when Restart is pressed (for example, when averaging/holding is on). Thus when we say that **Restart** "restarts a measurement," we may mean:

- It restarts the current sweep
- It restarts the current measurement
- It restarts the current set of sweeps if any trace is in Trace Average, Max Hold or Min Hold
- It restarts the current set of measurements if Averaging, or Max Hold, or Min Hold is on for the measurement
- depending on the current settings.

With **Average/Hold Number** (in **Meas Setup** menu) set to 1, or Averaging off, or no trace in Trace Average or Hold, a single sweep is equivalent to a single measurement. A single sweep is taken after the trigger condition is met; and the analyzer stops sweeping once that sweep has completed. However, with **Average/Hold Number** >1 and at least one trace set to **Trace Average, Max Hold, or Min Hold (SA Measurement)** or **Averaging on (most other measurements)**, multiple sweeps/data acquisitions are taken for a single measurement. The trigger condition must be met prior to each sweep. The sweep is stopped when the average count  $k$  equals the number  $N$  set for **Average/Hold Number**. A measurement average usually applies to all traces, marker results, and numeric results; but sometimes it only applies to the numeric results.

Once the full set of sweeps has been taken, the analyzer will go to idle state. To take one more sweep without resetting the average count, increment the average count by 1, by pressing the step up key while **Average/Hold Number** is the active function, or sending the remote command CALC:AVER:TCON UP.

## Save

The Save menu lets you choose what you want to save and where you want to save it. Among the types of files you can save are **States**, **Traces**, and **Screen Images**. In addition, an Export (Data) option lets you save a number of data types as CSV files for easy import into Excel and other spreadsheet programs.

Key Path	Front-panel key
Mode	All
Notes	No remote command for this key specifically, but the :MMEM:STORe command is available for specific file types. An example is :MMEM:STOR:STATe <filename>.
Initial S/W Revision	Prior to A.02.00

## State

The Save State menu lets you choose a register or file for saving the state.

The content of a state file includes all of the settings and data required to return the analyzer as closely as possible to the Mode it was in, with the exact settings which were in place, when the save occurred. The Mode settings in each state file include the settings that are affected by Mode Preset, as well as the additional settings affected by Restore Mode Defaults; all of the Mode's settings. In addition, all of the settings of the Input/Output system are included, even though they are outside of the Mode's state, because they are needed to restore the complete setup. Persistent System settings (for example, Verbose SCPI) are not affected by either Mode Preset or Restore Mode Defaults, nor are they included in a saved State file.

After the save completes, the message "File <filename> saved" or "State Register <register number> saved" is displayed.

For rapid saving, the State menu lists 16 registers to save to. Pressing a Register key initiates the save. You can also select a file to save to.

The default path for all State Files is:

My Documents\<<mode name>\state

where <mode name> is the parameter used to select the mode with the INST:SEL command (for example, SA for the Spectrum Analyzer).

Key Path	Save
Mode	All
Remote Command	:MMEMory:STORe:STATe <filename>
Example	MMEM:STOR:STATe "MyStateFile.state" This stores the current instrument state data in the file MyStateFile.state in the default directory.
Notes	Both single and double quotes are supported for any filename parameter over remote. After saving to a register, that register's menu key is updated with the date the time, unless a custom label has been entered for that key. After saving to a register, you remain in the Save State menu, so that you can see the Register key

	update. After saving to a file, the analyzer automatically returns to the previous menu and any Save As dialog goes away.
<b>Backwards Compatibility SCPI</b>	:MMEMory:STORe:STATe 1,<filename>
Initial S/W Revision	Prior to A.02.00

### To File . . .

When you press “To File”, the analyzer brings up a Windows dialog and a menu entitled “Save As.” This menu allows you to navigate to the various fields in the Windows dialog without using a keyboard or mouse. The Tab and Arrow keys can also be used for dialog navigation.

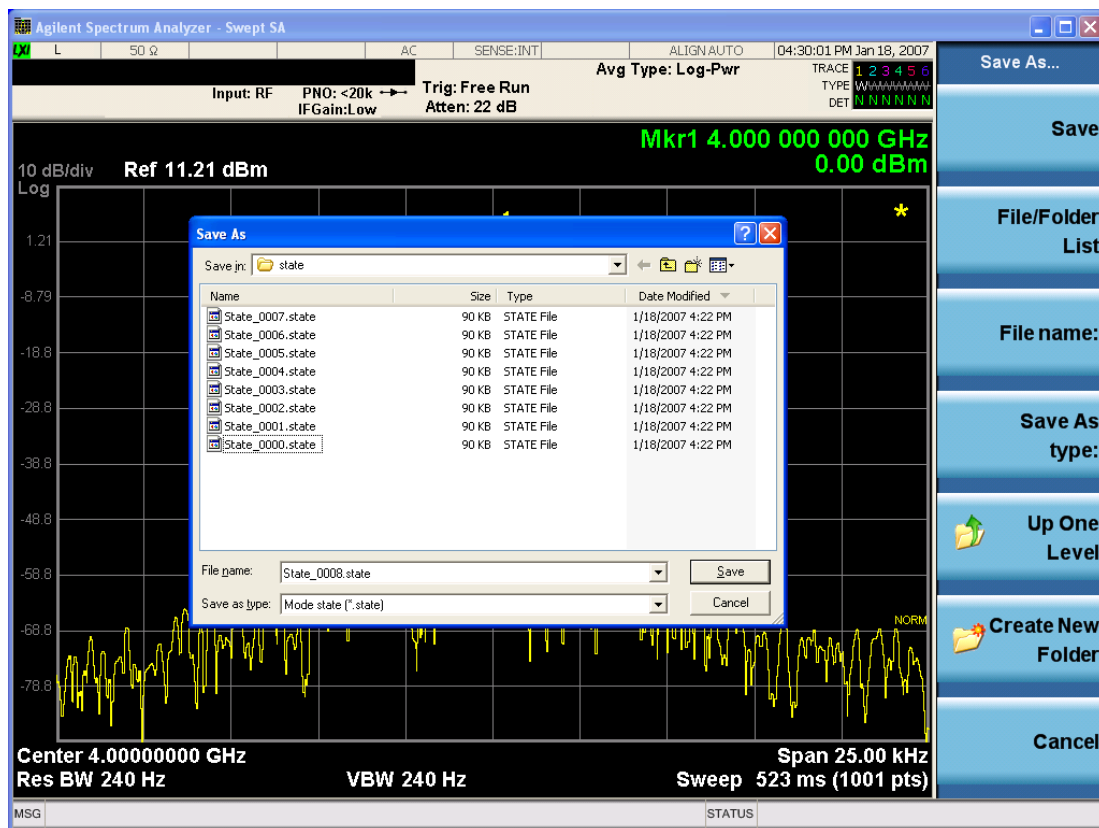

The Listed below

are the functions of the various fields in the dialog, and the corresponding softkeys:

#### Save

Performs the save to the specified file of the selected type. If the file already exists, a dialog will appear that allows you to replace the existing file by selecting OK, or you can Cancel the request. If you select OK, the file will be overwritten. Using the C: drive is strongly discouraged, since it runs the risk of being overwritten during an instrument software upgrade.

While the save is being performed, the floppy icon appears briefly in the Meas bar.

## File/Folder List

Enables you to navigate to the center of the dialog that contains the list of files and folders. Once here you can get information about the file and use the tab keys to navigate to the other fields in the dialog, such as Save In.

## Save In

The Save In field shows the path to which the file will be saved and allows you to change the path using the up and down arrow keys to navigate to other paths; the Enter key to open a directory; and the Backspace key to go back one directory. The **Save In field** defaults to the default path for this type of file and remembers the last path you used to save this type of file. There is no softkey for directly navigating to the Save In field but you can use left tab to get here from the File/Folder List.

User specified paths are remembered when you leave and return to a Mode and are reset back to the default using Restore Mode Defaults.

## File Name

The File Name field is initially loaded with an automatically generated filename specific to the appropriate Save Type. The automatically generated filename is guaranteed not to conflict with any filename currently in the directory. You may replace or modify this filename using the File Name key. See the ["Quick Save " on page 2880](#) documentation for more on the automatic file naming algorithm.

When you press the File Name key the analyzer displays the Alpha Editor. Use the knob to choose the letter to add and the front-panel Enter key to add the letter to the file name. The BK character moves you back and the FW character moves you forward in the filename. The Select key on the front panel generates a space character. When you are done entering the filename press the Done softkey. This returns back to the **File Open** dialog and menu, but does not cause the save to occur.

## Save As Type

This field shows the file suffix for the type of file you have selected to save. For example, if you navigated here while saving State, "Mode state (\*.state)" is in the field. If you navigated here from saving Trace, ""Mode state (\*.trace)" is in the field. If you navigated here while exporting a trace data file, "Trace Data (\*.csv)" is in the field. For some file types, there is more than one choice in the dropdown, which you can select by using the up and down arrow keys and Enter.

## Up One Level

This key corresponds to the icon of a folder with the up arrow that is in the tool bar of the dialog. When pressed, it causes the file and folder list to navigate up one level in the directory structure. The Backspace key does the same thing.

## Create New Folder

This key corresponds to the icon of a folder with the "\*" that is in the tool bar of the dialog. When pressed, a new folder is created in the current directory with the name **New Folder** and you can enter a new folder name using the Alpha Editor.

## Cancel

This key corresponds to the Cancel selection in the dialog. It causes the current **Save As** request to be cancelled. The ESC key does the same thing.

Key Path	Save, State
Mode	All
Notes	Brings up Save As dialog for saving a State Save Type
Initial S/W Revision	Prior to A.02.00

## Edit Register Names

You may enter a custom name on any of the Register keys, to help you remember what you are using that state to save. To do this, press the Edit Register Names key, choose the register whose name you wish to edit, and then enter the desired label using the Alpha Editor or an external PC keyboard.

The maximum number of characters that can be added is 30. In most cases, 30 characters will fit on two lines of the key.

See ["More Information" on page 2394](#)

Key Path	Save, State
Mode	All
<b>Remote Command</b>	:MMEMory:REGister:STATe:LABel <reg number>,"label" :MMEMory:REGister:STATe:LABel? <reg number>
<b>Example</b>	:MMEM:REG:STAT:LAB 1,"my label"
Notes	<reg number> is an integer from 1 to 16. If the SCPI specifies an invalid register number an error message is generated, -222,"Data out of range;Invalid register label number" "label" is a string from 0 to 30 characters in length. If a label exceeds 30 characters, an error message is generated, -150,"String data error;Label clipped to 30 characters" "label" of length 0 erases the custom label and restores the default (time and date) label. E.g.: :MMEM:REG:STAT:LAB 1,""
Dependencies	N9060A-7FP or N9060B-2FP license required to edit the register names. When the feature is not licensed, sending this command generates an error, -221,"Settings conflict;Option not available"
Preset	The names are unaffected by Preset or power cycle but are set to the default label (time and date) on a "Restore System Defaults->Misc"
Initial S/W Revision	A.11.00

## More Information

When you edit one of the register names, the time and date field will be replaced by the custom name.

If you delete all the characters in the custom name, it restores the default (time and date).

The register names are stored within the state files, but they are not part of the instrument state; that is, once you have edited a register name, loading a new state will not change that register name. Another consequence of this is that the names will be persistent through a power cycle. Also, if a named state file is transferred to another analyzer, it will bring its custom name along with it.

If you try to edit the name of an empty register, the analyzer will first save the state to have a file to put the name in. If you load a named state file into an analyzer with older firmware it will ignore the metadata.

The \*SAV and \*RCL commands will not be affected by the custom register names, nor will the MMEM commands.

### Register 1 thru Register 16

Selecting any one of these register menu keys causes the State of the currently active mode to be saved to the specified Register. The registers are provided for rapid saving and recalling, since you do not need to specify a filename or navigate to a file. Each of the register menu keys annotates whether it is empty or at what date and time it was last modified. In addition, you can use the Edit Register Names key to enter custom names for each register.

Although these 16 registers are the only registers available from the front panel, there are 128 state registers available in the instrument. Registers 17–128 are only available from the SCPI interface, using the \*SAV command.

There is one set of 128 state registers in the instrument, not one set for each Mode. When a state is saved, the Mode it was saved from is saved with it; then when it is recalled, the instrument switches to that Mode.

After the save completes, the corresponding register menu key annotation is updated with the date and time and the message "Register <register number> saved" is displayed.

Key Path	Save, State
Mode	All
<b>Example</b>	*SAV 1
Range	1–16 from front panel, 1–128 from SCPI
Readback	Date and time with seconds resolution are displayed on the key OR A custom name of up to 30 characters entered using the Edit Register Names key OR “(empty)” if no prior save operation has been performed to this register.
Initial S/W Revision	Prior to A.02.00
Modified at S/W Revision	A.11.00

### Register 1 thru Register 16

Selecting any one of these register menu keys causes the State of the currently active mode to be saved to the specified Register. The registers are provided for rapid saving and recalling, since you do not need to specify a filename or navigate to a file. Each of the register menu keys annotates whether it is empty or at what date and time it was last modified. In addition, you can use the Edit Register Names key to enter custom names for each register.

Although these 16 registers are the only registers available from the front panel, there are 128 state registers available in the instrument. Registers 17–128 are only available from the SCPI interface, using the \*SAV command.

There is one set of 128 state registers in the instrument, not one set for each Mode. When a state is saved, the Mode it was saved from is saved with it; then when it is recalled, the instrument switches to that Mode.

After the save completes, the corresponding register menu key annotation is updated with the date and time and the message "Register <register number> saved" is displayed.

Key Path	Save, State
Mode	All
Example	*SAV 1
Range	1-16 from front panel, 1-128 from SCPI
Readback	Date and time with seconds resolution are displayed on the key OR A custom name of up to 30 characters entered using the Edit Register Names key OR “(empty)” if no prior save operation has been performed to this register.
Initial S/W Revision	Prior to A.02.00
Modified at S/W Revision	A.11.00

## Data (Export)

Exporting a data file stores data from the current measurement to mass storage files. The Export Menu only contains data types that are supported by the current measurement.

Since the commonly exported data files are in .csv format, the data can be edited by you prior to importing. This allows you to export a data file, manipulate the data in Excel (the most common PC Application for manipulating .csv files) and then import it.

Selecting an Export Data menu key will not actually cause the exporting to occur, since the analyzer still needs to know where you wish to save the data. Pressing the Save As key in this menu brings up the Save As dialog and Save As menu that allows you to specify the destination file and directory. Once a filename has been selected or entered in the Open menu, the export will occur as soon as the Save key is pressed.

Key Path	Save
Mode	All
Notes	The menu is built from whatever data types are available for the mode. So the key locations in the sub menu will vary.  No SCPI command directly controls the Data Type that this key controls. The Data Type is included in the MMEM:STORe commands.
Dependencies	If a file type is not used by a certain measurement, that type is grayed out for that measurement. The key for a file type will not show at all if there are no measurements in the Mode that support it.
Preset	Is not affected by a Preset or shutdown, but is reset during Restore Mode Defaults
Readback	The data type that is currently selected
Initial S/W Revision	Prior to A.02.00



## Measurement Results

Pressing this key selects Meas Results as the data type to be exported. Pressing the key a second time brings up the Meas Results menu, which allows you to select which **Meas Result** to save. In the Swept SA measurement, there are three types of Measurement Results files: Peak Table, Marker Table and Spectrogram.

See "Meas Results File Contents" on page 2397.

See "Marker Table" on page 2397.

See "Peak Table" on page 2400.

See "Spectrogram" on page 2403

<b>Remote Command</b>	:MMEMory:STORe:RESults:MTABle PTABle SPEctrogram <filename>
<b>Example</b>	:MMEM:STOR:RES:MTAB "myResults.csv" Saves the results from the current marker table to the file myResults.csv in the current path. :MMEM:STOR:RES:PTAB "myResults.csv" Saves the results from the current peak table to the file myResults.csv in the current path. :MMEM:STOR:RES:SPEC "myResults.csv" Saves the results from the current Spectrogram display to the file myResults.csv in the current path. The default path is My Documents\SA\data\SAN\results
<b>Notes</b>	If the save is initiated via SCPI, and the file already exists, the file will be overwritten. Using the C: drive is strongly discouraged, since it runs the risk of being overwritten during an instrument software upgrade. Both single and double quotes are supported for any filename parameter over SCPI.
<b>Dependencies</b>	If a save of Marker Table results is requested and the Marker Table is not on, no file is saved and a message is generated If a save of Peak Table results is requested and the Peak Table is not on, no file is saved and a message is generated If a save of Spectrogram results is requested and the Spectrogram is not on, no file is saved and a message is generated. The Spectrogram choice only appears if option EDP is licensed.
<b>Preset</b>	Not part of Preset, but is reset to Peak Table by Restore Mode Defaults. Survives a shutdown.
<b>Initial S/W Revision</b>	Prior to A.02.00

## Meas Results File Contents

All files are .csv files. The following section details the data in each file type.

### Marker Table

This section discusses the Marker Table Meas Results file format.

Imagine that, at the point where a Marker Table Meas Result is requested, the following screen is showing:

18 Reverse Link Modulation Accuracy  
Save

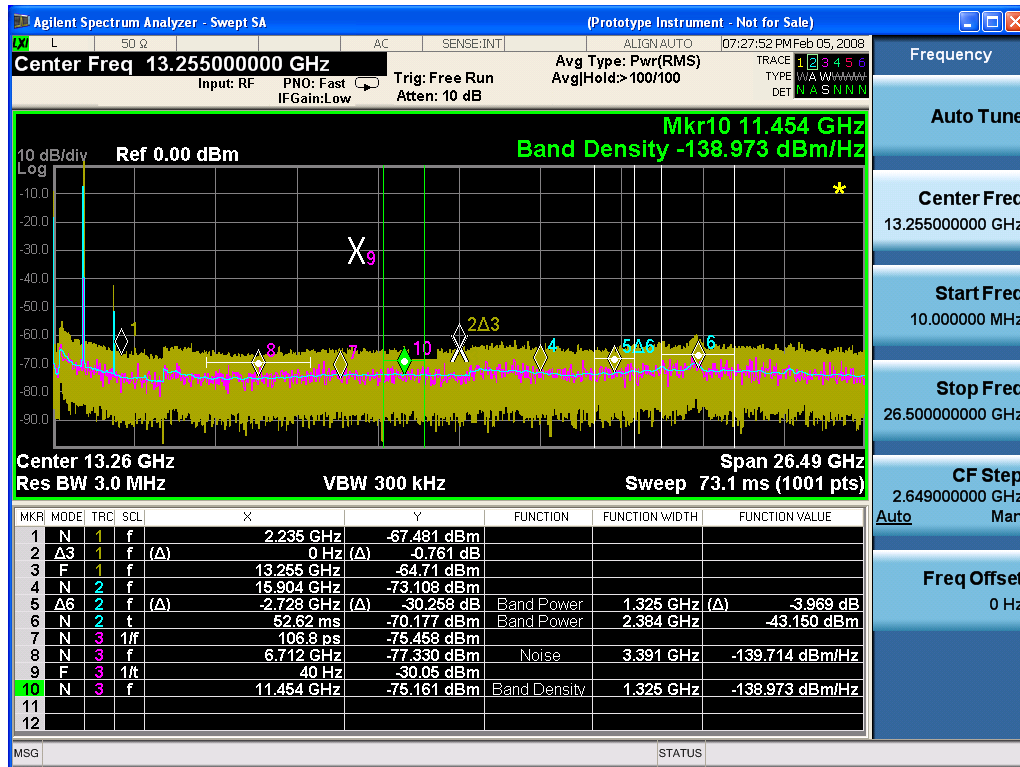

Then the Meas Results file, when opened, would show the following data:

MeasurementResult	
Swept SA	
A.01.40_R0017	N9020A
526 B25 PFR	1
P26 EA3	
Result Type	Marker Table
Ref Level	0
Number of Points	1001
Sweep Time	0.0662666 67
Start Frequency	10000000
Stop Frequency	26500000 000
Average Count	0
Average Type	LogPower (Video)
RBW	3000000

RBW Filter	Gaussian
RBW Filter BW	3dB
VBW	3000000
Sweep Type	Swept
X Axis Scale	Lin
PreAmp State	Off
PreAmp Band	Low
Trigger Source	Free
Trigger Level	1.2
Trigger Slope	Positive
Trigger Delay	1.00E-06
Phase Noise Optimization	Fast
Swept If Gain	Low
FFT If Gain	Autorange
RF Coupling	AC
FFT Width	411900
Ext Ref	10000000
Input	RF
RF Calibrator	Off
Attenuation	10
Ref Level Offset	0
External Gain	0
X Axis Units	Hz
Y Axis Units	dBm

DATA									
MKR	MODE	TR C	SCL	X	Y	FUNCTI ON	FUNCTIO N WIDTH	FUNCTI ON VALUE	FUNCTI ON UNIT
1	Normal	1	Freque ncy	2.2350E+09	- 67.481	Off	0.0000E+00	0	None
2	Delta3	1	Freque ncy	0.0000E+00	- 0.761	Off	0.0000E+00	0	None
3	Fixed	1	Freque ncy	1.3255E+10	- 64.71	Off	0.0000E+00	0	None
4	Normal	2	Freque ncy	1.5904E+10	- 73.1	Off	0.0000E+00	0	None

08									
5	Delta7	2	Frequ ncy	- 2.7280E+ 09	- 30.2 58	Band Power	1.3250E+ 06	-3.969	dB
6	Normal	2	Time	5.2620E- 02	- 70.1 77	Band Power	2.3840E+ 06	-43.15	dBm
7	Normal	3	Period	1.0680E- 10	- 75.4 58	Off	0.0000E+ 00	0	None
8	Normal	3	Frequ ncy	6.7120E+ 09	- 77.3 3	Noise	3.3910E+ 06	- 139.71 4	dBm/Hz
9	Fixed	3	Inverse Time	4.0000E+ 01	- 30.0 5	Off	0.0000E+ 00	0	None
10	Normal	3	Frequ ncy	1.1454E+ 10	- 75.1 61	Band Density	1.3250E+ 06	- 138.97 3	dBm/Hz
11	Off	1	Frequ ncy	0.0000E+ 00	0	Off	0.0000E+ 00	0	None
12	Off	1	Frequ ncy	0.0000E+ 00	0	Off	0.0000E+ 00	0	None

The numbers appear in the file exactly as they appear onscreen. If it says 11.454 GHz onscreen, then in the file it is 11.454E+09.

The metadata header is very similar to the metadata used in the trace data .csv files. See Trace File Contents. The only new information concerns the 1-of-N fields in the marker table itself.

### Peak Table

This section discusses the Peak Table Meas Results file format.

Imagine that, at the point where a Marker Table Meas Result is requested, the following screen is showing:

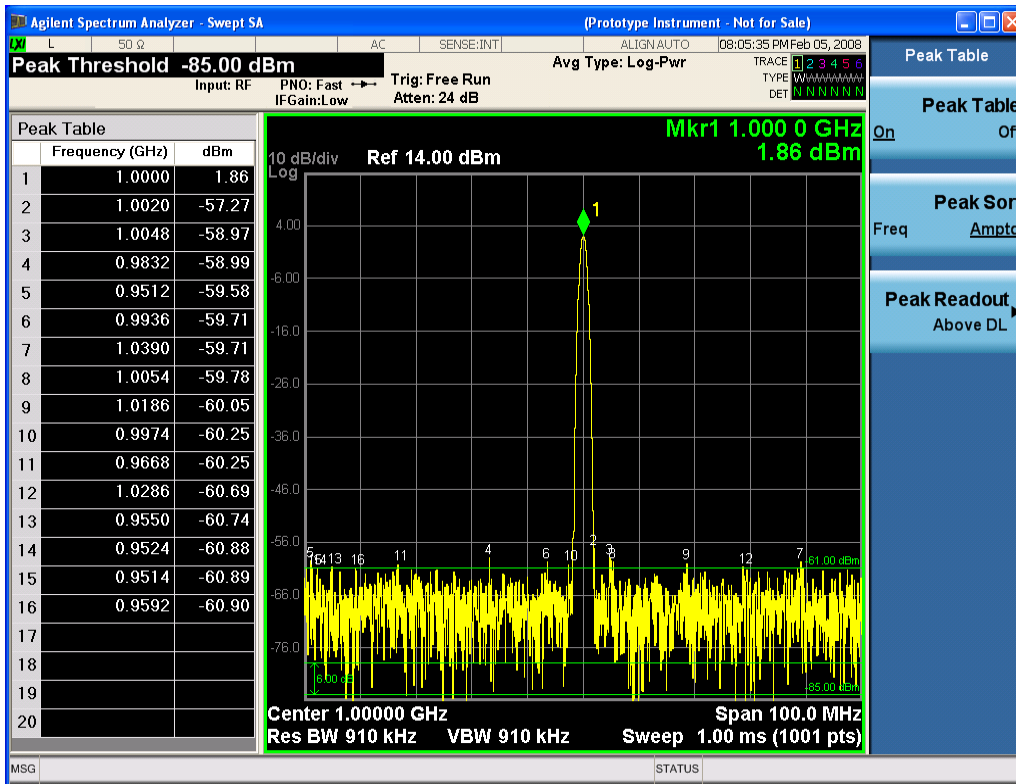

Then the Meas Results file, when opened, would show the header data (the same as for the Marker Table except that the Result Type is Peak Table) ending with a few fields of specific interest to Peak Table users:

- Peak Threshold
- Peak Threshold State (On|Off)
- Peak Excursion
- Peak Excursion State (On|Off)
- Display Line
- Peak Readout (All|AboveDL|BelowDL)
- Peak Sort (Freq|Amptd)

These fields are then followed by the data for the Peak Table itself.

Note that the label for the Frequency column changes to Time in 0 span.

Here is what the table for the above display looks like:

MeasurementResult	
Swept SA	
A.01.40_R0017	N9020A
526 B25 PFR P26 EA3	1

## 18 Reverse Link Modulation Accuracy

Save

Result Type	Peak Table
Ref Level	0
Number of Points	1001
Sweep Time	0.066266667
Start Frequency	10000000
Stop Frequency	26500000000
Average Count	0
Average Type	LogPower(Video)
RBW	3000000
RBW Filter	Gaussian
RBW Filter BW	3dB
VBW	3000000
Sweep Type	Swept
X Axis Scale	Lin
PreAmp State	Off
PreAmp Band	Low
Trigger Source	Free
Trigger Level	1.2
Trigger Slope	Positive
Trigger Delay	1.00E-06
Phase Noise Optimization	Fast
Swept If Gain	Low
FFT If Gain	Autorange
RF Coupling	AC
FFT Width	411900
Ext Ref	10000000
Input	RF
RF Calibrator	Off
Attenuation	10
Ref Level Offset	0
External Gain	0
X Axis Units	Hz
Y Axis Units	dBm
Peak Threshold	-85
Peak Threshold State	On
Peak Excursion	6
Peak Excursion State	On

Display Line	-61	
Peak Readout	AboveDL	
Peak Sort	Amptd	
DATA		
Peak	Frequency	Amplitude
1	1.0000E+06	1.86
2	1.0020E+06	-57.27
3	1.0048E+06	-58.97
4	9.8320E+05	-58.99
5	9.5120E+05	-59.58
6	9.9360E+05	-59.71
7	1.0390E+06	-59.71
8	1.0054E+06	-59.78
9	1.1086E+06	-60.05
10	9.9740E+05	-60.25
11	9.6680E+05	-60.25
12	1.0286E+06	-60.69
13	9.5500E+05	-60.74
14	9.5240E+05	-60.88
15	9.5140E+05	-60.89
16	9.5920E+05	-60.90
17		
18		
19		
20		

## Spectrogram

This section discusses the Spectrogram Results file format. The Spectrogram choice only appears if option EDP is licensed.

The Spectrogram results are the same as a Trace data export, except that instead of having just one trace's data, all 300 traces appear one after the other.

Each trace has its own data mark; the data for Spectrogram Trace 0 follows the row marked DATA, the data for Spectrogram Trace 1 follows the row marked DATA1, for Spectrogram Trace 2 follows the row marked DATA2, and so on.

Each DATA row has a timestamp in the second column (as of firmware revision A.11.01). So, for example, if Trace 0 had a relative start time of 1729.523 sec, then the first DATA row would look like this:

DATA,1729.523

And if Trace 13 had a relative start time of 100.45 sec, then the fourteenth data row would look like:

DATA13,100.453

To find the absolute time for the relative timestamps of each trace, the last row before the first DATA row gives the absolute start time of the Spectrogram, in the form YYYYMMDDHHMMSS

So, for example, if the absolute start time is 13:23:45:678 on January 30, 2012, this row would look like:

Start Time,20120130132345678

**NOTE** The resolution of the absolute time stored is 1 ms, which matches up with the fact that the fastest sweep time is also 1 ms. However, there is no specification for the absolute accuracy of the clock in the analyzer, nor is there any facility provided to allow the user to set this time to any particular degree of accuracy.

Traces that have not yet been filled in the Spectrogram display are empty; there is no DATA header for them. The file ends after the last non-empty trace.

Imagine that, at the point where a Spectrogram Meas Result is requested, the following screen is showing:



For the purpose of this example, we have set the Average/Hold Number to 10, thus we have only traces 0 thru 10. The Spectrogram was started at 02:28:08:700 pm on April 25, 2012 (that is, 700 ms after 2:28:08 pm), although the screen dump itself shows a different time, as it was taken ten minutes after the



Spectrogram data. Trace 0 is showing a start time of 5.30 seconds, meaning 5.3 seconds after the Spectrogram started (trace 10 has a start time of 0, as it was the first trace taken but has now rolled up into the tenth trace slot).

The Meas Results file, when opened, shows the header data and ten traces of trace data. Below is an extract from the result file for the above display. Note the start time of 20120425142808700 showing in the last row before the first DATA row, and the relative time of 5.299231048 showing in the first DATA row:

<b>Result Type</b>	<b>Spectrogram</b>
MeasResult	
Swept SA	
A.11.00.01	N9020A
503 508 513 526 ALL ALV B1C B1X B25 B2X B40 BAB BBA CR3 CRP DP2 DRD EA3 EDP EMC EP1 ERC ESC ESP EXM FSA HBA K03 LFE MPB P03 P08 P13 P26 PFR RTL RTS S40 SB1 SEC SM1 UK6 YAS YAV	1
Segment	0
Number of Points	1001
Sweep Time	0.523333333
Start Frequency	5999984415
Stop Frequency	6000009415
Average Count	0
Average Type	LogPower(Video)
RBW	240
RBW Filter	Gaussian
RBW Filter BW	3dB
VBW	240
Sweep Type	Swept
X Axis Scale	Lin
PreAmp State	Off
PreAmp Band	Low
Trigger Source	Free
Trigger Level	1.2
Trigger Slope	Positive
Trigger Delay	0
Phase Noise Optimization	Wide
Swept If Gain	Low
FFT If Gain	Autorange
RF Coupling	AC

Save

Result Type	Spectrogram
FFT Width	411900
Ext Ref	10000000
Input	RF
RF Calibrator	Off
Attenuation	14
Ref Level Offset	0
External Gain	0
Trace Type	Clearwrite
Detector	Normal
Trace Math	Off
Trace Math Oper1	Trace5
Trace Math Oper2	Trace6
Trace Math Offset	0
Trace Name	Trace1
X Axis Units	Hz
Y Axis Units	dBm
Start Time	20120425142808700
DATA	5.299231048
5999984415	-76.34749519
5999984440	-77.28097006
5999984465	-75.32317869
5999984490	-73.64417681
5999984515	-72.67154604

o

o

o

6000009315	-77.94423277
6000009340	-79.51829697
6000009365	-78.46108961
6000009390	-78.46108957
6000009415	-76.59570596
DATA2	4.708697055
5999984415	-80.98197882
5999984440	-80.98197879

5999984465	-75.83142132
5999984490	-74.02712079
5999984515	-73.57213005

- 
- 
- 

6000009315	-75.9183103
6000009340	-79.53787488
6000009365	-78.82602191
6000009390	-78.82602188
6000009415	-76.37486709
DATA10	0
5999984415	-75.56751112
5999984440	-75.76485645
5999984465	-76.67718717
5999984490	-78.79238489
5999984515	-83.72680212

- 
- 
- 

6000009315	-71.3942461
6000009340	-72.28308332
6000009365	-73.92684489
6000009390	-75.45548832
6000009415	-75.17904815

### Capture Buffer

Capture Buffer functionality is not available for all measurements. The captured data is raw data which is not processed.

Key Path	Save, Data
----------	------------

Mode	CDMA1XEV
Example	MMEM:STOR:CAPT "MyCaptureData.bin" This stores the capture data in the file MyCaptureData.bin in the default directory.
Dependencies	In case the capture buffer data is not available from the selected measurement, the key will be grayed out.
Initial S/W Revision	A.11.00

## Save As . . .

When you press "Save As", the analyzer brings up a Windows dialog and a menu entitled "**Save As.**" This menu allows you to navigate to the various fields in the Windows dialog without using a keyboard or mouse. The Tab and Arrow keys can also be used for dialog navigation.

See "[To File . . .](#)" on page 2897 in Save, State for a full description of this dialog and menu.

The default path for saving files is:

For all of the Trace Data Files:

My Documents\<<mode name>\data\traces

For all of the Limit Data Files:

My Documents\<<mode name>\data\limits

For all of the Measurement Results Data Files:

My Documents\<<mode name>\data\<<measurement name>\results

For all of the Capture Buffer Data Files:

My Documents\<<mode name>\data\captureBuffer

Key Path	Save, Data
Mode	All
Notes	The key location is mode-dependent and will vary. Brings up the Save As dialog for saving a <mode specific> Save Type. The save is performed immediately and does not wait until the measurement is complete.
Initial S/W Revision	Prior to A.02.00

## Screen Image

Pressing Screen Image accesses a menu of functions that enable you to specify a format and location for the saved screen image. It brings up a menu that allows you to specify the color scheme of the Screen Image (Themes) or navigate to the Save As dialog to perform the actual save.

Screen Image files contain an exact representation of the analyzer display. They cannot be loaded back onto the analyzer, but they can be loaded into your PC for use in many popular applications.

The image to be saved is actually captured when the Save front panel key is pressed, and kept in temporary storage to be used if you ask for a Screen Image save. When the Screen Image key is pressed, a "thumbnail" of the captured image is displayed, as shown below:

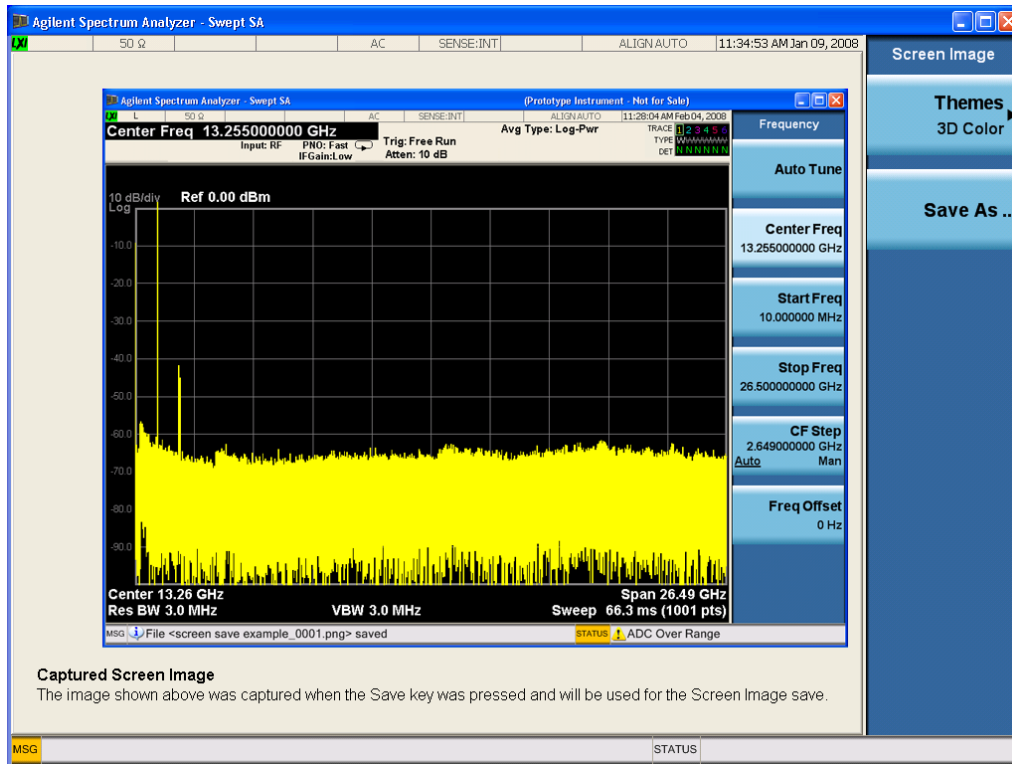

When you continue on into the Save As menu and complete the Screen Image save, the image depicted in the thumbnail is the one that gets saved, showing the menus that were on the screen before going into the Save menu. The save is performed immediately and does not wait until the measurement is complete.

After you have completed the save, the Quick Save front-panel key lets you quickly repeat the last save performed, using an auto-named file, with the current screen data.

**NOTE** For versions previous to A.01.55, if you initiate a screen image save by navigating through the Save menus, the image that is saved will contain the Save menu softkeys, not the menus and the active function that were on the screen when you first pressed the Save front panel key.

Key Path	Save
Mode	All
Remote Command	:MMEMory:STORe:SCReen <filename>
Example	:MMEM:STOR:SCR "myScreen.png" This stores the current screen image in the file MyScreenFile.png in the default directory.
Initial S/W Revision	Prior to A.02.00

## Themes

Accesses a menu of functions that enable you to choose the theme to be used when saving the screen image.

The **Themes** option is the same as the **Themes** option under the **Display** and **Page Setup** dialogs. It allows you to choose between themes to be used when saving the screen image.

Key Path	Save, Screen Image
Remote Command	:MMEMory:STORe:SCReen:THEMe TDColor   TDMonochrome   FCOLor   FMONochrome  :MMEMory:STORe:SCReen:THEMe?
Example	:MMEM:STOR:SCR:THEM TDM
Preset	3D Color; Is not part of Preset, but is reset by Restore Misc Defaults or Restore System Defaults All and survives subsequent running of the modes.
Readback	3D Color   3D Mono   Flat Color   Flat Mono
Backwards Compatibility Notes	In ESA and PSA we offer the choice of "Reverse Bitmap" or "Reverse Metafile" when saving screen images. This is much like the "Flat Color" theme available in X-Series. Also, if you selected Reverse Bitmap AND a black & white screen image, that would be much like "Flat Monochrome". In other words, each of the X-Series themes has a similar screen image type in ESA/PSA. But they are not identical.
Initial S/W Revision	Prior to A.02.00

### 3D Color

Selects a standard color theme with each object filled, shaded and colored as designed.

Key Path	Save, Screen Image, Themes
Example	MMEM:STOR:SCR:THEM TDC
Readback	3D Color
Initial S/W Revision	Prior to A.02.00

### 3D Monochrome

Selects a format that is like 3D color but shades of gray are used instead of colors.

Key Path	Save, Screen Image, Themes
Example	MMEM:STOR:SCR:THEM TDM
Readback	3D Mono
Initial S/W Revision	Prior to A.02.00

### Flat Color

Selects a format that is best when the screen is to be printed on an ink printer.

Key Path	Save, Screen Image, Themes
<b>Example</b>	MMEM:STOR:SCR:THEM FCOL
Readback	Flat Color
Initial S/W Revision	Prior to A.02.00

### Flat Monochrome

Selects a format that is like Flat Color. But only black is used (no colors, not even gray), and no fill.

Key Path	Save, Screen Image, Themes
<b>Example</b>	MMEM:STOR:SCR:THEM FMON
Readback	Flat Mono
Initial S/W Revision	Prior to A.02.00

### Save As...

When you press "Save As", the analyzer brings up a Windows dialog and a menu entitled "**Save As.**" This menu allows you to navigate to the various fields in the Windows dialog without using a keyboard or mouse. The Tab and Arrow keys can also be used for dialog navigation.

See "[To File . . .](#)" on page 2897 in Save, State for a full description of this dialog and menu.

The default path for Screen Images is

My Documents\`<mode name>`\screen.

where `<mode name>` is the parameter used to select the mode with the INST:SEL command (for example, SA for the Spectrum Analyzer).

Key Path	Save, Screen Image
Notes	Brings up Save As dialog for saving a Screen Image Save Type
Initial S/W Revision	Prior to A.02.00

### Mass Storage Catalog (Remote Command Only)

Key path	SCPI Only
<b>Remote Command</b>	:MMEMory:CATalog? [ <code>&lt;directory_name&gt;</code> ]
Notes	<p>The string must be a valid logical path.</p> <p>Queries disk usage information (drive capacity, free space available) and obtains a list of files and directories in a specified directory in the following format:</p> <p><code>&lt;numeric_value&gt;,&lt;numeric_value&gt;,{&lt;file_entry&gt;}</code></p> <p>It returns two numeric parameters and as many strings as there are files and directories. The first</p>

---

parameter indicates the total amount of storage currently used in bytes. The second parameter indicates the total amount of storage available, also in bytes. The <file\_entry> is a string. Each <file\_entry> indicates the name, type, and size of one file in the directory list:

<file\_name>,<file\_type>,<file\_size>

As the windows file system has an extension that indicates file type, <file\_type> is always empty. <file\_size> provides the size of the file in bytes. For directories, <file\_entry> is surrounded by square brackets and both <file\_type> and <file\_size> are empty

---

Initial S/W Revision      Prior to A.02.00

---

## Mass Storage Change Directory (Remote Command Only)

---

Key path                      SCPI Only

**Remote Command**        :MMEMory:CDIRectory [<directory\_name>]  
                              :MMEMory:CDIRectory?

**Notes**                      The string must be a valid logical path.  
                              Changes the default directory for a mass memory file system. The <directory\_name> parameter is a string. If no parameter is specified, the directory is set to the \*RST value.  
                              At \*RST, this value is set to the default user data storage area, that is defined as System.Environment.SpecialFolder.Personal.  
                              Query returns full path of the default directory.

---

Initial S/W Revision      Prior to A.02.00

---

## Mass Storage Copy (Remote Command Only)

---

Key path                      SCPI Only

**Remote Command**        :MMEMory:COPY <string>,<string>[,<string>,<string>]

**Notes**                      The string must be a valid logical path.  
                              Copies an existing file to a new file or an existing directory to a new directory.  
                              Two forms of parameters are allowed. The first form has two parameters. In this form, the first parameter specifies the source, and the second parameter specifies the destination.  
                              The second form has four parameters. In this form, the first and third parameters specify the source. The second and fourth parameters specify the directories. The first pair of parameters specifies the source. The second pair specifies the destination. An error is generated if the source doesn't exist or the destination file already exists.  
                              This command will generate an "access denied" error if the destination is a restricted folder (e.g., C:\Windows) and the current user does not have Power User or Administrator privileges.

---

## Mass Storage Device Copy (Remote Command Only)

This command transfers data to/from a file and a peripheral device.



Key path	SCPI Only
<b>Remote Command</b>	:MMEMory:COpy:DEvice <source_string>,<dest_string>
Notes	<p>The strings must be a valid logical path or a valid device keyword. If the dest_string is a device keyword, the data is copied from the source file to the device. If the source_string is a device keyword, the data is copied to the source file from the device.</p> <p>Valid device keywords are:          SNS (smart noise source)</p> <p>An error is generated if the file or device is not found.</p>

### Mass Storage Delete (Remote Command Only)

Key path	SCPI Only
<b>Remote Command</b>	:MMEMory:DElete <file_name>[,<directory_name>]
Notes	<p>The string must be a valid logical path.</p> <p>Removes a file from the specified directory. The &lt;file_name&gt; parameter specifies the file name to be removed. This command will generate an “access denied” error if the file is in a restricted folder (e.g., C:\Windows) and the current user does not have Power User or Administrator privileges.</p>
Initial S/W Revision	Prior to A.02.00

### Mass Storage Data (Remote Command Only)

Creates a file containing the specified data OR queries the data from an existing file.

Key path	SCPI Only
<b>Remote Command</b>	:MMEMory:DATA <file_name>, <data> :MMEMory:DATA? <file_name>
Notes	<p>The string must be a valid logical path.</p> <p>The command form is MMEMory:DATA &lt;file_name&gt;,&lt;data&gt;. It loads &lt;data&gt; into the file &lt;file_name&gt;. &lt;data&gt; is in 488.2 block format. &lt;file_name&gt; is string data.</p> <p>The query form is MMEMory:DATA? &lt;file_name&gt; with the response being the associated &lt;data&gt; in block format.</p>
Initial S/W Revision	Prior to A.02.00

### Mass Storage Make Directory (Remote Command Only)

Key path	SCPI Only
<b>Remote Command</b>	:MMEMory:MDIRectory <directory_name>
Notes	<p>The string must be a valid logical path.</p> <p>Creates a new directory. The &lt;directory_name&gt; parameter specifies the name to be created.</p>

---

	This command will generate an “access denied” error if the new directory would be in a restricted folder (e.g., C:\Windows) and the current user does not have Power User or Administrator privileges.
Initial S/W Revision	Prior to A.02.00

---

### Mass Storage Move (Remote Command Only)

---

Key path	SCPI Only
<b>Remote Command</b>	:MMEMory:MOVE <string>,<string>[,<string>,<string>]
Notes	<p>The string must be a valid logical path.</p> <p>Moves an existing file to a new file or an existing directory to a new directory.</p> <p>Two forms of parameters are allowed. The first form has two parameters. In this form, the first parameter specifies the source, and the second parameter specifies the destination.</p> <p>The second form has four parameters. In this form, the first and third parameters specify the source. The second and fourth parameters specify the directories. The first pair of parameters specifies the source. The second pair specifies the destination. An error is generated if the source doesn't exist or the destination file already exists.</p> <p>This command will generate an “access denied” error if the destination is a restricted folder (e.g., C:\Windows) and the current user does not have Power User or Administrator privileges.</p>
Initial S/W Revision	Prior to A.02.00

---

### Mass Storage Remove Directory (Remote Command Only)

---

Key path	SCPI Only
<b>Remote Command</b>	:MMEMory:RDIRECTory <directory_name>
Notes	<p>The string must be a valid logical path.</p> <p>Removes a directory. The &lt;directory_name&gt; parameter specifies the directory name to be removed. All files and directories under the specified directory shall also be removed.</p> <p>This command will generate an “access denied” error if the folder is a restricted folder (e.g., C:\Windows) or is in a restricted folder and the current user does not have Power User or Administrator privileges.</p>
Initial S/W Revision	Prior to A.02.00

---

## Single (Single Measurement/Sweep)

Sets the analyzer for Single measurement operation. The single/continuous state is Meas Global, so the setting will affect all the measurements. If you are Paused, pressing Single does a Resume.

See "[More Information](#)" on page 2415

Key Path	Front-panel key
Example	:INIT:CONT OFF
Notes	See Cont key description.
Backwards Compatibility Notes	<p>For Spectrum Analysis mode in ESA and PSA, the Single hardkey and the INITiate:IMM switched from continuous measurement to single measurement and restarted sweeps and averages (displayed average count reset to 1), but did not restart Max Hold and Min Hold. In the X-Series, the Single hardkey and the INITiate:IMM command initiate a sweep/ measurement/ average sequence/hold sequence including MaxHold and MinHold.</p> <p>For Spectrum Analysis mode in ESA and PSA, the Single hardkey restarted the sweep regardless of whether or not you were in an active sweep or sweep sequence. In the X-Series, Restart does this but Single only restarts the sweep or sweep sequence if you are in the idle state.</p> <p>INIT[:IMM] in ESA &amp; PSA Spectrum Analysis Mode does an implied ABORt. In some other PSA Modes, INIT[:IMM] is ignored if not in the idle state. . The X-Series follows the ESA/PSA SA Mode model, which may cause some Modes to have compatibility problems.</p>
Initial S/W Revision	Prior to A.02.00

### More Information

See "[Restart](#)" on page 2894 for details on the INIT:IMMediate (Restart) function.

If you are already in single sweep, the INIT:CONT OFF command has no effect.

If you are already in Single Sweep, then pressing the Single key in the middle of a sweep does not restart the sweep or sequence. Similarly, pressing the Single key does not restart the sweep or sequence if the sweep is not in the idle state (for example, if you are taking a very slow sweep, or the analyzer is waiting for a trigger). Instead, it results in a message. "Already in Single, press Restart to initiate a new sweep or sequence". Even though pressing the Single key in the middle of a sweep does not restart the sweep, sending INIT:IMMediate does reset it.

To take one more sweep without resetting the average count, increment the average count by 1, by pressing the step up key while **Average/Hold Number** is the active function, or sending the remote command CALC:AVER:TCON UP.

## Source

There is no Source functionality supported in the Modulation Accuracy measurement. The front-panel key will display a blank menu when key pressed.

---

Key Path	Front Panel key
Initial S/W Revision	Prior to A.02.00

---

## SPAN X Scale

Accesses a menu of functions that enable you to set the desired horizontal scale parameters.

Key Path	Front Panel key
Initial S/W Revision	Prior to A.02.00

## Sweep/Control

Accesses a menu that allows you to select parameters that affect the sweep of the displayed measurement signal.

Only the Pause/Resume key is available.

Key Path	Front panel key
Initial S/W Revision	Prior to A.02.00

## Pause/Resume

This key allows you to pause or resume the measurement of the displayed signal.

See "[Pause/Resume](#)" on page 2925 function.

Key Path	Sweep/Control
Initial S/W Revision	Prior to A.02.00

## System

See "System" on page 359

## Trace/Detector

There is no Trace/Detector functionality supported in the Modulation Accuracy measurement. The front-panel key will display a blank menu when key pressed.

---

Key Path	Front Panel key
Initial S/W Revision	Prior to A.02.00

---



## Trigger

See ["Trigger" on page 430](#)

### Free Run

See ["Free Run " on page 437](#)

### Video

See ["Video \(IF Envelope\) " on page 438](#)

### Trigger Level

See ["Trigger Level " on page 438](#)

### Trig Slope

See ["Trig Slope " on page 439](#)

### Trig Delay

See ["Trig Delay " on page 440](#)

### Line

See ["Line " on page 2729](#)

### Trig Slope

See ["Trig Slope " on page 2729](#)

### Trig Delay

See ["Trig Delay " on page 442](#)

### External 1

See ["External 1 " on page 2741](#)

### Trigger Level

See ["Trigger Level " on page 2741](#)

### Trig Slope

See ["Trig Slope " on page 2742](#)

### Trig Delay

See ["Trig Delay " on page 445](#)

### External 2

See ["External 2 " on page 2743](#)

### **Trigger Level**

See ["Trigger Level "](#) on page 2743

### **Trig Slope**

See ["Trig Slope "](#) on page 2744

### **Trig Delay**

See ["Trig Delay "](#) on page 447

### **RF Burst**

See ["RF Burst "](#) on page 2744

### **Absolute Trigger**

See ["Absolute Trigger Level"](#) on page 2745

### **Relative Trigger**

See ["Relative Trigger Level"](#) on page 2734

### **Trig Slope**

See ["Trigger Slope "](#) on page 2746

### **Trig Delay**

See ["Trig Delay "](#) on page 451

### **Periodic Timer**

See ["Periodic Timer \(Frame Trigger\) "](#) on page 2736

### **Period**

See ["Period "](#) on page 2737

### **Offset**

See ["Offset "](#) on page 2738

### **Offset Adjust (Remote Command Only)**

See ["Offset Adjust \(Remote Command Only\)"](#) on page 2739

### **Reset Offset Display**

See ["Reset Offset Display "](#) on page 2740

### **Sync Source**

See ["Sync Source "](#) on page 2740

## Off

See ["Off "](#) on page 2741

## External 1

See ["External 1 "](#) on page 2741

## Trigger Level

See ["Trigger Level "](#) on page 2741

## Trig Slope

See ["Trig Slope "](#) on page 2742

## External 2

See ["External 2 "](#) on page 2743

## Trigger Level

See ["Trigger Level "](#) on page 2743

## Trig Slope

See ["Trig Slope "](#) on page 2744

## RF Burst

See ["RF Burst "](#) on page 2744

## Absolute Trigger

See ["Absolute Trigger Level"](#) on page 2745

## Trig Slope

See ["Trigger Slope "](#) on page 2746

## Trig Delay

See ["Trig Delay"](#) on page 461

## Auto/Holdoff

See ["Auto/Holdoff "](#) on page 462

## Auto Trig

See ["Auto Trig "](#) on page 462

## Trig Holdoff

See ["Trig Holdoff "](#) on page 463

## Holdoff Type

See [\\_\\_](#) on page X

## User Preset

Accesses a menu that gives you the following three choices:

- User Preset – recalls a state previously saved using the Save User Preset function.
- User Preset All Modes – presets all of the modes in the analyzer
- Save User Preset– saves the current state for the current mode

Key Path	Front-panel key
Backwards Compatibility Notes	<p>User Preset is actually loading a state, and in legacy analyzers, it was possible to load a state without affecting the trace data, limit lines or correction data. Similarly it was possible to do a User Preset without affecting the trace data, limit lines or correction data.</p> <p>In the X-Series, “state” always includes all of this data; so whenever state is loaded, or User Preset is executed, all of the traces, limit lines and corrections are affected. Although this differs from previous behavior, it is desirable behavior, and should not cause adverse issues for users.</p> <p>On ESA and PSA, User Preset affected the entire instrument’s state. In the X-Series, User Preset only recalls the state for the active mode. There is a User Preset file for each mode. User Preset can never cause a mode switch as it can in legacy analyzers. If you want to recall all modes to their user preset file state, you will need to do a User Preset after mode switching into each mode.</p> <p>User Preset recalls mode state which can now include data like traces; whereas on ESA and PSA, User Preset did not affect data.</p>
Initial S/W Revision	Prior to A.02.00

## User Preset

User Preset sets the state of the currently active mode back to the state that was previously saved for this mode using the Save User Preset menu key or the SCPI command, SYST:PRES:USER:SAV. It not only recalls the Mode Preset settings, but it also recalls all of the mode persistent settings, and the Input/Output system setting that existed at the time Save User Preset was executed.

If a Save User Preset has not been done at any time, User Preset recalls the default user preset file for the currently active mode. The default user preset files are created if, at power-on, a mode detects there is no user preset file. There will never be a scenario when there is no user preset file to restore. For each mode, the default user preset state is the same state that would be saved if a Save User Preset is performed in each mode right after doing a Restore Mode Default and after a Restore Input/Output Defaults.

The User Preset function does the following:

- Aborts the currently running measurement.
- Sets the mode State to the values defined by Save User Preset.
- Makes the saved measurement for the currently running mode the active measurement.
- Brings up the saved menu for the power-on mode.
- Clears the input and output buffers.
- Sets the Status Byte to 0.

Key Path	User Preset
Remote Command	:SYSTem:PRESet:USER
Example	:SYST:PRES:USER:SAVE:SYST:PRES:USER
Notes	:SYST:PRES:USER:SAVE is used to save the current state as the user preset state. Clears all pending OPC bits. The Status Byte is set to 0. Pressing the User Preset front-panel key while already in the User Preset menu will cause the User Preset to get executed
Couplings	A user preset will cause the currently running measurement to be aborted and cause the saved measurement to be active. Recalling a User Preset file has the same issues that recalling a Save State file has. Some settings may need to be limited and therefore re-coupled, since the capabilities of the mode may have changes when the User Preset file was last saved.
Initial S/W Revision	Prior to A.02.00

## User Preset All Modes

Recalls all of the User Preset files for each mode, switches to the power-on mode, and activates the saved measurement from the power-on mode User Preset file.

**NOTE**

When the instrument is secured, all of the user preset files are converted back to their default user preset files.

The User Preset function does the following:

- Aborts the currently running measurement.
- Switches the Mode to the power-on mode.
- Restores the User Preset files for each mode.
- Makes the saved measurement for the power-on mode the active measurement.
- Brings up the saved menu for the power-on mode.
- Clears the input and output buffers.
- Sets the Status Byte to 0.

Key Path	User Preset
Remote Command	:SYSTem:PRESet:USER:ALL
Example	:SYST:PRES:USER:SAVE:SYST:PRES:USER:ALL
Notes	Clears all pending OPC bits. The Status Byte is set to 0. :SYST:PRES:USER:SAVE is used to save the current state as the user preset state.
Couplings	A user preset will cause the currently running measurement to be aborted, cause a mode switch to the power-on mode, and cause the saved measurement to be active in the power-on mode. Recalling a User Preset file has the same issues that recalling a Save State file has. Some settings may need to be limited and therefore re-coupled, since the capabilities of the mode may have changes when the User Preset file was last saved.
Initial S/W Revision	Prior to A.02.00

## Save User Preset

Saves the currently active mode and its State. You can recall this User Preset file by pressing the User Preset menu key or sending the SYST:PRES:USER remote command. This same state is also saved by the Save State function.

Key Path	User Preset
<b>Remote Command</b>	:SYSTem:PRESet:USER:SAVE
<b>Example</b>	:SYST:PRES:USER:SAVE
Notes	:SYST:PRES:SAVE creates the same file as if the user requested a *SAV or a MMEM:STOR:STAT, except User Preset Save does not allow the user to specify the filename or the location of the file.
Initial S/W Revision	Prior to A.02.00

## View/Display

Accesses a menu of functions that enable you to control the instrument display.

See ["View Selection \(Remote Command only\)" on page 2427](#)

See ["View Selection by number \(Remote Command only\)" on page 2428](#)

This measurement consists of four views. Some views display multiple windows. For more information about a specific view, see the following:

The default view is I/Q Measured Polar Graph (left/right).

Key Path	Front panel key
Initial S/W Revision	Prior to A.02.00

### View Selection (Remote Command only)

Selects the desired measurement view from the following selections:

- POLar – provides a combination view of I/Q measured polar vector graph and the summary data.
- TABLE – Provides a table of magnitude error, phase error, EVM, and the modulation accuracy summary data such as rho, peak and rms EVM, peak Modulation Accuracy (Rho) error, magnitude error, phase error, and so forth in a text window, in terms of averaged and detected peak/maximum value in the average cycle.
- ERRor – provides a combination view of a magnitude error, phase error, EVM graphs and one-slot result summary of selected channel.
- CDPower – provides a combination view of the code domain power graph and the summary table of code domain channel.

Key Path	View/Display
Mode	1xEVDO
<b>Remote Command</b>	:DISPlay:RHO:MS:VIEW[:SElect] POLar ERRor TABLE CDPower :DISPlay:RHO:MS:VIEW[:SElect]?
<b>Example</b>	:DISP:RHO:MS:VIEW TABL
Notes	Meaning of the numeric values: 1: I/Q Measured Polar Graph View 2: Peak/Avg Metrics View 3: I/Q Error (Quad View) View 4: Code Domain Power View
Preset	POLar
State Saved	Saved in instrument state.
Range	I/Q Measured Polar Graph   Peak/Avg Metrics   I/Q Error (Quad View)   Code Domain Power
<b>Backwards</b>	:DISPlay:TRHO:VIEW[:SElect]

---

### Compatibility SCPI

Initial S/W Revision	Prior to A.02.00
----------------------	------------------

---

### View Selection by number (Remote Command only)

Displays the numeric values of the measurement results. This function is available by SCPI command only.

Mode	1xEVDO
<b>Remote Command</b>	:DISPlay:RHO:MS:VIEW:NSElect <integer> :DISPlay:RHO:MS:VIEW:NSElect?
<b>Example</b>	DISP:RHO:MS:VIEW:NSEL 2 DISP:RHO:MS:VIEW:NSEL?
Preset	1
State Saved	Saved in instrument state.
Min	1
Max	4
<b>Backwards Compatibility SCPI</b>	:DISPlay:TRHO:VIEW:NSElect
Initial S/W Revision	Prior to A.02.00

### Display

The Display menu is common to most measurements, and is used for configuring items on the display. Some Display menu settings apply to all the measurements in a mode, and some only to the current measurement. Those under the System Display Settings key apply to all measurements in all modes.

Key Path	Display
Key Path	View/Display
Initial S/W Revision	Prior to A.02.00

### Annotation

Turns on and off various parts of the display annotation. The annotation is divided up into four categories:

1. Meas Bar: This is the measurement bar at the top of the screen. It does not include the settings panel or the Active Function. Turning off the Meas Bar turns off the settings panel and the Active Function. When the Meas Bar is off, the graticule area expands to fill the area formerly occupied by the Meas Bar.
2. Screen Annotation: this is the annotation and annunciation around the graticule, including any annotation on lines (such as the display line, the threshold line, etc.) This does NOT include the marker number or the N dB result. When off, the graticule expands to fill the entire graticule area.
3. Trace annotation: these are the labels on the traces, showing their detector (or their math mode).



4. Active Function annotation: this is the active function display in the meas bar, and all of the active function values displayed on softkeys.

See the figure below. Each type of annotation can be turned on and off individually.

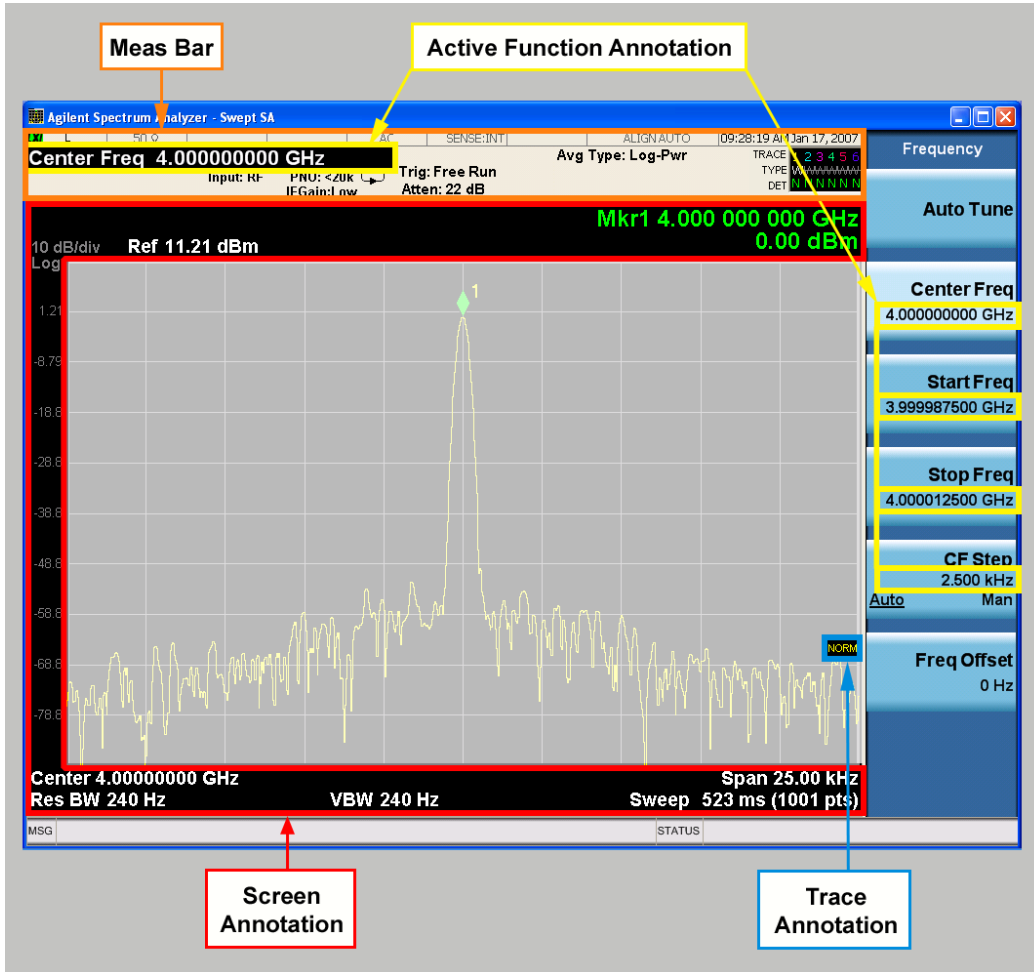

Key Path	View/Display, Display
Initial S/W Revision	Prior to A.02.00

### Meas Bar On/Off

This function turns the Measurement Bar on and off, including the settings panel. When off, the graticule area expands to fill the area formerly occupied by the Measurement Bar.

Key Path	View/Display, Display, Annotation
Remote Command	:DISPlay:ANNotation:MBAR[:STATe] OFF ON 0 1 :DISPlay:ANNotation:MBAR[:STATe]?
Example	DISP:ANN:MBAR OFF

Dependencies	Grayed out and forced to OFF when System Display Settings, Annotation is set to Off.
Preset	On This should remain Off through a Preset when System DisplaySettings, Annotation is set to Off.
State Saved	Saved in instrument state.
Initial S/W Revision	Prior to A.02.00

## Screen

This controls the display of the annunciation and annotation around the graticule, including any annotation on lines (such as the display line, the threshold line, etc.) and the y-axis annotation. This does NOT include marker annotation (or the N dB result). When off, the graticule expands to fill the entire graticule area, leaving only the 1.5% gap above the graticule as described in the Trace/Detector chapter.

Key Path	View/Display, Display, Annotation
Remote Command	:DISPlay:ANNotation:SCReen[:STATe] OFF ON 0 1 :DISPlay:ANNotation:SCReen[:STATe]?
Example	DISP:ANN:SCR OFF
Dependencies	Grayed-out and forced to OFF when System Display Settings, Annotation is set to Off.
Preset	On This should remain Off through a Preset when System DisplaySettings, Annotation is set to Off
State Saved	Saved in instrument state.
Initial S/W Revision	Prior to A.02.00

## Active Function Values On/Off

Turns on and off the active function display in the Meas Bar, and all of the active function values displayed on the softkeys.

Note that all of the softkeys that have active functions have these numeric values blanked when this function is on. This is a security feature..

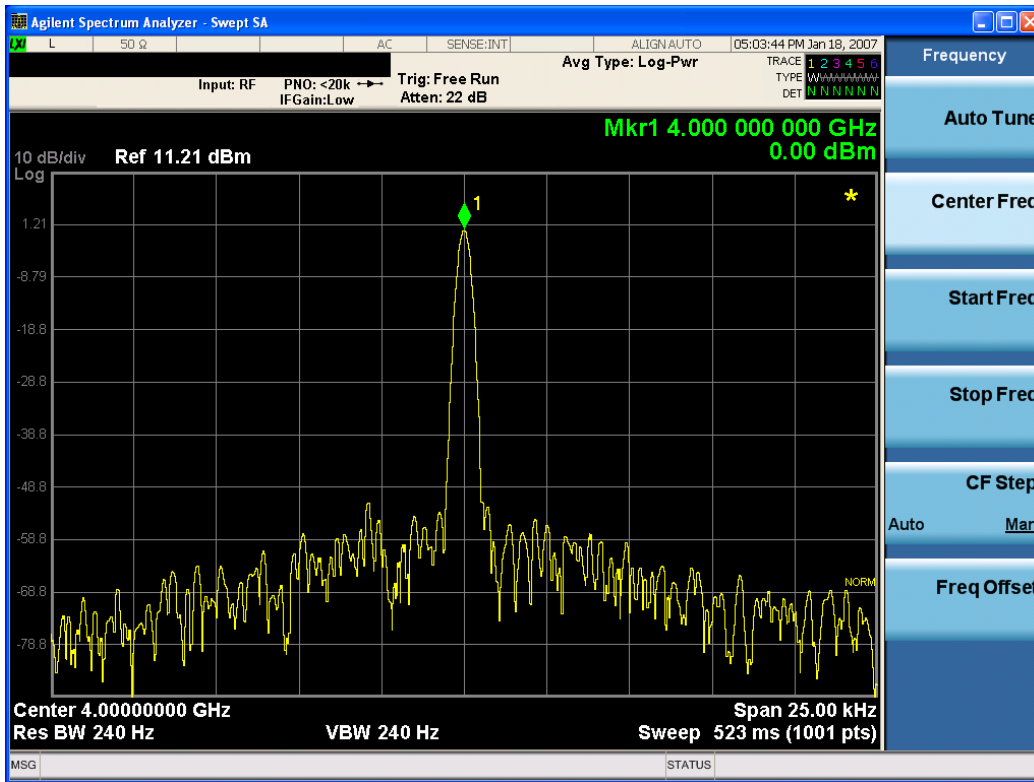

Key Path	View/Display, Display, Annotation
Remote Command	:DISPlay:ACTivefunc[:STATE] ON OFF 1 0 :DISPlay:ACTivefunc[:STATE]?
Example	DISP:ACT OFF
Dependencies	Grayed out and forced to OFF when System Display Settings, Annotation is set to Off.
Preset	On This should remain Off through a Preset when System DisplaySettings, Annotation is set to Off
State Saved	Saved in instrument state.
Initial S/W Revision	Prior to A.02.00

### Title

Displays menu keys that enable you to change or clear a title on your display.

Key Path	View/Display, Display
Initial S/W Revision	Prior to A.02.00

### Change Title

Writes a title into the "measurement name" field in the banner, for example, "Swept SA".

Press Change Title to enter a new title through the alpha editor. Press Enter or Return to complete the entry. Press ESC to cancel the entry and preserve your existing title.

The display title will replace the measurement name. It remains for this measurement until you press Change Title again, or you recall a state, or a Preset is performed. A title can also be cleared by pressing Title, Clear Title.

**NOTE**

Notice the inclusion of the <measurement> parameter in the command below. Because each measurement remembers the Display Title, the command must be qualified with the measurement name. For the Swept SA measurement this is not the case; no <measurement> parameter is used when changing the Display Title for the Swept SA measurement.

Key Path	View/Display, Display, Title
Mode	All
Remote Command	:DISPlay:<measurement>:ANNotation:TITLe:DATA <string> :DISPlay:<measurement>:ANNotation:TITLe:DATA?
Example	DISP:ANN:TITL:DATA "This Is My Title" This example is for the Swept SA measurement in the Spectrum Analyzer mode. The SANalyzer <measurement> name is not used. DISP:ACP:ANN:TITL:DATA "This Is My Title" This example is for Measurements other than Swept SA. Both set the title to: This Is My Title
Notes	Pressing this key cancels any active function. When a title is edited the previous title remains intact (it is not cleared) and the cursor goes at the end so that characters can be added or BKSP can be used to go back over previous characters.
Preset	No title (measurement name instead)
State Saved	Saved in instrument state.
Initial S/W Revision	Prior to A.02.00

**Clear Title**

Clears a title from the front-panel display. Once cleared, the title cannot be retrieved. After the title is cleared, the current Measurement Name replaces it in the title bar.

Key Path	View/Display, Display, Title
Example	The following commands clear the title and restore the measurement's original title: DISP:ANN:TITL:DATA "" This example is for the Swept SA measurement in the Spectrum Analyzer mode. The SANalyzer <measurement> name is not used. DISP:ACP:ANN:TITL:DATA "" This example is for ACP; in measurements other than Swept SA the measurement name is required.
Notes	Uses the :DISPlay:<measurement>:ANNotation:TITLe:DATA <string> command with an empty string (in the Swept SA, the <measurement> is omitted).
Preset	Performed on Preset.
Initial S/W Revision	Prior to A.02.00

## Graticule

Pressing Graticule turns the display graticule On or Off. It also turns the graticule y-axis annotation on and off.

Key Path	View/Display, Display
Remote Command	:DISPlay:WINDow[1]:TRACe:GRATicule:GRID[:STATe] OFF ON 0 1 :DISPlay:WINDow[1]:TRACe:GRATicule:GRID[:STATe]?
Example	DISP:WIND:TRAC:GRAT:GRID OFF
Notes	The graticule is the set of horizontal and vertical lines that make up the grid/divisions for the x-axis and y-axis.
Preset	On
State Saved	Saved in instrument state
Initial S/W Revision	Prior to A.02.00

## System Display Settings

These settings are "Mode Global" – they affect all modes and measurements and are reset only by Restore Misc Defaults or Restore System Defaults under System.

Key Path	View/Display, Display
Initial S/W Revision	Prior to A.02.00

## Annotation Local Settings

This is a Mode Global override of the meas local annotation settings. When it is All Off, it forces ScreenAnnotation, Meas Bar, Trace, and Active Function Values settings to be OFF for all measurements in all modes. This provides the security based "annotation off" function of previous analyzers; hence it uses the legacy SCPI command.

When it is All Off, the Screen, Meas Bar, Trace, and Active Function Values keys under the Display, Annotation menu are grayed out and forced to Off. When Local Settings is selected, you are able to set the local annotation settings on a measurement by measurement basis.

Key Path	View/Display, Display, System Display Settings
Remote Command	:DISPlay:WINDow[1]:ANNOtation[:ALL] OFF ON 0 1 :DISPlay:WINDow[1]:ANNOtation[:ALL]?
Example	:DISP:WIND:ANN OFF
Preset	On (Set by Restore Misc Defaults)
State Saved	Not saved in instrument state.
Backwards Compatibility Notes	The WINDow parameter and optional subopcode is included for backwards compatibility but ignored – all windows are equally affected.
Initial S/W Revision	Prior to A.02.00

## Themes

Accesses a menu of functions that enable you to choose the theme to be used when saving the screen image.

The **Themes** option is the same as the **Themes** option under the **Display** and **Page Setup** dialogs. It allows you to choose between themes to be used when saving the screen image.

<b>Key Path</b>	Save, Screen Image
<b>Remote Command</b>	:MMEMory:STORe:SCReen:THEMe TDColor   TDMonochrome   FCOLor   FMONochrome  :MMEMory:STORe:SCReen:THEMe?
<b>Example</b>	:MMEM:STOR:SCR:THEM TDM
<b>Preset</b>	3D Color; Is not part of Preset, but is reset by Restore Misc Defaults or Restore System Defaults All and survives subsequent running of the modes.
<b>Readback</b>	3D Color   3D Mono   Flat Color   Flat Mono
<b>Backwards Compatibility Notes</b>	In ESA and PSA we offer the choice of "Reverse Bitmap" or "Reverse Metafile" when saving screen images. This is much like the "Flat Color" theme available in X-Series. Also, if you selected Reverse Bitmap AND a black & white screen image, that would be much like "Flat Monochrome". In other words, each of the X-Series themes has a similar screen image type in ESA/PSA. But they are not identical.
<b>Initial S/W Revision</b>	Prior to A.02.00

### 3D Color

Selects a standard color theme with each object filled, shaded and colored as designed.

<b>Key Path</b>	Save, Screen Image, Themes
<b>Example</b>	MMEM:STOR:SCR:THEM TDC
<b>Readback</b>	3D Color
<b>Initial S/W Revision</b>	Prior to A.02.00

### 3D Monochrome

Selects a format that is like 3D color but shades of gray are used instead of colors.

<b>Key Path</b>	Save, Screen Image, Themes
<b>Example</b>	MMEM:STOR:SCR:THEM TDM
<b>Readback</b>	3D Mono
<b>Initial S/W Revision</b>	Prior to A.02.00

### Flat Color

Selects a format that is best when the screen is to be printed on an ink printer.

Key Path	Save, Screen Image, Themes
<b>Example</b>	MMEM:STOR:SCR:THEM FCOL
Readback	Flat Color
Initial S/W Revision	Prior to A.02.00

### Flat Monochrome

Selects a format that is like Flat Color. But only black is used (no colors, not even gray), and no fill.

Key Path	Save, Screen Image, Themes
<b>Example</b>	MMEM:STOR:SCR:THEM FMON
Readback	Flat Mono
Initial S/W Revision	Prior to A.02.00

### Backlight

Accesses the display backlight on/off keys. This setting may interact with settings under the Windows "Power" menu.

When the backlight is off, pressing ESC, TAB, SPACE, ENTER, UP, DOWN, LEFT, RIGHT, DEL, BKSP, CTRL, or ALT turns the backlight on without affecting the application. Pressing any other key will turn backlight on and could potentially perform the action as well.

Key Path	View/Display, Display, System Display Settings
<b>Remote Command</b>	:DISPlay:BACKlight ON OFF :DISPlay:BACKlight?
Preset	ON (Set by Restore Misc Defaults)
Initial S/W Revision	Prior to A.02.00

### Backlight Intensity

An active function used to set the backlight intensity. It goes from 0 to 100 where 100 is full on and 0 is off. This value is independent of the values set under the Backlight on/off key.

Key Path	View/Display, Display, System Display Settings
<b>Remote Command</b>	:DISPlay:BACKlight:INTensity <integer> :DISPlay:BACKlight:INTensity?
<b>Example</b>	DISP:BACK:INT 50

Preset	100 (Set by Restore Misc Defaults)
Min	0
Max	100
Initial S/W Revision	Prior to A.02.00

### I/Q Measured Polar Graph

Provides a combination view of I/Q measured polar vector graph and the summary data.

There are two windows:

- "I/Q Measured Polar Vector window" on page 2437
- "Metrics window" on page 2437

The result on the Metrics is not averaged result but single measurement result when average set to ON.

Slot number shows in I/Q Measured Polar Vector window.

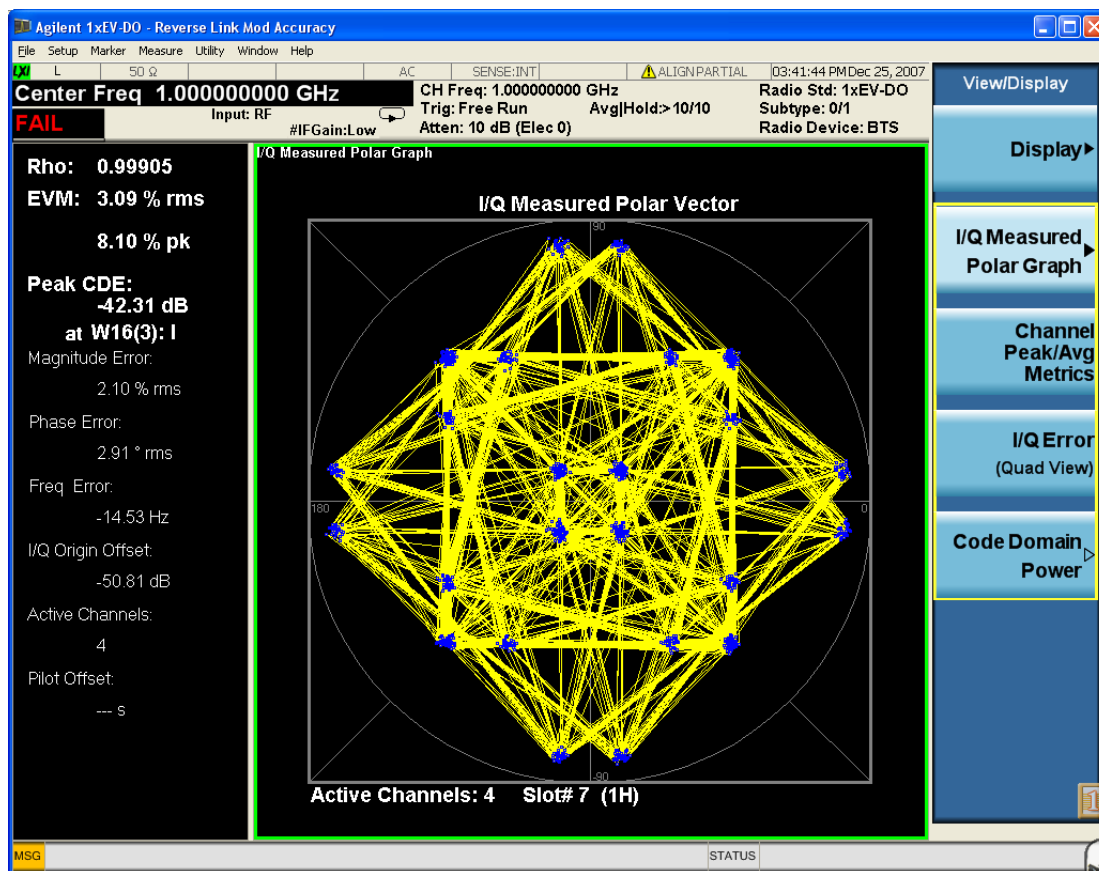

Figure 0-1 I/Q Measured Polar Graph View



## I/Q Measured Polar Vector window

Shows code domain power.

Marker Operation	Yes
Corresponding Trace	Corrected measured trace (n=5)

## Metrics window

Parameter Name	Corresponding Results	Display Format
Slot Number	n=1 20th	99 (xx) xx: 1H, 2H
Rho	n=11 7th rho	9.99999
EVM (rms)	n=11 1st EVM over the entire measurement area	99.99 % rms
EVM (pk)	n=11 2nd peak EVM in the measurement area	99.99 % pk
Pk CDE (dB)	n=11 8th Peak Code Domain Error relative to the mean power	-99.99 dB
Pk CDE (Ch No.)	n=11 9th Channel number in which the peak code domain error is detected.	WX(Y):Phase X: Walsh Code length (2 .. 32) 2: 614.4ksps ... 32:38.4ksps Y: Walsh code number (0 .. X-1) Phase: I or Q
Magnitude Error	n=11 3rd Average magnitude error over the entire measurement area	99.99 % rms
Phase Error	n=11 4th Average phase error over the entire measurement area	99.99 °rms
Freq Error	n=11 6th Frequency error in the measured signal	99.99 Hz
I/Q Origin Offset	n=11 5th I and Q error (magnitude squared) offset from the origin.	-99.99 dB
Active Channels	n=11 10th Number of Active channels	9
Pilot Offset	n=11 11th Pilot phase timing from the acquisition trigger point.	9999.99 us

Key Path	View/Display
<b>Example</b>	:DISP:RHO:MS:VIEW POL
Initial S/W Revision	Prior to A.02.00

### I/Q Polar Vector/Constellation

Sets IQ Polar graph display mode from Vector & Constellation, Vector and Constellation. This key appears when I/Q Polar Graph window is active.

- VCONStIn – Vector & Constellation
- VECTor – Vector
- CONSTIn – Constellation

Key Path	View/Display – I/Q Measured Polar Graph, I/Q Polar
Mode	1xEVDO
<b>Remote Command</b>	:DISPlay:RHO:MS:IQPTType VCONStIn VECTor CONSTIn :DISPlay:RHO:MS:IQPTType?
<b>Example</b>	:DISP:RHO:MS:IQPT VCON
Notes	VIEW1: I/Q Measured Polar Graph View WIND2: I/Q Polar graph window
Preset	VCONStIn
State Saved	Saved in instrument state.
Range	Vec & ConstIn   Vector   Constellation
Initial S/W Revision	Prior to A.02.00

### Chip Offset

Sets display trace length in IQ Polar Graph in chips.

Key Path	View/Display – I/Q Measured Polar Graph, Chip Offset
Mode	1xEVDO
<b>Remote Command</b>	:DISPlay:RHO:MS:OFFSet <integer> :DISPlay:RHO:MS:OFFSet?
<b>Example</b>	:DISPlay:RHO:MS:OFFS 10
Notes	Maximum varies so that (Chip Offset + I/Q Chips) does not exceed 1024 chips. VIEW1: I/Q Measured Polar Graph View WIND2: I/Q Polar graph window
Couplings	When (Chip Offset + I/Q Chips) exceeds 1024, Chip Offset is changed to keep it 1023.

Preset	0
State Saved	Saved in instrument state.
Range	0 to 1023
Min	0
Max	1023
Initial S/W Revision	Prior to A.02.00

## I/Q Chips

Sets display trace length in IQ Polar Graph in chips.

Key Path	View/Display - I/Q Measured Polar Graph, I/Q Chips
Mode	1xEVDO
<b>Remote Command</b>	:DISPlay:RHO:MS:IQChips <integer> :DISPlay:RHO:MS:IQChips?
<b>Example</b>	:DISPlay:RHO:MS:IQCH 1000
Notes	VIEW1: I/Q Measured Polar Graph View WIND2: I/Q Polar graph window
Couplings	When (Chip Offset + I/Q Chips) exceeds 1024, Chip Offset is changed to keep it 1024.
Preset	1024
State Saved	Saved in instrument state.
Range	1 to 1024
Min	1
Max	1024
Initial S/W Revision	Prior to A.02.00

## +45° Rotation

Allows you to toggle the 45 Degree Rotation of the trace on IQ Polar Graph. When On, the trace plotted on IQ Polar Graph is rotated by +45 degree. This setting affects display of the trace but not trace returned from RUI.

Key Path	View/Display - I/Q Measured Polar Graph, +45° Rot
Mode	1xEVDO
<b>Remote Command</b>	:DISPlay:RHO:MS:ROTQpi[:STATe] 0 1 OFF ON :DISPlay:RHO:MS:ROTQpi[:STATe]?
<b>Example</b>	:DISPlay:RHO:MS:ROTQ ON
Notes	VIEW1: I/Q Measured Polar Graph View WIND2: I/Q Polar graph window

Preset	OFF
State Saved	Saved in instrument state.
Range	On   Off
Initial S/W Revision	Prior to A.02.00

### Full Vector(Background)

Allows you to toggle the Full Vector display. Full Vector is a trace plotted on IQ Polar graph using the same IQ data plotted on the graph. Full trace data is always drawn with gray line behind the normal plot which is drawn with yellow line and/or blue dots. Full Vector provides the user an intuitive sense of relative magnitude of plotted IQ measured data which is specified by I/Q Chips and Chip Offset.

Key Path	View/Display – I/Q Measured Polar Graph, Full Vector
Mode	1xEVDO
<b>Remote Command</b>	:DISPlay:RHO:MS:FVECTor[:STATe] 0 1 OFF ON :DISPlay:RHO:MS:FVECTor[:STATe]?
<b>Example</b>	:DISPlay:RHO:MS:FVEC ON
Notes	VIEW1: I/Q Measured Polar Graph View WIND2: I/Q Polar graph window
Preset	OFF
State Saved	Saved in instrument state.
Range	On   Off
Initial S/W Revision	Prior to A.02.00

### Interpolation

This key specifies whether the input I/Q data should be interpolated.

Key Path	View/Display – I/Q Measured Polar Graph, Interpolation
Mode	1xEVDO
<b>Remote Command</b>	:DISPlay:RHO:MS:INTerpolate OFF ON 0 1 :DISPlay:RHO:MS:INTerpolate?
<b>Example</b>	:DISP:RHO:MS:INT ON
Preset	OFF
State Saved	Saved in instrument state.
Range	On   Off
Initial S/W Revision	Prior to A.02.00

## Peak/Avg Metrics

Provides a table of magnitude error, phase error, EVM, and the modulation accuracy summary data such as rho, peak and rms EVM, peak Modulation Accuracy (Rho) error, magnitude error, phase error, and so forth in a text window, in terms of averaged and detected peak/maximum value in the average cycle.

- Average : The value averaged in average cycle
- Peak Hold : The value detected and hold as Peak/Maximum in average cycle

In this view, “F” shows failure to setting limit.

<b>Example</b>	:DISP:RHO:MS:VIEW TABL
Initial S/W Revision	Prior to A.02.00

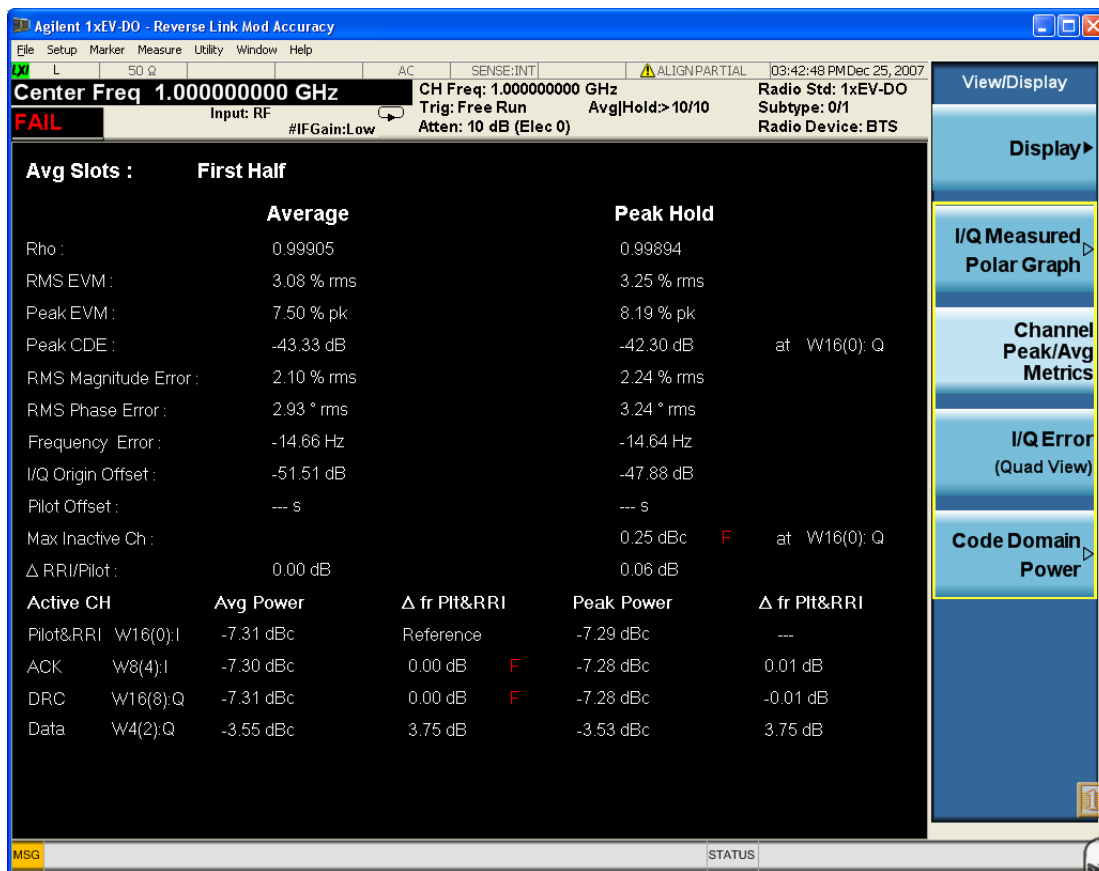

Figure 0-2 Peak/Avg Metrics View(Subtype0/1)

18 Reverse Link Modulation Accuracy  
View/Display

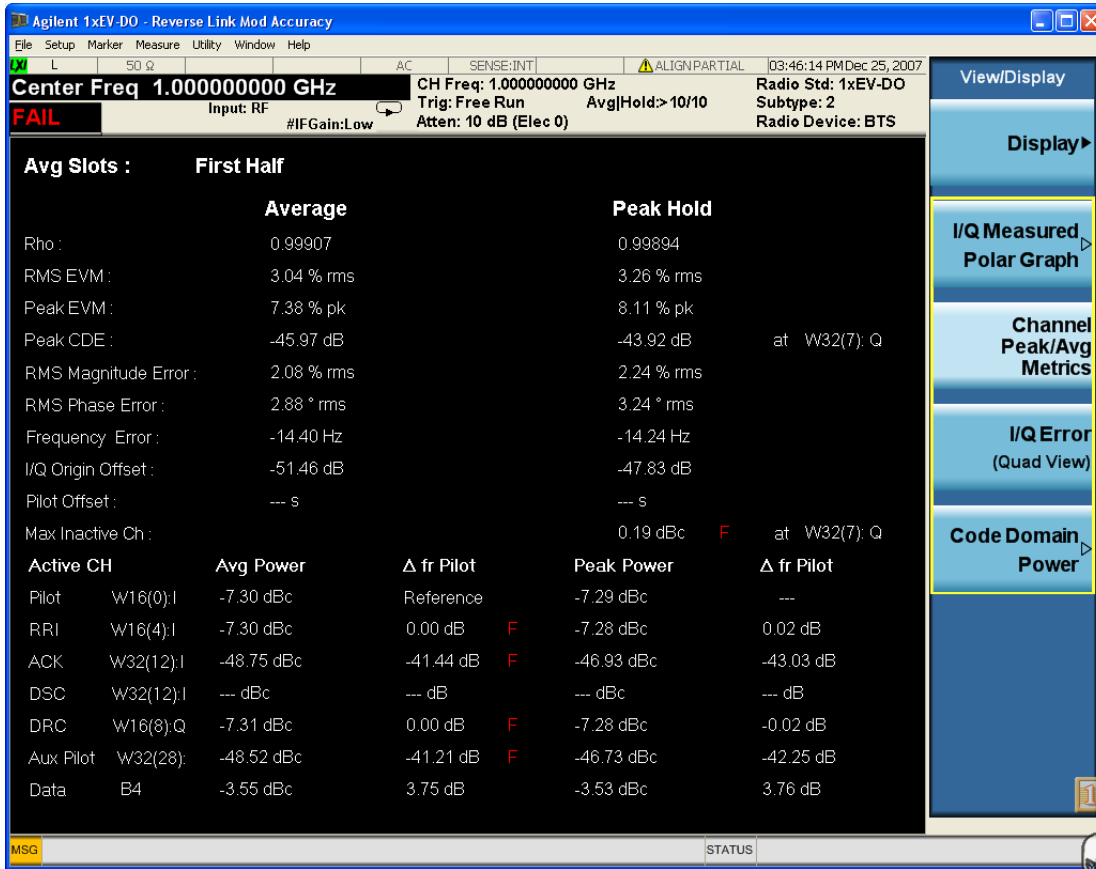

Figure 0-3 Peak/Avg Metrics View(Subtype 2/3)

Parameter Name	Corresponding Results	Display Format
Rho	n=1 7th and n=9 7th (Average) n=10 7th (Peak Hold) rho	9.99999
RMS EVM	n=1 1st and n=9 1st (Average) n=10 1st (Peak Hold) EVM over the entire measurement area	99.99 %
Peak EVM	n=9 2nd (Average) n=1 2nd and n=10 2nd (Peak Hold) Peak EVM in the measurement area	99.99 %
Peak CDE	n=9 8th (Average) n=1 8th and n=10 8th (Peak Hold) Peak Code Domain Error relative to the mean power	99.99 dB
Pk CDE (Ch No.)	n=1 9th and n=10 9th The channel number in which the peak code domain error is detected.	WX(Y):Phase X: Walsh Code length (2 .. 32) 2: 614.4ksps ... 32:38.4ksps

		Y: Walsh code number (0 .. X-1) Phase: I or Q
RMS Magnitude Error	n=1 3rd and n=9 3rd (Average) n=10 3rd (Peak Hold) Magnitude error over the entire measurement area	99.99 % rms
RMS Phase Error	n=1 4th and n=9 4th (Average) n=10 4th (Peak Hold) Phase error over the entire measurement area	99.99 °rms
Freq Error	n=1 6th and n=9 6th (Average) n=10 6th (Peak Hold) Frequency error in the measured signal	99.99 Hz
I/Q Origin Offset	n=1 5th and n=9 5th (Average) n=10 5th (Peak Hold) I and Q error (magnitude squared) offset from the origin	99.99 dB
Pilot Offset	n=1 11th and n=9 11th (Average) n=10 11th (Peak Hold) Pilot phase timing from the acquisition trigger point.	9999.99 us
Max Inactive Ch (dB)	n=1 12th and n=10 12th Max Inactive Code Domain power	99.99 dBc
Pilot & RRI Power (Subtype 0/1)	n=9 29th (Average) n=10 29th (Peak Hold) Pilot Power	99.99 dB
Pilot Power (Subtype 2/3)	n=9 13th (Average) n=10 13th (Peak Hold) Pilot Power	99.99 dB
RRI Channel Power	n=9 14th (Average) n=10 14th (Peak Hold) RRI Channel Power	99.99 dB
$\Delta$ RRI/Pilot (Subtype 0/1)	n=1 13th and n=9 15th (Average) n=10 15th (Peak Hold) RRI ch relative power to Pilot Ch	99.99 dB
RRI Channel Relative Power to Pilot (Subtype 2/3)	n=1 13th and n=9 15th (Average) n=10 15th (Peak Hold) RRI ch relative power to Pilot Ch	99.99 dB
ACK Channel Power	n=9 18th (Average) n=10 18th (Peak Hold) ACK Channel Power	99.99 dB

ACK Channel Relative Power to Pilot	n=1 14th and n=9 19th (Average) n=10 19th (Peak Hold) ACK ch relative power to Pilot Ch	99.99 dB
DSC Channel Power	n=9 30th (Average) n=10 30th (Peak Hold) DSC Channel Power	99.99 dB
DSC Channel Relative Power to Pilot	n=1 22nd and n=9 31st (Average) n=10 31st (Peak Hold) DSC ch relative power to Pilot Ch	99.99 dB
DRC Channel Power	n=9 16th (Average) n=10 16th (Peak Hold) DRC Channel Power	99.99 dB
DRC Channel Relative Power to Pilot	n=1 15th and n=9 17th (Average) n=10 17th (Peak Hold) DRC ch relative power to Pilot Ch	99.99 dB
Data Channel Power (W4(2))	n=9 20th (Average) n=10 20th (Peak Hold) DataChannel Power on W4(2)	99.99 dB
Data Channel Relative Power (W4(2))to Pilot	n=1 16th and n=9 21st (Average) n=10 21st (Peak Hold) Data ch relative power on W4(2) to Pilot Ch	99.99 dB
Data Channel Power (W2(1))	n=9 20th (Average) n=10 20th (Peak Hold) Data Channel Power on W2(1)	99.99 dB
Data Channel Relative Power (W2(1))to Pilot	n=1 16th and n=9 21st (Average) n=10 21st (Peak Hold) Data ch relative power on W2(1)to Pilot Ch	99.99 dB
Auxiliary Pilot Channel Power	n=9 26th (Average) n=10 26th (Peak Hold) Auxiliary Pilot Channel Power	99.99 dB
Auxiliary Pilot Channel Relative Power to Pilot	n=1 19th and n=9 27th (Average) n=10 27th (Peak Hold) Auxiliary Pilot ch relative power to Pilot Ch	99.99 dB

### I/Q Error (Quad View)

Provides a combination view of a magnitude error, phase error, EVM graphs and one-slot result summary of selected channel.

There are four windows:



- "Magnitude Error window" on page 2445 (upper left)
- "Phase Error window" on page 2445 (upper right)
- "EVM Window" on page 2446 (lower left)
- "Metrics Window" on page 2446 (lower right)

Magnitude Error, Phase Error and Symbol EVM always show 1 slot result. The highlighted half slot by two vertical lines indicates selected half slot by Meas Offset.

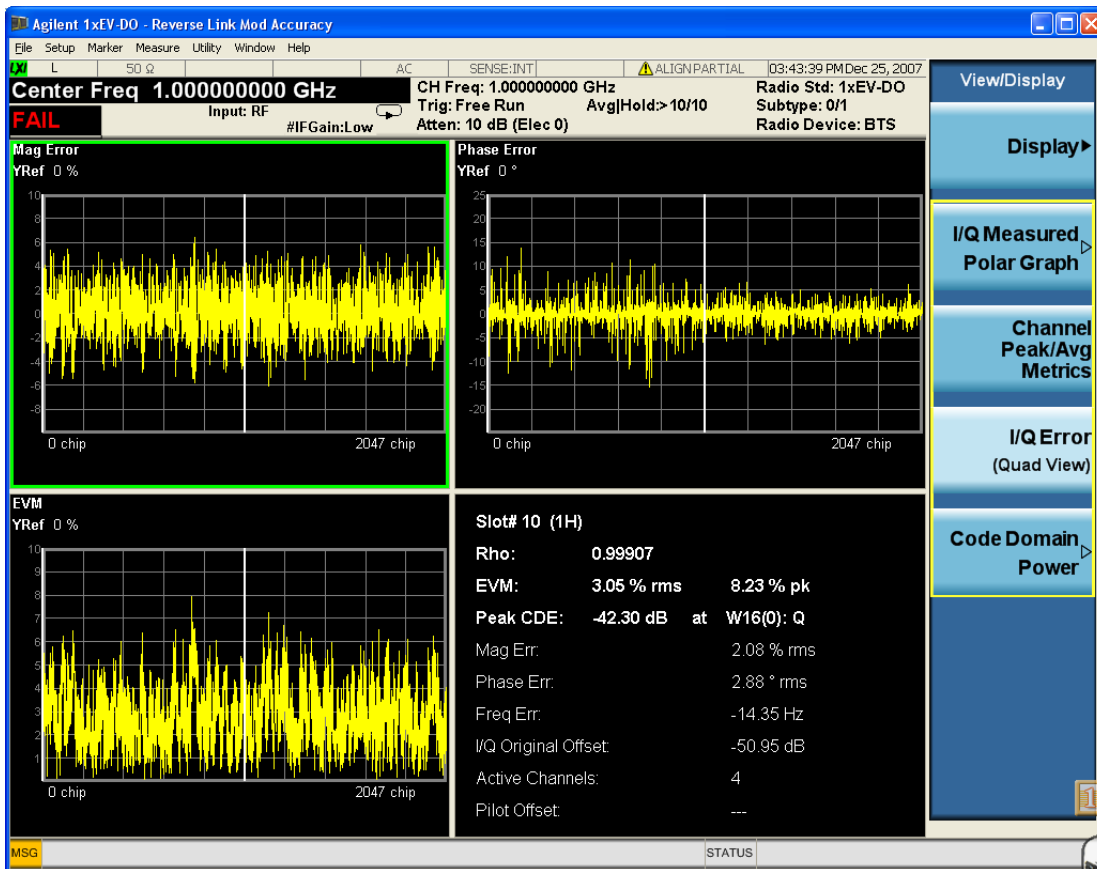

Figure 0-4 I/Q Error View

### Magnitude Error window

Marker Operation	Yes
Corresponding Trace	MERRor (n=3)

### Phase Error window

Marker Operation	Yes
Corresponding Trace	PERRor (n=4)

## EVM Window

Marker Operation	Yes
Corresponding Trace	EVM (n=2)

## Metrics Window

Parameter Name	Corresponding Results	Display Format
Rho	n=1 7th rho	9.99999
EVM (rms)	n=11 1st EVM over the entire measurement area	99.99 % rms
EVM (pk)	n=11 2nd peak EVM in the measurement area	99.99 % pk
Pk CDE (dB)	n=11 8th Peak Code Domain Error relative to the mean power	-99.99 dB
Pk CDE (Ch No.)	n=11 9th Channel number in which the peak code domain error is detected.	WX(Y):Phase X: Walsh Code length (2 .. 32) 2: 614.4ksps ... 32:38.4ksps Y: Walsh code number (0 .. X-1) Phase: I or Q
Magnitude Error	n=11 3rd Average magnitude error over the entire measurement area	99.99 % rms
Phase Error	n=11 4th Average phase error over the entire measurement area	99.99 °rms
Freq Error	n=11 6th Frequency error in the measured signal	99.99 Hz
I/Q Origin Offset	n=11 5th I and Q error (magnitude squared) offset from the origin.	-99.99 dB
Active Channels	n=11 10th Number of Active channels	9
Pilot Offset	n=11 11th Pilot phase timing from the acquisition trigger point.	9999.99 us

<b>Example</b>	:DISP:RHO:MS:VIEW ERR
Initial S/W Revision	Prior to A.02.00

## Code Domain Power

Provides a combination view of the code domain power graph and the summary table of code domain channel.

There are two windows:

- "Code Domain Power Graph window" on page 2448 (upper)
- "Metrics window" on page 2448 (lower)

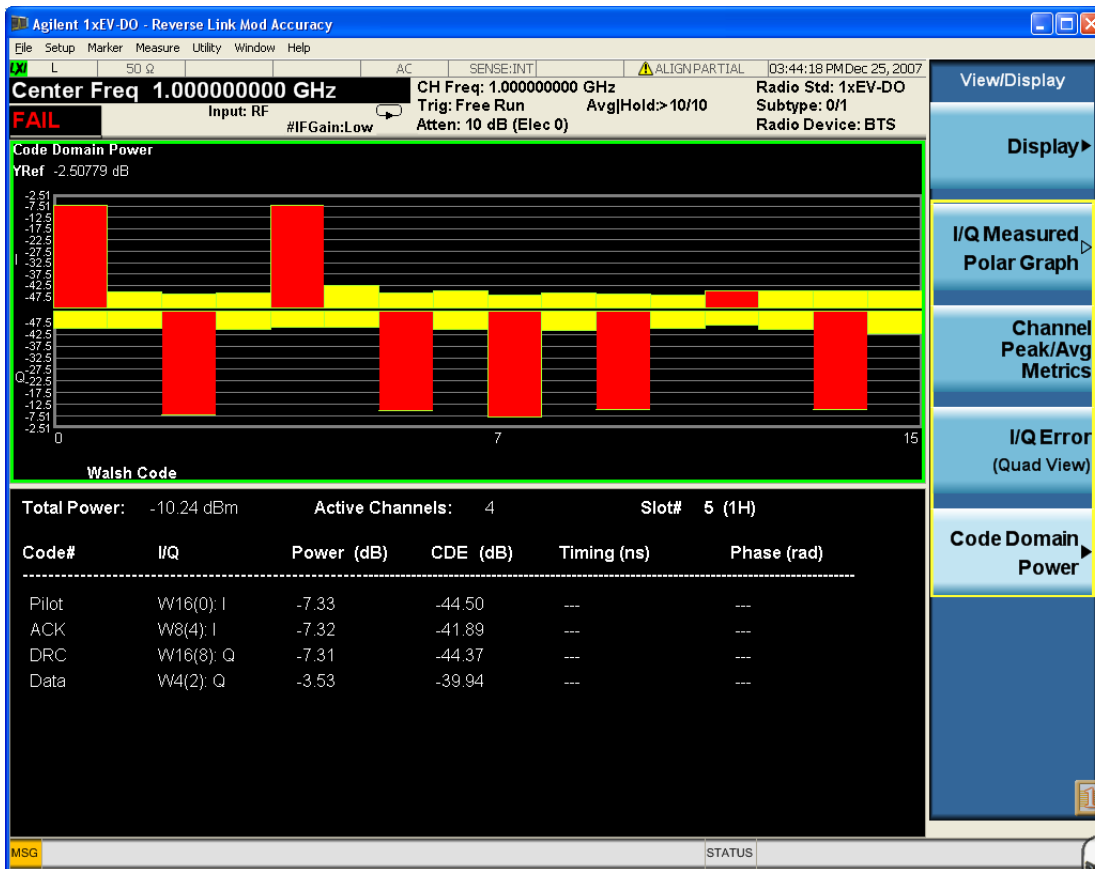

Figure 0-5 Code Domain Power View(Subtype0/1)

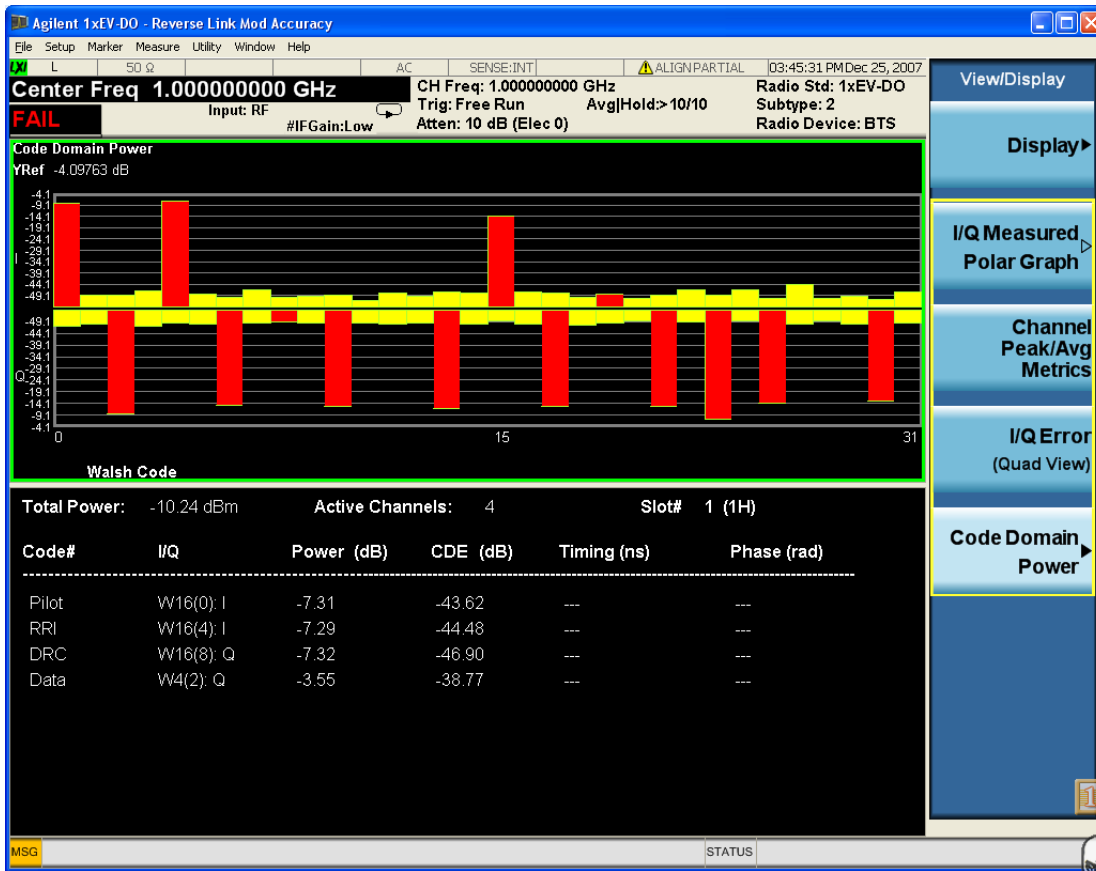

Figure 0-6 Code Domain Power View(Subtype2/3)

### Code Domain Power Graph window

Code domain power is calculated based on base code length 16 for Subtype 0/1, or 32 for Subtype 2/3.

Marker Operation	Yes
Corresponding Trace	CDP (n=8)

These traces and scalar results are of the slot specified by Meas Offset.

### Metrics window

Parameter Name	Corresponding Results	Display Format
Total Power	n=11 12th Absolute Total Power of slot	99.99 dBm
Slot	n=1 20th First slot number	9
Active Channels	n=11 10th Number of Active Channels	99

Code Number	n=7	WX(Y) X: Walsh Code length (2 .. 32) 2: 614.4ksps ... 32:38.4ksps Y: Walsh code number (0 .. X-1)
I/Q	n=7 Either +1 (I) or -1 (Q) or 0 (I and Q) for Nth Active Channel	I or Q
Power (dB)	n=7 Power Level (in dB) for n th Active Channel	99.99
CDE (dB)	n=7 Code Domain Error for n th Active Channel. CDE is calculated using the property (I phase only, Q phase only or I and Q phase) of the active channel.	99.99
Timing (ns)	n=7 Timing from Pilot Channel	9.99
Phase (rad)	n=7 Phase from Pilot Channel	9.999

<b>Example</b>	:DISP:RHO:MS:VIEW CDP
Initial S/W Revision	Prior to A.02.00

## Code Order

Sets the Walsh code order, Hadamard or Bit Reverse.

Key Path	View/Display, Code Domain Power
Mode	1xEVDO
<b>Remote Command</b>	:CALCulate:RHO:MS:WCODE:ORDER HADamard BREVerse :CALCulate:RHO:MS:WCODE:ORDER?
<b>Example</b>	:CALC:RHO:MS:WCOD:ORD BREV
Preset	HADamard
State Saved	Saved in instrument state.
Range	Hadamard Bit Reverse
<b>Backwards Compatibility SCPI</b>	:CALCulate:TRHO:WCODE:ORDER
Initial S/W Revision	Prior to A.02.00

## Consolidated Marker

Toggle the consolidated marker function between On and Off.

Key Path	View/Display, Code Domain Power, Consolidated Marker
Mode	1xEVDO
Remote Command	DISPlay:RHO:MS:MARKer:CONSolidated ON OFF 1 0 DISPlay:RHO:MS:MARKer:CONSolidated?
Example	DISPlay:RHO:MS:MARKer:CONSolidated ON DISPlay:RHO:MS:MARKer:CONSolidated?
Notes	This softkey is displayed only when the CDP window is selected. This key shall be grayed out when the Code Order Bit Reverse key is selected. If set to On, the corresponding Walsh code channel power will be marked in the different color upon placing the marker at the consolidated Walsh code channel power
Preset	ON
State Saved	Saved in instrument state.
Range	Off On
Backwards Compatibility SCPI	DISPlay:TRHO:MARKer:CONSolidated
Initial S/W Revision	Prior to A.02.00

## I/Q Combined Power Bar

Allows you to toggle the I/Q combined power display function between On and Off. If set to On, the I and Q power bars are consolidated on the upper side of the horizontal axis. If set to Off, the I and Q power bars are shown on the upper side and the lower side of the horizontal axis, respectively. In the graph, the red bar denotes active channel, while the yellow bar denotes inactive channel.

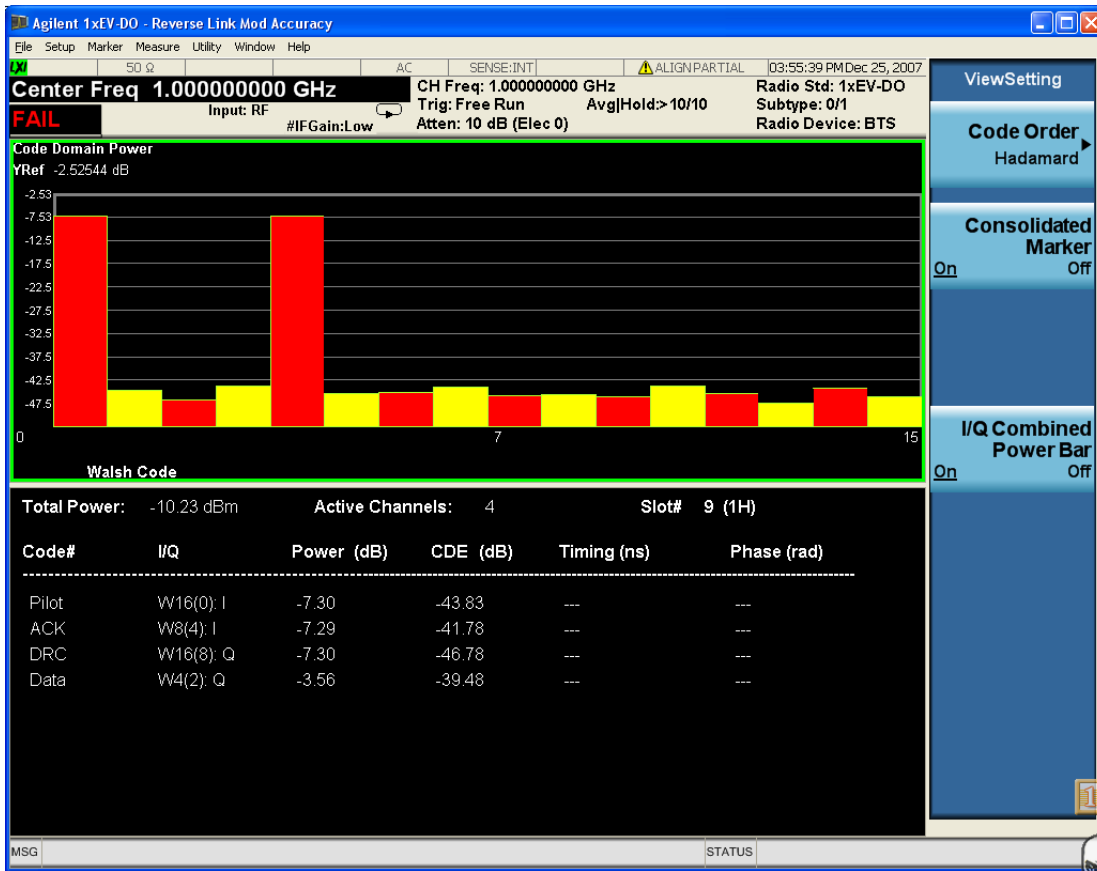

Figure 0-7 Code Domain Power when I/Q Combined Power Bar is set to ON

18 Reverse Link Modulation Accuracy  
View/Display

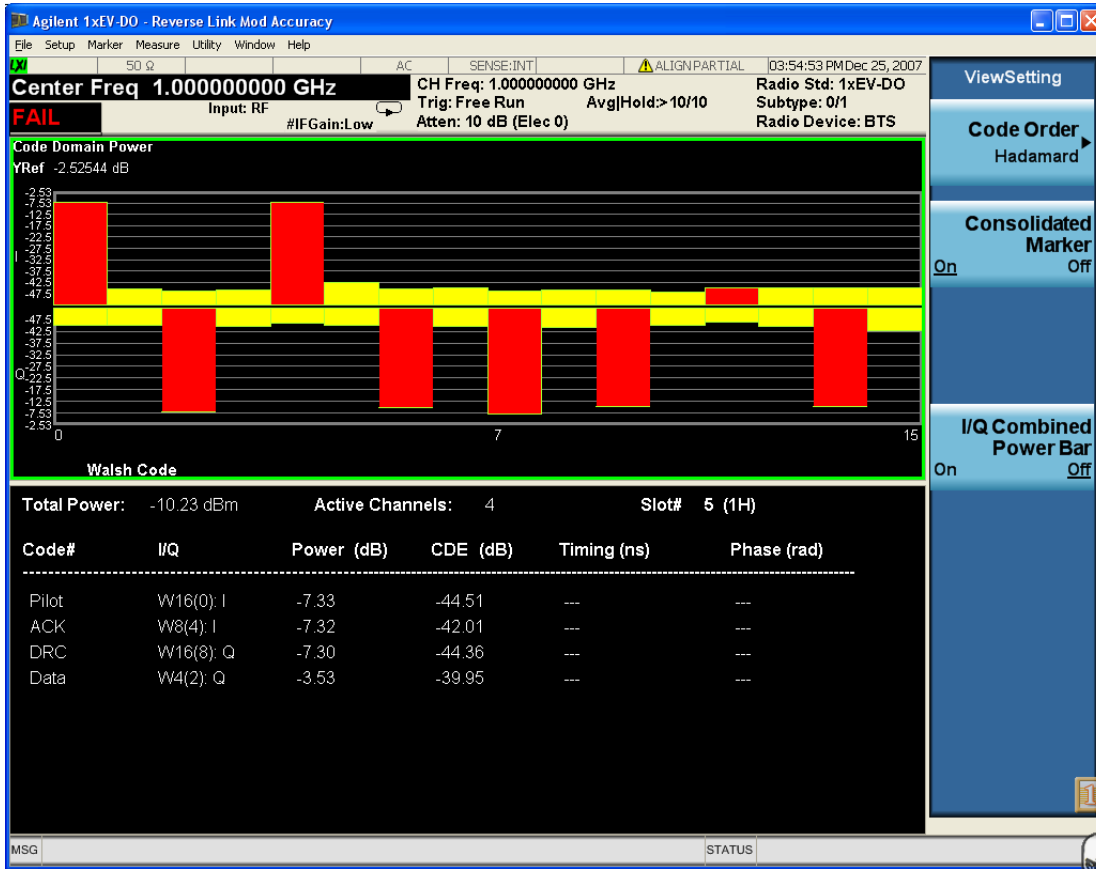

Figure 0-8 Code Domain Power when I/Q Combined Power Bar is set to OFF

Key Path	View/Display, Code Domain Power, I/Q Combined Power
Mode	1xEVDO
Remote Command	:CALCulate:RHO:MS:IQ:COMBined[:STATe] 0 1 OFF ON :CALCulate:RHO:MS:IQ:COMBined[:STATe]?
Example	:CALC:RHO:MS:IQ:COMB ON
Preset	OFF
State Saved	Saved in instrument state.
Range	On Off
Backwards Compatibility SCPI	:CALCulate:TRHO:IQ:COMBined[:STATe]
Initial S/W Revision	Prior to A.02.00



## 19 QPSK EVM Measurement

The quadrature phase shift keying (QPSK) error vector magnitude (EVM) measurement is a measure of phase and amplitude modulation quality that relates the performance of the actual signal compared to an ideal signal as a percentage, as calculated over the course of the ideal constellation. These phase and frequency errors are measures of modulation quality for the W-CDMA (3GPP) system, and can be quantified through QPSK EVM measurements. For measurement results and views, see ["View/Display" on page 2588](#).

This topic contains the following sections:

["Measurement Commands for QPSK EVM" on page 2454](#)

["Remote Command Results for QPSK EVM Measurement" on page 2455](#)

## Measurement Commands for QPSK EVM

The general functionality of CONFigure, FETCh, MEASure, and READ are described at the beginning of this section. See the SENSE:EVMQpsk commands for more measurement related commands.

```
:CONFigure:EVMQpsk
```

```
:CONFigure:EVMQpsk:NDEFault
```

```
:FETCh:EVMQpsk[n]?
```

```
:READ:EVMQpsk[n]?
```

```
:MEASure:EVMQpsk[n]?
```

For more measurement related commands, see the SENSE subsystem, and the section "[Remote Measurement Functions](#)" on page 2848.

## Remote Command Results for QPSK EVM Measurement

n	Results Returned
0	Returns unprocessed I/Q trace data, as a series of comma-separated trace points, in volts.
not specified or n = 1	Returns the following 11 scalar results: <ol style="list-style-type: none"> <li>1. RMS EVM is a floating point number (in percent) of EVM over the entire measurement area.</li> <li>2. RMS EVM maximum is the maximum RMS EVM over the average counts.</li> <li>3. Peak EVM is a floating point number (in percent) of peak EVM in the measurement area.</li> <li>4. Peak EVM maximum is the maximum peak EVM over the average counts.</li> <li>5. Magnitude Error is a floating point number (in percent) of averaged magnitude error over the entire measurement area.</li> <li>6. Magnitude Error maximum is a floating point number over the average counts.</li> <li>7. Phase Error is a floating point number (in degrees) of the averaged phase error over the entire measurement area.</li> <li>8. Phase Error maximum is the maximum phase error over the average counts.</li> <li>9. Frequency Error is a floating point number (in Hz) of the frequency error in the measured signal.</li> <li>10. Frequency Error maximum is the maximum frequency error over the average counts.</li> <li>11. I/Q Origin Offset is a floating point number (in dB) of the I and Q error (magnitude squared) offset from the origin.</li> </ol>
2	EVM trace – returns a series of floating point numbers (in percent) that represent each sample in the EVM trace. The first number is the symbol 0 decision point. There are X points per symbol (X=points/chip). Therefore, the decision points are at 0, 1*X, 2*X, and so on.
3	Magnitude error trace – returns a series of floating point numbers (in percent) that represent each sample in the magnitude error trace. The first number is the symbol 0 decision point. There are X points per symbol (X=points/chip). Therefore, the decision points are at 0, 1*X, 2*X, ...
4	Phase error trace – returns a series of floating point numbers (in percent) that represent each sample in the phase error trace. The first number is the symbol 0 decision point. There are X points per symbol (X=points/chip). Therefore, the decision points are at 0, 1*X, 2*X, ...
5	Corrected measured trace – returns a series of floating point numbers that alternately represent I and Q pairs of the corrected measured trace. The magnitude of each I and Q pair are normalized to 1.0. The first number is the I sample of symbol 0 decision point and the second number is the Q sample of symbol 0 decision point. There are X points per symbol (X=points/chip). Therefore, the series of numbers is: <p>1st number = I of the symbol 0 decision point</p> <p>2nd number = Q of the symbol 0 decision point</p> <p>...</p> <p>(2*X)+1 number = I of the symbol 1 decision point</p> <p>(2*X)+2 number = Q of the symbol 1 decision point</p> <p>...</p> <p>(2*X)*N+1 th number = I of the symbol N decision point</p> <p>(2*X)*N+2 th number = Q of the symbol N decision point</p>

Key Path	Meas
Initial S/W Revision	Prior to A.02.00



## AMPTD Y Scale

Accesses the AMPTD Y Scale menu that allows you to set the desired vertical scale and associated settings for the current measurement.

Key Path	Front-panel key
Initial S/W Revision	Prior to A.02.00

## Attenuation

This menu controls the attenuator functions and interactions between the attenuation system components.

There are two attenuator configurations in the X-Series. One is a dual attenuator configuration consisting of a mechanical attenuator and an optional electronic attenuator. The other configuration uses a single attenuator with combined mechanical and electronic sections that controls all the attenuation functions. Different models in the X-Series come with different configurations.

See "[Dual Attenuator Configurations:](#)" on page 2457

See "[Single Attenuator Configuration:](#)" on page 2458

Most Attenuation settings are the same for all measurements – they do not change as you change measurements. Settings like these are called “Meas Global” and are unaffected by Meas Preset.

Key Path	AMPTD Y Scale
Scope	Meas Global
Dependencies	In measurements that support the I/Q inputs, this key is unavailable when I/Q is the selected input, and is replaced by the Range key in that case.
Readback Line	Contains a summary in [ ] brackets of the current total attenuation. See the descriptions of the , " <a href="#">(Mech) Atten</a> " on page 2783, and " <a href="#">Enable Elec Atten</a> " on page 2785 keys for more detail on the contributors to the total attenuation.  Note that when "Pre-Adjust for Min Clip" is on, this value can change at the start of every measurement.
Initial S/W Revision	Prior to A.02.00
Modified at S/W Revision	A.03.00

## Dual Attenuator Configurations:

Configuration 1: Mechanical attenuator + optional electronic attenuator

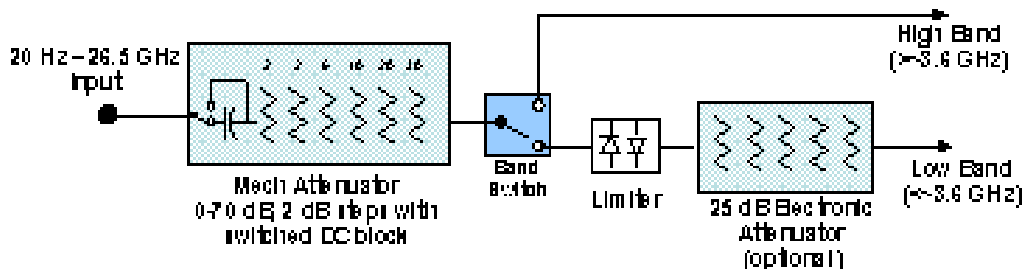

Configuration 2: Mechanical attenuator, no optional electronic attenuator

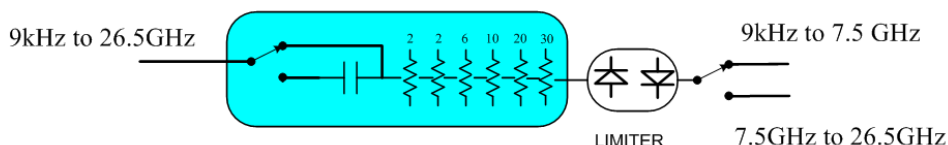

(note that Configuration 2 is not strictly speaking a dual-section attenuator, since there is no electronic section available. However, it behaves exactly like Configuration 1 without the Electronic Attenuator option EA3, therefore for the sake of this document it is grouped into the “Dual Attenuator” configuration)

**Single Attenuator Configuration:**

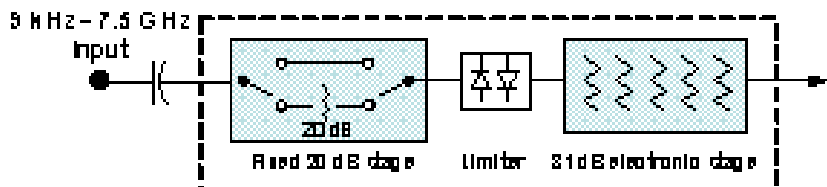

You can tell which attenuator configuration you have by pressing the Attenuation key, which (in most Modes) opens the Attenuation menu. If the first key in the Attenuation menu says Mech Atten you have the dual attenuator configuration. If the first key says Atten you have the single attenuator configuration.

Attenuation	Attenuation
<b>Mech Atten</b>	<b>Atten</b>
18 dB	6 dB
Auto Man	Auto Man
Dual Attenuator	Single Attenuator

In the single attenuator configuration, you control the attenuation with a single control, as the fixed stage has only two states. In the dual attenuator configuration, both stages have significant range so you are given separate control of the mechanical and electronic attenuator stages.

When you have the dual attenuator configuration, you may still have only a single attenuator, because unless option EA3 (the Electronic Attenuator option) is available, and you purchase it, you will have only the mechanical attenuator.

## (Mech) Atten

This key is labeled Mech Atten in dual attenuator models and Atten in single attenuator models. In the dual attenuator configuration, this key only affects the mechanical attenuator.

This key lets you modify the attenuation applied to the RF input signal path. This value is normally auto coupled to the Ref Level, the Internal Preamp Gain, any External Gain that is entered, and the Max Mixer Level, as described in the table below.

See ["Attenuator Configurations and Auto/Man" on page 2460](#)

<b>Key Path</b>	AMPTD Y Scale, Attenuation
<b>Remote Command</b>	<pre>[ :SENSe]:POWer[:RF]:ATTenuation &lt;rel_ampl&gt; [ :SENSe]:POWer[:RF]:ATTenuation? [ :SENSe]:POWer[:RF]:ATTenuation:AUTO OFF ON 0 1 [ :SENSe]:POWer[:RF]:ATTenuation:AUTO?</pre>
<b>Example</b>	<p>POW:ATT 20</p> <p>Dual attenuator configuration: sets the mechanical attenuator to 20 dB</p> <p>Single attenuator mode: sets the main attenuation to 20 dB (see below for definition of “main” attenuation).</p> <p>If the attenuator was in Auto, it sets it to Manual.</p>
<b>Dependencies</b>	<p>Some measurements do not support the Auto setting of (Mech) Atten. In these measurements, the Auto/Man selection is not available, and the Auto/Man line on the key disappears.</p> <p>In dual attenuator configurations, when the electronic attenuator is enabled, the mechanical attenuator has no auto setting and the Auto/Man line on the key disappears. The state of Auto/Man is remembered and restored when the electronic attenuator is once again disabled. This is described in more detail in the <a href="#">"Enable Elec Atten" on page 2785</a> key description.</p> <p>See <a href="#">"Attenuator Configurations and Auto/Man" on page 2460</a> for more information on the Auto/Man functionality of Attenuation.</p>
<b>Couplings</b>	<p>When (Mech) Atten is in Auto, it uses the following algorithm to determine a value:</p> <p>If the USB Preamp is connected to USB, use 0 dB.</p> <p>Otherwise, <math>Atten = ReferenceLevel + PreAmpGain + ExternalGain - RefLevelOffset - MaxMixerLevel + IF\ Gain</math>.</p> <p>Limit this value to be between 6 dB and the Max value. No value below 6 dB can ever be chosen by Auto.</p> <p>The resulting value is rounded up to the largest value possible given the attenuation step setting. That is, 50.01 dB would change to 60 dB (for a 10 dB attenuation step).</p> <p>The “IF Gain” term in the equation above is either 0 dB or +10 dB, depending on the settings of FFT IF Gain, Swept IF Gain, max Ref Level and the Auto/Man setting of Mech Atten.</p> <p>In External Mixing and BBIQ, where the Attenuator is not in the signal path, the Attenuator setting changes as described above when (Mech) Atten is in Auto, but no changes are made to the actual attenuator hardware setting until the input is changed back to the RF Input.</p>
<b>Preset</b>	<p>The preset for Mech Attenuation is “Auto.”</p> <p>The Auto value of attenuation is:</p> <p>CXA, EXA, MXA and PXA: 10 dB</p>

State Saved	Saved in instrument state
Min	0 dB The attenuation set by this key cannot be decreased below 6 dB with the knob or step keys. To get to a value below 6 dB it has to be directly entered from the keypad or via SCPI. This protects from adjusting the attenuation to a dangerously small value which can put the instrument at risk of damage to input circuitry. However, if the current mechanical attenuation is below 6 dB it can be increased with the knob and step keys, but not decreased.
Max	CXA N9000A-503/507: 50 dB CXA N9000A-513/526: 70dB EXA: 60 dB MXA and PXA: 70 dB In the single attenuator configuration, the total of ATT and EATT cannot exceed 50 dB, so if the EATT is set to 24 dB first, the main attenuation cannot be greater than 26 dB and will be reduced accordingly; if the main attenuator is set to 40 dB first, EATT cannot be greater than 10 dB.
Initial S/W Revision	Prior to A.02.00
Modified at S/W Revision	A.03.00

### Attenuator Configurations and Auto/Man

As described in the Attenuation key description, there are two distinct attenuator configurations available in the X-Series, the single attenuator and dual attenuator configurations. In dual attenuator configurations, we have the mechanical attenuation and the electronic attenuation, and the current total attenuation is the sum of the electronic + mechanical attenuation. In single attenuator configurations, we refer to the attenuation set using the (Mech) Atten key (or POW:ATT SCPI) as the “main” attenuation; and the attenuation that is set by the SCPI command POW:EATT as the “soft” attenuation (the POW:EATT command is honored even in the single attenuator configuration, for compatibility purposes). Then the current total attenuation is the sum of the main + soft attenuation. See the Elec Atten key description for more on “soft” attenuation.

In the dual attenuator configuration, when the electronic attenuator is enabled, there is no Auto/Man functionality for the mechanical attenuator, and the third line of the key label (the Auto/Man line) disappears:

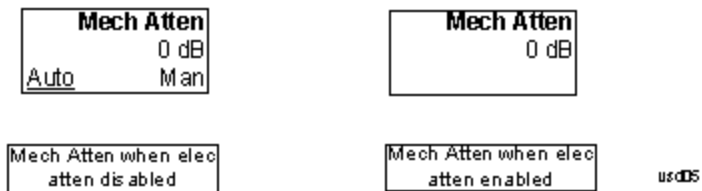

### Enable Elec Atten

Enables the Electronic Attenuator.

The electronic attenuator offers finer steps than the mechanical attenuator, has no acoustical noise, is faster, and is less subject to wear. These advantages primarily aid in remote operation and are negligible



for front panel use. See ["Using the Electronic Attenuator: Pros and Cons" on page 2462](#) for a detailed discussion of the pros and cons of using the electronic attenuator.

For the single attenuator configuration, for SCPI backwards compatibility, the “soft” attenuation feature replaces the dual attenuator configuration’s electronic attenuator. All the same couplings and limitations apply. See ["Attenuator Configurations and Auto/Man" on page 2785](#)

See ["More Information" on page 2461](#)

<b>Key Path</b>	AMPTD Y Scale, Attenuation
<b>Remote Command</b>	[ :SENSe ] :POWer [ :RF ] :EATTenuation:STATE OFF ON 0 1 [ :SENSe ] :POWer [ :RF ] :EATTenuation:STATE?
<b>Example</b>	POW:EATT:STAT ON
<b>Dependencies</b>	<p>This key only appears in Dual Attenuator models with an Electronic Attenuator installed. It does not appear in models with the Single Attenuator configuration, as in the single attenuator configuration there is no “electronic attenuator” there is only a single integrated attenuator (which has both a mechanical and electronic stage). However, in the single attenuator configuration, EATT SCPI commands are accepted for compatibility with other X-series instruments and set a “soft” attenuation as described in <a href="#">"Attenuator Configurations and Auto/Man" on page 2785</a>.</p> <p>The electronic attenuator (and the “soft” attenuation function provided in single attenuator configurations) is unavailable above 3.6 GHz. Therefore, if the Stop Frequency of the analyzer is &gt; 3.6 GHz then the Enable Elec Atten key will be OFF and grayed out.</p> <p>If the Internal Preamp is on, meaning it is set to Low Band or Full, the electronic attenuator (and the “soft” attenuation function provided in single attenuator configurations) is unavailable. In this case the Enable Elec Atten key will be OFF and grayed out.</p> <p>If either of the above is true, if the SCPI command is sent, an error indicating that the electronic attenuator is unavailable will be sent.</p> <p>If the electronic/soft Attenuator is enabled, then the Stop Freq of the analyzer is limited to 3.6 GHz and the Internal Preamp is unavailable.</p> <p>The SCPI-only “soft” electronic attenuation for the single-attenuator configuration is not available in all measurements; in particular, it is not available in the Swept SA measurement.</p>
<b>Couplings</b>	Enabling and disabling the Electronic Attenuator affects the setting of the Mechanical Attenuator (in dual attenuator configurations). This is described in more detail below this table.
<b>Preset</b>	OFF for Swept SA measurement; ON for all other measurements that support the electronic attenuator
<b>State Saved</b>	Saved in instrument state
<b>Initial S/W Revision</b>	Prior to A.02.00
<b>Modified at S/W Revision</b>	A.03.00

## More Information

### Mechanical Attenuator Transition Rules

When the Electronic Attenuator is enabled, the Mechanical Attenuator transitions to a state that has no Auto function. Below are the rules for transitioning the Mechanical Attenuator. NOTE that the information

below ONLY applies to the dual attenuator configurations, and ONLY when the Electronic Attenuator is installed:

**When the Electronic Attenuation is enabled from a disabled state:**

- The Mechanical Attenuator is initialized to 10 dB (this is its optimal performance setting). You can then set it as desired with SCPI, numeric keypad, step keys, or knob, and it behaves as it normally would in manual mode
- The Auto/Man state of (Mech) Atten is saved
- The Auto/Man line on the (Mech) Atten key disappears and the auto rules are disabled
- The Electronic Attenuator is set to 10 dB less than the previous value of the Mechanical Attenuator, within the limitation that it must stay within the range of 0 to 24 dB of attenuation.

**Examples in the dual attenuator configuration:**

- Mech Atten at 20 dB. Elec Atten enabled, Mech Atten set to 10 dB, and Elec Atten set to 10 dB. New total attenuation equals the value before Elec Atten enabled.
- Mech Atten at 0 dB. Elec Atten enabled, Mech Atten set to 10 dB, and Elec Atten set to 0 dB. New total attenuation does not equal the value before Elec Atten enabled.
- Mech Atten at 40 dB. Elec Atten enabled, Mech Atten set to 10 dB, and Elec Atten set to 24 dB. New total attenuation does not equal the value before Elec Atten enabled.

**When the Electronic Attenuation is disabled from an enabled state:**

- The Elec Atten key is grayed out
- The Auto/Man state of (Mech) Atten is restored
- If now in Auto, (Mech) Atten recouples
- If now in Man, (Mech) Atten is set to the value of total attenuation that existed before the Elec Atten was disabled. The resulting value is rounded up to the smallest value possible given the (Mech) Atten Step setting - (That is, 57 dB changes to 58 dB when (Mech) Atten Step is 2 dB.)

**Using the Electronic Attenuator: Pros and Cons**

The electronic attenuator offers finer steps than the mechanical attenuator, has no acoustical noise, is faster, and is less subject to wear.

The “finer steps” advantage of the electronic attenuator is beneficial in optimizing the alignment of the analyzer dynamic range to the signal power in the front panel as well as remote use. Thus, you can achieve improved relative signal measurement accuracy. Compared to a mechanical attenuator with 2 dB steps, the 1 dB resolution of the electronic attenuator only gives better resolution when the odd-decibel steps are used. Those odd-decibel steps are less accurately calibrated than the even-decibel steps, so one tradeoff for this superior relative accuracy is reduced absolute amplitude accuracy.

Another disadvantage of the electronic attenuator is that the spectrum analyzer loses its “Auto” setting, making operation less convenient.

Also, the relationship between the dynamic range specifications (TOI, SHI, compression and noise) and instrument performance are less well-known with the electrical attenuator. With the mechanical

attenuator, TOI, SHI and compression threshold levels increase dB-for-dB with increasing attenuation, and the noise floor does as well. With the electronic attenuator, there is an excess attenuation of about 1 to 3 dB between 0 and 3.6 GHz, making the effective TOI, SHI, and so forth, less well known. Excess attenuation is the actual attenuation relative to stated attenuation. Excess attenuation is accounted for in the analyzer calibration

## Elec Atten

Controls the Electronic Attenuator in dual attenuator configurations. This key does not appear in single attenuator configurations, as the control of both the mechanical and electronic stages of the single attenuator is integrated into the single Atten key.

Key Path	AMPTD Y Scale, Attenuation
Remote Command	[ :SENSe ] :POWer [ :RF ] :EATTenuation <rel_ampl> [ :SENSe ] :POWer [ :RF ] :EATTenuation?
Notes	Electronic Attenuation's specification is defined only when Mechanical Attenuation is 6 dB.
Dependencies	This key only appears in Dual Attenuator models with an Electronic Attenuator installed. It does not appear in models with the Single Attenuator configuration, as in the single attenuator configuration there is no "electronic attenuator" there is only a single integrated attenuator (which has both a mechanical and electronic stage). However, in the single attenuator configuration, EATT SCPI commands are accepted for compatibility with other X-series instruments and set a "soft" attenuation as described in <a href="#">"Attenuator Configurations and Auto/Man" on page 2785</a> . The "soft" attenuation is treated as an addition to the "main" attenuation value set by the Atten softkey or the POW:ATT SCPI command and affects the total attenuation displayed on the Attenuation key and the Meas Bar.  When Enable Elec Atten is off or grayed out, the Elec Atten key is grayed out.
Preset	0 dB
State Saved	Saved in instrument state
Min	0 dB
Max	Dual attenuator configuration: 24 dB  Single attenuator configuration: the total of ATT and EATT cannot exceed 50 dB, so if the EATT is set to 24 dB first, the main attenuation cannot be greater than 26 dB and will be reduced accordingly; if the main attenuator is set to 40 dB first, EATT cannot be greater than 10 dB
Initial S/W Revision	Prior to A.02.00
Modified at S/W Revision	A.03.00

## Adjust Atten for Min Clip

Sets the combination of mechanical and electronic attenuation and gain based on the current measured signal level so that clipping will be at a minimum.

This is an "immediate action" function, that is, it executes once, when the key is pressed.

This key is grayed out in measurements that do not support this functionality. The spectrum analyzer measurement, Swept SA, does not support this functionality.

Key Path	AMPTD Y Scale, Attenuation
Remote Command	<code>[ :SENSe ] :POWer [ :RF ] :RANGe:OPTimize IMMEDIATE</code>
Initial S/W Revision	Prior to A.02.00
Modified at S/W Revision	A.03.00

### Pre-Adjust for Min Clip

If this function is on, it does the adjustment described under ["Adjust Atten for Min Clip" on page 2788](#) each time a measurement restarts. Therefore, in Continuous measurement mode, it only executes before the first measurement.

In dual attenuator models, you can set Elec+Mech Atten, in which case both attenuators participate in the autoranging, or Elec Atten Only, in which case the mechanical attenuator does not participate in the autoranging. This latter case results in less wear on the mechanical attenuator and is usually faster.

This key is grayed out in measurements that do not support this functionality. The spectrum analyzer measurement, Swept SA, does not support this functionality.

Key Path	AMPTD Y Scale, Attenuation
Remote Command	<code>[ :SENSe ] :POWer [ :RF ] :RANGe:OPTimize:ATTenuation OFF   ELECTrical   COMBined</code>  <code>[ :SENSe ] :POWer [ :RF ] :RANGe:OPTimize:ATTenuation?</code>
Notes	The SCPI parameter ELECTrical sets this function to On in single attenuator models. The SCPI parameter COMBined is mapped to ELECTrical in single attenuator models; if you send COMBined, it sets the function to On and returns ELEC to a query.
Dependencies	This key only appears in Dual Attenuator models with an Electronic Attenuator installed. In instruments with Dual Attenuator model, when Enable Elec Atten is off or grayed out, the Pre-Adjust for Min Clip key is grayed out.
Preset	OFF for Swept SA measurement; ON for all other measurements that support Pre-Adjust for Min Clip
State Saved	Saved in instrument state
Range	Dual attenuator models: Off   Elec Atten Only   Mech + Elec Atten Single attenuator models: Off   On
Initial S/W Revision	Prior to A.02.00
Modified at S/W Revision	A.03.00

Remote Command	<code>[ :SENSe ] :POWer [ :RF ] :RANGe:AUTO ON OFF 1 0</code>  <code>[ :SENSe ] :POWer [ :RF ] :RANGe:AUTO?</code>
Notes	ON aliases to "Elec Atten Only" (:POW:RANG:OPT:ATT ELEC)

	OFF aliases to "Off" (:POW:RANG:OPT:ATT OFF) The query :POW:RANG:AUTO? returns true if :POW:RANG:OPT:ATT is not "Off"
Initial S/W Revision	Prior to A.02.00

## Off

Turns Pre-Adjust for Min Clip off. This is the default setting.

This key is grayed out in measurements that do not support this functionality. The spectrum analyzer measurement, Swept SA, does not support this functionality.

Key Path	AMPTD Y Scale, Attenuation, Pre-Adjust for Min Clip
Example	:POW:RANGe:OPT:ATT OFF
Initial S/W Revision	Prior to A.02.00

## Elec Atten Only

Selects only the electric attenuator to participate in auto ranging. This offers less wear on the mechanical attenuator and is usually faster.

This key is grayed out in measurements that do not support this functionality. The spectrum analyzer measurement, Swept SA, does not support this functionality.

Key Path	AMPTD Y Scale, Attenuation, Pre-Adjust for Min Clip
Example	:POW:RANGe:OPT:ATT ELEC
Initial S/W Revision	Prior to A.02.00

## Mech + Elec Atten

In dual attenuator models, this selects both attenuators participate in the autoranging.

This key is grayed out in measurements that do not support this functionality. The spectrum analyzer measurement, Swept SA, does not support this functionality.

Key Path	AMPTD Y Scale, Attenuation, Pre-Adjust for Min Clip
Example	:POW:RANGe:OPT:ATT COMB
Initial S/W Revision	Prior to A.02.00

## (Mech) Atten Step

This controls the step size used when making adjustments to the input attenuation.

This key is labeled Mech Atten Step in dual attenuator models and Atten Step in single attenuator models. In the dual attenuator configuration, this key only affects the step size of the mechanical attenuator.

Key Path	AMPTD Y Scale, Attenuation
Remote Command	<code>[ :SENSe ] :POWer [ :RF ] :ATTenuation :STEP [ :INCRement ] 10 dB   2 dB</code> <code>[ :SENSe ] :POWer [ :RF ] :ATTenuation :STEP [ :INCRement ] ?</code>
Example	POW:ATT:STEP 2
Notes	Note this feature works like a 1-N choice from the front panel, but it takes a specific value (in dB) when used remotely. The only valid values are 2 and 10.
Dependencies	Blanked in CXA and EXA if option FSA (2 dB steps) is not present. If blanked, attempts to set it via SCPI will yield an error.
Couplings	When the attenuation step size changes, the current mechanical attenuation value is adjusted (if necessary) to be quantized to the new step size. That is, if step is set to 10 dB, mech atten is increased if necessary so it is a multiple of 10 dB
Preset	PXA and MXA: 2 dB EXA and CXA: 10 dB (2 dB with option FSA)
State Saved	Saved in instrument state
Initial S/W Revision	Prior to A.02.00
Modified at S/W Revision	A.03.00

## Presel Center

When this key is pressed, the centering of the preselector filter is adjusted to optimize the amplitude accuracy at the frequency of the selected marker. If the selected marker is not on when Presel Center is pressed, the analyzer will turn on the selected marker, perform a peak search, and then perform centering on the marker's center frequency. If the selected marker is already on and between the start and stop frequencies of the analyzer, the analyzer performs the preselector calibration on that marker's frequency. If the selected marker is already on, but outside the frequency range between Start Freq and Stop Freq, the analyzer will first perform a peak search, and then perform centering on the marker's center frequency.

The value displayed on the Presel Adjust key will change to reflect the new preselector tuning (see Presel Adjust).

A number of considerations should be observed to ensure proper operation. See ["Proper Preselector Operation" on page 2467](#).

Key Path	AMPTD Y Scale
Remote Command	<code>[ :SENSe ] :POWer [ :RF ] :PCENter</code>
Example	POW:PCEN
Notes	Note that the rules outlined above under the key description apply for the remote command as well as the key. The result of the command is dependent on marker position, and so forth. Any message shown by the key press is also shown in response to the remote command.
Dependencies	<ul style="list-style-type: none"> <li>• Grayed out if the microwave preselector is off. )</li> </ul>

- If the selected marker's frequency is below Band 1, advisory message 0.5001 is generated and no action is taken.
- Grayed out if entirely in Band 0.
- Blank in models that do not include a preselector, such as option 503. If the SCPI is sent in these instruments, it is accepted without error, and the query always returns 0.
- Grayed out in the Spectrogram View.

Couplings	The active marker position determines where the centering will be attempted. If the analyzer is in a measurement such as averaging when centering is initiated, the act of centering the preselector will restart averaging but the first average trace will not be taken until the centering is completed.
Status Bits/OPC dependencies	When centering the preselector, *OPC will not return true until the process is complete and a subsequent measurement has completed, nor will results be returned to a READ or MEASure command. The Measuring bit should remain set while this command is operating and should not go false until the subsequent sweep/measurement has completed.
Initial S/W Revision	Prior to A.02.00
Modified at S/W Revision	A.03.00

## Proper Preselector Operation

A number of considerations should be observed to ensure proper operation:

1. If the selected marker is off, the analyzer will turn on a marker, perform a peak search, and adjust the preselector using the selected marker's frequency. It uses the "highest peak" peak search method unqualified by threshold or excursion, so that there is no chance of a 'no peak found' error. It continues with that peak, even if it is the peak of just noise. Therefore, for this operation to work properly, there should be a signal on screen in a preselected range for the peak search to find.
2. If the selected marker is already on, the analyzer will attempt the centering at that marker's frequency. There is no preselector for signals below about 3.6 GHz, therefore if the marker is on a signal below 3.6 GHz, no centering will be attempted and an advisory message generated
3. In some models, the preselector can be bypassed. If it is bypassed, no centering will be attempted in that range and a message will be generated.

## Preselector Adjust

Allows you to manually adjust the preselector filter frequency to optimize its response to the signal of interest. This function is only available when "[Presel Center](#)" on page 2791 is available.

For general purpose signal analysis, using Presel Center is recommended. Centering the filter minimizes the impact of long-term preselector drift. Presel Adjust can be used instead to manually optimize the preselector. One application of manual optimization would be to peak the preselector response, which both optimizes the signal-to-noise ratio and minimizes amplitude variations due to small (short-term) preselector drifting.

Key Path	AMPTD Y Scale
Scope	Meas Global
<b>Remote Command</b>	<code>[ :SENSe ] :POWer [ :RF ] :PADJust &lt;freq&gt;</code> <code>[ :SENSe ] :POWer [ :RF ] :PADJust?</code>
<b>Example</b>	POW:PADJ 100KHz POW:PADJ?
Notes	The value on the key reads out to 0.1 MHz resolution.
Dependencies	<ul style="list-style-type: none"> <li>• Grayed out if microwave preselector is off. )</li> <li>• Grayed out if entirely in Band 0.</li> <li>• Blank in models that do not include a preselector, such as option 503. If the SCPI is sent in these instruments, it is accepted without error, and the query always returns 0.</li> <li>• Grayed out in the Spectrogram View.</li> </ul>
Preset	0 MHz
State Saved	The Presel Adjust value set by Presel Center, or by manually adjusting Presel Adjust, is not saved in instrument state, and does not survive a Preset or power cycle.
Min	-500 MHz
Max	500 MHz
Default Unit	Hz
<b>Backwards Compatibility SCPI</b>	<code>[ :SENSe ] :POWer [ :RF ] :MW :PADJust</code> <code>[ :SENSe ] :POWer [ :RF ] :MMW :PADJust</code> PSA had multiple preselectors, but the X-Series has only one. These commands simply alias to <code>[ :SENSe ] :POWer [ :RF ] :PADJust</code>
Initial S/W Revision	Prior to A.02.00
Modified at S/W Revision	A.03.00
<b>Remote Command</b>	<code>[ :SENSe ] :POWer [ :RF ] :PADJust :PRESelector MWAVE   MMWave   EXTERNAL</code> <code>[ :SENSe ] :POWer [ :RF ] :PADJust :PRESelector?</code>
Notes	PSA had multiple preselectors, and you could select which preselector to adjust. Since the X-Series has only one mm/uW preselector, the preselector selection softkey is no longer available. However, to provide backward compatibility, we accept the legacy remote commands. The command form has no effect, the query always returns MWAVE
Initial S/W Revision	Prior to A.02.00



## μW Path Control

The μW Path Control functions include the μW Preselector Bypass (Option MPB) and Low Noise Path (Option LNP) controls in the High Band path circuits.

When the μW Preselector is bypassed, the user has better flatness, but will be subject to spurs from out of band interfering signals. When the Low Noise Path is enabled, the analyzer automatically switches around certain circuitry in the high frequency bands which can contribute to noise, when it is appropriate based on other analyzer settings.

For most applications, the preset state is Standard Path, which gives the best remote-control throughput, minimizes acoustic noise from switching and minimizes the risk of wear out in the hardware switches. For applications that utilize the wideband IF paths, the preset state is the μW Preselector Bypass path, if option MPB is present. This is because, when using a wideband IF such as the 140 MHz IF, the μW Preselector's bandwidth can be narrower than the available IF bandwidth, causing degraded amplitude flatness and phase linearity, so it is desirable to bypass the preselector in the default case.

Users may choose Low Noise Path Enable. It gives a lower noise floor, especially in the 21–26.5 GHz region, though without improving many measures of dynamic range, and without giving the best possible noise floor. The preamp, if purchased and used, gives better noise floor than does the Low Noise Path, however its compression threshold and third-order intercept are much poorer than that of the non-preamp Low Noise Path. There are some applications, typically for signals around –30 dBm, for which the third-order dynamic range of the standard path is good enough, but the noise floor is not low enough even with 0 dB input attenuation. When the third-order dynamic range of the preamp path is too little and the noise floor of the standard path is too high, the Low Noise Path can provide the best dynamic range.

<b>Key Path</b>	AMPTD Y Scale
<b>Mode</b>	SA, BASIC, PNOISE, VSA , LTE, LTETDD
<b>Scope</b>	Meas Global
<b>Remote Command</b>	[ :SENSe ] :POWer [ :RF ] :MW:PATH STD LNPath MPBypass FULL [ :SENSe ] :POWer [ :RF ] :MW:PATH?
<b>Example</b>	:POW:MW:PATH LNP Enables the Low Noise path
<b>Notes</b>	If a Presel Center is performed, the analyzer will momentarily switch to the Standard Path, regardless of the setting of μW Path Control  The DC Block will always be switched in when the low noise path is switched in, to protect succeeding circuitry from DC. Note that this does not mean “when the low noise path is enabled” but when, based on the Low Noise Path rules, the path is actually switched in. This can happen when the selection is Low Noise Path Enable . In the case where the DC Block is switched in the analyzer is now AC coupled. However, if the user has selected DC coupling, the UI will still behave as though it were DC coupled, including all annunciation, warnings, status bits, and responses to SCPI queries. This is because, based on other settings, the analyzer could switch out the low noise path at any time and hence go back to being DC coupled.  Alignment switching ignores the settings in this menu, and restores them when finished.
<b>Dependencies</b>	Unavailable in BBIQ and External Mixing
<b>Preset</b>	All modes other than IQ Analyzer mode and VXA: STD IQ Analyzer, VXA and WLAN mode: MPB option present and licensed: MPB

	MPB option not present and licensed: STD
State Saved	Save in instrument state
Readback	Value selected in the submenu
Initial S/W Revision	A.04.00
Modified at S/W Revision	A.10.00

## Standard Path

This path gives the best remote-control throughput, minimizes acoustic noise from switching and minimizes the risk of wear in the hardware switches, particularly in remote test scenarios where both low band and high band setups will follow in rapid succession.

In this path, the bypass of the low band/high band switch and microwave preamp is never activated, which can cause some noise degradation but preserves the life of the bypass switch.

Key Path	AMPTD Y Scale, $\mu$ W Path Control
<b>Example</b>	:POW:MW:PATH STD
Readback Text	Standard Path
Initial S/W Revision	A.04.00

## Low Noise Path Enable

You may choose Low Noise Path Enable, which gives a lower noise floor under some circumstances, particularly when operating in the 21–26.5 GHz region. With the Low Noise Path enabled, the low band/high band switch and microwave preamp are bypassed whenever all of the following are true:

- The analyzer is not in the Low Band, meaning:
- the start frequency is above 3.5 GHz and
- the stop frequency is above 3.6 GHz.
- the internal preamp is not installed or (if installed) is set to Off or Low Band

Note that this means that, when any part of a sweep is done in Low Band, the Low Noise Path is not used, whether or not the Low Noise Path Enable is selected in the user interface. Also, if the preamp is turned on, the Low Noise Path is not used, whether or not the Low Noise Path Enable is selected in the user interface. The only time the Low Noise Path is used is when Low Noise Path Enable is selected, the sweep is completely in High Band (> 3.6 GHz) and no preamp is in use.

See "[More Information](#)" on page 2471

Key Path	AMPTD Y Scale, $\mu$ W Path Control
Measurement	Swept SA
<b>Example</b>	:POW:MW:PATH LNP

Notes	<p>For measurements that use IQ acquisition, the low noise path is used when the Center Frequency is in High Band (&gt; 3.6 GHz) and no preamp is in use.</p> <p>In other words, the rules above are modified to use only the center frequency to qualify which path to switch in.</p> <p>This is not the case for FFT's in the Swept SA measurement; they use the same rules as swept measurements.</p>
Dependencies	<p>Key is blanked if current mode does not support it.</p> <p>Key is grayed out if mode supports it but current measurement does not support it.</p> <p>Unless Option LNP is present and licensed, key is blank and if SCPI command sent, error -241, "Hardware missing; Option not installed" is generated.</p>
Readback Text	Low Noise Path Enable
Initial S/W Revision	A.04.00

## More Information

The user should understand that the Low Noise Path, while giving improved DANL, has the disadvantage of decreased TOI performance and decreased gain compression performance relative to the standard path.

The user should also understand that the bypass switch is a mechanical switch and has finite life, so if the Low Noise Path is enabled, it is possible to cause frequent cycling of this switch by frequently changing analyzer settings such that the above conditions hold true only some of the time. A user making tests of this nature should consider opting for the Standard Path, which will never throw the bypass switch, at the expense of some degraded noise performance.

The low noise path is useful for situations where the signal level is so low that the analyzer performance is dominated by noise even with 0 dB attenuation, but still high enough that the preamp option would have excessive third-order intermodulation or compression. The preamp, if purchased and used, gives better noise floor than does the "Low Noise Path." However, its compression threshold and third-order intercept are much poorer than that of the non-preamp path. There are some applications, typically for signals around -30 dBm, for which the third-order dynamic range of the standard path is good enough, but the noise floor is not low enough even with 0 dB input attenuation. When the third-order dynamic range of the preamp path is too little and the noise floor of the standard path is too high, the Low Noise Path can provide the best dynamic range

The graph below illustrates the concept. It shows, in red, the performance of an analyzer at different attenuation settings, both with the preamp on and off, in a measurement that is affected by both analyzer noise and analyzer TOI. The green shows the best available dynamic range, offset by 0.5 dB for clarity. The blue shows how the best available dynamic range improves for moderate signal levels with the low noise path switched in. In this illustration, the preamp improves the noise floor by 15 dB while degrading the third-order intercept by 30 dB, and the low noise path reduces loss by 8 dB. The attenuator step size is 2 dB.

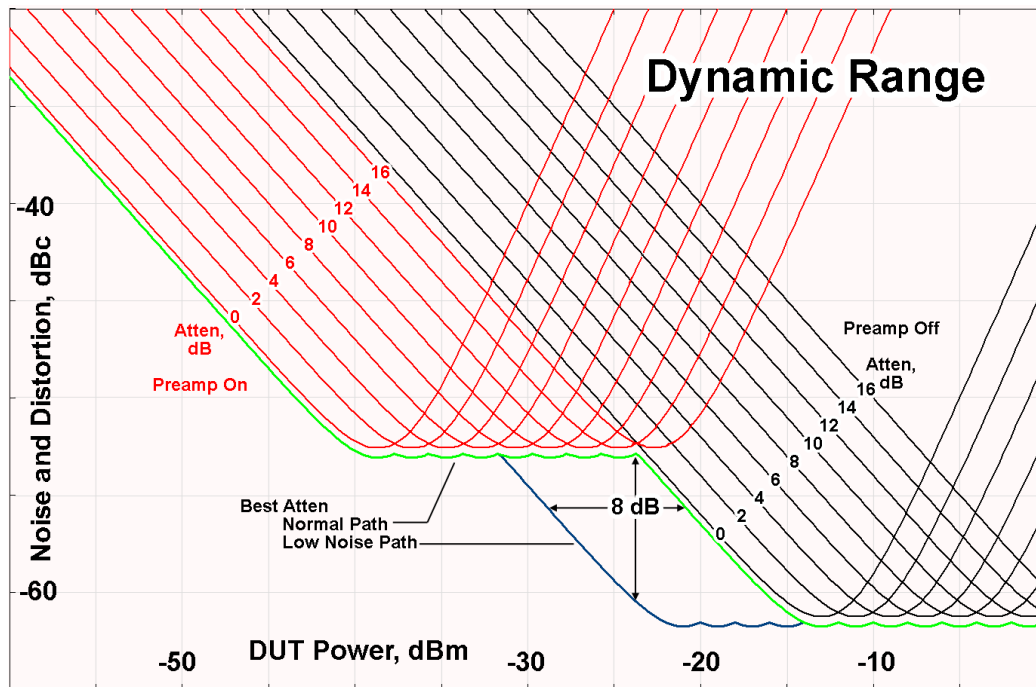

There are other times where selecting the low noise path improves performance, too. Compression-limited measurements such as finding the nulls in a pulsed-RF spectrum can profit from the low noise path in a way similar to the TOI-limited measurement illustrated. Accuracy can be improved when the low noise path allows the optimum attenuation to increase from a small amount like 0, 2 or 4 dB to a larger amount, giving better return loss at the analyzer input. Harmonic measurements, such as second and third harmonic levels, are much improved using the low noise path because of the superiority of that path for harmonic (though not intermodulation) distortion performance.

### μW Preselector Bypass

This key toggles the preselector bypass switch for band 1 and higher. When the microwave preselector is on, the signal path is preselected. When the microwave preselector is off, the signal path is not preselected. The preselected path is the normal path for the analyzer.

The preselector is a tunable bandpass filter which prevents signals away from the frequency of interest from combining in the mixer to generate in-band spurious signals (images). The consequences of using a preselector filter are its limited bandwidth, the amplitude and phase ripple in its passband, and any amplitude and phase instability due to center frequency drift.

Option MPB or pre-selector bypass provides an unpreselected input mixer path for certain X-Series signal analyzers with frequency ranges above 3.6 GHz. This signal path allows a wider bandwidth and less amplitude variability, which is an advantage when doing modulation analysis and broadband signal analysis. The disadvantage is that, without the preselector, image signals will be displayed. Another disadvantage of bypassing the preselector is increased LO emission levels at the front panel input port.

Image responses are separated from the real signal by twice the 1st IF. For IF Paths of 10 MHz and 25 MHz, the 1st IF is 322.5 MHz, so the image response and the real signal will be separated by 645 MHz. The 1st IF will be different for other IF Path settings. When viewing a real signal and its corresponding image response in internal mixing, the image response will be to the left of the real signal.

Also, the image response and the real signal typically have the same amplitude and exhibit the same shape factor.

However, if Option FS1, Fast Sweep Capability, is enabled, the image response in the Swept SA measurement will appear lower in amplitude and have a much wider shape factor compared to the real signal.

Key Path	AMPTD Y Scale, $\mu$ W Path Control
<b>Example</b>	:POW:MW:PATH MPB
Dependencies	Key is blanked if current mode does not support it. Key is grayed out if mode supports it but current measurement does not support it. Key is blank unless Option MPB is present and licensed. If SCPI command sent when MPB not present, error -241, "Hardware missing; Option not installed" is generated.
Readback Text	$\mu$ W Preselector Bypass
Initial S/W Revision	A.04.00

<b>Remote Command</b>	[ :SENSe ] :POWer [ :RF ] :MW :PRESelector [ :STATe ] ON   OFF   0   1 [ :SENSe ] :POWer [ :RF ] :MW :PRESelector [ :STATe ] ?
<b>Example</b>	:POW:MW:PRES OFF Bypasses the microwave preselector
Notes	The ON parameter sets the STD path (:POW:MW:PATH STD) The OFF parameter sets path MPB (:POW:MW:PATH MPB)
Preset	ON

## Internal Preamp

Accesses a menu of keys that control the internal preamps. Turning on the preamp gives a better noise figure, but a poorer TOI to noise floor dynamic range. You can optimize this setting for your particular measurement.

The instrument takes the preamp gain into account as it sweeps. If you sweep outside of the range of the preamp the instrument will also account for that. The displayed result will always reflect the correct gain.

For some measurements, when the preamp is on and any part of the displayed frequency range is below the lowest frequency for which the preamp has specifications, a warning condition message appears in the status line. For example, for a preamp with a 9 kHz lowest specified frequency: "Preamp: Accy unspec'd below 9 kHz".

Key Path	AMPTD Y Scale
Scope	Meas Global
<b>Remote Command</b>	[ :SENSe ] :POWer [ :RF ] :GAIN [ :STATe ] OFF   ON   0   1 [ :SENSe ] :POWer [ :RF ] :GAIN [ :STATe ] ?
Dependencies	Preamp is not available on all hardware platforms. If the preamp is not present or is unlicensed, the

---

	key is not shown. The preamp is not available when the electronic/soft attenuator is enabled.
--	--------------------------------------------------------------------------------------------------

---

Couplings	The act of connecting the U7227A USB Preamplifier to one of the analyzer's USB ports will cause the Internal Preamp to be switched on. When this happens an informational message will be generated: "Internal Preamp turned on for optimal operation with USB Preamp." Note that if the Internal Preamp was already on, there will be no change to the setting, but if it was Off it will be switched On, to Full Range.  Note that this same action occurs when the SA mode is selected while the USB Preamp is connected to one of the analyzer's USB ports, if it is the first time that the SA mode has run since powerup, or if the last time the SA mode was running the USB Preamp was NOT connected.  Subsequently disconnecting the USB Preamp from USB does not change the Internal Preamp setting nor restore the previous setting.
Preset	OFF
State Saved	Saved in instrument state
Initial S/W Revision	Prior to A.02.00
Modified at S/W Revision	A.14.00

---

Key Path	AMPTD Y Scale, Internal Preamp
Scope	Meas Global
<b>Remote Command</b>	[ :SENSe ] : POWer [ :RF ] : GAIN : BAND LOW   FULL [ :SENSe ] : POWer [ :RF ] : GAIN : BAND ?
Dependencies	Preamp is not available on all hardware platforms. If the preamp is not present or is unlicensed, the key is not shown.  If a POW:GAIN:BAND FULL command is sent when a low band preamp is available, the preamp band parameter is to LOW instead of FULL, and an "Option not installed" message is generated.
Preset	LOW
State Saved	Saved in instrument state
Initial S/W Revision	Prior to A.02.00

---

## Off

Turns the internal preamp off

---

Key Path	AMPTD Y Scale, Internal Preamp
<b>Example</b>	:POW:GAIN OFF
Readback	Off
Initial S/W Revision	Prior to A.02.00

---

## Low Band

Sets the internal preamp to use only the low band.

The frequency range of the installed (optional) low-band preamp is displayed in square brackets on the Low Band key label.

Key Path	AMPTD Y Scale, Internal Preamp
<b>Example</b>	:POW:GAIN ON :POW:GAIN:BAND LOW
Readback	Low Band
Initial S/W Revision	Prior to A.02.00

## Full Range

Sets the internal preamp to use its full range. The low band (0–3.6 GHz or 0–3GHz, depending on the model) is supplied by the low band preamp and the frequencies above low band are supplied by the high band preamp.

The frequency range of the installed (optional) preamp is displayed in square brackets on the Full Range key label. If the high band option is not installed the Full Range key does not appear.

Key Path	AMPTD Y Scale, Internal Preamp
<b>Example</b>	:POW:GAIN ON :POW:GAIN:BAND FULL
Readback	Full Range
Initial S/W Revision	Prior to A.02.00

## Range

This key is only available when I/Q is the selected input. It replaces the Attenuation key in that case.

Each input channel (I and Q) has four internal gain ranges. The maximum allowed voltage in each gain range is slightly more than the nominal value, so the break point between ranges is a couple of millivolts higher than the nominal (setting a peak voltage of 0.502 mV will still map to the 0.5 V Peak range).

Gain Setting	Volts RMS	Volts Peak	Volts Peak - Peak	dBm (50Ω)	Break Point
0 dB	0.7071	1.0	2.0	10	n/a
6 dB	0.3536	0.5	1.0	4	0.502 V Peak
12 dB	0.1768	0.25	0.5	-2	0.252 V Peak
18 dB	0.0884	0.125	0.25	-8	0.127 V Peak

Key Path	AMPTD Y Scale
Notes	Visible only when the selected input is I/Q.
State Saved	No
Readback Text	When Range is Auto, "[Auto]" When Range is Man and I & Q are the same, "<range value>" When Range is Man and I & Q are different: "[: <I range value> Q: <Q range value>]" See I Range and Q Range for the <range value> enumeration definition.
Initial S/W Revision	Prior to A.02.00

## Range Auto/Man

The Auto setting for Range causes the range to be set based on the Y Scale settings. When Range is "Auto", the I & Q Range are set based on the top of the Y Scale when the Y scale is in dB units (for example, power), or to the max(abs(top), abs(bottom)) when the Y scale reference is not at the top of the screen.

Not all measurements support Range Auto/Man. If Auto is not supported in the current measurement, this key is grayed out and shows "Man" and MAN is returned to a SCPI query, but this does NOT change the Auto/Man setting for Range. When you go to a measurement that supports Auto, it goes back to Auto if it was previously in Auto mode.

Key Path	AMPTD Y Scale, Range
Scope	Meas Global
Remote Command	[ :SENSe ] :VOLTage:IQ:RANGe:AUTO OFF ON 0 1 [ :SENSe ] :VOLTage:IQ:RANGe:AUTO?
Example	Put the I Range and Q Range in manual. VOLT:IQ:RANG:AUTO OFF
Dependencies	If Auto is not supported, sending the SCPI command will generate an error.
Couplings	When in Auto, both I Range and Q Range are set to the same value, computed as follows: Maximum absolute value is computed for the Y Scale. The top and bottom of the graph are computed based on Ref Value, Scale/Div, and Ref Position. Formula: YMax = max(abs(top), abs(bottom)). The I Range and Q Range are then set to YMax.
Preset	ON
State Saved	Saved in instrument state
Range	Auto   Man
Initial S/W Revision	Prior to A.02.00

Remote Command	[ :SENSe ] :POWer:IQ:RANGe:AUTO OFF ON 0 1 [ :SENSe ] :POWer:IQ:RANGe:AUTO?
----------------	--------------------------------------------------------------------------------



<b>Example</b>	Put the I Range and Q Range in manual. POW:IQ:RANG:AUTO OFF
Notes	The POW:IQ:RANG:AUTO is an alternate form of the VOLT:IQ:RANG:AUTO command. This is to maintain consistency with I Range and Q Range, which support both the POWER and VOLTage forms of the command.
Preset	ON
Range	Auto   Man
Initial S/W Revision	Prior to A.02.00

## I Range

This is the internal gain range for the I channel when Input Path is I Only or I and I/Q, and it is used for both the I and Q channels when the Input Path is I+jQ. See "[I/Q Gain Ranges](#)" on page 2807.

<b>Key Path</b>	AMPTD Y Scale, Range
<b>Remote Command</b>	[ :SENSe ] :VOLTage :IQ [ :I ] :RANGe [ :UPPer ] <voltage> [ :SENSe ] :VOLTage :IQ [ :I ] :RANGe [ :UPPer ] ?
<b>Example</b>	Set the I Range to 0.5 V Peak VOLT:IQ:RANG 0.5 V
Notes	The numeric entries are mapped to the smallest gain range whose break point is greater than or equal to the value, or 1 V Peak if the value is greater than 1 V.
Couplings	When Q Same as I is On, the I Range value will be copied to the Q Range. Changing the value will also set Range = Man.
Preset	1 V Peak
State Saved	Saved in instrument state
Range	1 V Peak   0.5 V Peak   0.25 V Peak   0.125 V Peak
Min	0.125 V
Max	1 V
Initial S/W Revision	Prior to A.02.00

<b>Remote Command</b>	[ :SENSe ] :POWer :IQ [ :I ] :RANGe [ :UPPer ] <ampl> [ :SENSe ] :POWer :IQ [ :I ] :RANGe [ :UPPer ] ?
<b>Example</b>	Set the I Range to 0.5 V Peak when Reference Z is 50Ω, and to 1.0 V Peak when Reference Z is 75Ω. POW:IQ:RANG 4 dBm
Notes	The POWER form of the command is provided for convenience. It maps to the same underlying gain range parameter as the VOLTage form of the command. The Reference Z (not the I channel Input Z) is used to convert the power to peak voltage, which is then used to set the I Range as with the VOLTage form of the command. The power values of the 4

---

range states (1V Peak, 0.5V Peak, 0.25V Peak, and 0.125V Peak) will vary with Reference Z. Here are some examples:

50Ω: 10, 4, -2, -8

75Ω: 8.2, 2.2, -3.8, -9.8

600Ω: -0.8, -6.8, -12.8, -18.9

---

Preset	10.0 dBm
Range	-20 dBm to 10 dBm
Min	-20 dBm
Max	10 dBm
Initial S/W Revision	Prior to A.02.00

---

### 1 V Peak

Set the channel gain state to 1 Volt Peak.

---

Key Path	AMPTD Y Scale, I Range   Q Range
Initial S/W Revision	Prior to A.02.00

---

### 0.5 V Peak

Set the channel gain state to 0.5 Volt Peak.

---

Key Path	AMPTD Y Scale, I Range   Q Range
Initial S/W Revision	Prior to A.02.00

---

### 0.25 V Peak

Set the channel gain state to 0.25 Volt Peak.

---

Key Path	AMPTD Y Scale, I Range   Q Range
Initial S/W Revision	Prior to A.02.00

---

### 0.125 V Peak

Set the channel gain state to 0.125 Volt Peak.

---

Key Path	AMPTD Y Scale, I Range   Q Range
Initial S/W Revision	Prior to A.02.00

---

## Q Range Value

This is the internal gain range for the Q channel. See "[I/Q Gain Ranges](#)" on page 2807. The Q Range only applies to Input Path Q Only and Ind I/Q. For input I+jQ the I Range determines both I and Q channel range settings.

Key Path	AMPTD Y Scale, Range
Remote Command	[ :SENSe ] :VOLTage:IQ:Q:RANGe[:UPPer] <voltage> [ :SENSe ] :VOLTage:IQ:Q:RANGe[:UPPer] ?
Example	Set the Q Range to 0.5 V Peak VOLT:IQ:Q:RANG 0.5 V
Notes	The numeric entries are mapped to the smallest gain range whose break point is greater than or equal to the value, or 1 V Peak if the value is greater than 1 V. The Q Range is only used for Input Path Q Only and Ind I/Q. For input I+jQ the I Range determines both I and Q channel range settings.
Couplings	When Q Same as I is On, the I Range value will be copied to the Q Range and the range value keys are disabled. Changing the value will also set Range = Man.
Preset	1 V Peak
State Saved	Saved in instrument state
Range	1 V Peak   0.5 V Peak   0.25 V Peak   0.125 V Peak
Min	0.125 V
Max	1 V
Initial S/W Revision	Prior to A.02.00

Remote Command	[ :SENSe ] :POWer:IQ:Q:RANGe[:UPPer] <ampl> [ :SENSe ] :POWer:IQ:Q:RANGe[:UPPer] ?
Example	Will set the Q Range to 0.5 V Peak when Reference Z is 50Ω, and to 1.0 V Peak when Reference Z is 75Ω. POW:IQ:Q:RANG 4 dBm
Notes	The POWer form of the command is provided for convenience. It maps to the same underlying gain range parameter as the VOLTage form of the command. The Reference Z (not the Q channel Input Z) is used to convert the power to peak voltage, which is then used to set the Q Range as with the VOLTage form of the command. The power values of the 4 range states (1V Peak, 0.5V Peak, 0.25V Peak, and 0.125V Peak) will vary with Reference Z. Here are some examples: 50Ω: 10, 4, -2, -8 75Ω: 8.2, 2.2, -3.8, -9.8 600Ω: -0.8, -6.8, -12.8, -18.9
Preset	10.0 dBm
Range	-20 dBm to 10 dBm

Min	-20 dBm
Max	10 dBm
Initial S/W Revision	Prior to A.02.00

### Q Same as I

Many, but not all, usages require the I and Q channels to have an identical setup. To simplify channel setup, the Q Same as I will cause the Q channel range to be mirrored from the I channel. That way you only need to set up one channel (the I channel). The I channel values are copied to the Q channel, so at the time Q Same as I is Off, the I and Q channel setups will be identical.

Key Path	AMPTD Y Scale, Range, Q Range
Remote Command	[ :SENSe] :VOLTage POWER:IQ:MIRRored OFF ON 0 1 [ :SENSe] :VOLTage POWER:IQ:MIRRored?
Example	Turn off the mirroring of I Range to Q Range. VOLT:IQ:MIRR OFF POW:IQ:MIRR OFF
Couplings	When On, the I Range value is mirrored (copied) to the Q Range.
Preset	On
State Saved	Saved in instrument state.
Range	On   Off
Readback Text	"Q Same as I" when On, otherwise none.
Initial S/W Revision	Prior to A.02.00

### 1 V Peak

Set the channel gain state to 1 Volt Peak.

Key Path	AMPTD Y Scale, I Range   Q Range
Initial S/W Revision	Prior to A.02.00

### 0.5 V Peak

Set the channel gain state to 0.5 Volt Peak.

Key Path	AMPTD Y Scale, I Range   Q Range
Initial S/W Revision	Prior to A.02.00

### 0.25 V Peak

Set the channel gain state to 0.25 Volt Peak.

Key Path	AMPTD Y Scale, I Range   Q Range
Initial S/W Revision	Prior to A.02.00

### 0.125 V Peak

Set the channel gain state to 0.125 Volt Peak.

Key Path	AMPTD Y Scale, I Range   Q Range
Initial S/W Revision	Prior to A.02.00

### I/Q Gain Ranges

See the following sections:

["1 V Peak" on page 2807](#)

["0.5 V Peak" on page 2807](#)

["0.25 V Peak" on page 2807](#)

["0.125 V Peak" on page 2808](#)

### 1 V Peak

Set the channel gain state to 1 Volt Peak.

Key Path	AMPTD Y Scale, I Range   Q Range
Initial S/W Revision	Prior to A.02.00

### 0.5 V Peak

Set the channel gain state to 0.5 Volt Peak.

Key Path	AMPTD Y Scale, I Range   Q Range
Initial S/W Revision	Prior to A.02.00

### 0.25 V Peak

Set the channel gain state to 0.25 Volt Peak.

Key Path	AMPTD Y Scale, I Range   Q Range
Initial S/W Revision	Prior to A.02.00

### 0.125 V Peak

Set the channel gain state to 0.125 Volt Peak.

Key Path	AMPTD Y Scale, I Range   Q Range
Initial S/W Revision	Prior to A.02.00

### Presel Center

When this key is pressed, the centering of the preselector filter is adjusted to optimize the amplitude accuracy at the frequency of the selected marker.

See AMPTD Y Scale, "[Presel Center](#)" on page 2791 for more information.

This is only available when the selected input is RF.

Key Path	AMPTD/Y Scale
Initial S/W Revision	Prior to A.02.00

### Presel Adjust

Allows you to manually adjust the preselector filter frequency to optimize its response to the signal of interest. This function is only available when Presel Center is available.

See AMPTD Y Scale, "[Preselector Adjust](#)" on page 2792 for more information.

This is only available when the selected input is RF.

Key Path	AMPTD/Y Scale
Initial S/W Revision	Prior to A.02.00

## Auto Couple

The Auto Couple feature provides a quick and convenient way to automatically couple multiple instrument settings. This helps ensure accurate measurements and optimum dynamic range. When the Auto Couple feature is activated, either from the front panel or remotely, all parameters of the current measurement that have an Auto/Manual mode are set to Auto mode and all measurement settings dependent on (or coupled to) the Auto/Man parameters are automatically adjusted for optimal performance.

However, the Auto Couple key actions are confined to the current measurement only. It does not affect other measurements in the mode, and it does not affect markers, marker functions, or trace or display attributes.

See "[More Information](#)" on page 2483

Key Path	Front-panel key
Remote Command	:COUPle ALL NONE
Example	:COUP ALL
Notes	:COUPle ALL puts all Auto/Man parameters in Auto mode (equivalent to pressing the Auto Couple key). :COUPLE NONE puts all Auto/Man parameters in manual mode. It decouples all the coupled instrument parameters and is not recommended for making measurements.
Initial S/W Revision	Prior to A.02.00

### More Information

There are two types of functions that have Auto/Manual modes.

#### Auto/Man Active Function keys

An Auto/Man toggle key controls the binary state associated with an instrument parameter by toggling between Auto (where the parameter is automatically coupled to the other parameters it is dependent upon) and Man (where the parameter is controlled independent of the other parameters), as well as making the parameter the active function. The current mode is indicated on the softkey with either Auto or Man underlined as illustrated below.



#### Auto/Man 1-of-N keys

An Auto/Man 1-of-N key allows you to manually pick from a list of parameter values, or place the function in Auto, in which case the value is automatically selected (and indicated) as shown below. If in Auto, Auto is underlined on the calling key. If in manual operation, manual is indicated on the calling key. But the calling key does not actually toggle the function, it simply opens the menu.

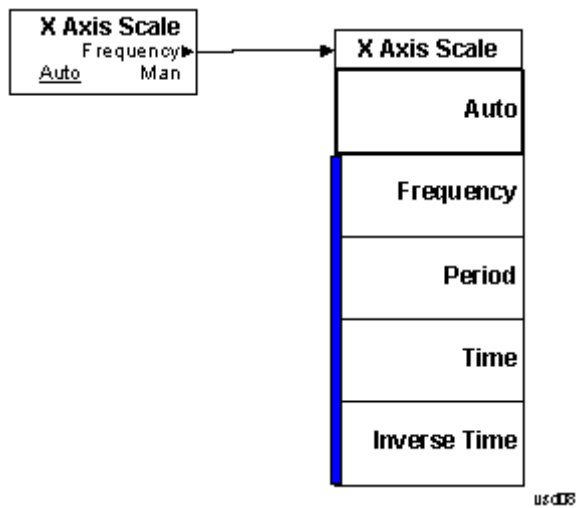



## BW

Accesses a menu of functions that enable you to specify and control the Info BW.

Key Path	Front-panel key
Initial S/W Revision	Prior to A.02.00

## Info BW

Activates the Info BW function, which enables you to manually set the information bandwidth of the analyzer. This is used to set the hardware filter of the ADC.

Key Path	BW
Mode	WCDMA, C2K, 1xEVDO
<b>Remote Command</b>	<code>[ :SENSe ] :EVMQpsk :BANDwidth [ :RESolution ] &lt;freq&gt;</code> <code>[ :SENSe ] :EVMQpsk :BANDwidth [ :RESolution ] ?</code>
<b>Example</b>	EVMQ:BAND 1 kHz EVMQ:BAND?
Notes	The values shown in this table reflect the conditions after a Mode Preset.
Preset	WCDMA: 6 MHz CDMA1xEVDO, C2K: 1.5MHz
State Saved	Saved in instrument state.
Min	1 kHz
Max	Hardware Dependent: RF Input: No Option = 10 MHz WB (25 MHz or wider) = Hardware Option Limit I/Q Input (for I+jQ) No Option = 20 MHz OptionB25 = 50 MHz
<b>Backwards Compatibility SCPI</b>	<code>[ :SENSe ] :EVMQpsk :BWIDth [ :RESolution ]</code>
Initial S/W Revision	Prior to A.02.00
Modified at S/W Revision	A.06.00

## Info BW Control

Accesses a menu that enables you to select either A Gaussian or Flat Top filter.

Key Path	BW
Initial S/W Revision	Prior to A.02.00

## Filter Type

Selects the type of bandwidth filter that is used. The choices are Gaussian or Flat top.

<b>Key Path</b>	BW, RBW Control
<b>Mode</b>	WCDMA, C2K, 1xEVDO
<b>Remote Command</b>	[ :SENSe ] :EVMQpsk :BANDwidth :SHAPE GAUSSian FLATtop [ :SENSe ] :EVMQpsk :BANDwidth :SHAPE?
<b>Example</b>	EVMQ:BAND:SHAP GAUS EVMQ:BAND:SHAP?
<b>Preset</b>	FLATtop
<b>State Saved</b>	Saved in instrument state.
<b>Range</b>	Gaussian FlatTop
<b>Backwards Compatibility SCPI</b>	[ :SENSe ] :EVMQpsk :BWIDth :SHAPE
<b>Initial S/W Revision</b>	Prior to A.02.00

## Cont (Continuous Measurement/Sweep)

Sets the analyzer for Continuous measurement operation. The single/continuous state is Meas Global so the setting will affect all measurements. If you are Paused, pressing Cont does a Resume.

Key Path	Front-panel key
Remote Command	:INITiate:CONTinuous OFF ON 0 1 :INITiate:CONTinuous?
Example	:INIT:CONT 0 puts analyzer in Single measurement operation. :INIT:CONT 1 puts analyzer in Continuous measurement operation
Preset	ON (Note that SYST:PRESet sets INIT:CONT to ON but *RST sets INIT:CONT to OFF)
State Saved	Saved in instrument state
Backwards Compatibility Notes	For Spectrum Analysis mode in ESA and PSA, there is no Cont hardkey, instead there is a Sweep Single/Cont key. In these analyzers, switching the Sweep Single/Cont key from Single to Cont restarts averages (displayed average count reset to 1), but does not restart Max Hold and Min Hold. The X-Series has Single and Cont keys in place of the SweepSingleCont key. In the X-Series, if in single measurement, the Cont key (and INIT:CONT ON ) switches to continuous measurement, but never restarts a measurement and never resets a sweep.
Initial S/W Revision	Prior to A.02.00

In Swept SA Measurement (Spectrum Analysis Mode):

The analyzer takes repetitive sweeps, averages, measurements, etc., when in Continuous mode. When the average count reaches the Average/Hold Number the count stops incrementing, but the analyzer keeps sweeping. See the Trace/Detector section for the averaging formula used both before and after the Average/Hold Number is reached. The trigger condition must be met prior to each sweep. The type of trace processing for multiple sweeps, is set under the Trace/Detector key, with choices of Trace Average, Max Hold, or Min Hold.

In Other Measurements/Modes:

With Avg/Hold Num (in the Meas Setup menu) set to Off or set to On with a value of 1, a sweep is taken after the trigger condition is met; and the analyzer continues to take new sweeps after the current sweep has completed and the trigger condition is again met. However, with Avg/Hold Num set to On with a value >1, multiple sweeps (data acquisitions) are taken for the measurement. The trigger condition must be met prior to each sweep. The sweep is not stopped when the average count k equals the number N set for Avg/Hold Num is reached, but the number k stops incrementing. A measurement average usually applies to all traces, marker results, and numeric results. But sometimes it only applies to the numeric results.

If the analyzer is in Single measurement, pressing the Cont key does not change k and does not cause the sweep to be reset; the only action is to put the analyzer into Continuous measurement operation.

If it is already in continuous sweep:

the INIT:CONT 1 command has no effect

19 QPSK EVM Measurement  
Cont (Continuous Measurement/Sweep)

the INIT:CONT 0 command will place the analyzer in Single Sweep but will have no effect on the current sequence until  $k = N$ , at which point the current sequence will stop and the instrument will go to the idle state.

File

See "File" on page 354

## FREQ Channel

Accesses a menu of keys that allow you to control the Frequency and Channel parameters of the instrument.

Some features in the Frequency menu are the same for all measurements – they do not change as you change measurements. Settings like these are called “Meas Global” and are unaffected by Meas Preset. For example, the Center Freq setting is the same for all measurements - it does not change as you change measurements.

<b>Key Path</b>	<b>Front-panel key</b>
<b>Initial S/W Revision</b>	<b>Prior to A.02.00</b>

### Center Freq

Sets the frequency that corresponds to the horizontal center of the graticule (when frequency Scale Type is set to linear). While adjusting the Center Frequency the Span is held constant, which means that both Start Frequency and Stop Frequency will change.

Pressing Center Freq also sets the frequency entry mode to Center/Span. In Center/Span mode, the center frequency and span values are displayed below the graticule, and the default active function in the Frequency menu is Center Freq.

The center frequency setting is the same for all measurements within a mode, that is, it is Meas Global. Some modes are also able to share a Mode Global center frequency value. If this is the case, the Mode will have a Global Settings key in its Mode Setup menu.

The Center Freq function sets (and queries) the Center Frequency for the currently selected input. If your analyzer has multiple inputs, and you select another input, the Center Freq changes to the value for that input. SCPI commands are available to directly set the Center Freq for a specific input.

Center Freq is remembered as you go from input to input. Thus you can set a Center Freq of 10 GHz with the RF Input selected, change to BBIQ and set a Center Freq of 20 MHz, then switch to External Mixing and set a Center Freq of 60 GHz, and when you go back to the RF Input the Center Freq will go back to 10 GHz; back to BBIQ and it is 20 MHz; back to External Mixing and it is 60 GHz.

See ["RF Center Freq" on page 2493](#)

See [Ext Mix Center Freq](#)

See ["I/Q Center Freq" on page 2495](#)

See ["Center Frequency Presets" on page 2491](#)

<b>Key Path</b>	<b>FREQ Channel</b>
<b>Scope</b>	<b>Meas Global</b>
<b>Remote Command</b>	<code>[ :SENSe ] :FREQuency:CENTer &lt;freq&gt;</code> <code>[ :SENSe ] :FREQuency:CENTer?</code>

<b>Example</b>	FREQ:CENT 50 MHz FREQ:CENT UP changes the center frequency to 150 MHz if you use FREQ:CENT:STEP 100 MHz to set the center frequency step size to 100 MHz FREQ:CENT?
<b>Notes</b>	This command sets either the RF or I/Q Center Frequency depending on the selected input. For RF input it is equivalent to FREQ:RF:CENT For I/Q input it is equivalent to FREQ:IQ:CENT Preset and Max values are dependent on Hardware Options (5xx) If no terminator (e.g. MHz) is sent the terminator Hz is used. If a terminator with unit other than Frequency is used, an invalid suffix error message is generated.
<b>Dependencies</b>	The Center Frequency can be limited by Start or Stop Freq limits, if the Span is so large that Start or Stop reach their limit.
<b>Couplings</b>	When operating in “swept span”, any value of the Center Frequency or Span that is within the frequency range of the analyzer is allowed when the value is being set through the front panel numeric key pad or the SCPI command. The other parameter is forced to a different value if needed, to keep the Start and the Stop Frequencies within the analyzer’s frequency range
<b>Preset</b>	Depends on instrument maximum frequency, mode, measurement, and selected input. See <a href="#">"Center Frequency Presets" on page 2491</a> and <a href="#">"RF Center Freq" on page 2493</a> and <a href="#">Ext Mix Center Freq</a> and <a href="#">"I/Q Center Freq" on page 2495</a> .
<b>State Saved</b>	Saved in instrument state
<b>Min</b>	Depends on instrument maximum frequency, mode, measurement, and selected input.. See <a href="#">"Center Frequency Presets" on page 2491</a> and <a href="#">"RF Center Freq" on page 2493</a> and <a href="#">"I/Q Center Freq" on page 2495</a> .
<b>Max</b>	Depends on instrument maximum frequency, mode, measurement, and selected input.. See <a href="#">"Center Frequency Presets" on page 2491</a> and <a href="#">"RF Center Freq" on page 2493</a> and <a href="#">"I/Q Center Freq" on page 2495</a> .
<b>Default Unit</b>	Hz
<b>Status Bits/OPC</b>	Non-overlapped
<b>Dependencies</b>	
<b>Initial S/W Revision</b>	Prior to A.02.00

## Center Frequency Presets

The following table provides the Center Frequency Presets for the Spectrum Analyzer mode, and the Max Freq, for the various frequency options:

Freq Option	CF after Mode Preset	Stop Freq after Mode Preset	Max Freq (can't tune)

19 QPSK EVM Measurement  
FREQ Channel

			above)
503 (all but N9000A)	1.805 GHz	3.6 GHz	3.7 GHz
503 (N9000A)	1.505 GHz	3.0 GHz	3.08 GHz
507 (all but N9000A)	3.505 GHz	7.0 GHz	7.1 GHz
507 (N9000A)	3.755 GHz	7.5 GHz	7.58 GHz
508 (all but N9038A)	1.805 GHz	3.6 GHz	8.5 GHz
508 (N9038A)	4.205 GHz	8.4 GHz	8.5 GHz
513	6.805 GHz	13.6 GHz	13.8 GHz
526 (all but N9000A and N9038A)	13.255 GHz	26.5 GHz	27.0 GHz
526 (N9000A)	13.255 GHz	26.5 GHz	26.55 GHz
526 (N9038A)	1.805 GHz	3.6 GHz	27.0 GHz
532	16.005 GHz	32.0 GHz	32.5 GHz
543	21.505 GHz	43.0 GHz	TBD
544	22.005 GHz	44.0 GHz	44.5 GHz
550	25.005 GHz	50.0 GHz	51 GHz

Input 2:

Model	CF after Mode Preset	Stop Freq after Mode Preset	Max Freq (can't tune above)
N9000A opt C75	0.7505GHz	1.5 GHz	1.58 GHz
N9038A	505 MHz	1 GHz	1.000025 GHz

Tracking Generator Frequency Limits (N9000A only):

Tracking Generator Option	Min Freq (clips to this freq when turn TG on and	If above this Freq, Stop Freq clipped to this Freq when	Max Freq (can't tune above) while TG



	can't tune below while TG on)	TG turned on	on
T03	9 kHz	3.0 GHz	3.08 GHz
T06	9 kHz	6.0 GHz	6.05 GHz

The following table shows the Center Frequency Presets for modes other than Spectrum Analyzer:

Mode	CF Preset for RF
WCDMA	1 GHz
WIMAXOFDMA,	1 GHz
BASIC	1 GHz
ADEMOD	1 GHz
VSA	1 GHz
TDSCDMA	1 GHz
PNOISE	1 GHz
LTE	1 GHz
LTETDD	1 GHz
MSR	1 GHz
GSM	935.2 MHz
NFIGURE	1.505 GHz

## RF Center Freq

SCPI command for specifying the RF Center Frequency. This command will set the Center Frequency to be used when the RF input is selected, even if the RF input is not the input that is selected at the time the command is sent. Note that the Center Freq function in the Frequency menu on the front panel always applies to the currently selected input.

Scope	Meas Global
<b>Remote Command</b>	<code>[ :SENSe ] :FREQuency:RF:CENTer &lt;freq&gt;</code> <code>[ :SENSe ] :FREQuency:RF:CENTer?</code>
<b>Example</b>	FREQ:RF:CENT 30 MHz
Notes	This command is the same in all modes, but the parameter is Measurement Global. So the value is independent in each mode and common across all the measurements in the mode.
Dependencies	If the electronic/soft attenuator is enabled, any attempt to set Center Frequency such that the Stop Frequency would be >3.6 GHz fails and results in an advisory message. If the equivalent SCPI command is sent, this same message is generated as part of a “-221, Settings conflict” warning. If Source Mode is set to Tracking, and the Max or Min Center Freq is therefore limited by the limits of the source, a warning message is generated, “Data out of range;clipped to source max/min” if these limits are exceeded. Note that for an external source, these limits can be affected by the settings of

	Source Numerator, Source Denominator and Power Sweep.
Preset	See table above
State Saved	Saved in instrument state.
Min	-79.999995 MHz, unless Source Mode is set to Tracking, in which case it is limited by the minimum frequency of the Source
Max	See table above. Basically instrument maximum frequency – 5 Hz. Note that, if the Source Mode is set to Tracking, the effective instrument maximum frequency may be limited by the source maximum frequency.  If the knob or step keys are being used, also depends on the value of the other three interdependent parameters Span, Start Frequency and Stop Frequency
Initial S/W Revision	Prior to A.02.00
Modified at S/W Revision	A.03.00

### Ext Mix Center Freq

SCPI command for specifying the External Mixer Center Frequency. This command will set the Center Frequency to be used when the External Mixer is selected, even if the External Mixer input is not the input which is selected at the time the command is sent. Note that the Center Freq function in the Frequency menu on the front panel always applies to the currently selected input.

Scope	Meas Global
Remote Command	<code>[ :SENSe ] :FREQuency:EMIXer:CENTer &lt;freq&gt;</code> <code>[ :SENSe ] :FREQuency:EMIXer:CENTer?</code>
Example	<code>:FREQ:EMIX:CENT 60 GHz</code> <code>:FREQ:EMIX:CENT?</code>
Notes	This command is the same in all modes, but the parameter is Measurement Global. So the value is independent in each mode and common across all the measurements in the mode.
Couplings	When returning to External Mixing after having been switched to one of the other inputs (e.g., RF), you will come back into the settings that you had when you left External Mixing. So you will come back to the band you were in with the Center Frequency that you had. However, Span is not an input-dependent parameter, therefore you will bring the span over from the other input. Therefore, the analyzer comes back with the span from the previous input, limited as necessary by the current mixer setup.
Preset	When a Mode Preset is performed while in External Mixing, the Start frequency of the current Mode is set to the nominal Min Freq of the lowest harmonic range in the Harmonic Table for the current mixer setup. Similarly, the Stop frequency of the current Mode is set to the nominal Max Freq of the highest harmonic range in the Harmonic Table. The Center Freq thus presets to the point arithmetically equidistant from these two frequencies.  If the current measurement has a limited Span available to it, and cannot achieve the Span shown in the table (Span=Stop Freq – Start Freq), the analyzer uses the maximum Span the measurement allows, and still sets the Center Freq to the midpoint of the Start and Stop Freq values in the Harmonic Table.

	When Restore Input/Output Defaults is performed, the mixer presets to the 11970A, whose Start and Stop frequencies are 26.5 and 40 GHz respectively. The center of these two frequencies is 33.25 GHz. Therefore, after a Restore Input/Output Defaults, if you go into External Mixing and do a Mode Preset while in the Spectrum Analyzer Mode, the resulting Center Freq is 33.25 GHz.
State Saved	Saved in instrument state.
Min	The minimum frequency in the currently selected mixer band + 5 Hz
Max	The maximum frequency in the currently selected mixer band – 5 Hz If the knob or step keys are being used, also depends on the value of the other three interdependent parameters Span, Start Frequency and Stop Frequency
Initial S/W Revision	A.08.01

## I/Q Center Freq

SCPI command for specifying the I/Q Center Frequency. This command will set the Center Frequency to be used when the I/Q input is selected, even if the I/Q input is not the input which is selected at the time the command is sent. Note that the Center Freq function in the Frequency menu on the front panel always applies to the currently selected input.

Scope	Meas Global
<b>Remote Command</b>	<code>[ :SENSe ] :FREQuency:IQ:CENTer &lt;freq&gt;</code> <code>[ :SENSe ] :FREQuency:IQ:CENTer?</code>
<b>Example</b>	FREQ:IQ:CENT: 30 MHz
Notes	This command is the same in all modes, but the parameter is Measurement Global. So the value is independent in each mode and common across all the measurements in the mode.
Preset	0 Hz
State Saved	Saved in instrument state.
Min	-40.049995 MHz
Max	40.049995 MHz
Initial S/W Revision	Prior to A.02.00

## CF Step

Changes the step size for the center frequency and start and stop frequency functions. Once a step size has been selected and the center frequency function is active, the step keys (and the UP|DOWN parameters for Center Frequency from remote commands) change the center frequency by the step-size value. The step size function is useful for finding harmonics and sidebands beyond the current frequency span of the analyzer.

Note that the start and stop frequencies also step by the CF Step value.

Key Path	FREQ Channel
Remote Command	[:SENSe]:FREQuency:CENTer:STEP[:INCRement] <freq> [:SENSe]:FREQuency:CENTer:STEP[:INCRement]? [:SENSe]:FREQuency:CENTer:STEP:AUTO OFF ON 0 1 [:SENSe]:FREQuency:CENTer:STEP:AUTO?
Example	FREQ:CENt:STEP:AUTO ON FREQ:CENt:STEP 500 MHz FREQ:CENt UP increases the current center frequency value by 500 MHz FREQ:CENt:STEP? FREQ:CENt:STEP:AUTO?
Notes	Preset and Max values are depending on Hardware Options (503, 507, 508, 513, 526)
Notes	Preset and Max values are dependent on Hardware Options (5xx)
Dependencies	Freq Offset is not available in External Mixing. In this case the Freq Offset key is grayed out and shows a value of zero. It will once again be available, and show the previously set value, when you return to the RF Input.
Dependencies	Span, RBW, Center frequency If the electronic/soft attenuator is enabled, any attempt to change the value of the center frequency >3.6 GHz by pressing the Up-arrow key, fails and results in an advisory message. If the equivalent SCPI command is sent, this same message is generated as part of a “-221, Settings conflict” warning.
Couplings	When auto-coupled in a non-zero span, the center frequency step size is set to 10% of the span. When auto-coupled in zero span, the center frequency step size is set to the equivalent -3 dB RBW value.
Preset	Auto ADEMOD: 1 MHz ON
State Saved	Saved in instrument state
Min	– (the maximum frequency of the instrument). That is, 27 GHz max freq instrument has a CF step range of +/- 27 GHz. Note that this is the maximum frequency given the current settings of the instrument, so in External Mixing, for example, it is the maximum frequency of the current mixer band.
Max	The maximum frequency of the instrument. That is, 27 GHz max freq instrument has a CF step range of +/- 27 GHz. Note that this is the maximum frequency given the current settings of the instrument, so in External Mixing, for example, it is the maximum frequency of the current mixer band.
Default Unit	Hz
Status Bits/OPC dependencies	non-overlapped
Initial S/W Revision	Prior to A.02.00
Modified at S/W Revision	A.03.00

## Input/Output

See ["Input/Output" on page 226](#)

## Marker

Accesses a menu that enables you to select, set up and control the markers for the current measurement.

---

Key Path	Front-panel key
Initial S/W Revision	Prior to A.02.00

---

### Select Marker

Displays 12 markers available for selection.

---

Key Path	Marker
Initial S/W Revision	Prior to A.02.00

---

### Marker Type

Sets the marker control mode. If the selected marker is Off, pressing Marker sets it to Normal and places it at the center of the screen on the trace determined by the Marker Trace rules. At the same time, reference value of the selected marker appears on the Active Function area. It is:

Marker Chip Value, at I/Q Polar

Marker X Axis Value, at EVM, Phase Error and Mag Error

Default Active Function: the active function for the selected marker's current control mode. If the current control mode is Off, there is no active function and the active function is turned off.

---

Key Path	Marker
Mode	WCDMA, C2K, 1xEVDO
Remote Command	:CALCulate:EVMQpsk:MARKer[1] 2 ...12:MODE POSition DELTA OFF :CALCulate:EVMQpsk:MARKer[1] 2 ...12:MODE?
Example	CALC:EVMQ:MARK:MODE POS CALC:EVMQ:MARK:MODE?

---

**Notes**

If the selected marker is Off, pressing Marker sets it to Normal and places it at the center of the screen on the trace determined by the Marker Trace rules. At the same time, reference value of the selected marker appears on the Active Function area. It is:

Marker Chip Value, at I/Q Polar

Marker X Axis Value, at EVM, Phase Error and Mag Error

Default Active Function: the active function for the selected marker's current control mode. If the current control mode is Off, there is no active function and the active function is turned off.

If the selected marker's trace is I/Q Polar, Delta is not supported. If DELTA is selected on the marker of the I/Q Polar, the command is ignored.

---

Preset	OFF
State Saved	Saved in instrument state.
Range	Normal Delta Off
Initial S/W Revision	Prior to A.02.00

## Marker Properties

Accesses a menu of functions that enable you to specify and control markers for the current measurement.

Key Path	Marker
Initial S/W Revision	Prior to A.02.00

## Select Marker

Displays 12 markers available for selection.

Key Path	Marker
Initial S/W Revision	Prior to A.02.00

## Relative To

Selects the marker the selected marker will be relative to (its reference marker).

Key Path	Marker, Properties
Mode	WCDMA, C2K, 1xEVDO
<b>Remote Command</b>	:CALCulate:EVMQpsk:MARKer[1] 2 ...12:REFerence <integer> :CALCulate:EVMQpsk:MARKer[1] 2 ...12:REFerence?
<b>Example</b>	CALC:EVMQ:MARK:REF 4 CALC:EVMQ:MARK:REF?
Notes	A marker cannot be relative to itself so that choice is grayed out, and if sent from SCPI generates error -221: "Settings conflict; marker cannot be relative to itself." When queried, a single value is returned (the specified marker numbers relative marker).
Preset	2 3 4 5 6 7 8 9 10 11 12 1
State Saved	Saved in instrument state.
Min	1
Max	12
Initial S/W Revision	Prior to A.02.00

## Marker Trace

Assigns the specified marker to the designated trace.

Key Path	Marker
Mode	WCDMA, C2K, 1xEVDO
Remote Command	:CALCulate:EVMQpsk:MARKer[1] 2 ...12:TRACe POLar   EVM   PERRor   MERRor :CALCulate:EVMQpsk:MARKer[1] 2 ...12:TRACe?
Example	CALC:EVMQ:MARK:TRAC MERR CALC:EVMQ:MARK:TRAC?
Notes	Assigns the specified marker to the designated trace.
Preset	POLar
State Saved	Saved in instrument state.
Range	I/Q Polar EVM Phase Error Mag Error
Initial S/W Revision	Prior to A.02.00
Modified at S/W Revision	A.08.00

## Couple Marker

Toggles the state of the markers to be coupled On or Off. When this function is true (On), moving any marker causes an equal X-axis movement of every other marker except those located to the polar trace, and Chip value of the marker located to the polar trace, which is not Off, including Fixed markers. "Equal X Axis movement" refers to the difference between each marker's X Axis value (in the fundamental x-axis units of the trace that marker is on) and the X Axis value of the marker being moved (in the same fundamental x-axis units). This may result in markers going off screen

See Couple Marker in the "Marker" section for more information.

Key Path	Marker
Mode	WCDMA, C2K, 1xEVDO
Remote Command	:CALCulate:EVMQpsk:MARKer:COUPle[:STATe] ON OFF 1 0 :CALCulate:EVMQpsk:MARKer:COUPle[:STATe]?
Example	CALC:EVMQ:MARK:COUP ON CALC:EVMQ:MARK:COUP?
Notes	In QPSK EVM, this marker behaves specially. Coupled values are "Chips" of the markers located to the polar trace, and "X" of the markers located to the other traces than the polar trace.
Preset	OFF
State Saved	Saved in instrument state.
Range	On Off
Initial S/W Revision	Prior to A.02.00



## All Markers Off

Turns off all markers.

Key Path	Marker
Mode	WCDMA, C2K, 1xEVDO
<b>Remote Command</b>	:CALCulate:EVMQpsk:MARKer:AOff
<b>Example</b>	CALC:EVMQ:MARK:AOff
Initial S/W Revision	Prior to A.02.00

## Marker X Axis Value (Remote Command only)

Sets the marker X Axis value in the current marker X Axis Scale unit. It has no effect if the control mode is Off, but is the SCPI equivalent of entering an X value if the control mode is Normal or Delta.

This parameter has different meaning between the cases where the marker trace is set to I/Q Polar and others. In the I/Q Polar Graph, X Axis Value is also the measured value and this command is query only.

Mode	WCDMA, C2K, 1xEVDO
<b>Remote Command</b>	:CALCulate:EVMQpsk:MARKer[1] 2 ...12:X <real> :CALCulate:EVMQpsk:MARKer[1] 2 ...12:X?
<b>Example</b>	CALC:EVMQ:MARK3:X 1280 CALC:EVMQ:MARK3:X?
Notes	<p>If no suffix is sent, it uses the fundamental units for the current marker X Axis Scale. If a suffix is sent that does not match the current marker X Axis Scale unit, an error "Invalid suffix" is generated. If the specified marker is Fixed and a Marker Function is on, error -221 "Settings conflict; cannot adjust Fixed marker while Marker Function is on" is generated.</p> <p>The query returns the marker's absolute X Axis value if the control mode is Normal, or the offset from the marker's reference marker if the control mode is Delta. The query is returned in the fundamental units for the current marker X Axis scale: Hz for Frequency and Inverse Time, seconds for Period and Time. If the marker is Off the response is not a number.</p> <p>This parameter has different meaning between the cases where the marker trace is set to I/Q Polar and others. In the I/Q Polar Graph, X Axis Value is also the measured value and the command is query only.</p>
Preset	After a preset, all Markers are turned OFF, so Marker X Axis Value query returns a Not A Number (NaN).
State Saved	No
Min	-9.9E+37
Max	9.9E+37
Initial S/W Revision	Prior to A.02.00

### Marker Chip Value (Remote Command only)

Sets the marker Chip value in the current marker for the trace of I/Q Polar. It has no effect if the control mode is Off, but is the SCPI equivalent of entering a Chip value if the control mode is Normal or Delta.

In other traces than I/Q Polar, this command is meaningless and ignored.

<b>Mode</b>	WCDMA, C2K, 1xEVDO
<b>Remote Command</b>	:CALCulate:EVMQpsk:MARKer[1] 2 ...12:CHIP <real> :CALCulate:EVMQpsk:MARKer[1] 2 ...12:CHIP?
<b>Example</b>	CALC:EVMQ:MARK3:X 0 CALC:EVMQ:MARK3:X?
<b>Notes</b>	If no suffix is sent it uses the fundamental units for the current marker X Axis Scale. If a suffix is sent that does not match the current marker X Axis Scale unit, an error "Invalid suffix" is generated. If the specified marker is Fixed and a Marker Function is on, error -221 "Settings conflict; cannot adjust Fixed marker while Marker Function is on" is generated.  The query returns the marker's absolute X Axis value if the control mode is Normal, or the offset from the marker's reference marker if the control mode is Delta. The query is returned in the fundamental units for the current marker X Axis scale: Hz for Frequency and Inverse Time, seconds for Period and Time. If the marker is Off the response is Not A Number.  This parameter is only available in the case where the marker trace is set to I/Q Polar.
<b>Preset</b>	0
<b>State Saved</b>	No
<b>Min</b>	-9.9E+37
<b>Max</b>	9.9E+37
<b>Initial S/W Revision</b>	Prior to A.02.00

### Marker X Axis Position (Remote Command only)

Sets the marker X position in trace points. It has no effect if the control mode is Off, but is the SCPI equivalent of entering a value if the control mode is Normal or Delta except in trace points rather than X Axis Scale units. The entered value is immediately translated into the current X Axis Scale units for setting the value of the marker.

If the Marker Trace is set to I/Q Polar (POLar), this command provides no effects.

<b>Mode</b>	WCDMA, C2K, 1xEVDO
<b>Remote Command</b>	:CALCulate:EVMQpsk:MARKer[1] 2 ...12:X:POSition <real> :CALCulate:EVMQpsk:MARKer[1] 2 ...12:X:POSition?
<b>Example</b>	CALC:EVMQ:MARK:X:POS 0.0 CALC:EVMQpsk:MARK10:X:POS?
<b>Notes</b>	If the specified marker is Fixed and a Marker Function is on, error -221 "Settings conflict; cannot adjust Fixed marker while Marker Function is on" is generated.  The query returns the marker's absolute X Axis value in trace points if the control mode is Normal, or

the offset from the marker's reference marker in trace points if the control mode is Delta. The value is returned as a real number, not an integer, corresponding to the translation from X Axis Scale units to trace points (see "Fractional Trace Points", above). If the marker is Off the response is not a number.

This command is not available when Marker Trace of the selected marker (:CALCulate:EVMQpsk:MARKer[1]|2|3|4|5|6|7|8|9|10|11|12:TRACe?) is set to POLar. In this case, this command is ignored.

Preset	After a preset, all Markers are turned OFF, so Marker X Axis Value query returns a Not A Number (NAN).
State Saved	No
Min	-9.9E+37
Max	9.9E+37
Initial S/W Revision	Prior to A.02.00

### Marker Y Axis Value (Query Only)

Returns the Marker Y Axis value, in the current marker Y Axis unit.

Mode	WCDMA, C2K, 1xEVDO
<b>Remote Command</b>	:CALCulate:EVMQpsk:MARKer[1] 2 ...12:Y?
<b>Example</b>	CALC:EVMQ:MARK11:Y?
Notes	The query returns the marker Y-axis result, if the control mode is Normal or Delta. If the marker is Off, the response is not a number.
Preset	Result dependant on markers setup and signal source
State Saved	No
<b>Backwards Compatibility SCPI</b>	:CALCulate:EVMQpsk:MARKer[1] 2 ...12:FUNction:RESult?
Initial S/W Revision	Prior to A.02.00

## Marker Function

There is no Marker Function functionality supported in QPSK EVM. This front panel key displays a blank menu when pressed.

---

Key Path	Front-panel key
Initial S/W Revision	Prior to A.02.00

---

## Marker To

There is no Marker To functionality supported in QPSK EVM. This front panel key displays a blank menu when pressed.

---

Key Path	Front-panel key
Initial S/W Revision	Prior to A.02.00

---

## Meas

The information in this section is common to all measurements. For key and remote command information for a specific measurement, refer to the section that describes the measurement of interest.

Measurements available under the Meas key are specific to the current Mode.

When viewing Help for measurements, note the following:

**NOTE**

Operation for some keys differs between measurements. The information displayed in Help pertains to the current measurement. To see how a key operates in a different measurement, exit Help (press the Cancel Esc key), select the measurement, then reenter Help (press the Help key) and press that key.

---

Key Path	Front-panel key
Initial S/W Revision	Prior to A.02.00

---

### Remote Measurement Functions

This section contains the following topics:

["Measurement Group of Commands" on page 2849](#)

["Current Measurement Query \(Remote Command Only\)" on page 2851](#)

["Limit Test Current Results \(Remote Command Only\)" on page 2851](#)

["Data Query \(Remote Command Only\)" on page 2851](#)

["Calculate/Compress Trace Data Query \(Remote Command Only\)" on page 2852](#)

["Calculate Peaks of Trace Data \(Remote Command Only\)" on page 2857](#)

[Hardware-Accelerated Fast Power Measurement \(Remote Command Only\)](#)

["Format Data: Numeric Data \(Remote Command Only\)" on page 2858](#)

["Format Data: Byte Order \(Remote Command Only\)" on page 2859](#)

---

Initial S/W Revision	Prior to A.02.00
----------------------	------------------

---

## Measurement Group of Commands

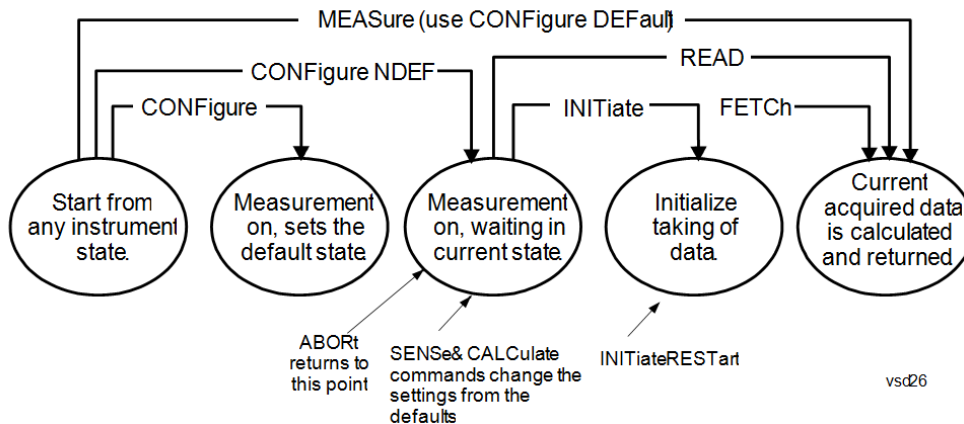

---

### Measure Commands:

:MEASure:<measurement>[n]?

This is a fast single-command way to make a measurement using the factory default instrument settings. These are the settings and units that conform to the Mode Setup settings (e.g. radio standard) that you have currently selected.

- Stops the current measurement (if any) and sets up the instrument for the specified measurement using the factory defaults
- Initiates the data acquisition for the measurement
- Blocks other SCPI communication, waiting until the measurement is complete before returning results.
- If the function does averaging, it is turned on and the number of averages is set to 10.
- After the data is valid it returns the scalar results, or the trace data, for the specified measurement. The type of data returned may be defined by an [n] value that is sent with the command.
- The scalar measurement results will be returned if the optional [n] value is not included, or is set to 1. If the [n] value is set to a value other than 1, the selected trace data results will be returned. See each command for details of what types of scalar results or trace data results are available.
- ASCII is the default format for the data output. (Older versions of Spectrum Analysis and Phase Noise mode measurements only use ASCII.) The binary data formats should be used for handling large blocks of data since they are smaller and faster than the ASCII format. Refer to the FORMat:DATA command for more information.

If you need to change some of the measurement parameters from the factory default settings you can set up the measurement with the CONFIGure command. Use the commands in the SENSE:<measurement> and CALCulate:<measurement> subsystems to change the settings. Then you can use the READ? command to initiate the measurement and query the results.

If you need to repeatedly make a given measurement with settings other than the factory defaults, you can use the commands in the SENSE:<measurement> and CALCulate:<measurement> subsystems to set up the measurement. Then use the READ? command to initiate the measurement and query results.

Measurement settings persist if you initiate a different measurement and then return to a previous one. Use READ:<measurement>? if you want to use those persistent settings. If you want to go back to the default settings, use MEASure:<measurement>?.

---

### Configure Commands:

:CONFigure:<measurement>

This command stops the current measurement (if any) and sets up the instrument for the specified measurement using

---

---

the factory default instrument settings. It does not initiate the taking of measurement data unless INIT:CONTinuous is ON. If you change any measurement settings after using the CONFigure command, the READ command can be used to initiate a measurement without changing the settings back to their defaults.

In the Swept SA measurement in Spectrum Analyzer mode the CONFigure command also turns the averaging function on and sets the number of averages to 10 for all measurements.

:CONFigure: <measurement>: NDEFault stops the current measurement and changes to the specified measurement. It does not change the settings to the defaults. It does not initiate the taking of measurement data unless INIT:CONTinuous is ON.

The CONFigure? query returns the current measurement name.

The CONFigure:CATalog? query returns a quoted string of all licensed measurement names in the current mode. For example, "SAN, CHP, OBW, ACP, PST, TXP, SPUR, SEM, LIST".

---

#### Fetch Commands:

---

:FETCh:<measurement>[n]?

This command puts selected data from the most recent measurement into the output buffer. Use FETCh if you have already made a good measurement and you want to return several types of data (different [n] values, for example, both scalars and trace data) from a single measurement. FETCh saves you the time of re-making the measurement. You can only FETCh results from the measurement that is currently active, it will not change to a different measurement. An error message is reported if a measurement other than the current one is specified.

If you need to get new measurement data, use the READ command, which is equivalent to an INITiate followed by a FETCh.

The scalar measurement results will be returned if the optional [n] value is not included, or is set to 1. If the [n] value is set to a value other than 1, the selected trace data results will be returned. See each command for details of what types of scalar results or trace data results are available. The binary data formats should be used for handling large blocks of data since they are smaller and transfer faster than the ASCII format. (FORMat:DATA)

FETCh may be used to return results other than those specified with the original READ or MEASure command that you sent.

---

#### INITiate Commands:

---

:INITiate:<measurement>

This command is not available for measurements in all the instrument modes:

- Initiates a trigger cycle for the specified measurement, but does not output any data. You must then use the FETCh<meas> command to return data. If a measurement other than the current one is specified, the instrument will switch to that measurement and then initiate it.
  - For example, suppose you have previously initiated the ACP measurement, but now you are running the channel power measurement. If you send INIT:ACP? it will change from channel power to ACP and will initiate an ACP measurement.
  - Does not change any of the measurement settings. For example, if you have previously started the ACP measurement and you send INIT:ACP? it will initiate a new ACP measurement using the same instrument settings as the last time ACP was run.
  - If your selected measurement is currently active (in the idle state) it triggers the measurement, assuming the trigger conditions are met. Then it completes one trigger cycle. Depending upon the measurement and the number of averages, there may be multiple data acquisitions, with multiple trigger events, for one full trigger cycle. It also holds off additional commands on GPIB until the acquisition is complete.
- 

#### READ Commands:

---

:READ:<measurement>[n]?

- Does not preset the measurement to the factory default settings. For example, if you have previously initiated the ACP
-



---

measurement and you send READ:ACP? it will initiate a new measurement using the same instrument settings.

- Initiates the measurement and puts valid data into the output buffer. If a measurement other than the current one is specified, the instrument will switch to that measurement before it initiates the measurement and returns results.
  - For example, suppose you have previously initiated the ACP measurement, but now you are running the channel power measurement. Then you send READ:ACP? It will change from channel power back to ACP and, using the previous ACP settings, will initiate the measurement and return results.
  - Blocks other SCPI communication, waiting until the measurement is complete before returning the results
  - If the optional [n] value is not included, or is set to 1, the scalar measurement results will be returned. If the [n] value is set to a value other than 1, the selected trace data results will be returned. See each command for details of what types of scalar results or trace data results are available. The binary data formats should be used when handling large blocks of data since they are smaller and faster than the ASCII format. (FORMat:DATA)
- 

---

Initial S/W Revision	Prior to A.02.00
----------------------	------------------

---

### Current Measurement Query (Remote Command Only)

This command returns the name of the measurement that is currently running.

---

<b>Remote Command</b>	:CONFigure?
-----------------------	-------------

<b>Example</b>	CONF?
----------------	-------

Initial S/W Revision	Prior to A.02.00
----------------------	------------------

---

### Limit Test Current Results (Remote Command Only)

Queries the status of the current measurement limit testing. It returns a 0 if the measured results pass when compared with the current limits. It returns a 1 if the measured results fail any limit tests.

---

<b>Remote Command</b>	:CALCulate:CLIMits:FAIL?
-----------------------	--------------------------

<b>Example</b>	CALC:CLIM:FAIL? queries the current measurement to see if it fails the defined limits. Returns a 0 or 1: 0 it passes, 1 it fails.
----------------	--------------------------------------------------------------------------------------------------------------------------------------

Initial S/W Revision	Prior to A.02.00
----------------------	------------------

---

### Data Query (Remote Command Only)

Returns the designated measurement data for the currently selected measurement and subopcode.

n = any valid subopcode for the current measurement. See the measurement command results table for your current measurement, for information about what data is returned for the subopcodes.

This command uses the data setting specified by the FORMat:BORDER and FORMat:DATA commands and can return real or ASCII data. (See the format command descriptions under Input/Output in the Analyzer Setup section.)

<b>Remote Command</b>	:CALCulate:DATA[n]?
<b>Notes</b>	The return trace depends on the measurement. In CALCulate:<meas>:DATA[n], n is any valid subopcode for the current measurement. It returns the same data as the FETCH:<measurement>? query where <measurement> is the current measurement.
<b>Initial S/W Revision</b>	Prior to A.02.00

### Calculate/Compress Trace Data Query (Remote Command Only)

Returns compressed data for the currently selected measurement and sub-opcode [n].

n = any valid sub-opcode for that measurement. See the MEASure:<measurement>? command description of your specific measurement for information on the data that can be returned.

The data is returned in the current Y Axis Unit of the analyzer. The command is used with a sub-opcode <n> (default=1) to specify the trace. With trace queries, it is best if the analyzer is not sweeping during the query. Therefore, it is generally advisable to be in Single Sweep, or Update=Off.

This command is used to compress or decimate a long trace to extract and return only the desired data. A typical example would be to acquire N frames of GSM data and return the mean power of the first burst in each frame. The command can also be used to identify the best curve fit for the data.

<b>Remote Command</b>	:CALCulate:DATA<n>:COMPRESS? BLOCK   CFIT   MAXimum   MINimum   MEAN   DMEan   RMS   RMSCubed   SAMPLE   SDEVIation   PPHase [,<soffset> [,<length>[,<roffset>[,<rlimit>]]]]
<b>Example</b>	To query the mean power of a set of GSM bursts: Supply a signal that is a set of GSM bursts. Select the IQ Waveform measurement (in IQ Analyzer Mode). Set the sweep time to acquire at least one burst. Set the triggers such that acquisition happens at a known position relative to a burst. Then query the mean burst levels using, CALC:DATA2:COMP? MEAN, 24e-6, 526e-6 (These parameter values correspond to GSM signals, where 526e-6 is the length of the burst in the slot and you just want 1 burst.)
<b>Notes</b>	The command supports 5 parameters. Note that the last 4 (<soffset>, <length>, <roffset>, <rlimit>) are optional. But these optional parameters must be entered in the specified order. For example, if you want to specify <length>, then you must also specify <soffset>. See details below for a definition of each of these parameters.  This command uses the data in the format specified by FORMat:DATA, returning either binary or ASCII data.
<b>Initial S/W Revision</b>	Prior to A.02.00

- BLOCK or block data - returns all the data points from the region of the trace data that you specify. For example, it could be used to return the data points of an input signal over several timeslots, excluding the portions of the trace data that you do not want. (This is x,y pairs for trace data and I,Q pairs for complex data.)

- CFIT or curve fit - applies curve fitting routines to the data. <soffset> and <length> are required to define the data that you want. <roffset> is an optional parameter for the desired order of the curve equation. The query will return the following values: the x-offset (in seconds) and the curve coefficients ((order + 1) values).

MIN, MAX, MEAN, DME, RMS, RMSC, SAMP, SDEV and PPH return one data value for each specified region (or <length>) of trace data, for as many regions as possible until you run out of trace data (using <roffset> to specify regions). Or they return the number of regions you specify (using <rlimit>) ignoring any data beyond that.

- MINimum - returns the minimum data point (y value) for the specified region(s) of trace data. For I/Q trace data, the minimum magnitude of the I/Q pairs is returned.
- MAXimum - returns the maximum data point (y value) for the specified region(s) of trace data. For I/Q trace data, the maximum magnitude of the I/Q pairs is returned.
- MEAN - returns a single value that is the arithmetic mean of the data point values (in dB/ dBm) for the specified region(s) of trace data. For I/Q trace data, the mean of the magnitudes of the I/Q pairs is returned. See the following equations.

•

**NOTE**

If the original trace data is in dB, this function returns the arithmetic mean of those log values, not log of the mean power which is a more useful value. The mean of the log is the better measurement technique when measuring CW signals in the presence of noise. The mean of the power, expressed in dB, is useful in power measurements such as Channel Power. To achieve the mean of the power, use the RMS option.

Equation 1

Mean Value of Data Points for Specified Region(s)

$$\text{MEAN} = \frac{1}{n} \sum_{X_i \in \text{region}(s)} X_i$$

where  $X_i$  is a data point value, and  $n$  is the number of data points in the specified region(s).

Equation 2

Mean Value of I/Q Data Pairs for Specified Region(s)

$$\text{MEAN} = \frac{1}{n} \sum_{X_i \in \text{region}(s)} |X_i|$$

where  $|X_i|$  is the magnitude of an I/Q pair, and  $n$  is the number of I/Q pairs in the specified region(s).

- DMEan - returns a single value that is the mean power (in dB/ dBm) of the data point values for the specified region(s) of trace data. See the following equation:

Equation 3

DMEan Value of Data Points for Specified Region(s)

$$\text{DME} = 10 \times \log_{10} \left( \frac{1}{n} \sum_{X_i \in \text{region}(s)} 10^{\frac{X_i}{10}} \right)$$

- RMS - returns a single value that is the average power on a root-mean-squared voltage scale (arithmetic rms) of the data point values for the specified region(s) of trace data. See the following equation.

**NOTE**

For I/Q trace data, the rms of the magnitudes of the I/Q pairs is returned. See the following equation. This function is very useful for I/Q trace data. However, if the original trace data is in dB, this function returns the rms of the log values which is not usually needed.

Equation 4

RMS Value of Data Points for Specified Region(s)

$$\text{RMS} = \sqrt{\frac{1}{n} \sum_{X_i \in \text{region}(s)} X_i^2}$$

where  $X_i$  is a data point value, and  $n$  is the number of data points in the specified region(s).

Equation 5

RMS Value of I/Q Data Pairs for Specified Region(s)

$$\text{RMS} = \sqrt{\frac{1}{n} \sum_{X_i \in \text{region}(s)} X_i X_i^*}$$

where  $X_i$  is the complex value representation of an I/Q pair,  $X_i^*$  its conjugate complex number, and  $n$  is the number of I/Q pairs in the specified region(s).

Once you have the rms value for a region of trace data (linear or I/Q), you may want to calculate the mean power. You must convert this rms value (peak volts) to power in dBm:

$$10 \times \log[10 \times (\text{rms value})^2]$$

- SAMPLe - returns the first data value (x,y pair) for the specified region(s) of trace data. For I/Q trace data, the first I/Q pair is returned.
- SDEViation - returns a single value that is the arithmetic standard deviation for the data point values for the specified region(s) of trace data. See the following equation.
- For I/Q trace data, the standard deviation of the magnitudes of the I/Q pairs is returned. See the following equation.

Equation 6

Standard Deviation of Data Point Values for Specified Region(s)

$$\text{SDEV} = \sqrt{\frac{1}{n} \sum_{X_i \in \text{region}(s)} (X_i - \bar{X})^2}$$

where  $X_i$  is a data point value,  $\bar{X}$  is the arithmetic mean of the data point values for the specified region (s), and  $n$  is the number of data points in the specified region(s).

$$\text{SDEV} = \sqrt{\frac{1}{n} \sum_{X_i \in \text{region}(s)} (|X_i| - \bar{X})^2}$$

where  $|X_i|$  is the magnitude of an I/Q pair,  $\bar{X}$  is the mean of the magnitudes for the specified region(s), and  $n$  is the number of data points in the specified region(s).

- PPHase - returns the x,y pairs of both rms power (dBm) and arithmetic mean phase (radian) for every specified region and frequency offset (Hz). The number of pairs is defined by the specified number of regions. This parameter can be used for I/Q vector ( $n=0$ ) in Waveform (time domain) measurement and all parameters are specified by data point in PPHase.

The rms power of the specified region may be expressed as:

$$\text{Power} = 10 \times \log [10 \times (\text{RMS I/Q value})] + 10.$$

The RMS I/Q value (peak volts) is:

$$\sqrt{\frac{1}{n} \sum_{X_i \in \text{region}} X_i X_i^*}$$

where  $X_i$  is the complex value representation of an I/Q pair,  $X_i^*$  its conjugate complex number, and  $n$  is the number of I/Q pairs in the specified region.

The arithmetic mean phase of the specified region may be expressed as:

$$\frac{1}{n} \sum_{Y_i \in \text{region}} Y_i$$

where  $Y_i$  is the unwrapped phase of I/Q pair with applying frequency correction and  $n$  is the number of I/Q pairs in the specified region.

The frequency correction is made by the frequency offset calculated by the arithmetic mean of every specified region's frequency offset. Each frequency offset is calculated by the least square method against the unwrapped phase of I/Q pair.

Sample Trace Data - Constant Envelope

(See below for explanation of variables.)

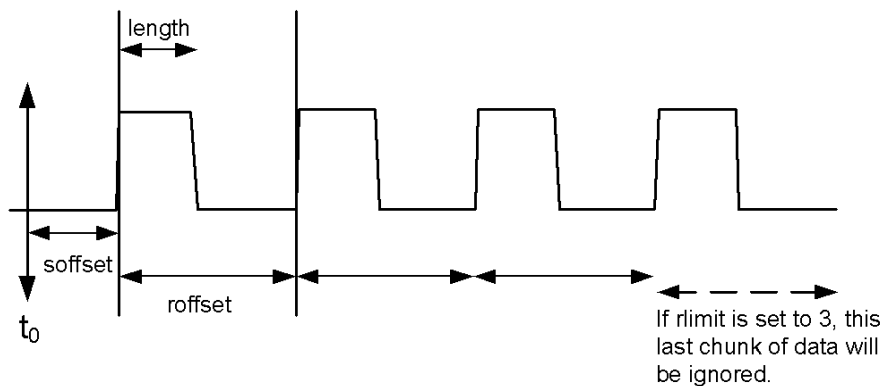

### Sample Trace Data - Not Constant Envelope

(See below for explanation of variables.)

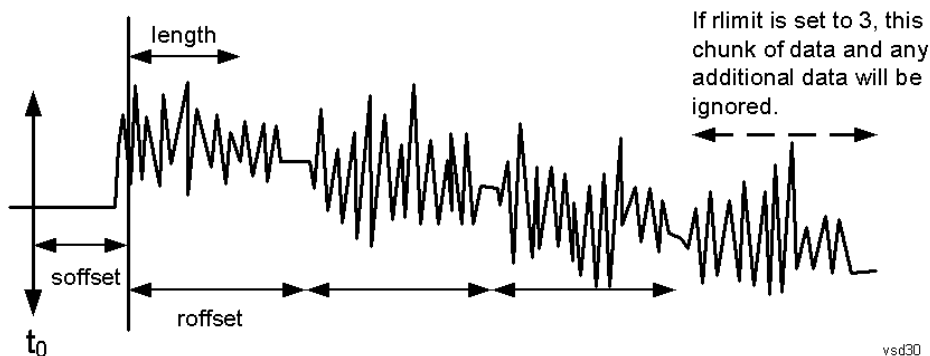

<soffset> - start offset is an optional real number. (It is in seconds for time-domain traces, and is a dimensionless index 0 to Npoints - 1, for frequency-domain traces). It specifies the amount of data at the beginning of the trace that will be ignored before the decimation process starts. It is the time or frequency change from the start of the trace to the point where you want to start using the data. The default value is zero.

<length> - is an optional real number. (It is in seconds for time-domain traces, and is a dimensionless index 0 to Npoints - 1, for frequency-domain traces). It defines how much data will be compressed into one value. This parameter has a default value equal to the current trace length.

<roffset> - repeat offset is an optional real number. (It is in seconds for time-domain traces, and is a dimensionless index 0 to Npoints - 1, for frequency-domain traces). It defines the beginning of the next field of trace elements to be compressed. This is relative to the beginning of the previous field. This parameter has a default value equal to the <length> variable. Note that this parameter is used for a completely different purpose when curve fitting (see CFIT above).

<rlimit> - repeat limit is an optional integer. It specifies the number of data items that you want returned. It will ignore any additional items beyond that number. You can use the Start offset and the Repeat limit to pick out exactly what part of the data you want to use. The default value is all the data.

## Calculate Peaks of Trace Data (Remote Command Only)

Returns a list of all the peaks for the currently selected measurement and sub-opcode [n]. The peaks must meet the requirements of the peak threshold and excursion values.

n = any valid sub-opcode for the current measurement. See the MEASure:<measurement> command description of your specific measurement for information on the data that can be returned.

The command can only be used with specific sub-opcodes with measurement results that are trace data. Both real and complex traces can be searched, but complex traces are converted to magnitude in dBm. In many measurements the sub-opcode n=0, is the raw trace data which cannot be searched for peaks. And Sub-opcode n=1, is often calculated results values which also cannot be searched for peaks.

This command uses the data setting specified by the FORMat:BORDER and FORMat:DATA commands and can return real or ASCII data. If the format is set to INT,32, it returns REAL,32 data.

The command has four types of parameters:

- Threshold (in dBm)
- Excursion (in dB)
- Sorting order (amplitude, frequency, time)
- Optional in some measurements: Display line use (all, > display line, < display line)

---

<b>Remote Command</b>	<p>For Swept SA measurement:</p> <pre>:CALCulate:DATA[1] 2 ... 6:PEAKs? &lt;threshold&gt;,&lt;excursion&gt;[,AMPLitude   FREQuency   TIME[,ALL   GTDLline   LTDLine]]</pre> <p>For most other measurements:</p> <pre>:CALCulate:DATA[1] 2 ... 6:PEAKs? &lt;threshold&gt;,&lt;excursion&gt;[,AMPLitude   FREQuency   TIME]</pre>
-----------------------	---------------------------------------------------------------------------------------------------------------------------------------------------------------------------------------------------------------------------------------------------------------------------------------------------------------------------------

---

<b>Example</b>	<p>Example for Swept SA measurement in Spectrum Analyzer Mode:</p> <p>CALC:DATA4:PEAK? -40, 10, FREQ, GTDL This will identify the peaks of trace 4 that are above -40 dBm, with excursions of at least 10 dB. The peaks are returned in order of increasing frequency, starting with the lowest frequency. Only the peaks that are above the display line are returned.</p> <p>Query Results 1:</p> <p>With FORMat:DATA REAL, 32 selected, it returns a list of floating-point numbers. The first value in the list is the number of peak points that are in the following list. A peak point consists of two values: a peak amplitude followed by its corresponding frequency (or time).</p> <p>If no peaks are found the peak list will consist of only the number of peaks, (0).</p>
----------------	-----------------------------------------------------------------------------------------------------------------------------------------------------------------------------------------------------------------------------------------------------------------------------------------------------------------------------------------------------------------------------------------------------------------------------------------------------------------------------------------------------------------------------------------------------------------------------------------------------------------------------------------------------------------------------------------------------------------------------------------------------------------------------------------

---

<b>Notes</b>	<p>&lt;n&gt; - is the trace that will be used</p> <p>&lt;threshold&gt; - is the level below which trace data peaks are ignored. Note that the threshold value is required and is always used as a peak criterion. To effectively disable the threshold criterion for this command, provide a substantially low threshold value such as -200 dBm. Also note that the threshold value used in this command is independent of and has no effect on the threshold value stored under the Peak Criteria menu.</p> <p>&lt;excursion&gt; - is the minimum amplitude variation (rise and fall) required for a signal to be identified as peak. Note that the excursion value is required and is always used as a peak criterion. To effectively disable the excursion criterion for this command, provide the minimum value of 0.0 dB. Also note that the excursion value used in this command is independent of and has no effect on the</p>
--------------	---------------------------------------------------------------------------------------------------------------------------------------------------------------------------------------------------------------------------------------------------------------------------------------------------------------------------------------------------------------------------------------------------------------------------------------------------------------------------------------------------------------------------------------------------------------------------------------------------------------------------------------------------------------------------------------------------------------------------------------------------------------------------------------------------------------------------------------------------------------------------------------------------------------------------------------

---

excursion value stored under the Peak Criteria menu.

Values must be provided for threshold and excursion. The sorting and display line parameters are optional (defaults are AMPLitude and ALL).

Note that there is always a Y-axis value for the display line, regardless of whether the display line state is on or off. It is the current Y-axis value of the display line which is used by this command to determine whether a peak should be reported

Sorting order:

AMPLitude - lists the peaks in order of descending amplitude, with the highest peak first (default if optional parameter not sent)

FREQuency - lists the peaks in order of occurrence, left to right across the x-axis.

TIME - lists the peaks in order of occurrence, left to right across the x-axis.

Peaks vs. Display Line:

ALL - lists all of the peaks found (default if optional parameter not sent).

GTDLine (greater than display line) - lists all of the peaks found above the display line.

LTDLine (less than display line) - lists all of the peaks found below the display line.

Initial S/W Revision      Prior to A.02.00

### Format Data: Numeric Data (Remote Command Only)

This command specifies the format of the trace data input and output. It specifies the formats used for trace data during data transfer across any remote port. It affects only the data format for setting and querying trace data for the :TRACe[:DATA], TRACe[:DATA]?, :CALCulate:DATA[n]? and FETCh:SANalyzer [n]? commands and queries.

**Remote Command**      :FORMat [:TRACe] [:DATA] ASCii | INTeger, 32 | REAL, 32 | REAL, 64  
:FORMat [:TRACe] [:DATA] ?

**Notes**      The query response is:  
ASCii: ASC,8  
REAL,32: REAL,32  
REAL,64: REAL,64  
INTeger,32: INT,32

When the numeric data format is REAL or ASCii, data is output in the current Y Axis unit. When the data format is INTeger, data is output in units of m dBm (.001 dBm).

The INT,32 format returns binary 32-bit integer values in internal units (m dBm), in a definite length block.

**Dependencies**      Sending a data format spec with an invalid number (for example, INT,48) generates no error. The analyzer simply uses the default (8 for ASCii, 32 for INTeger, 32 for REAL).

Sending data to the analyzer which does not conform to the current FORMat specified, results in an error. Sending ASCII data when a definite block is expected generates message -161 "Invalid Block Data" and sending a definite block when ASCII data is expected generates message -121 "Invalid Character in Number".

**Preset**      ASCii

**Backwards Compatibility Notes**      Note that the INT,32 format is only applicable to the command, TRACe:DATA. This preserves backwards compatibility for the Swept SA measurement. For all other commands/queries which honor FORMat:DATA, if INT,32 is sent the analyzer will behave as though it were set to REAL,32.

Initial S/W Revision      Prior to A.02.00



The specs for each output type follow:

ASCIi - Amplitude values are in ASCII, in the current Y Axis Unit, one ASCII character per digit, values separated by commas, each value in the form:

SX.YYYYYEsZZ

Where:

S = sign (+ or -)

X = one digit to left of decimal point

Y = 5 digits to right of decimal point

E = E, exponent header

s = sign of exponent (+ or -)

ZZ = two digit exponent

REAL,32 - Binary 32-bit real values in the current Y Axis Unit, in a definite length block.

REAL,64 - Binary 64-bit real values in the current Y Axis Unit, in a definite length block.

### Format Data: Byte Order (Remote Command Only)

This command selects the binary data byte order for data transfer and other queries. It controls whether binary data is transferred in normal or swapped mode. This command affects only the byte order for setting and querying trace data for the :TRACe[:DATA], TRACe[:DATA]? , :CALCulate:DATA[n]? and FETCh:SANalyzer[n]? commands and queries.

By definition any command that says it uses FORMat:DATA uses any format supported by FORMat:DATA.

The NORMal order is a byte sequence that begins with the most significant byte (MSB) first, and ends with the least significant byte (LSB) last in the sequence: 1|2|3|4. SWAPPed order is when the byte sequence begins with the LSB first, and ends with the MSB last in the sequence: 4|3|2|1.

<b>Remote Command</b>	:FORMat:BORDER NORMal SWAPPed :FORMat:BORDER?
<b>Preset</b>	NORMal
<b>Initial S/W Revision</b>	Prior to A.02.00

## Meas Setup

Displays the setup menu for the currently selected measurement.

Key Path	Front-panel key
Initial S/W Revision	Prior to A.02.00

### Avg/Hold Number

Specifies the number of N averages that will be used for the measurement. After the specified number (average counts) have been averaged, the averaging mode (termination control) setting determines the averaging action.

Key Path	Meas Setup
Mode	WCDMA, C2K, 1xEVDO
<b>Remote Command</b>	[:SENSe]:EVMQpsk:AVERage:COUNT <integer> [:SENSe]:EVMQpsk:AVERage:COUNT? [:SENSe]:EVMQpsk:AVERage[:STATe] OFF ON 0 1 [:SENSe]:EVMQpsk:AVERage[:STATe]?
<b>Example</b>	EVMQ:AVER:COUN 1001 EVMQ:AVER:COUN? EVMQ:AVER OFF EVMQ:AVER?
Preset	10 ON
State Saved	Saved in instrument state.
Min	1
Max	10000
Initial S/W Revision	Prior to A.02.00

### Avg Mode

Toggles the averaging mode between Exp (exponential) and Repeat. This selection only affects the averaging result after the number of N averages is reached. The N is set using the Avg/Hold Number key.

Exponential	Each successive data acquisition after the average count is reached, is exponentially weighted and then combined with the existing average.
Repeat	After reaching the average count, the averaging is reset and a new average is started.

Key Path	Meas Setup
Mode	WCDMA, C2K, 1xEVDO
<b>Remote Command</b>	<code>[ :SENSe ] :EVMQpsk :AVERage :TCONtrol EXPonential   REPeat</code> <code>[ :SENSe ] :EVMQpsk :AVERage :TCONtrol ?</code>
<b>Example</b>	<code>EVMQ:AVER:TCON REP</code> <code>EVMQ:AVER:TCON?</code>
Notes	Selects the type of termination control used for averaging. This determines the averaging action after the specified number of frames (average count) is reached. Exponential - Each successive data acquisition after the average count is reached, is exponentially weighted and combined with the existing average. Repeat - After reaching the average count, the averaging is reset and a new average is started.
Preset	REPeat
State Saved	Saved in instrument state.
Range	Exp Repeat
Initial S/W Revision	Prior to A.02.00

## Limits

Accesses a menu that enables you to change the RMS EVM and Frequency Error limits settings.

Key Path	Meas Setup
Initial S/W Revision	Prior to A.02.00

## RMS EVM

Sets the limit for the RMS EVM measurement. This value is used to judge whether the measurement passes or fails the RMS EVM limit.

Key Path	Meas Setup, Limits
Mode	WCDMA, C2K, 1xEVDO
<b>Remote Command</b>	<code>:CALCulate:EVMQpsk:LIMit:RMS &lt;real&gt;</code> <code>:CALCulate:EVMQpsk:LIMit:RMS?</code>
<b>Example</b>	<code>CALC:EVMQ:LIM:RMS 50</code> <code>CALC:EVMQ:LIM:RMS?</code>
Notes	Sets the limits of RMS EVM which is used to judge the result of RMS EVM passes or fails. If a measured RMS EVM value is not larger than the limit value, the result is PASS. Otherwise, the result is FAIL. You must be in the W-CDMA mode to use this command. Use INSTRument:SElect to set the mode.
Preset	WCDMA: 17.5

	C2K: 100.0
	1xEVDO: 100.0
Min	0.0
Max	100.0
Initial S/W Revision	Prior to A.02.00

## Freq Error

Sets the limit, in Hz, for the frequency error measurement. This value is used to judge whether the measurement passes or fails the Frequency Error limit.

Key Path	Meas Setup, Limits
Mode	WCDMA, C2K, 1xEVDO
<b>Remote Command</b>	:CALCulate:EVMQpsk:LIMit:FERRor <freq> :CALCulate:EVMQpsk:LIMit:FERRor?
<b>Example</b>	CALC:EVMQ:LIM:FERR 100 CALC:EVMQ:LIM:FERR?
Notes	Sets the limits of the Frequency Error, which is used to judge the result of the Frequency Error, whether it passes or fails. If the measured Frequency Error value is not larger than the limit value, the result is PASS. Otherwise, the result is FAIL.
Preset	100.0
State Saved	Saved in instrument state.
Min	0.0
Max	300000
Initial S/W Revision	Prior to A.02.00

## Meas Offset & Interval

This key is active only in 1xEVDO mode.

Allows you to measure the signal occupying different time domain respectively, such as the pilot in first half slot.

Key Path	Meas Setup
Initial S/W Revision	Prior to A.02.00

## Meas Offset

Specifies how long after the data capture the signal is observed.

Key Path	Meas Setup, Meas Offset & Interval
Mode	1xEVDO
<b>Remote Command</b>	[ :SENSe ] :EVMQpsk:MEAS:OFFSet <integer> [ :SENSe ] :EVMQpsk:MEAS:OFFSet?
<b>Example</b>	EVMQ:MEAS:OFFS 464 EVMQ:MEAS:OFFS?
Couplings	Coupled with Pre-Defined Ofs/Intvl. Changes according to the selected type. Meas Offset + Meas Interval <=2048
Preset	400 chips
State Saved	Saved in instrument state.
Min	0 chips
Max	2047 chips
Initial S/W Revision	Prior to A.02.00

## Meas Interval

Specifies how long the signal is observed.

Key Path	Meas Setup, Meas Offset & Interval
Mode	1xEVDO
<b>Remote Command</b>	[ :SENSe ] :EVMQpsk:MEAS:LENGth < integer > [ :SENSe ] :EVMQpsk:MEAS:LENGth?
<b>Example</b>	EVMQ:MEAS:LENG 96 EVMQ:MEAS:LENG?
Couplings	Coupled with Pre-Defined Ofs/Intvl. Changes according to the selected type. Meas Offset + Meas Interval <=2048
Preset	224 chips
State Saved	Saved in instrument state.
Min	1 chips
Max	2048 chips
Initial S/W Revision	Prior to A.02.00

## Spectrum

Toggles the spectrum function between Normal and Invert. If set to Invert, this function conjugates the spectrum. It is equivalent to taking the negative of the quadrature component in demodulation.

Key Path	Meas Setup
----------	------------

Mode	WCDMA, C2K, 1xEVDO
<b>Remote Command</b>	[ :SENSe ] :EVMQpsk :SPECTrum NORMal   INVert [ :SENSe ] :EVMQpsk :SPECTrum?
<b>Example</b>	EVMQ:SPEC NORM EVMQ:SPEC?
Preset	NORMal
State Saved	Saved in instrument state.
Range	Normal Invert
Initial S/W Revision	Prior to A.02.00

### Meas Preset

Restores all the measurement parameters to their default values.

Key Path	Meas Setup
Mode	WCDMA, C2K, 1xEVDO
<b>Remote Command</b>	:CONFigure :EVMQpsk
<b>Example</b>	CONF:EVMQ
Notes	Restore all defaults of parameters.
Initial S/W Revision	Prior to A.02.00

### Advanced

Accesses a menu of functions that enable you to set up more specific parameters for the measurement. These parameters include:

- EVM Result I/Q Offset
- IF Gain
- RRC Filter Control
- Filter Alpha
- Chip Rate

Key Path	Meas Setup
Initial S/W Revision	Prior to A.02.00

## EVM Result I/Q Offset

Toggles the I/Q Offset to be included or excluded in the measurement result. When it is set as "Standard" (ON), EVM is calculated without any compensation of I/Q offset. When it is set as "Exclude" (OFF), I/Q offset is compensated.

Key Path	Meas Setup, Advanced
Mode	WCDMA, C2K, 1xEVDO
<b>Remote Command</b>	:CALCulate:EVMQpsk:IQOffset:INCLude OFF ON 0 1 :CALCulate:EVMQpsk:IQOffset:INCLude?
<b>Example</b>	CALC:EVMQ:IQOF:INCL OFF CALC:EVMQ:IQOF:INCL?
Preset	ON
State Saved	Saved in instrument state.
Range	Std Exclude
Initial S/W Revision	Prior to A.02.00

## RRC Filter Control

Allows you to change the status (ON/OFF) of the Root Raised Cosine (RRC) filter. This ON/OFF state change involve measurement restart.

Key Path	Meas Setup, Advanced
Mode	WCDMA
<b>Remote Command</b>	[ :SENSe] :EVMQpsk:FILTer [:RRC] [:STATe] OFF ON 0 1 [:SENSe] :EVMQpsk:FILTer [:RRC] [:STATe] ?
<b>Example</b>	EVMQ:FILT ON EVMQ:FILT?
Preset	ON
State Saved	Saved in instrument state.
Range	On Off
Initial S/W Revision	Prior to A.02.00

## Filter Alpha

Sets the alpha value for the root raised cosine (RRC) filter. This key is available only in WCDMA mode and while employing an RRC filter.

Key Path	Meas Setup, Advanced
Mode	WCDMA, C2K, 1xEVDO
<b>Remote Command</b>	[ :SENSe] :EVMQpsk:FILTer:ALPHa <real>

	<code>[ :SENSe ] :EVMQpsk:FILTer:ALPHa?</code>
<b>Example</b>	EVMQ:FILT:ALPH 0.5 EVMQ:FILT:ALPH?
Notes	This parameter is available only in the WCDMA mode. In other modes, this key is invisible.
Preset	0.22
State Saved	Saved in instrument state.
Min	0.01
Max	0.5
<b>Backwards Compatibility SCPI</b>	<code>[ :SENSe ] :EVMQpsk:ALPHa</code>
Initial S/W Revision	Prior to A.02.00

## Chip Rate

Changes the chip rate for the measurement.

Key Path	Meas Setup, Advanced
Mode	WCDMA, C2K, 1xEVDO
<b>Remote Command</b>	<code>[ :SENSe ] :EVMQpsk:CRATe &lt;freq&gt;</code> <code>[ :SENSe ] :EVMQpsk:CRATe?</code>
<b>Example</b>	EVMQ:CRAT 2.5 MHz EVMQ:CRAT?
Notes	Enter a frequency value to set the chip rate.
Preset	WCDMA: 3.84 MHz C2K: 1.2288 MHz 1xEVDO: 1.2288 MHz
State Saved	Saved in instrument state.
Min	100 kHz
Max	20 MHz
Initial S/W Revision	Prior to A.02.00

## IF Gain

In order to take full advantage of the RF dynamic range of the analyzer, we will offer a switched IF amplifier with approximately 10 dB of gain. When it can be turned on without an overload, the dynamic range is always better with it on than off. The IF Gain key can be used to set the IF Gain function to Auto, or to On (the extra 10 dB) or Off. These settings affect sensitivity and IF overloads.

Sets the IF Gain function to Auto, Low Gain or High Gain. These settings affect sensitivity and IF overloads.

This only applies to the RF input. It does not apply to baseband I/Q input.



Key Path	Meas Setup, Advanced
Initial S/W Revision	Prior to A.02.00

### IF Gain Auto

Activates the auto rules for IF Gain

Key Path	Meas Setup, Advanced, IF Gain
Mode	WCDMA, C2K, 1xEVDO
<b>Remote Command</b>	[ :SENSe ] :EVMQpsk :IF :GAIN :AUTO [ :STATe ] ON   OFF   1   0 [ :SENSe ] :EVMQpsk :IF :GAIN :AUTO [ :STATe ] ?
<b>Example</b>	EVMQ:IF:GAIN:AUTO OFF EVMQ:IF:GAIN:AUTO?
Notes	This only applies to the RF input. It does not apply to baseband I/Q input.
Couplings	'When either the auto attenuation works (for example, with electrical attenuator), or the optimize mechanical attenuator range is requested, the IF Gain setting is changed as following rule. Auto sets IF Gain to On under any of the following conditions: the input attenuator is set to 0 dB, the preamp is turned on, or the Max Mixer Level is -20 dBm or lower. For other settings, Auto sets IF Gain to Off.
Preset	ON
State Saved	Saved in instrument state.
Range	Auto Man
Initial S/W Revision	Prior to A.02.00

### IF Gain State

Selects the range of IF gain.

Key Path	Meas Setup, Advanced, IF Gain
Mode	WCDMA, C2K, 1xEVDO
<b>Remote Command</b>	[ :SENSe ] :EVMQpsk :IF :GAIN [ :STATe ] ON   OFF   1   0 [ :SENSe ] :EVMQpsk :IF :GAIN [ :STATe ] ?
<b>Example</b>	EVMQ:IF:GAIN ON EVMQ:IF:GAIN?
Notes	This only applies to the RF input. It does not apply to baseband I/Q input. where ON = high gain OFF = low gain
Preset	OFF
State Saved	Saved in instrument state.

19 QPSK EVM Measurement  
Meas Setup

Range	Low Gain (Best for Large Signals) High Gain (Best Noise Level)
Readback Text	Low Gain High Gain
Initial S/W Revision	Prior to A.02.00

## Mode

See "Mode" on page 318

## Mode Preset

Returns the active mode to a known state.

Mode Preset does the following for the currently active mode:

- Aborts the currently running measurement.
- Brings up the default menu for the mode, with no active function.
- Sets measurement Global settings to their preset values for the active mode only.
- Activates the default measurement.
- Brings up the default menu for the mode.
- Clears the input and output buffers.
- Sets Status Byte to 0.

Mode Preset does not:

- Cause a mode switch
- Affect mode persistent settings
- Affect system settings

See "[How-To Preset](#)" on page 2529 for more information.

<b>Key Path</b>	Front-panel key
<b>Remote Command</b>	:SYSTem:PRESet
<b>Example</b>	:SYST:PRES
<b>Notes</b>	*RST is preferred over :SYST:PRES for remote operation. *RST does a Mode Preset, as done by the :SYST:PRES command, and it sets the measurement mode to Single measurement rather than Continuous for optimal remote control throughput. Clears all pending OPC bits. The Status Byte is set to 0.
<b>Couplings</b>	A Mode Preset aborts the currently running measurement, activates the default measurement, and gets the mode to a consistent state with all of the default couplings set.
<b>Backwards Compatibility Notes</b>	In the X-Series, the legacy "Factory Preset" has been replaced with Mode Preset, which only presets the currently active mode, not the entire instrument. In the X-Series, the way to preset the entire instrument is by using System, Restore System Defaults All, which behaves essentially the same way as restore System Defaults does on ESA and PSA. There is also no "Preset Type" as there is on the PSA. There is a green Mode Preset front-panel key that does a Mode Preset and a white-with-green-letters User Preset front-panel key that does a User Preset. The old PRESet:TYPE command is ignored (without generating an error), and SYST:PRES without a parameter does a Mode Preset, which should cover most backward code compatibility issues. The settings and correction data under the Input/Output front-panel key (examples: Input Z Corr, Ext Amp Gain, etc.) are no longer part of any Mode, so they will not be preset by a Mode Preset. They are preset using Restore Input/Output Defaults, Restore System Defaults All. Note that because User Preset does a Recall State, and all of these settings are saved in State, they ARE recalled when using

	User Preset.
Initial S/W Revision	Prior to A.02.00

## How-To Preset

The table below shows all possible presets, their corresponding SCPI commands and front-panel access (key paths). Instrument settings depend on the current measurement context. Some settings are local to the current measurement, some are global (common) across all the measurements in the current mode, and some are global to all the available modes. In a similar way, restoring the settings to their preset state can be done within the different contexts.

Auto Couple - is a measurement local key. It sets all Auto/Man parameter couplings in the measurement to Auto. Any Auto/Man selection that is local to other measurements in the mode will not be affected.

Meas Preset - is a measurement local key. Meas Preset resets all the variables local to the current measurement except the persistent ones.

Mode Preset - resets all the current mode's measurement local and measurement global variables except the persistent ones.

Restore Mode Defaults - resets ALL the Mode variables (and all the Meas global and Meas local variables), including the persistent ones.

Type Of Preset	SCPI Command	Front Panel Access
Auto Couple	:COUPlE ALL	Auto Couple front-panel key
Meas Preset	:CONFIgure:<Measurement>	Meas Setup Menu
Mode Preset	:SYSTem:PRESet	Mode Preset (green key)
Restore Mode Defaults	:INSTrument:DEFault	Mode Setup Menu
Restore All Mode Defaults	:SYSTem:DEFault MODEs	System Menu; Restore System Default Menu
*RST	*RST	not possible (Mode Preset with Single)
Restore Input/Output Defaults	:SYSTem:DEFault INPut	System Menu; Restore System Default Menu
Restore Power On Defaults	:SYSTem:DEFault PON	System Menu; Restore System Default Menu
Restore Alignment Defaults	:SYSTem:DEFault ALIGn	System Menu; Restore System Default Menu
Restore Miscellaneous Defaults	:SYSTem:DEFault MISC	System Menu; Restore System Default Menu
Restore All System Defaults	:SYSTem:DEFault [ALL] :SYSTem:PRESet:PERSistent	System Menu; Restore System Default Menu
User Preset	:SYSTem:PRESet:USER	User Preset Menu
User Preset All Modes	:SYSTem:PRESet:USER:ALL	User Preset Menu

Power On Mode Preset	:SYSTem:PON:TYPE MODE	System Menu
Power On User Preset	:SYSTem:PON:TYPE USER	System Menu
Power On Last State	:SYSTem:PON:TYPE LAST	System Menu

### Preset Type (Remote Command Only)

As stated in the Backward Compatibility section, to be compatible with ESA/PSA the PRESet:TYPE command will be implemented as a no-op.

<b>Mode</b>	All
<b>Remote Command</b>	:SYSTem:PRESet:TYPE FACTory MODE USER :SYSTem:PRESet:TYPE?
<b>Example</b>	:SYST:PRESet:TYPE FACT
<b>Notes</b>	This command is supported for backward compatibility only. It is a no-op which does not change the behavior of any preset operation.
<b>Preset</b>	This is unaffected by Preset but is set to Mode on a "Restore System Defaults->All"
<b>State Saved</b>	No
<b>Initial S/W Revision</b>	Prior to A.02.00

## Mode Setup

See ["Mode Setup" on page 348](#)

## Peak Search

Accesses a menu that enables you to control the peak search function and places a marker on the trace point with highest peak.

Key Path	Front-panel key
Mode	WCDMA, C2K, 1xEVDO
Remote Command	:CALCulate:EVMQpsk:MARKer[1] 2 ...12:MAXimum
Example	CALC:EVMQ:MARK2:MAX
Notes	This command does not work when the selected marker is located on the polar trace. In this case, the command is ignored.
Initial S/W Revision	Prior to A.02.00

## Next Peak

Moves the selected marker to the peak that has the next highest amplitude that is less than the marker's current value.

Key Path	Peak Search
Mode	WCDMA, C2K, 1xEVDO
Remote Command	:CALCulate:EVMQpsk:MARKer[1] 2 ...12:MAXimum:NEXT
Example	CALC:EVMQ:MARK2:MAX:NEXT
Notes	This command does not work when the selected marker is located on the polar trace. In this case, the command is ignored.
Initial S/W Revision	Prior to A.02.00

## Next Pk Right

Moves the selected marker to the nearest peak to the right of the current marker that meets all enabled peak criteria.

Key Path	Peak Search
Mode	WCDMA, C2K, 1xEVDO
Remote Command	:CALCulate:EVMQpsk:MARKer[1] 2 ...12:MAXimum:RIGHT
Example	CALC:EVMQ:MARK2:MAX:RIGH
Notes	This command does not work when the selected marker is located on the polar trace. In this case, the command is ignored.
Initial S/W Revision	Prior to A.02.00



## Next Pk Left

Moves the selected marker to the nearest peak to the left of the current marker that meets all enabled peak criteria.

Key Path	Peak Search
Mode	WCDMA, C2K, 1xEVDO
Remote Command	:CALCulate:EVMQpsk:MARKer [1]   2   . . . 12:MAXimum:LEFT
Example	CALC:EVMQ:MARK2:MAX:LEFT
Notes	This command does not work when the selected marker is located on the polar trace. In this case, the command is ignored.
Initial S/W Revision	Prior to A.02.00

## Marker Delta

Sets the control mode for the selected marker to Delta mode. This menu key performs the same function as the Delta 1-of-N selection key in the Marker menu. It is duplicated in the Peak Search Menu to allow you the convenience to simultaneously perform a peak search and change the marker control mode to Delta without having to access two separate menus.

Key Path	Peak Search
Initial S/W Revision	Prior to A.02.00

## Pk-Pk Search

Finds and displays the amplitude and frequency (or time, if in zero span) differences between the highest and lowest value on the y-axis.

Key Path	Peak Search
Mode	WCDMA, C2K, 1xEVDO
Remote Command	:CALCulate:EVMQpsk:MARKer [1]   2   . . . 12:PTPeak
Example	CALC:EVMQ:MARK:PTP
Notes	This command does not work when the selected marker is located on the polar trace. In this case, the command is ignored.
Couplings	This key is not available (key is grayed out) when Coupled Markers is on.
Initial S/W Revision	Prior to A.02.00

## Min Search

Moves the selected marker to the minimum value on the y-axis of the current trace.

Key Path	Peak Search
Mode	WCDMA, C2K, 1xEVDO
<b>Remote Command</b>	:CALCulate:EVMQpsk:MARKer[1] 2 ...12:MINimum
<b>Example</b>	CALC:EVMQ:MARK:MIN
Notes	This command does not work when the selected marker is located on the polar trace. In this case, the command is ignored.
Initial S/W Revision	Prior to A.02.00

Print

See "Print" on page 358

## Quick Save

The Quick Save front-panel key repeats the most recent save that was performed from the Save menu, with the following exceptions:

- Register saves are not remembered as Saves for the purpose of the Quick Save function
- If the current measurement does not support the last non-register save that was performed, an informational message is generated, “File type not supported for this measurement”

Quick Save repeats the last type of qualified save (that is, a save qualified by the above criteria) in the last save directory by creating a unique filename using the Auto File Naming algorithm described below.

If Quick Save is pressed after startup and before any qualified Save has been performed, the Quick Save function performs a Screen Image save using the current settings for Screen Image saves (current theme, current directory), which then becomes the “last save” for the purpose of subsequent Quick Saves.

The Auto File Naming feature automatically generates a file name for use when saving a file. The filename consists of a prefix and suffix separated by a dot, as is standard for the Windows® file system. A default prefix exists for each of the available file types:

Type	Default Prefix	Menu
State	State_	(Save/Recall)
Trace + State	State_	(Save/Recall)
Screen	Screen_	(Save/Recall)
Amplitude Corrections	Ampcor_	(Import/Export)
Traces	Trace_	(Import/Export)
Limit Lines	LLine_	(Import/Export)
Measurement Result	MeasR_	(Import/Export)
Capture Buffer	CapBuf_	(Import/Export)

A four digit number is appended to the prefix to create a unique file name. The numbering sequence starts at 0000 within each Mode for each file type and updates incrementally to 9999, then wraps to 0000 again. It remembers where it was through a Mode Preset and when leaving and returning to the Mode. It is reset by Restore Misc Defaults and Restore System Defaults and subsequent running of the instrument application. So, for example, the first auto file name generated for State files is State\_0000.state. The next is State\_0001, and so forth.

One of the key features of Auto File Name is that we guarantee that the Auto File Name will never conflict with an existing file. The algorithm looks for the next available number. If it gets to 9999, then it looks for holes. If it find no holes, that is no more numbers are available, it gives an error.

For example, if when we get to State\_0010.state there is already a State\_0010.state file in the current directory, it advances the counter to State\_0011.state to ensure that no conflict will exist (and then it verifies that State\_0011.state also does not exist in the current directory and advances again if it does, and so forth).

If you enter a file name for a given file type, then the prefix becomes the filename you entered instead of the default prefix, followed by an underscore. The last four letters (the suffix) are the 4-digit number.

For example, if you save a measurement results file as “fred.csv”, then the next auto file name chosen for a measurement results save will be fred\_0000.csv.

**NOTE** Although 0000 is used in the example above, the number that is used is actually the current number in the Meas Results sequence, that is, the number that would have been used if you had not entered your own file name.

**NOTE** If the filename you entered ends with \_dddd, where d=any number, making it look just like an auto file name, then the next auto file name picks up where you left off with the suffix being dddd + 1.

Key Path	Front-panel key
Notes	No remote command for this key specifically.
Initial S/W Revision	Prior to A.02.00

## Recall

The Recall menu lets you choose what you want to recall, and where you want to recall it from. Among the types of files you can recall are **States and Traces**. In addition, an Import (Data) option lets you recall a number of data types stored in CSV files (as used by Excel and other spreadsheet programs).

The default paths for Recall are data type dependent and are the same as for the Save key.

Key Path	Front-panel key
Notes	<p>No remote command for this key specifically, but the :MMEM:LOAD command is available for specific file types. An example is :MMEM:LOAD:STATe &lt;filename&gt;.</p> <p>If you try to recall a State file for a mode that is not licensed or not available in the instrument, an error message will occur and the state will not change.</p>
Backwards Compatibility Notes	<p>In legacy analyzers, it was possible to load a state without affecting the trace data, limit lines or correction data. Similarly (since User Preset is actually loading a state), it was possible to do a User Preset without affecting the trace data, limit lines or correction data.</p> <p>In the X-Series, “state” always includes all of this data; so whenever state is loaded, all of the traces, limit lines and corrections are affected. Although this differs from previous behavior, it is desirable behavior, and should not cause adverse issues for users.</p>
Backwards Compatibility Notes	<p>Recall for the X-Series supports backward compatibility in the sense that you can recall a state file from any X-Series model number and any version of X-Series software. This is only possible if part of the recalling process goes through a limiting step after recalling the mode settings, at least for settings that may vary with version number, model number, option and license differences. If you try to recall a state file onto an instrument with less capability than what was available on the instrument during the save, the recall will ignore the state it doesn't support and it will limit the recalled setting to what it allows.</p> <p>Example: if the saved state includes preamp ON, but the recalling instrument does not have a preamp; the preamp is limited to OFF. Conversely, if you save a state without a preamp, the preamp is OFF in the state file. When this saved file is recalled on an instrument with a licensed preamp, the preamp is changed to OFF. Another example is if the saved state has center frequency set to 20 GHz, but the instrument recalling the saved state is a different model and only supports 13.5 GHz. In this case, the center frequency is limited along with any other frequency based settings. Since the center frequency can't be preserved in this case, the recall limiting tries to at least preserve span to keep the measurement setup as intact as possible.</p> <p>It may be appropriate to issue a warning if the state is limited on the recall; warnings do not go out to SCPI so this would only affect the manual user.</p> <p>Note that there is no state file compatibility outside of the X-Series. For example, you cannot recall a state file from ESA or PSA.</p>
Initial S/W Revision	Prior to A.02.00

## State

The Recall State menu lets you choose a register or file from which to recall the state.

The content of a state file includes all of the settings and data required to return the analyzer as closely as possible to the Mode it was in, with the exact settings that were in place, when the save occurred. The Mode settings in each state file include the settings that are affected by Mode Preset, as well as the

additional settings affected by Restore Mode Defaults; all of the Mode’s settings. In addition, all of the settings of the Input/Output system are included, even though they are outside of the Mode’s state, because they are needed to restore the complete setup. Persistent System settings (for example, GPIB address) are not affected by either a Mode Preset or Restore Mode Defaults, nor are they included in a saved State file.

Since each state file is only for one Mode, the settings for other Modes are unaffected when it is loaded. Recall State will cause a mode switch if the state being recalled is not from the current active mode.

After the recall completes, the message "File <filename> recalled" or “Recalled State Register <register number>” is displayed.

For rapid recalls, the State menu lists 16 registers that you can choose from to recall. Pressing a Register key initiates the recall. You can also select a file from which to recall.

The default path for all State Files is:

My Documents\<<mode name>\state

where <mode name> is the parameter used to select the mode with the INST:SEL command (for example, SA for the Spectrum Analyzer).

See "[More Information](#)" on page 2540.

<b>Key Path</b>	Recall
<b>Mode</b>	All
<b>Remote Command</b>	:MMEMory:LOAD:STATe <filename>
<b>Example</b>	:MMEM:LOAD:STAT "myState.state" This recalls the file myState.state on the default path
<b>Example</b>	MMEM:LOAD:STAT "MyStateFile.state" This loads the state file data (on the default file directory path) into the instrument state.
<b>Notes</b>	<p>When you pick a file to recall, the analyzer first verifies that the file is recallable in the current instrument by checking the software version and model number of the instrument. If everything matches, a full recall proceeds by aborting the currently running measurement, clearing any pending operations, and then loading the State from the saved state file. You can open state files from any mode, so recalling a State file switches to the mode that was active when the save occurred. After switching to the mode of the saved state file, mode settings and data (if any for the mode) are loaded with values from the saved file. The saved measurement of the mode becomes the newly active measurement and the data relevant to the measurement (if there is any) is recalled.</p> <p>If there is a mismatch between file version or model number or instrument version or model number, the recall function tries to recall as much as possible and returns a warning message. It may limit settings that differ based on model number, licensing or version number.</p> <p>After recalling the state, the Recall State function does the following:</p> <ul style="list-style-type: none"> <li>• Makes the saved measurement for the mode the active measurement.</li> <li>• Clears the input and output buffers.</li> <li>• Status Byte is set to 0.</li> <li>• Executes a *CLS</li> </ul> <p>If the file specified is empty an error is generated. If the specified file does not exist, another error is generated. If there is a mismatch between the file and the proper file type, an error is generated. If</p>

	there is a mismatch between file version or model number or instrument version or model number, a warning is displayed. Then it returns to the State menu and File Open dialog goes away. After the Recall, the analyzer exits the Recall menu and returns to the previous menu.
<b>Backwards Compatibility SCPI</b>	:MMEMory:LOAD:STATe 1,<filename> For backwards compatibility, the above syntax is supported. The "1" is simply ignored.
Initial S/W Revision	Prior to A.02.00

## More Information

In measurements that support saving Traces, for example, Swept SA, the Trace data is saved along with the State in the State file. When recalling the State, the Trace data is recalled as well. Traces are recalled exactly as they were stored, including the writing mode and update and display modes. If a Trace was updating and visible when the State was saved, it will come back updating and visible, and its data will be rewritten right away. When you use State to save and recall traces, any trace whose data must be preserved should be placed in View or Blank mode before saving.

The following table describes the Trace Save and Recall possibilities:

You want to recall state and one trace's data, leaving other traces unaffected.	Save Trace+State from 1 trace. Make sure that no other traces are updating (they should all be in View or Blank mode) when the save is performed.	On Recall, specify the trace you want to load the one trace's data into. This trace will load in View. All other traces' data will be unaffected, although their trace mode will be as it was when the state save was performed.
You want to recall all traces	Save Trace+State from ALL traces.	On Recall, all traces will come back in View (or Blank if they were in Blank or Background when saved)
You want all traces to load exactly as they were when saved.	Save State	On recall, all traces' mode and data will be exactly as they were when saved. Any traces that were updating will have their data immediately overwritten.

## From File...

When you press "From File", the analyzer brings up a Windows dialog and a menu entitled "File Open." This menu allows you to navigate to the various fields in the Windows dialog without using a keyboard or mouse. The Tab and Arrow keys can also be used for dialog navigation.



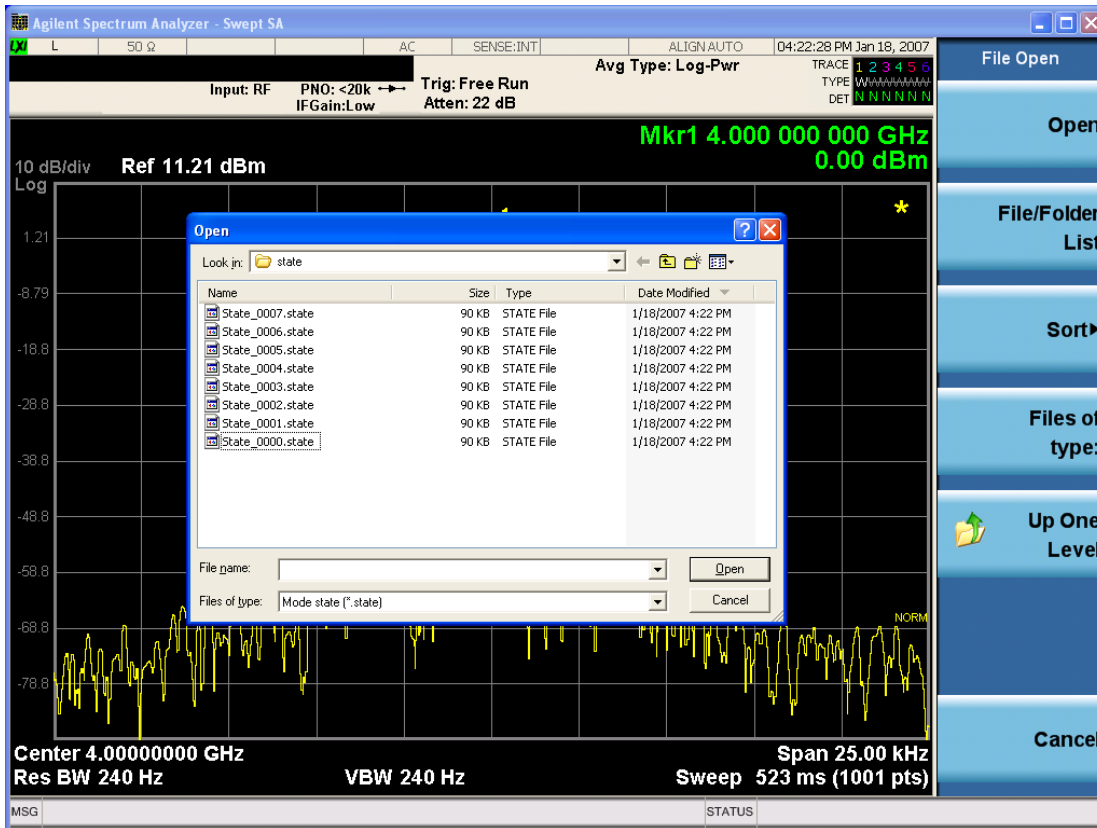

Listed below are the functions of the various fields in the dialog, and the corresponding softkeys:

#### Open

Performs the recall of the specified file. While the recall is being performed, the floppy icon appears briefly in the Meas bar.

#### File/Folder List

Enables you to navigate to the center of the dialog that contains the list of files and folders. Once here you can get information about the file and use the tab keys to navigate to the other fields in the dialog, such as Look In.

#### Look In

The Look In field shows the path from which the file will be recalled and allows you to change the path using the up and down arrow keys to navigate to other paths; the Enter key to open a directory; and the Backspace key to go back one directory. The **Look In field** first uses the last path from the Save As dialog **Save In:** path for that same file type. There is no softkey for directly navigating to the Look In field, but you can use the left tab to get here from the File/Folder List.

User specified paths are remembered when you leave and return to a Mode and are reset back to the default using Restore Mode Defaults.

#### Sort

Accesses a menu that enables you to sort the files within the File Open dialog. Only one sorting type can be selected at a time and the sorting happens immediately. The sorting types are By Date, By Name, By extension, and By Size.

#### Files of Type

This field shows the file suffix for the type of file you have selected to recall. For example, if you navigated here while recalling State, "Mode state (\*.state)" is in the field. If you navigated here while recalling Trace, ""Mode state (\*.trace)" is in the field. If you navigated here while importing a trace data file, "Trace Data (\*.csv)" is in the field. For some file types, there is more than one choice in the dropdown menu, which you can select by using the up and down arrow keys and Enter.

#### Up One Level

This key corresponds to the icon of a folder with the up arrow that is in the tool bar of the dialog. When pressed, it causes the file and folder list to navigate up one level in the directory structure. The Backspace key does the same thing.

#### Cancel

This key corresponds to the Cancel selection in the dialog. It causes the current **Open** request to be cancelled. The ESC key does the same thing.

Key Path	Recall, State
Notes	Brings up the Open dialog for recalling a State Save Type
Initial S/W Revision	Prior to A.02.00

### Edit Register Names

You may enter a custom name on any of the Register keys, to help you remember what you are using that state to save. To do this, press the Edit Register Names key, choose the register whose name you wish to edit, and then enter the desired label using the Alpha Editor or an external PC keyboard.

The maximum number of characters that can be added is 30. In most cases, 30 characters will fit on two lines of the key.

For more information and the SCPI command, see Edit Register Names under the Save, State function.

Key Path	Recall, State
Mode	All
Dependencies	N9060A-7FP or N9060B-2FP license required to edit the register names. When the feature is not licensed, sending the SCPI command generates an error, -221, "Settings conflict;Option not available"
Initial S/W Revision	A.11.00

### Register 1 thru Register 16

Selecting any one of these register keys causes the State of the mode from the specified Register to be recalled. Each of the register keys annotates whether it is empty or at what date and time it was last

modified. In addition, you can use the Edit Register Names key under Save, State to enter custom names for each register.

Registers are shared by all modes, so recalling from any one of the registers will cause a mode switch to the mode that was active when the save to the Register occurred.

Although these 16 registers are the only registers available from the front panel, there are 128 state registers available in the instrument. Registers 17–128 are only available from the SCPI interface, using the \*RCL command.

After the recall completes, the message "Register <register number> recalled" appears in the message bar. If you are in the Spectrum Analyzer Mode, and you are recalling a register that was saved in the Spectrum Analyzer Mode, then after the recall, you will still be in the Recall Register menu. If the Recall causes you to switch modes, then after the Recall, you will be in the Frequency menu.

If a requested register is empty an error is generated.

Key Path	Recall, State
<b>Example</b>	*RCL 1
Range	1–16 from front panel, 1–128 from SCPI
Readback	Date and time with seconds resolution are displayed on the key OR A custom name of up to 30 characters entered using the Save, State, Edit Register Names key OR “(empty)” if no prior save operation has been performed to this register.
Initial S/W Revision	Prior to A.02.00
Modified at S/W Revision	Prior to A.11.00

## Register 1 thru Register 16

Selecting any one of these register keys causes the State of the mode from the specified Register to be recalled. Each of the register keys annotates whether it is empty or at what date and time it was last modified. In addition, you can use the Edit Register Names key under Save, State to enter custom names for each register.

Registers are shared by all modes, so recalling from any one of the registers will cause a mode switch to the mode that was active when the save to the Register occurred.

Although these 16 registers are the only registers available from the front panel, there are 128 state registers available in the instrument. Registers 17–128 are only available from the SCPI interface, using the \*RCL command.

After the recall completes, the message "Register <register number> recalled" appears in the message bar. If you are in the Spectrum Analyzer Mode, and you are recalling a register that was saved in the Spectrum Analyzer Mode, then after the recall, you will still be in the Recall Register menu. If the Recall causes you to switch modes, then after the Recall, you will be in the Frequency menu.

If a requested register is empty an error is generated.

Key Path	Recall, State
Example	*RCL 1
Range	1-16 from front panel, 1-128 from SCPI
Readback	Date and time with seconds resolution are displayed on the key OR A custom name of up to 30 characters entered using the Save, State, Edit Register Names key OR “(empty)” if no prior save operation has been performed to this register.
Initial S/W Revision	Prior to A.02.00
Modified at S/W Revision	Prior to A.11.00

### Trace (+State)

The Recall Trace (+State) menu lets you choose a register or file from which to recall the Trace+State state file.

A saved state contains all of the settings and data required to return the analyzer as closely as possible to the exact setup it had when the save occurred. This includes the Input/Output settings, even though they are outside of the Mode’s state, because they are needed to restore the complete setup. A Trace+State file also includes trace data from one trace or all traces, which will load in View mode when the Trace+State file is recalled. Recall Trace (+State) will also cause a mode switch if the state being recalled is not for the current active mode.

After the recall completes, the message "File <filename> recalled" or “Recalled Trace Register <register number>” is displayed.

For rapid recalls, the Trace (+State) menu lists 5 registers to choose from to recall. Pressing a Register key initiates the recall. You can also select a file from which to recall.

The default path for all State Files including .trace files is:

My Documents\<mode name>\state

where <mode name> is the parameter used to select the mode with the INST:SEL command (for example, SA for the Spectrum Analyzer).

Key Path	Recall
Mode	SA
Remote Command	:MMEMory:LOAD:TRACe TRACE1   TRACE2   TRACE3   TRACE4   TRACE5   TRACE6, <filename>  :MMEMory:LOAD:TRACe:REGister TRACE1   TRACE2   TRACE3   TRACE4   TRACE5   TRACE6, <integer>
Example	MMEM:LOAD:TRAC TRACE2, "MyTraceFile.trace" This loads the trace file data (on the default file directory path) into the specified trace; if it is a "single trace" save file, that trace is loaded to trace 2, and is set to be not updating. :MMEM:LOAD:TRAC:REG TRACE1,2

---

restores the trace data in register 2 to Trace 1

---

Notes

When you perform the recall, the recalling Trace function must first verify the file is recallable in this instrument by checking instrument software version and model number, since it includes State. If everything matches, a full recall proceeds by aborting the currently running measurement, and loading the state from the saved state file to as close as possible to the context in which the save occurred. You can open .trace files from any mode that supports them, so recalling a Trace file switches to the mode that was active when the save occurred. After switching to the mode of the saved state file, mode settings and data (if any for the mode) are loaded with values from the saved file and the saved measurement of the mode becomes the newly active measurement, and the data relevant to the measurement (if there is any) is recalled.

Once the state is loaded, the trace data must be loaded. The internal flags are consulted to see which trace to load and the "To Trace" setting to see where to load it. Trace data is always loaded with the specified trace set to View, so that the data is visible and not updating (so as not to erase the recalled data). If the file is an "all trace" file, all traces are loaded with the saved data (to the original trace the data was saved from) and set to View. Traces whose data is not loaded are restored to the update state that existed when they were saved.

After the Recall the analyzer exits the Recall menu and returns to the previous menu.

Some modes and measurements do not have available all 6 traces. Phase Noise mode command, for example, is: `MMEMory:LOAD:TRACe TRACE1|TRACE2|TRACE3,<filename>`

Some modes and measurements have more than 6 traces available. The Realtime SA mode command, for example, is: `MMEMory:STORe:TRACe TRACE1 | TRACE2 | TRACE3 | TRACE4 | TRACE5 | TRACE6 | TRACE7 | TRACE8 | TRACE9 | TRACE10 | TRACE11 | TRACE12 | ALL,<filename>`

---

Initial S/W Revision	Prior to A.02.00
----------------------	------------------

---

## To Trace

These menu selections let you choose the Trace where the recalled saved trace will go. Not all modes have the full 6 traces available. The default is the currently selected trace, selected in this menu or in the Trace/Detector, Export Data, Import Data, or Save Trace menus, except if you have chosen All, then it remains chosen until you specifically change it to a single trace.

If the .trace file is an "all trace" file, "To Trace" is ignored and the traces each go back to the trace from which they were saved.

Once selected, the key returns back to the Recall Trace menu and the selected Trace number is annotated on the key. Now you have selected exactly where the trace needs to be recalled. To trigger a recall of the selected Trace, you must select the Open key in the Recall Trace menu.

When you select a trace, it makes that trace the current trace, so it displays on top of all of the other traces.

---

Key Path	Save, Data, Trace
Mode	SA
Initial S/W Revision	Prior to A.02.00

---

## Register 1 thru Register 16

Selecting any one of these register keys causes the State of the mode from the specified Register to be recalled. Each of the register keys annotates whether it is empty or at what date and time it was last modified. In addition, you can use the Edit Register Names key under Save, State to enter custom names for each register.

Registers are shared by all modes, so recalling from any one of the registers will cause a mode switch to the mode that was active when the save to the Register occurred.

Although these 16 registers are the only registers available from the front panel, there are 128 state registers available in the instrument. Registers 17–128 are only available from the SCPI interface, using the \*RCL command.

After the recall completes, the message "Register <register number> recalled" appears in the message bar. If you are in the Spectrum Analyzer Mode, and you are recalling a register that was saved in the Spectrum Analyzer Mode, then after the recall, you will still be in the Recall Register menu. If the Recall causes you to switch modes, then after the Recall, you will be in the Frequency menu.

If a requested register is empty an error is generated.

Key Path	Recall, State
<b>Example</b>	*RCL 1
Range	1–16 from front panel, 1–128 from SCPI
Readback	Date and time with seconds resolution are displayed on the key OR A custom name of up to 30 characters entered using the Save, State, Edit Register Names key OR “(empty)” if no prior save operation has been performed to this register.
Initial S/W Revision	Prior to A.02.00
Modified at S/W Revision	Prior to A.11.00

## From File...

When you press “From File”, the analyzer brings up a Windows dialog and a menu entitled “File Open.” This menu allows you to navigate to the various fields in the Windows dialog without using a keyboard or mouse. The Tab and Arrow keys can also be used for dialog navigation.

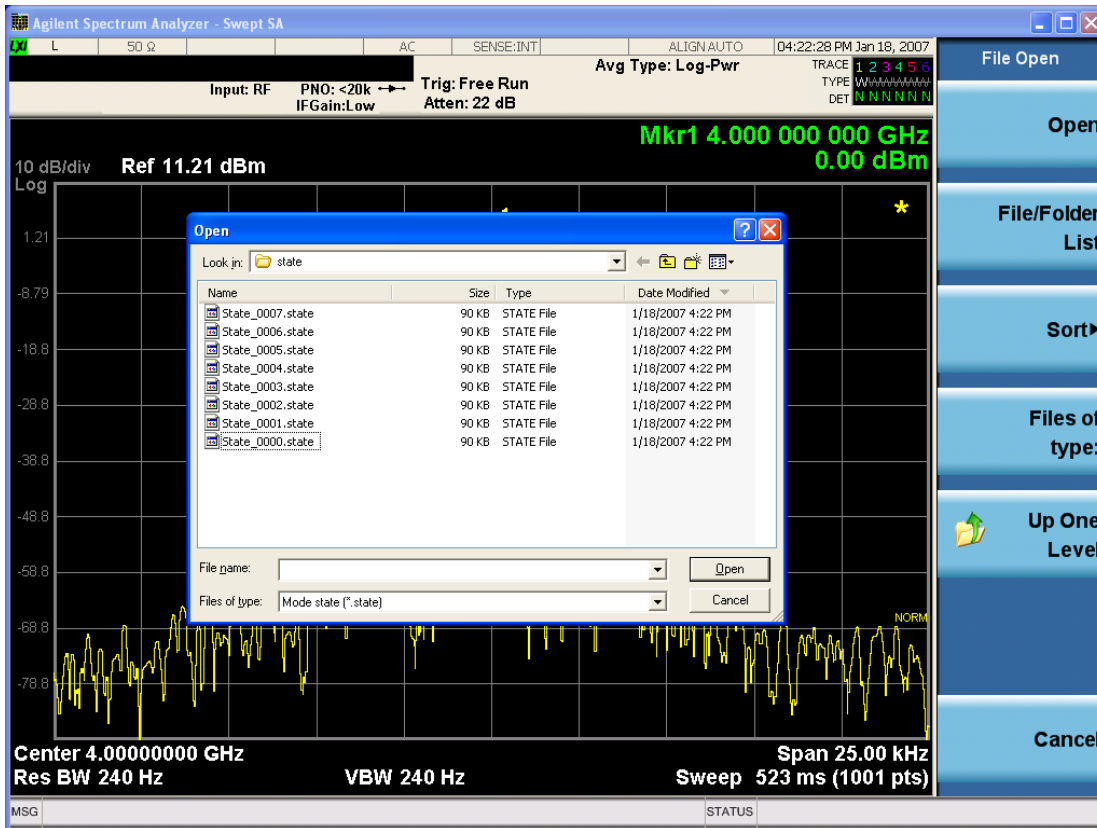

Listed below are the functions of the various fields in the dialog, and the corresponding softkeys:

#### Open

Performs the recall of the specified file. While the recall is being performed, the floppy icon appears briefly in the Meas bar.

#### File/Folder List

Enables you to navigate to the center of the dialog that contains the list of files and folders. Once here you can get information about the file and use the tab keys to navigate to the other fields in the dialog, such as Look In.

#### Look In

The Look In field shows the path from which the file will be recalled and allows you to change the path using the up and down arrow keys to navigate to other paths; the Enter key to open a directory; and the Backspace key to go back one directory. The **Look In field** first uses the last path from the Save As dialog **Save In:** path for that same file type. There is no softkey for directly navigating to the Look In field, but you can use the left tab to get here from the File/Folder List.

User specified paths are remembered when you leave and return to a Mode and are reset back to the default using Restore Mode Defaults.

#### Sort

Accesses a menu that enables you to sort the files within the File Open dialog. Only one sorting type can be selected at a time and the sorting happens immediately. The sorting types are By Date, By Name, By extension, and By Size.

#### Files of Type

This field shows the file suffix for the type of file you have selected to recall. For example, if you navigated here while recalling State, "Mode state (\*.state)" is in the field. If you navigated here while recalling Trace, ""Mode state (\*.trace)" is in the field. If you navigated here while importing a trace data file, "Trace Data (\*.csv)" is in the field. For some file types, there is more than one choice in the dropdown menu, which you can select by using the up and down arrow keys and Enter.

#### Up One Level

This key corresponds to the icon of a folder with the up arrow that is in the tool bar of the dialog. When pressed, it causes the file and folder list to navigate up one level in the directory structure. The Backspace key does the same thing.

#### Cancel

This key corresponds to the Cancel selection in the dialog. It causes the current **Open** request to be cancelled. The ESC key does the same thing.

Key Path	Recall, State
Notes	Brings up the Open dialog for recalling a State Save Type
Initial S/W Revision	Prior to A.02.00

## Data (Import)

Importing a data file loads data that was previously saved from the current measurement or from other measurements and/or modes that produce compatible data files. The Import Menu only contains Data Types that are supported by the current measurement.

Since the commonly exported data files are in .csv format, the data can be edited by the user prior to importing. This allows you to export a data file, manipulate the data in Excel (the most common PC Application for manipulating .csv files) and then import it.

Importing Data loads measurement data from the specified file into the specified or default destination, depending on the data type selected. Selecting an Import Data menu key will not actually cause the importing to occur, since the analyzer still needs to know from where to get the data. Pressing the Open key in this menu brings up the Open dialog and Open menu that provides you with the options from where to recall the data. Once a filename has been selected or entered in the Open menu, the recall occurs as soon as the Open button is pressed.

Key Path	Recall
Mode	All
Notes	The menu is built from whatever data types are available for the mode. Some keys will be missing completely, so the key locations in the sub-menu will vary. No SCPI command directly controls the Data Type that this key controls. The Data Type is included in the MMEM:LOAD commands.



Dependencies	If a file type is not used by a certain measurement, it is grayed out for that measurement. The key for a file type will not show at all if there are no measurements in the Mode that support it.
Preset	Is not affected by Preset or shutdown, but is reset during Restore Mode Defaults
Readback	The data type that is currently selected
Initial S/W Revision	Prior to A.02.00

## Capture Buffer

The captured data is raw data which is not processed.

Key Path	Recall, Data
Mode	<b>CDMA1XEV</b>
Example	MMEM:LOAD:CAPT "MyCaptureData.bin" This loads the file of capture data (on the default file directory path) into the instrument.
Dependencies	In case the capture buffer data is not available from the selected measurement, the key will be grayed out.
Initial S/W Revision	A.11.00

## Open...

When you press "Open", the analyzer brings up a Windows dialog and a menu entitled "**File Open.**" This menu allows you to navigate to the various fields in the Windows dialog without using a keyboard or mouse. The Tab and Arrow keys can also be used for dialog navigation.

See "[From File...](#)" on page 2890 in Recall, State, for a full description of this dialog and menu.

Key Path	Recall, Data
Notes	The key location is mode-dependent and will vary. Brings up Open dialog for recalling a <mode specific> Save Type
Initial S/W Revision	Prior to A.02.00

## Restart

The Restart function restarts the current sweep, or measurement, or set of averaged/held sweeps or measurements. If you are Paused, pressing Restart does a Resume.

The Restart function is accessed in several ways:

- Pressing the Restart key
- Sending the remote command INIT:IMMEDIATE
- Sending the remote command INIT:RESTART

See "[More Information](#)" on page 2550

Key Path	Front-panel key
Remote Command	:INITiate[:IMMEDIATE] :INITiate:RESTART
Example	:INIT:IMM :INIT:REST
Notes	:INITiate:RESTART and :INITiate:IMMEDIATE perform exactly the same function.
Couplings	Resets average/hold count k. For the first sweep overwrites all active (update=on) traces with new current data. For application modes, it resets other parameters as required by the measurement.
Status Bits/OPC dependencies	This is an Overlapped command. The STATus:OPERation register bits 0 through 8 are cleared. The STATus:QUESTionable register bit 9 (INTEgrity sum) is cleared. The SWEEPING bit is set. The MEASURING bit is set.
Backwards Compatibility Notes	For Spectrum Analysis mode in ESA and PSA, the Restart hardkey and the INITiate:RESTART command restart trace averages (displayed average count reset to 1) for a trace in Clear Write, but did not restart Max Hold and Min Hold.  In the X-Series, the Restart hardkey and the INITiate:RESTART command restart not only Trace Average, but MaxHold and MinHold traces as well.  For wireless comms modes in ESA and PSA, the Restart hardkey and the INITiate:RESTART command restart every measurement, which includes all traces and numeric results. There is no change to this operation.
Initial S/W Revision	Prior to A.02.00

### More Information

The **Restart** function first aborts the current sweep/measurement as quickly as possible. It then resets the sweep and trigger systems, sets up the measurement and initiates a new data measurement sequence with a new data acquisition (sweep) taken once the trigger condition is met.

If the analyzer is in the process of aligning when **Restart** is executed, the alignment finishes before the restart function is performed.

Even when set for Single operation, multiple sweeps may be taken when Restart is pressed (for example, when averaging/holding is on). Thus when we say that **Restart** "restarts a measurement," we may mean:

- It restarts the current sweep
- It restarts the current measurement
- It restarts the current set of sweeps if any trace is in Trace Average, Max Hold or Min Hold
- It restarts the current set of measurements if Averaging, or Max Hold, or Min Hold is on for the measurement
- depending on the current settings.

With **Average/Hold Number** (in **Meas Setup** menu) set to 1, or Averaging off, or no trace in Trace Average or Hold, a single sweep is equivalent to a single measurement. A single sweep is taken after the trigger condition is met; and the analyzer stops sweeping once that sweep has completed. However, with **Average/Hold Number** >1 and at least one trace set to **Trace Average, Max Hold, or Min Hold (SA Measurement)** or **Averaging on (most other measurements)**, multiple sweeps/data acquisitions are taken for a single measurement. The trigger condition must be met prior to each sweep. The sweep is stopped when the average count  $k$  equals the number  $N$  set for **Average/Hold Number**. A measurement average usually applies to all traces, marker results, and numeric results; but sometimes it only applies to the numeric results.

Once the full set of sweeps has been taken, the analyzer will go to idle state. To take one more sweep without resetting the average count, increment the average count by 1, by pressing the step up key while **Average/Hold Number** is the active function, or sending the remote command `CALC:AVER:TCON UP`.

## Save

The Save menu lets you choose what you want to save and where you want to save it. Among the types of files you can save are **States**, **Traces**, and **Screen Images**. In addition, an Export (Data) option lets you save a number of data types as CSV files for easy import into Excel and other spreadsheet programs.

Key Path	Front-panel key
Mode	All
Notes	No remote command for this key specifically, but the :MMEM:STORe command is available for specific file types. An example is :MMEM:STOR:STATe <filename>.
Initial S/W Revision	Prior to A.02.00

## State

The Save State menu lets you choose a register or file for saving the state.

The content of a state file includes all of the settings and data required to return the analyzer as closely as possible to the Mode it was in, with the exact settings which were in place, when the save occurred. The Mode settings in each state file include the settings that are affected by Mode Preset, as well as the additional settings affected by Restore Mode Defaults; all of the Mode's settings. In addition, all of the settings of the Input/Output system are included, even though they are outside of the Mode's state, because they are needed to restore the complete setup. Persistent System settings (for example, Verbose SCPI) are not affected by either Mode Preset or Restore Mode Defaults, nor are they included in a saved State file.

After the save completes, the message "File <filename> saved" or "State Register <register number> saved" is displayed.

For rapid saving, the State menu lists 16 registers to save to. Pressing a Register key initiates the save. You can also select a file to save to.

The default path for all State Files is:

My Documents\<<mode name>\state

where <mode name> is the parameter used to select the mode with the INST:SEL command (for example, SA for the Spectrum Analyzer).

Key Path	Save
Mode	All
Remote Command	:MMEMory:STORe:STATe <filename>
Example	MMEM:STOR:STATe "MyStateFile.state" This stores the current instrument state data in the file MyStateFile.state in the default directory.
Notes	Both single and double quotes are supported for any filename parameter over remote. After saving to a register, that register's menu key is updated with the date the time, unless a custom label has been entered for that key. After saving to a register, you remain in the Save State menu, so that you can see the Register key

update. After saving to a file, the analyzer automatically returns to the previous menu and any Save As dialog goes away.

<b>Backwards Compatibility SCPI</b>	:MMEMory:STORe:STATe 1,<filename>
Initial S/W Revision	Prior to A.02.00

### To File . . .

When you press “To File”, the analyzer brings up a Windows dialog and a menu entitled “**Save As.**” This menu allows you to navigate to the various fields in the Windows dialog without using a keyboard or mouse. The Tab and Arrow keys can also be used for dialog navigation.

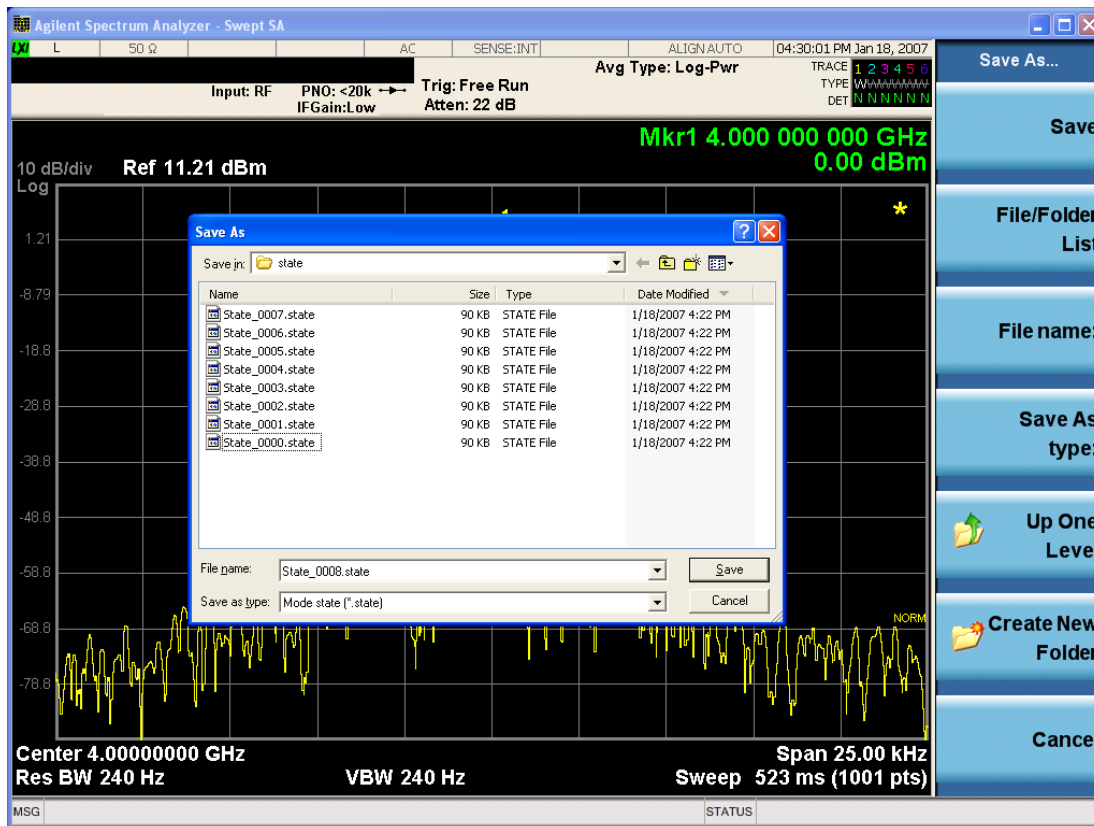

The Listed below

are the functions of the various fields in the dialog, and the corresponding softkeys:

#### Save

Performs the save to the specified file of the selected type. If the file already exists, a dialog will appear that allows you to replace the existing file by selecting OK, or you can Cancel the request. If you select OK, the file will be overwritten. Using the C: drive is strongly discouraged, since it runs the risk of being overwritten during an instrument software upgrade.

While the save is being performed, the floppy icon appears briefly in the Meas bar.

### File/Folder List

Enables you to navigate to the center of the dialog that contains the list of files and folders. Once here you can get information about the file and use the tab keys to navigate to the other fields in the dialog, such as Save In.

### Save In

The Save In field shows the path to which the file will be saved and allows you to change the path using the up and down arrow keys to navigate to other paths; the Enter key to open a directory; and the Backspace key to go back one directory. The **Save In field** defaults to the default path for this type of file and remembers the last path you used to save this type of file. There is no softkey for directly navigating to the Save In field but you can use left tab to get here from the File/Folder List.

User specified paths are remembered when you leave and return to a Mode and are reset back to the default using Restore Mode Defaults.

### File Name

The File Name field is initially loaded with an automatically generated filename specific to the appropriate Save Type. The automatically generated filename is guaranteed not to conflict with any filename currently in the directory. You may replace or modify this filename using the File Name key. See the ["Quick Save " on page 2880](#) documentation for more on the automatic file naming algorithm.

When you press the File Name key the analyzer displays the Alpha Editor. Use the knob to choose the letter to add and the front-panel Enter key to add the letter to the file name. The BK character moves you back and the FW character moves you forward in the filename. The Select key on the front panel generates a space character. When you are done entering the filename press the Done softkey. This returns back to the **File Open** dialog and menu, but does not cause the save to occur.

### Save As Type

This field shows the file suffix for the type of file you have selected to save. For example, if you navigated here while saving State, "Mode state (\*.state)" is in the field. If you navigated here from saving Trace, ""Mode state (\*.trace)" is in the field. If you navigated here while exporting a trace data file, "Trace Data (\*.csv)" is in the field. For some file types, there is more than one choice in the dropdown, which you can select by using the up and down arrow keys and Enter.

### Up One Level

This key corresponds to the icon of a folder with the up arrow that is in the tool bar of the dialog. When pressed, it causes the file and folder list to navigate up one level in the directory structure. The Backspace key does the same thing.

### Create New Folder

This key corresponds to the icon of a folder with the "\*" that is in the tool bar of the dialog. When pressed, a new folder is created in the current directory with the name **New Folder** and you can enter a new folder name using the Alpha Editor.

### Cancel

This key corresponds to the Cancel selection in the dialog. It causes the current **Save As** request to be cancelled. The ESC key does the same thing.

Key Path	Save, State
Mode	All
Notes	Brings up Save As dialog for saving a State Save Type
Initial S/W Revision	Prior to A.02.00

## Edit Register Names

You may enter a custom name on any of the Register keys, to help you remember what you are using that state to save. To do this, press the Edit Register Names key, choose the register whose name you wish to edit, and then enter the desired label using the Alpha Editor or an external PC keyboard.

The maximum number of characters that can be added is 30. In most cases, 30 characters will fit on two lines of the key.

See ["More Information" on page 2555](#)

Key Path	Save, State
Mode	All
<b>Remote Command</b>	:MMEMory:REGister:STATe:LABel <reg number>,"label" :MMEMory:REGister:STATe:LABel? <reg number>
<b>Example</b>	:MMEM:REG:STAT:LAB 1,"my label"
Notes	<reg number> is an integer from 1 to 16. If the SCPI specifies an invalid register number an error message is generated, -222,"Data out of range;Invalid register label number" "label" is a string from 0 to 30 characters in length. If a label exceeds 30 characters, an error message is generated, -150,"String data error;Label clipped to 30 characters" "label" of length 0 erases the custom label and restores the default (time and date) label. E.g.: :MMEM:REG:STAT:LAB 1,""
Dependencies	N9060A-7FP or N9060B-2FP license required to edit the register names. When the feature is not licensed, sending this command generates an error, -221,"Settings conflict;Option not available"
Preset	The names are unaffected by Preset or power cycle but are set to the default label (time and date) on a "Restore System Defaults->Misc"
Initial S/W Revision	A.11.00

## More Information

When you edit one of the register names, the time and date field will be replaced by the custom name.

If you delete all the characters in the custom name, it restores the default (time and date).

The register names are stored within the state files, but they are not part of the instrument state; that is, once you have edited a register name, loading a new state will not change that register name. Another consequence of this is that the names will be persistent through a power cycle. Also, if a named state file is transferred to another analyzer, it will bring its custom name along with it.

If you try to edit the name of an empty register, the analyzer will first save the state to have a file to put the name in. If you load a named state file into an analyzer with older firmware it will ignore the metadata.

The \*SAV and \*RCL commands will not be affected by the custom register names, nor will the MMEM commands.

### Register 1 thru Register 16

Selecting any one of these register menu keys causes the State of the currently active mode to be saved to the specified Register. The registers are provided for rapid saving and recalling, since you do not need to specify a filename or navigate to a file. Each of the register menu keys annotates whether it is empty or at what date and time it was last modified. In addition, you can use the Edit Register Names key to enter custom names for each register.

Although these 16 registers are the only registers available from the front panel, there are 128 state registers available in the instrument. Registers 17–128 are only available from the SCPI interface, using the \*SAV command.

There is one set of 128 state registers in the instrument, not one set for each Mode. When a state is saved, the Mode it was saved from is saved with it; then when it is recalled, the instrument switches to that Mode.

After the save completes, the corresponding register menu key annotation is updated with the date and time and the message "Register <register number> saved" is displayed.

Key Path	Save, State
Mode	All
Example	*SAV 1
Range	1–16 from front panel, 1–128 from SCPI
Readback	Date and time with seconds resolution are displayed on the key OR A custom name of up to 30 characters entered using the Edit Register Names key OR “(empty)” if no prior save operation has been performed to this register.
Initial S/W Revision	Prior to A.02.00
Modified at S/W Revision	A.11.00

### Register 1 thru Register 16

Selecting any one of these register menu keys causes the State of the currently active mode to be saved to the specified Register. The registers are provided for rapid saving and recalling, since you do not need to specify a filename or navigate to a file. Each of the register menu keys annotates whether it is empty or at what date and time it was last modified. In addition, you can use the Edit Register Names key to enter custom names for each register.

Although these 16 registers are the only registers available from the front panel, there are 128 state registers available in the instrument. Registers 17–128 are only available from the SCPI interface, using the \*SAV command.



There is one set of 128 state registers in the instrument, not one set for each Mode. When a state is saved, the Mode it was saved from is saved with it; then when it is recalled, the instrument switches to that Mode.

After the save completes, the corresponding register menu key annotation is updated with the date and time and the message "Register <register number> saved" is displayed.

Key Path	Save, State
Mode	All
Example	*SAV 1
Range	1–16 from front panel, 1–128 from SCPI
Readback	Date and time with seconds resolution are displayed on the key OR A custom name of up to 30 characters entered using the Edit Register Names key OR “(empty)” if no prior save operation has been performed to this register.
Initial S/W Revision	Prior to A.02.00
Modified at S/W Revision	A.11.00

## Data (Export)

Exporting a data file stores data from the current measurement to mass storage files. The Export Menu only contains data types that are supported by the current measurement.

Since the commonly exported data files are in .csv format, the data can be edited by you prior to importing. This allows you to export a data file, manipulate the data in Excel (the most common PC Application for manipulating .csv files) and then import it.

Selecting an Export Data menu key will not actually cause the exporting to occur, since the analyzer still needs to know where you wish to save the data. Pressing the Save As key in this menu brings up the Save As dialog and Save As menu that allows you to specify the destination file and directory. Once a filename has been selected or entered in the Open menu, the export will occur as soon as the Save key is pressed.

Key Path	Save
Mode	All
Notes	The menu is built from whatever data types are available for the mode. So the key locations in the sub menu will vary.  No SCPI command directly controls the Data Type that this key controls. The Data Type is included in the MMEM:STORe commands.
Dependencies	If a file type is not used by a certain measurement, that type is grayed out for that measurement. The key for a file type will not show at all if there are no measurements in the Mode that support it.
Preset	Is not affected by a Preset or shutdown, but is reset during Restore Mode Defaults
Readback	The data type that is currently selected
Initial S/W Revision	Prior to A.02.00

## Measurement Results

Pressing this key selects Meas Results as the data type to be exported. Pressing the key a second time brings up the Meas Results menu, which allows you to select which **Meas Result** to save. In the Swept SA measurement, there are three types of Measurement Results files: Peak Table, Marker Table and Spectrogram.

See "[Meas Results File Contents](#)" on page 2558.

See "[Marker Table](#)" on page 2558.

See "[Peak Table](#)" on page 2561.

See "[Spectrogram](#)" on page 2564

<b>Remote Command</b>	:MMEMory:STORe:RESults:MTABle PTABle SPEctrogram <filename>
<b>Example</b>	:MMEM:STOR:RES:MTAB "myResults.csv" Saves the results from the current marker table to the file myResults.csv in the current path. :MMEM:STOR:RES:PTAB "myResults.csv" Saves the results from the current peak table to the file myResults.csv in the current path. :MMEM:STOR:RES:SPEC "myResults.csv" Saves the results from the current Spectrogram display to the file myResults.csv in the current path. The default path is My Documents\SA\data\SAN\results
<b>Notes</b>	If the save is initiated via SCPI, and the file already exists, the file will be overwritten. Using the C: drive is strongly discouraged, since it runs the risk of being overwritten during an instrument software upgrade. Both single and double quotes are supported for any filename parameter over SCPI.
<b>Dependencies</b>	If a save of Marker Table results is requested and the Marker Table is not on, no file is saved and a message is generated If a save of Peak Table results is requested and the Peak Table is not on, no file is saved and a message is generated If a save of Spectrogram results is requested and the Spectrogram is not on, no file is saved and a message is generated. The Spectrogram choice only appears if option EDP is licensed.
<b>Preset</b>	Not part of Preset, but is reset to Peak Table by Restore Mode Defaults. Survives a shutdown.
<b>Initial S/W Revision</b>	Prior to A.02.00

## Meas Results File Contents

All files are .csv files. The following section details the data in each file type.

### Marker Table

This section discusses the Marker Table Meas Results file format.

Imagine that, at the point where a Marker Table Meas Result is requested, the following screen is showing:

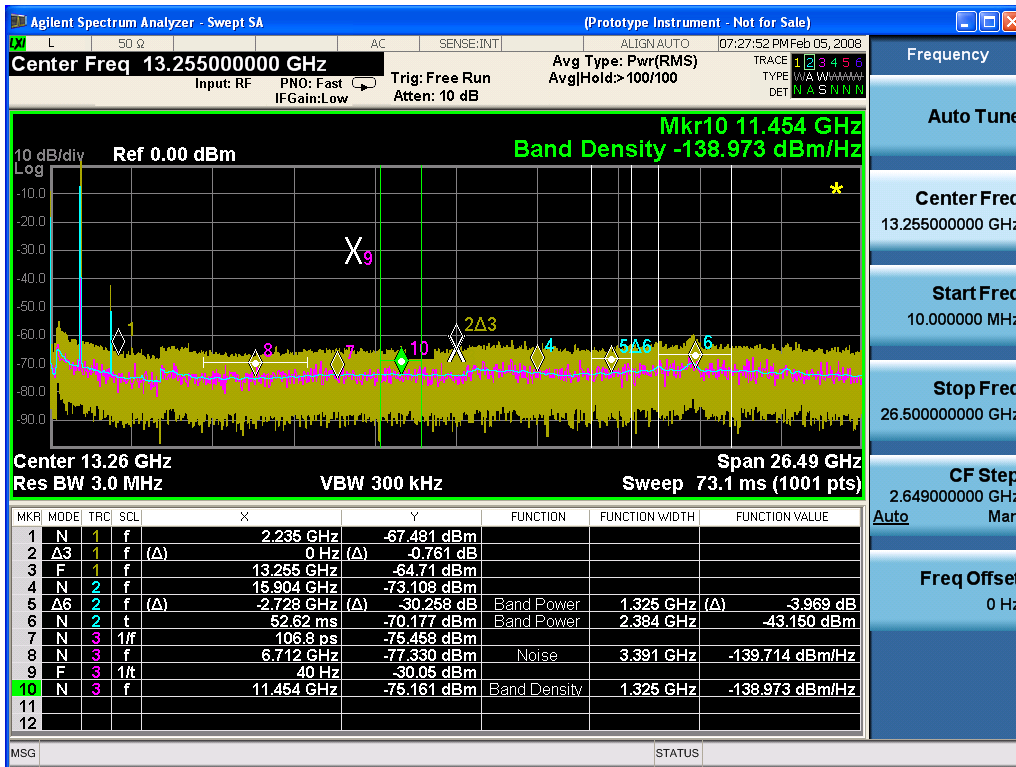

Then the Meas Results file, when opened, would show the following data:

MeasurementR	
result	
Swept SA	
A.01.40_R0017	N9020A
526 B25 PFR	1
P26 EA3	
Result Type	Marker Table
Ref Level	0
Number of Points	1001
Sweep Time	0.0662666 67
Start Frequency	10000000
Stop Frequency	26500000 000
Average Count	0
Average Type	LogPower (Video)
RBW	3000000

RBW Filter	Gaussian
RBW Filter BW	3dB
VBW	3000000
Sweep Type	Swept
X Axis Scale	Lin
PreAmp State	Off
PreAmp Band	Low
Trigger Source	Free
Trigger Level	1.2
Trigger Slope	Positive
Trigger Delay	1.00E-06
Phase Noise Optimization	Fast
Swept If Gain	Low
FFT If Gain	Autorange
RF Coupling	AC
FFT Width	411900
Ext Ref	10000000
Input	RF
RF Calibrator	Off
Attenuation	10
Ref Level Offset	0
External Gain	0
X Axis Units	Hz
Y Axis Units	dBm

DATA									
MKR	MODE	TRC	SCL	X	Y	FUNCTION	FUNCTION WIDTH	FUNCTION VALUE	FUNCTION UNIT
1	Normal	1	Frequency	2.2350E+09	-67.481	Off	0.0000E+00	0	None
2	Delta3	1	Frequency	0.0000E+00	-0.761	Off	0.0000E+00	0	None
3	Fixed	1	Frequency	1.3255E+10	-64.71	Off	0.0000E+00	0	None
4	Normal	2	Frequency	1.5904E+10	-73.1	Off	0.0000E+00	0	None

08									
5	Delta7	2	Freque ncy	- 2.7280E+ 09	- 30.2 58	Band Power	1.3250E+ 06	-3.969	dB
6	Normal	2	Time	5.2620E- 02	- 70.1 77	Band Power	2.3840E+ 06	-43.15	dBm
7	Normal	3	Period	1.0680E- 10	- 75.4 58	Off	0.0000E+ 00	0	None
8	Normal	3	Freque ncy	6.7120E+ 09	- 77.3 3	Noise	3.3910E+ 06	- 139.71 4	dBm/Hz
9	Fixed	3	Inverse Time	4.0000E+ 01	- 30.0 5	Off	0.0000E+ 00	0	None
10	Normal	3	Freque ncy	1.1454E+ 10	- 75.1 61	Band Density	1.3250E+ 06	- 138.97 3	dBm/Hz
11	Off	1	Freque ncy	0.0000E+ 00	0	Off	0.0000E+ 00	0	None
12	Off	1	Freque ncy	0.0000E+ 00	0	Off	0.0000E+ 00	0	None

The numbers appear in the file exactly as they appear onscreen. If it says 11.454 GHz onscreen, then in the file it is 11.454E+09.

The metadata header is very similar to the metadata used in the trace data .csv files. See Trace File Contents. The only new information concerns the 1-of-N fields in the marker table itself.

### Peak Table

This section discusses the Peak Table Meas Results file format.

Imagine that, at the point where a Marker Table Meas Result is requested, the following screen is showing:

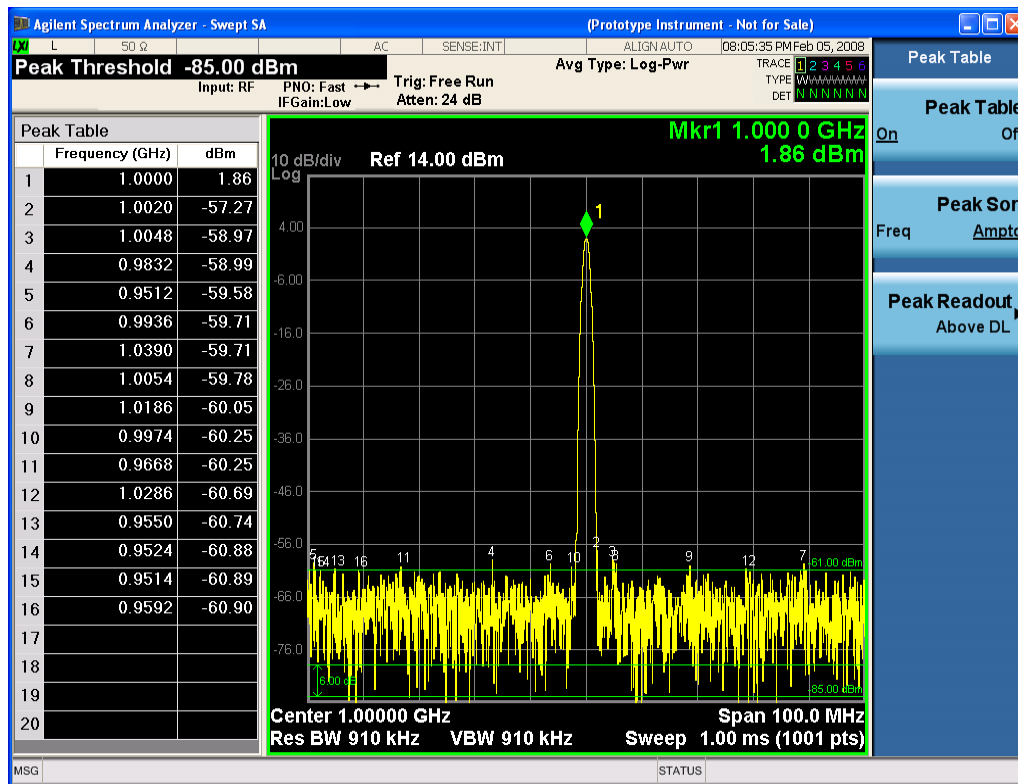

Then the Meas Results file, when opened, would show the header data (the same as for the Marker Table except that the Result Type is Peak Table) ending with a few fields of specific interest to Peak Table users:

- Peak Threshold
- Peak Threshold State (On|Off)
- Peak Excursion
- Peak Excursion State (On|Off)
- Display Line
- Peak Readout (All|AboveDL|BelowDL)
- Peak Sort (Freq|Amptd)

These fields are then followed by the data for the Peak Table itself.

Note that the label for the Frequency column changes to Time in 0 span.

Here is what the table for the above display looks like:

MeasurementResult	
Swept SA	
A.01.40_R0017	N9020A
526 B25 PFR P26 EA3	1

Result Type	Peak Table
Ref Level	0
Number of Points	1001
Sweep Time	0.066266667
Start Frequency	10000000
Stop Frequency	26500000000
Average Count	0
Average Type	LogPower(Video)
RBW	3000000
RBW Filter	Gaussian
RBW Filter BW	3dB
VBW	3000000
Sweep Type	Swept
X Axis Scale	Lin
PreAmp State	Off
PreAmp Band	Low
Trigger Source	Free
Trigger Level	1.2
Trigger Slope	Positive
Trigger Delay	1.00E-06
Phase Noise Optimization	Fast
Swept If Gain	Low
FFT If Gain	Autorange
RF Coupling	AC
FFT Width	411900
Ext Ref	10000000
Input	RF
RF Calibrator	Off
Attenuation	10
Ref Level Offset	0
External Gain	0
X Axis Units	Hz
Y Axis Units	dBm
Peak Threshold	-85
Peak Threshold State	On
Peak Excursion	6
Peak Excursion State	On

Display Line	-61	
Peak Readout	AboveDL	
Peak Sort	Amptd	
DATA		
Peak	Frequency	Amplitude
1	1.0000E+06	1.86
2	1.0020E+06	-57.27
3	1.0048E+06	-58.97
4	9.8320E+05	-58.99
5	9.5120E+05	-59.58
6	9.9360E+05	-59.71
7	1.0390E+06	-59.71
8	1.0054E+06	-59.78
9	1.1086E+06	-60.05
10	9.9740E+05	-60.25
11	9.6680E+05	-60.25
12	1.0286E+06	-60.69
13	9.5500E+05	-60.74
14	9.5240E+05	-60.88
15	9.5140E+05	-60.89
16	9.5920E+05	-60.90
17		
18		
19		
20		

## Spectrogram

This section discusses the Spectrogram Results file format. The Spectrogram choice only appears if option EDP is licensed.

The Spectrogram results are the same as a Trace data export, except that instead of having just one trace's data, all 300 traces appear one after the other.

Each trace has its own data mark; the data for Spectrogram Trace 0 follows the row marked DATA, the data for Spectrogram Trace 1 follows the row marked DATA1, for Spectrogram Trace 2 follows the row marked DATA2, and so on.



Each DATA row has a timestamp in the second column (as of firmware revision A.11.01). So, for example, if Trace 0 had a relative start time of 1729.523 sec, then the first DATA row would look like this:

DATA,1729.523

And if Trace 13 had a relative start time of 100.45 sec, then the fourteenth data row would look like:

DATA13,100.453

To find the absolute time for the relative timestamps of each trace, the last row before the first DATA row gives the absolute start time of the Spectrogram, in the form YYYYMMDDHHMMSS

So, for example, if the absolute start time is 13:23:45:678 on January 30, 2012, this row would look like:

Start Time,20120130132345678

**NOTE** The resolution of the absolute time stored is 1 ms, which matches up with the fact that the fastest sweep time is also 1 ms. However, there is no specification for the absolute accuracy of the clock in the analyzer, nor is there any facility provided to allow the user to set this time to any particular degree of accuracy.

Traces that have not yet been filled in the Spectrogram display are empty; there is no DATA header for them. The file ends after the last non-empty trace.

Imagine that, at the point where a Spectrogram Meas Result is requested, the following screen is showing:

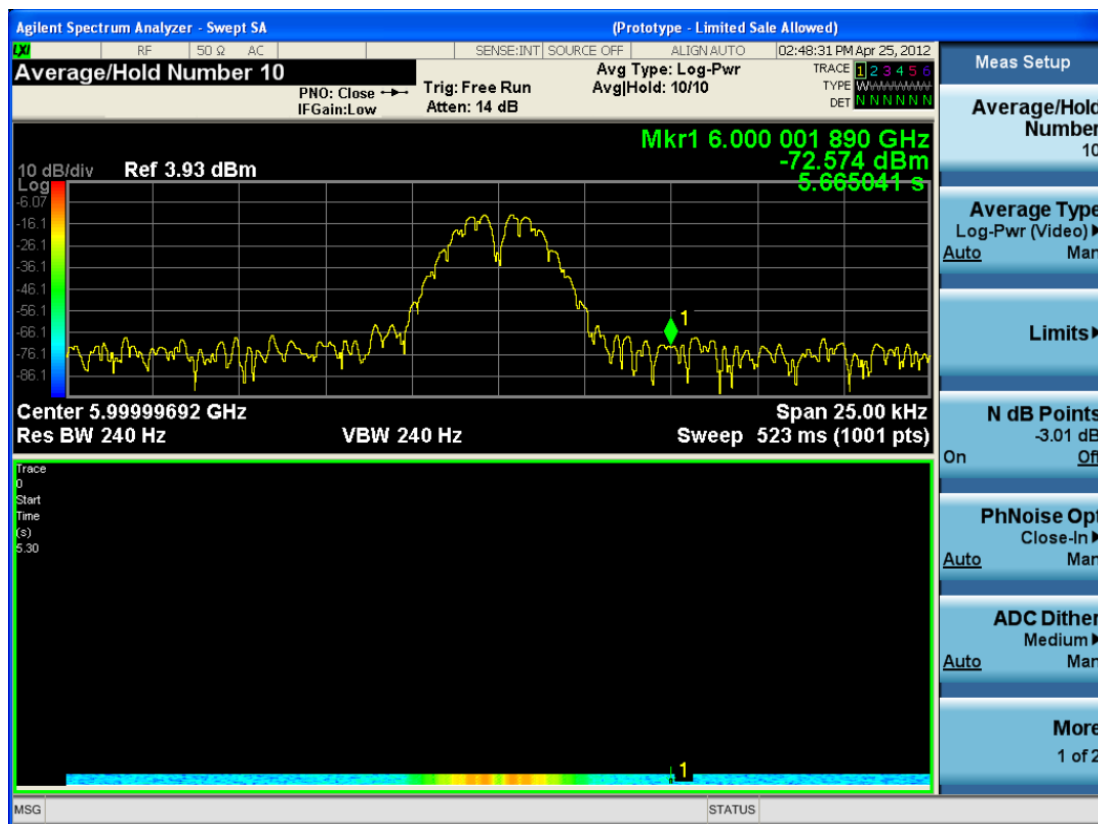

For the purpose of this example, we have set the Average/Hold Number to 10, thus we have only traces 0 thru 10. The Spectrogram was started at 02:28:08:700 pm on April 25, 2012 (that is, 700 ms after 2:28:08 pm), although the screen dump itself shows a different time, as it was taken ten minutes after the

Spectrogram data. Trace 0 is showing a start time of 5.30 seconds, meaning 5.3 seconds after the Spectrogram started (trace 10 has a start time of 0, as it was the first trace taken but has now rolled up into the tenth trace slot).

The Meas Results file, when opened, shows the header data and ten traces of trace data. Below is an extract from the result file for the above display. Note the start time of 20120425142808700 showing in the last row before the first DATA row, and the relative time of 5.299231048 showing in the first DATA row:

<b>Result Type</b>	<b>Spectrogram</b>
MeasResult	
Swept SA	
A.11.00.01	N9020A
503 508 513 526 ALL ALV B1C B1X B25 B2X B40 BAB BBA CR3 CRP DP2 DRD EA3 EDP EMC EP1 ERC ESC ESP EXM FSA HBA K03 LFE MPB P03 P08 P13 P26 PFR RTL RTS S40 SB1 SEC SM1 UK6 YAS YAV	1
Segment	0
Number of Points	1001
Sweep Time	0.523333333
Start Frequency	5999984415
Stop Frequency	6000009415
Average Count	0
Average Type	LogPower(Video)
RBW	240
RBW Filter	Gaussian
RBW Filter BW	3dB
VBW	240
Sweep Type	Swept
X Axis Scale	Lin
PreAmp State	Off
PreAmp Band	Low
Trigger Source	Free
Trigger Level	1.2
Trigger Slope	Positive
Trigger Delay	0
Phase Noise Optimization	Wide
Swept If Gain	Low
FFT If Gain	Autorange
RF Coupling	AC

Result Type	Spectrogram
FFT Width	411900
Ext Ref	10000000
Input	RF
RF Calibrator	Off
Attenuation	14
Ref Level Offset	0
External Gain	0
Trace Type	Clearwrite
Detector	Normal
Trace Math	Off
Trace Math Oper1	Trace5
Trace Math Oper2	Trace6
Trace Math Offset	0
Trace Name	Trace1
X Axis Units	Hz
Y Axis Units	dBm
Start Time	20120425142808700
DATA	5.299231048
5999984415	-76.34749519
5999984440	-77.28097006
5999984465	-75.32317869
5999984490	-73.64417681
5999984515	-72.67154604

- o
- o
- o

6000009315	-77.94423277
6000009340	-79.51829697
6000009365	-78.46108961
6000009390	-78.46108957
6000009415	-76.59570596
DATA2	4.708697055
5999984415	-80.98197882
5999984440	-80.98197879

---

5999984465	-75.83142132
5999984490	-74.02712079
5999984515	-73.57213005

---

O  
O  
O

---

6000009315	-75.9183103
6000009340	-79.53787488
6000009365	-78.82602191
6000009390	-78.82602188
6000009415	-76.37486709
DATA10	0
5999984415	-75.56751112
5999984440	-75.76485645
5999984465	-76.67718717
5999984490	-78.79238489
5999984515	-83.72680212

---

O  
O  
O

---

6000009315	-71.3942461
6000009340	-72.28308332
6000009365	-73.92684489
6000009390	-75.45548832
6000009415	-75.17904815

---

### Capture Buffer

Capture Buffer functionality is not available for all measurements. The captured data is raw data which is not processed.

---

Key Path	Save, Data
----------	------------

---

Mode	CDMA1XEV
Example	MMEM:STOR:CAPT "MyCaptureData.bin" This stores the capture data in the file MyCaptureData.bin in the default directory.
Dependencies	In case the capture buffer data is not available from the selected measurement, the key will be grayed out.
Initial S/W Revision	A.11.00

## Save As . . .

When you press “Save As”, the analyzer brings up a Windows dialog and a menu entitled “**Save As.**” This menu allows you to navigate to the various fields in the Windows dialog without using a keyboard or mouse. The Tab and Arrow keys can also be used for dialog navigation.

See "[To File . . .](#)" on page 2897 in Save, State for a full description of this dialog and menu.

The default path for saving files is:

For all of the Trace Data Files:

My Documents\`<mode name>`\data\traces

For all of the Limit Data Files:

My Documents\`<mode name>`\data\limits

For all of the Measurement Results Data Files:

My Documents\`<mode name>`\data\`<measurement name>`\results

For all of the Capture Buffer Data Files:

My Documents\`<mode name>`\data\captureBuffer

Key Path	Save, Data
Mode	All
Notes	The key location is mode-dependent and will vary. Brings up the Save As dialog for saving a <code>&lt;mode specific&gt;</code> Save Type. The save is performed immediately and does not wait until the measurement is complete.
Initial S/W Revision	Prior to A.02.00

## Screen Image

Pressing Screen Image accesses a menu of functions that enable you to specify a format and location for the saved screen image. It brings up a menu that allows you to specify the color scheme of the Screen Image (Themes) or navigate to the Save As dialog to perform the actual save.

Screen Image files contain an exact representation of the analyzer display. They cannot be loaded back onto the analyzer, but they can be loaded into your PC for use in many popular applications.

The image to be saved is actually captured when the Save front panel key is pressed, and kept in temporary storage to be used if you ask for a Screen Image save. When the Screen Image key is pressed, a "thumbnail" of the captured image is displayed, as shown below:

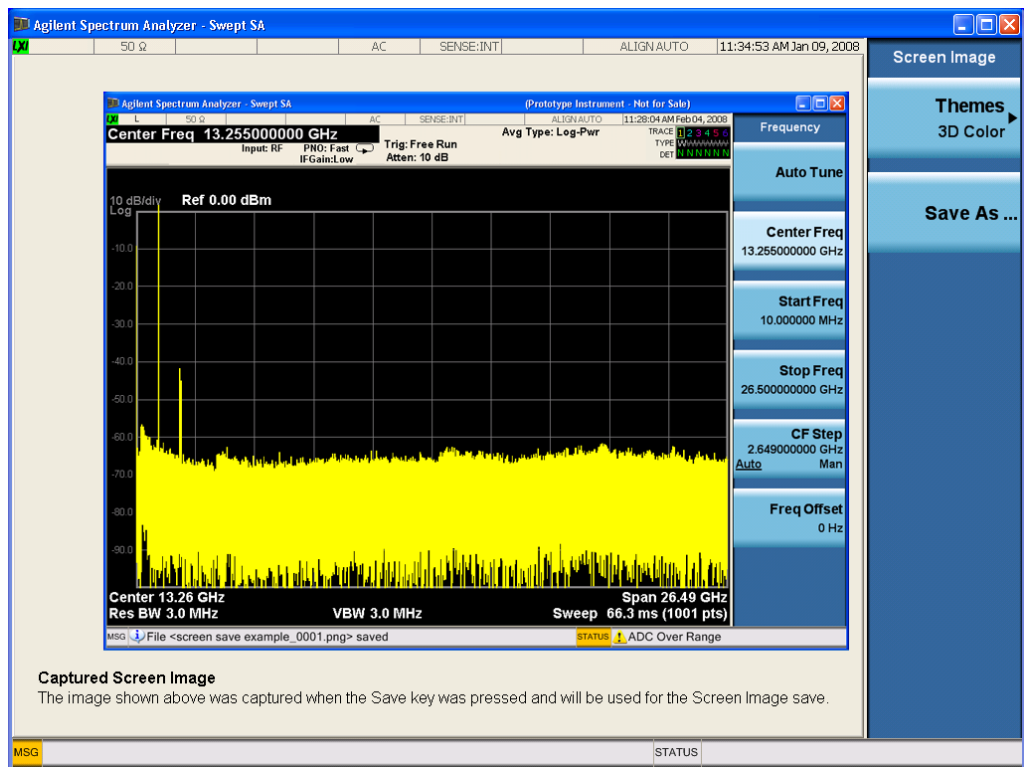

When you continue on into the Save As menu and complete the Screen Image save, the image depicted in the thumbnail is the one that gets saved, showing the menus that were on the screen before going into the Save menus. The save is performed immediately and does not wait until the measurement is complete.

After you have completed the save, the Quick Save front-panel key lets you quickly repeat the last save performed, using an auto-named file, with the current screen data.

**NOTE**

For versions previous to A.01.55, if you initiate a screen image save by navigating through the Save menus, the image that is saved will contain the Save menu softkeys, not the menus and the active function that were on the screen when you first pressed the Save front panel key.

Key Path	Save
Mode	All
Remote Command	:MMEMory:STORe:SCReen <filename>
Example	:MMEM:STOR:SCR "myScreen.png" This stores the current screen image in the file MyScreenFile.png in the default directory.
Initial S/W Revision	Prior to A.02.00

## Themes

Accesses a menu of functions that enable you to choose the theme to be used when saving the screen image.

The **Themes** option is the same as the **Themes** option under the **Display** and **Page Setup** dialogs. It allows you to choose between themes to be used when saving the screen image.

<b>Key Path</b>	Save, Screen Image
<b>Remote Command</b>	:MMEMory:STORe:SCReen:THEMe TDColor   TDMonochrome   FCOLor   FMONochrome  :MMEMory:STORe:SCReen:THEMe?
<b>Example</b>	:MMEM:STOR:SCR:THEM TDM
<b>Preset</b>	3D Color; Is not part of Preset, but is reset by Restore Misc Defaults or Restore System Defaults All and survives subsequent running of the modes.
<b>Readback</b>	3D Color   3D Mono   Flat Color   Flat Mono
<b>Backwards Compatibility Notes</b>	In ESA and PSA we offer the choice of "Reverse Bitmap" or "Reverse Metafile" when saving screen images. This is much like the "Flat Color" theme available in X-Series. Also, if you selected Reverse Bitmap AND a black & white screen image, that would be much like "Flat Monochrome". In other words, each of the X-Series themes has a similar screen image type in ESA/PSA. But they are not identical.
<b>Initial S/W Revision</b>	Prior to A.02.00

### 3D Color

Selects a standard color theme with each object filled, shaded and colored as designed.

<b>Key Path</b>	Save, Screen Image, Themes
<b>Example</b>	MMEM:STOR:SCR:THEM TDC
<b>Readback</b>	3D Color
<b>Initial S/W Revision</b>	Prior to A.02.00

### 3D Monochrome

Selects a format that is like 3D color but shades of gray are used instead of colors.

<b>Key Path</b>	Save, Screen Image, Themes
<b>Example</b>	MMEM:STOR:SCR:THEM TDM
<b>Readback</b>	3D Mono
<b>Initial S/W Revision</b>	Prior to A.02.00

### Flat Color

Selects a format that is best when the screen is to be printed on an ink printer.

Key Path	Save, Screen Image, Themes
<b>Example</b>	MMEM:STOR:SCR:THEM FCOL
Readback	Flat Color
Initial S/W Revision	Prior to A.02.00

### Flat Monochrome

Selects a format that is like Flat Color. But only black is used (no colors, not even gray), and no fill.

Key Path	Save, Screen Image, Themes
<b>Example</b>	MMEM:STOR:SCR:THEM FMON
Readback	Flat Mono
Initial S/W Revision	Prior to A.02.00

### Save As...

When you press “Save As”, the analyzer brings up a Windows dialog and a menu entitled “**Save As.**” This menu allows you to navigate to the various fields in the Windows dialog without using a keyboard or mouse. The Tab and Arrow keys can also be used for dialog navigation.

See "[To File . . .](#)" on page 2897 in Save, State for a full description of this dialog and menu.

The default path for Screen Images is

My Documents\`<mode name>`\screen.

where `<mode name>` is the parameter used to select the mode with the INST:SEL command (for example, SA for the Spectrum Analyzer).

Key Path	Save, Screen Image
Notes	Brings up Save As dialog for saving a Screen Image Save Type
Initial S/W Revision	Prior to A.02.00

### Mass Storage Catalog (Remote Command Only)

Key path	SCPI Only
<b>Remote Command</b>	:MMEMory:CATalog? [ <code>&lt;directory_name&gt;</code> ]
Notes	The string must be a valid logical path. Queries disk usage information (drive capacity, free space available) and obtains a list of files and directories in a specified directory in the following format: <code>&lt;numeric_value&gt;,&lt;numeric_value&gt;,{&lt;file_entry&gt;}</code> It returns two numeric parameters and as many strings as there are files and directories. The first



---

parameter indicates the total amount of storage currently used in bytes. The second parameter indicates the total amount of storage available, also in bytes. The <file\_entry> is a string. Each <file\_entry> indicates the name, type, and size of one file in the directory list:

<file\_name>,<file\_type>,<file\_size>

As the windows file system has an extension that indicates file type, <file\_type> is always empty. <file\_size> provides the size of the file in bytes. For directories, <file\_entry> is surrounded by square brackets and both <file\_type> and <file\_size> are empty

---

Initial S/W Revision      Prior to A.02.00

---

## Mass Storage Change Directory (Remote Command Only)

---

Key path                      SCPI Only

**Remote Command**        :MMEMory:CDIRectory [<directory\_name>]  
                                  :MMEMory:CDIRectory?

**Notes**                      The string must be a valid logical path.

Changes the default directory for a mass memory file system. The <directory\_name> parameter is a string. If no parameter is specified, the directory is set to the \*RST value.

At \*RST, this value is set to the default user data storage area, that is defined as System.Environment.SpecialFolder.Personal.

Query returns full path of the default directory.

---

Initial S/W Revision      Prior to A.02.00

---

## Mass Storage Copy (Remote Command Only)

---

Key path                      SCPI Only

**Remote Command**        :MMEMory:COPY <string>,<string> [,<string>,<string>]

**Notes**                      The string must be a valid logical path.

Copies an existing file to a new file or an existing directory to a new directory.

Two forms of parameters are allowed. The first form has two parameters. In this form, the first parameter specifies the source, and the second parameter specifies the destination.

The second form has four parameters. In this form, the first and third parameters specify the source. The second and fourth parameters specify the directories. The first pair of parameters specifies the source. The second pair specifies the destination. An error is generated if the source doesn't exist or the destination file already exists.

This command will generate an "access denied" error if the destination is a restricted folder (e.g., C:\Windows) and the current user does not have Power User or Administrator privileges.

---

## Mass Storage Device Copy (Remote Command Only)

This command transfers data to/from a file and a peripheral device.

Key path	SCPI Only
<b>Remote Command</b>	:MMEMory:COpy:DEvice <source_string>,<dest_string>
Notes	The strings must be a valid logical path or a valid device keyword. If the dest_string is a device keyword, the data is copied from the source file to the device. If the source_string is a device keyword, the data is copied to the source file from the device.  Valid device keywords are: SNS (smart noise source)  An error is generated if the file or device is not found.

### Mass Storage Delete (Remote Command Only)

Key path	SCPI Only
<b>Remote Command</b>	:MMEMory:DELeTe <file_name>[,<directory_name>]
Notes	The string must be a valid logical path.  Removes a file from the specified directory. The <file_name> parameter specifies the file name to be removed. This command will generate an "access denied" error if the file is in a restricted folder (e.g., C:\Windows) and the current user does not have Power User or Administrator privileges.
Initial S/W Revision	Prior to A.02.00

### Mass Storage Data (Remote Command Only)

Creates a file containing the specified data OR queries the data from an existing file.

Key path	SCPI Only
<b>Remote Command</b>	:MMEMory:DATA <file_name>, <data> :MMEMory:DATA? <file_name>
Notes	The string must be a valid logical path.  The command form is MMEMory:DATA <file_name>,<data>. It loads <data> into the file <file_name>. <data> is in 488.2 block format. <file_name> is string data.  The query form is MMEMory:DATA? <file_name> with the response being the associated <data> in block format.
Initial S/W Revision	Prior to A.02.00

### Mass Storage Make Directory (Remote Command Only)

Key path	SCPI Only
<b>Remote Command</b>	:MMEMory:MDIRectory <directory_name>
Notes	The string must be a valid logical path.  Creates a new directory. The <directory_name> parameter specifies the name to be created.

	This command will generate an “access denied” error if the new directory would be in a restricted folder (e.g., C:\Windows) and the current user does not have Power User or Administrator privileges.
Initial S/W Revision	Prior to A.02.00

### Mass Storage Move (Remote Command Only)

Key path	SCPI Only
<b>Remote Command</b>	:MMEMory:MOVE <string>,<string>[,<string>,<string>]
Notes	<p>The string must be a valid logical path.</p> <p>Moves an existing file to a new file or an existing directory to a new directory.</p> <p>Two forms of parameters are allowed. The first form has two parameters. In this form, the first parameter specifies the source, and the second parameter specifies the destination.</p> <p>The second form has four parameters. In this form, the first and third parameters specify the source. The second and fourth parameters specify the directories. The first pair of parameters specifies the source. The second pair specifies the destination. An error is generated if the source doesn't exist or the destination file already exists.</p> <p>This command will generate an “access denied” error if the destination is a restricted folder (e.g., C:\Windows) and the current user does not have Power User or Administrator privileges.</p>
Initial S/W Revision	Prior to A.02.00

### Mass Storage Remove Directory (Remote Command Only)

Key path	SCPI Only
<b>Remote Command</b>	:MMEMory:RDIRECTory <directory_name>
Notes	<p>The string must be a valid logical path.</p> <p>Removes a directory. The &lt;directory_name&gt; parameter specifies the directory name to be removed. All files and directories under the specified directory shall also be removed.</p> <p>This command will generate an “access denied” error if the folder is a restricted folder (e.g., C:\Windows) or is in a restricted folder and the current user does not have Power User or Administrator privileges.</p>
Initial S/W Revision	Prior to A.02.00

## Single (Single Measurement/Sweep)

Sets the analyzer for Single measurement operation. The single/continuous state is Meas Global, so the setting will affect all the measurements. If you are Paused, pressing Single does a Resume.

See ["More Information" on page 2576](#)

Key Path	Front-panel key
Example	:INIT:CONT OFF
Notes	See Cont key description.
Backwards Compatibility Notes	<p>For Spectrum Analysis mode in ESA and PSA, the Single hardkey and the INITiate:IMM switched from continuous measurement to single measurement and restarted sweeps and averages (displayed average count reset to 1), but did not restart Max Hold and Min Hold. In the X-Series, the Single hardkey and the INITiate:IMM command initiate a sweep/ measurement/ average sequence/hold sequence including MaxHold and MinHold.</p> <p>For Spectrum Analysis mode in ESA and PSA, the Single hardkey restarted the sweep regardless of whether or not you were in an active sweep or sweep sequence. In the X-Series, Restart does this but Single only restarts the sweep or sweep sequence if you are in the idle state.</p> <p>INIT[:IMM] in ESA &amp; PSA Spectrum Analysis Mode does an implied ABORT. In some other PSA Modes, INIT[:IMM] is ignored if not in the idle state. . The X-Series follows the ESA/PSA SA Mode model, which may cause some Modes to have compatibility problems.</p>
Initial S/W Revision	Prior to A.02.00

### More Information

See ["Restart" on page 2894](#) for details on the INIT:IMMEDIATE (Restart) function.

If you are already in single sweep, the INIT:CONT OFF command has no effect.

If you are already in Single Sweep, then pressing the Single key in the middle of a sweep does not restart the sweep or sequence. Similarly, pressing the Single key does not restart the sweep or sequence if the sweep is not in the idle state (for example, if you are taking a very slow sweep, or the analyzer is waiting for a trigger). Instead, it results in a message. "Already in Single, press Restart to initiate a new sweep or sequence". Even though pressing the Single key in the middle of a sweep does not restart the sweep, sending INIT:IMMEDIATE does reset it.

To take one more sweep without resetting the average count, increment the average count by 1, by pressing the step up key while **Average/Hold Number** is the active function, or sending the remote command CALC:AVER:TCON UP.

## Source

There is no Source control functionality for this measurement. When this key is pressed, the screen either displays a blank menu, or the previously-selected menu remains unchanged.

---

Key Path	Front-panel key
----------	-----------------

---

## SPAN X Scale

Accesses a menu of functions that enable you set the horizontal scale parameters.

This menu is blank if the selected **window** is:

- I/Q Measured Polar Graph or,
- RMS EVM (Numeric Results).

For details of available **views** in this measurement, see "[View/Display](#)" on page 2588. Within a view, you can change the selected window by pressing the Next Window key.

---

Key Path	Front-panel key
Initial S/W Revision	Prior to A.02.00

---

## Sweep/Control

Accesses a menu that enables you to pause and restart the measurement.

Key Path	Front-panel key
Initial S/W Revision	Prior to A.02.00

## Pause

Pauses a measurement after the current data acquisition is complete. When Paused, the label on the key changes to Resume. Pressing the Resume key resumes the measurement from the point it was at when paused. See ["Pause/Resume" on page 2925](#) for more details.

Key Path	Sweep/Control
Initial S/W Revision	Prior to A.02.00

## System

See "[System](#)" on page 359



## Trace/Detector

There is no Trace/Detector functionality supported in QPSK EVM. This front-panel key displays a blank menu when pressed.

---

Key Path	Front-panel key
Initial S/W Revision	Prior to A.02.00

---

## Trigger

See ["Trigger" on page 430](#)

### Free Run

See ["Free Run " on page 437](#)

### Video

See ["Video \(IF Envelope\) " on page 438](#)

### Trigger Level

See ["Trigger Level " on page 438](#)

### Trig Slope

See ["Trig Slope " on page 439](#)

### Trig Delay

See ["Trig Delay " on page 440](#)

### Line

See ["Line " on page 2729](#)

### Trig Slope

See ["Trig Slope " on page 2729](#)

### Trig Delay

See ["Trig Delay " on page 442](#)

### External 1

See ["External 1 " on page 2741](#)

### Trigger Level

See ["Trigger Level " on page 2741](#)

### Trig Slope

See ["Trig Slope " on page 2742](#)

### Trig Delay

See ["Trig Delay " on page 445](#)

### External 2

See ["External 2 " on page 2743](#)

## Trigger Level

See ["Trigger Level "](#) on page 2743

## Trig Slope

See ["Trig Slope "](#) on page 2744

## Trig Delay

See ["Trig Delay "](#) on page 447

## RF Burst

See ["RF Burst "](#) on page 2744

## Absolute Trigger

See ["Absolute Trigger Level"](#) on page 2745

## Relative Trigger

See ["Relative Trigger Level"](#) on page 2734

## Trig Slope

See ["Trigger Slope "](#) on page 2746

## Trig Delay

See ["Trig Delay "](#) on page 451

## Periodic Timer

See ["Periodic Timer \(Frame Trigger\) "](#) on page 2736

## Period

See ["Period "](#) on page 2737

## Offset

See ["Offset "](#) on page 2738

## Offset Adjust (Remote Command Only)

See ["Offset Adjust \(Remote Command Only\)"](#) on page 2739

## Reset Offset Display

See ["Reset Offset Display "](#) on page 2740

## Sync Source

See ["Sync Source "](#) on page 2740

## Off

See ["Off "](#) on page 2741

## External 1

See ["External 1 "](#) on page 2741

## Trigger Level

See ["Trigger Level "](#) on page 2741

## Trig Slope

See ["Trig Slope "](#) on page 2742

## External 2

See ["External 2 "](#) on page 2743

## Trigger Level

See ["Trigger Level "](#) on page 2743

## Trig Slope

See ["Trig Slope "](#) on page 2744

## RF Burst

See ["RF Burst "](#) on page 2744

## Absolute Trigger

See ["Absolute Trigger Level"](#) on page 2745

## Trig Slope

See ["Trigger Slope "](#) on page 2746

## Trig Delay

See ["Trig Delay"](#) on page 461

## Auto/Holdoff

See ["Auto/Holdoff "](#) on page 462

## Auto Trig

See ["Auto Trig "](#) on page 462

## Trig Holdoff

See ["Trig Holdoff "](#) on page 463

## User Preset

Accesses a menu that gives you the following three choices:

- User Preset – recalls a state previously saved using the Save User Preset function.
- User Preset All Modes – presets all of the modes in the analyzer
- Save User Preset– saves the current state for the current mode

Key Path	Front-panel key
Backwards Compatibility Notes	<p>User Preset is actually loading a state, and in legacy analyzers, it was possible to load a state without affecting the trace data, limit lines or correction data. Similarly it was possible to do a User Preset without affecting the trace data, limit lines or correction data.</p> <p>In the X-Series, “state” always includes all of this data; so whenever state is loaded, or User Preset is executed, all of the traces, limit lines and corrections are affected. Although this differs from previous behavior, it is desirable behavior, and should not cause adverse issues for users.</p> <p>On ESA and PSA, User Preset affected the entire instrument’s state. In the X-Series, User Preset only recalls the state for the active mode. There is a User Preset file for each mode. User Preset can never cause a mode switch as it can in legacy analyzers. If you want to recall all modes to their user preset file state, you will need to do a User Preset after mode switching into each mode.</p> <p>User Preset recalls mode state which can now include data like traces; whereas on ESA and PSA, User Preset did not affect data.</p>
Initial S/W Revision	Prior to A.02.00

## User Preset

User Preset sets the state of the currently active mode back to the state that was previously saved for this mode using the Save User Preset menu key or the SCPI command, SYST:PRES:USER:SAV. It not only recalls the Mode Preset settings, but it also recalls all of the mode persistent settings, and the Input/Output system setting that existed at the time Save User Preset was executed.

If a Save User Preset has not been done at any time, User Preset recalls the default user preset file for the currently active mode. The default user preset files are created if, at power-on, a mode detects there is no user preset file. There will never be a scenario when there is no user preset file to restore. For each mode, the default user preset state is the same state that would be saved if a Save User Preset is performed in each mode right after doing a Restore Mode Default and after a Restore Input/Output Defaults.

The User Preset function does the following:

- Aborts the currently running measurement.
- Sets the mode State to the values defined by Save User Preset.
- Makes the saved measurement for the currently running mode the active measurement.
- Brings up the saved menu for the power-on mode.
- Clears the input and output buffers.
- Sets the Status Byte to 0.

Key Path	User Preset
Remote Command	:SYSTem:PRESet:USER
Example	:SYST:PRES:USER:SAVE:SYST:PRES:USER
Notes	:SYST:PRES:USER:SAVE is used to save the current state as the user preset state. Clears all pending OPC bits. The Status Byte is set to 0. Pressing the User Preset front-panel key while already in the User Preset menu will cause the User Preset to get executed
Couplings	A user preset will cause the currently running measurement to be aborted and cause the saved measurement to be active. Recalling a User Preset file has the same issues that recalling a Save State file has. Some settings may need to be limited and therefore re-coupled, since the capabilities of the mode may have changes when the User Preset file was last saved.
Initial S/W Revision	Prior to A.02.00

## User Preset All Modes

Recalls all of the User Preset files for each mode, switches to the power-on mode, and activates the saved measurement from the power-on mode User Preset file.

**NOTE**

When the instrument is secured, all of the user preset files are converted back to their default user preset files.

The User Preset function does the following:

- Aborts the currently running measurement.
- Switches the Mode to the power-on mode.
- Restores the User Preset files for each mode.
- Makes the saved measurement for the power-on mode the active measurement.
- Brings up the saved menu for the power-on mode.
- Clears the input and output buffers.
- Sets the Status Byte to 0.

Key Path	User Preset
Remote Command	:SYSTem:PRESet:USER:ALL
Example	:SYST:PRES:USER:SAVE:SYST:PRES:USER:ALL
Notes	Clears all pending OPC bits. The Status Byte is set to 0. :SYST:PRES:USER:SAVE is used to save the current state as the user preset state.
Couplings	A user preset will cause the currently running measurement to be aborted, cause a mode switch to the power-on mode, and cause the saved measurement to be active in the power-on mode. Recalling a User Preset file has the same issues that recalling a Save State file has. Some settings may need to be limited and therefore re-coupled, since the capabilities of the mode may have changes when the User Preset file was last saved.
Initial S/W Revision	Prior to A.02.00

## Save User Preset

Saves the currently active mode and its State. You can recall this User Preset file by pressing the User Preset menu key or sending the SYST:PRES:USER remote command. This same state is also saved by the Save State function.

Key Path	User Preset
<b>Remote Command</b>	:SYSTem:PRESet:USER:SAVE
<b>Example</b>	:SYST:PRES:USER:SAVE
Notes	:SYST:PRES:SAVE creates the same file as if the user requested a *SAV or a MMEM:STOR:STAT, except User Preset Save does not allow the user to specify the filename or the location of the file.
Initial S/W Revision	Prior to A.02.00

## View/Display

Accesses a menu of functions that enable you to set up and control the display parameters for the current measurement.

Two views are available in this measurement, as described in the sections:

[I/Q Measured Polar Graph](#)

["I/Q Error View" on page 2600](#)

This topic contains the following sections:

["View Selection by name \(Remote Command Only\)" on page 2588](#)

["View Selection by number \(Remote Command only\)" on page 2588](#)

### View Selection by name (Remote Command Only)

Selects the format for the measurement results view.

Mode	WCDMA, C2K, 1xEVDO
<b>Remote Command</b>	:DISPlay:EVMQpsk:VIEW[:SElect] POLar ERRor :DISPlay:EVMQpsk:VIEW[:SElect]?
<b>Example</b>	DISP:EVMQ:VIEW ERR DISP:EVMQ:VIEW?
Couplings	Changing parameter of "ViewNum" (:DISPlay:EVMQpsk:VIEW:NSElect) also changes this parameter.
Preset	POLar
State Saved	Saved in instrument state.
Range	I/Q Measured Polar Vector I/Q Error
Initial S/W Revision	Prior to A.02.00

### View Selection by number (Remote Command only)

Displays the numeric values of the measurement results.

Mode	WCDMA, C2K, 1xEVDO
<b>Remote Command</b>	:DISPlay:EVMQpsk:VIEW:NSElect <integer> :DISPlay:EVMQpsk:VIEW:NSElect?
<b>Example</b>	DISP:EVMQ:VIEW:NSEL 2 DISP:EVMQ:VIEW:NSEL?
Couplings	Changing parameter of "View" (:DISPlay:EVMQpsk:VIEW[:SElect]) also changes this parameter.
Preset	1
State Saved	Saved in instrument state.
Min	1



Max	2
Initial S/W Revision	Prior to A.02.00

Key Path	Front-panel key
Initial S/W Revision	Prior to A.02.00

## Display

The Display menu is common to most measurements, and is used for configuring items on the display. Some Display menu settings apply to all the measurements in a mode, and some only to the current measurement. Those under the System Display Settings key apply to all measurements in all modes.

Key Path	Display
Key Path	View/Display
Initial S/W Revision	Prior to A.02.00

## Annotation

Turns on and off various parts of the display annotation. The annotation is divided up into four categories:

1. Meas Bar: This is the measurement bar at the top of the screen. It does not include the settings panel or the Active Function. Turning off the Meas Bar turns off the settings panel and the Active Function. When the Meas Bar is off, the graticule area expands to fill the area formerly occupied by the Meas Bar.
2. Screen Annotation: this is the annotation and annunciation around the graticule, including any annotation on lines (such as the display line, the threshold line, etc.) This does NOT include the marker number or the N dB result. When off, the graticule expands to fill the entire graticule area.
3. Trace annotation: these are the labels on the traces, showing their detector (or their math mode).
4. Active Function annotation: this is the active function display in the meas bar, and all of the active function values displayed on softkeys.

See the figure below. Each type of annotation can be turned on and off individually.

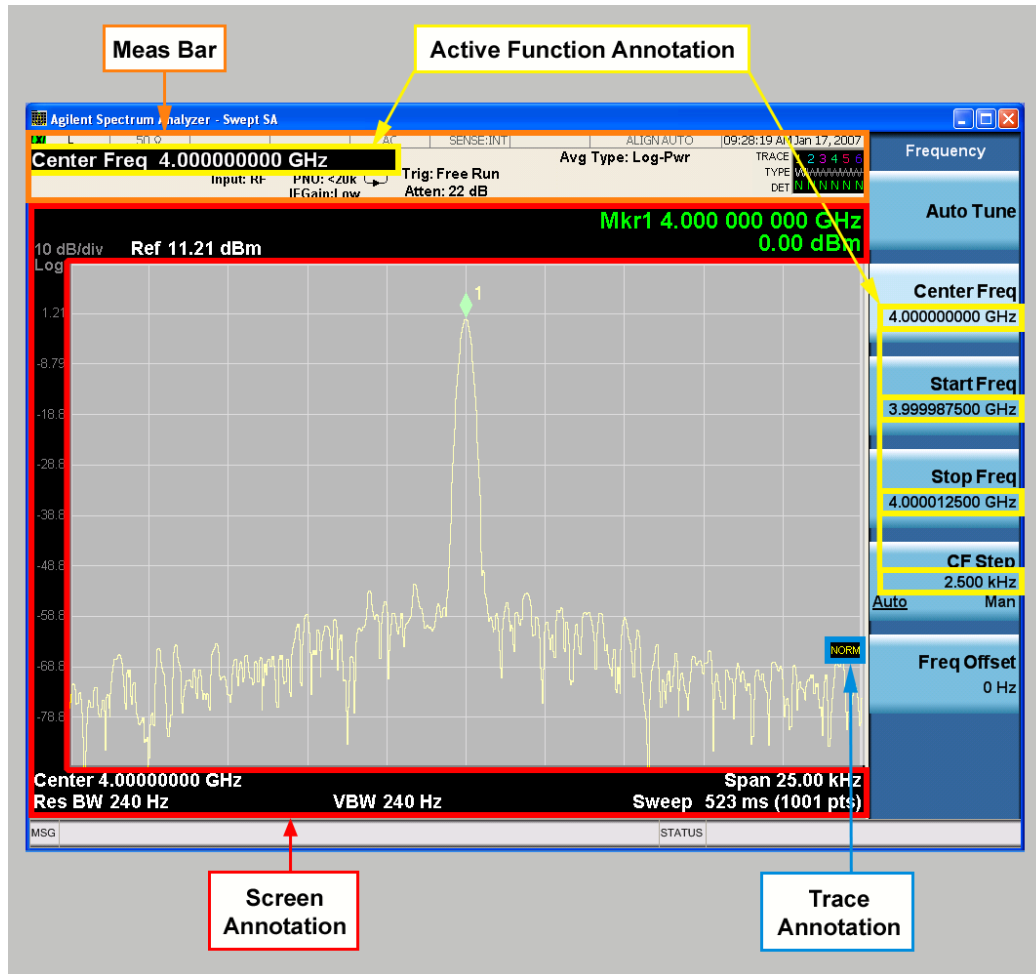

Key Path	View/Display, Display
Initial S/W Revision	Prior to A.02.00

### Meas Bar On/Off

This function turns the Measurement Bar on and off, including the settings panel. When off, the graticule area expands to fill the area formerly occupied by the Measurement Bar.

Key Path	View/Display, Display, Annotation
Remote Command	:DISPlay:ANNOtation:MBAR[:STATe] OFF ON 0 1 :DISPlay:ANNOtation:MBAR[:STATe]?
Example	DISP:ANN:MBAR OFF
Dependencies	Grayed out and forced to OFF when System Display Settings, Annotation is set to Off.
Preset	On This should remain Off through a Preset when System DisplaySettings, Annotation is set to Off.
State Saved	Saved in instrument state.
Initial S/W Revision	Prior to A.02.00

## Screen

This controls the display of the annunciation and annotation around the graticule, including any annotation on lines (such as the display line, the threshold line, etc.) and the y-axis annotation. This does NOT include marker annotation (or the N dB result). When off, the graticule expands to fill the entire graticule area, leaving only the 1.5% gap above the graticule as described in the Trace/Detector chapter.

Key Path	View/Display, Display, Annotation
Remote Command	:DISPlay:ANNotation:SCReen[:STATe] OFF ON 0 1 :DISPlay:ANNotation:SCReen[:STATe]?
Example	DISP:ANN:SCR OFF
Dependencies	Grayed-out and forced to OFF when System Display Settings, Annotation is set to Off.
Preset	On This should remain Off through a Preset when System DisplaySettings, Annotation is set to Off
State Saved	Saved in instrument state.
Initial S/W Revision	Prior to A.02.00

## Active Function Values On/Off

Turns on and off the active function display in the Meas Bar, and all of the active function values displayed on the softkeys.

Note that all of the softkeys that have active functions have these numeric values blanked when this function is on. This is a security feature..

19 QPSK EVM Measurement  
View/Display

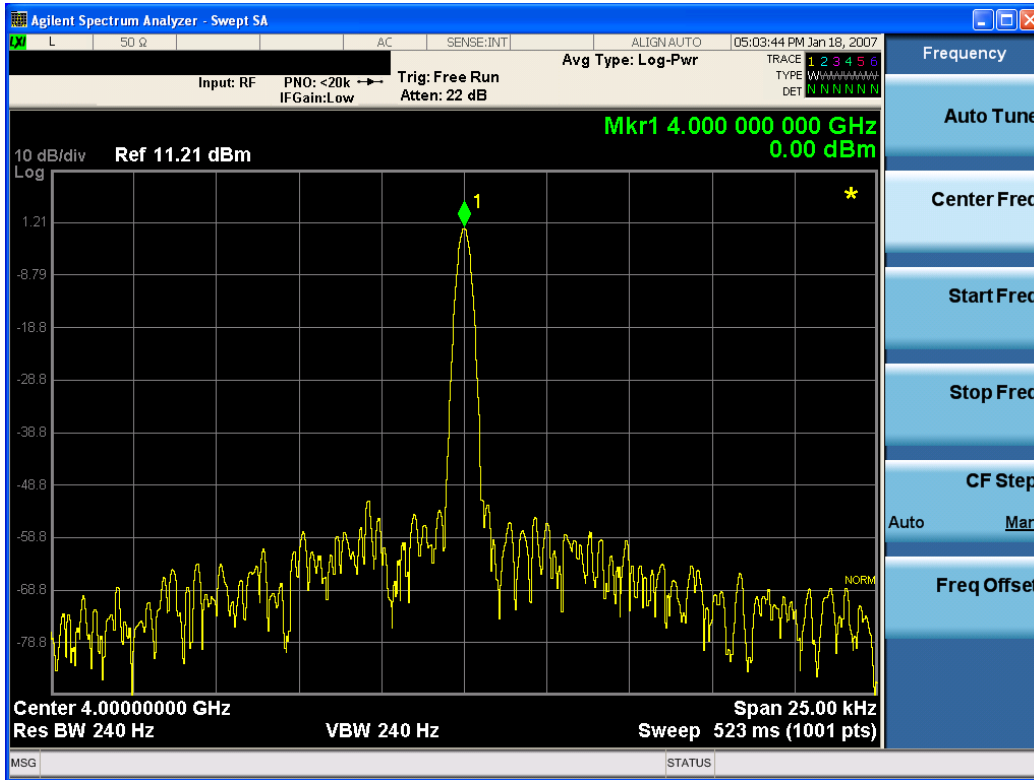

Key Path	View/Display, Display, Annotation
Remote Command	:DISPlay:ACTivefunc[:STATE] ON OFF 1 0 :DISPlay:ACTivefunc[:STATE] ?
Example	DISP:ACT OFF
Dependencies	Grayed out and forced to OFF when System Display Settings, Annotation is set to Off.
Preset	On This should remain Off through a Preset when System DisplaySettings, Annotation is set to Off
State Saved	Saved in instrument state.
Initial S/W Revision	Prior to A.02.00

Title

Displays menu keys that enable you to change or clear a title on your display.

Key Path	View/Display, Display
Initial S/W Revision	Prior to A.02.00

Change Title

Writes a title into the "measurement name" field in the banner, for example, "Swept SA".

Press Change Title to enter a new title through the alpha editor. Press Enter or Return to complete the entry. Press ESC to cancel the entry and preserve your existing title.

The display title will replace the measurement name. It remains for this measurement until you press Change Title again, or you recall a state, or a Preset is performed. A title can also be cleared by pressing Title, Clear Title.

**NOTE**

Notice the inclusion of the <measurement> parameter in the command below. Because each measurement remembers the Display Title, the command must be qualified with the measurement name. For the Swept SA measurement this is not the case; no <measurement> parameter is used when changing the Display Title for the Swept SA measurement.

Key Path	View/Display, Display, Title
Mode	All
Remote Command	:DISPlay:<measurement>:ANNotation:TITLe:DATA <string> :DISPlay:<measurement>:ANNotation:TITLe:DATA?
Example	DISP:ANN:TITL:DATA "This Is My Title" This example is for the Swept SA measurement in the Spectrum Analyzer mode. The SANalyzer <measurement> name is not used. DISP:ACP:ANN:TITL:DATA "This Is My Title" This example is for Measurements other than Swept SA. Both set the title to: This Is My Title
Notes	Pressing this key cancels any active function. When a title is edited the previous title remains intact (it is not cleared) and the cursor goes at the end so that characters can be added or BKSP can be used to go back over previous characters.
Preset	No title (measurement name instead)
State Saved	Saved in instrument state.
Initial S/W Revision	Prior to A.02.00

### Clear Title

Clears a title from the front-panel display. Once cleared, the title cannot be retrieved. After the title is cleared, the current Measurement Name replaces it in the title bar.

Key Path	View/Display, Display, Title
Example	The following commands clear the title and restore the measurement's original title: DISP:ANN:TITL:DATA "" This example is for the Swept SA measurement in the Spectrum Analyzer mode. The SANalyzer <measurement> name is not used. DISP:ACP:ANN:TITL:DATA "" This example is for ACP; in measurements other than Swept SA the measurement name is required.
Notes	Uses the :DISPlay:<measurement>:ANNotation:TITLe:DATA <string> command with an empty string (in the Swept SA, the <measurement> is omitted).
Preset	Performed on Preset.
Initial S/W Revision	Prior to A.02.00

## Graticule

Pressing Graticule turns the display graticule On or Off. It also turns the graticule y-axis annotation on and off.

Key Path	View/Display, Display
Remote Command	:DISPlay:WINDow[1]:TRACe:GRATicule:GRID[:STATe] OFF ON 0 1 :DISPlay:WINDow[1]:TRACe:GRATicule:GRID[:STATe]?
Example	DISP:WIND:TRAC:GRAT:GRID OFF
Notes	The graticule is the set of horizontal and vertical lines that make up the grid/divisions for the x-axis and y-axis.
Preset	On
State Saved	Saved in instrument state
Initial S/W Revision	Prior to A.02.00

## System Display Settings

These settings are "Mode Global" – they affect all modes and measurements and are reset only by Restore Misc Defaults or Restore System Defaults under System.

Key Path	View/Display, Display
Initial S/W Revision	Prior to A.02.00

## Annotation Local Settings

This is a Mode Global override of the meas local annotation settings. When it is All Off, it forces ScreenAnnotation, Meas Bar, Trace, and Active Function Values settings to be OFF for all measurements in all modes. This provides the security based "annotation off" function of previous analyzers; hence it uses the legacy SCPI command.

When it is All Off, the Screen, Meas Bar, Trace, and Active Function Values keys under the Display, Annotation menu are grayed out and forced to Off. When Local Settings is selected, you are able to set the local annotation settings on a measurement by measurement basis.

Key Path	View/Display, Display, System Display Settings
Remote Command	:DISPlay:WINDow[1]:ANNotation[:ALL] OFF ON 0 1 :DISPlay:WINDow[1]:ANNotation[:ALL]?
Example	:DISP:WIND:ANN OFF
Preset	On (Set by Restore Misc Defaults)
State Saved	Not saved in instrument state.
Backwards Compatibility Notes	The WINDow parameter and optional subopcode is included for backwards compatibility but ignored – all windows are equally affected.
Initial S/W Revision	Prior to A.02.00

## Themes

Accesses a menu of functions that enable you to choose the theme to be used when saving the screen image.

The **Themes** option is the same as the **Themes** option under the **Display** and **Page Setup** dialogs. It allows you to choose between themes to be used when saving the screen image.

<b>Key Path</b>	Save, Screen Image
<b>Remote Command</b>	:MMEMory:STORe:SCReem:THEMe TDColor   TDMonochrome   FCOlor   FMONochrome  :MMEMory:STORe:SCReem:THEMe?
<b>Example</b>	:MMEM:STOR:SCR:THEM TDM
<b>Preset</b>	3D Color; Is not part of Preset, but is reset by Restore Misc Defaults or Restore System Defaults All and survives subsequent running of the modes.
<b>Readback</b>	3D Color   3D Mono   Flat Color   Flat Mono
<b>Backwards Compatibility Notes</b>	In ESA and PSA we offer the choice of "Reverse Bitmap" or "Reverse Metafile" when saving screen images. This is much like the "Flat Color" theme available in X-Series. Also, if you selected Reverse Bitmap AND a black & white screen image, that would be much like "Flat Monochrome". In other words, each of the X-Series themes has a similar screen image type in ESA/PSA. But they are not identical.
<b>Initial S/W Revision</b>	Prior to A.02.00

### 3D Color

Selects a standard color theme with each object filled, shaded and colored as designed.

<b>Key Path</b>	Save, Screen Image, Themes
<b>Example</b>	MMEM:STOR:SCR:THEM TDC
<b>Readback</b>	3D Color
<b>Initial S/W Revision</b>	Prior to A.02.00

### 3D Monochrome

Selects a format that is like 3D color but shades of gray are used instead of colors.

<b>Key Path</b>	Save, Screen Image, Themes
<b>Example</b>	MMEM:STOR:SCR:THEM TDM
<b>Readback</b>	3D Mono
<b>Initial S/W Revision</b>	Prior to A.02.00

### Flat Color

Selects a format that is best when the screen is to be printed on an ink printer.

Key Path	Save, Screen Image, Themes
<b>Example</b>	MMEM:STOR:SCR:THEM FCOL
Readback	Flat Color
Initial S/W Revision	Prior to A.02.00

### Flat Monochrome

Selects a format that is like Flat Color. But only black is used (no colors, not even gray), and no fill.

Key Path	Save, Screen Image, Themes
<b>Example</b>	MMEM:STOR:SCR:THEM FMON
Readback	Flat Mono
Initial S/W Revision	Prior to A.02.00

### Backlight

Accesses the display backlight on/off keys. This setting may interact with settings under the Windows "Power" menu.

When the backlight is off, pressing ESC, TAB, SPACE, ENTER, UP, DOWN, LEFT, RIGHT, DEL, BKSP, CTRL, or ALT turns the backlight on without affecting the application. Pressing any other key will turn backlight on and could potentially perform the action as well.

Key Path	View/Display, Display, System Display Settings
<b>Remote Command</b>	:DISPlay:BACKlight ON OFF :DISPlay:BACKlight?
Preset	ON (Set by Restore Misc Defaults)
Initial S/W Revision	Prior to A.02.00

### Backlight Intensity

An active function used to set the backlight intensity. It goes from 0 to 100 where 100 is full on and 0 is off. This value is independent of the values set under the Backlight on/off key.

Key Path	View/Display, Display, System Display Settings
<b>Remote Command</b>	:DISPlay:BACKlight:INTensity <integer> :DISPlay:BACKlight:INTensity?
<b>Example</b>	DISP:BACK:INT 50



Preset	100 (Set by Restore Misc Defaults)
Min	0
Max	100
Initial S/W Revision	Prior to A.02.00

## I/Q Polar Vec/Constln

Specifies the format of the polar vector graph display. The following display options are available:

- Vector and Constellation
- Vector Only
- Constellation Only

Key Path	View/Display
Mode	WCDMA, C2K, 1xEVDO
<b>Remote Command</b>	:DISPlay:EVMQpsk:VIEW[1]:WINDow2:TRACe:POLar VC   VECTor   CONSTln :DISPlay:EVMQpsk:VIEW[1]:WINDow2:TRACe:POLar?
<b>Example</b>	DISP:EVMQ:VIEW:WIND2:TRAC:POL VECT DISP:EVMQ:VIEW:WIND2:TRAC:POL?
Notes	Allows to specify the format of the polar vector graph display by: Vector and Constellation Vector Only Constellation Only
Preset	VC
State Saved	Saved in instrument state.
Range	Vec & Constln Vector Constellation
Readback Text	Vec & Constln Vector Constln
Initial S/W Revision	Prior to A.02.00

## Chip Offset

Sets the chip offset number from the first chip in a measured signal.

Key Path	View/Display, Display
Mode	WCDMA, C2K, 1xEVDO
<b>Remote Command</b>	:DISPlay:EVMQpsk:VIEW[1]:WINDow2:TRACe:COFFset <integer> :DISPlay:EVMQpsk:VIEW[1]:WINDow2:TRACe:COFFset?
<b>Example</b>	DISP:EVMQ:VIEW:WIND2:TRAC:COFF 1001 DISP:EVMQ:VIEW:WIND2:TRAC:COFF?

Notes	The number of chip offset from the first chip in a measured signal.
Preset	0
State Saved	Saved in instrument state.
Min	0
Max	Meas Interval – I/Q Chips
Initial S/W Revision	Prior to A.02.00

## I/Q Chips

Specifies the number of I/Q chips used to display the I/Q waveforms.

Key Path	View/Display, Display
Mode	WCDMA, C2K, 1xEVDO
Remote Command	:DISPlay:EVMQpsk:VIEW[1]:WINDow2:TRACe:IQCHips <integer> :DISPlay:EVMQpsk:VIEW[1]:WINDow2:TRACe:IQCHips?
Example	DISP:EVMQ:VIEW:WIND2:TRAC:IQCH 1001 DISP:EVMQ:VIEW:WIND2:TRAC:IQCH?
Couplings	This parameter is dependent on Meas Interval and cannot be set to a value greater than Meas Interval.
Preset	C2K: 512 WCDMA: 2560 1xEVDO: 224
State Saved	Saved in instrument state.
Min	1
Max	WCDMA: 5120 C2K:1536
Initial S/W Revision	Prior to A.02.00

## Interpolation

Toggles the interpolation function from On to Off. If set to On, the vector lines between chip dots are converted into smooth curves by the interpolation function.

Key Path	View/Display, Display
Mode	WCDMA, C2K, 1xEVDO
Remote Command	:DISPlay:EVMQpsk:VIEW[1]:WINDow2:TRACe:INTPolation[:STATe] OFF   ON   0   1 :DISPlay:EVMQpsk:VIEW[1]:WINDow2:TRACe:INTPolation[:STATe]?
Example	DISP:EVMQ:VIEW:WIND2:TRAC:INTP ON

	DISP:EVMQ:VIEW:WIND2:TRAC:INTP?
Notes	If set to ON, the vector lines between chip dots are converted into smoothed curves by the interpolation function.
Preset	OFF
State Saved	Saved in instrument state.
Range	On Off
Initial S/W Revision	Prior to A.02.00

### +45° Rotation

Toggles the state of the rotation of the I/Q polar trace. If set to On, the I/Q polar trace is rotated by 45 degrees to provide a rectangular display.

Key Path	View/Display, Display
Mode	WCDMA, C2K, 1xEVDO
Remote Command	:DISPlay:EVMQpsk:VIEW[1]:WINDow2:TRACe:ROTQpi[:STATe] OFF   ON   0   1 :DISPlay:EVMQpsk:VIEW[1]:WINDow2:TRACe:ROTQpi[:STATe]?
Example	DISP:EVMQ:VIEW:WIND2:TRAC:ROTQ ON DISP:EVMQ:VIEW:WIND2:TRAC:ROTQ?
Notes	Enables you to toggle whether the I/Q polar trace is rotated by 45 degrees to provide a rectangular display.
Preset	OFF
State Saved	Saved in instrument state.
Range	On Off
Initial S/W Revision	Prior to A.02.00

### Full Vector

Toggles the gray background from On to Off when displaying the full measured trace or the selected vector on the display.

Key Path	View/Display, Display
Mode	WCDMA, C2K, 1xEVDO
Remote Command	:DISPlay:EVMQpsk:VIEW[1]:WINDow2:TRACe:FVECTor[:STATe] OFF   ON   0   1 :DISPlay:EVMQpsk:VIEW[1]:WINDow2:TRACe:FVECTor[:STATe]?
Example	DISP:EVMQ:VIEW:WIND2:TRAC:FVEC ON DISP:EVMQ:VIEW:WIND2:TRAC:FVEC?
Notes	This is useful when you want to observe the full vector and the selected vector set by I/Q Chips and Chip Offset simultaneously.

Preset	OFF
State Saved	Saved in instrument state.
Range	On Off
Initial S/W Revision	Prior to A.02.00

### I/Q Error View

Provides a combination view. This view consists of four windows:

"Mag Error vs. Symbol Window" on page 2600

"Phase Error vs. Symbol Window" on page 2601

"EVM vs. Symbol Window" on page 2601

"Numeric Results Window" on page 2601

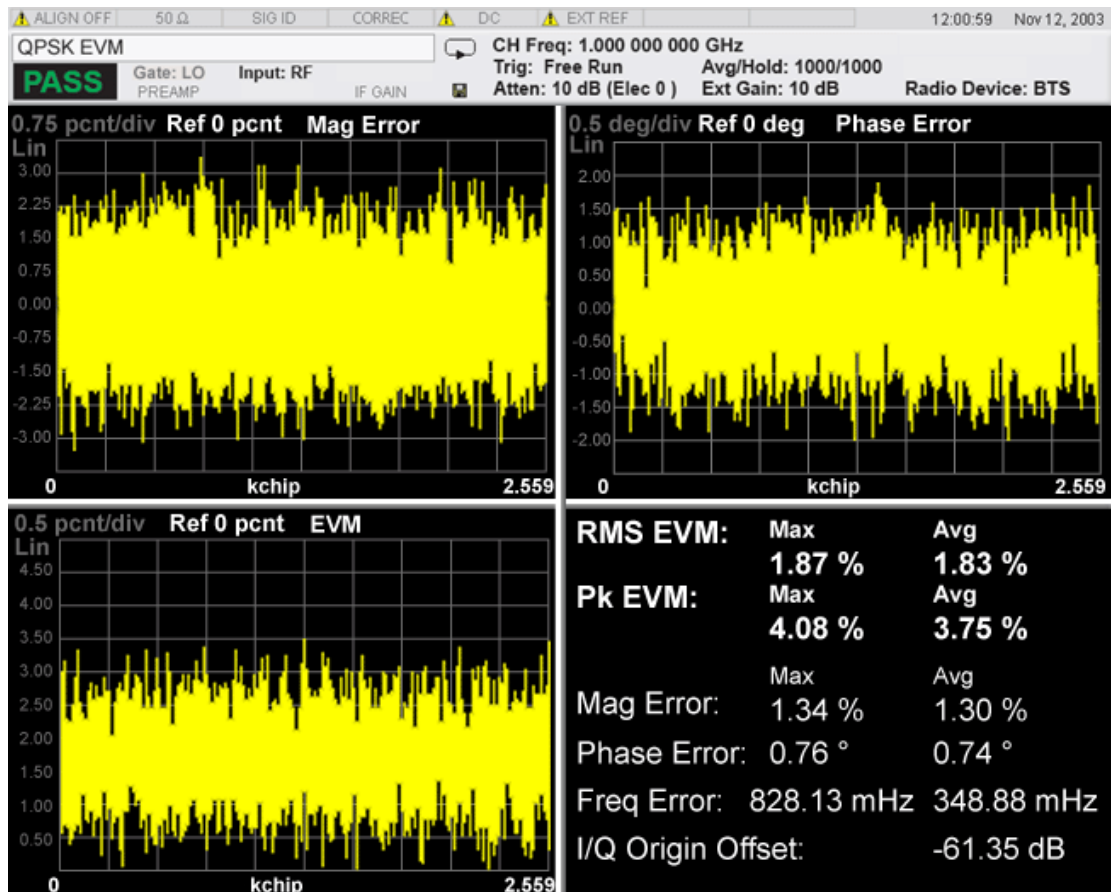

Figure 0-4 I/Q Error (Quad View)

### Mag Error vs. Symbol Window

Provides Magnitude Error vs. Symbol results.

Marker Trace	Yes
Corresponding Trace	Magnitude Error trace (n=3)

### Phase Error vs. Symbol Window

Provides Magnitude Error vs. Symbol results.

Marker Trace	Yes
Corresponding Trace	Phase Error trace (n=4)

### EVM vs. Symbol Window

Provides EVM vs. Symbol results.

Marker Trace	Yes
Corresponding Trace	EVM trace (n=2)

### Numeric Results Window

Shows numeric results as the same as the numeric results of the I/Q polar graph.

Key Path	View/Display
Initial S/W Revision	Prior to A.02.00



## 20 Monitor Spectrum Measurement

The monitor spectrum measurement is used as a quick, convenient means of looking at the entire spectrum. While the look and feel are similar to the Spectrum Analyzer mode, the functionality is greatly reduced for easy operation. The main purpose of the measurement is to show the spectrum. The default span should cover an appropriate frequency range of the application.

For measurement results and views, see ["View/Display" on page 2765](#).

This topic contains the following sections:

["Measurement Commands for Monitor Spectrum" on page 2604](#)

["Remote Command Results for Monitor Spectrum Measurement" on page 2605](#)

## Measurement Commands for Monitor Spectrum

The following commands can be used to retrieve the measurement results:

`:CONFigure:MONitor`

`:CONFigure:MONitor:NDEFault`

`:INITiate:MONitor`

`:FETCh:MONitor[n]?`

`:READ:MONitor[n]?`

`:MEASure:MONitor[n]?`

For more measurement related commands, see the SENSE subsystem, and the section "[Remote Measurement Functions](#)" on page 2848.



## Remote Command Results for Monitor Spectrum Measurement

The following table describes the results returned by the queries listed above, according to the index value n.

n	Results Returned
1 (or not specified)	Returns trace1 data with comma separated floating numbers
2	Returns trace2 data with comma separated floating numbers
3	Returns trace3 data with comma separated floating numbers

Key Path	Meas
Initial S/W Revision	Prior to A.02.00

## AMPTD Y Scale

Accesses a menu of functions that enable you to set the vertical scale parameters. These functions control how data on the vertical (Y) axis is displayed and control instrument settings that affect the vertical axis.

Key Path	Front-panel key
Initial S/W Revision	Prior to A.02.00

### Ref Value

Sets the absolute power reference value. However, since Auto Scaling defaults to On, this value is automatically determined by the measurement result. When you set a value manually, Auto Scaling automatically changes to Off.

Key Path	AMPTD Y Scale
Mode	All except SA and BASIC
Remote Command	:DISPlay:MONitor:VIEW[1]:WINDow[1]:TRACe:Y[:SCALe]:RLEVel <real> :DISPlay:MONitor:VIEW[1]:WINDow[1]:TRACe:Y[:SCALe]:RLEVel?
Example	DISP:MON:VIEW:WIND:TRAC:Y:RLEV 2.0 DISP:MON:VIEW:WIND:TRAC:Y:RLEV?
Couplings	When the Auto Scaling is On, this value is automatically determined by the measurement result. When you set a value manually, Auto Scaling automatically changes to Off.
Preset	10.00 dBm
State Saved	Saved in instrument state.
Min	-250.00 dBm
Max	250.00 dBm
Initial S/W Revision	Prior to A.02.00

### Attenuation

This menu controls the attenuator functions and interactions between the attenuation system components.

There are two attenuator configurations in the X-Series. One is a dual attenuator configuration consisting of a mechanical attenuator and an optional electronic attenuator. The other configuration uses a single attenuator with combined mechanical and electronic sections that controls all the attenuation functions. Different models in the X-Series come with different configurations.

See ["Dual Attenuator Configurations:" on page 2607](#)

See ["Single Attenuator Configuration:" on page 2607](#)

Most Attenuation settings are the same for all measurements – they do not change as you change measurements. Settings like these are called “Meas Global” and are unaffected by Meas Preset.

Key Path	AMPTD Y Scale
Scope	Meas Global
Dependencies	In measurements that support the I/Q inputs, this key is unavailable when I/Q is the selected input, and is replaced by the Range key in that case.
Readback Line	Contains a summary in [ ] brackets of the current total attenuation. See the descriptions of the , " <b>(Mech) Atten</b> " on page 2783, and " <b>Enable Elec Atten</b> " on page 2785 keys for more detail on the contributors to the total attenuation.  Note that when "Pre-Adjust for Min Clip" is on, this value can change at the start of every measurement.
Initial S/W Revision	Prior to A.02.00
Modified at S/W Revision	A.03.00

**Dual Attenuator Configurations:**

Configuration 1: Mechanical attenuator + optional electronic attenuator

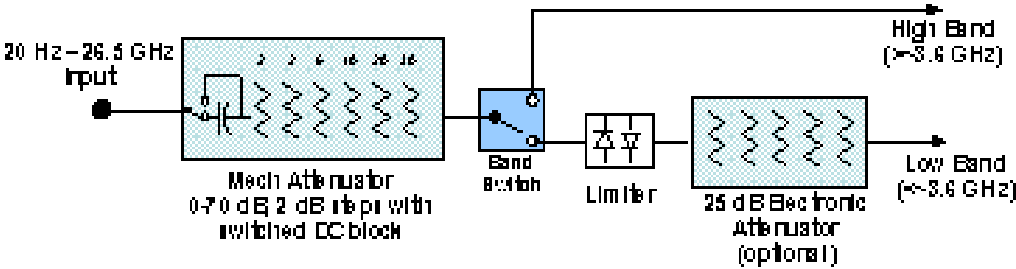

Configuration 2: Mechanical attenuator, no optional electronic attenuator

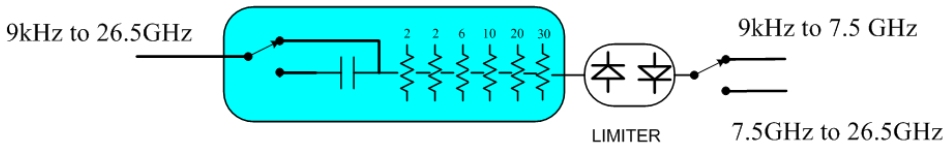

(note that Configuration 2 is not strictly speaking a dual-section attenuator, since there is no electronic section available. However, it behaves exactly like Configuration 1 without the Electronic Attenuator option EA3, therefore for the sake of this document it is grouped into the "Dual Attenuator" configuration)

**Single Attenuator Configuration:**

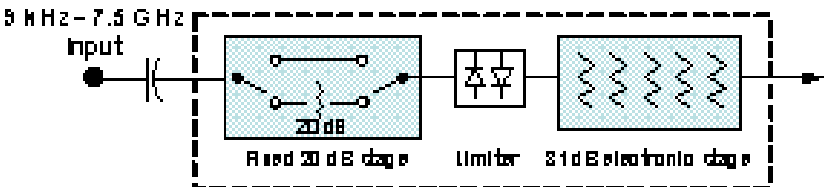

You can tell which attenuator configuration you have by pressing the Attenuation key, which (in most Modes) opens the Attenuation menu. If the first key in the Attenuation menu says Mech Atten you have the dual attenuator configuration. If the first key says Atten you have the single attenuator configuration.

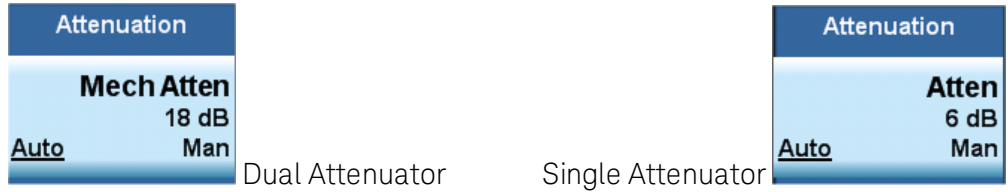

In the single attenuator configuration, you control the attenuation with a single control, as the fixed stage has only two states. In the dual attenuator configuration, both stages have significant range so you are given separate control of the mechanical and electronic attenuator stages.

When you have the dual attenuator configuration, you may still have only a single attenuator, because unless option EA3 (the Electronic Attenuator option) is available, and you purchase it, you will have only the mechanical attenuator.

**(Mech) Atten**

This key is labeled Mech Atten in dual attenuator models and Atten in single attenuator models. In the dual attenuator configuration, this key only affects the mechanical attenuator.

This key lets you modify the attenuation applied to the RF input signal path. This value is normally auto coupled to the Ref Level, the Internal Preamp Gain, any External Gain that is entered, and the Max Mixer Level, as described in the table below.

See "[Attenuator Configurations and Auto/Man](#)" on page 2609

<b>Key Path</b>	AMPTD Y Scale, Attenuation
<b>Remote Command</b>	[:SENSe]:POWer[:RF]:ATTenuation <rel_ampl> [:SENSe]:POWer[:RF]:ATTenuation? [:SENSe]:POWer[:RF]:ATTenuation:AUTO OFF ON 0 1 [:SENSe]:POWer[:RF]:ATTenuation:AUTO?
<b>Example</b>	POW:ATT 20 Dual attenuator configuration: sets the mechanical attenuator to 20 dB Single attenuator mode: sets the main attenuation to 20 dB (see below for definition of "main" attenuation). If the attenuator was in Auto, it sets it to Manual.
<b>Dependencies</b>	Some measurements do not support the Auto setting of (Mech) Atten. In these measurements, the Auto/Man selection is not available, and the Auto/Man line on the key disappears. In dual attenuator configurations, when the electronic attenuator is enabled, the mechanical attenuator has no auto setting and the Auto/Man line on the key disappears. The state of Auto/Man is remembered and restored when the electronic attenuator is once again disabled. This is described in more detail in the " <a href="#">Enable Elec Atten</a> " on page 2785 key description. See " <a href="#">Attenuator Configurations and Auto/Man</a> " on page 2609 for more information on the Auto/Man functionality of Attenuation.

**Couplings**

---

	<p>When (Mech) Atten is in Auto, it uses the following algorithm to determine a value:          If the USB Preamp is connected to USB, use 0 dB.          Otherwise, <math>Atten = ReferenceLevel + PreAmpGain + ExternalGain - RefLevelOffset - MaxMixerLevel + IF\ Gain</math>.          Limit this value to be between 6 dB and the Max value. No value below 6 dB can ever be chosen by Auto.          The resulting value is rounded up to the largest value possible given the attenuation step setting. That is, 50.01 dB would change to 60 dB (for a 10 dB attenuation step).          The "IF Gain" term in the equation above is either 0 dB or +10 dB, depending on the settings of FFT IF Gain, Swept IF Gain, max Ref Level and the Auto/Man setting of Mech Atten.          In External Mixing and BBIQ, where the Attenuator is not in the signal path, the Attenuator setting changes as described above when (Mech) Atten is in Auto, but no changes are made to the actual attenuator hardware setting until the input is changed back to the RF Input.</p>
Preset	<p>The preset for Mech Attenuation is "Auto."          The Auto value of attenuation is:          CXA, EXA, MXA and PXA: 10 dB</p>
State Saved	Saved in instrument state
Min	<p>0 dB          The attenuation set by this key cannot be decreased below 6 dB with the knob or step keys. To get to a value below 6 dB it has to be directly entered from the keypad or via SCPI. This protects from adjusting the attenuation to a dangerously small value which can put the instrument at risk of damage to input circuitry. However, if the current mechanical attenuation is below 6 dB it can be increased with the knob and step keys, but not decreased.</p>
Max	<p>CXA N9000A-503/507: 50 dB          CXA N9000A-513/526: 70dB          EXA: 60 dB          MXA and PXA: 70 dB          In the single attenuator configuration, the total of ATT and EATT cannot exceed 50 dB, so if the EATT is set to 24 dB first, the main attenuation cannot be greater than 26 dB and will be reduced accordingly; if the main attenuator is set to 40 dB first, EATT cannot be greater than 10 dB.</p>
Initial S/W Revision	Prior to A.02.00
Modified at S/W Revision	A.03.00

---

### Attenuator Configurations and Auto/Man

As described in the Attenuation key description, there are two distinct attenuator configurations available in the X-Series, the single attenuator and dual attenuator configurations. In dual attenuator configurations, we have the mechanical attenuation and the electronic attenuation, and the current total attenuation is the sum of the electronic + mechanical attenuation. In single attenuator configurations, we refer to the attenuation set using the (Mech) Atten key (or POW:ATT SCPI) as the "main" attenuation; and the attenuation that is set by the SCPI command POW:EATT as the "soft" attenuation (the POW:EATT command is honored even in the single attenuator configuration, for compatibility purposes). Then the

current total attenuation is the sum of the main + soft attenuation. See the Elec Atten key description for more on “soft” attenuation.

In the dual attenuator configuration, when the electronic attenuator is enabled, there is no Auto/Man functionality for the mechanical attenuator, and the third line of the key label (the Auto/Man line) disappears:

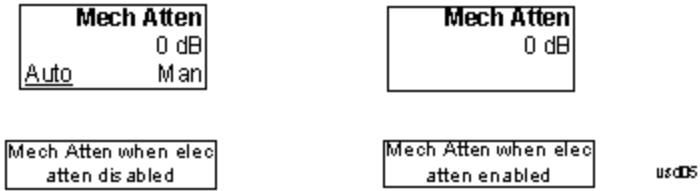

### Enable Elec Atten

Enables the Electronic Attenuator.

The electronic attenuator offers finer steps than the mechanical attenuator, has no acoustical noise, is faster, and is less subject to wear. These advantages primarily aid in remote operation and are negligible for front panel use. See ["Using the Electronic Attenuator: Pros and Cons" on page 2612](#) for a detailed discussion of the pros and cons of using the electronic attenuator.

For the single attenuator configuration, for SCPI backwards compatibility, the “soft” attenuation feature replaces the dual attenuator configuration’s electronic attenuator. All the same couplings and limitations apply. See ["Attenuator Configurations and Auto/Man" on page 2785](#)

See ["More Information" on page 2611](#)

<b>Key Path</b>	AMPTD Y Scale, Attenuation
<b>Remote Command</b>	[ :SENSE ] :POWER [ :RF ] :EATTenuation :STATe OFF   ON   0   1 [ :SENSE ] :POWER [ :RF ] :EATTenuation :STATe ?
<b>Example</b>	POW:EATT:STAT ON
<b>Dependencies</b>	<p>This key only appears in Dual Attenuator models with an Electronic Attenuator installed. It does not appear in models with the Single Attenuator configuration, as in the single attenuator configuration there is no “electronic attenuator” there is only a single integrated attenuator (which has both a mechanical and electronic stage). However, in the single attenuator configuration, EATT SCPI commands are accepted for compatibility with other X-series instruments and set a “soft” attenuation as described in <a href="#">"Attenuator Configurations and Auto/Man" on page 2785</a>.</p> <p>The electronic attenuator (and the “soft” attenuation function provided in single attenuator configurations) is unavailable above 3.6 GHz. Therefore, if the Stop Frequency of the analyzer is &gt; 3.6 GHz then the Enable Elec Atten key will be OFF and grayed out.</p> <p>If the Internal Preamp is on, meaning it is set to Low Band or Full, the electronic attenuator (and the “soft” attenuation function provided in single attenuator configurations) is unavailable. In this case the Enable Elec Atten key will be OFF and grayed out.</p> <p>If either of the above is true, if the SCPI command is sent, an error indicating that the electronic attenuator is unavailable will be sent.</p> <p>If the electronic/soft Attenuator is enabled, then the Stop Freq of the analyzer is limited to 3.6 GHz and the Internal Preamp is unavailable.</p> <p>The SCPI-only “soft” electronic attenuation for the single-attenuator configuration is not available in</p>

	all measurements; in particular, it is not available in the Swept SA measurement.
Couplings	Enabling and disabling the Electronic Attenuator affects the setting of the Mechanical Attenuator (in dual attenuator configurations). This is described in more detail below this table.
Preset	OFF for Swept SA measurement; ON for all other measurements that support the electronic attenuator
State Saved	Saved in instrument state
Initial S/W Revision	Prior to A.02.00
Modified at S/W Revision	A.03.00

## More Information

### Mechanical Attenuator Transition Rules

When the Electronic Attenuator is enabled, the Mechanical Attenuator transitions to a state that has no Auto function. Below are the rules for transitioning the Mechanical Attenuator. NOTE that the information below ONLY applies to the dual attenuator configurations, and ONLY when the Electronic Attenuator is installed:

#### When the Electronic Attenuation is enabled from a disabled state:

- The Mechanical Attenuator is initialized to 10 dB (this is its optimal performance setting). You can then set it as desired with SCPI, numeric keypad, step keys, or knob, and it behaves as it normally would in manual mode
- The Auto/Man state of (Mech) Atten is saved
- The Auto/Man line on the (Mech) Atten key disappears and the auto rules are disabled
- The Electronic Attenuator is set to 10 dB less than the previous value of the Mechanical Attenuator, within the limitation that it must stay within the range of 0 to 24 dB of attenuation.

#### Examples in the dual attenuator configuration:

- Mech Atten at 20 dB. Elec Atten enabled, Mech Atten set to 10 dB, and Elec Atten set to 10 dB. New total attenuation equals the value before Elec Atten enabled.
- Mech Atten at 0 dB. Elec Atten enabled, Mech Atten set to 10 dB, and Elec Atten set to 0 dB. New total attenuation does not equal the value before Elec Atten enabled.
- Mech Atten at 40 dB. Elec Atten enabled, Mech Atten set to 10 dB, and Elec Atten set to 24 dB. New total attenuation does not equal the value before Elec Atten enabled.

#### When the Electronic Attenuation is disabled from an enabled state:

- The Elec Atten key is grayed out
- The Auto/Man state of (Mech) Atten is restored
- If now in Auto, (Mech) Atten recouples

- If now in Man, (Mech) Atten is set to the value of total attenuation that existed before the Elec Atten was disabled. The resulting value is rounded up to the smallest value possible given the (Mech) Atten Step setting - (That is, 57 dB changes to 58 dB when (Mech) Atten Step is 2 dB.)

### Using the Electronic Attenuator: Pros and Cons

The electronic attenuator offers finer steps than the mechanical attenuator, has no acoustical noise, is faster, and is less subject to wear.

The “finer steps” advantage of the electronic attenuator is beneficial in optimizing the alignment of the analyzer dynamic range to the signal power in the front panel as well as remote use. Thus, you can achieve improved relative signal measurement accuracy. Compared to a mechanical attenuator with 2 dB steps, the 1 dB resolution of the electronic attenuator only gives better resolution when the odd-decibel steps are used. Those odd-decibel steps are less accurately calibrated than the even-decibel steps, so one tradeoff for this superior relative accuracy is reduced absolute amplitude accuracy.

Another disadvantage of the electronic attenuator is that the spectrum analyzer loses its “Auto” setting, making operation less convenient.

Also, the relationship between the dynamic range specifications (TOI, SHI, compression and noise) and instrument performance are less well-known with the electrical attenuator. With the mechanical attenuator, TOI, SHI and compression threshold levels increase dB-for-dB with increasing attenuation, and the noise floor does as well. With the electronic attenuator, there is an excess attenuation of about 1 to 3 dB between 0 and 3.6 GHz, making the effective TOI, SHI, and so forth, less well known. Excess attenuation is the actual attenuation relative to stated attenuation. Excess attenuation is accounted for in the analyzer calibration

### Elec Atten

Controls the Electronic Attenuator in dual attenuator configurations. This key does not appear in single attenuator configurations, as the control of both the mechanical and electronic stages of the single attenuator is integrated into the single Atten key.

Key Path	AMPTD Y Scale, Attenuation
Remote Command	<code>[ :SENSe ] :POWer [ :RF ] :EATTenuation &lt;rel_amp1&gt;</code> <code>[ :SENSe ] :POWer [ :RF ] :EATTenuation?</code>
Notes	Electronic Attenuation's specification is defined only when Mechanical Attenuation is 6 dB.
Dependencies	This key only appears in Dual Attenuator models with an Electronic Attenuator installed. It does not appear in models with the Single Attenuator configuration, as in the single attenuator configuration there is no “electronic attenuator” there is only a single integrated attenuator (which has both a mechanical and electronic stage). However, in the single attenuator configuration, EATT SCPI commands are accepted for compatibility with other X-series instruments and set a “soft” attenuation as described in <a href="#">"Attenuator Configurations and Auto/Man" on page 2785</a> . The “soft” attenuation is treated as an addition to the “main” attenuation value set by the Atten softkey or the POW:ATT SCPI command and affects the total attenuation displayed on the Attenuation key and the Meas Bar.  When Enable Elec Atten is off or grayed out, the Elec Atten key is grayed out.
Preset	0 dB
State Saved	Saved in instrument state



Min	0 dB
Max	Dual attenuator configuration: 24 dB Single attenuator configuration: the total of ATT and EATT cannot exceed 50 dB, so if the EATT is set to 24 dB first, the main attenuation cannot be greater than 26 dB and will be reduced accordingly; if the main attenuator is set to 40 dB first, EATT cannot be greater than 10 dB
Initial S/W Revision	Prior to A.02.00
Modified at S/W Revision	A.03.00

### Adjust Atten for Min Clip

Sets the combination of mechanical and electronic attenuation and gain based on the current measured signal level so that clipping will be at a minimum.

This is an "immediate action" function, that is, it executes once, when the key is pressed.

This key is grayed out in measurements that do not support this functionality. The spectrum analyzer measurement, Swept SA, does not support this functionality.

Key Path	AMPTD Y Scale, Attenuation
Remote Command	<code>[ :SENSe ] :POWer [ :RF ] :RANGe:OPTimize IMMEDIATE</code>
Initial S/W Revision	Prior to A.02.00
Modified at S/W Revision	A.03.00

### Pre-Adjust for Min Clip

If this function is on, it does the adjustment described under "[Adjust Atten for Min Clip](#)" on page 2788 each time a measurement restarts. Therefore, in Continuous measurement mode, it only executes before the first measurement.

In dual attenuator models, you can set Elec+Mech Atten, in which case both attenuators participate in the autoranging, or Elec Atten Only, in which case the mechanical attenuator does not participate in the autoranging. This latter case results in less wear on the mechanical attenuator and is usually faster.

This key is grayed out in measurements that do not support this functionality. The spectrum analyzer measurement, Swept SA, does not support this functionality.

Key Path	AMPTD Y Scale, Attenuation
Remote Command	<code>[ :SENSe ] :POWer [ :RF ] :RANGe:OPTimize:ATTenuation OFF   ELECTrical   COMBined</code>  <code>[ :SENSe ] :POWer [ :RF ] :RANGe:OPTimize:ATTenuation?</code>
Notes	The SCPI parameter ELECTrical sets this function to On in single attenuator models. The SCPI parameter COMBined is mapped to ELECTrical in single attenuator models; if you send COMBined, it sets the function to On and returns ELEC to a query.
Dependencies	This key only appears in Dual Attenuator models with an Electronic Attenuator installed.

---

	In instruments with Dual Attenuator model, when Enable Elec Atten is off or grayed out, the Pre-Adjust for Min Clip key is grayed out.
Preset	OFF for Swept SA measurement; ON for all other measurements that support Pre-Adjust for Min Clip
State Saved	Saved in instrument state
Range	Dual attenuator models: Off   Elec Atten Only   Mech + Elec Atten Single attenuator models: Off   On
Initial S/W Revision	Prior to A.02.00
Modified at S/W Revision	A.03.00

---

<b>Remote Command</b>	<code>[ :SENSe ] :POWer [ :RF ] :RANGe :AUTO ON   OFF   1   0</code> <code>[ :SENSe ] :POWer [ :RF ] :RANGe :AUTO ?</code>
Notes	ON aliases to "Elec Atten Only" (:POW:RANG:OPT:ATT ELEC) OFF aliases to "Off" (:POW:RANG:OPT:ATT OFF) The query :POW:RANG:AUTO? returns true if :POW:RANG:OPT:ATT is not "Off"
Initial S/W Revision	Prior to A.02.00

---

## Off

Turns Pre-Adjust for Min Clip off. This is the default setting.

This key is grayed out in measurements that do not support this functionality. The spectrum analyzer measurement, Swept SA, does not support this functionality.

---

Key Path	AMPTD Y Scale, Attenuation, Pre-Adjust for Min Clip
Example	:POW:RANG:OPT:ATT OFF
Initial S/W Revision	Prior to A.02.00

---

## Elec Atten Only

Selects only the electric attenuator to participate in auto ranging. This offers less wear on the mechanical attenuator and is usually faster.

This key is grayed out in measurements that do not support this functionality. The spectrum analyzer measurement, Swept SA, does not support this functionality.

---

Key Path	AMPTD Y Scale, Attenuation, Pre-Adjust for Min Clip
Example	:POW:RANG:OPT:ATT ELEC
Initial S/W Revision	Prior to A.02.00

---

## Mech + Elec Atten

In dual attenuator models, this selects both attenuators participate in the autoranging.

This key is grayed out in measurements that do not support this functionality. The spectrum analyzer measurement, Swept SA, does not support this functionality.

Key Path	AMPTD Y Scale, Attenuation, Pre-Adjust for Min Clip
Example	:POW:RANGe:OPT:ATT COMB
Initial S/W Revision	Prior to A.02.00

## (Mech) Atten Step

This controls the step size used when making adjustments to the input attenuation.

This key is labeled Mech Atten Step in dual attenuator models and Atten Step in single attenuator models. In the dual attenuator configuration, this key only affects the step size of the mechanical attenuator.

Key Path	AMPTD Y Scale, Attenuation
<b>Remote Command</b>	[ :SENSe ] :POWer [ :RF ] :ATTenuation:STEP [ :INCRement ] 10 dB   2 dB [ :SENSe ] :POWer [ :RF ] :ATTenuation:STEP [ :INCRement ] ?
<b>Example</b>	POW:ATT:STEP 2
Notes	Note this feature works like a 1-N choice from the front panel, but it takes a specific value (in dB) when used remotely. The only valid values are 2 and 10.
Dependencies	Blanked in CXA and EXA if option FSA (2 dB steps) is not present. If blanked, attempts to set it via SCPI will yield an error.
Couplings	When the attenuation step size changes, the current mechanical attenuation value is adjusted (if necessary) to be quantized to the new step size. That is, if step is set to 10 dB, mech atten is increased if necessary so it is a multiple of 10 dB
Preset	PXA and MXA: 2 dB EXA and CXA: 10 dB (2 dB with option FSA)
State Saved	Saved in instrument state
Initial S/W Revision	Prior to A.02.00
Modified at S/W Revision	A.03.00

## Scale/Div

Sets the logarithmic units per vertical graticule division on the display. However, since the Auto Scaling defaults to On, this value is automatically determined by the measurement result. When you set a value manually, Auto Scaling automatically changes to Off.

Key Path	AMPTD Y Scale
Mode	All except SA and BASIC
Remote Command	:DISPlay:MONitor:VIEW[1]:WINDow[1]:TRACe:Y[:SCALe]:PDIVision <rel_ampl> :DISPlay:MONitor:VIEW[1]:WINDow[1]:TRACe:Y[:SCALe]:PDIVision?
Example	DISP:MON:VIEW:WIND:TRAC:Y:PDIV 5.0 dB DISP:MON:VIEW:WIND:TRAC:Y:PDIV?
Couplings	When the Auto Scaling is On, this value is automatically determined by the measurement result. When you set a value manually, Auto Scaling automatically changes to Off.
Preset	10.00 dB
State Saved	Saved in instrument state.
Min	0.10 dB
Max	20.00 dB
Initial S/W Revision	Prior to A.02.00

## Presel Center

When this key is pressed, the centering of the preselector filter is adjusted to optimize the amplitude accuracy at the frequency of the selected marker. If the selected marker is not on when Presel Center is pressed, the analyzer will turn on the selected marker, perform a peak search, and then perform centering on the marker's center frequency. If the selected marker is already on and between the start and stop frequencies of the analyzer, the analyzer performs the preselector calibration on that marker's frequency. If the selected marker is already on, but outside the frequency range between Start Freq and Stop Freq, the analyzer will first perform a peak search, and then perform centering on the marker's center frequency.

The value displayed on the Presel Adjust key will change to reflect the new preselector tuning (see Presel Adjust).

A number of considerations should be observed to ensure proper operation. See ["Proper Preselector Operation" on page 2617](#).

Key Path	AMPTD Y Scale
Remote Command	[:SENSe]:POWer[:RF]:PCENter
Example	POW:PCEN
Notes	Note that the rules outlined above under the key description apply for the remote command as well as the key. The result of the command is dependent on marker position, and so forth. Any message shown by the key press is also shown in response to the remote command.
Dependencies	<ul style="list-style-type: none"> <li>• Grayed out if the microwave preselector is off. )</li> <li>• If the selected marker's frequency is below Band 1, advisory message 0.5001 is generated and no action is taken.</li> <li>• Grayed out if entirely in Band 0.</li> <li>• Blank in models that do not include a preselector, such as option 503. If the SCPI is sent in these instruments, it is accepted without error, and the query always returns 0.</li> </ul>

- Grayed out in the Spectrogram View.

Couplings	The active marker position determines where the centering will be attempted. If the analyzer is in a measurement such as averaging when centering is initiated, the act of centering the preselector will restart averaging but the first average trace will not be taken until the centering is completed.
Status Bits/OPC dependencies	When centering the preselector, *OPC will not return true until the process is complete and a subsequent measurement has completed, nor will results be returned to a READ or MEASURE command. The Measuring bit should remain set while this command is operating and should not go false until the subsequent sweep/measurement has completed.
Initial S/W Revision	Prior to A.02.00
Modified at S/W Revision	A.03.00

## Proper Preselector Operation

A number of considerations should be observed to ensure proper operation:

1. If the selected marker is off, the analyzer will turn on a marker, perform a peak search, and adjust the preselector using the selected marker's frequency. It uses the "highest peak" peak search method unqualified by threshold or excursion, so that there is no chance of a 'no peak found' error. It continues with that peak, even if it is the peak of just noise. Therefore, for this operation to work properly, there should be a signal on screen in a preselected range for the peak search to find.
2. If the selected marker is already on, the analyzer will attempt the centering at that marker's frequency. There is no preselector for signals below about 3.6 GHz, therefore if the marker is on a signal below 3.6 GHz, no centering will be attempted and an advisory message generated
3. In some models, the preselector can be bypassed. If it is bypassed, no centering will be attempted in that range and a message will be generated.

## Preselector Adjust

Allows you to manually adjust the preselector filter frequency to optimize its response to the signal of interest. This function is only available when "Presel Center" on page 2791 is available.

For general purpose signal analysis, using Presel Center is recommended. Centering the filter minimizes the impact of long-term preselector drift. Presel Adjust can be used instead to manually optimize the preselector. One application of manual optimization would be to peak the preselector response, which both optimizes the signal-to-noise ratio and minimizes amplitude variations due to small (short-term) preselector drifting.

Key Path	AMPTD Y Scale
Scope	Meas Global
Remote Command	<code>[ :SENSe ] :POWer [ :RF ] :PADJust &lt;freq&gt;</code>

	<code>[ :SENSe ] :POWer [ :RF ] :PADJust ?</code>
<b>Example</b>	POW:PADJ 100KHz POW:PADJ?
<b>Notes</b>	The value on the key reads out to 0.1 MHz resolution.
<b>Dependencies</b>	<ul style="list-style-type: none"> <li>• Grayed out if microwave preselector is off. )</li> <li>• Grayed out if entirely in Band 0.</li> <li>• Blank in models that do not include a preselector, such as option 503. If the SCPI is sent in these instruments, it is accepted without error, and the query always returns 0.</li> <li>• Grayed out in the Spectrogram View.</li> </ul>
<b>Preset</b>	0 MHz
<b>State Saved</b>	The Presel Adjust value set by Presel Center, or by manually adjusting Presel Adjust, is not saved in instrument state, and does not survive a Preset or power cycle.
<b>Min</b>	-500 MHz
<b>Max</b>	500 MHz
<b>Default Unit</b>	Hz
<b>Backwards Compatibility SCPI</b>	<code>[ :SENSe ] :POWer [ :RF ] :MW :PADJust</code> <code>[ :SENSe ] :POWer [ :RF ] :MMW :PADJust</code> PSA had multiple preselectors, but the X-Series has only one. These commands simply alias to <code>[ :SENSe ] :POWer [ :RF ] :PADJust</code>
<b>Initial S/W Revision</b>	Prior to A.02.00
<b>Modified at S/W Revision</b>	A.03.00

<b>Remote Command</b>	<code>[ :SENSe ] :POWer [ :RF ] :PADJust :PRESelector MWAVE   MMWave   EXTERNAL</code> <code>[ :SENSe ] :POWer [ :RF ] :PADJust :PRESelector ?</code>
<b>Notes</b>	PSA had multiple preselectors, and you could select which preselector to adjust. Since the X-Series has only one mm/uW preselector, the preselector selection softkey is no longer available. However, to provide backward compatibility, we accept the legacy remote commands. The command form has no effect, the query always returns MWAVE
<b>Initial S/W Revision</b>	Prior to A.02.00

## µW Path Control

The µW Path Control functions include the µW Preselector Bypass (Option MPB) and Low Noise Path (Option LNP) controls in the High Band path circuits.

When the µW Preselector is bypassed, the user has better flatness, but will be subject to spurs from out of band interfering signals. When the Low Noise Path is enabled, the analyzer automatically switches around

certain circuitry in the high frequency bands which can contribute to noise, when it is appropriate based on other analyzer settings.

For most applications, the preset state is Standard Path, which gives the best remote-control throughput, minimizes acoustic noise from switching and minimizes the risk of wear out in the hardware switches. For applications that utilize the wideband IF paths, the preset state is the  $\mu$ W Preselector Bypass path, if option MPB is present. This is because, when using a wideband IF such as the 140 MHz IF, the  $\mu$ W Preselector's bandwidth can be narrower than the available IF bandwidth, causing degraded amplitude flatness and phase linearity, so it is desirable to bypass the preselector in the default case.

Users may choose Low Noise Path Enable. It gives a lower noise floor, especially in the 21–26.5 GHz region, though without improving many measures of dynamic range, and without giving the best possible noise floor. The preamp, if purchased and used, gives better noise floor than does the Low Noise Path, however its compression threshold and third-order intercept are much poorer than that of the non-preamp Low Noise Path. There are some applications, typically for signals around –30 dBm, for which the third-order dynamic range of the standard path is good enough, but the noise floor is not low enough even with 0 dB input attenuation. When the third-order dynamic range of the preamp path is too little and the noise floor of the standard path is too high, the Low Noise Path can provide the best dynamic range.

<b>Key Path</b>	AMPTD Y Scale
<b>Mode</b>	SA, BASIC, PNOISE, VSA , LTE, LTETDD
<b>Scope</b>	Meas Global
<b>Remote Command</b>	[ :SENSe ] :POWer [ :RF ] :MW:PATH STD LNPath MPBypass FULL [ :SENSe ] :POWer [ :RF ] :MW:PATH?
<b>Example</b>	:POW:MW:PATH LNP Enables the Low Noise path
<b>Notes</b>	If a Presel Center is performed, the analyzer will momentarily switch to the Standard Path, regardless of the setting of $\mu$ W Path Control  The DC Block will always be switched in when the low noise path is switched in, to protect succeeding circuitry from DC. Note that this does not mean “when the low noise path is enabled” but when, based on the Low Noise Path rules, the path is actually switched in. This can happen when the selection is Low Noise Path Enable . In the case where the DC Block is switched in the analyzer is now AC coupled. However, if the user has selected DC coupling, the UI will still behave as though it were DC coupled, including all annunciation, warnings, status bits, and responses to SCPI queries. This is because, based on other settings, the analyzer could switch out the low noise path at any time and hence go back to being DC coupled.  Alignment switching ignores the settings in this menu, and restores them when finished.
<b>Dependencies</b>	Unavailable in BBIQ and External Mixing
<b>Preset</b>	All modes other than IQ Analyzer mode and VXA: STD IQ Analyzer, VXA and WLAN mode: MPB option present and licensed: MPB MPB option not present and licensed: STD
<b>State Saved</b>	Save in instrument state
<b>Readback</b>	Value selected in the submenu
<b>Initial S/W Revision</b>	A.04.00
<b>Modified at S/W Revision</b>	A.10.00

## Standard Path

This path gives the best remote-control throughput, minimizes acoustic noise from switching and minimizes the risk of wear in the hardware switches, particularly in remote test scenarios where both low band and high band setups will follow in rapid succession.

In this path, the bypass of the low band/high band switch and microwave preamp is never activated, which can cause some noise degradation but preserves the life of the bypass switch.

Key Path	AMPTD Y Scale, $\mu$ W Path Control
<b>Example</b>	:POW:MW:PATH STD
Readback Text	Standard Path
Initial S/W Revision	A.04.00

## Low Noise Path Enable

You may choose Low Noise Path Enable, which gives a lower noise floor under some circumstances, particularly when operating in the 21–26.5 GHz region. With the Low Noise Path enabled, the low band/high band switch and microwave preamp are bypassed whenever all of the following are true:

- The analyzer is not in the Low Band, meaning:
- the start frequency is above 3.5 GHz and
- the stop frequency is above 3.6 GHz.
- the internal preamp is not installed or (if installed) is set to Off or Low Band

Note that this means that, when any part of a sweep is done in Low Band, the Low Noise Path is not used, whether or not the Low Noise Path Enable is selected in the user interface. Also, if the preamp is turned on, the Low Noise Path is not used, whether or not the Low Noise Path Enable is selected in the user interface. The only time the Low Noise Path is used is when Low Noise Path Enable is selected, the sweep is completely in High Band (> 3.6 GHz) and no preamp is in use.

See "[More Information](#)" on page 2621

Key Path	AMPTD Y Scale, $\mu$ W Path Control
Measurement	Swept SA
<b>Example</b>	:POW:MW:PATH LNP
Notes	For measurements that use IQ acquisition, the low noise path is used when the Center Frequency is in High Band (> 3.6 GHz) and no preamp is in use. In other words, the rules above are modified to use only the center frequency to qualify which path to switch in. This is not the case for FFT's in the Swept SA measurement; they use the same rules as swept measurements.
Dependencies	Key is blanked if current mode does not support it. Key is grayed out if mode supports it but current measurement does not support it. Unless Option LNP is present and licensed, key is blank and if SCPI command sent, error -241,



	"Hardware missing; Option not installed" is generated.
Readback Text	Low Noise Path Enable
Initial S/W Revision	A.04.00

### More Information

The user should understand that the Low Noise Path, while giving improved DANL, has the disadvantage of decreased TOI performance and decreased gain compression performance relative to the standard path.

The user should also understand that the bypass switch is a mechanical switch and has finite life, so if the Low Noise Path is enabled, it is possible to cause frequent cycling of this switch by frequently changing analyzer settings such that the above conditions hold true only some of the time. A user making tests of this nature should consider opting for the Standard Path, which will never throw the bypass switch, at the expense of some degraded noise performance.

The low noise path is useful for situations where the signal level is so low that the analyzer performance is dominated by noise even with 0 dB attenuation, but still high enough that the preamp option would have excessive third-order intermodulation or compression. The preamp, if purchased and used, gives better noise floor than does the "Low Noise Path." However, its compression threshold and third-order intercept are much poorer than that of the non-preamp path. There are some applications, typically for signals around -30 dBm, for which the third-order dynamic range of the standard path is good enough, but the noise floor is not low enough even with 0 dB input attenuation. When the third-order dynamic range of the preamp path is too little and the noise floor of the standard path is too high, the Low Noise Path can provide the best dynamic range

The graph below illustrates the concept. It shows, in red, the performance of an analyzer at different attenuation settings, both with the preamp on and off, in a measurement that is affected by both analyzer noise and analyzer TOI. The green shows the best available dynamic range, offset by 0.5 dB for clarity. The blue shows how the best available dynamic range improves for moderate signal levels with the low noise path switched in. In this illustration, the preamp improves the noise floor by 15 dB while degrading the third-order intercept by 30 dB, and the low noise path reduces loss by 8 dB. The attenuator step size is 2 dB.

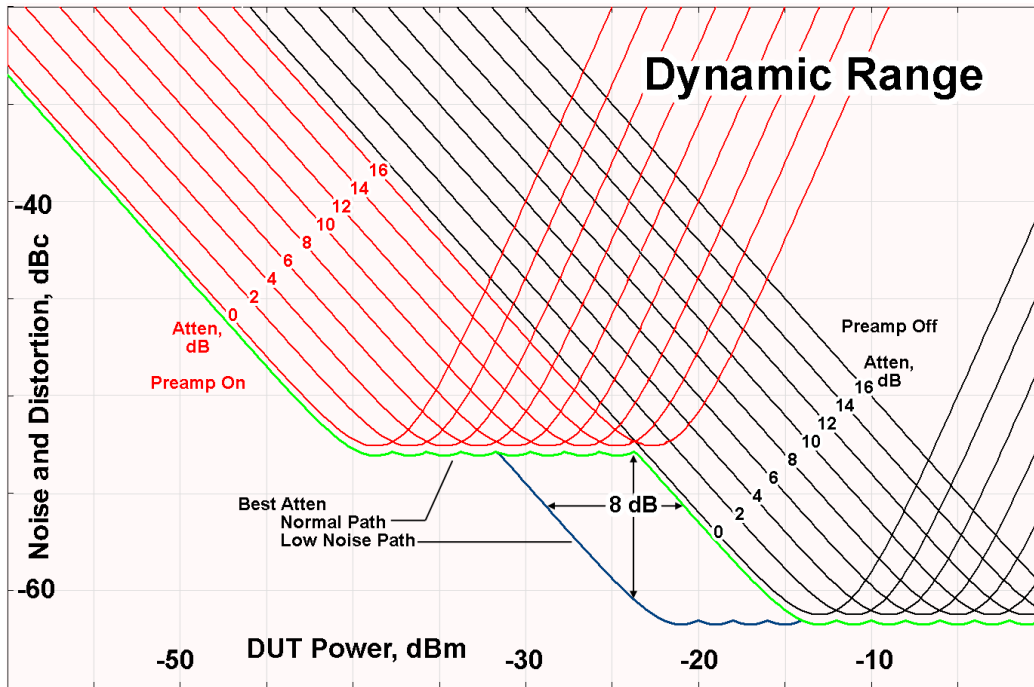

There are other times where selecting the low noise path improves performance, too. Compression-limited measurements such as finding the nulls in a pulsed-RF spectrum can profit from the low noise path in a way similar to the TOI-limited measurement illustrated. Accuracy can be improved when the low noise path allows the optimum attenuation to increase from a small amount like 0, 2 or 4 dB to a larger amount, giving better return loss at the analyzer input. Harmonic measurements, such as second and third harmonic levels, are much improved using the low noise path because of the superiority of that path for harmonic (though not intermodulation) distortion performance.

### µW Preselector Bypass

This key toggles the preselector bypass switch for band 1 and higher. When the microwave preselector is on, the signal path is preselected. When the microwave preselector is off, the signal path is not preselected. The preselected path is the normal path for the analyzer.

The preselector is a tunable bandpass filter which prevents signals away from the frequency of interest from combining in the mixer to generate in-band spurious signals (images). The consequences of using a preselector filter are its limited bandwidth, the amplitude and phase ripple in its passband, and any amplitude and phase instability due to center frequency drift.

Option MPB or pre-selector bypass provides an unpreselected input mixer path for certain X-Series signal analyzers with frequency ranges above 3.6 GHz. This signal path allows a wider bandwidth and less amplitude variability, which is an advantage when doing modulation analysis and broadband signal analysis. The disadvantage is that, without the preselector, image signals will be displayed. Another disadvantage of bypassing the preselector is increased LO emission levels at the front panel input port.

Image responses are separated from the real signal by twice the 1st IF. For IF Paths of 10 MHz and 25 MHz, the 1st IF is 322.5 MHz, so the image response and the real signal will be separated by 645 MHz. The 1st IF will be different for other IF Path settings. When viewing a real signal and its corresponding image response in internal mixing, the image response will be to the left of the real signal.

Also, the image response and the real signal typically have the same amplitude and exhibit the same shape factor.

However, if Option FS1, Fast Sweep Capability, is enabled, the image response in the Swept SA measurement will appear lower in amplitude and have a much wider shape factor compared to the real signal.

Key Path	AMPTD Y Scale, $\mu$ W Path Control
<b>Example</b>	:POW:MW:PATH MPB
Dependencies	Key is blanked if current mode does not support it. Key is grayed out if mode supports it but current measurement does not support it. Key is blank unless Option MPB is present and licensed. If SCPI command sent when MPB not present, error -241, "Hardware missing; Option not installed" is generated.
Readback Text	$\mu$ W Preselector Bypass
Initial S/W Revision	A.04.00

<b>Remote Command</b>	[ :SENSe ] :POWer [ :RF ] :MW:PRESelector [ :STATe ] ON OFF 0 1 [ :SENSe ] :POWer [ :RF ] :MW:PRESelector [ :STATe ] ?
<b>Example</b>	:POW:MW:PRES OFF Bypasses the microwave preselector
Notes	The ON parameter sets the STD path (:POW:MW:PATH STD) The OFF parameter sets path MPB (:POW:MW:PATH MPB)
Preset	ON

## Internal Preamp

Accesses a menu of keys that control the internal preamps. Turning on the preamp gives a better noise figure, but a poorer TOI to noise floor dynamic range. You can optimize this setting for your particular measurement.

The instrument takes the preamp gain into account as it sweeps. If you sweep outside of the range of the preamp the instrument will also account for that. The displayed result will always reflect the correct gain.

For some measurements, when the preamp is on and any part of the displayed frequency range is below the lowest frequency for which the preamp has specifications, a warning condition message appears in the status line. For example, for a preamp with a 9 kHz lowest specified frequency: "Preamp: Accy unspec'd below 9 kHz".

Key Path	AMPTD Y Scale
Scope	Meas Global
<b>Remote Command</b>	[ :SENSe ] :POWer [ :RF ] :GAIN [ :STATe ] OFF ON 0 1 [ :SENSe ] :POWer [ :RF ] :GAIN [ :STATe ] ?
Dependencies	Preamp is not available on all hardware platforms. If the preamp is not present or is unlicensed, the

---

	key is not shown. The preamp is not available when the electronic/soft attenuator is enabled.
--	--------------------------------------------------------------------------------------------------

---

Couplings	The act of connecting the U7227A USB Preamplifier to one of the analyzer's USB ports will cause the Internal Preamp to be switched on. When this happens an informational message will be generated: "Internal Preamp turned on for optimal operation with USB Preamp." Note that if the Internal Preamp was already on, there will be no change to the setting, but if it was Off it will be switched On, to Full Range.  Note that this same action occurs when the SA mode is selected while the USB Preamp is connected to one of the analyzer's USB ports, if it is the first time that the SA mode has run since powerup, or if the last time the SA mode was running the USB Preamp was NOT connected.  Subsequently disconnecting the USB Preamp from USB does not change the Internal Preamp setting nor restore the previous setting.
Preset	OFF
State Saved	Saved in instrument state
Initial S/W Revision	Prior to A.02.00
Modified at S/W Revision	A.14.00

---

Key Path	AMPTD Y Scale, Internal Preamp
Scope	Meas Global
<b>Remote Command</b>	[ :SENSe ] : POWer [ :RF ] : GAIN : BAND LOW   FULL [ :SENSe ] : POWer [ :RF ] : GAIN : BAND ?
Dependencies	Preamp is not available on all hardware platforms. If the preamp is not present or is unlicensed, the key is not shown.  If a POW:GAIN:BAND FULL command is sent when a low band preamp is available, the preamp band parameter is to LOW instead of FULL, and an "Option not installed" message is generated.
Preset	LOW
State Saved	Saved in instrument state
Initial S/W Revision	Prior to A.02.00

---

## Off

Turns the internal preamp off

Key Path	AMPTD Y Scale, Internal Preamp
<b>Example</b>	:POW:GAIN OFF
Readback	Off
Initial S/W Revision	Prior to A.02.00

---

## Low Band

Sets the internal preamp to use only the low band.

The frequency range of the installed (optional) low-band preamp is displayed in square brackets on the Low Band key label.

Key Path	AMPTD Y Scale, Internal Preamp
<b>Example</b>	:POW:GAIN ON :POW:GAIN:BAND LOW
Readback	Low Band
Initial S/W Revision	Prior to A.02.00

## Full Range

Sets the internal preamp to use its full range. The low band (0–3.6 GHz or 0–3GHz, depending on the model) is supplied by the low band preamp and the frequencies above low band are supplied by the high band preamp.

The frequency range of the installed (optional) preamp is displayed in square brackets on the Full Range key label. If the high band option is not installed the Full Range key does not appear.

Key Path	AMPTD Y Scale, Internal Preamp
<b>Example</b>	:POW:GAIN ON :POW:GAIN:BAND FULL
Readback	Full Range
Initial S/W Revision	Prior to A.02.00

## Ref Position

Positions the reference level at the top, center or bottom of the Y Scale display. Changing the reference position does not change the reference level value.

Key Path	AMPTD Y Scale
Mode	All except SA and BASIC
<b>Remote Command</b>	:DISPlay:MONitor:VIEW[1]:WINDow[1]:TRACe:Y[:SCALe]:RPOSition TOP   CENTer   BOTTom  :DISPlay:MONitor:VIEW[1]:WINDow[1]:TRACe:Y[:SCALe]:RPOSition?
<b>Example</b>	DISP:MON:VIEW:WIND:TRAC:Y:RPOS CENT DISP:MON:VIEW:WIND:TRAC:Y:RPOS?
Preset	TOP
State Saved	Saved in instrument state.
Range	Top Ctr Bot
Initial S/W Revision	Prior to A.02.00

## Auto Scaling

Toggles the Auto Scaling function between On and Off.

<b>Key Path</b>	AMPTD Y Scale
<b>Mode</b>	All except SA and BASIC
<b>Remote Command</b>	:DISPlay:MONitor:VIEW[1]:WINDow[1]:TRACe:Y[:SCALe]:COUPle 0   1   OFF   ON  :DISPlay:MONitor:VIEW[1]:WINDow[1]:TRACe:Y[:SCALe]:COUPle?
<b>Example</b>	DISP:MON:VIEW:WIND:TRAC:Y:COUP ON DISP:MON:VIEW:WIND:TRAC:Y:COUP?
<b>Couplings</b>	When Auto Scaling is On, and the Restart front-panel key is pressed, this function automatically determines the scale per division and reference values based on the measurement results. When you set a value to either Scale/Div or Ref Value manually, Auto Scaling automatically changes to Off.
<b>Preset</b>	ON
<b>State Saved</b>	Saved in instrument state.
<b>Range</b>	On Off
<b>Initial S/W Revision</b>	Prior to A.02.00

# Auto Couple

The Auto Couple feature provides a quick and convenient way to automatically couple multiple instrument settings. This helps ensure accurate measurements and optimum dynamic range. When the Auto Couple feature is activated, either from the front panel or remotely, all parameters of the current measurement that have an Auto/Manual mode are set to Auto mode and all measurement settings dependent on (or coupled to) the Auto/Man parameters are automatically adjusted for optimal performance.

However, the Auto Couple key actions are confined to the current measurement only. It does not affect other measurements in the mode, and it does not affect markers, marker functions, or trace or display attributes.

See ["More Information" on page 2627](#)

Key Path	Front-panel key
Remote Command	:COUPle ALL NONE
Example	:COUP ALL
Notes	:COUPle ALL puts all Auto/Man parameters in Auto mode (equivalent to pressing the Auto Couple key). :COUPLE NONE puts all Auto/Man parameters in manual mode. It decouples all the coupled instrument parameters and is not recommended for making measurements.
Initial S/W Revision	Prior to A.02.00

## More Information

There are two types of functions that have Auto/Manual modes.

### Auto/Man Active Function keys

An Auto/Man toggle key controls the binary state associated with an instrument parameter by toggling between Auto (where the parameter is automatically coupled to the other parameters it is dependent upon) and Man (where the parameter is controlled independent of the other parameters), as well as making the parameter the active function. The current mode is indicated on the softkey with either Auto or Man underlined as illustrated below.



uscIT

### Auto/Man 1-of-N keys

An Auto/Man 1-of-N key allows you to manually pick from a list of parameter values, or place the function in Auto, in which case the value is automatically selected (and indicated) as shown below. If in Auto, Auto is underlined on the calling key. If in manual operation, manual is indicated on the calling key. But the calling key does not actually toggle the function, it simply opens the menu.

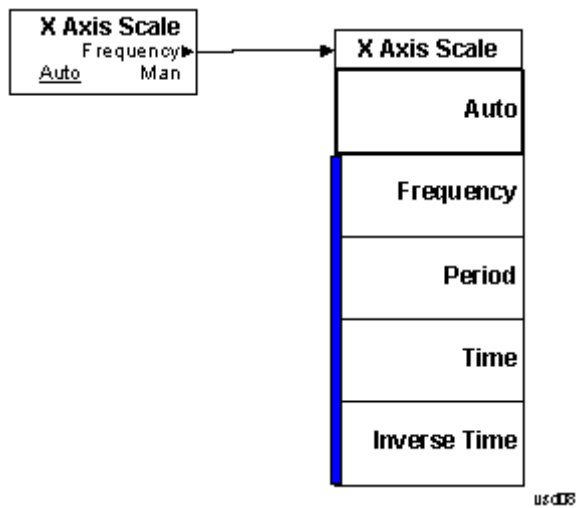



## BW

Accesses a menu that enables you to specify the resolution bandwidth functions that control the bandwidth and filter selection.

Key Path	Front-panel key
Initial S/W Revision	Prior to A.02.00

## Res BW

Sets the resolution bandwidth for the current measurement. If an unavailable bandwidth is entered with the numeric keypad, the closest available bandwidth is selected.

Key Path	BW
Mode	All except SA and BASIC
<b>Remote Command</b>	[:SENSe]:MONitor:BANDwidth[:RESolution] <freq> [:SENSe]:MONitor:BANDwidth[:RESolution]? [:SENSe]:MONitor:BANDwidth[:RESolution]:AUTO OFF ON 0 1 [:SENSe]:MONitor:BANDwidth[:RESolution]:AUTO?
<b>Example</b>	MON:BAND 2.4 MHz MON:BAND? MON:BAND:AUTO ON MON:BAND:AUTO?
Preset	WCDMA: Automatically calculated WIMAX OFDMA: 100kHz C2K: Automatically calculated BLUETOOTH: Automatically calculated PN: Automatically calculated GSM/EDGE: Automatically calculated TD-SCDMA: Automatically calculated 1xEVDO: 30kHz DVB-T/H: 3.9kHz DTMB (CTTB): 3.9kHz ISDB-T: 3.9kHz CMMB: 3.9kHz LTE: 100 kHz LTETDD: 100 kHz Digital Cable TV: 3.9kHz WLAN: 100 kHz MSR: Automatically calculated LTEAFDD, LTEATDD: 100kHz

---

	WCDMA: ON
	WIMAX: OFF
	C2K: ON
	BLUETOOTH: ON
	PN: ON
	GSM/EDGE: ON
	TD-SCDMA: ON
	1xEVDO: ON
	DVB-T/H: OFF
	DTMB (CTTB): OFF
	ISDB-T: OFF
	CMMB: OFF
	LTE:OFF
	LTETDD: OFF
	Digital Cable TV: OFF
	WLAN: OFF
	MSR: ON
	LTEAFDD, LTEATDD: OFF
State Saved	Saved in instrument state.
Min	1.0 Hz
Max	8.0 MHz
<b>Backwards Compatibility SCPI</b>	<code>[[:SENSe]:MONitor:BWIDth[:RESolution]</code>
Initial S/W Revision	Prior to A.02.00
Modified at S/W Revision	A.02.00
Modified at S/W Revision	A.03.00

---

## Video BW

Changes the analyzer post-detection filter.

---

Key Path	BW
Mode	All except SA and BASIC
<b>Remote Command</b>	<code>[[:SENSe]:MONitor:BANDwidth:VIDeo &lt;bandwidth&gt;</code> <code>[[:SENSe]:MONitor:BANDwidth:VIDeo?</code> <code>[[:SENSe]:MONitor:BANDwidth:VIDeo:AUTO ON OFF 1 0</code> <code>[[:SENSe]:MONitor:BANDwidth:VIDeo:AUTO?</code>
<b>Example</b>	MON:BAND:VID 10 MHz MON:BAND:VID? MON:BAND:VID:AUTO OFF

---

	MON:BAND:VID:AUTO?
Preset	WCDMA: Automatically calculated WIMAX OFDMA: 1 MHz C2K: Automatically calculated BLUETOOTH: Automatically calculated PN: Automatically calculated GSM/EDGE: Automatically calculated TD-SCDMA: Automatically calculated 1xEVDO: 300kHz DVB-T/H: 39kHz DTMB (CTTB): 39kHz ISDB-T: 39kHz CMMB: 39kHz LTE: 1 MHz LTETDD: 1 MHz Digital Cable TV: 39kHz WLAN: 1 MHz MSR: Automatically calculated LTEAFDD, LTEATDD:1 MHz WCDMA: ON WIMAX: OFF C2K: ON BLUETOOTH: ON PN: ON GSM/EDGE: ON TD-SCDMA: ON 1xEVDO: ON DVB-T/H: OFF DTMB (CTTB): OFF ISDB-T: OFF CMMB: OFF LTE:OFF LTETDD:OFF Digital Cable TV: OFF WLAN: OFF MSR: ON LTEAFDD, LTEATDD: OFF
State Saved	Saved in instrument state.
Min	1 Hz
Max	50 MHz

<b>Backwards Compatibility SCPI</b>	<code>[ :SENSe ] :MONitor :BWIDth :VIDeo</code>
Initial S/W Revision	Prior to A.02.00
Modified at S/W Revision	A.02.00
Modified at S/W Revision	A.03.00

### VBW:3dB RBW

Selects the ratio between the video bandwidth and the equivalent 3 dB resolution bandwidth to be used for setting the VBW when VBW is in Auto.

Key Path	BW
Mode	All except SA and BASIC
<b>Remote Command</b>	<code>[ :SENSe ] :MONitor :BANDwidth :VIDeo :RATio &lt;real&gt;</code> <code>[ :SENSe ] :MONitor :BANDwidth :VIDeo :RATio?</code> <code>[ :SENSe ] :MONitor :BANDwidth :VIDeo :RATio :AUTO OFF   ON   0   1</code> <code>[ :SENSe ] :MONitor :BANDwidth :VIDeo :RATio :AUTO?</code>
<b>Example</b>	MON:BAND:VID:RAT 2 MON:BAND:VID:RAT? MON:BAND:VID:RAT:AUTO 0 MON:BAND:VID:RAT:AUTO?
Preset	1 ON
State Saved	Saved in instrument state.
Min	0.00001
Max	3000000
<b>Backwards Compatibility SCPI</b>	<code>[ :SENSe ] :MONitor :BWIDth :VIDeo :RATio</code>
Initial S/W Revision	Prior to A.02.00

### Span:3dB RBW

Selects the ratio between span and resolution bandwidth.

The default setting is Auto with a Span:3 dB RBW ratio of 106:1. You can manually change this ratio by pressing the key, entering a new value, and pressing Enter.

Key Path	BW
Mode	All except SA and BASIC
<b>Remote Command</b>	<code>[ :SENSe ] :MONitor :FREQuency :SPAN :BANDwidth [ :RESolution ] :RATio &lt;integer&gt;</code>

	[:SENSe]:MONitor:FREQuency:SPAN:BANDwidth[:RESolution]:RATio?
	[:SENSe]:MONitor:FREQuency:SPAN:BANDwidth[:RESolution]:RATio:AUTO OFF   ON   0   1
	[:SENSe]:MONitor:FREQuency:SPAN:BANDwidth[:RESolution]:RATio:AUTO?
<b>Example</b>	MON:FREQ:SPAN:BAND:RAT 200 MON:FREQ:SPAN:BAND:RAT? MON:FREQ:SPAN:BAND:RAT:AUTO ON MON:FREQ:SPAN:BAND:RAT:AUTO?
Preset	106 ON
State Saved	Saved in instrument state.
Min	2
Max	10000
<b>Backwards Compatibility SCPI</b>	[:SENSe]:MONitor:FREQuency:SPAN:BWIDth[:RESolution]:RATio
Initial S/W Revision	Prior to A.02.00
Modified at S/W Revision	A.04.00

## Cont (Continuous Measurement/Sweep)

Sets the analyzer for Continuous measurement operation. The single/continuous state is Meas Global so the setting will affect all measurements. If you are Paused, pressing Cont does a Resume.

<b>Key Path</b>	Front-panel key
<b>Remote Command</b>	:INITiate:CONTinuous OFF ON 0 1 :INITiate:CONTinuous?
<b>Example</b>	:INIT:CONT 0 puts analyzer in Single measurement operation. :INIT:CONT 1 puts analyzer in Continuous measurement operation
<b>Preset</b>	ON (Note that SYST:PRESet sets INIT:CONT to ON but *RST sets INIT:CONT to OFF)
<b>State Saved</b>	Saved in instrument state
<b>Backwards Compatibility Notes</b>	For Spectrum Analysis mode in ESA and PSA, there is no Cont hardkey, instead there is a Sweep Single/Cont key. In these analyzers, switching the Sweep Single/Cont key from Single to Cont restarts averages (displayed average count reset to 1), but does not restart Max Hold and Min Hold. The X-Series has Single and Cont keys in place of the SweepSingleCont key. In the X-Series, if in single measurement, the Cont key (and INIT:CONT ON ) switches to continuous measurement, but never restarts a measurement and never resets a sweep.
<b>Initial S/W Revision</b>	Prior to A.02.00

In Swept SA Measurement (Spectrum Analysis Mode):

The analyzer takes repetitive sweeps, averages, measurements, etc., when in Continuous mode. When the average count reaches the Average/Hold Number the count stops incrementing, but the analyzer keeps sweeping. See the Trace/Detector section for the averaging formula used both before and after the Average/Hold Number is reached. The trigger condition must be met prior to each sweep. The type of trace processing for multiple sweeps, is set under the Trace/Detector key, with choices of Trace Average, Max Hold, or Min Hold.

In Other Measurements/Modes:

With Avg/Hold Num (in the Meas Setup menu) set to Off or set to On with a value of 1, a sweep is taken after the trigger condition is met; and the analyzer continues to take new sweeps after the current sweep has completed and the trigger condition is again met. However, with Avg/Hold Num set to On with a value >1, multiple sweeps (data acquisitions) are taken for the measurement. The trigger condition must be met prior to each sweep. The sweep is not stopped when the average count k equals the number N set for Avg/Hold Num is reached, but the number k stops incrementing. A measurement average usually applies to all traces, marker results, and numeric results. But sometimes it only applies to the numeric results.

If the analyzer is in Single measurement, pressing the Cont key does not change k and does not cause the sweep to be reset; the only action is to put the analyzer into Continuous measurement operation.

If it is already in continuous sweep:

the INIT:CONT 1 command has no effect

the INIT:CONT 0 command will place the analyzer in Single Sweep but will have no effect on the current sequence until  $k = N$ , at which point the current sequence will stop and the instrument will go to the idle state.

20 Monitor Spectrum Measurement  
File

File

See "File" on page 354



# FREQ Channel

Accesses a menu of keys that allow you to control the Frequency and Channel parameters of the instrument.

Some features in the Frequency menu are the same for all measurements – they do not change as you change measurements. Settings like these are called “Meas Global” and are unaffected by Meas Preset. For example, the Center Freq setting is the same for all measurements - it does not change as you change measurements.

Key Path	Front-panel key
Initial S/W Revision	Prior to A.02.00

## Center Freq

Sets the frequency that corresponds to the horizontal center of the graticule (when frequency Scale Type is set to linear). While adjusting the Center Frequency the Span is held constant, which means that both Start Frequency and Stop Frequency will change.

Pressing Center Freq also sets the frequency entry mode to Center/Span. In Center/Span mode, the center frequency and span values are displayed below the graticule, and the default active function in the Frequency menu is Center Freq.

The center frequency setting is the same for all measurements within a mode, that is, it is Meas Global. Some modes are also able to share a Mode Global center frequency value. If this is the case, the Mode will have a Global Settings key in its Mode Setup menu.

The Center Freq function sets (and queries) the Center Frequency for the currently selected input. If your analyzer has multiple inputs, and you select another input, the Center Freq changes to the value for that input. SCPI commands are available to directly set the Center Freq for a specific input.

Center Freq is remembered as you go from input to input. Thus you can set a Center Freq of 10 GHz with the RF Input selected, change to BBIQ and set a Center Freq of 20 MHz, then switch to External Mixing and set a Center Freq of 60 GHz, and when you go back to the RF Input the Center Freq will go back to 10 GHz; back to BBIQ and it is 20 MHz; back to External Mixing and it is 60 GHz.

See ["RF Center Freq" on page 2640](#)

See [Ext Mix Center Freq](#)

See ["I/Q Center Freq" on page 2642](#)

See ["Center Frequency Presets" on page 2638](#)

Key Path	FREQ Channel
Scope	Meas Global
Remote Command	[ :SENSe ] :FREQuency :CENTer <freq> [ :SENSe ] :FREQuency :CENTer?

<b>Example</b>	FREQ:CENT 50 MHz FREQ:CENT UP changes the center frequency to 150 MHz if you use FREQ:CENT:STEP 100 MHz to set the center frequency step size to 100 MHz FREQ:CENT?
<b>Notes</b>	This command sets either the RF or I/Q Center Frequency depending on the selected input. For RF input it is equivalent to FREQ:RF:CENT For I/Q input it is equivalent to FREQ:IQ:CENT Preset and Max values are dependent on Hardware Options (5xx) If no terminator (e.g. MHz) is sent the terminator Hz is used. If a terminator with unit other than Frequency is used, an invalid suffix error message is generated.
<b>Dependencies</b>	The Center Frequency can be limited by Start or Stop Freq limits, if the Span is so large that Start or Stop reach their limit.
<b>Couplings</b>	When operating in “swept span”, any value of the Center Frequency or Span that is within the frequency range of the analyzer is allowed when the value is being set through the front panel numeric key pad or the SCPI command. The other parameter is forced to a different value if needed, to keep the Start and the Stop Frequencies within the analyzer’s frequency range
<b>Preset</b>	Depends on instrument maximum frequency, mode, measurement, and selected input. See <a href="#">"Center Frequency Presets" on page 2638</a> and <a href="#">"RF Center Freq" on page 2640</a> and <a href="#">Ext Mix Center Freq</a> and <a href="#">"I/Q Center Freq" on page 2642</a> .
<b>State Saved</b>	Saved in instrument state
<b>Min</b>	Depends on instrument maximum frequency, mode, measurement, and selected input.. See <a href="#">"Center Frequency Presets" on page 2638</a> and <a href="#">"RF Center Freq" on page 2640</a> and <a href="#">"I/Q Center Freq" on page 2642</a> .
<b>Max</b>	Depends on instrument maximum frequency, mode, measurement, and selected input.. See <a href="#">"Center Frequency Presets" on page 2638</a> and <a href="#">"RF Center Freq" on page 2640</a> and <a href="#">"I/Q Center Freq" on page 2642</a> .
<b>Default Unit</b>	Hz
<b>Status Bits/OPC</b>	Non-overlapped
<b>Dependencies</b>	
<b>Initial S/W Revision</b>	Prior to A.02.00

## Center Frequency Presets

The following table provides the Center Frequency Presets for the Spectrum Analyzer mode, and the Max Freq, for the various frequency options:

Freq Option	CF after Mode Preset	Stop Freq after Mode Preset	Max Freq (can't tune)

			above)
503 (all but N9000A)	1.805 GHz	3.6 GHz	3.7 GHz
503 (N9000A)	1.505 GHz	3.0 GHz	3.08 GHz
507 (all but N9000A)	3.505 GHz	7.0 GHz	7.1 GHz
507 (N9000A)	3.755 GHz	7.5 GHz	7.58 GHz
508 (all but N9038A)	1.805 GHz	3.6 GHz	8.5 GHz
508 (N9038A)	4.205 GHz	8.4 GHz	8.5 GHz
513	6.805 GHz	13.6 GHz	13.8 GHz
526 (all but N9000A and N9038A)	13.255 GHz	26.5 GHz	27.0 GHz
526 (N9000A)	13.255 GHz	26.5 GHz	26.55 GHz
526 (N9038A)	1.805 GHz	3.6 GHz	27.0 GHz
532	16.005 GHz	32.0 GHz	32.5 GHz
543	21.505 GHz	43.0 GHz	TBD
544	22.005 GHz	44.0 GHz	44.5 GHz
550	25.005 GHz	50.0 GHz	51 GHz

Input 2:

Model	CF after Mode Preset	Stop Freq after Mode Preset	Max Freq (can't tune above)
N9000A opt C75	0.7505GHz	1.5 GHz	1.58 GHz
N9038A	505 MHz	1 GHz	1.000025 GHz

Tracking Generator Frequency Limits (N9000A only):

Tracking Generator Option	Min Freq (clips to this freq when turn TG on and	If above this Freq, Stop Freq clipped to this Freq when	Max Freq (can't tune above) while TG

	can't tune below while TG on)	TG turned on	on
T03	9 kHz	3.0 GHz	3.08 GHz
T06	9 kHz	6.0 GHz	6.05 GHz

The following table shows the Center Frequency Presets for modes other than Spectrum Analyzer:

Mode	CF Preset for RF
WCDMA	1 GHz
WIMAXOFDMA,	1 GHz
BASIC	1 GHz
ADEMOD	1 GHz
VSA	1 GHz
TDSCDMA	1 GHz
PNOISE	1 GHz
LTE	1 GHz
LTETDD	1 GHz
MSR	1 GHz
GSM	935.2 MHz
NFIGURE	1.505 GHz

## RF Center Freq

SCPI command for specifying the RF Center Frequency. This command will set the Center Frequency to be used when the RF input is selected, even if the RF input is not the input that is selected at the time the command is sent. Note that the Center Freq function in the Frequency menu on the front panel always applies to the currently selected input.

Scope	Meas Global
<b>Remote Command</b>	<code>[ :SENSe ] :FREQuency:RF:CENTer &lt;freq&gt;</code> <code>[ :SENSe ] :FREQuency:RF:CENTer?</code>
<b>Example</b>	FREQ:RF:CENT 30 MHz
Notes	This command is the same in all modes, but the parameter is Measurement Global. So the value is independent in each mode and common across all the measurements in the mode.
Dependencies	If the electronic/soft attenuator is enabled, any attempt to set Center Frequency such that the Stop Frequency would be >3.6 GHz fails and results in an advisory message. If the equivalent SCPI command is sent, this same message is generated as part of a “-221, Settings conflict” warning. If Source Mode is set to Tracking, and the Max or Min Center Freq is therefore limited by the limits of the source, a warning message is generated, “Data out of range;clipped to source max/min” if these limits are exceeded. Note that for an external source, these limits can be affected by the settings of

	Source Numerator, Source Denominator and Power Sweep.
Preset	See table above
State Saved	Saved in instrument state.
Min	-79.999995 MHz, unless Source Mode is set to Tracking, in which case it is limited by the minimum frequency of the Source
Max	See table above. Basically instrument maximum frequency - 5 Hz. Note that, if the Source Mode is set to Tracking, the effective instrument maximum frequency may be limited by the source maximum frequency.  If the knob or step keys are being used, also depends on the value of the other three interdependent parameters Span, Start Frequency and Stop Frequency
Initial S/W Revision	Prior to A.02.00
Modified at S/W Revision	A.03.00

## Ext Mix Center Freq

SCPI command for specifying the External Mixer Center Frequency. This command will set the Center Frequency to be used when the External Mixer is selected, even if the External Mixer input is not the input which is selected at the time the command is sent. Note that the Center Freq function in the Frequency menu on the front panel always applies to the currently selected input.

Scope	Meas Global
<b>Remote Command</b>	<code>[ :SENSe ] :FREQuency:EMIXer:CENTer &lt;freq&gt;</code> <code>[ :SENSe ] :FREQuency:EMIXer:CENTer?</code>
<b>Example</b>	<code>:FREQ:EMIX:CENT 60 GHz</code> <code>:FREQ:EMIX:CENT?</code>
Notes	This command is the same in all modes, but the parameter is Measurement Global. So the value is independent in each mode and common across all the measurements in the mode.
Couplings	When returning to External Mixing after having been switched to one of the other inputs (e.g., RF), you will come back into the settings that you had when you left External Mixing. So you will come back to the band you were in with the Center Frequency that you had. However, Span is not an input-dependent parameter, therefore you will bring the span over from the other input. Therefore, the analyzer comes back with the span from the previous input, limited as necessary by the current mixer setup.
Preset	When a Mode Preset is performed while in External Mixing, the Start frequency of the current Mode is set to the nominal Min Freq of the lowest harmonic range in the Harmonic Table for the current mixer setup. Similarly, the Stop frequency of the current Mode is set to the nominal Max Freq of the highest harmonic range in the Harmonic Table. The Center Freq thus presets to the point arithmetically equidistant from these two frequencies.  If the current measurement has a limited Span available to it, and cannot achieve the Span shown in the table ( $\text{Span} = \text{Stop Freq} - \text{Start Freq}$ ), the analyzer uses the maximum Span the measurement allows, and still sets the Center Freq to the midpoint of the Start and Stop Freq values in the Harmonic Table.

	<p>When Restore Input/Output Defaults is performed, the mixer presets to the 11970A, whose Start and Stop frequencies are 26.5 and 40 GHz respectively. The center of these two frequencies is 33.25 GHz.</p> <p>Therefore, after a Restore Input/Output Defaults, if you go into External Mixing and do a Mode Preset while in the Spectrum Analyzer Mode, the resulting Center Freq is 33.25 GHz.</p>
State Saved	Saved in instrument state.
Min	The minimum frequency in the currently selected mixer band + 5 Hz
Max	<p>The maximum frequency in the currently selected mixer band – 5 Hz</p> <p>If the knob or step keys are being used, also depends on the value of the other three interdependent parameters Span, Start Frequency and Stop Frequency</p>
Initial S/W Revision	A.08.01

### I/Q Center Freq

SCPI command for specifying the I/Q Center Frequency. This command will set the Center Frequency to be used when the I/Q input is selected, even if the I/Q input is not the input which is selected at the time the command is sent. Note that the Center Freq function in the Frequency menu on the front panel always applies to the currently selected input.

Scope	Meas Global
<b>Remote Command</b>	<pre>[ :SENSe ] :FREQuency:IQ:CENTer &lt;freq&gt;</pre> <pre>[ :SENSe ] :FREQuency:IQ:CENTer?</pre>
<b>Example</b>	FREQ:IQ:CENT: 30 MHz
Notes	This command is the same in all modes, but the parameter is Measurement Global. So the value is independent in each mode and common across all the measurements in the mode.
Preset	0 Hz
State Saved	Saved in instrument state.
Min	-40.049995 MHz
Max	40.049995 MHz
Initial S/W Revision	Prior to A.02.00

### CF Step

Changes the step size for the center frequency and start and stop frequency functions. Once a step size has been selected and the center frequency function is active, the step keys (and the UP|DOWN parameters for Center Frequency from remote commands) change the center frequency by the step-size value. The step size function is useful for finding harmonics and sidebands beyond the current frequency span of the analyzer.

Note that the start and stop frequencies also step by the CF Step value.

Key Path	FREQ Channel
Remote Command	[:SENSe]:FREQuency:CENTer:STEP[:INCRement] <freq> [:SENSe]:FREQuency:CENTer:STEP[:INCRement]? [:SENSe]:FREQuency:CENTer:STEP:AUTO OFF ON 0 1 [:SENSe]:FREQuency:CENTer:STEP:AUTO?
Example	FREQ:CENT:STEP:AUTO ON FREQ:CENT:STEP 500 MHz FREQ:CENT UP increases the current center frequency value by 500 MHz FREQ:CENT:STEP? FREQ:CENT:STEP:AUTO?
Notes	Preset and Max values are depending on Hardware Options (503, 507, 508, 513, 526)
Notes	Preset and Max values are dependent on Hardware Options (5xx)
Dependencies	Freq Offset is not available in External Mixing. In this case the Freq Offset key is grayed out and shows a value of zero. It will once again be available, and show the previously set value, when you return to the RF Input.
Dependencies	Span, RBW, Center frequency If the electronic/soft attenuator is enabled, any attempt to change the value of the center frequency >3.6 GHz by pressing the Up-arrow key, fails and results in an advisory message. If the equivalent SCPI command is sent, this same message is generated as part of a “-221, Settings conflict” warning.
Couplings	When auto-coupled in a non-zero span, the center frequency step size is set to 10% of the span. When auto-coupled in zero span, the center frequency step size is set to the equivalent -3 dB RBW value.
Preset	Auto ADEMOD: 1 MHz ON
State Saved	Saved in instrument state
Min	– (the maximum frequency of the instrument). That is, 27 GHz max freq instrument has a CF step range of +/- 27 GHz. Note that this is the maximum frequency given the current settings of the instrument, so in External Mixing, for example, it is the maximum frequency of the current mixer band.
Max	The maximum frequency of the instrument. That is, 27 GHz max freq instrument has a CF step range of +/- 27 GHz. Note that this is the maximum frequency given the current settings of the instrument, so in External Mixing, for example, it is the maximum frequency of the current mixer band.
Default Unit	Hz
Status Bits/OPC dependencies	non-overlapped
Initial S/W Revision	Prior to A.02.00
Modified at S/W Revision	A.03.00

20 Monitor Spectrum Measurement  
Input/Output

## Input/Output

See ["Input/Output" on page 226](#)



## Marker

Accesses a menu that enables you to select, set up and control the markers for the current measurement.

For remote-only commands associated with Marker functionality, see:

- "Marker X Axis Value (Remote Command only)" on page 2648
- "Marker X Axis Position (Remote Command only)" on page 2648
- "Marker Y Axis Value (Remote Command only)" on page 2649

Key Path	Front-panel key
Initial S/W Revision	Prior to A.02.00

## Select Marker

Displays 12 markers available for selection.

Key Path	Marker
Initial S/W Revision	Prior to A.02.00

## Marker Type

Sets the marker control mode to Normal, Delta or Off. If the selected marker is Off, pressing Marker sets it to Normal and places a single marker at the center of the display. At the same time, Marker X Axis Value appears on the Active Function area.

Key Path	Marker
Mode	All except SA and BASIC
Remote Command	:CALCulate:MONitor:MARKer[1] 2 ... 12:MODE POSition   DELTa   OFF :CALCulate:MONitor:MARKer[1] 2 ... 12:MODE?
Example	CALC:MON:MARK:MODE POS CALC:MON:MARK:MODE?
Notes	If the selected marker is Off, pressing Marker sets it to Normal and places it at the center of the screen on the trace determined by the Marker Trace rules. At the same time, Marker X Axis Value appears on the Active Function area.  Default Active Function: the active function for the selected marker's current control mode. If the current control mode is Off, there is no active function and the active function is turned off.  Active Function Display: the marker X axis value entered in the active function area displays the marker value to its full entered precision.
Preset	OFF
State Saved	Saved in instrument state.
Range	Normal Delta Off
Initial S/W Revision	Prior to A.02.00

## Properties

Accesses a menu that enables you to select the active marker, the reference marker and the trace for the current measurement.

Key Path	Marker
Initial S/W Revision	Prior to A.02.00

## Select Marker

Displays 12 markers available for selection.

Key Path	Marker
Initial S/W Revision	Prior to A.02.00

## Relative To

Selects the desired marker. The selected marker is relative to its reference marker.

Key Path	Marker, Properties
Mode	All except SA and BASIC
Remote Command	:CALCulate:MONitor:MARKer[1] 2 ... 12:REFerence <integer> :CALCulate:MONitor:MARKer[1] 2 ... 12:REFerence?
Example	CALC:MON:MARK2:REF 1 CALC:MON:MARK2:REF?
Notes	A marker cannot be relative to itself so that choice is grayed out, and if sent from SCPI generates error -221: "Settings conflict; marker cannot be relative to itself." When queried a single value is returned (the specified marker number's relative marker).
Preset	2 3 4 5 6 7 8 9 10 11 12 1
State Saved	Saved in instrument state.
Min	1
Max	12
Initial S/W Revision	Prior to A.02.00

## Marker Trace

Assigns the specified marker to the designated trace.

Key Path	Marker, Properties
Mode	All except SA and BASIC

<b>Remote Command</b>	:CALCulate:MONitor:MARKer[1] 2 ... 12:TRACe <integer> :CALCulate:MONitor:MARKer[1] 2 ... 12:TRACe?
<b>Example</b>	CALC:MON:MARK:TRAC 1 CALC:MON:MARK:TRAC?
Preset	1
State Saved	Saved in instrument state.
Min	1
Max	3
Initial S/W Revision	Prior to A.02.00

### Couple Markers

When this function is true, moving any marker causes an equal X Axis movement of every other marker that is not Off. By “equal X Axis movement” we mean that we preserve the difference between each marker’s X Axis value (in the fundamental x-axis units of the trace that marker is on) and the X Axis value of the marker being moved (in the same fundamental x-axis units).

Key Path	Marker
Mode	All except SA and BASIC
<b>Remote Command</b>	:CALCulate:MONitor:MARKer:COUPle[:STATe] ON OFF 1 0 :CALCulate:MONitor:MARKer:COUPle[:STATe]?
<b>Example</b>	CALC:MON:MARK:COUP ON CALC:MON:MARK:COUP?
Preset	OFF
State Saved	Saved in instrument state.
Range	On Off
Initial S/W Revision	Prior to A.02.00

### All Markers Off

Turns off all markers on the current measurement.

Key Path	Marker
Mode	All except SA and BASIC
<b>Remote Command</b>	:CALCulate:MONitor:MARKer:AOFF
<b>Example</b>	CALC:MON:MARK:AOFF
Initial S/W Revision	Prior to A.02.00

### Marker X Axis Value (Remote Command only)

Sets the marker X Axis value in the current marker X Axis Scale unit. It has no effect if the control mode is Off, but is the SCPI equivalent of entering an X value if the control mode is Normal or Delta.

Mode	All except SA and BASIC
Remote Command	:CALCulate:MONitor:MARKer[1] 2 ... 12:X <freq> :CALCulate:MONitor:MARKer[1] 2 ... 12:X?
Example	CALC:MON:MARK3:X 0 CALC:MON:MARK3:X?
Notes	If no suffix is sent, uses the fundamental units for the current marker X Axis Scale. If a suffix is sent that does not match the current marker X Axis Scale unit, an error "Invalid suffix" is generated. The query returns the marker's absolute X Axis value if the control mode is Normal, or the offset from the marker's reference marker if the control mode is Delta. The query is returned in the fundamental units for the current marker X Axis scale: Hz for Frequency and Inverse Time, seconds for Period and Time. If the marker is Off the response is not a number.
Preset	After a preset, all markers are turned OFF, so Marker X Axis Value query returns a not a number (NAN).
State Saved	No
Min	-9.9E+37
Max	9.9E+37
Initial S/W Revision	Prior to A.02.00

### Marker X Axis Position (Remote Command only)

Sets the marker X position in trace points. It has no effect if the control mode is Off, but is the SCPI equivalent of entering a value if the control mode is Normal or Delta – except in trace points rather than X Axis Scale units. The entered value is immediately translated into the current X Axis Scale units for setting the value of the marker.

Mode	All except SA and BASIC
Remote Command	:CALCulate:MONitor:MARKer[1] 2 ... 12:X:POSition <real> :CALCulate:MONitor:MARKer[1] 2 ... 12:X:POSition?
Example	CALC:MON:MARK:X:POS 0 CALC:MON:MARK:X:POS?
Notes	The query returns the marker's absolute X Axis value in trace points if the control mode is Normal, or the offset from the marker's reference marker in trace points if the control mode is Delta. The value is returned as a real number, not an integer, corresponding to the translation from X Axis Scale units to trace points. If the marker is Off the response is not a number.
Preset	After a preset, all markers are turned OFF, so Marker X Axis Value query returns a not a number (NAN).
State Saved	No
Min	-9.9E+37

Max	9.9E+37
Initial S/W Revision	Prior to A.02.00

**Marker Y Axis Value (Remote Command only)**

Returns the marker Y Axis value in the current marker.

Mode	All except SA and BASIC
<b>Remote Command</b>	:CALCulate:MONitor:MARKer[1] 2 ... 12:Y?
<b>Example</b>	CALC:MON:MARK11:Y?
Preset	Result dependent on markers setup and signal source
<b>Backwards Compatibility SCPI</b>	:CALCulate:MONitor:MARKer[1] 2 ... 12:FUNCTION:RESult?
Initial S/W Revision	Prior to A.02.00

## Marker Function

Accesses special marker functions such as marker noise, and power in a specified bandwidth or time interval.

Key Path	Front-panel key
Initial S/W Revision	Prior to A.02.00

### Select Marker

Displays 12 markers available for selection.

Key Path	Marker
Initial S/W Revision	Prior to A.02.00

### Marker Function Type

Sets the marker control function type to one of the following:

NOISe	Marker Noise
BPOWer	Band/Interval Power
BDENsity	Band Interval Density
OFF	Marker Function Off

Key Path	Marker Function
Mode	All except SA and BASIC
<b>Remote Command</b>	:CALCulate:MONitor:MARKer[1] 2 ... 12:FUNCTION NOISe   BPOWer   BDENsity   OFF  :CALCulate:MONitor:MARKer[1] 2 ... 12:FUNCTION?
<b>Example</b>	CALC:MON:MARK:FUNC NOISCALC:MON:MARK:FUNC?
Preset	OFF
State Saved	Saved in instrument state.
Range	Marker Noise Band/Interval Power Band Interval Density Marker Function Off
Initial S/W Revision	Prior to A.02.00

### Band Adjust

Accesses a menu that enables you to set the frequency span width and the left and right edge, or time values, for the band or interval of the selected marker.

Key Path	Marker Function
Initial S/W Revision	Prior to A.02.00

## Band/Interval Span for Frequency Domain

Sets the width of the frequency span for the selected marker.

Key Path	Marker Function
Mode	All except SA and BASIC
<b>Remote Command</b>	:CALCulate:MONitor:MARKer[1] 2 ... 12:FUNCtion:BAND:SPAN <freq> :CALCulate:MONitor:MARKer[1] 2 ... 12:FUNCtion:BAND:SPAN?
<b>Example</b>	CALC:MON:MARK12:FUNC:BAND:SPAN 20 MHz CALC:MON:MARK12:FUNC:BAND:SPAN?
Couplings	Changing the Band/Interval Span necessarily changes the Band/Interval Left and Band/Interval Right values.
Preset	Depends on X axis range of selected Trace.
State Saved	Saved in instrument state.
Min	-9.9E+37
Max	9.9E+37
Initial S/W Revision	Prior to A.02.00

## Band/Interval Left for Frequency Domain

Sets the left edge frequency or time value for the band of the selected marker.

Key Path	Marker Function
Mode	All except SA and BASIC
<b>Remote Command</b>	:CALCulate:MONitor:MARKer[1] 2 ... 12:FUNCtion:BAND:LEFT <freq> :CALCulate:MONitor:MARKer[1] 2 ... 12:FUNCtion:BAND:LEFT?
<b>Example</b>	CALC:MON:MARK12:FUNC:BAND:LEFT 20 GHz CALC:MON:MARK12:FUNC:BAND:LEFT?
Couplings	Changing the Band/Interval Left necessarily changes the Band/Interval Span value.
Preset	Depends on X axis range of selected Trace.
State Saved	Saved in instrument state.
Min	-9.9E+37
Max	9.9E+37
Initial S/W Revision	Prior to A.02.00

## Band/Interval Right for Frequency Domain

Sets the right edge frequency or time value for the band of the selected marker.

<b>Key Path</b>	Marker Function
<b>Mode</b>	All except SA and BASIC
<b>Remote Command</b>	:CALCulate:MONitor:MARKer[1] 2 ... 12:FUNction:BAND:RIGHT <freq> :CALCulate:MONitor:MARKer[1] 2 ... 12:FUNction:BAND:RIGHT?
<b>Example</b>	CALC:MON:MARK12:FUNC:BAND:RIGH 20 GHz CALC:MON:MARK12:FUNC:BAND:RIGH?
<b>Couplings</b>	Changing the Band/Interval Right necessarily changes the Band/Interval Span value.
<b>Preset</b>	Depends on X axis range of selected Trace.
<b>State Saved</b>	Saved in instrument state.
<b>Min</b>	-9.9E+37
<b>Max</b>	9.9E+37
<b>Initial S/W Revision</b>	Prior to A.02.00



# Marker To

There is no 'Marker To' functionality supported in Monitor Spectrum. The front-panel key displays a blank menu when pressed.

---

Key Path	Front-panel key
Initial S/W Revision	Prior to A.02.00

---

## Meas

The information in this section is common to all measurements. For key and remote command information for a specific measurement, refer to the section that describes the measurement of interest.

Measurements available under the Meas key are specific to the current Mode.

When viewing Help for measurements, note the following:

**NOTE**

Operation for some keys differs between measurements. The information displayed in Help pertains to the current measurement. To see how a key operates in a different measurement, exit Help (press the Cancel Esc key), select the measurement, then reenter Help (press the Help key) and press that key.

---

Key Path	Front-panel key
Initial S/W Revision	Prior to A.02.00

---

### Remote Measurement Functions

This section contains the following topics:

["Measurement Group of Commands" on page 2849](#)

["Current Measurement Query \(Remote Command Only\) " on page 2851](#)

["Limit Test Current Results \(Remote Command Only\)" on page 2851](#)

["Data Query \(Remote Command Only\)" on page 2851](#)

["Calculate/Compress Trace Data Query \(Remote Command Only\)" on page 2852](#)

["Calculate Peaks of Trace Data \(Remote Command Only\)" on page 2857](#)

[Hardware-Accelerated Fast Power Measurement \(Remote Command Only\)](#)

["Format Data: Numeric Data \(Remote Command Only\)" on page 2858](#)

["Format Data: Byte Order \(Remote Command Only\)" on page 2859](#)

---

Initial S/W Revision	Prior to A.02.00
----------------------	------------------

---

## Measurement Group of Commands

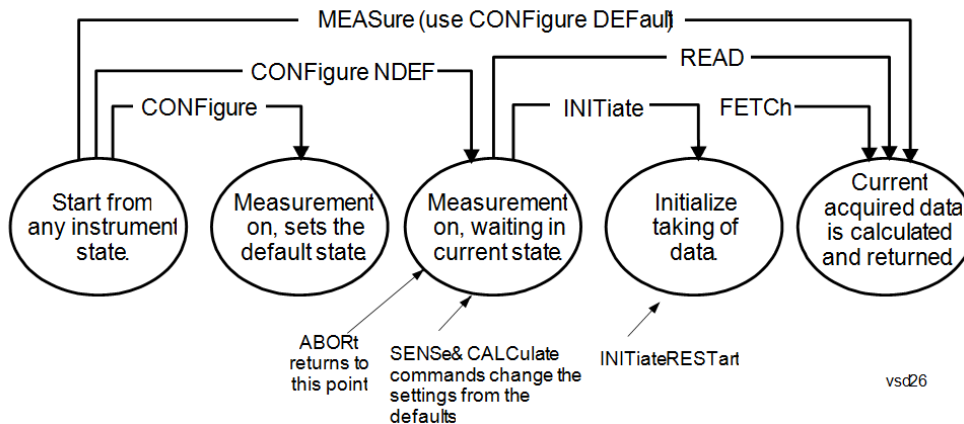

---

### Measure Commands:

:MEASure:<measurement>[n]?

This is a fast single-command way to make a measurement using the factory default instrument settings. These are the settings and units that conform to the Mode Setup settings (e.g. radio standard) that you have currently selected.

- Stops the current measurement (if any) and sets up the instrument for the specified measurement using the factory defaults
- Initiates the data acquisition for the measurement
- Blocks other SCPI communication, waiting until the measurement is complete before returning results.
- If the function does averaging, it is turned on and the number of averages is set to 10.
- After the data is valid it returns the scalar results, or the trace data, for the specified measurement. The type of data returned may be defined by an [n] value that is sent with the command.
- The scalar measurement results will be returned if the optional [n] value is not included, or is set to 1. If the [n] value is set to a value other than 1, the selected trace data results will be returned. See each command for details of what types of scalar results or trace data results are available.
- ASCII is the default format for the data output. (Older versions of Spectrum Analysis and Phase Noise mode measurements only use ASCII.) The binary data formats should be used for handling large blocks of data since they are smaller and faster than the ASCII format. Refer to the FORMat:DATA command for more information.

If you need to change some of the measurement parameters from the factory default settings you can set up the measurement with the CONFigure command. Use the commands in the SENSe:<measurement> and CALCulate:<measurement> subsystems to change the settings. Then you can use the READ? command to initiate the measurement and query the results.

If you need to repeatedly make a given measurement with settings other than the factory defaults, you can use the commands in the SENSe:<measurement> and CALCulate:<measurement> subsystems to set up the measurement. Then use the READ? command to initiate the measurement and query results.

Measurement settings persist if you initiate a different measurement and then return to a previous one. Use READ:<measurement>? if you want to use those persistent settings. If you want to go back to the default settings, use MEASure:<measurement>?.

---

### Configure Commands:

:CONFigure:<measurement>

This command stops the current measurement (if any) and sets up the instrument for the specified measurement using

---

---

the factory default instrument settings. It does not initiate the taking of measurement data unless INIT:CONTinuous is ON. If you change any measurement settings after using the CONFigure command, the READ command can be used to initiate a measurement without changing the settings back to their defaults.

In the Swept SA measurement in Spectrum Analyzer mode the CONFigure command also turns the averaging function on and sets the number of averages to 10 for all measurements.

:CONFigure: <measurement>: NDEFault stops the current measurement and changes to the specified measurement. It does not change the settings to the defaults. It does not initiate the taking of measurement data unless INIT:CONTinuous is ON.

The CONFigure? query returns the current measurement name.

The CONFigure:CATalog? query returns a quoted string of all licensed measurement names in the current mode. For example, "SAN, CHP, OBW, ACP, PST, TXP, SPUR, SEM, LIST".

---

#### Fetch Commands:

---

:FETCh:<measurement>[n]?

This command puts selected data from the most recent measurement into the output buffer. Use FETCh if you have already made a good measurement and you want to return several types of data (different [n] values, for example, both scalars and trace data) from a single measurement. FETCh saves you the time of re-making the measurement. You can only FETCh results from the measurement that is currently active, it will not change to a different measurement. An error message is reported if a measurement other than the current one is specified.

If you need to get new measurement data, use the READ command, which is equivalent to an INITiate followed by a FETCh.

The scalar measurement results will be returned if the optional [n] value is not included, or is set to 1. If the [n] value is set to a value other than 1, the selected trace data results will be returned. See each command for details of what types of scalar results or trace data results are available. The binary data formats should be used for handling large blocks of data since they are smaller and transfer faster than the ASCII format. (FORMat:DATA)

FETCh may be used to return results other than those specified with the original READ or MEASure command that you sent.

---

#### INITiate Commands:

---

:INITiate:<measurement>

This command is not available for measurements in all the instrument modes:

- Initiates a trigger cycle for the specified measurement, but does not output any data. You must then use the FETCh<meas> command to return data. If a measurement other than the current one is specified, the instrument will switch to that measurement and then initiate it.
  - For example, suppose you have previously initiated the ACP measurement, but now you are running the channel power measurement. If you send INIT:ACP? it will change from channel power to ACP and will initiate an ACP measurement.
  - Does not change any of the measurement settings. For example, if you have previously started the ACP measurement and you send INIT:ACP? it will initiate a new ACP measurement using the same instrument settings as the last time ACP was run.
  - If your selected measurement is currently active (in the idle state) it triggers the measurement, assuming the trigger conditions are met. Then it completes one trigger cycle. Depending upon the measurement and the number of averages, there may be multiple data acquisitions, with multiple trigger events, for one full trigger cycle. It also holds off additional commands on GPIB until the acquisition is complete.
- 

#### READ Commands:

---

:READ:<measurement>[n]?

- Does not preset the measurement to the factory default settings. For example, if you have previously initiated the ACP
-

---

measurement and you send READ:ACP? it will initiate a new measurement using the same instrument settings.

- Initiates the measurement and puts valid data into the output buffer. If a measurement other than the current one is specified, the instrument will switch to that measurement before it initiates the measurement and returns results.
  - For example, suppose you have previously initiated the ACP measurement, but now you are running the channel power measurement. Then you send READ:ACP? It will change from channel power back to ACP and, using the previous ACP settings, will initiate the measurement and return results.
  - Blocks other SCPI communication, waiting until the measurement is complete before returning the results
  - If the optional [n] value is not included, or is set to 1, the scalar measurement results will be returned. If the [n] value is set to a value other than 1, the selected trace data results will be returned. See each command for details of what types of scalar results or trace data results are available. The binary data formats should be used when handling large blocks of data since they are smaller and faster than the ASCII format. (FORMat:DATA)
- 

---

Initial S/W Revision	Prior to A.02.00
----------------------	------------------

---

### Current Measurement Query (Remote Command Only)

This command returns the name of the measurement that is currently running.

---

<b>Remote Command</b>	:CONFigure?
-----------------------	-------------

<b>Example</b>	CONF?
----------------	-------

Initial S/W Revision	Prior to A.02.00
----------------------	------------------

---

### Limit Test Current Results (Remote Command Only)

Queries the status of the current measurement limit testing. It returns a 0 if the measured results pass when compared with the current limits. It returns a 1 if the measured results fail any limit tests.

---

<b>Remote Command</b>	:CALCulate:CLIMits:FAIL?
-----------------------	--------------------------

<b>Example</b>	CALC:CLIM:FAIL? queries the current measurement to see if it fails the defined limits. Returns a 0 or 1: 0 it passes, 1 it fails.
----------------	--------------------------------------------------------------------------------------------------------------------------------------

Initial S/W Revision	Prior to A.02.00
----------------------	------------------

---

### Data Query (Remote Command Only)

Returns the designated measurement data for the currently selected measurement and subopcode.

n = any valid subopcode for the current measurement. See the measurement command results table for your current measurement, for information about what data is returned for the subopcodes.

This command uses the data setting specified by the FORMat:BORDER and FORMat:DATA commands and can return real or ASCII data. (See the format command descriptions under Input/Output in the Analyzer Setup section.)

<b>Remote Command</b>	:CALCulate:DATA[n]?
<b>Notes</b>	The return trace depends on the measurement. In CALCulate:<meas>:DATA[n], n is any valid subopcode for the current measurement. It returns the same data as the FETCH:<measurement>? query where <measurement> is the current measurement.
<b>Initial S/W Revision</b>	Prior to A.02.00

### Calculate/Compress Trace Data Query (Remote Command Only)

Returns compressed data for the currently selected measurement and sub-opcode [n].

n = any valid sub-opcode for that measurement. See the MEASure:<measurement>? command description of your specific measurement for information on the data that can be returned.

The data is returned in the current Y Axis Unit of the analyzer. The command is used with a sub-opcode <n> (default=1) to specify the trace. With trace queries, it is best if the analyzer is not sweeping during the query. Therefore, it is generally advisable to be in Single Sweep, or Update=Off.

This command is used to compress or decimate a long trace to extract and return only the desired data. A typical example would be to acquire N frames of GSM data and return the mean power of the first burst in each frame. The command can also be used to identify the best curve fit for the data.

<b>Remote Command</b>	:CALCulate:DATA<n>:COMPRESS? BLOCK   CFIT   MAXimum   MINimum   MEAN   DMEan   RMS   RMSCubed   SAMPLE   SDEVIation   PPHase [,<soffset> [,<length>[,<roffset>[,<rlimit>]]]]
<b>Example</b>	To query the mean power of a set of GSM bursts: Supply a signal that is a set of GSM bursts. Select the IQ Waveform measurement (in IQ Analyzer Mode). Set the sweep time to acquire at least one burst. Set the triggers such that acquisition happens at a known position relative to a burst. Then query the mean burst levels using, CALC:DATA2:COMP? MEAN, 24e-6, 526e-6 (These parameter values correspond to GSM signals, where 526e-6 is the length of the burst in the slot and you just want 1 burst.)
<b>Notes</b>	The command supports 5 parameters. Note that the last 4 (<soffset>, <length>, <roffset>, <rlimit>) are optional. But these optional parameters must be entered in the specified order. For example, if you want to specify <length>, then you must also specify <soffset>. See details below for a definition of each of these parameters.  This command uses the data in the format specified by FORMat:DATA, returning either binary or ASCII data.
<b>Initial S/W Revision</b>	Prior to A.02.00

- BLOCK or block data - returns all the data points from the region of the trace data that you specify. For example, it could be used to return the data points of an input signal over several timeslots, excluding the portions of the trace data that you do not want. (This is x,y pairs for trace data and I,Q pairs for complex data.)

- CFIT or curve fit - applies curve fitting routines to the data. <soffset> and <length> are required to define the data that you want. <roffset> is an optional parameter for the desired order of the curve equation. The query will return the following values: the x-offset (in seconds) and the curve coefficients ((order + 1) values).

MIN, MAX, MEAN, DME, RMS, RMSC, SAMP, SDEV and PPH return one data value for each specified region (or <length>) of trace data, for as many regions as possible until you run out of trace data (using <roffset> to specify regions). Or they return the number of regions you specify (using <rlimit>) ignoring any data beyond that.

- MINimum - returns the minimum data point (y value) for the specified region(s) of trace data. For I/Q trace data, the minimum magnitude of the I/Q pairs is returned.
- MAXimum - returns the maximum data point (y value) for the specified region(s) of trace data. For I/Q trace data, the maximum magnitude of the I/Q pairs is returned.
- MEAN - returns a single value that is the arithmetic mean of the data point values (in dB/ dBm) for the specified region(s) of trace data. For I/Q trace data, the mean of the magnitudes of the I/Q pairs is returned. See the following equations.

- 

**NOTE**

If the original trace data is in dB, this function returns the arithmetic mean of those log values, not log of the mean power which is a more useful value. The mean of the log is the better measurement technique when measuring CW signals in the presence of noise. The mean of the power, expressed in dB, is useful in power measurements such as Channel Power. To achieve the mean of the power, use the RMS option.

Equation 1

Mean Value of Data Points for Specified Region(s)

$$\text{MEAN} = \frac{1}{n} \sum_{X_i \in \text{region}(s)} X_i$$

where  $X_i$  is a data point value, and  $n$  is the number of data points in the specified region(s).

Equation 2

Mean Value of I/Q Data Pairs for Specified Region(s)

$$\text{MEAN} = \frac{1}{n} \sum_{X_i \in \text{region}(s)} |X_i|$$

where  $|X_i|$  is the magnitude of an I/Q pair, and  $n$  is the number of I/Q pairs in the specified region(s).

- DMEan - returns a single value that is the mean power (in dB/ dBm) of the data point values for the specified region(s) of trace data. See the following equation:

Equation 3

DMEan Value of Data Points for Specified Region(s)

$$\text{DME} = 10 \times \log_{10} \left( \frac{1}{n} \sum_{X_i \in \text{region}(s)} 10^{\frac{X_i}{10}} \right)$$

- RMS - returns a single value that is the average power on a root-mean-squared voltage scale (arithmetic rms) of the data point values for the specified region(s) of trace data. See the following equation.

**NOTE** For I/Q trace data, the rms of the magnitudes of the I/Q pairs is returned. See the following equation. This function is very useful for I/Q trace data. However, if the original trace data is in dB, this function returns the rms of the log values which is not usually needed.

Equation 4

RMS Value of Data Points for Specified Region(s)

$$\text{RMS} = \sqrt{\frac{1}{n} \sum_{X_i \in \text{region}(s)} X_i^2}$$

where  $X_i$  is a data point value, and  $n$  is the number of data points in the specified region(s).

Equation 5

RMS Value of I/Q Data Pairs for Specified Region(s)

$$\text{RMS} = \sqrt{\frac{1}{n} \sum_{X_i \in \text{region}(s)} X_i X_i^*}$$

where  $X_i$  is the complex value representation of an I/Q pair,  $X_i^*$  its conjugate complex number, and  $n$  is the number of I/Q pairs in the specified region(s).

Once you have the rms value for a region of trace data (linear or I/Q), you may want to calculate the mean power. You must convert this rms value (peak volts) to power in dBm:

$$10 \times \log[10 \times (\text{rms value})^2]$$

- SAMPlE - returns the first data value (x,y pair) for the specified region(s) of trace data. For I/Q trace data, the first I/Q pair is returned.
- SDEViation - returns a single value that is the arithmetic standard deviation for the data point values for the specified region(s) of trace data. See the following equation.
- For I/Q trace data, the standard deviation of the magnitudes of the I/Q pairs is returned. See the following equation.

Equation 6

Standard Deviation of Data Point Values for Specified Region(s)



$$\text{SDEV} = \sqrt{\frac{1}{n} \sum_{X_i \in \text{region}(s)} (X_i - \bar{X})^2}$$

where  $X_i$  is a data point value,  $\bar{X}$  is the arithmetic mean of the data point values for the specified region (s), and  $n$  is the number of data points in the specified region(s).

$$\text{SDEV} = \sqrt{\frac{1}{n} \sum_{X_i \in \text{region}(s)} (|X_i| - \bar{X})^2}$$

where  $|X_i|$  is the magnitude of an I/Q pair,  $\bar{X}$  is the mean of the magnitudes for the specified region(s), and  $n$  is the number of data points in the specified region(s).

- PPHase - returns the x,y pairs of both rms power (dBm) and arithmetic mean phase (radian) for every specified region and frequency offset (Hz). The number of pairs is defined by the specified number of regions. This parameter can be used for I/Q vector ( $n=0$ ) in Waveform (time domain) measurement and all parameters are specified by data point in PPHase.

The rms power of the specified region may be expressed as:

$$\text{Power} = 10 \times \log [10 \times (\text{RMS I/Q value})] + 10.$$

The RMS I/Q value (peak volts) is:

$$\sqrt{\frac{1}{n} \sum_{X_i \in \text{region}} X_i X_i^*}$$

where  $X_i$  is the complex value representation of an I/Q pair,  $X_i^*$  its conjugate complex number, and  $n$  is the number of I/Q pairs in the specified region.

The arithmetic mean phase of the specified region may be expressed as:

$$\frac{1}{n} \sum_{Y_i \in \text{region}} Y_i$$

where  $Y_i$  is the unwrapped phase of I/Q pair with applying frequency correction and  $n$  is the number of I/Q pairs in the specified region.

The frequency correction is made by the frequency offset calculated by the arithmetic mean of every specified region's frequency offset. Each frequency offset is calculated by the least square method against the unwrapped phase of I/Q pair.

Sample Trace Data - Constant Envelope

(See below for explanation of variables.)

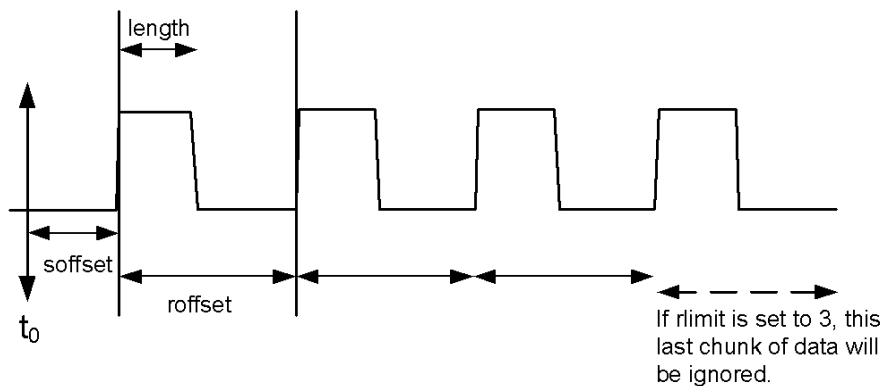

### Sample Trace Data - Not Constant Envelope

(See below for explanation of variables.)

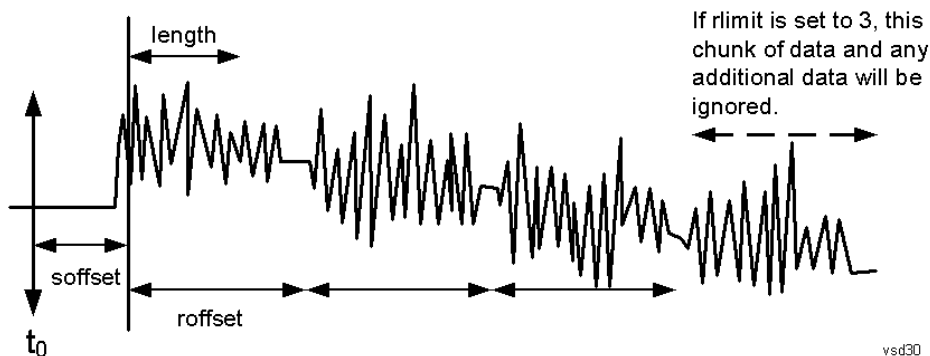

<soffset> - start offset is an optional real number. (It is in seconds for time-domain traces, and is a dimensionless index 0 to Npoints - 1, for frequency-domain traces). It specifies the amount of data at the beginning of the trace that will be ignored before the decimation process starts. It is the time or frequency change from the start of the trace to the point where you want to start using the data. The default value is zero.

<length> - is an optional real number. (It is in seconds for time-domain traces, and is a dimensionless index 0 to Npoints - 1, for frequency-domain traces). It defines how much data will be compressed into one value. This parameter has a default value equal to the current trace length.

<roffset> - repeat offset is an optional real number. (It is in seconds for time-domain traces, and is a dimensionless index 0 to Npoints - 1, for frequency-domain traces). It defines the beginning of the next field of trace elements to be compressed. This is relative to the beginning of the previous field. This parameter has a default value equal to the <length> variable. Note that this parameter is used for a completely different purpose when curve fitting (see CFIT above).

<rlimit> - repeat limit is an optional integer. It specifies the number of data items that you want returned. It will ignore any additional items beyond that number. You can use the Start offset and the Repeat limit to pick out exactly what part of the data you want to use. The default value is all the data.

## Calculate Peaks of Trace Data (Remote Command Only)

Returns a list of all the peaks for the currently selected measurement and sub-opcode [n]. The peaks must meet the requirements of the peak threshold and excursion values.

n = any valid sub-opcode for the current measurement. See the MEASure:<measurement> command description of your specific measurement for information on the data that can be returned.

The command can only be used with specific sub-opcodes with measurement results that are trace data. Both real and complex traces can be searched, but complex traces are converted to magnitude in dBm. In many measurements the sub-opcode n=0, is the raw trace data which cannot be searched for peaks. And Sub-opcode n=1, is often calculated results values which also cannot be searched for peaks.

This command uses the data setting specified by the FORMat:BORDER and FORMat:DATA commands and can return real or ASCII data. If the format is set to INT,32, it returns REAL,32 data.

The command has four types of parameters:

- Threshold (in dBm)
- Excursion (in dB)
- Sorting order (amplitude, frequency, time)
- Optional in some measurements: Display line use (all, > display line, < display line)

<b>Remote Command</b>	<p>For Swept SA measurement:</p> <pre>:CALCulate:DATA[1] 2 ... 6:PEAKs? &lt;threshold&gt;,&lt;excursion&gt;[,AMPLitude   FREQuency   TIME[,ALL   GTDLline   LTDLine]]</pre> <p>For most other measurements:</p> <pre>:CALCulate:DATA[1] 2 ... 6:PEAKs? &lt;threshold&gt;,&lt;excursion&gt;[,AMPLitude   FREQuency   TIME]</pre>
-----------------------	---------------------------------------------------------------------------------------------------------------------------------------------------------------------------------------------------------------------------------------------------------------------------------------------------------------------------------

<b>Example</b>	<p>Example for Swept SA measurement in Spectrum Analyzer Mode:</p> <p>CALC:DATA4:PEAK? -40, 10, FREQ, GTDL This will identify the peaks of trace 4 that are above -40 dBm, with excursions of at least 10 dB. The peaks are returned in order of increasing frequency, starting with the lowest frequency. Only the peaks that are above the display line are returned.</p> <p>Query Results 1:</p> <p>With FORMat:DATA REAL, 32 selected, it returns a list of floating-point numbers. The first value in the list is the number of peak points that are in the following list. A peak point consists of two values: a peak amplitude followed by its corresponding frequency (or time).</p> <p>If no peaks are found the peak list will consist of only the number of peaks, (0).</p>
----------------	-----------------------------------------------------------------------------------------------------------------------------------------------------------------------------------------------------------------------------------------------------------------------------------------------------------------------------------------------------------------------------------------------------------------------------------------------------------------------------------------------------------------------------------------------------------------------------------------------------------------------------------------------------------------------------------------------------------------------------------------------------------------------------------------

<b>Notes</b>	<p>&lt;n&gt; - is the trace that will be used</p> <p>&lt;threshold&gt; - is the level below which trace data peaks are ignored. Note that the threshold value is required and is always used as a peak criterion. To effectively disable the threshold criterion for this command, provide a substantially low threshold value such as -200 dBm. Also note that the threshold value used in this command is independent of and has no effect on the threshold value stored under the Peak Criteria menu.</p> <p>&lt;excursion&gt; - is the minimum amplitude variation (rise and fall) required for a signal to be identified as peak. Note that the excursion value is required and is always used as a peak criterion. To effectively disable the excursion criterion for this command, provide the minimum value of 0.0 dB. Also note that the excursion value used in this command is independent of and has no effect on the</p>
--------------	---------------------------------------------------------------------------------------------------------------------------------------------------------------------------------------------------------------------------------------------------------------------------------------------------------------------------------------------------------------------------------------------------------------------------------------------------------------------------------------------------------------------------------------------------------------------------------------------------------------------------------------------------------------------------------------------------------------------------------------------------------------------------------------------------------------------------------------------------------------------------------------------------------------------------------------

excursion value stored under the Peak Criteria menu.

Values must be provided for threshold and excursion. The sorting and display line parameters are optional (defaults are AMPLitude and ALL).

Note that there is always a Y-axis value for the display line, regardless of whether the display line state is on or off. It is the current Y-axis value of the display line which is used by this command to determine whether a peak should be reported

Sorting order:

AMPLitude - lists the peaks in order of descending amplitude, with the highest peak first (default if optional parameter not sent)

FREQuency - lists the peaks in order of occurrence, left to right across the x-axis.

TIME - lists the peaks in order of occurrence, left to right across the x-axis.

Peaks vs. Display Line:

ALL - lists all of the peaks found (default if optional parameter not sent).

GTDLine (greater than display line) - lists all of the peaks found above the display line.

LTDLine (less than display line) - lists all of the peaks found below the display line.

Initial S/W Revision      Prior to A.02.00

### Format Data: Numeric Data (Remote Command Only)

This command specifies the format of the trace data input and output. It specifies the formats used for trace data during data transfer across any remote port. It affects only the data format for setting and querying trace data for the :TRACe[:DATA], TRACe[:DATA]?, :CALCulate:DATA[n]? and FETCh:SANalyzer [n]? commands and queries.

**Remote Command**      :FORMat [:TRACe] [:DATA] ASCii|INTeger,32|REAL,32 |REAL,64  
:FORMat [:TRACe] [:DATA] ?

**Notes**      The query response is:  
ASCii: ASC,8  
REAL,32: REAL,32  
REAL,64: REAL,64  
INTeger,32: INT,32

When the numeric data format is REAL or ASCii, data is output in the current Y Axis unit. When the data format is INTeger, data is output in units of m dBm (.001 dBm).

The INT,32 format returns binary 32-bit integer values in internal units (m dBm), in a definite length block.

**Dependencies**      Sending a data format spec with an invalid number (for example, INT,48) generates no error. The analyzer simply uses the default (8 for ASCii, 32 for INTeger, 32 for REAL).

Sending data to the analyzer which does not conform to the current FORMat specified, results in an error. Sending ASCII data when a definite block is expected generates message -161 "Invalid Block Data" and sending a definite block when ASCII data is expected generates message -121 "Invalid Character in Number".

**Preset**      ASCii

**Backwards Compatibility Notes**      Note that the INT,32 format is only applicable to the command, TRACe:DATA. This preserves backwards compatibility for the Swept SA measurement. For all other commands/queries which honor FORMat:DATA, if INT,32 is sent the analyzer will behave as though it were set to REAL,32.

Initial S/W Revision      Prior to A.02.00

The specs for each output type follow:

ASCIi - Amplitude values are in ASCII, in the current Y Axis Unit, one ASCII character per digit, values separated by commas, each value in the form:

SX.YYYYYEsZZ

Where:

S = sign (+ or -)

X = one digit to left of decimal point

Y = 5 digits to right of decimal point

E = E, exponent header

s = sign of exponent (+ or -)

ZZ = two digit exponent

REAL,32 - Binary 32-bit real values in the current Y Axis Unit, in a definite length block.

REAL,64 - Binary 64-bit real values in the current Y Axis Unit, in a definite length block.

### Format Data: Byte Order (Remote Command Only)

This command selects the binary data byte order for data transfer and other queries. It controls whether binary data is transferred in normal or swapped mode. This command affects only the byte order for setting and querying trace data for the :TRACe[:DATA], TRACe[:DATA]? , :CALCulate:DATA[n]? and FETCh:SANalyzer[n]? commands and queries.

By definition any command that says it uses FORMat:DATA uses any format supported by FORMat:DATA.

The NORMal order is a byte sequence that begins with the most significant byte (MSB) first, and ends with the least significant byte (LSB) last in the sequence: 1|2|3|4. SWAPPed order is when the byte sequence begins with the LSB first, and ends with the MSB last in the sequence: 4|3|2|1.

<b>Remote Command</b>	:FORMat:BORDER NORMal SWAPPed :FORMat:BORDER?
<b>Preset</b>	NORMal
<b>Initial S/W Revision</b>	Prior to A.02.00

## Meas Setup

Displays the setup menu for the current measurement. The measurement setup parameters include the number of measurement averages used to calculate the measurement result and the averaging mode. The setup menu also includes the option to reset the measurement settings to their factory defaults.

Key Path	Front-panel key
Initial S/W Revision	Prior to A.02.00

### Avg/Hold Num

Specifies the number of measurement averages used when calculating the measurement result. The average is displayed at the end of each sweep.

After the specified number of average counts, the averaging mode (terminal control) setting determines the averaging action.

Key Path	Meas Setup
Mode	All except SA and BASIC
Remote Command	[:SENSe]:MONitor:AVERage:COUNT <integer> [:SENSe]:MONitor:AVERage:COUNT? [:SENSe]:MONitor:AVERage[:STATe] OFF ON 0 1 [:SENSe]:MONitor:AVERage[:STATe]?
Example	MON:AVER:COUN 25 MON:AVER:COUN? MON:AVER ON MON:AVER?
Preset	10 OFF
State Saved	Saved in instrument state.
Min	1
Max	1000
Initial S/W Revision	Prior to A.02.00

### Avg Mode

Toggles the average mode between exponential (Exp) and Repeat.

- **Exp**– continues measurement averaging, using the specified number of averages to compute each averaged value. The average is displayed at the end of each sweep.
- **Repeat**– causes the measurement to reset the average counter each time the specified number of averages is reached.

Key Path	Meas Setup
Mode	All except SA and BASIC
<b>Remote Command</b>	[ :SENSe]:MONitor:AVERage:TCONtrol EXPonential REPeat [ :SENSe]:MONitor:AVERage:TCONtrol?
<b>Example</b>	MON:AVER:TCON EXP MON:AVER:TCON?
Preset	EXPonential
State Saved	Saved in instrument state.
Range	ExpRepeat
Initial S/W Revision	Prior to A.02.00

### Meas Preset

Restores all the measurement parameters to their default values.

Key Path	Meas Setup
Mode	All except SA and BASIC
<b>Remote Command</b>	:CONFigure:MONitor
<b>Example</b>	CONF:MON
Initial S/W Revision	Prior to A.02.00

20 Monitor Spectrum Measurement  
Mode

Mode

See "[Mode](#)" on page 318



# Mode Preset

Returns the active mode to a known state.

Mode Preset does the following for the currently active mode:

- Aborts the currently running measurement.
- Brings up the default menu for the mode, with no active function.
- Sets measurement Global settings to their preset values for the active mode only.
- Activates the default measurement.
- Brings up the default menu for the mode.
- Clears the input and output buffers.
- Sets Status Byte to 0.

Mode Preset does not:

- Cause a mode switch
- Affect mode persistent settings
- Affect system settings

See ["How-To Preset" on page 2670](#) for more information.

Key Path	Front-panel key
<b>Remote Command</b>	:SYSTem:PRESet
<b>Example</b>	:SYST:PRES
Notes	*RST is preferred over :SYST:PRES for remote operation. *RST does a Mode Preset, as done by the :SYST:PRES command, and it sets the measurement mode to Single measurement rather than Continuous for optimal remote control throughput. Clears all pending OPC bits. The Status Byte is set to 0.
Couplings	A Mode Preset aborts the currently running measurement, activates the default measurement, and gets the mode to a consistent state with all of the default couplings set.
Backwards Compatibility Notes	In the X-Series, the legacy "Factory Preset" has been replaced with Mode Preset, which only presets the currently active mode, not the entire instrument. In the X-Series, the way to preset the entire instrument is by using System, Restore System Defaults All, which behaves essentially the same way as restore System Defaults does on ESA and PSA. There is also no "Preset Type" as there is on the PSA. There is a green Mode Preset front-panel key that does a Mode Preset and a white-with-green-letters User Preset front-panel key that does a User Preset. The old PRESet:TYPE command is ignored (without generating an error), and SYST:PRES without a parameter does a Mode Preset, which should cover most backward code compatibility issues. The settings and correction data under the Input/Output front-panel key (examples: Input Z Corr, Ext Amp Gain, etc.) are no longer part of any Mode, so they will not be preset by a Mode Preset. They are preset using Restore Input/Output Defaults, Restore System Defaults All. Note that because User Preset does a Recall State, and all of these settings are saved in State, they ARE recalled when using

	User Preset.
Initial S/W Revision	Prior to A.02.00

## How-To Preset

The table below shows all possible presets, their corresponding SCPI commands and front-panel access (key paths). Instrument settings depend on the current measurement context. Some settings are local to the current measurement, some are global (common) across all the measurements in the current mode, and some are global to all the available modes. In a similar way, restoring the settings to their preset state can be done within the different contexts.

Auto Couple - is a measurement local key. It sets all Auto/Man parameter couplings in the measurement to Auto. Any Auto/Man selection that is local to other measurements in the mode will not be affected.

Meas Preset - is a measurement local key. Meas Preset resets all the variables local to the current measurement except the persistent ones.

Mode Preset - resets all the current mode's measurement local and measurement global variables except the persistent ones.

Restore Mode Defaults - resets ALL the Mode variables (and all the Meas global and Meas local variables), including the persistent ones.

Type Of Preset	SCPI Command	Front Panel Access
Auto Couple	:COUPle ALL	Auto Couple front-panel key
Meas Preset	:CONFigure:<Measurement>	Meas Setup Menu
Mode Preset	:SYSTem:PRESet	Mode Preset (green key)
Restore Mode Defaults	:INSTrument:DEFault	Mode Setup Menu
Restore All Mode Defaults	:SYSTem:DEFault MODes	System Menu; Restore System Default Menu
*RST	*RST	not possible (Mode Preset with Single)
Restore Input/Output Defaults	:SYSTem:DEFault INPUt	System Menu; Restore System Default Menu
Restore Power On Defaults	:SYSTem:DEFault PON	System Menu; Restore System Default Menu
Restore Alignment Defaults	:SYSTem:DEFault ALIGN	System Menu; Restore System Default Menu
Restore Miscellaneous Defaults	:SYSTem:DEFault MISC	System Menu; Restore System Default Menu
Restore All System Defaults	:SYSTem:DEFault [ALL] :SYSTem:PRESet:PERsistent	System Menu; Restore System Default Menu
User Preset	:SYSTem:PRESet:USER	User Preset Menu
User Preset All Modes	:SYSTem:PRESet:USER:ALL	User Preset Menu

Power On Mode Preset	:SYSTem:PON:TYPE MODE	System Menu
Power On User Preset	:SYSTem:PON:TYPE USER	System Menu
Power On Last State	:SYSTem:PON:TYPE LAST	System Menu

**Preset Type (Remote Command Only)**

As stated in the Backward Compatibility section, to be compatible with ESA/PSA the PRESet:TYPE command will be implemented as a no-op.

Mode	All
<b>Remote Command</b>	:SYSTem:PRESet:TYPE FACTory MODE USER :SYSTem:PRESet:TYPE?
<b>Example</b>	:SYST:PRESet:TYPE FACT
Notes	This command is supported for backward compatibility only. It is a no-op which does not change the behavior of any preset operation.
Preset	This is unaffected by Preset but is set to Mode on a “Restore System Defaults->All”
State Saved	No
Initial S/W Revision	Prior to A.02.00

## Mode Setup

See "[Mode Setup](#)" on page 348

# Peak Search

Places the selected marker on the trace point with the maximum y-axis value for that marker's trace. Pressing Peak Search with the selected marker off causes the selected marker to be set to Normal, then a peak search is immediately performed.

Key Path	Front-panel key
Mode	All except SA and BASIC
Remote Command	:CALCulate:MONitor:MARKer[1] 2 ... 12:MAXimum
Example	CALC:MON:MARK2:MAX
Initial S/W Revision	Prior to A.02.00

20 Monitor Spectrum Measurement  
Print

Print

See ["Print" on page 358](#)

## Quick Save

The Quick Save front-panel key repeats the most recent save that was performed from the Save menu, with the following exceptions:

- Register saves are not remembered as Saves for the purpose of the Quick Save function
- If the current measurement does not support the last non-register save that was performed, an informational message is generated, “File type not supported for this measurement”

Quick Save repeats the last type of qualified save (that is, a save qualified by the above criteria) in the last save directory by creating a unique filename using the Auto File Naming algorithm described below.

If Quick Save is pressed after startup and before any qualified Save has been performed, the Quick Save function performs a Screen Image save using the current settings for Screen Image saves (current theme, current directory), which then becomes the “last save” for the purpose of subsequent Quick Saves.

The Auto File Naming feature automatically generates a file name for use when saving a file. The filename consists of a prefix and suffix separated by a dot, as is standard for the Windows® file system. A default prefix exists for each of the available file types:

Type	Default Prefix	Menu
State	State_	(Save/Recall)
Trace + State	State_	(Save/Recall)
Screen	Screen_	(Save/Recall)
Amplitude Corrections	Ampcor_	(Import/Export)
Traces	Trace_	(Import/Export)
Limit Lines	LLine_	(Import/Export)
Measurement Result	MeasR_	(Import/Export)
Capture Buffer	CapBuf_	(Import/Export)

A four digit number is appended to the prefix to create a unique file name. The numbering sequence starts at 0000 within each Mode for each file type and updates incrementally to 9999, then wraps to 0000 again. It remembers where it was through a Mode Preset and when leaving and returning to the Mode. It is reset by Restore Misc Defaults and Restore System Defaults and subsequent running of the instrument application. So, for example, the first auto file name generated for State files is State\_0000.state. The next is State\_0001, and so forth.

One of the key features of Auto File Name is that we guarantee that the Auto File Name will never conflict with an existing file. The algorithm looks for the next available number. If it gets to 9999, then it looks for holes. If it find no holes, that is no more numbers are available, it gives an error.

For example, if when we get to State\_0010.state there is already a State\_0010.state file in the current directory, it advances the counter to State\_0011.state to ensure that no conflict will exist (and then it verifies that State\_0011.state also does not exist in the current directory and advances again if it does, and so forth).

If you enter a file name for a given file type, then the prefix becomes the filename you entered instead of the default prefix, followed by an underscore. The last four letters (the suffix) are the 4-digit number.

For example, if you save a measurement results file as “fred.csv”, then the next auto file name chosen for a measurement results save will be fred\_0000.csv.

**NOTE**

Although 0000 is used in the example above, the number that is used is actually the current number in the Meas Results sequence, that is, the number that would have been used if you had not entered your own file name.

---

**NOTE**

If the filename you entered ends with \_dddd, where d=any number, making it look just like an auto file name, then the next auto file name picks up where you left off with the suffix being dddd + 1.

---

Key Path	Front-panel key
Notes	No remote command for this key specifically.
Initial S/W Revision	Prior to A.02.00



## Recall

The Recall menu lets you choose what you want to recall, and where you want to recall it from. Among the types of files you can recall are **States and Traces**. In addition, an Import (Data) option lets you recall a number of data types stored in CSV files (as used by Excel and other spreadsheet programs).

The default paths for Recall are data type dependent and are the same as for the Save key.

Key Path	Front-panel key
Notes	<p>No remote command for this key specifically, but the :MMEM:LOAD command is available for specific file types. An example is :MMEM:LOAD:STATe &lt;filename&gt;.</p> <p>If you try to recall a State file for a mode that is not licensed or not available in the instrument, an error message will occur and the state will not change.</p>
Backwards Compatibility Notes	<p>In legacy analyzers, it was possible to load a state without affecting the trace data, limit lines or correction data. Similarly (since User Preset is actually loading a state), it was possible to do a User Preset without affecting the trace data, limit lines or correction data.</p> <p>In the X-Series, “state” always includes all of this data; so whenever state is loaded, all of the traces, limit lines and corrections are affected. Although this differs from previous behavior, it is desirable behavior, and should not cause adverse issues for users.</p>
Backwards Compatibility Notes	<p>Recall for the X-Series supports backward compatibility in the sense that you can recall a state file from any X-Series model number and any version of X-Series software. This is only possible if part of the recalling process goes through a limiting step after recalling the mode settings, at least for settings that may vary with version number, model number, option and license differences. If you try to recall a state file onto an instrument with less capability than what was available on the instrument during the save, the recall will ignore the state it doesn't support and it will limit the recalled setting to what it allows.</p> <p>Example: if the saved state includes preamp ON, but the recalling instrument does not have a preamp; the preamp is limited to OFF. Conversely, if you save a state without a preamp, the preamp is OFF in the state file. When this saved file is recalled on an instrument with a licensed preamp, the preamp is changed to OFF. Another example is if the saved state has center frequency set to 20 GHz, but the instrument recalling the saved state is a different model and only supports 13.5 GHz. In this case, the center frequency is limited along with any other frequency based settings. Since the center frequency can't be preserved in this case, the recall limiting tries to at least preserve span to keep the measurement setup as intact as possible.</p> <p>It may be appropriate to issue a warning if the state is limited on the recall; warnings do not go out to SCPI so this would only affect the manual user.</p> <p>Note that there is no state file compatibility outside of the X-Series. For example, you cannot recall a state file from ESA or PSA.</p>
Initial S/W Revision	Prior to A.02.00

## State

The Recall State menu lets you choose a register or file from which to recall the state.

The content of a state file includes all of the settings and data required to return the analyzer as closely as possible to the Mode it was in, with the exact settings that were in place, when the save occurred. The Mode settings in each state file include the settings that are affected by Mode Preset, as well as the

additional settings affected by Restore Mode Defaults; all of the Mode's settings. In addition, all of the settings of the Input/Output system are included, even though they are outside of the Mode's state, because they are needed to restore the complete setup. Persistent System settings (for example, GPIB address) are not affected by either a Mode Preset or Restore Mode Defaults, nor are they included in a saved State file.

Since each state file is only for one Mode, the settings for other Modes are unaffected when it is loaded. Recall State will cause a mode switch if the state being recalled is not from the current active mode.

After the recall completes, the message "File <filename> recalled" or "Recalled State Register <register number>" is displayed.

For rapid recalls, the State menu lists 16 registers that you can choose from to recall. Pressing a Register key initiates the recall. You can also select a file from which to recall.

The default path for all State Files is:

My Documents\<mode name>\state

where <mode name> is the parameter used to select the mode with the INST:SEL command (for example, SA for the Spectrum Analyzer).

See ["More Information" on page 2679](#).

<b>Key Path</b>	Recall
<b>Mode</b>	All
<b>Remote Command</b>	:MMEMory:LOAD:STATe <filename>
<b>Example</b>	:MMEM:LOAD:STAT "myState.state" This recalls the file myState.state on the default path
<b>Example</b>	MMEM:LOAD:STAT "MyStateFile.state" This loads the state file data (on the default file directory path) into the instrument state.
<b>Notes</b>	<p>When you pick a file to recall, the analyzer first verifies that the file is recallable in the current instrument by checking the software version and model number of the instrument. If everything matches, a full recall proceeds by aborting the currently running measurement, clearing any pending operations, and then loading the State from the saved state file. You can open state files from any mode, so recalling a State file switches to the mode that was active when the save occurred. After switching to the mode of the saved state file, mode settings and data (if any for the mode) are loaded with values from the saved file. The saved measurement of the mode becomes the newly active measurement and the data relevant to the measurement (if there is any) is recalled.</p> <p>If there is a mismatch between file version or model number or instrument version or model number, the recall function tries to recall as much as possible and returns a warning message. It may limit settings that differ based on model number, licensing or version number.</p> <p>After recalling the state, the Recall State function does the following:</p> <ul style="list-style-type: none"> <li>• Makes the saved measurement for the mode the active measurement.</li> <li>• Clears the input and output buffers.</li> <li>• Status Byte is set to 0.</li> <li>• Executes a *CLS</li> </ul> <p>If the file specified is empty an error is generated. If the specified file does not exist, another error is generated. If there is a mismatch between the file and the proper file type, an error is generated. If</p>

	there is a mismatch between file version or model number or instrument version or model number, a warning is displayed. Then it returns to the State menu and File Open dialog goes away. After the Recall, the analyzer exits the Recall menu and returns to the previous menu.
<b>Backwards Compatibility SCPI</b>	:MMEMory:LOAD:STATe 1,<filename> For backwards compatibility, the above syntax is supported. The "1" is simply ignored.
Initial S/W Revision	Prior to A.02.00

## More Information

In measurements that support saving Traces, for example, Swept SA, the Trace data is saved along with the State in the State file. When recalling the State, the Trace data is recalled as well. Traces are recalled exactly as they were stored, including the writing mode and update and display modes. If a Trace was updating and visible when the State was saved, it will come back updating and visible, and its data will be rewritten right away. When you use State to save and recall traces, any trace whose data must be preserved should be placed in View or Blank mode before saving.

The following table describes the Trace Save and Recall possibilities:

You want to recall state and one trace's data, leaving other traces unaffected.	Save Trace+State from 1 trace. Make sure that no other traces are updating (they should all be in View or Blank mode) when the save is performed.	On Recall, specify the trace you want to load the one trace's data into. This trace will load in View. All other traces' data will be unaffected, although their trace mode will be as it was when the state save was performed.
You want to recall all traces	Save Trace+State from ALL traces.	On Recall, all traces will come back in View (or Blank if they were in Blank or Background when saved)
You want all traces to load exactly as they were when saved.	Save State	On recall, all traces' mode and data will be exactly as they were when saved. Any traces that were updating will have their data immediately overwritten.

## From File...

When you press "From File", the analyzer brings up a Windows dialog and a menu entitled "File Open." This menu allows you to navigate to the various fields in the Windows dialog without using a keyboard or mouse. The Tab and Arrow keys can also be used for dialog navigation.

## 20 Monitor Spectrum Measurement Recall

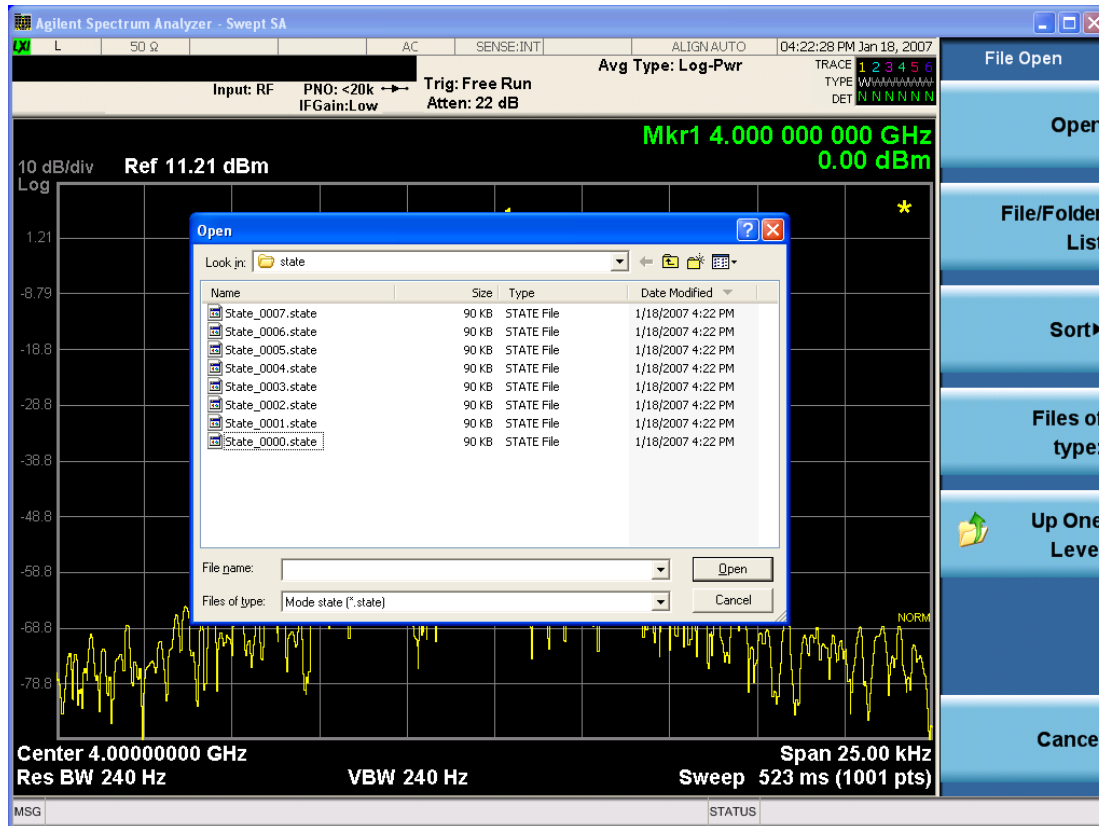

Listed below are the functions of the various fields in the dialog, and the corresponding softkeys:

### Open

Performs the recall of the specified file. While the recall is being performed, the floppy icon appears briefly in the Meas bar.

### File/Folder List

Enables you to navigate to the center of the dialog that contains the list of files and folders. Once here you can get information about the file and use the tab keys to navigate to the other fields in the dialog, such as Look In.

### Look In

The Look In field shows the path from which the file will be recalled and allows you to change the path using the up and down arrow keys to navigate to other paths; the Enter key to open a directory; and the Backspace key to go back one directory. The **Look In field** first uses the last path from the Save As dialog **Save In:** path for that same file type. There is no softkey for directly navigating to the Look In field, but you can use the left tab to get here from the File/Folder List.

User specified paths are remembered when you leave and return to a Mode and are reset back to the default using Restore Mode Defaults.

### Sort

Accesses a menu that enables you to sort the files within the File Open dialog. Only one sorting type can be selected at a time and the sorting happens immediately. The sorting types are By Date, By Name, By extension, and By Size.

#### Files of Type

This field shows the file suffix for the type of file you have selected to recall. For example, if you navigated here while recalling State, "Mode state (\*.state)" is in the field. If you navigated here while recalling Trace, ""Mode state (\*.trace)" is in the field. If you navigated here while importing a trace data file, "Trace Data (\*.csv)" is in the field. For some file types, there is more than one choice in the dropdown menu, which you can select by using the up and down arrow keys and Enter.

#### Up One Level

This key corresponds to the icon of a folder with the up arrow that is in the tool bar of the dialog. When pressed, it causes the file and folder list to navigate up one level in the directory structure. The Backspace key does the same thing.

#### Cancel

This key corresponds to the Cancel selection in the dialog. It causes the current **Open** request to be cancelled. The ESC key does the same thing.

Key Path	Recall, State
Notes	Brings up the Open dialog for recalling a State Save Type
Initial S/W Revision	Prior to A.02.00

### Edit Register Names

You may enter a custom name on any of the Register keys, to help you remember what you are using that state to save. To do this, press the Edit Register Names key, choose the register whose name you wish to edit, and then enter the desired label using the Alpha Editor or an external PC keyboard.

The maximum number of characters that can be added is 30. In most cases, 30 characters will fit on two lines of the key.

For more information and the SCPI command, see Edit Register Names under the Save, State function.

Key Path	Recall, State
Mode	All
Dependencies	N9060A-7FP or N9060B-2FP license required to edit the register names. When the feature is not licensed, sending the SCPI command generates an error, -221, "Settings conflict;Option not available"
Initial S/W Revision	A.11.00

### Register 1 thru Register 16

Selecting any one of these register keys causes the State of the mode from the specified Register to be recalled. Each of the register keys annotates whether it is empty or at what date and time it was last

modified. In addition, you can use the Edit Register Names key under Save, State to enter custom names for each register.

Registers are shared by all modes, so recalling from any one of the registers will cause a mode switch to the mode that was active when the save to the Register occurred.

Although these 16 registers are the only registers available from the front panel, there are 128 state registers available in the instrument. Registers 17–128 are only available from the SCPI interface, using the \*RCL command.

After the recall completes, the message "Register <register number> recalled" appears in the message bar. If you are in the Spectrum Analyzer Mode, and you are recalling a register that was saved in the Spectrum Analyzer Mode, then after the recall, you will still be in the Recall Register menu. If the Recall causes you to switch modes, then after the Recall, you will be in the Frequency menu.

If a requested register is empty an error is generated.

Key Path	Recall, State
<b>Example</b>	*RCL 1
Range	1–16 from front panel, 1–128 from SCPI
Readback	Date and time with seconds resolution are displayed on the key OR A custom name of up to 30 characters entered using the Save, State, Edit Register Names key OR “(empty)” if no prior save operation has been performed to this register.
Initial S/W Revision	Prior to A.02.00
Modified at S/W Revision	Prior to A.11.00

## Register 1 thru Register 16

Selecting any one of these register keys causes the State of the mode from the specified Register to be recalled. Each of the register keys annotates whether it is empty or at what date and time it was last modified. In addition, you can use the Edit Register Names key under Save, State to enter custom names for each register.

Registers are shared by all modes, so recalling from any one of the registers will cause a mode switch to the mode that was active when the save to the Register occurred.

Although these 16 registers are the only registers available from the front panel, there are 128 state registers available in the instrument. Registers 17–128 are only available from the SCPI interface, using the \*RCL command.

After the recall completes, the message "Register <register number> recalled" appears in the message bar. If you are in the Spectrum Analyzer Mode, and you are recalling a register that was saved in the Spectrum Analyzer Mode, then after the recall, you will still be in the Recall Register menu. If the Recall causes you to switch modes, then after the Recall, you will be in the Frequency menu.

If a requested register is empty an error is generated.

Key Path	Recall, State
<b>Example</b>	*RCL 1
Range	1-16 from front panel, 1-128 from SCPI
Readback	Date and time with seconds resolution are displayed on the key OR A custom name of up to 30 characters entered using the Save, State,Edit Register Names key OR “(empty)” if no prior save operation has been performed to this register.
Initial S/W Revision	Prior to A.02.00
Modified at S/W Revision	Prior to A.11.00

### Trace (+State)

The Recall Trace (+State) menu lets you choose a register or file from which to recall the Trace+State state file.

A saved state contains all of the settings and data required to return the analyzer as closely as possible to the exact setup it had when the save occurred. This includes the Input/Output settings, even though they are outside of the Mode’s state, because they are needed to restore the complete setup. A Trace+State file also includes trace data from one trace or all traces, which will load in View mode when the Trace+State file is recalled. Recall Trace (+State) will also cause a mode switch if the state being recalled is not for the current active mode.

After the recall completes, the message "File <filename> recalled" or “Recalled Trace Register <register number>” is displayed.

For rapid recalls, the Trace (+State) menu lists 5 registers to choose from to recall. Pressing a Register key initiates the recall. You can also select a file from which to recall.

The default path for all State Files including .trace files is:

My Documents\<mode name>\state

where <mode name> is the parameter used to select the mode with the INST:SEL command (for example, SA for the Spectrum Analyzer).

Key Path	Recall
Mode	SA
<b>Remote Command</b>	:MMEMory:LOAD:TRACe TRACE1   TRACE2   TRACE3   TRACE4   TRACE5   TRACE6,<filename>  :MMEMory:LOAD:TRACe:REGister TRACE1   TRACE2   TRACE3   TRACE4   TRACE5   TRACE6,<integer>
<b>Example</b>	MMEM:LOAD:TRAC TRACE2, "MyTraceFile.trace" This loads the trace file data (on the default file directory path) into the specified trace; if it is a "single trace" save file, that trace is loaded to trace 2, and is set to be not updating. :MMEM:LOAD:TRAC:REG TRACE1,2

	restores the trace data in register 2 to Trace 1
Notes	<p>When you perform the recall, the recalling Trace function must first verify the file is recallable in this instrument by checking instrument software version and model number, since it includes State. If everything matches, a full recall proceeds by aborting the currently running measurement, and loading the state from the saved state file to as close as possible to the context in which the save occurred. You can open .trace files from any mode that supports them, so recalling a Trace file switches to the mode that was active when the save occurred. After switching to the mode of the saved state file, mode settings and data (if any for the mode) are loaded with values from the saved file and the saved measurement of the mode becomes the newly active measurement, and the data relevant to the measurement (if there is any) is recalled.</p> <p>Once the state is loaded, the trace data must be loaded. The internal flags are consulted to see which trace to load and the "To Trace" setting to see where to load it. Trace data is always loaded with the specified trace set to View, so that the data is visible and not updating(so as not to erase the recalled data). If the file is an "all trace" file, all traces are loaded with the saved data(to the original trace the data was saved from) and set to View. Traces whose data is not loaded are restored to the update state that existed when they were saved.</p> <p>After the Recall the analyzer exits the Recall menu and returns to the previous menu.</p> <p>Some modes and measurements do not have available all 6 traces. Phase Noise mode command, for example, is: <code>MMEMOry:LOAD:TRACe TRACE1 TRACE2 TRACE3,&lt;filename&gt;</code></p> <p>Some modes and measurements have more than 6 traces available. The Realtime SA mode command, for example, is: <code>MMEMOry:STORe:TRACe TRACE1   TRACE2   TRACE3   TRACE4   TRACE5   TRACE6   TRACE7   TRACE8   TRACE9   TRACE10   TRACE11   TRACE12   ALL,&lt;filename&gt;</code></p>
Initial S/W Revision	Prior to A.02.00

## To Trace

These menu selections let you choose the Trace where the recalled saved trace will go. Not all modes have the full 6 traces available. The default is the currently selected trace, selected in this menu or in the Trace/Detector, Export Data, Import Data, or Save Trace menus, except if you have chosen All, then it remains chosen until you specifically change it to a single trace.

If the .trace file is an "all trace" file, "To Trace" is ignored and the traces each go back to the trace from which they were saved.

Once selected, the key returns back to the Recall Trace menu and the selected Trace number is annotated on the key. Now you have selected exactly where the trace needs to be recalled.To trigger a recall of the selected Trace, you must select the Open key in the Recall Trace menu.

When you select a trace, it makes that trace the current trace, so it displays on top of all of the other traces.

Key Path	Save, Data, Trace
Mode	SA
Initial S/W Revision	Prior to A.02.00



### Register 1 thru Register 16

Selecting any one of these register keys causes the State of the mode from the specified Register to be recalled. Each of the register keys annotates whether it is empty or at what date and time it was last modified. In addition, you can use the Edit Register Names key under Save, State to enter custom names for each register.

Registers are shared by all modes, so recalling from any one of the registers will cause a mode switch to the mode that was active when the save to the Register occurred.

Although these 16 registers are the only registers available from the front panel, there are 128 state registers available in the instrument. Registers 17–128 are only available from the SCPI interface, using the \*RCL command.

After the recall completes, the message "Register <register number> recalled" appears in the message bar. If you are in the Spectrum Analyzer Mode, and you are recalling a register that was saved in the Spectrum Analyzer Mode, then after the recall, you will still be in the Recall Register menu. If the Recall causes you to switch modes, then after the Recall, you will be in the Frequency menu.

If a requested register is empty an error is generated.

Key Path	Recall, State
<b>Example</b>	*RCL 1
Range	1–16 from front panel, 1–128 from SCPI
Readback	Date and time with seconds resolution are displayed on the key OR A custom name of up to 30 characters entered using the Save, State, Edit Register Names key OR “(empty)” if no prior save operation has been performed to this register.
Initial S/W Revision	Prior to A.02.00
Modified at S/W Revision	Prior to A.11.00

### From File...

When you press “From File”, the analyzer brings up a Windows dialog and a menu entitled “File Open.” This menu allows you to navigate to the various fields in the Windows dialog without using a keyboard or mouse. The Tab and Arrow keys can also be used for dialog navigation.

## 20 Monitor Spectrum Measurement Recall

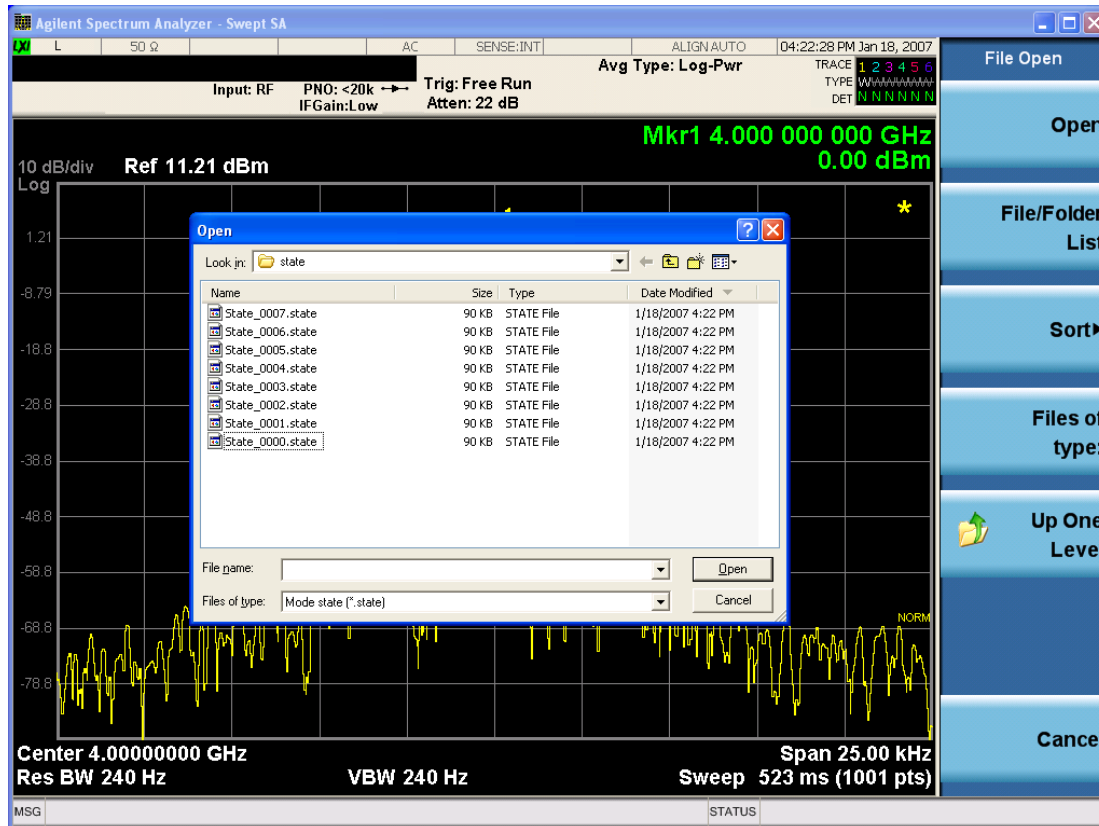

Listed below are the functions of the various fields in the dialog, and the corresponding softkeys:

### Open

Performs the recall of the specified file. While the recall is being performed, the floppy icon appears briefly in the Meas bar.

### File/Folder List

Enables you to navigate to the center of the dialog that contains the list of files and folders. Once here you can get information about the file and use the tab keys to navigate to the other fields in the dialog, such as Look In.

### Look In

The Look In field shows the path from which the file will be recalled and allows you to change the path using the up and down arrow keys to navigate to other paths; the Enter key to open a directory; and the Backspace key to go back one directory. The **Look In field** first uses the last path from the Save As dialog **Save In:** path for that same file type. There is no softkey for directly navigating to the Look In field, but you can use the left tab to get here from the File/Folder List.

User specified paths are remembered when you leave and return to a Mode and are reset back to the default using Restore Mode Defaults.

### Sort

Accesses a menu that enables you to sort the files within the File Open dialog. Only one sorting type can be selected at a time and the sorting happens immediately. The sorting types are By Date, By Name, By extension, and By Size.

#### Files of Type

This field shows the file suffix for the type of file you have selected to recall. For example, if you navigated here while recalling State, "Mode state (\*.state)" is in the field. If you navigated here while recalling Trace, ""Mode state (\*.trace)" is in the field. If you navigated here while importing a trace data file, "Trace Data (\*.csv)" is in the field. For some file types, there is more than one choice in the dropdown menu, which you can select by using the up and down arrow keys and Enter.

#### Up One Level

This key corresponds to the icon of a folder with the up arrow that is in the tool bar of the dialog. When pressed, it causes the file and folder list to navigate up one level in the directory structure. The Backspace key does the same thing.

#### Cancel

This key corresponds to the Cancel selection in the dialog. It causes the current **Open** request to be cancelled. The ESC key does the same thing.

Key Path	Recall, State
Notes	Brings up the Open dialog for recalling a State Save Type
Initial S/W Revision	Prior to A.02.00

## Data (Import)

Importing a data file loads data that was previously saved from the current measurement or from other measurements and/or modes that produce compatible data files. The Import Menu only contains Data Types that are supported by the current measurement.

Since the commonly exported data files are in .csv format, the data can be edited by the user prior to importing. This allows you to export a data file, manipulate the data in Excel (the most common PC Application for manipulating .csv files) and then import it.

Importing Data loads measurement data from the specified file into the specified or default destination, depending on the data type selected. Selecting an Import Data menu key will not actually cause the importing to occur, since the analyzer still needs to know from where to get the data. Pressing the Open key in this menu brings up the Open dialog and Open menu that provides you with the options from where to recall the data. Once a filename has been selected or entered in the Open menu, the recall occurs as soon as the Open button is pressed.

Key Path	Recall
Mode	All
Notes	The menu is built from whatever data types are available for the mode. Some keys will be missing completely, so the key locations in the sub-menu will vary. No SCPI command directly controls the Data Type that this key controls. The Data Type is included in the MMEM:LOAD commands.

Dependencies	If a file type is not used by a certain measurement, it is grayed out for that measurement. The key for a file type will not show at all if there are no measurements in the Mode that support it.
Preset	Is not affected by Preset or shutdown, but is reset during Restore Mode Defaults
Readback	The data type that is currently selected
Initial S/W Revision	Prior to A.02.00

## Capture Buffer

The captured data is raw data which is not processed.

Key Path	Recall, Data
Mode	<b>CDMA1XEV</b>
Example	MMEM:LOAD:CAPT "MyCaptureData.bin" This loads the file of capture data (on the default file directory path) into the instrument.
Dependencies	In case the capture buffer data is not available from the selected measurement, the key will be grayed out.
Initial S/W Revision	A.11.00

## Open...

When you press "Open", the analyzer brings up a Windows dialog and a menu entitled "**File Open.**" This menu allows you to navigate to the various fields in the Windows dialog without using a keyboard or mouse. The Tab and Arrow keys can also be used for dialog navigation.

See "[From File...](#)" on page 2890 in Recall, State, for a full description of this dialog and menu.

Key Path	Recall, Data
Notes	The key location is mode-dependent and will vary. Brings up Open dialog for recalling a <mode specific> Save Type
Initial S/W Revision	Prior to A.02.00

## Restart

The Restart function restarts the current sweep, or measurement, or set of averaged/held sweeps or measurements. If you are Paused, pressing Restart does a Resume.

The Restart function is accessed in several ways:

- Pressing the Restart key
- Sending the remote command INIT:IMMEDIATE
- Sending the remote command INIT:RESTART

See "[More Information](#)" on page 2689

Key Path	Front-panel key
Remote Command	:INITiate[:IMMEDIATE] :INITiate:RESTART
Example	:INIT:IMM :INIT:REST
Notes	:INITiate:RESTART and :INITiate:IMMEDIATE perform exactly the same function.
Couplings	Resets average/hold count k. For the first sweep overwrites all active (update=on) traces with new current data. For application modes, it resets other parameters as required by the measurement.
Status Bits/OPC dependencies	This is an Overlapped command. The STATUS:OPERation register bits 0 through 8 are cleared. The STATUS:QUESTIONable register bit 9 (INTEgrity sum) is cleared. The SWEEPING bit is set. The MEASURING bit is set.
Backwards Compatibility Notes	For Spectrum Analysis mode in ESA and PSA, the Restart hardkey and the INITiate:RESTART command restart trace averages (displayed average count reset to 1) for a trace in Clear Write, but did not restart Max Hold and Min Hold. In the X-Series, the Restart hardkey and the INITiate:RESTART command restart not only Trace Average, but MaxHold and MinHold traces as well. For wireless comms modes in ESA and PSA, the Restart hardkey and the INITiate:RESTART command restart every measurement, which includes all traces and numeric results. There is no change to this operation.
Initial S/W Revision	Prior to A.02.00

### More Information

The **Restart** function first aborts the current sweep/measurement as quickly as possible. It then resets the sweep and trigger systems, sets up the measurement and initiates a new data measurement sequence with a new data acquisition (sweep) taken once the trigger condition is met.

If the analyzer is in the process of aligning when **Restart** is executed, the alignment finishes before the restart function is performed.

Even when set for Single operation, multiple sweeps may be taken when Restart is pressed (for example, when averaging/holding is on). Thus when we say that **Restart** "restarts a measurement," we may mean:

- It restarts the current sweep
- It restarts the current measurement
- It restarts the current set of sweeps if any trace is in Trace Average, Max Hold or Min Hold
- It restarts the current set of measurements if Averaging, or Max Hold, or Min Hold is on for the measurement
- depending on the current settings.

With **Average/Hold Number** (in **Meas Setup** menu) set to 1, or Averaging off, or no trace in Trace Average or Hold, a single sweep is equivalent to a single measurement. A single sweep is taken after the trigger condition is met; and the analyzer stops sweeping once that sweep has completed. However, with **Average/Hold Number** >1 and at least one trace set to **Trace Average, Max Hold, or Min Hold (SA Measurement)** or **Averaging on (most other measurements)**, multiple sweeps/data acquisitions are taken for a single measurement. The trigger condition must be met prior to each sweep. The sweep is stopped when the average count  $k$  equals the number  $N$  set for **Average/Hold Number**. A measurement average usually applies to all traces, marker results, and numeric results; but sometimes it only applies to the numeric results.

Once the full set of sweeps has been taken, the analyzer will go to idle state. To take one more sweep without resetting the average count, increment the average count by 1, by pressing the step up key while **Average/Hold Number** is the active function, or sending the remote command CALC:AVER:TCON UP.

# Save

The Save menu lets you choose what you want to save and where you want to save it. Among the types of files you can save are **States**, **Traces**, and **Screen Images**. In addition, an Export (Data) option lets you save a number of data types as CSV files for easy import into Excel and other spreadsheet programs.

Key Path	Front-panel key
Mode	All
Notes	No remote command for this key specifically, but the :MMEM:STORe command is available for specific file types. An example is :MMEM:STOR:STATe <filename>.
Initial S/W Revision	Prior to A.02.00

## State

The Save State menu lets you choose a register or file for saving the state.

The content of a state file includes all of the settings and data required to return the analyzer as closely as possible to the Mode it was in, with the exact settings which were in place, when the save occurred. The Mode settings in each state file include the settings that are affected by Mode Preset, as well as the additional settings affected by Restore Mode Defaults; all of the Mode's settings. In addition, all of the settings of the Input/Output system are included, even though they are outside of the Mode's state, because they are needed to restore the complete setup. Persistent System settings (for example, Verbose SCPI) are not affected by either Mode Preset or Restore Mode Defaults, nor are they included in a saved State file.

After the save completes, the message "File <filename> saved" or "State Register <register number> saved" is displayed.

For rapid saving, the State menu lists 16 registers to save to. Pressing a Register key initiates the save. You can also select a file to save to.

The default path for all State Files is:

My Documents\<<mode name>\state

where <mode name> is the parameter used to select the mode with the INST:SEL command (for example, SA for the Spectrum Analyzer).

Key Path	Save
Mode	All
Remote Command	:MMEMory:STORe:STATe <filename>
Example	MMEM:STOR:STATe "MyStateFile.state" This stores the current instrument state data in the file MyStateFile.state in the default directory.
Notes	Both single and double quotes are supported for any filename parameter over remote. After saving to a register, that register's menu key is updated with the date the time, unless a custom label has been entered for that key. After saving to a register, you remain in the Save State menu, so that you can see the Register key

update. After saving to a file, the analyzer automatically returns to the previous menu and any Save As dialog goes away.

**Backwards Compatibility SCPI** :MMEMory:STORe:STATe 1,<filename>

For backwards compatibility, the above syntax is supported. The "1" is simply ignored. The command is sequential.

Initial S/W Revision Prior to A.02.00

### To File . . .

When you press “To File”, the analyzer brings up a Windows dialog and a menu entitled “Save As.” This menu allows you to navigate to the various fields in the Windows dialog without using a keyboard or mouse. The Tab and Arrow keys can also be used for dialog navigation.

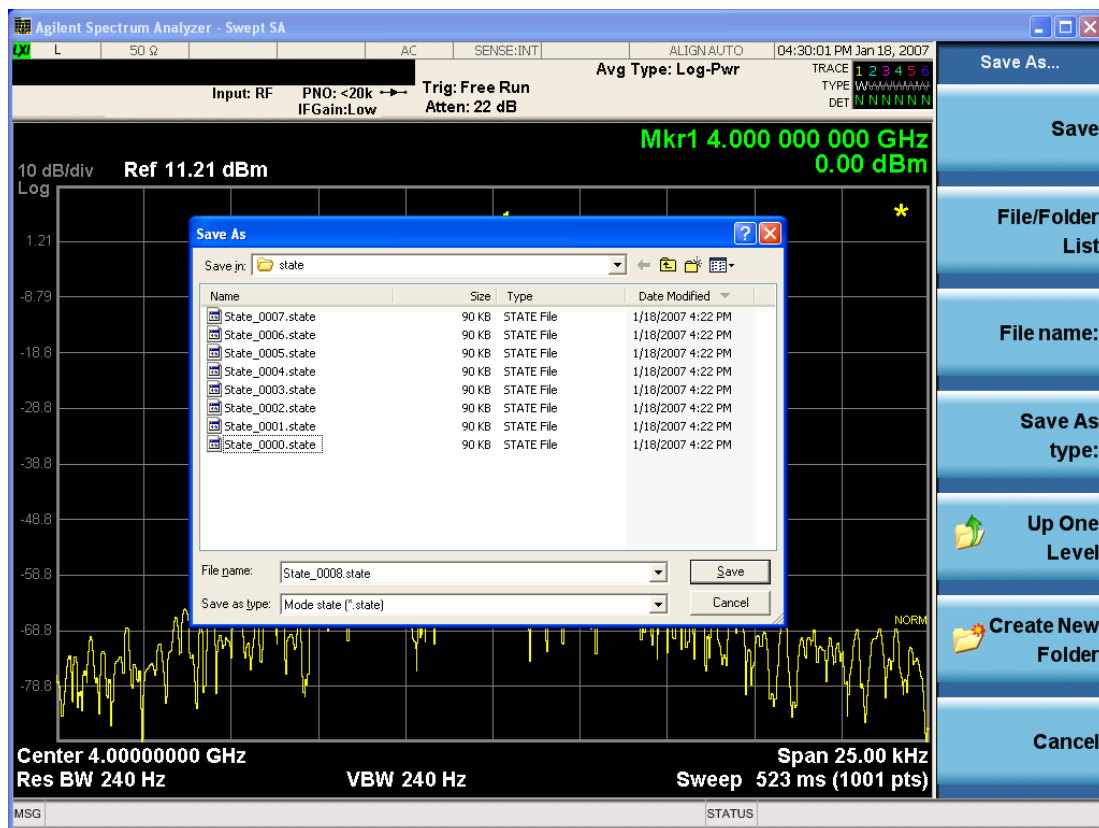

The Listed below

are the functions of the various fields in the dialog, and the corresponding softkeys:

#### Save

Performs the save to the specified file of the selected type. If the file already exists, a dialog will appear that allows you to replace the existing file by selecting OK, or you can Cancel the request. If you select OK, the file will be overwritten. Using the C: drive is strongly discouraged, since it runs the risk of being overwritten during an instrument software upgrade.

While the save is being performed, the floppy icon appears briefly in the Meas bar.



## File/Folder List

Enables you to navigate to the center of the dialog that contains the list of files and folders. Once here you can get information about the file and use the tab keys to navigate to the other fields in the dialog, such as Save In.

## Save In

The Save In field shows the path to which the file will be saved and allows you to change the path using the up and down arrow keys to navigate to other paths; the Enter key to open a directory; and the Backspace key to go back one directory. The **Save In field** defaults to the default path for this type of file and remembers the last path you used to save this type of file. There is no softkey for directly navigating to the Save In field but you can use left tab to get here from the File/Folder List.

User specified paths are remembered when you leave and return to a Mode and are reset back to the default using Restore Mode Defaults.

## File Name

The File Name field is initially loaded with an automatically generated filename specific to the appropriate Save Type. The automatically generated filename is guaranteed not to conflict with any filename currently in the directory. You may replace or modify this filename using the File Name key. See the ["Quick Save " on page 2880](#) documentation for more on the automatic file naming algorithm.

When you press the File Name key the analyzer displays the Alpha Editor. Use the knob to choose the letter to add and the front-panel Enter key to add the letter to the file name. The BK character moves you back and the FW character moves you forward in the filename. The Select key on the front panel generates a space character. When you are done entering the filename press the Done softkey. This returns back to the **File Open** dialog and menu, but does not cause the save to occur.

## Save As Type

This field shows the file suffix for the type of file you have selected to save. For example, if you navigated here while saving State, "Mode state (\*.state)" is in the field. If you navigated here from saving Trace, ""Mode state (\*.trace)" is in the field. If you navigated here while exporting a trace data file, "Trace Data (\*.csv)" is in the field. For some file types, there is more than one choice in the dropdown, which you can select by using the up and down arrow keys and Enter.

## Up One Level

This key corresponds to the icon of a folder with the up arrow that is in the tool bar of the dialog. When pressed, it causes the file and folder list to navigate up one level in the directory structure. The Backspace key does the same thing.

## Create New Folder

This key corresponds to the icon of a folder with the "\*" that is in the tool bar of the dialog. When pressed, a new folder is created in the current directory with the name **New Folder** and you can enter a new folder name using the Alpha Editor.

## Cancel

This key corresponds to the Cancel selection in the dialog. It causes the current **Save As** request to be cancelled. The ESC key does the same thing.

Key Path	Save, State
Mode	All
Notes	Brings up Save As dialog for saving a State Save Type
Initial S/W Revision	Prior to A.02.00

## Edit Register Names

You may enter a custom name on any of the Register keys, to help you remember what you are using that state to save. To do this, press the Edit Register Names key, choose the register whose name you wish to edit, and then enter the desired label using the Alpha Editor or an external PC keyboard.

The maximum number of characters that can be added is 30. In most cases, 30 characters will fit on two lines of the key.

See ["More Information" on page 2694](#)

Key Path	Save, State
Mode	All
<b>Remote Command</b>	:MMEMory:REGister:STATe:LABel <reg number>,"label" :MMEMory:REGister:STATe:LABel? <reg number>
<b>Example</b>	:MMEM:REG:STAT:LAB 1,"my label"
Notes	<reg number> is an integer from 1 to 16. If the SCPI specifies an invalid register number an error message is generated, -222,"Data out of range;Invalid register label number" "label" is a string from 0 to 30 characters in length. If a label exceeds 30 characters, an error message is generated, -150,"String data error;Label clipped to 30 characters" "label" of length 0 erases the custom label and restores the default (time and date) label. E.g.: :MMEM:REG:STAT:LAB 1,""
Dependencies	N9060A-7FP or N9060B-2FP license required to edit the register names. When the feature is not licensed, sending this command generates an error, -221,"Settings conflict;Option not available"
Preset	The names are unaffected by Preset or power cycle but are set to the default label (time and date) on a "Restore System Defaults->Misc"
Initial S/W Revision	A.11.00

## More Information

When you edit one of the register names, the time and date field will be replaced by the custom name.

If you delete all the characters in the custom name, it restores the default (time and date).

The register names are stored within the state files, but they are not part of the instrument state; that is, once you have edited a register name, loading a new state will not change that register name. Another consequence of this is that the names will be persistent through a power cycle. Also, if a named state file is transferred to another analyzer, it will bring its custom name along with it.

If you try to edit the name of an empty register, the analyzer will first save the state to have a file to put the name in. If you load a named state file into an analyzer with older firmware it will ignore the metadata.

The \*SAV and \*RCL commands will not be affected by the custom register names, nor will the MMEM commands.

**Register 1 thru Register 16**

Selecting any one of these register menu keys causes the State of the currently active mode to be saved to the specified Register. The registers are provided for rapid saving and recalling, since you do not need to specify a filename or navigate to a file. Each of the register menu keys annotates whether it is empty or at what date and time it was last modified. In addition, you can use the Edit Register Names key to enter custom names for each register.

Although these 16 registers are the only registers available from the front panel, there are 128 state registers available in the instrument. Registers 17–128 are only available from the SCPI interface, using the \*SAV command.

There is one set of 128 state registers in the instrument, not one set for each Mode. When a state is saved, the Mode it was saved from is saved with it; then when it is recalled, the instrument switches to that Mode.

After the save completes, the corresponding register menu key annotation is updated with the date and time and the message "Register <register number> saved" is displayed.

Key Path	Save, State
Mode	All
Example	*SAV 1
Range	1–16 from front panel, 1–128 from SCPI
Readback	Date and time with seconds resolution are displayed on the key OR A custom name of up to 30 characters entered using the Edit Register Names key OR “(empty)” if no prior save operation has been performed to this register.
Initial S/W Revision	Prior to A.02.00
Modified at S/W Revision	A.11.00

**Register 1 thru Register 16**

Selecting any one of these register menu keys causes the State of the currently active mode to be saved to the specified Register. The registers are provided for rapid saving and recalling, since you do not need to specify a filename or navigate to a file. Each of the register menu keys annotates whether it is empty or at what date and time it was last modified. In addition, you can use the Edit Register Names key to enter custom names for each register.

Although these 16 registers are the only registers available from the front panel, there are 128 state registers available in the instrument. Registers 17–128 are only available from the SCPI interface, using the \*SAV command.

There is one set of 128 state registers in the instrument, not one set for each Mode. When a state is saved, the Mode it was saved from is saved with it; then when it is recalled, the instrument switches to that Mode.

After the save completes, the corresponding register menu key annotation is updated with the date and time and the message "Register <register number> saved" is displayed.

Key Path	Save, State
Mode	All
Example	*SAV 1
Range	1-16 from front panel, 1-128 from SCPI
Readback	Date and time with seconds resolution are displayed on the key OR A custom name of up to 30 characters entered using the Edit Register Names key OR “(empty)” if no prior save operation has been performed to this register.
Initial S/W Revision	Prior to A.02.00
Modified at S/W Revision	A.11.00

## Data (Export)

Exporting a data file stores data from the current measurement to mass storage files. The Export Menu only contains data types that are supported by the current measurement.

Since the commonly exported data files are in .csv format, the data can be edited by you prior to importing. This allows you to export a data file, manipulate the data in Excel (the most common PC Application for manipulating .csv files) and then import it.

Selecting an Export Data menu key will not actually cause the exporting to occur, since the analyzer still needs to know where you wish to save the data. Pressing the Save As key in this menu brings up the Save As dialog and Save As menu that allows you to specify the destination file and directory. Once a filename has been selected or entered in the Open menu, the export will occur as soon as the Save key is pressed.

Key Path	Save
Mode	All
Notes	The menu is built from whatever data types are available for the mode. So the key locations in the sub menu will vary.  No SCPI command directly controls the Data Type that this key controls. The Data Type is included in the MMEM:STORe commands.
Dependencies	If a file type is not used by a certain measurement, that type is grayed out for that measurement. The key for a file type will not show at all if there are no measurements in the Mode that support it.
Preset	Is not affected by a Preset or shutdown, but is reset during Restore Mode Defaults
Readback	The data type that is currently selected
Initial S/W Revision	Prior to A.02.00

## Measurement Results

Pressing this key selects Meas Results as the data type to be exported. Pressing the key a second time brings up the Meas Results menu, which allows you to select which **Meas Result** to save. In the Swept SA measurement, there are three types of Measurement Results files: Peak Table, Marker Table and Spectrogram.

See "Meas Results File Contents" on page 2697.

See "Marker Table" on page 2697.

See "Peak Table" on page 2700.

See "Spectrogram" on page 2703

<b>Remote Command</b>	:MMEMory:STORe:RESults:MTABle PTABle SPEctrogram <filename>
<b>Example</b>	:MMEM:STOR:RES:MTAB "myResults.csv" Saves the results from the current marker table to the file myResults.csv in the current path. :MMEM:STOR:RES:PTAB "myResults.csv" Saves the results from the current peak table to the file myResults.csv in the current path. :MMEM:STOR:RES:SPEC "myResults.csv" Saves the results from the current Spectrogram display to the file myResults.csv in the current path. The default path is My Documents\SA\data\SAN\results
<b>Notes</b>	If the save is initiated via SCPI, and the file already exists, the file will be overwritten. Using the C: drive is strongly discouraged, since it runs the risk of being overwritten during an instrument software upgrade. Both single and double quotes are supported for any filename parameter over SCPI.
<b>Dependencies</b>	If a save of Marker Table results is requested and the Marker Table is not on, no file is saved and a message is generated If a save of Peak Table results is requested and the Peak Table is not on, no file is saved and a message is generated If a save of Spectrogram results is requested and the Spectrogram is not on, no file is saved and a message is generated. The Spectrogram choice only appears if option EDP is licensed.
<b>Preset</b>	Not part of Preset, but is reset to Peak Table by Restore Mode Defaults. Survives a shutdown.
<b>Initial S/W Revision</b>	Prior to A.02.00

## Meas Results File Contents

All files are .csv files. The following section details the data in each file type.

### Marker Table

This section discusses the Marker Table Meas Results file format.

Imagine that, at the point where a Marker Table Meas Result is requested, the following screen is showing:

20 Monitor Spectrum Measurement  
Save

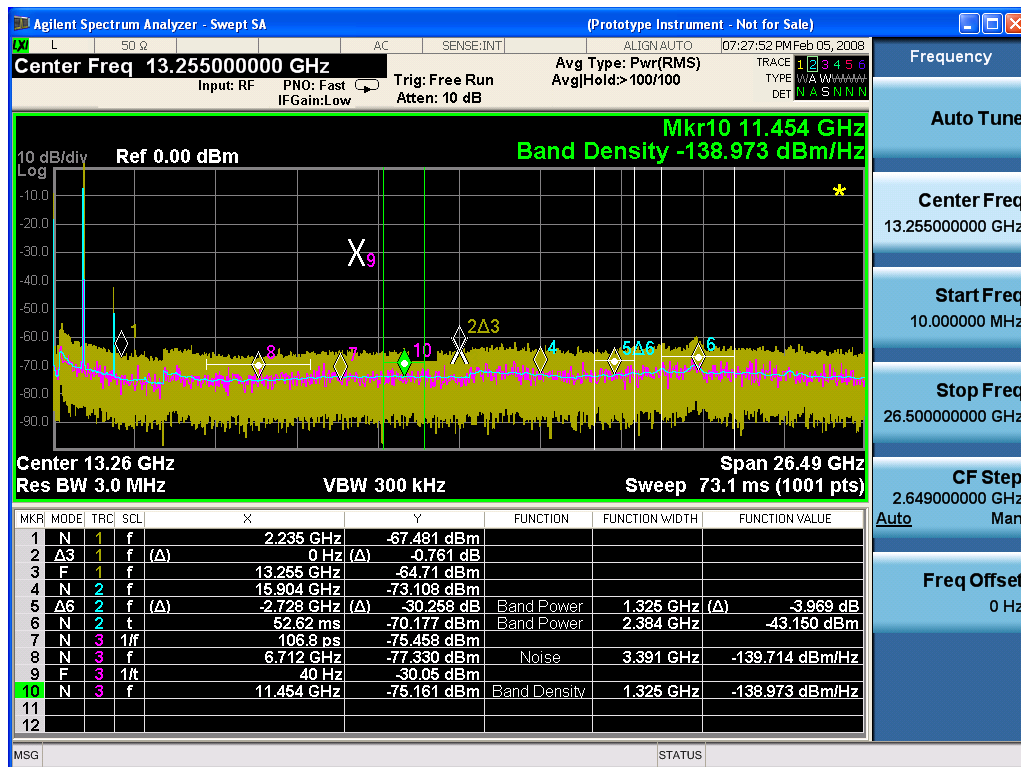

Then the Meas Results file, when opened, would show the following data:

MeasurementResult	
Swept SA	
A.01.40_R0017	N9020A
526 B25 PFR	1
P26 EA3	
Result Type	Marker Table
Ref Level	0
Number of Points	1001
Sweep Time	0.0662666 67
Start Frequency	10000000
Stop Frequency	26500000 000
Average Count	0
Average Type	LogPower (Video)
RBW	3000000

RBW Filter	Gaussian
RBW Filter BW	3dB
VBW	3000000
Sweep Type	Swept
X Axis Scale	Lin
PreAmp State	Off
PreAmp Band	Low
Trigger Source	Free
Trigger Level	1.2
Trigger Slope	Positive
Trigger Delay	1.00E-06
Phase Noise Optimization	Fast
Swept If Gain	Low
FFT If Gain	Autorange
RF Coupling	AC
FFT Width	411900
Ext Ref	10000000
Input	RF
RF Calibrator	Off
Attenuation	10
Ref Level Offset	0
External Gain	0
X Axis Units	Hz
Y Axis Units	dBm

DATA									
MKR	MODE	TR C	SCL	X	Y	FUNCTI ON	FUNCTIO N WIDTH	FUNCTI ON VALUE	FUNCTI ON UNIT
1	Normal	1	Freque ncy	2.2350E+09	- 67.481	Off	0.0000E+00	0	None
2	Delta3	1	Freque ncy	0.0000E+00	- 0.761	Off	0.0000E+00	0	None
3	Fixed	1	Freque ncy	1.3255E+10	- 64.71	Off	0.0000E+00	0	None
4	Normal	2	Freque ncy	1.5904E+10	- 73.1	Off	0.0000E+00	0	None

08									
5	Delta7	2	Frequ ncy	- 2.7280E+ 09	- 30.2 58	Band Power	1.3250E+ 06	-3.969	dB
6	Normal	2	Time	5.2620E- 02	- 70.1 77	Band Power	2.3840E+ 06	-43.15	dBm
7	Normal	3	Period	1.0680E- 10	- 75.4 58	Off	0.0000E+ 00	0	None
8	Normal	3	Frequ ncy	6.7120E+ 09	- 77.3 3	Noise	3.3910E+ 06	- 139.71 4	dBm/Hz
9	Fixed	3	Inverse Time	4.0000E+ 01	- 30.0 5	Off	0.0000E+ 00	0	None
10	Normal	3	Frequ ncy	1.1454E+ 10	- 75.1 61	Band Density	1.3250E+ 06	- 138.97 3	dBm/Hz
11	Off	1	Frequ ncy	0.0000E+ 00	0	Off	0.0000E+ 00	0	None
12	Off	1	Frequ ncy	0.0000E+ 00	0	Off	0.0000E+ 00	0	None

The numbers appear in the file exactly as they appear onscreen. If it says 11.454 GHz onscreen, then in the file it is 11.454E+09.

The metadata header is very similar to the metadata used in the trace data .csv files. See Trace File Contents. The only new information concerns the 1-of-N fields in the marker table itself.

### Peak Table

This section discusses the Peak Table Meas Results file format.

Imagine that, at the point where a Marker Table Meas Result is requested, the following screen is showing:



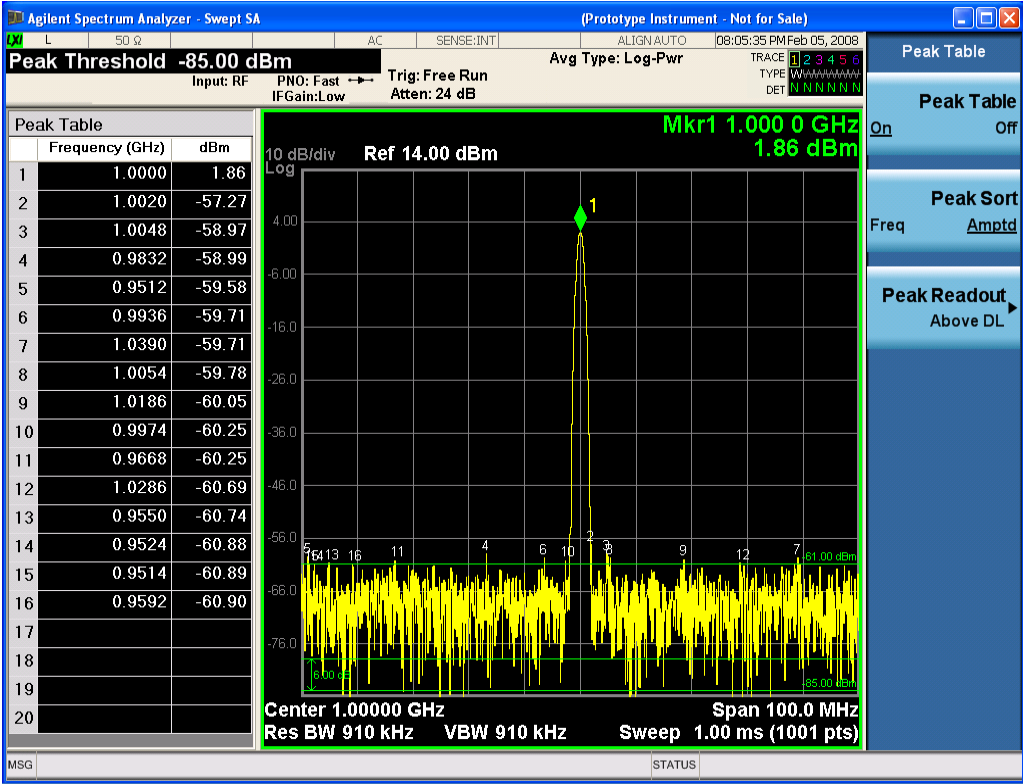

Then the Meas Results file, when opened, would show the header data (the same as for the Marker Table except that the Result Type is Peak Table) ending with a few fields of specific interest to Peak Table users:

- Peak Threshold
- Peak Threshold State (On|Off)
- Peak Excursion
- Peak Excursion State (On|Off)
- Display Line
- Peak Readout (All|AboveDL|BelowDL)
- Peak Sort (Freq|Amptd)

These fields are then followed by the data for the Peak Table itself.

Note that the label for the Frequency column changes to Time in 0 span.

Here is what the table for the above display looks like:

MeasurementResult	
Swept SA	
A.01.40_R0017	N9020A
526 B25 PFR P26 EA3	1

20 Monitor Spectrum Measurement  
Save

Result Type	Peak Table
Ref Level	0
Number of Points	1001
Sweep Time	0.066266667
Start Frequency	10000000
Stop Frequency	26500000000
Average Count	0
Average Type	LogPower(Video)
RBW	3000000
RBW Filter	Gaussian
RBW Filter BW	3dB
VBW	3000000
Sweep Type	Swept
X Axis Scale	Lin
PreAmp State	Off
PreAmp Band	Low
Trigger Source	Free
Trigger Level	1.2
Trigger Slope	Positive
Trigger Delay	1.00E-06
Phase Noise Optimization	Fast
Swept If Gain	Low
FFT If Gain	Autorange
RF Coupling	AC
FFT Width	411900
Ext Ref	10000000
Input	RF
RF Calibrator	Off
Attenuation	10
Ref Level Offset	0
External Gain	0
X Axis Units	Hz
Y Axis Units	dBm
Peak Threshold	-85
Peak Threshold State	On
Peak Excursion	6
Peak Excursion State	On

Display Line	-61	
Peak Readout	AboveDL	
Peak Sort	Amptd	
DATA		
Peak	Frequency	Amplitude
1	1.0000E+06	1.86
2	1.0020E+06	-57.27
3	1.0048E+06	-58.97
4	9.8320E+05	-58.99
5	9.5120E+05	-59.58
6	9.9360E+05	-59.71
7	1.0390E+06	-59.71
8	1.0054E+06	-59.78
9	1.1086E+06	-60.05
10	9.9740E+05	-60.25
11	9.6680E+05	-60.25
12	1.0286E+06	-60.69
13	9.5500E+05	-60.74
14	9.5240E+05	-60.88
15	9.5140E+05	-60.89
16	9.5920E+05	-60.90
17		
18		
19		
20		

**Spectrogram**

This section discusses the Spectrogram Results file format. The Spectrogram choice only appears if option EDP is licensed.

The Spectrogram results are the same as a Trace data export, except that instead of having just one trace's data, all 300 traces appear one after the other.

Each trace has its own data mark; the data for Spectrogram Trace 0 follows the row marked DATA, the data for Spectrogram Trace 1 follows the row marked DATA1, for Spectrogram Trace 2 follows the row marked DATA2, and so on.

Each DATA row has a timestamp in the second column (as of firmware revision A.11.01). So, for example, if Trace 0 had a relative start time of 1729.523 sec, then the first DATA row would look like this:

DATA,1729.523

And if Trace 13 had a relative start time of 100.45 sec, then the fourteenth data row would look like:

DATA13,100.453

To find the absolute time for the relative timestamps of each trace, the last row before the first DATA row gives the absolute start time of the Spectrogram, in the form YYYYMMDDHHMMSS

So, for example, if the absolute start time is 13:23:45:678 on January 30, 2012, this row would look like:

Start Time,20120130132345678

**NOTE** The resolution of the absolute time stored is 1 ms, which matches up with the fact that the fastest sweep time is also 1 ms. However, there is no specification for the absolute accuracy of the clock in the analyzer, nor is there any facility provided to allow the user to set this time to any particular degree of accuracy.

Traces that have not yet been filled in the Spectrogram display are empty; there is no DATA header for them. The file ends after the last non-empty trace.

Imagine that, at the point where a Spectrogram Meas Result is requested, the following screen is showing:

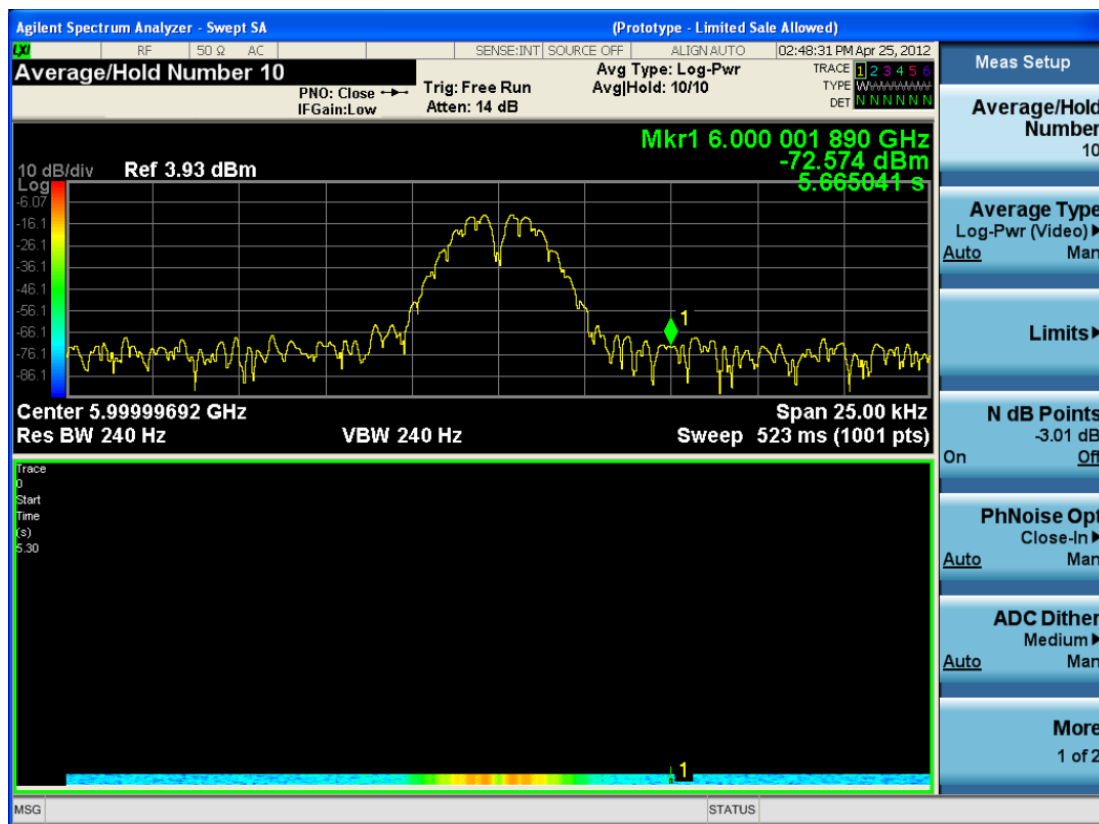

For the purpose of this example, we have set the Average/Hold Number to 10, thus we have only traces 0 thru 10. The Spectrogram was started at 02:28:08:700 pm on April 25, 2012 (that is, 700 ms after 2:28:08 pm), although the screen dump itself shows a different time, as it was taken ten minutes after the

Spectrogram data. Trace 0 is showing a start time of 5.30 seconds, meaning 5.3 seconds after the Spectrogram started (trace 10 has a start time of 0, as it was the first trace taken but has now rolled up into the tenth trace slot).

The Meas Results file, when opened, shows the header data and ten traces of trace data. Below is an extract from the result file for the above display. Note the start time of 20120425142808700 showing in the last row before the first DATA row, and the relative time of 5.299231048 showing in the first DATA row:

<b>Result Type</b>	<b>Spectrogram</b>
MeasResult	
Swept SA	
A.11.00.01	N9020A
503 508 513 526 ALL ALV B1C B1X B25 B2X B40 BAB BBA CR3 CRP DP2 DRD EA3 EDP EMC EP1 ERC ESC ESP EXM FSA HBA K03 LFE MPB P03 P08 P13 P26 PFR RTL RTS S40 SB1 SEC SM1 UK6 YAS YAV	1
Segment	0
Number of Points	1001
Sweep Time	0.523333333
Start Frequency	5999984415
Stop Frequency	6000009415
Average Count	0
Average Type	LogPower(Video)
RBW	240
RBW Filter	Gaussian
RBW Filter BW	3dB
VBW	240
Sweep Type	Swept
X Axis Scale	Lin
PreAmp State	Off
PreAmp Band	Low
Trigger Source	Free
Trigger Level	1.2
Trigger Slope	Positive
Trigger Delay	0
Phase Noise Optimization	Wide
Swept If Gain	Low
FFT If Gain	Autorange
RF Coupling	AC

Result Type	Spectrogram
FFT Width	411900
Ext Ref	10000000
Input	RF
RF Calibrator	Off
Attenuation	14
Ref Level Offset	0
External Gain	0
Trace Type	Clearwrite
Detector	Normal
Trace Math	Off
Trace Math Oper1	Trace5
Trace Math Oper2	Trace6
Trace Math Offset	0
Trace Name	Trace1
X Axis Units	Hz
Y Axis Units	dBm
Start Time	20120425142808700
DATA	5.299231048
5999984415	-76.34749519
5999984440	-77.28097006
5999984465	-75.32317869
5999984490	-73.64417681
5999984515	-72.67154604

o  
 o  
 o

6000009315	-77.94423277
6000009340	-79.51829697
6000009365	-78.46108961
6000009390	-78.46108957
6000009415	-76.59570596
DATA2	4.708697055
5999984415	-80.98197882
5999984440	-80.98197879

---

5999984465	-75.83142132
5999984490	-74.02712079
5999984515	-73.57213005

---

- 
- 
- 

---

6000009315	-75.9183103
6000009340	-79.53787488
6000009365	-78.82602191
6000009390	-78.82602188
6000009415	-76.37486709
DATA10	0
5999984415	-75.56751112
5999984440	-75.76485645
5999984465	-76.67718717
5999984490	-78.79238489
5999984515	-83.72680212

---

- 
- 
- 

---

6000009315	-71.3942461
6000009340	-72.28308332
6000009365	-73.92684489
6000009390	-75.45548832
6000009415	-75.17904815

---

### Capture Buffer

Capture Buffer functionality is not available for all measurements. The captured data is raw data which is not processed.

---

Key Path	Save, Data
----------	------------

---

Mode	CDMA1XEV
Example	MMEM:STOR:CAPT "MyCaptureData.bin" This stores the capture data in the file MyCaptureData.bin in the default directory.
Dependencies	In case the capture buffer data is not available from the selected measurement, the key will be grayed out.
Initial S/W Revision	A.11.00

## Save As . . .

When you press "Save As", the analyzer brings up a Windows dialog and a menu entitled "**Save As.**" This menu allows you to navigate to the various fields in the Windows dialog without using a keyboard or mouse. The Tab and Arrow keys can also be used for dialog navigation.

See "[To File . . .](#)" on page 2897 in Save, State for a full description of this dialog and menu.

The default path for saving files is:

For all of the Trace Data Files:

My Documents\<<mode name>\data\traces

For all of the Limit Data Files:

My Documents\<<mode name>\data\limits

For all of the Measurement Results Data Files:

My Documents\<<mode name>\data\<<measurement name>\results

For all of the Capture Buffer Data Files:

My Documents\<<mode name>\data\captureBuffer

Key Path	Save, Data
Mode	All
Notes	The key location is mode-dependent and will vary. Brings up the Save As dialog for saving a <mode specific> Save Type. The save is performed immediately and does not wait until the measurement is complete.
Initial S/W Revision	Prior to A.02.00

## Screen Image

Pressing Screen Image accesses a menu of functions that enable you to specify a format and location for the saved screen image. It brings up a menu that allows you to specify the color scheme of the Screen Image (Themes) or navigate to the Save As dialog to perform the actual save.

Screen Image files contain an exact representation of the analyzer display. They cannot be loaded back onto the analyzer, but they can be loaded into your PC for use in many popular applications.



The image to be saved is actually captured when the Save front panel key is pressed, and kept in temporary storage to be used if you ask for a Screen Image save. When the Screen Image key is pressed, a "thumbnail" of the captured image is displayed, as shown below:

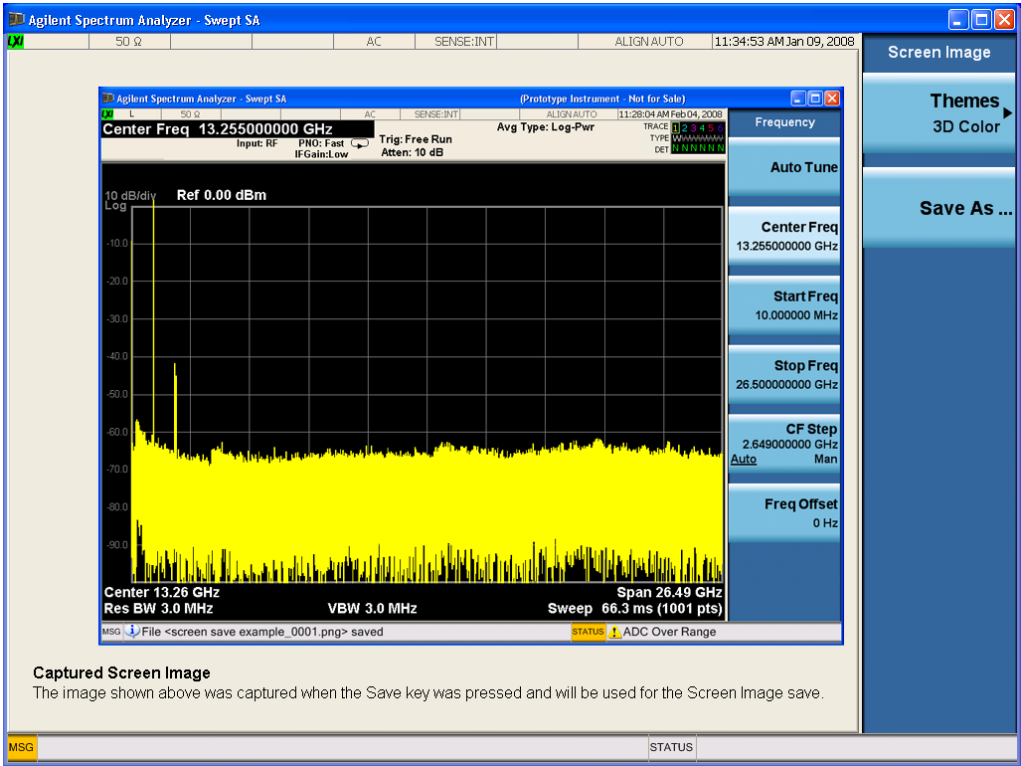

When you continue on into the Save As menu and complete the Screen Image save, the image depicted in the thumbnail is the one that gets saved, showing the menus that were on the screen before going into the Save menu. The save is performed immediately and does not wait until the measurement is complete.

After you have completed the save, the Quick Save front-panel key lets you quickly repeat the last save performed, using an auto-named file, with the current screen data.

**NOTE** For versions previous to A.01.55, if you initiate a screen image save by navigating through the Save menus, the image that is saved will contain the Save menu softkeys, not the menus and the active function that were on the screen when you first pressed the Save front panel key.

Key Path	Save
Mode	All
Remote Command	:MMEMory:STORe:SCReen <filename>
Example	:MMEM:STOR:SCR "myScreen.png" This stores the current screen image in the file MyScreenFile.png in the default directory.
Initial S/W Revision	Prior to A.02.00

## Themes

Accesses a menu of functions that enable you to choose the theme to be used when saving the screen image.

The **Themes** option is the same as the **Themes** option under the **Display** and **Page Setup** dialogs. It allows you to choose between themes to be used when saving the screen image.

<b>Key Path</b>	Save, Screen Image
<b>Remote Command</b>	:MMEMory:STORe:SCReen:THEMe TDColor   TDMonochrome   FCOLor   FMONochrome  :MMEMory:STORe:SCReen:THEMe?
<b>Example</b>	:MMEM:STOR:SCR:THEM TDM
<b>Preset</b>	3D Color; Is not part of Preset, but is reset by Restore Misc Defaults or Restore System Defaults All and survives subsequent running of the modes.
<b>Readback</b>	3D Color   3D Mono   Flat Color   Flat Mono
<b>Backwards Compatibility Notes</b>	In ESA and PSA we offer the choice of "Reverse Bitmap" or "Reverse Metafile" when saving screen images. This is much like the "Flat Color" theme available in X-Series. Also, if you selected Reverse Bitmap AND a black & white screen image, that would be much like "Flat Monochrome". In other words, each of the X-Series themes has a similar screen image type in ESA/PSA. But they are not identical.
<b>Initial S/W Revision</b>	Prior to A.02.00

### 3D Color

Selects a standard color theme with each object filled, shaded and colored as designed.

<b>Key Path</b>	Save, Screen Image, Themes
<b>Example</b>	MMEM:STOR:SCR:THEM TDC
<b>Readback</b>	3D Color
<b>Initial S/W Revision</b>	Prior to A.02.00

### 3D Monochrome

Selects a format that is like 3D color but shades of gray are used instead of colors.

<b>Key Path</b>	Save, Screen Image, Themes
<b>Example</b>	MMEM:STOR:SCR:THEM TDM
<b>Readback</b>	3D Mono
<b>Initial S/W Revision</b>	Prior to A.02.00

### Flat Color

Selects a format that is best when the screen is to be printed on an ink printer.

Key Path	Save, Screen Image, Themes
<b>Example</b>	MMEM:STOR:SCR:THEM FCOL
Readback	Flat Color
Initial S/W Revision	Prior to A.02.00

### Flat Monochrome

Selects a format that is like Flat Color. But only black is used (no colors, not even gray), and no fill.

Key Path	Save, Screen Image, Themes
<b>Example</b>	MMEM:STOR:SCR:THEM FMON
Readback	Flat Mono
Initial S/W Revision	Prior to A.02.00

### Save As...

When you press "Save As", the analyzer brings up a Windows dialog and a menu entitled "**Save As.**" This menu allows you to navigate to the various fields in the Windows dialog without using a keyboard or mouse. The Tab and Arrow keys can also be used for dialog navigation.

See "[To File . . .](#)" on page 2897 in Save, State for a full description of this dialog and menu.

The default path for Screen Images is

My Documents\`<mode name>`\screen.

where `<mode name>` is the parameter used to select the mode with the INST:SEL command (for example, SA for the Spectrum Analyzer).

Key Path	Save, Screen Image
Notes	Brings up Save As dialog for saving a Screen Image Save Type
Initial S/W Revision	Prior to A.02.00

### Mass Storage Catalog (Remote Command Only)

Key path	SCPI Only
<b>Remote Command</b>	:MMEMory:CATalog? [ <code>&lt;directory_name&gt;</code> ]
Notes	<p>The string must be a valid logical path.</p> <p>Queries disk usage information (drive capacity, free space available) and obtains a list of files and directories in a specified directory in the following format:</p> <p><code>&lt;numeric_value&gt;,&lt;numeric_value&gt;,{&lt;file_entry&gt;}</code></p> <p>It returns two numeric parameters and as many strings as there are files and directories. The first</p>

parameter indicates the total amount of storage currently used in bytes. The second parameter indicates the total amount of storage available, also in bytes. The <file\_entry> is a string. Each <file\_entry> indicates the name, type, and size of one file in the directory list:

<file\_name>,<file\_type>,<file\_size>

As the windows file system has an extension that indicates file type, <file\_type> is always empty. <file\_size> provides the size of the file in bytes. For directories, <file\_entry> is surrounded by square brackets and both <file\_type> and <file\_size> are empty

---

Initial S/W Revision      Prior to A.02.00

---

### Mass Storage Change Directory (Remote Command Only)

---

Key path                      SCPI Only

---

**Remote Command**        :MMEMory:CDIRectory [<directory\_name>]  
                                  :MMEMory:CDIRectory?

---

**Notes**                      The string must be a valid logical path.  
  
Changes the default directory for a mass memory file system. The <directory\_name> parameter is a string. If no parameter is specified, the directory is set to the \*RST value.  
  
At \*RST, this value is set to the default user data storage area, that is defined as System.Environment.SpecialFolder.Personal.  
  
Query returns full path of the default directory.

---

Initial S/W Revision      Prior to A.02.00

---

### Mass Storage Copy (Remote Command Only)

---

Key path                      SCPI Only

---

**Remote Command**        :MMEMory:COPY <string>,<string>[,<string>,<string>]

---

**Notes**                      The string must be a valid logical path.  
  
Copies an existing file to a new file or an existing directory to a new directory.  
  
Two forms of parameters are allowed. The first form has two parameters. In this form, the first parameter specifies the source, and the second parameter specifies the destination.  
  
The second form has four parameters. In this form, the first and third parameters specify the source. The second and fourth parameters specify the directories. The first pair of parameters specifies the source. The second pair specifies the destination. An error is generated if the source doesn't exist or the destination file already exists.  
  
This command will generate an "access denied" error if the destination is a restricted folder (e.g., C:\Windows) and the current user does not have Power User or Administrator privileges.

---

### Mass Storage Device Copy (Remote Command Only)

This command transfers data to/from a file and a peripheral device.

Key path	SCPI Only
<b>Remote Command</b>	:MMEMory:COpy:DEvice <source_string>,<dest_string>
Notes	<p>The strings must be a valid logical path or a valid device keyword. If the dest_string is a device keyword, the data is copied from the source file to the device. If the source_string is a device keyword, the data is copied to the source file from the device.</p> <p>Valid device keywords are:          SNS (smart noise source)</p> <p>An error is generated if the file or device is not found.</p>

### Mass Storage Delete (Remote Command Only)

Key path	SCPI Only
<b>Remote Command</b>	:MMEMory:DElete <file_name>[,<directory_name>]
Notes	<p>The string must be a valid logical path.</p> <p>Removes a file from the specified directory. The &lt;file_name&gt; parameter specifies the file name to be removed. This command will generate an “access denied” error if the file is in a restricted folder (e.g., C:\Windows) and the current user does not have Power User or Administrator privileges.</p>
Initial S/W Revision	Prior to A.02.00

### Mass Storage Data (Remote Command Only)

Creates a file containing the specified data OR queries the data from an existing file.

Key path	SCPI Only
<b>Remote Command</b>	:MMEMory:DATA <file_name>, <data> :MMEMory:DATA? <file_name>
Notes	<p>The string must be a valid logical path.</p> <p>The command form is MMEMory:DATA &lt;file_name&gt;,&lt;data&gt;. It loads &lt;data&gt; into the file &lt;file_name&gt;. &lt;data&gt; is in 488.2 block format. &lt;file_name&gt; is string data.</p> <p>The query form is MMEMory:DATA? &lt;file_name&gt; with the response being the associated &lt;data&gt; in block format.</p>
Initial S/W Revision	Prior to A.02.00

### Mass Storage Make Directory (Remote Command Only)

Key path	SCPI Only
<b>Remote Command</b>	:MMEMory:MDIRectory <directory_name>
Notes	<p>The string must be a valid logical path.</p> <p>Creates a new directory. The &lt;directory_name&gt; parameter specifies the name to be created.</p>

---

	This command will generate an “access denied” error if the new directory would be in a restricted folder (e.g., C:\Windows) and the current user does not have Power User or Administrator privileges.
Initial S/W Revision	Prior to A.02.00

---

### Mass Storage Move (Remote Command Only)

---

Key path	SCPI Only
<b>Remote Command</b>	:MMEMory:MOVE <string>,<string>[,<string>,<string>]
Notes	<p>The string must be a valid logical path.</p> <p>Moves an existing file to a new file or an existing directory to a new directory.</p> <p>Two forms of parameters are allowed. The first form has two parameters. In this form, the first parameter specifies the source, and the second parameter specifies the destination.</p> <p>The second form has four parameters. In this form, the first and third parameters specify the source. The second and fourth parameters specify the directories. The first pair of parameters specifies the source. The second pair specifies the destination. An error is generated if the source doesn't exist or the destination file already exists.</p> <p>This command will generate an “access denied” error if the destination is a restricted folder (e.g., C:\Windows) and the current user does not have Power User or Administrator privileges.</p>
Initial S/W Revision	Prior to A.02.00

---

### Mass Storage Remove Directory (Remote Command Only)

---

Key path	SCPI Only
<b>Remote Command</b>	:MMEMory:RDIRECTory <directory_name>
Notes	<p>The string must be a valid logical path.</p> <p>Removes a directory. The &lt;directory_name&gt; parameter specifies the directory name to be removed. All files and directories under the specified directory shall also be removed.</p> <p>This command will generate an “access denied” error if the folder is a restricted folder (e.g., C:\Windows) or is in a restricted folder and the current user does not have Power User or Administrator privileges.</p>
Initial S/W Revision	Prior to A.02.00

---

## Single (Single Measurement/Sweep)

Sets the analyzer for Single measurement operation. The single/continuous state is Meas Global, so the setting will affect all the measurements. If you are Paused, pressing Single does a Resume.

See "[More Information](#)" on page 2715

Key Path	Front-panel key
Example	:INIT:CONT OFF
Notes	See Cont key description.
Backwards Compatibility Notes	<p>For Spectrum Analysis mode in ESA and PSA, the Single hardkey and the INITiate:IMM switched from continuous measurement to single measurement and restarted sweeps and averages (displayed average count reset to 1), but did not restart Max Hold and Min Hold. In the X-Series, the Single hardkey and the INITiate:IMM command initiate a sweep/ measurement/ average sequence/hold sequence including MaxHold and MinHold.</p> <p>For Spectrum Analysis mode in ESA and PSA, the Single hardkey restarted the sweep regardless of whether or not you were in an active sweep or sweep sequence. In the X-Series, Restart does this but Single only restarts the sweep or sweep sequence if you are in the idle state.</p> <p>INIT[:IMM] in ESA &amp; PSA Spectrum Analysis Mode does an implied ABORT. In some other PSA Modes, INIT[:IMM] is ignored if not in the idle state. . The X-Series follows the ESA/PSA SA Mode model, which may cause some Modes to have compatibility problems.</p>
Initial S/W Revision	Prior to A.02.00

### More Information

See "[Restart](#)" on page 2894 for details on the INIT:IMMEDIATE (Restart) function.

If you are already in single sweep, the INIT:CONT OFF command has no effect.

If you are already in Single Sweep, then pressing the Single key in the middle of a sweep does not restart the sweep or sequence. Similarly, pressing the Single key does not restart the sweep or sequence if the sweep is not in the idle state (for example, if you are taking a very slow sweep, or the analyzer is waiting for a trigger). Instead, it results in a message. "Already in Single, press Restart to initiate a new sweep or sequence". Even though pressing the Single key in the middle of a sweep does not restart the sweep, sending INIT:IMMEDIATE does reset it.

To take one more sweep without resetting the average count, increment the average count by 1, by pressing the step up key while **Average/Hold Number** is the active function, or sending the remote command CALC:AVER:TCON UP.

## Source

There is no Source control functionality for this measurement. When this key is pressed, the screen either displays a blank menu, or the previously-selected menu remains unchanged.

---

Key Path	Front-panel key
----------	-----------------

---



## Span X Scale

Accesses a menu of functions that enable you to set the horizontal scale parameters.

Key Path	Front-panel key
Initial S/W Revision	Prior to A.02.00

### Span

Changes the frequency range symmetrically about the center frequency.

For details of WiDEN preset values, see ["IDEN Mode Span Preset for Monitor Spectrum" on page 2718](#).

Key Path	Span X Scale
Mode	All except SA, BASIC
<b>Remote Command</b>	[ :SENSe ] :MONitor:FREQuency:SPAN <freq> [ :SENSe ] :MONitor:FREQuency:SPAN?
<b>Example</b>	MON:FREQ:SPAN 1 MHz MON:FREQ:SPAN?
Couplings	Changing the span causes the resolution bandwidth to change automatically, and affects data acquisition time.
Preset	WCDMA: 10.0 MHz WIMAX OFDMA: 50.0 MHz C2K: 2.5MHz PN: 1.0 MHz GSM/EDGE: 1.0 MHz TD-SCDMA: 3.2 MHz 1xEVDO: 2.0MHz DVB-T/H: 10.0MHz DTMB (CTTB): 10.0MHz ISDB-T: 10.0MHz CMMB: 10.0MHz LTE: 50 MHz LTETDD: 50 MHz IDEN: See the table below Digital Cable TV: 10.0MHz WLAN: If Radio Std is 802.11a/b/g 802.11n(20MHz) 802.11ac(20MHz): 25 MHz If Radio Std is 802.11n(40MHz), 802.11 ac (40MHz): 50 MHz If Radio Std is 802.11ac(80MHz): 100MHz If Radio Std is 802.11ac(160MHz): 200MHz

	MSR: 20.0 MHz LTEAFDD, LTEATDD: 20.0MHz
State Saved	Saved in instrument state.
Min	10 Hz
Max	Hardware Dependent: Option 503 = 3.7 GHz Option 507 = 7.1GHz Option 508 = 8.5 GHz Option 513 = 13.8 GHz Option 526 = 27.0 GHz
Initial S/W Revision	Prior to A.02.00
Modified at S/W Revision	A.02.00
Modified at S/W Revision	A.03.00

### IDEN Mode Span Preset for Monitor Spectrum

iDEN Slot Format	WiDEN Slot Format 25kHz	WiDEN Slot Format 50kHz	WiDEN Slot Format 75kHz	WiDEN Slot Format 100kHz	WiDEN Slot Format 50kHz Out
60kHz	60kHz	85kHz	110kHz	135kHz	135kHz

### Full Span

Changes the Span to show the full frequency range of the analyzer.

Key Path	Span X Scale
Mode	All except SA and BASIC
<b>Remote Command</b>	[ :SENSe] :MONitor:FREQuency:SPAN:FULL
<b>Example</b>	MON:FREQ:SPAN:FULL
Couplings	Sets the span to the full frequency range, and adjusts the center frequency accordingly.
Initial S/W Revision	Prior to A.02.00

### Last Span

Changes the measurement span to the span setting of the previous measurement. If there is no existing previous span value, then the span remains unchanged.

Key Path	Span X Scale
----------	--------------

---

Mode	All except SA and BASIC
<b>Remote Command</b>	[ :SENSe ] :MONitor :FREQuency :SPAN :PREVious
<b>Example</b>	MON:FREQ:SPAN:PREV
Couplings	Selecting last span changes the measurement span value.
Initial S/W Revision	Prior to A.02.00

---

## Sweep/Control

Access a menu of functions that enable you to set up and control the sweep time for the current measurement

Key Path	Front-panel key
Initial S/W Revision	Prior to A.02.00

### Sweep Time

Selects the length of time in which the spectrum analyzer sweeps the displayed frequency span. Additional overhead time is required by the analyzer. It impacts the sweep rate, but is not calculated as part of the sweep time. Reducing the sweep time increases the rate of sweeps.

Key Path	Sweep/Control
Mode	All except SA and BASIC
<b>Remote Command</b>	[:SENSe]:MONitor:SWEep:TIME <time> [:SENSe]:MONitor:SWEep:TIME? [:SENSe]:MONitor:SWEep:TIME:AUTO OFF ON 0 1 [:SENSe]:MONitor:SWEep:TIME:AUTO?
<b>Example</b>	MON:SWE:TIME 100 ms MON:SWE:TIME? MON:SWE:TIME:AUTO ON MON:SWE:TIME:AUTO?
Preset	Automatically Calculated
State Saved	Saved in instrument state.
Min	1 ms
Max	4000 s
Initial S/W Revision	Prior to A.02.00
MIN/MAX/DEF Support	Yes

### Pause

Pauses a measurement after the current data acquisition is complete.

When Paused, the label on the key changes to Resume. Pressing Resume continues the measurement at the point where it had been paused.

See "[Pause/Resume](#)" on page 2925 under Sweep/Control for more information.

Key Path	Sweep/Control
Initial S/W Revision	Prior to A.02.00

**Gate**

Accesses a menu that enables you to control the gating function. The Gate functionality is used to view signals best viewed by qualifying them with other events.

Gate setup parameters are the same for all measurements – they do not change as you change measurements. Settings like these are called “Meas Global” and are unaffected by Meas Preset.

Note that Sweep Time autocoupling rules and annotation are changed by Gate being on.

Key Path	Sweep/Control
Scope	Meas Global
Readback	The state and method of Gate, as [Off, LO] or [On, Video]. Note that for measurements that only support gated LO, the method is nonetheless read back, but always as LO.
Initial S/W Revision	Prior to A.02.00

**Gate On/Off**

Turns the gate function on and off.

When the Gate Function is on, the selected Gate Method is used along with the gate settings and the signal at the gate source to control the sweep and video system with the gate signal. Not all measurements allow every type of Gate Methods.

When Gate is on, the annunciation in the measurement bar reflects that it is on and what method is used, as seen in the following "Gate: LO" annunciator graphic.

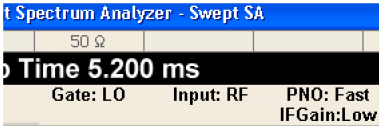

Key Path	Sweep/Control, Gate
Remote Command	[ :SENSe ] :SWEep:EGATe [ :STATe ] OFF ON 0 1 [ :SENSe ] :SWEep:EGATe [ :STATe ] ?
Example	SWE:EGAT ON SWE:EGAT?
Dependencies	The function is unavailable (grayed out) and Off when:

- Gate Method is LO or Video and FFT Sweep Type is manually selected.
- Gate Method is FFT and Swept Sweep Type is manually selected.
- Marker Count is ON.

The following are unavailable whenever Gate is on:

- FFT under Sweep Type when Method=LO or Video or Swept under Sweep Type when Method=FFT
- Marker Count

While Gate is on, the Auto Rules for Sweep Type are modified so that the choice agrees with the Gate Method: i.e., FFT for Method = FFT and Swept for Method = LO or Video.

The Gate softkey and all SCPI under the [:SENSe]:SWEep:EGATe SCPI node are grayed out when Source Mode is Tracking with an external source. This is because the Gate circuitry is used to sync the external source. If the Tracking Source is turned on, the Gate is turned off.

When in the ACP measurement:

- When Meas Method is RBW or FAST, this function is unavailable and the key is grayed out.
- Whenever Gate is on, Meas Method, RBW or FAST is unavailable and keys for those are grayed out.
- When Gate is on, Offset Res BW and Offset Video BW are ignored (if you set these values) and the measurement works as if all Offset Res BW and all Offset Video BW are coupled with the Res BW and the Video BW under the BW menu. When Gate is on, the Offset BW key in the Offset/Limit menu is grayed out.

Preset	Off LTETDD: On
State Saved	Saved in instrument state
Range	On Off
<b>Backwards Compatibility SCPI</b>	[:SENSe]:SWEep:TIME:GATE[:STATe] ESA compatibility
Backwards Compatibility Notes	In ESA, Trig Delay (On) and Gate (On) could not be active at the same time.. This dependency does not exist in PSA or in the X-Series.
Initial S/W Revision	Prior to A.02.00

## Gate View On/Off

Turning on Gate View in the Swept SA measurement provides a single-window gate view display..

Turning on Gate View in other measurements shows the split-screen Gate View. In these measurements, when the Gate View is on, the regular view of the current measurement traces and results are reduced vertically to about 70% of the regular height. The Zero Span window, showing the positions of the Gate, is shown between the Measurement Bar and the reduced measurement window. By reducing the height of the measurement window, some of the annotation on the Data Display may not fit and is not shown.

Key Path	Sweep/Control, Gate
<b>Remote Command</b>	[:SENSe]:SWEep:EGATe:VIEW ON OFF 1 0 [:SENSe]:SWEep:EGATe:VIEW?

<b>Example</b>	SWE:EGAT:VIEW ON turns on the gate view.
<b>Dependencies</b>	<p>In the Swept SA measurement:</p> <p>In Gate View, the regular Sweep Time key is grayed out . When pressed, the grayed out key puts up the informational message "Use Gate View Sweep Time in the Gate menu."</p> <p>In the other measurements:</p> <p>When you turn Gate View on, the lower window takes on the current state of the instrument. Upon leaving Gate View, the instrument takes on the state of the lower window.</p> <p>When you turn Gate View on, the upper window Sweep Time is set to the gate view sweep time.</p>
<b>Couplings</b>	<p>These couplings apply to the Swept SA measurement:</p> <ul style="list-style-type: none"> <li>• When Gate View is turned on, the instrument is set to Zero Span.</li> <li>• Gate View automatically turns off whenever a Span other than Zero is selected.</li> <li>• Gate View automatically turns off if you press the Last Span key while in Gate View, and the instrument returns to the Span it was in before entering Gate View (even if that is Zero Span).</li> <li>• When Gate View is turned on, the sweep time used is the gate view sweep time. This is set according to the rules in section "<a href="#">Gate View Setup</a>" on page 2725</li> <li>• When Gate View is turned off, Sweep Time is set to the normal Swept SA measurement sweep time.</li> <li>• If Gate View is on and Gate is off, then turning on Gate turns off Gate View.</li> </ul>
<b>Preset</b>	OFF
<b>State Saved</b>	Saved in instrument state
<b>Range</b>	On Off
<b>Initial S/W Revision</b>	Prior to A.02.00

A sample of the Gate View screen in the Swept SA measurement is shown in the following graphic :

20 Monitor Spectrum Measurement Sweep/Control

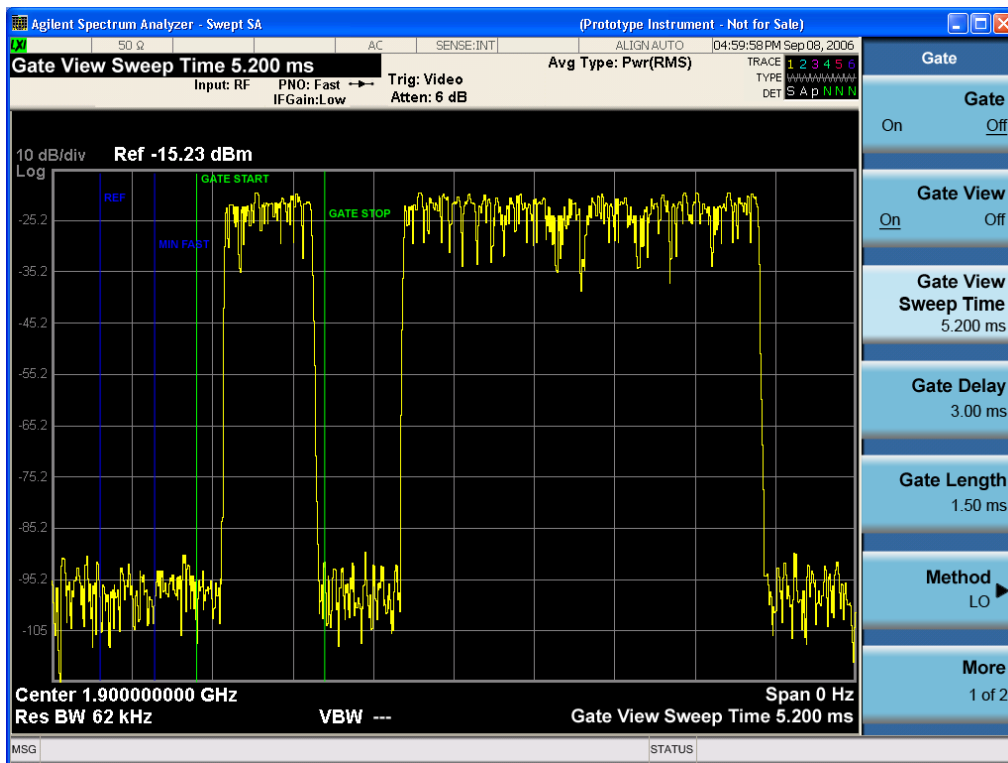

A sample of the Gate View screen in other measurements is shown in the following graphic. This example is for the ACP measurement:

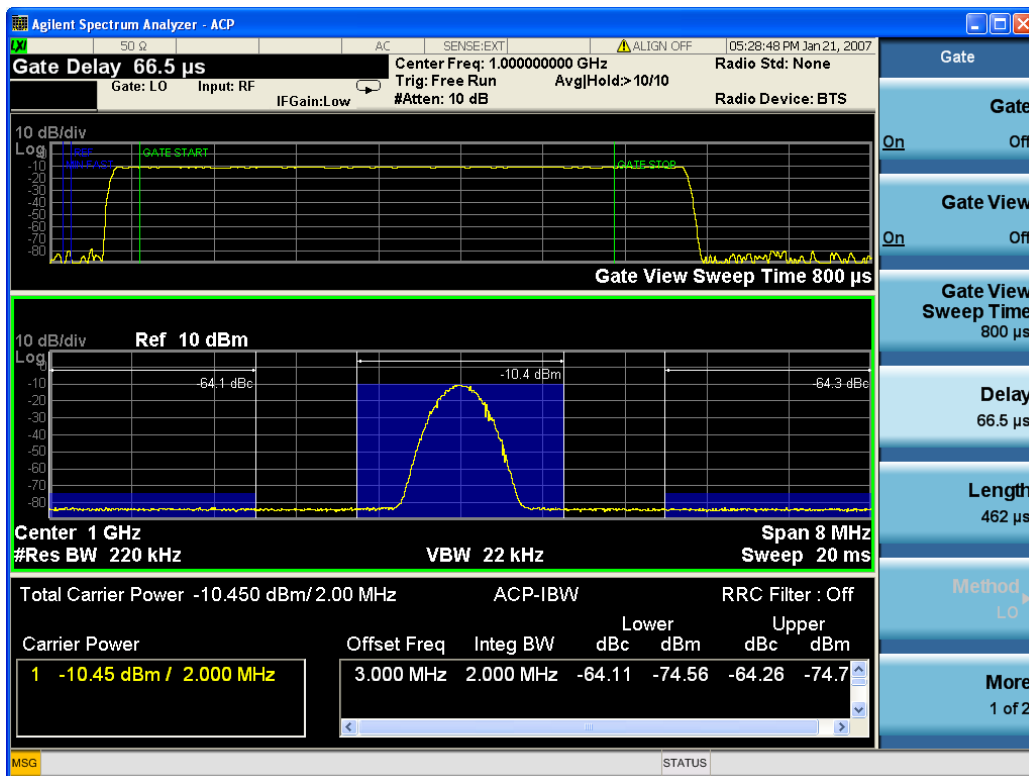



Turning Gate View off returns the analyzer to the Normal measurement view.

In the Swept SA, the normal measurement view is the single-window Swept SA view. When returning to this view, the Swept SA measurement returns to the Span it was in before entering **Gate View** (even if that is Zero Span).

The **Gate View** window is triggered from the Gate Source, with zero trigger delay. Also, when updating the **Gate View** window, the Gate itself must not operate. So it is internally shut off while the gate view window is being updated. For the Swept SA measurement, this means that the Gate is internally shut off whenever the gate view window is displayed. The measurement bar and softkeys continue to show the Trigger source for the main sweep window and give no indication that the Gate is shut off or that the Gate View window is triggered from the Gate Source.

When in **Gate View**, vertical lines are displayed in the Gate View window as follows:

- Green lines are displayed at the gate edges as follows: in Edge Gate, a line is shown for Delay and one for the end of the Gate period, defined by Length. In Level Gate a line is shown only for Delay. You can adjust the position of the green lines by adjusting the gate length and the gate delay. These lines update in the Gate View window as the active function changes, even if the window is not being updated. In Gated LO and Gated Video, these lines are positioned relative to the delay reference line (not relative to 0 time). In Gated FFT, their location is relative to the left edge of the screen.
- A blue line is displayed showing the delay reference, that is, the reference point for the Gate Delay within the Zero Span window. The blue line represents where (in time) the effective location of the gate start would be if the gate were programmed to zero delay.
- 
- The second blue line is labeled "MIN FAST" as shown in the figure above because it represents the minimum Gate Delay for fast Gated LO operation. This line is only displayed in Gated LO. You cannot scroll (knob) or decrement (down key) the Gate Delay to less than that represented by the position of this line, it can only be set below this position manually, although once there it can be moved freely with the knob while below the line.
- A yellow line in the Gated Video case only, is displayed at Blength, where Blength is the display point (bucket) length for the swept trace, which is given by the sweep time for that trace divided by number of Points – 1. So it is referenced to 0 time, not to the delay reference. This line is labeled NEXT PT (it is not shown in the figure above because the figure above is for Gated LO).
- The yellow line represents the edge of a display point (bucket). Normally in Gated Video, the bucket length must be selected so that it exceeds the off time of the burst. There is another way to use the analyzer in Gated Video measurements, and that is to set the bucket width much shorter than the off time of the burst. Then use the Max Hold trace function to fill in "missing" buckets more slowly. This allows you to see some of the patterns of the Gated Video results earlier, though seeing a completely filled-in spectrum later.

## Gate View Setup

Accesses a menu that enables you to setup parameters relevant to the Gate View

Key Path	Sweep/Control, Gate
Scope	Meas Global
Initial S/W Revision	A.10.00

## Gate View Sweep Time

Controls the sweep time in the Gate View window. To provide an optimal view of the gate signal, the analyzer initializes Gate View Sweep Time based on the current settings of Gate Delay and Gate Length.

<b>Key Path</b>	Sweep/Control, Gate, Gate View Setup
<b>Remote Command</b>	[ :SENSe ] :SWEep:EGATe:TIME <time> [ :SENSe ] :SWEep:EGATe:TIME?
<b>Example</b>	SWE:EGAT:TIME 500 ms
<b>Dependencies</b>	Gate View Sweep Time is initialized: <ul style="list-style-type: none"> <li>• On Preset (after initializing delay and length).</li> <li>• Every time the Gate Method is set/changed.</li> </ul> <p>Additionally, in the Swept SA measurement, whenever you do a Preset, or leave Gate View, the analyzer remembers the Gate Delay and Gate Length settings. Then, when returning to Gate View, if the current Gate Delay and/or Gate Length do not match the remembered values Gate View Sweep Time is re-initialized.</p> <ol style="list-style-type: none"> <li>1. Compute the location of the "gate stop" line, which you know is at time <math>t = t_{min} + \text{GateDelay} + \text{GateLength}</math>.</li> </ol>
<b>Preset</b>	519.3 $\mu$ s WiMAX OFDMA: 5 ms GSM/EDGE: 1 ms
<b>State Saved</b>	Saved in instrument state
<b>Max</b>	6000 s
<b>Initial S/W Revision</b>	Prior to A.02.00

## Gate View Start Time

Controls the time at the left edge of the Gate View.

<b>Key Path</b>	Sweep/Control, Gate, Gate View Setup
<b>Remote Command</b>	[ :SENSe ] :SWEep:EGATe:VIEW:START <time> [ :SENSe ] :SWEep:EGATe:VIEW:START?
<b>Example</b>	SWE:EGAT:VIEW:STAR 10ms
<b>Notes</b>	Units of time are required or no units; otherwise an invalid suffix error message will be generated. See error -131.
<b>Preset</b>	0 ms
<b>State Saved</b>	Saved in instrument state
<b>Min</b>	0
<b>Max</b>	500 ms
<b>Initial S/W Revision</b>	A.10.00

### Gate Delay

Controls the length of time from the time the gate condition goes True until the gate is turned on.

Key Path	Sweep/Control, Gate
Remote Command	[ :SENSe ] :SWEep:EGATe:DELay <time> [ :SENSe ] :SWEep:EGATe:DELay?
Example	SWE:EGAT:DELay 500ms SWE:EGAT:DELay?
Notes	Units of time are required or no units; otherwise an invalid suffix error message will be generated.
Preset	57.7 us WiMAX OFDMA: 71 us GSM/EDGE: 600 us WLAN: 500 us
State Saved	Saved in instrument state
Min	0.0 us
Max	100 s
Backwards Compatibility SCPI	[ :SENSe ] :SWEep:TIME:GATE:DELay ESA compatibility
Initial S/W Revision	Prior to A.02.00

### Gate Length

Controls the length of time that the gate is on after it opens.

Key Path	Sweep/Control, Gate
Remote Command	[ :SENSe ] :SWEep:EGATe:LENGth <time> [ :SENSe ] :SWEep:EGATe:LENGth?
Example	SWE:EGAT:LENG 1 SWE:EGAT:LENG?
Notes	Units of time are required or no units; otherwise an invalid suffix error message will be generated.
Dependencies	<p>Grayed out when Gate Method is set to FFT in which case the label changes to that shown below.</p>  <p>The key is also grayed out if Gate Control = Level.</p>
Preset	461.6 us

	WiMAX OFDMA: 50 us GSM/EDGE: 200 us WLAN: 1.54 ms
State Saved	Saved in instrument state
Min	100 ns
Max	5 s
<b>Backwards Compatibility SCPI</b>	[ :SENSe ] : SWEep : TIME : GATE : LENGth ESA compatibility
Initial S/W Revision	Prior to A.02.00

## Gate Source

The menus under the Gate Source key are the same as those under the Trigger key, with the exception that neither Free Run nor Video are available as Gate Source selections. However, a different SCPI command is used to select the Gate Source (see table below) because you may independently set the Gate Source and the Trigger Source.

Any changes to the settings in the setup menus under each Gate Source selection key (for example: Trigger Level, Trigger Delay, etc.) also affect the corresponding settings under the Trigger menu keys. The SCPI commands used for these are the same for Trigger and Gate, since there is only one setting which affects both Gate and Trigger. Example: to set the Trigger Level for External 1 you use the command :TRIG:EXT1:LEV regardless of whether you are using External 1 as a Trigger Source or a Gate Source.

Key Path	Sweep/Control, Gate
<b>Remote Command</b>	[ :SENSe ] : SWEep : EGATe : SOURce EXTernal1   EXTernal2   LINE   FRAME   RFBurst  [ :SENSe ] : SWEep : EGATe : SOURce?
Dependencies	In some models, there is no second External input. In these models, the External 2 key is blanked and the EXTernal2 parameter will generate a "Hardware missing; Not available for this model number" error.
Preset	EXTernal 1 GSM/EDGE, MSR: FRAME LTETDD: EXTernal 1When Direction is Downlink, FRAME when Direction is Uplink.
Backwards Compatibility Notes	In ESA, there is a single Gate input port. In PSA, the Gate Source may be taken from one of two specified input ports. In the X-Series, any Trigger Source can be a Gate Source.
Initial S/W Revision	Prior to A.02.00
Modified at S/W Revision	A.03.00, A.14.00

## Line

Pressing this key, when it is not selected, selects the line signal as the trigger. A new sweep/measurement will start synchronized with the next cycle of the line voltage. Pressing this key, when it is already selected, access the line trigger setup menu.

Key Path	Trigger
<b>Example</b>	TRIG:SOUR LINE Swept SA measurement TRIG:<meas>:SOUR LINE Measurements other than Swept SA
Dependencies	Line trigger is not available when operating from a "dc power source", for example, when the instrument is powered from batteries.
State Saved	Saved in instrument state
Status Bits/OPC dependencies	The Status Operation Register bit 5 "Waiting for Trigger" is set at the same time as the Sweeping or Measuring bit is set. It is cleared when the trigger actually occurs (that is, after the trigger event occurs and all the applicable trigger criteria have been met). A corresponding pop-up message ("Waiting for trigger") is generated if no trigger signal appears after approximately 2 sec. This message goes away when a trigger signal appears.
Initial S/W Revision	Prior to A.02.00

## Trig Slope

Controls the trigger polarity. It is set positive to trigger on a rising edge and negative to trigger on a falling edge.

Key Path	Trigger, Line
<b>Remote Command</b>	:TRIGger[:SEQuence]:LINE:SLOPe POSitive NEGative :TRIGger[:SEQuence]:LINE:SLOPe?
<b>Example</b>	TRIG:LINE:SLOP NEG
Preset	POSitive
State Saved	Saved in instrument state
Backwards Compatibility Notes	The legacy :TRIGger[:SEQuence]:SLOPe command affects the slopes for the VID, LINE, EXT1, EXT2, and RFB triggers.
Initial S/W Revision	Prior to A.02.00

## External 1

Pressing this key, when it is not selected, selects an external input signal as the trigger. A new sweep/measurement will start when the external trigger condition is met using the external 1 input connector on the rear panel.

Pressing this key, when it is already selected, accesses the external 1 trigger setup menu.

Key Path	Trigger
<b>Example</b>	TRIG:SOUR EXT1 Swept SA measurement TRIG:<meas>:SOUR EXT1 Measurements other than Swept SA
Dependencies	Grayed out if in use by Point Trigger in the Source Setup menu. Forced to Free Run if already selected and Point Trigger is set to External 1.
State Saved	Saved in instrument state
Status Bits/OPC dependencies	The Status Operation Register bit 5 "Waiting for Trigger" is set at the same time as the Sweeping or Measuring bit is set. It is cleared when the trigger actually occurs (that is, after the trigger event occurs and all the applicable trigger criteria have been met). A corresponding pop-up message ("Waiting for trigger") is generated if no trigger signal appears after approximately 2 sec. This message goes away when a trigger signal appears.
Initial S/W Revision	Prior to A.02.00

### Trigger Level

Sets the value where the external 1 trigger input will trigger a new sweep/measurement.

Key Path	Trigger, External 1
<b>Remote Command</b>	:TRIGger[:SEquence]:EXTernal1:LEVel <level> :TRIGger[:SEquence]:EXTernal1:LEVel?
<b>Example</b>	TRIG:EXT1:LEV 0.4 V
Couplings	This same level is used for the Ext1 trigger source in the Trigger menu, for the Ext1 selection in the Periodic Timer sync source (in the Trigger menu and in the Gate Source menu), and also for the Ext1 selection in the Gate Source menu.
Preset	1.2 V
State Saved	Saved in instrument state
Min	-5 V
Max	5 V
Default Unit	V
<b>Backwards Compatibility SCPI</b>	:TRIGger[:SEquence]:EXTernal:LEVel For backward compatibility, the parameter EXTernal is mapped to EXTernal1
<b>Backwards Compatibility SCPI</b>	:TRIGger[:SEquence]:FRAME:EXTernal1:LEVel
Initial S/W Revision	Prior to A.02.00

### Trig Slope

Controls the trigger polarity. It is set positive to trigger on a rising edge and negative to trigger on a falling edge.

Key Path	Trigger, External 1
<b>Remote Command</b>	:TRIGger[:SEquence]:EXTernal1:SLOPe POSitive NEGative :TRIGger[:SEquence]:EXTernal1:SLOPe?
<b>Example</b>	TRIG:EXT1:SLOP NEG
Couplings	This same slope is used in the Ext1 selection for the trigger source in the Trigger menu and for the period timer sync source (in the Trigger menu and in the Gate Source menu).
Preset	POSitive
State Saved	Saved in instrument state
<b>Backwards Compatibility SCPI</b>	:TRIGger[:SEquence]:EXTernal:SLOPe For backward compatibility, the parameter EXTernal is mapped to EXTernal1
<b>Backwards Compatibility SCPI</b>	:TRIGger[:SEquence]:FRAMe:EXTernal1:SLOPe
Backwards Compatibility Notes	The legacy :TRIGger[:SEquence]:SLOPe command affects the slopes for the VID, LINE, EXT1, EXT2, and RFB triggers.
Initial S/W Revision	Prior to A.02.00

## External 2

Pressing this key, when it is not selected, selects an external input signal as the trigger. A new sweep/measurement will start when the external trigger condition is met using the external 2 input connector. The external trigger 2 input connector is on the rear panel.

Pressing this key, when it is already selected, accesses the external 2 trigger setup menu.

Key Path	Trigger
<b>Example</b>	TRIG:SOUR EXT2 Swept SA measurement TRIG:<meas>:SOUR EXT2 Measurements other than Swept SA
Dependencies	In some models, there is no second External input. In these models, the External 2 key is blanked and the EXTernal2 parameter will generate a "Hardware missing; Not available for this model number" message. Grayed out if in use by Point Trigger in the Source Setup menu. Forced to Free Run if already selected and Point Trigger is set to External 2.
State Saved	Saved in instrument state
Status Bits/OPC dependencies	The Status Operation Register bit 5 "Waiting for Trigger" is set at the same time as the Sweeping or Measuring bit is set. It is cleared when the trigger actually occurs (that is, after the trigger event occurs and all the applicable trigger criteria have been met). A corresponding pop-up message ("Waiting for trigger") is generated if no trigger signal appears after approximately 2 sec. This message goes away when a trigger signal appears.
Initial S/W Revision	Prior to A.02.00
Modified at S/W Revision	A.03.00

### Trigger Level

Sets the value where the external 2 trigger input will trigger a new sweep/measurement.

Key Path	Trigger, External 2
<b>Remote Command</b>	:TRIGger[:SEquence]:EXTernal2:LEVel :TRIGger[:SEquence]:EXTernal2:LEVel?
<b>Example</b>	TRIG:EXT2:LEV 1.1 V
Couplings	This same level is used for the Ext2 trigger source in the Trigger menu, for the Ext2 selection in the Periodic Timer sync source (in the Trigger menu and in the Gate Source menu), and also for the Ext2 selection in the Gate Source menu.
Preset	1.2 V
State Saved	Saved in instrument state
Min	-5 V
Max	5 V
Default Unit	V
<b>Backwards Compatibility SCPI</b>	:TRIGger[:SEquence]:FRAMe:EXTernal2:LEVel
Initial S/W Revision	Prior to A.02.00

### Trig Slope

Controls the trigger polarity. It is set positive to trigger on a rising edge and negative to trigger on a falling edge.

Key Path	Trigger, External 2
<b>Remote Command</b>	:TRIGger[:SEquence]:EXTernal2:SLOPe POSitive NEGative :TRIGger[:SEquence]:EXTernal2:SLOPe?
<b>Example</b>	TRIG:EXT2:SLOP NEG
Couplings	This same slope is used in the Ext2 selection for the trigger source in the Trigger menu and for the period timer sync source (in the Trigger menu and in the Gate Source menu).
Preset	POSitive
State Saved	Saved in instrument state
<b>Backwards Compatibility SCPI</b>	:TRIGger[:SEquence]:FRAMe:EXTernal2:SLOPe
Backwards Compatibility Notes	The legacy :TRIGger[:SEquence]:SLOPe command affects the slopes for the VID, LINE, EXT1, EXT2, and RFB triggers.
Initial S/W Revision	Prior to A.02.00



## RF Burst

Pressing this key, when it is not selected, selects the RF Burst as the trigger. A new sweep/measurement will start when an RF burst envelope signal is identified from the signal at the RF Input connector. Pressing this key, when it is already selected, accesses the RF Burst trigger setup menu.

In some models, a variety of burst trigger circuitry is available, resulting in various available burst trigger bandwidths. The analyzer automatically chooses the appropriate trigger path based on the hardware configuration and other settings of the analyzer.

Key Path	Trigger
<b>Example</b>	TRIG:SOUR RFB Swept SA measurement TRIG:<meas>:SOUR RFB Measurements other than Swept SA
State Saved	Saved in instrument state
Status Bits/OPC dependencies	The Status Operation Register bit 5 "Waiting for Trigger" is set at the same time as the Sweeping or Measuring bit is set. It is cleared when the trigger actually occurs (that is, after the trigger event occurs and all the applicable trigger criteria have been met). A corresponding pop-up message ("Waiting for trigger") is generated if no trigger signal appears after approximately 2 sec. This message goes away when a trigger signal appears.
Backwards Compatibility Notes	The legacy command: :TRIGger[:SEQuence]:RFBurst:FSElectivity[:STATe] OFF ON 0 1 is not supported in the X-Series, as the hardware to do Frequency Selective burst triggers does not exist in X-Series.
Initial S/W Revision	Prior to A.02.00
Modified at S/W Revision	A.04.00

## Absolute Trigger Level

Sets the absolute trigger level for the RF burst envelope.

When using the External Mixing path, the Absolute Trigger Level is uncalibrated because the factory default was set to accommodate the expected IF levels for the RF path.

Key Path	Trigger, RF Burst
Scope	Meas Global
<b>Remote Command</b>	:TRIGger[:SEQuence]:RFBurst:LEVel:ABSolute <ampl> :TRIGger[:SEQuence]:RFBurst:LEVel:ABSolute?
<b>Example</b>	TRIG:RFB:LEV:ABS 10 dBm sets the trigger level of the RF burst envelope signal to the absolute level of 10 dBm
Notes	Sending this command does not switch the setting from relative to absolute; to switch it you need to send the :TRIGger[:SEQuence]:RFBurst:LEVel:TYPE command, below.  Amplitude Corrections are not taken into account by the Absolute Trigger Level. For example, if you have given yourself effective gain with an amplitude correction factor, the Absolute Trigger will not fire until you have set the trigger level that far below the displayed signal level, rather than simply to

	the displayed signal level. This is only true for Amplitude Corrections, not External Gain or Ref Level Offset functions. If mode is Bluetooth, the default value is -50 dBm.
Couplings	This same level is used for the RF Burst trigger source in the Trigger menu, for the RF Burst selection in the Periodic Timer sync source (in the Trigger menu and in the Gate Source menu), and also for the RF Burst selection in the Gate Source menu
Preset	-20 dBm
State Saved	Saved in instrument state
Min	-200 dBm
Max	100 dBm
Default Unit	depends on the current selected Y-Axis unit
<b>Backwards Compatibility SCPI</b>	:TRIGger[:SEquence]:FRAME:RFBurst:LEVel:ABSolute
Initial S/W Revision	Prior to A.02.00
Modified at S/W Revision	A.04.00

Key Path	Trigger, RF Burst
<b>Remote Command</b>	:TRIGger[:SEquence]:RFBurst:LEVel:TYPE ABSolute RELative :TRIGger[:SEquence]:RFBurst:LEVel:TYPE?
<b>Example</b>	TRIG:RFB:LEV:TYPE REL sets the trigger level type of the RF burst trigger to Relative.
Preset	ABSolute
State Saved	Saved in instrument state
Initial S/W Revision	Prior to A.02.00
Modified at S/W Revision	A.04.00

### Relative Trigger Level

Sets the relative trigger level for the RF burst envelope.

In some models, the relative burst trigger function is implemented in hardware. In other models, without the advanced triggering hardware required, the relative burst trigger function is implemented in software in some measurements, and is unavailable in other measurements.

When implemented in software, the relative RF Burst trigger function is implemented as follows:

1. The measurement starts with the absolute RF Burst trigger setting. If it cannot get a trigger with that level, auto trigger fires and the acquisition starts anyway. After the acquisition, the measurement searches for the peak in the acquired waveform and saves it.

2. Now, in the next cycle of the measurement, the measurement determines a new absolute RF Burst level based on the peak value from the first measurement and the Relative RF Burst Trigger Level (always 0 or negative dB) set by the user. The following formula is used:
  3. absolute RF Burst level = peak level of the previous acquisition + relative RF Burst level
  4. If the new absolute RF Burst level differs from the previous by more than 0.5 dB, the new level is sent to the hardware; otherwise it is not updated (to avoid slowing down the acquisition)
- Steps 2 and 3 repeat for subsequent measurements.

Key Path	Trigger, RF Burst
Scope	Meas Global
<b>Remote Command</b>	:TRIGger[:SEquence]:RFBurst:LEVel:RELative <rel_ampl> :TRIGger[:SEquence]:RFBurst:LEVel:RELative?
<b>Example</b>	TRIG:RFB:LEV:REL -10 dB sets the trigger level of the RF burst envelope signal to the relative level of -10 dB
Notes	Sending this command does not switch the setting from absolute to relative; to switch it you need to send the :TRIGger[:SEquence]:RFBurst:LEVel:TYPE command, above. The relative trigger level is not available in some measurements. In those measurements the RELative parameter, and the :TRIGger[:SEquence]:RFBurst:LEVel:TYPE command (above), will generate an error if sent.
Dependencies	This key is grayed out and Absolute Trigger Level selected if the required hardware is not present in your analyzer and the current measurement does not support Relative triggering.
Preset	-6 dB GSM: -25 dB
State Saved	Saved in instrument state
Min	-45 dB
Max	0 dB
Default Unit	dB or dBc
<b>Backwards Compatibility SCPI</b>	:TRIGger[:SEquence]:RFBurst:LEVel This legacy command is aliased to :TRIGger[:SEquence]:RFBurst:LEVel:RELative because the PSA had ONLY relative burst triggering
Initial S/W Revision	Prior to A.02.00
Modified at S/W Revision	A.04.00

### Trigger Slope

It is set positive to trigger on a rising edge and negative to trigger on a falling edge.

Key Path	Trigger, RF Burst
<b>Remote Command</b>	:TRIGger[:SEquence]:RFBurst:SLOPe Positive NEGative :TRIGger[:SEquence]:RFBurst:SLOPe?

<b>Example</b>	TRIG:RFB:SLOP NEG
Couplings	This same slope is used in the RF Burst selection for the trigger source in the Trigger menu and for the period timer sync source (in the Trigger menu and in the Gate Source menu).
Preset	POSitive
State Saved	Saved in instrument state
<b>Backwards Compatibility SCPI</b>	:TRIGger[:SEQuence]:FRAMe:RFBurst:SLOPe
Backwards Compatibility Notes	The legacy :TRIGger[:SEQuence]:SLOPe command affects the slopes for the VID, LINE, EXT1, EXT2, and RFB triggers.
Initial S/W Revision	Prior to A.02.00

### Periodic Timer (Frame Trigger)

Pressing this key, when it is not selected, selects the internal periodic timer signal as the trigger. Triggering occurrences are set by the **Period** parameter, which is modified by the **Sync Source** and **Offset**. Pressing this key, when it is already selected, accesses the periodic timer trigger setup functions.

If you do not have a sync source selected (it is Off), then the internal timer will not be synchronized with any external timing events.

<b>Key Path</b>	Trigger
<b>Example</b>	TRIG:SOUR FRAM Swept SA measurement TRIG:<meas>:SOUR FRAM Measurements other than Swept SA
State Saved	Saved in instrument state
Readback	[Sync: <value of Sync Source>], for example, [Sync: External 1]
Status Bits/OPC dependencies	The Status Operation Register bit 5 "Waiting for Trigger" is set at the same time as the Sweeping or Measuring bit is set. It is cleared when the trigger actually occurs (that is, after the trigger event occurs and all the applicable trigger criteria have been met). A corresponding pop-up message ("Waiting for trigger") is generated if no trigger signal appears after approximately 2 sec. This message goes away when a trigger signal appears.
Initial S/W Revision	Prior to A.02.00

### Periodic Timer Triggering:

This feature selects the internal periodic timer signal as the trigger. Trigger occurrences are set by the **Periodic Timer** parameter, which is modified by the **Sync Source** and **Offset**.

The figure below shows the action of the periodic timer trigger. Before reviewing the figure, we'll explain some uses for the periodic trigger.

A common application is measuring periodic burst RF signals for which a trigger signal is not easily available. For example, we might be measuring a TDMA radio which bursts every 20 ms. Let's assume that the 20 ms period is very consistent. Let's also assume that we do not have an external trigger source

available that is synchronized with the period, and that the signal-to-noise ratio of the signal is not high enough to provide a clean RF burst trigger at all of the analysis frequencies. For example, we might want to measure spurious transmissions at an offset from the carrier that is larger than the bandwidth of the RF burst trigger. In this application, we can set the Periodic Timer to a 20.00 ms period and adjust the offset from that timer to position our trigger just where we want it. If we find that the 20.00 ms is not exactly right, we can adjust the period slightly to minimize the drift between the period timer and the signal to be measured.

A second way to use this feature would be to use **Sync Source** temporarily, instead of **Offset**. In this case, we might tune to the signal in a narrow span and use the RF Burst trigger to synchronize the periodic timer. Then we would turn the sync source off so that it would not miss-trigger. Miss-triggering can occur when we are tuned so far away from the RF burst trigger that it is no longer reliable.

A third example would be to synchronize to a signal that has a reference time element of much longer period than the period of interest. In some CDMA applications, it is useful to look at signals with a short periodicity, by synchronizing that periodicity to the "even-second clock" edge that happens every two seconds. Thus, we could connect the even-second clock trigger to Ext1 and use then Ext1 as the sync source for the periodic timer.

The figure below illustrates this third example. The top trace represents the even-second clock. It causes the periodic timer to synchronize with the leading edge shown. The analyzer trigger occurs at a time delayed by the accumulated offset from the period trigger event. The periodic timer continues to run, and triggers continue to occur, with a periodicity determined by the analyzer time base. The timer output (labeled "late event") will drift away from its ideal time due to imperfect matching between the time base of the signal being measured and the time base of the analyzer, and also because of imperfect setting of the period parameter. But the synchronization is restored on the next even-second clock event. ("Accumulated offset" is described in the in the **Offset** function section.)

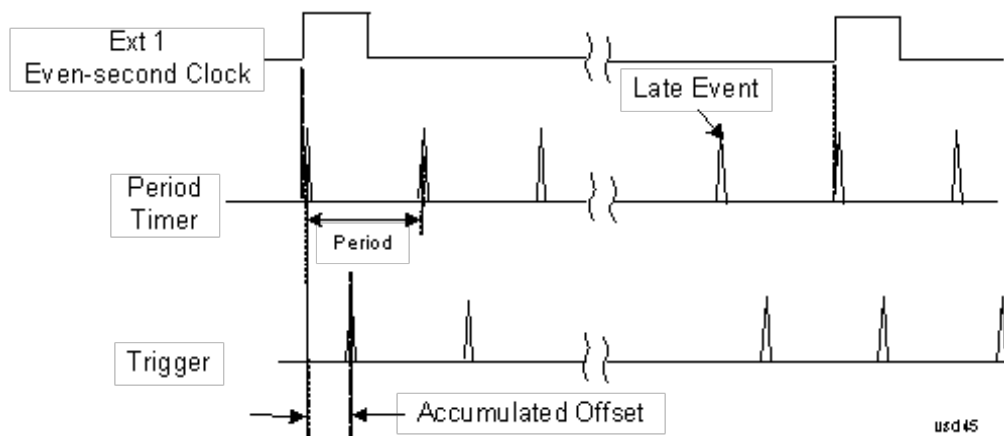

### Period

Sets the period of the internal periodic timer clock. For digital communications signals, this is usually set to the frame period of your current input signal. In the case that sync source is not set to OFF, and the external sync source rate is changed for some reason, the periodic timer is synchronized at the every external synchronization pulse by resetting the internal state of the timer circuit.

<b>Key Path</b>	Trigger, Periodic Timer
<b>Remote Command</b>	:TRIGger[:SEquence]:FRAMe:PERIOD <time>

	:TRIGger[:SEquence]:FRAMe:PERiod?
<b>Example</b>	TRIG:FRAM:PER 100 ms
<b>Dependencies</b>	The invalid data indicator turns on when the period is changed, until the next sweep/measurement completes.
<b>Couplings</b>	The same period is used in the Gate Source selection of the period timer.
<b>Preset</b>	20 ms GSM: 4.615383
<b>State Saved</b>	Saved in instrument state
<b>Min</b>	100.000 ns
<b>Max</b>	559.0000 ms
<b>Default Unit</b>	S
<b>Initial S/W Revision</b>	Prior to A.02.00

### Offset

Adjusts the accumulated offset between the periodic timer events and the trigger event. Adjusting the accumulated offset is different than setting an offset, and requires explanation.

The periodic timer is usually not synchronized with any external events, so the timing of its output events has no absolute meaning. Since the timing relative to external events (RF signals) is important, you need to be able to adjust (offset) it. However, you have no direct way to see when the periodic timer events occur. All that you can see is the trigger timing. When you want to adjust the trigger timing, you will be changing the internal offset between the periodic timer events and the trigger event. Because the absolute value of that internal offset is unknown, we will just call that the accumulated offset. Whenever the Offset parameter is changed, you are changing that accumulated offset. You can reset the displayed offset using Reset Offset Display. Changing the display does not change the value of the accumulated offset, and you can still make additional changes to accumulated offset.

To avoid ambiguity, we define that an increase in the "offset" parameter, either from the knob or the SCPI adjust command, serves to delay the timing of the trigger event.

<b>Key Path</b>	Trigger, Periodic Timer
<b>Remote Command</b>	:TRIGger[:SEquence]:FRAMe:OFFSet <time> :TRIGger[:SEquence]:FRAMe:OFFSet?
<b>Example</b>	TRIG:FRAM:OFFS 1.2 ms
<b>Notes</b>	The front panel interface (for example, the knob), and this command, adjust the accumulated offset, which is shown on the active function display. However, the actual amount sent to the hardware each time the offset is updated is the delta value, that is, the current accumulated offset value minus the previous accumulated offset value. Note that the accumulated offset value is essentially arbitrary; it represents the accumulated offset from the last time the offset was zeroed (with the Reset Offset Display key).  Note that this command does not change the period of the trigger waveform. Note also that Offset is used only when the sync source is set to OFF, otherwise delay is used, see section "Trig Delay" on page 461.

	An increase in the "offset" parameter, either from the knob or the SCPI adjust command, serves to delay the timing of the trigger event.
Notes	When the SCPI command is sent the value shown on the key (and the Active Function, if this happens to be the active function) is updated with the new value. However, the actual amount sent to the hardware is the delta value, that is, the current accumulated offset value minus the previous accumulated offset value.  The SCPI query simply returns the value currently showing on the key.
Dependencies	The invalid data indicator turns on when the offset is changed, until the next sweep/measurement completes.
Couplings	The same offset is used in the Gate Source selection of the period timer.
Preset	0 s
State Saved	Saved in instrument state
Min	-10.000 s
Max	10.000 s
Default Unit	S
Initial S/W Revision	Prior to A.02.00

#### Offset Adjust (Remote Command Only)

This remote command does not work at all like the related front panel keys. This command lets you advance the phase of the frame trigger by the amount you specify.

It does not change the period of the trigger waveform. If the command is sent multiple times, it advances the phase of the frame trigger an additional amount each time it is sent. Negative numbers are permitted.

<b>Remote Command</b>	:TRIGger[:SEquence]:FRAMe:ADJust <time>
<b>Example</b>	TRIG:FRAM:ADJ 1.2 ms
Notes	Note also that Offset is used only when the sync source is set to OFF, otherwise delay is used, see section " <a href="#">Trig Delay</a> " on page 461  An increase in the "offset" parameter, either from the knob or the SCPI adjust command, serves to delay the timing of the trigger event.
Notes	The front panel interface (for example, the knob) and the :TRIG:FRAM:OFFS command adjust the accumulated offset, which is shown on the active function display. However, the actual amount sent to the hardware is the delta value, that is, the current offset value minus the previous offset value.  When the SCPI command is sent the value shown on the key (and the Active Function, if this happens to be the active function) is updated by increasing it (or decreasing it if the value sent is negative) by the amount specified in the SCPI command.  This is a "command only" SCPI command, with no query.
Dependencies	The invalid data indicator turns on when the offset is changed, until the next sweep/measurement completes.
Couplings	The same offset is used in the Gate Source selection of the period timer.
Preset	0 s

State Saved	Saved in instrument state
Min	-10.000 s
Max	10.000 s
Default Unit	S
Initial S/W Revision	Prior to A.02.00

### Reset Offset Display

Resets the value of the periodic trigger offset display setting to 0.0 seconds. The current displayed trigger location may include an offset value defined with the Offset key. Pressing this key redefines the currently displayed trigger location as the new trigger point that is 0.0 s offset. The Offset key can then be used to add offset relative to this new timing.

Key Path	Trigger, Periodic Timer
Remote Command	:TRIGger[:SEquence]:FRAMe:OFFSet:DISPlay:RESet
Example	TRIG:FRAM:OFFS:DISP:RES
Initial S/W Revision	Prior to A.02.00

### Sync Source

Selects a signal source for you to synchronize your periodic timer trigger to, otherwise you are triggering at some arbitrary location in the frame. Synchronization reduces the precision requirements on the setting of the period.

For convenience you may adjust the level and slope of the selected sync source in a conditional branch setup menu accessed from the Sync Source menu. Note that these settings match those in the **Trigger** and **Gate Source** menus; that is, each trigger source has only one value of level and slope, regardless of which menu it is accessed from.

Key Path	Trigger, Periodic Timer
Remote Command	:TRIGger[:SEquence]:FRAMe:SYNC EXTernal1   EXTernal2   RFBurst   OFF :TRIGger[:SEquence]:FRAMe:SYNC?
Example	TRIG:FRAM:SYNC EXT2
Dependencies	In some models, there is no second External input. In these models, the External 2 key is blanked and the EXTernal2 parameter will generate a "Hardware missing; Not available for this model number" message.
Preset	Off GSM/EDGE, MSR,LTE,LTETDD: RFBurst
State Saved	Saved in instrument state
Readback	The current setting is read back to this key and it is also Readback to the previous Periodic Timer trigger key.



<b>Backwards Compatibility SCPI</b>	:TRIGger[:SEQuence]:FRAMe:SYNC EXTernal
Initial S/W Revision	Prior to A.02.00
Modified at S/W Revision	A.03.00, A.14.00

**Off**

Turns off the sync source for your periodic trigger. With the sync source off, the timing will drift unless the signal source frequency is locked to the analyzer frequency reference.

<b>Key Path</b>	Trigger, Periodic Timer, Sync Source
<b>Example</b>	TRIG:FRAM:SYNC OFF
<b>Readback</b>	Off
<b>Initial S/W Revision</b>	Prior to A.02.00

**External 1**

Pressing this key, when it is not selected, selects an external input signal as the trigger. A new sweep/measurement will start when the external trigger condition is met using the external 1 input connector on the rear panel.

Pressing this key, when it is already selected, accesses the external 1 trigger setup menu.

<b>Key Path</b>	Trigger
<b>Example</b>	TRIG:SOUR EXT1 Swept SA measurement TRIG:<meas>:SOUR EXT1 Measurements other than Swept SA
<b>Dependencies</b>	Grayed out if in use by Point Trigger in the Source Setup menu. Forced to Free Run if already selected and Point Trigger is set to External 1.
<b>State Saved</b>	Saved in instrument state
<b>Status Bits/OPC dependencies</b>	The Status Operation Register bit 5 "Waiting for Trigger" is set at the same time as the Sweeping or Measuring bit is set. It is cleared when the trigger actually occurs (that is, after the trigger event occurs and all the applicable trigger criteria have been met). A corresponding pop-up message ("Waiting for trigger") is generated if no trigger signal appears after approximately 2 sec. This message goes away when a trigger signal appears.
<b>Initial S/W Revision</b>	Prior to A.02.00

**Trigger Level**

Sets the value where the external 1 trigger input will trigger a new sweep/measurement.

Key Path	Trigger, External 1
Remote Command	:TRIGger[:SEquence]:EXTErnal1:LEVel <level> :TRIGger[:SEquence]:EXTErnal1:LEVel?
Example	TRIG:EXT1:LEV 0.4 V
Couplings	This same level is used for the Ext1 trigger source in the Trigger menu, for the Ext1 selection in the Periodic Timer sync source (in the Trigger menu and in the Gate Source menu), and also for the Ext1 selection in the Gate Source menu.
Preset	1.2 V
State Saved	Saved in instrument state
Min	-5 V
Max	5 V
Default Unit	V
Backwards Compatibility SCPI	:TRIGger[:SEquence]:EXTErnal:LEVel For backward compatibility, the parameter EXTErnal is mapped to EXTErnal1
Backwards Compatibility SCPI	:TRIGger[:SEquence]:FRAME:EXTErnal1:LEVel
Initial S/W Revision	Prior to A.02.00

### Trig Slope

Controls the trigger polarity. It is set positive to trigger on a rising edge and negative to trigger on a falling edge.

Key Path	Trigger, External 1
Remote Command	:TRIGger[:SEquence]:EXTErnal1:SLOPe POSitive NEGative :TRIGger[:SEquence]:EXTErnal1:SLOPe?
Example	TRIG:EXT1:SLOP NEG
Couplings	This same slope is used in the Ext1 selection for the trigger source in the Trigger menu and for the period timer sync source (in the Trigger menu and in the Gate Source menu).
Preset	POSitive
State Saved	Saved in instrument state
Backwards Compatibility SCPI	:TRIGger[:SEquence]:EXTErnal:SLOPe For backward compatibility, the parameter EXTErnal is mapped to EXTErnal1
Backwards Compatibility SCPI	:TRIGger[:SEquence]:FRAME:EXTErnal1:SLOPe
Backwards Compatibility Notes	The legacy :TRIGger[:SEquence]:SLOPe command affects the slopes for the VID, LINE, EXT1, EXT2, and RFB triggers.
Initial S/W Revision	Prior to A.02.00

## External 2

Pressing this key, when it is not selected, selects an external input signal as the trigger. A new sweep/measurement will start when the external trigger condition is met using the external 2 input connector. The external trigger 2 input connector is on the rear panel.

Pressing this key, when it is already selected, accesses the external 2 trigger setup menu.

Key Path	Trigger
<b>Example</b>	TRIG:SOUR EXT2 Swept SA measurement TRIG:<meas>:SOUR EXT2 Measurements other than Swept SA
Dependencies	In some models, there is no second External input. In these models, the External 2 key is blanked and the EXTernal2 parameter will generate a "Hardware missing; Not available for this model number" message. Grayed out if in use by Point Trigger in the Source Setup menu. Forced to Free Run if already selected and Point Trigger is set to External 2.
State Saved	Saved in instrument state
Status Bits/OPC dependencies	The Status Operation Register bit 5 "Waiting for Trigger" is set at the same time as the Sweeping or Measuring bit is set. It is cleared when the trigger actually occurs (that is, after the trigger event occurs and all the applicable trigger criteria have been met). A corresponding pop-up message ("Waiting for trigger") is generated if no trigger signal appears after approximately 2 sec. This message goes away when a trigger signal appears.
Initial S/W Revision	Prior to A.02.00
Modified at S/W Revision	A.03.00

## Trigger Level

Sets the value where the external 2 trigger input will trigger a new sweep/measurement.

Key Path	Trigger, External 2
<b>Remote Command</b>	:TRIGger[:SEquence]:EXTernal2:LEVel :TRIGger[:SEquence]:EXTernal2:LEVel?
<b>Example</b>	TRIG:EXT2:LEV 1.1 V
Couplings	This same level is used for the Ext2 trigger source in the Trigger menu, for the Ext2 selection in the Periodic Timer sync source (in the Trigger menu and in the Gate Source menu), and also for the Ext2 selection in the Gate Source menu.
Preset	1.2 V
State Saved	Saved in instrument state
Min	-5 V
Max	5 V
Default Unit	V
<b>Backwards Compatibility SCPI</b>	:TRIGger[:SEquence]:FRAMe:EXTernal2:LEVel
Initial S/W Revision	Prior to A.02.00

### Trig Slope

Controls the trigger polarity. It is set positive to trigger on a rising edge and negative to trigger on a falling edge.

<b>Key Path</b>	Trigger, External 2
<b>Remote Command</b>	:TRIGger[:SEQuence]:EXTernal2:SLOPe POSitive NEGative :TRIGger[:SEQuence]:EXTernal2:SLOPe?
<b>Example</b>	TRIG:EXT2:SLOP NEG
<b>Couplings</b>	This same slope is used in the Ext2 selection for the trigger source in the Trigger menu and for the period timer sync source (in the Trigger menu and in the Gate Source menu).
<b>Preset</b>	POSitive
<b>State Saved</b>	Saved in instrument state
<b>Backwards Compatibility SCPI</b>	:TRIGger[:SEQuence]:FRAMe:EXTernal2:SLOPe
<b>Backwards Compatibility Notes</b>	The legacy :TRIGger[:SEQuence]:SLOPe command affects the slopes for the VID, LINE, EXT1, EXT2, and RFB triggers.
<b>Initial S/W Revision</b>	Prior to A.02.00

### RF Burst

Pressing this key, when it is not selected, selects the RF Burst as the trigger. A new sweep/measurement will start when an RF burst envelope signal is identified from the signal at the RF Input connector. Pressing this key, when it is already selected, accesses the RF Burst trigger setup menu.

In some models, a variety of burst trigger circuitry is available, resulting in various available burst trigger bandwidths. The analyzer automatically chooses the appropriate trigger path based on the hardware configuration and other settings of the analyzer.

<b>Key Path</b>	Trigger
<b>Example</b>	TRIG:SOUR RFB Swept SA measurement TRIG:<meas>:SOUR RFB Measurements other than Swept SA
<b>State Saved</b>	Saved in instrument state
<b>Status Bits/OPC dependencies</b>	The Status Operation Register bit 5 "Waiting for Trigger" is set at the same time as the Sweeping or Measuring bit is set. It is cleared when the trigger actually occurs (that is, after the trigger event occurs and all the applicable trigger criteria have been met). A corresponding pop-up message ("Waiting for trigger") is generated if no trigger signal appears after approximately 2 sec. This message goes away when a trigger signal appears.
<b>Backwards Compatibility Notes</b>	The legacy command: :TRIGger[:SEQuence]:RFBurst:FSElectivity[:STATe] OFF ON 0 1 is not supported in the X-Series, as the hardware to do Frequency Selective burst triggers does not exist in X-Series.

Initial S/W Revision	Prior to A.02.00
Modified at S/W Revision	A.04.00

### Absolute Trigger Level

Sets the absolute trigger level for the RF burst envelope.

When using the External Mixing path, the Absolute Trigger Level is uncalibrated because the factory default was set to accommodate the expected IF levels for the RF path.

Key Path	Trigger, RF Burst
Scope	Meas Global
<b>Remote Command</b>	:TRIGger[:SEquence]:RFBurst:LEVel:ABSolute <ampl> :TRIGger[:SEquence]:RFBurst:LEVel:ABSolute?
<b>Example</b>	TRIG:RFB:LEV:ABS 10 dBm sets the trigger level of the RF burst envelope signal to the absolute level of 10 dBm
Notes	Sending this command does not switch the setting from relative to absolute; to switch it you need to send the :TRIGger[:SEquence]:RFBurst:LEVel:TYPE command, below.  Amplitude Corrections are not taken into account by the Absolute Trigger Level. For example, if you have given yourself effective gain with an amplitude correction factor, the Absolute Trigger will not fire until you have set the trigger level that far below the displayed signal level, rather than simply to the displayed signal level. This is only true for Amplitude Corrections, not External Gain or Ref Level Offset functions.  If mode is Bluetooth, the default value is -50 dBm.
Couplings	This same level is used for the RF Burst trigger source in the Trigger menu, for the RF Burst selection in the Periodic Timer sync source (in the Trigger menu and in the Gate Source menu), and also for the RF Burst selection in the Gate Source menu
Preset	-20 dBm
State Saved	Saved in instrument state
Min	-200 dBm
Max	100 dBm
Default Unit	depends on the current selected Y-Axis unit
<b>Backwards Compatibility SCPI</b>	:TRIGger[:SEquence]:FRAME:RFBurst:LEVel:ABSolute
Initial S/W Revision	Prior to A.02.00
Modified at S/W Revision	A.04.00

Key Path	Trigger, RF Burst
<b>Remote Command</b>	:TRIGger[:SEquence]:RFBurst:LEVel:TYPE ABSolute RELative :TRIGger[:SEquence]:RFBurst:LEVel:TYPE?

<b>Example</b>	TRIG:RFB:LEV:TYPE REL sets the trigger level type of the RF burst trigger to Relative.
Preset	ABSolute
State Saved	Saved in instrument state
Initial S/W Revision	Prior to A.02.00
Modified at S/W Revision	A.04.00

### Trigger Slope

It is set positive to trigger on a rising edge and negative to trigger on a falling edge.

Key Path	Trigger, RF Burst
<b>Remote Command</b>	:TRIGger[:SEquence]:RFBurst:SLOPe POSitive NEGative :TRIGger[:SEquence]:RFBurst:SLOPe?
<b>Example</b>	TRIG:RFB:SLOP NEG
Couplings	This same slope is used in the RF Burst selection for the trigger source in the Trigger menu and for the period timer sync source (in the Trigger menu and in the Gate Source menu).
Preset	POSitive
State Saved	Saved in instrument state
<b>Backwards Compatibility SCPI</b>	:TRIGger[:SEquence]:FRAME:RFBurst:SLOPe
Backwards Compatibility Notes	The legacy :TRIGger[:SEquence]:SLOPe command affects the slopes for the VID, LINE, EXT1, EXT2, and RFB triggers.
Initial S/W Revision	Prior to A.02.00

### Sync Holdoff

Sync Holdoff specifies the duration that the sync source signal must be kept false before the transition to true to be recognized as the sync timing. The periodic timer phase is aligned when the sync source signal becomes true, after the Holdoff time is satisfied.

A holdoff of 2 ms will work with most WiMAX signals, but there may be cases where the burst off duration is less than 1 ms and this value will need to be changed.

Key Path	Trigger, Periodic Timer
<b>Remote Command</b>	:TRIGger[:SEquence]:FRAME:SYNC:HOLDoff <time> :TRIGger[:SEquence]:FRAME:SYNC:HOLDoff? :TRIGger[:SEquence]:FRAME:SYNC:HOLDoff:STATE OFF ON 0 1 :TRIGger[:SEquence]:FRAME:SYNC:HOLDoff:STATE?
Preset	On, 1.000 ms

State Saved	Saved in instrument state
Min	0 ms
Max	+500 ms
Default Unit	s
Initial S/W Revision	Prior to A.02.00

## Control Edge/Level

Sets the method of controlling the gating function from the gating signal.

### Edge

In Edge triggering, the gate opens (after the Delay) on the selected edge (for example, positive) of the gate signal and closes on the alternate edge (for example, negative).

### Level

In Level triggering, the gate opens (after the Delay) when the gate signal has achieved a certain level and stays open as long as that level is maintained.

Key Path	Sweep/Control, Gate
Remote Command	[ :SENSe ] :SWEep:EGATe:CONTRol EDGE LEVe1 [ :SENSe ] :SWEep:EGATe:CONTRol?
Example	SWE:EGAT:CONT EDGE
Dependencies	If the Gate Method is FFT the Control key is grayed out and Edge is selected. If the Gate Source is TV, Frame or Line, the Control key is grayed out and Edge is selected.
Preset	EDGE
State Saved	Saved in instrument state
Backwards Compatibility SCPI	[ :SENSe ] :SWEep:TIME:GATE:TYPE ESA Compatibility
Initial S/W Revision	Prior to A.02.00

## Gate Holdoff

Lets you increase or decrease the wait time after a gate event ends before the analyzer will respond to the next gate signal.

After any Gate event finishes, the analyzer must wait for the sweep system to settle before it can respond to another Gate signal. The analyzer calculates a "wait time," taking into account a number of factors, including RBW and Phase Noise Optimization settings. The goal is to achieve the same accuracy when gated as in ungated operation. The figure below illustrates this concept:

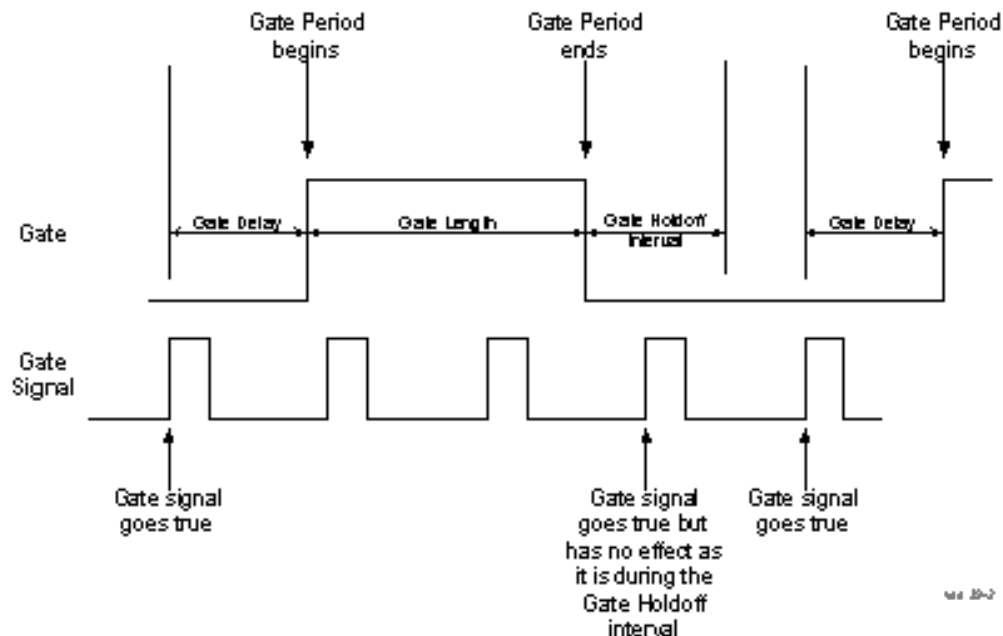

When Gate Holdoff is in Auto, the wait time calculated by the analyzer is used. When Gate Time is in Manual, the user may adjust the wait time, usually decreasing it in order to achieve greater speed, but at the risk of decreasing accuracy.

When the Method key is set to Video or FFT, the Gate Holdoff function has no effect.

In measurements that do not support Auto, the value shown when Auto is selected is “---” and the manually set holdoff is returned to a query.

Key Path	Sweep/Control, Gate
<b>Remote Command</b>	<pre>[ :SENSe ] :SWEep:EGATe:HOLDoff &lt;time&gt; [ :SENSe ] :SWEep:EGATe:HOLDoff? [ :SENSe ] :SWEep:EGATe:HOLDoff:AUTO OFF ON 0 1 [ :SENSe ] :SWEep:EGATe:HOLDoff:AUTO?</pre>
<b>Example</b>	<pre>SWE:EGAT:HOLD 0.0002 SWE:EGAT:HOLD? SWE:EGAT:HOLD:AUTO ON SWE:EGAT:HOLD:AUTO?</pre>
<b>Couplings</b>	<p>When Gate Holdoff is Auto, the Gate Holdoff key shows the value calculated by the analyzer for the wait time.</p> <p>Pressing the Gate Holdoff key while it is in Auto and not selected, causes the key to become selected and allows the user to adjust the value. If the value is adjusted, the setting changes to Man.</p> <p>Pressing the Gate Holdoff key, while it is in Auto and selected, does not change the value of Gate Holdoff, but causes the setting to change to Man. Now the user can adjust the value.</p> <p>Pressing the key while it is in Man and selected, cause the value to change back to Auto.</p> <p>Pressing the key while it is in Man and not selected, causes the key to become selected and allows the user to adjust the value.</p>



	When Method is set to Video or FFT, the Gate Holdoff function has no effect.
Preset	Auto Auto/On
State Saved	Saved in instrument state
Min	1 $\mu$ sec
Max	1 sec
Initial S/W Revision	Prior to A.02.00

## Gate Delay Compensation

This function allows you to select an RBW-dependent value by which to adjust the gate delay, to compensate for changes in the delay caused by RBW effects.

You can select between uncompensated operation and two types of compensation, Delay Until RBW Settled and Compensate for RBW Group Delay.

See ["More Information" on page 2750](#)

Key Path	Sweep/Control, Gate
Scope	Meas Global
Remote Command	[ :SENSe ] :SWEep:EGATe:DELaY:COMPensation:TYPE OFF   SETTled   GDELaY [ :SENSe ] :SWEep:EGATe:DELaY:COMPensation:TYPE?
Example	SWE:EGAT:DEL:COMP:TYPE SETT SWE:EGAT:DEL:COMP:TYPE?
Notes	Although this function is Meas Global, there are some measurements that do not support this function. In those measurements the operation will be Uncompensated. Going into one of those measurements will not change the Meas Global selection; it will simply display the grayed-out menu key with "Uncompensated" showing as the selection. This is a non-forceful grayout, so the SCPI command is still accepted.  If Gate Delay Compensation is not supported at all within a particular mode, the key is not displayed, and if the SCPI command is sent while in a measurement within that mode, an "Undefined Header" message is generated.  Measurements that do not support this function include: Swept SA
Preset	TD-SCDMA mode: Compensate for RBW Group Delay All other modes: Delay Until RBW Settled
State Saved	Saved in instrument state
Range	Uncompensated Delay Until RBW Settled Compensate for RBW Group Delay
Readback text	Uncompensated Settled Group Delay
Initial S/W Revision	Prior to A.02.00
Modified at S/W Revision	A.11.0

## More Information

Selecting Uncompensated means that the actual gate delay is as you sets it.

Selecting Delay Until RBW Settled causes the gate delay to be increased above the user setting by an amount equal to  $3.06/\text{RBW}$ . This compensated delay causes the GATE START and GATE STOP lines on the display to move by the compensation amount, and the actual hardware gate delay to be increased by the same amount. All the other gate lines (for example, MIN FAST) are unaffected. If the RBW subsequently changes, the compensation is readjusted for the new RBW. The value shown on the Gate Delay key does NOT change.

Delay Until RBW Settled allows excellent measurements of gated signals, by allowing the IF to settle following any transient that affects the burst. Excellent measurements also require that the analysis region not extend into the region affected by the falling edge of the burst. Thus, excellent measurements can only be made over a width that declines with narrowing RBWs, which is achieved by decreasing the gate length below the user setting by an amount equal to  $2.53/\text{RBW}$ . Therefore, for general purpose compensation, you will still want to change the gate length with changes in RBW even if the gate delay is compensated. The compensated Gate Length is limited by the analyzer so that it will never go below 10% of the value shown on the Gate Length key, as otherwise the sweep times could get very long. Anytime the Gate Length and RBW values combine in such a way that this limiting takes place, a warning is displayed. For measurements which contain multiple sweeps with different RBW like SEM and SPUR, the smallest RBW is used for this limiting.

Selecting Compensate for RBW Group Delay causes the gate delay to be increased above the user setting by an amount equal to  $1.81/\text{RBW}$ . This compensated delay causes the GATE START, GATE STOP lines on the display to move by the compensation amount, and the actual hardware gate delay to be increased by the same amount. All the other gate lines (for example, MIN FAST) are unaffected. If the RBW subsequently changes, the compensation is readjusted for the new RBW. The value shown on the Gate Delay key does NOT change. Compensate for RBW Group Delay also includes gate length compensation; the gate length itself is adjusted as necessary to attempt to compensate for delay effects imposed by the RBW.

Compensate for RBW Group Delay is similar to Delay Until RBW Settled, but compensates for the group delay of the RBW filter, rather than the filter settling time. As the RBW gets narrow, this can allow the settling tail of the RBW to affect the beginning part of the gated measurement, and allow the beginning of the RBW settling transient to affect the end of the gated measurement. These two effects are symmetric because the RBW response is symmetric. Because the gate length is not automatically compensated, some users might find this compensation to be more intuitive than compensation for RBW settling.

## Min Fast Position Query (Remote Command Only)

This command queries the position of the MIN FAST line, relative to the delay reference (REF) line. See section ["Gate View On/Off" on page 2722](#). If this query is sent while not in gate view, the MinFast calculation is performed based on the current values of the appropriate parameters and the result is returned. Knowing this value lets you set an optimal gate delay value for the current measurement setup.

<b>Remote Command</b>	<code>[ :SENSe ] :SWEep:EGATe:MINFast?</code>
<b>Example</b>	<code>SWE:EGAT:MIN?</code>
<b>Initial S/W Revision</b>	Prior to A.02.00

### Gate Preset (Remote Command Only)

Presets the time-gated spectrum analysis capability.

This command sets gate parameter values to the ESA preset values, as follows:

Gate trigger type = edge

Gate polarity = positive

Gate delay = 1 us

Gate length = 1 us

<b>Remote Command</b>	<code>[[:SENSe]:SWEep:TIME:GATE:PRESet</code> ESA Compatibility
Initial S/W Revision	Prior to A.02.00

### Gate Level (Remote Command Only)

Sets the gate input transition point level for the external TRIGGER inputs on the front and rear panel. This is a legacy command for PSA compatibility. It is simply an alias to the equivalent trigger level command.

<b>Remote Command</b>	<code>[[:SENSe]:SWEep:EGATE:EXTernal[1] 2:LEVel &lt;voltage&gt;</code> <code>[[:SENSe]:SWEep:EGATE:EXTernal[1] 2:LEVel?</code>
Notes	This command is simply an alias to <code>:TRIGger[:SEQUence]:EXTernal[1] 2:LEVel</code> For details refer
Initial S/W Revision	Prior to A.02.00

### Gate Polarity (Remote Command Only)

Sets the polarity for the gate signal. This setup is now done using the gate trigger's slope setting.

When Positive (Pos) is selected, a positive-going edge (Edge) or a high voltage (Level) will satisfy the gate condition, after the delay set with the Gate Delay key. When Negative (Neg) is selected, a negative-going edge (Edge) or a low voltage (Level) will satisfy the gate condition after the delay.

<b>Remote Command</b>	<code>[[:SENSe]:SWEep:EGATE:POLarity NEGative POSitive</code> <code>[[:SENSe]:SWEep:EGATE:POLarity?</code>
<b>Example</b>	<code>SWE:EGAT:POL NEG</code> <code>SWE:EGAT:POL?</code>
Preset	POSitive
State Saved	Saved in instrument state
<b>Backwards Compatibility SCPI</b>	<code>[[:SENSe]:SWEep:TIME:GATE:POLarity</code> ESA compatibility
Initial S/W Revision	Prior to A.02.00

<b>Remote Command</b>	<code>[ :SENSe ] :SWEep:TIME:GATE:LEVel HIGH LOW</code> <code>[ :SENSe ] :SWEep:TIME:GATE:LEVel?</code> ESA compatibility
Preset	HIGH
Initial S/W Revision	Prior to A.02.00

## Points

Sets the number of points per sweep. The resolution of setting the sweep time depends on the number of points selected. If Preset is selected, the number of points per sweep defaults to 1001. The current value of points is displayed parenthetically, next to the sweep time in the lower right corner of the display.

Key Path	Sweep/Control
Mode	All except SA and BASIC
<b>Remote Command</b>	<code>[ :SENSe ] :MONitor:SWEep:POINts &lt;integer&gt;</code> <code>[ :SENSe ] :MONitor:SWEep:POINts?</code>
<b>Example</b>	<code>:MON:SWE:POIN 1000</code> <code>:MON:SWE:POIN?</code>
Couplings	Whenever the number of sweep points changes, the sweep time is re-quantized.
Preset	1001
State Saved	Saved in instrument state.
Range	1 to 20001
Min	1
Max	20001
Initial S/W Revision	Prior to A.02.00

# System

See "System" on page 359

## Trace/Detector

Accesses a menu that enables you to control the display, storage, detection and manipulation of trace data. Each trace is comprised of a series of data points in which X and Y axis information is stored. The analyzer updates the information for the active trace with each sweep of the current measurement.

Key Path	Front-panel key
Initial S/W Revision	Prior to A.02.00

### Select Trace

Allows you to select which trace you want to use for the current measurement. You can select one of three traces. Monitor Spectrum supports 3 traces, numbered 1 through 3.

Key Path	Trace/Detector
Mode	All except SA and BASIC
Preset	Trace 1
State Saved	The number of the selected trace is saved in Instrument State
Initial S/W Revision	Prior to A.02.00

### Trace Type

Allows you to select the type of trace you want to use for the current measurement. You can assign a trace type to one of the three available traces.

The first page of this menu contains a 1-of-N selection of the trace type for the selected trace:

WRITe	Clear Write
AVERAge	Average
MAXHold	Max Hold
MINHold	Min Hold

Key Path	Trace/Detector
Mode	All except SA and BASIC
<b>Remote Command</b>	:TRACe[1] 2 3:MONitor:TYPE WRITe AVERAge MAXHold MINHold :TRACe[1] 2 3:MONitor:TYPE?
<b>Example</b>	TRAC:MON:TYPE WRIT TRAC:MON:TYPE?
Preset	WRITe
State Saved	Saved in instrument state.

Range	WRITe AVERAge MAXHold MINHold for traces 1 through 3
<b>Backwards Compatibility SCPI</b>	:DISPlay:MONitor:VIEW:WINDow:TRACe [1]   2   3 :TYPE
Initial S/W Revision	Prior to A.02.00

## Update

Toggles a trace state between Update and Off. The Off selection makes the trace inactive (or a *stored trace*). This does not affect whether the trace is visible or not. To change the trace visibility, see "[Display](#)" on page 2755.

Key Path	Trace/Detector
Mode	All except SA and BASIC
<b>Remote Command</b>	:TRACe [1]   2   3 :MONitor:UPDate[:STATe] ON OFF 0 1 :TRACe [1]   2   3 :MONitor:UPDate[:STATe]?
<b>Example</b>	TRAC3:MON:UPD OFF TRAC3:MON:UPD?
Preset	ON
State Saved	Saved in instrument state.
Range	On Off(View)
Initial S/W Revision	Prior to A.02.00

## Display

Controls the visibility of a trace. When set to Blank, traces do not display nor appear on printouts but are otherwise unaffected. They may be queried and markers may be placed on them.

Key Path	Trace/Detector
Mode	All except SA and BASIC
<b>Remote Command</b>	:TRACe [1]   2   3 :MONitor:DISPlay[:STATe] ON OFF 0 1 :TRACe [1]   2   3 :MONitor:DISPlay[:STATe]?
<b>Example</b>	TRAC:MON:DISP ON TRAC:MON:DISP?
Preset	ON OFF OFF
State Saved	Saved in instrument state.
Range	Show Blank
Initial S/W Revision	Prior to A.02.00

## Detector

Accesses a menu of functions that enable you to control the detectors for the current measurement. The following choices are available:

- **Auto** – the detector selected depends on marker functions, trace functions, average type, and the trace averaging function. See "[Auto](#)" on page 2757.
- **Normal** – the detector determines the peak of the CW-like signals, and it yields alternating maximums and minimums of noise-like signals. This is also referred to as Rosenfell detection.
- **Average** – the detector determines the average of the signal within the sweep points. The averaging method depends upon the Average Type selection (voltage, power or log scales).
- **Peak** – the detector determines the maximum of the signal within the sweep points.
- **Sample** – the detector indicates the instantaneous level of the signal at the center of the sweep points represented by each display point.
- **Negative Peak** – the detector determines the minimum of the signal within the sweep points.

In swept analysis, the time interval of the data collection for the display sweep points also represents a frequency interval. In FFT analysis, the sweep points represent just a frequency interval. The detector determines the relationship between the spectrum computed by the FFT and the single data point displayed for the sweep points.

Key Path	Trace/Detector
Mode	All except SA and BASIC
Remote Command	<code>[ :SENSe ] :MONitor:DETEctor:TRACe AVERAge   NEGative   NORMal   POSitive   SAMPle  [ :SENSe ] :MONitor:DETEctor:TRACe?</code>
Example	<code>MON:DET:TRAC NORM MON:DET:TRAC?</code>
Notes	The query returns a name that corresponds to the detector type as shown below. String Returned - Definition <ul style="list-style-type: none"> <li>• NORM - Normal</li> <li>• AVER - Average</li> <li>• POS - Peak</li> <li>• SAMP - Sample</li> <li>• NEG - Negative Peak</li> </ul>
Couplings	When the Detector choice is Auto, the detector selected depends on average type.
Preset	NORMal
State Saved	Saved in instrument state.
Range	Normal Average(RMS) Peak Sample Negative Peak
Backwards Compatibility SCPI	<code>[ :SENSe ] :MONitor:DETEctor [ :FUNction ]</code>
Initial S/W Revision	Prior to A.02.00



## Auto

Sets the detector for the currently selected trace to Auto. When the detector choice is Auto, the analyzer selects the detector. The selected detector depends on marker functions, trace functions, and trace averaging functions for the current measurement.

Key Path	Trace/DetectorTrace/Detector, Detector
Mode	All except SA and BASIC
<b>Remote Command</b>	<code>[ :SENSe ] :MONitor :DETECTOR :AUTO ON   OFF   1   0</code> <code>[ :SENSe ] :MONitor :DETECTOR :AUTO ?</code>
<b>Example</b>	<code>MON:DET:AUTO OFF</code> <code>MON:DET:AUTO ?</code>
Couplings	When the Detector choice is Auto, the detector selected depends on average state and trace type.
Preset	ON
State Saved	Saved in instrument state.
Range	Auto Man
Initial S/W Revision	Prior to A.02.00

## Clear Trace

Clears the selected trace from the display.

Key Path	Trace/Detector
Mode	All except SA and BASIC
<b>Remote Command</b>	<code>:TRACe :MONitor :CLEAr [ TRACE1 ]   TRACE2   TRACE3</code>
<b>Example</b>	<code>TRAC:MON:CLE</code>
Initial S/W Revision	Prior to A.02.00

Mode	All except SA and BASIC
<b>Remote Command</b>	<code>:DISPlay :MONitor :VIEW :WINDow :TRACe [ 1 ]   2   3 :CLEAr</code>
<b>Example</b>	<code>DISP:MON:VIEW:WIND:TRAC:CLE</code>
Initial S/W Revision	Prior to A.02.00

## Clear All Traces

Clears all traces from the display.

Key Path	Trace/Detector
Mode	All except SA and BASIC

---

<b>Remote Command</b>	:TRACe:MONitor:CLEar:ALL
<b>Example</b>	TRAC:MON:CLE:ALL
<b>Backwards Compatibility SCPI</b>	:DISPlay:MONitor:VIEW:WINDow:TRACe:CLEar:ALL
<b>Initial S/W Revision</b>	Prior to A.02.00

---

## Trigger

See "Trigger" on page 430

### Free Run

See "Free Run " on page 437

### Video

See "Video (IF Envelope) " on page 438

### Trigger Level

See "Trigger Level " on page 438

### Trig Slope

See "Trig Slope " on page 439

### Trig Delay

See "Trig Delay " on page 440

### Line

See "Line " on page 2729

### Trig Slope

See "Trig Slope " on page 2729

### Trig Delay

See "Trig Delay " on page 442

### External 1

See "External 1 " on page 2741

### Trigger Level

See "Trigger Level " on page 2741

### Trig Slope

See "Trig Slope " on page 2742

### Trig Delay

See "Trig Delay " on page 445

### External 2

See "External 2 " on page 2743

### **Trigger Level**

See "[Trigger Level](#) " on page 2743

### **Trig Slope**

See "[Trig Slope](#) " on page 2744

### **Trig Delay**

See "[Trig Delay](#) " on page 447

### **RF Burst**

See "[RF Burst](#) " on page 2744

### **Absolute Trigger**

See "[Absolute Trigger Level](#)" on page 2745

### **Relative Trigger**

See "[Relative Trigger Level](#)" on page 2734

### **Trig Slope**

See "[Trigger Slope](#) " on page 2746

### **Trig Delay**

See "[Trig Delay](#) " on page 451

### **Periodic Timer**

See "[Periodic Timer \(Frame Trigger\)](#) " on page 2736

### **Period**

See "[Period](#) " on page 2737

### **Offset**

See "[Offset](#) " on page 2738

### **Reset Offset Display**

See "[Reset Offset Display](#) " on page 2740

### **Sync Source**

See "[Sync Source](#) " on page 2740

### **Off**

See "[Off](#) " on page 2741

## External 1

See "External 1 " on page 2741

### Trigger Level

See "Trigger Level " on page 2741

### Trig Slope

See "Trig Slope " on page 2742

## External 2

See "External 2 " on page 2743

### Trigger Level

See "Trigger Level " on page 2743

### Trig Slope

See "Trig Slope " on page 2744

## RF Burst

See "RF Burst " on page 2744

## Absolute Trigger

See "Absolute Trigger Level" on page 2745

### Trig Slope

See "Trigger Slope " on page 2746

## Trig Delay

See "Trig Delay" on page 461

## Auto/Holdoff

See "Auto/Holdoff " on page 462

## Auto Trig

See "Auto Trig " on page 462

## Trig Holdoff

See "Trig Holdoff " on page 463

## User Preset

Accesses a menu that gives you the following three choices:

- User Preset – recalls a state previously saved using the Save User Preset function.
- User Preset All Modes – presets all of the modes in the analyzer
- Save User Preset– saves the current state for the current mode

Key Path	Front-panel key
Backwards Compatibility Notes	<p>User Preset is actually loading a state, and in legacy analyzers, it was possible to load a state without affecting the trace data, limit lines or correction data. Similarly it was possible to do a User Preset without affecting the trace data, limit lines or correction data.</p> <p>In the X-Series, “state” always includes all of this data; so whenever state is loaded, or User Preset is executed, all of the traces, limit lines and corrections are affected. Although this differs from previous behavior, it is desirable behavior, and should not cause adverse issues for users.</p> <p>On ESA and PSA, User Preset affected the entire instrument’s state. In the X-Series, User Preset only recalls the state for the active mode. There is a User Preset file for each mode. User Preset can never cause a mode switch as it can in legacy analyzers. If you want to recall all modes to their user preset file state, you will need to do a User Preset after mode switching into each mode.</p> <p>User Preset recalls mode state which can now include data like traces; whereas on ESA and PSA, User Preset did not affect data.</p>
Initial S/W Revision	Prior to A.02.00

## User Preset

User Preset sets the state of the currently active mode back to the state that was previously saved for this mode using the Save User Preset menu key or the SCPI command, SYST:PRES:USER:SAV. It not only recalls the Mode Preset settings, but it also recalls all of the mode persistent settings, and the Input/Output system setting that existed at the time Save User Preset was executed.

If a Save User Preset has not been done at any time, User Preset recalls the default user preset file for the currently active mode. The default user preset files are created if, at power-on, a mode detects there is no user preset file. There will never be a scenario when there is no user preset file to restore. For each mode, the default user preset state is the same state that would be saved if a Save User Preset is performed in each mode right after doing a Restore Mode Default and after a Restore Input/Output Defaults.

The User Preset function does the following:

- Aborts the currently running measurement.
- Sets the mode State to the values defined by Save User Preset.
- Makes the saved measurement for the currently running mode the active measurement.
- Brings up the saved menu for the power-on mode.
- Clears the input and output buffers.
- Sets the Status Byte to 0.

Key Path	User Preset
Remote Command	:SYSTem:PRESet:USER
Example	:SYST:PRES:USER:SAVE:SYST:PRES:USER
Notes	:SYST:PRES:USER:SAVE is used to save the current state as the user preset state. Clears all pending OPC bits. The Status Byte is set to 0. Pressing the User Preset front-panel key while already in the User Preset menu will cause the User Preset to get executed
Couplings	A user preset will cause the currently running measurement to be aborted and cause the saved measurement to be active. Recalling a User Preset file has the same issues that recalling a Save State file has. Some settings may need to be limited and therefore re-coupled, since the capabilities of the mode may have changes when the User Preset file was last saved.
Initial S/W Revision	Prior to A.02.00

## User Preset All Modes

Recalls all of the User Preset files for each mode, switches to the power-on mode, and activates the saved measurement from the power-on mode User Preset file.

**NOTE**

When the instrument is secured, all of the user preset files are converted back to their default user preset files.

The User Preset function does the following:

- Aborts the currently running measurement.
- Switches the Mode to the power-on mode.
- Restores the User Preset files for each mode.
- Makes the saved measurement for the power-on mode the active measurement.
- Brings up the saved menu for the power-on mode.
- Clears the input and output buffers.
- Sets the Status Byte to 0.

Key Path	User Preset
Remote Command	:SYSTem:PRESet:USER:ALL
Example	:SYST:PRES:USER:SAVE:SYST:PRES:USER:ALL
Notes	Clears all pending OPC bits. The Status Byte is set to 0. :SYST:PRES:USER:SAVE is used to save the current state as the user preset state.
Couplings	A user preset will cause the currently running measurement to be aborted, cause a mode switch to the power-on mode, and cause the saved measurement to be active in the power-on mode. Recalling a User Preset file has the same issues that recalling a Save State file has. Some settings may need to be limited and therefore re-coupled, since the capabilities of the mode may have changes when the User Preset file was last saved.
Initial S/W Revision	Prior to A.02.00

## Save User Preset

Saves the currently active mode and its State. You can recall this User Preset file by pressing the User Preset menu key or sending the SYST:PRES:USER remote command. This same state is also saved by the Save State function.

Key Path	User Preset
Remote Command	:SYSTem:PRESet:USER:SAVE
Example	:SYST:PRES:USER:SAVE
Notes	:SYST:PRES:SAVE creates the same file as if the user requested a *SAV or a MMEM:STOR:STAT, except User Preset Save does not allow the user to specify the filename or the location of the file.
Initial S/W Revision	Prior to A.02.00



## View/Display

Accesses a menu of functions that enable you to control certain functions related to the display of the analyzer.

The available views and related commands depend on the currently-selected mode. This section includes the following topics:

- ["View for all modes except MSR, 1xEV-DO, LTE-Advanced FDD/TDD" on page 2765](#), LTE-Advanced FDD/TDD
- ["1xEV-DO Mode View" on page 2766](#)
- ["MSR and LTE-Advanced FDD/TDD Mode Views" on page 2766](#)
- ["View Selection by Name \(MSR and LTE-Advanced FDD/TDD mode only\)" on page 2767](#)
- ["View Selection by Number \(MSR and LTE-Advanced FDD/TDD mode only\)" on page 2767](#)

### View for all modes except MSR, 1xEV-DO, LTE-Advanced FDD/TDD

When the current mode is **not** MSR, LTE-Advanced FDD/TDD or 1xEV-DO, there is a single trace view for this measurement, as shown below:

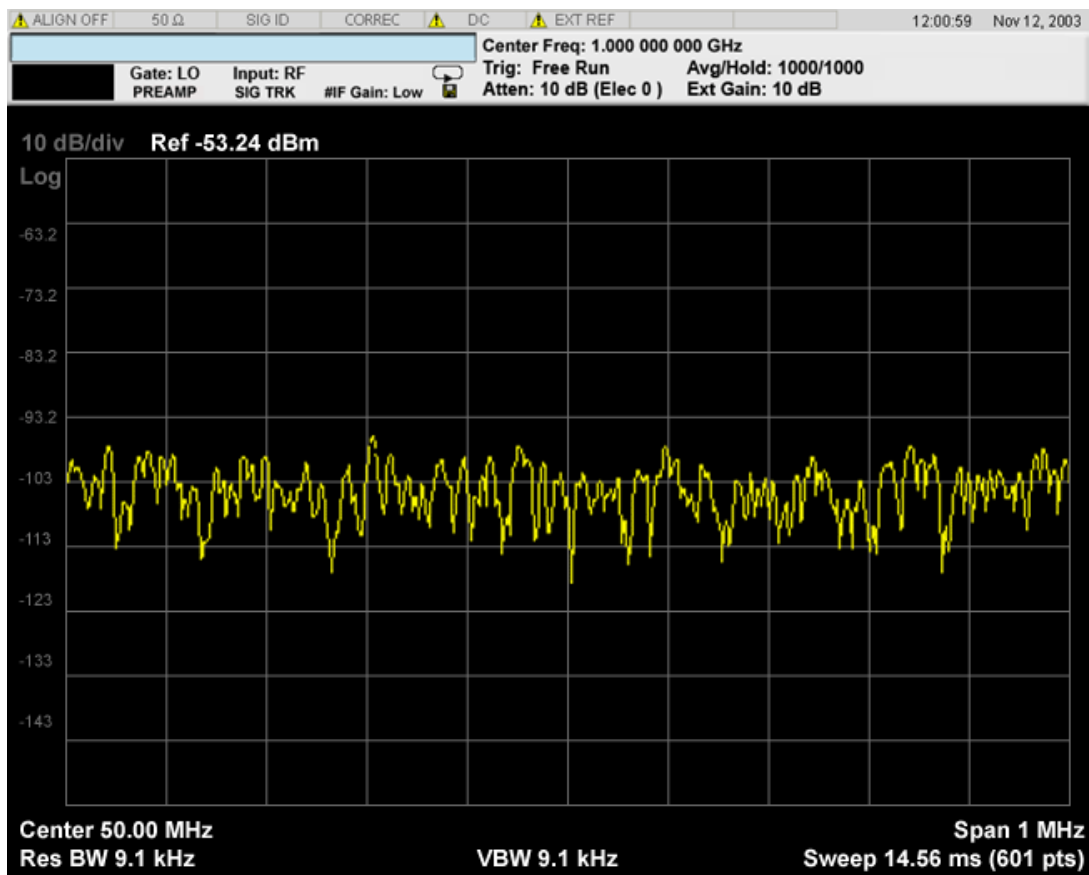

### 1xEV-DO Mode View

When the current mode is 1xEV-DO, a single view is available, as shown in the example below:

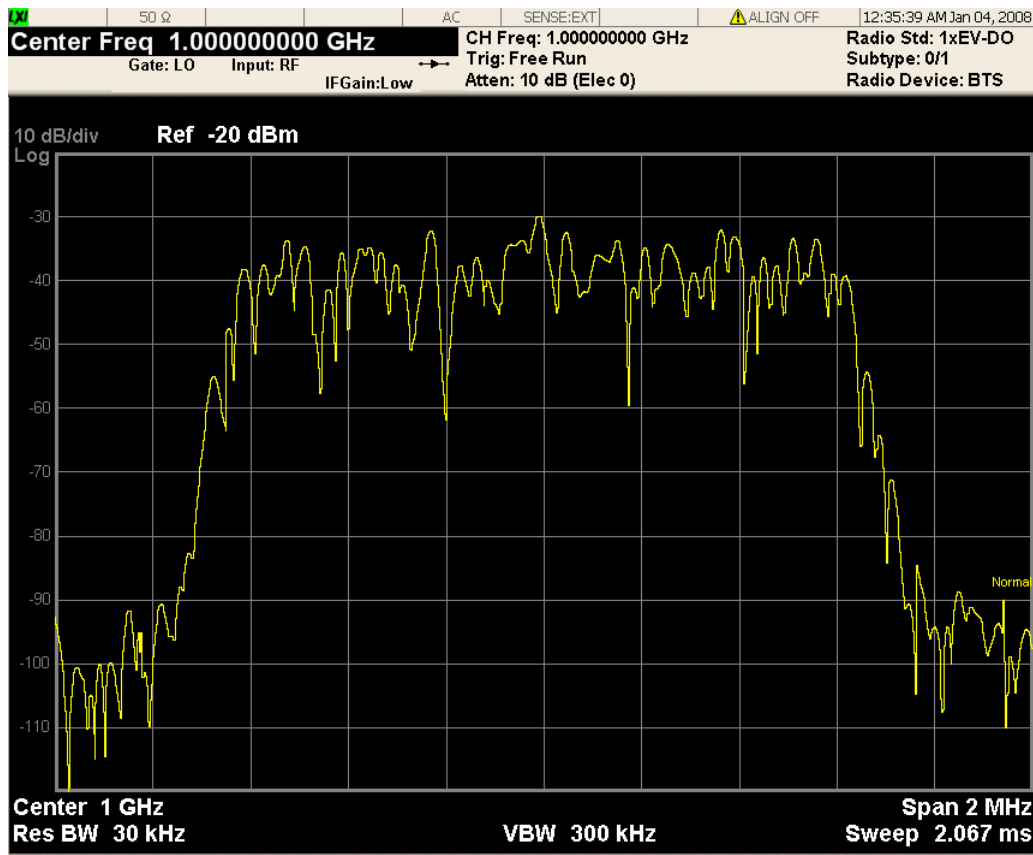

The measurement has no results, but has a number of features that make it flexible and simple to use.

### MSR and LTE-Advanced FDD/TDD Mode Views

When the current mode is MSR and LTE-Advanced FDD/TDD, there are two views, Result Trace and Carrier Info, as described in the table below. The Result Trace view is the same as the common Monitor Spectrum view in other modes. Carrier Info is available on the spectrum trace.

<b>Result Trace</b>	<p>The spectrum trace and power bars are displayed in the upper window. Carrier and offset powers are summarized in the lower window.</p> <p>For more details, see <a href="#">Result Trace (MSR and LTE-Advanced FDD/TDD mode only)</a>.</p>
<b>Carrier Info</b>	<p>Carrier center frequency can be displayed in either offset or absolute frequency depending on Carrier Freq. The table can be scrolled by Select Carrier in the Config Carriers menu. The highlighted row changes as Select Carrier is changed. The highlighted row and Select Carrier are not coupled.</p> <p>For more details, see <a href="#">Carrier Info (MSR and LTE-Advanced FDD/TDD mode only)</a>.</p>

### View Selection by Name (MSR and LTE-Advanced FDD/TDD mode only)

Key Path	Display
Mode	MSR, LTEAFDD, LTEATDD
<b>Remote Command</b>	:DISPlay:MONitor:VIEW[:SElect] RTRace CINformation :DISPlay:MONitor:VIEW[:SElect]?
<b>Example</b>	DISP:MON:VIEW RTR DISP:MON:VIEW?
Preset	RTRace
State Saved	Saved in instrument state
Range	Power Results Carrier Info
Initial S/W Revision	A.10.00

### View Selection by Number (MSR and LTE-Advanced FDD/TDD mode only)

Key Path	DISP:MON:VIEW
Mode	MSR, LTEAFDD, LTEATDD
<b>Remote Command</b>	:DISPlay:MONitor:VIEW:NSElect <integer> :DISPlay:MONitor:VIEW:NSElect?
<b>Example</b>	DISP:MON:VIEW:NSEL 1 DISP:MON:VIEW:NSEL?
Preset	1
State Saved	Saved in instrument state
Min	1
Max	2
Initial S/W Revision	A.10.00

Key Path	Front-panel key
Initial S/W Revision	Prior to A.02.00

## Display

The Display menu is common to most measurements, and is used for configuring items on the display. Some Display menu settings apply to all the measurements in a mode, and some only to the current measurement. Those under the System Display Settings key apply to all measurements in all modes.

Key Path	Display
Key Path	View/Display
Initial S/W Revision	Prior to A.02.00

## Annotation

Turns on and off various parts of the display annotation. The annotation is divided up into four categories:

1. Meas Bar: This is the measurement bar at the top of the screen. It does not include the settings panel or the Active Function. Turning off the Meas Bar turns off the settings panel and the Active Function. When the Meas Bar is off, the graticule area expands to fill the area formerly occupied by the Meas Bar.
2. Screen Annotation: this is the annotation and annunciation around the graticule, including any annotation on lines (such as the display line, the threshold line, etc.) This does NOT include the marker number or the N dB result. When off, the graticule expands to fill the entire graticule area.
3. Trace annotation: these are the labels on the traces, showing their detector (or their math mode).
4. Active Function annotation: this is the active function display in the meas bar, and all of the active function values displayed on softkeys.

See the figure below. Each type of annotation can be turned on and off individually.

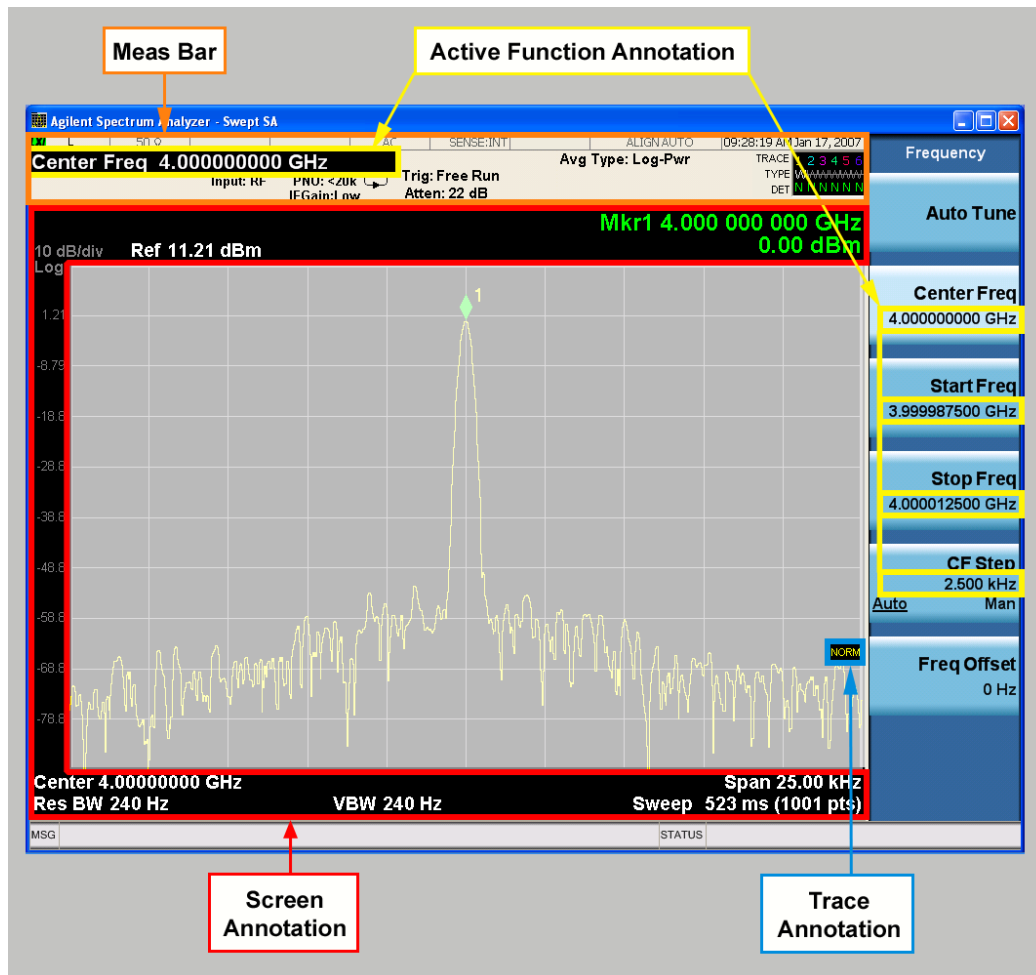

Key Path	View/Display, Display
Initial S/W Revision	Prior to A.02.00

## Meas Bar On/Off

This function turns the Measurement Bar on and off, including the settings panel. When off, the graticule area expands to fill the area formerly occupied by the Measurement Bar.

Key Path	View/Display, Display, Annotation
Remote Command	:DISPlay:ANNotation:MBAR[:STATe] OFF ON 0 1 :DISPlay:ANNotation:MBAR[:STATe]?
Example	DISP:ANN:MBAR OFF
Dependencies	Grayed out and forced to OFF when System Display Settings, Annotation is set to Off.
Preset	On This should remain Off through a Preset when System DisplaySettings, Annotation is set to Off.
State Saved	Saved in instrument state.
Initial S/W Revision	Prior to A.02.00

## Screen

This controls the display of the annunciation and annotation around the graticule, including any annotation on lines (such as the display line, the threshold line, etc.) and the y-axis annotation. This does NOT include marker annotation (or the N dB result). When off, the graticule expands to fill the entire graticule area, leaving only the 1.5% gap above the graticule as described in the Trace/Detector chapter.

Key Path	View/Display, Display, Annotation
Remote Command	:DISPlay:ANNotation:SCReen[:STATe] OFF ON 0 1 :DISPlay:ANNotation:SCReen[:STATe]?
Example	DISP:ANN:SCR OFF
Dependencies	Grayed-out and forced to OFF when System Display Settings, Annotation is set to Off.
Preset	On This should remain Off through a Preset when System DisplaySettings, Annotation is set to Off
State Saved	Saved in instrument state.
Initial S/W Revision	Prior to A.02.00

## Active Function Values On/Off

Turns on and off the active function display in the Meas Bar, and all of the active function values displayed on the softkeys.

Note that all of the softkeys that have active functions have these numeric values blanked when this function is on. This is a security feature..

20 Monitor Spectrum Measurement  
View/Display

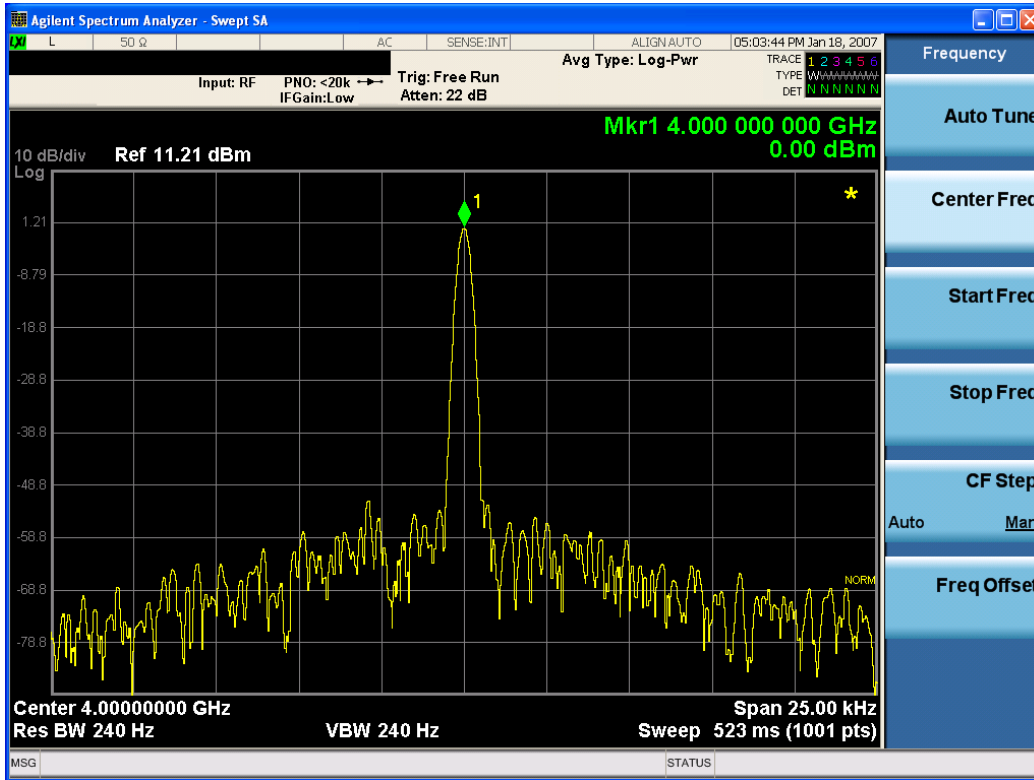

Key Path	View/Display, Display, Annotation
Remote Command	:DISPlay:ACTivefunc[:STATE] ON OFF 1 0 :DISPlay:ACTivefunc[:STATE] ?
Example	DISP:ACT OFF
Dependencies	Grayed out and forced to OFF when System Display Settings, Annotation is set to Off.
Preset	On This should remain Off through a Preset when System DisplaySettings, Annotation is set to Off
State Saved	Saved in instrument state.
Initial S/W Revision	Prior to A.02.00

Title

Displays menu keys that enable you to change or clear a title on your display.

Key Path	View/Display, Display
Initial S/W Revision	Prior to A.02.00

Change Title

Writes a title into the "measurement name" field in the banner, for example, "Swept SA".

Press Change Title to enter a new title through the alpha editor. Press Enter or Return to complete the entry. Press ESC to cancel the entry and preserve your existing title.

The display title will replace the measurement name. It remains for this measurement until you press Change Title again, or you recall a state, or a Preset is performed. A title can also be cleared by pressing Title, Clear Title.

**NOTE**

Notice the inclusion of the <measurement> parameter in the command below. Because each measurement remembers the Display Title, the command must be qualified with the measurement name. For the Swept SA measurement this is not the case; no <measurement> parameter is used when changing the Display Title for the Swept SA measurement.

Key Path	View/Display, Display, Title
Mode	All
Remote Command	:DISPlay:<measurement>:ANNotation:TITLe:DATA <string> :DISPlay:<measurement>:ANNotation:TITLe:DATA?
Example	DISP:ANN:TITL:DATA "This Is My Title" This example is for the Swept SA measurement in the Spectrum Analyzer mode. The SANalyzer <measurement> name is not used. DISP:ACP:ANN:TITL:DATA "This Is My Title" This example is for Measurements other than Swept SA. Both set the title to: This Is My Title
Notes	Pressing this key cancels any active function. When a title is edited the previous title remains intact (it is not cleared) and the cursor goes at the end so that characters can be added or BKSP can be used to go back over previous characters.
Preset	No title (measurement name instead)
State Saved	Saved in instrument state.
Initial S/W Revision	Prior to A.02.00

### Clear Title

Clears a title from the front-panel display. Once cleared, the title cannot be retrieved. After the title is cleared, the current Measurement Name replaces it in the title bar.

Key Path	View/Display, Display, Title
Example	The following commands clear the title and restore the measurement's original title: DISP:ANN:TITL:DATA "" This example is for the Swept SA measurement in the Spectrum Analyzer mode. The SANalyzer <measurement> name is not used. DISP:ACP:ANN:TITL:DATA "" This example is for ACP; in measurements other than Swept SA the measurement name is required.
Notes	Uses the :DISPlay:<measurement>:ANNotation:TITLe:DATA <string> command with an empty string (in the Swept SA, the <measurement> is omitted).
Preset	Performed on Preset.
Initial S/W Revision	Prior to A.02.00

## Graticule

Pressing Graticule turns the display graticule On or Off. It also turns the graticule y-axis annotation on and off.

Key Path	View/Display, Display
Remote Command	:DISPlay:WINDow[1]:TRACe:GRATicule:GRID[:STATe] OFF ON 0 1 :DISPlay:WINDow[1]:TRACe:GRATicule:GRID[:STATe]?
Example	DISP:WIND:TRAC:GRAT:GRID OFF
Notes	The graticule is the set of horizontal and vertical lines that make up the grid/divisions for the x-axis and y-axis.
Preset	On
State Saved	Saved in instrument state
Initial S/W Revision	Prior to A.02.00

## System Display Settings

These settings are "Mode Global" – they affect all modes and measurements and are reset only by Restore Misc Defaults or Restore System Defaults under System.

Key Path	View/Display, Display
Initial S/W Revision	Prior to A.02.00

## Annotation Local Settings

This is a Mode Global override of the meas local annotation settings. When it is All Off, it forces ScreenAnnotation, Meas Bar, Trace, and Active Function Values settings to be OFF for all measurements in all modes. This provides the security based "annotation off" function of previous analyzers; hence it uses the legacy SCPI command.

When it is All Off, the Screen, Meas Bar, Trace, and Active Function Values keys under the Display, Annotation menu are grayed out and forced to Off. When Local Settings is selected, you are able to set the local annotation settings on a measurement by measurement basis.

Key Path	View/Display, Display, System Display Settings
Remote Command	:DISPlay:WINDow[1]:ANNotation[:ALL] OFF ON 0 1 :DISPlay:WINDow[1]:ANNotation[:ALL]?
Example	:DISP:WIND:ANN OFF
Preset	On (Set by Restore Misc Defaults)
State Saved	Not saved in instrument state.
Backwards Compatibility Notes	The WINDow parameter and optional subopcode is included for backwards compatibility but ignored – all windows are equally affected.
Initial S/W Revision	Prior to A.02.00



## Themes

Accesses a menu of functions that enable you to choose the theme to be used when saving the screen image.

The **Themes** option is the same as the **Themes** option under the **Display** and **Page Setup** dialogs. It allows you to choose between themes to be used when saving the screen image.

<b>Key Path</b>	Save, Screen Image
<b>Remote Command</b>	:MMEMory:STORe:SCReem:THEMe TDColor   TDMonochrome   FCOLOR   FMONochrome  :MMEMory:STORe:SCReem:THEMe?
<b>Example</b>	:MMEM:STOR:SCR:THEM TDM
<b>Preset</b>	3D Color; Is not part of Preset, but is reset by Restore Misc Defaults or Restore System Defaults All and survives subsequent running of the modes.
<b>Readback</b>	3D Color   3D Mono   Flat Color   Flat Mono
<b>Backwards Compatibility Notes</b>	In ESA and PSA we offer the choice of "Reverse Bitmap" or "Reverse Metafile" when saving screen images. This is much like the "Flat Color" theme available in X-Series. Also, if you selected Reverse Bitmap AND a black & white screen image, that would be much like "Flat Monochrome". In other words, each of the X-Series themes has a similar screen image type in ESA/PSA. But they are not identical.
<b>Initial S/W Revision</b>	Prior to A.02.00

### 3D Color

Selects a standard color theme with each object filled, shaded and colored as designed.

<b>Key Path</b>	Save, Screen Image, Themes
<b>Example</b>	MMEM:STOR:SCR:THEM TDC
<b>Readback</b>	3D Color
<b>Initial S/W Revision</b>	Prior to A.02.00

### 3D Monochrome

Selects a format that is like 3D color but shades of gray are used instead of colors.

<b>Key Path</b>	Save, Screen Image, Themes
<b>Example</b>	MMEM:STOR:SCR:THEM TDM
<b>Readback</b>	3D Mono
<b>Initial S/W Revision</b>	Prior to A.02.00

### Flat Color

Selects a format that is best when the screen is to be printed on an ink printer.

Key Path	Save, Screen Image, Themes
<b>Example</b>	MMEM:STOR:SCR:THEM FCOL
Readback	Flat Color
Initial S/W Revision	Prior to A.02.00

### Flat Monochrome

Selects a format that is like Flat Color. But only black is used (no colors, not even gray), and no fill.

Key Path	Save, Screen Image, Themes
<b>Example</b>	MMEM:STOR:SCR:THEM FMON
Readback	Flat Mono
Initial S/W Revision	Prior to A.02.00

### Backlight

Accesses the display backlight on/off keys. This setting may interact with settings under the Windows "Power" menu.

When the backlight is off, pressing ESC, TAB, SPACE, ENTER, UP, DOWN, LEFT, RIGHT, DEL, BKSP, CTRL, or ALT turns the backlight on without affecting the application. Pressing any other key will turn backlight on and could potentially perform the action as well.

Key Path	View/Display, Display, System Display Settings
<b>Remote Command</b>	:DISPlay:BACKlight ON OFF :DISPlay:BACKlight?
Preset	ON (Set by Restore Misc Defaults)
Initial S/W Revision	Prior to A.02.00

### Backlight Intensity

An active function used to set the backlight intensity. It goes from 0 to 100 where 100 is full on and 0 is off. This value is independent of the values set under the Backlight on/off key.

Key Path	View/Display, Display, System Display Settings
<b>Remote Command</b>	:DISPlay:BACKlight:INTensity <integer> :DISPlay:BACKlight:INTensity?
<b>Example</b>	DISP:BACK:INT 50

---

Preset	100 (Set by Restore Misc Defaults)
Min	0
Max	100
Initial S/W Revision	Prior to A.02.00

---



## 21 Waveform Measurement

The waveform measurement is a generic measurement for viewing the input signal waveforms in the time domain. This measurement represents how the instrument performs the zero span functionality found in traditional spectrum analyzers. For more details, see ["Waveform Measurement Description" on page 2780](#) below.

This topic contains the following sections:

["Measurement Commands for Waveform" on page 2778](#)

["Remote Command Results for the Waveform Measurement" on page 2779](#)

## Measurement Commands for Waveform

The general functionality of CONFigure, INITiate, FETCh, MEASure, and READ are described at this section.

:CONFigure:WAVeform

:CONFigure:WAVeform:NDEFault

:INITiate:WAVeform

:FETCh:WAVeform[n]?

:MEASure:WAVeform[n]?

:READ:WAVeform[n]?

For more measurement related commands, see the SENSE subsystem, and the section "[Remote Measurement Functions](#)" on page 2848.

## Remote Command Results for the Waveform Measurement

The following table denotes the returned results from the FETCh|MEASure|READ commands:

n	Results Returned
0	Returns unprocessed I/Q trace data, as a series of trace point values, in volts. The I values are listed first in each pair, using the 0 through even-indexed values. The Q values are the odd-indexed values.
1	<p>Returns the following scalar results:</p> <ol style="list-style-type: none"> <li>1. <b>Sample Time</b> is a floating point number representing the time between samples when using the trace queries (n=0, 2, and so forth).</li> <li>2. <b>Mean Power</b> is the mean power (in dBm). This is the power across the entire trace. If averaging is on, the power is for the latest acquisition.</li> <li>3. <b>Mean Power Averaged</b> is the power (in dBm) for N averages, if averaging is on. This is the power across the entire trace. If averaging is on, the power is for the latest acquisition. If averaging is off, the value of the mean power averaged is the same as the value of the mean power.</li> <li>4. <b>Number of samples</b> is the number of data points in the captured signal. This number is useful when performing a query on the signal (i.e. when n=0, 2, etc.).</li> <li>5. <b>Peak-to-mean ratio</b> has units of dB. This is the ratio of the maximum signal level to the mean power. Valid values are only obtained with averaging turned off. If averaging is on, the peak-to-mean ratio is calculated using the highest peak value, rather than the displayed average peak value.</li> <li>6. <b>Maximum value</b> is the maximum of the most recently acquired data (in dBm).</li> <li>7. <b>Minimum value</b> is the minimum of the most recently acquired data (in dBm).</li> </ol>
2	Returns trace point values of the entire captured signal envelope trace data. These data points are floating point numbers representing the power of the signal (in dBm). There are N data points, where N is the number of samples. The period between the samples is defined by the sample time.

## Waveform Measurement Description

Also available under the basic Waveform measurement is an I/Q window, which shows the I and Q signal waveforms in parameters of voltage versus time to disclose the voltages that comprise the complex modulated waveform of a digital signal.

The waveform measurement can also be used to perform general purpose power measurements to a high degree of accuracy.

Key Path	Front-panel key
Initial S/W Revision	Prior to A.02.00



## AMPTD Y Scale

Accesses a menu of functions that enable you to set the vertical scale parameters.

Key Path	Front-panel key
Initial S/W Revision	Prior to A.02.00

### Ref Value (RF Envelope View)

Sets the Y Scale reference value (in dBm) when the RF Envelope View is active. By default, the measurement determines the reference value with Auto Scaling. Entering a reference value manually turns Auto Scaling off.

Key Path	AMPTD Y Scale
Mode	BASIC, PNOISE, WCDMA, C2K, GSM, WIMAXOFDMA, TDSCDMA, 1XEVD0, DVB, DTMB, ISDBT, CMMB, LTE, LTETDD, DCATV, WLAN,LTEATDD, LTEAFDD
Remote Command	:DISPlay:WAVeform:VIEW[1]:WINDow[1]:TRACe:Y[:SCALE]:RLEVel <ampl> :DISPlay:WAVeform:VIEW[1]:WINDow[1]:TRACe:Y[:SCALE]:RLEVel?
Example	DISP:WAV:VIEW:WIND:TRAC:Y:RLEV -50 dBm DISP:WAV:VIEW:WIND:TRAC:Y:RLEV?
Notes	You must be in the mode that includes Waveform measurement to use this command. Use INSTRument:SElect to set the mode.
Couplings	When Auto Scaling is On, this value is automatically determined by the measurement result. When you set a value manually, Auto Scaling automatically changes to Off.
Preset	10.00 dBm
State Saved	Saved in instrument state.
Range	-250.00 dBm to 250.00 dBm
Min	-250.00 dBm
Max	250.00 dBm
Initial S/W Revision	Prior to A.02.00
Modified at S/W Revision	A.03.00

### Attenuation

This menu controls the attenuator functions and interactions between the attenuation system components.

There are two attenuator configurations in the X-Series. One is a dual attenuator configuration consisting of a mechanical attenuator and an optional electronic attenuator. The other configuration uses a single attenuator with combined mechanical and electronic sections that controls all the attenuation functions. Different models in the X-Series come with different configurations.

See "[Dual Attenuator Configurations:](#)" on page 2782

See "Single Attenuator Configuration:" on page 2783

Most Attenuation settings are the same for all measurements – they do not change as you change measurements. Settings like these are called “Meas Global” and are unaffected by Meas Preset.

Key Path	AMPTD Y Scale
Scope	Meas Global
Dependencies	In measurements that support the I/Q inputs, this key is unavailable when I/Q is the selected input, and is replaced by the Range key in that case.
Readback Line	Contains a summary in [ ] brackets of the current total attenuation. See the descriptions of the , " (Mech) Atten " on page 2783, and "Enable Elec Atten" on page 2785 keys for more detail on the contributors to the total attenuation.  Note that when "Pre-Adjust for Min Clip" is on, this value can change at the start of every measurement.
Initial S/W Revision	Prior to A.02.00
Modified at S/W Revision	A.03.00

### Dual Attenuator Configurations:

Configuration 1: Mechanical attenuator + optional electronic attenuator

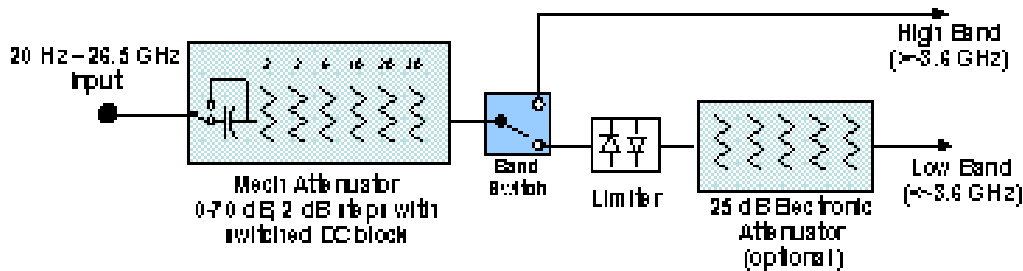

Configuration 2: Mechanical attenuator, no optional electronic attenuator

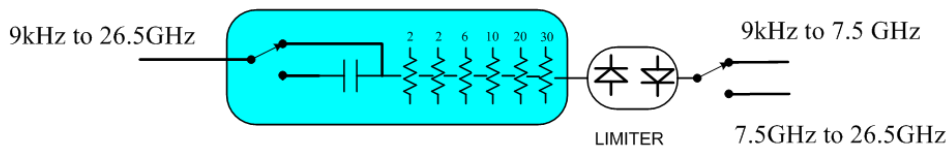

(note that Configuration 2 is not strictly speaking a dual-section attenuator, since there is no electronic section available. However, it behaves exactly like Configuration 1 without the Electronic Attenuator option EA3, therefore for the sake of this document it is grouped into the “Dual Attenuator” configuration)

### Single Attenuator Configuration:

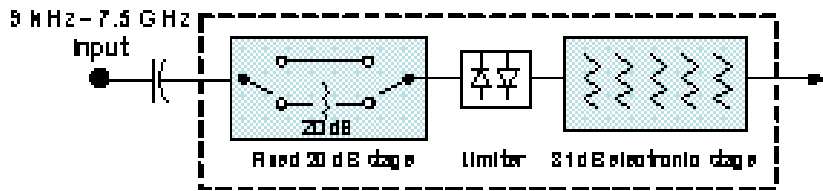

You can tell which attenuator configuration you have by pressing the Attenuation key, which (in most Modes) opens the Attenuation menu. If the first key in the Attenuation menu says Mech Atten you have the dual attenuator configuration. If the first key says Atten you have the single attenuator configuration.

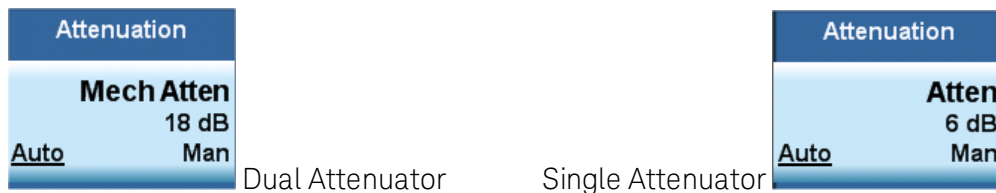

In the single attenuator configuration, you control the attenuation with a single control, as the fixed stage has only two states. In the dual attenuator configuration, both stages have significant range so you are given separate control of the mechanical and electronic attenuator stages.

When you have the dual attenuator configuration, you may still have only a single attenuator, because unless option EA3 (the Electronic Attenuator option) is available, and you purchase it, you will have only the mechanical attenuator.

### (Mech) Atten

This key is labeled Mech Atten in dual attenuator models and Atten in single attenuator models. In the dual attenuator configuration, this key only affects the mechanical attenuator.

This key lets you modify the attenuation applied to the RF input signal path. This value is normally auto coupled to the Ref Level, the Internal Preamp Gain, any External Gain that is entered, and the Max Mixer Level, as described in the table below.

See "[Attenuator Configurations and Auto/Man](#)" on page 2785

Key Path	AMPTD Y Scale, Attenuation
<b>Remote Command</b>	<pre>[ :SENSe]:POWer[:RF]:ATTenuation &lt;rel_amp1&gt;</pre> <pre>[ :SENSe]:POWer[:RF]:ATTenuation?</pre> <pre>[ :SENSe]:POWer[:RF]:ATTenuation:AUTO OFF ON 0 1</pre> <pre>[ :SENSe]:POWer[:RF]:ATTenuation:AUTO?</pre>
<b>Example</b>	<p>POW:ATT 20</p> <p>Dual attenuator configuration: sets the mechanical attenuator to 20 dB</p> <p>Single attenuator mode: sets the main attenuation to 20 dB (see below for definition of "main" attenuation).</p> <p>If the attenuator was in Auto, it sets it to Manual.</p>
<b>Dependencies</b>	Some measurements do not support the Auto setting of (Mech) Atten. In these measurements, the

---

Auto/Man selection is not available, and the Auto/Man line on the key disappears.

In dual attenuator configurations, when the electronic attenuator is enabled, the mechanical attenuator has no auto setting and the Auto/Man line on the key disappears. The state of Auto/Man is remembered and restored when the electronic attenuator is once again disabled. This is described in more detail in the ["Enable Elec Atten" on page 2785](#) key description.

See ["Attenuator Configurations and Auto/Man" on page 2785](#) for more information on the Auto/Man functionality of Attenuation.

---

Couplings

When (Mech) Atten is in Auto, it uses the following algorithm to determine a value:

If the USB Preamp is connected to USB, use 0 dB.

Otherwise,  $Atten = ReferenceLevel + PreAmpGain + ExternalGain - RefLevelOffset - MaxMixerLevel + IF\ Gain$ .

Limit this value to be between 6 dB and the Max value. No value below 6 dB can ever be chosen by Auto.

The resulting value is rounded up to the largest value possible given the attenuation step setting. That is, 50.01 dB would change to 60 dB (for a 10 dB attenuation step).

The "IF Gain" term in the equation above is either 0 dB or +10 dB, depending on the settings of FFT IF Gain, Swept IF Gain, max Ref Level and the Auto/Man setting of Mech Atten.

In External Mixing and BBIQ, where the Attenuator is not in the signal path, the Attenuator setting changes as described above when (Mech) Atten is in Auto, but no changes are made to the actual attenuator hardware setting until the input is changed back to the RF Input.

---

Preset The preset for Mech Attenuation is "Auto."  
 The Auto value of attenuation is:  
 CXA, EXA, MXA and PXA: 10 dB

---

State Saved Saved in instrument state

---

Min 0 dB

The attenuation set by this key cannot be decreased below 6 dB with the knob or step keys. To get to a value below 6 dB it has to be directly entered from the keypad or via SCPI. This protects from adjusting the attenuation to a dangerously small value which can put the instrument at risk of damage to input circuitry. However, if the current mechanical attenuation is below 6 dB it can be increased with the knob and step keys, but not decreased.

---

Max CXA N9000A-503/507: 50 dB  
 CXA N9000A-513/526: 70dB  
 EXA: 60 dB  
 MXA and PXA: 70 dB

In the single attenuator configuration, the total of ATT and EATT cannot exceed 50 dB, so if the EATT is set to 24 dB first, the main attenuation cannot be greater than 26 dB and will be reduced accordingly; if the main attenuator is set to 40 dB first, EATT cannot be greater than 10 dB.

---

Initial S/W Revision Prior to A.02.00

---

Modified at S/W Revision A.03.00

---

## Attenuator Configurations and Auto/Man

As described in the Attenuation key description, there are two distinct attenuator configurations available in the X-Series, the single attenuator and dual attenuator configurations. In dual attenuator configurations, we have the mechanical attenuation and the electronic attenuation, and the current total attenuation is the sum of the electronic + mechanical attenuation. In single attenuator configurations, we refer to the attenuation set using the (Mech) Atten key (or POW:ATT SCPI) as the “main” attenuation; and the attenuation that is set by the SCPI command POW:EATT as the “soft” attenuation (the POW:EATT command is honored even in the single attenuator configuration, for compatibility purposes). Then the current total attenuation is the sum of the main + soft attenuation. See the Elec Atten key description for more on “soft” attenuation.

In the dual attenuator configuration, when the electronic attenuator is enabled, there is no Auto/Man functionality for the mechanical attenuator, and the third line of the key label (the Auto/Man line) disappears:

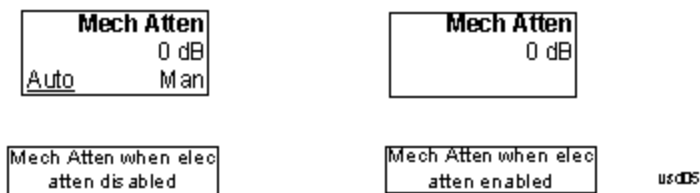

## Enable Elec Atten

Enables the Electronic Attenuator.

The electronic attenuator offers finer steps than the mechanical attenuator, has no acoustical noise, is faster, and is less subject to wear. These advantages primarily aid in remote operation and are negligible for front panel use. See ["Using the Electronic Attenuator: Pros and Cons" on page 2787](#) for a detailed discussion of the pros and cons of using the electronic attenuator.

For the single attenuator configuration, for SCPI backwards compatibility, the “soft” attenuation feature replaces the dual attenuator configuration’s electronic attenuator. All the same couplings and limitations apply. See ["Attenuator Configurations and Auto/Man" on page 2785](#)

See ["More Information" on page 2786](#)

Key Path	AMPTD Y Scale, Attenuation
Remote Command	[ :SENSE ] :POWER [ :RF ] :EATTenuation:STATE OFF ON 0 1 [ :SENSE ] :POWER [ :RF ] :EATTenuation:STATE?
Example	POW:EATT:STAT ON
Dependencies	This key only appears in Dual Attenuator models with an Electronic Attenuator installed. It does not appear in models with the Single Attenuator configuration, as in the single attenuator configuration there is no “electronic attenuator” there is only a single integrated attenuator (which has both a mechanical and electronic stage). However, in the single attenuator configuration, EATT SCPI commands are accepted for compatibility with other X-series instruments and set a “soft” attenuation as described in <a href="#">"Attenuator Configurations and Auto/Man" on page 2785</a> . The electronic attenuator (and the “soft” attenuation function provided in single attenuator configurations) is unavailable above 3.6 GHz. Therefore, if the Stop Frequency of the analyzer is > 3.6 GHz then the Enable Elec Atten key will be OFF and grayed out.

---

	<p>If the Internal Preamp is on, meaning it is set to Low Band or Full, the electronic attenuator (and the “soft” attenuation function provided in single attenuator configurations) is unavailable. In this case the Enable Elec Atten key will be OFF and grayed out.</p> <p>If either of the above is true, if the SCPI command is sent, an error indicating that the electronic attenuator is unavailable will be sent.</p> <p>If the electronic/soft Attenuator is enabled, then the Stop Freq of the analyzer is limited to 3.6 GHz and the Internal Preamp is unavailable.</p> <p>The SCPI-only “soft” electronic attenuation for the single-attenuator configuration is not available in all measurements; in particular, it is not available in the Swept SA measurement.</p>
Couplings	Enabling and disabling the Electronic Attenuator affects the setting of the Mechanical Attenuator (in dual attenuator configurations). This is described in more detail below this table.
Preset	OFF for Swept SA measurement; ON for all other measurements that support the electronic attenuator
State Saved	Saved in instrument state
Initial S/W Revision	Prior to A.02.00
Modified at S/W Revision	A.03.00

---

## More Information

### Mechanical Attenuator Transition Rules

When the Electronic Attenuator is enabled, the Mechanical Attenuator transitions to a state that has no Auto function. Below are the rules for transitioning the Mechanical Attenuator. NOTE that the information below ONLY applies to the dual attenuator configurations, and ONLY when the Electronic Attenuator is installed:

#### When the Electronic Attenuation is enabled from a disabled state:

- The Mechanical Attenuator is initialized to 10 dB (this is its optimal performance setting). You can then set it as desired with SCPI, numeric keypad, step keys, or knob, and it behaves as it normally would in manual mode
- The Auto/Man state of (Mech) Atten is saved
- The Auto/Man line on the (Mech) Atten key disappears and the auto rules are disabled
- The Electronic Attenuator is set to 10 dB less than the previous value of the Mechanical Attenuator, within the limitation that it must stay within the range of 0 to 24 dB of attenuation.

#### Examples in the dual attenuator configuration:

- Mech Atten at 20 dB. Elec Atten enabled, Mech Atten set to 10 dB, and Elec Atten set to 10 dB. New total attenuation equals the value before Elec Atten enabled.
- Mech Atten at 0 dB. Elec Atten enabled, Mech Atten set to 10 dB, and Elec Atten set to 0 dB. New total attenuation does not equal the value before Elec Atten enabled.
- Mech Atten at 40 dB. Elec Atten enabled, Mech Atten set to 10 dB, and Elec Atten set to 24 dB. New total attenuation does not equal the value before Elec Atten enabled.

### When the Electronic Attenuation is disabled from an enabled state:

- The Elec Atten key is grayed out
- The Auto/Man state of (Mech) Atten is restored
- If now in Auto, (Mech) Atten recouples
- If now in Man, (Mech) Atten is set to the value of total attenuation that existed before the Elec Atten was disabled. The resulting value is rounded up to the smallest value possible given the (Mech) Atten Step setting - (That is, 57 dB changes to 58 dB when (Mech) Atten Step is 2 dB.)

### Using the Electronic Attenuator: Pros and Cons

The electronic attenuator offers finer steps than the mechanical attenuator, has no acoustical noise, is faster, and is less subject to wear.

The “finer steps” advantage of the electronic attenuator is beneficial in optimizing the alignment of the analyzer dynamic range to the signal power in the front panel as well as remote use. Thus, you can achieve improved relative signal measurement accuracy. Compared to a mechanical attenuator with 2 dB steps, the 1 dB resolution of the electronic attenuator only gives better resolution when the odd-decibel steps are used. Those odd-decibel steps are less accurately calibrated than the even-decibel steps, so one tradeoff for this superior relative accuracy is reduced absolute amplitude accuracy.

Another disadvantage of the electronic attenuator is that the spectrum analyzer loses its “Auto” setting, making operation less convenient.

Also, the relationship between the dynamic range specifications (TOI, SHI, compression and noise) and instrument performance are less well-known with the electrical attenuator. With the mechanical attenuator, TOI, SHI and compression threshold levels increase dB-for-dB with increasing attenuation, and the noise floor does as well. With the electronic attenuator, there is an excess attenuation of about 1 to 3 dB between 0 and 3.6 GHz, making the effective TOI, SHI, and so forth, less well known. Excess attenuation is the actual attenuation relative to stated attenuation. Excess attenuation is accounted for in the analyzer calibration

### Elec Atten

Controls the Electronic Attenuator in dual attenuator configurations. This key does not appear in single attenuator configurations, as the control of both the mechanical and electronic stages of the single attenuator is integrated into the single Atten key.

Key Path	AMPTD Y Scale, Attenuation
<b>Remote Command</b>	<code>[ :SENSe ] :POWer [ :RF ] :EATTenuation &lt;rel_ampl&gt;</code> <code>[ :SENSe ] :POWer [ :RF ] :EATTenuation?</code>
<b>Notes</b>	Electronic Attenuation's specification is defined only when Mechanical Attenuation is 6 dB.
<b>Dependencies</b>	This key only appears in Dual Attenuator models with an Electronic Attenuator installed. It does not appear in models with the Single Attenuator configuration, as in the single attenuator configuration there is no “electronic attenuator” there is only a single integrated attenuator (which has both a mechanical and electronic stage). However, in the single attenuator configuration, EATT SCPI commands are accepted for compatibility with other X-series instruments and set a “soft” attenuation as described in <a href="#">"Attenuator Configurations and Auto/Man" on page 2785</a> . The “soft” attenuation is treated as an addition to the “main” attenuation value set by the Atten softkey or the

	POW:ATT SCPI command and affects the total attenuation displayed on the Attenuation key and the Meas Bar. When Enable Elec Atten is off or grayed out, the Elec Atten key is grayed out.
Preset	0 dB
State Saved	Saved in instrument state
Min	0 dB
Max	Dual attenuator configuration: 24 dB Single attenuator configuration: the total of ATT and EATT cannot exceed 50 dB, so if the EATT is set to 24 dB first, the main attenuation cannot be greater than 26 dB and will be reduced accordingly; if the main attenuator is set to 40 dB first, EATT cannot be greater than 10 dB
Initial S/W Revision	Prior to A.02.00
Modified at S/W Revision	A.03.00

### Adjust Atten for Min Clip

Sets the combination of mechanical and electronic attenuation and gain based on the current measured signal level so that clipping will be at a minimum.

This is an "immediate action" function, that is, it executes once, when the key is pressed.

This key is grayed out in measurements that do not support this functionality. The spectrum analyzer measurement, Swept SA, does not support this functionality.

Key Path	AMPTD Y Scale, Attenuation
Remote Command	<code>[ :SENSe ] :POWer [ :RF ] :RANGe:OPTimize IMMEDIATE</code>
Initial S/W Revision	Prior to A.02.00
Modified at S/W Revision	A.03.00

### Pre-Adjust for Min Clip

If this function is on, it does the adjustment described under ["Adjust Atten for Min Clip" on page 2788](#) each time a measurement restarts. Therefore, in Continuous measurement mode, it only executes before the first measurement.

In dual attenuator models, you can set Elec+Mech Atten, in which case both attenuators participate in the autoranging, or Elec Atten Only, in which case the mechanical attenuator does not participate in the autoranging. This latter case results in less wear on the mechanical attenuator and is usually faster.

This key is grayed out in measurements that do not support this functionality. The spectrum analyzer measurement, Swept SA, does not support this functionality.

Key Path	AMPTD Y Scale, Attenuation
Remote Command	<code>[ :SENSe ] :POWer [ :RF ] :RANGe:OPTimize:ATTenuation OFF   ELECTRical   COMBined</code>



	<code>[ :SENSe ] :POWer [ :RF ] :RANGe:OPTimize:ATTenuation?</code>
Notes	The SCPI parameter <code>ELECTrical</code> sets this function to On in single attenuator models. The SCPI parameter <code>COMBined</code> is mapped to <code>ELECTrical</code> in single attenuator models; if you send <code>COMBined</code> , it sets the function to On and returns <code>ELEC</code> to a query.
Dependencies	This key only appears in Dual Attenuator models with an Electronic Attenuator installed. In instruments with Dual Attenuator model, when Enable Elec Atten is off or grayed out, the Pre-Adjust for Min Clip key is grayed out.
Preset	OFF for Swept SA measurement; ON for all other measurements that support Pre-Adjust for Min Clip
State Saved	Saved in instrument state
Range	Dual attenuator models: Off   Elec Atten Only   Mech + Elec Atten Single attenuator models: Off   On
Initial S/W Revision	Prior to A.02.00
Modified at S/W Revision	A.03.00

<b>Remote Command</b>	<code>[ :SENSe ] :POWer [ :RF ] :RANGe:AUTO ON OFF 1 0</code> <code>[ :SENSe ] :POWer [ :RF ] :RANGe:AUTO?</code>
Notes	ON aliases to "Elec Atten Only" ( <code>:POW:RANG:OPT:ATT ELEC</code> ) OFF aliases to "Off" ( <code>:POW:RANG:OPT:ATT OFF</code> ) The query <code>:POW:RANG:AUTO?</code> returns true if <code>:POW:RANG:OPT:ATT</code> is not "Off"
Initial S/W Revision	Prior to A.02.00

## Off

Turns Pre-Adjust for Min Clip off. This is the default setting.

This key is grayed out in measurements that do not support this functionality. The spectrum analyzer measurement, Swept SA, does not support this functionality.

Key Path	AMPTD Y Scale, Attenuation, Pre-Adjust for Min Clip
Example	<code>:POW:RANGe:OPT:ATT OFF</code>
Initial S/W Revision	Prior to A.02.00

## Elec Atten Only

Selects only the electric attenuator to participate in auto ranging. This offers less wear on the mechanical attenuator and is usually faster.

This key is grayed out in measurements that do not support this functionality. The spectrum analyzer measurement, Swept SA, does not support this functionality.

Key Path	AMPTD Y Scale, Attenuation, Pre-Adjust for Min Clip
Example	:POW:RANGe:OPT:ATT ELEC
Initial S/W Revision	Prior to A.02.00

### Mech + Elec Atten

In dual attenuator models, this selects both attenuators participate in the autoranging.

This key is grayed out in measurements that do not support this functionality. The spectrum analyzer measurement, Swept SA, does not support this functionality.

Key Path	AMPTD Y Scale, Attenuation, Pre-Adjust for Min Clip
Example	:POW:RANGe:OPT:ATT COMB
Initial S/W Revision	Prior to A.02.00

### (Mech) Atten Step

This controls the step size used when making adjustments to the input attenuation.

This key is labeled Mech Atten Step in dual attenuator models and Atten Step in single attenuator models. In the dual attenuator configuration, this key only affects the step size of the mechanical attenuator.

Key Path	AMPTD Y Scale, Attenuation
<b>Remote Command</b>	[ :SENSe ] : POWer [ :RF ] : ATTenuation : STEP [ :INCRement ] 10 dB   2 dB [ :SENSe ] : POWer [ :RF ] : ATTenuation : STEP [ :INCRement ] ?
<b>Example</b>	POW:ATT:STEP 2
Notes	Note this feature works like a 1-N choice from the front panel, but it takes a specific value (in dB) when used remotely. The only valid values are 2 and 10.
Dependencies	Blanked in CXA and EXA if option FSA (2 dB steps) is not present. If blanked, attempts to set it via SCPI will yield an error.
Couplings	When the attenuation step size changes, the current mechanical attenuation value is adjusted (if necessary) to be quantized to the new step size. That is, if step is set to 10 dB, mech atten is increased if necessary so it is a multiple of 10 dB
Preset	PXA and MXA: 2 dB EXA and CXA: 10 dB (2 dB with option FSA)
State Saved	Saved in instrument state
Initial S/W Revision	Prior to A.02.00
Modified at S/W Revision	A.03.00

## Scale/Div (RF Envelope View)

Sets the scale per division for the RF Envelope result waveform (time domain) measurements in the graph window.

Key Path	AMPTD Y Scale
Mode	BASIC, PNOISE, WCDMA, C2K, GSM, WIMAXOFDMA, TDSCDMA, 1XEVD0, DVB, DTMB, ISDBT, CMMB, LTE, LTETDD, DCATV, WLAN, LTEATDD, LTEAFDD
Remote Command	:DISPlay:WAVeform:VIEW[1]:WINDow[1]:TRACe:Y[:SCALe]:PDIVision <rel_ ampl> :DISPlay:WAVeform:VIEW[1]:WINDow[1]:TRACe:Y[:SCALe]:PDIVision?
Example	DISP:WAV:VIEW:WIND:TRAC:Y:PDIV 5 DISP:WAV:VIEW:WIND:TRAC:Y:PDIV?
Notes	You must be in a mode that includes the Waveform measurement to use this command. Use INSTRUMENT:SElect to set the mode.
Couplings	When Auto Scaling is On, this value is automatically determined by the measurement result. When you set a value manually, Auto Scaling automatically changes to Off.
Preset	10.00 dB
State Saved	Saved in instrument state.
Range	0.10 dB to 20.00 dB
Min	0.10 dB
Max	20.00 dB
Initial S/W Revision	Prior to A.02.00
Modified at S/W Revision	A.03.00

## Presel Center

When this key is pressed, the centering of the preselector filter is adjusted to optimize the amplitude accuracy at the frequency of the selected marker. If the selected marker is not on when Presel Center is pressed, the analyzer will turn on the selected marker, perform a peak search, and then perform centering on the marker's center frequency. If the selected marker is already on and between the start and stop frequencies of the analyzer, the analyzer performs the preselector calibration on that marker's frequency. If the selected marker is already on, but outside the frequency range between Start Freq and Stop Freq, the analyzer will first perform a peak search, and then perform centering on the marker's center frequency.

The value displayed on the Presel Adjust key will change to reflect the new preselector tuning (see Presel Adjust).

A number of considerations should be observed to ensure proper operation. See ["Proper Preselector Operation" on page 2792](#).

Key Path	AMPTD Y Scale
Remote Command	[:SENSe]:POWer[:RF]:PCENter

<b>Example</b>	POW:PCEN
<b>Notes</b>	Note that the rules outlined above under the key description apply for the remote command as well as the key. The result of the command is dependent on marker position, and so forth. Any message shown by the key press is also shown in response to the remote command.
<b>Dependencies</b>	<ul style="list-style-type: none"> <li>• Grayed out if the microwave preselector is off. )</li> <li>• If the selected marker's frequency is below Band 1, advisory message 0.5001 is generated and no action is taken.</li> <li>• Grayed out if entirely in Band 0.</li> <li>• Blank in models that do not include a preselector, such as option 503. If the SCPI is sent in these instruments, it is accepted without error, and the query always returns 0.</li> <li>• Grayed out in the Spectrogram View.</li> </ul>
<b>Couplings</b>	<p>The active marker position determines where the centering will be attempted.</p> <p>If the analyzer is in a measurement such as averaging when centering is initiated, the act of centering the preselector will restart averaging but the first average trace will not be taken until the centering is completed.</p>
<b>Status Bits/OPC dependencies</b>	<p>When centering the preselector, *OPC will not return true until the process is complete and a subsequent measurement has completed, nor will results be returned to a READ or MEASure command.</p> <p>The Measuring bit should remain set while this command is operating and should not go false until the subsequent sweep/measurement has completed.</p>
<b>Initial S/W Revision</b>	Prior to A.02.00
<b>Modified at S/W Revision</b>	A.03.00

## Proper Preselector Operation

A number of considerations should be observed to ensure proper operation:

1. If the selected marker is off, the analyzer will turn on a marker, perform a peak search, and adjust the preselector using the selected marker's frequency. It uses the "highest peak" peak search method unqualified by threshold or excursion, so that there is no chance of a 'no peak found' error. It continues with that peak, even if it is the peak of just noise. Therefore, for this operation to work properly, there should be a signal on screen in a preselected range for the peak search to find.
2. If the selected marker is already on, the analyzer will attempt the centering at that marker's frequency. There is no preselector for signals below about 3.6 GHz, therefore if the marker is on a signal below 3.6 GHz, no centering will be attempted and an advisory message generated
3. In some models, the preselector can be bypassed. If it is bypassed, no centering will be attempted in that range and a message will be generated.

## Preselector Adjust

Allows you to manually adjust the preselector filter frequency to optimize its response to the signal of interest. This function is only available when **"Presel Center"** on page 2791 is available.

For general purpose signal analysis, using Presel Center is recommended. Centering the filter minimizes the impact of long-term preselector drift. Presel Adjust can be used instead to manually optimize the preselector. One application of manual optimization would be to peak the preselector response, which both optimizes the signal-to-noise ratio and minimizes amplitude variations due to small (short-term) preselector drifting.

Key Path	AMPTD Y Scale
Scope	Meas Global
<b>Remote Command</b>	<code>[ :SENSe ] :POWer [ :RF ] :PADJust &lt;freq&gt;</code> <code>[ :SENSe ] :POWer [ :RF ] :PADJust?</code>
<b>Example</b>	POW:PADJ 100KHz POW:PADJ?
Notes	The value on the key reads out to 0.1 MHz resolution.
Dependencies	<ul style="list-style-type: none"> <li>• Grayed out if microwave preselector is off. )</li> <li>• Grayed out if entirely in Band 0.</li> <li>• Blank in models that do not include a preselector, such as option 503. If the SCPI is sent in these instruments, it is accepted without error, and the query always returns 0.</li> <li>• Grayed out in the Spectrogram View.</li> </ul>
Preset	0 MHz
State Saved	The Presel Adjust value set by Presel Center, or by manually adjusting Presel Adjust, is not saved in instrument state, and does not survive a Preset or power cycle.
Min	-500 MHz
Max	500 MHz
Default Unit	Hz
<b>Backwards Compatibility SCPI</b>	<code>[ :SENSe ] :POWer [ :RF ] :MW :PADJust</code> <code>[ :SENSe ] :POWer [ :RF ] :MMW :PADJust</code> PSA had multiple preselectors, but the X-Series has only one. These commands simply alias to <code>[ :SENSe ] :POWer [ :RF ] :PADJust</code>
Initial S/W Revision	Prior to A.02.00
Modified at S/W Revision	A.03.00

<b>Remote Command</b>	<code>[ :SENSe ] :POWer [ :RF ] :PADJust :PRESelector MWAVE   MMWave   EXTERNAL</code> <code>[ :SENSe ] :POWer [ :RF ] :PADJust :PRESelector?</code>
Notes	PSA had multiple preselectors, and you could select which preselector to adjust. Since the X-Series has only one mm/uW preselector, the preselector selection softkey is no longer available. However, to provide backward compatibility, we accept the legacy remote commands. The command form has no effect, the query always returns MWAVE
Initial S/W Revision	Prior to A.02.00

## μW Path Control

The μW Path Control functions include the μW Preselector Bypass (Option MPB) and Low Noise Path (Option LNP) controls in the High Band path circuits.

When the μW Preselector is bypassed, the user has better flatness, but will be subject to spurs from out of band interfering signals. When the Low Noise Path is enabled, the analyzer automatically switches around certain circuitry in the high frequency bands which can contribute to noise, when it is appropriate based on other analyzer settings.

For most applications, the preset state is Standard Path, which gives the best remote-control throughput, minimizes acoustic noise from switching and minimizes the risk of wear out in the hardware switches. For applications that utilize the wideband IF paths, the preset state is the μW Preselector Bypass path, if option MPB is present. This is because, when using a wideband IF such as the 140 MHz IF, the μW Preselector's bandwidth can be narrower than the available IF bandwidth, causing degraded amplitude flatness and phase linearity, so it is desirable to bypass the preselector in the default case.

Users may choose Low Noise Path Enable. It gives a lower noise floor, especially in the 21–26.5 GHz region, though without improving many measures of dynamic range, and without giving the best possible noise floor. The preamp, if purchased and used, gives better noise floor than does the Low Noise Path, however its compression threshold and third-order intercept are much poorer than that of the non-preamp Low Noise Path. There are some applications, typically for signals around –30 dBm, for which the third-order dynamic range of the standard path is good enough, but the noise floor is not low enough even with 0 dB input attenuation. When the third-order dynamic range of the preamp path is too little and the noise floor of the standard path is too high, the Low Noise Path can provide the best dynamic range.

<b>Key Path</b>	AMPTD Y Scale
<b>Mode</b>	SA, BASIC, PNOISE, VSA , LTE, LTETDD
<b>Scope</b>	Meas Global
<b>Remote Command</b>	[ :SENSe ] :POWer [ :RF ] :MW:PATH STD   LNPath   MPBypass   FULL [ :SENSe ] :POWer [ :RF ] :MW:PATH?
<b>Example</b>	:POW:MW:PATH LNP Enables the Low Noise path
<b>Notes</b>	If a Presel Center is performed, the analyzer will momentarily switch to the Standard Path, regardless of the setting of μW Path Control  The DC Block will always be switched in when the low noise path is switched in, to protect succeeding circuitry from DC. Note that this does not mean “when the low noise path is enabled” but when, based on the Low Noise Path rules, the path is actually switched in. This can happen when the selection is Low Noise Path Enable . In the case where the DC Block is switched in the analyzer is now AC coupled. However, if the user has selected DC coupling, the UI will still behave as though it were DC coupled, including all annunciation, warnings, status bits, and responses to SCPI queries. This is because, based on other settings, the analyzer could switch out the low noise path at any time and hence go back to being DC coupled.  Alignment switching ignores the settings in this menu, and restores them when finished.
<b>Dependencies</b>	Unavailable in BBIQ and External Mixing
<b>Preset</b>	All modes other than IQ Analyzer mode and VXA: STD IQ Analyzer, VXA and WLAN mode:

	MPB option present and licensed: MPB MPB option not present and licensed: STD
State Saved	Save in instrument state
Readback	Value selected in the submenu
Initial S/W Revision	A.04.00
Modified at S/W Revision	A.10.00

## Standard Path

This path gives the best remote-control throughput, minimizes acoustic noise from switching and minimizes the risk of wear in the hardware switches, particularly in remote test scenarios where both low band and high band setups will follow in rapid succession.

In this path, the bypass of the low band/high band switch and microwave preamp is never activated, which can cause some noise degradation but preserves the life of the bypass switch.

Key Path	AMPTD Y Scale, $\mu$ W Path Control
<b>Example</b>	:POW:MW:PATH STD
Readback Text	Standard Path
Initial S/W Revision	A.04.00

## Low Noise Path Enable

You may choose Low Noise Path Enable, which gives a lower noise floor under some circumstances, particularly when operating in the 21–26.5 GHz region. With the Low Noise Path enabled, the low band/high band switch and microwave preamp are bypassed whenever all of the following are true:

- The analyzer is not in the Low Band, meaning:
- the start frequency is above 3.5 GHz and
- the stop frequency is above 3.6 GHz.
- the internal preamp is not installed or (if installed) is set to Off or Low Band

Note that this means that, when any part of a sweep is done in Low Band, the Low Noise Path is not used, whether or not the Low Noise Path Enable is selected in the user interface. Also, if the preamp is turned on, the Low Noise Path is not used, whether or not the Low Noise Path Enable is selected in the user interface. The only time the Low Noise Path is used is when Low Noise Path Enable is selected, the sweep is completely in High Band (> 3.6 GHz) and no preamp is in use.

See "[More Information](#)" on page 2796

Key Path	AMPTD Y Scale, $\mu$ W Path Control
Measurement	Swept SA

<b>Example</b>	:POW:MW:PATH LNP
<b>Notes</b>	<p>For measurements that use IQ acquisition, the low noise path is used when the Center Frequency is in High Band (&gt; 3.6 GHz) and no preamp is in use.</p> <p>In other words, the rules above are modified to use only the center frequency to qualify which path to switch in.</p> <p>This is not the case for FFT's in the Swept SA measurement; they use the same rules as swept measurements.</p>
<b>Dependencies</b>	<p>Key is blanked if current mode does not support it.</p> <p>Key is grayed out if mode supports it but current measurement does not support it.</p> <p>Unless Option LNP is present and licensed, key is blank and if SCPI command sent, error -241, "Hardware missing; Option not installed" is generated.</p>
<b>Readback Text</b>	Low Noise Path Enable
<b>Initial S/W Revision</b>	A.04.00

### More Information

The user should understand that the Low Noise Path, while giving improved DANL, has the disadvantage of decreased TOI performance and decreased gain compression performance relative to the standard path.

The user should also understand that the bypass switch is a mechanical switch and has finite life, so if the Low Noise Path is enabled, it is possible to cause frequent cycling of this switch by frequently changing analyzer settings such that the above conditions hold true only some of the time. A user making tests of this nature should consider opting for the Standard Path, which will never throw the bypass switch, at the expense of some degraded noise performance.

The low noise path is useful for situations where the signal level is so low that the analyzer performance is dominated by noise even with 0 dB attenuation, but still high enough that the preamp option would have excessive third-order intermodulation or compression. The preamp, if purchased and used, gives better noise floor than does the "Low Noise Path." However, its compression threshold and third-order intercept are much poorer than that of the non-preamp path. There are some applications, typically for signals around -30 dBm, for which the third-order dynamic range of the standard path is good enough, but the noise floor is not low enough even with 0 dB input attenuation. When the third-order dynamic range of the preamp path is too little and the noise floor of the standard path is too high, the Low Noise Path can provide the best dynamic range

The graph below illustrates the concept. It shows, in red, the performance of an analyzer at different attenuation settings, both with the preamp on and off, in a measurement that is affected by both analyzer noise and analyzer TOI. The green shows the best available dynamic range, offset by 0.5 dB for clarity. The blue shows how the best available dynamic range improves for moderate signal levels with the low noise path switched in. In this illustration, the preamp improves the noise floor by 15 dB while degrading the third-order intercept by 30 dB, and the low noise path reduces loss by 8 dB. The attenuator step size is 2 dB.



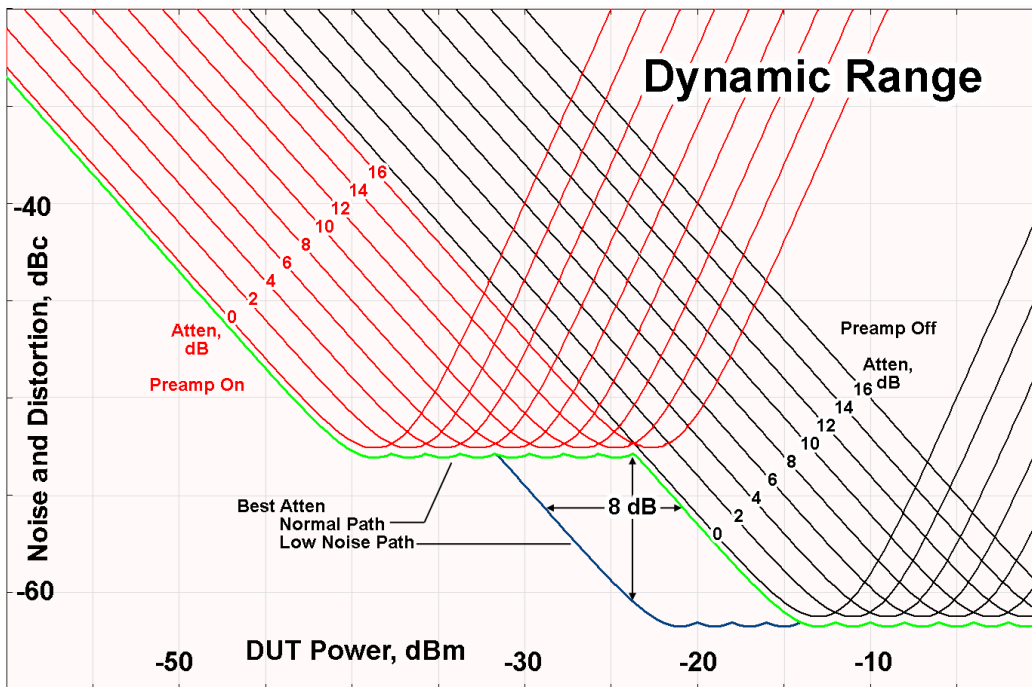

There are other times where selecting the low noise path improves performance, too. Compression-limited measurements such as finding the nulls in a pulsed-RF spectrum can profit from the low noise path in a way similar to the TOI-limited measurement illustrated. Accuracy can be improved when the low noise path allows the optimum attenuation to increase from a small amount like 0, 2 or 4 dB to a larger amount, giving better return loss at the analyzer input. Harmonic measurements, such as second and third harmonic levels, are much improved using the low noise path because of the superiority of that path for harmonic (though not intermodulation) distortion performance.

### $\mu$ W Preselector Bypass

This key toggles the preselector bypass switch for band 1 and higher. When the microwave preselector is on, the signal path is preselected. When the microwave preselector is off, the signal path is not preselected. The preselected path is the normal path for the analyzer.

The preselector is a tunable bandpass filter which prevents signals away from the frequency of interest from combining in the mixer to generate in-band spurious signals (images). The consequences of using a preselector filter are its limited bandwidth, the amplitude and phase ripple in its passband, and any amplitude and phase instability due to center frequency drift.

Option MPB or pre-selector bypass provides an unpreselected input mixer path for certain X-Series signal analyzers with frequency ranges above 3.6 GHz. This signal path allows a wider bandwidth and less amplitude variability, which is an advantage when doing modulation analysis and broadband signal analysis. The disadvantage is that, without the preselector, image signals will be displayed. Another disadvantage of bypassing the preselector is increased LO emission levels at the front panel input port.

Image responses are separated from the real signal by twice the 1st IF. For IF Paths of 10 MHz and 25 MHz, the 1st IF is 322.5 MHz, so the image response and the real signal will be separated by 645 MHz. The 1st IF will be different for other IF Path settings. When viewing a real signal and its corresponding image response in internal mixing, the image response will be to the left of the real signal.

Also, the image response and the real signal typically have the same amplitude and exhibit the same shape factor.

However, if Option FS1, Fast Sweep Capability, is enabled, the image response in the Swept SA measurement will appear lower in amplitude and have a much wider shape factor compared to the real signal.

Key Path	AMPTD Y Scale, $\mu$ W Path Control
Example	:POW:MW:PATH MPB
Dependencies	Key is blanked if current mode does not support it. Key is grayed out if mode supports it but current measurement does not support it. Key is blank unless Option MPB is present and licensed. If SCPI command sent when MPB not present, error -241, "Hardware missing; Option not installed" is generated.
Readback Text	$\mu$ W Preselector Bypass
Initial S/W Revision	A.04.00

Remote Command	[ :SENSe ] :POWeR [ :RF ] :MW:PRESelector [ :STATe ] ON   OFF   0   1 [ :SENSe ] :POWeR [ :RF ] :MW:PRESelector [ :STATe ] ?
Example	:POW:MW:PRES OFF Bypasses the microwave preselector
Notes	The ON parameter sets the STD path (:POW:MW:PATH STD) The OFF parameter sets path MPB (:POW:MW:PATH MPB)
Preset	ON

## Internal Preamp

Accesses a menu of keys that control the internal preamps. Turning on the preamp gives a better noise figure, but a poorer TOI to noise floor dynamic range. You can optimize this setting for your particular measurement.

The instrument takes the preamp gain into account as it sweeps. If you sweep outside of the range of the preamp the instrument will also account for that. The displayed result will always reflect the correct gain.

For some measurements, when the preamp is on and any part of the displayed frequency range is below the lowest frequency for which the preamp has specifications, a warning condition message appears in the status line. For example, for a preamp with a 9 kHz lowest specified frequency: "Preamp: Accy unspec'd below 9 kHz".

Key Path	AMPTD Y Scale
Scope	Meas Global
Remote Command	[ :SENSe ] :POWeR [ :RF ] :GAIN [ :STATe ] OFF   ON   0   1 [ :SENSe ] :POWeR [ :RF ] :GAIN [ :STATe ] ?
Dependencies	Preamp is not available on all hardware platforms. If the preamp is not present or is unlicensed, the

key is not shown.  
The preamp is not available when the electronic/soft attenuator is enabled.

Couplings	<p>The act of connecting the U7227A USB Preamplifier to one of the analyzer's USB ports will cause the Internal Preamp to be switched on. When this happens an informational message will be generated: "Internal Preamp turned on for optimal operation with USB Preamp." Note that if the Internal Preamp was already on, there will be no change to the setting, but if it was Off it will be switched On, to Full Range.</p> <p>Note that this same action occurs when the SA mode is selected while the USB Preamp is connected to one of the analyzer's USB ports, if it is the first time that the SA mode has run since powerup, or if the last time the SA mode was running the USB Preamp was NOT connected.</p> <p>Subsequently disconnecting the USB Preamp from USB does not change the Internal Preamp setting nor restore the previous setting.</p>
Preset	OFF
State Saved	Saved in instrument state
Initial S/W Revision	Prior to A.02.00
Modified at S/W Revision	A.14.00

Key Path	AMPTD Y Scale, Internal Preamp
Scope	Meas Global
<b>Remote Command</b>	<pre>[ :SENSe] :POWer [ :RF] :GAIN: BAND LOW FULL [ :SENSe] :POWer [ :RF] :GAIN: BAND?</pre>
Dependencies	<p>Preamp is not available on all hardware platforms. If the preamp is not present or is unlicensed, the key is not shown.</p> <p>If a POW:GAIN: BAND FULL command is sent when a low band preamp is available, the preamp band parameter is to LOW instead of FULL, and an "Option not installed" message is generated.</p>
Preset	LOW
State Saved	Saved in instrument state
Initial S/W Revision	Prior to A.02.00

## Off

Turns the internal preamp off

Key Path	AMPTD Y Scale, Internal Preamp
<b>Example</b>	:POW:GAIN OFF
Readback	Off
Initial S/W Revision	Prior to A.02.00

## Low Band

Sets the internal preamp to use only the low band.

The frequency range of the installed (optional) low-band preamp is displayed in square brackets on the Low Band key label.

Key Path	AMPTD Y Scale, Internal Preamp
<b>Example</b>	:POW:GAIN ON :POW:GAIN:BAND LOW
Readback	Low Band
Initial S/W Revision	Prior to A.02.00

## Full Range

Sets the internal preamp to use its full range. The low band (0–3.6 GHz or 0–3GHz, depending on the model) is supplied by the low band preamp and the frequencies above low band are supplied by the high band preamp.

The frequency range of the installed (optional) preamp is displayed in square brackets on the Full Range key label. If the high band option is not installed the Full Range key does not appear.

Key Path	AMPTD Y Scale, Internal Preamp
<b>Example</b>	:POW:GAIN ON :POW:GAIN:BAND FULL
Readback	Full Range
Initial S/W Revision	Prior to A.02.00

## Ref Position (RF Envelope View)

Positions the reference level at the top, center or bottom of the Y Scale display. Changing the reference position does not change the reference level value.

Key Path	AMPTD Y Scale
Mode	BASIC, PNOISE, WCDMA, C2K, GSM, WIMAXOFDMA, TDSCDMA, 1XEVD0, DVB, DTMB, ISDBT, CMMB, LTE, LTETDD, DCATV, WLAN,LTEATDD, LTEAFDD
<b>Remote Command</b>	:DISPlay:WAVeform:VIEW[1]:WINDow[1]:TRACe:Y[:SCALE]:RPOSition TOP   CENTer   BOTTom  :DISPlay:WAVeform:VIEW[1]:WINDow[1]:TRACe:Y[:SCALE]:RPOSition?
<b>Example</b>	DISP:WAV:VIEW:WIND:TRAC:Y:RPOS CENT DISP:WAV:VIEW:WIND:TRAC:Y:RPOS?
Notes	You must be in a mode that includes the Waveform measurement to use this command. Use INSTRument:SElect to set the mode.
Preset	TOP

State Saved	Saved in instrument state.
Range	Top Ctr Bot
Initial S/W Revision	Prior to A.02.00
Modified at S/W Revision	A.03.00

## Auto Scaling

Toggles the Auto Scaling function between On and Off. When the Restart front-panel key is pressed, this function automatically determines the scale per division and reference values based on the measurement results.

Key Path	AMPTD Y Scale
Mode	BASIC, PNOISE, WCDMA, C2K, GSM, WIMAXOFDMA, TDSCDMA, 1XEVD0, DVB, DTMB, ISDBT, CMMB, LTE, LTETDD, DCATV, WLAN,LTEATDD, LTEAFDD
Remote Command	:DISPlay:WAVeform:VIEW[1] 2:WINDow[1]:TRACe:Y[:SCALE]:COUPle 0   1   OFF   ON :DISPlay:WAVeform:VIEW[1] 2:WINDow[1]:TRACe:Y[:SCALE]:COUPle?
Example	DISP:WAV:VIEW:WIND:TRAC:Y:COUP OFF DISP:WAV:VIEW:WIND:TRAC:Y:COUP?
Notes	You must be in a mode that includes the Waveform measurement to use this command. Use INSTRument:SElect to set the mode.
Couplings	When Auto Scaling is On, upon pressing the Restart front-panel key, this function automatically switches the scale per division and reference values into the defaults. When you set a value to either Scale/Div or Ref Value manually, Auto Scaling automatically changes to Off.
Preset	OFF
State Saved	Saved in instrument state.
Range	On Off
Initial S/W Revision	Prior to A.02.00
Modified at S/W Revision	A.03.00

## Range

This key is only available when I/Q is the selected input. It replaces the Attenuation key in that case.

Each input channel (I and Q) has four internal gain ranges. The maximum allowed voltage in each gain range is slightly more than the nominal value, so the break point between ranges is a couple of millivolts higher than the nominal (setting a peak voltage of 0.502 mV will still map to the 0.5 V Peak range).

Gain Setting	Volts RMS	Volts Peak	Volts Peak - Peak	dBm (50Ω)	Break Point
0 dB	0.7071	1.0	2.0	10	n/a

6 dB	0.3536	0.5	1.0	4	0.502 V Peak
12 dB	0.1768	0.25	0.5	-2	0.252 V Peak
18 dB	0.0884	0.125	0.25	-8	0.127 V Peak

Key Path	AMPTD Y Scale
Notes	Visible only when the selected input is I/Q.
State Saved	No
Readback Text	When Range is Auto, "[Auto]" When Range is Man and I & Q are the same, "[<range value>]" When Range is Man and I & Q are different: "[: <I range value> Q: <Q range value>]" See I Range and Q Range for the <range value> enumeration definition.
Initial S/W Revision	Prior to A.02.00

## Range Auto/Man

The Auto setting for Range causes the range to be set based on the Y Scale settings. When Range is "Auto", the I & Q Range are set based on the top of the Y Scale when the Y scale is in dB units (for example, power), or to the max(abs(top), abs(bottom)) when the Y scale reference is not at the top of the screen.

Not all measurements support Range Auto/Man. If Auto is not supported in the current measurement, this key is grayed out and shows "Man" and MAN is returned to a SCPI query, but this does NOT change the Auto/Man setting for Range. When you go to a measurement that supports Auto, it goes back to Auto if it was previously in Auto mode.

Key Path	AMPTD Y Scale, Range
Scope	Meas Global
Remote Command	<code>[:SENSe]:VOLTage:IQ:RANGe:AUTO OFF ON 0 1</code> <code>[:SENSe]:VOLTage:IQ:RANGe:AUTO?</code>
Example	Put the I Range and Q Range in manual. <code>VOLT:IQ:RANG:AUTO OFF</code>
Dependencies	If Auto is not supported, sending the SCPI command will generate an error.
Couplings	When in Auto, both I Range and Q Range are set to the same value, computed as follows: Maximum absolute value is computed for the Y Scale. The top and bottom of the graph are computed based on Ref Value, Scale/Div, and Ref Position. Formula: $Y_{Max} = \max(\text{abs}(\text{top}), \text{abs}(\text{bottom}))$ . The I Range and Q Range are then set to YMax.
Preset	ON
State Saved	Saved in instrument state
Range	Auto   Man
Initial S/W Revision	Prior to A.02.00

<b>Remote Command</b>	<code>[ :SENSe ] :POWeR :IQ :RANGe :AUTO OFF   ON   0   1</code> <code>[ :SENSe ] :POWeR :IQ :RANGe :AUTO ?</code>
<b>Example</b>	Put the I Range and Q Range in manual. <code>POW:IQ:RANG:AUTO OFF</code>
<b>Notes</b>	The <code>POW:IQ:RANG:AUTO</code> is an alternate form of the <code>VOLT:IQ:RANG:AUTO</code> command. This is to maintain consistency with I Range and Q Range, which support both the <code>POWeR</code> and <code>VOLTage</code> forms of the command.
<b>Preset</b>	ON
<b>Range</b>	Auto   Man
<b>Initial S/W Revision</b>	Prior to A.02.00

## I Range

This is the internal gain range for the I channel when Input Path is I Only or I and I/Q, and it is used for both the I and Q channels when the Input Path is I+Q. See "[I/Q Gain Ranges](#)" on page 2807.

<b>Key Path</b>	AMPTD Y Scale, Range
<b>Remote Command</b>	<code>[ :SENSe ] :VOLTagE :IQ [ :I ] :RANGe [ :UPPer ] &lt;voltage&gt;</code> <code>[ :SENSe ] :VOLTagE :IQ [ :I ] :RANGe [ :UPPer ] ?</code>
<b>Example</b>	Set the I Range to 0.5 V Peak <code>VOLT:IQ:RANG 0.5 V</code>
<b>Notes</b>	The numeric entries are mapped to the smallest gain range whose break point is greater than or equal to the value, or 1 V Peak if the value is greater than 1 V.
<b>Couplings</b>	When Q Same as I is On, the I Range value will be copied to the Q Range. Changing the value will also set Range = Man.
<b>Preset</b>	1 V Peak
<b>State Saved</b>	Saved in instrument state
<b>Range</b>	1 V Peak   0.5 V Peak   0.25 V Peak   0.125 V Peak
<b>Min</b>	0.125 V
<b>Max</b>	1 V
<b>Initial S/W Revision</b>	Prior to A.02.00

<b>Remote Command</b>	<code>[ :SENSe ] :POWeR :IQ [ :I ] :RANGe [ :UPPer ] &lt;amp;pl&gt;</code> <code>[ :SENSe ] :POWeR :IQ [ :I ] :RANGe [ :UPPer ] ?</code>
<b>Example</b>	Set the I Range to 0.5 V Peak when Reference Z is 50Ω, and to 1.0 V Peak when Reference Z is 75Ω. <code>POW:IQ:RANG 4 dBm</code>
<b>Notes</b>	The <code>POWeR</code> form of the command is provided for convenience. It maps to the same underlying gain

range parameter as the VOLTage form of the command.

The Reference Z (not the I channel Input Z) is used to convert the power to peak voltage, which is then used to set the I Range as with the VOLTage form of the command. The power values of the 4 range states (1V Peak, 0.5V Peak, 0.25V Peak, and 0.125V Peak) will vary with Reference Z. Here are some examples:

50Ω: 10, 4, -2, -8  
 75Ω: 8.2, 2.2, -3.8, -9.8  
 600Ω: -0.8, -6.8, -12.8, -18.9

Preset	10.0 dBm
Range	-20 dBm to 10 dBm
Min	-20 dBm
Max	10 dBm
Initial S/W Revision	Prior to A.02.00

### 1 V Peak

Set the channel gain state to 1 Volt Peak.

Key Path	AMPTD Y Scale, I Range   Q Range
Initial S/W Revision	Prior to A.02.00

### 0.5 V Peak

Set the channel gain state to 0.5 Volt Peak.

Key Path	AMPTD Y Scale, I Range   Q Range
Initial S/W Revision	Prior to A.02.00

### 0.25 V Peak

Set the channel gain state to 0.25 Volt Peak.

Key Path	AMPTD Y Scale, I Range   Q Range
Initial S/W Revision	Prior to A.02.00

### 0.125 V Peak

Set the channel gain state to 0.125 Volt Peak.

Key Path	AMPTD Y Scale, I Range   Q Range
Initial S/W Revision	Prior to A.02.00



## Q Range Value

This is the internal gain range for the Q channel. See "[I/Q Gain Ranges](#)" on page 2807. The Q Range only applies to Input Path Q Only and Ind I/Q. For input I+jQ the I Range determines both I and Q channel range settings.

Key Path	AMPTD Y Scale, Range
Remote Command	<code>[ :SENSe ] :VOLTage:IQ:Q:RANGe [ :UPPer ] &lt;voltage&gt;</code> <code>[ :SENSe ] :VOLTage:IQ:Q:RANGe [ :UPPer ] ?</code>
Example	Set the Q Range to 0.5 V Peak <code>VOLT:IQ:Q:RANG 0.5 V</code>
Notes	The numeric entries are mapped to the smallest gain range whose break point is greater than or equal to the value, or 1 V Peak if the value is greater than 1 V. The Q Range is only used for Input Path Q Only and Ind I/Q. For input I+jQ the I Range determines both I and Q channel range settings.
Couplings	When Q Same as I is On, the I Range value will be copied to the Q Range and the range value keys are disabled. Changing the value will also set Range = Man.
Preset	1 V Peak
State Saved	Saved in instrument state
Range	1 V Peak   0.5 V Peak   0.25 V Peak   0.125 V Peak
Min	0.125 V
Max	1 V
Initial S/W Revision	Prior to A.02.00

Remote Command	<code>[ :SENSe ] :POWer:IQ:Q:RANGe [ :UPPer ] &lt;amp;lt;math&gt;1\text{ dBm}&lt;/math&gt;</code> <code>[ :SENSe ] :POWer:IQ:Q:RANGe [ :UPPer ] ?</code>
Example	Will set the Q Range to 0.5 V Peak when Reference Z is 50Ω, and to 1.0 V Peak when Reference Z is 75Ω. <code>POW:IQ:Q:RANG 4 dBm</code>
Notes	The POWER form of the command is provided for convenience. It maps to the same underlying gain range parameter as the VOLTage form of the command. The Reference Z (not the Q channel Input Z) is used to convert the power to peak voltage, which is then used to set the Q Range as with the VOLTage form of the command. The power values of the 4 range states (1V Peak, 0.5V Peak, 0.25V Peak, and 0.125V Peak) will vary with Reference Z. Here are some examples: 50Ω: 10, 4, -2, -8 75Ω: 8.2, 2.2, -3.8, -9.8 600Ω: -0.8, -6.8, -12.8, -18.9
Preset	10.0 dBm

Range	-20 dBm to 10 dBm
Min	-20 dBm
Max	10 dBm
Initial S/W Revision	Prior to A.02.00

### Q Same as I

Many, but not all, usages require the I and Q channels to have an identical setup. To simplify channel setup, the Q Same as I will cause the Q channel range to be mirrored from the I channel. That way you only need to set up one channel (the I channel). The I channel values are copied to the Q channel, so at the time Q Same as I is Off, the I and Q channel setups will be identical.

Key Path	AMPTD Y Scale, Range, Q Range
Remote Command	[ :SENSe ] :VOLTage   POWer : IQ : MIRRored OFF   ON   0   1 [ :SENSe ] :VOLTage   POWer : IQ : MIRRored ?
Example	Turn off the mirroring of I Range to Q Range. VOLT:IQ:MIRR OFF POW:IQ:MIRR OFF
Couplings	When On, the I Range value is mirrored (copied) to the Q Range.
Preset	On
State Saved	Saved in instrument state.
Range	On   Off
Readback Text	"Q Same as I" when On, otherwise none.
Initial S/W Revision	Prior to A.02.00

### 1 V Peak

Set the channel gain state to 1 Volt Peak.

Key Path	AMPTD Y Scale, I Range   Q Range
Initial S/W Revision	Prior to A.02.00

### 0.5 V Peak

Set the channel gain state to 0.5 Volt Peak.

Key Path	AMPTD Y Scale, I Range   Q Range
Initial S/W Revision	Prior to A.02.00

### 0.25 V Peak

Set the channel gain state to 0.25 Volt Peak.

---

Key Path	AMPTD Y Scale, I Range   Q Range
Initial S/W Revision	Prior to A.02.00

---

### 0.125 V Peak

Set the channel gain state to 0.125 Volt Peak.

---

Key Path	AMPTD Y Scale, I Range   Q Range
Initial S/W Revision	Prior to A.02.00

---

### I/Q Gain Ranges

See the following sections:

["1 V Peak" on page 2807](#)

["0.5 V Peak" on page 2807](#)

["0.25 V Peak" on page 2807](#)

["0.125 V Peak" on page 2808](#)

### 1 V Peak

Set the channel gain state to 1 Volt Peak.

---

Key Path	AMPTD Y Scale, I Range   Q Range
Initial S/W Revision	Prior to A.02.00

---

### 0.5 V Peak

Set the channel gain state to 0.5 Volt Peak.

---

Key Path	AMPTD Y Scale, I Range   Q Range
Initial S/W Revision	Prior to A.02.00

---

### 0.25 V Peak

Set the channel gain state to 0.25 Volt Peak.

---

Key Path	AMPTD Y Scale, I Range   Q Range
Initial S/W Revision	Prior to A.02.00

---

## 0.125 V Peak

Set the channel gain state to 0.125 Volt Peak.

Key Path	AMPTD Y Scale, I Range   Q Range
Initial S/W Revision	Prior to A.02.00

## Ref Value

Sets the absolute power reference value. However, since Auto Scaling is defaulted to On, this value is automatically determined by the measurement result. When you set a value manually, Auto Scaling automatically changes to Off.

This functionality depends on the selected view:

- ["Ref Value \(RF Envelope View\)" on page 2808](#)
- ["Ref Value \(I/Q Waveform View\)" on page 2809](#)

## Ref Value (RF Envelope View)

Sets the Y Scale reference value (in dBm) when the RF Envelope View is active. By default, the measurement determines the reference value with Auto Scaling. Entering a reference value manually turns Auto Scaling off.

Key Path	AMPTD Y Scale
Mode	BASIC, PNOISE, WCDMA, C2K, GSM, WIMAXOFDMA, TDSCDMA, 1XEVD0, DVB, DTMB, ISDBT, CMMB, LTE, LTETDD, DCATV, WLAN, LTEATDD, LTEAFDD
Remote Command	:DISPlay:WAVeform:VIEW[1]:WINDow[1]:TRACe:Y[:SCALe]:RLEVel <ampl> :DISPlay:WAVeform:VIEW[1]:WINDow[1]:TRACe:Y[:SCALe]:RLEVel?
Example	DISP:WAV:VIEW:WIND:TRAC:Y:RLEV -50 dBm DISP:WAV:VIEW:WIND:TRAC:Y:RLEV?
Notes	You must be in the mode that includes Waveform measurement to use this command. Use INSTRument:SElect to set the mode.
Couplings	When Auto Scaling is On, this value is automatically determined by the measurement result. When you set a value manually, Auto Scaling automatically changes to Off.
Preset	10.00 dBm
State Saved	Saved in instrument state.
Range	-250.00 dBm to 250.00 dBm
Min	-250.00 dBm
Max	250.00 dBm
Initial S/W Revision	Prior to A.02.00
Modified at S/W Revision	A.03.00

## Ref Value (I/Q Waveform View)

Sets the Y Scale reference value (in volts) when the I/Q Waveform View is active. By default, the measurement determines the reference value with Auto Scaling. Entering a reference value manually turns Auto Scaling off.

Key Path	AMPTD Y Scale
Mode	BASIC, PNOISE, WCDMA, C2K, GSM, WIMAXOFDMA, TDSCDMA, 1XEVD0, DVB, DTMB, ISDB-T, CMMB, LTE, LTETDD, DCATV, WLAN, LTEATDD, LTEAFDD
Remote Command	:DISPlay:WAVeform:VIEW2:WINDow[1]:TRACe:Y[:SCALE]:RLEVel <voltage> :DISPlay:WAVeform:VIEW2:WINDow[1]:TRACe:Y[:SCALE]:RLEVel?
Example	DISP:WAV:VIEW2:WIND:TRAC:Y:RLEV 25 V DISP:WAV:VIEW2:WIND:TRAC:Y:RLEV?
Notes	You must be in a mode that includes the Waveform measurement to use this command. Use INSTRument:SElect to set the mode.
Couplings	When Auto Scaling is On, this value is automatically determined by the measurement result. When you set a value manually, Auto Scaling automatically changes to Off.
Preset	0 V
State Saved	Saved in instrument state.
Min	-250 V
Max	250 V
Initial S/W Revision	Prior to A.02.00
Modified at S/W Revision	A.03.00

## Scale/Div

Sets the units per division of vertical scale in the logarithmic display. However, since Auto Scaling is defaulted to On, this value is automatically determined by the measurement result. When you set a value manually, Auto Scaling automatically changes to Off.

This functionality depends on the selected view:

- ["Scale/Div \(RF Envelope View\)" on page 2809](#)
- ["Scale/Div \(I/Q Waveform View\)" on page 2810](#)

## Scale/Div (RF Envelope View)

Sets the scale per division for the RF Envelope result waveform (time domain) measurements in the graph window.

Key Path	AMPTD Y Scale
Mode	BASIC, PNOISE, WCDMA, C2K, GSM, WIMAXOFDMA, TDSCDMA, 1XEVD0, DVB, DTMB, ISDBT, CMMB, LTE, LTETDD, DCATV, WLAN, LTEATDD, LTEAFDD
Remote Command	:DISPlay:WAVeform:VIEW[1]:WINDow[1]:TRACe:Y[:SCALE]:PDIVision <rel_

	<pre> ampl&gt; :DISPlay:WAVeform:VIEW[1]:WINDow[1]:TRACe:Y[:SCALe]:PDIVision? </pre>
<b>Example</b>	<pre> DISP:WAV:VIEW:WIND:TRAC:Y:PDIV 5 DISP:WAV:VIEW:WIND:TRAC:Y:PDIV? </pre>
<b>Notes</b>	You must be in a mode that includes the Waveform measurement to use this command. Use INSTRUMENT:SELEct to set the mode.
<b>Couplings</b>	When Auto Scaling is On, this value is automatically determined by the measurement result. When you set a value manually, Auto Scaling automatically changes to Off.
<b>Preset</b>	10.00 dB
<b>State Saved</b>	Saved in instrument state.
<b>Range</b>	0.10 dB to 20.00 dB
<b>Min</b>	0.10 dB
<b>Max</b>	20.00 dB
<b>Initial S/W Revision</b>	Prior to A.02.00
<b>Modified at S/W Revision</b>	A.03.00

### Scale/Div (I/Q Waveform View)

Sets the scale per division for the I/Q signal waveform graph.

<b>Key Path</b>	AMPTD Y Scale
<b>Mode</b>	BASIC, PNOISE, WCDMA, C2K, GSM, WIMAXOFDMA, TDSCDMA, 1XEVD0, DVB, DTMB, ISDBT, CMMB, LTE, LTETDD, DCATV, WLAN,LTEATDD, LTEAFDD
<b>Remote Command</b>	<pre> :DISPlay:WAVeform:VIEW2:WINDow[1]:TRACe:Y[:SCALe]:PDIVision &lt;voltage&gt; :DISPlay:WAVeform:VIEW2:WINDow[1]:TRACe:Y[:SCALe]:PDIVision? </pre>
<b>Example</b>	<pre> DISP:WAV:VIEW2:WIND:TRAC:Y:PDIV 25mV DISP:WAV:VIEW2:WIND:TRAC:Y:PDIV? </pre>
<b>Notes</b>	You must be in a mode that includes the Waveform measurement to use this command. Use INSTRUMENT:SELEct to set the mode.
<b>Couplings</b>	When Auto Scaling is On, this value is automatically determined by the measurement result. When you set a value manually, Auto Scaling automatically changes to Off.
<b>Preset</b>	100.0 mV
<b>State Saved</b>	Saved in instrument state.
<b>Min</b>	1.0 nV
<b>Max</b>	20 V
<b>Initial S/W Revision</b>	Prior to A.02.00
<b>Modified at S/W Revision</b>	A.03.00

## Ref Position

Positions the reference level at the top, center or bottom of the Y Scale display. Changing the reference position does not change the reference level value.

This functionality depends on the selected view:

- "Ref Position (RF Envelope View)" on page 2811
- "Ref Position (I/Q Waveform View)" on page 2811

### Ref Position (RF Envelope View)

Positions the reference level at the top, center or bottom of the Y Scale display. Changing the reference position does not change the reference level value.

Key Path	AMPTD Y Scale
Mode	BASIC, PNOISE, WCDMA, C2K, GSM, WIMAXOFDMA, TDSCDMA, 1XEVD0, DVB, DTMB, ISDBT, CMMB, LTE, LTETDD, DCATV, WLAN,LTEATDD, LTEAFDD
Remote Command	:DISPlay:WAVeform:VIEW[1]:WINDow[1]:TRACe:Y[:SCALE]:RPOSition TOP   CENTER   BOTTom :DISPlay:WAVeform:VIEW[1]:WINDow[1]:TRACe:Y[:SCALE]:RPOSition?
Example	DISP:WAV:VIEW:WIND:TRAC:Y:RPOS CENT DISP:WAV:VIEW:WIND:TRAC:Y:RPOS?
Notes	You must be in a mode that includes the Waveform measurement to use this command. Use INSTRument:SElect to set the mode.
Preset	TOP
State Saved	Saved in instrument state.
Range	Top Ctr Bot
Initial S/W Revision	Prior to A.02.00
Modified at S/W Revision	A.03.00

### Ref Position (I/Q Waveform View)

Positions the reference level at the top, center or bottom of the Y Scale display. Changing the reference position does not change the reference level value.

Key Path	AMPTD Y Scale
Mode	BASIC, PNOISE, WCDMA, C2K, GSM, WIMAXOFDMA, TDSCDMA, 1XEVD0, DVB, DTMB, ISDBT, CMMB, LTE, LTETDD, DCATV, WLAN,LTEATDD, LTEAFDD
Remote Command	:DISPlay:WAVeform:VIEW2:WINDow[1]:TRACe:Y[:SCALE]:RPOSition TOP   CENTER   BOTTom :DISPlay:WAVeform:VIEW2:WINDow[1]:TRACe:Y[:SCALE]:RPOSition?
Example	DISP:WAV:VIEW2:WIND:TRAC:Y:RPOS CENT DISP:WAV:VIEW2:WIND:TRAC:Y:RPOS?

Notes	You must be in a mode that includes the Waveform measurement to use this command. Use INSTRument:SElect to set the mode.
Preset	CENT
State Saved	Saved in instrument state.
Range	Top Ctr Bot
Initial S/W Revision	Prior to A.02.00
Modified at S/W Revision	A.03.00



## Auto Couple

The Auto Couple feature provides a quick and convenient way to automatically couple multiple instrument settings. This helps ensure accurate measurements and optimum dynamic range. When the Auto Couple feature is activated, either from the front panel or remotely, all parameters of the current measurement that have an Auto/Manual mode are set to Auto mode and all measurement settings dependent on (or coupled to) the Auto/Man parameters are automatically adjusted for optimal performance.

However, the Auto Couple key actions are confined to the current measurement only. It does not affect other measurements in the mode, and it does not affect markers, marker functions, or trace or display attributes.

See ["More Information" on page 2813](#)

Key Path	Front-panel key
Remote Command	:COUPle ALL NONE
Example	:COUP ALL
Notes	:COUPle ALL puts all Auto/Man parameters in Auto mode (equivalent to pressing the Auto Couple key). :COUPLE NONE puts all Auto/Man parameters in manual mode. It decouples all the coupled instrument parameters and is not recommended for making measurements.
Initial S/W Revision	Prior to A.02.00

### More Information

There are two types of functions that have Auto/Manual modes.

#### Auto/Man Active Function keys

An Auto/Man toggle key controls the binary state associated with an instrument parameter by toggling between Auto (where the parameter is automatically coupled to the other parameters it is dependent upon) and Man (where the parameter is controlled independent of the other parameters), as well as making the parameter the active function. The current mode is indicated on the softkey with either Auto or Man underlined as illustrated below.



#### Auto/Man 1-of-N keys

An Auto/Man 1-of-N key allows you to manually pick from a list of parameter values, or place the function in Auto, in which case the value is automatically selected (and indicated) as shown below. If in Auto, Auto is underlined on the calling key. If in manual operation, manual is indicated on the calling key. But the calling key does not actually toggle the function, it simply opens the menu.

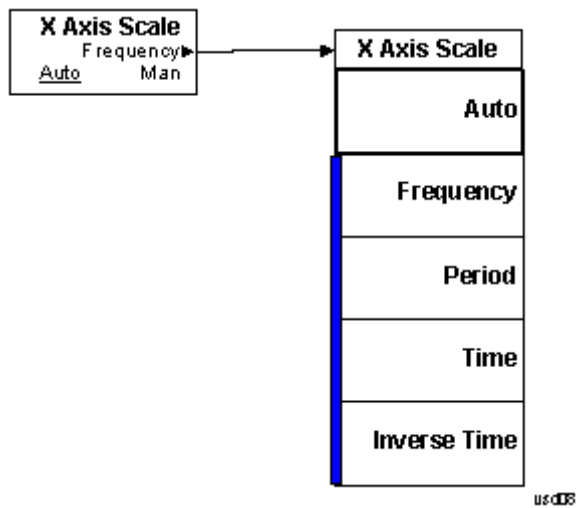

## BW

Accesses a menu that enables you to control the information bandwidth functions of the instrument. You can also select the filter type for the measurement.

Key Path	Front-panel key
Initial S/W Revision	Prior to A.02.00

## Digital IF BW

Enables you to set the Digital IF (formerly Info BW) bandwidth of the instrument.

Key Path	BW
Mode	BASIC, PNOISE, WCDMA, C2K, GSM, WIMAXOFDMA, TD-SCDMA, 1XEVD0, DVB, DTMB, ISDBT, CMMB, LTE, LTETDD, DCATV, WLAN, MSR,LTEATDD, LTEAFDD
Remote Command	<code>[ :SENSe ] :WAVeform :DIF :BANDwidth &lt;freq&gt;</code> <code>[ :SENSe ] :WAVeform :DIF :BANDwidth?</code>
Example	WAV:DIF:BAND 1kHz WAV:DIF:BAND?
Notes	Max value depends on the IF Path Selection
Remote Command Notes	You must be in a mode that includes the Waveform measurements to use this command. Use INSTRument:SElect to set the mode.
Dependencies	For applications that have the IF Path Selection menu such as the BASIC mode, if IF Path Auto is OFF, the maximum value depends on which IF Path is currently selected. If 10 MHz, 25 MHz, 40 MHz, 85 MHz, 125 MHz, 140 MHz or 160 MHz paths are selected, the maximum value of this parameter will be 10, 25, 40, 85, 125, 140 or 160 MHz, respectively. If IF Path Auto is ON, the maximum value will be the maximum Digital IF BW available in the instrument regardless of the current IF Path Selection. For example, if the instrument has the options B25, B40, and B1X installed, the maximum available Digital IF BW of the instrument is 140 MHz. Thus, if IF Path Auto is ON and IF Path Selection is 25 MHz, the maximum Digital IF BW is not limited to 25 MHz but is 140 MHz.
Preset	All except the following list: 100 kHz GSM/EDGE: 510 kHz TDSCDMA: 1.3 MHz 1xEVD0: 1.3 MHz DVB-T/H: 8.0 MHz DTMB (CTTB): 8.0 MHz ISDB-T: 6.0 MHz CMMB: 8.0 MHz Digital Cable TV: 8 MHz LTEAFDD, LTEATDD: 6 MHz LTETDD: 6 MHz

	WLAN: Hardware Dependent No option = 10 MHz Option B25 = 25 MHz Option B40: if Radio Std is 802.11a/b/g/n(20MHz) = 25 MHz if Radio Std is 802.11n(40MHz) = 40 MHz if Radio Std is 802.11ac(20MHz) = 25 MHz if Radio Std is 802.11ac(40MHz) = 40 MHz Option B1X: if Radio Std is 802.11ac(80MHz) = 80 MHz Option B1Y: if Radio Std is 802.11ac(160MHz) = 160 MHz
State Saved	Saved in instrument state.
Min	10 Hz
Max	Hardware Dependent: RF Input: No Option = 10 MHz Option B25 = 25 MHz Option B40 = 40 MHz Option B85 = 85.0 MHz Option B1A = 125.0 MHz Option B1X = 140 MHz Option B1Y = 160 MHz I/Q Input: No Option = 10 MHz per channel (20 MHz for I+jQ) Option B25 = 25 MHz per channel (50 MHz for I+jQ) Option S40 = 40 MHz per channel (80 MHz for I+jQ)
<b>Backwards Compatibility SCPI</b>	[:SENSe]:WAVEform:BWIDth[:RESolution]
Initial S/W Revision	Prior to A.02.00
Modified at S/W Revision	A.03.00, A.13.00

## Filter Type

Selects the type of bandwidth filter that is used.

Besides the Gaussian filter shape, a variety of other filter types are available with variable alpha settings for maximum control over the filter shape..

Key Path	BW
Mode	BASIC, PNOISE, WCDMA, C2K, GSM, WIMAXOFDMA, TDSCDMA, 1XEVD0, DVB, DTMB, ISDBT,

	CMMB, LTE, LTE40, DCATV, WLAN, MSR,,LTE40, LTEAFDD
<b>Remote Command</b>	[:SENSe]:WAVeform:DIF:FILTer:TYPE GAUSSian FLATtop [:SENSe]:WAVeform:DIF:FILTer:TYPE?  (With DIF40 and/or WBDIF) [:SENSe]:WAVeform:DIF:FILTer:TYPE GAUSSian   FLATtop   SNYQuist   RSNYquist   RCOSine   RRCosine [:SENSe]:WAVeform:DIF:FILTer:TYPE?
<b>Example</b>	WAV:DIF:FILT:TYPE GAUS WAV:DIF:FILT:TYPE?
Remote Command Notes	You must be in a mode that includes the Waveform measurements to use this command. Use INSTRument:SElect to set the mode.
Dependencies	Gaussian and FlatTop are available in all DIF configurations. For the other filter types, the filters are only available when Option DP2, B40, or wider IF Bandwidth option is installed.
Preset	BASIC with DP2, B40, or wider IF Bandwidth option: FLATtop All other apps: GAUSSian
State Saved	Saved in instrument state.
Range	Gaussian FlatTop When Option DP2, B40, or wider IF Bandwidth option is installed, the range is as follows. Gaussian FlatTop Short nyquist Root Short Nquist Raised Cosine Root RaisedCosine
<b>Backwards Compatibility SCPI</b>	[:SENSe]:WAVeform:BANDwidth:SHApe [:SENSe]:WAVeform:BWIDth:SHApe [:SENSe]:WAVeform:BANDwidth BWIDth[:RESolution]:TYPE
Initial S/W Revision	Prior to A.02.00
Modified at S/W Revision	A.03.00, A.13.00

## Filter BW

This feature is only available when Option DP2, B40, or wider IF Bandwidth option is installed.

<b>Key Path</b>	BW
<b>Mode</b>	BASIC
<b>Remote Command</b>	[:SENSe]:WAVeform:DIF:FILTer:BANDwidth <freq> [:SENSe]:WAVeform:DIF:FILTer:BANDwidth? [:SENSe]:WAVeform:DIF:FILTer:BANDwidth:AUTO ON OFF 1 0 [:SENSe]:WAVeform:DIF:FILTer:BANDwidth:AUTO?
<b>Example</b>	WAV:DIF:FILT:BAND 1MHz WAV:DIF:FILT:BAND? WAV:DIF:FILT:BAND:AUTO 0

	<b>WAV:DIF:FILT:BAND:AUTO?</b>
Notes	You must be in the IQ Analyzer (Basic) mode to use this command. Use INSTRUMENT:SElect to set the mode.
Dependencies	This feature is only available when Option DP2, B40, or wider IF Bandwidth option is installed.
Couplings	Sets the same value as the current Digital IF BW value upon a preset or when Channel Filter Bandwidth Auto is ON.
Preset	Same value as Digital IF BW ON
State Saved	Saved in instrument state.
Min	10 Hz
Max	Clipped to the current Digital IF BW value.
Initial S/W Revision	A.04.00, A.13.00

### Filter Alpha

Sets the filter alpha for the DIF filter. This feature is only available when Option DP2, B40, or wider IF Bandwidth option is installed.

Key Path	BW
Mode	BASIC
<b>Remote Command</b>	[ :SENSE ] :WAVeform:DIF:FILTer:ALPHa <real> [ :SENSE ] :WAVeform:DIF:FILTer:ALPHa?
<b>Example</b>	WAV:DIF:FILT:ALPH 0.5 WAV:DIF:FILT:ALPH?
Notes	You must be in the IQ Analyzer (Basic) mode to use this command. Use INSTRUMENT:SElect to set the mode.
Dependencies	This feature is only available when Option DP2, B40, or wider IF Bandwidth option is installed.
Preset	0.2
State Saved	Saved in instrument state.
Min	0.01
Max	1.00
<b>Backwards Compatibility SCPI</b>	[ :SENSE ] :WAVeform:WBIF:FILTer:ALPHa
Modified at S/W Revision	A.13.00

### Filter Type Bwcc

This parameter is strictly for Bwcc purposes.

<b>Remote Command</b>	[ :SENSe ] :WAVeform:WBIF:FILTer[:TYPE] GAUSSian   NONE   NYQuist   RNYQuist   RCOSine   RRCosine  [ :SENSe ] :WAVeform:WBIF:FILTer[:TYPE] ?
<b>Preset</b>	BASIC with Option DP2, B40, or wider IF Bandwidth option: FLATtop All other apps: GAUSSian

## Gaussian

When Option DP2, B40, or wider IF Bandwidth option is installed, the capability for arbitrary Digital IF bandwidths is available. However, for instruments without DP2, B40, or wider IF Bandwidth option, the selectable Gaussian filter bandwidths are predetermined as shown in the following list. There are 160 Info BWs (RBWs) arranged in a 24-per-decade sequence from 1 Hz through 3 MHz, plus the 4, 5, 6 and 8 MHz settings.

The following table list all 160 Gaussian filter types

### Gaussian filters

<b>Normal (-3 dB)</b>	<b>-6 dB</b>	<b>Noise</b>	<b>Impulse</b>
1.0 Hz	1.41 Hz	1.06 Hz	1.49 Hz
1.1 Hz	1.55 Hz	1.16 Hz	1.63 Hz
1.2 Hz	1.69 Hz	1.27 Hz	1.77 Hz
1.3 Hz	1.83 Hz	1.37 Hz	1.92 Hz
1.5 Hz	2.11 Hz	1.59 Hz	2.22 Hz
1.6 Hz	2.25 Hz	1.69 Hz	2.37 Hz
1.8 Hz	2.53 Hz	1.90 Hz	2.66 Hz
2.0 Hz	2.81 Hz	2.12 Hz	2.96 Hz
2.2 Hz	3.09 Hz	2.33 Hz	3.25 Hz
2.4 Hz	3.38 Hz	2.54 Hz	3.55 Hz
2.7 Hz	3.80 Hz	2.86 Hz	3.99 Hz
3.0 Hz	4.22 Hz	3.17 Hz	4.44 Hz
3.3 Hz	4.64 Hz	3.49 Hz	4.88 Hz
3.6 Hz	5.06 Hz	3.81 Hz	5.32 Hz
3.9 Hz	5.49 Hz	4.12 Hz	5.77 Hz
4.3 Hz	6.05 Hz	4.55 Hz	6.36 Hz
4.7 Hz	6.61 Hz	4.97 Hz	6.95 Hz
5.1 Hz	7.17 Hz	5.39 Hz	7.54 Hz
5.6 Hz	7.87 Hz	5.92 Hz	8.27 Hz
6.2 Hz	8.72 Hz	6.56 Hz	9.17 Hz

21 Waveform Measurement  
BW

6.8 Hz	9.55 Hz	7.18 Hz	10.0 Hz
7.5 Hz	10.5 Hz	7.93 Hz	11.1 Hz
8.2 Hz	11.5 Hz	8.66 Hz	12.1 Hz
9.1 Hz	12.8 Hz	9.64 Hz	13.5 Hz
10 Hz	14.0 Hz	10.6 Hz	14.8 Hz
11 Hz	15.4 Hz	11.6 Hz	16.2 Hz
12 Hz	16.9 Hz	12.7 Hz	17.7 Hz
13 Hz	18.3 Hz	13.7 Hz	19.2 Hz
15 Hz	21.1 Hz	15.9 Hz	22.2 Hz
16 Hz	22.5 Hz	16.9 Hz	23.7 Hz
18 Hz	25.3 Hz	19.1 Hz	26.6 Hz
20 Hz	28.1 Hz	21.1 Hz	29.5 Hz
22 Hz	30.9 Hz	23.2 Hz	32.5 Hz
24 Hz	33.8 Hz	25.4 Hz	35.5 Hz
27 Hz	38.0 Hz	28.6 Hz	40.0 Hz
30 Hz	42.3 Hz	31.8 Hz	44.5 Hz
33 Hz	46.3 Hz	34.8 Hz	48.7 Hz
36 Hz	50.7 Hz	38.1 Hz	53.3 Hz
39 Hz	54.9 Hz	41.3 Hz	57.7 Hz
43 Hz	60.5 Hz	45.5 Hz	63.6 Hz
47 Hz	66.1 Hz	49.7 Hz	69.5 Hz
51 Hz	71.7 Hz	53.9 Hz	75.3 Hz
56 Hz	78.9 Hz	59.3 Hz	83.0 Hz
62 Hz	87.3 Hz	65.6 Hz	91.7 Hz
68 Hz	95.5 Hz	71.8 Hz	100 Hz
75 Hz	106 Hz	79.4 Hz	111 Hz
82 Hz	115 Hz	86.8 Hz	121 Hz
91 Hz	128 Hz	96.4 Hz	135 Hz
100 Hz	141 Hz	106 Hz	148 Hz
110 Hz	154 Hz	116 Hz	162 Hz
120 Hz	169 Hz	127 Hz	178 Hz
130 Hz	183 Hz	137 Hz	192 Hz
150 Hz	211 Hz	159 Hz	222 Hz
160 Hz	225 Hz	169 Hz	237 Hz
180 Hz	253 Hz	190 Hz	266 Hz
200 Hz	281 Hz	211 Hz	295 Hz
220 Hz	309 Hz	232 Hz	325 Hz



240 Hz	337 Hz	254 Hz	355 Hz
270 Hz	380 Hz	286 Hz	400 Hz
300 Hz	422 Hz	317 Hz	444 Hz
330 Hz	463 Hz	348 Hz	487 Hz
360 Hz	507 Hz	381 Hz	533 Hz
390 Hz	550 Hz	413 Hz	578 Hz
430 Hz	605 Hz	455 Hz	636 Hz
470 Hz	662 Hz	498 Hz	696 Hz
510 Hz	718 Hz	540 Hz	755 Hz
560 Hz	789 Hz	593 Hz	829 Hz
620 Hz	872 Hz	655 Hz	916 Hz
680 Hz	958 Hz	720 Hz	1.01 kHz
750 Hz	1.06 kHz	794 Hz	1.11 kHz
820 Hz	1.15 kHz	866 Hz	1.21 kHz
910 Hz	1.28 kHz	964 Hz	1.35 kHz
1.0 kHz	1.41 kHz	1.06 kHz	1.48 kHz
1.1 kHz	1.55 kHz	1.17 kHz	1.63 kHz
1.2 kHz	1.69 kHz	1.27 kHz	1.78 kHz
1.3 kHz	1.83 kHz	1.38 kHz	1.93 kHz
1.5 kHz	2.11 kHz	1.59 kHz	2.22 kHz
1.6 kHz	2.26 kHz	1.70 kHz	2.37 kHz
1.8 kHz	2.54 kHz	1.91 kHz	2.67 kHz
2.0 kHz	2.82 kHz	2.12 kHz	2.96 kHz
2.2 kHz	3.10 kHz	2.33 kHz	3.26 kHz
2.4 kHz	3.38 kHz	2.54 kHz	3.56 kHz
2.7 kHz	3.80 kHz	2.86 kHz	4.00 kHz
3.0 kHz	4.23 kHz	3.18 kHz	4.44 kHz
3.3 kHz	4.65 kHz	3.49 kHz	4.89 kHz
3.6 kHz	5.06 kHz	3.81 kHz	5.32 kHz
3.9 kHz	5.48 kHz	4.12 kHz	5.76 kHz
4.3 kHz	6.07 kHz	4.56 kHz	6.38 kHz
4.7 kHz	6.62 kHz	4.98 kHz	6.96 kHz
5.1 kHz	7.16 kHz	5.38 kHz	7.53 kHz
5.6 kHz	7.87 kHz	5.92 kHz	8.27 kHz
6.2 kHz	8.74 kHz	6.57 kHz	9.18 kHz
6.8 kHz	9.58 kHz	7.20 kHz	10.1 kHz
7.5 kHz	10.5 kHz	7.92 kHz	11.1 kHz

8.2 kHz	11.5 kHz	8.66 kHz	12.1 kHz
9.1 kHz	12.8 kHz	9.64 kHz	13.5 kHz
10 kHz	14.1 kHz	10.6 kHz	14.8 kHz
11 kHz	15.4 kHz	11.6 kHz	16.2 kHz
12 kHz	16.9 kHz	12.7 kHz	17.8 kHz
13 kHz	18.3 kHz	13.7 kHz	19.2 kHz
15 kHz	21.2 kHz	15.9 kHz	22.3 kHz
16 kHz	22.4 kHz	16.8 kHz	23.5 kHz
18 kHz	25.2 kHz	19.0 kHz	26.5 kHz
20 kHz	28.4 kHz	21.3 kHz	29.8 kHz
22 kHz	31.2 kHz	23.4 kHz	32.8 kHz
24 kHz	33.8 kHz	25.4 kHz	35.6 kHz
27 kHz	38.1 kHz	28.7 kHz	40.1 kHz
30 kHz	42.1 kHz	31.7 kHz	44.3 kHz
33 kHz	46.8 kHz	35.2 kHz	49.2 kHz
36 kHz	50.1 kHz	37.7 kHz	52.7 kHz
39 kHz	54.8 kHz	41.2 kHz	57.6 kHz
43 kHz	61.1 kHz	46.0 kHz	64.3 kHz
47 kHz	66.2 kHz	49.8 kHz	69.6 kHz
51 kHz	72.3 kHz	54.3 kHz	76.0 kHz
56 kHz	79.5 kHz	59.8 kHz	83.6 kHz
62 kHz	86.3 kHz	64.9 kHz	90.8 kHz
68 kHz	96.5 kHz	72.6 kHz	101 kHz
75 kHz	106 kHz	79.7 kHz	111 kHz
82 kHz	114 kHz	86.0 kHz	120 kHz
91 kHz	129 kHz	97.3 kHz	136 kHz
100 kHz	140 kHz	105 kHz	147 kHz
110 kHz	154 kHz	116 kHz	162 kHz
120 kHz	169 kHz	127 kHz	178 kHz
130 kHz	182 kHz	137 kHz	192 kHz
150 kHz	210 kHz	158 kHz	221 kHz
160 kHz	223 kHz	168 kHz	235 kHz
180 kHz	253 kHz	190 kHz	266 kHz
200 kHz	280 kHz	211 kHz	295 kHz
220 kHz	308 kHz	232 kHz	324 kHz
240 kHz	336 kHz	253 kHz	353 kHz
270 kHz	380 kHz	286 kHz	400 kHz

300 kHz	420 kHz	316 kHz	441 kHz
330 kHz	467 kHz	352 kHz	491 kHz
360 kHz	506 kHz	380 kHz	532 kHz
390 kHz	550 kHz	414 kHz	578 kHz
430 kHz	599 kHz	451 kHz	629 kHz
470 kHz	660 kHz	497 kHz	693 kHz
510 kHz	715 kHz	538 kHz	750 kHz
560 kHz	786 kHz	592 kHz	826 kHz
620 kHz	867 kHz	653 kHz	912 kHz
680 kHz	952 kHz	717 kHz	1.00 MHz
750 kHz	1.05 MHz	791 kHz	1.10 MHz
820 kHz	1.14 MHz	859 kHz	1.19 MHz
910 kHz	1.27 MHz	960 kHz	1.34 MHz
1.0 MHz	1.40 MHz	1.06 MHz	1.47 MHz
1.1 MHz	1.53 MHz	1.15 MHz	1.61 MHz
1.2 MHz	1.66 MHz	1.26 MHz	1.75 MHz
1.3 MHz	1.80 MHz	1.36 MHz	1.89 MHz
1.5 MHz	2.06 MHz	1.56 MHz	2.17 MHz
1.6 MHz	2.19 MHz	1.66 MHz	2.29 MHz
1.8 MHz	2.51 MHz	1.91 MHz	2.63 MHz
2.0 MHz	2.75 MHz	2.10 MHz	2.88 MHz
2.2 MHz	3.00 MHz	2.30 MHz	3.14 MHz
2.4 MHz	3.30 MHz	2.54 MHz	3.45 MHz
2.7 MHz	3.63 MHz	2.81 MHz	3.78 MHz
3.0 MHz	4.09 MHz	3.18 MHz	4.22 MHz
4 MHz	5.30 MHz	4.23 MHz	5.30 MHz
5 MHz	5.78 MHz	4.81 MHz	5.41 MHz
6 MHz	6.31 MHz	5.50 MHz	5.82 MHz
8 MHz	8.07 MHz	7.21 MHz	6.90 MHz

## Flattop

When Option DP2, B40, or wider IF Bandwidth option is installed, the capability for arbitrary Digital IF bandwidths is available. However, for instruments without Option DP2, B40 or wider IF Bandwidth option, the selectable Flattop filter bandwidths are predefined as shown in the following table. There are 134 Digital IF BWs (RBWs).

The table in the section ["Flattop Filters" on page 2824](#) lists all 134 Flattop filter types.

### Flattop Filters

3.0 Hz	3.3 Hz	3.6 Hz	3.9 Hz
4.3 Hz	4.7 Hz	5.1 Hz	5.6 Hz
6.2 Hz	6.8 Hz	7.5 Hz	8.2 Hz
9.1 Hz	10 Hz	11 Hz	12 Hz
13 Hz	15 Hz	16 Hz	18 Hz
20 Hz	22 Hz	24 Hz	27 Hz
30 Hz	33 Hz	36 Hz	39 Hz
43 Hz	47 Hz	51 Hz	56 Hz
62 Hz	68 Hz	75 Hz	82 Hz
91 Hz	100 Hz	110 Hz	120 Hz
130 Hz	150 Hz	160 Hz	180 Hz
200 Hz	220 Hz	240 Hz	270 Hz
300 Hz	330 Hz	360 Hz	390 Hz
430 Hz	470 Hz	510 Hz	560 Hz
620 Hz	680 Hz	750 Hz	820 Hz
910 Hz	1.0 kHz	1.1 kHz	1.2 kHz
1.3 kHz	1.5 kHz	1.6 kHz	1.8 kHz
2.0 kHz	2.2 kHz	2.4 kHz	2.7 kHz
3.0 kHz	3.3 kHz	3.6 kHz	3.9 kHz
4.3 kHz	4.7 kHz	5.1 kHz	5.6 kHz
6.2 kHz	6.8 kHz	7.5 kHz	8.2 kHz
9.1 kHz	10 kHz	11 kHz	12 kHz
13 kHz	15 kHz	16 kHz	18 kHz
20 kHz	22 kHz	24 kHz	27 kHz
30 kHz	33 kHz	36 kHz	39 kHz
43 kHz	47 kHz	51 kHz	56 kHz
62 kHz	68 kHz	75 kHz	82 kHz
91 kHz	100 kHz	110 kHz	120 kHz
130 kHz	150 kHz	160 kHz	180 kHz
200 kHz	220 kHz	240 kHz	270 kHz
300 kHz	330 kHz	390 kHz	430 kHz
510 kHz	620 kHz	750 kHz	1.0 MHz
1.5 MHz	3.0 MHz	4 MHz	5 MHz
6 MHz	8 MHz		

## Channel Filter Bandwidth Bwcc (Remote Command Only)

This is the backward compatibility command for Channel Filter Bandwidth.

Mode	BASIC
<b>Remote Command</b>	[ :SENSe ] :WAVeform:WBIF:FILTer:BA NDwidth <real> [ :SENSe ] :WAVeform:WBIF:FILTer:BA NDwidth?
<b>Example</b>	WAV:WBIF:FILT:BA ND 0.3 WAV:WBIF:FILT:BA ND?
Notes	You must be in the IQ Analyzer (Basic) mode to use this command. Use INSTRument:SElect to set the mode.
Dependencies	This feature is only available when Option DP2, B40, or wider IF Bandwidth option is installed.
Couplings	The value is determined by the following equation. $\text{ChannelFilterBwBwcc} = (\text{ChannelFilterBw} / (\text{DigitalIFBw} * \text{OverSampleRatio}))$
Preset	0.8
State Saved	Saved in instrument state.
Min	0.01
Max	1.0
Initial S/W Revision	A.04.00
Modified at S/W Revision	A.13.00

## Cont (Continuous Measurement/Sweep)

Sets the analyzer for Continuous measurement operation. The single/continuous state is Meas Global so the setting will affect all measurements. If you are Paused, pressing Cont does a Resume.

<b>Key Path</b>	Front-panel key
<b>Remote Command</b>	:INITiate:CONTinuous OFF ON 0 1 :INITiate:CONTinuous?
<b>Example</b>	:INIT:CONT 0 puts analyzer in Single measurement operation. :INIT:CONT 1 puts analyzer in Continuous measurement operation
<b>Preset</b>	ON (Note that SYST:PRESet sets INIT:CONT to ON but *RST sets INIT:CONT to OFF)
<b>State Saved</b>	Saved in instrument state
<b>Backwards Compatibility Notes</b>	For Spectrum Analysis mode in ESA and PSA, there is no Cont hardkey, instead there is a Sweep Single/Cont key. In these analyzers, switching the Sweep Single/Cont key from Single to Cont restarts averages (displayed average count reset to 1), but does not restart Max Hold and Min Hold. The X-Series has Single and Cont keys in place of the SweepSingleCont key. In the X-Series, if in single measurement, the Cont key (and INIT:CONT ON ) switches to continuous measurement, but never restarts a measurement and never resets a sweep.
<b>Initial S/W Revision</b>	Prior to A.02.00

In Swept SA Measurement (Spectrum Analysis Mode):

The analyzer takes repetitive sweeps, averages, measurements, etc., when in Continuous mode. When the average count reaches the Average/Hold Number the count stops incrementing, but the analyzer keeps sweeping. See the Trace/Detector section for the averaging formula used both before and after the Average/Hold Number is reached. The trigger condition must be met prior to each sweep. The type of trace processing for multiple sweeps, is set under the Trace/Detector key, with choices of Trace Average, Max Hold, or Min Hold.

In Other Measurements/Modes:

With Avg/Hold Num (in the Meas Setup menu) set to Off or set to On with a value of 1, a sweep is taken after the trigger condition is met; and the analyzer continues to take new sweeps after the current sweep has completed and the trigger condition is again met. However, with Avg/Hold Num set to On with a value >1, multiple sweeps (data acquisitions) are taken for the measurement. The trigger condition must be met prior to each sweep. The sweep is not stopped when the average count k equals the number N set for Avg/Hold Num is reached, but the number k stops incrementing. A measurement average usually applies to all traces, marker results, and numeric results. But sometimes it only applies to the numeric results.

If the analyzer is in Single measurement, pressing the Cont key does not change k and does not cause the sweep to be reset; the only action is to put the analyzer into Continuous measurement operation.

If it is already in continuous sweep:

the INIT:CONT 1 command has no effect

the INIT:CONT 0 command will place the analyzer in Single Sweep but will have no effect on the current sequence until  $k = N$ , at which point the current sequence will stop and the instrument will go to the idle state.

21 Waveform Measurement  
File

File

See "File" on page 354



## FREQ Channel

Accesses a menu of keys that allow you to control the Frequency and Channel parameters of the instrument.

Some features in the Frequency menu are the same for all measurements – they do not change as you change measurements. Settings like these are called “Meas Global” and are unaffected by Meas Preset. For example, the Center Freq setting is the same for all measurements – it does not change as you change measurements.

<b>Key Path</b>	Front-panel key
<b>Initial S/W Revision</b>	Prior to A.02.00

### Center Freq

Sets the frequency that corresponds to the horizontal center of the graticule (when frequency Scale Type is set to linear). While adjusting the Center Frequency the Span is held constant, which means that both Start Frequency and Stop Frequency will change.

Pressing Center Freq also sets the frequency entry mode to Center/Span. In Center/Span mode, the center frequency and span values are displayed below the graticule, and the default active function in the Frequency menu is Center Freq.

The center frequency setting is the same for all measurements within a mode, that is, it is Meas Global. Some modes are also able to share a Mode Global center frequency value. If this is the case, the Mode will have a Global Settings key in its Mode Setup menu.

The Center Freq function sets (and queries) the Center Frequency for the currently selected input. If your analyzer has multiple inputs, and you select another input, the Center Freq changes to the value for that input. SCPI commands are available to directly set the Center Freq for a specific input.

Center Freq is remembered as you go from input to input. Thus you can set a Center Freq of 10 GHz with the RF Input selected, change to BBIQ and set a Center Freq of 20 MHz, then switch to External Mixing and set a Center Freq of 60 GHz, and when you go back to the RF Input the Center Freq will go back to 10 GHz; back to BBIQ and it is 20 MHz; back to External Mixing and it is 60 GHz.

See ["RF Center Freq" on page 2832](#)

See [Ext Mix Center Freq](#)

See ["I/Q Center Freq" on page 2834](#)

See ["Center Frequency Presets" on page 2830](#)

<b>Key Path</b>	FREQ Channel
<b>Scope</b>	Meas Global
<b>Remote Command</b>	[ :SENSe ] :FREQuency :CENTer <freq> [ :SENSe ] :FREQuency :CENTer ?

<b>Example</b>	FREQ:CENT 50 MHz FREQ:CENT UP changes the center frequency to 150 MHz if you use FREQ:CENT:STEP 100 MHz to set the center frequency step size to 100 MHz FREQ:CENT?
<b>Notes</b>	This command sets either the RF or I/Q Center Frequency depending on the selected input. For RF input it is equivalent to FREQ:RF:CENT For I/Q input it is equivalent to FREQ:IQ:CENT Preset and Max values are dependent on Hardware Options (5xx) If no terminator (e.g. MHz) is sent the terminator Hz is used. If a terminator with unit other than Frequency is used, an invalid suffix error message is generated.
<b>Dependencies</b>	The Center Frequency can be limited by Start or Stop Freq limits, if the Span is so large that Start or Stop reach their limit.
<b>Couplings</b>	When operating in “swept span”, any value of the Center Frequency or Span that is within the frequency range of the analyzer is allowed when the value is being set through the front panel numeric key pad or the SCPI command. The other parameter is forced to a different value if needed, to keep the Start and the Stop Frequencies within the analyzer’s frequency range
<b>Preset</b>	Depends on instrument maximum frequency, mode, measurement, and selected input. See <a href="#">"Center Frequency Presets" on page 2830</a> and <a href="#">"RF Center Freq" on page 2832</a> and <a href="#">Ext Mix Center Freq</a> and <a href="#">"I/Q Center Freq" on page 2834</a> .
<b>State Saved</b>	Saved in instrument state
<b>Min</b>	Depends on instrument maximum frequency, mode, measurement, and selected input.. See <a href="#">"Center Frequency Presets" on page 2830</a> and <a href="#">"RF Center Freq" on page 2832</a> and <a href="#">"I/Q Center Freq" on page 2834</a> .
<b>Max</b>	Depends on instrument maximum frequency, mode, measurement, and selected input.. See <a href="#">"Center Frequency Presets" on page 2830</a> and <a href="#">"RF Center Freq" on page 2832</a> and <a href="#">"I/Q Center Freq" on page 2834</a> .
<b>Default Unit</b>	Hz
<b>Status Bits/OPC</b>	Non-overlapped
<b>Dependencies</b>	
<b>Initial S/W Revision</b>	Prior to A.02.00

### Center Frequency Presets

The following table provides the Center Frequency Presets for the Spectrum Analyzer mode, and the Max Freq, for the various frequency options:

Freq Option	CF after Mode Preset	Stop Freq after Mode Preset	Max Freq (can't tune

			above)
503 (all but N9000A)	1.805 GHz	3.6 GHz	3.7 GHz
503 (N9000A)	1.505 GHz	3.0 GHz	3.08 GHz
507 (all but N9000A)	3.505 GHz	7.0 GHz	7.1 GHz
507 (N9000A)	3.755 GHz	7.5 GHz	7.58 GHz
508 (all but N9038A)	1.805 GHz	3.6 GHz	8.5 GHz
508 (N9038A)	4.205 GHz	8.4 GHz	8.5 GHz
513	6.805 GHz	13.6 GHz	13.8 GHz
526 (all but N9000A and N9038A)	13.255 GHz	26.5 GHz	27.0 GHz
526 (N9000A)	13.255 GHz	26.5 GHz	26.55 GHz
526 (N9038A)	1.805 GHz	3.6 GHz	27.0 GHz
532	16.005 GHz	32.0 GHz	32.5 GHz
543	21.505 GHz	43.0 GHz	TBD
544	22.005 GHz	44.0 GHz	44.5 GHz
550	25.005 GHz	50.0 GHz	51 GHz

Input 2:

Model	CF after Mode Preset	Stop Freq after Mode Preset	Max Freq (can't tune above)
N9000A opt C75	0.7505GHz	1.5 GHz	1.58 GHz
N9038A	505 MHz	1 GHz	1.000025 GHz

Tracking Generator Frequency Limits (N9000A only):

Tracking Generator Option	Min Freq (clips to this freq when turn TG on and	If above this Freq, Stop Freq clipped to this Freq when	Max Freq (can't tune above) while TG

	can't tune below while TG on)	TG turned on	on
T03	9 kHz	3.0 GHz	3.08 GHz
T06	9 kHz	6.0 GHz	6.05 GHz

The following table shows the Center Frequency Presets for modes other than Spectrum Analyzer:

Mode	CF Preset for RF
WCDMA	1 GHz
WIMAXOFDMA,	1 GHz
BASIC	1 GHz
ADEMOD	1 GHz
VSA	1 GHz
TDSCDMA	1 GHz
PNOISE	1 GHz
LTE	1 GHz
LTETDD	1 GHz
MSR	1 GHz
GSM	935.2 MHz
NFIGURE	1.505 GHz

## RF Center Freq

SCPI command for specifying the RF Center Frequency. This command will set the Center Frequency to be used when the RF input is selected, even if the RF input is not the input that is selected at the time the command is sent. Note that the Center Freq function in the Frequency menu on the front panel always applies to the currently selected input.

Scope	Meas Global
<b>Remote Command</b>	<code>[ :SENSe ] :FREQuency:RF:CENTer &lt;freq&gt;</code> <code>[ :SENSe ] :FREQuency:RF:CENTer?</code>
<b>Example</b>	FREQ:RF:CENT 30 MHz
Notes	This command is the same in all modes, but the parameter is Measurement Global. So the value is independent in each mode and common across all the measurements in the mode.
Dependencies	If the electronic/soft attenuator is enabled, any attempt to set Center Frequency such that the Stop Frequency would be >3.6 GHz fails and results in an advisory message. If the equivalent SCPI command is sent, this same message is generated as part of a “-221, Settings conflict” warning. If Source Mode is set to Tracking, and the Max or Min Center Freq is therefore limited by the limits of the source, a warning message is generated, “Data out of range;clipped to source max/min” if these limits are exceeded. Note that for an external source, these limits can be affected by the settings of

	Source Numerator, Source Denominator and Power Sweep.
Preset	See table above
State Saved	Saved in instrument state.
Min	-79.999995 MHz, unless Source Mode is set to Tracking, in which case it is limited by the minimum frequency of the Source
Max	See table above. Basically instrument maximum frequency - 5 Hz. Note that, if the Source Mode is set to Tracking, the effective instrument maximum frequency may be limited by the source maximum frequency.  If the knob or step keys are being used, also depends on the value of the other three interdependent parameters Span, Start Frequency and Stop Frequency
Initial S/W Revision	Prior to A.02.00
Modified at S/W Revision	A.03.00

## Ext Mix Center Freq

SCPI command for specifying the External Mixer Center Frequency. This command will set the Center Frequency to be used when the External Mixer is selected, even if the External Mixer input is not the input which is selected at the time the command is sent. Note that the Center Freq function in the Frequency menu on the front panel always applies to the currently selected input.

Scope	Meas Global
<b>Remote Command</b>	<code>[ :SENSe ] :FREQuency:EMIXer:CENTer &lt;freq&gt;</code> <code>[ :SENSe ] :FREQuency:EMIXer:CENTer?</code>
<b>Example</b>	<code>:FREQ:EMIX:CENT 60 GHz</code> <code>:FREQ:EMIX:CENT?</code>
Notes	This command is the same in all modes, but the parameter is Measurement Global. So the value is independent in each mode and common across all the measurements in the mode.
Couplings	When returning to External Mixing after having been switched to one of the other inputs (e.g., RF), you will come back into the settings that you had when you left External Mixing. So you will come back to the band you were in with the Center Frequency that you had. However, Span is not an input-dependent parameter, therefore you will bring the span over from the other input. Therefore, the analyzer comes back with the span from the previous input, limited as necessary by the current mixer setup.
Preset	When a Mode Preset is performed while in External Mixing, the Start frequency of the current Mode is set to the nominal Min Freq of the lowest harmonic range in the Harmonic Table for the current mixer setup. Similarly, the Stop frequency of the current Mode is set to the nominal Max Freq of the highest harmonic range in the Harmonic Table. The Center Freq thus presets to the point arithmetically equidistant from these two frequencies.  If the current measurement has a limited Span available to it, and cannot achieve the Span shown in the table (Span=Stop Freq - Start Freq), the analyzer uses the maximum Span the measurement allows, and still sets the Center Freq to the midpoint of the Start and Stop Freq values in the Harmonic Table.

	<p>When Restore Input/Output Defaults is performed, the mixer presets to the 11970A, whose Start and Stop frequencies are 26.5 and 40 GHz respectively. The center of these two frequencies is 33.25 GHz.</p> <p>Therefore, after a Restore Input/Output Defaults, if you go into External Mixing and do a Mode Preset while in the Spectrum Analyzer Mode, the resulting Center Freq is 33.25 GHz.</p>
State Saved	Saved in instrument state.
Min	The minimum frequency in the currently selected mixer band + 5 Hz
Max	<p>The maximum frequency in the currently selected mixer band – 5 Hz</p> <p>If the knob or step keys are being used, also depends on the value of the other three interdependent parameters Span, Start Frequency and Stop Frequency</p>
Initial S/W Revision	A.08.01

### I/Q Center Freq

SCPI command for specifying the I/Q Center Frequency. This command will set the Center Frequency to be used when the I/Q input is selected, even if the I/Q input is not the input which is selected at the time the command is sent. Note that the Center Freq function in the Frequency menu on the front panel always applies to the currently selected input.

Scope	Meas Global
<b>Remote Command</b>	<pre>[ :SENSe ] :FREQuency:IQ:CENTer &lt;freq&gt;</pre> <pre>[ :SENSe ] :FREQuency:IQ:CENTer?</pre>
<b>Example</b>	FREQ:IQ:CENT: 30 MHz
Notes	This command is the same in all modes, but the parameter is Measurement Global. So the value is independent in each mode and common across all the measurements in the mode.
Preset	0 Hz
State Saved	Saved in instrument state.
Min	-40.049995 MHz
Max	40.049995 MHz
Initial S/W Revision	Prior to A.02.00

### CF Step

Changes the step size for the center frequency and start and stop frequency functions. Once a step size has been selected and the center frequency function is active, the step keys (and the UP|DOWN parameters for Center Frequency from remote commands) change the center frequency by the step-size value. The step size function is useful for finding harmonics and sidebands beyond the current frequency span of the analyzer.

Note that the start and stop frequencies also step by the CF Step value.

Key Path	FREQ Channel
Remote Command	[:SENSe]:FREQuency:CENTer:STEP[:INCRement] <freq> [:SENSe]:FREQuency:CENTer:STEP[:INCRement]? [:SENSe]:FREQuency:CENTer:STEP:AUTO OFF ON 0 1 [:SENSe]:FREQuency:CENTer:STEP:AUTO?
Example	FREQ:CENT:STEP:AUTO ON FREQ:CENT:STEP 500 MHz FREQ:CENT UP increases the current center frequency value by 500 MHz FREQ:CENT:STEP? FREQ:CENT:STEP:AUTO?
Notes	Preset and Max values are depending on Hardware Options (503, 507, 508, 513, 526)
Notes	Preset and Max values are dependent on Hardware Options (5xx)
Dependencies	Freq Offset is not available in External Mixing. In this case the Freq Offset key is grayed out and shows a value of zero. It will once again be available, and show the previously set value, when you return to the RF Input.
Dependencies	Span, RBW, Center frequency If the electronic/soft attenuator is enabled, any attempt to change the value of the center frequency >3.6 GHz by pressing the Up-arrow key, fails and results in an advisory message. If the equivalent SCPI command is sent, this same message is generated as part of a “-221, Settings conflict” warning.
Couplings	When auto-coupled in a non-zero span, the center frequency step size is set to 10% of the span. When auto-coupled in zero span, the center frequency step size is set to the equivalent -3 dB RBW value.
Preset	Auto ADEMOD: 1 MHz ON
State Saved	Saved in instrument state
Min	– (the maximum frequency of the instrument). That is, 27 GHz max freq instrument has a CF step range of +/- 27 GHz. Note that this is the maximum frequency given the current settings of the instrument, so in External Mixing, for example, it is the maximum frequency of the current mixer band.
Max	The maximum frequency of the instrument. That is, 27 GHz max freq instrument has a CF step range of +/- 27 GHz. Note that this is the maximum frequency given the current settings of the instrument, so in External Mixing, for example, it is the maximum frequency of the current mixer band.
Default Unit	Hz
Status Bits/OPC dependencies	non-overlapped
Initial S/W Revision	Prior to A.02.00
Modified at S/W Revision	A.03.00

## Input/Output

See ["Input/Output" on page 226](#)



## Marker

Accesses a menu that enables you to select, set up and control the markers for the current measurement.

Key Path	Front-panel key
Initial S/W Revision	Prior to A.02.00

### Select Marker

Displays 12 markers available for selection.

Key Path	Marker
Initial S/W Revision	Prior to A.02.00

### Marker Type

Sets the marker control mode to Normal, Delta, Fixed or Off. All interactions and dependencies detailed under the key description are enforced when the remote command is sent. If the selected marker is Off, pressing Marker sets it to Normal and places it at the center of the screen on the trace determined by the Marker Trace rules. At the same time, the Marker X Axis Value appears on the Active Function area.

The default active function is the active function for the currently selected marker control mode. If the current control mode is Off, there is no active function and the active function is turned off.

Key Path	Marker
Mode	BASIC, PNOISE, WCDMA, C2K, GSM, WIMAXOFDMA, TDSCDMA, 1XEVD0, DVB, DTMB, ISDBT, CMMB, LTE, LTETDD, DCATV, WLAN,,LTEATDD, LTEAFDD
Remote Command	:CALCulate:WAVeform:MARKer[1] 2 ... 12:MODE POSition   DELTa   OFF :CALCulate:WAVeform:MARKer[1] 2 ... 12:MODE?
Example	CALC:WAV:MARK:MODE OFF CALC:WAV:MARK:MODE?
Notes	If the selected marker is Off, pressing Marker sets it to Normal and places it at the center of the screen on the trace determined by the Marker Trace rules. At the same time, Marker X Axis Value appears on the Active Function area.  Default Active Function: the active function for the selected marker's current control mode. If the current control mode is Off, there is no active function and the active function is turned off.  Active Function Display: the marker X axis value entered in the active function area displays the marker value to its full entered precision.  You must be in a mode that includes the Waveform measurement to use this command. Use INSTRument:SElect to set the mode.
Preset	OFF
State Saved	Saved in instrument state.

Range	Normal Delta Off
Initial S/W Revision	Prior to A.02.00
Modified at S/W Revision	A.03.00

## Properties

Accesses the marker properties menu.

Key Path	Marker
Initial S/W Revision	Prior to A.02.00

## Select Marker

Displays 12 markers available for selection.

Key Path	Marker
Initial S/W Revision	Prior to A.02.00

## Relative To

Selects the marker that the selected marker is relative to (its *reference marker*).

Key Path	Marker, Properties
Mode	BASIC, PNOISE, WCDMA, C2K, GSM, WIMAXOFDMA, TDSCDMA, 1XEVD0, DVB, DTMB, ISDBT, CMMB, LTE, LTETDD, DCATV, WLAN,,LTEATDD, LTEAFDD
<b>Remote Command</b>	:CALCulate:WAVeform:MARKer[1] 2 ... 12:REFerence <integer> :CALCulate:WAVeform:MARKer[1] 2 ... 12:REFerence?
<b>Example</b>	CALC:WAV:MARK:REF 8 CALC:WAV:MARK:REF?
Notes	A marker cannot be relative to itself so that choice is grayed out, and if sent from SCPI generates error -221: "Settings conflict; marker cannot be relative to itself." When queried a single value is returned (the specified marker numbers relative marker). You must be in a mode that includes the Waveform measurement to use this command. Use INSTRument:SElect to set the mode.
Preset	2 3 4 5 6 7 8 9 10 11 12 1
State Saved	Saved in instrument state.
Min	1
Max	12
Initial S/W Revision	Prior to A.02.00
Modified at S/W Revision	A.03.00

## Marker Trace

Assigns the specified marker to the designated trace.

Key Path	Marker
Mode	BASIC, PNOISE, WCDMA, C2K, GSM, WIMAXOFDMA, TDSCDMA, 1XEVD0, DVB, DTMB, ISDBT, CMMB, LTE, LTETDD, DCATV, WLAN,,LTEATDD, LTEAFDD
Remote Command	:CALCulate:WAVeform:MARKer[1] 2 ... 12:TRACe RFENvelope   I   Q   IQ :CALCulate:WAVeform:MARKer[1] 2 ... 12:TRACe?
Example	CALC:WAV:MARK:TRAC RFEN CALC:WAV:MARK:TRAC?
Notes	Assigns the specified marker to the designated trace. The IQ selection is for backward compatibility purposes. It is recommended that the users use the I and/or Q selection instead. You must be in a mode that includes the Waveform measurement to use this command. Use INSTRument:SElect to set the mode.
Preset	RFEN
State Saved	Saved in instrument state.
Range	RF Envelope   I   Q   IQ
Initial S/W Revision	Prior to A.02.00
Modified at S/W Revision	A.03.00

## Couple Markers

Toggles the state of the markers to be coupled On or Off. When this function is true (On), moving any marker causes an equal X-axis movement of every other marker which is not Off. “Equal X-axis movement” refers to the difference between each marker’s X-Axis value (in the fundamental x-axis units of the trace that marker is on) and the X-Axis value of the marker being moved (in the same fundamental x-axis units) are preserved.

Key Path	Marker
Mode	BASIC, PNOISE, WCDMA, C2K, GSM, WIMAXOFDMA, TDSCDMA, 1XEVD0, DVB, DTMB, ISDBT, CMMB, LTE, LTETDD, DCATV, WLAN,,LTEATDD, LTEAFDD
Remote Command	:CALCulate:WAVeform:MARKer:COUPle[:STATe] ON OFF 1 0 :CALCulate:WAVeform:MARKer:COUPle[:STATe]?
Example	CALC:WAV:MARK:COUP ON CALC:WAV:MARK:COUP ON
Notes	You must be in a mode that includes the Waveform measurement to use this command. Use INSTRument:SElect to set the mode.
Preset	OFF

State Saved	Saved in instrument state.
Range	On Off
Initial S/W Revision	Prior to A.02.00
Modified at S/W Revision	A.03.00

## All Markers Off

Turns off all markers.

Key Path	Marker
Mode	BASIC, PNOISE, WCDMA, C2K, GSM, WIMAXOFDMA, TDSCDMA, 1XEVD0, DVB, DTMB, ISDBT, CMMB, LTE, LTETDD, DCATV, WLAN,LTEATDD, LTEAFDD
Remote Command	:CALCulate:WAVeform:MARKer:AOFF
Example	CALC:WAV:MARK:AOFF
Notes	You must be in a mode that includes the Waveform measurement to use this command. Use INSTRument:SElect to set the mode.
Initial S/W Revision	Prior to A.02.00
Modified at S/W Revision	A.03.00

## Marker X Axis Value (Remote Command Only)

Sets the marker X Axis value in the current marker X Axis Scale unit. It has no effect if the control mode is Off, but is the SCPI equivalent of entering an X value if the control mode is Normal or Delta.

Mode	BASIC, PNOISE, WCDMA, C2K, GSM, WIMAXOFDMA, TDSCDMA, 1XEVD0, DVB, DTMB, ISDBT, CMMB, LTE, LTETDD, DCATV, WLAN,,LTEATDD, LTEAFDD
Remote Command	:CALCulate:WAVeform:MARKer[1] 2 ... 12:X <time> :CALCulate:WAVeform:MARKer[1] 2 ... 12:X?
Example	CALC:WAV:MARK:X 50 ms CALC:WAV:MARK:X?
Notes	If no suffix is sent, uses the fundamental units for the current marker X Axis Scale. If a suffix is sent that does not match the current marker X Axis Scale unit, an error "Invalid suffix" is generated. If the specified marker is Fixed and a Marker Function is on, error -221 "Settings conflict; cannot adjust Fixed marker while Marker Function is on" is generated.  The query returns the marker's absolute X Axis value if the control mode is Normal, or the offset from the marker's reference marker if the control mode is Delta. The query is returned in the fundamental units for the current marker X Axis scale: Hz for Frequency and Inverse Time, seconds for Period and Time. If the marker is Off the response is not a number.  You must be in a mode that includes the Waveform measurement to use this command. Use INSTRument:SElect to set the mode.
Preset	0

Preset	After a preset, all markers are turned OFF, so Marker X Axis Value query returns a not a number (NAN).
State Saved	No
Min	(9.9E+37
Max	9.9E+37
Initial S/W Revision	Prior to A.02.00
Modified at S/W Revision	A.03.00

### Marker X Axis Position (Remote Command Only)

Sets the marker X position in trace points. It has no effect if the control mode is Off, but is the SCPI equivalent of entering a value if the control mode is Normal or Delta. The entered value is immediately translated into the current X Axis Scale units for setting the value of the marker.

Mode	BASIC, PNOISE, WCDMA, C2K, GSM, WIMAXOFDMA, TDSCDMA, 1XEVD0, DVB, DTMB, ISDBT, CMMB, LTE, LTETDD, DCATV, WLAN,,LTEATDD, LTEAFDD
<b>Remote Command</b>	:CALCulate:WAVeform:MARKer[1] 2 ... 12:X:POSition <real> :CALCulate:WAVeform:MARKer[1] 2 ... 12:X:POSition?
<b>Example</b>	CALC:WAV:MARK:X:POS 500 CALC:WAV:MARK:X:POS?
Notes	The query returns the marker's absolute X Axis value in trace points if the control mode is Normal or the offset from the marker's reference marker in trace points if the control mode is Delta. The value is returned as a real number, not an integer, corresponding to the translation from X Axis Scale units to trace points.  You must be in a mode that includes the Waveform measurement to use this command. Use INSTRument:SElect to set the mode.
Preset	0
Preset	After a preset, all markers are turned OFF, so Marker X Axis Value query returns a not a number (NAN).
State Saved	No
Min	(9.9E+37
Max	9.9E+37
Initial S/W Revision	Prior to A.02.00
Modified at S/W Revision	A.03.00

### Marker Y Axis Value (Remote Command Only)

Queries the marker Y Axis value in the current marker Y Axis unit.

Mode	BASIC, PNOISE, WCDMA, C2K, GSM, WIMAXOFDMA, TDSCDMA, 1XEVD0, DVB, DTMB, ISDBT, CMMB, LTE, LTETDD, DCATV, WLAN,,LTEATDD, LTEAFDD
------	---------------------------------------------------------------------------------------------------------------------------------

<b>Remote Command</b>	:CALCulate:WAVeform:MARKer[1] 2 ... 12:Y?
<b>Example</b>	CALC:WAV:MARK11:Y?
<b>Notes</b>	<p>When the marker is on, IQ waveform returns I and Q values.</p> <p>Case #1 - Trace RF, I or Q: returns a single double value.</p> <p>&gt;:CALC:WAV:MARK1:Y? -2.402406506109E+001</p> <p>Case #2 - Trace IQ: returns a double array of two values, the first is I, and the second is Q.</p> <p>&gt;:CALC:WAV:MARK1:Y? -3.006944493834E-003,+9.9870666467354E-004</p> <p>The IQ selection is for backward compatibility purposes. It is recommended that the users use the I and/or Q selection instead.</p> <p>You must be in a mode that includes the Waveform measurement to use this command. Use INSTRument:SElect to set the mode.</p>
<b>Preset</b>	Result dependent on the marker setup and signal source.
<b>State Saved</b>	No
<b>Backwards Compatibility SCPI</b>	:CALCulate:WAVeform:MARKer[1] 2 ... 12:FUNction:RESult?
<b>Initial S/W Revision</b>	Prior to A.02.00
<b>Modified at S/W Revision</b>	A.03.00

## Backward Compatibility SCPI Commands

Sets or queries the state of a marker. Setting a marker that is OFF to state ON or 1 puts it in Normal mode and places it at the center of the screen.

<b>Mode</b>	BASIC, PNOISE, WCDMA, CDMA2K, EDGE GSM, WIMAX OFDMA, TDSCDMA, CDMA1XEV, DVB, DTMB, ISDBT, CMMB, LTE, LTETDD, DCATV, WLAN
<b>Remote Command</b>	:CALCulate:WAVeform:MARKer[1] 2 ... 12:STATe OFF ON 0 1 :CALCulate:WAVeform:MARKer[1] 2 ... 12:STATe?
<b>Example</b>	CALC:WAV:MARK:STAT ON CALC:WAV:MARK:STAT?
<b>Notes</b>	You must be in a mode that includes the Waveform measurement to use this command. Use INSTRument:SElect to set the mode.
<b>Preset</b>	OFF
<b>State Saved</b>	Saved in instrument state.
<b>Range</b>	On Off
<b>Initial S/W Revision</b>	Prior to A.02.00
<b>Modified at S/W Revision</b>	A.03.00

## Marker ->

There is no 'Marker ->' functionality supported in Waveform measurements. The front-panel key displays a blank menu when pressed.

---

Key Path	Front-panel key
Initial S/W Revision	Prior to A.02.00

---

## Marker Function

Accesses a menu of marker functions that perform post-processing operations on markers based on the measurement specifications. Marker functions are distinct from measurement functions, which automatically perform complex sequences of setup, data acquisition, and display operations in order to measure specified signal characteristics. Marker Functions are specified for each individual marker and may be turned on individually for each marker.

The Marker Function menu controls which marker functions are turned on and allows you to adjust the setup parameters for each function. These parameters include the following, but only one parameter can be assigned to a given marker:

- Marker Noise
- BandInterval Power
- Band/Interval Density
- Marker Function Off

Key Path	Front-panel key
Initial S/W Revision	Prior to A.02.00

### Select Marker

Displays 12 markers available for selection.

Key Path	Marker
Initial S/W Revision	Prior to A.02.00

### Marker Function Type

Sets the marker control function type to, Marker Noise, Band/Interval Power, Band Interval Density, or Marker Function Off

Key Path	Marker Function
Mode	BASIC, PNOISE, WCDMA, C2K, GSM, WIMAXOFDMA, TDSCDMA, 1XEVD0, DVB, DTMB, ISDBT, CMMB, LTE, LTETDD, DCATV, WLAN,,LTEATDD, LTEAFDD
Remote Command	:CALCulate:WAVeform:MARKer[1] 2 ... 12:FUNction BPower   BDENsity   OFF :CALCulate:WAVeform:MARKer[1] 2 ... 12:FUNction?
Example	CALC:WAV:MARK:FUNC BPOW CALC:WAV:MARK:FUNC?
Notes	You must be in a mode that includes the Waveform measurement to use this command. Use INSTRument:SElect to set the mode.
Preset	OFF



State Saved	Saved in instrument state.
Range	Band/Interval Power Band Interval Density Marker Function Off
Initial S/W Revision	Prior to A.02.00
Modified at S/W Revision	A.03.00

## Band Adjust

Accesses a menu that enables you to set the frequency span width and the left and right edge, or time values, for the band or interval of the selected marker.

Key Path	Marker Function
Initial S/W Revision	Prior to A.02.00

## Band/Interval Span for Time Domain

Sets the width of the frequency span for the selected marker.

Key Path	Marker Function
Mode	BASIC, PNOISE, WCDMA, C2K, GSM, WIMAXOFDMA, TDSCDMA, 1XEVD0, DVB, DTMB, ISDBT, CMMB, LTE, LTETDD, DCATV, WLAN,LTEATDD, LTEAFDD
<b>Remote Command</b>	:CALCulate:WAVEform:MARKer[1] 2 ... 12:FUNCTION:BAND:SPAN <time> :CALCulate:WAVEform:MARKer[1] 2 ... 12:FUNCTION:BAND:SPAN?
<b>Example</b>	CALC:WAV:MARK:FUNC:BAND:SPAN 20 ms CALC:WAV:MARK:FUNC:BAND:SPAN?
Notes	You must be in a mode that includes the Waveform measurement to use this command. Use INSTRUMENT:SElect to set the mode.
Couplings	Changing the Band/Interval Span necessarily changes the Band/Interval Left and Band/Interval Right values
Preset	0
Preset	10% of Meas Time
State Saved	Saved in instrument state.
Min	0
Max	100 s
<b>Backwards Compatibility SCPI</b>	:CALCulate:WAVEform:MARKer[1] 2 ... 4:X:SPAN
Initial S/W Revision	Prior to A.02.00
Modified at S/W Revision	A.03.00

## Band/Interval Left for Time Domain

Sets the left edge frequency or time value for the band of the selected marker.

Key Path	Marker Function
Mode	BASIC, PNOISE, WCDMA, C2K, GSM, WIMAXOFDMA, TDSCDMA, 1XEVD0, DVB, DTMB, ISDBT, CMMB, LTE, LTETDD, DCATV, WLAN,,LTEATDD, LTEAFDD
<b>Remote Command</b>	:CALCulate:WAVeform:MARKer[1] 2 ... 12:FUNction:BAND:LEFT <time> :CALCulate:WAVeform:MARKer[1] 2 ... 12:FUNction:BAND:LEFT?
<b>Example</b>	CALC:WAV:MARK12:FUNC:BAND:LEFT 1 s CALC:WAV:MARK12:FUNC:BAND:LEFT?
Notes	You must be in a mode that includes the Waveform measurement to use this command. Use INSTRument:SElect to set the mode.
Couplings	Changing the Band/Interval Left necessarily changes the Band/Interval Span and Band/Interval Right values
Preset	0
Preset	5% of Meas Time
State Saved	Saved in instrument state.
Min	0
Max	100 s
Initial S/W Revision	Prior to A.02.00
Modified at S/W Revision	A.03.00

## Band/Interval Right for Time Domain

Sets the right edge frequency or time value for the band of the selected marker.

Key Path	Marker Function
Mode	BASIC, PNOISE, WCDMA, C2K, GSM, WIMAXOFDMA, TDSCDMA, 1XEVD0, DVB, DTMB, ISDBT, CMMB, LTE, LTETDD, DCATV, WLAN,,LTEATDD, LTEAFDD
<b>Remote Command</b>	:CALCulate:WAVeform:MARKer[1] 2 ... 12:FUNction:BAND:RIGHT <time> :CALCulate:WAVeform:MARKer[1] 2 ... 12:FUNction:BAND:RIGHT?
<b>Example</b>	CALC:WAV:MARK12:FUNC:BAND:RIGH 1 s CALC:WAV:MARK12:FUNC:BAND:RIGH?
Notes	You must be in a mode that includes the Waveform measurement to use this command. Use INSTRument:SElect to set the mode.
Couplings	Changing the Band/Interval Left necessarily changes the Band/Interval Span and Band/Interval Right values
Preset	0
Preset	5% of Meas Time
State Saved	Saved in instrument state.

Min	0
Max	100 s
Initial S/W Revision	Prior to A.02.00
Modified at S/W Revision	A.03.00

## Meas

The information in this section is common to all measurements. For key and remote command information for a specific measurement, refer to the section that describes the measurement of interest.

Measurements available under the Meas key are specific to the current Mode.

When viewing Help for measurements, note the following:

**NOTE**

Operation for some keys differs between measurements. The information displayed in Help pertains to the current measurement. To see how a key operates in a different measurement, exit Help (press the Cancel Esc key), select the measurement, then reenter Help (press the Help key) and press that key.

---

Key Path	Front-panel key
Initial S/W Revision	Prior to A.02.00

---

### Remote Measurement Functions

This section contains the following topics:

["Measurement Group of Commands" on page 2849](#)

["Current Measurement Query \(Remote Command Only\)" on page 2851](#)

["Limit Test Current Results \(Remote Command Only\)" on page 2851](#)

["Data Query \(Remote Command Only\)" on page 2851](#)

["Calculate/Compress Trace Data Query \(Remote Command Only\)" on page 2852](#)

["Calculate Peaks of Trace Data \(Remote Command Only\)" on page 2857](#)

[Hardware-Accelerated Fast Power Measurement \(Remote Command Only\)](#)

["Format Data: Numeric Data \(Remote Command Only\)" on page 2858](#)

["Format Data: Byte Order \(Remote Command Only\)" on page 2859](#)

---

Initial S/W Revision	Prior to A.02.00
----------------------	------------------

---

## Measurement Group of Commands

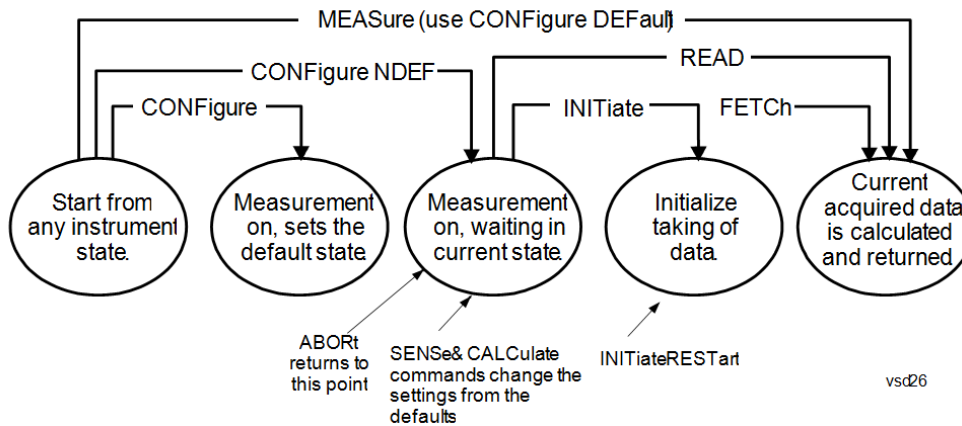

---

### Measure Commands:

:MEASure:<measurement>[n]?

This is a fast single-command way to make a measurement using the factory default instrument settings. These are the settings and units that conform to the Mode Setup settings (e.g. radio standard) that you have currently selected.

- Stops the current measurement (if any) and sets up the instrument for the specified measurement using the factory defaults
- Initiates the data acquisition for the measurement
- Blocks other SCPI communication, waiting until the measurement is complete before returning results.
- If the function does averaging, it is turned on and the number of averages is set to 10.
- After the data is valid it returns the scalar results, or the trace data, for the specified measurement. The type of data returned may be defined by an [n] value that is sent with the command.
- The scalar measurement results will be returned if the optional [n] value is not included, or is set to 1. If the [n] value is set to a value other than 1, the selected trace data results will be returned. See each command for details of what types of scalar results or trace data results are available.
- ASCII is the default format for the data output. (Older versions of Spectrum Analysis and Phase Noise mode measurements only use ASCII.) The binary data formats should be used for handling large blocks of data since they are smaller and faster than the ASCII format. Refer to the FORMat:DATA command for more information.

If you need to change some of the measurement parameters from the factory default settings you can set up the measurement with the CONFIGure command. Use the commands in the SENSe:<measurement> and CALCulate:<measurement> subsystems to change the settings. Then you can use the READ? command to initiate the measurement and query the results.

If you need to repeatedly make a given measurement with settings other than the factory defaults, you can use the commands in the SENSe:<measurement> and CALCulate:<measurement> subsystems to set up the measurement. Then use the READ? command to initiate the measurement and query results.

Measurement settings persist if you initiate a different measurement and then return to a previous one. Use READ:<measurement>? if you want to use those persistent settings. If you want to go back to the default settings, use MEASure:<measurement>?.

---

### Configure Commands:

:CONFigure:<measurement>

This command stops the current measurement (if any) and sets up the instrument for the specified measurement using

---

---

the factory default instrument settings. It does not initiate the taking of measurement data unless INIT:CONTinuous is ON. If you change any measurement settings after using the CONFigure command, the READ command can be used to initiate a measurement without changing the settings back to their defaults.

In the Swept SA measurement in Spectrum Analyzer mode the CONFigure command also turns the averaging function on and sets the number of averages to 10 for all measurements.

:CONFigure: <measurement>: NDEFault stops the current measurement and changes to the specified measurement. It does not change the settings to the defaults. It does not initiate the taking of measurement data unless INIT:CONTinuous is ON.

The CONFigure? query returns the current measurement name.

The CONFigure:CATalog? query returns a quoted string of all licensed measurement names in the current mode. For example, "SAN, CHP, OBW, ACP, PST, TXP, SPUR, SEM, LIST".

---

#### Fetch Commands:

---

:FETCh:<measurement>[n]?

This command puts selected data from the most recent measurement into the output buffer. Use FETCh if you have already made a good measurement and you want to return several types of data (different [n] values, for example, both scalars and trace data) from a single measurement. FETCh saves you the time of re-making the measurement. You can only FETCh results from the measurement that is currently active, it will not change to a different measurement. An error message is reported if a measurement other than the current one is specified.

If you need to get new measurement data, use the READ command, which is equivalent to an INITiate followed by a FETCh.

The scalar measurement results will be returned if the optional [n] value is not included, or is set to 1. If the [n] value is set to a value other than 1, the selected trace data results will be returned. See each command for details of what types of scalar results or trace data results are available. The binary data formats should be used for handling large blocks of data since they are smaller and transfer faster than the ASCII format. (FORMat:DATA)

FETCh may be used to return results other than those specified with the original READ or MEASure command that you sent.

---

#### INITiate Commands:

---

:INITiate:<measurement>

This command is not available for measurements in all the instrument modes:

- Initiates a trigger cycle for the specified measurement, but does not output any data. You must then use the FETCh<meas> command to return data. If a measurement other than the current one is specified, the instrument will switch to that measurement and then initiate it.
  - For example, suppose you have previously initiated the ACP measurement, but now you are running the channel power measurement. If you send INIT:ACP? it will change from channel power to ACP and will initiate an ACP measurement.
  - Does not change any of the measurement settings. For example, if you have previously started the ACP measurement and you send INIT:ACP? it will initiate a new ACP measurement using the same instrument settings as the last time ACP was run.
  - If your selected measurement is currently active (in the idle state) it triggers the measurement, assuming the trigger conditions are met. Then it completes one trigger cycle. Depending upon the measurement and the number of averages, there may be multiple data acquisitions, with multiple trigger events, for one full trigger cycle. It also holds off additional commands on GPIB until the acquisition is complete.
- 

#### READ Commands:

---

:READ:<measurement>[n]?

- Does not preset the measurement to the factory default settings. For example, if you have previously initiated the ACP
-

---

measurement and you send READ:ACP? it will initiate a new measurement using the same instrument settings.

- Initiates the measurement and puts valid data into the output buffer. If a measurement other than the current one is specified, the instrument will switch to that measurement before it initiates the measurement and returns results.
  - For example, suppose you have previously initiated the ACP measurement, but now you are running the channel power measurement. Then you send READ:ACP? It will change from channel power back to ACP and, using the previous ACP settings, will initiate the measurement and return results.
  - Blocks other SCPI communication, waiting until the measurement is complete before returning the results
  - If the optional [n] value is not included, or is set to 1, the scalar measurement results will be returned. If the [n] value is set to a value other than 1, the selected trace data results will be returned. See each command for details of what types of scalar results or trace data results are available. The binary data formats should be used when handling large blocks of data since they are smaller and faster than the ASCII format. (FORMat:DATA)
- 

---

Initial S/W Revision	Prior to A.02.00
----------------------	------------------

---

### Current Measurement Query (Remote Command Only)

This command returns the name of the measurement that is currently running.

---

<b>Remote Command</b>	:CONFigure?
-----------------------	-------------

<b>Example</b>	CONF?
----------------	-------

Initial S/W Revision	Prior to A.02.00
----------------------	------------------

---

### Limit Test Current Results (Remote Command Only)

Queries the status of the current measurement limit testing. It returns a 0 if the measured results pass when compared with the current limits. It returns a 1 if the measured results fail any limit tests.

---

<b>Remote Command</b>	:CALCulate:CLIMits:FAIL?
-----------------------	--------------------------

<b>Example</b>	CALC:CLIM:FAIL? queries the current measurement to see if it fails the defined limits. Returns a 0 or 1: 0 it passes, 1 it fails.
----------------	--------------------------------------------------------------------------------------------------------------------------------------

Initial S/W Revision	Prior to A.02.00
----------------------	------------------

---

### Data Query (Remote Command Only)

Returns the designated measurement data for the currently selected measurement and subopcode.

n = any valid subopcode for the current measurement. See the measurement command results table for your current measurement, for information about what data is returned for the subopcodes.

This command uses the data setting specified by the FORMat:BORDER and FORMat:DATA commands and can return real or ASCII data. (See the format command descriptions under Input/Output in the Analyzer Setup section.)

<b>Remote Command</b>	:CALCulate:DATA[n]?
<b>Notes</b>	The return trace depends on the measurement. In CALCulate:<meas>:DATA[n], n is any valid subopcode for the current measurement. It returns the same data as the FETCH:<measurement>? query where <measurement> is the current measurement.
<b>Initial S/W Revision</b>	Prior to A.02.00

### Calculate/Compress Trace Data Query (Remote Command Only)

Returns compressed data for the currently selected measurement and sub-opcode [n].

n = any valid sub-opcode for that measurement. See the MEASure:<measurement>? command description of your specific measurement for information on the data that can be returned.

The data is returned in the current Y Axis Unit of the analyzer. The command is used with a sub-opcode <n> (default=1) to specify the trace. With trace queries, it is best if the analyzer is not sweeping during the query. Therefore, it is generally advisable to be in Single Sweep, or Update=Off.

This command is used to compress or decimate a long trace to extract and return only the desired data. A typical example would be to acquire N frames of GSM data and return the mean power of the first burst in each frame. The command can also be used to identify the best curve fit for the data.

<b>Remote Command</b>	:CALCulate:DATA<n>:COMPRESS? BLOCK   CFIT   MAXimum   MINimum   MEAN   DMEan   RMS   RMSCubed   SAMPLE   SDEViation   PPHase [,<soffset> [,<length>[,<roffset>[,<rlimit>]]]]
<b>Example</b>	To query the mean power of a set of GSM bursts: Supply a signal that is a set of GSM bursts. Select the IQ Waveform measurement (in IQ Analyzer Mode). Set the sweep time to acquire at least one burst. Set the triggers such that acquisition happens at a known position relative to a burst. Then query the mean burst levels using, CALC:DATA2:COMP? MEAN, 24e-6, 526e-6 (These parameter values correspond to GSM signals, where 526e-6 is the length of the burst in the slot and you just want 1 burst.)
<b>Notes</b>	The command supports 5 parameters. Note that the last 4 (<soffset>, <length>, <roffset>, <rlimit>) are optional. But these optional parameters must be entered in the specified order. For example, if you want to specify <length>, then you must also specify <soffset>. See details below for a definition of each of these parameters.  This command uses the data in the format specified by FORMat:DATA, returning either binary or ASCII data.
<b>Initial S/W Revision</b>	Prior to A.02.00

- BLOCK or block data - returns all the data points from the region of the trace data that you specify. For example, it could be used to return the data points of an input signal over several timeslots, excluding the portions of the trace data that you do not want. (This is x,y pairs for trace data and I,Q pairs for complex data.)



- CFIT or curve fit - applies curve fitting routines to the data. <soffset> and <length> are required to define the data that you want. <roffset> is an optional parameter for the desired order of the curve equation. The query will return the following values: the x-offset (in seconds) and the curve coefficients ((order + 1) values).

MIN, MAX, MEAN, DME, RMS, RMSC, SAMP, SDEV and PPH return one data value for each specified region (or <length>) of trace data, for as many regions as possible until you run out of trace data (using <roffset> to specify regions). Or they return the number of regions you specify (using <rlimit>) ignoring any data beyond that.

- MINimum - returns the minimum data point (y value) for the specified region(s) of trace data. For I/Q trace data, the minimum magnitude of the I/Q pairs is returned.
- MAXimum - returns the maximum data point (y value) for the specified region(s) of trace data. For I/Q trace data, the maximum magnitude of the I/Q pairs is returned.
- MEAN - returns a single value that is the arithmetic mean of the data point values (in dB/ dBm) for the specified region(s) of trace data. For I/Q trace data, the mean of the magnitudes of the I/Q pairs is returned. See the following equations.

- 

**NOTE**

If the original trace data is in dB, this function returns the arithmetic mean of those log values, not log of the mean power which is a more useful value. The mean of the log is the better measurement technique when measuring CW signals in the presence of noise. The mean of the power, expressed in dB, is useful in power measurements such as Channel Power. To achieve the mean of the power, use the RMS option.

Equation 1

Mean Value of Data Points for Specified Region(s)

$$\text{MEAN} = \frac{1}{n} \sum_{X_i \in \text{region}(s)} X_i$$

where  $X_i$  is a data point value, and  $n$  is the number of data points in the specified region(s).

Equation 2

Mean Value of I/Q Data Pairs for Specified Region(s)

$$\text{MEAN} = \frac{1}{n} \sum_{X_i \in \text{region}(s)} |X_i|$$

where  $|X_i|$  is the magnitude of an I/Q pair, and  $n$  is the number of I/Q pairs in the specified region(s).

- DMEan - returns a single value that is the mean power (in dB/ dBm) of the data point values for the specified region(s) of trace data. See the following equation:

Equation 3

DMEan Value of Data Points for Specified Region(s)

$$\text{DME} = 10 \times \log_{10} \left( \frac{1}{n} \sum_{X_i \in \text{region}(s)} 10^{\frac{X_i}{10}} \right)$$

- RMS - returns a single value that is the average power on a root-mean-squared voltage scale (arithmetic rms) of the data point values for the specified region(s) of trace data. See the following equation.

**NOTE**

For I/Q trace data, the rms of the magnitudes of the I/Q pairs is returned. See the following equation. This function is very useful for I/Q trace data. However, if the original trace data is in dB, this function returns the rms of the log values which is not usually needed.

Equation 4

RMS Value of Data Points for Specified Region(s)

$$\text{RMS} = \sqrt{\frac{1}{n} \sum_{X_i \in \text{region}(s)} X_i^2}$$

where  $X_i$  is a data point value, and  $n$  is the number of data points in the specified region(s).

Equation 5

RMS Value of I/Q Data Pairs for Specified Region(s)

$$\text{RMS} = \sqrt{\frac{1}{n} \sum_{X_i \in \text{region}(s)} X_i X_i^*}$$

where  $X_i$  is the complex value representation of an I/Q pair,  $X_i^*$  its conjugate complex number, and  $n$  is the number of I/Q pairs in the specified region(s).

Once you have the rms value for a region of trace data (linear or I/Q), you may want to calculate the mean power. You must convert this rms value (peak volts) to power in dBm:

$$10 \times \log[10 \times (\text{rms value})^2]$$

- SAMPlE - returns the first data value (x,y pair) for the specified region(s) of trace data. For I/Q trace data, the first I/Q pair is returned.
- SDEViation - returns a single value that is the arithmetic standard deviation for the data point values for the specified region(s) of trace data. See the following equation.
- For I/Q trace data, the standard deviation of the magnitudes of the I/Q pairs is returned. See the following equation.

Equation 6

Standard Deviation of Data Point Values for Specified Region(s)

$$\text{SDEV} = \sqrt{\frac{1}{n} \sum_{X_i \in \text{region}(s)} (X_i - \bar{X})^2}$$

where  $X_i$  is a data point value,  $\bar{X}$  is the arithmetic mean of the data point values for the specified region (s), and  $n$  is the number of data points in the specified region(s).

$$\text{SDEV} = \sqrt{\frac{1}{n} \sum_{X_i \in \text{region}(s)} (|X_i| - \bar{X})^2}$$

where  $|X_i|$  is the magnitude of an I/Q pair,  $\bar{X}$  is the mean of the magnitudes for the specified region(s), and  $n$  is the number of data points in the specified region(s).

- PPHase - returns the x,y pairs of both rms power (dBm) and arithmetic mean phase (radian) for every specified region and frequency offset (Hz). The number of pairs is defined by the specified number of regions. This parameter can be used for I/Q vector ( $n=0$ ) in Waveform (time domain) measurement and all parameters are specified by data point in PPHase.

The rms power of the specified region may be expressed as:

$$\text{Power} = 10 \times \log [10 \times (\text{RMS I/Q value})] + 10.$$

The RMS I/Q value (peak volts) is:

$$\sqrt{\frac{1}{n} \sum_{X_i \in \text{region}} X_i X_i^*}$$

where  $X_i$  is the complex value representation of an I/Q pair,  $X_i^*$  its conjugate complex number, and  $n$  is the number of I/Q pairs in the specified region.

The arithmetic mean phase of the specified region may be expressed as:

$$\frac{1}{n} \sum_{Y_i \in \text{region}} Y_i$$

where  $Y_i$  is the unwrapped phase of I/Q pair with applying frequency correction and  $n$  is the number of I/Q pairs in the specified region.

The frequency correction is made by the frequency offset calculated by the arithmetic mean of every specified region's frequency offset. Each frequency offset is calculated by the least square method against the unwrapped phase of I/Q pair.

Sample Trace Data - Constant Envelope

(See below for explanation of variables.)

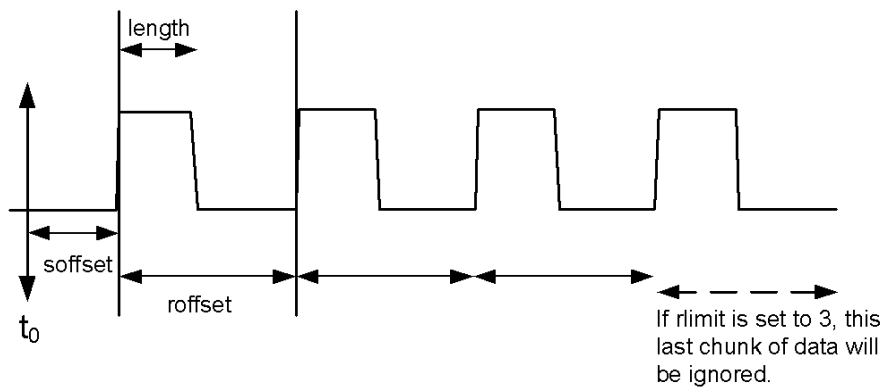

Sample Trace Data - Not Constant Envelope

(See below for explanation of variables.)

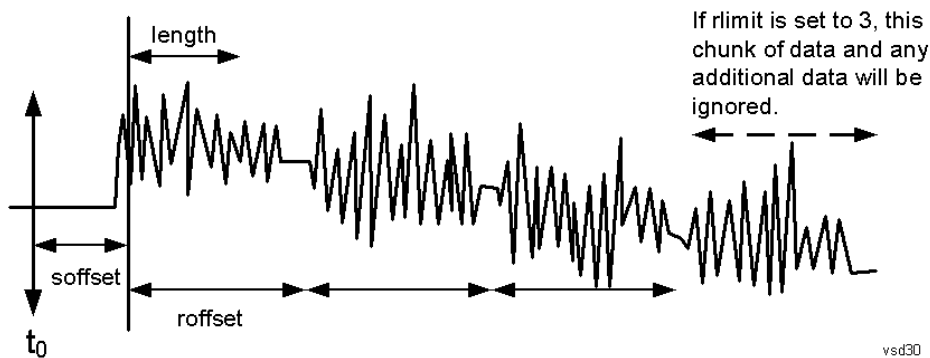

<soffset> - start offset is an optional real number. (It is in seconds for time-domain traces, and is a dimensionless index 0 to Npoints - 1, for frequency-domain traces). It specifies the amount of data at the beginning of the trace that will be ignored before the decimation process starts. It is the time or frequency change from the start of the trace to the point where you want to start using the data. The default value is zero.

<length> - is an optional real number. (It is in seconds for time-domain traces, and is a dimensionless index 0 to Npoints - 1, for frequency-domain traces). It defines how much data will be compressed into one value. This parameter has a default value equal to the current trace length.

<roffset> - repeat offset is an optional real number. (It is in seconds for time-domain traces, and is a dimensionless index 0 to Npoints - 1, for frequency-domain traces). It defines the beginning of the next field of trace elements to be compressed. This is relative to the beginning of the previous field. This parameter has a default value equal to the <length> variable. Note that this parameter is used for a completely different purpose when curve fitting (see CFIT above).

<rlimit> - repeat limit is an optional integer. It specifies the number of data items that you want returned. It will ignore any additional items beyond that number. You can use the Start offset and the Repeat limit to pick out exactly what part of the data you want to use. The default value is all the data.

## Calculate Peaks of Trace Data (Remote Command Only)

Returns a list of all the peaks for the currently selected measurement and sub-opcode [n]. The peaks must meet the requirements of the peak threshold and excursion values.

n = any valid sub-opcode for the current measurement. See the MEASure:<measurement> command description of your specific measurement for information on the data that can be returned.

The command can only be used with specific sub-opcodes with measurement results that are trace data. Both real and complex traces can be searched, but complex traces are converted to magnitude in dBm. In many measurements the sub-opcode n=0, is the raw trace data which cannot be searched for peaks. And Sub-opcode n=1, is often calculated results values which also cannot be searched for peaks.

This command uses the data setting specified by the FORMat:BORDER and FORMat:DATA commands and can return real or ASCII data. If the format is set to INT,32, it returns REAL,32 data.

The command has four types of parameters:

- Threshold (in dBm)
- Excursion (in dB)
- Sorting order (amplitude, frequency, time)
- Optional in some measurements: Display line use (all, > display line, < display line)

---

<b>Remote Command</b>	<p>For Swept SA measurement:</p> <pre>:CALCulate:DATA[1] 2 ... 6:PEAKs? &lt;threshold&gt;,&lt;excursion&gt;[,AMPLitude   FREQuency   TIME[,ALL   GTDLLine   LTDLine]]</pre> <p>For most other measurements:</p> <pre>:CALCulate:DATA[1] 2 ... 6:PEAKs? &lt;threshold&gt;,&lt;excursion&gt;[,AMPLitude   FREQuency   TIME]</pre>
-----------------------	---------------------------------------------------------------------------------------------------------------------------------------------------------------------------------------------------------------------------------------------------------------------------------------------------------------------------------

---

<b>Example</b>	<p>Example for Swept SA measurement in Spectrum Analyzer Mode:</p> <p>CALC:DATA4:PEAK? -40, 10, FREQ, GTDL This will identify the peaks of trace 4 that are above -40 dBm, with excursions of at least 10 dB. The peaks are returned in order of increasing frequency, starting with the lowest frequency. Only the peaks that are above the display line are returned.</p> <p>Query Results 1:</p> <p>With FORMat:DATA REAL, 32 selected, it returns a list of floating-point numbers. The first value in the list is the number of peak points that are in the following list. A peak point consists of two values: a peak amplitude followed by its corresponding frequency (or time).</p> <p>If no peaks are found the peak list will consist of only the number of peaks, (0).</p>
----------------	-----------------------------------------------------------------------------------------------------------------------------------------------------------------------------------------------------------------------------------------------------------------------------------------------------------------------------------------------------------------------------------------------------------------------------------------------------------------------------------------------------------------------------------------------------------------------------------------------------------------------------------------------------------------------------------------------------------------------------------------------------------------------------------------

---

<b>Notes</b>	<p>&lt;n&gt; - is the trace that will be used</p> <p>&lt;threshold&gt; - is the level below which trace data peaks are ignored. Note that the threshold value is required and is always used as a peak criterion. To effectively disable the threshold criterion for this command, provide a substantially low threshold value such as -200 dBm. Also note that the threshold value used in this command is independent of and has no effect on the threshold value stored under the Peak Criteria menu.</p> <p>&lt;excursion&gt; - is the minimum amplitude variation (rise and fall) required for a signal to be identified as peak. Note that the excursion value is required and is always used as a peak criterion. To effectively disable the excursion criterion for this command, provide the minimum value of 0.0 dB. Also note that the excursion value used in this command is independent of and has no effect on the</p>
--------------	---------------------------------------------------------------------------------------------------------------------------------------------------------------------------------------------------------------------------------------------------------------------------------------------------------------------------------------------------------------------------------------------------------------------------------------------------------------------------------------------------------------------------------------------------------------------------------------------------------------------------------------------------------------------------------------------------------------------------------------------------------------------------------------------------------------------------------------------------------------------------------------------------------------------------------------

---

---

excursion value stored under the Peak Criteria menu.

Values must be provided for threshold and excursion. The sorting and display line parameters are optional (defaults are AMPLitude and ALL).

Note that there is always a Y-axis value for the display line, regardless of whether the display line state is on or off. It is the current Y-axis value of the display line which is used by this command to determine whether a peak should be reported

Sorting order:

AMPLitude - lists the peaks in order of descending amplitude, with the highest peak first (default if optional parameter not sent)

FREQuency - lists the peaks in order of occurrence, left to right across the x-axis.

TIME - lists the peaks in order of occurrence, left to right across the x-axis.

Peaks vs. Display Line:

ALL - lists all of the peaks found (default if optional parameter not sent).

GTDLine (greater than display line) - lists all of the peaks found above the display line.

LTDLine (less than display line) - lists all of the peaks found below the display line.

---

Initial S/W Revision      Prior to A.02.00

---

### Format Data: Numeric Data (Remote Command Only)

This command specifies the format of the trace data input and output. It specifies the formats used for trace data during data transfer across any remote port. It affects only the data format for setting and querying trace data for the :TRACe[:DATA], TRACe[:DATA]?, :CALCulate:DATA[n]? and FETCh:SANalyzer [n]? commands and queries.

---

**Remote Command**      :FORMat [:TRACe] [:DATA] ASCii|INTeger,32|REAL,32 |REAL,64  
:FORMat [:TRACe] [:DATA] ?

---

**Notes**      The query response is:  
ASCii: ASC,8  
REAL,32: REAL,32  
REAL,64: REAL,64  
INTeger,32: INT,32

When the numeric data format is REAL or ASCii, data is output in the current Y Axis unit. When the data format is INTeger, data is output in units of m dBm (.001 dBm).

The INT,32 format returns binary 32-bit integer values in internal units (m dBm), in a definite length block.

---

**Dependencies**      Sending a data format spec with an invalid number (for example, INT,48) generates no error. The analyzer simply uses the default (8 for ASCii, 32 for INTeger, 32 for REAL).

Sending data to the analyzer which does not conform to the current FORMat specified, results in an error. Sending ASCII data when a definite block is expected generates message -161 "Invalid Block Data" and sending a definite block when ASCII data is expected generates message -121 "Invalid Character in Number".

---

**Preset**      ASCii

---

**Backwards Compatibility Notes**      Note that the INT,32 format is only applicable to the command, TRACe:DATA. This preserves backwards compatibility for the Swept SA measurement. For all other commands/queries which honor FORMat:DATA, if INT,32 is sent the analyzer will behave as though it were set to REAL,32.

---

Initial S/W Revision      Prior to A.02.00

---

The specs for each output type follow:

ASCIi - Amplitude values are in ASCII, in the current Y Axis Unit, one ASCII character per digit, values separated by commas, each value in the form:

SX.YYYYYEsZZ

Where:

S = sign (+ or -)

X = one digit to left of decimal point

Y = 5 digits to right of decimal point

E = E, exponent header

s = sign of exponent (+ or -)

ZZ = two digit exponent

REAL,32 - Binary 32-bit real values in the current Y Axis Unit, in a definite length block.

REAL,64 - Binary 64-bit real values in the current Y Axis Unit, in a definite length block.

### Format Data: Byte Order (Remote Command Only)

This command selects the binary data byte order for data transfer and other queries. It controls whether binary data is transferred in normal or swapped mode. This command affects only the byte order for setting and querying trace data for the :TRACe[:DATA], TRACe[:DATA]? , :CALCulate:DATA[n]? and FETCh:SANalyzer[n]? commands and queries.

By definition any command that says it uses FORMat:DATA uses any format supported by FORMat:DATA.

The NORMal order is a byte sequence that begins with the most significant byte (MSB) first, and ends with the least significant byte (LSB) last in the sequence: 1|2|3|4. SWAPPed order is when the byte sequence begins with the LSB first, and ends with the MSB last in the sequence: 4|3|2|1.

<b>Remote Command</b>	:FORMat:BORDER NORMal SWAPPed :FORMat:BORDER?
<b>Preset</b>	NORMal
<b>Initial S/W Revision</b>	Prior to A.02.00

## Meas Setup

Displays the setup menu keys that enable you to control the parameters for the current measurement.

Key Path	Front-panel key
Initial S/W Revision	Prior to A.02.00

### Average/Hold Num

Sets the number of sweeps (average counts) that are averaged. After the specified number of sweeps, the averaging mode (terminal control) setting determines the averaging action.

Key Path	Meas Setup
Mode	BASIC, PNOISE, WCDMA, C2K, GSM, WIMAXOFDMA, TDSCDMA, 1XEVD0, DVB, DTMB, ISDBT, CMMB, LTE, LTETDD, DCATV, WLAN, MSR,LTEATDD, LTEAFDD
Remote Command	[ :SENSe ] :WAVeform:AVErAge:COUNt <integer> [ :SENSe ] :WAVeform:AVErAge:COUNt? [ :SENSe ] :WAVeform:AVErAge [ :STATe ] OFF ON 0 1 [ :SENSe ] :WAVeform:AVErAge [ :STATe ] ?
Example	WAV:AVER:COUN 1001 WAV:AVER:COUN? WAV:AVER ON WAV:AVER?
Notes	You must be in a mode that includes the Waveform measurement to use this command. Use INSTRument:SElect to set the mode.
Preset	10 OFF
State Saved	Saved in instrument state.
Min	1
Max	20001
Initial S/W Revision	Prior to A.02.00
Modified at S/W Revision	A.03.00

### Avg Mode

Enables you to set the averaging mode.

- When set to Exponential (Exp) the measurement averaging continues using the specified number of averages to compute each averaged value. The average is displayed at the end of each sweep.
- When set to Repeat, the measurement resets the average counter each time the specified number of averages is reached.



Key Path	Meas Setup
Mode	BASIC, PNOISE, WCDMA, C2K, GSM, WIMAXOFDMA, TDSCDMA, 1XEVD0, DVB, DTMB, ISDBT, CMMB, LTE, LTETDD, DCATV, WLAN, MSR,LTEATDD, LTEAFDD
<b>Remote Command</b>	<code>[ :SENSe ] :WAVeform:AVERage:TCONtrol EXPONential REPeat</code> <code>[ :SENSe ] :WAVeform:AVERage:TCONtrol?</code>
<b>Example</b>	WAV:AVER:TCON REP WAV:AVER:TCON?
Notes	You must be in a mode that includes the Waveform measurement to use this command. Use INSTRUMENT:SElect to set the mode.
Preset	EXPONential
State Saved	Saved in instrument state.
Range	Exp Repeat
Initial S/W Revision	Prior to A.02.00
Modified at S/W Revision	A.03.00

## Avg Type

Selects the type of averaging.

Key Path	Meas Setup
Mode	BASIC, PNOISE, WCDMA, C2K, GSM, WIMAXOFDMA, TDSCDMA, 1XEVD0, DVB, DTMB, ISDBT, CMMB, LTE, LTETDD, DCATV, WLAN, MSR,LTEATDD, LTEAFDD
<b>Remote Command</b>	<code>[ :SENSe ] :WAVeform:AVERage:TYPE LOG   MAXimum   MINimum   RMS   SCALar</code> <code>[ :SENSe ] :WAVeform:AVERage:TYPE?</code>
<b>Example</b>	WAV:AVER:TYPE RMS WAV:AVER:TYPE?
Notes	The SCPI selection of MAX and MIN are kept for BWCC, but they are removed from the front panel access because they are not an Average function. You must be in a mode that includes the Waveform measurement to use this command. Use INSTRUMENT:SElect to set the mode.
Preset	RMS
State Saved	Saved in instrument state.
Range	Pwr Avg(RMS) Log-Pwr Avg(Video) Voltage Avg
Initial S/W Revision	Prior to A.02.00
Modified at S/W Revision	A.03.00

## Time Avg Num

Sets the number of HW averages to be executed per each data acquisition.

Key Path	Meas Setup
Mode	BASIC
Remote Command	[ :SENSe ] :WAVeform:AVERage:TACount <integer> [ :SENSe ] :WAVeform:AVERage:TACount?
Example	WAV:AVER:TAC 10WAV:AVER:TAC?
Notes	This feature is only available when Option DP2, B40, or wider IF Bandwidth option is installed.
Preset	1
State Saved	Saved in instrument state
Min	1
Max	65535
Default Unit	Enter

## Meas Time

Sets how long the measurement is performed. X Scale only changes the representation of the display.

Key Path	Meas Setup
Mode	BASIC, PNOISE, WCDMA, C2K, GSM, WIMAXOFDMA, TDSCDMA, 1XEVD0, DVB, DTMB, ISDBT, CMMB, LTE, LTETDD, DCATV, WLAN, MSR,LTEATDD, LTEAFDD
Remote Command	[ :SENSe ] :WAVeform:SWEep:TIME <time> [ :SENSe ] :WAVeform:SWEep:TIME?
Example	WAV:SWE:TIME 50 ms WAV:SWE:TIME?
Notes	Specifies and returns how long the measurement is performed. It is the time record length of the measurement waveform. The Max time may be reduced when the sample frequency is high due to the memory limitation. You must be in a mode that includes the Waveform measurement to use this command. Use INSTRument:SElect to set the mode.
Preset	All except the following list: 2.000000 ms LTEAFDD, LTEATDD: 10 ms LTETDD: 10 ms
State Saved	Saved in instrument state.
Range	1.000 (s to 100.00 s
Min	1.000 us
Max	3200 s
Initial S/W Revision	Prior to A.02.00
Modified at S/W Revision	A.03.00, A.14.00

## Sample Rate

Enables you to set an arbitrary sample rate for the acquired data to be processed.

Key Path	Meas Setup
Mode	BASIC
Remote Command	[ :SENSe ] :WAVeform:SRATe <freq> [ :SENSe ] :WAVeform:SRATe?
Example	WAV:SRAT 1.3636 MHz
Notes	Command and query available when Option DP2, B40, or wider IF Bandwidth option is installed. For other configuration, only query is available.
Couplings	The coupling between Sample Rate and IF BW depends on Physics implementation.
Preset	125.0 kHz
Min	12.5 Hz
Max	<ul style="list-style-type: none"> <li>• (For Option DP2, B40 or wider IF Bandwidth option )</li> <li>• Digital IF 10 MHz path: 12.5 MHz</li> <li>• Digital IF 25 MHz path: 31.25 MHz</li> <li>• Digital IF 40 MHz path: 50 MHz</li> <li>• Option B85 85 MHz path: 106.25 MHz</li> <li>• Option B1A 125 MHz path: 156.25 MHz</li> <li>• Option B1X 140 MHz path: 175 MHz</li> <li>• Option B1Y 160 MHz path: 200 MHz</li> <li>• (For all other configuration)</li> <li>• 10 MHz path: 15 MHz</li> <li>• Option B25 25 MHz path: 45 MHz</li> </ul>
Modified at S/W Revision	13.00

## PhNoise Opt

Selects the LO (local oscillator) phase noise behavior for various desired operating conditions.

Key Path	Meas Setup
Remote Command	[ :SENSe ] :WAVeform:FREQuency:SYNThesis [ :STATe ] 1   2   3 [ :SENSe ] :WAVeform:FREQuency:SYNThesis [ :STATe ] ?
Example	WAV:FREQ:SYNT 2 Selects optimization for best wide offset phase noise
Notes	Parameter: 1 optimizes phase noise for small frequency offsets from the carrier. 2 optimizes phase noise for wide frequency offsets from the carrier. 3 optimizes LO for tuning speed

	(In PXA, the local oscillator hardware provides for extra-low phase noise at the expense of some speed.)
Dependencies	Does not appear in all models. The key is blank in those models, but the SCPI command is accepted for compatibility (although no action is taken).
Preset	Because this function is in Auto after preset, and because Digital IF BW after preset < 150 kHz for MXA/EXA and > 400 kHz for PXA the state of this function after Preset will be 1 for MXA/EXA and 2 for PXA.
State Saved	Saved in instrument state.
Min	1
Min	1
Max	3
Initial S/W Revision	Prior to A.07.00
Modified at S/W Revision	A.07.00

## Auto

Selects the LO (local oscillator) phase noise behavior to optimize dynamic range and speed for various instrument operating conditions.

The X-Series has two grades of LO; a high performance LO that gives the best phase noise performance; and a medium-performance LO that gives excellent performance.

In models with the high performance LO, Auto will choose:

	Best Close in Phase Noise	Best Wide-offset Phase Noise
Filter BW	≤ 400 kHz	> 400 kHz

In models with the medium-performance LO, Auto will choose:

	Best Close in Phase Noise	Best Wide-offset Phase Noise
Filter BW	≤ 150 kHz	>150 kHz

Note that Fast Tuning will not be selected when in Auto.

Key Path	Meas Setup, PhNoise Opt
Remote Command	[ :SENSe ] :WAVEform:FREQuency:SYNTHeSis:AUTO[ :STATe ] OFF   ON   0   1 [ :SENSe ] :WAVEform:FREQuency:SYNTHeSis:AUTO[ :STATe ] ?
Example	WAV:FREQ:SYNT:AUTO ON
Preset	ON
State Saved	Saved in instrument state.
Initial S/W Revision	Prior to A.07.00

## Best Close-in P Noise

The LO phase noise is optimized for smaller offsets from the carrier, at the expense of phase noise farther out.

Key Path	Meas Setup, PhNoise Opt
<b>Example</b>	WAV:FREQ:SYNT 1
Couplings	<p>The frequency below which the phase noise is optimized is model dependent:</p> <ul style="list-style-type: none"> <li>• <b>CXA:</b> n/a</li> <li>• <b>EXA:</b> [offset <math>\leq</math>150 kHz]</li> <li>• <b>MXA:</b> [offset <math>\leq</math>150 kHz]</li> <li>• <b>PXA:</b> [offset <math>\leq</math>400 kHz]</li> </ul>
Readback	<p>Close-in.</p> <p>If manually selected, “Man” will be underlined. The actual frequency offset within which noise is optimized is shown with in square brackets, as this can vary depending on the hardware set in use. For example, in some analyzers this annotation appears as [offset &lt;150 kHz]</p>
Initial S/W Revision	Prior to A.07.00

## Best Wide-offset P Noise

The LO phase noise is optimized for wider offsets from the carrier. Closer offsets are compromised and the throughput of measurements (especially remote measurements where the center frequency is changing rapidly), is reduced.

Key Path	Meas Setup, PhNoise Opt
<b>Example</b>	WAV:FREQ:SYNT 2
Couplings	<p>The frequency below which the phase noise is optimized is model dependent:</p> <p>CXA: n/a</p> <p>EXA: [offset &gt;150 kHz]</p> <p>MXA: [offset &gt;150 kHz]</p> <p>PXA: [offset &gt;400 kHz]</p>
Readback	<p>Wide-offset.</p> <p>If manually selected, “Man” will be underlined. The actual frequency offset beyond which noise is optimized is shown with in square brackets, as this can vary depending on the hardware set in use. For example, in some analyzers this annotation appears as [offset &gt;150 kHz]</p>
Initial S/W Revision	Prior to A.07.00

## Fast Tuning

In this mode, the LO behavior compromises phase noise at many offsets from the carrier in order to allow rapid measurement throughput when changing the center frequency. The term “fast tuning” refers to the time it takes to move the local oscillator to the start frequency and begin a capture; this setting does not impact the actual measurement time in any way.

Key Path	Meas Setup, PhNoise Opt
<b>Example</b>	WAV:FREQ:SYNT 3
State Saved	Saved in instrument state.
Readback	Fast Tuning. If manually selected the “Man” will be underlined.
Initial S/W Revision	Prior to A.07.00

## Advanced

Accesses a menu of advanced functions that are used for specific applications. These settings should not be changed for most measurements.

Key Path	Meas Setup
Initial S/W Revision	Prior to A.02.00

## ADC Dither

Accesses the ADC Dither control menu.

Key Path	Meas Setup, Advanced
Initial S/W Revision	Prior to A.02.00

## ADC Dither Auto

Sets ADC dithering to automatically select whether dithering is needed.

Key Path	Meas Setup, Advanced, ADC Dither
Mode	BASIC, PNOISE, WCDMA, C2K, GSM, WIMAXOFDMA, TDSCDMA, 1XEVD0, DVB, DTMB, ISDBT, CMMB, LTE, LTETDD, DCATV, WLAN, MSR,LTEATDD, LTEAFDD
<b>Remote Command</b>	[ :SENSe ] :WAVeform:ADC:DITHer:AUTO [ :STATe ] OFF ON 0 1 [ :SENSe ] :WAVeform:ADC:DITHer:AUTO [ :STATe ] ?
<b>Example</b>	WAV:ADC:DITH:AUTO ON WAV:ADC:DITH:AUTO?
Notes	The dither function improves linearity for low level signals, at the expense of a higher noise floor. You must be in a mode that includes the Waveform measurement to use this command. Use

	INSTRument:SElect to set the mode.
Preset	OFF
State Saved	Saved in instrument state.
Range	On Off
Initial S/W Revision	Prior to A.02.00
Modified at S/W Revision	A.03.00

### ADC Dither

Toggles the dither function On and Off. The dither function improves linearity for low level signals, at the expense of a higher noise floor.

The reduced clipping-to-noise ratio results in higher noise, because the clipping level of the ADC relative to the front terminals remains unchanged with the introduction of dither. The enhanced linearity is mostly improved scale fidelity.

With dither on, the third-order distortions are usually invisible for mixer levels below  $-35$  dBm. With dither off, these distortions can be visible, with typical power levels of  $-110$  dBm referred to the mixer. Detection nonlinearity can reach 1 dB for dither off at mixer levels around  $-70$  dBm and lower, while the specified nonlinearity is many times smaller with dither on.

Key Path	Meas Setup, Advanced, ADC Dither
Mode	BASIC, PNOISE, WCDMA, C2K, GSM, WIMAXOFDMA, TDSCDMA, 1XEVD0, DVB, DTMB, ISDBT, CMMB, LTE, LTE4DD, DCATV, WLAN, MSR, LTEATDD, LTEAFDD
Remote Command	[ :SENSe ] :WAVeform:ADC:DITHer [ :STATe ] OFF ON 0 1 [ :SENSe ] :WAVeform:ADC:DITHer [ :STATe ] ?
Example	WAV:ADC:DITH ON WAV:ADC:DITH?
Notes	The dither function improves linearity for low level signals, at the expense of a higher noise floor. . You must be in a mode that includes the Waveform measurement to use this command. Use INSTRument:SElect to set the mode.
Preset	OFF
State Saved	Saved in instrument state.
Range	Auto Man
Backwards Compatibility SCPI	[ :SENSe ] :WAVeform:WBIF:ADC:DITHer [ :SENSe ] :WAVeform:PDITHer
Initial S/W Revision	Prior to A.02.00
Modified at S/W Revision	A.03.00

## IF Gain

Accesses the keys to select the IF Gain settings.

When in Autorange mode, the IF checks its range once for data acquisition, to provide the best signal to noise ratio. You can specify the range for the best speed, and optimize for noise or for large signals.

When the IF Gain is set to Autorange, the IF Gain is set to High initially for each chunk of data. The data is then acquired. If the IF overloads, then the IF Gain is set to Low and the data is re-acquired. Because of this operation, the Autorange setting uses more measurement time as the instrument checks/resets its range. You can get faster measurement speed by forcing the range to either the high or low gain setting. But you must know that your measurement conditions will not overload the IF (in the high gain range) and that your signals are well above the noise floor (for the low gain range), and that the signals are not changing.

When Digital Bus Out (under the Input/Output menu) is ON, the IF Gain State Autorange selection is not allowed. Thus, in this case, IF Gain State will be set to Low.

This only applies to the RF input. It does not apply to baseband I/Q input.

Key Path	Meas Setup, Advanced
Initial S/W Revision	Prior to A.02.00

## IF Gain Auto

Activates the auto rules for IF Gain

Key Path	Meas Setup, Advanced, IF Gain
Mode	BASIC, PNOISE, WCDMA, C2K, GSM, WIMAXOFDMA, TDSCDMA, 1XEVD0, DVB, DTMB, ISDBT, CMMB, LTE, LTETDD, DCATV, WLAN, MSR,LTEATDD, LTEAFDD
Remote Command	[ :SENSe ] :WAVeform:IF:GAIN:AUTO [ :STATe ] ON OFF 1 0 [ :SENSe ] :WAVeform:IF:GAIN:AUTO [ :STATe ] ?
Example	WAV:IF:GAIN:AUTO ON WAV:IF:GAIN:AUTO?
Notes	This only applies to the RF input. It does not apply to baseband I/Q input. You must be in a mode that includes the Waveform measurement to use this command. Use INSTRument:SElect to set the mode.
Preset	ON
State Saved	Saved in instrument state.
Range	On Off
Initial S/W Revision	Prior to A.02.00
Modified at S/W Revision	A.03.00

## IF Gain State

Selects the range of IF gain.



Key Path	Meas Setup, Advanced, IF Gain
Mode	BASIC, PNOISE, WCDMA, C2K, GSM, WIMAXOFDMA, TDSCDMA, 1XEVD0, DVB, DTMB, ISDBT, CMMB, LTE, LTE4DD, DCATV, WLAN, MSR, LTEATDD, LTEAFDD
Remote Command	[ :SENSe ] :WAVeform:IF:GAIN [ :STATe ] AUTOrange   LOW   HIGH [ :SENSe ] :WAVeform:IF:GAIN [ :STATe ] ?
Example	WAV:IF:GAIN HIGH WAV:IF:GAIN?
Notes	This only applies to the RF input and does not apply to baseband I/Q input. You must be in a mode that includes the Waveform measurement to use this command. Use INSTRUMENT:SElect to set the mode. If the user tries to select Autorange while Digital Bus Out is ON, an error message -221 "Settings conflict; "IF Gain Autorange not allowed when Digital Bus Out is ON" is displayed.
Couplings	If the user tries to select Autorange via SCPI while Digital Bus Out is ON, an error message -224, "Illegal parameter value; "IF Gain Autorange not allowed when Digital Bus Out is on" is displayed. If the user tries to select Autorange via front panel while Digital Bus Out is ON, an advisory message "IF Gain Autorange not allowed when Digital Bus Out is on" is displayed.
Preset	LOW
State Saved	Saved in instrument state.
Range	Autorange (Slower Follows Signals) Low (Best for Large Signals) High (Best Noise Level)
Readback Text	Autorange Low High
Initial S/W Revision	Prior to A.02.00
Modified at S/W Revision	A.03.00

## IF Gain Offset

Sets the IF Gain offset in 2 dB step from -6 dB to +6 dB. Increasing the gain can increase the amplitude of small signals as long as you do not overdrive the hardware. Wideband gain should usually be adjusted after setting the input attenuation.

Internally, the IF Gain value will change based on the current configuration of the hardware. If you choose to offset this value, you may do so with this parameter. The value specified is not an absolute value but relative to the current internal IF Gain setting.

For example:

IF Gain Low + IF Gain Offset +4 dB = Total IF Gain of +4 dB (0 + 4 = 4)

IF Gain High + IF Gain Offset +4 dB = Total IF Gain of +14 dB (10 + 4 = 14)

IF Gain Low + IF Gain Offset -6 dB = Total IF Gain of -6 dB (0 - 6 = -6)

IF Gain High + IF Gain Offset -6 dB = Total IF Gain of +6 dB (10 - 6 = 4)

The total IF Gain range when IF Gain Offset is available is a minimum of  $0 - 6 = -6$  dB and a maximum of  $10 + 6 = 16$  dB. The available IF Gain depends on the IF Path and center frequency. The maximum IF Gain may not be achievable at all times depending on the configuration.

Key Path	Meas Setup, Advanced
Remote Command	<code>[ :SENSe ] :WAVeform:IF:GAIN:OFFSet &lt;rel_ampl &gt;</code> <code>[ :SENSe ] :WAVeform:IF:GAIN:OFFSet?</code>
Example	WAV:IF:GAIN:OFFS 2 Sets the IF Gain offset to 2
Preset	0
State Saved	Saved in instrument state.
Min	-6
Max	+6
Default Unit	dB

## Meas Preset

Restores all the measurement parameters to their default values.

Key Path	Meas Setup
Mode	BASIC, PNOISE, WCDMA, C2K, GSM, WIMAXOFDMA, TDSCDMA, 1XEVD0, DVB, DTMB, ISDBT, CMMB, LTE, LTETDD, DCATV, WLAN, MSR,LTEATDD, LTEAFDD
Remote Command	<code>:CONFigure:WAVeform</code>
Example	CONF:WAV
Notes	Restore default values of all parameters. You must be in a mode that includes the Waveform measurement to use this command. Use INSTRument:SElect to set the mode.
Initial S/W Revision	Prior to A.02.00
Modified at S/W Revision	A.03.00

## HW Averaging

Changes the number of time averages is to be made using hardware. This averaging is much faster than the standard averaging done in software. The hardware averaging is done on the complex voltage time trace data before any measurement application averaging is done. Both types of averaging (HW and SW) can be done on the same measurement data.

When time averaging is being done in HW, each trace update represents N fresh data acquisitions averaged together, where N is the number of averages. You cannot access the individual time data. Note that in the spectrum measurement this averaging is done prior to the standard averaging done within the application. Thus the yellow trace in this measurement shows the result of the time averaging. Subsequent averaging is orthogonal to this hardware based time averaging and its result is seen as the blue trace in this and other applications.

So it is possible to turn off the averaging within the application but still have the HW averaging set to a certain number. In other words, turning averaging off within the measurement will not affect HW averaging. If HW averaging needs to be turned off, simply set the HW Averaging parameter to 1.

Since it is time averaging, a trigger source something other than Free Run should be used to avoid cancelling out the signal to be measured. It is most useful for a periodic signal with known periods.

### Sample Period (Aperture) Setting (Remote Command Only)

Returns the time between samples (sample period or aperture).

Mode	BASIC
<b>Remote Command</b>	[ :SENSe ] :WAVeform:APERture?
<b>Example</b>	WAV:APER?
Notes	Query only.
Couplings	Coupled to Sample Rate by the following equation. Sample Period = 1/(Sample Rate)
Preset	1/(Sample Rate Default)
Min	1/(Max Sample Rate)
Max	1/(Min Sample Rate)

21 Waveform Measurement  
Mode

Mode

See "[Mode](#)" on page 318

## Mode Preset

Returns the active mode to a known state.

Mode Preset does the following for the currently active mode:

- Aborts the currently running measurement.
- Brings up the default menu for the mode, with no active function.
- Sets measurement Global settings to their preset values for the active mode only.
- Activates the default measurement.
- Brings up the default menu for the mode.
- Clears the input and output buffers.
- Sets Status Byte to 0.

Mode Preset does not:

- Cause a mode switch
- Affect mode persistent settings
- Affect system settings

See "[How-To Preset](#)" on page 2874 for more information.

Key Path	Front-panel key
<b>Remote Command</b>	:SYSTem:PRESet
<b>Example</b>	:SYST:PRES
Notes	*RST is preferred over :SYST:PRES for remote operation. *RST does a Mode Preset, as done by the :SYST:PRES command, and it sets the measurement mode to Single measurement rather than Continuous for optimal remote control throughput. Clears all pending OPC bits. The Status Byte is set to 0.
Couplings	A Mode Preset aborts the currently running measurement, activates the default measurement, and gets the mode to a consistent state with all of the default couplings set.
Backwards Compatibility Notes	In the X-Series, the legacy "Factory Preset" has been replaced with Mode Preset, which only presets the currently active mode, not the entire instrument. In the X-Series, the way to preset the entire instrument is by using System, Restore System Defaults All, which behaves essentially the same way as restore System Defaults does on ESA and PSA. There is also no "Preset Type" as there is on the PSA. There is a green Mode Preset front-panel key that does a Mode Preset and a white-with-green-letters User Preset front-panel key that does a User Preset. The old PRESet:TYPE command is ignored (without generating an error), and SYST:PRES without a parameter does a Mode Preset, which should cover most backward code compatibility issues. The settings and correction data under the Input/Output front-panel key (examples: Input Z Corr, Ext Amp Gain, etc.) are no longer part of any Mode, so they will not be preset by a Mode Preset. They are preset using Restore Input/Output Defaults, Restore System Defaults All. Note that because User Preset does a Recall State, and all of these settings are saved in State, they ARE recalled when using

	User Preset.
Initial S/W Revision	Prior to A.02.00

## How-To Preset

The table below shows all possible presets, their corresponding SCPI commands and front-panel access (key paths). Instrument settings depend on the current measurement context. Some settings are local to the current measurement, some are global (common) across all the measurements in the current mode, and some are global to all the available modes. In a similar way, restoring the settings to their preset state can be done within the different contexts.

Auto Couple - is a measurement local key. It sets all Auto/Man parameter couplings in the measurement to Auto. Any Auto/Man selection that is local to other measurements in the mode will not be affected.

Meas Preset - is a measurement local key. Meas Preset resets all the variables local to the current measurement except the persistent ones.

Mode Preset - resets all the current mode's measurement local and measurement global variables except the persistent ones.

Restore Mode Defaults - resets ALL the Mode variables (and all the Meas global and Meas local variables), including the persistent ones.

Type Of Preset	SCPI Command	Front Panel Access
Auto Couple	:COUPle ALL	Auto Couple front-panel key
Meas Preset	:CONFigure:<Measurement>	Meas Setup Menu
Mode Preset	:SYSTem:PRESet	Mode Preset (green key)
Restore Mode Defaults	:INSTrument:DEFault	Mode Setup Menu
Restore All Mode Defaults	:SYSTem:DEFault MODes	System Menu; Restore System Default Menu
*RST	*RST	not possible (Mode Preset with Single)
Restore Input/Output Defaults	:SYSTem:DEFault INPUt	System Menu; Restore System Default Menu
Restore Power On Defaults	:SYSTem:DEFault PON	System Menu; Restore System Default Menu
Restore Alignment Defaults	:SYSTem:DEFault ALIGN	System Menu; Restore System Default Menu
Restore Miscellaneous Defaults	:SYSTem:DEFault MISC	System Menu; Restore System Default Menu
Restore All System Defaults	:SYSTem:DEFault [ALL] :SYSTem:PRESet:PERsistent	System Menu; Restore System Default Menu
User Preset	:SYSTem:PRESet:USER	User Preset Menu
User Preset All Modes	:SYSTem:PRESet:USER:ALL	User Preset Menu

Power On Mode Preset	:SYSTem:PON:TYPE MODE	System Menu
Power On User Preset	:SYSTem:PON:TYPE USER	System Menu
Power On Last State	:SYSTem:PON:TYPE LAST	System Menu

### Preset Type (Remote Command Only)

As stated in the Backward Compatibility section, to be compatible with ESA/PSA the PRESet:TYPE command will be implemented as a no-op.

Mode	All
<b>Remote Command</b>	:SYSTem:PRESet:TYPE FACTory MODE USER :SYSTem:PRESet:TYPE?
<b>Example</b>	:SYST:PRESet:TYPE FACT
Notes	This command is supported for backward compatibility only. It is a no-op which does not change the behavior of any preset operation.
Preset	This is unaffected by Preset but is set to Mode on a "Restore System Defaults->All"
State Saved	No
Initial S/W Revision	Prior to A.02.00

## Mode Setup

See "[Mode Setup](#)" on page 348



## Peak Search

Places the selected marker on the trace point with the maximum y-axis value for that marker's trace and accesses a menu that enables you to select to do a next peak or minimum peak search.

Key Path	Front-panel key
Mode	BASIC, PNOISE, WCDMA, C2K, GSM, WIMAXOFDMA, TDSCDMA, 1XEVD0, DVB, DTMB, ISDBT, CMMB, LTE, LTETDD, DCATV, WLAN, MSR,LTEATDD, LTEAFDD
<b>Remote Command</b>	:CALCulate:WAVeform:MARKer[1] 2 ... 12:MAXimum
<b>Example</b>	CALC:WAV:MARK2:MAX
Notes	You must be in a mode that includes the Waveform measurement to use this command. Use INSTRument:SElect to set the mode.
Initial S/W Revision	Prior to A.02.00
Modified at S/W Revision	A.03.00

## Next Peak

Moves the selected marker to the next highest local maximum with a value less than that of the current marker.

Key Path	Peak Search
Mode	BASIC, PNOISE, WCDMA, C2K, GSM, WIMAXOFDMA, TDSCDMA, 1XEVD0, DVB, DTMB, ISDBT, CMMB, LTE, LTETDD, DCATV, WLAN, MSR,LTEATDD, LTEAFDD
<b>Remote Command</b>	:CALCulate:WAVeform:MARKer[1] 2 ... 12:MAXimum:NEXT
<b>Example</b>	CALC:WAV:MARK:MAX:NEXT
Notes	You must be in a mode that includes the Waveform measurement to use this command. Use INSTRument:SElect to set the mode.
Initial S/W Revision	Prior to A.02.00
Modified at S/W Revision	A.03.00

## Min Search

Moves the selected marker to the minimum y-axis value on the current trace.

Key Path	Peak Search
Mode	BASIC, PNOISE, WCDMA, C2K, GSM, WIMAXOFDMA, TDSCDMA, 1XEVD0, DVB, DTMB, ISDBT, CMMB, LTE, LTETDD, DCATV, WLAN, MSR,LTEATDD, LTEAFDD
<b>Remote Command</b>	:CALCulate:WAVeform:MARKer[1] 2 ... 12:MINimum
<b>Example</b>	CALC:WAV:MARK:MIN
Notes	You must be in a mode that includes the Waveform measurement to use this command. Use INSTRument:SElect to set the mode.

21 Waveform Measurement  
Peak Search

---

Initial S/W Revision	Prior to A.02.00
Modified at S/W Revision	A.03.00

---

Print

See "Print" on page 358

## Quick Save

The Quick Save front-panel key repeats the most recent save that was performed from the Save menu, with the following exceptions:

- Register saves are not remembered as Saves for the purpose of the Quick Save function
- If the current measurement does not support the last non-register save that was performed, an informational message is generated, “File type not supported for this measurement”

Quick Save repeats the last type of qualified save (that is, a save qualified by the above criteria) in the last save directory by creating a unique filename using the Auto File Naming algorithm described below.

If Quick Save is pressed after startup and before any qualified Save has been performed, the Quick Save function performs a Screen Image save using the current settings for Screen Image saves (current theme, current directory), which then becomes the “last save” for the purpose of subsequent Quick Saves.

The Auto File Naming feature automatically generates a file name for use when saving a file. The filename consists of a prefix and suffix separated by a dot, as is standard for the Windows® file system. A default prefix exists for each of the available file types:

Type	Default Prefix	Menu
State	State_	(Save/Recall)
Trace + State	State_	(Save/Recall)
Screen	Screen_	(Save/Recall)
Amplitude Corrections	Ampcor_	(Import/Export)
Traces	Trace_	(Import/Export)
Limit Lines	LLine_	(Import/Export)
Measurement Result	MeasR_	(Import/Export)
Capture Buffer	CapBuf_	(Import/Export)

A four digit number is appended to the prefix to create a unique file name. The numbering sequence starts at 0000 within each Mode for each file type and updates incrementally to 9999, then wraps to 0000 again. It remembers where it was through a Mode Preset and when leaving and returning to the Mode. It is reset by Restore Misc Defaults and Restore System Defaults and subsequent running of the instrument application. So, for example, the first auto file name generated for State files is State\_0000.state. The next is State\_0001, and so forth.

One of the key features of Auto File Name is that we guarantee that the Auto File Name will never conflict with an existing file. The algorithm looks for the next available number. If it gets to 9999, then it looks for holes. If it find no holes, that is no more numbers are available, it gives an error.

For example, if when we get to State\_0010.state there is already a State\_0010.state file in the current directory, it advances the counter to State\_0011.state to ensure that no conflict will exist (and then it verifies that State\_0011.state also does not exist in the current directory and advances again if it does, and so forth).

If you enter a file name for a given file type, then the prefix becomes the filename you entered instead of the default prefix, followed by an underscore. The last four letters (the suffix) are the 4-digit number.

For example, if you save a measurement results file as “fred.csv”, then the next auto file name chosen for a measurement results save will be fred\_0000.csv.

**NOTE**

Although 0000 is used in the example above, the number that is used is actually the current number in the Meas Results sequence, that is, the number that would have been used if you had not entered your own file name.

---

**NOTE**

If the filename you entered ends with \_dddd, where d=any number, making it look just like an auto file name, then the next auto file name picks up where you left off with the suffix being dddd + 1.

---

Key Path	Front-panel key
Notes	No remote command for this key specifically.
Initial S/W Revision	Prior to A.02.00

---

## Recall

The Recall menu lets you choose what you want to recall, and where you want to recall it from. Among the types of files you can recall are **States and Traces**. In addition, an Import (Data) option lets you recall a number of data types stored in CSV files (as used by Excel and other spreadsheet programs).

The default paths for Recall are data type dependent and are the same as for the Save key.

Key Path	Front-panel key
Notes	<p>No remote command for this key specifically, but the :MMEM:LOAD command is available for specific file types. An example is :MMEM:LOAD:STATe &lt;filename&gt;.</p> <p>If you try to recall a State file for a mode that is not licensed or not available in the instrument, an error message will occur and the state will not change.</p>
Backwards Compatibility Notes	<p>In legacy analyzers, it was possible to load a state without affecting the trace data, limit lines or correction data. Similarly (since User Preset is actually loading a state), it was possible to do a User Preset without affecting the trace data, limit lines or correction data.</p> <p>In the X-Series, “state” always includes all of this data; so whenever state is loaded, all of the traces, limit lines and corrections are affected. Although this differs from previous behavior, it is desirable behavior, and should not cause adverse issues for users.</p>
Backwards Compatibility Notes	<p>Recall for the X-Series supports backward compatibility in the sense that you can recall a state file from any X-Series model number and any version of X-Series software. This is only possible if part of the recalling process goes through a limiting step after recalling the mode settings, at least for settings that may vary with version number, model number, option and license differences. If you try to recall a state file onto an instrument with less capability than what was available on the instrument during the save, the recall will ignore the state it doesn't support and it will limit the recalled setting to what it allows.</p> <p>Example: if the saved state includes preamp ON, but the recalling instrument does not have a preamp; the preamp is limited to OFF. Conversely, if you save a state without a preamp, the preamp is OFF in the state file. When this saved file is recalled on an instrument with a licensed preamp, the preamp is changed to OFF. Another example is if the saved state has center frequency set to 20 GHz, but the instrument recalling the saved state is a different model and only supports 13.5 GHz. In this case, the center frequency is limited along with any other frequency based settings. Since the center frequency can't be preserved in this case, the recall limiting tries to at least preserve span to keep the measurement setup as intact as possible.</p> <p>It may be appropriate to issue a warning if the state is limited on the recall; warnings do not go out to SCPI so this would only affect the manual user.</p> <p>Note that there is no state file compatibility outside of the X-Series. For example, you cannot recall a state file from ESA or PSA.</p>
Initial S/W Revision	Prior to A.02.00

## State

The Recall State menu lets you choose a register or file from which to recall the state.

The content of a state file includes all of the settings and data required to return the analyzer as closely as possible to the Mode it was in, with the exact settings that were in place, when the save occurred. The Mode settings in each state file include the settings that are affected by Mode Preset, as well as the

additional settings affected by Restore Mode Defaults; all of the Mode’s settings. In addition, all of the settings of the Input/Output system are included, even though they are outside of the Mode’s state, because they are needed to restore the complete setup. Persistent System settings (for example, GPIB address) are not affected by either a Mode Preset or Restore Mode Defaults, nor are they included in a saved State file.

Since each state file is only for one Mode, the settings for other Modes are unaffected when it is loaded. Recall State will cause a mode switch if the state being recalled is not from the current active mode.

After the recall completes, the message "File <filename> recalled" or “Recalled State Register <register number>” is displayed.

For rapid recalls, the State menu lists 16 registers that you can choose from to recall. Pressing a Register key initiates the recall. You can also select a file from which to recall.

The default path for all State Files is:

My Documents\<<mode name>\state

where <mode name> is the parameter used to select the mode with the INST:SEL command (for example, SA for the Spectrum Analyzer).

See "[More Information](#)" on page 2884.

<b>Key Path</b>	Recall
<b>Mode</b>	All
<b>Remote Command</b>	:MMEMory:LOAD:STATe <filename>
<b>Example</b>	:MMEM:LOAD:STAT "myState.state" This recalls the file myState.state on the default path
<b>Example</b>	MMEM:LOAD:STAT "MyStateFile.state" This loads the state file data (on the default file directory path) into the instrument state.
<b>Notes</b>	<p>When you pick a file to recall, the analyzer first verifies that the file is recallable in the current instrument by checking the software version and model number of the instrument. If everything matches, a full recall proceeds by aborting the currently running measurement, clearing any pending operations, and then loading the State from the saved state file. You can open state files from any mode, so recalling a State file switches to the mode that was active when the save occurred. After switching to the mode of the saved state file, mode settings and data (if any for the mode) are loaded with values from the saved file. The saved measurement of the mode becomes the newly active measurement and the data relevant to the measurement (if there is any) is recalled.</p> <p>If there is a mismatch between file version or model number or instrument version or model number, the recall function tries to recall as much as possible and returns a warning message. It may limit settings that differ based on model number, licensing or version number.</p> <p>After recalling the state, the Recall State function does the following:</p> <ul style="list-style-type: none"> <li>• Makes the saved measurement for the mode the active measurement.</li> <li>• Clears the input and output buffers.</li> <li>• Status Byte is set to 0.</li> <li>• Executes a *CLS</li> </ul> <p>If the file specified is empty an error is generated. If the specified file does not exist, another error is generated. If there is a mismatch between the file and the proper file type, an error is generated. If</p>

---

	there is a mismatch between file version or model number or instrument version or model number, a warning is displayed. Then it returns to the State menu and File Open dialog goes away. After the Recall, the analyzer exits the Recall menu and returns to the previous menu.
<b>Backwards Compatibility SCPI</b>	:MMEMory:LOAD:STATe 1,<filename> For backwards compatibility, the above syntax is supported. The "1" is simply ignored.
Initial S/W Revision	Prior to A.02.00

---

### More Information

In measurements that support saving Traces, for example, Swept SA, the Trace data is saved along with the State in the State file. When recalling the State, the Trace data is recalled as well. Traces are recalled exactly as they were stored, including the writing mode and update and display modes. If a Trace was updating and visible when the State was saved, it will come back updating and visible, and its data will be rewritten right away. When you use State to save and recall traces, any trace whose data must be preserved should be placed in View or Blank mode before saving.

The following table describes the Trace Save and Recall possibilities:

You want to recall state and one trace's data, leaving other traces unaffected.	Save Trace+State from 1 trace. Make sure that no other traces are updating (they should all be in View or Blank mode) when the save is performed.	On Recall, specify the trace you want to load the one trace's data into. This trace will load in View. All other traces' data will be unaffected, although their trace mode will be as it was when the state save was performed.
You want to recall all traces	Save Trace+State from ALL traces.	On Recall, all traces will come back in View (or Blank if they were in Blank or Background when saved)
You want all traces to load exactly as they were when saved.	Save State	On recall, all traces' mode and data will be exactly as they were when saved. Any traces that were updating will have their data immediately overwritten.

### From File...

When you press "From File", the analyzer brings up a Windows dialog and a menu entitled "File Open." This menu allows you to navigate to the various fields in the Windows dialog without using a keyboard or mouse. The Tab and Arrow keys can also be used for dialog navigation.



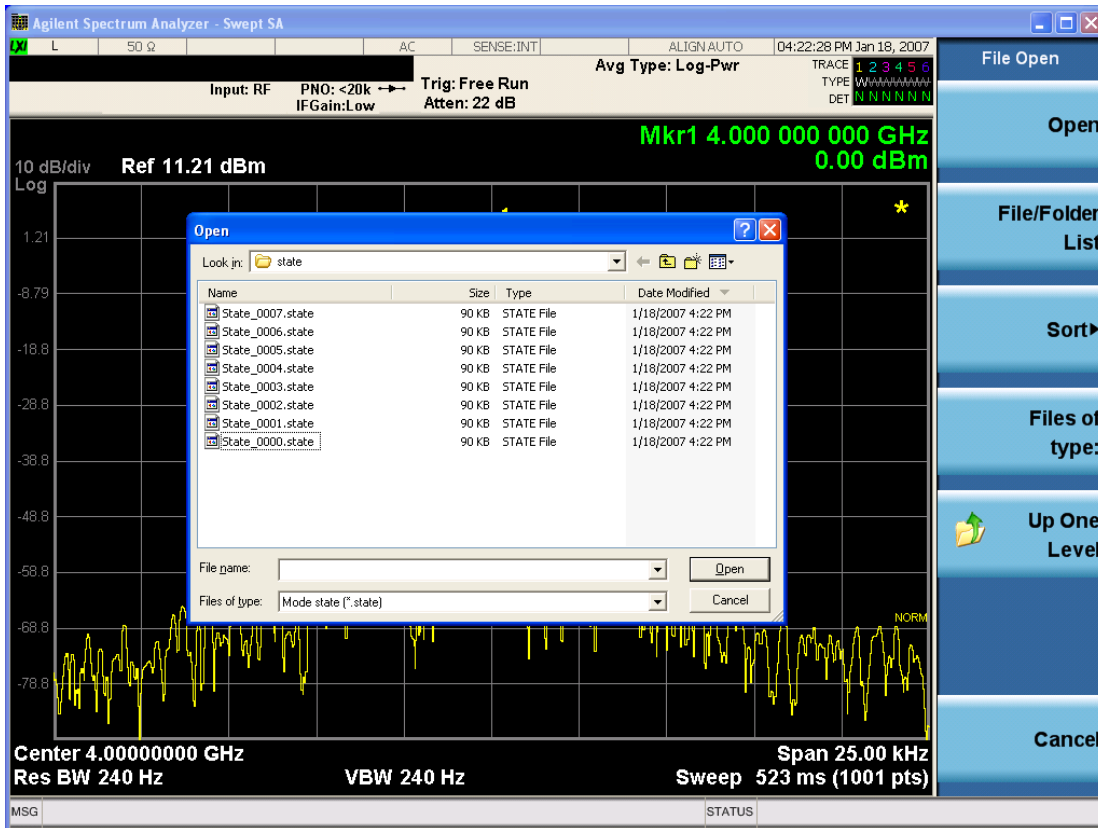

Listed below are the functions of the various fields in the dialog, and the corresponding softkeys:

#### Open

Performs the recall of the specified file. While the recall is being performed, the floppy icon appears briefly in the Meas bar.

#### File/Folder List

Enables you to navigate to the center of the dialog that contains the list of files and folders. Once here you can get information about the file and use the tab keys to navigate to the other fields in the dialog, such as Look In.

#### Look In

The Look In field shows the path from which the file will be recalled and allows you to change the path using the up and down arrow keys to navigate to other paths; the Enter key to open a directory; and the Backspace key to go back one directory. The **Look In field** first uses the last path from the Save As dialog **Save In:** path for that same file type. There is no softkey for directly navigating to the Look In field, but you can use the left tab to get here from the File/Folder List.

User specified paths are remembered when you leave and return to a Mode and are reset back to the default using Restore Mode Defaults.

#### Sort

Accesses a menu that enables you to sort the files within the File Open dialog. Only one sorting type can be selected at a time and the sorting happens immediately. The sorting types are By Date, By Name, By extension, and By Size.

#### Files of Type

This field shows the file suffix for the type of file you have selected to recall. For example, if you navigated here while recalling State, "Mode state (\*.state)" is in the field. If you navigated here while recalling Trace, ""Mode state (\*.trace)" is in the field. If you navigated here while importing a trace data file, "Trace Data (\*.csv)" is in the field. For some file types, there is more than one choice in the dropdown menu, which you can select by using the up and down arrow keys and Enter.

#### Up One Level

This key corresponds to the icon of a folder with the up arrow that is in the tool bar of the dialog. When pressed, it causes the file and folder list to navigate up one level in the directory structure. The Backspace key does the same thing.

#### Cancel

This key corresponds to the Cancel selection in the dialog. It causes the current **Open** request to be cancelled. The ESC key does the same thing.

Key Path	Recall, State
Notes	Brings up the Open dialog for recalling a State Save Type
Initial S/W Revision	Prior to A.02.00

### Edit Register Names

You may enter a custom name on any of the Register keys, to help you remember what you are using that state to save. To do this, press the Edit Register Names key, choose the register whose name you wish to edit, and then enter the desired label using the Alpha Editor or an external PC keyboard.

The maximum number of characters that can be added is 30. In most cases, 30 characters will fit on two lines of the key.

For more information and the SCPI command, see Edit Register Names under the Save, State function.

Key Path	Recall, State
Mode	All
Dependencies	N9060A-7FP or N9060B-2FP license required to edit the register names. When the feature is not licensed, sending the SCPI command generates an error, -221, "Settings conflict;Option not available"
Initial S/W Revision	A.11.00

### Register 1 thru Register 16

Selecting any one of these register keys causes the State of the mode from the specified Register to be recalled. Each of the register keys annotates whether it is empty or at what date and time it was last

modified. In addition, you can use the Edit Register Names key under Save, State to enter custom names for each register.

Registers are shared by all modes, so recalling from any one of the registers will cause a mode switch to the mode that was active when the save to the Register occurred.

Although these 16 registers are the only registers available from the front panel, there are 128 state registers available in the instrument. Registers 17–128 are only available from the SCPI interface, using the \*RCL command.

After the recall completes, the message "Register <register number> recalled" appears in the message bar. If you are in the Spectrum Analyzer Mode, and you are recalling a register that was saved in the Spectrum Analyzer Mode, then after the recall, you will still be in the Recall Register menu. If the Recall causes you to switch modes, then after the Recall, you will be in the Frequency menu.

If a requested register is empty an error is generated.

Key Path	Recall, State
<b>Example</b>	*RCL 1
Range	1–16 from front panel, 1–128 from SCPI
Readback	Date and time with seconds resolution are displayed on the key OR A custom name of up to 30 characters entered using the Save, State, Edit Register Names key OR “(empty)” if no prior save operation has been performed to this register.
Initial S/W Revision	Prior to A.02.00
Modified at S/W Revision	Prior to A.11.00

## Register 1 thru Register 16

Selecting any one of these register keys causes the State of the mode from the specified Register to be recalled. Each of the register keys annotates whether it is empty or at what date and time it was last modified. In addition, you can use the Edit Register Names key under Save, State to enter custom names for each register.

Registers are shared by all modes, so recalling from any one of the registers will cause a mode switch to the mode that was active when the save to the Register occurred.

Although these 16 registers are the only registers available from the front panel, there are 128 state registers available in the instrument. Registers 17–128 are only available from the SCPI interface, using the \*RCL command.

After the recall completes, the message "Register <register number> recalled" appears in the message bar. If you are in the Spectrum Analyzer Mode, and you are recalling a register that was saved in the Spectrum Analyzer Mode, then after the recall, you will still be in the Recall Register menu. If the Recall causes you to switch modes, then after the Recall, you will be in the Frequency menu.

If a requested register is empty an error is generated.

Key Path	Recall, State
<b>Example</b>	*RCL 1
Range	1-16 from front panel, 1-128 from SCPI
Readback	Date and time with seconds resolution are displayed on the key OR A custom name of up to 30 characters entered using the Save, State, Edit Register Names key OR “(empty)” if no prior save operation has been performed to this register.
Initial S/W Revision	Prior to A.02.00
Modified at S/W Revision	Prior to A.11.00

### Trace (+State)

The Recall Trace (+State) menu lets you choose a register or file from which to recall the Trace+State state file.

A saved state contains all of the settings and data required to return the analyzer as closely as possible to the exact setup it had when the save occurred. This includes the Input/Output settings, even though they are outside of the Mode’s state, because they are needed to restore the complete setup. A Trace+State file also includes trace data from one trace or all traces, which will load in View mode when the Trace+State file is recalled. Recall Trace (+State) will also cause a mode switch if the state being recalled is not for the current active mode.

After the recall completes, the message "File <filename> recalled" or “Recalled Trace Register <register number>” is displayed.

For rapid recalls, the Trace (+State) menu lists 5 registers to choose from to recall. Pressing a Register key initiates the recall. You can also select a file from which to recall.

The default path for all State Files including .trace files is:

My Documents\<<mode name>\state

where <mode name> is the parameter used to select the mode with the INST:SEL command (for example, SA for the Spectrum Analyzer).

Key Path	Recall
Mode	SA
<b>Remote Command</b>	:MMEMory:LOAD:TRACe TRACE1   TRACE2   TRACE3   TRACE4   TRACE5   TRACE6, <filename>  :MMEMory:LOAD:TRACe:REGister TRACE1   TRACE2   TRACE3   TRACE4   TRACE5   TRACE6, <integer>
<b>Example</b>	MMEM:LOAD:TRAC TRACE2, "MyTraceFile.trace" This loads the trace file data (on the default file directory path) into the specified trace; if it is a "single trace" save file, that trace is loaded to trace 2, and is set to be not updating. :MMEM:LOAD:TRAC:REG TRACE1,2

---

restores the trace data in register 2 to Trace 1

---

Notes

When you perform the recall, the recalling Trace function must first verify the file is recallable in this instrument by checking instrument software version and model number, since it includes State. If everything matches, a full recall proceeds by aborting the currently running measurement, and loading the state from the saved state file to as close as possible to the context in which the save occurred. You can open .trace files from any mode that supports them, so recalling a Trace file switches to the mode that was active when the save occurred. After switching to the mode of the saved state file, mode settings and data (if any for the mode) are loaded with values from the saved file and the saved measurement of the mode becomes the newly active measurement, and the data relevant to the measurement (if there is any) is recalled.

Once the state is loaded, the trace data must be loaded. The internal flags are consulted to see which trace to load and the "To Trace" setting to see where to load it. Trace data is always loaded with the specified trace set to View, so that the data is visible and not updating (so as not to erase the recalled data). If the file is an "all trace" file, all traces are loaded with the saved data (to the original trace the data was saved from) and set to View. Traces whose data is not loaded are restored to the update state that existed when they were saved.

After the Recall the analyzer exits the Recall menu and returns to the previous menu.

Some modes and measurements do not have available all 6 traces. Phase Noise mode command, for example, is: `MMEMory:LOAD:TRACe TRACE1|TRACE2|TRACE3,<filename>`

Some modes and measurements have more than 6 traces available. The Realtime SA mode command, for example, is: `MMEMory:STORe:TRACe TRACE1 | TRACE2 | TRACE3 | TRACE4 | TRACE5 | TRACE6 | TRACE7 | TRACE8 | TRACE9 | TRACE10 | TRACE11 | TRACE12 | ALL,<filename>`

---

Initial S/W Revision	Prior to A.02.00
----------------------	------------------

---

## To Trace

These menu selections let you choose the Trace where the recalled saved trace will go. Not all modes have the full 6 traces available. The default is the currently selected trace, selected in this menu or in the Trace/Detector, Export Data, Import Data, or Save Trace menus, except if you have chosen All, then it remains chosen until you specifically change it to a single trace.

If the .trace file is an "all trace" file, "To Trace" is ignored and the traces each go back to the trace from which they were saved.

Once selected, the key returns back to the Recall Trace menu and the selected Trace number is annotated on the key. Now you have selected exactly where the trace needs to be recalled. To trigger a recall of the selected Trace, you must select the Open key in the Recall Trace menu.

When you select a trace, it makes that trace the current trace, so it displays on top of all of the other traces.

---

Key Path	Save, Data, Trace
Mode	SA
Initial S/W Revision	Prior to A.02.00

---

## Register 1 thru Register 16

Selecting any one of these register keys causes the State of the mode from the specified Register to be recalled. Each of the register keys annotates whether it is empty or at what date and time it was last modified. In addition, you can use the Edit Register Names key under Save, State to enter custom names for each register.

Registers are shared by all modes, so recalling from any one of the registers will cause a mode switch to the mode that was active when the save to the Register occurred.

Although these 16 registers are the only registers available from the front panel, there are 128 state registers available in the instrument. Registers 17–128 are only available from the SCPI interface, using the \*RCL command.

After the recall completes, the message "Register <register number> recalled" appears in the message bar. If you are in the Spectrum Analyzer Mode, and you are recalling a register that was saved in the Spectrum Analyzer Mode, then after the recall, you will still be in the Recall Register menu. If the Recall causes you to switch modes, then after the Recall, you will be in the Frequency menu.

If a requested register is empty an error is generated.

Key Path	Recall, State
<b>Example</b>	*RCL 1
Range	1–16 from front panel, 1–128 from SCPI
Readback	Date and time with seconds resolution are displayed on the key OR A custom name of up to 30 characters entered using the Save, State, Edit Register Names key OR “(empty)” if no prior save operation has been performed to this register.
Initial S/W Revision	Prior to A.02.00
Modified at S/W Revision	Prior to A.11.00

## From File...

When you press “From File”, the analyzer brings up a Windows dialog and a menu entitled “File Open.” This menu allows you to navigate to the various fields in the Windows dialog without using a keyboard or mouse. The Tab and Arrow keys can also be used for dialog navigation.

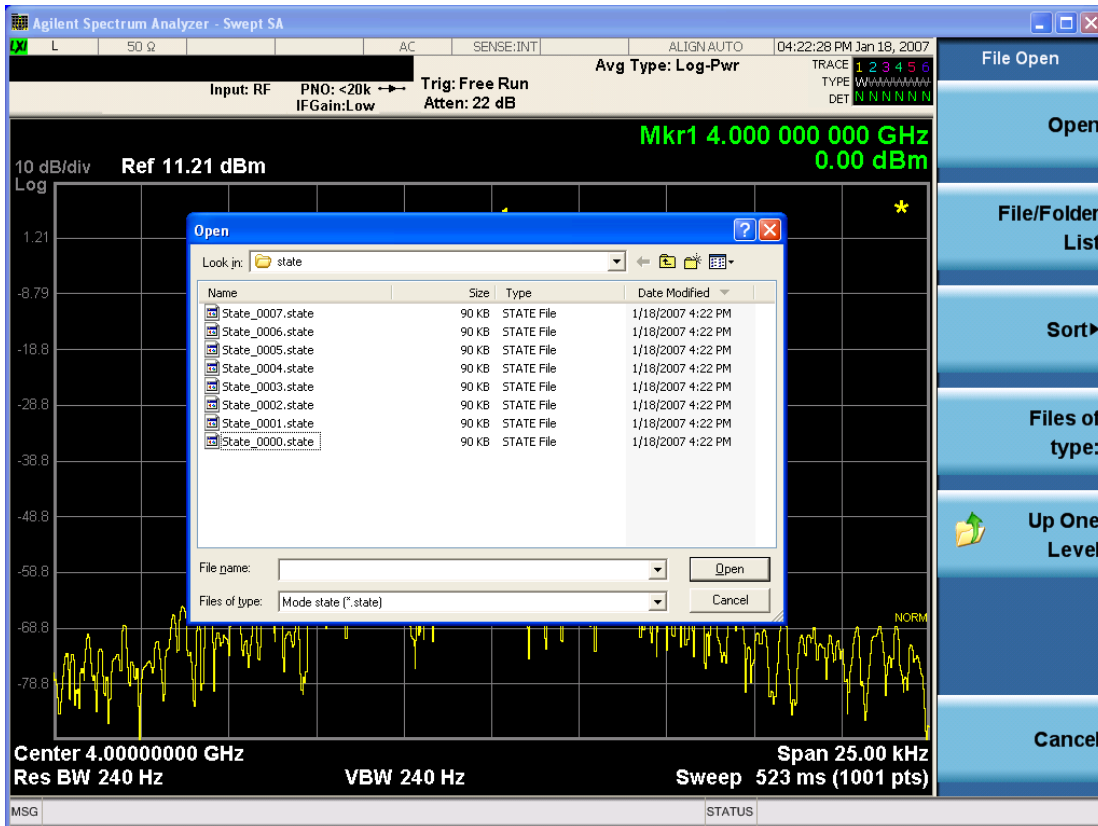

Listed below are the functions of the various fields in the dialog, and the corresponding softkeys:

#### Open

Performs the recall of the specified file. While the recall is being performed, the floppy icon appears briefly in the Meas bar.

#### File/Folder List

Enables you to navigate to the center of the dialog that contains the list of files and folders. Once here you can get information about the file and use the tab keys to navigate to the other fields in the dialog, such as Look In.

#### Look In

The Look In field shows the path from which the file will be recalled and allows you to change the path using the up and down arrow keys to navigate to other paths; the Enter key to open a directory; and the Backspace key to go back one directory. The **Look In field** first uses the last path from the Save As dialog **Save In:** path for that same file type. There is no softkey for directly navigating to the Look In field, but you can use the left tab to get here from the File/Folder List.

User specified paths are remembered when you leave and return to a Mode and are reset back to the default using Restore Mode Defaults.

#### Sort

Accesses a menu that enables you to sort the files within the File Open dialog. Only one sorting type can be selected at a time and the sorting happens immediately. The sorting types are By Date, By Name, By extension, and By Size.

#### Files of Type

This field shows the file suffix for the type of file you have selected to recall. For example, if you navigated here while recalling State, "Mode state (\*.state)" is in the field. If you navigated here while recalling Trace, ""Mode state (\*.trace)" is in the field. If you navigated here while importing a trace data file, "Trace Data (\*.csv)" is in the field. For some file types, there is more than one choice in the dropdown menu, which you can select by using the up and down arrow keys and Enter.

#### Up One Level

This key corresponds to the icon of a folder with the up arrow that is in the tool bar of the dialog. When pressed, it causes the file and folder list to navigate up one level in the directory structure. The Backspace key does the same thing.

#### Cancel

This key corresponds to the Cancel selection in the dialog. It causes the current **Open** request to be cancelled. The ESC key does the same thing.

Key Path	Recall, State
Notes	Brings up the Open dialog for recalling a State Save Type
Initial S/W Revision	Prior to A.02.00

## Data (Import)

Importing a data file loads data that was previously saved from the current measurement or from other measurements and/or modes that produce compatible data files. The Import Menu only contains Data Types that are supported by the current measurement.

Since the commonly exported data files are in .csv format, the data can be edited by the user prior to importing. This allows you to export a data file, manipulate the data in Excel (the most common PC Application for manipulating .csv files) and then import it.

Importing Data loads measurement data from the specified file into the specified or default destination, depending on the data type selected. Selecting an Import Data menu key will not actually cause the importing to occur, since the analyzer still needs to know from where to get the data. Pressing the Open key in this menu brings up the Open dialog and Open menu that provides you with the options from where to recall the data. Once a filename has been selected or entered in the Open menu, the recall occurs as soon as the Open button is pressed.

Key Path	Recall
Mode	All
Notes	The menu is built from whatever data types are available for the mode. Some keys will be missing completely, so the key locations in the sub-menu will vary. No SCPI command directly controls the Data Type that this key controls. The Data Type is included in the MMEM:LOAD commands.



Dependencies	If a file type is not used by a certain measurement, it is grayed out for that measurement. The key for a file type will not show at all if there are no measurements in the Mode that support it.
Preset	Is not affected by Preset or shutdown, but is reset during Restore Mode Defaults
Readback	The data type that is currently selected
Initial S/W Revision	Prior to A.02.00

## Capture Buffer

The captured data is raw data which is not processed.

Key Path	Recall, Data
Mode	<b>CDMA1XEV</b>
Example	MMEM:LOAD:CAPT "MyCaptureData.bin" This loads the file of capture data (on the default file directory path) into the instrument.
Dependencies	In case the capture buffer data is not available from the selected measurement, the key will be grayed out.
Initial S/W Revision	A.11.00

## Open...

When you press "Open", the analyzer brings up a Windows dialog and a menu entitled "**File Open.**" This menu allows you to navigate to the various fields in the Windows dialog without using a keyboard or mouse. The Tab and Arrow keys can also be used for dialog navigation.

See "[From File...](#)" on page 2890 in Recall, State, for a full description of this dialog and menu.

Key Path	Recall, Data
Notes	The key location is mode-dependent and will vary. Brings up Open dialog for recalling a <mode specific> Save Type
Initial S/W Revision	Prior to A.02.00

## Restart

The Restart function restarts the current sweep, or measurement, or set of averaged/held sweeps or measurements. If you are Paused, pressing Restart does a Resume.

The Restart function is accessed in several ways:

- Pressing the Restart key
- Sending the remote command INIT:IMMEDIATE
- Sending the remote command INIT:RESTART

See "[More Information](#)" on page 2894

Key Path	Front-panel key
Remote Command	:INITiate[:IMMEDIATE] :INITiate:RESTART
Example	:INIT:IMM :INIT:REST
Notes	:INITiate:RESTART and :INITiate:IMMEDIATE perform exactly the same function.
Couplings	Resets average/hold count k. For the first sweep overwrites all active (update=on) traces with new current data. For application modes, it resets other parameters as required by the measurement.
Status Bits/OPC dependencies	This is an Overlapped command. The STATus:OPERation register bits 0 through 8 are cleared. The STATus:QUESTionable register bit 9 (INTEgrity sum) is cleared. The SWEEPING bit is set. The MEASURING bit is set.
Backwards Compatibility Notes	For Spectrum Analysis mode in ESA and PSA, the Restart hardkey and the INITiate:RESTART command restart trace averages (displayed average count reset to 1) for a trace in Clear Write, but did not restart Max Hold and Min Hold.  In the X-Series, the Restart hardkey and the INITiate:RESTART command restart not only Trace Average, but MaxHold and MinHold traces as well.  For wireless comms modes in ESA and PSA, the Restart hardkey and the INITiate:RESTART command restart every measurement, which includes all traces and numeric results. There is no change to this operation.
Initial S/W Revision	Prior to A.02.00

### More Information

The **Restart** function first aborts the current sweep/measurement as quickly as possible. It then resets the sweep and trigger systems, sets up the measurement and initiates a new data measurement sequence with a new data acquisition (sweep) taken once the trigger condition is met.

If the analyzer is in the process of aligning when **Restart** is executed, the alignment finishes before the restart function is performed.

Even when set for Single operation, multiple sweeps may be taken when Restart is pressed (for example, when averaging/holding is on). Thus when we say that **Restart** "restarts a measurement," we may mean:

- It restarts the current sweep
- It restarts the current measurement
- It restarts the current set of sweeps if any trace is in Trace Average, Max Hold or Min Hold
- It restarts the current set of measurements if Averaging, or Max Hold, or Min Hold is on for the measurement
- depending on the current settings.

With **Average/Hold Number** (in **Meas Setup** menu) set to 1, or Averaging off, or no trace in Trace Average or Hold, a single sweep is equivalent to a single measurement. A single sweep is taken after the trigger condition is met; and the analyzer stops sweeping once that sweep has completed. However, with **Average/Hold Number** >1 and at least one trace set to **Trace Average, Max Hold, or Min Hold (SA Measurement)** or **Averaging on (most other measurements)**, multiple sweeps/data acquisitions are taken for a single measurement. The trigger condition must be met prior to each sweep. The sweep is stopped when the average count  $k$  equals the number  $N$  set for **Average/Hold Number**. A measurement average usually applies to all traces, marker results, and numeric results; but sometimes it only applies to the numeric results.

Once the full set of sweeps has been taken, the analyzer will go to idle state. To take one more sweep without resetting the average count, increment the average count by 1, by pressing the step up key while **Average/Hold Number** is the active function, or sending the remote command `CALC:AVER:TCON UP`.

## Save

The Save menu lets you choose what you want to save and where you want to save it. Among the types of files you can save are **States**, **Traces**, and **Screen Images**. In addition, an Export (Data) option lets you save a number of data types as CSV files for easy import into Excel and other spreadsheet programs.

Key Path	Front-panel key
Mode	All
Notes	No remote command for this key specifically, but the :MMEM:STOR:STATe <filename> command is available for specific file types. An example is :MMEM:STOR:STATe <filename>.
Initial S/W Revision	Prior to A.02.00

## State

The Save State menu lets you choose a register or file for saving the state.

The content of a state file includes all of the settings and data required to return the analyzer as closely as possible to the Mode it was in, with the exact settings which were in place, when the save occurred. The Mode settings in each state file include the settings that are affected by Mode Preset, as well as the additional settings affected by Restore Mode Defaults; all of the Mode's settings. In addition, all of the settings of the Input/Output system are included, even though they are outside of the Mode's state, because they are needed to restore the complete setup. Persistent System settings (for example, Verbose SCPI) are not affected by either Mode Preset or Restore Mode Defaults, nor are they included in a saved State file.

After the save completes, the message "File <filename> saved" or "State Register <register number> saved" is displayed.

For rapid saving, the State menu lists 16 registers to save to. Pressing a Register key initiates the save. You can also select a file to save to.

The default path for all State Files is:

My Documents\<<mode name>\state

where <mode name> is the parameter used to select the mode with the INST:SEL command (for example, SA for the Spectrum Analyzer).

Key Path	Save
Mode	All
Remote Command	:MMEMory:STORe:STATe <filename>
Example	MMEM:STOR:STATe "MyStateFile.state" This stores the current instrument state data in the file MyStateFile.state in the default directory.
Notes	Both single and double quotes are supported for any filename parameter over remote. After saving to a register, that register's menu key is updated with the date the time, unless a custom label has been entered for that key. After saving to a register, you remain in the Save State menu, so that you can see the Register key

update. After saving to a file, the analyzer automatically returns to the previous menu and any Save As dialog goes away.

<b>Backwards Compatibility SCPI</b>	:MMEMory:STORe:STATe 1,<filename>
Initial S/W Revision	Prior to A.02.00

For backwards compatibility, the above syntax is supported. The "1" is simply ignored. The command is sequential.

### To File . . .

When you press “To File”, the analyzer brings up a Windows dialog and a menu entitled “**Save As.**” This menu allows you to navigate to the various fields in the Windows dialog without using a keyboard or mouse. The Tab and Arrow keys can also be used for dialog navigation.

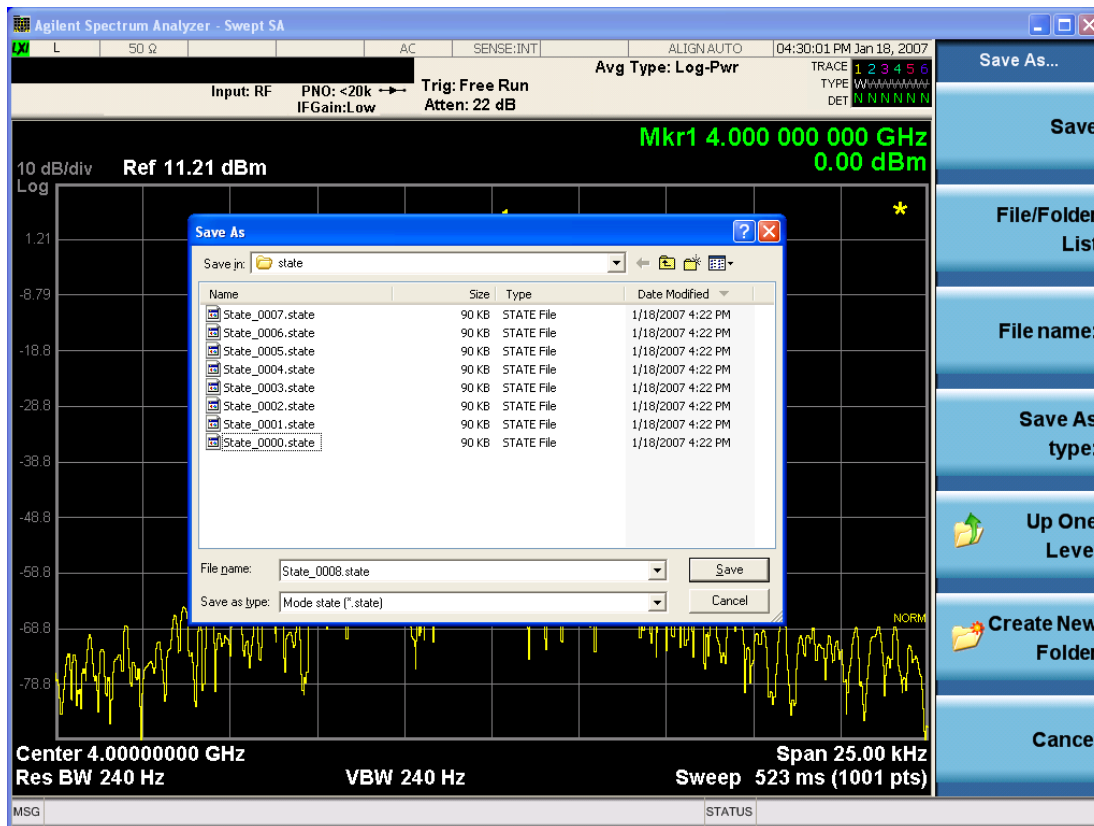

The Listed below

are the functions of the various fields in the dialog, and the corresponding softkeys:

#### Save

Performs the save to the specified file of the selected type. If the file already exists, a dialog will appear that allows you to replace the existing file by selecting OK, or you can Cancel the request. If you select OK, the file will be overwritten. Using the C: drive is strongly discouraged, since it runs the risk of being overwritten during an instrument software upgrade.

While the save is being performed, the floppy icon appears briefly in the Meas bar.

### File/Folder List

Enables you to navigate to the center of the dialog that contains the list of files and folders. Once here you can get information about the file and use the tab keys to navigate to the other fields in the dialog, such as Save In.

### Save In

The Save In field shows the path to which the file will be saved and allows you to change the path using the up and down arrow keys to navigate to other paths; the Enter key to open a directory; and the Backspace key to go back one directory. The **Save In field** defaults to the default path for this type of file and remembers the last path you used to save this type of file. There is no softkey for directly navigating to the Save In field but you can use left tab to get here from the File/Folder List.

User specified paths are remembered when you leave and return to a Mode and are reset back to the default using Restore Mode Defaults.

### File Name

The File Name field is initially loaded with an automatically generated filename specific to the appropriate Save Type. The automatically generated filename is guaranteed not to conflict with any filename currently in the directory. You may replace or modify this filename using the File Name key. See the ["Quick Save " on page 2880](#) documentation for more on the automatic file naming algorithm.

When you press the File Name key the analyzer displays the Alpha Editor. Use the knob to choose the letter to add and the front-panel Enter key to add the letter to the file name. The BK character moves you back and the FW character moves you forward in the filename. The Select key on the front panel generates a space character. When you are done entering the filename press the Done softkey. This returns back to the **File Open** dialog and menu, but does not cause the save to occur.

### Save As Type

This field shows the file suffix for the type of file you have selected to save. For example, if you navigated here while saving State, "Mode state (\*.state)" is in the field. If you navigated here from saving Trace, ""Mode state (\*.trace)" is in the field. If you navigated here while exporting a trace data file, "Trace Data (\*.csv)" is in the field. For some file types, there is more than one choice in the dropdown, which you can select by using the up and down arrow keys and Enter.

### Up One Level

This key corresponds to the icon of a folder with the up arrow that is in the tool bar of the dialog. When pressed, it causes the file and folder list to navigate up one level in the directory structure. The Backspace key does the same thing.

### Create New Folder

This key corresponds to the icon of a folder with the "\*" that is in the tool bar of the dialog. When pressed, a new folder is created in the current directory with the name **New Folder** and you can enter a new folder name using the Alpha Editor.

### Cancel

This key corresponds to the Cancel selection in the dialog. It causes the current **Save As** request to be cancelled. The ESC key does the same thing.

Key Path	Save, State
Mode	All
Notes	Brings up Save As dialog for saving a State Save Type
Initial S/W Revision	Prior to A.02.00

## Edit Register Names

You may enter a custom name on any of the Register keys, to help you remember what you are using that state to save. To do this, press the Edit Register Names key, choose the register whose name you wish to edit, and then enter the desired label using the Alpha Editor or an external PC keyboard.

The maximum number of characters that can be added is 30. In most cases, 30 characters will fit on two lines of the key.

See ["More Information" on page 2899](#)

Key Path	Save, State
Mode	All
<b>Remote Command</b>	:MMEMory:REGister:STATe:LABel <reg number>,"label" :MMEMory:REGister:STATe:LABel? <reg number>
<b>Example</b>	:MMEM:REG:STAT:LAB 1,"my label"
Notes	<reg number> is an integer from 1 to 16. If the SCPI specifies an invalid register number an error message is generated, -222,"Data out of range;Invalid register label number" "label" is a string from 0 to 30 characters in length. If a label exceeds 30 characters, an error message is generated, -150,"String data error;Label clipped to 30 characters" "label" of length 0 erases the custom label and restores the default (time and date) label. E.g.: :MMEM:REG:STAT:LAB 1,""
Dependencies	N9060A-7FP or N9060B-2FP license required to edit the register names. When the feature is not licensed, sending this command generates an error, -221,"Settings conflict;Option not available"
Preset	The names are unaffected by Preset or power cycle but are set to the default label (time and date) on a "Restore System Defaults->Misc"
Initial S/W Revision	A.11.00

## More Information

When you edit one of the register names, the time and date field will be replaced by the custom name.

If you delete all the characters in the custom name, it restores the default (time and date).

The register names are stored within the state files, but they are not part of the instrument state; that is, once you have edited a register name, loading a new state will not change that register name. Another consequence of this is that the names will be persistent through a power cycle. Also, if a named state file is transferred to another analyzer, it will bring its custom name along with it.

If you try to edit the name of an empty register, the analyzer will first save the state to have a file to put the name in. If you load a named state file into an analyzer with older firmware it will ignore the metadata.

The \*SAV and \*RCL commands will not be affected by the custom register names, nor will the MMEM commands.

### Register 1 thru Register 16

Selecting any one of these register menu keys causes the State of the currently active mode to be saved to the specified Register. The registers are provided for rapid saving and recalling, since you do not need to specify a filename or navigate to a file. Each of the register menu keys annotates whether it is empty or at what date and time it was last modified. In addition, you can use the Edit Register Names key to enter custom names for each register.

Although these 16 registers are the only registers available from the front panel, there are 128 state registers available in the instrument. Registers 17–128 are only available from the SCPI interface, using the \*SAV command.

There is one set of 128 state registers in the instrument, not one set for each Mode. When a state is saved, the Mode it was saved from is saved with it; then when it is recalled, the instrument switches to that Mode.

After the save completes, the corresponding register menu key annotation is updated with the date and time and the message "Register <register number> saved" is displayed.

Key Path	Save, State
Mode	All
Example	*SAV 1
Range	1–16 from front panel, 1–128 from SCPI
Readback	Date and time with seconds resolution are displayed on the key OR A custom name of up to 30 characters entered using the Edit Register Names key OR “(empty)” if no prior save operation has been performed to this register.
Initial S/W Revision	Prior to A.02.00
Modified at S/W Revision	A.11.00

### Register 1 thru Register 16

Selecting any one of these register menu keys causes the State of the currently active mode to be saved to the specified Register. The registers are provided for rapid saving and recalling, since you do not need to specify a filename or navigate to a file. Each of the register menu keys annotates whether it is empty or at what date and time it was last modified. In addition, you can use the Edit Register Names key to enter custom names for each register.

Although these 16 registers are the only registers available from the front panel, there are 128 state registers available in the instrument. Registers 17–128 are only available from the SCPI interface, using the \*SAV command.



There is one set of 128 state registers in the instrument, not one set for each Mode. When a state is saved, the Mode it was saved from is saved with it; then when it is recalled, the instrument switches to that Mode.

After the save completes, the corresponding register menu key annotation is updated with the date and time and the message "Register <register number> saved" is displayed.

Key Path	Save, State
Mode	All
Example	*SAV 1
Range	1–16 from front panel, 1–128 from SCPI
Readback	Date and time with seconds resolution are displayed on the key OR A custom name of up to 30 characters entered using the Edit Register Names key OR “(empty)” if no prior save operation has been performed to this register.
Initial S/W Revision	Prior to A.02.00
Modified at S/W Revision	A.11.00

## Data (Export)

Exporting a data file stores data from the current measurement to mass storage files. The Export Menu only contains data types that are supported by the current measurement.

Since the commonly exported data files are in .csv format, the data can be edited by you prior to importing. This allows you to export a data file, manipulate the data in Excel (the most common PC Application for manipulating .csv files) and then import it.

Selecting an Export Data menu key will not actually cause the exporting to occur, since the analyzer still needs to know where you wish to save the data. Pressing the Save As key in this menu brings up the Save As dialog and Save As menu that allows you to specify the destination file and directory. Once a filename has been selected or entered in the Open menu, the export will occur as soon as the Save key is pressed.

Key Path	Save
Mode	All
Notes	The menu is built from whatever data types are available for the mode. So the key locations in the sub menu will vary.  No SCPI command directly controls the Data Type that this key controls. The Data Type is included in the MMEM:STORe commands.
Dependencies	If a file type is not used by a certain measurement, that type is grayed out for that measurement. The key for a file type will not show at all if there are no measurements in the Mode that support it.
Preset	Is not affected by a Preset or shutdown, but is reset during Restore Mode Defaults
Readback	The data type that is currently selected
Initial S/W Revision	Prior to A.02.00

## Measurement Results

Pressing this key selects Meas Results as the data type to be exported. Pressing the key a second time brings up the Meas Results menu, which allows you to select which **Meas Result** to save. In the Swept SA measurement, there are three types of Measurement Results files: Peak Table, Marker Table and Spectrogram.

See "[Meas Results File Contents](#)" on page 2902.

See "[Marker Table](#)" on page 2902.

See "[Peak Table](#)" on page 2905.

See "[Spectrogram](#)" on page 2908

<b>Remote Command</b>	:MMEMory:STORe:RESults:MTABle PTABle SPEctrogram <filename>
<b>Example</b>	:MMEM:STOR:RES:MTAB "myResults.csv" Saves the results from the current marker table to the file myResults.csv in the current path. :MMEM:STOR:RES:PTAB "myResults.csv" Saves the results from the current peak table to the file myResults.csv in the current path. :MMEM:STOR:RES:SPEC "myResults.csv" Saves the results from the current Spectrogram display to the file myResults.csv in the current path. The default path is My Documents\SA\data\SAN\results
<b>Notes</b>	If the save is initiated via SCPI, and the file already exists, the file will be overwritten. Using the C: drive is strongly discouraged, since it runs the risk of being overwritten during an instrument software upgrade. Both single and double quotes are supported for any filename parameter over SCPI.
<b>Dependencies</b>	If a save of Marker Table results is requested and the Marker Table is not on, no file is saved and a message is generated If a save of Peak Table results is requested and the Peak Table is not on, no file is saved and a message is generated If a save of Spectrogram results is requested and the Spectrogram is not on, no file is saved and a message is generated. The Spectrogram choice only appears if option EDP is licensed.
<b>Preset</b>	Not part of Preset, but is reset to Peak Table by Restore Mode Defaults. Survives a shutdown.
<b>Initial S/W Revision</b>	Prior to A.02.00

## Meas Results File Contents

All files are .csv files. The following section details the data in each file type.

### Marker Table

This section discusses the Marker Table Meas Results file format.

Imagine that, at the point where a Marker Table Meas Result is requested, the following screen is showing:

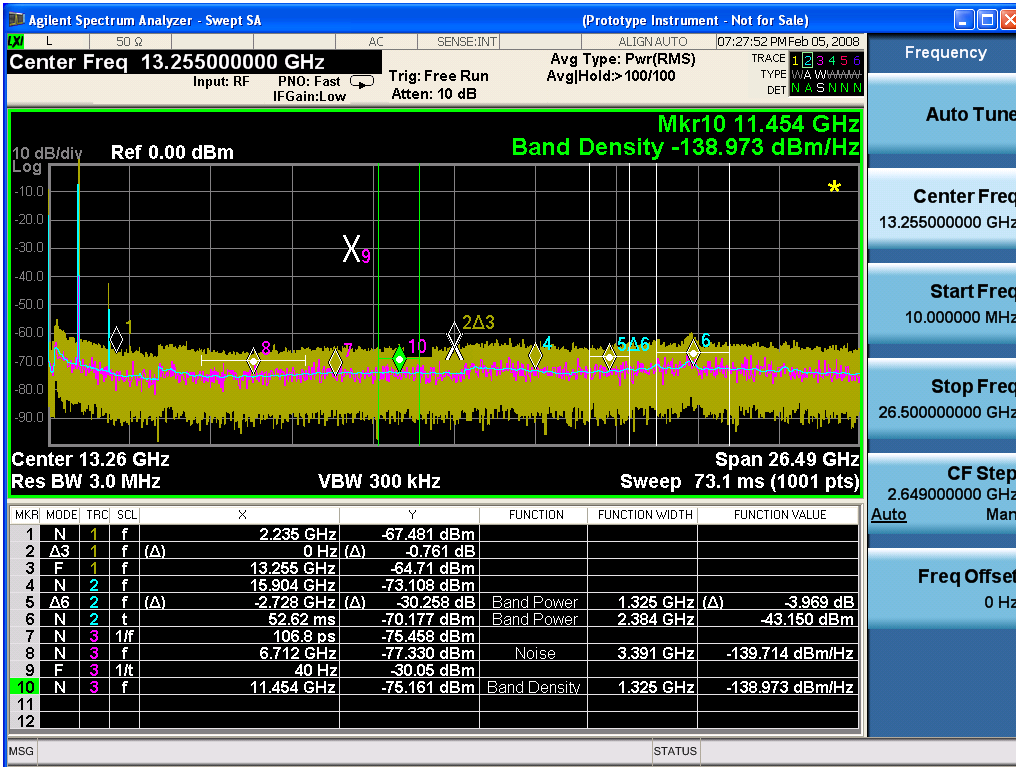

Then the Meas Results file, when opened, would show the following data:

MeasurementR	
result	
Swept SA	
A.01.40_R0017	N9020A
526 B25 PFR	1
P26 EA3	
Result Type	Marker Table
Ref Level	0
Number of Points	1001
Sweep Time	0.0662666 67
Start Frequency	10000000
Stop Frequency	26500000 000
Average Count	0
Average Type	LogPower (Video)
RBW	3000000

RBW Filter	Gaussian
RBW Filter BW	3dB
VBW	3000000
Sweep Type	Swept
X Axis Scale	Lin
PreAmp State	Off
PreAmp Band	Low
Trigger Source	Free
Trigger Level	1.2
Trigger Slope	Positive
Trigger Delay	1.00E-06
Phase Noise Optimization	Fast
Swept If Gain	Low
FFT If Gain	Autorange
RF Coupling	AC
FFT Width	411900
Ext Ref	10000000
Input	RF
RF Calibrator	Off
Attenuation	10
Ref Level Offset	0
External Gain	0
X Axis Units	Hz
Y Axis Units	dBm

DATA									
MKR	MODE	TR C	SCL	X	Y	FUNCTI ON	FUNCTIO N WIDTH	FUNCTI ON VALUE	FUNCTI ON UNIT
1	Normal	1	Freque ncy	2.2350E+09	- 67.481	Off	0.0000E+00	0	None
2	Delta3	1	Freque ncy	0.0000E+00	- 0.761	Off	0.0000E+00	0	None
3	Fixed	1	Freque ncy	1.3255E+10	- 64.71	Off	0.0000E+00	0	None
4	Normal	2	Freque ncy	1.5904E+10	- 73.1	Off	0.0000E+00	0	None

08									
5	Delta7	2	Frequency	- 2.7280E+ 09	- 30.2 58	Band Power	1.3250E+ 06	-3.969	dB
6	Normal	2	Time	5.2620E- 02	- 70.1 77	Band Power	2.3840E+ 06	-43.15	dBm
7	Normal	3	Period	1.0680E- 10	- 75.4 58	Off	0.0000E+ 00	0	None
8	Normal	3	Frequency	6.7120E+ 09	- 77.3 3	Noise	3.3910E+ 06	- 139.71 4	dBm/Hz
9	Fixed	3	Inverse Time	4.0000E+ 01	- 30.0 5	Off	0.0000E+ 00	0	None
10	Normal	3	Frequency	1.1454E+ 10	- 75.1 61	Band Density	1.3250E+ 06	- 138.97 3	dBm/Hz
11	Off	1	Frequency	0.0000E+ 00	0	Off	0.0000E+ 00	0	None
12	Off	1	Frequency	0.0000E+ 00	0	Off	0.0000E+ 00	0	None

The numbers appear in the file exactly as they appear onscreen. If it says 11.454 GHz onscreen, then in the file it is 11.454E+09.

The metadata header is very similar to the metadata used in the trace data .csv files. See Trace File Contents. The only new information concerns the 1-of-N fields in the marker table itself.

### Peak Table

This section discusses the Peak Table Meas Results file format.

Imagine that, at the point where a Marker Table Meas Result is requested, the following screen is showing:

21 Waveform Measurement  
Save

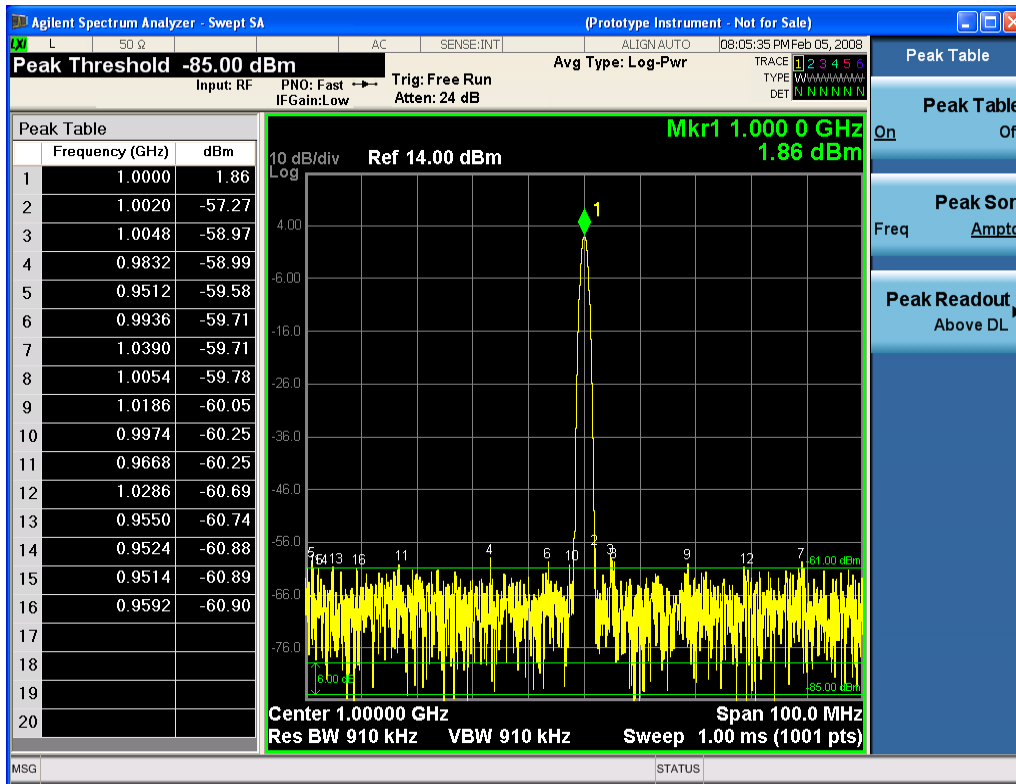

Then the Meas Results file, when opened, would show the header data (the same as for the Marker Table except that the Result Type is Peak Table) ending with a few fields of specific interest to Peak Table users:

- Peak Threshold
- Peak Threshold State (On|Off)
- Peak Excursion
- Peak Excursion State (On|Off)
- Display Line
- Peak Readout (All|AboveDL|BelowDL)
- Peak Sort (Freq|Amptd)

These fields are then followed by the data for the Peak Table itself.

Note that the label for the Frequency column changes to Time in 0 span.

Here is what the table for the above display looks like:

MeasurementResult	
Swept SA	
A.01.40_R0017	N9020A
526 B25 PFR P26 EA3	1

Result Type	Peak Table
Ref Level	0
Number of Points	1001
Sweep Time	0.066266667
Start Frequency	10000000
Stop Frequency	26500000000
Average Count	0
Average Type	LogPower(Video)
RBW	3000000
RBW Filter	Gaussian
RBW Filter BW	3dB
VBW	3000000
Sweep Type	Swept
X Axis Scale	Lin
PreAmp State	Off
PreAmp Band	Low
Trigger Source	Free
Trigger Level	1.2
Trigger Slope	Positive
Trigger Delay	1.00E-06
Phase Noise Optimization	Fast
Swept If Gain	Low
FFT If Gain	Autorange
RF Coupling	AC
FFT Width	411900
Ext Ref	10000000
Input	RF
RF Calibrator	Off
Attenuation	10
Ref Level Offset	0
External Gain	0
X Axis Units	Hz
Y Axis Units	dBm
Peak Threshold	-85
Peak Threshold State	On
Peak Excursion	6
Peak Excursion State	On

Display Line	-61	
Peak Readout	AboveDL	
Peak Sort	Amptd	
DATA		
Peak	Frequency	Amplitude
1	1.0000E+06	1.86
2	1.0020E+06	-57.27
3	1.0048E+06	-58.97
4	9.8320E+05	-58.99
5	9.5120E+05	-59.58
6	9.9360E+05	-59.71
7	1.0390E+06	-59.71
8	1.0054E+06	-59.78
9	1.1086E+06	-60.05
10	9.9740E+05	-60.25
11	9.6680E+05	-60.25
12	1.0286E+06	-60.69
13	9.5500E+05	-60.74
14	9.5240E+05	-60.88
15	9.5140E+05	-60.89
16	9.5920E+05	-60.90
17		
18		
19		
20		

## Spectrogram

This section discusses the Spectrogram Results file format. The Spectrogram choice only appears if option EDP is licensed.

The Spectrogram results are the same as a Trace data export, except that instead of having just one trace's data, all 300 traces appear one after the other.

Each trace has its own data mark; the data for Spectrogram Trace 0 follows the row marked DATA, the data for Spectrogram Trace 1 follows the row marked DATA1, for Spectrogram Trace 2 follows the row marked DATA2, and so on.



Each DATA row has a timestamp in the second column (as of firmware revision A.11.01). So, for example, if Trace 0 had a relative start time of 1729.523 sec, then the first DATA row would look like this:

DATA,1729.523

And if Trace 13 had a relative start time of 100.45 sec, then the fourteenth data row would look like:

DATA13,100.453

To find the absolute time for the relative timestamps of each trace, the last row before the first DATA row gives the absolute start time of the Spectrogram, in the form YYYYMMDDHHMMSS

So, for example, if the absolute start time is 13:23:45:678 on January 30, 2012, this row would look like:

Start Time,20120130132345678

**NOTE** The resolution of the absolute time stored is 1 ms, which matches up with the fact that the fastest sweep time is also 1 ms. However, there is no specification for the absolute accuracy of the clock in the analyzer, nor is there any facility provided to allow the user to set this time to any particular degree of accuracy.

Traces that have not yet been filled in the Spectrogram display are empty; there is no DATA header for them. The file ends after the last non-empty trace.

Imagine that, at the point where a Spectrogram Meas Result is requested, the following screen is showing:

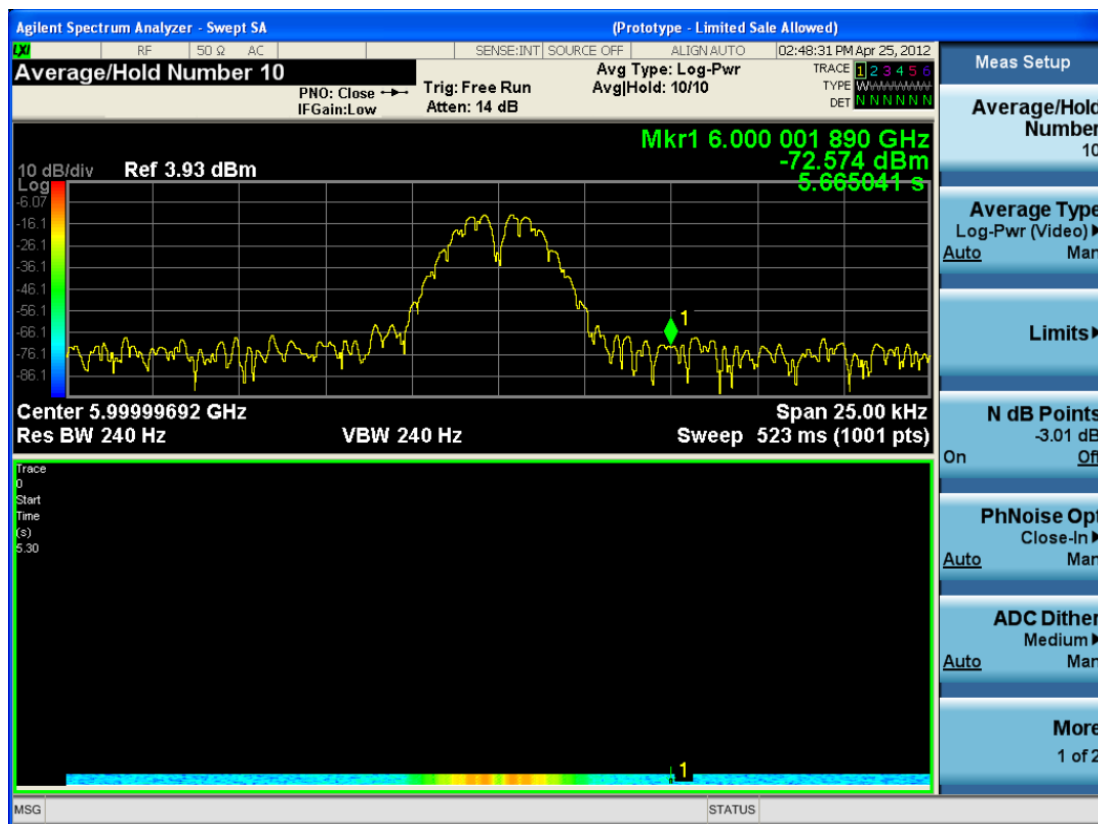

For the purpose of this example, we have set the Average/Hold Number to 10, thus we have only traces 0 thru 10. The Spectrogram was started at 02:28:08:700 pm on April 25, 2012 (that is, 700 ms after 2:28:08 pm), although the screen dump itself shows a different time, as it was taken ten minutes after the

Spectrogram data. Trace 0 is showing a start time of 5.30 seconds, meaning 5.3 seconds after the Spectrogram started (trace 10 has a start time of 0, as it was the first trace taken but has now rolled up into the tenth trace slot).

The Meas Results file, when opened, shows the header data and ten traces of trace data. Below is an extract from the result file for the above display. Note the start time of 20120425142808700 showing in the last row before the first DATA row, and the relative time of 5.299231048 showing in the first DATA row:

<b>Result Type</b>	<b>Spectrogram</b>
MeasResult	
Swept SA	
A.11.00.01	N9020A
503 508 513 526 ALL ALV B1C B1X B25 B2X B40 BAB BBA CR3 CRP DP2 DRD EA3 EDP EMC EP1 ERC ESC ESP EXM FSA HBA K03 LFE MPB P03 P08 P13 P26 PFR RTL RTS S40 SB1 SEC SM1 UK6 YAS YAV	1
Segment	0
Number of Points	1001
Sweep Time	0.523333333
Start Frequency	5999984415
Stop Frequency	6000009415
Average Count	0
Average Type	LogPower(Video)
RBW	240
RBW Filter	Gaussian
RBW Filter BW	3dB
VBW	240
Sweep Type	Swept
X Axis Scale	Lin
PreAmp State	Off
PreAmp Band	Low
Trigger Source	Free
Trigger Level	1.2
Trigger Slope	Positive
Trigger Delay	0
Phase Noise Optimization	Wide
Swept If Gain	Low
FFT If Gain	Autorange
RF Coupling	AC

Result Type	Spectrogram
FFT Width	411900
Ext Ref	10000000
Input	RF
RF Calibrator	Off
Attenuation	14
Ref Level Offset	0
External Gain	0
Trace Type	Clearwrite
Detector	Normal
Trace Math	Off
Trace Math Oper1	Trace5
Trace Math Oper2	Trace6
Trace Math Offset	0
Trace Name	Trace1
X Axis Units	Hz
Y Axis Units	dBm
Start Time	20120425142808700
DATA	5.299231048
5999984415	-76.34749519
5999984440	-77.28097006
5999984465	-75.32317869
5999984490	-73.64417681
5999984515	-72.67154604

- o
- o
- o

6000009315	-77.94423277
6000009340	-79.51829697
6000009365	-78.46108961
6000009390	-78.46108957
6000009415	-76.59570596
DATA2	4.708697055
5999984415	-80.98197882
5999984440	-80.98197879

---

5999984465	-75.83142132
5999984490	-74.02712079
5999984515	-73.57213005

---

O  
O  
O

---

6000009315	-75.9183103
6000009340	-79.53787488
6000009365	-78.82602191
6000009390	-78.82602188
6000009415	-76.37486709
DATA10	0
5999984415	-75.56751112
5999984440	-75.76485645
5999984465	-76.67718717
5999984490	-78.79238489
5999984515	-83.72680212

---

O  
O  
O

---

6000009315	-71.3942461
6000009340	-72.28308332
6000009365	-73.92684489
6000009390	-75.45548832
6000009415	-75.17904815

---

### Capture Buffer

Capture Buffer functionality is not available for all measurements. The captured data is raw data which is not processed.

---

Key Path	Save, Data
----------	------------

---

Mode	CDMA1XEV
Example	MMEM:STOR:CAPT "MyCaptureData.bin" This stores the capture data in the file MyCaptureData.bin in the default directory.
Dependencies	In case the capture buffer data is not available from the selected measurement, the key will be grayed out.
Initial S/W Revision	A.11.00

## Save As . . .

When you press “Save As”, the analyzer brings up a Windows dialog and a menu entitled “**Save As.**” This menu allows you to navigate to the various fields in the Windows dialog without using a keyboard or mouse. The Tab and Arrow keys can also be used for dialog navigation.

See "[To File . . .](#)" on page 2897 in Save, State for a full description of this dialog and menu.

The default path for saving files is:

For all of the Trace Data Files:

My Documents\`<mode name>`\data\traces

For all of the Limit Data Files:

My Documents\`<mode name>`\data\limits

For all of the Measurement Results Data Files:

My Documents\`<mode name>`\data\`<measurement name>`\results

For all of the Capture Buffer Data Files:

My Documents\`<mode name>`\data\captureBuffer

Key Path	Save, Data
Mode	All
Notes	The key location is mode-dependent and will vary. Brings up the Save As dialog for saving a <code>&lt;mode specific&gt;</code> Save Type. The save is performed immediately and does not wait until the measurement is complete.
Initial S/W Revision	Prior to A.02.00

## Screen Image

Pressing Screen Image accesses a menu of functions that enable you to specify a format and location for the saved screen image. It brings up a menu that allows you to specify the color scheme of the Screen Image (Themes) or navigate to the Save As dialog to perform the actual save.

Screen Image files contain an exact representation of the analyzer display. They cannot be loaded back onto the analyzer, but they can be loaded into your PC for use in many popular applications.

21 Waveform Measurement  
Save

The image to be saved is actually captured when the Save front panel key is pressed, and kept in temporary storage to be used if you ask for a Screen Image save. When the Screen Image key is pressed, a "thumbnail" of the captured image is displayed, as shown below:

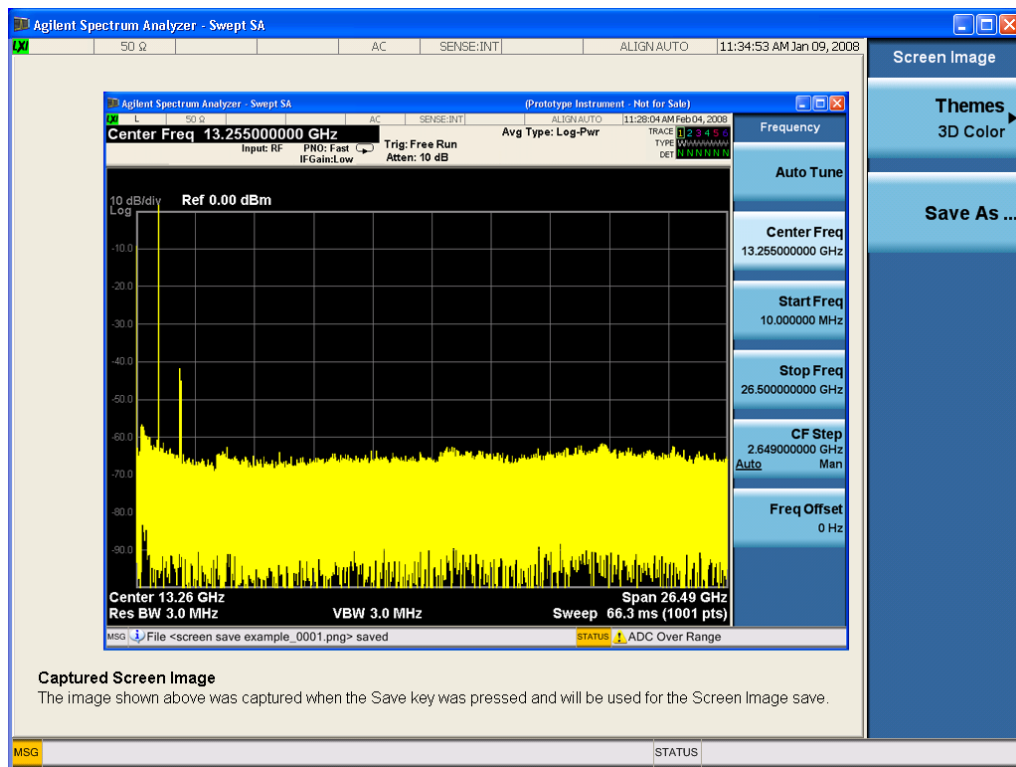

When you continue on into the Save As menu and complete the Screen Image save, the image depicted in the thumbnail is the one that gets saved, showing the menus that were on the screen before going into the Save menus. The save is performed immediately and does not wait until the measurement is complete.

After you have completed the save, the Quick Save front-panel key lets you quickly repeat the last save performed, using an auto-named file, with the current screen data.

**NOTE**

For versions previous to A.01.55, if you initiate a screen image save by navigating through the Save menus, the image that is saved will contain the Save menu softkeys, not the menus and the active function that were on the screen when you first pressed the Save front panel key.

Key Path	Save
Mode	All
Remote Command	:MMEMory:STORe:SCReen <filename>
Example	:MMEM:STOR:SCR "myScreen.png" This stores the current screen image in the file MyScreenFile.png in the default directory.
Initial S/W Revision	Prior to A.02.00

## Themes

Accesses a menu of functions that enable you to choose the theme to be used when saving the screen image.

The **Themes** option is the same as the **Themes** option under the **Display** and **Page Setup** dialogs. It allows you to choose between themes to be used when saving the screen image.

<b>Key Path</b>	Save, Screen Image
<b>Remote Command</b>	:MMEMory:STORe:SCReen:THEMe TDColor   TDMonochrome   FCOlor   FMONochrome  :MMEMory:STORe:SCReen:THEMe?
<b>Example</b>	:MMEM:STOR:SCR:THEM TDM
<b>Preset</b>	3D Color; Is not part of Preset, but is reset by Restore Misc Defaults or Restore System Defaults All and survives subsequent running of the modes.
<b>Readback</b>	3D Color   3D Mono   Flat Color   Flat Mono
<b>Backwards Compatibility Notes</b>	In ESA and PSA we offer the choice of "Reverse Bitmap" or "Reverse Metafile" when saving screen images. This is much like the "Flat Color" theme available in X-Series. Also, if you selected Reverse Bitmap AND a black & white screen image, that would be much like "Flat Monochrome". In other words, each of the X-Series themes has a similar screen image type in ESA/PSA. But they are not identical.
<b>Initial S/W Revision</b>	Prior to A.02.00

### 3D Color

Selects a standard color theme with each object filled, shaded and colored as designed.

<b>Key Path</b>	Save, Screen Image, Themes
<b>Example</b>	MMEM:STOR:SCR:THEM TDC
<b>Readback</b>	3D Color
<b>Initial S/W Revision</b>	Prior to A.02.00

### 3D Monochrome

Selects a format that is like 3D color but shades of gray are used instead of colors.

<b>Key Path</b>	Save, Screen Image, Themes
<b>Example</b>	MMEM:STOR:SCR:THEM TDM
<b>Readback</b>	3D Mono
<b>Initial S/W Revision</b>	Prior to A.02.00

### Flat Color

Selects a format that is best when the screen is to be printed on an ink printer.

Key Path	Save, Screen Image, Themes
<b>Example</b>	MMEM:STOR:SCR:THEM FCOL
Readback	Flat Color
Initial S/W Revision	Prior to A.02.00

### Flat Monochrome

Selects a format that is like Flat Color. But only black is used (no colors, not even gray), and no fill.

Key Path	Save, Screen Image, Themes
<b>Example</b>	MMEM:STOR:SCR:THEM FMON
Readback	Flat Mono
Initial S/W Revision	Prior to A.02.00

### Save As...

When you press "Save As", the analyzer brings up a Windows dialog and a menu entitled "Save As." This menu allows you to navigate to the various fields in the Windows dialog without using a keyboard or mouse. The Tab and Arrow keys can also be used for dialog navigation.

See "[To File . . .](#)" on page 2897 in Save, State for a full description of this dialog and menu.

The default path for Screen Images is

My Documents\`<mode name>`\screen.

where `<mode name>` is the parameter used to select the mode with the INST:SEL command (for example, SA for the Spectrum Analyzer).

Key Path	Save, Screen Image
Notes	Brings up Save As dialog for saving a Screen Image Save Type
Initial S/W Revision	Prior to A.02.00

### Mass Storage Catalog (Remote Command Only)

Key path	SCPI Only
<b>Remote Command</b>	:MMEMory:CATalog? [ <code>&lt;directory_name&gt;</code> ]
Notes	The string must be a valid logical path. Queries disk usage information (drive capacity, free space available) and obtains a list of files and directories in a specified directory in the following format: <code>&lt;numeric_value&gt;,&lt;numeric_value&gt;,{&lt;file_entry&gt;}</code> It returns two numeric parameters and as many strings as there are files and directories. The first



---

parameter indicates the total amount of storage currently used in bytes. The second parameter indicates the total amount of storage available, also in bytes. The <file\_entry> is a string. Each <file\_entry> indicates the name, type, and size of one file in the directory list:

<file\_name>,<file\_type>,<file\_size>

As the windows file system has an extension that indicates file type, <file\_type> is always empty. <file\_size> provides the size of the file in bytes. For directories, <file\_entry> is surrounded by square brackets and both <file\_type> and <file\_size> are empty

---

Initial S/W Revision      Prior to A.02.00

---

## Mass Storage Change Directory (Remote Command Only)

---

Key path                      SCPI Only

**Remote Command**        :MMEMory:CDIRectory [<directory\_name>]  
                                  :MMEMory:CDIRectory?

**Notes**                      The string must be a valid logical path.  
  
Changes the default directory for a mass memory file system. The <directory\_name> parameter is a string. If no parameter is specified, the directory is set to the \*RST value.  
At \*RST, this value is set to the default user data storage area, that is defined as System.Environment.SpecialFolder.Personal.  
Query returns full path of the default directory.

---

Initial S/W Revision      Prior to A.02.00

---

## Mass Storage Copy (Remote Command Only)

---

Key path                      SCPI Only

**Remote Command**        :MMEMory:COPY <string>,<string> [,<string>,<string>]

**Notes**                      The string must be a valid logical path.  
  
Copies an existing file to a new file or an existing directory to a new directory.  
Two forms of parameters are allowed. The first form has two parameters. In this form, the first parameter specifies the source, and the second parameter specifies the destination.  
The second form has four parameters. In this form, the first and third parameters specify the source. The second and fourth parameters specify the directories. The first pair of parameters specifies the source. The second pair specifies the destination. An error is generated if the source doesn't exist or the destination file already exists.  
  
This command will generate an "access denied" error if the destination is a restricted folder (e.g., C:\Windows) and the current user does not have Power User or Administrator privileges.

---

## Mass Storage Device Copy (Remote Command Only)

This command transfers data to/from a file and a peripheral device.

Key path	SCPI Only
<b>Remote Command</b>	:MMEMory:COpy:DEvice <source_string>,<dest_string>
Notes	<p>The strings must be a valid logical path or a valid device keyword. If the dest_string is a device keyword, the data is copied from the source file to the device. If the source_string is a device keyword, the data is copied to the source file from the device.</p> <p>Valid device keywords are: SNS (smart noise source)</p> <p>An error is generated if the file or device is not found.</p>

### Mass Storage Delete (Remote Command Only)

Key path	SCPI Only
<b>Remote Command</b>	:MMEMory:DELeTe <file_name>[,<directory_name>]
Notes	<p>The string must be a valid logical path.</p> <p>Removes a file from the specified directory. The &lt;file_name&gt; parameter specifies the file name to be removed. This command will generate an “access denied” error if the file is in a restricted folder (e.g., C:\Windows) and the current user does not have Power User or Administrator privileges.</p>
Initial S/W Revision	Prior to A.02.00

### Mass Storage Data (Remote Command Only)

Creates a file containing the specified data OR queries the data from an existing file.

Key path	SCPI Only
<b>Remote Command</b>	:MMEMory:DATA <file_name>, <data> :MMEMory:DATA? <file_name>
Notes	<p>The string must be a valid logical path.</p> <p>The command form is MMEMory:DATA &lt;file_name&gt;,&lt;data&gt;. It loads &lt;data&gt; into the file &lt;file_name&gt;. &lt;data&gt; is in 488.2 block format. &lt;file_name&gt; is string data.</p> <p>The query form is MMEMory:DATA? &lt;file_name&gt; with the response being the associated &lt;data&gt; in block format.</p>
Initial S/W Revision	Prior to A.02.00

### Mass Storage Make Directory (Remote Command Only)

Key path	SCPI Only
<b>Remote Command</b>	:MMEMory:MDIRectory <directory_name>
Notes	<p>The string must be a valid logical path.</p> <p>Creates a new directory. The &lt;directory_name&gt; parameter specifies the name to be created.</p>

	This command will generate an “access denied” error if the new directory would be in a restricted folder (e.g., C:\Windows) and the current user does not have Power User or Administrator privileges.
Initial S/W Revision	Prior to A.02.00

### Mass Storage Move (Remote Command Only)

Key path	SCPI Only
<b>Remote Command</b>	:MMEMory:MOVE <string>,<string>[,<string>,<string>]
Notes	<p>The string must be a valid logical path.</p> <p>Moves an existing file to a new file or an existing directory to a new directory.</p> <p>Two forms of parameters are allowed. The first form has two parameters. In this form, the first parameter specifies the source, and the second parameter specifies the destination.</p> <p>The second form has four parameters. In this form, the first and third parameters specify the source. The second and fourth parameters specify the directories. The first pair of parameters specifies the source. The second pair specifies the destination. An error is generated if the source doesn't exist or the destination file already exists.</p> <p>This command will generate an “access denied” error if the destination is a restricted folder (e.g., C:\Windows) and the current user does not have Power User or Administrator privileges.</p>
Initial S/W Revision	Prior to A.02.00

### Mass Storage Remove Directory (Remote Command Only)

Key path	SCPI Only
<b>Remote Command</b>	:MMEMory:RDIRECTory <directory_name>
Notes	<p>The string must be a valid logical path.</p> <p>Removes a directory. The &lt;directory_name&gt; parameter specifies the directory name to be removed. All files and directories under the specified directory shall also be removed.</p> <p>This command will generate an “access denied” error if the folder is a restricted folder (e.g., C:\Windows) or is in a restricted folder and the current user does not have Power User or Administrator privileges.</p>
Initial S/W Revision	Prior to A.02.00

## Single (Single Measurement/Sweep)

Sets the analyzer for Single measurement operation. The single/continuous state is Meas Global, so the setting will affect all the measurements. If you are Paused, pressing Single does a Resume.

See ["More Information" on page 2920](#)

Key Path	Front-panel key
Example	:INIT:CONT OFF
Notes	See Cont key description.
Backwards Compatibility Notes	<p>For Spectrum Analysis mode in ESA and PSA, the Single hardkey and the INITiate:IMM switched from continuous measurement to single measurement and restarted sweeps and averages (displayed average count reset to 1), but did not restart Max Hold and Min Hold. In the X-Series, the Single hardkey and the INITiate:IMM command initiate a sweep/ measurement/ average sequence/hold sequence including MaxHold and MinHold.</p> <p>For Spectrum Analysis mode in ESA and PSA, the Single hardkey restarted the sweep regardless of whether or not you were in an active sweep or sweep sequence. In the X-Series, Restart does this but Single only restarts the sweep or sweep sequence if you are in the idle state.</p> <p>INIT[:IMM] in ESA &amp; PSA Spectrum Analysis Mode does an implied ABORT. In some other PSA Modes, INIT[:IMM] is ignored if not in the idle state. . The X-Series follows the ESA/PSA SA Mode model, which may cause some Modes to have compatibility problems.</p>
Initial S/W Revision	Prior to A.02.00

### More Information

See ["Restart" on page 2894](#) for details on the INIT:IMMEDIATE (Restart) function.

If you are already in single sweep, the INIT:CONT OFF command has no effect.

If you are already in Single Sweep, then pressing the Single key in the middle of a sweep does not restart the sweep or sequence. Similarly, pressing the Single key does not restart the sweep or sequence if the sweep is not in the idle state (for example, if you are taking a very slow sweep, or the analyzer is waiting for a trigger). Instead, it results in a message. "Already in Single, press Restart to initiate a new sweep or sequence". Even though pressing the Single key in the middle of a sweep does not restart the sweep, sending INIT:IMMEDIATE does reset it.

To take one more sweep without resetting the average count, increment the average count by 1, by pressing the step up key while **Average/Hold Number** is the active function, or sending the remote command CALC:AVER:TCON UP.

## Source

There is no Source control functionality for this measurement. When this key is pressed, the screen either displays a blank menu, or the previously-selected menu remains unchanged.

---

Key Path	Front-panel key
----------	-----------------

---

## Span X Scale

Accesses a menu of functions that enable you to set the horizontal scale parameters.

Key Path	Front-panel key
Initial S/W Revision	Prior to A.02.00

### Ref Value

Sets the reference value for time on the horizontal axis. When Auto Scaling is set to On, the displayed plots use a Scale/Div value determined by the analyzer, based on the measurement result.

Key Path	SPAN X Scale
Mode	BASIC, PNOISE, WCDMA, C2K, GSM, WIMAXOFDMA, TDSCDMA, 1XEVD0, DVB, DTMB, ISDBT, CMMB, LTE, LTETDD, DCATV, WLAN, MSR,LTEATDD, LTEAFDD
Remote Command	:DISPlay:WAVeform:VIEW[1] 2:WINDow[1]:TRACe:X[:SCALE]:RLEVel <time> :DISPlay:WAVeform:VIEW[1] 2:WINDow[1]:TRACe:X[:SCALE]:RLEVel?
Example	DISP:WAV:VIEW:WIND:TRAC:X:RLEV 10 ms DISP:WAV:VIEW:WIND:TRAC:X:RLEV?
Notes	You must be in a mode that includes the Waveform measurement to use this command. Use INSTRument:SElect to set the mode.
Couplings	If Auto Scaling is set to On, this value is automatically determined by the measurement result. When you set this value manually, Auto Scaling automatically changes to Off.
Preset	0.00 s
State Saved	Saved in instrument state.
Min	-1.000 s
Max	10.00 s
Initial S/W Revision	Prior to A.02.00
Modified at S/W Revision	A.03.00

### Scale/Div

Sets the horizontal scale by changing a time value per division.

Key Path	SPAN X Scale
Mode	BASIC, PNOISE, WCDMA, C2K, GSM, WIMAXOFDMA, TDSCDMA, 1XEVD0, DVB, DTMB, ISDBT, CMMB, LTE, LTETDD, DCATV, WLAN, MSR,LTEATDD, LTEAFDD
Remote Command	:DISPlay:WAVeform:VIEW[1] 2:WINDow[1]:TRACe:X[:SCALE]:PDIVision <time> :DISPlay:WAVeform:VIEW[1] 2:WINDow[1]:TRACe:X[:SCALE]:PDIVision?
Example	DISP:WAV:VIEW:WIND:TRAC:X:PDIV 500 us DISP:WAV:VIEW:WIND:TRAC:X:PDIV?

Notes	You must be in a mode that includes the Waveform measurement to use this command. Use INSTRUMENT:SElect to set the mode.
Couplings	If Auto Scaling is set to On, this value is automatically determined by the measurement result. When you set this value manually, Auto Scaling automatically changes to Off.
Preset	All except the following list: 200.0 us LTEAFDD, LTEATDD: 1.000 ms LTETDD: 1.000 ms
State Saved	Saved in instrument state.
Min	1.000 ns
Max	320 s
Initial S/W Revision	Prior to A.02.00
Modified at S/W Revision	A.03.00, A.14.00

## Ref Position

Sets the reference position for the X axis to Left, Center or Right.

Key Path	SPAN X Scale
Mode	BASIC, PNOISE, WCDMA, C2K, GSM, WIMAXOFDMA, TDSCDMA, 1XEVD0, DVB, DTMB, ISDBT, CMMB, LTE, LTETDD, DCATV, WLAN, MSR,LTEATDD, LTEAFDD
<b>Remote Command</b>	:DISPlay:WAVeform:VIEW[1] 2:WINDow[1]:TRACe:X[:SCALE]:RPOSition LEFT   CENTER   RIGHT  :DISPlay:WAVeform:VIEW[1] 2:WINDow[1]:TRACe:X[:SCALE]:RPOSition?
<b>Example</b>	DISP:WAV:VIEW:WIND:TRAC:X:RPOS LEFT DISP:WAV:VIEW:WIND:TRAC:X:RPOS?
Notes	Allows you to set the reference position to Left, Ctr (center) or Right. You must be in a mode that includes the Waveform measurement to use this command. Use INSTRUMENT:SElect to set the mode.
Preset	LEFT
State Saved	Saved in instrument state.
Range	Left Ctr Right
Initial S/W Revision	Prior to A.02.00
Modified at S/W Revision	A.03.00

## Auto Scaling

Toggles the scale coupling function between On and Off.

<b>Key Path</b>	SPAN X Scale
<b>Mode</b>	BASIC, PNOISE, WCDMA, C2K, GSM, WIMAXOFDMA, TDSCDMA, 1XEVD0, DVB, DTMB, ISDBT, CMMB, LTE, LTETDD, DCATV, WLAN, MSR,LTEATDD, LTEAFDD
<b>Remote Command</b>	:DISPlay:WAVeform:VIEW[1] 2:WINDow[1]:TRACe:X[:SCALE]:COUPle 0   1   OFF   ON  :DISPlay:WAVeform:VIEW[1] 2:WINDow[1]:TRACe:X[:SCALE]:COUPle?
<b>Example</b>	DISP:WAV:VIEW:WIND:TRAC:X:COUP ON DISP:WAV:VIEW:WIND:TRAC:X:COUP?
<b>Notes</b>	You must be in a mode that includes the Waveform measurement to use this command. Use INSTRument:SElect to set the mode.
<b>Couplings</b>	When Auto Scaling is On and the Restart front-panel key is pressed, this function automatically determines the scale per division and reference values based on the measurement results.  When you set a value to either Scale/Div or Ref Value manually, Auto Scaling automatically changes to Off.
<b>Preset</b>	1
<b>State Saved</b>	Saved in instrument state.
<b>Range</b>	On Off
<b>Initial S/W Revision</b>	Prior to A.02.00
<b>Modified at S/W Revision</b>	A.03.00



## Sweep/Control

Accesses a menu that enables you to configure the Sweep and Control functions of the analyzer, such as Sweep Time and Gating.

Key Path	Front-panel key
Initial S/W Revision	Prior to A.02.00

### Pause/Resume

Pauses a measurement after the current data acquisition is complete.

When Paused, the label on the key changes to Resume. Pressing Resume un-pauses the measurement. When you are Paused, pressing Restart, Single or Cont does a Resume.

Key Path	Sweep/Control
<b>Remote Command</b>	:INITiate:PAUSE
Dependencies	Grayed out in Measurements that do not support Pausing. Blanked in Modes that do not support Pausing.
Initial S/W Revision	Prior to A.02.00

Key Path	Sweep/Control
<b>Remote Command</b>	:INITiate:RESume
Dependencies	Grayed out in Measurements that do not support Pausing. Blanked in Modes that do not support Pausing.
Initial S/W Revision	Prior to A.02.00

### Abort (Remote Command Only)

This command is used to stop the current measurement. It aborts the current measurement as quickly as possible, resets the sweep and trigger systems, and puts the measurement into an "idle" state. If the analyzer is in the process of aligning when ABORT is sent, the alignment finishes before the abort function is performed. So ABORT does not abort an alignment.

If the analyzer is set for Continuous measurement, it sets up the measurement and initiates a new data measurement sequence with a new data acquisition (sweep) taken once the trigger condition is met.

If the analyzer is set for Single measurement, it remains in the "idle" state until an :INIT:IMM command is received.

<b>Remote Command</b>	:ABORT
<b>Example</b>	:ABOR

---

Notes	If :INITiate:CONTInuous is ON, then a new continuous measurement will start immediately, with sweep (data acquisition) occurring once the trigger condition has been met. If :INITiate:CONTInuous is OFF, then :INITiate:IMMEDIATE is used to start a single measurement; with sweep (data acquisition) occurring once the trigger condition has been met.
Dependencies	For continuous measurement, ABORt is equivalent to the Restart key. Not all measurements support the abort command.
Status Bits/OPC dependencies	The STATus:OPERation register bits 0 through 8 are cleared. The STATus:QUEStionable register bit 9 (INTegrity sum) is cleared. Since all the bits that feed into OPC are cleared by the ABORt, the ABORt will cause the *OPC query to return true.
Initial S/W Revision	Prior to A.02.00

---

## System

See "System" on page 359

## Trace/Detector

There is no Trace/Detector functionality supported in the Waveform measurement. The front-panel key displays a blank menu when pressed.

---

Key Path	Front-panel key
Initial S/W Revision	Prior to A.02.00

---

## Trigger

See ["Trigger" on page 430](#)

### Free Run

See ["Free Run " on page 437](#)

### Video

See ["Video \(IF Envelope\) " on page 438](#)

### Trigger Level

See ["Trigger Level " on page 438](#)

### Trig Slope

See ["Trig Slope " on page 439](#)

### Trig Delay

See ["Trig Delay " on page 440](#)

### Line

See ["Line " on page 2729](#)

### Trig Slope

See ["Trig Slope " on page 2729](#)

### Trig Delay

See ["Trig Delay " on page 442](#)

### External 1

See ["External 1 " on page 2741](#)

### Trigger Level

See ["Trigger Level " on page 2741](#)

### Trig Slope

See ["Trig Slope " on page 2742](#)

### Trig Delay

See ["Trig Delay " on page 445](#)

### External 2

See ["External 2 " on page 2743](#)

### **Trigger Level**

See ["Trigger Level "](#) on page 2743

### **Trig Slope**

See ["Trig Slope "](#) on page 2744

### **Trig Delay**

See ["Trig Delay "](#) on page 447

### **RF Burst**

See ["RF Burst "](#) on page 2744

### **Absolute Trigger**

See ["Absolute Trigger Level"](#) on page 2745

### **Relative Trigger**

See ["Relative Trigger Level"](#) on page 2734

### **Trig Slope**

See ["Trigger Slope "](#) on page 2746

### **Trig Delay**

See ["Trig Delay "](#) on page 451

### **Periodic Timer**

See ["Periodic Timer \(Frame Trigger\) "](#) on page 2736

### **Period**

See ["Period "](#) on page 2737

### **Offset**

See ["Offset "](#) on page 2738

### **Offset Adjust (Remote Command Only)**

See ["Offset Adjust \(Remote Command Only\)"](#) on page 2739

### **Reset Offset Display**

See ["Reset Offset Display "](#) on page 2740

### **Sync Source**

See ["Sync Source "](#) on page 2740

## Off

See "Off " on page 2741

## External 1

See "External 1 " on page 2741

## Trigger Level

See "Trigger Level " on page 2741

## Trig Slope

See "Trig Slope " on page 2742

## External 2

See "External 2 " on page 2743

## Trigger Level

See "Trigger Level " on page 2743

## Trig Slope

See "Trig Slope " on page 2744

## RF Burst

See "RF Burst " on page 2744

## Absolute Trigger

See "Absolute Trigger Level" on page 2745

## Trig Slope

See "Trigger Slope " on page 2746

## Trig Delay

See "Trig Delay" on page 461

## Auto/Holdoff

See "Auto/Holdoff " on page 462

## Auto Trig

See "Auto Trig " on page 462

## Trig Holdoff

See "Trig Holdoff " on page 463

## User Preset

Accesses a menu that gives you the following three choices:

- User Preset – recalls a state previously saved using the Save User Preset function.
- User Preset All Modes – presets all of the modes in the analyzer
- Save User Preset– saves the current state for the current mode

Key Path	Front-panel key
Backwards Compatibility Notes	<p>User Preset is actually loading a state, and in legacy analyzers, it was possible to load a state without affecting the trace data, limit lines or correction data. Similarly it was possible to do a User Preset without affecting the trace data, limit lines or correction data.</p> <p>In the X-Series, “state” always includes all of this data; so whenever state is loaded, or User Preset is executed, all of the traces, limit lines and corrections are affected. Although this differs from previous behavior, it is desirable behavior, and should not cause adverse issues for users.</p> <p>On ESA and PSA, User Preset affected the entire instrument’s state. In the X-Series, User Preset only recalls the state for the active mode. There is a User Preset file for each mode. User Preset can never cause a mode switch as it can in legacy analyzers. If you want to recall all modes to their user preset file state, you will need to do a User Preset after mode switching into each mode.</p> <p>User Preset recalls mode state which can now include data like traces; whereas on ESA and PSA, User Preset did not affect data.</p>
Initial S/W Revision	Prior to A.02.00

## User Preset

User Preset sets the state of the currently active mode back to the state that was previously saved for this mode using the Save User Preset menu key or the SCPI command, SYST:PRES:USER:SAV. It not only recalls the Mode Preset settings, but it also recalls all of the mode persistent settings, and the Input/Output system setting that existed at the time Save User Preset was executed.

If a Save User Preset has not been done at any time, User Preset recalls the default user preset file for the currently active mode. The default user preset files are created if, at power-on, a mode detects there is no user preset file. There will never be a scenario when there is no user preset file to restore. For each mode, the default user preset state is the same state that would be saved if a Save User Preset is performed in each mode right after doing a Restore Mode Default and after a Restore Input/Output Defaults.

The User Preset function does the following:

- Aborts the currently running measurement.
- Sets the mode State to the values defined by Save User Preset.
- Makes the saved measurement for the currently running mode the active measurement.
- Brings up the saved menu for the power-on mode.
- Clears the input and output buffers.
- Sets the Status Byte to 0.



Key Path	User Preset
Remote Command	:SYSTem:PRESet:USER
Example	:SYST:PRES:USER:SAVE:SYST:PRES:USER
Notes	:SYST:PRES:USER:SAVE is used to save the current state as the user preset state. Clears all pending OPC bits. The Status Byte is set to 0. Pressing the User Preset front-panel key while already in the User Preset menu will cause the User Preset to get executed
Couplings	A user preset will cause the currently running measurement to be aborted and cause the saved measurement to be active. Recalling a User Preset file has the same issues that recalling a Save State file has. Some settings may need to be limited and therefore re-coupled, since the capabilities of the mode may have changes when the User Preset file was last saved.
Initial S/W Revision	Prior to A.02.00

## User Preset All Modes

Recalls all of the User Preset files for each mode, switches to the power-on mode, and activates the saved measurement from the power-on mode User Preset file.

### NOTE

When the instrument is secured, all of the user preset files are converted back to their default user preset files.

The User Preset function does the following:

- Aborts the currently running measurement.
- Switches the Mode to the power-on mode.
- Restores the User Preset files for each mode.
- Makes the saved measurement for the power-on mode the active measurement.
- Brings up the saved menu for the power-on mode.
- Clears the input and output buffers.
- Sets the Status Byte to 0.

Key Path	User Preset
Remote Command	:SYSTem:PRESet:USER:ALL
Example	:SYST:PRES:USER:SAVE:SYST:PRES:USER:ALL
Notes	Clears all pending OPC bits. The Status Byte is set to 0. :SYST:PRES:USER:SAVE is used to save the current state as the user preset state.
Couplings	A user preset will cause the currently running measurement to be aborted, cause a mode switch to the power-on mode, and cause the saved measurement to be active in the power-on mode. Recalling a User Preset file has the same issues that recalling a Save State file has. Some settings may need to be limited and therefore re-coupled, since the capabilities of the mode may have changes when the User Preset file was last saved.
Initial S/W Revision	Prior to A.02.00

## Save User Preset

Saves the currently active mode and its State. You can recall this User Preset file by pressing the User Preset menu key or sending the SYST:PRES:USER remote command. This same state is also saved by the Save State function.

Key Path	User Preset
Remote Command	:SYSTem:PRESet:USER:SAVE
Example	:SYST:PRES:USER:SAVE
Notes	:SYST:PRES:SAVE creates the same file as if the user requested a *SAV or a MMEM:STOR:STAT, except User Preset Save does not allow the user to specify the filename or the location of the file.
Initial S/W Revision	Prior to A.02.00

## View/Display

Accesses a menu of functions that enable you to set up and control the display parameters for the current measurement.

This topic contains the following sections:

["View Selection by name \(Remote Command Only\)" on page 2935](#)

["View Selection by number \(Remote Command Only\)" on page 2935](#)

### View Selection by name (Remote Command Only)

Selects the results view.

Key Path	View/Display
Mode	BASIC, PNOISE, WCDMA, C2K, GSM, WIMAXOFDMA, TDSCDMA, 1XEVDO, DVB, DTMB, ISDBT, CMMB, LTE, LTE4DD, DCATV, WLAN, MSR,LTE4TDD, LTE4FDD
<b>Remote Command</b>	:DISPlay:WAVeform:VIEW[:SElect] RFENvelope IQ :DISPlay:WAVeform:VIEW[:SElect]?
<b>Example</b>	DISP:WAV:VIEW RFEN DISP:WAV:VIEW?
Notes	You must be in a mode that includes the Waveform measurement to use this command. Use INSTRument:SElect to set the mode.
Preset	RFENveloper
State Saved	Saved in instrument state.
Range	RF Envelope IQ Waveform
Initial S/W Revision	Prior to A.02.00
Modified at S/W Revision	A.03.00

### View Selection by number (Remote Command Only)

Displays the numeric values of the measurement results.

Mode	BASIC, PNOISE, WCDMA, C2K, GSM, WIMAXOFDMA, TDSCDMA, 1XEVDO, DVB, DTMB, ISDBT, CMMB, LTE, LTE4DD, DCATV, WLAN, MSR,LTE4TDD, LTE4FDD
<b>Remote Command</b>	:DISPlay:WAVeform:VIEW:NSElect <integer> :DISPlay:WAVeform:VIEW:NSElect?
<b>Example</b>	DISP:WAV:VIEW:NSEL 1 DISP:WAV:VIEW:NSEL?
Notes	You must be in a mode that includes the Waveform measurement to use this command. Use INSTRument:SElect to set the mode.
Preset	1
State Saved	Saved in instrument state.

Min	1
Max	2
Initial S/W Revision	Prior to A.02.00
Modified at S/W Revision	A.03.00

Key Path	Front-panel key
Initial S/W Revision	Prior to A.02.00

## Display

The Display menu is common to most measurements, and is used for configuring items on the display. Some Display menu settings apply to all the measurements in a mode, and some only to the current measurement. Those under the System Display Settings key apply to all measurements in all modes.

Key Path	Display
Key Path	View/Display
Initial S/W Revision	Prior to A.02.00

## Annotation

Turns on and off various parts of the display annotation. The annotation is divided up into four categories:

1. Meas Bar: This is the measurement bar at the top of the screen. It does not include the settings panel or the Active Function. Turning off the Meas Bar turns off the settings panel and the Active Function. When the Meas Bar is off, the graticule area expands to fill the area formerly occupied by the Meas Bar.
2. Screen Annotation: this is the annotation and annunciation around the graticule, including any annotation on lines (such as the display line, the threshold line, etc.) This does NOT include the marker number or the N dB result. When off, the graticule expands to fill the entire graticule area.
3. Trace annotation: these are the labels on the traces, showing their detector (or their math mode).
4. Active Function annotation: this is the active function display in the meas bar, and all of the active function values displayed on softkeys.

See the figure below. Each type of annotation can be turned on and off individually.

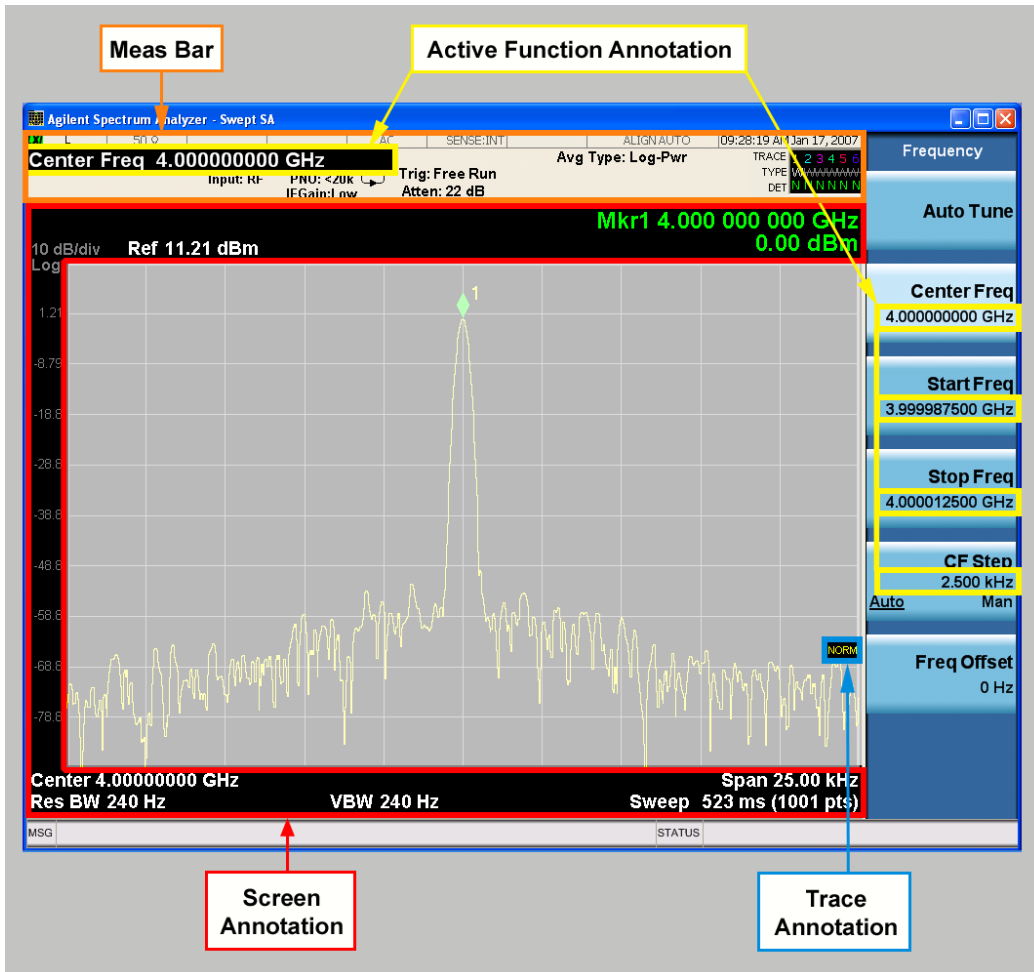

Key Path	View/Display, Display
Initial S/W Revision	Prior to A.02.00

### Meas Bar On/Off

This function turns the Measurement Bar on and off, including the settings panel. When off, the graticule area expands to fill the area formerly occupied by the Measurement Bar.

Key Path	View/Display, Display, Annotation
Remote Command	:DISPlay:ANNotation:MBAR[:STATE] OFF ON 0 1 :DISPlay:ANNotation:MBAR[:STATE]?
Example	DISP:ANN:MBAR OFF
Dependencies	Grayed out and forced to OFF when System Display Settings, Annotation is set to Off.
Preset	On This should remain Off through a Preset when System DisplaySettings, Annotation is set to Off.
State Saved	Saved in instrument state.
Initial S/W Revision	Prior to A.02.00

## Screen

This controls the display of the annunciation and annotation around the graticule, including any annotation on lines (such as the display line, the threshold line, etc.) and the y-axis annotation. This does NOT include marker annotation (or the N dB result). When off, the graticule expands to fill the entire graticule area, leaving only the 1.5% gap above the graticule as described in the Trace/Detector chapter.

<b>Key Path</b>	View/Display, Display, Annotation
<b>Remote Command</b>	:DISPlay:ANNotation:SCReen[:STATe] OFF ON 0 1 :DISPlay:ANNotation:SCReen[:STATe]?
<b>Example</b>	DISP:ANN:SCR OFF
<b>Dependencies</b>	Grayed-out and forced to OFF when System Display Settings, Annotation is set to Off.
<b>Preset</b>	On This should remain Off through a Preset when System DisplaySettings, Annotation is set to Off
<b>State Saved</b>	Saved in instrument state.
<b>Initial S/W Revision</b>	Prior to A.02.00

## Active Function Values On/Off

Turns on and off the active function display in the Meas Bar, and all of the active function values displayed on the softkeys.

Note that all of the softkeys that have active functions have these numeric values blanked when this function is on. This is a security feature..

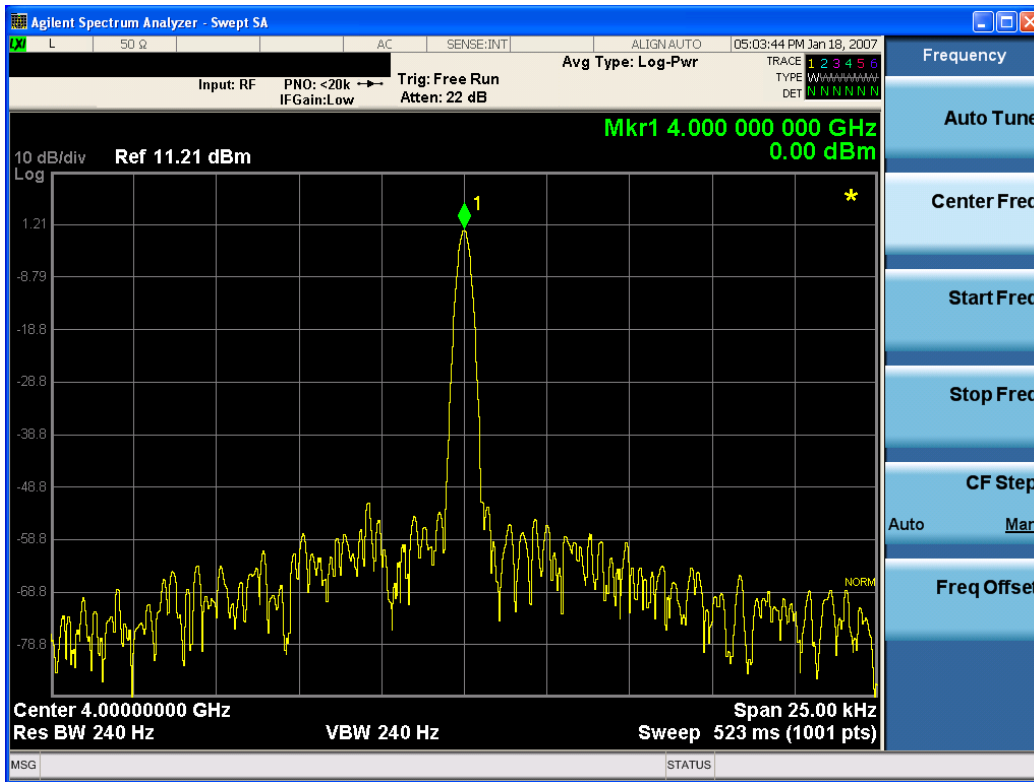

Key Path	View/Display, Display, Annotation
Remote Command	:DISPlay:ACTivefunc[:STATE] ON OFF 1 0 :DISPlay:ACTivefunc[:STATE]?
Example	DISP:ACT OFF
Dependencies	Grayed out and forced to OFF when System Display Settings, Annotation is set to Off.
Preset	On This should remain Off through a Preset when System DisplaySettings, Annotation is set to Off
State Saved	Saved in instrument state.
Initial S/W Revision	Prior to A.02.00

### Title

Displays menu keys that enable you to change or clear a title on your display.

Key Path	View/Display, Display
Initial S/W Revision	Prior to A.02.00

### Change Title

Writes a title into the "measurement name" field in the banner, for example, "Swept SA".

Press Change Title to enter a new title through the alpha editor. Press Enter or Return to complete the entry. Press ESC to cancel the entry and preserve your existing title.

The display title will replace the measurement name. It remains for this measurement until you press Change Title again, or you recall a state, or a Preset is performed. A title can also be cleared by pressing Title, Clear Title.

**NOTE**

Notice the inclusion of the <measurement> parameter in the command below. Because each measurement remembers the Display Title, the command must be qualified with the measurement name. For the Swept SA measurement this is not the case; no <measurement> parameter is used when changing the Display Title for the Swept SA measurement.

Key Path	View/Display, Display, Title
Mode	All
Remote Command	:DISPlay:<measurement>:ANNotation:TITLe:DATA <string> :DISPlay:<measurement>:ANNotation:TITLe:DATA?
Example	DISP:ANN:TITL:DATA "This Is My Title" This example is for the Swept SA measurement in the Spectrum Analyzer mode. The SANalyzer <measurement> name is not used. DISP:ACP:ANN:TITL:DATA "This Is My Title" This example is for Measurements other than Swept SA. Both set the title to: This Is My Title
Notes	Pressing this key cancels any active function. When a title is edited the previous title remains intact (it is not cleared) and the cursor goes at the end so that characters can be added or BKSP can be used to go back over previous characters.
Preset	No title (measurement name instead)
State Saved	Saved in instrument state.
Initial S/W Revision	Prior to A.02.00

### Clear Title

Clears a title from the front-panel display. Once cleared, the title cannot be retrieved. After the title is cleared, the current Measurement Name replaces it in the title bar.

Key Path	View/Display, Display, Title
Example	The following commands clear the title and restore the measurement's original title: DISP:ANN:TITL:DATA "" This example is for the Swept SA measurement in the Spectrum Analyzer mode. The SANalyzer <measurement> name is not used. DISP:ACP:ANN:TITL:DATA "" This example is for ACP; in measurements other than Swept SA the measurement name is required.
Notes	Uses the :DISPlay:<measurement>:ANNotation:TITLe:DATA <string> command with an empty string (in the Swept SA, the <measurement> is omitted).
Preset	Performed on Preset.
Initial S/W Revision	Prior to A.02.00



## Graticule

Pressing Graticule turns the display graticule On or Off. It also turns the graticule y-axis annotation on and off.

Key Path	View/Display, Display
Remote Command	:DISPlay:WINDow[1]:TRACe:GRATicule:GRID[:STATe] OFF ON 0 1 :DISPlay:WINDow[1]:TRACe:GRATicule:GRID[:STATe]?
Example	DISP:WIND:TRAC:GRAT:GRID OFF
Notes	The graticule is the set of horizontal and vertical lines that make up the grid/divisions for the x-axis and y-axis.
Preset	On
State Saved	Saved in instrument state
Initial S/W Revision	Prior to A.02.00

## System Display Settings

These settings are "Mode Global" – they affect all modes and measurements and are reset only by Restore Misc Defaults or Restore System Defaults under System.

Key Path	View/Display, Display
Initial S/W Revision	Prior to A.02.00

## Annotation Local Settings

This is a Mode Global override of the meas local annotation settings. When it is All Off, it forces ScreenAnnotation, Meas Bar, Trace, and Active Function Values settings to be OFF for all measurements in all modes. This provides the security based "annotation off" function of previous analyzers; hence it uses the legacy SCPI command.

When it is All Off, the Screen, Meas Bar, Trace, and Active Function Values keys under the Display, Annotation menu are grayed out and forced to Off. When Local Settings is selected, you are able to set the local annotation settings on a measurement by measurement basis.

Key Path	View/Display, Display, System Display Settings
Remote Command	:DISPlay:WINDow[1]:ANNOtation[:ALL] OFF ON 0 1 :DISPlay:WINDow[1]:ANNOtation[:ALL]?
Example	:DISP:WIND:ANN OFF
Preset	On (Set by Restore Misc Defaults)
State Saved	Not saved in instrument state.
Backwards Compatibility Notes	The WINDow parameter and optional subopcode is included for backwards compatibility but ignored – all windows are equally affected.
Initial S/W Revision	Prior to A.02.00

## Themes

Accesses a menu of functions that enable you to choose the theme to be used when saving the screen image.

The **Themes** option is the same as the **Themes** option under the **Display** and **Page Setup** dialogs. It allows you to choose between themes to be used when saving the screen image.

<b>Key Path</b>	Save, Screen Image
<b>Remote Command</b>	:MMEMory:STORe:SCReen:THEMe TDColor   TDMonochrome   FCOLor   FMONochrome  :MMEMory:STORe:SCReen:THEMe?
<b>Example</b>	:MMEM:STOR:SCR:THEM TDM
<b>Preset</b>	3D Color; Is not part of Preset, but is reset by Restore Misc Defaults or Restore System Defaults All and survives subsequent running of the modes.
<b>Readback</b>	3D Color   3D Mono   Flat Color   Flat Mono
<b>Backwards Compatibility Notes</b>	In ESA and PSA we offer the choice of "Reverse Bitmap" or "Reverse Metafile" when saving screen images. This is much like the "Flat Color" theme available in X-Series. Also, if you selected Reverse Bitmap AND a black & white screen image, that would be much like "Flat Monochrome". In other words, each of the X-Series themes has a similar screen image type in ESA/PSA. But they are not identical.
<b>Initial S/W Revision</b>	Prior to A.02.00

### 3D Color

Selects a standard color theme with each object filled, shaded and colored as designed.

<b>Key Path</b>	Save, Screen Image, Themes
<b>Example</b>	MMEM:STOR:SCR:THEM TDC
<b>Readback</b>	3D Color
<b>Initial S/W Revision</b>	Prior to A.02.00

### 3D Monochrome

Selects a format that is like 3D color but shades of gray are used instead of colors.

<b>Key Path</b>	Save, Screen Image, Themes
<b>Example</b>	MMEM:STOR:SCR:THEM TDM
<b>Readback</b>	3D Mono
<b>Initial S/W Revision</b>	Prior to A.02.00

### Flat Color

Selects a format that is best when the screen is to be printed on an ink printer.

Key Path	Save, Screen Image, Themes
<b>Example</b>	MMEM:STOR:SCR:THEM FCOL
Readback	Flat Color
Initial S/W Revision	Prior to A.02.00

### Flat Monochrome

Selects a format that is like Flat Color. But only black is used (no colors, not even gray), and no fill.

Key Path	Save, Screen Image, Themes
<b>Example</b>	MMEM:STOR:SCR:THEM FMON
Readback	Flat Mono
Initial S/W Revision	Prior to A.02.00

### Backlight

Accesses the display backlight on/off keys. This setting may interact with settings under the Windows "Power" menu.

When the backlight is off, pressing ESC, TAB, SPACE, ENTER, UP, DOWN, LEFT, RIGHT, DEL, BKSP, CTRL, or ALT turns the backlight on without affecting the application. Pressing any other key will turn backlight on and could potentially perform the action as well.

Key Path	View/Display, Display, System Display Settings
<b>Remote Command</b>	:DISPlay:BACKlight ON OFF :DISPlay:BACKlight?
Preset	ON (Set by Restore Misc Defaults)
Initial S/W Revision	Prior to A.02.00

### Backlight Intensity

An active function used to set the backlight intensity. It goes from 0 to 100 where 100 is full on and 0 is off. This value is independent of the values set under the Backlight on/off key.

Key Path	View/Display, Display, System Display Settings
<b>Remote Command</b>	:DISPlay:BACKlight:INTensity <integer> :DISPlay:BACKlight:INTensity?
<b>Example</b>	DISP:BACK:INT 50

Preset	100 (Set by Restore Misc Defaults)
Min	0
Max	100
Initial S/W Revision	Prior to A.02.00

### RF Envelope

This view shows an example of the RF Envelope result for the waveform (time domain) measurements in the graph window. The measured values for the mean power and peak-to-mean power are shown in the text window.

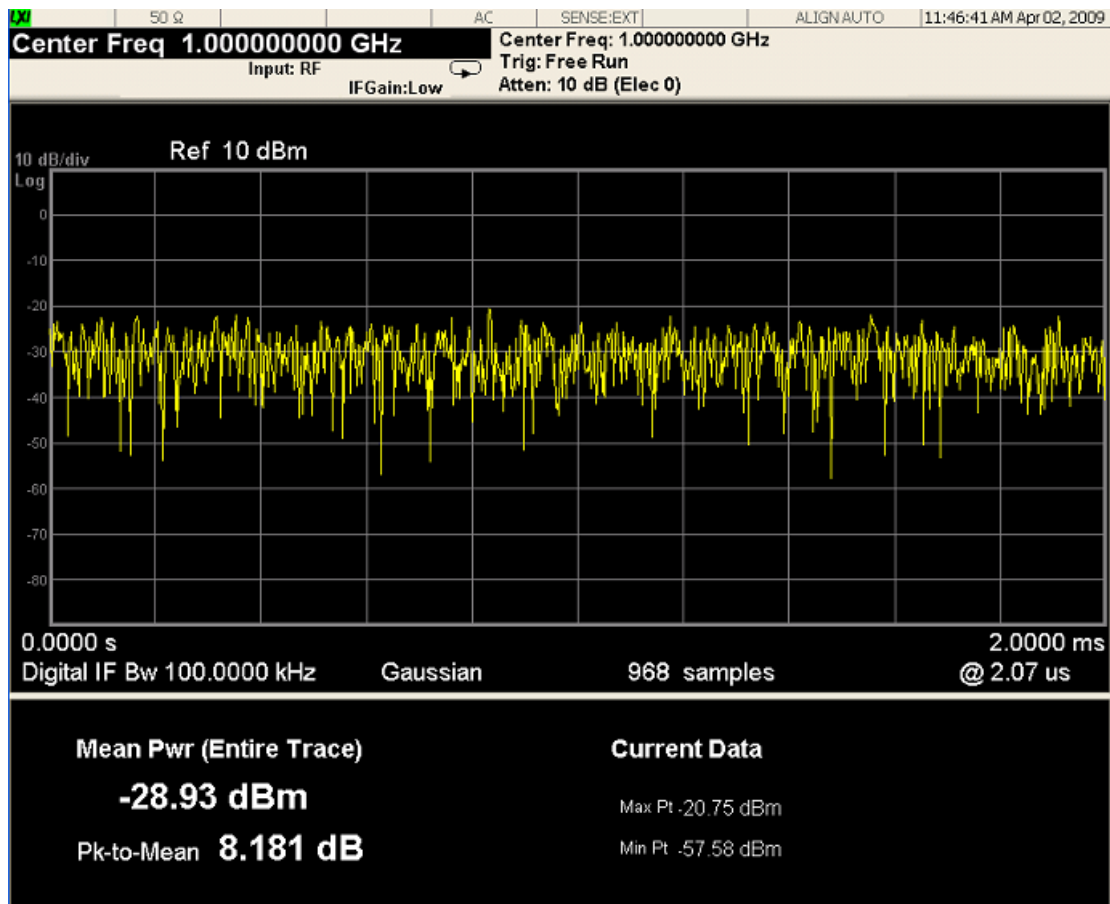

### Numeric Results

Name	Type	Description	Unit	Format
Mean Pwr	Float64	The mean power (dBm). This is either the power across the entire trace, or the power between markers if the markers are enabled.	dBm	XX.XX dBm

Name	Type	Description	Unit	Format
Pk-to-Mean	Float64	This is the ratio of the maximum signal level to the mean power.	dB	XX.XX dB
Max Pt	Float64	The maximum of the most recently acquired data.	dBm	XX.XX dBm
Min Pt	Float64	The minimum of the most recently acquired data.	dBm	XX.XX dBm

Key Path	View/Display
Initial S/W Revision	Prior to A.02.00

### I/Q Waveform

This view shows the I and Q signal waveforms in parameters of voltage versus time.

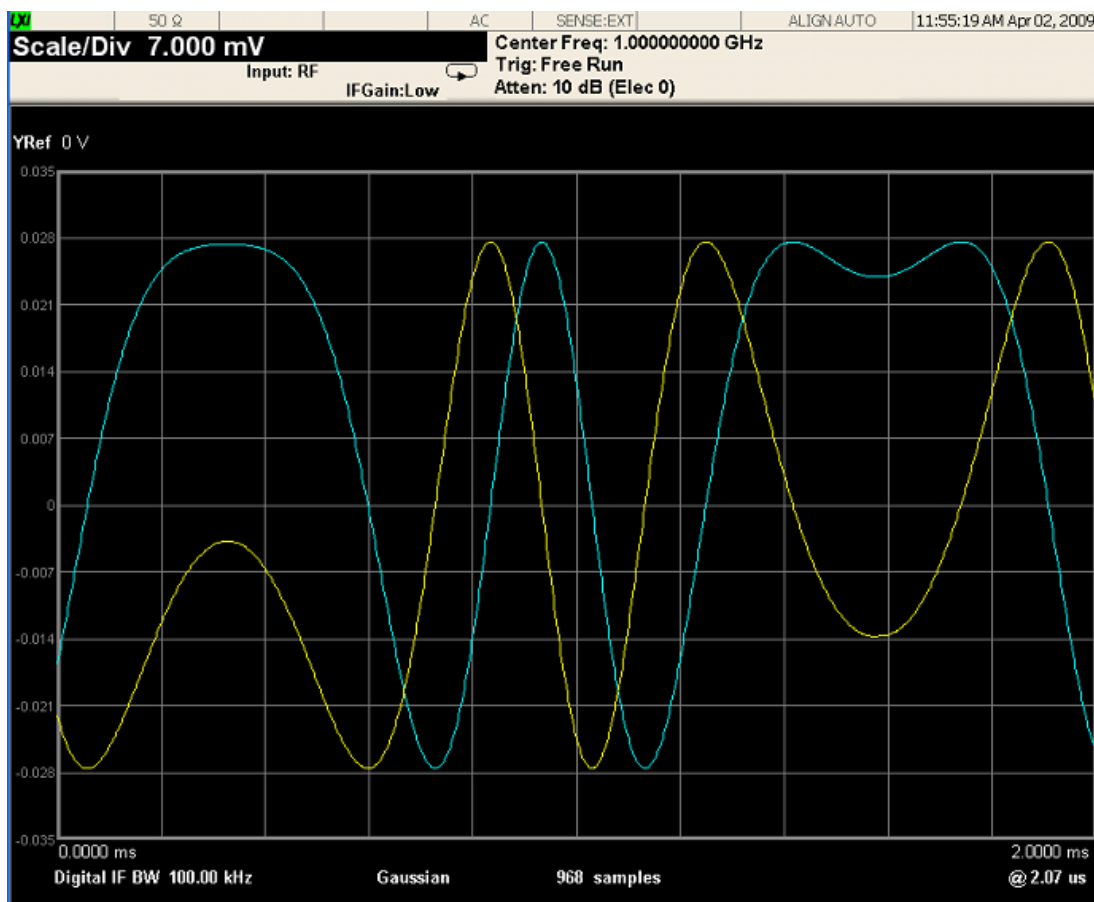

Key Path	View/Display
Initial S/W Revision	Prior to A.02.00

