

Keysight X-Series Signal Analyzer

This manual provides documentation for the following

X-Series Analyzers:

PXA Signal Analyzer N9030A

MXA Signal Analyzer N9020A

EXA Signal Analyzer N9010A

CXA Signal Analyzer N9000A

N9075A & W9075A
802.16 OFDMA
(WiMAX/WiBro)
Measurement
Application User's &
Programmer's
Reference

Notices

© Keysight Technologies, Inc.
2006-2014

No part of this manual may be reproduced in any form or by any means (including electronic storage and retrieval or translation into a foreign language) without prior agreement and written consent from Keysight Technologies, Inc. as governed by United States and international copyright laws.

Acknowledgments

Adobe Acrobat® and Reader® are U.S. registered trademarks of Adobe Systems Incorporated.

Manual Part Number

N9075-90012

Edition

August 2014

Printed in USA

Keysight Technologies, Inc.
1400 Fountaingrove Parkway
Santa Rosa, CA 95403

Warranty

The material contained in this document is provided “as is,” and is subject to being changed, without notice, in future editions. Further, to the maximum extent permitted by applicable law, Keysight disclaims all warranties, either express or implied, with regard to this manual and any information contained herein, including but not limited to the implied warranties of merchantability and fitness for a particular purpose. Keysight shall not be liable for errors or for incidental or consequential

damages in connection with the furnishing, use, or performance of this document or of any information contained herein. Should Keysight and the user have a separate written agreement with warranty terms covering the material in this document that conflict with these terms, the warranty terms in the separate agreement shall control.

Technology Licenses

The hardware and/or software described in this document are furnished under a license and may be used or copied only in accordance with the terms of such license.

Restricted Rights

Legend

If software is for use in the performance of a U.S. Government prime contract or subcontract, Software is delivered and licensed as “Commercial computer software” as defined in DFAR 252.227-7014 (June 1995), or as a “commercial item” as defined in FAR 2.101(a) or as “Restricted computer software” as defined in FAR 52.227-19 (June 1987) or any equivalent agency regulation or contract clause. Use, duplication or disclosure of Software is subject to Keysight Technologies’ standard commercial license terms, and non-DOD Departments and Agencies of the U.S. Government will receive no greater than Restricted Rights as defined in FAR 52.227-19(c)(1-2) (June 1987). U.S. Government users will

receive no greater than Limited Rights as defined in FAR 52.227-14 (June 1987) or DFAR 252.227-7015 (b)(2) (November 1995), as applicable in any technical data.

Safety Notices

CAUTION

A CAUTION notice denotes a hazard. It calls attention to an operating procedure, practice, or the like that, if not correctly performed or adhered to, could result in damage to the product or loss of important data. Do not proceed beyond a CAUTION notice until the indicated conditions are fully understood and met.

WARNING

A WARNING notice denotes a hazard. It calls attention to an operating procedure, practice, or the like that, if not correctly performed or adhered to, could result in personal injury or death. Do not proceed beyond a WARNING notice until the indicated conditions are fully understood and met.

Table of Contents

N9075A & W9075A 802.16 OFDMA (WiMAX/WiBro) Measurement Application User's & Programmer's Reference	i
Table of Contents	iii
1 About the Analyzer	81
Installing Application Software	82
Viewing a License Key	82
Obtaining and Installing a License Key	82
Updating Measurement Application Software	82
X-Series Options and Accessories	84
Front-Panel Features	85
Display Annotations	86
Rear-Panel Features	87
Window Control Keys	88
Multi-Window	88
Zoom	88
Next Window	89
Full Screen	90
Display Enable (Remote Command Only)	90
Mouse and Keyboard Control	92
Right-Click	92
PC Keyboard	94
Instrument Security & Memory Volatility	97
2 About the 802.16 OFDMA Measurement Application	99
3 Programming the Analyzer	101
What Programming Information is Available?	102
List of SCPI Commands	103
STATus Subsystem	143
Detailed Description	145
What Are Status Registers	146
What Are Status Register SCPI Commands	146
How to Use the Status Registers	147
Using a Status Register	148
Using the Service Request (SRQ) Method	149
Generating a Service Request	149
Status Register System	150
The Status Byte Register	151
Standard Event Status Register	153
Operation and Questionable Status Registers	155
Operation Status Register	155
Questionable Status Register	155

STATus Subsystem Command Descriptions	156
Operation Register	156
Operation Condition Query	156
Operation Enable	157
Operation Event Query	157
Operation Negative Transition	157
Operation Positive Transition	158
Preset the Status Byte	158
Questionable Register	159
Questionable Condition	159
Questionable Enable	159
Questionable Event Query	160
Questionable Negative Transition	160
Questionable Positive Transition	160
Questionable Calibration Register	161
Questionable Calibration Condition	161
Questionable Calibration Enable	161
Questionable Calibration Event Query	162
Questionable Calibration Negative Transition	162
Questionable Calibration Positive Transition	163
Questionable Calibration Skipped Register	163
Questionable Calibration Skipped Condition	163
Questionable Calibration Skipped Enable	164
Questionable Calibration Skipped Event Query	164
Questionable Calibration Skipped Negative Transition	165
Questionable Calibration Skipped Positive Transition	165
Questionable Calibration Extended Failure Register	165
Questionable Calibration Extended Failure Condition	166
Questionable Calibration Extended Failure Enable	166
Questionable Calibration Extended Failure Event Query	166
Questionable Calibration Extended Failure Negative Transition	167
Questionable Calibration Extended Failure Positive Transition	167
Questionable Calibration Extended Needed Register	168
Questionable Calibration Extended Needed Condition	168
Questionable Calibration Extended Needed Enable	168
Questionable Calibration Extended Needed Event Query	169
Questionable Calibration Extended Needed Negative Transition	169
Questionable Calibration Extended Needed Positive Transition	170
Questionable Frequency Register	170
Questionable Frequency Condition	170
Questionable Frequency Enable	171
Questionable Frequency Event Query	171
Questionable Frequency Negative Transition	171

Questionable Frequency Positive Transition	172
Questionable Integrity Register	172
Questionable Integrity Condition	172
Questionable Integrity Enable	173
Questionable Integrity Event Query	173
Questionable Integrity Negative Transition	174
Questionable Integrity Positive Transition	174
Questionable Integrity Signal Register	174
Questionable Integrity Signal Condition	175
Questionable Integrity Signal Enable	175
Questionable Integrity Signal Event Query	176
Questionable Integrity Signal Negative Transition	176
Questionable Integrity Signal Positive Transition	176
Questionable Integrity Uncalibrated Register	177
Questionable Integrity Uncalibrated Condition	177
Questionable Integrity Uncalibrated Enable	177
Questionable Integrity Uncalibrated Event Query	178
Questionable Integrity Uncalibrated Negative Transition	178
Questionable Integrity Uncalibrated Positive Transition	179
Questionable Power Register	179
Questionable Power Condition	179
Questionable Power Enable	180
Questionable Power Event Query	180
Questionable Power Negative Transition	181
Questionable Power Positive Transition	181
Questionable Temperature Register	181
Questionable Temperature Condition	182
Questionable Temperature Enable	182
Questionable Temperature Event Query	182
Questionable Temperature Negative Transition	183
Questionable Temperature Positive Transition	183
IEEE 488.2 Common Commands	185
All	185
Clear Status	187
Standard Event Status Enable	187
Standard Event Status Register Query	188
Identification Query	188
Operation Complete	189
Query Instrument Options	190
Recall Instrument State	190
*RST (Remote Command Only)	191
Save Instrument State	191
Service Request Enable	191

Status Byte Query	192
Trigger	192
Self Test Query	192
Wait-to-Continue	193
4 Input/Output Functions	195
Input/Output	196
Input/Output variables - Preset behavior	197
RF Input	198
Input Z Correction	198
RF Coupling	199
External Mixer	200
More Information	201
Ext Mix Setup	203
Mixer Presets	208
Mixer Bias	213
Cable IF Loss	213
I/Q	214
Baseband I/Q (Option BBA)	214
Baseband I/Q Remote Language Compatibility	216
I/Q Path	217
I+jQ	218
I Only	218
Q Only	218
I Setup	219
I Differential Input	219
I Input Z	220
I Skew	220
I Probe	221
Combined Differential/Input Z (Remote Command Only)	223
Q Setup	224
Q Same as I	224
Q Differential Input	224
Q Input Z	225
Q Skew	226
Q Probe	226
Reference Z	228
I/Q Cable Calibrate...	229
I/Q Probe Setup	230
Attenuation	230
Offset	231
Coupling	231
Calibrate	233
Clear Calibration	233

RF Calibrator	233
50 MHz	234
4.8 GHz	235
Off	235
External Gain	235
Ext Preamp	236
More Information	237
MS	237
BTS	238
I Ext Gain	239
Q Ext Gain	240
Restore Input/Output Defaults	240
Corrections	241
Select Correction	242
Correction On/Off	242
Properties	243
Select Correction	243
Antenna Unit	243
Frequency Interpolation	245
Description	247
Comment	248
Edit	248
Navigate	249
Frequency	249
Amplitude	249
Insert Point Below	250
Delete Point	250
Scale X Axis	250
Delete Correction	250
Apply Corrections	251
Delete All Corrections	251
Remote Correction Data Set Commands	251
Set (Replace) Data (Remote Command Only)	252
Merge Correction Data (Remote Command Only)	252
Freq Ref In	253
Sense	254
Internal	255
External	255
Ext Ref Freq	255
External Reference Lock BW	256
External Ref Coupling	257
Output Config	259
Trig Out	259

Polarity	259
Off	260
Sweeping (HSWP)	260
Measuring	260
Main Trigger	260
Gate Trigger	261
Gate	261
Source Point Trigger	261
Odd/Even Trace Point	262
Analog Out	262
More Information	262
Auto	263
Off	263
Screen Video	263
Log Video (RF Envelope, Ref=Mixer Level)	264
Linear Video (RF Envelope, Ref=Ref Level)	265
Demod Audio	266
Digital Bus	266
Bus Out On/Off	267
I/Q Cal Out	267
1 kHz Square Wave	268
250 kHz Square Wave	268
Off	268
Aux IF Out	268
Off	269
Second IF	269
Arbitrary IF	270
Fast Log Video	270
I/Q Guided Calibration	271
I/Q Isolation Calibration	271
Next	271
Exit	271
I/Q Isolation Calibration Time (Remote Command Only)	272
I/Q Cable Calibrate...	272
I Port	273
I-bar Port	274
Q Port	275
Q-bar Port	276
I/Q Cable Calibration Time (Remote Command Only)	277
I/Q Probe Calibration	277
I Port	278
I-bar Port	279
Q Port	280

Q-bar Port	281
Show Adapter Screen	282
I/Q Probe Calibration Time (Remote Command Only)	283
Exit Confirmation	283
5 Mode Functions	285
Mode	286
More Information	287
Spectrum Analyzer	288
DVB-T/H with T2	289
cdma2000	289
Vector Signal Analyzer (VXA)	289
Analog Demod	290
Phase Noise	290
CMMB	290
Combined WLAN	291
TD-SCDMA with HSPA/8PSK	291
IQ Analyzer (Basic)	291
W-CDMA with HSPA+	292
GSM/EDGE/EDGE Evo	292
Noise Figure	292
WLAN	292
EMI Receiver	293
802.16 OFDM (Fixed WiMAX)	293
DTMB (CTTB)	293
1xEV-DO	294
802.16 OFDMA (WiMAX/WiBro)	294
89601 VSA	294
MSR	295
Bluetooth	296
LTE	296
SCPI Language Compatibility	296
Combined Fixed WiMAX	297
ISDB-T	297
Digital Cable TV	297
LTE TDD	297
Remote Language Compatibility	298
iDEN/WiDEN/MOTOTalk	298
Application Mode Number Selection (Remote Command Only)	298
Application Mode Catalog Query (Remote Command Only)	300
Application Identification (Remote Commands Only)	300
Current Application Model	301
Current Application Revision	301
Current Application Options	301

Application Identification Catalog (Remote Commands Only)	302
Application Catalog Number of Entries	302
Application Catalog Model Numbers	302
Application Catalog Revision	302
Application Catalog Options	303
Detailed List of Modes	303
1xEV-DO	303
802.16 OFDMA (WiMAX/WiBro)	304
802.16 OFDM (Fixed WiMAX)	304
89601 VSA	304
Analog Demod	305
Bluetooth	305
cdma2000	306
CMMB	306
Combined WLAN	306
Combined Fixed WiMAX	307
Digital Cable TV	307
DTMB (CTTB)	307
DVB-T/H with T2	308
EMI Receiver	308
GSM/EDGE/EDGE Evo	308
iDEN/WiDEN/MOTOTalk	309
IQ Analyzer (Basic)	309
ISDB-T	309
LTE	309
LTE TDD	310
MSR	310
Noise Figure	310
Phase Noise	311
Remote Language Compatibility	311
SCPI Language Compatibility	311
Spectrum Analyzer	312
TD-SCDMA with HSPA/8PSK	312
Vector Signal Analyzer (VXA)	312
W-CDMA with HSPA+	313
WLAN	313
Global Settings	314
Global Center Freq	314
Restore Defaults	315
Mode Setup	316
Radio Device	316
Radio Standard	316
802.16e-2005 mode	317

FFT Size	317
BW Ratio	318
Guard Interval	318
Frame Duration	319
Downlink Ratio	319
WiBro mode	320
FFT Size	320
BW Ratio	320
Guard Interval	321
Frame Duration	321
Downlink Ratio	322
Preset Profile	323
802.16e–2005 mode	323
WiBro mode	323
Noise Reduction	323
Noise Floor Extension	324
More Information	324
Restore Mode Defaults	326
Global Settings	326
Global Center Freq	326
Restore Defaults	327
SCPI Only Commands	327
Nominal Bandwidth	327
BW Ratio – Fractional Number	328
Guard Interval – Fractional Number	329
Zone Map Data	329
Key Definition	330
Summary of Key Types	331
6 System Functions	335
File	336
File Explorer	336
Page Setup	337
Print	338
Restore Down	338
Minimize	338
Exit	339
Print	339
Maximize/Restore Down	339
Maximize	339
Restore Down	340
Print	341
System	342
Show	342

Errors	342
Previous Page	343
Next Page	344
History	344
Verbose SCPI On/Off	344
Refresh	345
Clear Error Queue	345
Input Overload Enable (Remote Command Only)	345
System	346
Show System contents (Remote Command Only)	347
Computer System description (Remote Command Only)	347
Hardware	347
LXI	348
Power On	348
Mode and Input/Output Defaults	349
User Preset	349
Last State	350
Power On Application	350
Configure Applications	351
Preloading Applications	352
Access to Configure Applications utility	352
Virtual memory usage	352
Select All	353
Deselect All	353
Move Up	353
Move Down	353
Select/Deselect	353
Save Changes and Exit	354
Exit Without Saving	354
Restore Power On Defaults	354
Configure Applications - Instrument boot-up	355
Configure Applications - Windows desktop	355
Configure Applications - Remote Commands	355
Configuration list (Remote Command Only)	356
Configuration Memory Available (Remote Command Only)	356
Configuration Memory Total (Remote Command Only)	356
Configuration Memory Used (Remote Command Only)	356
Configuration Application Memory (Remote Command Only)	357
Alignments	357
Auto Align	357
Normal	358
Partial	359
Off	359

All but RF	360
Alert	360
Execute Expired Alignments (Remote Command Only)	363
Align Now	364
All	364
All but RF	366
RF	367
External Mixer	368
Show Alignment Statistics	369
Restore Align Defaults	374
Backup or Restore Align Data...	374
Alignment Data Wizard	375
Perform Backup (Remote Command Only)	380
Perform Restore (Remote Command Only)	381
Advanced	381
Characterize Preselector	381
Characterize Reference Clock	382
Timebase DAC	385
Calibrated	386
User	386
I/O Config	387
GPIB	387
GPIB Address	387
GPIB Controller	388
SCPI LAN	389
SCPI Telnet	389
SCPI Socket	389
SICL Server	390
HiSLIP Server	391
SCPI Socket Control Port (Remote Command Only)	391
Reset Web Password	392
LXI	392
LAN Reset	392
Device Identification (Remote Command Only)	393
System IDN Response	393
Factory	393
User	394
Query USB Connection (Remote Command Only)	394
USB Connection Status (Remote Command Only)	394
USB Packet Count (Remote Command Only)	395
Restore Defaults	395
Restore Input/Output Defaults	396
Restore Power On Defaults	396

Restore Align Defaults	397
Restore Misc Defaults	397
Restore Mode Defaults (All Modes)	398
All	399
Control Panel...	400
Licensing...	401
Security	403
USB	403
Read-Write	403
Read only	404
Diagnostics	404
Show Hardware Statistics	404
SCPI for Show Hardware Statistics (Remote Commands Only)	405
Internet Explorer...	407
System Remote Commands (Remote Commands Only)	407
System Powerdown (Remote Command Only)	407
List installed Options (Remote Command Only)	408
Lock the Front-panel keys (Remote Command Only)	408
List SCPI Commands (Remote Command Only)	408
SCPI Version Query (Remote Command Only)	409
Date (Remote Command Only)	409
Time (Remote Command Only)	409
7 Trigger Functions	411
Trigger	412
Trigger Source Presets	413
RF Trigger Source	416
I/Q Trigger Source	417
More Information	418
Free Run	419
Video (IF Envelope)	420
Trigger Level	420
Trig Slope	421
Trig Delay	422
Line	423
Trig Slope	424
Trig Delay	424
External 1	425
Trigger Level	425
Trig Slope	426
Trig Delay	427
External 2	427
Trigger Level	428
Trig Slope	428

Trig Delay	429
RF Burst	430
Absolute Trigger Level	430
Relative Trigger Level	431
Trigger Slope	432
Trig Delay	433
Periodic Timer (Frame Trigger)	434
Period	435
Offset	436
Reset Offset Display	437
Sync Source	437
Off	438
External 1	438
External 2	439
RF Burst	441
Trig Delay	443
Auto/Holdoff	444
Auto Trig	444
Trig Holdoff	445
8 Channel Power Measurement	447
AMPTD Y Scale	456
Ref Value	456
Attenuation	456
Dual Attenuator Configurations:	457
Single Attenuator Configuration:	458
(Mech) Atten	458
Attenuator Configurations and Auto/Man	460
Enable Elec Atten	460
More Information	461
Mechanical Attenuator Transition Rules	461
When the Electronic Attenuation is enabled from a disabled state:	461
Examples in the dual attenuator configuration:	461
When the Electronic Attenuation is disabled from an enabled state:	462
Using the Electronic Attenuator: Pros and Cons	462
Elec Atten	462
Adjust Atten for Min Clip	463
Pre-Adjust for Min Clip	463
Off	464
Elec Atten Only	464
Mech + Elec Atten	465
(Mech) Atten Step	465
Scale/Div	466
Presel Center	466

Proper Preselector Operation	467
Preselector Adjust	467
μ W Path Control	469
Standard Path	470
Low Noise Path Enable	470
More Information	471
μ W Preselector Bypass	472
Internal Preamp	473
Off	474
Low Band	475
Full Range	475
Ref Position	475
Auto Scaling	476
Auto Couple	477
More Information	477
Auto/Man Active Function keys	477
Auto/Man 1-of-N keys	477
BW	479
Res BW	479
Video BW	480
Filter Type	482
Cont (Continuous Measurement/Sweep)	483
File	485
FREQ Channel	486
Center Freq	486
Center Frequency Presets	487
RF Center Freq	489
Ext Mix Center Freq	490
I/Q Center Freq	491
Input/Output	492
Marker	493
Select Marker	493
Marker Type	493
Properties	494
Select Marker	494
Relative To	494
All Markers Off	494
Marker X Axis Value (Remote Command Only)	495
Marker X Axis Position (Remote Command Only)	495
Marker Y Axis Value (Remote Command only)	496
Backward Compatibility SCPI Commands	496
Marker Function	498
Marker To	499

Meas	500
Remote Measurement Functions	500
Measurement Group of Commands	501
Current Measurement Query (Remote Command Only)	503
Limit Test Current Results (Remote Command Only)	503
Data Query (Remote Command Only)	503
Calculate/Compress Trace Data Query (Remote Command Only)	504
Calculate Peaks of Trace Data (Remote Command Only)	509
Format Data: Numeric Data (Remote Command Only)	510
Format Data: Byte Order (Remote Command Only)	511
Meas Setup	512
Avg/Hold Num	512
Avg Mode	513
Integ BW	514
PhNoise Opt	515
PhNoise Opt Auto	515
PhNoise Opt State	515
IF Gain	516
IF Gain Auto	517
IF Gain State	517
Method	518
Method	519
Filter Alpha	519
Filter BW	520
Limits	521
Power Limit	521
PSD Limit	522
Power Limit Fail (remote command only)	523
PSD Limit Fail (remote command only)	524
Meas Preset	524
PSD Unit	524
Mode	526
Mode Preset	527
How-To Preset	528
Preset Type (Remote Command Only)	529
Mode Setup	530
Peak Search	531
Print	532
Quick Save	533
Recall	535
State	535
More Information	537
From File...	537

Edit Register Names	539
Register 1 thru Register 16	539
Register 1 thru Register 16	540
Data (Import)	541
Mask	542
File location and extension	542
Example of Preset Mask file	543
Zone Map	543
Open...	544
Restart	545
More Information	545
Save	547
State	547
To File . . .	548
Edit Register Names	550
More Information	550
Register 1 thru Register 16	551
Register 1 thru Register 16	551
Data (Export)	552
Measurement Results	553
Zone Map	555
Zone Map File Contents	556
Save As . . .	558
Screen Image	558
Themes	560
3D Color	560
3D Monochrome	560
Flat Color	561
Flat Monochrome	561
Save As...	561
Mass Storage Catalog (Remote Command Only)	561
Mass Storage Change Directory (Remote Command Only)	562
Mass Storage Copy (Remote Command Only)	562
Mass Storage Device Copy (Remote Command Only)	563
Mass Storage Delete (Remote Command Only)	563
Mass Storage Data (Remote Command Only)	563
Mass Storage Make Directory (Remote Command Only)	563
Mass Storage Move (Remote Command Only)	564
Mass Storage Remove Directory (Remote Command Only)	564
Single (Single Measurement/Sweep)	565
More Information	565
Source	566
Span X Scale	567

Span	567
Full Span	568
Last Span	569
Sweep/Control	570
Sweep Time	570
Sweep Setup	571
Auto Sweep Time Rules	571
Pause	572
Gate	572
Gate On/Off	572
Gate View On/Off	573
Gate View Setup	576
Gate View Sweep Time	577
Gate View Start Time	577
Gate Delay	578
Gate Length	578
Gate Source	579
Line	580
External 1	580
External 2	582
RF Burst	584
Periodic Timer (Frame Trigger)	587
Control Edge/Level	598
Gate Holdoff	598
Gate Delay Compensation	600
More Information	601
Min Fast Position Query (Remote Command Only)	601
Gate Preset (Remote Command Only)	602
Gate Level (Remote Command Only)	602
Gate Polarity (Remote Command Only)	602
Points	603
System	605
Trace/Detector	606
Trace Type	606
Detector	606
Auto	607
Detector Selection	607
Trigger	609
Free Run	609
Video	609
Trigger Level	609
Trig Slope	609
Trig Delay	609

Line	609
Trig Slope	609
Trig Delay	609
External 1	609
Trigger Level	609
Trig Slope	609
Trig Delay	609
External 2	609
Trigger Level	610
Trig Slope	610
Trig Delay	610
RF Burst	610
Absolute Trigger	610
Relative Trigger	610
Trig Slope	610
Trig Delay	610
Periodic Timer	610
Period	610
Offset	610
Reset Offset Display	610
Sync Source	610
Off	610
External 1	611
External 2	611
RF Burst	611
Trig Delay	611
Auto/Holdoff	611
Auto Trig	611
Trig Holdoff	611
User Preset	612
User Preset	612
User Preset All Modes	613
Save User Preset	614
View/Display	615
View selection by name (MSR and LTE-Advanced FDD/TDD only)	617
Selects the results view. The following SCPI command allows you to select the desired measurement view by enumeration.	617
Selects the results view. The following SCPI command allows you to select the desired measurement view by enumeration.	618
View selection by name (DTMB (CTTB), DVB-T/H only)	618
View selection by name (ISDB-T, CMMB only)	619
Display	619
Annotation	619

Meas Bar On/Off	620
Screen	621
Active Function Values On/Off	621
Title	622
Change Title	622
Clear Title	623
Graticule	624
System Display Settings	624
Annotation Local Settings	624
Themes	625
Backlight	626
Backlight Intensity	626
Bar Graph	627
9 ACP Measurement	629
AMPTD Y Scale	641
Ref Value	641
Attenuation	641
Dual Attenuator Configurations:	642
Single Attenuator Configuration:	643
(Mech) Atten	643
Attenuator Configurations and Auto/Man	645
Enable Elec Atten	645
More Information	646
Mechanical Attenuator Transition Rules	646
When the Electronic Attenuation is enabled from a disabled state:	646
Examples in the dual attenuator configuration:	646
When the Electronic Attenuation is disabled from an enabled state:	647
Using the Electronic Attenuator: Pros and Cons	647
Elec Atten	647
Adjust Atten for Min Clip	648
Pre-Adjust for Min Clip	648
Off	649
Elec Atten Only	649
Mech + Elec Atten	650
(Mech) Atten Step	650
Scale/Div	651
Presel Center	651
Proper Preselector Operation	652
Preselector Adjust	652
μ W Path Control	654
Standard Path	655
Low Noise Path Enable	655
More Information	656

μW Preselector Bypass	657
Internal Preamp	658
Off	659
Low Band	660
Full Range	660
Ref Position	660
Auto Scaling	661
Auto Couple	662
More Information	662
Auto/Man Active Function keys	662
Auto/Man 1-of-N keys	662
BW	664
Res BW	664
Video BW	665
RBW Control	667
Filter Type	667
Filter BW	668
Cont (Continuous Measurement/Sweep)	669
File	671
FREQ Channel	672
Center Freq	672
Center Frequency Presets	673
RF Center Freq	675
Ext Mix Center Freq	676
I/Q Center Freq	677
Input/Output	678
Marker	679
Select Marker	679
Marker Type	679
Properties	680
Select Marker	680
Relative To	680
Marker Trace	681
Couple Markers	682
Marker All Off	682
Marker X Axis Value (Remote Command only)	682
Marker X Axis Position (Remote Command only)	683
Marker Y Axis Value (Remote Command only)	684
Backward Compatibility Remote Commands	684
Marker Function	685
Marker To	686
Meas	687
Remote Measurement Functions	687

Measurement Group of Commands	688
Current Measurement Query (Remote Command Only)	690
Limit Test Current Results (Remote Command Only)	690
Data Query (Remote Command Only)	690
Calculate/Compress Trace Data Query (Remote Command Only)	691
Calculate Peaks of Trace Data (Remote Command Only)	696
Format Data: Numeric Data (Remote Command Only)	697
Format Data: Byte Order (Remote Command Only)	698
Meas Setup	699
Average/Hold Number	699
Avg Mode	700
Carrier Setup (This menu is unavailable in MSR and LTE-Advanced FDD/TDD)	700
Carriers	700
Ref Carrier	701
Ref Car Freq	702
Power Ref	703
Total Power	703
PSD	704
Configure Carriers	705
Carrier	705
Carrier Pwr Present	706
Carrier Spacing	707
Measurement Noise Bandwidth	708
Method for Carrier	709
Offset/Limits	711
Select Offset	711
Offset Freq	711
Integ BW	713
Offset BW	715
Res BW	715
Video BW	716
RBW Control	718
Limits	719
Select Offset	719
Abs Limit	720
Rel Lim (Car)	721
Rel Limit (PSD)	724
Fail Mask	725
Offset Side	726
Method for Offset	727
Method for Offset	728
Offset Frequency Define	730
Carrier Result	731

Table of Contents

Meas Method	731
Meas Type	733
PSD Ref	733
Limit Test	734
Noise Correction	735
Meas Preset	735
Offset RRC Weighting (Backward Compatibility SCPI)	736
Offset Filter Alpha (Backward Compatibility SCPI)	737
Method for Carrier (Backward Compatibility SCPI)	738
Mode	739
Mode Preset	740
How-To Preset	741
Preset Type (Remote Command Only)	742
Mode Setup	743
Peak Search	744
Next Peak	744
Next Pk Right	744
Next Pk Left	745
Marker Delta	745
Pk-Pk Search	745
Min Search	745
Print	747
Quick Save	748
Recall	750
State	750
More Information	752
From File...	752
Edit Register Names	754
Register 1 thru Register 16	754
Register 1 thru Register 16	755
Data (Import)	756
Mask	757
File location and extension	757
Example of Preset Mask file	758
Zone Map	758
Open...	759
Restart	760
More Information	760
Save	762
State	762
To File . . .	763
Edit Register Names	765
More Information	765

Register 1 thru Register 16	766
Register 1 thru Register 16	766
Data (Export)	767
Measurement Results	768
Zone Map	776
Zone Map File Contents	776
Save As . . .	778
Screen Image	779
Themes	780
3D Color	780
3D Monochrome	781
Flat Color	781
Flat Monochrome	781
Save As...	781
Mass Storage Catalog (Remote Command Only)	782
Mass Storage Change Directory (Remote Command Only)	782
Mass Storage Copy (Remote Command Only)	783
Mass Storage Device Copy (Remote Command Only)	783
Mass Storage Delete (Remote Command Only)	783
Mass Storage Data (Remote Command Only)	783
Mass Storage Make Directory (Remote Command Only)	784
Mass Storage Move (Remote Command Only)	784
Mass Storage Remove Directory (Remote Command Only)	785
Single (Single Measurement/Sweep)	786
More Information	786
Source	787
SPAN X Scale	788
Span	788
Full Span	789
Last Span	789
Sweep/Control	791
Sweep Time	791
Sweep Setup	792
Auto Sweep Time Rules	793
Pause	793
Gate	793
Gate On/Off	794
Gate View On/Off	795
Gate View Setup	798
Gate View Sweep Time	798
Gate View Start Time	799
Gate Delay	799
Gate Length	800

Gate Source	800
Line	801
External 1	802
External 2	804
RF Burst	805
Periodic Timer (Frame Trigger)	808
Control Edge/Level	819
Gate Holdoff	820
Gate Delay Compensation	821
More Information	822
Min Fast Position Query (Remote Command Only)	823
Gate Preset (Remote Command Only)	823
Gate Level (Remote Command Only)	823
Gate Polarity (Remote Command Only)	823
Points	824
System	826
Trace/Detector	827
Select Trace (Front-panel Only)	827
Trace Type	827
View/Blank	828
Detector	829
Auto	830
Detector Selection	830
Trigger	832
Free Run	832
Video	832
Trigger Level	832
Trig Slope	832
Trig Delay	832
Line	832
Trig Slope	832
Trig Delay	832
External 1	832
Trigger Level	832
Trig Slope	832
Trig Delay	832
External 2	832
Trigger Level	833
Trig Slope	833
Trig Delay	833
RF Burst	833
Absolute Trigger	833
Relative Trigger	833

Trig Slope	833
Trig Delay	833
Periodic Timer	833
Period	833
Offset	833
Reset Offset Display	833
Sync Source	833
Off	833
External 1	834
External 2	834
RF Burst	834
Trig Delay	834
Auto/Holdoff	834
Auto Trig	834
Trig Holdoff	834
User Preset	835
User Preset	835
User Preset All Modes	836
Save User Preset	837
View/Display	838
Spectrum Window	840
Results Window	840
Display	843
Annotation	843
Meas Bar On/Off	844
Screen	845
Active Function Values On/Off	845
Title	846
Change Title	846
Clear Title	847
Graticule	848
System Display Settings	848
Annotation Local Settings	848
Themes	849
Backlight	850
Backlight Intensity	850
Bar Graph	851
10 Spectrum Emission Mask Measurement	853
AMPTD Y Scale	876
Ref Value	876
Attenuation	876
Dual Attenuator Configurations:	877
Single Attenuator Configuration:	878

(Mech) Atten	878
Attenuator Configurations and Auto/Man	880
Enable Elec Atten	880
More Information	881
Mechanical Attenuator Transition Rules	881
When the Electronic Attenuation is enabled from a disabled state:	881
Examples in the dual attenuator configuration:	881
When the Electronic Attenuation is disabled from an enabled state:	882
Using the Electronic Attenuator: Pros and Cons	882
Elec Atten	882
Adjust Atten for Min Clip	883
Pre-Adjust for Min Clip	883
Off	884
Elec Atten Only	884
Mech + Elec Atten	885
(Mech) Atten Step	885
Scale/Div	886
Presel Center	886
Proper Preselector Operation	887
Preselector Adjust	887
μ W Path Control	889
Standard Path	890
Low Noise Path Enable	890
More Information	891
μ W Preselector Bypass	892
Internal Preamp	893
Off	894
Low Band	895
Full Range	895
Ref Position	895
Auto Scaling	896
Auto Couple	897
More Information	897
Auto/Man Active Function keys	897
Auto/Man 1-of-N keys	897
BW	899
Filter Type	899
Cont (Continuous Measurement/Sweep)	900
File	902
FREQ Channel	903
Center Freq	903
Center Frequency Presets	904
RF Center Freq	906

Ext Mix Center Freq	907
I/Q Center Freq	908
Input/Output	909
Marker	910
Select Marker	910
Marker Type	910
Couple Markers	911
All Markers Off	911
Marker X Axis Value (Remote Command Only)	911
Marker X Axis Position (Remote Command Only)	912
Marker Y Axis Value (Remote Command Only)	913
Marker Function	914
Marker To	915
Meas	916
Remote Measurement Functions	916
Measurement Group of Commands	917
Current Measurement Query (Remote Command Only)	919
Limit Test Current Results (Remote Command Only)	919
Data Query (Remote Command Only)	919
Calculate/Compress Trace Data Query (Remote Command Only)	920
Calculate Peaks of Trace Data (Remote Command Only)	925
Format Data: Numeric Data (Remote Command Only)	926
Format Data: Byte Order (Remote Command Only)	927
Meas Setup	928
Avg/Hold Num	928
Meas Type	928
Ref Channel	929
Integ BW	929
Span	930
Sweep Time	932
Res BW	932
Video BW	934
VBW/RBW	935
Power Ref (for the modes except MSR and LTE-Advanced FDD/TDD)	936
Total Power	936
PSD	937
Spectrum Peak	938
Offset/Limits	939
Select Offset	939
Start Freq	939
Stop Freq	942
Sweep Time	944
Offset Side	945

Table of Contents

Res BW	946
Meas BW	948
Video BW	949
VBW/RBW	950
Limits	952
Select Offset	952
Abs Start	952
Abs Stop	954
Rel Start	957
Rel Stop	959
Fail Mask	961
Offset Freq Define	963
Method	965
Filter Alpha	966
Meas Preset	966
Mode	968
Mode Preset	969
How-To Preset	970
Preset Type (Remote Command Only)	971
Mode Setup	972
Peak Search	973
Print	974
Quick Save	975
Recall	977
State	977
More Information	979
From File...	979
Edit Register Names	981
Register 1 thru Register 16	981
Register 1 thru Register 16	982
Data (Import)	983
Mask	984
File location and extension	984
Example of Preset Mask file	985
Zone Map	985
Open...	986
Restart	987
More Information	987
Save	989
State	989
To File . . .	990
Edit Register Names	992
More Information	992

Register 1 thru Register 16	993
Register 1 thru Register 16	993
Data (Export)	994
Measurement Results	995
Meas Results File Contents	995
Zone Map	1004
Zone Map File Contents	1005
Save As . . .	1007
Screen Image	1008
Themes	1009
3D Color	1009
3D Monochrome	1009
Flat Color	1010
Flat Monochrome	1010
Save As...	1010
Mass Storage Catalog (Remote Command Only)	1011
Mass Storage Change Directory (Remote Command Only)	1011
Mass Storage Copy (Remote Command Only)	1011
Mass Storage Device Copy (Remote Command Only)	1012
Mass Storage Delete (Remote Command Only)	1012
Mass Storage Data (Remote Command Only)	1012
Mass Storage Make Directory (Remote Command Only)	1013
Mass Storage Move (Remote Command Only)	1013
Mass Storage Remove Directory (Remote Command Only)	1013
Single (Single Measurement/Sweep)	1014
More Information	1014
Source	1015
Span X Scale	1016
Ref Value	1016
Scale/Div	1016
Ref Position	1017
Auto Scaling	1017
Sweep/Control	1019
Pause	1019
Gate	1019
Gate On/Off	1019
Gate View On/Off	1020
Gate View Setup	1023
Gate View Sweep Time	1024
Gate View Start Time	1024
Gate Delay	1025
Gate Length	1025
Gate Source	1026

Table of Contents

Line	1027
External 1	1027
External 2	1029
RF Burst	1031
Periodic Timer (Frame Trigger)	1034
Control Edge/Level	1045
Gate Holdoff	1045
Gate Delay Compensation	1047
More Information	1048
Min Fast Position Query (Remote Command Only)	1048
Gate Preset (Remote Command Only)	1049
Gate Level (Remote Command Only)	1049
Gate Polarity (Remote Command Only)	1049
System	1051
Trace/Detector	1052
Trace Type	1052
Chan Detector	1052
Chan Detector Auto	1053
Chan Detector Selection	1053
Offset Detector	1054
Offset Detector Auto	1054
Offset Detector Selection	1055
Trigger	1056
Free Run	1056
Video	1056
Trigger Level	1056
Trig Slope	1056
Trig Delay	1056
Line	1056
Trig Slope	1056
Trig Delay	1056
External 1	1056
Trigger Level	1056
Trig Slope	1056
Trig Delay	1056
External 2	1056
Trigger Level	1057
Trig Slope	1057
Trig Delay	1057
RF Burst	1057
Absolute Trigger	1057
Relative Trigger	1057
Trig Slope	1057

Trig Delay	1057
Periodic Timer	1057
Period	1057
Offset	1057
Reset Offset Display	1057
Sync Source	1057
Off	1057
External 1	1058
External 2	1058
RF Burst	1058
Trig Delay	1058
Auto/Holdoff	1058
Auto Trig	1058
Trig Holdoff	1058
User Preset	1059
User Preset	1059
User Preset All Modes	1060
Save User Preset	1061
View/Display	1062
View Selection by Name (Remote Command Only)	1062
Views Selection by Number (Remote Command only)	1063
Display	1063
Annotation	1064
Meas Bar On/Off	1065
Screen	1066
Active Function Values On/Off	1066
Title	1067
Change Title	1067
Clear Title	1068
Graticule	1069
System Display Settings	1069
Annotation Local Settings	1069
Themes	1070
Backlight	1071
Backlight Intensity	1071
Abs Pwr Freq	1072
Abs Peak Pwr & Freq (Total Pwr Ref)	1072
Trace Window	1074
Results Window	1074
Abs Peak Pwr & Freq (PSD Ref)	1074
Trace Window	1076
Results Window	1076
Abs Peak Pwr & Freq (Spectrum Pk Ref)	1076

Trace Window	1078
Results Window	1078
Rel Pwr Freq	1078
Rel Peak Pwr & Freq (Total Pwr Ref)	1078
Trace Window	1079
Results Window	1079
Rel Peak Pwr & Freq (PSD Ref)	1080
Trace Window	1080
Results Window	1081
Rel Peak Pwr & Freq (Spectrum Pk Ref)	1081
Trace Window	1082
Results Window	1082
Integrated Power	1083
Integrated Power (Total Pwr Ref)	1083
Trace Window	1085
Results Window	1085
Integrated Power (PSD Ref)	1086
Trace Window	1088
Results Window	1088
Integrated Power (Spectrum Pk Ref)	1089
Trace Window	1090
Results Window	1090
Limit Lines	1091
11 Spurious Emissions Measurement	1093
AMPTD Y Scale	1096
Ref Value	1096
Attenuation	1096
Dual Attenuator Configurations:	1097
Single Attenuator Configuration:	1098
(Mech) Atten	1098
Attenuator Configurations and Auto/Man	1100
Enable Elec Atten	1100
More Information	1101
Mechanical Attenuator Transition Rules	1101
When the Electronic Attenuation is enabled from a disabled state:	1101
Examples in the dual attenuator configuration:	1101
When the Electronic Attenuation is disabled from an enabled state:	1102
Using the Electronic Attenuator: Pros and Cons	1102
Elec Atten	1102
Adjust Atten for Min Clip	1103
Pre-Adjust for Min Clip	1103
Off	1104
Elec Atten Only	1104

Mech + Elec Atten	1105
(Mech) Atten Step	1105
Scale/Div	1106
Presel Center	1106
Proper Preselector Operation	1107
Preselector Adjust	1108
μ W Path Control	1109
Standard Path	1110
Low Noise Path Enable	1110
More Information	1111
μ W Preselector Bypass	1112
Internal Preamp	1113
Off	1114
Low Band	1115
Full Range	1115
Auto Scaling	1115
Auto Couple	1117
More Information	1117
Auto/Man Active Function keys	1117
Auto/Man 1-of-N keys	1117
BW	1119
Cont (Continuous Measurement/Sweep)	1120
File	1122
FREQ Channel	1123
Center Freq	1123
Center Frequency Presets	1124
RF Center Freq	1126
Ext Mix Center Freq	1127
I/Q Center Freq	1128
Input/Output	1129
Marker	1130
Select Marker	1130
Marker Type	1130
Properties	1131
Select Marker	1131
Relative To	1131
Couple Markers	1132
All Markers Off	1132
Marker X Axis Value (Remote Command only)	1133
Marker X Axis Position (Remote Command only)	1133
Marker Y Axis Value (Remote Command only)	1134
Marker Function	1135
Marker To	1136

Meas	1137
Remote Measurement Functions	1137
Measurement Group of Commands	1138
Current Measurement Query (Remote Command Only)	1140
Limit Test Current Results (Remote Command Only)	1140
Data Query (Remote Command Only)	1140
Calculate/Compress Trace Data Query (Remote Command Only)	1141
Calculate Peaks of Trace Data (Remote Command Only)	1146
Format Data: Numeric Data (Remote Command Only)	1147
Format Data: Byte Order (Remote Command Only)	1148
Meas Setup	1149
Avg/Hold Num	1149
Avg Mode	1149
Range Table	1150
Range	1150
Start Freq	1152
Stop Freq	1153
Res BW	1154
Video BW	1156
Filter Type	1157
Abs Start Limit	1158
Abs Stop Limit	1159
Peak Excursion	1161
Pk Threshold	1161
Attenuation	1162
Detector 1	1163
Detector 2	1164
Sweep Time	1165
Points	1165
IF Gain	1167
IF Gain Auto	1167
IF Gain State	1168
Meas Type	1168
Spur	1169
Spurious Report Mode	1170
Meas Preset	1170
Fast Spurious Meas (Remote Command only)	1171
Mode	1172
Mode Preset	1173
How-To Preset	1174
Preset Type (Remote Command Only)	1175
Mode Setup	1176
Peak Search	1177

Next Peak	1177
Next Pk Right	1177
Next Pk Left	1178
Marker Delta	1178
Pk-Pk Search	1178
Min Search	1178
Print	1180
Quick Save	1181
Recall	1183
State	1183
More Information	1185
From File...	1185
Edit Register Names	1187
Register 1 thru Register 16	1187
Register 1 thru Register 16	1188
Data (Import)	1189
Mask	1190
File location and extension	1190
Example of Preset Mask file	1191
Zone Map	1191
Open...	1192
Restart	1193
More Information	1193
Save	1195
State	1195
To File . . .	1196
Edit Register Names	1198
More Information	1198
Register 1 thru Register 16	1199
Register 1 thru Register 16	1199
Data (Export)	1200
Measurement Results	1201
Meas Results File Definition	1201
Meas Results File Example	1203
Zone Map	1206
Zone Map File Contents	1207
Save As . . .	1209
Screen Image	1210
Themes	1211
3D Color	1211
3D Monochrome	1211
Flat Color	1212
Flat Monochrome	1212

Save As...	1212
Mass Storage Catalog (Remote Command Only)	1213
Mass Storage Change Directory (Remote Command Only)	1213
Mass Storage Copy (Remote Command Only)	1213
Mass Storage Device Copy (Remote Command Only)	1214
Mass Storage Delete (Remote Command Only)	1214
Mass Storage Data (Remote Command Only)	1214
Mass Storage Make Directory (Remote Command Only)	1215
Mass Storage Move (Remote Command Only)	1215
Mass Storage Remove Directory (Remote Command Only)	1215
Single (Single Measurement/Sweep)	1216
More Information	1216
Source	1217
Span X Scale	1218
Sweep/Control	1219
Sweep Setup	1219
Auto Sweep Time Rules	1219
Sweep Type	1220
Pause	1220
Gate	1220
Gate On/Off	1221
Gate View On/Off	1222
Gate View Setup	1225
Gate View Sweep Time	1225
Gate View Start Time	1226
Gate Delay	1226
Gate Length	1227
Gate Source	1227
Line	1228
External 1	1229
External 2	1231
RF Burst	1232
Periodic Timer (Frame Trigger)	1235
Control Edge/Level	1246
Gate Holdoff	1247
Gate Delay Compensation	1248
More Information	1249
Min Fast Position Query (Remote Command Only)	1250
Gate Preset (Remote Command Only)	1250
Gate Level (Remote Command Only)	1250
Gate Polarity (Remote Command Only)	1250
Gate	1251
System	1252

Trace/Detector	1253
Trigger	1254
Free Run	1254
Video	1254
Trigger Level	1254
Trig Slope	1254
Trig Delay	1254
Line	1254
Trig Slope	1254
Trig Delay	1254
External 1	1254
Trigger Level	1254
Trig Slope	1254
Trig Delay	1254
External 2	1254
Trigger Level	1255
Trig Slope	1255
Trig Delay	1255
RF Burst	1255
Absolute Trigger	1255
Relative Trigger	1255
Trig Slope	1255
Trig Delay	1255
Periodic Timer	1255
Period	1255
Offset	1255
Reset Offset Display	1255
Sync Source	1255
Off	1255
External 1	1256
External 2	1256
RF Burst	1256
Trig Delay	1256
Auto/Holdoff	1256
Auto Trig	1256
Trig Holdoff	1256
User Preset	1257
User Preset	1257
User Preset All Modes	1258
Save User Preset	1259
View/Display	1260
Display	1260
Annotation	1260

Meas Bar On/Off	1261
Screen	1262
Active Function Values On/Off	1262
Title	1263
Change Title	1263
Clear Title	1264
Graticule	1265
System Display Settings	1265
Annotation Local Settings	1265
Themes	1266
Backlight	1267
Backlight Intensity	1267
View Selection	1268
Graph + Metrics	1268
Range Table	1269
All Ranges	1272
Range Table Selection (SCPI only command)	1273
12 Occupied Bandwidth Measurement	1275
AMPTD Y Scale (Amplitude/Y Scale)	1278
Ref Value	1278
Attenuation	1278
Dual Attenuator Configurations:	1279
Single Attenuator Configuration:	1280
(Mech) Atten	1280
Attenuator Configurations and Auto/Man	1282
Enable Elec Atten	1282
More Information	1283
Mechanical Attenuator Transition Rules	1283
When the Electronic Attenuation is enabled from a disabled state:	1283
Examples in the dual attenuator configuration:	1283
When the Electronic Attenuation is disabled from an enabled state:	1284
Using the Electronic Attenuator: Pros and Cons	1284
Elec Atten	1284
Adjust Atten for Min Clip	1285
Pre-Adjust for Min Clip	1285
Off	1286
Elec Atten Only	1286
Mech + Elec Atten	1287
(Mech) Atten Step	1287
Scale/Div	1288
Presel Center	1288
Proper Preselector Operation	1289
Preselector Adjust	1289

μW Path Control	1291
Standard Path	1292
Low Noise Path Enable	1292
More Information	1293
μW Preselector Bypass	1294
Internal Preamp	1295
Off	1296
Low Band	1297
Full Range	1297
Ref Position	1297
Auto Scaling	1298
Auto Couple	1299
More Information	1299
Auto/Man Active Function keys	1299
Auto/Man 1-of-N keys	1299
BW	1301
Res BW	1301
Video BW	1302
Filter Type	1303
Cont (Continuous Measurement/Sweep)	1305
File	1307
FREQ Channel	1308
Center Freq	1308
Center Frequency Presets	1309
RF Center Freq	1311
Ext Mix Center Freq	1312
I/Q Center Freq	1313
Input/Output	1314
Marker	1315
Select Marker	1315
Select Marker	1315
Marker Type	1315
Properties	1316
Select Marker	1316
Select Marker	1316
Relative To	1316
All Markers Off	1317
Marker X Axis Value (Remote Command Only)	1317
Marker X Axis Position (Remote Command Only)	1318
Marker Y Axis Value (Remote Command Only)	1318
Backward Compatibility SCPI Commands	1319
Marker Function	1320
Marker To	1321

Meas	1322
Remote Measurement Functions	1322
Measurement Group of Commands	1323
Current Measurement Query (Remote Command Only)	1325
Limit Test Current Results (Remote Command Only)	1325
Data Query (Remote Command Only)	1325
Calculate/Compress Trace Data Query (Remote Command Only)	1326
Calculate Peaks of Trace Data (Remote Command Only)	1331
Format Data: Numeric Data (Remote Command Only)	1332
Format Data: Byte Order (Remote Command Only)	1333
Meas Setup	1334
Avg/Hold Num	1334
Avg Mode	1335
Occ BW % Pwr	1335
x dB	1336
IF Gain	1337
IF Gain Auto	1337
IF Gain State	1337
Limit (for all modes except MSR and LTE-Advanced FDD/TDD)	1338
Meas Preset	1339
Max Hold (Remote Command Only)	1340
Mode	1341
Mode Preset	1342
How-To Preset	1343
Preset Type (Remote Command Only)	1344
Mode Setup	1345
Peak Search	1346
Print	1347
Quick Save	1348
Recall	1350
State	1350
More Information	1352
From File...	1352
Edit Register Names	1354
Register 1 thru Register 16	1354
Register 1 thru Register 16	1355
Data (Import)	1356
Mask	1357
File location and extension	1357
Example of Preset Mask file	1358
Zone Map	1358
Open...	1359
Restart	1360

More Information	1360
Save	1362
State	1362
To File . . .	1363
Edit Register Names	1365
More Information	1365
Register 1 thru Register 16	1366
Register 1 thru Register 16	1366
Data (Export)	1367
Measurement Results	1368
Meas Results File Definition	1368
Meas Results File Example	1369
Zone Map	1370
Zone Map File Contents	1371
Save As . . .	1373
Screen Image	1374
Themes	1375
3D Color	1375
3D Monochrome	1375
Flat Color	1376
Flat Monochrome	1376
Save As...	1376
Mass Storage Catalog (Remote Command Only)	1377
Mass Storage Change Directory (Remote Command Only)	1377
Mass Storage Copy (Remote Command Only)	1377
Mass Storage Device Copy (Remote Command Only)	1378
Mass Storage Delete (Remote Command Only)	1378
Mass Storage Data (Remote Command Only)	1378
Mass Storage Make Directory (Remote Command Only)	1379
Mass Storage Move (Remote Command Only)	1379
Mass Storage Remove Directory (Remote Command Only)	1379
Single (Single Measurement/Sweep)	1380
More Information	1380
Source	1381
Span X Scale	1382
Span	1382
Full Span	1383
Last Span	1383
Sweep/Control	1385
Sweep Time	1385
Sweep Setup	1386
Auto Sweep Time Rules	1386
Pause	1387

Table of Contents

Gate	1387
Gate On/Off	1387
Gate View On/Off	1388
Gate View Setup	1391
Gate View Sweep Time	1392
Gate View Start Time	1392
Gate Delay	1393
Gate Length	1393
Gate Source	1394
Line	1395
External 1	1395
External 2	1397
RF Burst	1399
Periodic Timer (Frame Trigger)	1402
Control Edge/Level	1413
Gate Holdoff	1413
Gate Delay Compensation	1415
More Information	1416
Min Fast Position Query (Remote Command Only)	1416
Gate Preset (Remote Command Only)	1417
Gate Level (Remote Command Only)	1417
Gate Polarity (Remote Command Only)	1417
Points	1418
System	1420
Trace/Detector	1421
Trace Type	1421
Detector	1421
Auto	1422
Detector Selection	1422
Trigger	1424
Free Run	1424
Video	1424
Trigger Level	1424
Trig Slope	1424
Trig Delay	1424
Line	1424
Trig Slope	1424
Trig Delay	1424
External 1	1424
Trigger Level	1424
Trig Slope	1424
Trig Delay	1424
External 2	1424

Trigger Level	1425
Trig Slope	1425
Trig Delay	1425
RF Burst	1425
Absolute Trigger	1425
Relative Trigger	1425
Trig Slope	1425
Trig Delay	1425
Periodic Timer	1425
Period	1425
Offset	1425
Reset Offset Display	1425
Sync Source	1425
Off	1425
External 1	1426
External 2	1426
RF Burst	1426
Trig Delay	1426
Auto/Holdoff	1426
Auto Trig	1426
Trig Holdoff	1426
User Preset	1427
User Preset	1427
User Preset All Modes	1428
Save User Preset	1429
View/Display	1430
Spectrum View	1430
Display	1435
Annotation	1435
Meas Bar On/Off	1437
Screen	1437
Active Function Values On/Off	1437
Title	1438
Change Title	1438
Clear Title	1439
Graticule	1440
System Display Settings	1440
Annotation Local Settings	1440
Themes	1441
Backlight	1442
Backlight Intensity	1442
13 Power vs Time Measurement	1445
AMPTD Y Scale	1452

Ref Value	1452
Attenuation	1452
Dual Attenuator Configurations:	1453
Single Attenuator Configuration:	1453
(Mech) Atten	1454
Attenuator Configurations and Auto/Man	1455
Enable Elec Atten	1456
More Information	1457
Mechanical Attenuator Transition Rules	1457
When the Electronic Attenuation is enabled from a disabled state:	1457
Examples in the dual attenuator configuration:	1457
When the Electronic Attenuation is disabled from an enabled state:	1457
Using the Electronic Attenuator: Pros and Cons	1458
Elec Atten	1458
Adjust Atten for Min Clip	1459
Pre-Adjust for Min Clip	1459
Off	1460
Elec Atten Only	1460
Mech + Elec Atten	1461
(Mech) Atten Step	1461
Scale/Div	1461
Presel Center	1462
Proper Preselector Operation	1463
Preselector Adjust	1463
μ W Path Control	1464
Standard Path	1466
Low Noise Path Enable	1466
More Information	1467
μ W Preselector Bypass	1468
Internal Preamp	1469
Off	1470
Low Band	1471
Full Range	1471
Ref Position	1471
Auto Scaling	1472
Auto Couple	1473
More Information	1473
Auto/Man Active Function keys	1473
Auto/Man 1-of-N keys	1473
BW	1475
Info BW	1475
Filter Type	1475
Cont (Continuous Measurement/Sweep)	1477

File	1479
FREQ Channel	1480
Center Freq	1480
Center Frequency Presets	1481
RF Center Freq	1483
Ext Mix Center Freq	1484
I/Q Center Freq	1485
Input/Output	1486
Marker	1487
Select Marker	1487
Marker Type	1487
Properties	1488
Select Marker	1488
Relative To	1488
Marker Trace	1488
Couple Marker	1489
All Markers Off	1489
Marker Function	1491
Marker To	1492
Meas	1493
Remote Measurement Functions	1493
Measurement Group of Commands	1494
Current Measurement Query (Remote Command Only)	1496
Limit Test Current Results (Remote Command Only)	1496
Data Query (Remote Command Only)	1496
Calculate/Compress Trace Data Query (Remote Command Only)	1497
Calculate Peaks of Trace Data (Remote Command Only)	1502
Format Data: Numeric Data (Remote Command Only)	1503
Format Data: Byte Order (Remote Command Only)	1504
Meas Setup	1505
Avg/Hold Num	1505
Avg Mode	1505
Avg Type	1506
Capture Length	1506
Burst Sync	1507
Region/Limits	1508
Region	1508
Start Time	1508
Stop Time	1509
Upper Abs Start	1509
Upper Abs Stop	1510
Upper Rel Start	1511
Upper Rel Stop	1511

Table of Contents

Upper Fail Mask	1512
Lower Abs Start	1513
Lower Abs Stop	1514
Lower Rel Start	1514
Lower Rel Stop	1515
Lower Fail Mask	1516
Power Reference	1516
Time Reference	1517
Meas Preset	1518
Advanced	1518
Threshold Lvl	1518
Burst Slope Threshold	1519
Burst Slope Detect Intvl	1519
Time Ref Offset	1520
IF Gain	1520
IF Gain Auto	1521
IF Gain State	1521
Mode	1523
Mode Preset	1524
How-To Preset	1525
Preset Type (Remote Command Only)	1526
Mode Setup	1527
Peak Search	1528
Print	1529
Quick Save	1530
Recall	1532
State	1532
More Information	1534
From File...	1534
Edit Register Names	1536
Register 1 thru Register 16	1536
Register 1 thru Register 16	1537
Data (Import)	1538
Mask	1539
File location and extension	1539
Example of Preset Mask file	1540
Zone Map	1540
Open...	1541
Restart	1542
More Information	1542
Save	1544
State	1544
To File . . .	1545

Edit Register Names	1547
More Information	1547
Register 1 thru Register 16	1548
Register 1 thru Register 16	1548
Data (Export)	1549
Measurement Results	1550
Meas Results File Contents	1550
Marker Table	1550
Peak Table	1553
Spectrogram	1556
Zone Map	1560
Zone Map File Contents	1561
Save As . . .	1563
Screen Image	1564
Themes	1565
3D Color	1565
3D Monochrome	1565
Flat Color	1566
Flat Monochrome	1566
Save As...	1566
Mass Storage Catalog (Remote Command Only)	1567
Mass Storage Change Directory (Remote Command Only)	1567
Mass Storage Copy (Remote Command Only)	1567
Mass Storage Device Copy (Remote Command Only)	1568
Mass Storage Delete (Remote Command Only)	1568
Mass Storage Data (Remote Command Only)	1568
Mass Storage Make Directory (Remote Command Only)	1569
Mass Storage Move (Remote Command Only)	1569
Mass Storage Remove Directory (Remote Command Only)	1569
Single (Single Measurement/Sweep)	1570
More Information	1570
Source	1571
SPAN X Scale	1572
Ref Value	1572
Scale/Div	1572
Ref Position	1573
Auto Scaling	1573
Sweep/Control	1575
Pause/Resume	1575
System	1576
Trace/Detector	1577
Max Hold Trace	1577
Min Hold Trace	1577

Table of Contents

Trigger	1578
Free Run	1578
Video	1578
Trigger Level	1578
Trig Slope	1578
Trig Delay	1578
Line	1578
Trig Slope	1578
Trig Delay	1578
External 1	1578
Trigger Level	1578
Trig Slope	1578
Trig Delay	1578
External 2	1578
Trigger Level	1579
Trig Slope	1579
Trig Delay	1579
RF Burst	1579
Absolute Trigger	1579
Relative Trigger	1579
Trig Slope	1579
Trig Delay	1579
Periodic Timer	1579
Period	1579
Offset	1579
Offset Adjust (Remote Command Only)	1579
Reset Offset Display	1579
Sync Source	1579
Off	1580
External 1	1580
External 2	1580
RF Burst	1580
Trig Delay	1580
Auto/Holdoff	1580
Auto Trig	1580
Trig Holdoff	1580
User Preset	1581
User Preset	1581
User Preset All Modes	1582
Save User Preset	1583
View/Display	1584
RF Envelop window	1584
Numeric Results window	1585

Display	1585
Annotation	1586
Meas Bar On/Off	1587
Screen	1587
Active Function Values On/Off	1587
Title	1588
Change Title	1588
Clear Title	1589
Graticule	1590
System Display Settings	1590
Annotation Local Settings	1590
Themes	1591
Backlight	1592
Backlight Intensity	1592
Limit Mask	1593
Scroll	1593
Prev Page	1593
Next Page	1593
Scroll Up	1594
Scroll Down	1594
First Page	1594
Last Page	1594
14 Modulation Analysis Measurement	1597
AMPTD Y Scale	1615
Ref Value	1615
Ref Value (Symbol Error vs. Subcarrier/Symbol Error vs. Symbol Window - Log)	1615
Ref Value (Symbol Error vs. Subcarrier/Symbol Error vs. Symbol Window - Lin)	1616
Ref Value (Absolute Flatness Window)	1616
Ref Value (Differential Flatness Window)	1617
Ref Value (Power vs. Time/Power vs. Spectrum Window)	1617
Ref Value (Symbol Power vs. Subcarrier/Symbol Power vs. Symbol Window)	1618
Attenuation	1618
Dual Attenuator Configurations:	1619
Single Attenuator Configuration:	1619
(Mech) Atten	1620
Attenuator Configurations and Auto/Man	1621
Enable Elec Atten	1622
More Information	1623
Mechanical Attenuator Transition Rules	1623
When the Electronic Attenuation is enabled from a disabled state:	1623
Examples in the dual attenuator configuration:	1623
When the Electronic Attenuation is disabled from an enabled state:	1623
Using the Electronic Attenuator: Pros and Cons	1624

Elec Atten	1624
Adjust Atten for Min Clip	1625
Pre-Adjust for Min Clip	1625
Off	1626
Elec Atten Only	1626
Mech + Elec Atten	1627
(Mech) Atten Step	1627
Scale/Div	1627
Scale/Div (Symbol Error vs. Subcarrier/Symbol Error vs. Symbol Window - Log)	1628
Scale/Div (Symbol Error vs. Subcarrier/Symbol Error vs. Symbol Window - Lin)	1628
Scale/Div (Absolute Flatness Window)	1629
Scale/Div (Differential Flatness Window)	1629
Scale/Div (Power vs. Time/Power vs. Spectrum Window)	1630
Scale/Div (Symbol Power vs. Subcarrier/Symbol Power vs. Symbol Window)	1630
Presel Center	1631
Proper Preselector Operation	1632
Preselector Adjust	1632
μ W Path Control	1633
Standard Path	1634
Low Noise Path Enable	1635
More Information	1636
μ W Preselector Bypass	1637
Internal Preamp	1638
Off	1639
Low Band	1639
Full Range	1639
Range	1640
Range Auto/Man	1640
I Range	1641
1 V Peak	1642
0.5 V Peak	1643
0.25 V Peak	1643
0.125 V Peak	1643
Q Range Value	1643
Q Same as I	1644
1 V Peak	1645
0.5 V Peak	1645
0.25 V Peak	1645
0.125 V Peak	1645
I/Q Gain Ranges	1645
1 V Peak	1646
0.5 V Peak	1646
0.25 V Peak	1646

0.125 V Peak	1646
Ref Position	1646
Ref Position (Symbol Error vs. Subcarrier/Symbol Error vs. Symbol Window)	1647
Ref Position (Absolute Flatness Window)	1647
Ref Position (Differential Flatness Window)	1647
Ref Position (Power vs. Time/Power vs. Spectrum Window)	1648
Ref Position (Symbol Power vs. Subcarrier/Symbol Power vs. Symbol Window)	1648
Auto Scaling	1649
AutoScaling (Symbol Error vs. Subcarrier/Symbol Error vs. Symbol Window)	1649
AutoScaling (Absolute Flatness/Differential Flatness Window)	1649
AutoScaling (Power vs. Time/Power vs. Spectrum Window)	1650
AutoScaling (Symbol Power vs. Subcarrier/Symbol Power vs. Symbol Window)	1650
Auto Couple	1652
More Information	1652
Auto/Man Active Function keys	1652
Auto/Man 1-of-N keys	1652
BW	1654
Info BW	1654
Cont (Continuous Measurement/Sweep)	1655
File	1657
FREQ Channel	1658
Center Freq	1658
Center Frequency Presets	1659
RF Center Freq	1661
Ext Mix Center Freq	1662
I/Q Center Freq	1663
Input/Output	1664
Marker	1665
Select Marker	1665
Marker Type	1665
Properties	1666
Select Marker	1666
Relative To	1666
Marker Trace	1666
All Markers Off	1667
Marker X Axis Value (Remote Command only)	1667
Marker X Axis Position (Remote Command only)	1668
Marker X Axis Subcarrier (Remote Command only)	1668
Marker X Axis Symbol (Remote Command only)	1669
Marker Y Axis Value (Remote Command only)	1670
Backward Compatibility SCPI Commands	1670
Marker Function	1672
Marker To	1673

Meas	1674
Remote Measurement Functions	1674
Measurement Group of Commands	1675
Current Measurement Query (Remote Command Only)	1677
Limit Test Current Results (Remote Command Only)	1677
Data Query (Remote Command Only)	1677
Calculate/Compress Trace Data Query (Remote Command Only)	1678
Calculate Peaks of Trace Data (Remote Command Only)	1683
Format Data: Numeric Data (Remote Command Only)	1684
Format Data: Byte Order (Remote Command Only)	1685
Meas Setup	1686
Avg/Hold Num	1686
Avg Mode	1686
Limits	1687
RMS RCE	1687
Limits	1687
Composite	1688
QPSK-1/2	1688
QPSK-3/4	1689
16QAM-1/2	1689
16QAM-3/4	1690
64QAM-1/2	1690
64QAM-2/3	1691
64QAM-3/4	1691
Peak RCE	1691
Pilot RCE	1692
Frequency Error	1693
Time Offset	1693
I/Q Offset	1694
Abs Spectral Flatness	1694
Offset	1694
Start Subcarrier	1695
Stop Subcarrier	1696
Offset Side	1697
Upper Mask Start	1698
Upper Mask Stop	1699
Lower Mask Start	1700
Lower Mask Stop	1700
Zone/Data Burst Map	1701
Auto Detect Now	1702
Zone Num	1702
Data Burst Analysis	1702
Burst Map	1703

Use Defined Boosting Level	1703
Single Burst	1703
Subchan Offset	1703
Burst Region Subchannel Interval	1704
Symbol Offset	1704
Symbol Interval	1705
Burst Shape	1705
Data Mod Type	1705
Uniform Zone	1706
Data Mod Type	1706
Zone Offset	1706
Zone Interval	1707
Data Burst Select	1707
Data Burst Num	1708
All On	1708
Single	1708
Preamble Index	1708
Subchannel Group Bitmask	1709
Meas Preset	1709
Advanced	1710
Pilot in RMS/Pk RCE	1710
Spectrum	1710
Symbol Timing Adjust	1711
Pilot Tracking	1712
Track Amplitude	1712
Track Phase	1713
Track Timing	1713
Equalizer Training	1714
Equalizer Smoothing	1714
PhNoise Opt	1714
I/Q Mismatch Compensation	1715
Multi Carrier Filter	1716
UL Permbase	1716
Mode	1717
Mode Preset	1718
How-To Preset	1719
Preset Type (Remote Command Only)	1720
Mode Setup	1721
Peak Search	1722
Next Peak	1722
Next Pk Right	1722
Next Pk Left	1722
Marker Delta	1723

Table of Contents

Pk-Pk Search	1723
Min Search	1723
Print	1724
Quick Save	1725
Recall	1727
State	1727
More Information	1729
From File...	1729
Edit Register Names	1731
Register 1 thru Register 16	1731
Register 1 thru Register 16	1732
Data (Import)	1733
Mask	1734
File location and extension	1734
Example of Preset Mask file	1735
Zone Map	1735
Open...	1736
Restart	1737
More Information	1737
Save	1739
State	1739
To File . . .	1740
Edit Register Names	1742
More Information	1742
Register 1 thru Register 16	1743
Register 1 thru Register 16	1743
Data (Export)	1744
Measurement Results	1745
Meas Results File Contents	1745
Marker Table	1745
Peak Table	1748
Spectrogram	1751
Zone Map	1755
Zone Map File Contents	1756
Save As . . .	1758
Screen Image	1759
Themes	1760
3D Color	1760
3D Monochrome	1760
Flat Color	1761
Flat Monochrome	1761
Save As...	1761
Mass Storage Catalog (Remote Command Only)	1762

Mass Storage Change Directory (Remote Command Only)	1762
Mass Storage Copy (Remote Command Only)	1762
Mass Storage Device Copy (Remote Command Only)	1763
Mass Storage Delete (Remote Command Only)	1763
Mass Storage Data (Remote Command Only)	1763
Mass Storage Make Directory (Remote Command Only)	1764
Mass Storage Move (Remote Command Only)	1764
Mass Storage Remove Directory (Remote Command Only)	1764
Single (Single Measurement/Sweep)	1765
More Information	1765
Source	1766
SPAN X Scale	1767
Ref Value	1767
Ref Value (Error vs. Subcarrier Window)	1767
Ref Value (Symbol Power vs. Subcarrier Window)	1768
Ref Value (Absolute Flatness Window/Differential Flatness Window)	1768
Ref Value (Power vs Time Window)	1769
Ref Value (Symbol Error vs. Symbol Window)	1769
Ref Value (Symbol Power vs. Symbol Window)	1770
Scale/Div	1770
Scale/Div (Symbol Error vs. Subcarrier Window)	1770
Scale/Div (Symbol Power vs. Subcarrier Window)	1771
Scale/Div (Absolute Flatness/Differential Flatness Window)	1771
Scale/Div (Power vs Time Window)	1772
Scale/Div (Symbol Error vs. Symbol Window)	1772
Scale/Div (Symbol Power vs. Symbol Window)	1773
Ref Position	1773
Ref Position (Symbol Error vs. Subcarrier Window)	1774
Ref Position (Symbol Power vs. Subcarrier Window)	1774
Ref Position (Absolute Flatness/Differential Flatness Window)	1774
Ref Position (Power vs Time Window)	1775
Ref Position (Symbol Error vs Symbol Window)	1775
Ref Position (Symbol Power vs Symbol Window)	1776
Auto Scaling	1776
AutoScaling (Symbol Error vs. Subcarrier Window)	1776
AutoScaling (Symbol Power vs. Subcarrier Window)	1777
AutoScaling (Absolute Flatness/Differential Flatness Window)	1777
AutoScaling (Power vs Time Window)	1778
AutoScaling (Symbol Error vs Symbol Window)	1778
AutoScaling (Symbol Power vs Symbol Window)	1779
Sweep/Control	1780
Pause/Resume	1780
System	1781

Table of Contents

Trace/Detector	1782
Trigger	1783
Free Run	1783
Video	1783
Trigger Level	1783
Trig Slope	1783
Trig Delay	1783
Line	1783
Trig Slope	1783
Trig Delay	1783
External 1	1783
Trigger Level	1783
Trig Slope	1783
Trig Delay	1783
External 2	1783
Trigger Level	1784
Trig Slope	1784
Trig Delay	1784
RF Burst	1784
Absolute Trigger	1784
Relative Trigger	1784
Trig Slope	1784
Trig Delay	1784
Periodic Timer	1784
Period	1784
Offset	1784
Offset Adjust (Remote Command Only)	1784
Reset Offset Display	1784
Sync Source	1784
Off	1785
External 1	1785
External 2	1785
RF Burst	1785
Trig Delay	1785
Auto/Holdoff	1785
Auto Trig	1785
Trig Holdoff	1785
Baseband I/Q	1785
I/Q Mag	1786
Trigger Level	1786
Trig Slope	1786
Trig Delay	1786
I	1786

Trigger Level	1786
Trig Slope	1786
Trig Delay	1786
Q	1786
Trigger Level	1786
Trig Slope	1786
Trig Delay	1786
Input I	1786
Trigger Level	1786
Trig Slope	1787
Trig Delay	1787
Input Q	1787
Trigger Level	1787
Trig Slope	1787
Trig Delay	1787
Aux Channel Center Freq	1787
Trigger Level	1787
Trig Slope	1787
Trig Delay	1787
Trigger Center Freq	1787
Trigger BW	1787
User Preset	1788
User Preset	1788
User Preset All Modes	1789
Save User Preset	1790
View/Display	1791
Understanding Front Panel Results to Use Remote Commands	1791
Front Panel Results	1791
View Selection by name (SCPI Only)	1792
View Selection by number (SCPI Only)	1792
Display	1793
Annotation	1793
Meas Bar On/Off	1794
Screen	1795
Active Function Values On/Off	1795
Title	1796
Change Title	1796
Clear Title	1797
Graticule	1798
System Display Settings	1798
Annotation Local Settings	1798
Themes	1799
Backlight	1800

Backlight Intensity	1800
IQ Symbol Measured Constin	1801
I/Q Symbol Constellation Window	1801
Numeric Results Window	1802
Inactive Subchannels	1802
Zone Data Burst Info	1803
Zone List Window	1804
Zone Definition Window	1804
Data Burst List Window	1804
Symbol Error (Quad View)	1805
Symbol Error vs Subcarrier Window	1806
Symbol Error vs Symbol Window	1806
I/Q Symbol Constellation Window	1806
Zone Definition Window	1806
Inactive Subchannels	1806
Symbol Power (Quad View)	1807
Symbol Power Vector vs Subcarrier Window	1808
Symbol Power Vector vs Symbol	1808
I/Q Symbol Constellation	1808
Zone Definition	1809
Inactive Subchannels	1809
Peak/Avg Metrics	1810
Zoomed Result Metrics	1812
Power vs. Time and Spectrum	1818
Power vs Time Window	1819
Power vs Spectrum Window	1819
OBW Line	1820
15 Power Stat CCDF Measurement	1821
AMPTD Y Scale	1826
Attenuation	1826
Dual Attenuator Configurations:	1826
Single Attenuator Configuration:	1827
(Mech) Atten	1828
Attenuator Configurations and Auto/Man	1829
Enable Elec Atten	1829
More Information	1830
Mechanical Attenuator Transition Rules	1830
When the Electronic Attenuation is enabled from a disabled state:	1831
Examples in the dual attenuator configuration:	1831
When the Electronic Attenuation is disabled from an enabled state:	1831
Using the Electronic Attenuator: Pros and Cons	1831
Elec Atten	1832
Adjust Atten for Min Clip	1832

Pre-Adjust for Min Clip	1833
Off	1834
Elec Atten Only	1834
Mech + Elec Atten	1834
(Mech) Atten Step	1834
Presel Center	1835
Proper Preselector Operation	1836
Preselector Adjust	1836
μ W Path Control	1838
Standard Path	1839
Low Noise Path Enable	1839
More Information	1840
μ W Preselector Bypass	1841
Internal Preamp	1842
Off	1843
Low Band	1844
Full Range	1844
Range	1844
Range Auto/Man	1845
I Range	1846
1 V Peak	1847
0.5 V Peak	1847
0.25 V Peak	1847
0.125 V Peak	1847
Q Range Value	1848
Q Same as I	1849
1 V Peak	1849
0.5 V Peak	1849
0.25 V Peak	1850
0.125 V Peak	1850
I/Q Gain Ranges	1850
1 V Peak	1850
0.5 V Peak	1850
0.25 V Peak	1850
0.125 V Peak	1851
Presel Center	1851
Auto Couple	1852
More Information	1852
Auto/Man Active Function keys	1852
Auto/Man 1-of-N keys	1852
BW	1854
Info BW	1854
Cont (Continuous Measurement/Sweep)	1856

Table of Contents

File	1858
FREQ Channel	1859
Center Freq	1859
Center Frequency Presets	1860
RF Center Freq	1862
Ext Mix Center Freq	1863
I/Q Center Freq	1864
Input/Output	1865
Marker	1866
Select Marker	1866
Marker Type	1866
Properties	1867
Select Marker	1867
Relative To	1867
Marker Trace	1868
Couple Markers	1868
All Markers Off	1868
Marker X Axis Value (Remote Command Only)	1869
Marker Y Axis Value (Remote Command Only)	1869
Marker Function	1871
Marker To	1872
Meas	1873
Remote Measurement Functions	1873
Measurement Group of Commands	1874
Current Measurement Query (Remote Command Only)	1876
Limit Test Current Results (Remote Command Only)	1876
Data Query (Remote Command Only)	1876
Calculate/Compress Trace Data Query (Remote Command Only)	1877
Calculate Peaks of Trace Data (Remote Command Only)	1882
Format Data: Numeric Data (Remote Command Only)	1883
Format Data: Byte Order (Remote Command Only)	1884
Meas Setup	1885
Counts	1885
Meas Cycles	1885
Meas Interval (Not 1xEVDO)	1886
IF Gain	1887
IF Gain Auto	1887
IF Gain State	1888
Meas Preset	1888
Mode	1890
Mode Preset	1891
How-To Preset	1892
Preset Type (Remote Command Only)	1893

Mode Setup	1894
Peak Search	1895
Print	1896
Quick Save	1897
Recall	1899
State	1899
More Information	1901
From File...	1901
Edit Register Names	1903
Register 1 thru Register 16	1903
Register 1 thru Register 16	1904
Data (Import)	1905
Mask	1906
File location and extension	1906
Example of Preset Mask file	1907
Zone Map	1907
Open...	1908
Restart	1909
More Information	1909
Save	1911
State	1911
To File . . .	1912
Edit Register Names	1914
More Information	1914
Register 1 thru Register 16	1915
Register 1 thru Register 16	1915
Data (Export)	1916
Measurement Results	1917
Meas Results File Definition	1917
Meas Results File Example	1919
Zone Map	1920
Zone Map File Contents	1921
Save As . . .	1923
Screen Image	1924
Themes	1925
3D Color	1925
3D Monochrome	1925
Flat Color	1926
Flat Monochrome	1926
Save As...	1926
Mass Storage Catalog (Remote Command Only)	1927
Mass Storage Change Directory (Remote Command Only)	1927
Mass Storage Copy (Remote Command Only)	1927

Table of Contents

Mass Storage Device Copy (Remote Command Only)	1928
Mass Storage Delete (Remote Command Only)	1928
Mass Storage Data (Remote Command Only)	1928
Mass Storage Make Directory (Remote Command Only)	1929
Mass Storage Move (Remote Command Only)	1929
Mass Storage Remove Directory (Remote Command Only)	1929
Single (Single Measurement/Sweep)	1930
More Information	1930
Source	1931
Span X Scale	1932
Scale/Div	1932
Sweep/Control	1933
Pause/Resume	1933
System	1934
Trace/Detector	1935
Store Ref Trace	1935
Ref Trace	1935
Gaussian Line	1936
Trigger	1937
Free Run	1937
Video	1937
Trigger Level	1937
Trig Slope	1937
Trig Delay	1937
Line	1937
Trig Slope	1937
Trig Delay	1937
External 1	1937
Trigger Level	1937
Trig Slope	1937
Trig Delay	1937
External 2	1937
Trigger Level	1938
Trig Slope	1938
Trig Delay	1938
RF Burst	1938
Absolute Trigger	1938
Relative Trigger	1938
Trig Slope	1938
Trig Delay	1938
Periodic Timer	1938
Period	1938
Offset	1938

Offset Adjust (Remote Command Only)	1938
Reset Offset Display	1938
Sync Source	1938
Off	1939
External 1	1939
External 2	1939
RF Burst	1939
Trig Delay	1939
Auto/Holdoff	1939
Auto Trig	1939
Trig Holdoff	1939
Baseband I/Q	1939
I/Q Mag	1940
Trigger Level	1940
Trig Slope	1940
Trig Delay	1940
I	1940
Trigger Level	1940
Trig Slope	1940
Trig Delay	1940
Q	1940
Trigger Level	1940
Trig Slope	1940
Trig Delay	1940
Input I	1940
Trigger Level	1940
Trig Slope	1941
Trig Delay	1941
Input Q	1941
Trigger Level	1941
Trig Slope	1941
Trig Delay	1941
Aux Channel Center Freq	1941
Trigger Level	1941
Trig Slope	1941
Trig Delay	1941
Trigger Center Freq	1941
Trigger BW	1941
User Preset	1942
User Preset	1942
User Preset All Modes	1943
Save User Preset	1944
View/Display	1945

Metrics window	1947
Graph window	1948
Wave window (TD-SCDMA and LTE TDD only)	1948
Display	1949
Annotation	1949
Meas Bar On/Off	1950
Screen	1951
Active Function Values On/Off	1951
Title	1952
Change Title	1952
Clear Title	1953
Graticule	1954
System Display Settings	1954
Annotation Local Settings	1954
Themes	1955
Backlight	1956
Backlight Intensity	1956
SCPI Only Parameters	1958
Number of Bursts (Query Only)	1958
Selected Burst Number	1958
DIUC Burst Profiles	1958
16 Monitor Spectrum Measurement	1961
AMPTD Y Scale	1964
Ref Value	1964
Attenuation	1964
Dual Attenuator Configurations:	1965
Single Attenuator Configuration:	1965
(Mech) Atten	1966
Attenuator Configurations and Auto/Man	1967
Enable Elec Atten	1968
More Information	1969
Mechanical Attenuator Transition Rules	1969
When the Electronic Attenuation is enabled from a disabled state:	1969
Examples in the dual attenuator configuration:	1969
When the Electronic Attenuation is disabled from an enabled state:	1969
Using the Electronic Attenuator: Pros and Cons	1970
Elec Atten	1970
Adjust Atten for Min Clip	1971
Pre-Adjust for Min Clip	1971
Off	1972
Elec Atten Only	1972
Mech + Elec Atten	1973
(Mech) Atten Step	1973

Scale/Div	1973
Presel Center	1974
Proper Preselector Operation	1975
Preselector Adjust	1975
μ W Path Control	1976
Standard Path	1978
Low Noise Path Enable	1978
More Information	1979
μ W Preselector Bypass	1980
Internal Preamp	1981
Off	1982
Low Band	1983
Full Range	1983
Ref Position	1983
Auto Scaling	1984
Auto Couple	1985
More Information	1985
Auto/Man Active Function keys	1985
Auto/Man 1-of-N keys	1985
BW	1987
Res BW	1987
Video BW	1988
VBW:3dB RBW	1990
Span:3dB RBW	1990
Cont (Continuous Measurement/Sweep)	1992
File	1994
FREQ Channel	1995
Center Freq	1995
Center Frequency Presets	1996
RF Center Freq	1998
Ext Mix Center Freq	1999
I/Q Center Freq	2000
CF Step	2000
Input/Output	2002
Marker	2003
Select Marker	2003
Marker Type	2003
Properties	2004
Select Marker	2004
Relative To	2004
Marker Trace	2004
Couple Markers	2005
All Markers Off	2005

Table of Contents

Marker X Axis Value (Remote Command only)	2006
Marker X Axis Position (Remote Command only)	2006
Marker Y Axis Value (Remote Command only)	2007
Marker Function	2008
Select Marker	2008
Marker Function Type	2008
Band Adjust	2008
Band/Interval Span for Frequency Domain	2009
Band/Interval Left for Frequency Domain	2009
Band/Interval Right for Frequency Domain	2010
Marker To	2011
Meas	2012
Remote Measurement Functions	2012
Measurement Group of Commands	2013
Current Measurement Query (Remote Command Only)	2015
Limit Test Current Results (Remote Command Only)	2015
Data Query (Remote Command Only)	2015
Calculate/Compress Trace Data Query (Remote Command Only)	2016
Calculate Peaks of Trace Data (Remote Command Only)	2021
Format Data: Numeric Data (Remote Command Only)	2022
Format Data: Byte Order (Remote Command Only)	2023
Meas Setup	2024
Avg/Hold Num	2024
Avg Mode	2024
Meas Preset	2025
Mode	2026
Mode Preset	2027
How-To Preset	2028
Preset Type (Remote Command Only)	2029
Mode Setup	2030
Peak Search	2031
Print	2032
Quick Save	2033
Recall	2035
State	2035
More Information	2037
From File...	2037
Edit Register Names	2039
Register 1 thru Register 16	2039
Register 1 thru Register 16	2040
Data (Import)	2041
Mask	2042
File location and extension	2042

Example of Preset Mask file	2043
Zone Map	2043
Open...	2044
Restart	2045
More Information	2045
Save	2047
State	2047
To File . . .	2048
Edit Register Names	2050
More Information	2050
Register 1 thru Register 16	2051
Register 1 thru Register 16	2051
Data (Export)	2052
Measurement Results	2053
Meas Results File Contents	2053
Marker Table	2053
Peak Table	2056
Spectrogram	2059
Zone Map	2063
Zone Map File Contents	2064
Save As . . .	2066
Screen Image	2067
Themes	2068
3D Color	2068
3D Monochrome	2068
Flat Color	2069
Flat Monochrome	2069
Save As...	2069
Mass Storage Catalog (Remote Command Only)	2070
Mass Storage Change Directory (Remote Command Only)	2070
Mass Storage Copy (Remote Command Only)	2070
Mass Storage Device Copy (Remote Command Only)	2071
Mass Storage Delete (Remote Command Only)	2071
Mass Storage Data (Remote Command Only)	2071
Mass Storage Make Directory (Remote Command Only)	2072
Mass Storage Move (Remote Command Only)	2072
Mass Storage Remove Directory (Remote Command Only)	2072
Single (Single Measurement/Sweep)	2073
More Information	2073
Source	2074
Span X Scale	2075
Span	2075
IDEN Mode Span Preset for Monitor Spectrum	2076

Table of Contents

Full Span	2076
Last Span	2076
Sweep/Control	2078
Sweep Time	2078
Pause	2078
Gate	2079
Gate On/Off	2079
Gate View On/Off	2080
Gate View Setup	2083
Gate View Sweep Time	2084
Gate View Start Time	2084
Gate Delay	2085
Gate Length	2085
Gate Source	2086
Line	2087
External 1	2087
External 2	2089
RF Burst	2091
Periodic Timer (Frame Trigger)	2094
Control Edge/Level	2105
Gate Holdoff	2105
Gate Delay Compensation	2107
More Information	2108
Min Fast Position Query (Remote Command Only)	2108
Gate Preset (Remote Command Only)	2109
Gate Level (Remote Command Only)	2109
Gate Polarity (Remote Command Only)	2109
Points	2110
System	2111
Trace/Detector	2112
Select Trace	2112
Trace Type	2112
Update	2113
Display	2113
Detector	2114
Auto	2115
Clear Trace	2115
Clear All Traces	2115
Trigger	2117
Free Run	2117
Video	2117
Trigger Level	2117
Trig Slope	2117

Trig Delay	2117
Line	2117
Trig Slope	2117
Trig Delay	2117
External 1	2117
Trigger Level	2117
Trig Slope	2117
Trig Delay	2117
External 2	2117
Trigger Level	2118
Trig Slope	2118
Trig Delay	2118
RF Burst	2118
Absolute Trigger	2118
Relative Trigger	2118
Trig Slope	2118
Trig Delay	2118
Periodic Timer	2118
Period	2118
Offset	2118
Reset Offset Display	2118
Sync Source	2118
Off	2118
External 1	2119
External 2	2119
RF Burst	2119
Trig Delay	2119
Auto/Holdoff	2119
Auto Trig	2119
Trig Holdoff	2119
User Preset	2120
User Preset	2120
User Preset All Modes	2121
Save User Preset	2122
View/Display	2123
View for all modes except MSR, 1xEV-DO, LTE-Advanced FDD/TDD	2123
1xEV-DO Mode View	2124
MSR and LTE-Advanced FDD/TDD Mode Views	2124
View Selection by Name (MSR and LTE-Advanced FDD/TDD mode only)	2125
View Selection by Number (MSR and LTE-Advanced FDD/TDD mode only)	2125
Display	2125
Annotation	2126
Meas Bar On/Off	2127

Screen	2127
Active Function Values On/Off	2127
Title	2128
Change Title	2128
Clear Title	2129
Graticule	2130
System Display Settings	2130
Annotation Local Settings	2130
Themes	2131
Backlight	2132
Backlight Intensity	2132
17 Waveform Measurement	2135
AMPTD Y Scale	2139
Ref Value (RF Envelope View)	2139
Attenuation	2139
Dual Attenuator Configurations:	2140
Single Attenuator Configuration:	2141
(Mech) Atten	2141
Attenuator Configurations and Auto/Man	2143
Enable Elec Atten	2143
More Information	2144
Mechanical Attenuator Transition Rules	2144
When the Electronic Attenuation is enabled from a disabled state:	2144
Examples in the dual attenuator configuration:	2144
When the Electronic Attenuation is disabled from an enabled state:	2145
Using the Electronic Attenuator: Pros and Cons	2145
Elec Atten	2145
Adjust Atten for Min Clip	2146
Pre-Adjust for Min Clip	2146
Off	2147
Elec Atten Only	2147
Mech + Elec Atten	2148
(Mech) Atten Step	2148
Scale/Div (RF Envelope View)	2149
Presel Center	2149
Proper Preselector Operation	2150
Preselector Adjust	2150
μ W Path Control	2152
Standard Path	2153
Low Noise Path Enable	2153
More Information	2154
μ W Preselector Bypass	2155
Internal Preamp	2156

Off	2157
Low Band	2158
Full Range	2158
Ref Position (RF Envelope View)	2158
Auto Scaling	2159
Range	2159
Range Auto/Man	2160
I Range	2161
1 V Peak	2162
0.5 V Peak	2162
0.25 V Peak	2162
0.125 V Peak	2162
Q Range Value	2163
Q Same as I	2164
1 V Peak	2164
0.5 V Peak	2164
0.25 V Peak	2165
0.125 V Peak	2165
I/Q Gain Ranges	2165
1 V Peak	2165
0.5 V Peak	2165
0.25 V Peak	2165
0.125 V Peak	2166
Ref Value	2166
Ref Value (RF Envelope View)	2166
Ref Value (I/Q Waveform View)	2167
Scale/Div	2167
Scale/Div (RF Envelope View)	2167
Scale/Div (I/Q Waveform View)	2168
Ref Position	2169
Ref Position (RF Envelope View)	2169
Ref Position (I/Q Waveform View)	2169
Auto Couple	2171
More Information	2171
Auto/Man Active Function keys	2171
Auto/Man 1-of-N keys	2171
BW	2173
Digital IF BW	2173
Filter Type	2174
Filter BW	2175
Filter Alpha	2176
Filter Type Bwcc	2176
Gaussian	2177

Gaussian filters	2177
Flattop	2181
Flattop Filters	2182
Channel Filter Bandwidth Bwcc (Remote Command Only)	2183
Cont (Continuous Measurement/Sweep)	2184
File	2186
FREQ Channel	2187
Center Freq	2187
Center Frequency Presets	2188
RF Center Freq	2190
Ext Mix Center Freq	2191
I/Q Center Freq	2192
Input/Output	2193
Marker	2194
Select Marker	2194
Marker Type	2194
Properties	2195
Select Marker	2195
Relative To	2195
Marker Trace	2196
Couple Markers	2196
All Markers Off	2197
Marker X Axis Value (Remote Command Only)	2197
Marker X Axis Position (Remote Command Only)	2198
Marker Y Axis Value (Remote Command Only)	2198
Backward Compatibility SCPI Commands	2199
Marker ->	2200
Marker Function	2201
Select Marker	2201
Marker Function Type	2201
Band Adjust	2202
Band/Interval Span for Time Domain	2202
Band/Interval Left for Time Domain	2203
Band/Interval Right for Time Domain	2203
Meas	2205
Remote Measurement Functions	2205
Measurement Group of Commands	2206
Current Measurement Query (Remote Command Only)	2208
Limit Test Current Results (Remote Command Only)	2208
Data Query (Remote Command Only)	2208
Calculate/Compress Trace Data Query (Remote Command Only)	2209
Calculate Peaks of Trace Data (Remote Command Only)	2214
Format Data: Numeric Data (Remote Command Only)	2215

Format Data: Byte Order (Remote Command Only)	2216
Meas Setup	2217
Average/Hold Num	2217
Avg Mode	2217
Avg Type	2218
Time Avg Num	2219
Meas Time	2219
Sample Rate	2220
PhNoise Opt	2220
Auto	2221
Best Close-in P Noise	2222
Best Wide-offset P Noise	2222
Fast Tuning	2223
Advanced	2223
ADC Dither	2223
ADC Dither Auto	2223
ADC Dither	2224
IF Gain	2225
IF Gain Auto	2225
IF Gain State	2225
IF Gain Offset	2226
Meas Preset	2227
HW Averaging	2227
Sample Period (Aperture) Setting (Remote Command Only)	2228
Mode	2229
Mode Preset	2230
How-To Preset	2231
Preset Type (Remote Command Only)	2232
Mode Setup	2233
Peak Search	2234
Next Peak	2234
Min Search	2234
Print	2236
Quick Save	2237
Recall	2239
State	2239
More Information	2241
From File...	2241
Edit Register Names	2243
Register 1 thru Register 16	2243
Register 1 thru Register 16	2244
Data (Import)	2245
Mask	2246

Table of Contents

File location and extension	2246
Example of Preset Mask file	2247
Zone Map	2247
Open...	2248
Restart	2249
More Information	2249
Save	2251
State	2251
To File . . .	2252
Edit Register Names	2254
More Information	2254
Register 1 thru Register 16	2255
Register 1 thru Register 16	2255
Data (Export)	2256
Measurement Results	2257
Meas Results File Contents	2257
Marker Table	2257
Peak Table	2260
Spectrogram	2263
Zone Map	2267
Zone Map File Contents	2268
Save As . . .	2270
Screen Image	2271
Themes	2272
3D Color	2272
3D Monochrome	2272
Flat Color	2273
Flat Monochrome	2273
Save As...	2273
Mass Storage Catalog (Remote Command Only)	2274
Mass Storage Change Directory (Remote Command Only)	2274
Mass Storage Copy (Remote Command Only)	2274
Mass Storage Device Copy (Remote Command Only)	2275
Mass Storage Delete (Remote Command Only)	2275
Mass Storage Data (Remote Command Only)	2275
Mass Storage Make Directory (Remote Command Only)	2276
Mass Storage Move (Remote Command Only)	2276
Mass Storage Remove Directory (Remote Command Only)	2276
Single (Single Measurement/Sweep)	2277
More Information	2277
Source	2278
Span X Scale	2279
Ref Value	2279

Scale/Div	2279
Ref Position	2280
Auto Scaling	2280
Sweep/Control	2282
Pause/Resume	2282
Abort (Remote Command Only)	2282
System	2284
Trace/Detector	2285
Trigger	2286
Free Run	2286
Video	2286
Trigger Level	2286
Trig Slope	2286
Trig Delay	2286
Line	2286
Trig Slope	2286
Trig Delay	2286
External 1	2286
Trigger Level	2286
Trig Slope	2286
Trig Delay	2286
External 2	2286
Trigger Level	2287
Trig Slope	2287
Trig Delay	2287
RF Burst	2287
Absolute Trigger	2287
Relative Trigger	2287
Trig Slope	2287
Trig Delay	2287
Periodic Timer	2287
Period	2287
Offset	2287
Offset Adjust (Remote Command Only)	2287
Reset Offset Display	2287
Sync Source	2287
Off	2288
External 1	2288
External 2	2288
RF Burst	2288
Trig Delay	2288
Auto/Holdoff	2288
Auto Trig	2288

Table of Contents

Trig Holdoff	2288
Baseband I/Q	2288
I/Q Mag	2289
Trigger Level	2289
Trig Slope	2289
Trig Delay	2289
I	2289
Trigger Level	2289
Trig Slope	2289
Trig Delay	2289
Q	2289
Trigger Level	2289
Trig Slope	2289
Trig Delay	2289
Input I	2289
Trigger Level	2289
Trig Slope	2290
Trig Delay	2290
Input Q	2290
Trigger Level	2290
Trig Slope	2290
Trig Delay	2290
Aux Channel Center Freq	2290
Trigger Level	2290
Trig Slope	2290
Trig Delay	2290
Trigger Center Freq	2290
Trigger BW	2290
User Preset	2291
User Preset	2291
User Preset All Modes	2292
Save User Preset	2293
View/Display	2294
View Selection by name (Remote Command Only)	2294
View Selection by number (Remote Command Only)	2294
Display	2295
Annotation	2295
Meas Bar On/Off	2296
Screen	2297
Active Function Values On/Off	2297
Title	2298
Change Title	2298
Clear Title	2299

Graticule	2300
System Display Settings	2300
Annotation Local Settings	2300
Themes	2301
Backlight	2302
Backlight Intensity	2302
RF Envelope	2303
I/Q Waveform	2304

1 About the Analyzer

The X-Series signal analyzer measures and monitors complex RF and microwave signals. Analog baseband analysis is available on MXA. The analyzer integrates traditional spectrum measurements with advanced vector signal analysis to optimize speed, accuracy, and dynamic range. The analyzer has Windows 7[®] built in as an operating system, which expands its usability.

With a broad set of applications and demodulation capabilities, an intuitive user interface, outstanding connectivity and powerful one-button measurements, the analyzer is ideal for both R&D and manufacturing engineers working on cellular, emerging wireless communications, general purpose, aerospace and defense applications.

Installing Application Software

If you want to install a measurement application after your initial hardware purchase, you need only to license it. All of the available applications are loaded in your analyzer at the time of purchase.

Thus, when you purchase a new application, you will receive an entitlement certificate that you can use to obtain a license key for that application. To activate the new measurement application, enter the license key that you obtain into the Signal Analyzer.

For the latest information on Keysight Signal Analyzer measurement applications and upgrade kits, visit the following internet URL.

http://www.agilent.com/find/sa_upgrades

Viewing a License Key

Measurement applications that you purchased with your instrument have been installed and activated at the factory before shipment. The instrument requires a unique License Key for every measurement application purchased. The license key is a hexadecimal string that is specific to your measurement application, instrument model number and serial number. It enables you to install, or reactivate, that particular application.

Press **System, Show, System** to display the measurement applications that are currently licensed in your analyzer.

Go to the following location to view the license keys for the installed measurement applications:

C:\Program Files\Agilent\Licensing

You may want to keep a copy of your license key in a secure location. To do this, you can print out a copy of the display showing the license numbers. If you should lose your license key, call your nearest Keysight Technologies service or sales office for assistance.

Obtaining and Installing a License Key

If you purchase an additional application that requires installation, you will receive an "Entitlement Certificate", which may be redeemed for a license key for one instrument. To obtain your license key, follow the instructions that accompany the certificate.

Installing a license key for the selected application can be done automatically using a USB memory device. To do this, you copy the license file to the USB memory device, at the root level. Follow the instructions that come with your software installation kit.

Installing a license key can also be done manually using the built-in license management application, which may be found via the instrument front panel keys at **System, Licensing. . .**, or on-disk at:

C:\Programming Files\Agilent\Licensing

You can also use these procedures to reinstall a license key that has been accidentally deleted, or lost due to a memory failure.

Updating Measurement Application Software

All the software applications were loaded at the time of original instrument manufacture. It is a good idea to regularly update your software with the latest available version. This helps to ensure that you receive

any improvements and expanded functionality.

Because the software was loaded at the initial purchase, further additional measurement applications may now be available. If the application you are interested in licensing is not available, you will need to do a software update. (To display a list of installed applications, press **System, Show, System.**)

Check the appropriate page of the Keysight web site for the latest available software versions, according to the name of your instrument, as follows:

http://www.agilent.com/find/pxa_software

http://www.agilent.com/find/mxa_software

http://www.agilent.com/find/exa_software

http://www.agilent.com/find/cxa_software

You can load the updated software package into the analyzer from a USB drive, or directly from the internet. An automatic loading program is included with the files.

X-Series Options and Accessories

You can view an online list of available Options and Accessories for your instrument as follows:

1. Browse to one of the following URLs, according to the product name of your analyzer:

www.agilent.com/find/cxa

www.agilent.com/find/exa

www.agilent.com/find/mxa

www.agilent.com/find/pxa

2. The home page for your instrument appears (in some cases, you may see an initial splash screen containing a button named View the Webpage, which you should click to display the home page).
3. Locate the Options tab, as highlighted in the example below, which shows the home page for the MXA.



4. Click the Options tab, to display a list of available options and accessories for your instrument.

Front-Panel Features

The instrument's Front-panel features are fully detailed in the section "Front-Panel Features" (under the chapter "Front and Rear Panel Features") of the document:

[Getting Started Guide](#)

If you are viewing this information as a Help file in the instrument, then you can click on the link above to open the PDF document.

Display Annotations

Display Annotations are fully detailed under the chapter "Front and Rear Panel Features" of the document:

[Getting Started Guide](#)

If you are viewing this information as a Help file in the instrument, then you can click on the link above to open the PDF document.

Rear-Panel Features

The instrument's Rear-panel features are fully detailed in the section "Rear-Panel Features" (under the chapter "Front and Rear Panel Features") of the document:

[Getting Started Guide](#)

If you are viewing this information as a Help file in the instrument, then you can click on the link above to open the PDF document.

Window Control Keys

The instrument provides three front-panel keys for controlling windows. They are Multi Window, Zoom, and Next Window. These are all “immediate action” keys.

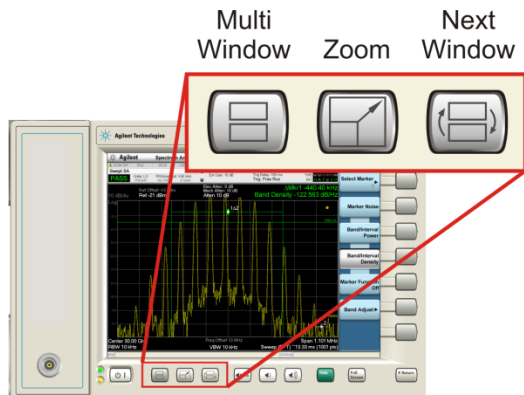

Multi-Window



The Multi Window front-panel key will toggle you back and forth between the Normal View and the last Multi Window View (Zone Span, Trace Zoom or Spectrogram) that you were in, when using the Swept SA measurement of the Spectrum Analyzer Mode. It remembers which View you were in through a Preset. This “previous view” is set to Zone Span on a Restore Mode Defaults.

Key Path	Front-panel key
Initial S/W Revision	Prior to A.02.00

Zoom

Zoom is a toggle function. Pressing this key once increases the size of the selected window. Pressing the key again returns the window to the original size.

When Zoom is on for a window, that window will get the entire primary display area. The zoomed window, since it is the selected window, is outlined in green.

Zoom is local to each Measurement. Each Measurement remembers its Zoom state. The Zoom state of each Measurement is part of the Mode’s state.

NOTE

Data acquisition and processing for the other windows continues while a window is zoomed, as does all SCPI communication with the other windows.

Remote Command	<code>:DISPlay:WINDow:FORMat:ZOOM</code>
-----------------------	--

Remote Command	:DISPlay:WINDow:FORMat:TILE
Example	:DISP:WIND:FORM:ZOOM sets zoomed :DISP:WIND:FORM:TILE sets un-zoomed
Preset	TILE
Initial S/W Revision	Prior to A.02.00

Next Window

Selects the next window of the current view. When the Next Window key is pressed, the next window in the order of precedence becomes selected. If the selected window was zoomed, the next window will also be zoomed.

The window numbers are as follows. Note that these numbers also determine the order of precedence (that is, Next Window goes from 1 to 2, then 2 to 3, etc.):

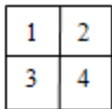

Four window display

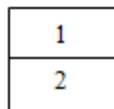

Two window display

RTSA measurements:

Only two windows are available in the Spectrogram view under the Spectrum measurement and up to three windows are available in the Power vs. Time measurement, depending on the view set up.

Remote Command	:DISPlay:WINDow[:SElect] <number> :DISPlay:WINDow[:SElect]?
Example	:DISP:WIND 1
Preset	1
Min	1
Max	If <number> is greater than the number of windows, limit to <number of windows>
Initial S/W Revision	Prior to A.02.00

One and only one window is always selected. The selected window has the focus; this means that all window-specific key presses apply only to that window. You can tell which window is selected by the thick green border around it. If a window is not selected, its boundary is gray.

If a window in a multi-window display is zoomed it is still outlined in green. If there is only one window, the green outline is not used. This allows the user to distinguish between a zoomed window and a display with only one window.

The selected window is local to each Measurement. Each Measurement remembers which window is selected. The selected window for each Measurement is remembered in Mode state.

NOTE

When this key is pressed in Help Mode, it toggles focus between the table of contents window and the topic pane window.

Full Screen

When Full Screen is pressed the measurement window expands horizontally over the entire instrument display. The screen graticule area expands to fill the available display area.

It turns off the display of the softkey labels, however the menus and active functions still work. (Though it would obviously be very hard to navigate without the key labels displayed.) Pressing Full Screen again while Full Screen is in effect cancels Full Screen.

Note that the banner and status lines are unaffected. You can get even more screen area for your data display by turning off the Meas Bar (in the Display menu) which also turns off the settings panel.

Full Screen is a Meas Global function. Therefore it is cancelled by the Preset key.

Key Path	Display
Remote Command	:DISPlay:FSCReen[:STAtE] OFF ON 0 1 :DISPlay:FSCReen[:STAtE]?
Preset	Unaffected by Preset but set to Off by Restore Misc Defaults or shutdown and restart
State Saved	Not saved in instrument state.
Backwards Compatibility SCPI	:DISPlay:MENU[:STAtE] OFF ON 0 1 This emulates ESA full screen functionality, which is the same as the FSCReen command in PSA except that the sense of on/off is reversed (that is, OFF means the menus are OFF, so Fullscreen is ON) and the default is ON (meaning Fullscreen is OFF).
Backwards Compatibility Notes	In ESA/PSA, Full Screen was turned on with a softkey, so pressing any other key turned Full Screen off. In the X-Series, because a hardkey is provided to turn this function on and off, pressing any other key no longer turns off Full Screen
Initial S/W Revision	Prior to A.02.00

Display Enable (Remote Command Only)

Turns the display on/off, including the display drive circuitry. The backlight stays lit so you can tell that the instrument is on. The display enable setting is mode global. The reasons for turning the display off are three:

- To increase speed as much as possible by freeing the instrument from having to update the display
- To reduce emissions from the display, drive circuitry
- For security purposes

If you have turned off the display:

- and you are in local operation, the display can be turned back on by pressing any key or by sending the SYSTem:DEFaults MISC command or the DISPlay:ENABle ON (neither *RST nor SYSTem:PRESet enable the display.)
- and you are in remote operation, the display can be turned back on by pressing the Local or Esc keys or by sending the SYSTem:DEFaults MISC command or the DISPlay:ENABle ON (neither *RST nor SYSTem:PRESet enable the display.)

and you are using either the SYSTem:KLOCK command or GPIB local lockout, then no front-panel key press will turn the display back on. You must turn it back on remotely.

Remote Command	:DISPlay:ENABle OFF ON 0 1 :DISPlay:ENABle?
Example	DISP:ENAB OFF
Couplings	DISP:ENAB OFF turns Backlight OFF and DISP:ENAB ON turns Backlight ON. However, settings of Backlight do not change the state of DISP:ENAB
Preset	On Set by SYST:DEF MISC, but Not affected by *RST or SYSTem:PRESet.
State Saved	Not saved in instrument state.
Backwards Compatibility Notes	SYST:PRES no longer turns on DISPlay:ENABle as it did in legacy analyzers
Initial S/W Revision	Prior to A.02.00

Mouse and Keyboard Control

If you do not have access to the instrument front-panel, there are several ways that a mouse and PC Keyboard can give you access to functions normally accessed using the front-panel keys.

Right-Click

If you plug in a mouse and right-click on the analyzer screen, a menu will appear as below:

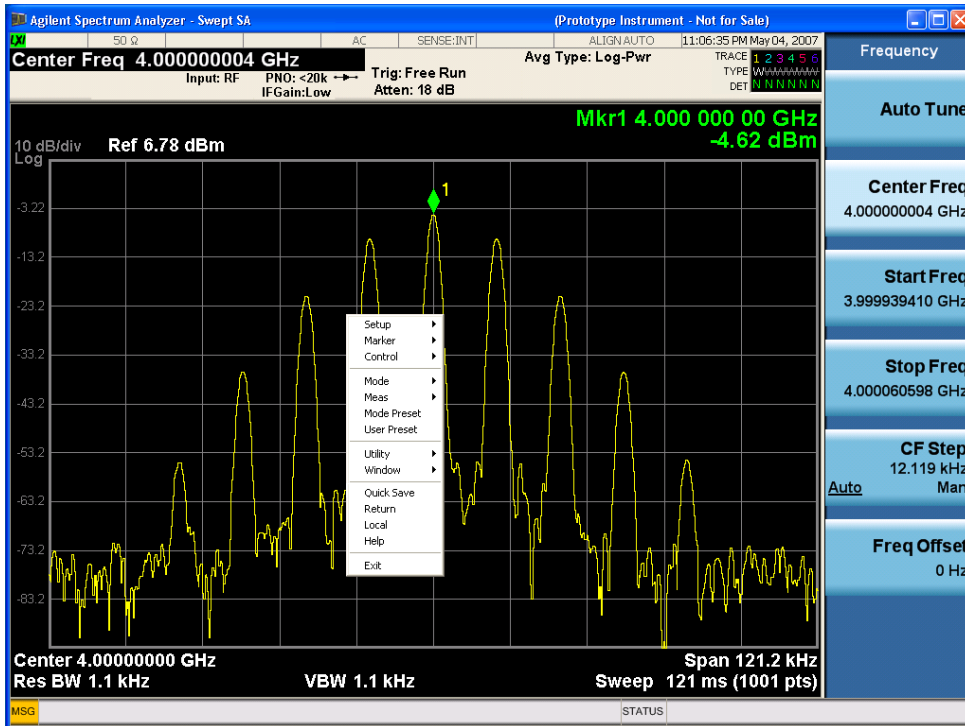

Placing the mouse on one of the rows marked with a right arrow symbol will cause that row to expand, as for example below where the mouse is hovered over the “Utility” row:

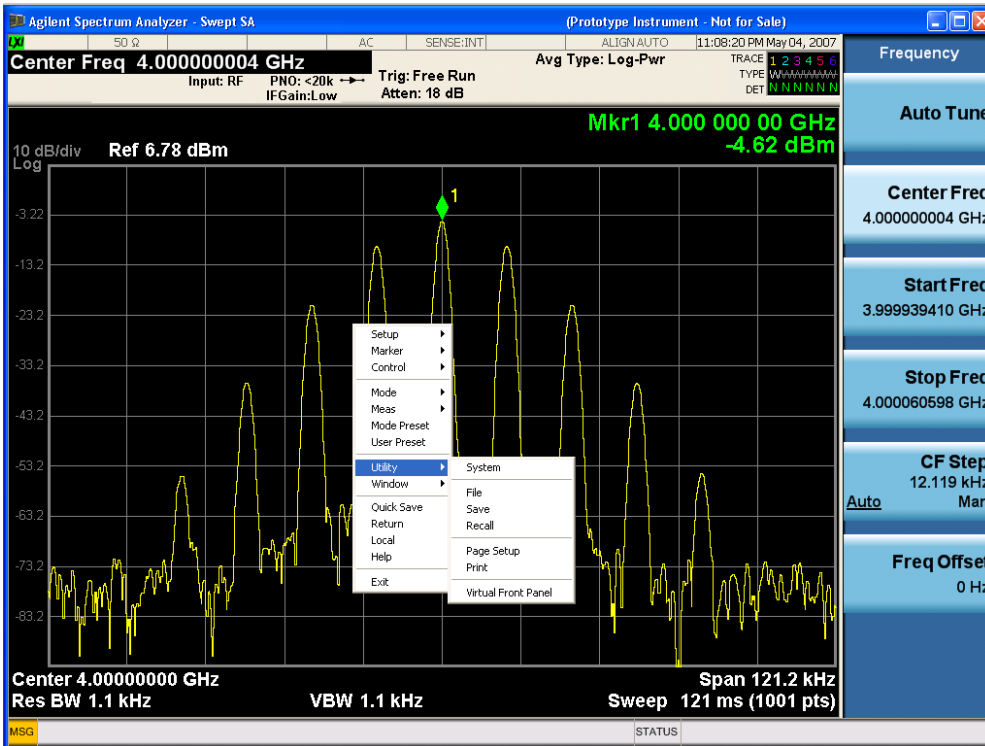

This method can be used to access any of the front-panel keys by using a mouse; as for example if you are accessing the instrument through Remote Desktop.

The array of keys thus available is shown below:

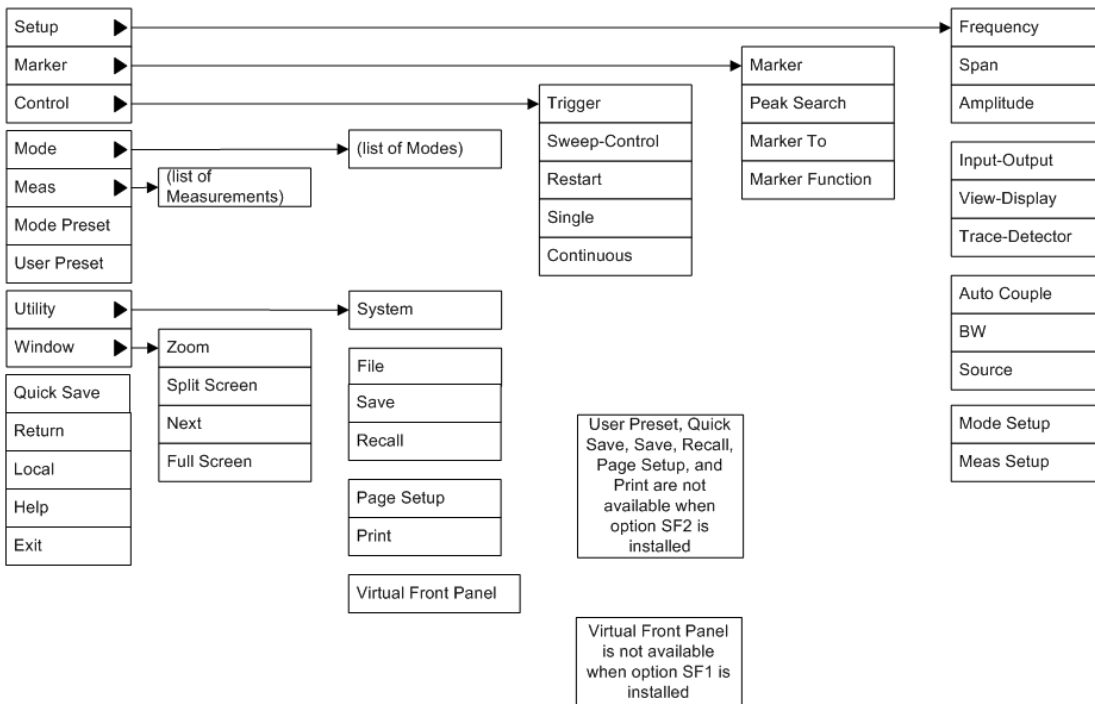

PC Keyboard

If you have a PC keyboard plugged in (or via Remote Desktop), certain key codes on the PC keyboard map to front-panel keys on the GPSA front panel. These key codes are shown below:

Front-panel key	Key code
Frequency	CTRL+SHIFT+F
Span	CTRL+SHIFT+S
Amplitude	CTRL+SHIFT+A
Input/Output	CTRL+SHIFT+O
View/Display	CTRL+SHIFT+V
Trace/Detector	CTRL+ALT+T
Auto Couple	CTRL+SHIFT+C
Bandwidth	CTRL+ALT+B
Source	CTRL+ALT-U
Marker	CTRL+ALT+K
Peak Search	CTRL+ALT+P
Marker To	CTRL+ALT+N
Marker Function	CTRL+ALT+F
System	CTRL+SHIFT+Y
Quick Save	CTRL+Q
Save	CTRL+S
Recall	CTRL+R
Mode Preset	CTRL+M
User Preset	CTRL+U
Print	CTRL+P
File	CTRL+SHIFT+L
Mode	CTRL+SHIFT+M
Measure	CTRL+ALT+M
Mode Setup	CTRL+SHIFT+E
Meas Setup	CTRL+ALT+E
Trigger	CTRL+SHIFT+T
Sweep/Control	CTRL+SHIFT+W
Restart	CTRL+ALT+R
Single	CTRL+ALT+S
Cont	CTRL+ALT+C
Zoom	CTRL+SHIFT+Z
Next Window	CTRL+SHIFT+N
Split Screen	CTRL+L

Front-panel key	Key code
Full Screen	CTRL+SHIFT+B
Return	CTRL+SHIFT+R
Mute	Mute
Inc Audio	Volume Up
Dec Audio	Volume Down
Help	F1
Control	CTRL
Alt	ALT
Enter	Return
Cancel	Esc
Del	Delete
Backspace	Backspace
Select	Space
Up Arrow	Up
Down Arrow	Down
Left Arrow	Left
Right Arrow	Right
Menu key 1	CTRL+SHIFT+F1
Menu key 2	CTRL+SHIFT+F2
Menu key 3	CTRL+SHIFT+F3
Menu key 4	CTRL+SHIFT+F4
Menu key 5	CTRL+SHIFT+F5
Menu key 6	CTRL+SHIFT+F6
Menu key 7	CTRL+SHIFT+F7
Backspace	BACKSPACE
Enter	ENTER
Tab	Tab
1	1
2	2
3	3
4	4
5	5
6	6
7	7
8	8
9	9
0	0

1 About the Analyzer
Mouse and Keyboard Control

This is a pictorial view of the table:

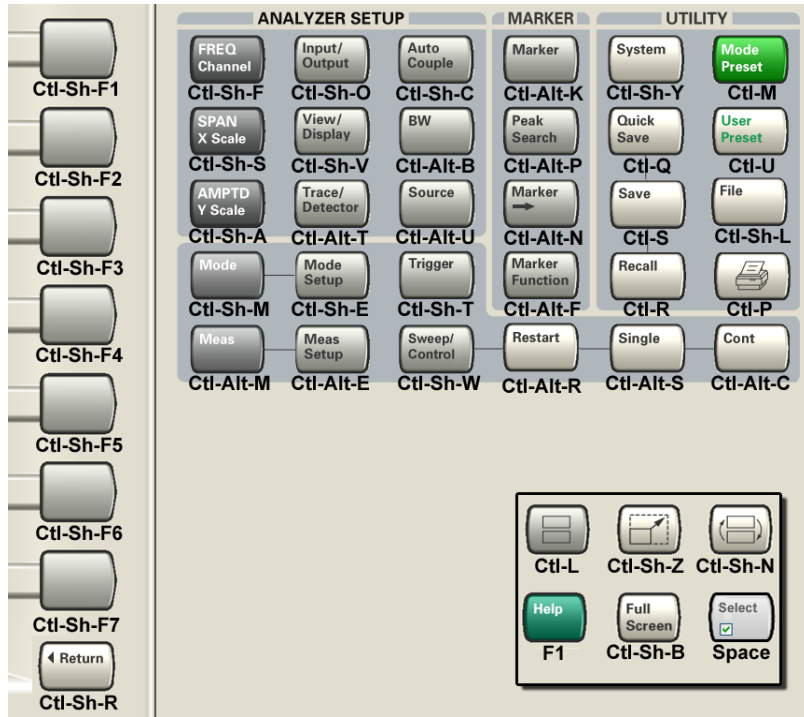

Instrument Security & Memory Volatility

If you are using the instrument in a secure environment, you may need details of how to clear or sanitize its memory, in compliance with published security standards of the United States Department of Defense, or other similar authorities.

For X-Series analyzers, this information is contained in the document "Security Features and Document of Volatility". This document is not included in the Documentation CD, or the instrument's on-disk library, but it may be downloaded from Keysight's web site.

To obtain a copy of the document, click on or browse to the following URL:

<http://www.agilent.com/find/security>

To locate and download the document, select Model Number "N9020A", then click "Submit". Then, follow the on-screen instructions to download the file.

2 About the 802.16 OFDMA Measurement Application

This chapter provides overall information for the 802.16 OFDMA Mobile Measurement Application, which supports two similar wireless technologies: WiMAX and WiBro. To illustrate OFDMA measurements, this chapter describes only WiMAX-OFDMA examples for BTS and MS.

The IEEE 802.16 OFDMA wireless standard supports fixed and mobile wireless access (BWA) systems for metropolitan and area networks. The IEEE 802.16 standard is an OFDMA based system that supports a range of bandwidths (e.g. 1.25 MHz, 10 MHz, and 20 MHz) with fixed subcarrier spacing through use of a scalable architecture. The scalable architecture uses a scalable subchannelization structure with variable Fast Fourier Transform (FFT) sizes, where the FFT sizes scale with bandwidth to keep subcarrier spacing fixed.)

WiBro is a wireless broadband internet technology. WiBro base stations will offer an aggregate data throughput of 30 to 50 Mbits/s and cover a radius of 1 - 5 km, enabling portable internet usage within range of the base station. WiBro also offers Quality of Service (QoS). QoS enables WiBro to stream video content and other loss-sensitive data in a reliable manner.

The 802.16 OFDMA Measurement Application supports the following standards:

- IEEE 802.16e -2005
- WiBro (Korean mobile WiMAX OFDMA service)

The following measurements may be performed using the 802.16 OFDMA Measurement Application:

- Channel Power
- ACP
- Spectrum Emission Mask
- Spurious Emissions
- Occupied Bandwidth
- Power Stat CCDF
- Modulation Analysis

2 About the 802.16 OFDMA Measurement Application

- Power vs. Time
- Monitor Spectrum
- Waveform

3 Programming the Analyzer

This section provides introductory information about the programming documentation included with your product.

- ["What Programming Information is Available?" on page 102](#)
- ["STATus Subsystem " on page 143](#)
- ["IEEE 488.2 Common Commands" on page 185](#)

What Programming Information is Available?

The X-Series Documentation can be accessed through the Additional Documentation page in the instrument Help system and is included on the Documentation DVD shipped with the instrument. It can also be found online at: http://www.agilent.com/find/mxa_manuals.

The following resources are available to help you create programs for automating your X-Series measurements:

Resource	Description
X-Series Programmer's Guide	Provides general SCPI programming information on the following topics: <ul style="list-style-type: none">• Programming the X-Series Applications• Programming fundamentals• Programming examples Note that SCPI command descriptions for measurement applications are not in this book, but are in the User's and Programmer's Reference.
User's and Programmer's Reference manuals	Describes all front-panel keys and softkeys, including SCPI commands for a measurement application. Note that: <ul style="list-style-type: none">• Each measurement application has its own User's and Programmer's Reference.• The content in this manual is duplicated in the instrument's Help (the Help that you see for a key is identical to what you see in this manual).
Embedded Help in your instrument	Describes all front-panel keys and softkeys, including SCPI commands, for a measurement application. Note that the content that you see in Help when you press a key is identical to what you see in the User's and Programmer's Reference.
X-Series Getting Started Guide	Provides valuable sections related to programming including: <ul style="list-style-type: none">• Licensing New Measurement Application Software - After Initial Purchase• Configuring instrument LAN Hostname, IP Address, and Gateway Address• Using the Windows Remote Desktop to connect to the instrument remotely• Using the Embedded Web Server Telnet connection to communicate SCPI This printed document is shipped with the instrument.
Keysight Application Notes	Printable PDF versions of pertinent application notes.
Keysight VISA User's Guide	Describes the Keysight Virtual Instrument Software Architecture (VISA) library and shows how to use it to develop I/O applications and instrument drivers on Windows PCs.

List of SCPI Commands

```

*CAL?
*CLS
*ESE <integer>
*ESE?
*ESR?
*IDN?
*OPC
*OPC?
*OPT?
*RCL <register#>
*RST
*SAV <register#>
*SRE <integer>
*SRE?
*STB?
*TRG
*TST?
*WAI
ABORT
CALCulate:ACPower:LIMit:STATe OFF | ON | 0 | 1
CALCulate:ACPower:LIMit:STATe?
CALCulate:ACPower:MARKer:AOff
CALCulate:ACPower:MARKer:COUple[:STATe] ON | OFF | 1 | 0
CALCulate:ACPower:MARKer:COUple[:STATe]?
CALCulate:ACPower:MARKer[1]|2|...|12:FUNCTion:RESult?
CALCulate:ACPower:MARKer[1]|2|...|12:MAXimum
CALCulate:ACPower:MARKer[1]|2|...|12:MAXimum:LEfT
CALCulate:ACPower:MARKer[1]|2|...|12:MAXimum:NEXt
CALCulate:ACPower:MARKer[1]|2|...|12:MAXimum:RIGHT
CALCulate:ACPower:MARKer[1]|2|...|12:MINimum
CALCulate:ACPower:MARKer[1]|2|...|12:MODE POSition | DELTA | OFF
CALCulate:ACPower:MARKer[1]|2|...|12:MODE?
CALCulate:ACPower:MARKer[1]|2|...|12:PTPeak
CALCulate:ACPower:MARKer[1]|2|...|12:REFerence <integer>
CALCulate:ACPower:MARKer[1]|2|...|12:REFerence?
CALCulate:ACPower:MARKer[1]|2|...|12:STATe OFF | ON | 0 | 1
CALCulate:ACPower:MARKer[1]|2|...|12:STATe?
CALCulate:ACPower:MARKer[1]|2|...|12:TRACe 1 | 2 | 3
CALCulate:ACPower:MARKer[1]|2|...|12:TRACe?
CALCulate:ACPower:MARKer[1]|2|...|12:X <freq>
CALCulate:ACPower:MARKer[1]|2|...|12:X?
CALCulate:ACPower:MARKer[1]|2|...|12:X:POSition <real>
CALCulate:ACPower:MARKer[1]|2|...|12:X:POSition?
CALCulate:ACPower:MARKer[1]|2|...|12:Y?
CALCulate:ACPower:OFFSet[:OUTer]:LIST:LIMit:NEGative[:UPPer]:DATA <real>,
...
CALCulate:ACPower:OFFSet[:OUTer]:LIST:LIMit:NEGative[:UPPer]:DATA?
CALCulate:ACPower:OFFSet[:OUTer]:LIST:LIMit:POSitive[:UPPer]:DATA <real>,
...
CALCulate:ACPower:OFFSet[:OUTer]:LIST:LIMit:POSitive[:UPPer]:DATA?

```

```

CALCulate:CHPower:LIMit:POWer <ampl>
CALCulate:CHPower:LIMit:POWer?
CALCulate:CHPower:LIMit:POWer:FAIL?
CALCulate:CHPower:LIMit:POWer:STATe OFF | ON | 0 | 1
CALCulate:CHPower:LIMit:POWer:STATe?
CALCulate:CHPower:LIMit:PSDeNsity <real>
CALCulate:CHPower:LIMit:PSDeNsity?
CALCulate:CHPower:LIMit:PSDeNsity:STATe OFF | ON | 0 | 1
CALCulate:CHPower:LIMit:PSDeNsity:STATe?
CALCulate:CHPower:LIMit:PSD:FAIL?
CALCulate:CHPower:MARKer:AOFF
CALCulate:CHPower:MARKer[1]|2|...|12:MAXimum
CALCulate:CHPower:MARKer[1]|2|...|12:MODE POSition | DELTa | OFF
CALCulate:CHPower:MARKer[1]|2|...|12:MODE?
CALCulate:CHPower:MARKer[1]|2|...|12:REFerence <integer>
CALCulate:CHPower:MARKer[1]|2|...|12:REFerence?
CALCulate:CHPower:MARKer[1]|2|...|12:STATe OFF | ON | 0 | 1
CALCulate:CHPower:MARKer[1]|2|...|12:STATe?
CALCulate:CHPower:MARKer[1]|2|...|12:X <real>
CALCulate:CHPower:MARKer[1]|2|...|12:X?
CALCulate:CHPower:MARKer[1]|2|...|12:X:POSition <real>
CALCulate:CHPower:MARKer[1]|2|...|12:X:POSition?
CALCulate:CHPower:MARKer[1]|2|...|12:Y?
CALCulate:CLIMits:FAIL?
CALCulate:DATA<n>:COMPRESS? BLOCK | CFIT | MAXimum | MINimum | MEAN |
DMEan | RMS | RMSCubed | SAMPLE | SDEviation | PPHase[, <soffset>[,
<length>[, <roffset>[, <rlimit>]]]]
CALCulate:DATA[n]?
CALCulate:DATA[1]|2|...|6:PEAKs? <threshold>, <excursion>[, AMPLitude |
FREQuency | TIME[, ALL | GTDLine | LTDLine]]
CALCulate:DATA[1]|2|...|6:PEAKs? <threshold>, <excursion>[, AMPLitude |
FREQuency | TIME]
CALCulate:EVM:BURSt[1]|2:MODulation:TYPE QPSKR1BY2 | QPSKR3BY4 |
QAM16R1BY2 | QAM16R3BY4 | QAM64R1BY2 | QAM64R2BY3 | QAM64R3BY4
CALCulate:EVM:BURSt[1]|2:MODulation:TYPE?
CALCulate:EVM:BURSt:NUMBer?
CALCulate:EVM:BURSt:POWer:MAP ON | OFF | 1 | 0
CALCulate:EVM:BURSt:POWer:MAP?
CALCulate:EVM:BURSt[1]|2:SHAPE WRAPped | RECTangle
CALCulate:EVM:BURSt[1]|2:SHAPE?
CALCulate:EVM:BURSt:STATe ON | OFF | 1 | 0, ...
CALCulate:EVM:BURSt:STATe?
CALCulate:EVM:BURSt[1]|2:SUBChannel:INTerval <integer>
CALCulate:EVM:BURSt[1]|2:SUBChannel:INTerval?
CALCulate:EVM:BURSt[1]|2:SUBChannel:OFFSet <integer>
CALCulate:EVM:BURSt[1]|2:SUBChannel:OFFSet?
CALCulate:EVM:BURSt[1]|2:SYMBOL:INTerval <integer>
CALCulate:EVM:BURSt[1]|2:SYMBOL:INTerval?
CALCulate:EVM:BURSt[1]|2:SYMBOL:OFFSet <integer>
CALCulate:EVM:BURSt[1]|2:SYMBOL:OFFSet?
CALCulate:EVM:BURSt:TYPE[:SElect] MAP | SINGLE | UZONe
CALCulate:EVM:BURSt:TYPE[:SElect]?

```



```

CALCulate:EVM:DIUC[1]|2|...12:CODE:TYPE[:SElect] QPSKCC1BY2 | QPSKCC3BY4 |
QPSKCTC1BY2 | QPSKCC3BY4 | QAM16CC1BY2 | QAM16CC3BY4 | QAM16CTC1BY2 |
QAM16CTC3BY4 | QAM64CC1BY2 | QAM64CC2BY3 | QAM64CC3BY4 | QAM64CTC1BY2 |
QAM64CTC2BY3 | QAM64CTC3BY4 | QAM64CTC5BY6
CALCulate:EVM:DIUC[1]|2|...12:CODE:TYPE[:SElect]?
CALCulate:EVM:EQualizer:SMOothing:STATe OFF | ON | 0 | 1
CALCulate:EVM:EQualizer:SMOothing:STATe?
CALCulate:EVM:EQualizer:TMOde SEQuence | SDATa | SPILOt
CALCulate:EVM:EQualizer:TMOde?
CALCulate:EVM:INformation:BURSt <integer>
CALCulate:EVM:INformation:BURSt?
CALCulate:EVM:IQMismatch:COMPensation OFF | ON | 0 | 1
CALCulate:EVM:IQMismatch:COMPensation?
CALCulate:EVM:LIMit[1]|2:FERRor <real>
CALCulate:EVM:LIMit[1]|2:FERRor?
CALCulate:EVM:LIMit[1]|2:FERRor:STATe OFF | ON | 0 | 1
CALCulate:EVM:LIMit[1]|2:FERRor:STATe?
CALCulate:EVM:LIMit[1]|2:IQOFFset <rel_ampl>
CALCulate:EVM:LIMit[1]|2:IQOFFset?
CALCulate:EVM:LIMit[1]|2:IQOFFset:STATe OFF | ON | 0 | 1
CALCulate:EVM:LIMit[1]|2:IQOFFset:STATe?
CALCulate:EVM:LIMit[1]|2:PRCE <rel_ampl>
CALCulate:EVM:LIMit[1]|2:PRCE?
CALCulate:EVM:LIMit[1]|2:PRCE:STATe OFF | ON | 0 | 1
CALCulate:EVM:LIMit[1]|2:PRCE:STATe?
CALCulate:EVM:LIMit[1]|2:RCEPilot <rel_ampl>
CALCulate:EVM:LIMit[1]|2:RCEPilot?
CALCulate:EVM:LIMit[1]|2:RCEPilot:STATe OFF | ON | 0 | 1
CALCulate:EVM:LIMit[1]|2:RCEPilot:STATe?
CALCulate:EVM:LIMit[1]|2:RRCE <rel_ampl>
CALCulate:EVM:LIMit[1]|2:RRCE?
CALCulate:EVM:LIMit[1]|2:RRCE:AUTO 0 | 1 | OFF | ON
CALCulate:EVM:LIMit[1]|2:RRCE:AUTO?
CALCulate:EVM:LIMit[1]|2:RRCE:QA16:R1B2 <rel_ampl>
CALCulate:EVM:LIMit[1]:RRCE:QA64:R3B4 <rel_ampl>
CALCulate:EVM:LIMit[1]:RRCE:QA64:R2B3 <rel_ampl>
CALCulate:EVM:LIMit[1]:RRCE:QA64:R1B2 <rel_ampl>
CALCulate:EVM:LIMit[1]|2:RRCE:QA16:R3B4 <rel_ampl>
CALCulate:EVM:LIMit[1]:RRCE:QA64:R1B2?
CALCulate:EVM:LIMit[1]|2:RRCE:QA16:R3B4?
CALCulate:EVM:LIMit[1]|2:RRCE:QA16:R1B2?
CALCulate:EVM:LIMit[1]:RRCE:QA64:R2B3?
CALCulate:EVM:LIMit[1]:RRCE:QA64:R3B4?
CALCulate:EVM:LIMit[1]|2:RRCE:QPSK:R3B4 <rel_ampl>
CALCulate:EVM:LIMit[1]|2:RRCE:QPSK:R1B2 <rel_ampl>
CALCulate:EVM:LIMit[1]|2:RRCE:QPSK:R3B4?
CALCulate:EVM:LIMit[1]|2:RRCE:QPSK:R1B2?
CALCulate:EVM:LIMit[1]|2:RRCE:STATe OFF | ON | 0 | 1
CALCulate:EVM:LIMit[1]|2:RRCE:STATe?
CALCulate:EVM:LIMit[1]|2:SPECTrum:AMPFlatness:ABS:OFFSet:LIST:LOWer:START
<real>, ...

```

```
CALCulate:EVM:LIMit[1]|2:SPECTrum:AMPFlatness:ABS:OFFSet:LIST:LOWer:START?
CALCulate:EVM:LIMit[1]|2:SPECTrum:AMPFlatness:ABS:OFFSet:LIST:LOWer:STATE
ON|OFF|1|0, ...
CALCulate:EVM:LIMit[1]|2:SPECTrum:AMPFlatness:ABS:OFFSet:LIST:LOWer:STATE?

CALCulate:EVM:LIMit[1]|2:SPECTrum:AMPFlatness:ABS:OFFSet:LIST:LOWer:STOP
<real>, ...
CALCulate:EVM:LIMit[1]|2:SPECTrum:AMPFlatness:ABS:OFFSet:LIST:LOWer:STOP?
CALCulate:EVM:LIMit[1]
|2:SPECTrum:AMPFlatness:ABS:OFFSet:LIST:LOWer:STOP:AUTO MANual|AUTO, ...
CALCulate:EVM:LIMit[1]
|2:SPECTrum:AMPFlatness:ABS:OFFSet:LIST:LOWer:STOP:AUTO?
CALCulate:EVM:LIMit[1]|2:SPECTrum:AMPFlatness:ABS:OFFSet:LIST:SIDE
BOTH|NEGative|POSitive, ...
CALCulate:EVM:LIMit[1]|2:SPECTrum:AMPFlatness:ABS:OFFSet:LIST:SIDE?
CALCulate:EVM:LIMit[1]
|2:SPECTrum:AMPFlatness:ABS:OFFSet:LIST:SUBCarrier:START <integer>, ...
CALCulate:EVM:LIMit[1]
|2:SPECTrum:AMPFlatness:ABS:OFFSet:LIST:SUBCarrier:START?
CALCulate:EVM:LIMit[1]
|2:SPECTrum:AMPFlatness:ABS:OFFSet:LIST:SUBCarrier:STATE ON|OFF|1|0, ...
CALCulate:EVM:LIMit[1]
|2:SPECTrum:AMPFlatness:ABS:OFFSet:LIST:SUBCarrier:STATE?
CALCulate:EVM:LIMit[1]
|2:SPECTrum:AMPFlatness:ABS:OFFSet:LIST:SUBCarrier:STOP <integer>,
<integer>, <integer>, <integer>, <integer>,
CALCulate:EVM:LIMit[1]
|2:SPECTrum:AMPFlatness:ABS:OFFSet:LIST:SUBCarrier:STOP?
CALCulate:EVM:LIMit[1]|2:SPECTrum:AMPFlatness:ABS:OFFSet:LIST:UPPer:START
<real>, <real>, <real>, <real><real><real>
CALCulate:EVM:LIMit[1]|2:SPECTrum:AMPFlatness:ABS:OFFSet:LIST:UPPer:START?

CALCulate:EVM:LIMit[1]|2:SPECTrum:AMPFlatness:ABS:OFFSet:LIST:UPPer:STATE
ON|OFF|1|0, ...
CALCulate:EVM:LIMit[1]|2:SPECTrum:AMPFlatness:ABS:OFFSet:LIST:UPPer:STATE?

CALCulate:EVM:LIMit[1]|2:SPECTrum:AMPFlatness:ABS:OFFSet:LIST:UPPer:STOP
<real>, ...
CALCulate:EVM:LIMit[1]|2:SPECTrum:AMPFlatness:ABS:OFFSet:LIST:UPPer:STOP?
CALCulate:EVM:LIMit[1]
|2:SPECTrum:AMPFlatness:ABS:OFFSet:LIST:UPPer:STOP:AUTO MANual|AUTO, ...
CALCulate:EVM:LIMit[1]
|2:SPECTrum:AMPFlatness:ABS:OFFSet:LIST:UPPer:STOP:AUTO?
CALCulate:EVM:LIMit[1]|2:TOFFset <time>
CALCulate:EVM:LIMit[1]|2:TOFFset?
CALCulate:EVM:LIMit[1]|2:TOFF:STATE OFF | ON | 0 | 1
CALCulate:EVM:LIMit[1]|2:TOFF:STATE?
CALCulate:EVM:MAP:DETECT
CALCulate:EVM:MAP:SELEct:TYPE AUTO | CUSTom | FCH
CALCulate:EVM:MAP:SELEct:TYPE?
```

```

CALCulate:EVM:MARKer:AOff
CALCulate:EVM:MARKer[1]|2|...12:FUNCTION:RESult?
CALCulate:EVM:MARKer[1]|2|...12:MAXimum
CALCulate:EVM:MARKer[1]|2|...12:MAXimum:LEFT
CALCulate:EVM:MARKer[1]|2|...12:MAXimum:NEXT
CALCulate:EVM:MARKer[1]|2|...12:MAXimum:RIGHT
CALCulate:EVM:MARKer[1]|2|...12:MINimum
CALCulate:EVM:MARKer[1]|2|...12:MODE POSITION | DELTA | OFF
CALCulate:EVM:MARKer[1]|2|...12:MODE?
CALCulate:EVM:MARKer[1]|2|...12:PTPeak
CALCulate:EVM:MARKer[1]|2|...12:REference <integer>
CALCulate:EVM:MARKer[1]|2|...12:REference?
CALCulate:EVM:MARKer[1]|2|...12:STATE OFF | ON | 0 | 1
CALCulate:EVM:MARKer[1]|2|...12:STATE?
CALCulate:EVM:MARKer[1]|2|...12:TRACE SYMBOL | POLar | EVCarrier |
RECarrier | EVSymbol | RESymbol | PCARrier | RPCarrier | PSYMBOL |
RPSymbol | FLATness | DFLatness | PVT | SPECTrum
CALCulate:EVM:MARKer[1]|2|...12:TRACE?
CALCulate:EVM:MARKer[1]|2|...12:X <real>
CALCulate:EVM:MARKer[1]|2|...12:X?
CALCulate:EVM:MARKer[1]|2|...12:X:POSITION <real>
CALCulate:EVM:MARKer[1]|2|...12:X:POSITION?
CALCulate:EVM:MARKer[1]|2|...12:X:SUBCarrier <integer>
CALCulate:EVM:MARKer[1]|2|...12:X:SUBCarrier?
CALCulate:EVM:MARKer[1]|2|...12:X:SYMBOL <integer>
CALCulate:EVM:MARKer[1]|2|...12:X:SYMBOL?
CALCulate:EVM:MARKer[1]|2|...12:Y?
CALCulate:EVM:MCFilter:STATE OFF | ON | 0 | 1
CALCulate:EVM:MCFilter:STATE?
CALCulate:EVM:MS:PBASe <integer>
CALCulate:EVM:MS:PBASe?
CALCulate:EVM:PILOt INCLude | EXCLude
CALCulate:EVM:PILOt?
CALCulate:EVM:PILOt:TRACk:AMPLitude OFF | ON | 0 | 1
CALCulate:EVM:PILOt:TRACk:AMPLitude?
CALCulate:EVM:PILOt:TRACk:PHASe OFF | ON | 0 | 1
CALCulate:EVM:PILOt:TRACk:PHASe?
CALCulate:EVM:PILOt:TRACk:TIMing OFF | ON | 0 | 1
CALCulate:EVM:PILOt:TRACk:TIMing?
CALCulate:EVM:PINdex <integer>
CALCulate:EVM:PINdex?
CALCulate:EVM:SPECTrum INVert | NORMAl
CALCulate:EVM:SPECTrum?
CALCulate:EVM:SUBChannel:MASK OFF | ON | 0 | 1, ...
CALCulate:EVM:SUBChannel:MASK?
CALCulate:EVM:SYMBOL:ADJust <real>
CALCulate:EVM:SYMBOL:ADJust?
CALCulate:EVM:UZONE[1]|2:MODulation:TYPE QPSKR1BY2 | QPSKR3BY4 |
QAM16R1BY2 | QAM16R3BY4 | QAM64R1BY2 | QAM64R2BY3 | QAM64R3BY4
CALCulate:EVM:UZONE[1]|2:MODulation:TYPE?
CALCulate:EVM:ZONE <integer>
CALCulate:EVM:ZONE?

```

```
CALCulate:EVM:ZONE:INTERval <integer>
CALCulate:EVM:ZONE:INTERval?
CALCulate:EVM:ZONE:OFFSet <integer>
CALCulate:EVM:ZONE:OFFSet?
CALCulate:MCPower:OFFSet:LIST:LIMit:NEGative[:UPPer]:DATA (PSAPowerSuite)
CALCulate:MCPower:OFFSet:LIST:LIMit:POSitive[:UPPer]:DATA (PSAPowerSuite)
CALCulate:MONitor:MARKer:AOFF
CALCulate:MONitor:MARKer:COUPle[:STATE] ON | OFF | 1 | 0
CALCulate:MONitor:MARKer:COUPle[:STATE]?
CALCulate:MONitor:MARKer[1]|2|...|12:FUNction NOISe | BPOwer | BDENsity |
OFF
CALCulate:MONitor:MARKer[1]|2|...|12:FUNction?
CALCulate:MONitor:MARKer[1]|2|...|12:FUNction:BAND:LEFT <freq>
CALCulate:MONitor:MARKer[1]|2|...|12:FUNction:BAND:LEFT?
CALCulate:MONitor:MARKer[1]|2|...|12:FUNction:BAND:RIGHT <freq>
CALCulate:MONitor:MARKer[1]|2|...|12:FUNction:BAND:RIGHT?
CALCulate:MONitor:MARKer[1]|2|...|12:FUNction:BAND:SPAN <freq>
CALCulate:MONitor:MARKer[1]|2|...|12:FUNction:BAND:SPAN?
CALCulate:MONitor:MARKer[1]|2|...|12:FUNction:RESult?
CALCulate:MONitor:MARKer[1]|2|...|12:MAXimum
CALCulate:MONitor:MARKer[1]|2|...|12:MODE POSition | DELTa | OFF
CALCulate:MONitor:MARKer[1]|2|...|12:MODE?
CALCulate:MONitor:MARKer[1]|2|...|12:REFerence <integer>
CALCulate:MONitor:MARKer[1]|2|...|12:REFerence?
CALCulate:MONitor:MARKer[1]|2|...|12:TRACe <integer>
CALCulate:MONitor:MARKer[1]|2|...|12:TRACe?
CALCulate:MONitor:MARKer[1]|2|...|12:X <freq>
CALCulate:MONitor:MARKer[1]|2|...|12:X?
CALCulate:MONitor:MARKer[1]|2|...|12:X:POSition <real>
CALCulate:MONitor:MARKer[1]|2|...|12:X:POSition?
CALCulate:MONitor:MARKer[1]|2|...|12:Y?
CALCulate:OBWidth:LIMit:FBLimit <freq>
CALCulate:OBWidth:LIMit:FBLimit?
CALCulate:OBWidth:LIMit[:TEST] ON | OFF | 1 | 0
CALCulate:OBWidth:LIMit[:TEST]?
CALCulate:OBWidth:MARKer:AOFF
CALCulate:OBWidth:MARKer[1]|2|...|12:MAXimum
CALCulate:OBWidth:MARKer[1]|2|...|12:MODE POSition | DELTa | OFF
CALCulate:OBWidth:MARKer[1]|2|...|12:MODE?
CALCulate:OBWidth:MARKer[1]|2|...|12:REFerence <integer>
CALCulate:OBWidth:MARKer[1]|2|...|12:REFerence?
CALCulate:OBWidth:MARKer[1]|2|...|12:STATE OFF | ON | 0 | 1
CALCulate:OBWidth:MARKer[1]|2|...|12:STATE?
CALCulate:OBWidth:MARKer[1]|2|...|12:X <freq>
CALCulate:OBWidth:MARKer[1]|2|...|12:X?
CALCulate:OBWidth:MARKer[1]|2|...|12:X:POSition <real>
CALCulate:OBWidth:MARKer[1]|2|...|12:X:POSition?
CALCulate:OBWidth:MARKer[1]|2|...|12:Y?
CALCulate:PStatistic:MARKer:AOFF
CALCulate:PStatistic:MARKer[1]|2|...|12:FUNction:RESult?
CALCulate:PStatistic:MARKer[1]|2|...|12:MODE POSition | DELTa | OFF
CALCulate:PStatistic:MARKer[1]|2|...|12:MODE?
CALCulate:PStatistic:MARKer[1]|2|...|12:REFerence <integer>
```

```

CALCulate:PStatistic:MARKer[1]|2|...|12:REfERENCE?
CALCulate:PStatistic:MARKer[1]|2|...|12:TRACe MEASured | GAUSSian |
REfERENCE
CALCulate:PStatistic:MARKer[1]|2|...|12:TRACe?
CALCulate:PStatistic:MARKer[1]|2|...|12:X <rel_ampl>
CALCulate:PStatistic:MARKer[1]|2|...|12:X?
CALCulate:PStatistic:MARKer[1]|2|...|12:Y?
CALCulate:PStatistic:STORe:REfERENCE
CALCulate:PVTime:MARKer:AOFF
CALCulate:PVTime:MARKer:COUPle[:STATe] ON | OFF | 1 | 0
CALCulate:PVTime:MARKer:COUPle[:STATe]?
CALCulate:PVTime:MARKer[1]|2|...12:MAXimum
CALCulate:PVTime:MARKer[1]|2|...12:MODE POSition | DELTA | OFF
CALCulate:PVTime:MARKer[1]|2|...12:MODE?
CALCulate:PVTime:MARKer[1]|2|...12:REfERENCE <integer>
CALCulate:PVTime:MARKer[1]|2|...12:REfERENCE?
CALCulate:PVTime:MARKer[1]|2|...12:TRACe RFENvelope | UMASK | LMASK |
MAXHold | MINHold
CALCulate:PVTime:MARKer[1]|2|...12:TRACe?
CALCulate:PVTime:MASK[1]|2:LIST:LOWer:START:ABSolute <real>, ...
CALCulate:PVTime:MASK[1]|2:LIST:LOWer:START:ABSolute?
CALCulate:PVTime:MASK[1]|2:LIST:LOWer:START:RELative <rel_ampl>, ...
CALCulate:PVTime:MASK[1]|2:LIST:LOWer:START:RELative?
CALCulate:PVTime:MASK[1]|2:LIST:LOWer:STOP:ABSolute <real>, ...
CALCulate:PVTime:MASK[1]|2:LIST:LOWer:STOP:ABSolute?
CALCulate:PVTime:MASK[1]|2:LIST:LOWer:STOP:ABSolute:AUTO ON|OFF|1|0, ...
CALCulate:PVTime:MASK[1]|2:LIST:LOWer:STOP:ABSolute:AUTO?
CALCulate:PVTime:MASK[1]|2:LIST:LOWer:STOP:RELative <rel_ampl>, ...
CALCulate:PVTime:MASK[1]|2:LIST:LOWer:STOP:RELative?
CALCulate:PVTime:MASK[1]|2:LIST:LOWer:STOP:RELative:AUTO ON|OFF|1|0, ...
CALCulate:PVTime:MASK[1]|2:LIST:LOWer:STOP:RELative:AUTO?
CALCulate:PVTime:MASK[1]|2:LIST:LOWer:TEST ABSolute | RELative | AND | OR,
ABSolute | RELative | AND | OR, ABSolute | RELative | AND | OR, ABSolute |
RELative | AND | OR, ABSolute | RELative | AND | OR, ABSolute | RELative |
AND | OR, ABSolute | RELative | AND | OR, ABSolute | RELative | AND | OR,
ABSolute | RELative | AND | OR, ABSolute | RELative | AND | OR, ABSolute |
RELative | AND | OR, ABSolute | RELative | AND | OR, ABSolute |
RELative | AND | OR, ABSolute | RELative | AND | OR,
CALCulate:PVTime:MASK[1]|2:LIST:LOWer:TEST?
CALCulate:PVTime:MASK[1]|2:LIST:STATe ON|OFF|1|0, ...
CALCulate:PVTime:MASK[1]|2:LIST:STATe?
CALCulate:PVTime:MASK[1]|2:LIST:TIME:START <real>, ...
CALCulate:PVTime:MASK[1]|2:LIST:TIME:START?
CALCulate:PVTime:MASK[1]|2:LIST:TIME:STOP <real>, ...
CALCulate:PVTime:MASK[1]|2:LIST:TIME:STOP?
CALCulate:PVTime:MASK[1]|2:LIST:UPPer:START:ABSolute <real>, ...
CALCulate:PVTime:MASK[1]|2:LIST:UPPer:START:ABSolute?
CALCulate:PVTime:MASK[1]|2:LIST:UPPer:START:RELative <rel_ampl>, ...
CALCulate:PVTime:MASK[1]|2:LIST:UPPer:START:RELative?
CALCulate:PVTime:MASK[1]|2:LIST:UPPer:STOP:ABSolute <real>, ...
CALCulate:PVTime:MASK[1]|2:LIST:UPPer:STOP:ABSolute?
CALCulate:PVTime:MASK[1]|2:LIST:UPPer:STOP:ABSolute:AUTO ON|OFF|1|0, ...
CALCulate:PVTime:MASK[1]|2:LIST:UPPer:STOP:ABSolute:AUTO?

```

```
CALCulate:PVTIME:MASK[1]|2:LIST:UPPER:STOP:RELATIVE <rel_ampl>, ...
CALCulate:PVTIME:MASK[1]|2:LIST:UPPER:STOP:RELATIVE?
CALCulate:PVTIME:MASK[1]|2:LIST:UPPER:STOP:RELATIVE:AUTO ON|OFF|1|0, ...
CALCulate:PVTIME:MASK[1]|2:LIST:UPPER:STOP:RELATIVE:AUTO?
CALCulate:PVTIME:MASK[1]|2:LIST:UPPER:TEST ABSOLUTE | RELATIVE | AND | OR,
ABSOLUTE | RELATIVE | AND | OR, ABSOLUTE | RELATIVE | AND | OR, ABSOLUTE |
RELATIVE | AND | OR, ABSOLUTE | RELATIVE | AND | OR, ABSOLUTE | RELATIVE |
AND | OR, ABSOLUTE | RELATIVE | AND | OR, ABSOLUTE | RELATIVE | AND | OR,
ABSOLUTE | RELATIVE | AND | OR, ABSOLUTE | RELATIVE | AND | OR, ABSOLUTE |
RELATIVE | AND | OR, ABSOLUTE | RELATIVE | AND | OR, ABSOLUTE |
RELATIVE | AND | OR, ABSOLUTE | RELATIVE | AND | OR,
CALCulate:PVTIME:MASK[1]|2:LIST:UPPER:TEST?
CALCulate:PVTIME:MASK[1]|2:PREFERENCE A | B | C | D | E | F | G | H | I |
J | K | L
CALCulate:PVTIME:MASK[1]|2:PREFERENCE?
CALCulate:PVTIME:MASK[1]|2:REFERENCE
CALCulate:PVTIME:MASK[1]|2:REFERENCE RISE | CENTER | TRIGGER
CALCulate:PVTIME:MASK[1]|2:REFERENCE?
CALCulate:PVTIME:REFERENCE[:OFFSET]:TIME
CALCulate:PVTIME:REFERENCE[:OFFSET]:TIME <time>
CALCulate:PVTIME:REFERENCE[:OFFSET]:TIME?
CALCulate:SEMask:LLINE:STATE ON | OFF | 1 | 0
CALCulate:SEMask:LLINE:STATE?
CALCulate:SEMask:MARKER:AOFF
CALCulate:SEMask:MARKER:COUPLE[:STATE] ON | OFF | 1 | 0
CALCulate:SEMask:MARKER:COUPLE[:STATE]?
CALCulate:SEMask:MARKER[1]|2|...|12:FUNCTION:RESULT?
CALCulate:SEMask:MARKER[1]|2|...|12:MODE POSITION | OFF
CALCulate:SEMask:MARKER[1]|2|...|12:MODE?
CALCulate:SEMask:MARKER[1]|2|...|12:X <freq>
CALCulate:SEMask:MARKER[1]|2|...|12:X?
CALCulate:SEMask:MARKER[1]|2|...|12:X:POSITION <real>
CALCulate:SEMask:MARKER[1]|2|...|12:X:POSITION?
CALCulate:SEMask:MARKER[1]|2|...|12:Y?
CALCulate:SPURious:MARKER:AOFF
CALCulate:SPURious:MARKER:COUPLE[:STATE] ON | OFF | 1 | 0
CALCulate:SPURious:MARKER:COUPLE[:STATE]?
CALCulate:SPURious:MARKER[1]|2|...|12:MAXimum
CALCulate:SPURious:MARKER[1]|2|...|12:MAXimum:LEFT
CALCulate:SPURious:MARKER[1]|2|...|12:MAXimum:NEXT
CALCulate:SPURious:MARKER[1]|2|...|12:MAXimum:RIGHT
CALCulate:SPURious:MARKER[1]|2|...|12:MINimum
CALCulate:SPURious:MARKER[1]|2|...|12:MODE POSITION | DELTA | OFF
CALCulate:SPURious:MARKER[1]|2|...|12:MODE?
CALCulate:SPURious:MARKER[1]|2|...|12:PTPeak
CALCulate:SPURious:MARKER[1]|2|...|12:REFERENCE <integer>
CALCulate:SPURious:MARKER[1]|2|...|12:REFERENCE?
CALCulate:SPURious:MARKER[1]|2|...|12:X <freq>
CALCulate:SPURious:MARKER[1]|2|...|12:X?
CALCulate:SPURious:MARKER[1]|2|...|12:X:POSITION <integer>
CALCulate:SPURious:MARKER[1]|2|...|12:X:POSITION?
CALCulate:SPURious:MARKER[1]|2|...|12:Y?
```

```

CALCulate:SPURious[:RANGE][:LIST]:LIMit:ABSolute[:UPPer]:DATA[:START]
<ampl>, ...
CALCulate:SPURious[:RANGE][:LIST]:LIMit:ABSolute[:UPPer]:DATA[:START]?
CALCulate:SPURious[:RANGE][:LIST]:LIMit:ABSolute[:UPPer]:DATA:STOP <ampl>,
...
CALCulate:SPURious[:RANGE][:LIST]:LIMit:ABSolute[:UPPer]:DATA:STOP?
CALCulate:SPURious[:RANGE][:LIST]:LIMit:ABSolute[:UPPer]:DATA:STOP:AUTO
OFF|ON|0|1, ...
CALCulate:SPURious[:RANGE][:LIST]:LIMit:ABSolute[:UPPer]:DATA:STOP:AUTO?
CALCulate:WAVEform:MARKer:AOff
CALCulate:WAVEform:MARKer:COUPle[:STATe] ON | OFF | 1 | 0
CALCulate:WAVEform:MARKer:COUPle[:STATe]?
CALCulate:WAVEform:MARKer[1]|2|...|12:FUNCTion BPOwer | BDENsity | OFF
CALCulate:WAVEform:MARKer[1]|2|...|12:FUNCTion?
CALCulate:WAVEform:MARKer[1]|2|...|12:FUNCTion:BAND:LEFT <time>
CALCulate:WAVEform:MARKer[1]|2|...|12:FUNCTion:BAND:LEFT?
CALCulate:WAVEform:MARKer[1]|2|...|12:FUNCTion:BAND:RIGHT <time>
CALCulate:WAVEform:MARKer[1]|2|...|12:FUNCTion:BAND:RIGHT?
CALCulate:WAVEform:MARKer[1]|2|...|12:FUNCTion:BAND:SPAN <time>
CALCulate:WAVEform:MARKer[1]|2|...|12:FUNCTion:BAND:SPAN?
CALCulate:WAVEform:MARKer[1]|2|...|12:FUNCTion:RESUlt?
CALCulate:WAVEform:MARKer[1]|2|...|12:MAXimum
CALCulate:WAVEform:MARKer[1]|2|...|12:MAXimum:NEXt
CALCulate:WAVEform:MARKer[1]|2|...|12:MINimum
CALCulate:WAVEform:MARKer[1]|2|...|12:MODE POSition | DELTA | OFF
CALCulate:WAVEform:MARKer[1]|2|...|12:MODE?
CALCulate:WAVEform:MARKer[1]|2|...|12:REFerence <integer>
CALCulate:WAVEform:MARKer[1]|2|...|12:REFerence?
CALCulate:WAVEform:MARKer[1]|2|...|12:STATe OFF | ON | 0 | 1
CALCulate:WAVEform:MARKer[1]|2|...|12:STATe?
CALCulate:WAVEform:MARKer[1]|2|...|12:TRACe RFENvelope | I | Q | IQ
CALCulate:WAVEform:MARKer[1]|2|...|12:TRACe?
CALCulate:WAVEform:MARKer[1]|2|...|12:X <time>
CALCulate:WAVEform:MARKer[1]|2|...|12:X?
CALCulate:WAVEform:MARKer[1]|2|...|12:X:POSition <real>
CALCulate:WAVEform:MARKer[1]|2|...|12:X:POSition?
CALCulate:WAVEform:MARKer[1]|2|...|4:X:SPAN
CALCulate:WAVEform:MARKer[1]|2|...|12:Y?
CALCulate:ZMAP:DATA <string>, ...
CALCulate:ZMAP:DATA?
CALibration[:ALL]
CALibration[:ALL]?
CALibration:AUTO ON | PARTIAL | OFF
CALibration:AUTO ALERT
CALibration:AUTO?
CALibration:AUTO:ALERT TEMPerature | DAY | WEEK | NONE
CALibration:AUTO:ALERT?
CALibration:AUTO:MODE ALL | NRF
CALibration:AUTO:MODE?
CALibration:AUTO:TIME:OFF?
CALibration:DATA:BACKup <filename>
CALibration:DATA:DEFault

```

3 Programming the Analyzer

List of SCPI Commands

```
CALibration:DATA:REStore <filename>
CALibration:EMIXer
CALibration:EMIXer?
CALibration:EXPIred?
CALibration:FREQuency:REFeRence:COARse <integer>
CALibration:FREQuency:REFeRence:COARse
CALibration:FREQuency:REFeRence:COARse?
CALibration:FREQuency:REFeRence:FINE <integer>
CALibration:FREQuency:REFeRence:FINE?
CALibration:FREQuency:REFeRence:MODE CALibrated | USER
CALibration:FREQuency:REFeRence:MODE?
CALibration:IQ:FLATness:I
CALibration:IQ:FLATness:IBAR
CALibration:IQ:FLATness:I|IBAR|Q|QBAR:TIME?
CALibration:IQ:FLATness:Q
CALibration:IQ:FLATness:QBAR
CALibration:IQ:ISOLation
CALibration:IQ:ISOLation:TIME?
CALibration:IQ:PROBE:I
CALibration:IQ:PROBE:IBar
CALibration:IQ:PROBE:I|IBAR|Q|QBAR:TIME?
CALibration:IQ:PROBE:I|Q:CLEar
CALibration:IQ:PROBE:Q
CALibration:IQ:PROBE:QBar
CALibration:NRF
CALibration:NRF?
CALibration:REFeRence:CLOCK?
CALibration:REFeRence:CLOCK:END?
CALibration:REFeRence:CLOCK:INITialize?
CALibration:RF
CALibration:RF?
CALibration:RFPSelector:SCHeduler:TIME:NEXT?
CALibration:SOURce:STATe OFF | ON | 0 | 1
CALibration:SOURce:STATe?
CALibration:TEMPerature:CURRent?
CALibration:TEMPerature:LALL?
CALibration:TEMPerature:LPReselector?
CALibration:TEMPerature:LRF?
CALibration:TEMPerature:RFPSelector:LCONducted?
CALibration:TEMPerature:RFPSelector:LRADiated?
CALibration:TIME:LALL?
CALibration:TIME:LPReselector?
CALibration:TIME:LRF?
CALibration:TIME:REFeRence:CLOCK?
CALibration:TIME:RFPSelector:LCONducted?
CALibration:TIME:RFPSelector:LRADiated?
CALibration:YTF
CALibration:YTF?
CONF FSC
CONFigure?
CONFigure:ACP
CONFigure:ACP:NDEFault
CONFigure:ACPower
```



```

CONFigure:CHPower
CONFigure:CHPower
CONFigure:CHPower:NDEFault
CONFigure:EVM
CONFigure:EVM
CONFigure:EVM:NDEFault
CONFigure:MONitor
CONFigure:MONitor
CONFigure:MONitor:NDEFault
CONFigure:OBWidth
CONFigure:OBWidth
CONFigure:OBWidth:NDEFault
CONFigure:PStatistic
CONFigure:PStatistic
CONFigure:PStatistic:NDEFault
CONFigure:PVTime
CONFigure:PVTime
CONFigure:PVTime:NDEFault
CONFigure:SEMAsk
CONFigure:SEMAsk
CONFigure:SEMAsk:NDEFault
CONFigure:SPURious
CONFigure:SPURious
CONFigure:SPURious:NDEFault
CONFigure:WAVeform
CONFigure:WAVeform
CONFigure:WAVeform:NDEFault
COUple ALL | NONE
DISPlay:<measurement>:ANNOtation:TITLe:DATA <string>
DISPlay:<measurement>:ANNOtation:TITLe:DATA?
DISPlay:ACPower:VIEW:NSElect <integer>
DISPlay:ACPower:VIEW:NSElect?
DISPlay:ACPower:VIEW[:SElect] PRESult | CINformation
DISPlay:ACPower:VIEW[:SElect]?
DISPlay:ACPower:VIEW[1]:WINDow[1]:BGRaph OFF | ON | 0 | 1
DISPlay:ACPower:VIEW[1]:WINDow[1]:BGRaph?
DISPlay:ACPower:VIEW[1]:WINDow[1]:TRACe:Y[:SCALe]:COUple 0 | 1 | OFF | ON
DISPlay:ACPower:VIEW[1]:WINDow[1]:TRACe:Y[:SCALe]:COUple?
DISPlay:ACPower:VIEW[1]:WINDow[1]:TRACe:Y[:SCALe]:PDIVision <rel_ampl>
DISPlay:ACPower:VIEW[1]:WINDow[1]:TRACe:Y[:SCALe]:PDIVision?
DISPlay:ACPower:VIEW[1]:WINDow[1]:TRACe:Y[:SCALe]:RLEVel <real>
DISPlay:ACPower:VIEW[1]:WINDow[1]:TRACe:Y[:SCALe]:RLEVel?
DISPlay:ACPower:VIEW[1]:WINDow[1]:TRACe:Y[:SCALe]:RPOSition TOP | CENTER |
BOTTom
DISPlay:ACPower:VIEW[1]:WINDow[1]:TRACe:Y[:SCALe]:RPOSition?
DISPlay:ACTivefunc[:STATe] ON | OFF | 1 | 0
DISPlay:ACTivefunc[:STATe]?
DISPlay:ANNOtation:MBAR[:STATe] OFF | ON | 0 | 1
DISPlay:ANNOtation:MBAR[:STATe]?
DISPlay:ANNOtation:SCREen[:STATe] OFF | ON | 0 | 1
DISPlay:ANNOtation:SCREen[:STATe]?
DISPlay:BACKlight ON | OFF
DISPlay:BACKlight?

```

```

DISPlay:BACKlight:INTensity <integer>
DISPlay:BACKlight:INTensity?
DISPlay:CHPower:VIEW:NSElect <integer>
DISPlay:CHPower:VIEW:NSElect?
DISPlay:CHPower:VIEW[:SElect] PRESult | CINformation
DISPlay:CHPower:VIEW[:SElect] RFSpectrum | SHOULder
DISPlay:CHPower:VIEW[:SElect] RFSpectrum | SHOULder | MASK
DISPlay:CHPower:VIEW[:SElect]?
DISPlay:CHPower:VIEW[:SElect]?
DISPlay:CHPower:VIEW[:SElect]?
DISPlay:CHPower:VIEW[1]:WINDow[1]:BGRaph ON | OFF | 1 | 0
DISPlay:CHPower:VIEW[1]:WINDow[1]:BGRaph?
DISPlay:CHPower:VIEW[1]:WINDow[1]:TRACe:Y[:SCALe]:COUPle 0 | 1 | OFF | ON
DISPlay:CHPower:VIEW[1]:WINDow[1]:TRACe:Y[:SCALe]:COUPle?
DISPlay:CHPower:VIEW[1]:WINDow[1]:TRACe:Y[:SCALe]:PDIVision <rel_ampl>
DISPlay:CHPower:VIEW[1]:WINDow[1]:TRACe:Y[:SCALe]:PDIVision?
DISPlay:CHPower:VIEW[1]:WINDow[1]:TRACe:Y[:SCALe]:RLEVel <real>
DISPlay:CHPower:VIEW[1]:WINDow[1]:TRACe:Y[:SCALe]:RLEVel?
DISPlay:CHPower:VIEW[1]:WINDow[1]:TRACe:Y[:SCALe]:RPOStion TOP | CENTer |
BOTTom
DISPlay:CHPower:VIEW[1]:WINDow[1]:TRACe:Y[:SCALe]:RPOStion?
DISPlay:ENABLE OFF | ON | 0 | 1
DISPlay:ENABLE?
DISPlay:EVM:SUBChannel:INACTive INCLude | EXCLude
DISPlay:EVM:SUBChannel:INACTive?
DISPlay:EVM:VIEW:NSElect <integer>
DISPlay:EVM:VIEW:NSElect?
DISPlay:EVM:VIEW[:SElect] POLar | ZMAP | SERRor | SPOWer | SUMMary |
FLATness | PVT
DISPlay:EVM:VIEW[:SElect]?
DISPlay:EVM:VIEW4:WINDow2:TRACe:OBW ON | OFF | 0 | 1
DISPlay:EVM:VIEW4:WINDow2:TRACe:OBW?
DISPlay:EVM:VIEW4:WINDow[1]:TRACe:X[:SCALe]:COUPle 0 | 1 | OFF | ON
DISPlay:EVM:VIEW3:WINDow[1]:TRACe:X[:SCALe]:COUPle 0 | 1 | OFF | ON
DISPlay:EVM:VIEW6:WINDow[1]|2:TRACe:X[:SCALe]:COUPle 0 | 1 | OFF | ON
DISPlay:EVM:VIEW3:WINDow2:TRACe:X[:SCALe]:COUPle 0 | 1 | OFF | ON
DISPlay:EVM:VIEW7:WINDow[1]:TRACe:X[:SCALe]:COUPle 0 | 1 | OFF | ON
DISPlay:EVM:VIEW4:WINDow2:TRACe:X[:SCALe]:COUPle 0 | 1 | OFF | ON
DISPlay:EVM:VIEW7:WINDow[1]:TRACe:X[:SCALe]:COUPle?
DISPlay:EVM:VIEW4:WINDow2:TRACe:X[:SCALe]:COUPle?
DISPlay:EVM:VIEW3:WINDow2:TRACe:X[:SCALe]:COUPle?
DISPlay:EVM:VIEW4:WINDow[1]:TRACe:X[:SCALe]:COUPle?
DISPlay:EVM:VIEW3:WINDow[1]:TRACe:X[:SCALe]:COUPle?
DISPlay:EVM:VIEW6:WINDow[1]|2:TRACe:X[:SCALe]:COUPle?
DISPlay:EVM:VIEW3:WINDow[1]:TRACe:X[:SCALe]:PDIVision <real>
DISPlay:EVM:VIEW4:WINDow[1]:TRACe:X[:SCALe]:PDIVision <real>
DISPlay:EVM:VIEW6:WINDow[1]|2:TRACe:X[:SCALe]:PDIVision <real>
DISPlay:EVM:VIEW3:WINDow2:TRACe:X[:SCALe]:PDIVision <real>
DISPlay:EVM:VIEW4:WINDow2:TRACe:X[:SCALe]:PDIVision <real>
DISPlay:EVM:VIEW7:WINDow[1]:TRACe:X[:SCALe]:PDIVision <time>
DISPlay:EVM:VIEW4:WINDow2:TRACe:X[:SCALe]:PDIVision?
DISPlay:EVM:VIEW6:WINDow[1]|2:TRACe:X[:SCALe]:PDIVision?
DISPlay:EVM:VIEW3:WINDow[1]:TRACe:X[:SCALe]:PDIVision?

```

```

DISPlay:EVM:VIEW4:WINDow[1]:TRACe:X[:SCALe]:PDIVision?
DISPlay:EVM:VIEW7:WINDow[1]:TRACe:X[:SCALe]:PDIVision?
DISPlay:EVM:VIEW3:WINDow2:TRACe:X[:SCALe]:PDIVision?
DISPlay:EVM:VIEW3:WINDow[1]:TRACe:X[:SCALe]:RLEVel <real>
DISPlay:EVM:VIEW4:WINDow2:TRACe:X[:SCALe]:RLEVel <real>
DISPlay:EVM:VIEW3:WINDow2:TRACe:X[:SCALe]:RLEVel <real>
DISPlay:EVM:VIEW7:WINDow[1]:TRACe:X[:SCALe]:RLEVel <time>
DISPlay:EVM:VIEW4:WINDow[1]:TRACe:X[:SCALe]:RLEVel <real>
DISPlay:EVM:VIEW6:WINDow[1]|2:TRACe:X[:SCALe]:RLEVel <real>
DISPlay:EVM:VIEW3:WINDow2:TRACe:X[:SCALe]:RLEVel?
DISPlay:EVM:VIEW6:WINDow[1]|2:TRACe:X[:SCALe]:RLEVel?
DISPlay:EVM:VIEW7:WINDow[1]:TRACe:X[:SCALe]:RLEVel?
DISPlay:EVM:VIEW4:WINDow[1]:TRACe:X[:SCALe]:RLEVel?
DISPlay:EVM:VIEW4:WINDow2:TRACe:X[:SCALe]:RLEVel?
DISPlay:EVM:VIEW3:WINDow[1]:TRACe:X[:SCALe]:RLEVel?
DISPlay:EVM:VIEW7:WINDow[1]:TRACe:X[:SCALe]:RPOStion LEFT | CENTER |
RIGHT
DISPlay:EVM:VIEW3:WINDow2:TRACe:X[:SCALe]:RPOStion LEFT | CENTER | RIGHT
DISPlay:EVM:VIEW3:WINDow[1]:TRACe:X[:SCALe]:RPOStion LEFT | CENTER |
RIGHT
DISPlay:EVM:VIEW6:WINDow[1]|2:TRACe:X[:SCALe]:RPOStion LEFT | CENTER |
RIGHT
DISPlay:EVM:VIEW4:WINDow2:TRACe:X[:SCALe]:RPOStion LEFT | CENTER | RIGHT
DISPlay:EVM:VIEW4:WINDow[1]:TRACe:X[:SCALe]:RPOStion LEFT | CENTER |
RIGHT
DISPlay:EVM:VIEW3:WINDow[1]:TRACe:X[:SCALe]:RPOStion?
DISPlay:EVM:VIEW6:WINDow[1]|2:TRACe:X[:SCALe]:RPOStion?
DISPlay:EVM:VIEW7:WINDow[1]:TRACe:X[:SCALe]:RPOStion?
DISPlay:EVM:VIEW4:WINDow[1]:TRACe:X[:SCALe]:RPOStion?
DISPlay:EVM:VIEW3:WINDow2:TRACe:X[:SCALe]:RPOStion?
DISPlay:EVM:VIEW4:WINDow2:TRACe:X[:SCALe]:RPOStion?
DISPlay:EVM:VIEW4:WINDow[1]|2:TRACe:Y[:SCALe]:COUPle ON | OFF | 1 | 0
DISPlay:EVM:VIEW7:WINDow[1]|2:TRACe:Y[:SCALe]:COUPle ON | OFF | 1 | 0
DISPlay:EVM:VIEW6:WINDow[1]|2:TRACe:Y[:SCALe]:COUPle ON | OFF | 1 | 0
DISPlay:EVM:VIEW3:WINDow[1]|2:TRACe:Y[1]|2[:SCALe]:COUPle ON | OFF | 1 | 0
DISPlay:EVM:VIEW3:WINDow[1]|2:TRACe:Y[1]|2[:SCALe]:COUPle?
DISPlay:EVM:VIEW6:WINDow[1]|2:TRACe:Y[:SCALe]:COUPle?
DISPlay:EVM:VIEW7:WINDow[1]|2:TRACe:Y[:SCALe]:COUPle?
DISPlay:EVM:VIEW4:WINDow[1]|2:TRACe:Y[:SCALe]:COUPle?
DISPlay:EVM:VIEW6:WINDow[1]:TRACe:Y[:SCALe]:PDIVision <rel_ampl>
DISPlay:EVM:VIEW7:WINDow[1]|2:TRACe:Y[:SCALe]:PDIVision <rel_ampl>
DISPlay:EVM:VIEW6:WINDow2:TRACe:Y[:SCALe]:PDIVision <rel_ampl>
DISPlay:EVM:VIEW3:WINDow[1]|2:TRACe:Y2[:SCALe]:PDIVision <real>
DISPlay:EVM:VIEW3:WINDow[1]|2:TRACe:Y[1][:SCALe]:PDIVision <rel_ampl>
DISPlay:EVM:VIEW4:WINDow[1]|2:TRACe:Y[:SCALe]:PDIVision <rel_ampl>
DISPlay:EVM:VIEW6:WINDow2:TRACe:Y[:SCALe]:PDIVision?
DISPlay:EVM:VIEW7:WINDow[1]|2:TRACe:Y[:SCALe]:PDIVision?
DISPlay:EVM:VIEW4:WINDow[1]|2:TRACe:Y[:SCALe]:PDIVision?
DISPlay:EVM:VIEW3:WINDow[1]|2:TRACe:Y[1][:SCALe]:PDIVision?
DISPlay:EVM:VIEW3:WINDow[1]|2:TRACe:Y2[:SCALe]:PDIVision?
DISPlay:EVM:VIEW6:WINDow[1]:TRACe:Y[:SCALe]:PDIVision?
DISPlay:EVM:VIEW3:WINDow[1]|2:TRACe:Y[1][:SCALe]:RLEVel <rel_ampl>

```

3 Programming the Analyzer

List of SCPI Commands

```
DISPlay:EVM:VIEW3:WINDow[1]|2:TRACe:Y2[:SCALe]:RLEVel <real>
DISPlay:EVM:VIEW4:WINDow[1]|2:TRACe:Y[:SCALe]:RLEVel <real>
DISPlay:EVM:VIEW6:WINDow[1]:TRACe:Y[:SCALe]:RLEVel <rel_ampl>
DISPlay:EVM:VIEW6:WINDow2:TRACe:Y[:SCALe]:RLEVel <rel_ampl>
DISPlay:EVM:VIEW7:WINDow[1]|2:TRACe:Y[:SCALe]:RLEVel <real>
DISPlay:EVM:VIEW6:WINDow[1]:TRACe:Y[:SCALe]:RLEVel?
DISPlay:EVM:VIEW6:WINDow2:TRACe:Y[:SCALe]:RLEVel?
DISPlay:EVM:VIEW3:WINDow[1]|2:TRACe:Y[1][:SCALe]:RLEVel?
DISPlay:EVM:VIEW3:WINDow[1]|2:TRACe:Y2[:SCALe]:RLEVel?
DISPlay:EVM:VIEW7:WINDow[1]|2:TRACe:Y[:SCALe]:RLEVel?
DISPlay:EVM:VIEW4:WINDow[1]|2:TRACe:Y[:SCALe]:RLEVel?
DISPlay:EVM:VIEW7:WINDow[1]|2:TRACe:Y[:SCALe]:RPOSition TOP | CENTER |
BOTTom
DISPlay:EVM:VIEW3:WINDow[1]|2:TRACe:Y[1]|2[:SCALe]:RPOSition TOP | CENTER
| BOTTom
DISPlay:EVM:VIEW4:WINDow[1]|2:TRACe:Y[:SCALe]:RPOSition TOP | CENTER |
BOTTom
DISPlay:EVM:VIEW6:WINDow[1]:TRACe:Y[:SCALe]:RPOSition TOP | CENTER |
BOTTom
DISPlay:EVM:VIEW6:WINDow2:TRACe:Y[:SCALe]:RPOSition TOP | CENTER | BOTTom
DISPlay:EVM:VIEW6:WINDow2:TRACe:Y[:SCALe]:RPOSition?
DISPlay:EVM:VIEW6:WINDow[1]:TRACe:Y[:SCALe]:RPOSition?
DISPlay:EVM:VIEW3:WINDow[1]|2:TRACe:Y[1]|2[:SCALe]:RPOSition?
DISPlay:EVM:VIEW4:WINDow[1]|2:TRACe:Y[:SCALe]:RPOSition?
DISPlay:EVM:VIEW7:WINDow[1]|2:TRACe:Y[:SCALe]:RPOSition?
DISPlay:FSCREEN[:STATE] OFF | ON | 0 | 1
DISPlay:FSCREEN[:STATE]?
DISPlay:MENU[:STATE] OFF | ON | 0 | 1
DISPlay:MONitor:VIEW:NSElect <integer>
DISPlay:MONitor:VIEW:NSElect?
DISPlay:MONitor:VIEW[:SElect] RTRace | CINformation
DISPlay:MONitor:VIEW[:SElect]?
DISPlay:MONitor:VIEW:WINDow:TRACe[1]|2|3:CLEAr
DISPlay:MONitor:VIEW:WINDow:TRACe:CLEAr:ALL
DISPlay:MONitor:VIEW:WINDow:TRACe[1]|2|3:TYPE
DISPlay:MONitor:VIEW[1]:WINDow[1]:TRACe:Y[:SCALe]:COUPle 0 | 1 | OFF | ON
DISPlay:MONitor:VIEW[1]:WINDow[1]:TRACe:Y[:SCALe]:COUPle?
DISPlay:MONitor:VIEW[1]:WINDow[1]:TRACe:Y[:SCALe]:PDIVision <rel_ampl>
DISPlay:MONitor:VIEW[1]:WINDow[1]:TRACe:Y[:SCALe]:PDIVision?
DISPlay:MONitor:VIEW[1]:WINDow[1]:TRACe:Y[:SCALe]:RLEVel <real>
DISPlay:MONitor:VIEW[1]:WINDow[1]:TRACe:Y[:SCALe]:RLEVel?
DISPlay:MONitor:VIEW[1]:WINDow[1]:TRACe:Y[:SCALe]:RPOSition TOP | CENTER |
BOTTom
DISPlay:MONitor:VIEW[1]:WINDow[1]:TRACe:Y[:SCALe]:RPOSition?
DISPlay:OBWidth:VIEW[1]:WINDow[1]:TRACe:Y[:SCALe]:COUPle 0 | 1 | OFF | ON
DISPlay:OBWidth:VIEW[1]:WINDow[1]:TRACe:Y[:SCALe]:COUPle?
DISPlay:OBWidth:VIEW[1]:WINDow[1]:TRACe:Y[:SCALe]:PDIVision <rel_ampl>
DISPlay:OBWidth:VIEW[1]:WINDow[1]:TRACe:Y[:SCALe]:PDIVision?
DISPlay:OBWidth:VIEW[1]:WINDow[1]:TRACe:Y[:SCALe]:RLEVel <real>
DISPlay:OBWidth:VIEW[1]:WINDow[1]:TRACe:Y[:SCALe]:RLEVel?
DISPlay:OBWidth:VIEW[1]:WINDow[1]:TRACe:Y[:SCALe]:RPOSition TOP | CENTER |
BOTTom
```

```

DISPlay:OBWidth:VIEW[1]:WINDow[1]:TRACe:Y[:SCALe]:RPOSition?
DISPlay:PStatistic:GAUSSian[:STATE] OFF | ON | 0 | 1
DISPlay:PStatistic:GAUSSian[:STATE]?
DISPlay:PStatistic:RTRace[:STATE] OFF | ON | 0 | 1
DISPlay:PStatistic:RTRace[:STATE]?
DISPlay:PStatistic:VIEW[1]:WINDow2:TRACe:X[:SCALe]:PDIVision <rel_ampl>
DISPlay:PStatistic:VIEW[1]:WINDow2:TRACe:X[:SCALe]:PDIVision?
DISPlay:PStatistic:XSCale
DISPlay:PVTime:VIEW[1]:WINDow[1]:LMASk ON | OFF | 1 | 0
DISPlay:PVTime:VIEW[1]:WINDow[1]:LMASk?
DISPlay:PVTime:VIEW[1]:WINDow[1]:TRACe:MAXHold[:STATE] ON | OFF | 1 | 0
DISPlay:PVTime:VIEW[1]:WINDow[1]:TRACe:MAXHold[:STATE]?
DISPlay:PVTime:VIEW[1]:WINDow[1]:TRACe:MINHold[:STATE] ON | OFF | 1 | 0
DISPlay:PVTime:VIEW[1]:WINDow[1]:TRACe:MINHold[:STATE]?
DISPlay:PVTime:VIEW[1]:WINDow[1]:TRACe:X[:SCALe]:COUple 0 | 1 | OFF | ON
DISPlay:PVTime:VIEW[1]:WINDow[1]:TRACe:X[:SCALe]:COUple?
DISPlay:PVTime:VIEW[1]:WINDow[1]:TRACe:X[:SCALe]:PDIVision <time>
DISPlay:PVTime:VIEW[1]:WINDow[1]:TRACe:X[:SCALe]:PDIVision?
DISPlay:PVTime:VIEW[1]:WINDow[1]:TRACe:X[:SCALe]:RLEVel <time>
DISPlay:PVTime:VIEW[1]:WINDow[1]:TRACe:X[:SCALe]:RLEVel?
DISPlay:PVTime:VIEW[1]:WINDow[1]:TRACe:X[:SCALe]:RPOSition LEFT | CENTER |
RIGHT
DISPlay:PVTime:VIEW[1]:WINDow[1]:TRACe:X[:SCALe]:RPOSition?
DISPlay:PVTime:VIEW[1]:WINDow[1]:TRACe:Y[:SCALe]:COUple 0 | 1 | OFF | ON
DISPlay:PVTime:VIEW[1]:WINDow[1]:TRACe:Y[:SCALe]:COUple?
DISPlay:PVTime:VIEW[1]:WINDow[1]:TRACe:Y[:SCALe]:PDIVision <rel_ampl>
DISPlay:PVTime:VIEW[1]:WINDow[1]:TRACe:Y[:SCALe]:PDIVision?
DISPlay:PVTime:VIEW[1]:WINDow[1]:TRACe:Y[:SCALe]:RLEVel <real>
DISPlay:PVTime:VIEW[1]:WINDow[1]:TRACe:Y[:SCALe]:RLEVel?
DISPlay:PVTime:VIEW[1]:WINDow[1]:TRACe:Y[:SCALe]:RPOSition TOP | CENTER |
BOTTOm
DISPlay:PVTime:VIEW[1]:WINDow[1]:TRACe:Y[:SCALe]:RPOSition?
DISPlay:SEMAsk:VIEW:NSElect <integer>
DISPlay:SEMAsk:VIEW:NSElect?
DISPlay:SEMAsk:VIEW[:SElect] APFReq | RPFReq | IPOWer | CINformation
DISPlay:SEMAsk:VIEW[:SElect]?
DISPlay:SEMAsk:VIEW[1]:WINDow[1]:TRACe:X[:SCALe]:COUple 0 | 1 | OFF | ON
DISPlay:SEMAsk:VIEW[1]:WINDow[1]:TRACe:X[:SCALe]:COUple?
DISPlay:SEMAsk:VIEW[1]:WINDow[1]:TRACe:X[:SCALe]:PDIVision <freq>
DISPlay:SEMAsk:VIEW[1]:WINDow[1]:TRACe:X[:SCALe]:PDIVision ?
DISPlay:SEMAsk:VIEW[1]:WINDow[1]:TRACe:X[:SCALe]:RLEVel <freq>
DISPlay:SEMAsk:VIEW[1]:WINDow[1]:TRACe:X[:SCALe]:RLEVel?
DISPlay:SEMAsk:VIEW[1]:WINDow[1]:TRACe:X[:SCALe]:RPOSition LEFT | CENTER |
RIGHT
DISPlay:SEMAsk:VIEW[1]:WINDow[1]:TRACe:X[:SCALe]:RPOSition?
DISPlay:SEMAsk:VIEW[1]:WINDow[1]:TRACe:Y[:SCALe]:COUple 0 | 1 | ON | OFF
DISPlay:SEMAsk:VIEW[1]:WINDow[1]:TRACe:Y[:SCALe]:COUple?
DISPlay:SEMAsk:VIEW[1]:WINDow[1]:TRACe:Y[:SCALe]:PDIVision <rel_ampl>
DISPlay:SEMAsk:VIEW[1]:WINDow[1]:TRACe:Y[:SCALe]:PDIVision?
DISPlay:SEMAsk:VIEW[1]:WINDow[1]:TRACe:Y[:SCALe]:RLEVel <real>
DISPlay:SEMAsk:VIEW[1]:WINDow[1]:TRACe:Y[:SCALe]:RLEVel?

```

```

DISPlay:SEMask:VIEW[1]:WINDow[1]:TRACe:Y[:SCALe]:RPOSition TOP | CENTer |
BOTTom
DISPlay:SEMask:VIEW[1]:WINDow[1]:TRACe:Y[:SCALe]:RPOSition?
DISPlay:SPURious:VIEW:RANGe[:SELEct] <integer>
DISPlay:SPURious:VIEW:RANGe[:SELEct]?
DISPlay:SPURious:VIEW:RANGe:TABLE <integer>
DISPlay:SPURious:VIEW:RANGe:TABLE?
DISPlay:SPURious:VIEW[:SELEct] RESult | RANGe | ALL
DISPlay:SPURious:VIEW[:SELEct]?
DISPlay:SPURious:VIEW[1]:WINDow[1]:TRACe:Y[:SCALe]:COUPlE 0 | 1 | OFF | ON
DISPlay:SPURious:VIEW[1]:WINDow[1]:TRACe:Y[:SCALe]:COUPlE?
DISPlay:SPURious:VIEW[1]:WINDow[1]:TRACe:Y[:SCALe]:PDIVision <rel_ampl>
DISPlay:SPURious:VIEW[1]:WINDow[1]:TRACe:Y[:SCALe]:PDIVision?
DISPlay:SPURious:VIEW[1]:WINDow[1]:TRACe:Y[:SCALe]:RLEVel <real>
DISPlay:SPURious:VIEW[1]:WINDow[1]:TRACe:Y[:SCALe]:RLEVel?
DISPlay:WAVEform:VIEW:NSELEct <integer>
DISPlay:WAVEform:VIEW:NSELEct?
DISPlay:WAVEform:VIEW[:SELEct] RFENvelope | IQ
DISPlay:WAVEform:VIEW[:SELEct]?
DISPlay:WAVEform:VIEW[1]|2:WINDow[1]:TRACe:X[:SCALe]:COUPlE 0 | 1 | OFF |
ON
DISPlay:WAVEform:VIEW[1]|2:WINDow[1]:TRACe:X[:SCALe]:COUPlE?
DISPlay:WAVEform:VIEW[1]|2:WINDow[1]:TRACe:X[:SCALe]:PDIVision <time>
DISPlay:WAVEform:VIEW[1]|2:WINDow[1]:TRACe:X[:SCALe]:PDIVision?
DISPlay:WAVEform:VIEW[1]|2:WINDow[1]:TRACe:X[:SCALe]:RLEVel <time>
DISPlay:WAVEform:VIEW[1]|2:WINDow[1]:TRACe:X[:SCALe]:RLEVel?
DISPlay:WAVEform:VIEW[1]|2:WINDow[1]:TRACe:X[:SCALe]:RPOSition LEFT |
CENTer | RIGHT
DISPlay:WAVEform:VIEW[1]|2:WINDow[1]:TRACe:X[:SCALe]:RPOSition?
DISPlay:WAVEform:VIEW[1]|2:WINDow[1]:TRACe:Y[:SCALe]:COUPlE 0 | 1 | OFF |
ON
DISPlay:WAVEform:VIEW[1]|2:WINDow[1]:TRACe:Y[:SCALe]:COUPlE?
DISPlay:WAVEform:VIEW2:WINDow[1]:TRACe:Y[:SCALe]:PDIVision <voltage>
DISPlay:WAVEform:VIEW[1]:WINDow[1]:TRACe:Y[:SCALe]:PDIVision <rel_ampl>
DISPlay:WAVEform:VIEW[1]:WINDow[1]:TRACe:Y[:SCALe]:PDIVision?
DISPlay:WAVEform:VIEW2:WINDow[1]:TRACe:Y[:SCALe]:PDIVision?
DISPlay:WAVEform:VIEW[1]:WINDow[1]:TRACe:Y[:SCALe]:RLEVel <ampl>
DISPlay:WAVEform:VIEW2:WINDow[1]:TRACe:Y[:SCALe]:RLEVel <voltage>
DISPlay:WAVEform:VIEW2:WINDow[1]:TRACe:Y[:SCALe]:RLEVel?
DISPlay:WAVEform:VIEW[1]:WINDow[1]:TRACe:Y[:SCALe]:RLEVel?
DISPlay:WAVEform:VIEW[1]:WINDow[1]:TRACe:Y[:SCALe]:RPOSition TOP | CENTer
| BOTTom
DISPlay:WAVEform:VIEW2:WINDow[1]:TRACe:Y[:SCALe]:RPOSition TOP | CENTer |
BOTTom
DISPlay:WAVEform:VIEW[1]:WINDow[1]:TRACe:Y[:SCALe]:RPOSition?
DISPlay:WAVEform:VIEW2:WINDow[1]:TRACe:Y[:SCALe]:RPOSition?
DISPlay:WINDow[1]:ANNotation[:ALL] OFF | ON | 0 | 1
DISPlay:WINDow[1]:ANNotation[:ALL]?
DISPlay:WINDow:FORMat:TILE
DISPlay:WINDow:FORMat:ZOOM
DISPlay:WINDow[:SELEct] <number>
DISPlay:WINDow[:SELEct]?

```

```

DISPlay:WINDow[1]:TRACe:GRATicule:GRID[:STATe] OFF | ON | 0 | 1
DISPlay:WINDow[1]:TRACe:GRATicule:GRID[:STATe]?
FETCh:ACP[n]?
FETCh:CHPower:CHPower?
FETCh:CHPower:DENSity?
FETCh:CHPower[n]?
FETCh:EVM[n]?
FETCh:MONitor[n]?
FETCh:OBwidth:FERRor?
FETCh:OBwidth[n]?
FETCh:OBwidth:OBwidth?
FETCh:OBwidth:XDB?
FETCh:PStAtistic[n]?
FETCh:PVTime[n]?
FETCh:SEMAsk[n]?
FETCh:SPURious[n]?
FETCh:WAVEform[n]?
FORMat:BORDER NORMAl | SWAPped
FORMat:BORDER?
FORMat[:TRACe][:DATA] ASCii | INTeger, 32 | REAL, 32 | REAL, 64
FORMat[:TRACe][:DATA]?
GLOBal:DEFault
GLOBal:FREQUency:CENTER[:STATe] 1 | 0 | ON | OFF
GLOBal:FREQUency:CENTER[:STATe]?
HCOPY:ABORT
HCOPY[:IMMEdiate]
INITiate:ACP
INITiate:CHPower
INITiate:CONTinuous OFF | ON | 0 | 1
INITiate:CONTinuous?
INITiate:EVM
INITiate[:IMMEdiate]
INITiate:MONitor
INITiate:OBwidth
INITiate:PAUSE
INITiate:PStAtistic
INITiate:PVTime
INITiate:REStArt
INITiate:RESume
INITiate:SEMAsk
INITiate:SPURious
INITiate:WAVEform
INPut:COUPling AC | DC
INPut:COUPling?
INPut:COUPling:I|Q DC | LFR1 | LFR2
INPut:COUPling:I|Q?
INPut:IMPedance:IQ U50 | B50 | U1M | B1M
INPut:IMPedance:IQ?
INPut:IMPedance:REFerence <integer>
INPut:IMPedance:REFerence?
INPut[1]:IQ:BALanced[:STATe] OFF | ON | 0 | 1
INPut[1]:IQ:BALanced[:STATe]?
INPut:IQ[:I]:DIFFerential OFF | ON | 0 | 1

```

3 Programming the Analyzer

List of SCPI Commands

```
INPut:IQ[:I]:DIFFerential?
INPut[1]:IQ[:I]:IMPedance LOW | HIGH
INPut[1]:IQ[:I]:IMPedance?
INPut:IQ:MIRROred OFF | ON | 0 | 1
INPut:IQ:MIRROred?
INPut:IQ:Q:DIFFerential OFF | ON | 0 | 1
INPut:IQ:Q:DIFFerential?
INPut[1]:IQ:Q:IMPedance LOW | HIGH
INPut[1]:IQ:Q:IMPedance?
INPut[1]:IQ:TYPE IQ | I | Q
INPut[1]:IQ:TYPE?
INPut:MIXer EXTernal | INTernal
INPut:MIXer?
INPut:OFFSet:I|Q <voltage>
INPut:OFFSet:I|Q?
INSTRument:CATalog?
INSTRument:COUple:DEFault
INSTRument:COUple:FREQuency:CENTer ALL | NONE
INSTRument:COUple:FREQuency:CENTer?
INSTRument:DEFault
INSTRument:NSElect <integer>
INSTRument:NSElect?
INSTRument[:SElect] RECeiver
INSTRument[:SElect] SANalyzer
INSTRument[:SElect] 'SA' | 'PNOISE' | 'EDGE' | 'GSM' | 'BASIC'
INSTRument[:SElect] SA | RTSA | SEQAN | EMI | BASIC | WCDMA | EDGE GSM |
WIMAXOFDMA | VSA | PNOISE | NFIGure | ADEMOD | BTooth | TDSCDMA | CDMA2K |
CDMA1XEV | LTE | LTETDD | LTEAFDD | LTEATDD | MSR | DVB | DTMB | DCATV |
ISDBT | CMMB | WLAN | CWLAN | CWIMAXOFDM | WIMAXFIXED | IDEN | RLC |
SCPILC | VSA89601
INSTRument[:SElect] GSM
INSTRument[:SElect]?
INST:SEL EMI
INST:SEL SCPILC
LXI:IDENtify[:STATE] OFF | ON | 0 | 1
LXI:IDENtify[:STATE]?
MEASure:ACP[n]?
MEASure:CHPower:CHPower?
MEASure:CHPower:DENSity?
MEASure:CHPower[n]?
MEASure:EVM[n]
MEASure:MONitor[n]?
MEASure:OBWidth:FERRor?
MEASure:OBWidth[n]?
MEASure:OBWidth:OBWidth?
MEASure:OBWidth:XDB?
MEASure:PStatistic[n]?
MEASure:PVTime[n]?
MEASure:SEMask[n]?
MEASure:SPURious[n]?
MEASure:WAVEform[n]?
MMEMory:CATalog? [<directory_name>]
```



```

MMEMory:CDIRectory [<directory_name>]
MMEMory:CDIRectory?
MMEMory:COpy <string>, <string>[, <string>, <string>]
MMEMory:COpy:DEvice <source_string>, <dest_string>
MMEMory:DATA <file_name>, <data>
MMEMory:DATA? <file_name>
MMEMory:DElete <file_name>[, <directory_name>]
MMEMory:LOAD:MASK <string>
MMEMory:LOAD:STATE <filename>
MMEMory:LOAD:STATE 1, <filename>
MMEMory:LOAD:ZMAP <string>
MMEMory:MDIRectory <directory_name>
MMEMory:MOVE <string>, <string>[, <string>, <string>]
MMEMory:RDIRectory <directory_name>
MMEMory:REGister:STATE:LABel <regnumber>, "label"
MMEMory:REGister:STATE:LABel? <regnumber>
MMEMory:STORE:RESults <string>
MMEMory:STORE:RESults <string>
MMEMory:STORE:RESults <string>
MMEMory:STORE:RESults <string>
MMEMory:STORE:RESults <string>
MMEMory:STORE:RESults <string>
MMEMory:STORE:RESults:MTABLE|PTABLE|SPECTrogram <filename>
MMEMory:STORE:SCReen <filename>
MMEMory:STORE:SCReen:THEME TDColor | TDMonochrome | FCOLOR | FMONochrome
MMEMory:STORE:SCReen:THEME?
MMEMory:STORE:STATE 1, <filename>
MMEMory:STORE:STATE <filename>
MMEMory:STORE:ZMAP <string>
OUTPut:ANALog OFF | SVIDeo | LOGVideo | LINVideo | DAUDio
OUTPut:ANALog?
OUTPut:ANALog:AUTO OFF | ON | 0 | 1
OUTPut:ANALog:AUTO?
OUTPut:AUX SIF | AIF | LOGVideo | OFF
OUTPut:AUX?
OUTPut:AUX:AIF <value>
OUTPut:AUX:AIF?
OUTPut:DBUS[1][:STATE] ON | OFF | 1 | 0
OUTPut:DBUS[1][:STATE]?
OUTPut:IQ:OUTPut IQ1 | IQ250 | OFF
OUTPut:IQ:OUTPut?
READ:ACP[n]?
READ:CHPower:CHPower?
READ:CHPower:DENSity
READ:CHPower[n]?
READ:EVM[n]?
READ:MONitor[n]?
READ:OBWidth:FERRor?
READ:OBWidth[n]?
READ:OBWidth:OBWidth?
READ:OBWidth:XDB?
READ:PStatistic[n]?
READ:PVTime[n]?

```

```

READ:SEMask[n]?
READ:SPURious[n]?
READ:WAVEform[n]?
[:SENSe]:<measurement>:TRIGger:SOURce
[:SENSe]:<measurement>:TRIGger:SOURce IF
[:SENSe]:ACPower:AVERAge:COUNT <integer>
[:SENSe]:ACPower:AVERAge:COUNT?
[:SENSe]:ACPower:AVERAge[:STATe] OFF | ON | 0 | 1
[:SENSe]:ACPower:AVERAge[:STATe]?
[:SENSe]:ACPower:AVERAge:TCONtrol EXPonential | REPeat
[:SENSe]:ACPower:AVERAge:TCONtrol?
[:SENSe]:ACPower:BANDwidth:INTEgration
[:SENSe]:ACPower:BANDwidth[:RESolution] <freq>
[:SENSe]:ACPower:BANDwidth[:RESolution]?
[:SENSe]:ACPower:BANDwidth[:RESolution]:AUTO ON | OFF | 1 | 0
[:SENSe]:ACPower:BANDwidth[:RESolution]:AUTO?
[:SENSe]:ACPower:BANDwidth:SHAPE GAUSSian | FLATtop
[:SENSe]:ACPower:BANDwidth:SHAPE?
[:SENSe]:ACPower:BANDwidth:TYPE DB3 | DB6
[:SENSe]:ACPower:BANDwidth:TYPE?
[:SENSe]:ACPower:BANDwidth:VIDeo <freq>
[:SENSe]:ACPower:BANDwidth:VIDeo?
[:SENSe]:ACPower:BANDwidth:VIDeo:AUTO OFF | ON | 0 | 1
[:SENSe]:ACPower:BANDwidth:VIDeo:AUTO?
[:SENSe]:ACPower:BWIDth:INTEgration
[:SENSe]:ACPower:BWIDth[:RESolution]
[:SENSe]:ACPower:BWIDth:SHAPE
[:SENSe]:ACPower:BWIDth:TYPE
[:SENSe]:ACPower:BWIDth:VIDeo
[:SENSe]:ACPower:CARRier[1]|2:AUTO[:STATe] OFF | ON | 0 | 1
[:SENSe]:ACPower:CARRier[1]|2:AUTO[:STATe]?
[:SENSe]:ACPower:CARRier[1]|2:COUNT <integer>
[:SENSe]:ACPower:CARRier[1]|2:COUNT?
[:SENSe]:ACPower:CARRier[1]|2:CPSD <real>
[:SENSe]:ACPower:CARRier[1]|2:CPSD?
[:SENSe]:ACPower:CARRier[1]|2:LIST:BANDwidth[:INTEgration] <freq>, ...
[:SENSe]:ACPower:CARRier[1]|2:LIST:BANDwidth[:INTEgration]?
[:SENSe]:ACPower:CARRier[1]|2:LIST:BWIDth[:INTEgration]
[:SENSe]:ACPower:CARRier[1]|2:LIST:FILTer:ALPHa <real>, ...
[:SENSe]:ACPower:CARRier[1]|2:LIST:FILTer:ALPHa?
[:SENSe]:ACPower:CARRier[1]|2:LIST:FILTer[:RRC][:STATe] ON|OFF|1|0, ...
[:SENSe]:ACPower:CARRier[1]|2:LIST:FILTer[:RRC][:STATe]?
[:SENSe]:ACPower:CARRier[1]|2:LIST:METHod IBW | RRC, ...
[:SENSe]:ACPower:CARRier[1]|2:LIST:METHod?
[:SENSe]:ACPower:CARRier[1]|2:LIST:PPResent YES|NO, ...
[:SENSe]:ACPower:CARRier[1]|2:LIST:PPResent?
[:SENSe]:ACPower:CARRier[1]|2:LIST:WIDTh <freq>, ...
[:SENSe]:ACPower:CARRier[1]|2:LIST:WIDTh?
[:SENSe]:ACPower:CARRier[1]|2[:POWER] <real>
[:SENSe]:ACPower:CARRier[1]|2[:POWER]?
[:SENSe]:ACPower:CARRier[1]|2:RCARrier <integer>
[:SENSe]:ACPower:CARRier[1]|2:RCARrier?
[:SENSe]:ACPower:CARRier[1]|2:RCARrier:AUTO OFF | ON | 0 | 1

```

```

[:SENSe]:ACPower:CARRier[1]|2:RCARrier:AUTO?
[:SENSe]:ACPower:CARRier[1]|2:RCFRequency <freq>
[:SENSe]:ACPower:CARRier[1]|2:RCFRequency?
[:SENSe]:ACPower:CARRier[1]|2:RCFRequency:AUTO OFF | ON | 0 | 1
[:SENSe]:ACPower:CARRier[1]|2:RCFRequency:AUTO?
[:SENSe]:ACPower:CORRection:NOISe[:AUTO] OFF | ON | 0 | 1
[:SENSe]:ACPower:CORRection:NOISe[:AUTO]?
[:SENSe]:ACPower:DETEctor:AUTO ON | OFF | 1 | 0
[:SENSe]:ACPower:DETEctor:AUTO?
[:SENSe]:ACPower:DETEctor[:FUNction] AVERAge | NEGAtive | NORMAl |
POSitive | SAMPlE
[:SENSe]:ACPower:DETEctor[:FUNction]?
[:SENSe]:ACPower:FILTer[:RRC]:ALPHa <real>
[:SENSe]:ACPower:FILTer[:RRC]:ALPHa?
[:SENSe]:ACPower:FILTer[:RRC][:STATe] OFF | ON | 0 | 1
[:SENSe]:ACPower:FILTer[:RRC][:STATe]?
[:SENSe]:ACPower:FREQuency:SPAN <freq>
[:SENSe]:ACPower:FREQuency:SPAN?
[:SENSe]:ACPower:FREQuency:SPAN:FULL
[:SENSe]:ACPower:FREQuency:SPAN:PREVIOUS
[:SENSe]:ACPower:FREQuency:SYNThesis:AUTO[:STATe] OFF | ON | 0 | 1
[:SENSe]:ACPower:FREQuency:SYNThesis:AUTO[:STATe]?
[:SENSe]:ACPower:FREQuency:SYNThesis[:STATe] 1 | 2 | 3
[:SENSe]:ACPower:FREQuency:SYNThesis[:STATe]?
[:SENSe]:ACPower:LIMit[:STATe]
[:SENSe]:ACPower:METHod IBW | IBWRange | FAST | RBW
[:SENSe]:ACPower:METHod?
[:SENSe]:ACPower:OFFSet[1]|2:LIST:BWIDth[:INTEgration]
[:SENSe]:ACPower:OFFSet[1]|2:LIST:BWIDth:RESolution
[:SENSe]:ACPower:OFFSet[1]|2:LIST:BWIDth:SHAPE
[:SENSe]:ACPower:OFFSet[1]|2:LIST:BWIDth:TYPE
[:SENSe]:ACPower:OFFSet[1]|2:LIST:BWIDth:VIDeo
[:SENSe]:ACPower:OFFSet[1]|2[:OUTer]:LIST:ABSolute <real>, ...
[:SENSe]:ACPower:OFFSet[1]|2[:OUTer]:LIST:ABSolute?
[:SENSe]:ACPower:OFFSet[1]|2[:OUTer]:LIST:BANDwidth[:INTEgration] <freq>,
...
[:SENSe]:ACPower:OFFSet[1]|2[:OUTer]:LIST:BANDwidth[:INTEgration]?
[:SENSe]:ACPower:OFFSet[1]|2[:OUTer]:LIST:BANDwidth:RESolution <freq>, ...
[:SENSe]:ACPower:OFFSet[1]|2[:OUTer]:LIST:BANDwidth:RESolution?
[:SENSe]:ACPower:OFFSet[1]|2[:OUTer]:LIST:BANDwidth:RESolution:AUTO
ON|OFF|1|0, ...
[:SENSe]:ACPower:OFFSet[1]|2[:OUTer]:LIST:BANDwidth:RESolution:AUTO?
[:SENSe]:ACPower:OFFSet[1]|2[:OUTer]:LIST:BANDwidth:SHAPE
GAUSSian|FLATtop, ...
[:SENSe]:ACPower:OFFSet[1]|2[:OUTer]:LIST:BANDwidth:SHAPE?
[:SENSe]:ACPower:OFFSet[1]|2[:OUTer]:LIST:BANDwidth:TYPE DB3|DB6, ...
[:SENSe]:ACPower:OFFSet[1]|2[:OUTer]:LIST:BANDwidth:TYPE?
[:SENSe]:ACPower:OFFSet[1]|2[:OUTer]:LIST:BANDwidth:VIDeo <freq>, ...
[:SENSe]:ACPower:OFFSet[1]|2[:OUTer]:LIST:BANDwidth:VIDeo?
[:SENSe]:ACPower:OFFSet[1]|2[:OUTer]:LIST:BANDwidth:VIDeo:AUTO OFF|ON|0|1,
...
[:SENSe]:ACPower:OFFSet[1]|2[:OUTer]:LIST:BANDwidth:VIDeo:AUTO?

```

3 Programming the Analyzer

List of SCPI Commands

```

[:SENSe]:ACPower:OFFSet[1]|2[:OUTer]:LIST:FILTer:ALPHa <real>, ...
[:SENSe]:ACPower:OFFSet[1]|2[:OUTer]:LIST:FILTer:ALPHa?
[:SENSe]:ACPower:OFFSet[1]|2[:OUTer]:LIST:FILTer[:RRC][:STATe] ON|OFF|1|0,
...
[:SENSe]:ACPower:OFFSet[1]|2[:OUTer]:LIST:FILTer[:RRC][:STATe]?
[:SENSe]:ACPower:OFFSet[1]|2[:OUTer]:LIST[:FREQuency] <freq>, ...
[:SENSe]:ACPower:OFFSet[1]|2[:OUTer]:LIST[:FREQuency]?
[:SENSe]:ACPower:OFFSet[1]|2[:OUTer]:LIST:RCARrier <real>, ...
[:SENSe]:ACPower:OFFSet[1]|2[:OUTer]:LIST:RCARrier?
[:SENSe]:ACPower:OFFSet[1]|2[:OUTer]:LIST:RPSDeNsity <rel_ampl>, ...
[:SENSe]:ACPower:OFFSet[1]|2[:OUTer]:LIST:RPSDeNsity?
[:SENSe]:ACPower:OFFSet[1]|2[:OUTer]:LIST:SIDE NEgative|BOTH|POSitive, ...
[:SENSe]:ACPower:OFFSet[1]|2[:OUTer]:LIST:SIDE?
[:SENSe]:ACPower:OFFSet[1]|2[:OUTer]:LIST:STATe OFF|ON|0|1, ...
[:SENSe]:ACPower:OFFSet[1]|2[:OUTer]:LIST:STATe?
[:SENSe]:ACPower:OFFSet[1]|2[:OUTer]:LIST:TEST ABSolute|AND|OR|RELative,
...
[:SENSe]:ACPower:OFFSet[1]|2[:OUTer]:LIST:TEST?
[:SENSe]:ACPower:OFFSet[1]|2[:OUTer]:TYPE CTOCenter | CTOEdge | ETOCenter
| ETOEdge
[:SENSe]:ACPower:OFFSet[1]|2[:OUTer]:TYPE?
[:SENSe]:ACPower:SWEep:POINts <integer>
[:SENSe]:ACPower:SWEep:POINts?
[:SENSe]:ACPower:SWEep:TIME <time>
[:SENSe]:ACPower:SWEep:TIME?
[:SENSe]:ACPower:SWEep:TIME:AUTO OFF | ON | 0 | 1
[:SENSe]:ACPower:SWEep:TIME:AUTO?
[:SENSe]:ACPower:SWEep:TIME:AUTO:RULEs NORMAl | ACCuracy
[:SENSe]:ACPower:SWEep:TIME:AUTO:RULEs?
[:SENSe]:ACPower:TYPE TPRef | PSDRef
[:SENSe]:ACPower:TYPE?
[:SENSe]:ACPR:AVERAge:COUNT
[:SENSe]:ACPR:AVERAge:TCONtrol
[:SENSe]:ACPR:FILTer[:RRC]:ALPHa
[:SENSe]:ACPR:FILTer[:RRC][:STATe]
[:SENSe]:ACPR:OFFSet[1]|2:LIST:ABSolute (PSAW-CDMA, PSAcDMA2000)
[:SENSe]:ACPR:OFFSet[1]|2:LIST:BANDwidth
[:SENSe]:ACPR:OFFSet[1]|2:LIST:BWIDth
[:SENSe]:ACPR:SWEep:DETEctor[:FUNction]
[:SENSe]:ACPR:SWEep:TYPE
[:SENSe]:ACPR:TRIGger:SOURce
[:SENSe]:ACP:SWEep:BANDwidth|BWIDth[:RESolution] (PSAW-CDMA, PSAcDMA2000)
[:SENSe]:CHPower:AVERAge:COUNT <integer>
[:SENSe]:CHPower:AVERAge:COUNT?
[:SENSe]:CHPower:AVERAge[:STATe] ON | OFF | 1 | 0
[:SENSe]:CHPower:AVERAge[:STATe]?
[:SENSe]:CHPower:AVERAge:TCONtrol EXPOntial | REPeat
[:SENSe]:CHPower:AVERAge:TCONtrol?
[:SENSe]:CHPower:BANDwidth:INTEgration <bandwidth>
[:SENSe]:CHPower:BANDwidth:INTEgration?
[:SENSe]:CHPower:BANDwidth[:RESolution] <bandwidth>
[:SENSe]:CHPower:BANDwidth[:RESolution]?

```

```

[:SENSE]:CHPower:BANDwidth[:RESolution]:AUTO ON | OFF | 1 | 0
[:SENSE]:CHPower:BANDwidth[:RESolution]:AUTO?
[:SENSE]:CHPower:BANDwidth:SHAPE GAUSSian | FLATtop
[:SENSE]:CHPower:BANDwidth:SHAPE?
[:SENSE]:CHPower:BANDwidth:VIDeo <bandwidth>
[:SENSE]:CHPower:BANDwidth:VIDeo?
[:SENSE]:CHPower:BANDwidth:VIDeo:AUTO ON | OFF | 1 | 0
[:SENSE]:CHPower:BANDwidth:VIDeo:AUTO?
[:SENSE]:CHPower:BWIDth[:RESolution]
[:SENSE]:CHPower:BWIDth:SHAPE
[:SENSE]:CHPower:DETEctor:AUTO ON | OFF | 1 | 0
[:SENSE]:CHPower:DETEctor:AUTO?
[:SENSE]:CHPower:DETEctor[:FUNCTion] NORMal | AVERAge | POSitive | SAMPlE
| NEGative
[:SENSE]:CHPower:DETEctor[:FUNCTion]?
[:SENSE]:CHPower:FILTer[:RRC]:ALPHa <real>
[:SENSE]:CHPower:FILTer[:RRC]:ALPHa?
[:SENSE]:CHPower:FILTer[:RRC]:BANDwidth <real>
[:SENSE]:CHPower:FILTer[:RRC]:BANDwidth?
[:SENSE]:CHPower:FILTer[:RRC]:BWIDth
[:SENSE]:CHPower:FILTer[:RRC][:STATE] OFF | ON | 0 | 1
[:SENSE]:CHPower:FILTer[:RRC][:STATE]?
[:SENSE]:CHPower:FREQuency:SPAN <freq>
[:SENSE]:CHPower:FREQuency:SPAN?
[:SENSE]:CHPower:FREQuency:SPAN:FULL
[:SENSE]:CHPower:FREQuency:SPAN:PREVIOUS
[:SENSE]:CHPower:FREQuency:SYNThesis:AUTO[:STATE] OFF | ON | 0 | 1
[:SENSE]:CHPower:FREQuency:SYNThesis:AUTO[:STATE]?
[:SENSE]:CHPower:FREQuency:SYNThesis[:STATE] 1 | 2 | 3
[:SENSE]:CHPower:FREQuency:SYNThesis[:STATE]?
[:SENSE]:CHPower:IF:GAIN:AUTO[:STATE] ON | OFF | 1 | 0
[:SENSE]:CHPower:IF:GAIN:AUTO[:STATE]?
[:SENSE]:CHPower:IF:GAIN[:STATE] ON | OFF | 1 | 0
[:SENSE]:CHPower:IF:GAIN[:STATE]?
[:SENSE]:CHPower:SWEep:POINts <integer>
[:SENSE]:CHPower:SWEep:POINts?
[:SENSE]:CHPower:SWEep:TIME <time>
[:SENSE]:CHPower:SWEep:TIME?
[:SENSE]:CHPower:SWEep:TIME:AUTO OFF | ON | 0 | 1
[:SENSE]:CHPower:SWEep:TIME:AUTO?
[:SENSE]:CHPower:SWEep:TIME:AUTO:RULEs NORMal | ACCuracy
[:SENSE]:CHPower:SWEep:TIME:AUTO:RULEs?
[:SENSE]:CORREction:BTS[:RF]:GAIN <rel_ampl>
[:SENSE]:CORREction:BTS[:RF]:GAIN?
[:SENSE]:CORREction:BTS[:RF]:LOSS <rel_ampl>
[:SENSE]:CORREction:BTS[:RF]:LOSS?
[:SENSE]:CORREction:CSET:ALL:DELeTe
[:SENSE]:CORREction:CSET:ALL[:STATE] ON | OFF | 1 | 0
[:SENSE]:CORREction:CSET:ALL[:STATE]?
[:SENSE]:CORREction:CSET[1]:ANTenna[:UNIT] GAUSS | PTESla | UVM | UAM | UA
| NOConversion
[:SENSE]:CORREction:CSET[1]:ANTenna[:UNIT]?
[:SENSE]:CORREction:CSET[1]|2|...|8:COMMENT "text"

```

```

[:SENSe]:CORRection:CSET[1]|2|...|8:COMMeNt?
[:SENSe]:CORRection:CSET[1]|2|...|8:DATA <freq>, <ampl>, ...
[:SENSe]:CORRection:CSET[1]|2|...|8:DATA?
[:SENSe]:CORRection:CSET[1]|2|...|8:DATA:MERGe <freq>, <ampl>, ...
[:SENSe]:CORRection:CSET[1]|2|...|6:DELeTe
[:SENSe]:CORRection:CSET[1]|2|...|8:DESCription "text"
[:SENSe]:CORRection:CSET[1]|2|...|8:DESCription?
[:SENSe]:CORRection:CSET[1]|2|...|8[:STATE] ON | OFF | 1 | 0
[:SENSe]:CORRection:CSET[1]|2|...|8[:STATE]?
[:SENSe]:CORRection:CSET[1]|2|...|8:X:SPACing LINear | LOGarithmic
[:SENSe]:CORRection:CSET[1]|2|...|8:X:SPACing?
[:SENSe]:CORRection:IMPedance[:INPut][:MAGNitude] 50 | 75
[:SENSe]:CORRection:IMPedance[:INPut][:MAGNitude]?
[:SENSe]:CORRection:IQ:I:GAIN <rel_ampl>
[:SENSe]:CORRection:IQ:I:GAIN?
[:SENSe]:CORRection:IQ:I|Q:ATTenuation <rel_ampl>
[:SENSe]:CORRection:IQ:I|Q:ATTenuation?
[:SENSe]:CORRection:IQ:I|Q:ATTenuation:RATio <real>
[:SENSe]:CORRection:IQ:I|Q:ATTenuation:RATio?
[:SENSe]:CORRection:IQ[:I]:SKEW <seconds>
[:SENSe]:CORRection:IQ[:I]:SKEW?
[:SENSe]:CORRection:IQ:Q:GAIN <rel_ampl>
[:SENSe]:CORRection:IQ:Q:GAIN?
[:SENSe]:CORRection:IQ:Q:SKEW <seconds>
[:SENSe]:CORRection:IQ:Q:SKEW?
[:SENSe]:CORRection:MS[:RF]:GAIN <rel_ampl>
[:SENSe]:CORRection:MS[:RF]:GAIN?
[:SENSe]:CORRection:MS[:RF]:LOSS <rel_ampl>
[:SENSe]:CORRection:MS[:RF]:LOSS?
[:SENSe]:CORRection:NOISe:FLOor ON | OFF | 1 | 0
[:SENSe]:CORRection:NOISe:FLOor?
[:SENSe]:CORRection:OFFSet[:MAGNitude]
[:SENSe]:CORRection:SA[:RF]:GAIN <rel_ampl>
[:SENSe]:CORRection:SA[:RF]:GAIN?
[:SENSe]:EBWidth:AVERAge:COUNT
[:SENSe]:EBWidth:FREQuency:SPAN
[:SENSe]:EBWidth:MAXHold
[:SENSe]:EBWidth:XDB
[:SENSe]:EVM:AVERAge:COUNT <integer>
[:SENSe]:EVM:AVERAge:COUNT?
[:SENSe]:EVM:AVERAge[:STATE] OFF | ON | 0 | 1
[:SENSe]:EVM:AVERAge[:STATE]?
[:SENSe]:EVM:AVERAge:TCONtrol EXPonential | REPeat
[:SENSe]:EVM:AVERAge:TCONtrol?
[:SENSe]:EVM:BANDwidth[:RESolution] <bandwidth>
[:SENSe]:EVM:BANDwidth[:RESolution]?
[:SENSe]:EVM:BWIDth[:RESolution]
[:SENSe]:EVM:FREQuency:SYNThesis[:STATE] 1 | 2 | 3
[:SENSe]:EVM:FREQuency:SYNThesis[:STATE]?
[:SENSe]:FEED RF | AIQ | EMIXer
[:SENSe]:FEED AREFereNce
[:SENSe]:FEED IQ | IONLy | QONLy
[:SENSe]:FEED?

```

```

[:SENSe]:FEED?
[:SENSe]:FEED:AREFERENCE REF50 | REF4800 | OFF
[:SENSe]:FEED:AREFERENCE?
[:SENSe]:FEED:IQ:TYPE IQ | IONLY | QONLY
[:SENSe]:FEED:IQ:TYPE?
[:SENSe]:FREQUENCY:CENTER <freq>
[:SENSe]:FREQUENCY:CENTER?
[:SENSe]:FREQUENCY:CENTER:STEP:AUTO OFF | ON | 0 | 1
[:SENSe]:FREQUENCY:CENTER:STEP:AUTO?
[:SENSe]:FREQUENCY:CENTER:STEP[:INCREMENT] <freq>
[:SENSe]:FREQUENCY:CENTER:STEP[:INCREMENT]?
[:SENSe]:FREQUENCY:EMIXER:CENTER <freq>
[:SENSe]:FREQUENCY:EMIXER:CENTER?
[:SENSe]:FREQUENCY:IQ:CENTER <freq>
[:SENSe]:FREQUENCY:IQ:CENTER?
[:SENSe]:FREQUENCY:RF:CENTER <freq>
[:SENSe]:FREQUENCY:RF:CENTER?
[:SENSe]:MCPower:AVERAGE:COUNT (PSAPowerSuite, PSAW-CDMA, PSACDMA2000)
[:SENSe]:MCPower:CARRIER[1]|2:LIST:BANDWIDTH[:INTEGRATION] (PSAPowerSuite)
[:SENSe]:MCPower:CARRIER[1]|2:LIST:BWIDTh[:INTEGRATION] (PSAPowerSuite)
[:SENSe]:MCPower:CARRIER[1]|2:LIST:PPRESENT (PSAPowerSuite)
[:SENSe]:MCPower:CARRIER[1]|2:LIST:WIDTh (PSAPowerSuite)
[:SENSe]:MCPower:CARRIER[1]|2[:POWER]
[:SENSe]:MCPower:FILTer[:RRC]:ALPHa
[:SENSe]:MCPower:FILTer[:RRC][:STATE]
[:SENSe]:MCPower:LIMit[:STATE]
[:SENSe]:MCPower:METHod (PSAPowerSuite)
[:SENSe]:MCPower:OFFSet[1]|2:LIST:ABSolute (PSAW-CDMA)
[:SENSe]:MCPower:OFFSet[1]|2:LIST:BANDWIDTH[:INTEGRATION] (PSAPowerSuite)
[:SENSe]:MCPower:OFFSet[1]|2:LIST:BWIDTh[:INTEGRATION] (PSAPowerSuite)
[:SENSe]:MCPower:OFFSet[1]|2:LIST[:FREQUENCY] (PSAPowerSuite)
[:SENSe]:MCPower:OFFSet[1]|2:LIST:RCARRIER (PSAWCDMA)
[:SENSe]:MCPower:OFFSet[1]|2:LIST:TEST
[:SENSe]:MCPower:RCARRIER[1]|2 (PSAPowerSuite)
[:SENSe]:MIXer:BAND A | Q | U | V | W | NA | ND | NE | NF | NG | NJ | NK |
NQ | NU | NV | NW | NY | NEXT | DD | DF | DG | DJ | DK | DQ | DV | DW | DY
| DEXT | MA | ME | MU | MCOAX | USB
[:SENSe]:MIXer:BAND?
[:SENSe]:MIXer:BIAS <real>
[:SENSe]:MIXer:BIAS?
[:SENSe]:MIXer:BIAS:STATE OFF | ON | 0 | 1
[:SENSe]:MIXer:BIAS:STATE?
[:SENSe]:MIXer:CIFLoss <rel_ampl>
[:SENSe]:MIXer:CIFLoss?
[:SENSe]:MONitor:AVERAGE:COUNT <integer>
[:SENSe]:MONitor:AVERAGE:COUNT?
[:SENSe]:MONitor:AVERAGE[:STATE] OFF | ON | 0 | 1
[:SENSe]:MONitor:AVERAGE[:STATE]?
[:SENSe]:MONitor:AVERAGE:TCONtrol EXPonential | REPeat
[:SENSe]:MONitor:AVERAGE:TCONtrol?
[:SENSe]:MONitor:BANDwidth[:RESolution] <freq>
[:SENSe]:MONitor:BANDwidth[:RESolution]?
[:SENSe]:MONitor:BANDwidth[:RESolution]:AUTO OFF | ON | 0 | 1

```

3 Programming the Analyzer

List of SCPI Commands

```
[ :SENSe]:MONitor:BANDwidth[:RESolution]:AUTO?
[ :SENSe]:MONitor:BANDwidth:VIDeo <bandwidth>
[ :SENSe]:MONitor:BANDwidth:VIDeo?
[ :SENSe]:MONitor:BANDwidth:VIDeo:AUTO ON | OFF | 1 | 0
[ :SENSe]:MONitor:BANDwidth:VIDeo:AUTO?
[ :SENSe]:MONitor:BANDwidth:VIDeo:RATio <real>
[ :SENSe]:MONitor:BANDwidth:VIDeo:RATio?
[ :SENSe]:MONitor:BANDwidth:VIDeo:RATio:AUTO OFF | ON | 0 | 1
[ :SENSe]:MONitor:BANDwidth:VIDeo:RATio:AUTO?
[ :SENSe]:MONitor:BWIDth[:RESolution]
[ :SENSe]:MONitor:BWIDth:VIDeo
[ :SENSe]:MONitor:BWIDth:VIDeo:RATio
[ :SENSe]:MONitor:DETEctor:AUTO ON | OFF | 1 | 0
[ :SENSe]:MONitor:DETEctor:AUTO?
[ :SENSe]:MONitor:DETEctor[:FUNction]
[ :SENSe]:MONitor:DETEctor:TRACe AVERAge | NEGAtive | NORMAl | POSitive |
SAMPle
[ :SENSe]:MONitor:DETEctor:TRACe?
[ :SENSe]:MONitor:FREQUency:SPAN <freq>
[ :SENSe]:MONitor:FREQUency:SPAN?
[ :SENSe]:MONitor:FREQUency:SPAN:BANDwidth[:RESolution]:RATio <integer>
[ :SENSe]:MONitor:FREQUency:SPAN:BANDwidth[:RESolution]:RATio?
[ :SENSe]:MONitor:FREQUency:SPAN:BANDwidth[:RESolution]:RATio:AUTO OFF | ON
| 0 | 1
[ :SENSe]:MONitor:FREQUency:SPAN:BANDwidth[:RESolution]:RATio:AUTO?
[ :SENSe]:MONitor:FREQUency:SPAN:BWIDth[:RESolution]:RATio
[ :SENSe]:MONitor:FREQUency:SPAN:FULL
[ :SENSe]:MONitor:FREQUency:SPAN:PREVious
[ :SENSe]:MONitor:SWEep:POINts <integer>
[ :SENSe]:MONitor:SWEep:POINts?
[ :SENSe]:MONitor:SWEep:TIME <time>
[ :SENSe]:MONitor:SWEep:TIME?
[ :SENSe]:MONitor:SWEep:TIME:AUTO OFF | ON | 0 | 1
[ :SENSe]:MONitor:SWEep:TIME:AUTO?
[ :SENSe]:OBwidth:AVERAge:COUNT <integer>
[ :SENSe]:OBwidth:AVERAge:COUNT?
[ :SENSe]:OBwidth:AVERAge[:STATe] ON | OFF | 1 | 0
[ :SENSe]:OBwidth:AVERAge[:STATe]?
[ :SENSe]:OBwidth:AVERAge:TCONtrol EXPONential | REPeat
[ :SENSe]:OBwidth:AVERAge:TCONtrol?
[ :SENSe]:OBwidth:BANDwidth[:RESolution] <bandwidth>
[ :SENSe]:OBwidth:BANDwidth[:RESolution]?
[ :SENSe]:OBwidth:BANDwidth[:RESolution]:AUTO ON | OFF | 1 | 0
[ :SENSe]:OBwidth:BANDwidth[:RESolution]:AUTO?
[ :SENSe]:OBwidth:BANDwidth:SHApe GAUSSian | FLATtop
[ :SENSe]:OBwidth:BANDwidth:SHApe?
[ :SENSe]:OBwidth:BANDwidth:VIDeo <bandwidth>
[ :SENSe]:OBwidth:BANDwidth:VIDeo?
[ :SENSe]:OBwidth:BANDwidth:VIDeo:AUTO ON | OFF | 1 | 0
[ :SENSe]:OBwidth:BANDwidth:VIDeo:AUTO?
[ :SENSe]:OBwidth:BWIDth[:RESolution]
[ :SENSe]:OBwidth:BWIDth:SHApe
[ :SENSe]:OBwidth:BWIDth:VIDeo
```



```

[:SENSE]:OBwidth:DETECTOR:AUTO ON | OFF | 1 | 0
[:SENSE]:OBwidth:DETECTOR:AUTO?
[:SENSE]:OBwidth:DETECTOR[:FUNCTION] NORMAl | AVERAge | POSitive | SAMPlE
| NEGative
[:SENSE]:OBwidth:DETECTOR[:FUNCTION]?
[:SENSE]:OBwidth:FREQuency:SPAN <freq>
[:SENSE]:OBwidth:FREQuency:SPAN?
[:SENSE]:OBwidth:FREQuency:SPAN:AUTO ON | OFF | 0 | 1
[:SENSE]:OBwidth:FREQuency:SPAN:AUTO?
[:SENSE]:OBwidth:FREQuency:SPAN:FULL
[:SENSE]:OBwidth:FREQuency:SPAN:PREVious
[:SENSE]:OBwidth:IF:GAIN:AUTO[:STATE] ON | OFF | 1 | 0
[:SENSE]:OBwidth:IF:GAIN:AUTO[:STATE]?
[:SENSE]:OBwidth:IF:GAIN[:STATE] ON | OFF | 1 | 0
[:SENSE]:OBwidth:IF:GAIN[:STATE]?
[:SENSE]:OBwidth:MAXHold ON | OFF | 1 | 0
[:SENSE]:OBwidth:MAXHold?
[:SENSE]:OBwidth:PERCent <real>
[:SENSE]:OBwidth:PERCent?
[:SENSE]:OBwidth:SWEep:POINTs <integer>
[:SENSE]:OBwidth:SWEep:POINTs?
[:SENSE]:OBwidth:SWEep:TIME <time>
[:SENSE]:OBwidth:SWEep:TIME?
[:SENSE]:OBwidth:SWEep:TIME:AUTO OFF | ON | 0 | 1
[:SENSE]:OBwidth:SWEep:TIME:AUTO?
[:SENSE]:OBwidth:SWEep:TIME:AUTO:RULEs NORMAl | ACCuracy
[:SENSE]:OBwidth:SWEep:TIME:AUTO:RULEs?
[:SENSE]:OBwidth:XDB <rel_ampl>
[:SENSE]:OBwidth:XDB?
[:SENSE]:POWER:IQ[:I]:RANGE[:UPPer] <ampl>
[:SENSE]:POWER:IQ[:I]:RANGE[:UPPer]?
[:SENSE]:POWER:IQ:Q:RANGE[:UPPer] <ampl>
[:SENSE]:POWER:IQ:Q:RANGE[:UPPer]?
[:SENSE]:POWER:IQ:RANGE:AUTO OFF | ON | 0 | 1
[:SENSE]:POWER:IQ:RANGE:AUTO?
[:SENSE]:POWER[:RF]:ATTenuation <rel_ampl>
[:SENSE]:POWER[:RF]:ATTenuation?
[:SENSE]:POWER[:RF]:ATTenuation:AUTO OFF | ON | 0 | 1
[:SENSE]:POWER[:RF]:ATTenuation:AUTO?
[:SENSE]:POWER[:RF]:ATTenuation:STEP[:INCRement] 10 dB | 2 dB
[:SENSE]:POWER[:RF]:ATTenuation:STEP[:INCRement]?
[:SENSE]:POWER[:RF]:EATTenuation <rel_ampl>
[:SENSE]:POWER[:RF]:EATTenuation?
[:SENSE]:POWER[:RF]:EATTenuation:STATE OFF | ON | 0 | 1
[:SENSE]:POWER[:RF]:EATTenuation:STATE?
[:SENSE]:POWER[:RF]:GAIN:BAND LOW | FULL
[:SENSE]:POWER[:RF]:GAIN:BAND?
[:SENSE]:POWER[:RF]:GAIN[:STATE] OFF | ON | 0 | 1
[:SENSE]:POWER[:RF]:GAIN[:STATE]?
[:SENSE]:POWER[:RF]:MMW:PADJust
[:SENSE]:POWER[:RF]:MW:PADJust
[:SENSE]:POWER[:RF]:MW:PATH STD | LNPath | MPByPass | FULL
[:SENSE]:POWER[:RF]:MW:PATH?

```

3 Programming the Analyzer

List of SCPI Commands

```
[ :SENSe]:POWER[:RF]:MW:PRESelector[:STATE] ON | OFF | 0 | 1
[:SENSe]:POWER[:RF]:MW:PRESelector[:STATE]?
[:SENSe]:POWER[:RF]:PADJust <freq>
[:SENSe]:POWER[:RF]:PADJust?
[:SENSe]:POWER[:RF]:PADJust:PRESelector MWAVE | MMWave | EXTERNAL
[:SENSe]:POWER[:RF]:PADJust:PRESelector?
[:SENSe]:POWER[:RF]:PCENTER
[:SENSe]:POWER[:RF]:RANGE:AUTO ON | OFF | 1 | 0
[:SENSe]:POWER[:RF]:RANGE:AUTO?
[:SENSe]:POWER[:RF]:RANGE:OPTimize IMMEDIATE
[:SENSe]:POWER[:RF]:RANGE:OPTimize:ATTenuation OFF | ELECTRICAL | COMBINED
[:SENSe]:POWER[:RF]:RANGE:OPTimize:ATTenuation?
[:SENSe]:PSTATistic:BANDwidth <freq>
[:SENSe]:PSTATistic:BANDwidth?
[:SENSe]:PSTATistic:BWIDth
[:SENSe]:PSTATistic:COUNTs <integer>
[:SENSe]:PSTATistic:COUNTs?
[:SENSe]:PSTATistic:GAUSSian[:STATE]
[:SENSe]:PSTATistic:IF:GAIN:AUTO[:STATE] ON | OFF | 1 | 0
[:SENSe]:PSTATistic:IF:GAIN:AUTO[:STATE]?
[:SENSe]:PSTATistic:IF:GAIN[:STATE] ON | OFF | 1 | 0
[:SENSe]:PSTATistic:IF:GAIN[:STATE]?
[:SENSe]:PSTATistic:RTRace[:STATE]
[:SENSe]:PSTATistic:SRTRace
[:SENSe]:PSTATistic:SWEep:CYCLes <integer>
[:SENSe]:PSTATistic:SWEep:CYCLes?
[:SENSe]:PSTATistic:SWEep:TIME <time>
[:SENSe]:PSTATistic:SWEep:TIME?
[:SENSe]:PVTime:AVERage:COUNT <integer>
[:SENSe]:PVTime:AVERage:COUNT?
[:SENSe]:PVTime:AVERage[:STATE] OFF | ON | 0 | 1
[:SENSe]:PVTime:AVERage[:STATE]?
[:SENSe]:PVTime:AVERage:TCONTROL EXPONENTIAL | REPEAT
[:SENSe]:PVTime:AVERage:TCONTROL?
[:SENSe]:PVTime:AVERage:TYPE LOG | LPOWER | RMS | POWER
[:SENSe]:PVTime:AVERage:TYPE?
[:SENSe]:PVTime:BANDwidth|BWIDth[:RESolution]:TYPE
[:SENSe]:PVTime:BANDwidth[:RESolution] <bandwidth>
[:SENSe]:PVTime:BANDwidth[:RESolution]?
[:SENSe]:PVTime:BANDwidth:TYPE GAUSSIAN | FLATTOP
[:SENSe]:PVTime:BANDwidth:TYPE?
[:SENSe]:PVTime:BSYNc:SOURce RFBURST | NONE
[:SENSe]:PVTime:BSYNc:SOURce?
[:SENSe]:PVTime:BURSt:SLOPe <real>
[:SENSe]:PVTime:BURSt:SLOPe?
[:SENSe]:PVTime:BURSt:SLOPe:DETEction:TIME <time>
[:SENSe]:PVTime:BURSt:SLOPe:DETEction:TIME?
[:SENSe]:PVTime:BURSt:SLOPe:INTEgration:TIME
[:SENSe]:PVTime:BURSt:STHReshold
[:SENSe]:PVTime:BURSt:THReshold <real>
[:SENSe]:PVTime:BURSt:THReshold?
[:SENSe]:PVTime:BURSt:THReshold:TYPE ABSOLUTE | RELATIVE
[:SENSe]:PVTime:BURSt:THReshold:TYPE?
```

```

[:SENSE]:PVTime:BWIDth[:RESolution]
[:SENSE]:PVTime:IF:GAIN:AUTO OFF | ON | 0 | 1
[:SENSE]:PVTime:IF:GAIN:AUTO?
[:SENSE]:PVTime:IF:GAIN[:STATe] LOW | HIGH
[:SENSE]:PVTime:IF:GAIN[:STATe]?
[:SENSE]:PVTime:SWEEp:TIME <integer>
[:SENSE]:PVTime:SWEEp:TIME?
[:SENSE]:RADio:STANdard WM80216E05 | WIBRO
[:SENSE]:RADio:STANdard?
[:SENSE]:RADio:STANdard:BANDwidth[:CONFigure]:BWRatio R8BY7 | R28BY25
[:SENSE]:RADio:STANdard:BANDwidth[:CONFigure]:BWRatio?
[:SENSE]:RADio:STANdard:BANDwidth[:CONFigure]:BWRatio:FRAction <integer>,
...
[:SENSE]:RADio:STANdard:BANDwidth[:CONFigure]:BWRatio:FRAction?
[:SENSE]:RADio:STANdard:BANDwidth[:CONFigure]:NFFT <integer>
[:SENSE]:RADio:STANdard:BANDwidth[:CONFigure]:NFFT?
[:SENSE]:RADio:STANdard:BANDwidth[:CONFigure]:VALue <freq>
[:SENSE]:RADio:STANdard:BANDwidth[:CONFigure]:VALue?
[:SENSE]:RADio:STANdard:DEVIce BTS | MS
[:SENSE]:RADio:STANdard:DEVIce?
[:SENSE]:RADio:STANdard:DRATio
[:SENSE]:RADio:STANdard:DRATio <real>
[:SENSE]:RADio:STANdard:FDURation <time>
[:SENSE]:RADio:STANdard:FDURation
[:SENSE]:RADio:STANdard:GINterval:RATio R1BY32 | R1BY16 | R1BY8 | R1BY4
[:SENSE]:RADio:STANdard:GINterval:RATio?
[:SENSE]:RADio:STANdard:GINterval:RATio:FRAction <integer>, ...
[:SENSE]:RADio:STANdard:GINterval:RATio:FRAction?
[:SENSE]:RADio:STANdard:WIBro[:PROFile] B4M375 | B8M75 | B17M5
[:SENSE]:RADio:STANdard:WIBro[:PROFile]?
[:SENSE]:RADio:STANdard:Y05[:PROFile] B1M25 | B3M5 | B5M | B7M | B8M75 |
B10M | B14M | B15M | B17M5 | B20M | B28M
[:SENSE]:RADio:STANdard:Y05[:PROFile]?
[:SENSE]:ROSCillator:BANDwidth WIDE | NARROW
[:SENSE]:ROSCillator:BANDwidth?
[:SENSE]:ROSCillator:COUPLing NORMal | NACquisition
[:SENSE]:ROSCillator:COUPLing?
[:SENSE]:ROSCillator:EXTErnal:FREQuency <freq>
[:SENSE]:ROSCillator:EXTErnal:FREQuency?
[:SENSE]:ROSCillator:SOURce INTernal | EXTErnal
[:SENSE]:ROSCillator:SOURce?
[:SENSE]:ROSCillator:SOURce:TYPE INTernal | EXTErnal | SENSE | PULSE
[:SENSE]:ROSCillator:SOURce:TYPE?
[:SENSE]:SEMask:AVERage:COUNT <integer>
[:SENSE]:SEMask:AVERage:COUNT?
[:SENSE]:SEMask:AVERage[:STATe] ON | OFF | 1 | 0
[:SENSE]:SEMask:AVERage[:STATe]?
[:SENSE]:SEMask:BANDwidth[1]|2:INTEgration <bandwidth>
[:SENSE]:SEMask:BANDwidth[1]|2:INTEgration?
[:SENSE]:SEMask:BANDwidth[1]|2[:RESolution] <bandwidth>
[:SENSE]:SEMask:BANDwidth[1]|2[:RESolution]?
[:SENSE]:SEMask:BANDwidth[1]|2[:RESolution]:AUTO OFF | ON | 1 | 0
[:SENSE]:SEMask:BANDwidth[1]|2[:RESolution]:AUTO?

```

```

[:SENSe]:SEMAsk:BANDwidth:SHAPE ASENse | GAUSSian | FLATtop
[:SENSe]:SEMAsk:BANDwidth:SHAPE?
[:SENSe]:SEMAsk:BANDwidth[1]|2:VIDEo <bandwidth>
[:SENSe]:SEMAsk:BANDwidth[1]|2:VIDEo?
[:SENSe]:SEMAsk:BANDwidth[1]|2:VIDEo:AUTO OFF | ON | 1 | 0
[:SENSe]:SEMAsk:BANDwidth[1]|2:VIDEo:AUTO?
[:SENSe]:SEMAsk:BANDwidth[1]|2:VIDEo:RATio <real>
[:SENSe]:SEMAsk:BANDwidth[1]|2:VIDEo:RATio
[:SENSe]:SEMAsk:BANDwidth[1]|2:VIDEo:RATio:AUTO OFF | ON | 1 | 0
[:SENSe]:SEMAsk:BANDwidth[1]|2:VIDEo:RATio:AUTO?
[:SENSe]:SEMAsk:BWIDth[1]|2[:RESolution]
[:SENSe]:SEMAsk:BWIDth[1]|2:VIDEo
[:SENSe]:SEMAsk:BWIDth[1]|2:VIDEo:RATio
[:SENSe]:SEMAsk:CARRier:AUTO[:STATE] OFF | ON | 1 | 0
[:SENSe]:SEMAsk:CARRier:AUTO[:STATE]?
[:SENSe]:SEMAsk:CARRier:CPSD <real>
[:SENSe]:SEMAsk:CARRier:CPSD?
[:SENSe]:SEMAsk:CARRier:PEAK[:POWER] <real>
[:SENSe]:SEMAsk:CARRier:PEAK[:POWER]?
[:SENSe]:SEMAsk:CARRier[:POWER] <real>
[:SENSe]:SEMAsk:CARRier[:POWER]?
[:SENSe]:SEMAsk:DETEctor:CARRier:AUTO ON | OFF | 1 | 0
[:SENSe]:SEMAsk:DETEctor:CARRier:AUTO?
[:SENSe]:SEMAsk:DETEctor:CARRier[:FUNCTION] AVERAge | NEGAtive | NORMAl |
POSitive | SAMPlE
[:SENSe]:SEMAsk:DETEctor:CARRier[:FUNCTION]?
[:SENSe]:SEMAsk:DETEctor:OFFSet:AUTO ON | OFF | 1 | 0
[:SENSe]:SEMAsk:DETEctor:OFFSet:AUTO?
[:SENSe]:SEMAsk:DETEctor:OFFSet[:FUNCTION] AVERAge | NEGAtive | NORMAl |
POSitive | SAMPlE
[:SENSe]:SEMAsk:DETEctor:OFFSet[:FUNCTION]?
[:SENSe]:SEMAsk:FILTEr[:RRC]:ALPHa <real>
[:SENSe]:SEMAsk:FILTEr[:RRC]:ALPHa?
[:SENSe]:SEMAsk:FILTEr[:RRC][:STATE] OFF | ON | 0 | 1
[:SENSe]:SEMAsk:FILTEr[:RRC][:STATE]?
[:SENSe]:SEMAsk:FREQuency[1]|2:SPAN <freq>
[:SENSe]:SEMAsk:FREQuency[1]|2:SPAN?
[:SENSe]:SEMAsk:OFFSet[1]|2:LIST:BWIDth:IMULti
[:SENSe]:SEMAsk:OFFSet[1]|2:LIST:BWIDth[:RESolution]
[:SENSe]:SEMAsk:OFFSet[1]|2:LIST:BWIDth:VIDEo
[:SENSe]:SEMAsk:OFFSet[1]|2:LIST:SWEep[:TIME]
[:SENSe]:SEMAsk:OFFSet[1]|2[:OUTer]:LIST:BANDwidth:IMULti <integer>, ...
[:SENSe]:SEMAsk:OFFSet[1]|2[:OUTer]:LIST:BANDwidth:IMULti?
[:SENSe]:SEMAsk:OFFSet[1]|2[:OUTer]:LIST:BANDwidth[:RESolution]
<bandwidth>, ...
[:SENSe]:SEMAsk:OFFSet[1]|2[:OUTer]:LIST:BANDwidth[:RESolution]?
[:SENSe]:SEMAsk:OFFSet[1]|2[:OUTer]:LIST:BANDwidth[:RESolution]:AUTO OFF |
ON | 1 | 0, ...
[:SENSe]:SEMAsk:OFFSet[1]|2[:OUTer]:LIST:BANDwidth[:RESolution]:AUTO?
[:SENSe]:SEMAsk:OFFSet[1]|2[:OUTer]:LIST:BANDwidth:VIDEo <freq>, ...
[:SENSe]:SEMAsk:OFFSet[1]|2[:OUTer]:LIST:BANDwidth:VIDEo?

```

```

[:SENSE]:SEMask:OFFSet[1]|2[:OUTer]:LIST:BANDwidth:VIDeo:AUTO OFF | ON | 0
| 1, ...
[:SENSE]:SEMask:OFFSet[1]|2[:OUTer]:LIST:BANDwidth:VIDeo:AUTO?
[:SENSE]:SEMask:OFFSet[1]|2[:OUTer]:LIST:BANDwidth:VIDeo:RATio <real>, ...
[:SENSE]:SEMask:OFFSet[1]|2[:OUTer]:LIST:BANDwidth:VIDeo:RATio?
[:SENSE]:SEMask:OFFSet[1]|2[:OUTer]:LIST:BANDwidth:VIDeo:RATio:AUTO OFF |
ON | 0 | 1, ...
[:SENSE]:SEMask:OFFSet[1]|2[:OUTer]:LIST:BANDwidth:VIDeo:RATio:AUTO?
[:SENSE]:SEMask:OFFSet[1]|2[:OUTer]:LIST:FREQuency:STARt <freq>, ...
[:SENSE]:SEMask:OFFSet[1]|2[:OUTer]:LIST:FREQuency:STARt?
[:SENSE]:SEMask:OFFSet[1]|2[:OUTer]:LIST:FREQuency:STOP <freq>, ...
[:SENSE]:SEMask:OFFSet[1]|2[:OUTer]:LIST:FREQuency:STOP?
[:SENSE]:SEMask:OFFSet[1]|2[:OUTer]:LIST:SIDE BOTH | NEGative | POSitive,
...
[:SENSE]:SEMask:OFFSet[1]|2[:OUTer]:LIST:SIDE?
[:SENSE]:SEMask:OFFSet[1]|2[:OUTer]:LIST:STARt:ABSolute <real>, ...
[:SENSE]:SEMask:OFFSet[1]|2[:OUTer]:LIST:STARt:ABSolute?
[:SENSE]:SEMask:OFFSet[1]|2[:OUTer]:LIST:STARt:RCARrier <rel_ampl>, ...
[:SENSE]:SEMask:OFFSet[1]|2[:OUTer]:LIST:STARt:RCARrier?
[:SENSE]:SEMask:OFFSet[1]|2[:OUTer]:LIST:STARt:STATE ON | OFF | 1 | 0, ...
[:SENSE]:SEMask:OFFSet[1]|2[:OUTer]:LIST:STARt:STATE?
[:SENSE]:SEMask:OFFSet[1]|2[:OUTer]:LIST:STOP:ABSolute <real>, ...
[:SENSE]:SEMask:OFFSet[1]|2[:OUTer]:LIST:STOP:ABSolute?
[:SENSE]:SEMask:OFFSet[1]|2[:OUTer]:LIST:STOP:ABSolute:COUple ON | OFF | 1
| 0, ...
[:SENSE]:SEMask:OFFSet[1]|2[:OUTer]:LIST:STOP:ABSolute:COUple?
[:SENSE]:SEMask:OFFSet[1]|2[:OUTer]:LIST:STOP:RCARrier <rel_ampl>, ...
[:SENSE]:SEMask:OFFSet[1]|2[:OUTer]:LIST:STOP:RCARrier?
[:SENSE]:SEMask:OFFSet[1]|2[:OUTer]:LIST:STOP:RCARrier:COUple ON | OFF | 1
| 0, ...
[:SENSE]:SEMask:OFFSet[1]|2[:OUTer]:LIST:STOP:RCARrier:COUple?
[:SENSE]:SEMask:OFFSet[1]|2[:OUTer]:LIST:SWEep:TIME <time>, ...
[:SENSE]:SEMask:OFFSet[1]|2[:OUTer]:LIST:SWEep:TIME?
[:SENSE]:SEMask:OFFSet[1]|2[:OUTer]:LIST:SWEep:TIME:AUTO ON | OFF | 1 | 0,
...
[:SENSE]:SEMask:OFFSet[1]|2[:OUTer]:LIST:SWEep:TIME:AUTO?
[:SENSE]:SEMask:OFFSet[1]|2[:OUTer]:LIST:TEST ABSolute | AND | OR |
RElative, ...
[:SENSE]:SEMask:OFFSet[1]|2[:OUTer]:LIST:TEST?
[:SENSE]:SEMask:OFFSet[1]|2:TYPE CTOCenter | CTOEdge | ETOCenter | ETOEdge
[:SENSE]:SEMask:OFFSet[1]|2:TYPE?
[:SENSE]:SEMask:SWEep[1]|2:TIME <time>
[:SENSE]:SEMask:SWEep[1]|2:TIME?
[:SENSE]:SEMask:SWEep[1]|2:TIME:AUTO OFF | 0 | ON | 1
[:SENSE]:SEMask:SWEep[1]|2:TIME:AUTO?
[:SENSE]:SEMask:TYPE PSDRef | TPreF | SPRef
[:SENSE]:SEMask:TYPE?
[:SENSE]:SPURious:AVERage:COUNT <integer>
[:SENSE]:SPURious:AVERage:COUNT?
[:SENSE]:SPURious:AVERage[:STATE] ON | OFF | 1 | 0
[:SENSE]:SPURious:AVERage[:STATE]?
[:SENSE]:SPURious:AVERage:TCONtrol EXPonential | REPeat

```

```

[:SENSe]:SPURious:AVERage:TCONtrol?
[:SENSe]:SPURious:FSMeas ON | OFF | 1 | 0
[:SENSe]:SPURious:FSMeas?
[:SENSe]:SPURious:IF:GAIN:AUTO[:STATe] OFF|ON|0|1, ...
[:SENSe]:SPURious:IF:GAIN:AUTO[:STATe]?
[:SENSe]:SPURious:IF:GAIN[:STATe] OFF|ON|0|1, ...
[:SENSe]:SPURious:IF:GAIN[:STATe]?
[:SENSe]:SPURious:POWer[:RF]:RANGe:AUTO
[:SENSe]:SPURious[:RANGe]:ALL:SWEep:TYPE:AUTO OFF | ON | 0 | 1
[:SENSe]:SPURious[:RANGe]:ALL:SWEep:TYPE:AUTO?
[:SENSe]:SPURious[:RANGe][:LIST]:ATTenuation <rel_ampl>, ...
[:SENSe]:SPURious[:RANGe][:LIST]:ATTenuation?
[:SENSe]:SPURious[:RANGe][:LIST]:ATTenuation:AUTO OFF|ON|0|1, ...
[:SENSe]:SPURious[:RANGe][:LIST]:ATTenuation:AUTO?
[:SENSe]:SPURious[:RANGe][:LIST]:BANDwidth[:RESolution] <freq>, ...
[:SENSe]:SPURious[:RANGe][:LIST]:BANDwidth[:RESolution]?
[:SENSe]:SPURious[:RANGe][:LIST]:BANDwidth[:RESolution]:AUTO OFF|ON|0|1,
...
[:SENSe]:SPURious[:RANGe][:LIST]:BANDwidth[:RESolution]:AUTO?
[:SENSe]:SPURious[:RANGe][:LIST]:BANDwidth:SHApe GAUSSian|FLATtop, ...
[:SENSe]:SPURious[:RANGe][:LIST]:BANDwidth:SHApe?
[:SENSe]:SPURious[:RANGe][:LIST]:BANDwidth:VIDeo <freq>, ...
[:SENSe]:SPURious[:RANGe][:LIST]:BANDwidth:VIDeo?
[:SENSe]:SPURious[:RANGe][:LIST]:BANDwidth:VIDeo:AUTO OFF|ON|0|1, ...
[:SENSe]:SPURious[:RANGe][:LIST]:BANDwidth:VIDeo:AUTO?
[:SENSe]:SPURious[:RANGe][:LIST]:BWIDth[:RESolution]
[:SENSe]:SPURious[:RANGe][:LIST]:BWIDth:SHApe
[:SENSe]:SPURious[:RANGe][:LIST]:BWIDth:VIDeo
[:SENSe]:SPURious[:RANGe][:LIST]:DETector[1][:FUNction]
AVERage|NEGative|NORMal|POSitive|SAMPle|RMS, ...
[:SENSe]:SPURious[:RANGe][:LIST]:DETector2[:FUNction]
OFF|AVERage|NEGative|NORMal|POSitive|SAMPle|RMS, ...
[:SENSe]:SPURious[:RANGe][:LIST]:DETector2[:FUNction]?
[:SENSe]:SPURious[:RANGe][:LIST]:DETector[1][:FUNction]?
[:SENSe]:SPURious[:RANGe][:LIST]:FREQuency:START <freq>, ...
[:SENSe]:SPURious[:RANGe][:LIST]:FREQuency:START?
[:SENSe]:SPURious[:RANGe][:LIST]:FREQuency:STOP <freq>, ...
[:SENSe]:SPURious[:RANGe][:LIST]:FREQuency:STOP?
[:SENSe]:SPURious[:RANGe][:LIST]:PEAK:EXCursion <rel_ampl>, ...
[:SENSe]:SPURious[:RANGe][:LIST]:PEAK:EXCursion?
[:SENSe]:SPURious[:RANGe][:LIST]:PEAK:THReshold <real>, ...
[:SENSe]:SPURious[:RANGe][:LIST]:PEAK:THReshold?
[:SENSe]:SPURious[:RANGe][:LIST]:STATe ON|OFF|1|0, ...
[:SENSe]:SPURious[:RANGe][:LIST]:STATe?
[:SENSe]:SPURious[:RANGe][:LIST]:SWEep:POINts <integer>
[:SENSe]:SPURious[:RANGe][:LIST]:SWEep:POINts?
[:SENSe]:SPURious[:RANGe][:LIST]:SWEep:POINts:AUTO OFF|ON|0|1, ...
[:SENSe]:SPURious[:RANGe][:LIST]:SWEep:POINts:AUTO?
[:SENSe]:SPURious[:RANGe][:LIST]:SWEep:TIME <time>, ...
[:SENSe]:SPURious[:RANGe][:LIST]:SWEep:TIME?
[:SENSe]:SPURious[:RANGe][:LIST]:SWEep:TIME:AUTO OFF|ON|0|1, ...
[:SENSe]:SPURious[:RANGe][:LIST]:SWEep:TIME:AUTO?

```

```

[:SENSe]:SPURious:REPT:MODE ALL | LIMTest | MMARgin
[:SENSe]:SPURious:REPT:MODE?
[:SENSe]:SPURious:SPUR <integer>
[:SENSe]:SPURious:SPUR?
[:SENSe]:SPURious:SWEep:TIME:AUTO:RULEs NORMAl | ACCuracy
[:SENSe]:SPURious:SWEep:TIME:AUTO:RULEs?
[:SENSe]:SPURious:TYPE EXAMine | FULL
[:SENSe]:SPURious:TYPE?
[:SENSe]:SWEep:EGATE:CONTRol EDGE | LEVel
[:SENSe]:SWEep:EGATE:CONTRol?
[:SENSe]:SWEep:EGATE:DELay <time>
[:SENSe]:SWEep:EGATE:DELay?
[:SENSe]:SWEep:EGATE:DELay:COMPensation:TYPE OFF | SETTled | GDELay
[:SENSe]:SWEep:EGATE:DELay:COMPensation:TYPE?
[:SENSe]:SWEep:EGATE:EXTernal[1]|2:LEVel <voltage>
[:SENSe]:SWEep:EGATE:EXTernal[1]|2:LEVel?
[:SENSe]:SWEep:EGATE:HOLDoff <time>
[:SENSe]:SWEep:EGATE:HOLDoff?
[:SENSe]:SWEep:EGATE:HOLDoff:AUTO OFF | ON | 0 | 1
[:SENSe]:SWEep:EGATE:HOLDoff:AUTO?
[:SENSe]:SWEep:EGATE:LENGth <time>
[:SENSe]:SWEep:EGATE:LENGth?
[:SENSe]:SWEep:EGATE:MINFast?
[:SENSe]:SWEep:EGATE:POLarity NEGative | POSitive
[:SENSe]:SWEep:EGATE:POLarity?
[:SENSe]:SWEep:EGATE:SOURce EXTernal1 | EXTernal2 | LINE | FRAME | RFBurst
[:SENSe]:SWEep:EGATE:SOURce?
[:SENSe]:SWEep:EGATE[:STATE] OFF | ON | 0 | 1
[:SENSe]:SWEep:EGATE[:STATE]?
[:SENSe]:SWEep:EGATE:TIME <time>
[:SENSe]:SWEep:EGATE:TIME?
[:SENSe]:SWEep:EGATE:VIEW ON | OFF | 1 | 0
[:SENSe]:SWEep:EGATE:VIEW?
[:SENSe]:SWEep:EGATE:VIEW:STARt <time>
[:SENSe]:SWEep:EGATE:VIEW:STARt?
[:SENSe]:SWEep:TIME:GATE:LEVel HIGH | LOW
[:SENSe]:SWEep:TIME:GATE:LEVel?
[:SENSe]:VOLTage:IQ[:I]:RANGE[:UPPer] <voltage>
[:SENSe]:VOLTage:IQ[:I]:RANGE[:UPPer]?
[:SENSe]:VOLTage:IQ:Q:RANGE[:UPPer] <voltage>
[:SENSe]:VOLTage:IQ:Q:RANGE[:UPPer]?
[:SENSe]:VOLTage:IQ:RANGE:AUTO OFF | ON | 0 | 1
[:SENSe]:VOLTage:IQ:RANGE:AUTO?
[:SENSe]:VOLTage|POWER:IQ:MIRROred OFF | ON | 0 | 1
[:SENSe]:VOLTage|POWER:IQ:MIRROred?
[:SENSe]:WAVEform:ADC:DITHer:AUTO[:STATE] OFF | ON | 0 | 1
[:SENSe]:WAVEform:ADC:DITHer:AUTO[:STATE]?
[:SENSe]:WAVEform:ADC:DITHer[:STATE] OFF | ON | 0 | 1
[:SENSe]:WAVEform:ADC:DITHer[:STATE]?
[:SENSe]:WAVEform:APERture?
[:SENSe]:WAVEform:AVERage:COUNt <integer>
[:SENSe]:WAVEform:AVERage:COUNt?
[:SENSe]:WAVEform:AVERage[:STATE] OFF | ON | 0 | 1

```

3 Programming the Analyzer

List of SCPI Commands

```
[ :SENSe]:WAVeform:AVERAge[:STATe]?
[ :SENSe]:WAVeform:AVERAge:TACount <integer>
[ :SENSe]:WAVeform:AVERAge:TACount?
[ :SENSe]:WAVeform:AVERAge:TCONTRol EXPonential | REPeat
[ :SENSe]:WAVeform:AVERAge:TCONTRol?
[ :SENSe]:WAVeform:AVERAge:TYPE LOG | MAXimum | MINimum | RMS | SCALar
[ :SENSe]:WAVeform:AVERAge:TYPE?
[ :SENSe]:WAVeform:BANDwidth|BWIDth[:RESolution]:TYPE
[ :SENSe]:WAVeform:BANDwidth[:RESolution]
[ :SENSe]:WAVeform:BANDwidth:SHAPE
[ :SENSe]:WAVeform:BWIDth[:RESolution]
[ :SENSe]:WAVeform:BWIDth:SHAPE
[ :SENSe]:WAVeform:DIF:BANDwidth <freq>
[ :SENSe]:WAVeform:DIF:BANDwidth?
[ :SENSe]:WAVeform:DIF:FILTer:ALPHa <real>
[ :SENSe]:WAVeform:DIF:FILTer:ALPHa?
[ :SENSe]:WAVeform:DIF:FILTer:BANDwidth <freq>
[ :SENSe]:WAVeform:DIF:FILTer:BANDwidth?
[ :SENSe]:WAVeform:DIF:FILTer:BANDwidth:AUTO ON | OFF | 1 | 0
[ :SENSe]:WAVeform:DIF:FILTer:BANDwidth:AUTO?
[ :SENSe]:WAVeform:DIF:FILTer:TYPE GAUSSian | FLATtop | SNYquist |
RSNYquist | RCOSine | RRCosine
[ :SENSe]:WAVeform:DIF:FILTer:TYPE GAUSSian | FLATtop
[ :SENSe]:WAVeform:DIF:FILTer:TYPE?
[ :SENSe]:WAVeform:DIF:FILTer:TYPE?
[ :SENSe]:WAVeform:FREQuency:SYNThesis:AUTO[:STATe] OFF | ON | 0 | 1
[ :SENSe]:WAVeform:FREQuency:SYNThesis:AUTO[:STATe]?
[ :SENSe]:WAVeform:FREQuency:SYNThesis[:STATe] 1 | 2 | 3
[ :SENSe]:WAVeform:FREQuency:SYNThesis[:STATe]?
[ :SENSe]:WAVeform:IF:GAIN:AUTO[:STATe] ON | OFF | 1 | 0
[ :SENSe]:WAVeform:IF:GAIN:AUTO[:STATe]?
[ :SENSe]:WAVeform:IF:GAIN:OFFSet <rel_ampl>
[ :SENSe]:WAVeform:IF:GAIN:OFFSet?
[ :SENSe]:WAVeform:IF:GAIN[:STATe] AUTOrange | LOW | HIGH
[ :SENSe]:WAVeform:IF:GAIN[:STATe]?
[ :SENSe]:WAVeform:PDITHer
[ :SENSe]:WAVeform:SRATE <freq>
[ :SENSe]:WAVeform:SRATE?
[ :SENSe]:WAVeform:SWEep:TIME <time>
[ :SENSe]:WAVeform:SWEep:TIME?
[ :SENSe]:WAVeform:WBIF:ADC:DITHer
[ :SENSe]:WAVeform:WBIF:FILTer:ALPHa
[ :SENSe]:WAVeform:WBIF:FILTer:BANDwidth <real>
[ :SENSe]:WAVeform:WBIF:FILTer:BANDwidth?
[ :SENSe]:WAVeform:WBIF:FILTer[:TYPE] GAUSSian | NONE | NYquist | RNYquist
| RCOSine | RRCosine
[ :SENSe]:WAVeform:WBIF:FILTer[:TYPE]?
STATus:OPERation:CONDition?
STATus:OPERation:ENABle <integer>
STATus:OPERation:ENABle?
STATus:OPERation[:EVENT]?
STATus:OPERation:NTRAnsition <integer>
STATus:OPERation:NTRAnsition?
```



```

STATUS:OPERation:PTRansition <integer>
STATUS:OPERation:PTRansition?
STATUS:PRESet
STATUS:QUEStionable:CALibration:CONDition?
STATUS:QUEStionable:CALibration:ENABle <integer>
STATUS:QUEStionable:CALibration:ENABle?
STATUS:QUEStionable:CALibration[:EVENT]?
STATUS:QUEStionable:CALibration:EXTended:FAILure:CONDition?
STATUS:QUEStionable:CALibration:EXTended:FAILure:ENABle <integer>
STATUS:QUEStionable:CALibration:EXTended:FAILure:ENABle?
STATUS:QUEStionable:CALibration:EXTended:FAILure[:EVENT]?
STATUS:QUEStionable:CALibration:EXTended:FAILure:NTRansition <integer>
STATUS:QUEStionable:CALibration:EXTended:FAILure:NTRansition?
STATUS:QUEStionable:CALibration:EXTended:FAILure:PTRansition <integer>
STATUS:QUEStionable:CALibration:EXTended:FAILure:PTRansition?
STATUS:QUEStionable:CALibration:EXTended:NEEDed:CONDition?
STATUS:QUEStionable:CALibration:EXTended:NEEDed:ENABle <integer>
STATUS:QUEStionable:CALibration:EXTended:NEEDed:ENABle?
STATUS:QUEStionable:CALibration:EXTended:NEEDed[:EVENT]?
STATUS:QUEStionable:CALibration:EXTended:NEEDed:NTRansition <integer>
STATUS:QUEStionable:CALibration:EXTended:NEEDed:NTRansition?
STATUS:QUEStionable:CALibration:EXTended:NEEDed:PTRansition <integer>
STATUS:QUEStionable:CALibration:EXTended:NEEDed:PTRansition?
STATUS:QUEStionable:CALibration:NTRansition <integer>
STATUS:QUEStionable:CALibration:NTRansition?
STATUS:QUEStionable:CALibration:PTRansition <integer>
STATUS:QUEStionable:CALibration:PTRansition?
STATUS:QUEStionable:CALibration:SKIPPed:CONDition?
STATUS:QUEStionable:CALibration:SKIPPed:ENABle <integer>
STATUS:QUEStionable:CALibration:SKIPPed:ENABle?
STATUS:QUEStionable:CALibration:SKIPPed[:EVENT]?
STATUS:QUEStionable:CALibration:SKIPPed:NTRansition <integer>
STATUS:QUEStionable:CALibration:SKIPPed:NTRansition?
STATUS:QUEStionable:CALibration:SKIPPed:PTRansition <integer>
STATUS:QUEStionable:CALibration:SKIPPed:PTRansition?
STATUS:QUEStionable:CONDition?
STATUS:QUEStionable:ENABle <integer>
STATUS:QUEStionable:ENABle?
STATUS:QUEStionable[:EVENT]?
STATUS:QUEStionable:FREQuency:CONDition?
STATUS:QUEStionable:FREQuency:ENABle <integer>
STATUS:QUEStionable:FREQuency:ENABle?
STATUS:QUEStionable:FREQuency[:EVENT]?
STATUS:QUEStionable:FREQuency:NTRansition <integer>
STATUS:QUEStionable:FREQuency:NTRansition?
STATUS:QUEStionable:FREQuency:PTRansition <integer>
STATUS:QUEStionable:FREQuency:PTRansition?
STATUS:QUEStionable:INTEgrity:CONDition?
STATUS:QUEStionable:INTEgrity:ENABle <integer>
STATUS:QUEStionable:INTEgrity:ENABle?
STATUS:QUEStionable:INTEgrity[:EVENT]?
STATUS:QUEStionable:INTEgrity:NTRansition <integer>
STATUS:QUEStionable:INTEgrity:NTRansition?

```

```
STaTus:QUEStionable:INTEgrity:PTRansition <integer>
STaTus:QUEStionable:INTEgrity:PTRansition?
STaTus:QUEStionable:INTEgrity:SIGNal:CONDition?
STaTus:QUEStionable:INTEgrity:SIGNal:ENABle <integer>
STaTus:QUEStionable:INTEgrity:SIGNal:ENABle?
STaTus:QUEStionable:INTEgrity:SIGNal[:EVENT]?
STaTus:QUEStionable:INTEgrity:SIGNal:NTRansition <integer>
STaTus:QUEStionable:INTEgrity:SIGNal:NTRansition?
STaTus:QUEStionable:INTEgrity:SIGNal:PTRansition <integer>
STaTus:QUEStionable:INTEgrity:SIGNal:PTRansition?
STaTus:QUEStionable:INTEgrity:UNCalibrated:CONDition?
STaTus:QUEStionable:INTEgrity:UNCalibrated:ENABle
STaTus:QUEStionable:INTEgrity:UNCalibrated:ENABle?
STaTus:QUEStionable:INTEgrity:UNCalibrated[:EVENT]?
STaTus:QUEStionable:INTEgrity:UNCalibrated:NTRansition <integer>
STaTus:QUEStionable:INTEgrity:UNCalibrated:NTRansition?
STaTus:QUEStionable:INTEgrity:UNCalibrated:PTRansition <integer>
STaTus:QUEStionable:INTEgrity:UNCalibrated:PTRansition?
STaTus:QUEStionable:NTRansition <integer>
STaTus:QUEStionable:NTRansition?
STaTus:QUEStionable:POWEr:CONDition?
STaTus:QUEStionable:POWEr:ENABle <integer>
STaTus:QUEStionable:POWEr:ENABle?
STaTus:QUEStionable:POWEr[:EVENT]?
STaTus:QUEStionable:POWEr:NTRansition <integer>
STaTus:QUEStionable:POWEr:NTRansition?
STaTus:QUEStionable:POWEr:PTRansition <integer>
STaTus:QUEStionable:POWEr:PTRansition?>
STaTus:QUEStionable:PTRansition <integer>
STaTus:QUEStionable:PTRansition?
STaTus:QUEStionable:TEMPerature:CONDition?
STaTus:QUEStionable:TEMPerature:ENABle <integer>
STaTus:QUEStionable:TEMPerature:ENABle?
STaTus:QUEStionable:TEMPerature[:EVENT]?
STaTus:QUEStionable:TEMPerature:NTRansition <integer>
STaTus:QUEStionable:TEMPerature:NTRansition?
STaTus:QUEStionable:TEMPerature:PTRansition <integer>
STaTus:QUEStionable:TEMPerature:PTRansition?
SYSTem:APPLication:CATalog[:NAME]?
SYSTem:APPLication:CATalog[:NAME]:COUNT?
SYSTem:APPLication:CATalog:OPTion? <model>
SYSTem:APPLication:CATalog:REVision? <model>
SYSTem:APPLication[:CURRent][:NAME]?
SYSTem:APPLication[:CURRent]:OPTion?
SYSTem:APPLication[:CURRent]:REVision?
SYSTem:COMMunicate:GPIB[1][:SELF]:ADDRes <integer>
SYSTem:COMMunicate:GPIB[1][:SELF]:ADDRes?
SYSTem:COMMunicate:GPIB[1][:SELF]:CONTroller[:ENABle] ON | OFF | 0 | 1
SYSTem:COMMunicate:GPIB[1][:SELF]:CONTroller[:ENABle]?
SYSTem:COMMunicate:LAN:SCPI:HISLip:ENABle OFF | ON | 0 | 1
SYSTem:COMMunicate:LAN:SCPI:HISLip:ENABle?
SYSTem:COMMunicate:LAN:SCPI:SICL:ENABle OFF | ON | 0 | 1
SYSTem:COMMunicate:LAN:SCPI:SICL:ENABle?
```

```

SYSTEM:COMMunicate:LAN:SCPI:SOCKET:CONTRol?
SYSTEM:COMMunicate:LAN:SCPI:SOCKET:ENABle OFF | ON | 0 | 1
SYSTEM:COMMunicate:LAN:SCPI:SOCKET:ENABle?
SYSTEM:COMMunicate:LAN:SCPI:TELNet:ENABle OFF | ON | 0 | 1
SYSTEM:COMMunicate:LAN:SCPI:TELNet:ENABle?
SYSTEM:COMMunicate:USB:CONNection?
SYSTEM:COMMunicate:USB:PACKets?
SYSTEM:COMMunicate:USB:STATus?
SYSTEM:CONFigure[:SYSTem]?
SYSTEM:CSYSTem?
SYSTEM:DATE "<year>, <month>, <day>"
SYSTEM:DATE?
SYSTEM:DEFault [ALL] | ALIGn | INPut | MISC | MODes | PON
SYSTEM:ERRor[:NEXT]?
SYSTEM:ERRor:OVERload[:STATe] 0 | 1 | OFF | ON
SYSTEM:ERRor:VERBose OFF | ON | 0 | 1
SYSTEM:ERRor:VERBose?
SYSTEM:HELP:HEADers?
SYSTEM:HID?
SYSTEM:IDN <string>
SYSTEM:IDN?
SYSTEM:KLOCK OFF | ON | 0 | 1
SYSTEM:KLOCK?
SYSTEM:LKEY <"OptionInfo">, <"LicenseInfo">
SYSTEM:LKEY? <"OptionInfo">
SYSTEM:LKEY:DELeTe <"OptionInfo">, <"LicenseInfo">
SYSTEM:LKEY:LIST?
SYSTEM:MRELay:COUNT?
SYSTEM:OPTions?
SYSTEM:PDOWN [NORMal | FORCe]
SYSTEM:PON:APPLication:LLIST <stringofINSTrument:SElectnames>
SYSTEM:PON:APPLication:LLIST?
SYSTEM:PON:APPLication:VMEMory[:AVAILable]?
SYSTEM:PON:APPLication:VMEMory:TOTAL?
SYSTEM:PON:APPLication:VMEMory:USED?
SYSTEM:PON:APPLication:VMEMory:USED:NAME? <INSTrument:SElectname>
SYSTEM:PON:ETIME?
SYSTEM:PON:MODE SA | BASIC | ADEMOD | NFIGURE | PNOISE | CDMA2K | TDSCDMA
| VSA | VSA89601 | WCDMA | WIMAXOFDMA
SYSTEM:PON:MODE?
SYSTEM:PON:TIME?
SYSTEM:PON:TYPE PRESet
SYSTEM:PON:TYPE MODE | USER | LAST
SYSTEM:PON:TYPE?
SYSTEM:PRESet
SYSTEM:PRESet:TYPE FACTory | MODE | USER
SYSTEM:PRESet:TYPE?
SYSTEM:PRESet:USER
SYSTEM:PRESet:USER:ALL
SYSTEM:PRESet:USER:SAVE
SYSTEM:PRINT:THEMe TDColor | TDMonochrome | FCOLOR | FMONochrome
SYSTEM:PRINT:THEMe?
SYSTEM:PUP:PROCEss

```

3 Programming the Analyzer

List of SCPI Commands

```
SYSTem:SECurity:USB:WPRotect[:ENABLE] ON | OFF | 0 | 1
SYSTem:SECurity:USB:WPRotect[:ENABLE]?
SYSTem:SHOW OFF | ERROR | SYSTem | HARDware | LXI | HWStatistics |
ALIGNment | SOFTware | CAPplication
SYSTem:SHOW?
SYSTem:TEMPerature:HEXTreme?
SYSTem:TEMPerature:LEXTreme?
SYSTem:TIME "<hour>, <minute>, <second>"
SYSTem:TIME?
SYSTem:VERSion?
TRACe[1]|2|3:ACPowEr:DISPlay[:STATE] ON | OFF | 0 | 1
TRACe[1]|2|3:ACPowEr:DISPlay[:STATE]?
TRACe[1]|2|3:ACPowEr:TYPE WRITE | AVERAge | MAXHold | MINHold
TRACe[1]|2|3:ACPowEr:TYPE?
TRACe[1]|2|3:ACPowEr:UPDate[:STATE] ON | OFF | 0 | 1
TRACe[1]|2|3:ACPowEr:UPDate[:STATE]?
TRACe:CHPower:TYPE WRITE | AVERAge | MAXHold | MINHold
TRACe:CHPower:TYPE?
TRACe:MONitor:CLear [TRACE1] | TRACE2 | TRACE3
TRACe:MONitor:CLear:ALL
TRACe[1]|2|3:MONitor:DISPlay[:STATE] ON | OFF | 0 | 1
TRACe[1]|2|3:MONitor:DISPlay[:STATE]?
TRACe[1]|2|3:MONitor:TYPE WRITE | AVERAge | MAXHold | MINHold
TRACe[1]|2|3:MONitor:TYPE?
TRACe[1]|2|3:MONitor:UPDate[:STATE] ON | OFF | 0 | 1
TRACe[1]|2|3:MONitor:UPDate[:STATE]?
TRACe:OBWidth:TYPE WRITE | AVERAge | MAXHold | MINHold
TRACe:OBWidth:TYPE?
TRACe:SEMAsk:TYPE WRITE | AVERAge | MAXHold | MINHold
TRACe:SEMAsk:TYPE?
TRIGger:<measurement>[:SEQUence]:IQ:SOURce EXTernal1 | EXTernal2 |
IMMEdiate | IQMag | IDEMod | QDEMod | IINPut | QINPut | AIQMag
TRIGger:<measurement>[:SEQUence]:IQ:SOURce?
TRIGger:<measurement>[:SEQUence]:RF:SOURce EXTernal1 | EXTernal2 |
IMMEdiate | LINE | FRAME | RFBurst | VIDEo | IF | ALARm | LAN | TV
TRIGger:<measurement>[:SEQUence]:RF:SOURce?
TRIGger:<measurement>[:SEQUence]:SOURce EXTernal1 | EXTernal2 | IMMEdiate
| LINE | FRAME | RFBurst | VIDEo | IF | ALARm | LAN | IQMag | IDEMod |
QDEMod | IINPut | QINPut | AIQMag | TV
TRIGger:<measurement>[:SEQUence]:SOURce?
TRIGger[:SEQUence]:ATRigger <time>
TRIGger[:SEQUence]:ATRigger?
TRIGger[:SEQUence]:ATRigger:STATE OFF | ON | 0 | 1
TRIGger[:SEQUence]:ATRigger:STATE?
TRIGger[:SEQUence]:DELay <time>
TRIGger[:SEQUence]:DELay?
TRIGger[:SEQUence]:DELay:STATE OFF | ON | 0 | 1
TRIGger[:SEQUence]:DELay:STATE?
TRIGger[:SEQUence]:EXTernal:DELay
TRIGger[:SEQUence]:EXTernal1:DELay <time>
TRIGger[:SEQUence]:EXTernal2:DELay <time>
TRIGger[:SEQUence]:EXTernal2:DELay?
```

```

TRIGger[:SEQuence]:EXTErnal1:DELay?
TRIGger[:SEQuence]:EXTErnal2:DELay:STATE OFF | ON | 0 | 1
TRIGger[:SEQuence]:EXTErnal1:DELay:STATE OFF | ON | 0 | 1
TRIGger[:SEQuence]:EXTErnal2:DELay:STATE?
TRIGger[:SEQuence]:EXTErnal1:DELay:STATE?
TRIGger[:SEQuence]:EXTErnal:LEVel
TRIGger[:SEQuence]:EXTErnal1:LEVel <level>
TRIGger[:SEQuence]:EXTErnal2:LEVel
TRIGger[:SEQuence]:EXTErnal1:LEVel?
TRIGger[:SEQuence]:EXTErnal2:LEVel?
TRIGger[:SEQuence]:EXTErnal1:SLOPe POSitive | NEGative
TRIGger[:SEQuence]:EXTErnal:SLOPe
TRIGger[:SEQuence]:EXTErnal2:SLOPe POSitive | NEGative
TRIGger[:SEQuence]:EXTErnal1:SLOPe?
TRIGger[:SEQuence]:EXTErnal2:SLOPe?
TRIGger[:SEQuence]:FRAME:ADJust <time>
TRIGger[:SEQuence]:FRAME:DELay <time>
TRIGger[:SEQuence]:FRAME:DELay?
TRIGger[:SEQuence]:FRAME:DELay:STATE OFF | ON | 0 | 1
TRIGger[:SEQuence]:FRAME:DELay:STATE?
TRIGger[:SEQuence]:FRAME:EXTErnal2:LEVel
TRIGger[:SEQuence]:FRAME:EXTErnal1:LEVel
TRIGger[:SEQuence]:FRAME:EXTErnal2:SLOPe
TRIGger[:SEQuence]:FRAME:EXTErnal1:SLOPe
TRIGger[:SEQuence]:FRAME:OFFSet <time>
TRIGger[:SEQuence]:FRAME:OFFSet?
TRIGger[:SEQuence]:FRAME:OFFSet:DISPlay:RESet
TRIGger[:SEQuence]:FRAME:PERiod <time>
TRIGger[:SEQuence]:FRAME:PERiod?
TRIGger[:SEQuence]:FRAME:RFBurst:LEVel:ABSolute
TRIGger[:SEQuence]:FRAME:RFBurst:SLOPe
TRIGger[:SEQuence]:FRAME:SYNC EXTErnal1 | EXTErnal2 | RFBurst | OFF
TRIGger[:SEQuence]:FRAME:SYNC EXTErnal
TRIGger[:SEQuence]:FRAME:SYNC?
TRIGger[:SEQuence]:FRAME:SYNC:HOLDoff <time>
TRIGger[:SEQuence]:FRAME:SYNC:HOLDoff?
TRIGger[:SEQuence]:FRAME:SYNC:HOLDoff:STATE OFF | ON | 0 | 1
TRIGger[:SEQuence]:FRAME:SYNC:HOLDoff:STATE?
TRIGger[:SEQuence]:HOLDoff <time>
TRIGger[:SEQuence]:HOLDoff?
TRIGger[:SEQuence]:HOLDoff:STATE OFF | ON | 0 | 1
TRIGger[:SEQuence]:HOLDoff:STATE?
TRIGger[:SEQuence]:IF:LEVel
TRIGger[:SEQuence]:IF:LEVel?
TRIGger[:SEQuence]:IF:SLOPe NEGative | POSitive
TRIGger[:SEQuence]:IF:SLOPe?
TRIGger[:SEQuence]:LINE:DELay <time>
TRIGger[:SEQuence]:LINE:DELay?
TRIGger[:SEQuence]:LINE:DELay:STATE OFF | ON | 0 | 1
TRIGger[:SEQuence]:LINE:DELay:STATE?
TRIGger[:SEQuence]:LINE:SLOPe POSitive | NEGative
TRIGger[:SEQuence]:LINE:SLOPe?
TRIGger[:SEQuence]:OFFSet <time>

```

```
TRIGger[:SEquence]:OFFSet?
TRIGger[:SEquence]:OFFSet:STATE OFF | ON | 0 | 1
TRIGger[:SEquence]:OFFSet:STATE?
TRIGger[:SEquence]:RFBurst:DElay <time>
TRIGger[:SEquence]:RFBurst:DElay?
TRIGger[:SEquence]:RFBurst:DElay:STATE OFF | ON | 0 | 1
TRIGger[:SEquence]:RFBurst:DElay:STATE?
TRIGger[:SEquence]:RFBurst:LEVel
TRIGger[:SEquence]:RFBurst:LEVel:ABSolute <ampl>
TRIGger[:SEquence]:RFBurst:LEVel:ABSolute?
TRIGger[:SEquence]:RFBurst:LEVel:RELative <rel_ampl>
TRIGger[:SEquence]:RFBurst:LEVel:RELative?
TRIGger[:SEquence]:RFBurst:LEVel:TYPE ABSolute | RELative
TRIGger[:SEquence]:RFBurst:LEVel:TYPE?
TRIGger[:SEquence]:RFBurst:SLOPe POSitive | NEGative
TRIGger[:SEquence]:RFBurst:SLOPe?
TRIGger[:SEquence]:SLOPe POSitive | NEGative
TRIGger[:SEquence]:SLOPe?
TRIGger[:SEquence]:SOURCe EXTernal
TRIGger[:SEquence]:VIDeo:DElay <time>
TRIGger[:SEquence]:VIDeo:DElay?
TRIGger[:SEquence]:VIDeo:DElay:STATE OFF | ON | 0 | 1
TRIGger[:SEquence]:VIDeo:DElay:STATE?
TRIGger[:SEquence]:VIDeo:LEVel <ampl>
TRIGger[:SEquence]:VIDeo:LEVel?
TRIGger[:SEquence]:VIDeo:SLOPe POSitive | NEGative
TRIGger[:SEquence]:VIDeo:SLOPe?
TRIGger|TRIGger1|TRIGger2[:SEquence]:OUTPut HSWP | MEASuring | MAIN | GATE
| GTRigger | OEven | SPoint | SSweep | SSETtled | S1Marker | S2Marker |
S3Marker | S4Marker | OFF
TRIGger|TRIGger1|TRIGger2[:SEquence]:OUTPut?
TRIGger|TRIGger1|TRIGger2[:SEquence]:OUTPut:POLarity POSitive | NEGative
TRIGger|TRIGger1|TRIGger2[:SEquence]:OUTPut:POLarity?
UNIT:ACPoweR:POWeR:PSD DBMHZ | DBMMHZ
UNIT:ACPoweR:POWeR:PSD?
UNIT:CHPoweR:POWeR:PSD DBMHZ | DBMMHZ
UNIT:CHPoweR:POWeR:PSD?
```

STATus Subsystem

The following diagram provides a graphical overview of the entire X-Series Status Register System.

For readability, the diagram is split into two sections:

- ["X-Series Status Register System \(1\)" on page 144](#)
- ["X-Series Status Register System \(2\)" on page 145](#)

X-Series Status Register System (1)

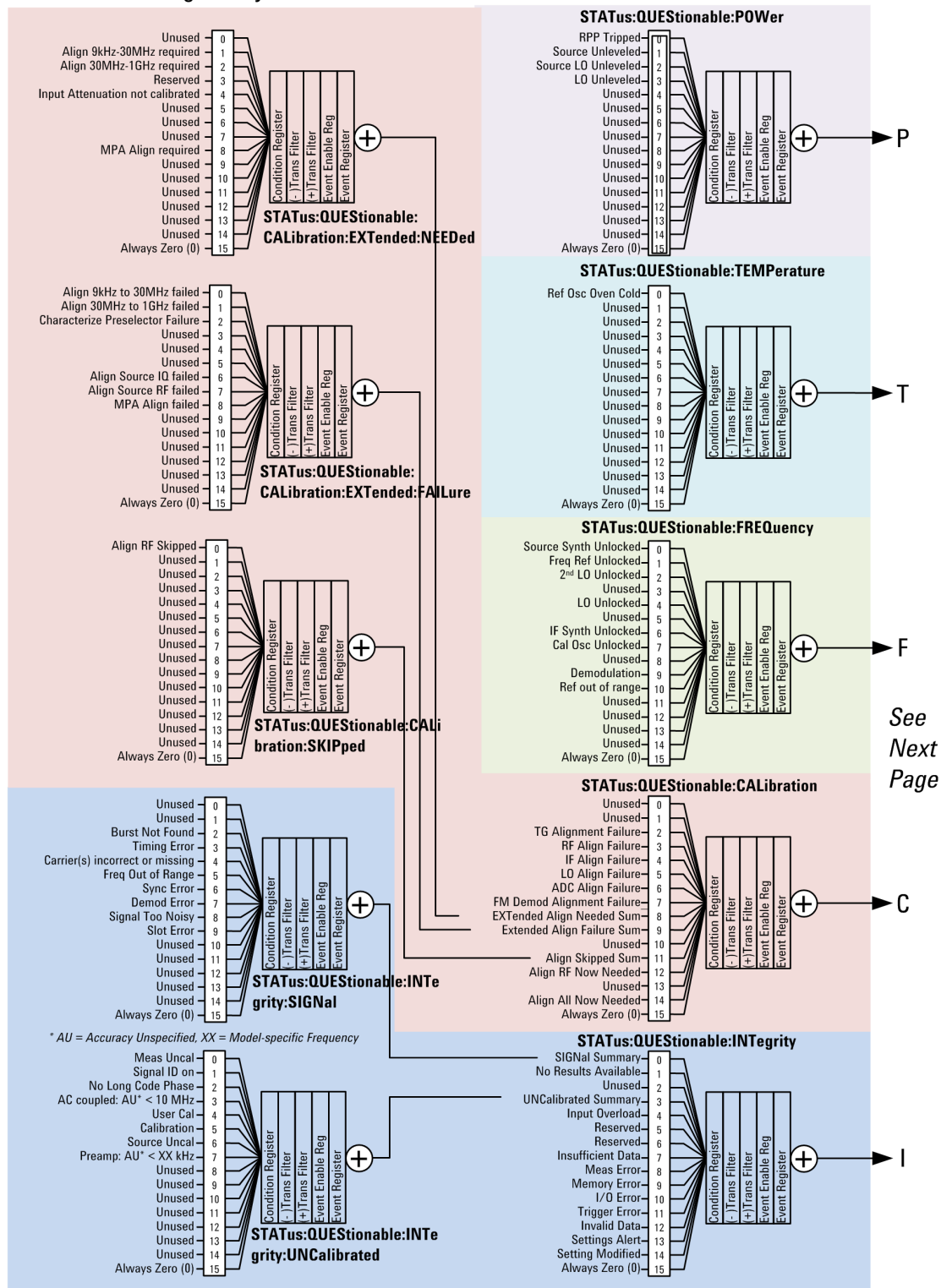

See Next Page

X-Series Status Register System (2)

See
Previous
Page

P
T
F

C
I

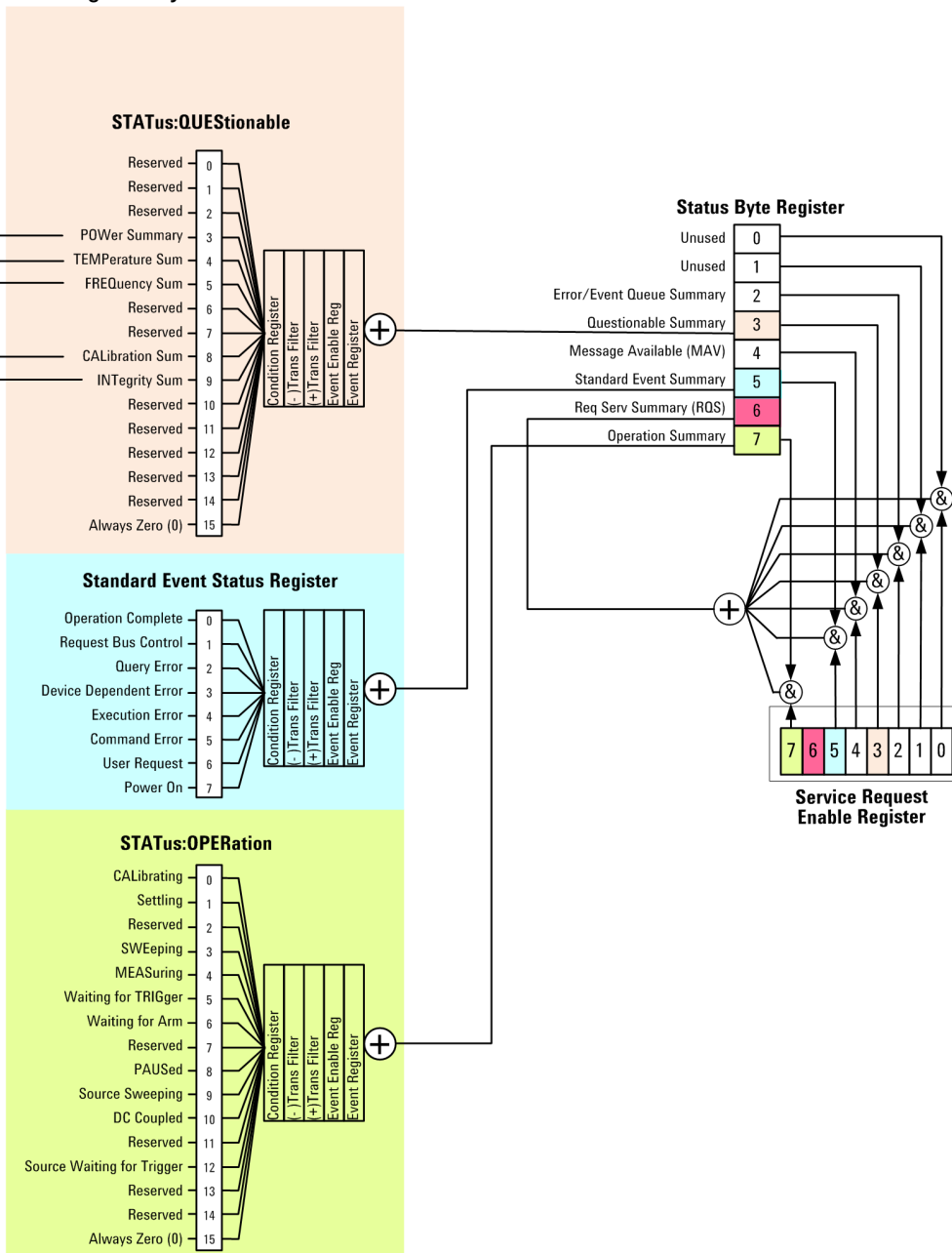

Detailed Description

The STATus subsystem remote commands set and query the status hardware registers. This system of registers monitors various events and conditions in the instrument. Software written to control the instrument may need to monitor some of these events and conditions.

NOTE

All status register commands are sequential. Most commands can be started immediately and will overlap with any existing commands that are already running. This is not true of status commands. All the commands in the spectrum analyzer are assumed to be overlapped unless a command description specifically says that it is sequential.

What Are Status Registers

The status system contains multiple registers that are arranged in a hierarchical order. The lower-level status registers propagate their data to the higher-level registers in the data structures by means of summary bits. The status byte register is at the top of the hierarchy and contains general status information for the instrument's events and conditions. All other individual registers are used to determine the specific events or conditions. For a diagram of the registers and their interconnections, see above.

The operation and questionable status registers are sets of registers that monitor the overall instrument condition. They are accessed with the STATus:OPERation and STATus:QUEStionable commands in the STATus command subsystem. Each register set is made up of five registers:

- Condition Register—It reports the real-time state of the signals monitored by this register set. There is no latching or buffering for a condition register.
- Positive Transition Register—This filter register controls which signals will set a bit in the event register when the signal makes a low to high transition (when the condition bit changes from 0 to 1).
- Negative Transition Register—This filter register controls which signals will set a bit in the event register when the signal makes a high to low transition (when the condition bit changes from 1 to 0).
- Event Register—It latches any signal state changes, in the way specified by the filter registers. Bits in the event register are never cleared by signal state changes. Event registers are cleared when read. They are also cleared by *CLS and by presetting the instrument.
- Event Enable Register—It controls which of the bits, being set in the event register, will be summarized as a single output for the register set. Summary bits are then used by the next higher register.

The STATus:QUEStionable registers report abnormal operating conditions. The status register hierarchy is:

1. The summary outputs from the six STATus:QUEStionable:<keyword> detail registers are inputs to the STATus:QUEStionable register.
2. The summary output from the STATus:QUEStionable register is an input to the Status Byte Register. See the overall system in Figure at the beginning of this section.

The STATus:OPERation register set has no summarized inputs. The inputs to the STATus:OPERation:CONDition register indicate the real time state of the instrument. The STATus:OPERation:EVENT register summary output is an input to the Status Byte Register.

What Are Status Register SCPI Commands

Most monitoring of the instrument conditions is done at the highest level using the IEEE common commands indicated below. Complete command descriptions are available in the IEEE commands section at the beginning of the language reference. Individual status registers can be set and queried using the commands in the STATus subsystem of the language reference.

- *CLS (clear status) clears the status byte by emptying the error queue and clearing all the event registers.
- *ESE, *ESE? (event status enable) sets and queries the bits in the enable register part of the standard event status register.
- *ESR? (event status register) queries and clears the event register part of the standard event status register.

- *OPC, *OPC? (operation complete) sets the standard event status register to monitor the completion of all commands. The query stops any new commands from being processed until the current processing is complete, then returns a '1'.
- *PSC, *PSC? (power-on state clear) sets the power-on state so that it clears the service request enable register and the event status enable register at power on.
- *SRE, *SRE? (service request enable) sets and queries the value of the service request enable register.
- *STB? (status byte) queries the value of the status byte register without erasing its contents.

How to Use the Status Registers

A program often needs to be able to detect and manage error conditions or changes in instrument status. There are two methods you can use to programmatically access the information in status registers:

- The polling method
- The service request (SRQ) method

In the polling method, the instrument has a passive role. It only tells the controller that conditions have changed when the controller asks the right question. In the SRQ method, the instrument takes a more active role. It tells the controller when there has been a condition change without the controller asking. Either method allows you to monitor one or more conditions.

The polling method works well if you do not need to know about changes the moment they occur. The SRQ method should be used if you must know immediately when a condition changes. To detect a change using the polling method, the program must repeatedly read the registers.

Use the SRQ method when:

- you need time-critical notification of changes
- you are monitoring more than one device which supports SRQs
- you need to have the controller do something else while waiting
- you can't afford the performance penalty inherent to polling

Use polling when:

- your programming language/development environment does not support SRQ interrupts
- you want to write a simple, single-purpose program and don't want the added complexity of setting up an SRQ handler
- To monitor a condition:
 - a. Determine which register contains the bit that reports the condition.
 - b. Send the unique SCPI query that reads that register.
 - c. Examine the bit to see if the condition has changed.

You can monitor conditions in different ways.

- Check the current instrument hardware and firmware status.

Do this by querying the condition registers which continuously monitor status. These registers represent the current state of the instrument. Bits in a condition register are updated in real time. When the condition monitored by a particular bit becomes true, the bit is set to 1. When the condition becomes false, the bit is reset to 0.

- Monitor a particular condition (bit).

You can enable a particular bit(s), using the event enable register. The instrument will then monitor that particular condition(s). If the bit becomes true (0 to 1 transition) in the event register, it will stay set until the event register is cleared. Querying the event register allows you to detect that this condition occurred even if the condition no longer exists. The event register can only be cleared by querying it or sending the *CLS command.

- Monitor a particular type of change in a condition (bit).
 - The transition registers are preset to register if the condition goes from 0 to 1 (false to true, or a positive transition).
 - This can be changed so the selected condition is detected if the bit goes from 1 to 0 (true to false, or a negative transition).
 - It can also be set for both types of transitions occurring.
 - Or it can be set for neither transition. If both transition registers are set to 0 for a particular bit position, that bit will not be set in the event register for either type of change.

Using a Status Register

Each bit in a register is represented by a numerical value based on its location. See figure below. This number is sent with the command to enable a particular bit. If you want to enable more than one bit, you would send the sum of all the bits that you want to monitor.

Figure: Status Register Bit Values

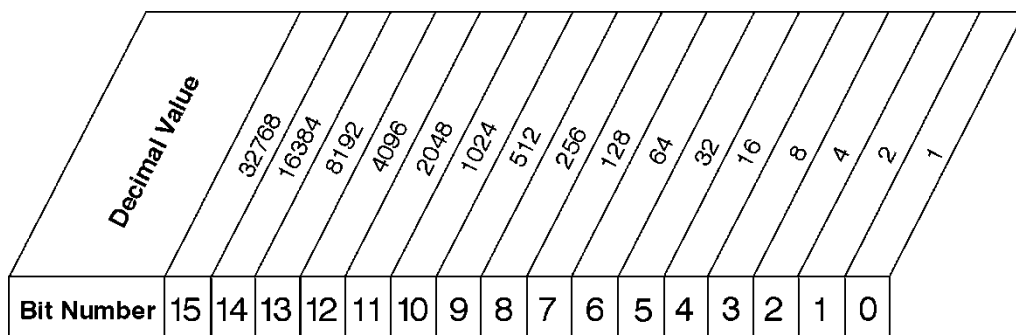

STATus:OPERation:ENABLE < num >
 STATus:OPERation:ENABLE?

Standard Operation Event Enable Register

ck730a

Bit 15 is not used to report status.

Example 1:

1. To enable bit 0 and bit 6 of standard event status register, you would send the command *ESE 65 because 1 + 64 = 65.

- The results of a query are evaluated in a similar way. If the *STB? command returns a decimal value of 140, ($140 = 128 + 8 + 4$) then bit 7 is true, bit 3 is true and bit 2 is true.

Example 2:

- Suppose you want to know if an Auto-trigger Timeout occurs, but you only cared about that specific condition. So you would want to know what was happening with bit 10 in the Status Questionable Integrity register, and not about any other bits.
- It's usually a good idea to start by clearing all the status registers with *CLS.
- Sending the STAT:QUES:INT:ENAB 1024 command lets you monitor only bit 10 events, instead of the default monitoring all the bits in the register. The register default is for positive transition events (0 to 1 transition). That is, when an auto-trigger timeout occurs. If instead, you wanted to know when the Auto-trigger timeout condition is cleared, then you would set the STAT:QUES:INT:PTR 0 and the STAT:QUES:INT:NTR 32767.
- So now the only output from the Status Questionable Integrity register will come from a bit 10 positive transition. That output goes to the Integrity Sum bit 9 of the Status Questionable register.
- You can do a similar thing with this register to only look at bit 9 using, STAT:QUES:ENAB 512.
- The Status Questionable register output goes to the "Status Questionable Summary" bit 3 of the Status Byte Register. The output from this register can be enabled using the *SRE 8 command.
- Finally, you would use the serial polling functionality available for the particular bus/software that you are using to monitor the Status Byte Register. (You could also use *STB? to poll the Status Byte Register.)

Using the Service Request (SRQ) Method

Your language, bus, and programming environment must be able to support SRQ interrupts. (For example, BASIC used with VXI-11.3 (GPIB over LAN). When you monitor a condition with the SRQ method, you must:

- Determine which bit monitors the condition.
- Determine how that bit reports to the request service (RQS) bit of the status byte.
- Send SCPI commands to enable the bit that monitors the condition and to enable the summary bits that report the condition to the RQS bit.
- Enable the controller to respond to service requests.

When the condition changes, the instrument sets its RQS bit. The controller is informed of the change as soon as it occurs. As a result, the time the controller would otherwise have used to monitor the condition can be used to perform other tasks. Your program determines how the controller responds to the SRQ.

Generating a Service Request

To use the SRQ method, you must understand how service requests are generated. Bit 6 of the status byte register is the request service (RQS) bit. The *SRE command is used to configure the RQS bit to report changes in instrument status. When such a change occurs, the RQS bit is set. It is cleared when the status byte register is queried using *SRE? (with a serial poll.) It can be queried without erasing the contents with *STB?.

When a register set causes a summary bit in the status byte to change from 0 to 1, the instrument can initiate the service request (SRQ) process. However, the process is only initiated if both of the following conditions are true:

- The corresponding bit of the service request enable register is also set to 1.
- The instrument does not have a service request pending. (A service request is considered to be pending between the time the instrument's SRQ process is initiated and the time the controller reads the status byte register.)

The SRQ process sets the SRQ true. It also sets the status byte's request service (RQS) bit to 1. Both actions are necessary to inform the controller that the instrument requires service. Setting the SRQ line only informs the controller that some device on the bus requires service. Setting the RQS bit allows the controller to determine which instrument requires service.

If your program enables the controller to detect and respond to service requests, it should instruct the controller to perform a serial poll when the SRQ is set true. Each device on the bus returns the contents of its status byte register in response to this poll. The device whose RQS bit is set to 1 is the device that requested service.

When you read the instrument's status byte register with a serial poll, the RQS bit is reset to 0. Other bits in the register are not affected.

If the status register is configured to SRQ on end-of-measurement and the measurement is in continuous mode, then restarting a measurement (INIT command) can cause the measuring bit to pulse low. This causes an SRQ when you have not actually reached the "end-of-measurement" condition. To avoid this:

1. Set INITiate:CONTinuous off.
2. Set/enable the status registers.
3. Restart the measurement (send INIT).

Status Register System

The hardware status registers are combined to form the instrument status system. Specific status bits are assigned to monitor various aspects of the instrument operation and status. See the diagram of the status system above for information about the bit assignments and status register interconnections.

The Status Byte Register

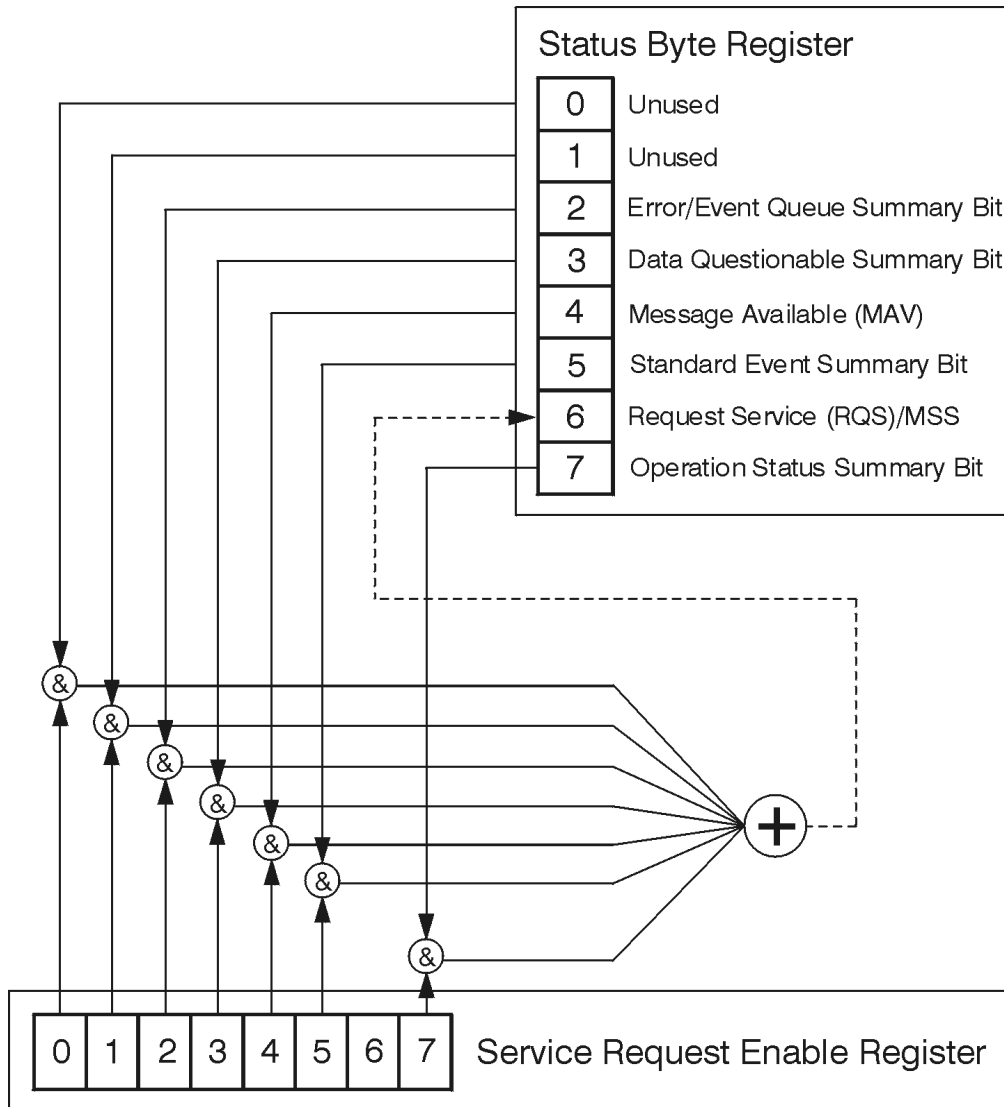

ck776a

The RQS bit is read and reset by a serial poll. The same bit position (MSS) is read, non-destructively by the *STB? command. If you serial poll bit 6 it is read as RQS, but if you send *STB it reads bit 6 as MSS. For more information refer to IEEE 488.2 standards, section 11.

	Description								
	Standard Operation Status Summary Bit	Request Service (RQS) Summary Bit	Standard Event Status Summary Bit	Message Available (MAV)	Data Questionable Status Summary Bit	Error/Event Queue Summary Bit	Unused	Unused	
Bit Number	7	6	5	4	3	2	1	0	

*STB?

Status Byte Register

ck725a

Bit	Description
0, 1	These bits are always set to 0.
2	A 1 in this bit position indicates that the SCPI error queue is not empty which means that it contains at least one error message.
3	A 1 in this bit position indicates that the data questionable summary bit has been set. The data questionable event register can then be read to determine the specific condition that caused this bit to be set.
4	A 1 in this bit position indicates that the instrument has data ready in the output queue. There are no lower status groups that provide input to this bit.
5	A 1 in this bit position indicates that the standard event summary bit has been set. The standard event status register can then be read to determine the specific event that caused this bit to be set.
6	A 1 in this bit position indicates that the instrument has at least one reason to report a status change. This bit is also called the master summary status bit (MSS).
7	A 1 in this bit position indicates that the standard operation summary bit has been set. The standard operation event register can then be read to determine the specific condition that caused this bit to be set.

To query the status byte register, send the command *STB?. The response will be the decimal sum of the bits which are set to 1. For example, if bit number 7 and bit number 3 are set to 1, the decimal sum of the 2 bits is 128 plus 8. So the decimal value 136 is returned. The *STB command does not clear the status register.

In addition to the status byte register, the status byte group also contains the service request enable register. This register lets you choose which bits in the status byte register will trigger a service request.

Send the *SRE <integer> command where <integer> is the sum of the decimal values of the bits you want to enable plus the decimal value of bit 6. For example, assume that you want to enable bit 7 so that whenever the standard operation status register summary bit is set to 1 it will trigger a service request. Send the command *SRE 192 (because 192 = 128 + 64). You must always add 64 (the numeric value of RQS

bit 6) to your numeric sum when you enable any bits for a service request. The command *SRE? returns the decimal value of the sum of the bits previously enabled with the *SRE <integer> command.

The service request enable register presets to zeros (0).

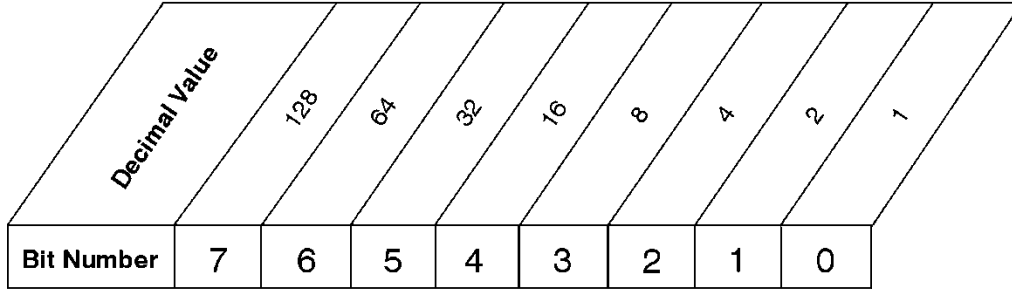

*SRE <num>
 *SRE?

Service Request Enable Register

ck726a

Standard Event Status Register

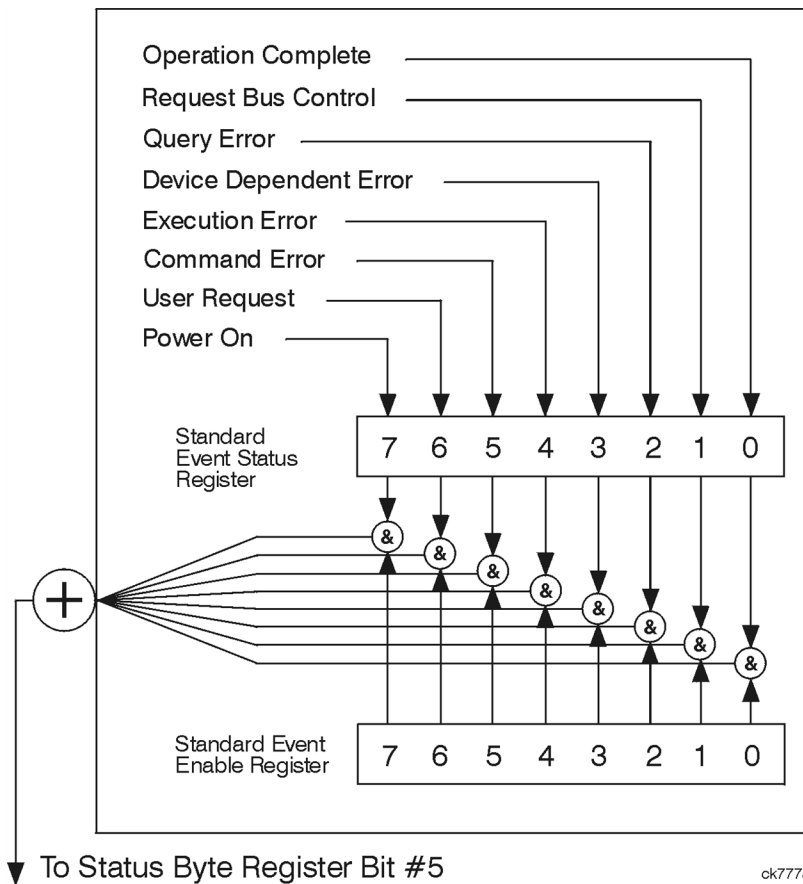

ck777a

The standard event status register contains the following bits:

Bit Number	7	6	5	4	3	2	1	0	

*ESR?

Standard Event Status Register

ck727a

Bit	Description
0	A 1 in this bit position indicates that all pending operations were completed following execution of the *OPC command.
1	This bit is for GPIB handshaking to request control. Currently it is set to 0 because there are no implementations where the spectrum analyzer controls another instrument.
2	A 1 in this bit position indicates that a query error has occurred. Query errors have SCPI error numbers from -499 to -400.
3	A 1 in this bit position indicates that a device dependent error has occurred. Device dependent errors have SCPI error numbers from -399 to -300 and 1 to 32767.
4	A 1 in this bit position indicates that an execution error has occurred. Execution errors have SCPI error numbers from -299 to -200.
5	A 1 in this bit position indicates that a command error has occurred. Command errors have SCPI error numbers from -199 to -100.
6	A 1 in this bit position indicates that the LOCAL key has been pressed. This is true even if the instrument is in local lockout mode.
7	A 1 in this bit position indicates that the instrument has been turned off and then on.

The standard event status register is used to determine the specific event that set bit 5 in the status byte register. To query the standard event status register, send the command *ESR?. The response will be the decimal sum of the bits which are enabled (set to 1). For example, if bit number 7 and bit number 3 are enabled, the decimal sum of the 2 bits is 128 plus 8. So the decimal value 136 is returned.

In addition to the standard event status register, the standard event status group also contains a standard event status enable register. This register lets you choose which bits in the standard event status register will set the summary bit (bit 5 of the status byte register) to 1. Send the *ESE <integer> command where <integer> is the sum of the decimal values of the bits you want to enable. For example, to enable bit 7 and bit 6 so that whenever either of those bits is set to 1, the standard event status summary bit of the status

byte register will be set to 1, send the command *ESE 192 (128 + 64). The command *ESE? returns the decimal value of the sum of the bits previously enabled with the *ESE <integer> command.

The standard event status enable register presets to zeros (0).

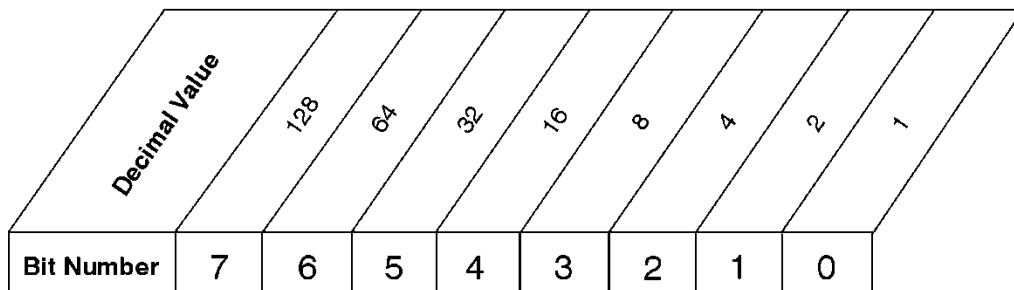

*ESE <num>
 *ESE?

Standard Event Status Enable Register

ck728a

Operation and Questionable Status Registers

The operation and questionable status registers are registers that monitor the overall instrument condition. They are accessed with the STATUS:OPERation and STATUS:QUESTionable commands in the STATUS command subsystem. See the figure at the beginning of this chapter.

Operation Status Register

The operation status register monitors the current instrument measurement state. It checks to see if the instrument is calibrating, sweeping, or waiting for a trigger. For more information see the *OPC? command located in the IEEE Common Commands section.

Bit	Condition	Operation
0	Calibrating	The instrument is busy executing its Align Now process
3	Sweeping	The instrument is busy taking a sweep.
4	Measuring	The instrument is busy making a measurement. Measurements often require multiple sweeps. They are initiated by keys under the MEASURE key or with the MEASure group of commands. The bit is valid for most X-Series Modes.
5	Waiting for trigger	The instrument is waiting for the trigger conditions to be met, then it will trigger a sweep or measurement.

Questionable Status Register

The questionable status register monitors the instrument's condition to see if anything questionable has happened to it. It is looking for anything that might cause an error or a bad measurement like a hardware problem, an out of calibration situation, or a unusual signal. All the bits are summary bits from lower-level event registers.

Bit	Condition	Operation
-----	-----------	-----------

3	Power summary	The instrument hardware has detected a power unlevelled condition.
4	Temperature summary	The instrument is still warming up.
5	Frequency summary	The instrument hardware has detected an unlocked condition or a problem with the external frequency reference.
8	Calibration summary	The instrument has detected a hardware problem while doing the automatic internal alignment process.
9	Integrity summary	The instrument has detected a questionable measurement condition such as: bad timing, bad signal/data, timeout problem, signal overload, or "meas uncal".

STATus Subsystem Command Descriptions

The STATus subsystem controls the SCPI-defined instrument status reporting structures. Each status register has a set of five commands used for querying or masking that particular register.

Numeric values for bit patterns can be entered using decimal or hexadecimal representations. (i.e. 0 to 32767 is equivalent to #H0 to #H7FFF. It is also equal to all ones, 11111111111111) See the SCPI Basics information about using bit patterns for variable parameters.

Operation Register

"Operation Condition Query" on page 156

"Operation Enable" on page 157

"Operation Event Query" on page 157

"Operation Negative Transition" on page 157

"Operation Positive Transition" on page 158

Operation Condition Query

This query returns the decimal value of the sum of the bits in the Status Operation Condition register.

NOTE The data in this register is continuously updated and reflects the current conditions.

Mode	All
Remote Command	:STATus:OPERation:CONDition?
Example	STAT:OPER:COND?
Preset	0
Status Bits/OPC dependencies	Sequential command
Initial S/W Revision	Prior to A.02.00

Operation Enable

This command determines which bits in the Operation Event register, will set the Operation Status Summary bit (bit 7) in the Status Byte Register. The variable <integer> is the sum of the decimal values of the bits you want to enable.

NOTE

The preset condition is to have all bits in this enable register set to 0. To have any Operation Events reported to the Status Byte Register, one or more bits need to be set to 1.

Mode	All
Remote Command	:STATus:OPERation:ENABle <integer> :STATus:OPERation:ENABle?
Example	STAT:OPER:ENAB 1 Sets the register so that Align Now operation will be reported to the Status Byte Register.
Preset	0
Min	0
Max	32767
Status Bits/OPC dependencies	Sequential command
Initial S/W Revision	Prior to A.02.00

Operation Event Query

This query returns the decimal value of the sum of the bits in the Operation Event register.

NOTE

The register requires that the associated PTR or NTR filters be set before a condition register bit can set a bit in the event register. The data in this register is latched until it is queried. Once queried, the register is cleared.

Mode	All
Remote Command	:STATus:OPERation[:EVENT]?
Example	STAT:OPER?
Preset	0
Status Bits/OPC dependencies	Sequential command
Initial S/W Revision	Prior to A.02.00

Operation Negative Transition

This command determines which bits in the Operation Condition register will set the corresponding bit in the Operation Event register when the condition register bit has a negative transition (1 to 0). The variable <integer> is the sum of the decimal values of the bits that you want to enable.

Mode	All
Remote Command	:STATus:OPERation:NTRansition <integer> :STATus:OPERation:NTRansition?
Example	STAT:OPER:NTR 1 Align Now operation complete will be reported to the Status Byte Register.
Preset	0
Min	0
Max	32767
Status Bits/OPC dependencies	Sequential command
Initial S/W Revision	Prior to A.02.00

Operation Positive Transition

This command determines which bits in the Operation Condition register will set the corresponding bit in the Operation Event register when the condition register bit has a positive transition (0 to 1). The variable <integer> is the sum of the decimal values of the bits that you want to enable.

Mode	All
Remote Command	:STATus:OPERation:PTRansition <integer> :STATus:OPERation:PTRansition?
Example	STAT:OPER:PTR 1 Align Now operation beginning will be reported to the Status Byte Register.
Preset	32767
Min	0
Max	32767
Status Bits/OPC dependencies	Sequential command
Initial S/W Revision	Prior to A.02.00

Preset the Status Byte

Sets bits in most of the enable and transition registers to their default state. It presets all the Transition Filters, Enable Registers, and the Error/Event Queue Enable. It has no effect on Event Registers, Error/Event QUEUE, IEEE 488.2 ESE, and SRE Registers as described in IEEE Standard 488.2–1992, IEEE Standard Codes, Formats, Protocols, and Common Commands for Use with ANSI/IEEE Std 488.1–1987. New York, NY, 1992.

Remote Command	:STATus:PRESet
Example	STAT:PRES
Initial S/W Revision	Prior to A.02.00

Questionable Register

"Questionable Condition " on page 159

"Questionable Enable " on page 159

"Questionable Event Query " on page 160

"Questionable Negative Transition " on page 160

"Questionable Positive Transition" on page 160

Questionable Condition

This query returns the decimal value of the sum of the bits in the Questionable Condition register.

NOTE

The data in this register is continuously updated and reflects the current conditions.

Mode	All
Remote Command	:STATus:QUEStionable:CONDition?
Example	STAT:QUES:COND?
Preset	0
Status Bits/OPC dependencies	Sequential command
Initial S/W Revision	Prior to A.02.00

Questionable Enable

This command determines which bits in the Questionable Event register will set the Questionable Status Summary bit (bit3) in the Status Byte Register. The variable <integer> is the sum of the decimal values of the bits you want to enable.

NOTE

The preset condition is all bits in this enable register set to 0. To have any Questionable Events reported to the Status Byte Register, one or more bits need to be set to 1. The Status Byte Event Register should be queried after each measurement to check the Questionable Status Summary (bit 3). If it is equal to 1, a condition during the test may have made the test results invalid. If it is equal to 0, this indicates that no hardware problem or measurement problem was detected by the analyzer.

Mode	All
Remote Command	:STATus:QUEStionable:ENABle <integer> :STATus:QUEStionable:ENABle?
Example	STAT:OPER:PTR 1 Align Now operation beginning will be reported to the Status Byte Register.
Preset	0
Min	0
Max	32767
Status Bits/OPC dependencies	Sequential command
Initial S/W Revision	Prior to A.02.00

Questionable Event Query

This query returns the decimal value of the sum of the bits in the Questionable Event register.

NOTE The register requires that the associated PTR or NTR filters be set before a condition register bit can set a bit in the event register. The data in this register is latched until it is queried. Once queried, the register is cleared.

Mode	All
Remote Command	:STATus:QUEStionable[:EVENT]?
Example	STAT:QUES?
Preset	0
Status Bits/OPC dependencies	Sequential command
Initial S/W Revision	Prior to A.02.00

Questionable Negative Transition

This command determines which bits in the Questionable Condition register will set the corresponding bit in the Questionable Event register when the condition register bit has a negative transition (1 to 0). The variable <integer> is the sum of the decimal values of the bits that you want to enable.

Mode	All
Remote Command	:STATus:QUEStionable:NTRansition <integer> :STATus:QUEStionable:NTRansition?
Example	STAT:QUES:NTR 16 Temperature summary 'questionable cleared' will be reported to the Status Byte Register.
Preset	0
Min	0
Max	32767
Status Bits/OPC dependencies	Sequential command
Initial S/W Revision	Prior to A.02.00

Questionable Positive Transition

This command determines which bits in the Questionable Condition register will set the corresponding bit in the Questionable Event register when the condition register bit has a positive transition (0 to 1). The variable <integer> is the sum of the decimal values of the bits that you want to enable.

Mode	All
------	-----

Remote Command	:STATus:QUESTionable:PTRansition <integer> :STATus:QUESTionable:PTRansition?
Example	STAT:QUES:PTR 16 Temperature summary 'questionable asserted' will be reported to the Status Byte Register.
Preset	32767
Min	0
Max	32767
Status Bits/OPC dependencies	Sequential command
Initial S/W Revision	Prior to A.02.00

Questionable Calibration Register

"Questionable Calibration Condition " on page 161

"Questionable Calibration Enable " on page 161

"Questionable Calibration Event Query " on page 162

"Questionable Calibration Negative Transition " on page 162

"Questionable Calibration Positive Transition " on page 163

Questionable Calibration Condition

This query returns the decimal value of the sum of the bits in the Questionable Calibration Condition register.

NOTE The data in this register is continuously updated and reflects the current conditions.

Mode	All
Remote Command	:STATus:QUESTionable:CALibration:CONDition?
Example	STAT:QUES:CAL:COND?
Preset	0
Status Bits/OPC dependencies	Sequential command
Initial S/W Revision	Prior to A.02.00

Questionable Calibration Enable

This command determines which bits in the Questionable Calibration Condition Register will set bits in the Questionable Calibration Event register, which also sets the Calibration Summary bit (bit 8) in the Questionable Register. The variable <integer> is the sum of the decimal values of the bits you want to enable.

Mode	All
Remote Command	:STATus:QUESTionable:CALibration:ENABLE <integer> :STATus:QUESTionable:CALibration:ENABLE?
Example	STAT:QUES:CAL:ENAB 16384 Can be used to query if an alignment is needed, if you have turned off the automatic alignment process.
Min	0
Max	32767
Status Bits/OPC dependencies	Sequential command
Initial S/W Revision	Prior to A.02.00

Questionable Calibration Event Query

This query returns the decimal value of the sum of the bits in the Questionable Calibration Event register.

NOTE

The register requires that the associated PTR or NTR filters be set before a condition register bit can set a bit in the event register. The data in this register is latched until it is queried. Once queried, the register is cleared.

Mode	All
Remote Command	:STATus:QUESTionable:CALibration[:EVENT]?
Example	STAT:QUES:CAL?
Preset	0
Status Bits/OPC dependencies	Sequential command
Initial S/W Revision	Prior to A.02.00

Questionable Calibration Negative Transition

This command determines which bits in the Questionable Calibration Condition register will set the corresponding bit in the Questionable Calibration Event register when the condition register bit has a negative transition (1 to 0). The variable <integer> is the sum of the decimal values of the bits that you want to enable.

Mode	All
Remote Command	:STATus:QUESTionable:CALibration:NTRansition <integer> :STATus:QUESTionable:CALibration:NTRansition?
Example	STAT:QUES:CAL:NTR 16384 Alignment is not required.
Preset	0
Min	0

Max	32767
Status Bits/OPC dependencies	Sequential command
Initial S/W Revision	Prior to A.02.00

Questionable Calibration Positive Transition

This command determines which bits in the Questionable Calibration Condition register will set the corresponding bit in the Questionable Calibration Event register when the condition register bit has a positive transition (0 to 1). The variable <integer> is the sum of the decimal values of the bits that you want to enable.

Mode	All
Remote Command	:STATus:QUESTionable:CALibration:PTRansition <integer> :STATus:QUESTionable:CALibration:PTRansition?
Example	STAT:QUES:CAL:PTR 16384 Alignment is required.
Preset	32767
Min	0
Max	32767
Status Bits/OPC dependencies	Sequential command
Initial S/W Revision	Prior to A.02.00

Questionable Calibration Skipped Register

"Questionable Calibration Skipped Condition " on page 163

"Questionable Calibration Skipped Enable " on page 164

"Questionable Calibration Skipped Event Query " on page 164

"Questionable Calibration Skipped Negative Transition " on page 165

"Questionable Calibration Skipped Positive Transition " on page 165

Questionable Calibration Skipped Condition

This query returns the decimal value of the sum of the bits in the Questionable Calibration Skipped Condition register.

NOTE The data in this register is continuously updated and reflects the current conditions.

Mode	All
Remote Command	:STATus:QUESTionable:CALibration:SKIpped:CONDition?

Example	STAT:QUES:CAL:SKIP:COND?
Preset	0
Status Bits/OPC dependencies	Sequential command
Initial S/W Revision	Prior to A.02.00

Questionable Calibration Skipped Enable

This command determines which bits in the Questionable Calibration Skipped Condition Register will set bits in the Questionable Calibration Skipped Event register, which also sets bit 11 of the Questionable Calibration Register. The variable <integer> is the sum of the decimal values of the bits you want to enable.

Mode	All
Remote Command	:STATus:QUESTionable:CALibration:SKIpped:ENABle <integer> :STATus:QUESTionable:CALibration:SKIpped:ENABle?
Example	STAT:QUES:CAL:SKIP:ENAB 1 Can be used to query if an EMI alignment skipped condition is detected
Preset	32767
Min	0
Max	32767
Status Bits/OPC dependencies	Sequential command
Initial S/W Revision	Prior to A.02.00

Questionable Calibration Skipped Event Query

This query returns the decimal value of the sum of the bits in the Questionable Calibration Event register.

NOTE

The register requires that the associated PTR or NTR filters be set before a condition register bit can set a bit in the event register. The data in this register is latched until it is queried. Once queried, the register is cleared.

Mode	All
Remote Command	:STATus:QUESTionable:CALibration:SKIpped[:EVENT]?
Example	STAT:QUES:CAL:SKIP?
Preset	0
Status Bits/OPC dependencies	Sequential command
Initial S/W Revision	Prior to A.02.00

Questionable Calibration Skipped Negative Transition

This command determines which bits in the Questionable Calibration Skipped Condition register will set the corresponding bit in the Questionable Calibration Skipped Event register when the condition register bit has a negative transition (1 to 0). The variable <integer> is the sum of the decimal values of the bits that you want to enable.

Mode	All
Remote Command	:STATus:QUEStionable:CALibration:SKIPped:NTRansition <integer> :STATus:QUEStionable:CALibration:SKIPped:NTRansition?
Example	STAT:QUES:CAL:SKIP:NTR 1 Align RF skipped is not required.
Preset	0
Min	0
Max	32767
Status Bits/OPC dependencies	Sequential command
Initial S/W Revision	Prior to A.02.00

Questionable Calibration Skipped Positive Transition

This command determines which bits in the Questionable Calibration Skipped Condition register will set the corresponding bit in the Questionable Calibration Skipped Event register when the condition register bit has a positive transition (0 to 1). The variable <integer> is the sum of the decimal values of the bits that you want to enable.

Mode	All
Remote Command	:STATus:QUEStionable:CALibration:SKIPped:PTRansition <integer> :STATus:QUEStionable:CALibration:SKIPped:PTRansition?
Example	STAT:QUES:CAL:SKIP:PTR 1 Align RF skipped is required.
Preset	32767
Min	0
Max	32767
Status Bits/OPC dependencies	Sequential command
Initial S/W Revision	Prior to A.02.00

Questionable Calibration Extended Failure Register

"Questionable Calibration Extended Failure Condition " on page 166

"Questionable Calibration Extended Failure Enable " on page 166

"Questionable Calibration Extended Failure Event Query " on page 166

"Questionable Calibration Extended Failure Negative Transition " on page 167

"Questionable Calibration Extended Failure Positive Transition " on page 167

Questionable Calibration Extended Failure Condition

This query returns the decimal value of the sum of the bits in the Questionable Calibration Extended Failure Condition register.

NOTE The data in this register is continuously updated and reflects the current conditions.

Mode	All
Remote Command	:STATus:QUESTionable:CALibration:EXTended:FAILure:CONDition?
Example	STAT:QUES:CAL:EXT:FAIL:COND?
Preset	0
Status Bits/OPC dependencies	Sequential command
Initial S/W Revision	Prior to A.02.00

Questionable Calibration Extended Failure Enable

This command determines which bits in the Questionable Calibration Extended Failure Condition Register will set bits in the Questionable Calibration Extended Failure Event register, which also sets bit 9 of the Questionable Calibration Register. The variable <integer> is the sum of the decimal values of the bits you want to enable.

Mode	All
Remote Command	:STATus:QUESTionable:CALibration:EXTended:FAILure:ENABle <integer> :STATus:QUESTionable:CALibration:EXTended:FAILure:ENABle?
Example	STAT:QUES:CAL:EXT:FAIL:ENAB 1 Can be used to query if an EMI conducted alignment is needed.
Preset	32767
Min	0
Max	32767
Status Bits/OPC dependencies	Sequential command
Initial S/W Revision	Prior to A.02.00

Questionable Calibration Extended Failure Event Query

This query returns the decimal value of the sum of the bits in the Questionable Calibration Extended Failure Event register.

NOTE The register requires that the associated PTR or NTR filters be set before a condition register bit can set a bit in the event register. The data in this register is latched until it is queried. Once queried, the register is cleared.

Mode	All
Remote Command	:STATus:QUESTionable:CALibration:EXTended:FAILure[:EVENT]?
Example	STAT:QUES:CAL:EXT:FAIL?
Preset	0
Status Bits/OPC dependencies	Sequential command
Initial S/W Revision	Prior to A.02.00

Questionable Calibration Extended Failure Negative Transition

This command determines which bits in the Questionable Calibration Extended Failure Condition register will set the corresponding bit in the Questionable Calibration Extended Failure Event register when the condition register bit has a negative transition (1 to 0). The variable <integer> is the sum of the decimal values of the bits that you want to enable.

Mode	All
Remote Command	:STATus:QUESTionable:CALibration:EXTended:FAILure:NTRansition <integer> :STATus:QUESTionable:CALibration:EXTended:FAILure:NTRansition?
Example	STAT:QUES:CAL:EXT:FAIL:NTR 1 EMI conducted align failure is not required.
Preset	0
Min	0
Max	32767
Status Bits/OPC dependencies	Sequential command
Initial S/W Revision	Prior to A.02.00

Questionable Calibration Extended Failure Positive Transition

This command determines which bits in the Questionable Calibration Extended Failure Condition register will set the corresponding bit in the Questionable Calibration Extended Failure Event register when the condition register bit has a positive transition (0 to 1). The variable <integer> is the sum of the decimal values of the bits that you want to enable.

Mode	All
Remote Command	:STATus:QUESTionable:CALibration:EXTended:FAILure:PTRansition <integer> :STATus:QUESTionable:CALibration:EXTended:FAILure:PTRansition?
Example	STAT:QUES:CAL:EXT:FAIL:PTR 1 EMI conducted align failure is required.
Preset	32767
Min	0
Max	32767

Status Bits/OPC dependencies	Sequential command
Initial S/W Revision	Prior to A.02.00

Questionable Calibration Extended Needed Register

"Questionable Calibration Extended Needed Condition " on page 168

"Questionable Calibration Extended Needed Enable " on page 168

"Questionable Calibration Extended Needed Event Query " on page 169

"Questionable Calibration Extended Needed Negative Transition " on page 169

"Questionable Calibration Extended Needed Positive Transition " on page 170

Questionable Calibration Extended Needed Condition

This query returns the decimal value of the sum of the bits in the Questionable Calibration Extended Needed Condition register.

NOTE

The data in this register is continuously updated and reflects the current conditions.

Mode	All
Remote Command	:STATus:QUESTionable:CALibration:EXTended:NEEDed:CONDition?
Example	STAT:QUES:CAL:EXT:NEED:COND?
Preset	0
Status Bits/OPC dependencies	Sequential command
Initial S/W Revision	Prior to A.02.00

Questionable Calibration Extended Needed Enable

This command determines which bits in the Questionable Calibration Extended Needed Condition Register will set bits in the Questionable Calibration Extended Needed Event register, which also sets bit 14 of the Questionable Calibration Register. The variable <integer> is the sum of the decimal values of the bits you want to enable.

Mode	All
Remote Command	:STATus:QUESTionable:CALibration:EXTended:NEEDed:ENABle <integer> :STATus:QUESTionable:CALibration:EXTended:NEEDed:ENABle?
Example	STAT:QUES:CAL:EXT:NEED:ENAB 2 Can be used to query if an EMI conducted alignment is needed.
Preset	32767
Min	0

Max	32767
Status Bits/OPC dependencies	Sequential command
Initial S/W Revision	Prior to A.02.00

Questionable Calibration Extended Needed Event Query

This query returns the decimal value of the sum of the bits in the Questionable Calibration Extended Needed Event register.

NOTE

The register requires that the associated PTR or NTR filters be set before a condition register bit can set a bit in the event register. The data in this register is latched until it is queried. Once queried, the register is cleared.

Mode	All
Remote Command	:STATus:QUESTionable:CALibration:EXTended:NEEDED[:EVENT]?
Example	STAT:QUES:CAL:EXT:NEED?
Preset	0
Status Bits/OPC dependencies	Sequential command
Initial S/W Revision	Prior to A.02.00

Questionable Calibration Extended Needed Negative Transition

This command determines which bits in the Questionable Calibration Extended Needed Condition register will set the corresponding bit in the Questionable Calibration Extended Needed Event register when the condition register bit has a negative transition (1 to 0). The variable <integer> is the sum of the decimal values of the bits that you want to enable.

Mode	All
Remote Command	:STATus:QUESTionable:CALibration:EXTended:NEEDED:NTRansition <integer> :STATus:QUESTionable:CALibration:EXTended:NEEDED:NTRansition?
Example	STAT:QUES:CAL:EXT:NEED:NTR 2 Align EMI conducted is not required.
Preset	0
Min	0
Max	32767
Status Bits/OPC dependencies	Sequential command
Initial S/W Revision	Prior to A.02.00

Questionable Calibration Extended Needed Positive Transition

This command determines which bits in the Questionable Calibration Extended Needed Condition register will set the corresponding bit in the Questionable Calibration Extended Needed Event register when the condition register bit has a positive transition (0 to 1). The variable <integer> is the sum of the decimal values of the bits that you want to enable.

Mode	All
Remote Command	:STATus:QUESTionable:CALibration:EXTended:NEEDed:PTRansition <integer> :STATus:QUESTionable:CALibration:EXTended:NEEDed:PTRansition?
Example	STAT:QUES:CAL:EXT:NEED:PTR 2 Align EMI conducted is required.
Preset	32767
Min	0
Max	32767
Status Bits/OPC dependencies	Sequential command
Initial S/W Revision	Prior to A.02.00

Questionable Frequency Register

"Questionable Frequency Condition " on page 170

"Questionable Frequency Enable " on page 171

"Questionable Frequency Event Query " on page 171

"Questionable Frequency Negative Transition " on page 171

"Questionable Frequency Positive Transition " on page 172

Questionable Frequency Condition

This query returns the decimal value of the sum of the bits in the Questionable Frequency Condition register.

NOTE The data in this register is continuously updated and reflects the current conditions.

Mode	All
Remote Command	:STATus:QUESTionable:FREquency:CONDition?
Example	STAT:QUES:FREQ:COND?
Preset	0
Status Bits/OPC dependencies	Sequential command
Initial S/W Revision	Prior to A.02.00

Questionable Frequency Enable

This command determines which bits in the Questionable Frequency Condition Register will set bits in the Questionable Frequency Event register, which also sets the Frequency Summary bit (bit 5) in the Questionable Register. The variable <integer> is the sum of the decimal values of the bits you want to enable.

Mode	All
Remote Command	:STATus:QUEStionable:FREQuency:ENABle <integer> :STATus:QUEStionable:FREQuency:ENABle?
Example	STAT:QUES:FREQ:ENAB 2 Frequency Reference Unlocked will be reported to the Frequency Summary of the Status Questionable register.
Preset	32767
Min	0
Max	32767
Status Bits/OPC dependencies	Sequential command
Initial S/W Revision	Prior to A.02.00

Questionable Frequency Event Query

This query returns the decimal value of the sum of the bits in the Questionable Frequency Event register.

NOTE

The register requires that the associated PTR or NTR filters be set before a condition register bit can set a bit in the event register. The data in this register is latched until it is queried. Once queried, the register is cleared.

Mode	All
Remote Command	:STATus:QUEStionable:FREQuency[:EVENT]?
Example	STAT:QUES:FREQ?
Preset	0
Status Bits/OPC dependencies	Sequential command
Initial S/W Revision	Prior to A.02.00

Questionable Frequency Negative Transition

This command determines which bits in the Questionable Frequency Condition register will set the corresponding bit in the Questionable Frequency Event register when the condition register bit has a negative transition (1 to 0). The variable <integer> is the sum of the decimal values of the bits that you want to enable.

Mode	All
------	-----

Remote Command	:STATus:QUESTionable:FREQuency:NTRansition <integer> :STATus:QUESTionable:FREQuency:NTRansition?
Example	STAT:QUES:FREQ:NTR 2 Frequency Reference 'regained lock' will be reported to the Frequency Summary of the Status Questionable register.
Preset	0
Min	0
Max	32767
Status Bits/OPC dependencies	Sequential command
Initial S/W Revision	Prior to A.02.00

Questionable Frequency Positive Transition

This command determines which bits in the Questionable Frequency Condition register will set the corresponding bit in the Questionable Frequency Event register when the condition register bit has a positive transition (0 to 1). The variable <integer> is the sum of the decimal values of the bits that you want to enable.

Mode	All
Remote Command	:STATus:QUESTionable:FREQuency:PTRansition <integer> :STATus:QUESTionable:FREQuency:PTRansition?
Example	STAT:QUES:FREQ:PTR 2 Frequency Reference 'became unlocked' will be reported to the Frequency Summary of the Status Questionable register.
Preset	32767
Min	0
Max	32767
Status Bits/OPC dependencies	Sequential command
Initial S/W Revision	Prior to A.02.00

Questionable Integrity Register

["Questionable Integrity Condition " on page 172](#)

["Questionable Integrity Enable " on page 173](#)

["Questionable Integrity Event Query " on page 173](#)

["Questionable Integrity Negative Transition " on page 174](#)

["Questionable Integrity Positive Transition " on page 174](#)

Questionable Integrity Condition

This query returns the decimal value of the sum of the bits in the Questionable Integrity Condition register.

NOTE

The data in this register is continuously updated and reflects the current conditions.

Mode	All
Remote Command	:STATus:QUESTionable:INTEgrity:CONDition?
Example	STAT:QUES:INT:COND?
Preset	0
Status Bits/OPC dependencies	Sequential command
Initial S/W Revision	Prior to A.02.00

Questionable Integrity Enable

This command determines which bits in the Questionable Integrity Condition Register will set bits in the Questionable Integrity Event register, which also sets the Integrity Summary bit (bit 9) in the Questionable Register. The variable <integer> is the sum of the decimal values of the bits you want to enable.

Mode	All
Remote Command	:STATus:QUESTionable:INTEgrity:ENABle <integer> :STATus:QUESTionable:INTEgrity:ENABle?
Example	STAT:QUES:INT:ENAB 8 Measurement Uncalibrated Summary will be reported to the Integrity Summary of the Status Questionable register.
Preset	32767
Min	0
Max	32767
Status Bits/OPC dependencies	Sequential command
Initial S/W Revision	Prior to A.02.00

Questionable Integrity Event Query

This query returns the decimal value of the sum of the bits in the Questionable Integrity Event register.

NOTE

The register requires that the associated PTR or NTR filters be set before a condition register bit can set a bit in the event register. The data in this register is latched until it is queried. Once queried, the register is cleared.

Mode	All
Remote Command	:STATus:QUESTionable:INTEgrity[:EVENT]?
Example	STAT:QUES:INT?
Preset	0
Status Bits/OPC dependencies	Sequential command
Initial S/W Revision	Prior to A.02.00

Questionable Integrity Negative Transition

This command determines which bits in the Questionable Integrity Condition register will set the corresponding bit in the Questionable Integrity Event register when the condition register bit has a negative transition (1 to 0)

The variable <integer> is the sum of the decimal values of the bits that you want to enable.

Mode	All
Remote Command	:STATus:QUEStionable:INTEgrity:NTRansition <integer> :STATus:QUEStionable:INTEgrity:NTRansition?
Example	STAT:QUES:INT:NTR 8 Measurement 'regained calibration' Summary will be reported to the Integrity Summary of the Status Questionable register.
Preset	0
Min	0
Max	32767
Status Bits/OPC dependencies	Sequential command
Initial S/W Revision	Prior to A.02.00

Questionable Integrity Positive Transition

This command determines which bits in the Questionable Integrity Condition register will set the corresponding bit in the Questionable Integrity Event register when the condition register bit has a positive transition (0 to 1). The variable <integer> is the sum of the decimal values of the bits that you want to enable.

Mode	All
Remote Command	:STATus:QUEStionable:INTEgrity:PTRansition <integer> :STATus:QUEStionable:INTEgrity:PTRansition?
Example	STAT:QUES:INT:PTR 8 Measurement 'became uncalibrated' Summary will be reported to the Integrity Summary of the Status Questionable register.
Preset	32767
Min	0
Max	32767
Status Bits/OPC dependencies	Sequential command
Initial S/W Revision	Prior to A.02.00

Questionable Integrity Signal Register

"Questionable Integrity Signal Condition" on page 175

"Questionable Integrity Signal Enable" on page 175

"Questionable Integrity Signal Event Query" on page 176

"Questionable Integrity Signal Negative Transition" on page 176

"Questionable Integrity Signal Positive Transition" on page 176

Questionable Integrity Signal Condition

This query returns the decimal value of the sum of the bits in the Questionable Integrity Signal Condition register.

NOTE The data in this register is continuously updated and reflects the current conditions.

Mode	All
Remote Command	:STATus:QUEStionable:INTEgrity:SIGNal:CONDition?
Example	STAT:QUES:INT:SIGN:COND?
Preset	0
Status Bits/OPC dependencies	Sequential command
Initial S/W Revision	Prior to A.02.00

Questionable Integrity Signal Enable

This command determines which bits in the Questionable Integrity Signal Condition Register will set bits in the Questionable Integrity Signal Event register, which also sets the Integrity Summary bit (bit 9) in the Questionable Register. The variable <integer> is the sum of the decimal values of the bits you want to enable.

Mode	All
Remote Command	:STATus:QUEStionable:INTEgrity:SIGNal:ENABle <integer> :STATus:QUEStionable:INTEgrity:SIGNal:ENABle?
Example	STAT:QUES:INT:SIGN:ENAB 4 Burst Not Found will be reported to the Integrity Summary of the Status Questionable register.
Preset	32767
Min	0
Max	32767
Status Bits/OPC dependencies	Sequential command
Initial S/W Revision	Prior to A.02.00

Questionable Integrity Signal Event Query

This query returns the decimal value of the sum of the bits in the Questionable Integrity Signal Event register.

NOTE

The register requires that the associated PTR or NTR filters be set before a condition register bit can set a bit in the event register. The data in this register is latched until it is queried. Once queried, the register is cleared.

Mode	All
Remote Command	:STATus:QUESTionable:INTEgrity:SIGNal[:EVENT]?
Example	STAT:QUES:INT:SIGN?
Preset	0
Status Bits/OPC dependencies	Sequential command
Initial S/W Revision	Prior to A.02.00

Questionable Integrity Signal Negative Transition

This command determines which bits in the Questionable Integrity Signal Condition register will set the corresponding bit in the Questionable Integrity Signal Event register when the condition register bit has a negative transition (1 to 0). The variable <integer> is the sum of the decimal values of the bits that you want to enable.

Mode	All
Remote Command	:STATus:QUESTionable:INTEgrity:SIGNal:NTRansition <integer> :STATus:QUESTionable:INTEgrity:SIGNal:NTRansition?
Example	STAT:QUES:INT:SIGN:NTR 4 Burst found will be reported to the Integrity Summary of the Status Questionable register.
Preset	0
Min	0
Max	32767
Status Bits/OPC dependencies	Sequential command
Initial S/W Revision	Prior to A.02.00

Questionable Integrity Signal Positive Transition

This command determines which bits in the Questionable Integrity Signal Condition register will set the corresponding bit in the Questionable Integrity Signal Event register when the condition register bit has a positive transition (0 to 1). The variable <integer> is the sum of the decimal values of the bits that you want to enable.

Mode	All
Remote Command	:STATus:QUEStionable:INTEgrity:SIGNal:PTRansition <integer> :STATus:QUEStionable:INTEgrity:SIGNal:PTRansition?
Example	STAT:QUES:INT:SIGN:PTR 4 Burst not found will be reported to the Integrity Summary of the Status Questionable register.
Preset	32767
Min	0
Max	32767
Status Bits/OPC dependencies	Sequential command
Initial S/W Revision	Prior to A.02.00

Questionable Integrity Uncalibrated Register

"Questionable Integrity Uncalibrated Condition " on page 177

"Questionable Integrity Uncalibrated Enable " on page 177

"Questionable Integrity Uncalibrated Event Query " on page 178

"Questionable Integrity Uncalibrated Negative Transition " on page 178

"Questionable Integrity Uncalibrated Positive Transition " on page 179

Questionable Integrity Uncalibrated Condition

This query returns the decimal value of the sum of the bits in the Questionable Integrity Uncalibrated Condition register.

NOTE The data in this register is continuously updated and reflects the current conditions.

Mode	All
Remote Command	:STATus:QUEStionable:INTEgrity:UNCalibrated:CONDition?
Example	STAT:QUES:INT:UNC:COND?
Preset	0
Status Bits/OPC dependencies	Sequential command
Initial S/W Revision	Prior to A.02.00

Questionable Integrity Uncalibrated Enable

This command determines which bits in the Questionable Integrity Uncalibrated Condition Register will set bits in the Questionable Integrity Uncalibrated Event register, which also sets the Data Uncalibrated Summary bit (bit 3) in the Questionable Integrity Register. The variable <integer> is the sum of the decimal values of the bits you want to enable.

Mode	All
Remote Command	:STATus:QUEStionable:INTEgrity:UNCalibrated:ENABle :STATus:QUEStionable:INTEgrity:UNCalibrated:ENABle?
Example	STAT:QUES:INT:UNC:ENAB 1 Oversweep (Meas Uncal) will be reported to the Integrity Summary of the Status Questionable register.
Preset	32767
Min	0
Max	32767
Status Bits/OPC dependencies	Sequential command
Initial S/W Revision	Prior to A.02.00

Questionable Integrity Uncalibrated Event Query

This query returns the decimal value of the sum of the bits in the Questionable Integrity Uncalibrated Event register.

NOTE

The register requires that the associated PTR or NTR filters be set before a condition register bit can set a bit in the event register. The data in this register is latched until it is queried. Once queried, the register is cleared.

Mode	All
Remote Command	:STATus:QUEStionable:INTEgrity:UNCalibrated[:EVENT]?
Example	STAT:QUES:INT:UNC?
Preset	0
Status Bits/OPC dependencies	Sequential command
Initial S/W Revision	Prior to A.02.00

Questionable Integrity Uncalibrated Negative Transition

This command determines which bits in the Questionable Integrity Uncalibrated Condition register will set the corresponding bit in the Questionable Integrity Uncalibrated Event register when the condition register bit has a negative transition (1 to 0). The variable <integer> is the sum of the decimal values of the bits that you want to enable.

Mode	All
Remote Command	:STATus:QUEStionable:INTEgrity:UNCalibrated:NTRansition <integer> :STATus:QUEStionable:INTEgrity:UNCalibrated:NTRansition?
Example	STAT:QUES:INT:UNC:NTR 1 Oversweep cleared will be reported to the Integrity Summary of the Status Questionable register.

Preset	0
Min	0
Max	32767
Status Bits/OPC dependencies	Sequential command
Initial S/W Revision	Prior to A.02.00

Questionable Integrity Uncalibrated Positive Transition

This command determines which bits in the Questionable Integrity Uncalibrated Condition register will set the corresponding bit in the Questionable Integrity Uncalibrated Event register when the condition register bit has a positive transition (0 to 1). The variable <integer> is the sum of the decimal values of the bits that you want to enable.

Mode	All
Remote Command	:STATus:QUEStionable:INTEgrity:UNCalibrated:PTRansition <integer> :STATus:QUEStionable:INTEgrity:UNCalibrated:PTRansition?
Example	STAT:QUES:INT:UNC:PTR 1 Oversweep (Meas Uncal) occurred will be reported to the Integrity Summary of the Status Questionable register.
Preset	32767
Min	0
Max	32767
Status Bits/OPC dependencies	Sequential command
Initial S/W Revision	Prior to A.02.00

Questionable Power Register

"Questionable Power Condition " on page 179

"Questionable Power Enable " on page 180

"Questionable Power Event Query " on page 180

"Questionable Power Negative Transition " on page 181

"Questionable Power Positive Transition " on page 181

Questionable Power Condition

This query returns the decimal value of the sum of the bits in the Questionable Power Condition register.

NOTE

The data in this register is continuously updated and reflects the current conditions.

Mode	All
Remote Command	:STATus:QUESTionable:POWer:CONDition?
Example	STAT:QUES:POW:COND?
Preset	0
Status Bits/OPC dependencies	Sequential command
Initial S/W Revision	Prior to A.02.00

Questionable Power Enable

This command determines which bits in the Questionable Power Condition Register will set bits in the Questionable Power Event register, which also sets the Power Summary bit (bit 3) in the Questionable Register. The variable <integer> is the sum of the decimal values of the bits you want to enable.

Mode	All
Remote Command	:STATus:QUESTionable:POWer:ENABle <integer> :STATus:QUESTionable:POWer:ENABle?
Example	STAT:QUES:POW:ENAB 32 50 MHz Input Pwr too High for Cal will be reported to the Power Summary of the Status Questionable register.
Preset	32767
Min	0
Max	32767
Status Bits/OPC dependencies	Sequential command
Initial S/W Revision	Prior to A.02.00

Questionable Power Event Query

This query returns the decimal value of the sum of the bits in the Questionable Power Event register.

NOTE

The register requires that the associated PTR or NTR filters be set before a condition register bit can set a bit in the event register. The data in this register is latched until it is queried. Once queried, the register is cleared.

Mode	All
Remote Command	:STATus:QUESTionable:POWer[:EVENT]?
Example	STAT:QUES:POW?
Preset	0
Status Bits/OPC dependencies	Sequential command
Initial S/W Revision	Prior to A.02.00

Questionable Power Negative Transition

This command determines which bits in the Questionable Power Condition register will set the corresponding bit in the Questionable Power Event register when the condition register bit has a negative transition (1 to 0). The variable <integer> is the sum of the decimal values of the bits that you want to enable.

Mode	All
Remote Command	:STATus:QUESTionable:POWer:NTRansition <integer> :STATus:QUESTionable:POWer:NTRansition?
Example	STAT:QUES:POW:NTR 32 50 MHz Input Power became OK for Cal will be reported to the Power Summary of the Status Questionable register.
Preset	0
Min	0
Max	32767
Status Bits/OPC dependencies	Sequential command
Initial S/W Revision	Prior to A.02.00

Questionable Power Positive Transition

This command determines which bits in the Questionable Power Condition register will set the corresponding bit in the Questionable Power Event register when the condition register bit has a positive transition (0 to 1). The variable <integer> is the sum of the decimal values of the bits that you want to enable.

Mode	All
Remote Command	:STATus:QUESTionable:POWer:PTRansition <integer> :STATus:QUESTionable:POWer:PTRansition?>
Example	STAT:QUES:POW:PTR 32 50 MHz Input Power became too high for Cal will be reported to the Power Summary of the Status Questionable register.
Preset	32767
Min	0
Max	32767
Status Bits/OPC dependencies	Sequential command
Initial S/W Revision	Prior to A.02.00

Questionable Temperature Register

"Questionable Temperature Condition" on page 182

"Questionable Temperature Enable" on page 182

"Questionable Temperature Event Query" on page 182

"Questionable Temperature Negative Transition" on page 183

"Questionable Temperature Positive Transition" on page 183

Questionable Temperature Condition

This query returns the decimal value of the sum of the bits in the Questionable Temperature Condition register.

NOTE

The data in this register is continuously updated and reflects the current conditions.

Mode	All
Remote Command	:STATus:QUESTionable:TEMPerature:CONDition?
Example	STAT:QUES:TEMP:COND?
Preset	0
Status Bits/OPC dependencies	Sequential command
Initial S/W Revision	Prior to A.02.00

Questionable Temperature Enable

This command determines which bits in the Questionable Temperature Condition Register will set bits in the Questionable Temperature Event register, which also sets the Temperature Summary bit (bit 4) in the Questionable Register. The variable <integer> is the sum of the decimal values of the bits you want to enable.

Mode	All
Remote Command	:STATus:QUESTionable:TEMPerature:ENABle <integer> :STATus:QUESTionable:TEMPerature:ENABle?
Example	STAT:QUES:TEMP:ENAB 1 Reference Oscillator Oven Cold will be reported to the Temperature Summary of the Status Questionable register.
Preset	32767
Min	0
Max	32767
Status Bits/OPC dependencies	Sequential command
Initial S/W Revision	Prior to A.02.00

Questionable Temperature Event Query

This query returns the decimal value of the sum of the bits in the Questionable Temperature Event register.

NOTE

The register requires that the associated PTR or NTR filters be set before a condition register bit can set a bit in the event register. The data in this register is latched until it is queried. Once queried, the register is cleared

Mode	All
Remote Command	:STATus:QUEStionable:TEMPerature[:EVENT]?
Example	STAT:QUES:TEMP?
Preset	0
Status Bits/OPC dependencies	Sequential command
Initial S/W Revision	Prior to A.02.00

Questionable Temperature Negative Transition

This command determines which bits in the Questionable Temperature Condition register will set the corresponding bit in the Questionable Temperature Event register when the condition register bit has a negative transition (1 to 0). The variable <integer> is the sum of the decimal values of the bits that you want to enable.

Mode	All
Remote Command	:STATus:QUEStionable:TEMPerature:NTRansition <integer> :STATus:QUEStionable:TEMPerature:NTRansition?
Example	STAT:QUES:TEMP:NTR 1 Reference Oscillator Oven not cold will be reported to the Temperature Summary of the Status Questionable register.
Preset	0
Min	0
Max	32767
Status Bits/OPC dependencies	Sequential command
Initial S/W Revision	Prior to A.02.00

Questionable Temperature Positive Transition

This command determines which bits in the Questionable Temperature Condition register will set the corresponding bit in the Questionable Temperature Event register when the condition register bit has a positive transition (0 to 1). The variable <integer> is the sum of the decimal values of the bits that you want to enable.

Mode	All
Remote Command	:STATus:QUEStionable:TEMPerature:PTRansition <integer> :STATus:QUEStionable:TEMPerature:PTRansition?
Example	STAT:QUES:TEMP:PTR 1 Reference Oscillator Oven became cold will be reported to the

	Temperature Summary of the Status Questionable register.
Preset	32767
Min	0
Max	32767
Status Bits/OPC dependencies	Sequential command
Initial S/W Revision	Prior to A.02.00

IEEE 488.2 Common Commands

The instrument supports the following subset of IEEE 488.2 Common Commands, as defined in Chapter 10 of [IEEE Standard 488.2–1992](#). As indicated in the detailed descriptions, some of these commands correspond directly to instrument front-panel key functionality, while others are available only as remote commands.

Command	Description
*CAL?	Align Now "All " on page 364
*CLS	"Clear Status " on page 187
*ESE	"Standard Event Status Enable " on page 187
*ESE?	
*ESR?	"Standard Event Status Register Query " on page 188
*IDN?	"Identification Query " on page 188
*OPC	"Operation Complete " on page 189
*OPC?	
*OPT?	"Query Instrument Options " on page 190
*RCL	"Recall Instrument State " on page 190
*RST	"*RST (Remote Command Only)" on page 191
*SAV	"Save Instrument State " on page 191
*SRE	"Service Request Enable " on page 191
*SRE?	
*STB?	"Status Byte Query " on page 192
*TRG	"Trigger " on page 192
*TST?	"Self Test Query " on page 192
*WAI	"Wait-to-Continue " on page 193

All

(In MXE the key label is "All (plus RF Presel 20 Hz – 3.6 GHz)")Immediately executes an alignment of all subsystems In MXE, the Align Now All is followed by additionally aligning the RF Preselector section, so in MXE, the key label contains the parenthetical note "(plus RF Presel 20 Hz – 3.6 GHz)". The instrument stops any measurement currently underway, performs the alignment, then restarts the measurement from the beginning (similar to pressing the Restart key).

If an interfering user signal is present at the RF Input, the alignment is performed on all subsystems except the RF. After completion, the Error Condition message "Align skipped: 50 MHz interference" or "Align skipped: 4.8 GHz interference" is generated. In addition the Error Condition message "Align Now, RF required" is generated, and bits 11 and 12 are set in the Status Questionable Calibration register.

The query form of the remote commands (:CALibration[:ALL]? or *CAL?) invokes the alignment of all subsystems and returns a success or failure value. An interfering user signal is not grounds for failure; if the

alignment was able to succeed on all portions but unable to align the RF because of an interfering signal, the resultant will be the success value.

Successful completion of Align Now, All will clear the “Align Now, All required” Error Condition, and clear bit 14 in the Status Questionable Calibration register. It will also begin the elapsed time counter for Last Align Now, All Time, and capture the Last Align Now, All Temperature.

In the MXE, successful completion will also clear the “Align 20 Hz to 30 MHz required” Error Condition, the “Align 30 MHz to 3.6 GHz required” Error Condition, and the “Align 20 Hz to 3.6 GHz required” Error Condition, and clear bits 1 and bit 2 and clear the bit 1 in the Status Questionable Calibration Extended Needed register.

If the Align RF subsystem succeeded in aligning (no interfering signal present), the elapsed time counter begins for Last Align Now, RF Time, and the temperature is captured for the Last Align Now, RF Temperature. In addition the Error Conditions “Align skipped: 50 MHz interference” and “Align skipped: 4.8 GHz interference” are cleared, the Error Condition “Align Now, RF required” is cleared, and bits 11 and 12 are cleared in the Status Questionable Calibration register

Align Now, All can be interrupted by pressing the Cancel (ESC) front-panel key or remotely with Device Clear followed by the :ABORt SCPI command. When this occurs the Error Condition message “Align Now, All required” is generated, and bit 14 is set in the Status Questionable Condition register. This is because new alignment data may be employed for an individual subsystem, but not a cohesive set of data for all subsystems.

In many cases, you might find it more convenient to change alignments to Normal, instead of executing Align Now, All. When the Auto Align process transitions to Normal, the analyzer will immediately start to update only the alignments that have expired, thus efficiently restoring the alignment process.

Key Path	System, Alignments, Align Now
Mode	All
Remote Command	:CALibration[:ALL] :CALibration[:ALL]?
Example	:CAL
Notes	:CALibration[:ALL]? returns 0 if successful :CALibration[:ALL]? returns 1 if failed :CALibration[:ALL]? is the same as *CAL? While Align Now, All is performing the alignment, bit 0 in the Status Operation register is set. Completion, or termination, will clear bit 0 in the Status Operation register. This command is sequential; it must complete before further SCPI commands are processed. Interrupting the alignment from remote is accomplished by invoking Device Clear followed by the :ABORt command. Successful completion will clear bit 14 in the Status Questionable Calibration register. An interfering user signal is not grounds for failure of Align Now, All. However, bits 11 and 12 are set in the Status Questionable Calibration register to indicate Align Now, RF is required. An interfering user supplied signal will result in the instrument requiring an Align Now, RF with the interfering signal removed.
Couplings	Initializes the time for the Last Align Now, All Time. Records the temperature for the Last Align Now, All Temperature.

	If Align RF component succeeded, initializes the time for the Last Align Now, RF Time. If Align RF component succeeded, records the temperature for the Last Align Now, RF Temperature.
Status Bits/OPC dependencies	Bits 11, 12, or 14 may be set in the Status Questionable Calibration register.
Initial S/W Revision	Prior to A.02.00

Mode	All
Remote Command	*CAL?
Example	*CAL?
Notes	*CAL? returns 0 if successful *CAL? returns 1 if failed :CALibration[:ALL]? is the same as *CAL? See additional remarks described with :CALibration[:ALL]? Everything about :CALibration[:ALL]? is synonymous with *CAL? including all conditions, status register bits, and couplings
Initial S/W Revision	Prior to A.02.00

Clear Status

Clears the status byte register. It does this by emptying the error queue and clearing all bits in all of the event registers. The status byte register summarizes the states of the other registers. It is also responsible for generating service requests.

Key Path	No equivalent key. Related key System, Show Errors, Clear Error Queue
Remote Command	*CLS
Example	*CLS Clears the error queue and the Status Byte Register.
Notes	For related commands, see the SYSTem:ERRor[:NEXT]? command. See also the STATus:PRESet command and all commands in the STATus subsystem.
Status Bits/OPC dependencies	Resets all bits in all event registers to 0, which resets all the status byte register bits to 0 also.
Backwards Compatibility Notes	In general the status bits used in the X-Series status system will be backwards compatible with ESA and PSA. However, note that all conditions will generate events that go into the event log, and some will also generate status bits.
Initial S/W Revision	Prior to A.02.00

Standard Event Status Enable

Selects the desired bits from the standard event status enable register. This register monitors I/O errors and synchronization conditions such as operation complete, request control, query error, device

dependent error, status execution error, command error, and power on. The selected bits are OR'd to become a summary bit (bit 5) in the byte register which can be queried.

The query returns the state of the standard event status enable register.

Key Path	No equivalent key. Related key System, Show Errors, Clear Error Queue
Remote Command	*ESE <integer> *ESE?
Example	*ESE 36 Enables the Standard Event Status Register to monitor query and command errors (bits 2 and 5). *ESE? Returns a 36 indicating that the query and command status bits are enabled.
Notes	For related commands, see the STATus subsystem and SYSTem:ERRor[:NEXT]? commands.
Preset	255
State Saved	Not saved in state.
Min	0
Max	255
Status Bits/OPC dependencies	Event Enable Register of the Standard Event Status Register.
Initial S/W Revision	Prior to A.02.00

Standard Event Status Register Query

Queries and clears the standard event status event register. (This is a destructive read.) The value returned is a hexadecimal number that reflects the current state (0/1) of all the bits in the register.

Remote Command	*ESR?
Example	*ESR? Returns a 1 if there is either a query or command error, otherwise it returns a zero.
Notes	For related commands, see the STATus subsystem commands.
Preset	0
Min	0
Max	255
Status Bits/OPC dependencies	Standard Event Status Register (bits 0 - 7).
Initial S/W Revision	Prior to A.02.00

Identification Query

Returns a string of instrument identification information. The string will contain the model number, serial number, and firmware revision.

The response is organized into four fields separated by commas. The field definitions are as follows:

- Manufacturer

- Model
- Serial number
- Firmware version

Key Path	No equivalent key. See related key System, Show System.
Remote Command	*IDN?
Example	*IDN? Returns instrument identification information, such as: Keysight Technologies, N9020A, US01020004, A.01.02
Initial S/W Revision	Prior to A.02.00

Operation Complete

The *OPC command sets bit 0 in the standard event status register (SER) to “1” when pending operations have finished, that is when all overlapped commands are complete. It does not hold off subsequent operations. You can determine when the overlapped commands have completed either by polling the OPC bit in SER, or by setting up the status system such that a service request (SRQ) is asserted when the OPC bit is set.

The *OPC? query returns a “1” after all the current overlapped commands are complete. So it holds off subsequent commands until the “1” is returned, then the program continues. This query can be used to synchronize events of other instruments on the external bus.

Remote Command	*OPC *OPC?
Example	INIT:CONT 0 Selects single sweeping. INIT:IMM Initiates a sweep. *OPC? Holds off any further commands until the sweep is complete.
Status Bits/OPC dependencies	Not global to all remote ports or front panel. *OPC only considers operation that was initiated on the same port as the *OPC command was issued from. *OPC is an overlapped command, but *OPC? is sequential.
Backwards Compatibility Notes	<ol style="list-style-type: none"> 1. The ESA/PSA/VSA products do not meet all the requirements for the *OPC command specified by IEEE 488.2. This is corrected for X-Series. This will sometimes cause behavior that is not backward compatible, but it will work as customers expect. 2. Commands such as, *OPC/*OPC?/*WAI/*RST used to be global. They considered front panel operation in conjunction with the GPIB functionality. Now they are evaluated on a per channel basis. That is, the various rear panel remote ports and the front panel i/o are all considered separately. Only the functionality initiated on the port where the *OPC was sent, is considered for its operation. 3. *OPC used to hold off until the operation bits were cleared. Now it holds off until all overlapping commands are completed. Also, earlier instruments did not wait for completion of all processes, only the ones identified here (in the STATus:OPERation register): Calibrating: monitored by PSA, ESA, VSA (E4406A) Sweeping: monitored by PSA, ESA, VSA (E4406A) Waiting for Trigger: monitored by PSA, ESA, VSA (E4406A)

	Measuring: monitored by PSA and ESA (but not in all Modes). Paused: monitored by VSA (E4406A). Printing: monitored by VSA (E4406A). Mass memory busy: monitored by VSA (E4406A).
Initial S/W Revision	Prior to A.02.00

Query Instrument Options

Returns a string of all the installed instrument options. It is a comma separated list with quotes, such as: "503,P03,PFR".

To be IEEE compliant, this command should return an arbitrary ascii variable that would not begin and end with quotes. But the quotes are needed to be backward compatible with previous SA products and software. So, the actual implementation will use arbitrary ascii. But quotes will be sent as the first and last ascii characters that are sent with the comma-separated option list.

Remote Command	*OPT?
Initial S/W Revision	Prior to A.02.00

Recall Instrument State

This command recalls the instrument state from the specified instrument memory register.

- If the state being loaded has a newer firmware revision than the revision of the instrument, no state is recalled and an error is reported
- If the state being loaded has an equal firmware revision than the revision of the instrument, the state will be loaded.
- If the state being loaded has an older firmware revision than the revision of the instrument, the instrument will only load the parts of the state that apply to the older revision.

Remote Command	*RCL <register #>
Example	*RCL 7 Recalls the instrument state that is currently stored in register 7.
Notes	Registers 0 through 6 are accessible from the front panel in menu keys for Recall Registers.
Min	0
Max	127
Status Bits/OPC dependencies	The command is sequential.
Initial S/W Revision	Prior to A.02.00

*RST (Remote Command Only)

*RST is equivalent to :SYST:PRES::INIT:CONT OFF, which is a Mode Preset in the Single measurement state. This remote command is preferred over Mode Preset remote command - :SYST:PRES, as optimal remote programming occurs with the instrument in the single measurement state.

Remote Command	*RST
Example	*RST
Notes	Sequential Clears all pending OPC bits and the Status Byte is set to 0.
Couplings	A *RST will cause the currently running measurement to be aborted and cause the default measurement to be active. *RST gets the mode to a consistent state with all of the default couplings set.
Backwards Compatibility Notes	In legacy analyzers *RST did not set the analyzer to Single, but in the X-Series it does, for compliance with the IEEE 488.2 specification. In the X-Series, *RST does not do a *CLS (clear the status bits and the error queue). In legacy analyzers, *RST used to do the equivalent of SYSTem:PRESet, *CLS and INITiate:CONTinuous OFF. But to be 488.2 compliant, *RST in the X-Series does not do a *CLS.
Initial S/W Revision	Prior to A.02.00

Save Instrument State

This command saves the current instrument state and mode to the specified instrument memory register.

Remote Command	*SAV <register #>
Example	*SAV 9 Saves the instrument state in register 9.
Notes	Registers 0 through 6 are accessible from the front panel in menu keys for Save Registers.
Min	0
Max	127
Status Bits/OPC dependencies	The command is sequential.
Initial S/W Revision	Prior to A.02.00

Service Request Enable

This command enables the desired bits of the service request enable register.

The query returns the value of the register, indicating which bits are currently enabled.

Remote Command	*SRE <integer> *SRE?
Example	*SRE 22 Enables bits 1, 2, and 4 in the service request enable register.

Notes	For related commands, see the STATus subsystem and SYSTem:ERRor[:NEXT]? commands.
Preset	0
Min	0
Max	255
Status Bits/OPC dependencies	Service Request Enable Register (all bits, 0 – 7).
Initial S/W Revision	Prior to A.02.00

Status Byte Query

Returns the value of the status byte register without erasing its contents.

Remote Command	*STB?
Example	*STB? Returns a decimal value for the bits in the status byte register. For example, if a 16 is returned, it indicates that bit 5 is set and one of the conditions monitored in the standard event status register is set.
Notes	See related command *CLS.
Status Bits/OPC dependencies	Status Byte Register (all bits, 0 – 7).
Initial S/W Revision	Prior to A.02.00

Trigger

This command triggers the instrument. Use the :TRIGger[:SEQuence]:SOURce command to select the trigger source.

Key Path	No equivalent key. See related keys Single and Restart.
Remote Command	*TRG
Example	*TRG Triggers the instrument to take a sweep or start a measurement, depending on the current instrument settings.
Notes	See related command :INITiate:IMMediate.
Initial S/W Revision	Prior to A.02.00

Self Test Query

This query performs the internal self-test routines and returns a number indicating the success of the testing. A zero is returned if the test is successful, 1 if it fails.

Remote Command	*TST?
Example	*TST? Runs the self-test routines and returns 0=passed, 1=some part failed.
Initial S/W Revision	Prior to A.02.00

Wait-to-Continue

This command causes the instrument to wait until all overlapped commands are completed before executing any additional commands. There is no query form for the command.

Remote Command	*WAI
Example	INIT:CONT OFF; INIT;*WAI Sets the instrument to single sweep. Starts a sweep and waits for its completion.
Status Bits/OPC dependencies	Not global to all remote ports or front panel. *OPC only considers operation that was initiated on the same port as the *OPC command was issued from.
Initial S/W Revision	Prior to A.02.00

4 Input/Output Functions

Input/Output

The Input/Output features are common across multiple Modes and Measurements. These common features are described in this section. See the Measurement description for information on features that are unique.

The Input/Output key accesses the keys that control the Input/Output parameters of the instrument. In general, these are functions associated with external connections to the analyzer, either to the inputs or the outputs. Since these connections tend to be fairly stable within a given setup, in general, the input/output settings do not change when you Preset the analyzer.

Other functions related to the input/output connections, but which tend to change on a measurement by measurement basis, can be found under the Trigger and AMPTD Y Scale keys. In addition, some of the digital I/O bus configurations can be found under the System key.

NOTE

The functions in the Input/Output menu are "global" (common) to all Modes (applications). But individual Input/Output functions only appear in a Mode if they apply to that Mode. Functions that apply to a Mode but not to all measurements in the Mode may be grayed-out in some measurements.

["Input/Output variables - Preset behavior" on page 197](#)

The Input Port selection is the first menu under the Input/Output key:

Key Path	Front-panel key
Remote Command	<code>[:SENSe] :FEED RF AIQ EMIXer</code> <code>[:SENSe] :FEED?</code>
Example	<code>:FEED RF</code> <code>:FEED?</code>
Couplings	The <code>[:SENSe] :FEED RF</code> command turns the calibrator OFF
Preset	This setting is unaffected by a Preset or power cycle. It survives a Mode Preset and mode changes. It is set to RF on a "Restore Input/Output Defaults" or "Restore System Defaults->All"
State Saved	Saved in instrument state
Backwards Compatibility SCPI	<code>[:SENSe] :FEED AREFERENCE</code> In the PSA the calibrator was one of the inputs and selected using the AREF parameter to the same <code>:FEED</code> command that switched the inputs. In the X-Series it is controlled in a separate menu and overrides the input selection. For code compatibility the <code>[:SENSe] :FEED AREFERENCE</code> command is provided, and is aliased to <code>[:SENSe] :FEED :AREF REF50</code> , which causes the input to be switched to the 50 MHz calibrator. The <code>[:SENSe] :FEED RF</code> command switches the input back to the RF port and turns the calibrator OFF, thus providing full compatibility with the PSA calibrator function. Note that after sending this, the query <code>[:SENSe] :FEED?</code> will NOT return "AREF" but instead the currently selected input.
Backwards Compatibility SCPI	<code>[:SENSe] :FEED IQ IONLy QONLy</code> <code>[:SENSe] :FEED?</code> The parameters <code>IQ IONLy QONLy</code> are supported for backwards compatibility with the E44406A. <code>[:SENSe] :FEED IQ</code> aliases to <code>[:SENSe] :FEED :IQ :TYPE IQ</code> <code>[:SENSe] :FEED IONLy</code> aliases to <code>[:SENSe] :FEED :IQ :TYPE IONLy</code>

	<p>[;SENSe]:FEED QONLy aliases to [;SENSe]:FEED:IQ:TYPE QONLy</p> <p>The query [;SENSe]:FEED? will always returns AIQ whatever the type of legacy parameters IQ IONLy QONLy has been used.</p>
Backwards Compatibility Notes	<p>Most of the settings in the X-Series Input/Output system, including External Gain, Amplitude Corrections settings and data, etc., are shared by all modes and are not changed by a mode switch. Furthermore, most variables in the Input/Output system key are not affected by Mode Preset. Both of these behaviors represent a departure from legacy behavior.</p> <p>In the X-Series. Input/Output settings are reset by using the "Restore Input/Output Defaults" function. They can also be reset to their default values through the System->Restore System Defaults-> In/Out Config key or through the System ->Restore System Defaults -> All key (and corresponding SCPI).</p> <p>While this matches most use cases better, it does create some code compatibility issues. For example, Amplitude Corrections are no longer turned off by a Mode Preset, but instead by using the "Restore Input/Output Defaults" key/SCPI.</p> <p>Although Input/Output settings are not part of each Mode's State, they are saved in the Save State files, so that all of the instrument settings can be recalled with Recall State, as in legacy instruments.</p>
Initial S/W Revision	Prior to A.02.00
Remote Command	<p>:INPut:MIXer EXTernal INTernal</p> <p>:INPut:MIXer?</p>
Example	<p>INP:MIX INT</p> <p>INP:MIX?</p>
Notes	<p>In legacy analyzers you choose between the Internal mixer or an External Mixer. In the X-Series, the External Mixer is one of the choices for the Input and is selected using the FEED command (:SENSe:FEED EXTMIxer).</p> <p>For compatibility, the INPut:MIXer EXTernal INTernal legacy command is mapped as follows:</p> <ol style="list-style-type: none"> 1. When INPut:MIXer EXTernal is received, SENSe:FEED EMIXer is executed. 2. When INPut:MIXer INTernal is received, SENSe:FEED RF is executed. 3. When INPut:MIXer? is received, the response will be INT if any input other than the external mixer is selected and EXT if the external mixer is selected
Preset	INT
Backwards Compatibility Notes	<p>PSA supports the following SCPI Command :</p> <p>:INPut:MIXer:TYPE PRESelected UNPReselect</p> <p>:INPut:MIXer:TYPE?</p> <p>PXA does not support the :INPut:MIXer:TYPE command.</p>
Initial S/W Revision	A.08.01

Input/Output variables - Preset behavior

Virtually all the input/output settings are NOT a part of mode preset. They can be set to their default value

by one of the three ways:

- by using the Restore Input/Output Defaults key on the first page of the input/output menu,
- by using the System->Restore System Defaults->Input/Output Settings or,
- by using the System -> Restore System Defaults->All. Also, they survive a Preset and a Power cycle.

A very few of the Input/Output settings do respond to a Mode Preset; for example, if the Calibrator is on it turns off on a Preset, and if DC coupling is in effect it switches to AC on a Preset. These exceptions are made in the interest of reliability and usability, which overrides the need for absolute consistency. Exceptions are noted in the SCPI table for the excepted functions.

RF Input

Selects the front-panel RF input port to be the analyzer signal input. If RF is already selected, pressing this key accesses the RF input setup functions.

Key Path	Input/Output
Example	[:SENSe]:FEED RF
Couplings	The act of connecting the U7227A USB Preamplifier to one of the analyzer's USB ports will cause the Input to automatically switch to the RF Input. If the RF Calibrator is on, it is turned off. Subsequently disconnecting the USB Preamp from USB does not change the Input selection nor restore the previous selection.
Readback	The RF input port, RF coupling, and current input impedance settings appear on this key as: "XX, YY, ZZ" where XX is RF, RF2, RFIO1, RFIO2, depending on what input is selected (only appears on analyzers with multiple RF inputs) YY is AC or DC ZZ is 50Ω or 75Ω
Initial S/W Revision	Prior to A.02.00
Modified at S/W Revision	A.14.00

Input Z Correction

Sets the input impedance for unit conversions. This affects the results when the y-axis unit is voltage or current units (dBmV, dBμV, dBμA, V, A), but not when it is power units (dBm, W). The impedance you select is for computational purposes only, since the actual impedance is set by internal hardware to 50 ohms. Setting the computational input impedance to 75 ohms is useful when using a 75 ohm to 50 ohm adapter to measure a 75 ohm device on an analyzer with a 50 ohm input impedance.

There are a variety of ways to make 50 to 75 ohm transitions, such as impedance transformers or minimum loss pads. The choice of the solution that is best for your measurement situation requires balancing the amount of loss that you can tolerate with the amount of measurement frequency range that you need. If you are using one of these pads/adaptors with the Input Z Corr function, you might also want to use the Ext Gain key. This function is used to set a correction value to compensate for the gain (loss) through your pad. This correction factor is applied to the displayed measurement values.

Key Path	Input/Output, RF Input
Remote Command	[:SENSe] :CORRection:IMPedance [:INPut] [:MAGNitude] 50 75 [:SENSe] :CORRection:IMPedance [:INPut] [:MAGNitude] ?
Example	CORR:IMP 75 sets the input impedance correction to 75 ohms. CORR:IMP?
Couplings	In the N9000A option C75, when RF Input 2 is selected, the Input Z Correction will automatically change to 75 ohms. You may then change it to whatever is desired. When the main RF Input is selected, the Input Z Correction will automatically change to 50 ohms. You may then change it to whatever is desired.
Preset	This is unaffected by a Preset but is set to 50 ohms on a "Restore Input/Output Defaults" or "Restore System Defaults->All" Some instruments/options may have 75 ohms available.
State Saved	Saved in instrument state
Readback	50 Ω or 75 Ω . Current setting reads back to the RF key.
Initial S/W Revision	Prior to A.02.00

RF Coupling

Specifies alternating current (AC) or direct current (DC) coupling at the analyzer RF input port. Selecting AC coupling switches in a blocking capacitor that blocks any DC voltage present at the analyzer input. This decreases the input frequency range of the analyzer, but prevents damage to the input circuitry of the analyzer if there is a DC voltage present at the RF input.

In AC coupling mode, you can view signals below the corner frequency of the DC block, but below a certain frequency the amplitude accuracy is not specified. The frequency below which specifications do not apply is:

X-Series Model	Lowest Freq for meeting specs when AC coupled	Lowest Freq for meeting specs when DC coupled
N9000A-503/507	100 kHz	n/a
N9000A-C75 Input 2	1 MHz	n/a
N9000A-513/526	10 MHz	9 kHz
N9010A	10 MHz	9 kHz
N9020A	10 MHz	20 Hz
N9030A	10 MHz	3 Hz

Some amplitude specifications apply only when coupling is set to DC. Refer to the appropriate amplitude specifications and characteristics for your analyzer.

When operating in DC coupled mode, ensure protection of the analyzer input circuitry by limiting the DC part of the input level to within 200 mV of 0 Vdc. In AC or DC coupling, limit the input RF power to +30 dBm (1 Watt).

Key Path	Input/Output, RF Input
Remote Command	:INPut:COUPling AC DC :INPut:COUPling?
Example	INP:COUP DC
Dependencies	This key does not appear in models that are always AC coupled. When the SCPI command to set DC coupling is sent to these models, it results in the error "Illegal parameter value; This model is always AC coupled" In these models, the SCPI query INP:COUP? always returns AC. This key does not appear in models that are always DC coupled. When the SCPI command to set AC coupling is sent to these models, it results in the error "Illegal parameter value; This instrument is always DC coupled" In these models, the SCPI query INP:COUP? always returns DC.
Preset	AC on models that support AC coupling On models that are always DC coupled, such as millimeter wave models (frequency ranges 30 GHz and above), the preset is DC.
State Saved	Saved in instrument state.
Initial S/W Revision	Prior to A.02.00
Modified at S/W Revision	A.03.00

External Mixer

This key allows you to choose an External Mixer through which to apply signal input to the analyzer. When chosen, the LO/IF port becomes the input to the analyzer.

External Mixing requires option EXM. The External Mixer key will not appear unless option EXM is installed. The presence of the LO/IF connector alone does not indicate that you have Option EXM licensed. To verify that option EXM is installed, press System, Show, System.

When External Mixer is selected, the Center Freq key controls the setting of the Center Freq in external mixing, which is separate from the settings of Center Freq for the RF Input or BBIQ. Each input retains its unique settings for Center Freq. A unique SCPI command is provided solely for the external mixing Center Freq (see the Center Freq key description), which only affects the External Mixer CF, although sending the generic Center Freq command while External Mixer is selected also controls the External Mixer CF.

See "[More Information](#)" on page 201

Key Path	Input/Output
Example	:FEED EMIX
Notes	Not all measurements support the use of the External Mixer input. When External Mixer is selected in a measurement that does not support it, the "No result; Meas invalid with Ext Mixing" error condition occurs.
Dependencies	Unless option EXM is present, the External Mixer key is blanked, and all SCPI commands associated with menus accessed by this key return an error

	Manual FFT mode is available with external mixing, but not with Signal ID.
Preset	All settings under this key are returned to their default state when Restore Input/Output Defaults is pressed.
State Saved	All settings under this key, and all Frequency settings, are remembered when you go out of External Mixer, so that when External Mixer is chosen again, all the external mixer functions will retain their previous settings, with the exception of Signal ID which is set to OFF (Signal ID is also set to Off unless External Mixer is the selected Input).
Readback Text	The readback text on this key shows the currently selected mixer, in square brackets.
Backwards Compatibility Notes	Unlike PSA, all external mixer settings including Center Frequency are retained when you go in and out of External Mixing. Also, Preset does not take you out of External Mixing (Restore Input/Output Defaults does).
Initial S/W Revision	A.08.01

More Information

X-series analyzers have a combined LO Out/IF In connection, whereas earlier analyzers used separate ports for the LO Out and the IF in. Internal diplexers in the analyzer and the mixer simplify the connection for the user – only a single SMA cable is required.

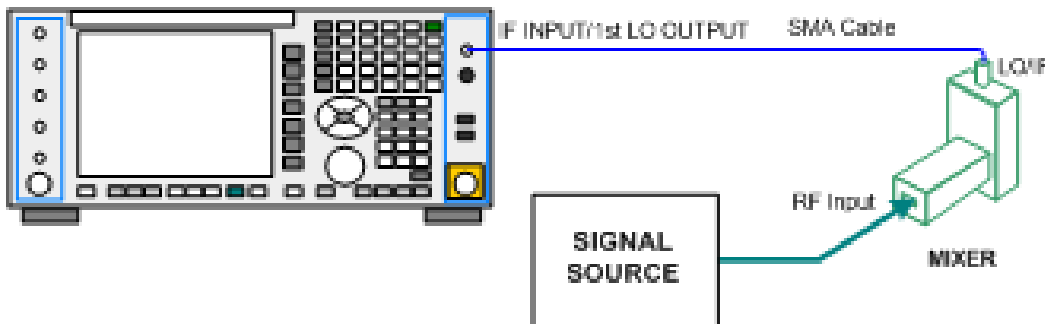

Legacy HP/Agilent and some third party mixers have separate LO In and IF out connections. This requires you to use an external diplexer to connect these mixers. A diplexer can easily be purchased for this purpose (for example, Diplexer Model # DPL.26 or # DPL.313B from OML Inc., Morgan Hill CA)

The connection diagram for such a legacy mixer is:

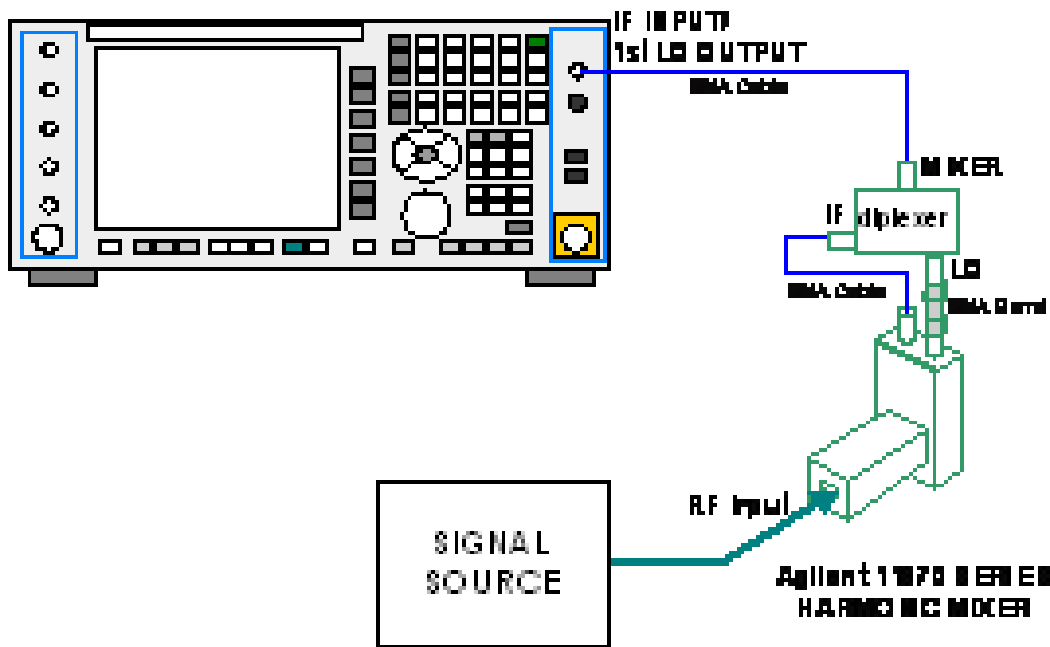

In addition, External Mixing in the X-Series supports the new Agilent M1970 series of Harmonic Mixers, which provide a USB connection for download of calibration data and additional control.

The connection diagram for one of the Agilent USB mixers is:

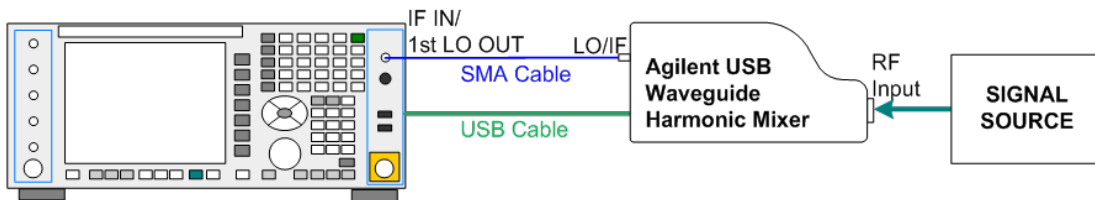

External Mixing is only supported in certain Modes and Measurements in the X-Series, as shown in the table below:

Mode	Measurements	Sig ID (Image Suppress only)
Spectrum Analyzer	Swept SA	Y*
	TOI	Y
	Harmonics	N
	Spurious Emissions	Y
	Channel Power	Y
	Occupied BW	Y
	ACP	Y
	Spectrum Emissions Mask	Y
	CCDF	N

	Burst Power	N
	List Sweep	N
Phase Noise	Monitor Spectrum	Y
	Log Plot	Y
	Spot Frequency	N
	Waveform	N
I/Q Analyzer	Complex Spectrum	N
	Waveform	N
Vector Signal Analyzer	Vector Analysis	N
	Analog Demod	N
	Digital Demod	N

* the Swept SA measurement also supports Image Shift

Ext Mix Setup

This menu lets you select the mixer type, and lets you configure your mixer (if necessary). While in this menu, and any of its submenus, the External Mixer Setup screen appears, showing you the current settings for the selected mixer. These settings may be dependent on which IF path is currently in use, whether a + or – harmonic is currently selected, etc.

To apply any amplitude correction factors needed to correct mixer flatness, you enter values into one of the Correction tables (under Input/Output, Corrections). The correction conversion loss values can be extracted from data supplied with the mixer or from manual measurements you make to determine the conversion loss. Note that the correction applied by the Correction tables is global to the analyzer; therefore you should make sure to turn off the External Mixer corrections when you are not using the External Mixer input.

NOTE

The Agilent USB Mixers automatically give their flatness data to the analyzer, and the correction is applied internally. No correction needs to be entered by the user, and the correction does not appear in the user-accessible Corrections tables. The user is free to enter additional corrections into the Correction tables under Input/Output, Corrections.

Key Path	Input/Output, External Mixer
State Saved	All settings in the Mixer Setup are part of the Input/Output system, and hence are saved whenever State is saved.
Readback Text	The readback line on this key shows the currently selected mixer, in square brackets.
Initial S/W Revision	A.08.01
Modified at S/W Revision	A.08.50

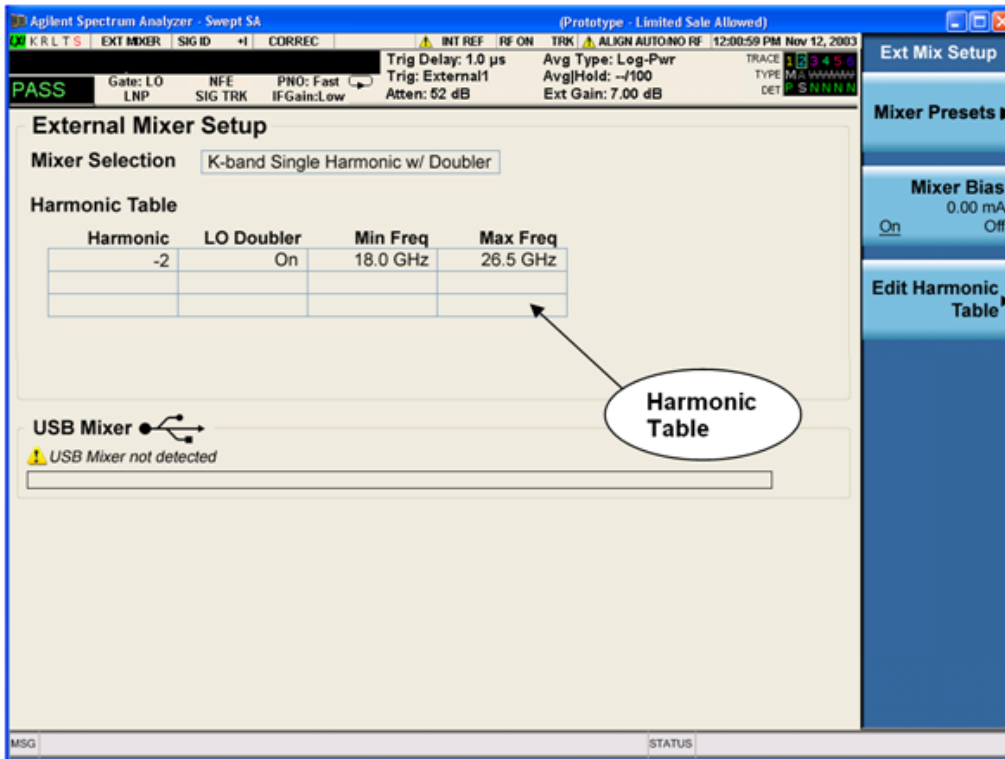

The External Mixer Setup screen looks like this

The current Mixer selection (the current or most recently connected USB Mixer, or the most recent Mixer Preset, or “Custom” if the user has modified the setup) reads out at the top of this screen.

The Harmonic Table currently being used reads out below the Mixer Selection. It shows each range being used for the current mixer. Note that a band may be made up of up to 3 ranges. Each range represents a choice of mixer harmonic and doubler state. When you select a Mixer Preset, it sets the analyzer Start and Stop frequency to the values shown in the Harmonic Table; Start Freq is set to the Min Freq for the bottom range, and Stop Freq is set to the Max Freq for the top range. In many cases you can exceed these nominal values; the absolute maximum and minimum frequency for each preset are shown in the tables that accompany the key descriptions for the Mixer Presets.

NOTE

If the current measurement has a limited Span available to it, and cannot achieve the Span shown in the table (Span=Stop Freq – Start Freq), the analyzer uses the maximum Span the measurement allows, and sets the Center Freq to the midpoint of the Start and Stop Freq values in the Harmonic Table.

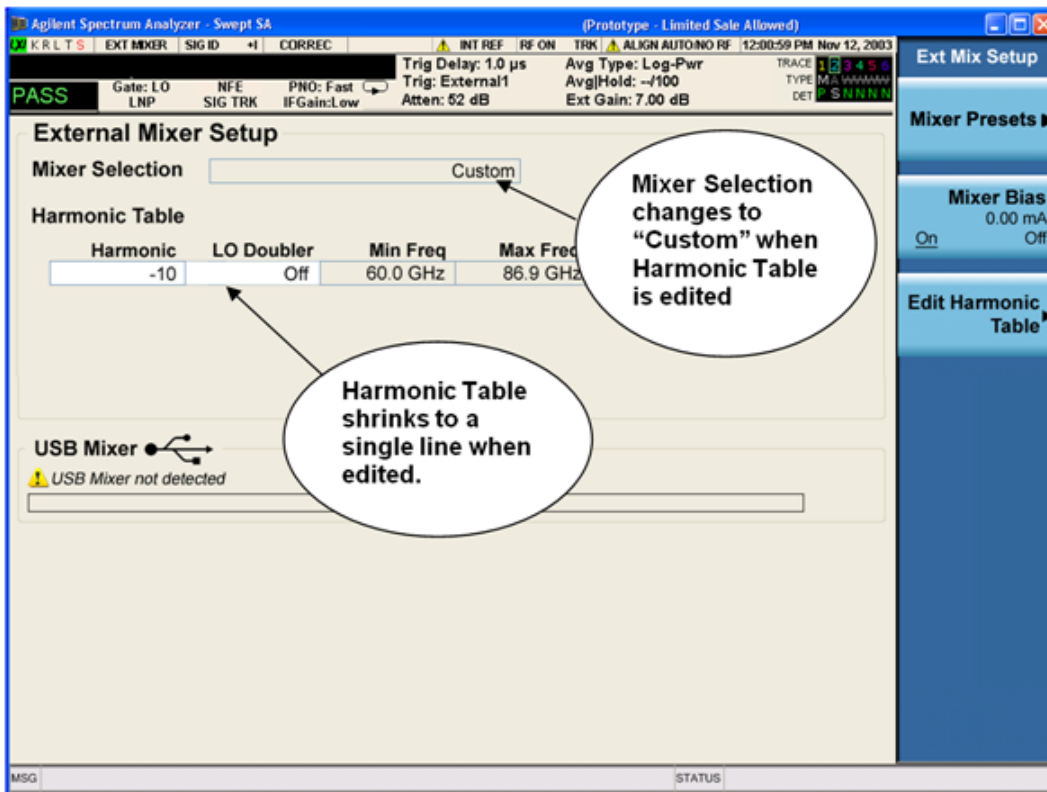

You may customize the Harmonic Table, but when you do this the analyzer goes into “single harmonic” mode. You may enter the harmonic number and whether to use the doubler or not, but now range switching is not supported, so you can only have one harmonic.

When you edit the Harmonic Table, the Mixer Selection changes to “Custom.” To change it back you must go back into the Mixer Presets menu and select a Preset.

When you edit the Harmonic Table, the nominal Min Freq and Max Freq that are available will usually be different than the Preset you were using; and the absolute frequency limits will change as well. This may result in a change to your Start and/or Stop Freq, if the current values fall outside the new range, requiring you to retune your Center Freq to get your signal back in the center.

The analyzer supports the Agilent M1970 Series Harmonic Mixers with USB connection. While in External Mixing, if one of these mixers is plugged in to a USB port, it is automatically detected and displayed in the “USB Mixer” area of the setup screen, including its model number and serial number.

The analyzer assumes that if you plug a mixer into the USB, that is the mixer you want to use. Therefore:

1. If a USB mixer is connected to the USB port, the Mixer Presets menu is grayed out, as none of the presets make sense with a USB Mixer connected. Note that once the analyzer has acquired the USB Mixer, the mixer selection will remain if it is subsequently unplugged from the USB, allowing you to plug it back in with no change to your settings. However, once you unplug it, the Mixer Presets key will stop being grayed out, allowing you to preset to a different mixer.
2. When Restore Input/Output Defaults is performed, if an Agilent USB Mixer is plugged into the analyzer’s USB port, the Mixer Selection remains unchanged.

3. When recalling an instrument state, if an Agilent USB Mixer is plugged into the analyzer's USB port, and the Mixer Selection in the recalled state is for a USB Mixer that does not match the mixer currently plugged in, you will have to unplug your mixer and then plug it back in to get the analyzer to recognize your mixer.

As long as the selection in Ext Mixer Setup shows one of the USB mixers, both the Mixer Bias and Edit Harmonic Table keys will be grayed out.

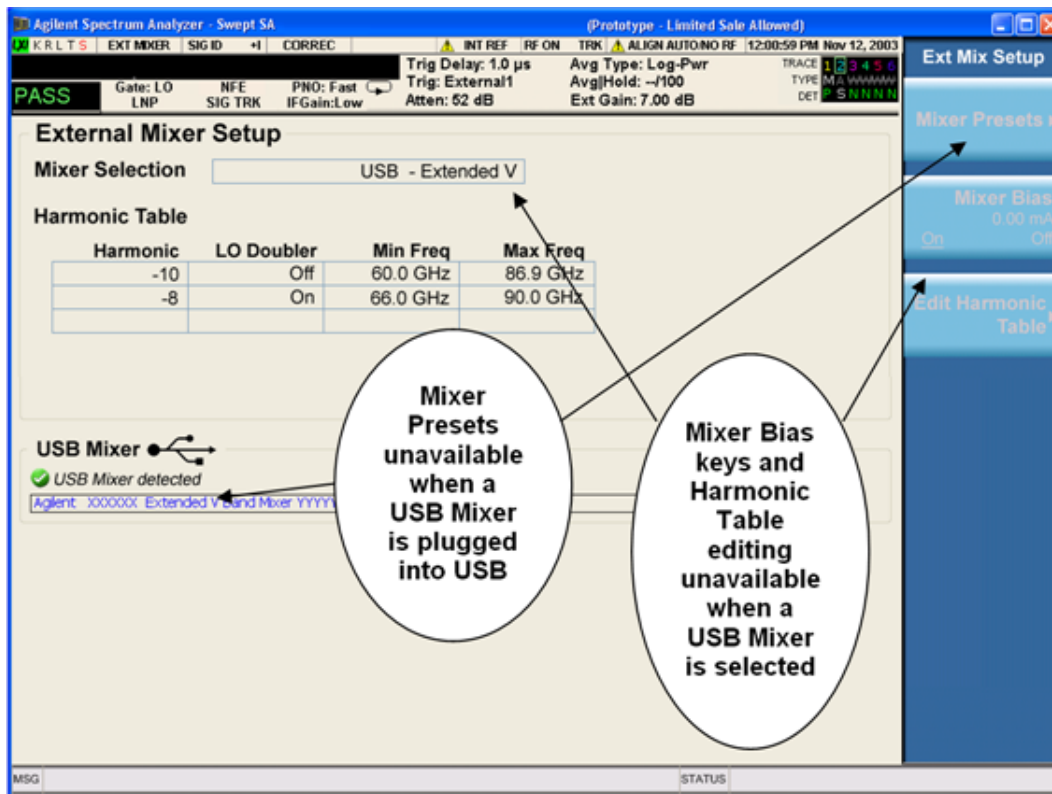

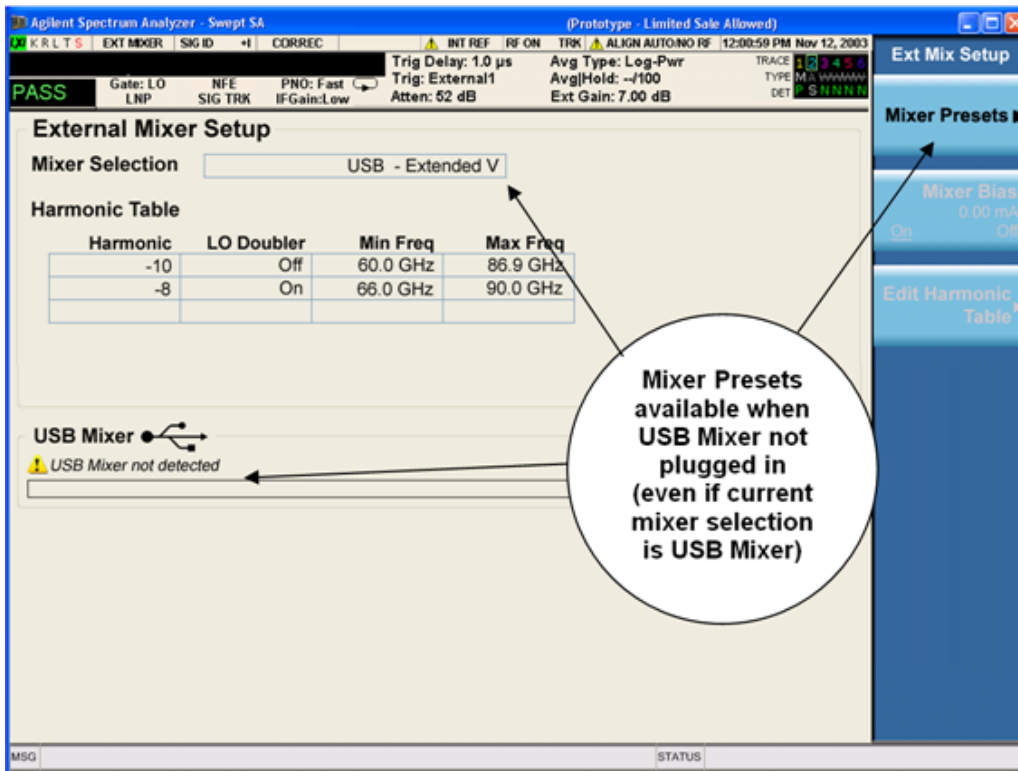

Only one USB Mixer is supported at a time. To switch to a different USB Mixer, disconnect the one that is no longer being used prior to connecting a new one.

The Mixer Selection displayed and softkey readback for the Agilent M1970 series mixers is:

Mixer Model	Mixer Selection display on Setup Screen	Readback on softkeys
Agilent M1970E: Option 001: 60 to 90 GHz Waveguide Harmonic Mixer	USB - M1970E E-Band	USB Mixer E-Band
Agilent M1970V Option 001: 50 to 75 GHz Waveguide Harmonic Mixer	USB - M1970V-001 V-Band	USB Mixer V-Band
Agilent M1970V Option 002: 50 to 80 GHz Waveguide Harmonic Mixer	USB - M1970V-002 Extended V-Band	USB Mixer Extended V
Agilent M1970W: 75 to 110 GHz Waveguide Harmonic Mixer	USB - M1970W W-Band	USB Mixer W-Band

The Agilent USB mixer essentially acts as a “remote front end” and is fully calibrated over the specified frequency range, without requiring any user interaction. This is particularly useful at high mm-wave frequencies, where cable loss is typically quite large, and it is desirable to bring the front end right up to the device under test, rather than bringing the mm-wave signal to the analyzer using a lossy and uncalibrated cable or waveguide connection.

Connecting the mixer to the USB port on the analyzer switches you to External Mixing, aborts the current measurement, and initiates an alignment of the mixer. A popup message, “USB Mixer connected” appears on the display. When a USB mixer and the LO/IF cable are connected the alignment is performed. When the alignment begins, an “Aligning” popup replaces the previous message on the display. When the alignment completes, the current measurement restarts.

Mixer Presets

This menu lets you preset the mixer setup for the particular type of mixer that you are using.

These presets are divided into four groups:

- one for Agilent legacy mixers,
- three for general purpose mixers:
 - o presets that use a single harmonic and no doubling
 - o presets that use a single harmonic but double the LO
 - o presets that use multiple harmonics

Note that the IF/LO port provides a 3.8–14 GHz LO in two bands: 3.8–8.7 (LO fundamental), and 8.6–14 GHz (doubled LO).

In most cases, once you have executed the preset, you will not need to adjust any further settings.

Key Path	Input/Output, External Mixer, Ext Mix Setup
Remote Command	[:SENSe]:MIXer:BAND A Q U V W NA ND NE NF NG NJ NK NQ NU NV NW NY NEXT DD DF DG DJ DK DQ DV DW DY DEXT MA ME MU MCOAX USB [:SENSe]:MIXer:BAND?
Example	:MIX:BAND A :MIX:BAND?
Notes	A Q U V W select Agilent 11970 mixer presets NA ND NE NF NG NJ NK NQ NU NV NW NY NEXT select single harmonic, non-doubled LO presets DD DF DG DJ DK DQ DV DW DY DEXT select single harmonic, doubled LO presets MA ME MU MCOAX select multiple harmonic presets All of these presets are detailed in their respective key descriptions The query form of this command returns the most recent preset, UNLESS the harmonic table has been edited after the preset was executed. If the harmonic table has been edited it returns CUSTOM The command USB will refresh the USB mixer connection and automatically detect the mixer band. The query form of this command returns the following if an Agilent USB Mixer is plugged into the analyzer’s USB port: USB E Agilent E-Band USB Mixer USB V Agilent V-Band USB Mixer USB VEXT Agilent Extended V-Band USB Mixer USB W Agilent W-Band USB Mixer Note that the parameters CUSTOM, USBV, USBVEXT, and USBW are query responses only, and cannot be sent TO the analyzer.

	<p>The following cross-reference matches the mixer band designators used by Agilent to the EIA waveguide designations:</p> <p>EIAAgilentFreq Range</p> <p>WR-28 A26.5 – 40 GHz</p> <p>WR-22 Q33 – 50 GHz</p> <p>WR-19 U40 – 60 GHz</p> <p>WR-15 V50 – 75 GHz</p> <p>WR-12 E60 – 90 GHz</p> <p>WR-10 W75 – 110 GHz</p> <p>WR-8 F90 – 140 GHz</p> <p>WR-6 D110 – 170 GHz</p> <p>WR-5 G140 – 220 GHz</p> <p>WR-3 J220 – 325 GHz</p>
Preset	<p>When Restore Input/Output Defaults is performed, an “A” mixer preset is also issued (11970A band), unless an Agilent USB Mixer is plugged into the analyzer’s USB port, in which case the Mixer Selection remains unchanged.</p> <p>When using Agilent USB Mixers, if a Restore All Defaults (SCPI command SYSTem:DEFault) has been performed, either remove and reinsert the USB cable or press the Refresh USB Mixer Connection softkey.</p>
Backwards Compatibility Notes	<p>The [:SENSE]:MIXer:BAND command was used in PSA and ESA to select the mixer band. In the X-Series, only the legacy parameters A, Q, U, V, and W are honored, and they preset the analyzer to match the corresponding Agilent 11970 legacy mixer. Parameters D, E, F, G, J, K, Y, which were accepted in ESA and PSA, return an error if sent. If you are using a mixer in one of these bands, you should study the tables of presets and choose the appropriate preset to match your application. Also the USER parameter is no longer accepted, as the control model for mixer customization is very different in the X-Series.</p>
Initial S/W Revision	A.08.01
Modified at S/W Revision	A.14.00

Agilent 11970

This menu allows you to preset for one of the models in the HP/Agilent 11970 series.

Because the X-Series has an LO range of 3.8 – 14 GHz, and older analyzers had an LO range of 3.0 – 6.8 GHz, the harmonic numbers used in the X-Series may differ from those used on older analyzers for the same mixers. Additionally, some of the 11970 mixers cannot be operated over their full range with the X-Series without switching harmonics. Consequently, you will find that some of the bands (A-Band, for example) are broken into two ranges for use with the X-Series.

See ["More Information" on page 210](#)

Key Path	Input/Output, External Mixer, Ext Mix Setup, Mixer Presets
Example	MIX:BAND A
Initial S/W Revision	A.08.01

More Information

Below are the 11970A presets. The 11970U and the 11970W use a single harmonic. The other three switch harmonics mid-band. Both harmonic ranges are shown in the table. None of these mixers use LO doubling.

The 11970 K-band mixer and the 11974 preselected mixer series are not supported.

Preset	Readout in setup screen	Readback on softkeys	Range	Harm #	RF start	RF stop	RF center
A-band	Agilent 11970A	Agilent 11970A	1	-6	26.5	30.45	28.475
			2	-8	30.35	40	35.175
Q-band	Agilent 11970Q	Agilent 11970Q	1	-8	33	40.8	36.9
			2	-10	39.8	50	44.9
U-band	Agilent 11970U	Agilent 11970U	..	-10	40	60	50
V-band	Agilent 11970V	Agilent 11970V	1	-12	50	66	58
			2	-14	53	75	64
W-band	Agilent 11970W	Agilent 11970W	..	-18	75	110	92.5

Single Harmonic

These presets choose a setup that uses a single harmonic and no doubling for the LO.

Key Path	Input/Output, External Mixer, Ext Mix Setup, Mixer Presets
Example	MIX:BAND NA
Initial S/W Revision	A.08.01

These are the presets for single harmonic operation with no doubler:

Mixer	Readout in setup screen	Readback on softkeys	Harm #	RF start	RF stop	RF center
K-band	K-band Single Harmonic, no doubler	Sngl harm LOx1 K-band	-4	18	26.5	22.25
A-band	A-band Single Harmonic, no doubler	Sngl harm LOx1 A-band	-6	26.5	40	33.25
D-band	D-band Single Harmonic, no doubler	Sngl harm LOx1 D-band	-20	110	170	140
E-band	E-band Single Harmonic, no doubler	Sngl harm LOx1 E-band	-12	60	90	75
F-band	F-band Single Harmonic, no doubler	Sngl harm LOx1	-18	90	140	115

Mixer	Readout in setup screen	Readback on softkeys	Harm #	RF start	RF stop	RF center
		F-band				
Q-band	Q-band Single Harmonic, no doubler	Sngl harm LOx1 Q-band	-6	33	50	41.5
U-band	U-band Single Harmonic, no doubler	Sngl harm LOx1 U-band	-8	40	60	50
V-band	V-band Single Harmonic, no doubler	Sngl harm LOx1 V-band	-10	50	75	62.5
W-band	W-band Single Harmonic, no doubler	Sngl harm LOx1 W-band	-14	75	110	92.5
G-band	G-band Single Harmonic, no doubler	Sngl harm LOx1 G-band	-26	140	220	180
Y-band	Y-band Single Harmonic, no doubler	Sngl harm LOx1 Y-band	-30	170	260	215
J-band	J-band Single Harmonic, no doubler	Sngl harm LOx1 J-band	-38	220	325	272.5
Extended	Extended Single Harmonic, no doubler	Sngl harm LOx1 Extended	-40	155	345	250

Single Harmonic w/doubler

These presets choose a setup that uses a single harmonic and doubling for the LO.

Key Path	Input/Output, External Mixer, Ext Mix Setup, Mixer Presets
Example	MIX:BAND DW
Initial S/W Revision	A.08.01

These are the presets for single harmonic operation with LO doubling:

Mixer	Readout in setup screen	Readback on softkeys	Harm #	RF start	RF stop	RF center
D-band	D-band Single Harmonic w/doubler	Sngl harm LOx2 K-band	-14	110	170	140
F-band	F-band Single Harmonic w/doubler	Sngl harm LOx2 A-band	-10	90	140	115
G-band	G-band Single Harmonic w/doubler	Sngl harm LOx2 A-band	-16	140	220	180
J-band	J-band Single	Sngl harm LOx2	-24	220	325	272.5

Mixer	Readout in setup screen	Readback on softkeys	Harm #	RF start	RF stop	RF center
	Harmonic w/doubler	A-band				
K-band	K-band Single Harmonic w/doubler	Sngl harm LOx2 A-band	-2	18	26.5	22.25
Q-band	Q-band Single Harmonic w/doubler	Sngl harm LOx2 A-band	-4	33	50	41.5
V-band	V-band Single Harmonic w/doubler	Sngl harm LOx2 A-band	-6	50	75	62.5
W-band	W-band Single Harmonic w/doubler	Sngl harm LOx2 A-band	-8	75	110	92.5
Y-band	Y-band Single Harmonic w/doubler	Sngl harm LOx2 A-band	-20	170	260	215
Extended	Extended Single Harmonic w/doubler	Sngl harm LOx2 A-band	-28	245	390	317.5

Multiple Harmonics

These presets choose a setup that uses multiple harmonics and may or may not use doubling for the LO.

Key Path	Input/Output, External Mixer, Ext Mix Setup, Mixer Presets
Example	MIX:BAND MA
Initial S/W Revision	A.08.01

These are the presets for multiple harmonic operation:

Mixer	Readout in setup screen	Readback on softkeys	Range	Harm #	Dblr?	RF start	RF stop	RF Center
A-band	A-band Multiple Harmonic	Multi harm A-band	1	-4	N	26.5	34.1	30.3
			2	-4	Y	33.1	40	36.55
E-band	E-band Multiple Harmonic	Multi harm E-band	1	-6	Y	60	83	71.5
			2	-8	Y	65	90	77.5
U-band	U-band Multiple Harmonic	Multi harm U-band	1	-6	N	40	51.5	45.75
			2	-6	Y	49.5	60	54.75
Coaxial	Coaxial Multiple Harmonic	Multi harm Coaxial	1	-4	N	26.5	34	30.25
			2	-4	Y	32.5	55	43.75
			3	-6	Y	50	70	60

Mixer Bias

Adjusts an internal bias source for use with external mixers. The bias signal is present on the center conductor of the IF input connector on the front panel. The shunt current range is from –10 mA to 10 mA and it can be set whether Mixer Bias state is On or Off, but it will only be applied if it is On.

The bias remains as set if the user switches to another input (e.g., the RF Input).

Key Path	Input/Output, External Mixer, Ext Mix Setup
Remote Command	[:SENSe]:MIXer:BIAS <real> [:SENSe]:MIXer:BIAS? [:SENSe]:MIXer:BIAS:STATe OFF ON 0 1 [:SENSe]:MIXer:BIAS:STATe?
Example	:MIX:BIAS 0 :MIX:BIAS? MIX:BIAS:STAT 0 MIX:BIAS:STAT?
Preset	This is unaffected by Preset but is set to OFF and 0 on a "Restore Input/Output Defaults"
State Saved	Saved in instrument state
Min	-10 mA
Max	10 mA
Initial S/W Revision	A.08.01

Cable IF Loss

The loss at the IF in the IF/LO cable can be compensated for with this function, by entering the loss in dB for your cable.

The cable loss will depend on the IF frequency. The IF frequency varies depending on which IF path your measurement is using. For best accuracy, characterize your cable's loss for the IF frequency or frequencies you will be using.

IF Frequencies:

10 MHz path: 322.5 MHz

25 MHz path: 322.5 MHz

40 MHz path: 250 MHz

140 MHz path: 300 MHz

Key Path	Input/Output, External Mixer
Key Path	Input/Output, External Mixer, Calibrate Mixer
Remote Command	[:SENSe]:MIXer:CIFLoss <rel_amp1> [:SENSe]:MIXer:CIFLoss?

Example	:MIX:CIFL 0.23 DB :MIX:CIFL?
Preset	0.26 dB
State Saved	Saved in instrument state
Min	-100
Max	100
Initial S/W Revision	A.08.01

I/Q

This feature is not available unless the "[Baseband I/Q \(Option BBA\)](#)" on page 214 is installed.

Selects the front-panel I/Q input ports to be the analyzer signal input. If I/Q is already selected, pressing this key accesses the I/Q setup menu.

Key Path	Input/Output
Mode	BASIC, CDMA2K, EDGE GSM, TDSCDMA, VSA89601, WIMAX OFDMA, LTE, LTE TDD, LTE FDD, LTE ATDD, DCATV, DTMB (CTTB), DVB-T/H with T2, CMMB, ISDBT, WCDMA, VXA, CDMA1XEV
Example	FEED AIQ
Notes	Not all measurements support the use of the I/Q signal input. When I/Q is selected in a measurement that does not support it, the "No Result; Meas invalid with I/Q inputs" error condition message appears. This is error 135
Initial S/W Revision	Prior to A.02.00

Baseband I/Q (Option BBA)

The Baseband I/Q functionality is a hardware option. It is option BBA. If the option is not installed, none of the I/Q functionality is enabled.

The Baseband I/Q has four input ports and one output port. The input ports are I, I-bar, Q, and Q-bar. The I and I-bar together compose the I channel and the Q and Q-bar together compose the Q channel. Each channel has two modes of operation, Single-Ended (also called "unbalanced") and Differential Input (also called "balanced"). When in Single-Ended operation, only the main port (I or Q) is used and the complementary port (I-bar or Q-bar) is ignored. When in Differential Input mode, both main and complementary ports are used.

The input settings (range, attenuation, skew, impedance, external gain) apply to the channels, not the individual ports.

The system supports a variety of 1 M Ω input passive probes as well as the Agilent 113x Series active differential probes using the Infinimax probe interface.

The Agilent 113x Series active probes can be used for both single ended and differential measurements. In either case a single connection is made for each channel (on either the I or Q input). The input is

automatically configured to 50 Ω single ended and the probe power is supplied through the Infinimax interface. The probe can be configured for a variety of input coupling and low frequency rejection modes. In addition, a wide range of offset voltages and probe attenuation accessories are supported at the probe interface. The active probe has the advantage that it does not significantly load the circuit under test, even with unity gain probing.

With passive 1 M Ω probes, the probe will introduce a capacitive load on the circuit, unless higher attenuation is used at the probe interface. Higher attenuation reduces the signal level and degrades the signal-to-noise-ratio of the measurement. Passive probes are available with a variety of attenuation values for a moderate cost. Most Agilent passive probes can be automatically identified by the system, setting the input impedance setting required as well as the nominal attenuation. For single ended measurements a single probe is used for each channel. Other passive probes can be used, with the attenuation and impedance settings configured manually.

For full differential measurements, the system supports probes on each of the four inputs. The attenuation of the probes should be the same for good common mode rejection and channel match.

Both active and passive probes in single ended and differential configurations can be calibrated. This calibration uses the Cal Out BNC connection and a probe connection accessory. The calibration achieves excellent absolute gain flatness in a probed measurement. It matches both the gain and frequency response of the I and Q channels as well as any delay skew, resulting in high accuracy in derived measurements such as Error Vector Magnitude (EVM).

When a probe is connected a status message will be displayed. The message will indicate if calibration data is available or not. Calibration data is saved for each type of probe (including "none") for each port and will be reapplied whenever that type of probe is re-connected to the same port. For probes with EEPROM identification, the calibration data will be stored based on the unique probe identifier and will reapply data for that particular probe if it is available. The data will not follow a probe from one port to another. For probes without EEPROM identification, the instrument cannot distinguish between different probes of the same type and it will use the data from the last calibration for that probe type on that port.

When in differential mode, both the main and complementary probes are expected to be of the same type.

In some situations, the I and Q channels should be configured identically. In other situations it is convenient to control them independently. Some menus have a "Q Same as I" setting that will cause the Q channel configuration to mirror the I channel configuration, avoiding the overhead of double data entry when the channels should be the same.

The output port is for calibrating the I/Q input ports, although it can also be manually controlled.

There are two types of calibrations available: cable calibration and probe calibration. The cable calibration will guide the user through connecting each input port in turn. All ports must be calibrated together. The probe calibration is done for a specific channel (I or Q). If in Single-Ended mode, only the main port is calibrated. When in Differential Input mode, the user is guided through calibrating both main and complementary ports.

The front panel I/Q port LEDs indicate the current state of that port. On (green) indicates it is active, and off (dark) indicates it is not in use. For example, the Cal Out port LED is on if and only if there is signal coming out of that port.

The input is a context and some parameters have separate values for each context. The SCPI for these parameters has an optional "[:RF|IQ]" node. If the specific context is omitted, the command acts on the current input context's value. Here are the parameters that are input context sensitive:

- Center Frequency
- Trigger Source

It is important to distinguish between the I and Q input ports and the displayed I and Q data values. The I and Q input ports feed into a digital receiver that does digital tuning and filtering. The I and Q data seen by the user (either on the display or through SCPI) corresponds to the real ("I") and the imaginary ("Q") output from the digital receiver. When the input path is I+jQ or I Only and the center frequency is 0 Hz the I input ends up in as the real output from the receiver and appears as "I" data. Likewise, when the input path is I+jQ and the center frequency is 0 Hz, the Q input ends up as the imaginary output from the receiver and appears as "Q" data. However, when the input path is Q Only, the Q input is sent to the receiver as Q+j0, so the receiver output has the Q input coming out on the real output, and so in Q Only, the signal from the Q input port appears as the "I" data. Another situation where the I and Q data do not necessarily correspond directly to the I and Q inputs is when the center frequency is non-zero. The digital processing involved in the tuning is a complex operation. This will result in I Only data appearing as both "I" and "Q" data, the same as that signal would appear if seen through the RF input port.

Baseband I/Q Remote Language Compatibility

For the Agilent E4406A VSA Series Transmitter Tester, Option B7C provided baseband I/Q inputs. Code compatibility has been provided to allow many of the commands for option B7C to function properly with the X-Series. The X-Series has hardware differences and additional capabilities (e.g., E4406A does not have independent settings of I & Q nor does it provide for probe calibrations) which make 100% compatibility impossible.

1. The following commands are supported:

:CALibration:IQ:FLATness

:INPut:IMPedance:IQ U50|B50|U1M|B1M

:INPut:IMPedance:REFerence <integer>

2. The [:SENSe]:FEED RF|IQ|IONLy|QONLy|AREFerence|IFALign command supports all parameters except IFALign. The FEED? query will return only RF|AIQ|AREF.

3. The following commands are not supported:

:CALibration:GIQ

:CALibration:IQ:CMR

:INPut:IQ:ALIGn OFF|ON|0|1

The Rohde & Schwarz FSQ-B71 also provides baseband I/Q inputs. A certain amount of code compatibility is provided in the X-Series, however hardware differences make this a somewhat limited set.

Supported:

The "<1|2>" is supported as "[1]".

INPut<1|2>:IQ:BALanced[:STATe] ON | OFF

INPut<1|2>:IQ:TYPE I | Q | IQ

INPut<1|2>:IQ:IMPedance LOW | HIGH

Not Supported:

INPut<1|2>:SElect AIQ | RF

TRACe<1|2>:IQ:DATA:FORMat COMPatible | IQBLock | IQPair>

TRACe<1|2>:IQ:DATA:MEMory? <offset samples>,<# of samples>

TRACe<1|2>:IQ:DATA?

TRACe<1|2>:IQ:SET <filter type>,<rbw>,<sample rate>,<trigger source>,<trigger slope>,<pretrigger samples>,<# of samples>

TRACe<1|2>:IQ:SRATe 10.0kHz to 81.6MHz

TRACe<1|2>:IQ[:STATe] ON|OFF

The Rohde & Schwarz FMU has the following SCPI, which is not supported (these commands start/abort the probe calibration procedure, which is manually interactive from the front panel):

CALibration:ABORT

CALibration:PROBe[:START]

I/Q Path

Selects which I/Q input channels are active. The LED next to each I/Q input port will be on when that port is active.

The analysis bandwidth for each channel is the same as that of the instrument. For example, the base N9020A has a bandwidth of 10 MHz. With I/Q input the I and Q channels would each have an analysis bandwidth of 10 MHz, giving 20 MHz of bandwidth when the I/Q Path is I+jQ. With option B25, the available bandwidth becomes 25 MHz, giving 25 MHz each to I and Q and 50 MHz to I+jQ.

I/Q voltage to power conversion processing is dependent on the I/Q Path selected.

- With I+jQ input we know that the input signal may not be symmetrical about 0 Hz, because it has a complex component. Therefore, above 0 Hz only the positive frequency information is displayed, and below 0 Hz only the negative frequency information is displayed.
- With all other Input Path selections, the input signal has no complex component and therefore is always symmetrical about 0 Hz. In this case, by convention, the power conversion shows the combined voltage for both the positive and negative frequencies. The information displayed below 0 Hz is the mirror of the information displayed above 0 Hz. This results in a power reading 6.02 dB higher (for both) than would be seen with only the positive frequency voltage. Note also that, in this case the real signal may have complex modulation embedded in it, but that must be recovered by further signal processing.

Key Path	Input/Output, I/Q
Remote Command	[:SENSe] :FEED:IQ:TYPE IQ IONLy QONLy [:SENSe] :FEED:IQ:TYPE?
Example	Set the input to be both the I and Q channels, combined as I + j * Q. FEED:IQ:TYPE IQ
Preset	IQ
State Saved	Yes This is unaffected by a Preset but is set to the default value on a "Restore Input/Output Defaults" or

	"Restore System Defaults->All"
Range	I+jQ I Only Q Only
Readback Text	I+jQ I Only Q Only
Initial S/W Revision	Prior to A.02.00

Remote Command	:INPut [1] :IQ:TYPE IQ I Q :INPut [1] :IQ:TYPE?
Notes	For R&S FSQ-B71 compatibility
Preset	IQ
Initial S/W Revision	Prior to A.02.00

I+jQ

Sets the signal input to be both the I and Q channels. The I and Q channel data will be combined as $I + j * Q$.

Key Path	Input/Output, I/Q, I/Q Path
Example	Set the input to be both the I and Q channels, combined as $I + j * Q$. FEED:IQ:TYPE IQ
Initial S/W Revision	Prior to A.02.00

I Only

Sets the signal input to be only the I channel. The Q channel will be ignored. The data collected is still complex. When the center frequency is 0 the imaginary part will always be zero, but for any other center frequency both the real and imaginary parts will be significant.

Key Path	Input/Output, I/Q, I/Q Path
Example	Set the input to be only the I channel. FEED:IQ:TYPE IONL
Initial S/W Revision	Prior to A.02.00

Q Only

Sets the signal input to be only the Q channel. The I channel will be ignored. The Q channel will be sent to the digital receiver block as $Q+j0$. The receiver's output is still complex. When the center frequency is 0 the imaginary part will always be zero, but for any other center frequency both the real and imaginary parts will be significant. Note that since the receiver's real output is displayed as the "I" data, when the center frequency is 0, the Q Only input appears as the "I" data.

Key Path	Input/Output, I/Q, I/Q Path
Example	Set the input to be only the Q channel. FEED:IQ:TYPE QONL
Initial S/W Revision	Prior to A.02.00

I Setup

Access the channel setup parameters for the I channel.

Key Path	Input/Output, I/Q
Initial S/W Revision	Prior to A.02.00

I Differential Input

Selects differential input on or off for the I channel. For differential input (also called balanced input), the analyzer uses both main and complementary ports. When differential input is off (also called single-ended or unbalanced input), the analyzer uses only the main port.

Key Path	Input/Output, I/Q, I Setup
Remote Command	:INPut:IQ[:I]:DIFFerential OFF ON 0 1 :INPut:IQ[:I]:DIFFerential?
Example	Put the I channel in Differential Input mode INP:IQ:DIFF ON
Notes	When I Differential Input = On, the analyzer will check for attenuation mismatches between the I and I-bar ports. If the difference in attenuation values exceeds 0.5 dB a Settings Alert error condition, error 159 will be set. When I Differential Input = On, and IQ Path is I+jQ, the Q Differential input must also be On. Similarly, when I Differential Input = Off, and IQ Path is I+jQ, the Q Differential input must also be Off. If the states of the two inputs do not match, an error condition message is generated, 159;Settings Alert;I/Q mismatch:Differential.
Couplings	Some active probes include built-in differential capability. When one of these probes is sensed, this key is disabled. Since the differential capability is handled in the probe, the Analyzer will use only the main port and the key will show that the Analyzer's Differential Input mode is Off (indicating that the complementary port is not in use). When Q Same as I is On, the value set for I will also be copied to Q.
Preset	Off
State Saved	Yes This is unaffected by a Preset but is set to the default value on a "Restore Input/Output Defaults" or "Restore System Defaults->All"
Range	Off On
Initial S/W Revision	Prior to A.02.00

Remote Command	:INPut [1] :IQ:BAALanced [:STATe] OFF ON 0 1 :INPut [1] :IQ:BAALanced [:STATe] ?
Notes	For R&S FSQ-B71 compatibility, with no independent settings for the I and Q channels. Therefore, it is tied only to the I channel and does not provide an equivalent for the Q channel. For proper operation of the backwards compatibility command Q Same as I should be set to On.
Preset	OFF
Initial S/W Revision	Prior to A.02.00

I Input Z

Selects the input impedance for the I channel. The impedance applies to both the I and I-bar ports.

The input impedance controls the hardware signal path impedance match. It is not used for converting voltage to power. The voltage to power conversion always uses the Reference Z parameter. The Reference Z parameter applies to both I and Q channels.

Key Path	Input/Output, I/Q, I Setup
Remote Command	:INPut [1] :IQ[:I] :IMPedance LOW HIGH :INPut [1] :IQ[:I] :IMPedance?
Example	Set the I channel input impedance to 1 M Ω INP:IQ:IMP HIGH
Notes	LOW = 50 Ω , HIGH = 1 M Ω When IQ Path is I+jQ, the I Input Z setting must be the same as the Q Input Z setting. If the settings of the two inputs do not match, an error condition message is generated, 159;Settings Alert;I/Q mismatch:Input Z.
Couplings	Input impedance is a built-in characteristic of a probe. Therefore, whenever a probe is sensed, this key is disabled and the value is set to match the probe. When no probe is sensed on Q and Q Same as I is On, the value set for I will also be copied to Q.
Preset	LOW
State Saved	Yes This is unaffected by a Preset but is set to the default value on a "Restore Input/Output Defaults" or "Restore System Defaults->All"
Range	50 Ω 1 M Ω
Initial S/W Revision	Prior to A.02.00

I Skew

Sets the skew factor for the I channel. The skew will shift the channel's data in time. Use this to compensate for differences in the electrical lengths of the input paths due to cabling.

Key Path	Input/Output, I/Q, I Setup
Remote Command	[:SENSe]:CORRection:IQ[:I]:SKEW <seconds>

	<code>[:SENSe] :CORRection:IQ[:I]:SKEW?</code>
Example	Delay the data for the I channel by 10 ns. <code>CORR:IQ:SKEW 10 ns</code>
Preset	0
State Saved	Yes This is unaffected by Preset but is set to the default value on a "Restore Input/Output Defaults" or "Restore System Defaults->All"
Range	0 s to 100 ns
Min	0 s
Max	+100 ns
Initial S/W Revision	Prior to A.02.00

I Probe

Access the probe setup parameters for the I channel. See ["I/Q Probe Setup" on page 230](#).

Key Path	Input/Output, I/Q, I Setup
State Saved	No
Readback Text	[<I port probe id>] This is reporting the type of probe sensed on the I port. There is no parameter for overriding what is sensed.
Initial S/W Revision	Prior to A.02.00

Attenuation

The attenuation is part of the calibration data stored with the probe type and is initially the value that was returned by the last calibration. You can modify this value and any changes will be stored with the calibration data and will survive power cycles and presets. When a probe calibration is performed the attenuation value will be overwritten by the calibration.

Key Path	Input/Output, I/Q, I Setup Q Setup, I Probe Q Probe
Remote Command	<code>[:SENSe] :CORRection:IQ:I Q:ATTenuation:RATio <real></code> <code>[:SENSe] :CORRection:IQ:I Q:ATTenuation:RATio?</code>
Example	Set the attenuation for the current I probe to 100.00:1. <code>CORR:IQ:I:ATT:RAT 100</code>
Notes	Each probe type has its own attenuation setting. As probes are changed the attenuation value will reflect the new probe's setting. Changing the attenuation affects only the current probe type's setting and leaves all others unchanged. When the IQ Path is I+jQ, the Q probe attenuation setting must match the I Probe attenuation setting within 1 dB. If this is not the case, an error condition message is generated, 159;Settings Alert;I/Q mismatch:Attenuation.

Preset	Each probe type has its own default. The default for the "Unknown" probe type is 1:1.
State Saved	Saved with probe calibration data. It survives a power cycle and is not affected by a Preset or Restore.
Range	0.001 to 10000
Min	0.001
Max	10000
Initial S/W Revision	Prior to A.02.00

This is an alternate form of the SCPI that allows input as a power instead of a ratio.

Remote Command	<code>[[:SENSe]:CORRection:IQ:I Q:ATTenuation <rel_ampl></code> <code>[[:SENSe]:CORRection:IQ:I Q:ATTenuation?</code>
Example	Set the attenuation for the current I probe type to 100.00:1. CORR:IQ:I:ATT 20 dB
Range	-60 dB to +80 dB
Min	-60 dB
Max	+80 dB
Initial S/W Revision	Prior to A.02.00

Calibrate

Invokes the guided probe calibration. The guided probe calibration is context sensitive and depends on the channel (I or Q) and the Differential Input state. The calibration is only performed on the selected channel. When Differential Input is on, both the probe attached to the main port and the probe attached to the complementary port are calibrated. When Differential Input is off, only the probe attached to the main port is calibrated. See "[I/Q Guided Calibration](#)" on page 271.

Key Path	Input/Output, I/Q, I Setup Q Setup, I Probe Q Probe, Coupling
Readback Text	The last calibration date, or if no calibration exists, "(empty)". Last: <cal date> <cal time> Example: Last: 8/22/2007 1:02:49 PM
Initial S/W Revision	Prior to A.02.00

Clear Calibration

Clears the calibration data for the current port and probe. It does not clear the data for other probe types or other ports. If the sensed probe has EEPROM identification, only the data for that specific probe is

cleared. After this command has completed, the probe calibration state will be the same as if no probe calibration had ever been performed for the specified channel and probe. The probe attenuation will be the default value for that probe type and the Cable Calibration frequency response corrections will be used. This command is dependent on the Differential Input state. When Differential Input is on, both the data for the probe attached to the main port and the data for the probe attached to the complementary port are cleared. When Differential Input is off, only data for the probe attached to the main port is cleared.

Key Path	Input/Output, I/Q, I Setup Q Setup, I Probe Q Probe
Remote Command	:CALibration:IQ:PROBe:I Q:CLEar
Example	Clear the calibration data for the I channel and the current probe (with EEPROM identification) or probe type (without EEPROM identification). :CAL:IQ:PROBe:I:CLE
Initial S/W Revision	Prior to A.02.00

Combined Differential/Input Z (Remote Command Only)

This is Remote Command only (no front panel) and is for backwards compatibility only. It combines the Differential Input and Input Z selections into a single SCPI command.

Remote Command	:INPut:IMPedance:IQ U50 B50 U1M B1M :INPut:IMPedance:IQ?
Example	:INPut:IMPedance:IQ U50 This is equivalent to the following two SCPI commands: :INP:IQ:DIFF OFF :INP:IQ:IMP 50
Notes	Provided for E4406A code compatibility. The enum values translate as follows: U50: Differential Input = Off, Input Z = 50Ω B50: Differential Input = On, Input Z = 50Ω U1M: Differential Input = Off, Input Z = 1 MΩ B1M: Differential Input = On, Input Z = 1 MΩ This command is for backwards compatibility. It combines the Input Z (50Ω or 1 MΩ) parameter with the Differential Input (Off = "Unbalanced", On = "Balanced") parameter into a single enumeration. This backwards compatibility SCPI command was for an instrument without independent settings for the I and Q channels. Therefore, it is tied only to the I channel and does not provide an equivalent for the Q channel. For proper operation of the backwards compatibility command Q Same as I should be set to On. Also, note the subtle difference between this SCPI command and the backwards compatibility command for Input Z. The Input Z SCPI has "IQ" before "IMP" while this command has that order reversed.
Couplings	This command does not have an independent parameter, but instead is tied to the Differential Input and Input Z parameters. The coupling for those parameters apply to this command too.
Preset	U50
Initial S/W Revision	Prior to A.02.00

Q Setup

Access the channel setup parameters for the Q channel.

Key Path	Input/Output, I/Q
Readback Text	When Q Same as I is On the readback is "Q Same as I".
Initial S/W Revision	Prior to A.02.00

Q Same as I

Many, but not all, usages require the I and Q channels have an identical setup. To simplify channel setup, the Q Same as I will cause the Q channel parameters to be mirrored from the I channel. That way you only need to set up one channel (the I channel). The I channel values are copied to the Q channel, so at the time Q Same as I is turned off the I and Q channel setups will be identical. This does not apply to Probe settings or to parameters that are determined by the probe.

Key Path	Input/Output, I/Q, Q Setup
Remote Command	:INPut:IQ:MIRRored OFF ON 0 1 :INPut:IQ:MIRRored?
Example	Turn off the mirroring of parameters from I to Q. INP:IQ:MIRR OFF
Couplings	Only displayed for the Q channel. When Yes, the I channel values for some parameters are mirrored (copied) to the Q channel. However, when a parameter is determined by the type of probe and a probe is sensed, the probe setting is always used and the I channel setting is ignored. The following parameters are mirrored: Differential Input (when not determined by probe) Input Z (when not determined by probe)
Preset	This is unaffected by a Preset but is set to the default value (Q Same as I set to "On") on a "Restore Input/Output Defaults" or "Restore System Defaults->All"
State Saved	Saved in instrument state
Range	On Off
Readback Text	"Q Same as I" when On, otherwise none.
Initial S/W Revision	Prior to A.02.00

Q Differential Input

Selects differential input on or off for the Q channel. For differential input (also called balanced input), the analyzer uses both the Q and Q-bar ports. When differential input is off (also called single-ended or unbalanced input), the analyzer uses only the Q port.

Key Path	Input/Output, I/Q, Q Setup
----------	----------------------------

Remote Command	:INPut:IQ:Q:DIFFerential OFF ON 0 1 :INPut:IQ:Q:DIFFerential?
Example	Put the Q channel in Differential Input mode INP:IQ:Q:DIFF ON
Notes	When Differential Input = On, the analyzer will check for attenuation mismatches between the Q and Q-bar ports. If the difference in attenuation values exceeds 0.5 dB a Settings Alert error condition, error 159 will be set. When Q Differential Input = On, and IQ Path is I+jQ, the I Differential input must also be On. Similarly, when Q Differential Input = Off, and IQ Path is I+jQ, the I Differential input must also be Off. If the states of the two inputs do not match, an error condition message is generated, 159;Settings Alert;I/Q mismatch:Differential.
Couplings	Some active probes include built-in differential capability. When one of these probes is sensed, this key is disabled. Since the differential capability is handled in the probe, the Analyzer will use only the main port and the key will show that the Analyzer's Differential Input mode is Off (indicating that the complementary port not in use). When a differential probe is not sensed and Q Same as I is On, the value set for I will be copied to Q. This key is disabled when Q Same as I is On.
Preset	Off
State Saved	Yes This is unaffected by a Preset but is set to the default value on a "Restore Input/Output Defaults" or "Restore System Defaults->All"
Range	Off On
Initial S/W Revision	Prior to A.02.00

Q Input Z

Selects the input impedance for the Q channel. The impedance applies to both the Q and Q-bar ports.

The input impedance controls the hardware signal path impedance match. It is not used for converting voltage to power. The voltage to power conversion always uses the Reference Z parameter. The Reference Z parameter applies to both I and Q channels.

Key Path	Input/Output, I/Q, Q Setup
Remote Command	:INPut [1] :IQ:Q:IMPedance LOW HIGH :INPut [1] :IQ:Q:IMPedance?
Example	Set the Q channel input impedance to 1 M Ω INP:IQ:Q:IMP HIGH
Notes	LOW = 50 Ω , HIGH = 1 M Ω When IQ Path is I+jQ, the I Input Z setting must be the same as the Q Input Z setting. If the settings of the two inputs do not match, an error condition message is generated, 159;Settings Alert;I/Q mismatch:Input Z.
Couplings	Input impedance is a built-in characteristic of a probe. Therefore, whenever a probe is sensed, this key is disabled and the value is set to match the probe.

	When no probe is sensed and Q Same as I is On, the value set for I will also be copied to Q. This key is disabled when Q Same as I is On.
Preset	LOW
State Saved	Yes This is unaffected by Preset but is set to the default value on a "Restore Input/Output Defaults" or "Restore System Defaults->All"
Range	50 Ω 1 M Ω
Initial S/W Revision	Prior to A.02.00

Q Skew

Sets the skew factor for the Q channel. The skew will shift the channel's data in time. Use this to compensate for differences in the electrical lengths of the input paths due to cabling and probes.

Key Path	Input/Output, I/Q, Q Setup
Remote Command	[:SENSe] :CORRection:IQ:Q:SKEW <seconds> [:SENSe] :CORRection:IQ:Q:SKEW?
Example	Delay the data for the Q channel by 10 ns. CORR:IQ:Q:SKEW 10 ns
Preset	0
State Saved	Yes This is unaffected by a Preset but is set to the default value on a "Restore Input/Output Defaults" or "Restore System Defaults->All"
Range	0 s to 100 ns
Min	0 s
Max	+100 ns
Initial S/W Revision	Prior to A.02.00

Q Probe

Accesses the probe setup parameters for the Q channel. See "[I/Q Probe Setup](#)" on page 230.

Key Path	Input/Output, I/Q, Q Setup
State Saved	No
Readback Text	[<Q port probe id>] This is reporting the type of probe sensed on the Q port. There is no parameter for overriding what is sensed.
Initial S/W Revision	Prior to A.02.00

Attenuation

The attenuation is part of the calibration data stored with the probe type and is initially the value that was returned by the last calibration. You can modify this value and any changes will be stored with the calibration data and will survive power cycles and presets. When a probe calibration is performed the attenuation value will be overwritten by the calibration.

Key Path	Input/Output, I/Q, I Setup Q Setup, I Probe Q Probe
Remote Command	[:SENSe]:CORRection:IQ:I Q:ATTenuation:RATio <real> [:SENSe]:CORRection:IQ:I Q:ATTenuation:RATio?
Example	Set the attenuation for the current I probe to 100.00:1. CORR:IQ:I:ATT:RAT 100
Notes	Each probe type has its own attenuation setting. As probes are changed the attenuation value will reflect the new probe's setting. Changing the attenuation affects only the current probe type's setting and leaves all others unchanged. When the IQ Path is I+jQ, the Q probe attenuation setting must match the I Probe attenuation setting within 1 dB. If this is not the case, an error condition message is generated, 159;Settings Alert;I/Q mismatch:Attenuation.
Preset	Each probe type has its own default. The default for the "Unknown" probe type is 1:1.
State Saved	Saved with probe calibration data. It survives a power cycle and is not affected by a Preset or Restore.
Range	0.001 to 10000
Min	0.001
Max	10000
Initial S/W Revision	Prior to A.02.00

This is an alternate form of the SCPI that allows input as a power instead of a ratio.

Remote Command	[:SENSe]:CORRection:IQ:I Q:ATTenuation <rel_ampl> [:SENSe]:CORRection:IQ:I Q:ATTenuation?
Example	Set the attenuation for the current I probe type to 100.00:1. CORR:IQ:I:ATT 20 dB
Range	-60 dB to +80 dB
Min	-60 dB
Max	+80 dB
Initial S/W Revision	Prior to A.02.00

Calibrate

Invokes the guided probe calibration. The guided probe calibration is context sensitive and depends on the channel (I or Q) and the Differential Input state. The calibration is only performed on the selected channel. When Differential Input is on, both the probe attached to the main port and the probe attached to the

complementary port are calibrated. When Differential Input is off, only the probe attached to the main port is calibrated. See "[I/Q Guided Calibration](#)" on page 271.

Key Path	Input/Output, I/Q, I Setup Q Setup, I Probe Q Probe, Coupling
Readback Text	The last calibration date, or if no calibration exists, "(empty)". Last: <cal date> <cal time> Example: Last: 8/22/2007 1:02:49 PM
Initial S/W Revision	Prior to A.02.00

Clear Calibration

Clears the calibration data for the current port and probe. It does not clear the data for other probe types or other ports. If the sensed probe has EEPROM identification, only the data for that specific probe is cleared. After this command has completed, the probe calibration state will be the same as if no probe calibration had ever been performed for the specified channel and probe. The probe attenuation will be the default value for that probe type and the Cable Calibration frequency response corrections will be used. This command is dependent on the Differential Input state. When Differential Input is on, both the data for the probe attached to the main port and the data for the probe attached to the complementary port are cleared. When Differential Input is off, only data for the probe attached to the main port is cleared.

Key Path	Input/Output, I/Q, I Setup Q Setup, I Probe Q Probe
Remote Command	:CALibration:IQ:PROBe:I Q:CLEar
Example	Clear the calibration data for the I channel and the current probe (with EEPROM identification) or probe type (without EEPROM identification). :CAL:IQ:PROBe:I:CLE
Initial S/W Revision	Prior to A.02.00

Reference Z

Sets the value of the impedance to be used in converting voltage to power for the I and Q channels. This does not change the hardware's path impedance (see "[I Input Z](#)" on page 220).

Key Path	Input/Output, I/Q
Remote Command	:INPut:IMPedance:REFerence <integer> :INPut:IMPedance:REFerence?
Example	Set the I/Q reference impedance to 50 Ω INP:IMP:REF 50
Preset	50 Ω
State Saved	Yes

	This is unaffected by a Preset but is set to the default value on a "Restore Input/Output Defaults" or "Restore System Defaults->All"
Range	1 Ω to 1 M Ω
Min	1 Ω
Max	1 M Ω
Initial S/W Revision	Prior to A.02.00

I/Q Cable Calibrate...

The I/Q cable calibration creates correction data for each of the front panel I/Q ports. This calibration data is used whenever no probe specific calibration data is available. It is important that all ports are calibrated using the same short BNC cable so that the data is comparable from port to port.

The guided calibration (front panel only) will show connection diagrams and guide you through the isolation calibration and calibrating each port. The calibration data for each port is stored separately, so as soon as a port is calibrated that data is saved and will be used. If you press "Exit" to exit the calibration process, the data for the ports already completed will still be used. It is recommended that a calibration be completed once started, or if exited, that it be properly done before the next use of the I/Q ports. The "Next" button will perform the calibration for the current port and then proceed to the next step in the calibration procedure. The "Back" button will return to the prior port in the procedure. Both keys and dialog buttons are supplied for ease of use. The dialog buttons are for mouse use and the softkeys for front panel use.

The calibration can also be done via SCPI, but no connection diagrams will be shown. You will have to make the correct connections before issuing each port calibration command. Again, it is recommended that all ports be calibrated at the same time.

The instrument state remains as it was prior to entering the calibration procedure except while a port is actually being calibrated. Once a port is calibrated it returns to the prior state. A port calibration is in process only from the time the "Next" button is pressed until the next screen is shown. For SCPI, this corresponds to the time from issuing the CAL:IQ:FLAT:I|B|Q|QB command until the operation is complete.

For example, if the prior instrument state is Cal Out = Off, Input = I+jQ, and Differential = Off, then up until the time the "Next" button is pressed the I Input and Q Input LEDs are on and the Cal Out, I-bar Input and Q-bar Input LEDs are off. Once the "Next" button is pressed for the I port calibration, only the Cal Out and I Input LEDs will be on and the others will be off. When the screen progresses to the next step ("Next" button again enabled), the prior state is restored and only the I Input and Q Input LEDs are on (Cal Out is off again).

The last calibration date and time for each port will be displayed. Any calibrations that are more than a day older than the most recent calibration will be displayed with the color amber.

Key Path	Input/Output, I/Q
Initial S/W Revision	Prior to A.02.00

I/Q Probe Setup

The set of I/Q probe setup parameters will change based on the type of probe that is sensed. All probe types have the Attenuation parameter, and all probe types can be calibrated. The remaining parameters are only available for some probe types and will not be shown when not available. The probe type is determined by and reported for only for the I and Q ports, never the I-bar or Q-bar ports. The menu title will be "<ch>: <probe id>", where "<ch>" is either "I" or "Q" and "<probe id>" is the type of probe. For example, for the I Probe setup with an Agilent 1130A probe connected to the I port, the title will be "I: 1130A".

Probe calibration data is stored for each probe type for each channel. When no probe is sensed, the probe type "Unknown" is used, and this is also treated like a probe type with its own calibration data. When a probe is changed, the calibration data for that probe type for that port is restored. An advisory message will be displayed showing the new probe type and the calibration status. The calibration data is stored permanently (survives a power cycle) and is not affected by a Preset or any of the Restore commands. When the probe has EEPROM identification (most newer Agilent probes have this), the calibration data is stored by probe serial number and port, so if you have two probes of the same type, the correct calibration data will be used for each. For probes that do not have EEPROM identification, the calibration data is stored by probe type and port and the instrument cannot distinguish between different probes of the same type. In all cases (with or without EEPROM identification), the calibration data is port specific, so it will not follow a specific probe from port to port if the probe is moved.

The "Unknown" probe type is used whenever no probe is sensed. When no calibration data exists for "Unknown" the latest cable calibration data is used (see ["I/Q Guided Calibration " on page 271](#)).

Attenuation

The attenuation is part of the calibration data stored with the probe type and is initially the value that was returned by the last calibration. You can modify this value and any changes will be stored with the calibration data and will survive power cycles and presets. When a probe calibration is performed the attenuation value will be overwritten by the calibration.

Key Path	Input/Output, I/Q, I Setup Q Setup, I Probe Q Probe
Remote Command	[:SENSe] :CORRection:IQ:I Q:ATTenuation:RATio <real> [:SENSe] :CORRection:IQ:I Q:ATTenuation:RATio?
Example	Set the attenuation for the current I probe to 100.00:1. CORR:IQ:I:ATT:RAT 100
Notes	Each probe type has its own attenuation setting. As probes are changed the attenuation value will reflect the new probe's setting. Changing the attenuation affects only the current probe type's setting and leaves all others unchanged. When the IQ Path is I+jQ, the Q probe attenuation setting must match the I Probe attenuation setting within 1 dB. If this is not the case, an error condition message is generated, 159;Settings Alert;I/Q mismatch:Attenuation.
Preset	Each probe type has its own default. The default for the "Unknown" probe type is 1:1.
State Saved	Saved with probe calibration data. It survives a power cycle and is not affected by a Preset or Restore.
Range	0.001 to 10000
Min	0.001
Max	10000
Initial S/W Revision	Prior to A.02.00

This is an alternate form of the SCPI that allows input as a power instead of a ratio.

Remote Command	<code>[:SENSE] :CORREction:IQ:I Q:ATTenuation <rel_ampl></code> <code>[:SENSE] :CORREction:IQ:I Q:ATTenuation?</code>
Example	Set the attenuation for the current I probe type to 100.00:1. <code>CORR:IQ:I:ATT 20 dB</code>
Range	-60 dB to +80 dB
Min	-60 dB
Max	+80 dB
Initial S/W Revision	Prior to A.02.00

Offset

Some active probes have DC offset capability. When one of these probes is connected this control will be visible. The signal is adjusted for the DC offset before entering the analyzer's port. This allows for removal of a DC offset before reaching the analyzer's input port voltage limits. For example, a signal that varies 1 V peak-to-peak with a DC offset equal to the analyzer's max input voltage would exceed the input limits of the analyzer for half its cycle. Removing the DC offset allows the analyzer to correctly process the entire signal.

Key Path	Input/Output, I/Q, I Setup Q Setup, I Probe Q Probe
Remote Command	<code>:INPut:OFFSet:I Q <voltage></code> <code>:INPut:OFFSet:I Q?</code>
Example	Remove a DC offset of -0.5 V from the I channel input. <code>INP:OFFS:I -0.5</code>
Notes	Only some probe types support Offset. For those that do, each probe type has its own Offset setting. As probes are changed the Offset value will reflect the new probe's setting. Changing the Offset affects only the current probe type's setting and leaves all others unchanged.
Preset	0 V
State Saved	Saved with probe calibration data. It survives power cycle and is not affected by Preset or Restore.
Range	-18 V to +18 V
Min	-18 V
Max	+18 V
Initial S/W Revision	Prior to A.02.00

Coupling

Some probe types allow coupling to reject low frequencies. This will filter out the DC component of a signal that is composed of a DC bias plus some AC signal. This control is visible only for probe types that have this capability.

Key Path	Input/Output, I/Q, I Setup Q Setup, I Probe Q Probe
Remote Command	:INPut:COUPling:I Q DC LFR1 LFR2 :INPut:COUPling:I Q?
Example	Set the probe to low frequency rejection below 1.7 Hz. INP:COUP:I LFR1
Notes	Only some probe types support Coupling. For those that do, each probe type has its own Coupling setting. As probes are changed the Coupling value will reflect the new probe's setting. Changing the Coupling affects only the current probe type's setting and leaves all others unchanged.
Preset	DC
State Saved	Saved with probe calibration data. It survives a power cycle and is not affected by a Preset or Restore.
Range	DC AC 1.7 Hz LFR1 AC 0.14 Hz LFR2
Readback Text	DC LFR1 LFR2
Initial S/W Revision	Prior to A.02.00

DC

Turns off low frequency rejection, allowing signals down to DC.

Key Path	Input/Output, I/Q, I Setup Q Setup, I Probe Q Probe, Coupling
Example	Turn off low frequency rejection on the I channel INP:COUP:I DC
Initial S/W Revision	Prior to A.02.00

LFR1

Turns on low frequency rejection, rejecting signal component lower than 1.7 Hz.

Key Path	Input/Output, I/Q, I Setup Q Setup, I Probe Q Probe, Coupling
Example	Turn on low frequency rejection on the I channel for frequencies lower than 1.7 Hz INP:COUP:I LFR1
Initial S/W Revision	Prior to A.02.00

LFR2

Turns on low frequency rejection, rejecting signal component lower than 0.14 Hz.

Key Path	Input/Output, I/Q, I Setup Q Setup, I Probe Q Probe, Coupling
Example	Turn on low frequency rejection on the I channel for frequencies lower than 0.14 Hz INP:COUP:I LFR2
Initial S/W Revision	Prior to A.02.00

Calibrate

Invokes the guided probe calibration. The guided probe calibration is context sensitive and depends on the channel (I or Q) and the Differential Input state. The calibration is only performed on the selected channel. When Differential Input is on, both the probe attached to the main port and the probe attached to the complementary port are calibrated. When Differential Input is off, only the probe attached to the main port is calibrated. See "[I/Q Guided Calibration](#)" on page 271.

Key Path	Input/Output, I/Q, I Setup Q Setup, I Probe Q Probe, Coupling
Readback Text	The last calibration date, or if no calibration exists, "(empty)". Last: <cal date> <cal time> Example: Last: 8/22/2007 1:02:49 PM
Initial S/W Revision	Prior to A.02.00

Clear Calibration

Clears the calibration data for the current port and probe. It does not clear the data for other probe types or other ports. If the sensed probe has EEPROM identification, only the data for that specific probe is cleared. After this command has completed, the probe calibration state will be the same as if no probe calibration had ever been performed for the specified channel and probe. The probe attenuation will be the default value for that probe type and the Cable Calibration frequency response corrections will be used. This command is dependent on the Differential Input state. When Differential Input is on, both the data for the probe attached to the main port and the data for the probe attached to the complementary port are cleared. When Differential Input is off, only data for the probe attached to the main port is cleared.

Key Path	Input/Output, I/Q, I Setup Q Setup, I Probe Q Probe
Remote Command	:CALibration:IQ:PROBe:I Q:CLEAr
Example	Clear the calibration data for the I channel and the current probe (with EEPROM identification) or probe type (without EEPROM identification). :CAL:IQ:PROBe:I:CLE
Initial S/W Revision	Prior to A.02.00

RF Calibrator

Lets you choose a calibrator signal to look at or turns the calibrator "off".

Key Path	Input/Output
Remote Command	[:SENSe] :FEED:AREFERENCE REF50 REF4800 OFF [:SENSe] :FEED:AREFERENCE?

Example	FEED:AREF REF50 selects the 50 MHz amplitude reference as the signal input. FEED:AREF REF4800 selects the 4.8 GHz amplitude reference as the signal input FEED:AREF OFF turns the calibrator "off" (switches back to the selected input – RF or I/Q)
Dependencies	Selecting an input (RF or I/Q) turns the Calibrator OFF. This is true whether the input is selected by the keys or with the [:SENSe]:FEED command. The 4.8 GHz internal reference is only available in some models and frequency range options. If the 4.8 GHz reference is not present, the 4.8 GHz softkey will be blanked, and if the REF4800 parameter is sent, the analyzer will generate an error.
Couplings	When one of the calibrator signals is selected, the analyzer routes that signal (an internal amplitude reference) to the analyzer, and changes the main input selection to RF so the calibrator signal can be seen. When you turn the calibrator off it does not switch back to the previously selected input.
Preset	OFF
State Saved	Saved in instrument state
Readback	Off, 50 MHz, 4.8 GHz
Initial S/W Revision	Prior to A.02.00

Remote Command	:CALibration:SOURce:STATe OFF ON 0 1 :CALibration:SOURce:STATe?
Notes	For ESA backwards compatibility. In the ESA the calibrator was a separate output which you connected to the input and switched on with this command. In the X-Series, the ON parameter is aliased to the [:SENSe]:FEED:AREF REF50 command and the OFF parameter is aliased to [:SENSe]:FEED:AREF OFF. When CALibration:SOURce:STATe? is received, 1 will be returned if any of the references is selected and 0 if the Calibrator is "Off"
Preset	OFF
Initial S/W Revision	Prior to A.02.00

50 MHz

Selects the 50 MHz internal reference as the input signal.

Key Path	Input/Output, RF Calibrator
Example	:FEED:AREF REF50
Readback	50 MHz
Initial S/W Revision	Prior to A.02.00

4.8 GHz

Selects the 4.8 GHz internal reference as the input signal.

Key Path	Input/Output, RF Calibrator
Example	:FEED:AREF REF4800
Dependencies	The 4.8 GHz internal reference is only available in some models and frequency range options. If the 4.8 GHz reference is not present, the 4.8 GHz softkey will be blanked, and if the REF4800 parameter is sent, the analyzer will generate an error.
Readback	4.8 GHz
Initial S/W Revision	Prior to A.02.00
Modified at S/W Revision	A.03.00

Off

Switches the input back to the selected input (RF or I/Q)

Key Path	Input/Output, RF Calibrator
Example	:FEED:AREF OFF
Readback	Off
Initial S/W Revision	Prior to A.02.00

External Gain

Compensates for gain or loss in the measurement system outside the spectrum analyzer. The External Gain is subtracted from the amplitude readout (or the loss is added to the amplitude readout). So, the displayed signal level represents the signal level at the output of the device-under-test, which can be the input of an external device that provides gain or loss.

Entering an External Gain value does not affect the Reference Level, therefore the trace position on screen changes, as do all of the values represented by the trace data. Thus, the values of exported trace data, queried trace data, marker amplitudes, trace data used in calculations such as N dB points, trace math, peak threshold, etc., are all affected by External Gain. Changing the External Gain, even on a trace that is not updating, will immediately change all of the above, without new data needing to be taken.

NOTE

Changing the External Gain causes the analyzer to immediately stop the current sweep and prepare to begin a new sweep. The data will not change until the trace data updates because the offset is applied to the data as it is taken. If a trace is exported with a nonzero External Gain, the exported data will contain the trace data with the offset applied.

In the Spectrum Analyzer mode, a Preamp is the common external device providing gain or loss. In a measurement application mode like GSM or W-CDMA, the gain or loss could be from a BTS (Base Transceiver Station) or an MS (Mobile Station). So in the Spectrum Analyzer mode MS and BTS would be

grayed out and the only choice would be Ext Preamp. Similarly in some of the digital communications applications, Ext Preamp will be grayed out and you would have a choice of MS or BTS.

Key Path	Input/Output
Couplings	The Ext Preamp, MS, and BS keys may be grayed out depending on which measurement is currently selected. If any of the grayed out keys are pressed, or the equivalent SCPI command is sent, an advisory message is generated.
Readback	1-of-N selection [variable]
Initial S/W Revision	Prior to A.02.00

Ext Preamp

This function is similar to the reference level offset function. Both affect the displayed signal level. Ref Lvl Offset is a mathematical offset only, no analyzer configuration is affected. Ext Preamp gain is used when determining the auto-coupled value of the Attenuator. The External Gain value and the Maximum Mixer Level settings are both part of the automatic setting equation for the RF attenuation setting. (10 dB of Attenuation is added for every 10 dB of External Gain.)

Note that the Ref Lvl Offset and Maximum Mixer Level are described in the Amplitude section. They are reset by the instrument Preset. The External Preamp Gain is reset by the "Restore Input/Output Defaults" or "Restore System Defaults->All functions. . The External Gain is subtracted from the amplitude readout so that the displayed signal level represents the signal level at the output of the device-under-test, which is the input of the external device that is providing gain or loss.

["More Information" on page 237](#)

Key Path	Input/Output, External Gain
Remote Command	<code>[[:SENSE]:CORRection:SA[:RF]:GAIN <rel_ampl></code> <code>[[:SENSE]:CORRection:SA[:RF]:GAIN?</code>
Example	CORR:SA:GAIN 10 sets the Ext Gain value to 10 dB CORR:SA:GAIN -10 sets the Ext Gain value to -10 dB (that is, an attenuation of 10 dB)
Notes	Does not auto return.
Dependencies	The reference level limits are determined in part by the External Gain/Atten, Max Mixer Level, and RF Atten. This key is grayed out in Modes that do not support External Gain
Preset	This is unaffected by Preset but is set to 0 dB on a "Restore Input/Output Defaults" or "Restore System Defaults->All"
State Saved	Saved in instrument state
Min	-120 dB
Max	120 dB
Readback	Preamp Gain, <Ext Gain value> dB
Backwards Compatibility SCPI	<code>[[:SENSE]:CORRection:OFFSet[:MAGNitude]</code> The legacy "Ext Preamp Gain" key is now called "Ext Gain" and the sub-menu has choices of Ext

	Preamp MS BTS for backwards compatibility.
Initial S/W Revision	Prior to A.02.00
Modified at S/W Revision	A.14.00

More Information

The U7227A USB Preamplifier is an accessory for the X-Series Signal Analyzer that provides gain externally, and whose gain settings are automatically loaded into the analyzer over USB whenever it is connected to one of the analyzer's USB ports.

While the USB Preamplifier is plugged into one of the analyzer's USB ports, the analyzer will consider it to be in the signal path of the RF Input and will apply the calibration data from the USB Preamp to measurements taken at the RF Input (on 2 input boxes, it will be considered to be in the signal path of RF Input 1; it is not supported for RF Input 2).

The USB Preamplifier contains its own cal data. This includes a noise trace suitable for use with NFE, for those models which support NFE. The act of connecting the Preamp to USB will cause the cal data to be downloaded from the preamp. When this happens an informational message is provided saying "Cal data loaded from USB Preamp". The analyzer will then automatically apply the calibration factors loaded from the Preamp in any measurement that supports the USB Preamp.

The External Preamp Gain setting may still be used, even though it is not required for the USB Preamp (since the USB Preamp supplies its own gain data to the analyzer which is applied automatically). Connecting the USB Preamp does not change the External Preamp Gain setting, however unless you have another gain or attenuation element in the signal path, the appropriate setting for External Preamp Gain is 0 dB.

Overload detection and reporting will apply when the USB preamplifier is connected to USB. The USB Preamplifier has its own overload detector which reports overloads to the instrument over USB. This generates an error condition, "Input Overload;USB Preamp."

If, while the USB Preamp is connected to USB, a measurement is selected that does not support the USB preamplifier, the "No result; Meas invalid with Preamp" error condition is generated.

MS

Sets an external gain/attenuation value for MS (Mobile Station) tests.

Key Path	Input/Output, External Gain
Remote Command	<code>[:SENSe] :CORRection:MS[:RF]:GAIN <rel_amp1></code> <code>[:SENSe] :CORRection:MS[:RF]:GAIN?</code>
Example	<code>CORR:MS:GAIN 10</code> sets the Ext Gain value to 10 dB <code>CORR:MS:GAIN -10</code> sets the Ext Gain value to -10 dB (that is, a loss of 10 dB.)
Notes	Does not auto return.
Dependencies	The reference level limits are determined in part by the External Gain, Max Mixer Level, RF Atten This key is grayed out in modes that do not support MS.
Preset	This is unaffected by a Preset but is set to 0 dB on a "Restore Input/Output Defaults" or "Restore

	System Defaults->All"
State Saved	Saved in instrument state.
Min	-100 dB
Max	100 dB
Readback	MS, <Ext Gain value> dB
Initial S/W Revision	Prior to A.02.00

Remote Command	<code>[:SENSe] :CORRection:MS[:RF]:LOSS <rel_ampl></code> <code>[:SENSe] :CORRection:MS[:RF]:LOSS?</code>
Example	<code>CORR:MS:LOSS 10</code> sets the Ext Gain value to -10 dB, and subsequently querying <code>:LOSS</code> will give 10 dB <code>CORR:MS:LOSS -10</code> sets the Ext Gain value to 10 dB, and subsequently querying <code>:LOSS</code> will give -10 dB
Notes	A positive value of <rel_ampl> in the above command means a loss and a negative value indicates a gain. Anytime <code>:LOSS</code> is set it sets <code>:GAIN</code> to the negative value of the parameter sent. Anytime <code>:LOSS</code> is queried it gives the negative of <code>:GAIN</code>
Preset	This is unaffected by a Preset but is set to 0 dB on a "Restore Input/Output Defaults" or "Restore System Defaults->All"
Min	100 dB
Max	-100 dB
Initial S/W Revision	Prior to A.02.00

BTS

Sets an external attenuation value for BTS (Base Transceiver Station) tests.

Key Path	Input/Output, External Gain
Remote Command	<code>[:SENSe] :CORRection:BTS[:RF]:GAIN <rel_ampl></code> <code>[:SENSe] :CORRection:BTS[:RF]:GAIN?</code>
Example	<code>CORR:BTS:GAIN 10</code> sets the Ext Gain value to 10 dB <code>CORR:BTS:GAIN -10</code> sets the Ext Gain value to -10 dB (that is, a loss of 10 dB.)
Notes	Does not auto return.
Dependencies	The reference level limits are determined in part by the External Gain, Max Mixer Level, RF Atten This key is grayed out in modes that do not support BTS.
Preset	This is unaffected by a Preset but is set to 0 dB on a "Restore Input/Output Defaults" or "Restore System Defaults->All"

State Saved	Saved in instrument state.
Min	-100 dB
Max	100 dB
Readback	BTS, <Ext Gain value> dB
Initial S/W Revision	Prior to A.02.00
<hr/>	
Remote Command	<code>[:SENSe] :CORRection:BTS[:RF]:LOSS <rel_ampl></code> <code>[:SENSe] :CORRection:BTS[:RF]:LOSS?</code>
Example	<code>CORR:BTS:LOSS 10</code> sets the Ext Gain value to -10 dB, and subsequently querying <code>:LOSS</code> will give 10 dB <code>CORR:BTS:LOSS -10</code> sets the Ext Gain value to 10 dB, and subsequently querying <code>:LOSS</code> will give -10 dB
Notes	A positive value of <rel_ampl> in the above command means a loss and a negative value indicates a gain. Anytime <code>:LOSS</code> is set it sets <code>:GAIN</code> to the negative value of the parameter sent. Anytime <code>:LOSS</code> is queried it gives the negative of <code>:GAIN</code>
Preset	This is unaffected by a Preset but is set to 0 dB on a "Restore Input/Output Defaults" or "Restore System Defaults->All"
Min	100 dB
Max	-100 dB
Initial S/W Revision	Prior to A.02.00

I Ext Gain

This function affects the I channel input. However, when Q Gain in I+jQ is set to Same as I Gain, this value is applied to both I and Q channel inputs.

Key Path	Input/Output, External Gain
Remote Command	<code>[:SENSe] :CORRection:IQ:I:GAIN <rel_ampl></code> <code>[:SENSe] :CORRection:IQ:I:GAIN?</code>
Example	Set the I Ext Gain to 10 dB <code>CORR:IQ:I:GAIN 10</code> Set the I Ext Gain to -10 dB (that is, a loss of 10 dB.) <code>CORR:IQ:I:GAIN -10</code>
Dependencies	Not available unless option BBA is installed
Preset	0 dB This is unaffected by a Preset but is set to 0 dB on a "Restore Input/Output Defaults" or "Restore System Defaults->All"

State Saved	Saved in instrument state.
Min	-100 dB
Max	100 dB
Readback Text	I Gain, <I Ext Gain> dB
Initial S/W Revision	Prior to A.02.00

Q Ext Gain

This function affects the Q channel input.

Key Path	Input/Output, External Gain
Remote Command	[:SENSe] :CORRection:IQ:Q:GAIN <rel_ampl> [:SENSe] :CORRection:IQ:Q:GAIN?
Example	Set the Q Ext Gain to 10 dB CORR:IQ:Q:GAIN 10 Set the Q Ext Gain to -10 dB (that is, a loss of 10 dB.) CORR:IQ:Q:GAIN -10
Dependencies	Not available unless option BBA is installed.
Preset	0 dB This is unaffected by a Preset but is set to 0 dB on a "Restore Input/Output Defaults" or "Restore System Defaults->All"
State Saved	Saved in instrument state
Min	-100 dB
Max	100 dB
Readback Text	Q Gain, <I Ext Gain> dB
Initial S/W Revision	Prior to A.02.00

Restore Input/Output Defaults

This selection causes the group of settings and data associated with the Input/Output key to be a reset to their default values. In addition, when a Source is installed, licensed and selected, Restore Input/Output defaults will initiate a Source Preset.

This level of Restore System Defaults does not affect any other system settings or mode settings and does not cause a mode switch. All the features described in this section are reset using this key, including Input Corrections and Data (described in the Corrections section).

Key Path	Input/Output
Example	:SYST:DEF INP presets all the Input/Output variables to their factory default values.

Notes	Refer to the Utility Functions for information about Restore System Defaults and the complete description of the :SYSTem:DEFAult INPut: command.
Initial S/W Revision	Prior to A.02.00

Corrections

This key accesses the Amplitude Corrections menu.

Amplitude Corrections arrays can be entered, sent over SCPI, or loaded from a file. They allow you to correct the response of the analyzer for various use cases. The X-series supports four separate Corrections arrays, each of which can contain up to 2000 points. They can be turned on and off individually and any or all can be on at the same time.

Trace data is in absolute units and corrections data is in relative units, but we want to be able to display trace data at the same time as corrections data. Therefore we establish a reference line to be used while building or editing a Corrections table. The reference line is halfway up the display and represents 0 dB of correction. It is labeled "0 dB CORREC". It is drawn in blue.

Corrections data is always in dB. Whatever dB value appears in the correction table represents the correction applied to that trace at that frequency. So if a table entry shows 30 dB that means we ADD 30 dB to each trace to correct it before displaying it.

In zero span, where the frequency is always the center frequency of the analyzer, we apply the (interpolated) correction for the center frequency to all points in the trace. In the event where there are two correction amplitudes at the center frequency, we apply the first one in the table.

Note that the corrections are applied as the data is taken; therefore, a trace in View (Update Off) will not be affected by changes made to the corrections table after the trace is put in View.

Key Path	Input/Output, Corrections
Mode	SA, I/Q Analyzer, Phase Noise, VXA, RTSA, EMI Receiver, DVB-T/H, DTMB, DVB-T/H, DTMB, W-CDMA, LTE & LTE-Adv FDD, LTE & LTE-Adv TDD, Sequence Analyzer, BTooth
Dependencies	This key will only appear if you have the proper option installed in your instrument. Amplitude correction may not be available in all modes; if a mode does not support amplitude correction, the Corrections key should be blanked while in that mode. If an application supports corrections but the current measurement does not, then the key should be grayed out in that measurement
Preset	Corrections arrays are reset (deleted) by Restore Input/Output Defaults. They survive shutdown and restarting of the analyzer application, which means they will survive a power cycle.
Initial S/W Revision	A.02.00
Modified at S/W Revision	x.14.50

Select Correction

Specifies the selected correction. The term "selected correction" is used throughout this document to specify which correction will be affected by the functions.

Key Path	Input/Output, Corrections
Mode	SA, I/Q Analyzer, Phase Noise, VXA, RTSA, EMI Receiver, DVB-T/H, DTMB, DVB-T/H, DTMB, W-CDMA, LTE & LTE-Adv FDD, LTE & LTE-Adv TDD, Sequence Analyzer, BTooth
Notes	The selected correction is remembered even when not in the correction menu.
Preset	Set to Correction 1 by Restore Input/Output Defaults
Readback	Correction 1 Correction 2 Correction 3 Correction 4 Correction 5 Correction 6 Correction 7 Correction 8
Initial S/W Revision	A.02.00
Modified at S/W Revision	x.14.50

Correction On/Off

Turning the Selected Correction from the OFF state to the ON state allows the values in it to be applied to the data. This state transition also automatically turns on "Apply Corrections" (sets it to ON), otherwise the correction would not take effect.

A new sweep is initiated if an amplitude correction is switched on or off. Note that changing, sending or loading corrections data does NOT directly initiate a sweep, however in general these operations will turn corrections on, which DOES initiate a sweep.

Key Path	Input/Output, Corrections
Remote Command	[[:SENSe]:CORRection:CSET[1] 2 ... 8[:STATe] ON OFF 1 0 [:SENSe]:CORRection:CSET[1] 2 ... 8[:STATe]?
Example	SENS:CORR:CSET1 ON
Dependencies	Changing this from the OFF state to the ON state automatically turns on "Apply Corrections". Only the first correction array (Correction 1) supports antenna units. When this array is turned on, and it contains an Antenna Unit other than "None", the Y Axis Unit of the analyzer is forced to that Antenna Unit. All other Y Axis Unit choices are grayed out. Note that this means that a correction file with an Antenna Unit can only be loaded into the Corrections 1 register. Consequently only for Correction 1 does the dropdown in the Recall dialog include.ant, and if an attempt is made to load a correction file into any other Correction register which DOES contain an antenna unit, a Mass Storage error is generated. This command will generate an "Option not available" error unless you have the proper option installed in your instrument.
Preset	Not affected by a Preset. Set to OFF by Restore Input/Output Defaults
State Saved	Saved in instrument state.
Backwards Compatibility Notes	Unlike legacy analyzers, Preset does not turn Corrections off (Restore Input/Output Defaults does).
Initial S/W Revision	A.02.00
Modified at S/W Revision	A.14.00

Properties

Accesses a menu that lets you set the properties of the selected correction.

Key Path	Input/Output, Corrections
Initial S/W Revision	A.02.00

Select Correction

Specifies the selected correction. The term "selected correction" is used throughout this document to specify which correction will be affected by the functions.

Key Path	Input/Output, Corrections
Mode	SA, I/Q Analyzer, Phase Noise, VXA, RTSA, EMI Receiver, DVB-T/H, DTMB, DVB-T/H, DTMB, W-CDMA, LTE & LTE-Adv FDD, LTE & LTE-Adv TDD, Sequence Analyzer, BTooth
Notes	The selected correction is remembered even when not in the correction menu.
Preset	Set to Correction 1 by Restore Input/Output Defaults
Readback	Correction 1 Correction 2 Correction 3 Correction 4 Correction 5 Correction 6 Correction7 Correction8
Initial S/W Revision	A.02.00
Modified at S/W Revision	x.14.50

Antenna Unit

For devices (like antennas) that make measurements of field strength or flux density, the correction array should contain within its values the appropriate conversion factors such that, when the data on the analyzer is presented in dBμV, the display is calibrated in the appropriate units. The "Antenna Unit" used for the conversion is contained within the corrections array database. It may be specified or loaded in from an external file or SCPI.

When an array with an Antenna Unit other than "None" is turned on, the Y Axis Unit of the analyzer is forced to that unit. When this array is turned on, and it contains an Antenna Unit other than "None", the Y Axis Unit of the analyzer is forced to that Antenna Unit., and all other Y Axis Unit choices are grayed out.

Antenna Unit does not appear in all Modes that support Corrections. Only the modes listed in the Mode row of the table below support Antenna Units.

Key Path	Input/Output, Corrections, Properties
Mode	SA, I/Q Analyzer, Phase Noise, VXA, RTSA, EMI Receiver, DVB-T/H, DTMB, DVB-T/H, DTMB, W-CDMA, LTE & LTE-Adv FDD, LTE & LTE-Adv TDD, Sequence Analyzer, BTooth
Remote Command	[:SENSe]:CORRection:CSET[1]:ANTenna[:UNIT] GAUSS PTESla UVM UAM UA NOConversion [:SENSe]:CORRection:CSET[1]:ANTenna[:UNIT]?

Example	CORR:CSET:ANT GAUS
Dependencies	Only the first correction array (Correction 1) supports antenna units. Note that this means that a correction file with an Antenna Unit can only be loaded into the Corrections 1 register. Consequently only for Correction 1 does the dropdown in the Recall dialog include.ant, and if an attempt is made to load a correction file into any other Correction register which DOES contain an antenna unit, a Mass Storage error is generated.
Preset	Unaffected by Preset. Set to NOC by Restore Input/Output Defaults
State Saved	Saved in instrument state
Initial S/W Revision	A.02.00
Modified at S/W Revision	x.14.50

None

Selects no antenna unit for this Correction set. Thus no Y Axis unit will be forced.

Key Path	Input/Output, Corrections, Properties, Antenna Unit
Example	:CORR:CSET:ANT NOC
Readback	"None"
Initial S/W Revision	A.02.00

dB μ V/m

Sets the antenna unit to dB μ V/m. If this correction is turned on, and Apply Corrections is on, the Y Axis Unit will then be forced to dB μ V/m and all other Y Axis Unit selections will be grayed out.

Key Path	Input/Output, Corrections, Properties, Antenna Unit
Example	:CORR:CSET:ANT UVM
Readback	"dB μ V/m"
Initial S/W Revision	A.02.00

dB μ A/m

Sets the antenna unit to dB μ A/m. If this correction is turned on, and Apply Corrections is on, the Y Axis Unit will then be forced to dB μ A/m and all other Y Axis Unit selections will be grayed out.

Key Path	Input/Output, Corrections, Properties, Antenna Unit
Example	:CORR:CSET:ANT UVA
Readback	" dB μ A/m"
Initial S/W Revision	A.02.00

dBpT

Sets the antenna unit to dBpT. If this correction is turned on, and Apply Corrections is on, the Y Axis Unit will then be forced to dBpT and all other Y Axis Unit selections will be grayed out.

Key Path	Input/Output, Corrections, Properties, Antenna Unit
Example	:CORR:CSET:ANT PTES
Readback	"dBpT"
Initial S/W Revision	A.02.00

DBG

Sets the antenna unit to DBG. If this correction is turned on, and Apply Corrections is on, the Y Axis Unit will then be forced to DBG and all other Y Axis Unit selections will be grayed out.

Key Path	Input/Output, Corrections, Properties, Antenna Unit
Example	:CORR:CSET:ANT GAUS
Readback	" DBG"
Initial S/W Revision	A.02.00

dBμA

Sets the antenna unit to dBμA. If this correction is turned on, and Apply Corrections is on, the Y Axis Unit will then be forced to dBμA and all other Y Axis Unit selections will be grayed out.

Key Path	Input/Output, Corrections, Properties, Antenna Unit
Example	:CORR:CSET:ANT UA
Readback	" dBμA"
Initial S/W Revision	A.11.00

Frequency Interpolation

This setting controls how the correction values per-bucket are calculated. We interpolate between frequencies in either the logarithmic or linear scale.

This setting is handled and stored individually per correction set.

See ["Interpolation" on page 246](#)

Key Path	Input/Output, Corrections, Properties
Remote Command	[:SENSE] :CORRection:CSET[1] 2 ... 8:X:SPACing LINear LOGarithmic [:SENSe] :CORRection:CSET[1] 2 ... 8:X:SPACing?
Example	CORR:CSET:X:SPAC LIN

Preset	Unaffected by a Preset. Set to Linear by Restore Input/Output Defaults.
State Saved	Saved in instrument state.
Initial S/W Revision	A.02.00
Modified at S/W Revision	A.14.00

Interpolation

For each bucket processed by the application, all of the correction factors at the frequency of interest (center frequency of each bucket) are summed and added to the amplitude. All trace operations and post processing treat this post-summation value as the true signal to use.

To effect this correction, the goal, for any particular start and stop frequency, is to build a correction trace, whose number of points matches the current Sweep Points setting of the instrument, which will be used to apply corrections on a bucket by bucket basis to the data traces.

For amplitudes that lie between two user specified frequency points, we interpolate to determine the amplitude value. You may select either linear or logarithmic interpolation between the frequencies.

If we interpolate on a log scale, we assume that the line between the two points is a straight line on the log scale. For example, let's say the two points are (2,4) and (20,1). A straight line between them on a log scale looks like:

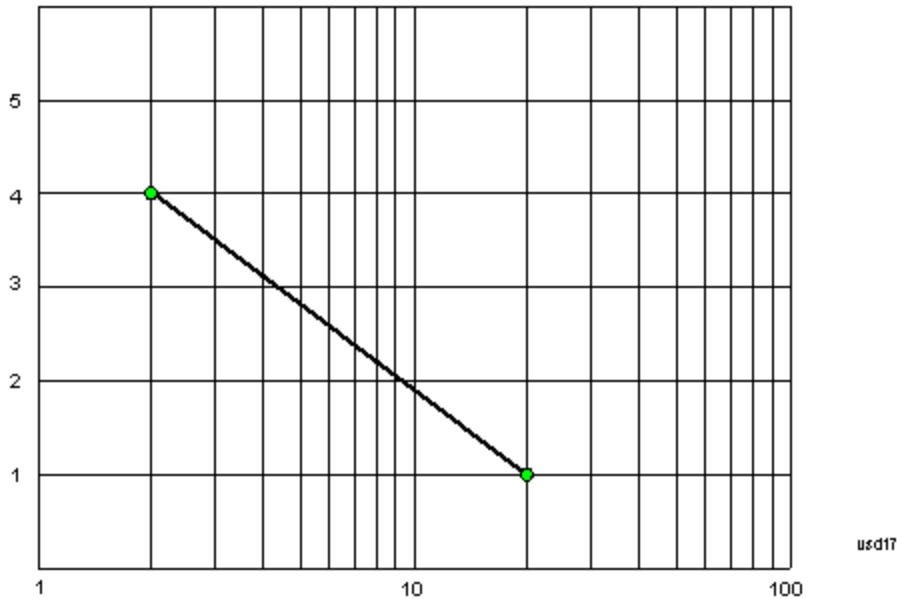

On a linear scale (like that of the spectrum analyzer), this translates to:



If we interpolate on a linear scale, we assume that the two points are connected by a straight line on the linear scale, as below:

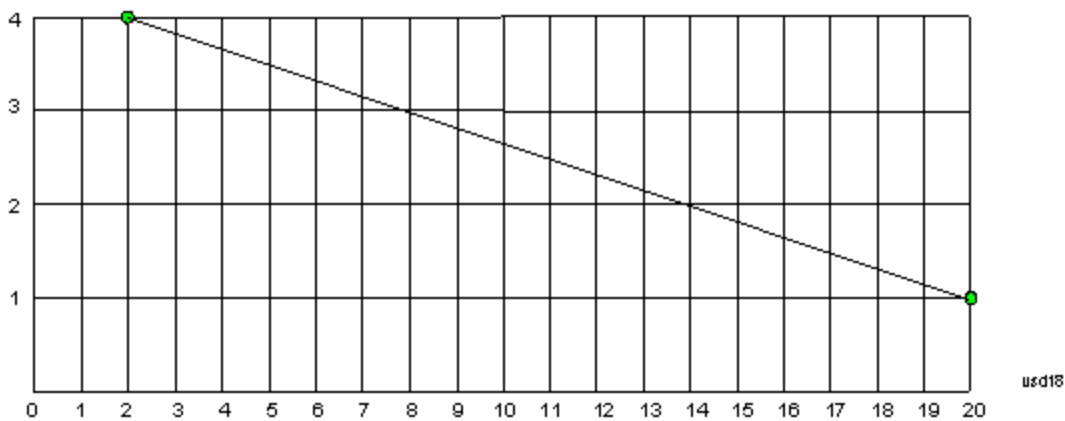

The correction to be used for each bucket is taken from the interpolated correction curve at the center of the bucket.

Description

Sets an ASCII description field which will be stored in an exported file. Can be displayed in the active function area by selecting as the active function, if desired to appear in a screen capture.

Key Path	Input/Output, Corrections, Properties
Remote Command	<code>[:SENSe]:CORRection:CSET[1] 2 ... 8:DESCription "text"</code> <code>[:SENSe]:CORRection:CSET[1] 2 ... 8:DESCription?</code>
Example	<code>:CORR:CSET1:DESC "11941A Antenna correction"</code>
Notes	45 chars max; may not fit on display if max chars used
Preset	Unaffected by a Preset. Set to empty by Restore Input/Output Defaults
State Saved	Saved in instrument state.
Initial S/W Revision	A.02.00
Modified at S/W Revision	A.14.00

Comment

Sets an ASCII comment field which will be stored in an exported file. Can be displayed in the active function area by selecting as the active function, if desired to appear in a screen capture.

Key Path	Input/Output, Corrections, Properties
Remote Command	<code>[[:SENSe]:CORRection:CSET[1] 2 ... 8:COMMeNt "text"</code> <code>[[:SENSe]:CORRection:CSET[1] 2 ... 8:COMMeNt?</code>
Example	<code>:CORR:CSET1:COMM "this is a comment"</code>
Notes	60 chars max; may not fit on display if max chars used
Preset	Unaffected by Preset. Set to empty by Restore Input/Output Defaults
State Saved	Saved in instrument state
Initial S/W Revision	A.02.00
Modified at S/W Revision	A.14.00

Edit

Invokes the integrated editing facility for this correction set.

When entering the menu, the editor window turns on, the selected correction is turned On, Apply Corrections is set to On, the amplitude scale is set to Log, and the Amplitude Correction (“Ampcor”) trace is displayed. The actual, interpolated correction trace is shown in green for the selected correction. Note that since the actual interpolated correction is shown, the correction trace may have some curvature to it. This trace represents only the correction currently being edited, rather than the total, accumulated amplitude correction for all amplitude corrections which are currently on, although the total, accumulated correction for all corrections which are turned on is still applied to the data traces.

Because corrections data is always in dB, but the Y-axis of the analyzer is in absolute units, it is necessary to establish a reference line for display of the Corrections data. The reference line is halfway up the display and represents 0 dB of correction. It is labeled “0 dB CORREC”. It is drawn in blue.

Corrections data is always in dB. Whatever dB value appears in the correction table represents the correction to be applied to that trace at that frequency. So if a table entry shows 30 dB that means we ADD 30 dB to each trace to correct it before displaying it. By definition all points are connected. If a gap is desired for corrections data, enter 0 dB.

Note that a well-designed Corrections array should start at 0 dB and end at 0 dB. This is because whatever the high end point is will be extended to the top frequency of the instrument, and whatever the low end point is will be extended down to 0 Hz. So for a Corrections array to have no effect outside its range, you should start and end the array at 0 dB.

NOTE

The table editor will only operate properly if the analyzer is sweeping, because its updates are tied to the sweep system. Thus, you should not try to use the editor in single sweep, and it will be sluggish during compute-intensive operations like narrow-span FFT sweeps.

When exiting the edit menu (by using the Return key or by pressing an instrument front-panel key), the editor window turns off and the Ampcor trace is no longer displayed; however, Apply Corrections remains

On, any correction that was on while in the editor remains on, and the amplitude scale returns to its previous setting.

Corrections arrays are not affected by a Preset, because they are in the Input/Output system. They also survive shutdown and restarting of the analyzer application, which means they will survive a power cycle.

When editing a correction, the editor remembers which correction and which element in the correction array you were editing, and returns you to that correction and that element when you return to the editor after leaving it.

Key Path	Input/Output, Corrections
Initial S/W Revision	A.02.00

Navigate

Lets you move through the table to edit the desired point.

Key Path	Input/Output, Corrections, Edit
Notes	There is no value readback on the key
Min	1
Max	2000
Initial S/W Revision	A.02.00

Frequency

Lets you edit the frequency of the current row.

Key Path	Input/Output, Corrections, Edit
Notes	There is no value readback on the key.
Min	0
Max	1 THz
Initial S/W Revision	A.02.00

Amplitude

Lets you edit the Amplitude of the current row.

Key Path	Input/Output, Corrections, Edit
Notes	There is no value readback on the key.
Min	-1000 dB
Max	1000 dB
Initial S/W Revision	A.02.00

Insert Point Below

Inserts a point below the current point. The new point is a copy of the current point and becomes the current point. The new point is not yet entered into the underlying table, and the data in the row is displayed in light gray.

Key Path	Input/Output, Corrections, Edit
Initial S/W Revision	A.02.00

Delete Point

Deletes the currently-selected point, whether or not that point is being edited, and selects the Navigate functionality. The point following the currently-selected point (or the point preceding if there is none) will be selected.

Key Path	Input/Output, Corrections, Edit
Initial S/W Revision	A.02.00

Scale X Axis

Matches the X Axis to the selected Correction, as well as possible. Sets the Start and Stop Frequency to contain the minimum and maximum Frequency of the selected Correction. The range between Start Frequency and Stop Frequency is 12.5% above the range between the minimum and maximum Frequency, so that span exceeds this range by one graticule division on either side. If in zero-span, or there is no data in the Ampcor table, or the frequency range represented by the table is zero, no action is taken. Standard clipping rules apply if the value in the table is outside the allowable range for the X axis.

Key Path	Input/Output, Corrections, Edit
Dependencies	If either the first or last point in the array is outside the frequency range of the current input, an error message is generated: “-221. Settings conflict; Start or Stop Freq out of range for current input settings”
Initial S/W Revision	A.02.00

Delete Correction

Deletes the correction values for this set. When this key is pressed a prompt is placed on the screen that says “Please press Enter or OK key to delete correction. Press ESC or Cancel to close this dialog.” The deletion is only performed if you press OK or Enter.

Key Path	Input/Output, Corrections
Remote Command	[:SENSe] :CORRection:CSET [1 2 ... 6 :DELete
Example	CORR:CSET:DEL

	CORR:CSET1:DEL CORR:CSET4:DEL
Notes	Pressing this key when no corrections are present is accepted without error.
Initial S/W Revision	A.02.00

Apply Corrections

Applies amplitude corrections, which are marked as ON to the measured data. If this is set to OFF, then no amplitude correction sets will be used, regardless of their individual on/off settings. If set to ON, the corrections that are marked as ON (see ["Correction On/Off" on page 242](#)) are used.

Key Path	Input/Output, Corrections
Remote Command	[:SENSe] :CORRection:CSET:ALL [:STATe] ON OFF 1 0 [:SENSe] :CORRection:CSET:ALL [:STATe] ?
Example	SENS:CORR:CSET:ALL OFF This command makes sure that no amplitude corrections are applied, regardless of their individual on/off settings.
Preset	Not affected by Preset. Set to OFF by Restore Input/Output Defaults
State Saved	Saved in instrument state.
Initial S/W Revision	A.02.00

Delete All Corrections

Erases all correction values for all 4 Amplitude Correction sets.

When this key is pressed a prompt is placed on the screen that says "Please press Enter or OK key to delete all corrections. Press ESC or Cancel to close this dialog." The deletion is only performed if you press OK or Enter.

Key Path	Input/Output, Corrections
Remote Command	[:SENSe] :CORRection:CSET:ALL:DELeTe
Example	CORR:CSET:ALL:DEL
Initial S/W Revision	A.02.00

Remote Correction Data Set Commands

This section describes the remote (SCPI) commands used to put values into correction sets. See the correction / table editor section of the Input/Output section for the information on front panel entry of correction data.

["Set \(Replace\) Data \(Remote Command Only\)" on page 252](#)

["Merge Correction Data \(Remote Command Only\)" on page 252](#)

Set (Replace) Data (Remote Command Only)

The command takes an ASCII series of alternating frequency and amplitude points, each value separated by commas.

The values sent in the command will totally replace all existing correction points in the specified set.

An Ampcor array can contain 2000 points maximum.

Remote Command	<code>[[:SENSe]:CORRection:CSET[1] 2 ... 8:DATA <freq>, <ampl>, . . .</code> <code>[[:SENSe]:CORRection:CSET[1] 2 ... 8:DATA?</code>
Example	<code>CORR:CSET1:DATA 10000000, -1.0, 20000000, 1.0</code> This defines two correction points at (10 MHz, -1.0 dB) and (20 MHz, 1.0 dB) for correction set 1.
Preset	Empty after Restore Input/Output Defaults. Survives a shutdown or restart of analyzer application (including a power cycle).
State Saved	Saved in instrument state.
Min	Freq: 0 Hz Amptd: -1000 dBm
Max	Freq: 1 THz Amptd: +1000 dBm
Initial S/W Revision	A.02.00
Modified at S/W Revision	A.14.00

Merge Correction Data (Remote Command Only)

The command takes an ASCII series of alternating frequency and amplitude points, each value separated by commas. The difference between this command and Set Data is that this merges new correction points into an existing set.

Any new point with the same frequency as an existing correction point will replace the existing point's amplitude with that of the new point.

An Ampcor array can contain 2000 total points, maximum.

Remote Command	<code>[[:SENSe]:CORRection:CSET[1] 2 ... 8:DATA:MERGe <freq>, <ampl>, ...</code>
Example	<code>CORR:CSET1:DATA:MERGE 15000000, -5.0, 25000000, 5.0</code> This adds two correction points at (15 MHz, -5.0 dB) and (25 MHz, 5.0 dB) to whatever values already exist in correction set 1.
Preset	Empty after Restore Input/Output Defaults. Survives shutdown/restart of analyzer application (including power cycle)
Min	Freq: 0 Hz Amptd: -1000 dBm
Max	Freq: 1 THz Amptd: +1000 dBm
Initial S/W Revision	A.02.00
Modified at S/W Revision	A.14.00

Freq Ref In

Specifies the frequency reference as being the internal reference at the rear panel input labeled EXT REF IN, a 1 pulse per second signal at the EXT REF IN input, external reference or sensing the presence of a signal at the EXT REF IN input.

When the frequency reference is set to internal, the internal 10 MHz reference is used even if an external reference is connected.

When the frequency reference is set to external, the instrument will use the external reference. However, if there is no external signal present, or it is not within the proper amplitude range, a condition error message is generated. When the external signal becomes valid, the error is cleared.

When the frequency reference is set to Pulse, the instrument expects a 1 pulse per second signal at the EXT REF IN input. The instrument uses this signal to adjust the frequency of the internal reference.

If Sense is selected, the instrument checks whether a signal is present at the external reference connector. If it senses a signal within 5 ppm of the External Ref Freq (as set on the External Ref Freq softkey), it will automatically switch to the external reference. If it senses a 1 pulse per second signal, it enters Pulse mode, wherein the signal is used to adjust the internal reference. When no signal is present, it automatically switches to the internal reference. No message is generated as the reference switches between pulse, external and internal. The monitoring of the external reference occurs approximately on 1 millisecond intervals, and never occurs in the middle of a measurement acquisition, only at the end of the measurement (end of the request).

If for any reason the instrument's frequency reference is not able to obtain lock, Status bit 1 in the Questionable Frequency register will be true and a condition error message is generated. When lock is regained, Status bit 1 in the Questionable Frequency register will be cleared and the condition error will be cleared.

If an external frequency reference is being used, you must enter the frequency of the external reference if it is not exactly 10 MHz. The External Ref Freq key is provided for this purpose.

Key Path	Input/Output
Remote Command	<code>[:SENSe] :ROSCillator :SOURce :TYPE INTernal EXTernal SENSE PULSe</code> <code>[:SENSe] :ROSCillator :SOURce :TYPE?</code>
Dependencies	The PULSe parameter, and support of the 1 pps signal at the EXT REF IN input, are not available in firmware prior to A.13.00. They are also not available in some model numbers. If not available, the Pulse key will be blank, and sending the PULSe parameter via SCPI will generate an error:
Preset	This is unaffected by a Preset but is set to SENSE on a "Restore Input/Output Defaults" or "Restore System Defaults->All".
State Saved	Saved in instrument state.
Status Bits/OPC dependencies	STATus:QUESTionable:FREQUency bit 1 set if unlocked.
Backwards Compatibility Notes	Freq Ref In was not saved in state in the legacy instruments. It is a part of state in the X-Series.
Initial S/W Revision	Prior to A.02.00
Modified at S/W Revision	A.14.00

Remote Command	<code>[[:SENSe]:ROSCillator:SOURce?</code>
Notes	<p>The query <code>[SENSe]:ROSCillator:SOURce?</code> returns the current switch setting. This means:</p> <ol style="list-style-type: none"> 1. If it was set to <code>SENSe</code> but there is no external reference nor 1 pps signal so the instrument is actually using the internal reference, then this query returns <code>INTernal</code> and not <code>SENSe</code>. 2. If it was set to <code>SENSe</code> and there is an external reference present, the query returns <code>EXTernal</code> and not <code>SENSe</code>. 3. If it was set to <code>SENSe</code> and there is a 1 pps signal present, the query returns <code>PULSe</code> and not <code>SENSe</code>. 4. If it was set to <code>EXTernal</code>, then the query returns "EXTernal" 5. If it was set to <code>INTernal</code>, then the query returns "INTernal". 6. If it was set to <code>PULSe</code>, then the query returns "PULSe"
Preset	<code>SENSe</code>
Backwards Compatibility Notes	<p>The query <code>[[:SENSe]:ROSCillator:SOURce?</code> was a query-only command in ESA which always returned whichever reference the instrument was using. The instrument automatically switched to the ext ref if it was present.</p> <p>In PSA (which had no sensing) the command <code>[[:SENSe]:ROSCillator:SOURce</code> set the reference (INT or EXT), so again its query returned the actual routing.</p> <p>Thus the query form of this command is 100% backwards compatible with both instruments.</p>
Initial S/W Revision	Prior to A.02.00

Remote Command	<code>[[:SENSe]:ROSCillator:SOURce INTernal EXTernal</code>
Notes	<p>For PSA compatibility the command form is provided and is directly mapped to <code>[[:SENSe]:ROSCillator:SOURce:TYPE</code></p>
Initial S/W Revision	Prior to A.02.00

Sense

If Sense is selected, the instrument checks whether a signal is present at the external reference connector. If it senses a signal within 5 ppm of the External Ref Freq (as set on the External Ref Freq softkey), it will use this signal as an External Reference. If it senses a 1 pulse per second signal, it will use this signal to adjust the internal reference by adjusting the User setting of the Timebase DAC. When no signal is present, it automatically switches to the internal reference.

Key Path	Input/Output, Freq Ref In
Example	<code>:ROSC:SOUR:TYPE SENS</code>
Couplings	<p>If set to <code>SENSe</code> and the analyzer senses a 1 pulse per second signal, it sets the System, Alignments, Timebase DAC setting to "User". This setting survives Preset and Power Cycle but is set to "Calibrated" on a System, Restore Defaults, Align or a System, Restore Defaults, All</p>

Readback	Sense
Initial S/W Revision	Prior to A.02.00
Modified at S/W Revision	A.14.00

Internal

The internal reference is used. A 1 pps signal at the EXT REF IN port, or a signal there between 1 and 50 MHz, will cause a warning triangle to appear in the settings panel next to the word "INTERNAL", but will otherwise be ignored.

Key Path	Input/Output, Freq Ref In
Example	:ROSC:SOUR:TYPE INT
Readback	Internal
Initial S/W Revision	Prior to A.02.00
Modified at S/W Revision	A.14.00

External

The external reference is used.

Key Path	Input/Output, Freq Ref In
Example	:ROSC:SOUR:TYPE EXT
Readback	External
Initial S/W Revision	Prior to A.02.00

Ext Ref Freq

This key tells the analyzer the frequency of the external reference. When the external reference is in use (either because the reference has been switched to External or because the Reference has been switched to Sense and there is a valid external reference present) this information is used by the analyzer to determine the internal settings needed to lock to that particular external reference signal.

For the instrument to stay locked, the value entered must be within 5 ppm of the actual external reference frequency. So it is important to get it close, or you risk an unlock condition.

Note that this value only affects the instrument's ability to lock. It does not affect any calculations or measurement results. See "Freq Offset" in the Frequency section for information on how to offset frequency values.

Key Path	Input/Output, Freq Ref In
Remote Command	[:SENSe] :ROSCillator:EXTernal:FREQuency <freq> [:SENSe] :ROSCillator:EXTernal:FREQuency?

Example	ROSC:EXT:FREQ 20 MHz sets the external reference frequency to 20 MHz, but does not select the external reference. ROSC:SOUR:TYPE EXT selects the external reference.
Dependencies	Still available with Internal or Pulse selected, to allow setup for when External is in use. However, the setting has no effect if the Internal Reference is in use (Freq Ref In set to Internal, Pulse, or SENSE:INT or SENSE:PULSE).
Preset	This is unaffected by a Preset but is set to 10 MHz on a "Restore Input/Output Defaults" or "Restore System Defaults->All"
Min	CXA: 10 MHz EXA: 10 MHz MXA: 1 MHz PXA: 1 MHz N8973B, N8974B, N8975B, or N8976B: 10 MHz
Max	CXA: 10 MHz EXA: 10 MHz EXA with option R13: 20 MHz MXA: 50 MHz PXA: 50 MHz N8973B, N8974B, N8975B, or N8976B: 10 MHz
Default Unit	Hz
Initial S/W Revision	Prior to A.02.00
Modified at S/W Revision	A.14.00

External Reference Lock BW

This control lets you adjust the External Reference phase lock bandwidth. This control is available in some models of the X-Series.

The PXA variable reference loop bandwidth allows an external reference to be used and have the analyzer close-in phase noise improved to match that of the reference. This could result in an improvement of tens of decibels. The choice of "Wide" or "Narrow" affects the phase noise at low offset frequencies, especially 4 to 400 Hz offset. When using an external reference with superior phase noise, we recommend setting the external reference phase-locked-loop bandwidth to wide (60 Hz), to take advantage of that superior performance. When using an external reference with inferior phase noise performance, we recommend setting that bandwidth to narrow (15 Hz). In these relationships, inferior and superior phase noise are with respect to -134 dBc/Hz at 30 Hz offset from a 10 MHz reference. Because most reference sources have phase noise behavior that falls off at a rate of 30 dB/decade, this is usually equivalent to -120 dBc/Hz at 10 Hz offset.

Key Path	Input/Output, Freq Ref In
Scope	Mode Global
Remote Command	<code>[:SENSe] :ROSCillator :BANDwidth WIDE NARRow</code> <code>[:SENSe] :ROSCillator :BANDwidth ?</code>
Example	ROSC:BAND WIDE
Dependencies	Still available with Internal or Pulse selected, to allow setup for when External is in use. However, the setting has no effect if the Internal Reference is in use (Freq Ref In set to Internal, Pulse, or SENSE:INT or SENSE:PULSE). This key only appears in analyzers equipped with the required hardware.
Preset	This is unaffected by a Preset but is set to Narrow on a "Restore Input/Output Defaults" or "Restore System Defaults -> All"
State Saved	Saved in Input/Output state.
Initial S/W Revision	A.04.00
Modified at S/W Revision	A.14.00

External Ref Coupling

Only appears with option ERC installed and licensed.

This function lets you couple the sweep system of the analyzer to the state of the External Reference. If Normal is selected, data acquisition proceeds regardless of the state of the External Reference. When you select Ext Ref Out Of Range Stops Acquisition, the data acquisition (sweep or measurement) stops when either the "521, External ref out of range" or the "503, Frequency Reference unlocked" error message is asserted. Note that this will only take place if the Freq Ref In selection is External.

With the acquisition stopped, the data display will stop updating (even if this occurs in the middle of a sweep or measurement) and no data will be returned to a READ? or MEASure? query; that is, these queries will not complete because the analyzer will not respond to them. Furthermore, no response will be generated to a *WAI? or *OPC? query.

Proper SCPI sequences are shown below, which will always fail to return if the acquisition stops during the requested sweep or measurement. Note that, for predictable operation of this function, it is best to operate the analyzer in single measurement mode (INIT:CONT OFF), because if operating in continuous mode, the analyzer may respond to the above queries even after the acquisition stops, with data left over from the previous acquisition.

```
:INIT:CONT OFF
```

```
:INIT:IMM;*OPC?
```

```
--
```

```
:INIT:CONT OFF
```

```
:INIT:IMM;*WAI?
```

```
--
```

:INIT:CONT OFF

:READ?

--

:INIT:CONT OFF

:MEASure?

When the acquisition ceases, in addition to the error condition(s) described above, a popup error message will be generated informing you that the acquisition has ceased due to an invalid external reference. This message will stay on the screen while the acquisition is suspended.

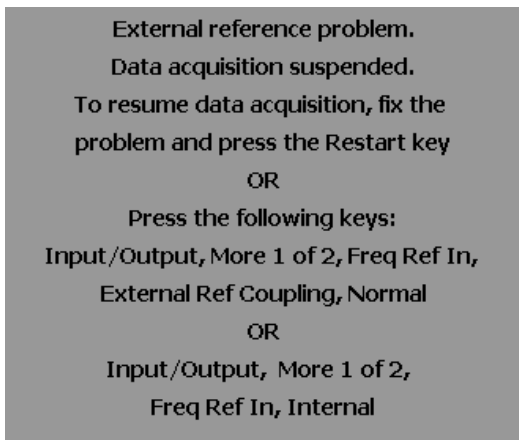

If you press the Restart key this message will be taken off the screen and a new acquisition will be attempted. If the External Reference problem persists the message will re-appear. You can also remove the message by changing back to the Normal setting of Sweep/Ext Ref Coupling, or by pressing Freq Ref In, Internal, or Freq Ref In, Sense, or Restore Input/Output Defaults.

The setting of External Ref Coupling is persistent across power-cycling and is not reset with a Preset. It is reset to the default state (Normal) when Restore Input/Output Defaults is invoked, which will also restart normal data acquisition.

The detection of invalid external reference is under interrupt processing. If the external reference becomes invalid then returns to valid in too short a time, no error condition will be detected or reported and therefore the acquisition will not be stopped.

Key Path	Input/Output, Freq Ref In
Mode	All
Remote Command	[:SENSe] :ROScillator :COUPling NORMal NACQuisition [:SENSe] :ROScillator :COUPling ?
Preset	This setting is persistent: it survives power-cycling or a Preset and is reset with Restore Input/Output defaults.
State Saved	Not saved in instrument state
Readback	Normal Stop Acq
Initial S/W Revision	A.02.00

Output Config

Accesses keys that configure various output settings, like the frequency reference output, trigger output and analog output.

Key Path	Input/Output
Backwards Compatibility Notes	In ESA there was not a user interface to enable the Video Output (Analog Output), Trigger Output, or Gate Output. In the X-Series each of these physical connectors requires configuration, thus the user interface has been added for X-Series, along with the potential for an output you think is always on to be switched off.
Initial S/W Revision	Prior to A.02.00

Trig Out

Select the type of output signal that will be output from the Trig 1 Out, or Trig 2 Out connectors.

Key Path	Input/Output, Output Config
Remote Command	:TRIGger TRIGger1 TRIGger2[:SEquence]:OUTPut HSWP MEASuring MAIN GATE GTRigger OEVEN SPOint SSWeep SSEtled S1Marker S2Marker S3Marker S4Marker OFF :TRIGger TRIGger1 TRIGger2[:SEquence]:OUTPut?
Example	TRIG:OUTP HSWP TRIG2:OUTP GATE
Dependencies	The second Trigger output (Trig 2 Out) does not appear in all models; in models that do not support it, the Trig 2 Out key is blanked, and sending the SCPI command for this output generates an error, "Hardware missing; Not available for this model number" In models that do not support the Trigger 2 output, this error is returned if trying to set Trig 2 Out and a query of Trig 2 Out returns OFF.
Preset	Trigger 1: Sweeping (HSWP) Trigger 2: Gate This is unaffected by a Preset but is preset to the above values on a "Restore Input/Output Defaults" or "Restore System Defaults->All"
State Saved	Saved in instrument state
Initial S/W Revision	Prior to A.02.00

Polarity

Sets the output to the Trig 1 Out, or Trig 2 Out, connector to trigger on either the positive or negative polarity.

Key Path	Input/Output, Output Config, Trig 1/2 Output
Remote Command	:TRIGger TRIGger1 TRIGger2[:SEquence]:OUTPut:POLarity POSitive NEGative :TRIGger TRIGger1 TRIGger2[:SEquence]:OUTPut:POLarity?

Example	TRIG1:OUTP:POL POS
Preset	This is unaffected by a Preset but is set to POSitive on a "Restore Input/Output Defaults" or "Restore System Defaults->All"
State Saved	Saved in instrument state
Initial S/W Revision	Prior to A.02.00

Off

Selects no signal to be output to the Trig 1 Out, or Trig 2 Out, connector.

Key Path	Input/Output, Output Config, Trig 1/2 Output
Example	TRIG1:OUTP OFF
Readback	Off
Initial S/W Revision	Prior to A.02.00

Sweeping (HSWP)

Selects the Sweeping Trigger signal to be output to the Trig 1 Out, or Trig 2 Out, connector when a measurement is made. This signal has historically been known as "HSWP" (High = Sweeping), and is 5 V TTL level with 50 ohm output impedance.

Key Path	Input/Output, Output Config, Trig 1/2 Output
Example	TRIG1:OUTP HSWP
Readback	Sweeping
Initial S/W Revision	Prior to A.02.00

Measuring

Selects the Measuring trigger signal to be output to the Trig 1 Out, or Trig 2 Out, connector. This signal is true while the Measuring status bit is true.

Key Path	Input/Output, Output Config, Trig 1/2 Output
Example	TRIG1:OUTP MEAS
Readback	Measuring
Initial S/W Revision	Prior to A.02.00

Main Trigger

Selects the current instrument trigger signal to be output to the Trig 1 Out, or Trig 2 Out, connector.

Key Path	Input/Output, Output Config, Trig 1/2 Output
Example	TRIG1:OUTP MAIN
Readback	Main Trigger
Initial S/W Revision	Prior to A.02.00

Gate Trigger

Selects the gate trigger signal to be output to the Trig 1 Out, or Trig 2 Out, connector. This is the source of the gate timing, not the actual gate signal.

Key Path	Input/Output, Output Config, Trig 1/2 Output
Example	TRIG1:OUTP GTR
Readback	Gate Trigger
Initial S/W Revision	Prior to A.02.00

Gate

Selects the gate signal to be output to the Trig 1 Out, or Trig 2 Out, connector. The gate signal has been delayed and its length determined by delay and length settings. When the polarity is positive, a high on the Trig 1 Out, or Trig 2 Out, represents the time the gate is configured to pass the signal.

Key Path	Input/Output, Output Config, Trig 1/2 Output
Example	TRIG1:OUTP GATE
Readback	Gate
Initial S/W Revision	Prior to A.02.00

Source Point Trigger

Selects the gate signal to be output to the Trig 1 Out, or Trig 2 Out, connector for use as the Point Trigger when operating an external source in Tracking mode. When Ext Trigger 1 is selected as the Point Trigger under Source, the Source Point Trigger under Trig1 Out automatically gets selected. Similarly, when Ext Trigger 2 is selected as the Point Trigger under Source, the Source Point Trigger key under Trig 2 Out automatically gets selected

Key Path	Input/Output, Output Config, Trig 1/2 Output
Example	TRIG1:OUTP SPO
Readback	Source Point
Initial S/W Revision	Prior to A.02.00

Odd/Even Trace Point

Selects either the odd or even trace points as the signal to be output to the Trig 1 Out, or Trig 2 Out, connector when performing swept spectrum analysis. When the polarity is positive, this output goes high during the time the analyzer is sweeping past the first point (Point 0) and every other following trace point. The opposite is true if the polarity is negative.

Key Path	Input/Output, Output Config, Trig 1/2 Output
Example	TRIG1:OUTP OEV
Readback	Odd/Even
Initial S/W Revision	Prior to A.02.00

Analog Out

This menu lets you control which signal is fed to the “Analog Out” connector on the analyzer rear panel.

See ["More Information" on page 262](#)

Key Path	Input/Output, Output Config
Remote Command	:OUTPut:ANALog OFF SVIDeo LOGVIdeo LINVIdeo DAUDio :OUTPut:ANALog?
Example	OUTP:ANAL SVIDeo ! causes the analog output type to be Screen Video
Preset	This is unaffected by Preset but is set to DAUDio on a "Restore Input/Output Defaults" or "Restore System Defaults->All
Preset	OFF
State Saved	Saved in Input/Output State
Readback line	1-of-N selection [variable]
Backwards Compatibility Notes	Prior to A.04.00, OFF was the default functionality except when in the Analog Demod application or with Tune and Listen, in which case it was DAUDio, and there was no selection menu. So for backwards compatibility with earlier X-Series firmware versions, Auto (:OUTP:ANAL:AUTO ON) will duplicate the prior behavior. The DNWB and SANalyzer parameters, which were legal in PSA but perform no function in the X-Series, are accepted without error.
Initial S/W Revision	A.04.00

More Information

The table below gives the range for each output.

Analog Out	Nominal Range exc. (10% overrange)	Scale Factor	Notes
Off	0 V		

Analog Out	Nominal Range exc. (10% overrange)	Scale Factor	Notes
Screen Video	0 – 1 V open circuit	10%/division	8566 compatible
Log Video	0 – 1 V terminated	1/(192.66 dB/V)	dB referenced to mixer level, 1V out for –10 dBm at the mixer.
Linear Video	0 – 1 V terminated	100%/V	Linear referenced to Ref Level, 1 V out for RF envelope at the Ref Level.
Demod Audio	(varies with analyzer setting)		

Auto

Selects the Auto state for the Analog Output menu. In this state, the Analog Output will automatically be set to the most sensible setting for the current mode or measurement.

If you make a selection manually from the Analog Out menu, this selection will remain in force until you change it (or re-select Auto), even if you go to a mode or measurement for which the selected output does not apply.

Key Path	Input/Output, Output Config, Analog Out
Remote Command	OUTPut:ANALog:AUTO OFF ON 0 1 OUTPut:ANALog:AUTO?
Example	OUTP:ANAL:AUTO ON
Preset	ON
State Saved	Saved in Input/Output State
Initial S/W Revision	A.04.00

Off

Turns off the analog output.

Key Path	Input/Output, Output Config, Analog Out
Example	OUTP:ANAL OFF ! causes the analog output to be off
Readback Text	Off
Initial S/W Revision	A.04.00

Screen Video

Selects the analog output to be the screen video signal. In this mode, the pre-detector data is output to the Analog Out connector. The output looks very much like the trace displayed on the analyzer's screen,

and depends on the Log/Lin display Scale, Reference Level, and dB per division, but is not influenced by the selected detector or any digital flatness corrections or trace post-processing (like Trace Averaging).

Note that this mode is similar to the Analog Output of the HP 8566 family and the Video Out (opt 124) capability of the Agilent PSA analyzer (E444x), although there are differences in the behavior.

Key Path	Input/Output, Output Config, Analog Out
Example	OUTP:ANAL SVID
Dependencies	<p>Because the Screen Video output uses one of the two IF processing channels, only one detector is available while Screen Video is selected. All active traces will change to use the same detector as the selected trace when Screen Video is activated.</p> <p>Screen Video output is not available while any EMI Detector is selected (Quasi Peak, RMS Average or EMI Average), because these detectors use both IF processing channels. Consequently, if the user chooses an EMI Detector, there will be no Screen Video output.</p> <p>The output holds at its last value during an alignment and during a marker count. After a sweep:</p> <ul style="list-style-type: none"> • If a new sweep is to follow (as in Continuous sweep mode), the output holds at its last value during the retrace before the next sweep starts. If the analyzer is in zero-span, there is no retrace, as the analyzer remains tuned to the Center Frequency and does not sweep. Therefore, in zero-span, the output simply remains live between display updates. • If no new sweep is to follow (as in Single sweep mode), the output remains live, and continues to show the pre-detector data <p>This function depends on optional capability; the key will be blanked and the command will generate an "Option not available" error unless you have Option YAV or YAS licensed in your instrument.</p>
Couplings	Screen Video output changes while in FFT Sweeps, so for measurements that use exclusively FFT Sweeps, or if the user manually chooses FFT Sweeps, the Screen Video output will look different than it does in swept mode.
Readback Text	Screen Video
Backwards Compatibility Notes	See " Backwards Compatibility: " on page 264, below.
Initial S/W Revision	A.04.00

Backwards Compatibility:

The Screen Video function is intended to be very similar to the 8566 Video Output and the PSA Option 124. However, unlike the PSA, it is not always on; it must be switched on by the Screen Video key. Also, unlike the PSA, there are certain dependencies (detailed above) – for example, the Quasi Peak Detector is unavailable when Screen Video is on.

Furthermore, the PSA Option 124 hardware was unipolar and its large range was padded to be exactly right for use as a Screen Video output. In the X-Series, the hardware is bipolar and has a wider range to accommodate the other output choices. Therefore, the outputs won't match up exactly and users may have to modify their setup when applying the X-Series in a PSA application.

Log Video (RF Envelope, Ref=Mixer Level)

Selects the analog output to be the log of the video signal. In this mode, the pre-detector data is output to the Analog Out connector with a Log scaling. The output is referenced to the current level at the mixer, does not depend on display settings like Reference Level or dB per division, and it is not influenced by the

selected detector or any digital flatness corrections or trace post-processing (like Trace Averaging), but does change with input attenuation.

The output is designed so that full scale (1 V) corresponds to -10 dBm at the mixer. The full range (0–1 V) covers 192.66 dB ; thus, 0 V corresponds to -202.66 dBm at the mixer.

Key Path	Input/Output, Output Config, Analog Out
Example	OUTP:ANAL LOGV
Dependencies	<p>Because the Log Video output uses one of the two IF processing channels, only one detector is available while Screen Video is selected. All active traces will change to use the same detector as the selected trace when Log Video is activated.</p> <p>Log Video output is not available while any EMI Detector is selected (Quasi Peak, RMS Average or EMI Average), because these detectors use both IF processing channels. Consequently, if the user chooses an EMI Detector, there will be no Log Video output.</p> <p>The output holds at its last value during an alignment, during a marker count, and during retrace (after a sweep and before the next sweep starts).</p> <p>This function depends on optional capability. The key will be blanked and the command will generate an “Option not available” error unless you have Option YAV licensed in your instrument.</p>
Couplings	Log Video output changes while in FFT Sweeps, so for measurements that use exclusively FFT Sweeps, or if the user manually chooses FFT Sweeps, the Log Video output will look different than it does in swept mode.
Readback Text	Log Video
Initial S/W Revision	A.04.00

Linear Video (RF Envelope, Ref=Ref Level)

Selects the analog output to be the envelope signal on a linear (voltage) scale. In this mode, the pre-detector data is output to the Analog Out connector with a Linear scaling. The output is based on the current Reference Level, and is not influenced by the selected detector or any digital flatness corrections or trace post-processing (like Trace Averaging).

The scaling is set so that 1 V output occurs with an instantaneous video level equal to the reference level, and 0 V occurs at the bottom of the graticule. This scaling gives you the ability to control the gain without having another setup control for the key. But it requires you to control the look of the display (the reference level) in order to control the analog output.

This mode is ideal for looking at Amplitude Modulated signals, as the linear envelope effectively demodulates the signal.

Key Path	Input/Output, Output Config, Analog Out
Example	OUTP:ANAL LINV
Dependencies	<p>Because the Linear Video output uses one of the two IF processing channels, only one detector is available while Linear Video is selected. All active traces will change to use the same detector as the selected trace when Log Video is activated.</p> <p>Linear Video output is not available while any EMI Detector is selected (Quasi Peak, RMS Average or EMI Average), because these detectors use both IF processing channels. Consequently, if the user chooses an EMI Detector, there will be no Linear Video output.</p>

	The output holds at its last value during an alignment and during a marker count and during retrace (after a sweep and before the next sweep starts). This function depends on optional capability; the key will be blanked and the command will generate an “Option not available” error unless you have Option YAV licensed in your instrument.
Couplings	Linear Video output changes while in FFT Sweeps, so for measurements that use exclusively FFT Sweeps, or if the user manually chooses FFT Sweeps, the Linear Video output will look different than it does in swept mode.
Readback Text	Linear Video
Initial S/W Revision	A.04.00

Demod Audio

Selects the analog output to be the demodulation of the video signal.

When Demod Audio is selected, the demodulated audio signal appears at this output whenever the Analog Demod application is demodulating a signal or when Analog Demod Tune and Listen is operating in the Swept SA measurement.

When Analog Out is in the Auto state, this output is auto-selected when in the Analog Demod mode or when Analog Demod Tune and Listen is operating in the Swept SA measurement.

If any other Analog Output is manually selected when in the Analog Demod mode or when Analog Demod Tune and Listen is operating in the Swept SA measurement, a condition warning message appears.

Key Path	Input/Output, Output Config, Analog Out
Example	OUTP:ANAL DAUD
Dependencies	This key only appears if the Analog Demod application (N9063A), the N6141A or W6141A application, or Option EMC is installed and licensed, otherwise the key will be blanked and the command will generate an “Option not available” error. The output holds at its last value during an alignment and during a marker count. It is not held between sweeps, in order for Tune and Listen to work properly. When Demod Audio is the selected Analog Output: <ul style="list-style-type: none"> • all active traces are forced to use the same detector. • CISPR detectors (QPD, EMI Avg, RMS Avg) are unavailable
Readback Text	Demod Audio
Initial S/W Revision	Prior to A.02.00 (this was the default functionality, and there was no selection)
Modified at S/W Revision	A.04.00

Digital Bus

This menu allows you to configure the LVDS connector located on the rear panel of the instrument. It is a unidirectional link of real time data at a 90 MSa/s rate. The ADC is sampling a 22.5 MHz IF.

The data that appears on this port is raw, uncorrected ADC samples, unless you have option RTL. With option RTL, you get fully corrected I/Q data.

This connector will only be active when the Narrowband IF Path is currently in use.

Key Path	Input/Output, Output Config
Initial S/W Revision	A.04.00

Bus Out On/Off

When Bus Out is on, all acquisitions are streamed to the output port including acquisitions for internal purposes such as Alignment. The internal processing and routing of acquisitions continues as usual and is unaffected by the state of Bus Out.

When Bus Out is off, no signal appears on the LVDS port.

Key Path	Input/Output, Output Config, Digital Bus
Scope	Mode Global
Remote Command	:OUTPut:DBUS[1][:STATe] ON OFF 1 0 :OUTPut:DBUS[1][:STATe]?
Example	OUTP:DBUS ON
Preset	This is unaffected by a Preset but is set to Off on a "Restore Input/Output Defaults" or "Restore System Defaults -> All"
State Saved	Saved in Input/Output State
Initial S/W Revision	Prior to A.02.00
Modified at S/W Revision	A.04.00

I/Q Cal Out

The Baseband I/Q "Cal Out" port can be turned on with either a 1 kHz or a 250 kHz square wave. This can be turned on independent of the input selection. A Preset will reset this to Off.

Key Path	Input/Output, Output Config
Remote Command	:OUTPut:IQ:OUTPut IQ1 IQ250 OFF :OUTPut:IQ:OUTPut?
Example	OUTP:IQ:OUTP IQ1
Couplings	An I/Q Cable Calibration or an I/Q Probe Calibration will change the state of the Cal Out port as needed by the calibration routine. When the calibration is finished the I/Q Cal Out is restored to the pre-calibration state.
Preset	Off
State Saved	Saved in instrument state
Range	1 kHz Square Wave 250 kHz Square Wave Off
Readback Text	1 kHz 250 kHz Off
Initial S/W Revision	Prior to A.02.00

1 kHz Square Wave

Turns on the 1 kHz square wave signal at the Cal Out port. This choice is only available with option BBA.

Key Path	Input/Output, Output Config, I/Q Cal Out
Readback	I/Q 1kHz
Initial S/W Revision	Prior to A.02.00

250 kHz Square Wave

Turns on the 250 kHz square wave signal at the Cal Out port. This choice is only available with option BBA.

Key Path	Input/Output, Output Config, I/Q Cal Out
Readback	I/Q 250kHz
Initial S/W Revision	Prior to A.02.00

Off

Turns off the signal at the Cal Out port. This choice is only available with option BBA.

Key Path	Input/Output, Output Config, I/Q Cal Out
Readback	Off
Initial S/W Revision	Prior to A.02.00

Aux IF Out

This menu controls the signals that appear on the SMA output on the rear panel labeled "AUX IF OUT"

The Aux IF Out functionality is only valid for RF and External Mixer inputs. When using the External Mixing path, the Aux IF Out levels (for all three Options CR3, CRP, and ALV) will be uncalibrated because the factory default Aux IF level was set to accommodate the expected IF levels for the RF path.

Key Path	Input/Output, Output Config
Remote Command	:OUTPut:AUX SIF AIF LOGVideo OFF :OUTPut:AUX?
Dependencies	The softkey does not appear in models that do not support the Aux IF Out.
Preset	This is unaffected by a Preset but is set to OFF on a "Restore Input/Output Defaults" or "Restore System Defaults->All"
State Saved	Saved in Input/Output state
Readback line	1-of-N selection [variable]

Backwards Compatibility Notes	In the PSA, the IF output has functionality equivalent to the "Second IF" function in the X-Series' Aux IF Out menu. In the X-Series, it is necessary to switch the Aux IF Out to "Second IF" to get this functionality, whereas in PSA it is always on, since there are no other choices. Hence a command to switch this function to "Second IF" will have to be added by customers migrating from PSA who use the IF Output in PSA.
Initial S/W Revision	A.04.00

Off

In this mode nothing comes out of the "AUX IF OUT" connector on the rear panel. The connector appears as an open-circuit (that is, it is not terminated in any way).

Key Path	Input/Output, Output Config, Aux IF Out
Example	OUTP:AUX OFF causes the aux output type to be off
Readback Text	Off
Initial S/W Revision	A.04.00

Second IF

In this mode the 2nd IF output is routed to the rear panel connector. The annotation on the key shows the current 2nd IF frequency in use in the analyzer.

The frequency of the 2nd IF depends on the current IF signal path as shown in the table below:

IF Path Selected	Frequency of "Second IF" Output
10 MHz	322.5 MHz
25 MHz	322.5 MHz
40 MHz	250 MHz
140 MHz	300 MHz

The signal quality, such as signal to noise ratio and phase noise, are excellent in this mode.

Key Path	Input/Output, Output Config, Aux IF Out
Example	OUTP:AUX SIF causes the aux output type to be Second IF
Dependencies	Does not appear unless Option CR3 is installed.
Readback Text	Second IF
Initial S/W Revision	A.04.00

Arbitrary IF

In this mode the 2nd IF output is mixed with a local oscillator and mixer to produce an arbitrary IF output between 10 MHz and 75 MHz with 500 kHz resolution. The phase noise in this mode will not be as good as in Second IF mode.

The IF output frequency is adjustable, through an active function which appears on the Arbitrary IF selection key, from 10 MHz to 75 MHz with 500 kHz resolution.

The bandwidth of this IF output varies with band and center frequency, but is about 40 MHz at the -3 dB width. When the output is centered at lower frequencies in its range, signal frequencies at the bottom of the bandwidth will “fold”. For example, with a 40 MHz bandwidth (20 MHz half-bandwidth), and a 15 MHz IF center, a signal -20 MHz relative to the spectrum analyzer center frequency will have a relative response of about -3 dB with a frequency 20 MHz below the 15 MHz IF center. This -5 MHz frequency will fold to become a $+5$ MHz signal at the IF output. Therefore, lower IF output frequencies are only useful with known band-limited signals.

Key Path	Input/Output, Output Config, Aux IF Out
Example	OUTP:AUX AIF causes the aux output type to be the Arbitrary IF
Dependencies	Does not appear unless Option CRP is installed.
Readback Text	Arbitrary IF
Initial S/W Revision	A.04.00

Key Path	Input/Output, Output Config, Aux IF Out
Scope	Mode Global
Remote Command	:OUTPut:AUX:AIF <value> :OUTPut:AUX:AIF?
Example	:OUTP:AUX:AIF 50 MHZ
Preset	This is unaffected by a Preset but is set to 70 MHz on a "Restore Input/Output Defaults" or "Restore System Defaults->All"
State Saved	Saved in Input/Output State
Min	10 MHz
Max	75 MHz
Default Unit	Hz
Initial S/W Revision	A.04.00

Fast Log Video

In this mode the 2nd IF output is passed through a log amp and the log envelope of the IF signal is sent to the rear panel. The open circuit output level varies by about 25 mV per dB, with a top-of-screen signal producing about 1.6 Volts. The output impedance is nominally 50 ohms.

This mode is intended to meet the same needs as Option E4440A-H7L Fast Rise Time Video Output on the Agilent E4440A PSA Series, allowing you to characterize pulses with fast rise times using standard measurement suites on modern digital scopes.

Key Path	Input/Output, Output Config, Aux IF Out
Example	OUTP:AUX LOGVideo causes the aux output type to be Fast Log Video
Dependencies	Does not appear unless Option ALV is installed. The output is off during an alignment but not during a marker count, and is not blanked during retrace (after a sweep and before the next sweep starts).
Readback Text	Fast Log Video
Initial S/W Revision	A.04.00

I/Q Guided Calibration

Calibrating the Baseband I/Q ports requires several steps and manual connections. The Guided Calibration will interactively step you through the required steps, displaying diagrams to help with the connections. The steps will vary depending on the setup.

In the Guided Calibration windows, the date and time of the last calibration are displayed. If any of the items listed are displayed in yellow, this indicates that the calibration for that item is inconsistent with the latest calibration, and you should complete the entire calibration process before you exit the calibration.

I/Q Isolation Calibration

The I/Q Isolation Calibration must be run before calibrating any port with either the I/Q Cable Calibration or I/Q Probe Calibration. This calibration is performed with nothing connected to any of the front panel I/Q ports. This is the first step in both the I/Q Cable Calibration and the I/Q Probe Calibration.

Next

Perform the I/Q Isolation calibration.

Key Path	Input/Output, I/Q, I/Q Cable Calibration
Remote Command	:CALibration:IQ:ISOLation
Example	CAL:IQ:ISOL
Notes	All front panel I/Q ports must not be connected to anything.
Notes	All cables and probes should be disconnected from the I/Q ports before issuing the SCPI command.
State Saved	No.
Initial S/W Revision	Prior to A.02.00

Exit

Exits the calibration procedure. All ports calibrated before pressing Exit will use the newly acquired calibration data.

Key Path	Input/Output, I/Q, I/Q Cable Calibration
Notes	Using the Exit button will not restore the calibration data to the state prior to entering the guided calibration. Once a port is calibrated the data is stored immediately and the only way to change it is to redo the calibration step. When the calibration may be left in an inconsistent state, a confirmation dialog will be displayed (see "Exit Confirmation" on page 283).
Initial S/W Revision	Prior to A.02.00

I/Q Isolation Calibration Time (Remote Command Only)

Returns the last date and time that the I/Q Isolation Calibration was performed. This is a remote query command only.

Remote Command	:CALibration:IQ:ISOLation:TIME?
Example	:CAL:IQ:ISOL:TIME?
Notes	This returns 6 integer values: year, month, day, hour, minute, second. When no calibration has been performed, all values will be 0.
Initial S/W Revision	A.02.00

I/Q Cable Calibrate...

The I/Q cable calibration creates correction data for each of the front panel I/Q ports. This calibration data is used whenever no probe specific calibration data is available. It is important that all ports are calibrated using the same short BNC cable so that the data is comparable from port to port.

The guided calibration (front panel only) will show connection diagrams and guide you through the isolation calibration and calibrating each port. The calibration data for each port is stored separately, so as soon as a port is calibrated that data is saved and will be used. If you press "Exit" to exit the calibration process, the data for the ports already completed will still be used. It is recommended that a calibration be completed once started, or if exited, that it be properly done before the next use of the I/Q ports. The "Next" button will perform the calibration for the current port and then proceed to the next step in the calibration procedure. The "Back" button will return to the prior port in the procedure. Both keys and dialog buttons are supplied for ease of use. The dialog buttons are for mouse use and the softkeys for front panel use.

The calibration can also be done via SCPI, but no connection diagrams will be shown. You will have to make the correct connections before issuing each port calibration command. Again, it is recommended that all ports be calibrated at the same time.

The instrument state remains as it was prior to entering the calibration procedure except while a port is actually being calibrated. Once a port is calibrated it returns to the prior state. A port calibration is in process only from the time the "Next" button is pressed until the next screen is shown. For SCPI, this corresponds to the time from issuing the CAL:IQ:FLAT:|I|B|Q|QB command until the operation is complete.

For example, if the prior instrument state is Cal Out = Off, Input = I+jQ, and Differential = Off, then up until the time the "Next" button is pressed the I Input and Q Input LEDs are on and the Cal Out, I-bar Input and Q-bar Input LEDs are off. Once the "Next" button is pressed for the I port calibration, only the Cal Out and I

Input LEDs will be on and the others will be off. When the screen progresses to the next step ("Next" button again enabled), the prior state is restored and only the I Input and Q Input LEDs are on (Cal Out is off again).

The last calibration date and time for each port will be displayed. Any calibrations that are more than a day older than the most recent calibration will be displayed with the color amber.

Key Path	Input/Output, I/Q
Initial S/W Revision	Prior to A.02.00

I Port

The I port calibration is performed with the front panel's I port connected via a short BNC cable to the Cal Out port. The guided calibration will show a diagram of the required connections.

Back

Return to the prior step in the calibration procedure.

Key Path	Input/Output, I/Q, Q Setup, Q Probe, Calibrate
Initial S/W Revision	Prior to A.02.00

Next

Perform the I port calibration.

Key Path	Input/Output, I/Q, I/Q Cable Calibrate...
Remote Command	:CALibration:IQ:FLATness:I
Example	CAL:IQ:FLAT:I
Notes	The recommended procedure is to use the same BNC cable to calibrate all I/Q ports. All I/Q ports should be calibrated sequentially during the procedure. The calibration data is saved as soon as the port is calibrated and will survive power cycles. It is not reset by any preset or restore data commands.
Notes	The I port must be connected to the Cal Out port before issuing the SCPI command.
State Saved	No.
Initial S/W Revision	Prior to A.02.00

Exit

Exit the calibration procedure. All ports calibrated before pressing Exit will use the newly acquired calibration data.

Key Path	Input/Output, I/Q, I/Q Cable Calibrate...
Notes	Using the Exit button will not restore the calibration data to the state prior to entering the guided calibration. Once a port is calibrated the data is stored immediately and the only way to change it is

to redo the calibration step.
When the calibration may be left in an inconsistent state, a confirmation dialog will be displayed (see "Exit Confirmation" on page 283).

Initial S/W Revision	Prior to A.02.00
----------------------	------------------

I-bar Port

The I-bar port calibration is performed with the front panel's I-bar port connected via a short BNC cable to the Cal Out port. The guided calibration will show a diagram of the required connections.

Back

Return to the prior step in the calibration procedure.

Key Path	Input/Output, I/Q, I/Q Cable Calibration
Notes	Using the Back button will not restore the calibration data to a prior state. Once a port is calibrated the data is stored immediately and the only way to change it is to redo the calibration step. The Back button allows the user to go back to a prior step to redo that calibration step.
Initial S/W Revision	Prior to A.02.00

Next

Perform the I-bar port calibration.

Key Path	Input/Output, I/Q, I/Q Cable Calibrate...
Remote Command	:CALibration:IQ:FLATness:IBAR
Example	CAL:IQ:FLAT:IBAR
Notes	The recommended procedure is to use the same BNC cable to calibrate all I/Q ports. All I/Q ports should be calibrated sequentially during the procedure. The calibration data is saved as soon as the port is calibrated and will survive power cycles. It is not reset by any preset or restore data commands.
Notes	The I-bar port must be connected to the Cal Out port before issuing the SCPI command.
State Saved	No
Initial S/W Revision	Prior to A.02.00

Exit

Exit the calibration procedure. All ports calibrated before pressing Exit will use the newly acquired calibration data.

Key Path	Input/Output, I/Q, I/Q Cable Calibrate...
Notes	Using the Exit button will not restore the calibration data to the state prior to entering the guided calibration. Once a port is calibrated the data is stored immediately and the only way to change it is

to redo the calibration step.

When the calibration may be left in an inconsistent state, a confirmation dialog will be displayed (see ["Exit Confirmation" on page 283](#)).

Initial S/W Revision	Prior to A.02.00
----------------------	------------------

Q Port

The Q port calibration is performed with the front panel's Q port connected via a short BNC cable to the Cal Out port. The guided calibration will show a diagram of the required connections.

Back

Return to the prior step in the calibration procedure.

Key Path	Input/Output, I/Q, I/Q Cable Calibrate...
Notes	Using the Back button will not restore the calibration data to a prior state. Once a port is calibrated the data is stored immediately and the only way to change it is to redo the calibration step. The Back button allows the user to go back to a prior step to redo that calibration step.
Initial S/W Revision	Prior to A.02.00

Next

Perform the Q port calibration.

Key Path	Input/Output, I/Q, I/Q Cable Calibrate...
Remote Command	:CALibration:IQ:FLATness:Q
Example	CAL:IQ:FLAT:Q
Notes	The recommended procedure is to use the same BNC cable to calibrate all I/Q ports. All I/Q ports should be calibrated sequentially during the procedure. The calibration data is saved as soon as the port is calibrated and will survive power cycles. It is not reset by any preset or restore data commands.
Notes	The Q port must be connected to the Cal Out port before issuing the SCPI command.
State Saved	No
Initial S/W Revision	Prior to A.02.00

Exit

Exit the calibration procedure. All ports calibrated before pressing Exit will use the newly acquired calibration data.

Key Path	Input/Output, I/Q, I/Q Cable Calibrate...
Notes	Using the Exit button will not restore the calibration data to the state prior to entering the guided calibration. Once a port is calibrated the data is stored immediately and the only way to change it is

to redo the calibration step.

When the calibration may be left in an inconsistent state, a confirmation dialog will be displayed (see ["Exit Confirmation" on page 283](#)).

Initial S/W Revision	Prior to A.02.00
----------------------	------------------

Q-bar Port

The Q-bar port calibration is performed with the front panel's Q-bar port connected via a short BNC cable to the Cal Out port. The guided calibration will show a diagram of the required connections.

Back

Return to the prior step in the calibration procedure.

Key Path	Input/Output, I/Q, I/Q Cable Calibrate...
Notes	Using the Back button will not restore the calibration data to a prior state. Once a port is calibrated the data is stored immediately and the only way to change it is to redo the calibration step. The Back button allows the user to go back to a prior step to redo that calibration step.
Initial S/W Revision	Prior to A.02.00

Next

Perform the Q-bar port calibration.

Key Path	Input/Output, I/Q, I/Q Cable Calibrate...
Remote Command	:CALibration:IQ:FLATness:QBAR
Example	CAL:IQ:FLAT:QBAR
Notes	The recommended procedure is to use the same BNC cable to calibrate all I/Q ports. All I/Q ports should be calibrated sequentially during the procedure. The calibration data is saved as soon as the port is calibrated and will survive power cycles. It is not reset by any preset or restore data commands.
Notes	The Q-bar port must be connected to the Cal Out port before issuing the SCPI command.
State Saved	No
Initial S/W Revision	Prior to A.02.00

Exit

Exit the calibration procedure. All ports calibrated before pressing Exit will use the newly acquired calibration data.

Key Path	Input/Output, I/Q, I/Q Cable Calibrate...
Notes	Using the Exit button will not restore the calibration data to the state prior to entering the guided calibration. Once a port is calibrated the data is stored immediately and the only way to change it is

to redo the calibration step.

When the calibration may be left in an inconsistent state, a confirmation dialog will be displayed (see ["Exit Confirmation" on page 283](#)).

Initial S/W Revision Prior to A.02.00

I/Q Cable Calibration Time (Remote Command Only)

Returns the last date and time that the I/Q Cable Calibration was performed for a specific port. This is a remote query command only.

Remote Command :CALibration:IQ:FLATness:I|IBAR|Q|QBAR:TIME?

Example :CAL:IQ:FLAT:I:TIME?

Notes This returns 6 integer values: year, month, day, hour, minute, second. When no calibration has been performed, all values will be 0.

Initial S/W Revision A.02.00

I/Q Probe Calibration

The I/Q probe calibration creates correction data for one of the front panel I/Q channels. When the probe has EEPROM identification, the data is unique to that specific probe. When the probe does not have EEPROM identification, the data will be used for all probes of the same type. The data is also unique to the channel, so calibration data for the I channel will not be used for the Q channel and vice versa.

The guided calibration (front panel only) will show connection diagrams and guide the user through the I/Q Isolation Calibration and through calibrating each port. The calibration data for each port is stored separately, so as soon as a port is calibrated that data is saved and will be used. If a user presses "Exit" to exit the calibration process, the data for the port already completed will still be used. It is recommended that a calibration be completed once started, or if exited, that it be properly done before the next use of the probe. The "Next" button will perform the calibration for the current port and then proceed to the next step in the calibration procedure. The "Back" button will return to the prior port in the procedure. Both softkeys and dialog buttons are supplied for ease of use. The dialog buttons are for mouse use and the softkeys for front panel use.

The calibration can also be done via SCPI, but no connection diagrams will be shown. The user will have to make the correct connections before issuing each port calibration command. Again, it is recommended that all ports be calibrated at the same time.

For Active probes or when Differential is Off, only the main port is calibrated, otherwise both the main and complementary ports are calibrated.

The instrument state remains as it was prior to entering the calibration procedure except while a port is actually being calibrated. Once a port is calibrated it returns to the prior state. A port calibration is in process only from the time the "Next" button is pressed until the next screen is shown. For SCPI, this corresponds to the time from issuing the CAL:IQ:PROB:I|B|Q|QB command until the operation is complete.

For example, if the prior instrument state is Cal Out = Off, Input = I+jQ, and Differential = Off, then up until the time the "Next" button is pressed the I Input and Q Input LEDs are on and the Cal Out, I-bar Input and

Q-bar Input LEDs are off. Once the "Next" button is pressed for the I port calibration, only the Cal Out and I Input LEDs will be on and the others will be off. When the screen progresses to the next step ("Next" button again enabled), the prior state is restored and only the I Input and Q Input LEDs are on (Cal Out is off again).

The last calibration date and time for each relevant port will be displayed. For passive probes with Differential On, any calibration that is more than a day older than the most recent calibration will be displayed with the color amber.

I Port

The I port calibration is performed with the probe body attached to the front panel's I port and the probe tip connected via an adapter to the Cal Out port. The guided calibration will show a diagram of the required connections.

Show Adapter

Show a connection diagram and instructions for the probe and adapter. See ["Show Adapter Screen" on page 282](#).

Key Path	Input/Output, I/Q, I Setup, I Probe, Calibrate
Notes	Either a passive or an active probe adapter diagram will be shown, depending on the type of probe attached.
Initial S/W Revision	Prior to A.02.00

Back

Return to the prior step in the calibration procedure.

Key Path	Input/Output, I/Q, Q Setup, Q Probe, Calibrate
Initial S/W Revision	Prior to A.02.00

Next

Perform the I port calibration.

Key Path	Input/Output, I/Q, I Setup, I Probe, Calibrate
Remote Command	:CALibration:IQ:PROBe:I
Example	CAL:IQ:PROB:I
Notes	The I port must be connected to the Cal Out port before issuing the SCPI command. The calibration data is saved as soon as the port is calibrated and will survive power cycles. It is not reset by any preset or restore data commands.
State Saved	No
Initial S/W Revision	Prior to A.02.00

Exit

Exit the calibration procedure. All ports calibrated before pressing Exit will use the newly acquired calibration data.

Key Path	Input/Output, I/Q, I Setup, I Probe, Calibrate
Notes	Using the Exit button will not restore the calibration data to the state prior to entering the guided calibration. Once a port is calibrated the data is stored immediately and the only way to change it is to redo the calibration step. When the calibration may be left in an inconsistent state, a confirmation dialog will be displayed (see "Exit Confirmation" on page 283).
Initial S/W Revision	Prior to A.02.00

I-bar Port

The I-bar port calibration is performed with the probe body attached to the front panel's I-bar port and the probe tip connected via an adapter to the Cal Out port. The I-bar probe calibration is only available for passive probes with Differential On. The guided calibration will show a diagram of the required connections.

Show Adapter

Show a connection diagram and instructions for the probe and adapter. See ["Show Adapter Screen" on page 282](#).

Key Path	Input/Output, I/Q, I Setup, I Probe, Calibrate
Notes	Either a passive or an active probe adapter diagram will be shown, depending on the type of probe attached.
Initial S/W Revision	Prior to A.02.00

Back

Return to the prior step in the calibration procedure.

Key Path	Input/Output, I/Q, I Setup, I Probe, Calibrate
Notes	Using the Back button will not restore the calibration data to a prior state. Once a port is calibrated the data is stored immediately and the only way to change it is to redo the calibration step. The Back button allows the user to go back to a prior step to redo that calibration step.
Initial S/W Revision	Prior to A.02.00

Next

Perform the I-bar port calibration.

Key Path	Input/Output, I/Q, I Setup, I Probe, Calibrate
----------	--

Remote Command	:CALibration:IQ:PROBE:IBar
Example	CAL:IQ:PROB:IB
Notes	The I-bar port must be connected to the Cal Out port before issuing the SCPI command. The calibration data is saved as soon as the port is calibrated and will survive power cycles. It is not reset by any preset or restore data commands.
State Saved	No
Initial S/W Revision	Prior to A.02.00

Exit

Exit the calibration procedure. All ports calibrated before pressing Exit will use the newly acquired calibration data.

Key Path	Input/Output, I/Q, I Setup, I Probe, Calibrate
Notes	Using the Exit button will not restore the calibration data to the state prior to entering the guided calibration. Once a port is calibrated the data is stored immediately and the only way to change it is to redo the calibration step. When the calibration may be left in an inconsistent state, a confirmation dialog will be displayed (see "Exit Confirmation" on page 283).
Initial S/W Revision	Prior to A.02.00

Q Port

The Q port calibration is performed with the probe body attached to the front panel's Q port and the probe tip connected via an adapter to the Cal Out port. The guided calibration will show a diagram of the required connections.

Show Adapter

Show a connection diagram and instructions for the probe and adapter. See ["Show Adapter Screen" on page 282](#).

Key Path	Input/Output, I/Q, Q Setup, Q Probe, Calibrate
Notes	Either a passive or an active probe adapter diagram will be shown, depending on the type of probe attached.
Initial S/W Revision	Prior to A.02.00

Back

Return to the prior step in the calibration procedure.

Key Path	Input/Output, I/Q, Q Setup, Q Probe, Calibrate
Initial S/W Revision	Prior to A.02.00

Next

Perform the Q port calibration.

Key Path	Input/Output, I/Q, Q Setup, Q Probe, Calibrate
Remote Command	:CALibration:IQ:PROBe:Q
Example	CAL:IQ:PROB:Q
Notes	The Q port must be connected to the Cal Out port before issuing the SCPI command. The calibration data is saved as soon as the port is calibrated and will survive power cycles. It is not reset by any preset or restore data commands.
State Saved	No
Initial S/W Revision	Prior to A.02.00

Exit

Exit the calibration procedure. All ports calibrated before pressing Exit will use the newly acquired calibration data.

Key Path	Input/Output, I/Q, Q Setup, Q Probe, Calibrate
Notes	Using the Exit button will not restore the calibration data to the state prior to entering the guided calibration. Once a port is calibrated the data is stored immediately and the only way to change it is to redo the calibration step. When the calibration may be left in an inconsistent state, a confirmation dialog will be displayed (see "Exit Confirmation" on page 283).
Initial S/W Revision	Prior to A.02.00

Q-bar Port

The Q-bar port calibration is performed with the probe body attached to the front panel's Q-bar port and the probe tip connected via an adapter to the Cal Out port. The Q-bar probe calibration is only available for passive probes with Differential On. The guided calibration will show a diagram of the required connections.

Show Adapter

Show a connection diagram and instructions for the probe and adapter. See ["Show Adapter Screen" on page 282](#).

Key Path	Input/Output, I/Q, Q Setup, Q Probe, Calibrate
Notes	Either a passive or an active probe adapter diagram will be shown, depending on the type of probe attached.
Initial S/W Revision	Prior to A.02.00

Back

Return to the prior step in the calibration procedure.

Key Path	Input/Output, I/Q, Q Setup, Q Probe, Calibrate
Notes	Using the Back button will not restore the calibration data to a prior state. Once a port is calibrated the data is stored immediately and the only way to change it is to redo the calibration step. The Back button allows the user to go back to a prior step to redo that calibration step.
Initial S/W Revision	Prior to A.02.00

Next

Perform the Q-bar port calibration.

Key Path	Input/Output, I/Q, Q Setup, Q Probe, Calibrate
Remote Command	:CALibration:IQ:PROBe:QBar
Example	CAL:IQ:PROB:QB
Notes	The Q-bar port must be connected to the Cal Out port before issuing the SCPI command. The calibration data is saved as soon as the port is calibrated and will survive power cycles. It is not reset by any preset or restore data commands.
State Saved	No
Initial S/W Revision	Prior to A.02.00

Exit

Exit the calibration procedure. All ports calibrated before pressing Exit will use the newly acquired calibration data.

Key Path	Input/Output, I/Q, Q Setup, Q Probe, Calibrate
Notes	Using the Exit button will not restore the calibration data to the state prior to entering the guided calibration. Once a port is calibrated the data is stored immediately and the only way to change it is to redo the calibration step. When the calibration may be left in an inconsistent state, a confirmation dialog will be displayed (see "Exit Confirmation" on page 283).
Initial S/W Revision	Prior to A.02.00

Show Adapter Screen

When one of the Probe Calibration Show Adapter buttons is pressed, a diagram of the probe with its adapter will be shown. Depending on the type of probe attached, either the Passive Probe Adapter or the Active Probe Adapter diagram will be shown.

I/Q Probe Calibration Time (Remote Command Only)

Return the last date and time that the I/Q Probe Calibration was performed for a specific port. This is a remote query command only.

Remote Command	:CALibration:IQ:PROBe:I IBAR Q QBAR:TIME?
Example	:CAL:IQ:PROB:I:TIME?
Notes	This returns 6 integer values: year, month, day, hour, minute, second. When no calibration has been performed, all values will be 0. The value is specific to both the port and probe, so the value will change as probes are connected or disconnected.
Initial S/W Revision	A.02.00

Exit Confirmation

When Exit is pressed during one of the calibration routines, the calibration may be in an inconsistent state with some of the ports having newly measured calibration data and others with old data. If this is the case, a dialog box will appear to confirm that the user really wants to exit. A "Yes" answer will exit the calibration procedure, leaving potentially inconsistent calibration data in place. A "No" answer will return to the calibration procedure.

5 Mode Functions

Mode

The Mode key allows you to select the available measurement applications or “Modes”. Modes are a collection of measurement capabilities packaged together to provide an instrument personality that is specific to your measurement needs. Each application software product is ordered separately by Model Number and must be licensed to be available. Once an instrument mode is selected, only the commands that are valid for that mode can be executed.

NOTE

Key operation can be different between modes. The information displayed in Help is about the current mode.

To access Help for a different Mode you must first exit Help (by pressing the Cancel (Esc) key). Then select the desired mode and re-access Help.

For more information on Modes, preloading Modes, and memory requirements for Modes,

see ["More Information" on page 287](#)

Key Path	Front-panel key
Remote Command	:INSTrument[:SElect] SA RTSA SEQAN EMI BASIC WCDMA EDGE GSM WIMAXOFDMA VSA PNOISE NFIGure ADEMOD BTooth TDSCDMA CDMA2K CDMA1XEV LTE LTTETDD LTTAFDD LTTATDD MSR DVB DTMB DCATV ISDBT CMMB WLAN CWLAN CWIMAXOFDM WIMAXFIXED IDEN RLC SCPI LC VSA89601 :INSTrument[:SElect]?
Example	:INST SA
Notes	The available parameters are dependent upon installed and licensed applications resident in the instrument. Parameters given here are an example, specific parameters are in the individual Application. A list of the valid mode choices is returned with the INST:CAT? Query.
Preset	This is unaffected by a Preset but is set on a “Restore System Defaults->All” to: For N9038A: EMI For N8973B, N8974B, N8975B, or N8976B: NFIG For all other models: SA
State Saved	Saved in instrument state
Backwards Compatibility SCPI	:INSTrument[:SElect] GSM provided for backwards compatibility. Mapped to EDGE GSM.
Backwards Compatibility SCPI	:INSTrument[:SElect] SANalyzer provided for ESU compatibility. When this command is received, the analyzer aliases it to the following: INST:SEL SCPI LC This results in the analyzer being placed in SCPI Language Compatibility Mode, in order to emulate

	the ESU Spectrum Analyzer Mode.
Backwards Compatibility SCPI	:INSTrument[:SElect] RECeiver provided for ESU compatibility. When this command is received, the analyzer aliases it to the following: :INST:SEL EMI :CONF FSC This results in the analyzer being placed in the EMI Receiver Mode, running the Frequency Scan measurement, in order to emulate the ESU Receiver Mode.
Initial S/W Revision	Prior to A.02.00
Modified at S/W Revision	A.13.00

Example	:INST 'SA'
Notes	The query is not a quoted string. It is an enumeration as indicated in the Instrument Select table above. The command must be sequential: i.e. continued parsing of commands cannot proceed until the instrument select is complete and the resultant SCPI trees are available.
Backwards Compatibility SCPI	:INSTrument[:SElect] 'SA' 'PNOISE' 'EDGE' 'GSM' 'BASIC'
Initial S/W Revision	Prior to A.02.00

More Information

The Mode name appears on the banner after the word “Agilent” followed by the Measurement Title. For example, for the Spectrum Analyzer mode with the Swept SA measurement running:



It is possible to specify the order in which the Modes appear in the Mode menu, using the Configure Applications utility (System, Power On, Configure Applications). It is also possible, using the same utility, to specify a subset of the available applications to load into memory at startup time, which can significantly decrease the startup time of the analyzer. During runtime, if an application that is not loaded into memory is selected (by either pressing that applications Mode key or sending that applications :INST:SEL command over SCPI), there will be a pause while the Application is loaded. During this pause a message box that says “Loading application, please wait...” is displayed.

Each application (Mode) that runs in the X-Series signal analyzers consumes virtual memory. The various applications consume varying amounts of virtual memory, and as more applications run, the memory consumption increases. Once an application is run, some of its memory remains allocated even when it is not running, and is not released until the analyzer program (xSA.exe) is shut down.

Agilent characterizes each Mode and assigns a memory usage quantity based on a conservative estimate. There is a limited amount of virtual memory available to applications (note that this is virtual memory and is independent of how much physical RAM is in the instrument). The instrument keeps track of how much

memory is being used by all loaded applications – which includes those that preloaded at startup, and all of those that have been run since startup.

When you request a Mode that is not currently loaded, the instrument looks up the memory estimate for that Mode, and adds it to the residual total for all currently loaded Modes. If there is not enough virtual memory to load the Mode, a dialog box and menu will appear that gives you four options:

1. Close and restart the analyzer program without changing your configured preloads. This may free up enough memory to load the requested Mode, depending on your configured preloads
2. Clear out all preloads and close and restart the analyzer program with only the requested application preloaded, and with that application running. This choice is guaranteed to allow you to run the requested application; but you will lose your previously configured preloads. In addition, there may be little or no room for other applications, depending on the size of the requested application.
3. Bring up the Configure Applications utility in order to reconfigure the preloaded apps to make room for the applications you want to run (this will then require restarting the analyzer program with your new configuration). This is the recommended choice because it gives you full flexibility to select exactly what you want.
4. Exit the dialog box without doing anything, which means you will be unable to load the application you requested.

In each case except 4, this will cause the analyzer software to close, and you will lose all unsaved traces and results.

If you attempt to load a mode via SCPI that will exceed memory capacity, the Mode does not load and an error message is returned:

```
-225,"Out of memory;Insufficient resources to load Mode (mode name)"
```

where “mode name” is the SCPI parameter for the Mode in question, for example, SA for Spectrum Analyzer Mode.

Spectrum Analyzer

Selects the Spectrum Analyzer mode for general purpose measurements. There are several measurements available in this mode. General spectrum analysis measurements, in swept and zero span, can be done using the first key in the Meas menu, labeled Swept SA. Other measurements in the Meas Menu are designed to perform specialized measurement tasks, including power and demod measurements.

If you are using the Help feature, this mode must be currently active to access its detailed information. If it is not active, exit the Help feature (Esc key), select the mode, and re-access Help.

Key Path	Mode
Example	INST:SEL SA INST:NSEL 1
Initial S/W Revision	Prior to A.02.00

DVB-T/H with T2

Selects the DVB-T/H mode for measurements of digital video signals using this format. There are several power and demod measurements available in this mode.

If you are using the Help feature, this mode must be currently active to access its detailed information. If it is not active, exit the Help feature (Esc key), select the mode, and re-access Help.

Key Path	Mode
Example	INST:SEL DVB INST:NSEL 235
Initial S/W Revision	A.02.00
Modified at S/W Revision	A.07.00

cdma2000

Selects the cdma2000 mode for general purpose measurements of signals following this standard. There are several measurements available in this mode.

If you are using the Help feature, this mode must be currently active to access its detailed information. If it is not active, exit the Help feature (Esc key), select the mode, and re-access Help.

Key Path	Mode
Example	INST:SEL CDMA2K INST:NSEL 10
Initial S/W Revision	Prior to A.02.00

Vector Signal Analyzer (VXA)

The N9064A (formerly 89601X) VXA Vector signal and WLAN modulation analysis application provides solutions for basic vector signal analysis, analog demodulation, and digital demodulation. The digital demodulation portion of N9064A allows you to perform measurements on standard-based formats such as cellular, wireless networking and digital video as well as general purpose flexible modulation analysis for wide range of digital formats, FSK to 1024QAM, with easy-to-use measurements and display tools such as constellation and eye diagram, EVM traces and up to four simultaneous displays. Analog baseband analysis is available using the MXA and PXA with option BBA. Option 3FP WLAN has been discontinued.

N9064A honors existing 89601X licenses with all features and functionalities found on X-Series software versions prior to A.06.00. Specifically:

N9064A-1 is equivalent to 89601X-205

N9064A-2 is equivalent to 89601X-AYA

If you are using the Help feature, this mode must be currently active to access its detailed information. If it is not active, exit the Help feature (Esc key), select the mode, and re-access Help.

Key Path	Mode
Example	INST:SEL VSA INST:NSEL 100
Initial S/W Revision	Prior to A.02.00

Analog Demod

Selects the Analog Demod mode for making measurements of AM, FM and phase modulated signals.

If you are using the Help feature, this mode must be currently active to access its detailed information. If it is not active, exit the Help feature (Esc key), select the mode, and re-access Help.

Key Path	Mode
Example	INST:SEL ADEMODO INST:NSEL 234
Initial S/W Revision	Prior to A.02.00

Phase Noise

The Phase Noise mode provides pre-configured measurements for making general purpose measurements of device phase noise.

If you are using the Help feature, this mode must be currently active to access its detailed information. If it is not active, exit the Help feature (Esc key), select the mode, and re-access Help.

Key Path	Mode
Example	INST:SEL PNOISE or INST:NSEL 14
Initial S/W Revision	Prior to A.02.00

CMMB

Selects the CMMB mode for measurements of digital video signals using this format. There are several power and demod measurements available in this mode.

If you are using the Help feature, this mode must be currently active to access its detailed information. If it is not active, exit the Help feature (Esc key), select the mode, and re-access Help.

Key Path	Mode
Example	INST:SEL CMMB INST:NSEL 240
Initial S/W Revision	A.03.00

Combined WLAN

Selects the CWLAN mode for general purpose measurements of signals following this standard. There are several measurements available in this mode.

If you are using the Help feature, this mode must be currently active to access its detailed information. If it is not active, exit the Help feature (Esc key), select the mode, and re-access Help.

Key Path	Mode
Example	INST:SEL CWLAN INST:NSEL 19
Initial S/W Revision	A.02.00

TD-SCDMA with HSPA/8PSK

Selects the TD-SCDMA mode for general purpose measurements of signals following this standard. There are several measurements available in this mode.

If you are using the Help feature, this mode must be currently active to access its detailed information. If it is not active, exit the Help feature (Esc key), select the mode, and re-access Help.

Key Path	Mode
Example	INST:SEL TDSCDMA INST:NSEL 211
Initial S/W Revision	Prior to A.02.00

IQ Analyzer (Basic)

The IQ Analyzer Mode makes general purpose frequency domain and time domain measurements. These measurements often use alternate hardware signal paths when compared with a similar measurement in the Signal Analysis Mode using the Swept SA measurement. These frequency domain and time domain measurements can be used to output I/Q data results when measuring complex modulated digital signals.

If you are using the Help feature, this mode must be currently active to access its detailed information. If it is not active, exit the Help feature (Esc key), select the mode, and re-access Help.

Key Path	Mode
Example	INST:SEL BASIC INST:NSEL 8
Initial S/W Revision	Prior to A.02.00

W-CDMA with HSPA+

Selects the W-CDMA with HSPA+ mode for general purpose measurements of signals following this standard. There are several measurements available in this mode.

If you are using the Help feature, this mode must be currently active to access its detailed information. If it is not active, exit the Help feature (Esc key), select the mode, and re-access Help.

Key Path	Mode
Example	INST:SEL WCDMA INST:NSEL 9
Initial S/W Revision	Prior to A.02.00

GSM/EDGE/EDGE Evo

Selects the GSM with EDGE mode for general purpose measurements of signals following this standard. There are several measurements available in this mode.

If you are using the Help feature, this mode must be currently active to access its detailed information. If it is not active, exit the Help feature (Esc key), select the mode, and re-access Help.

Key Path	Mode
Example	INST:SEL EDGE GSM INST:NSEL 13
Initial S/W Revision	Prior to A.02.00
Modified at S/W Revision	A.02.00

Noise Figure

The Noise Figure mode provides pre-configured measurements for making general purpose measurements of device noise figure.

If you are using the Help feature, this mode must be currently active to access its detailed information. If it is not active, exit the Help feature (Esc key), select the mode, and re-access Help.

Key Path	Mode
Example	INST:SEL NFIGURE INST:NSEL 219
Initial S/W Revision	Prior to A.02.00

WLAN

Selects the WLAN mode for general purpose measurements of signals following this standard. There are several measurements available in this mode.

If you are using the Help feature, this mode must be currently active to access its detailed information. If it is not active, exit the Help feature (Esc key), select the mode, and re-access Help.

Key Path	Mode
Example	INST:SEL WLAN INST:NSEL 217
Initial S/W Revision	A.09.491

EMI Receiver

The EMI Receiver Mode makes EMC measurements. Several measurements are provided to aid the user in characterizing EMC performance of their systems, including looking at signals with CISPR-16 compliant detectors, performing scans for interfering signals, and determining and charting interfering signals over time.

If you are using the Help feature, this mode must be currently active to access its detailed information. If it is not active, exit the Help feature (Esc key), select the mode, and re-access Help.

Key Path	Mode
Example	INST:SEL EMI INST:NSEL 141
Initial S/W Revision	A.07.01

802.16 OFDM (Fixed WiMAX)

Selects the 802.16 OFDM (Fixed WiMAX) mode. This mode allows modulation quality measurements of signals that comply with IEEE 802.16a-2003 and IEEE 802.16-2004 standards, with flexibility to measure nonstandard OFDM formats. Along with the typical digital demodulation measurement results, several additional 802.16 OFDM unique trace data formats and numeric error data results provide enhanced data analysis.

If you are using the Help feature, this mode must be currently active to access its detailed information. If it is not active, exit the Help feature (Esc key), select the mode, and re-access Help.

Key Path	Mode
Example	INST:SEL WIMAXFIXED INST:NSEL 104
Initial S/W Revision	A.02.00

DTMB (CTTB)

Selects the DTMB (CTTB) mode for measurements of digital video signals using this format. There are several power and demod measurements available in this mode.

If you are using the Help feature, this mode must be currently active to access its detailed information. If it is not active, exit the Help feature (Esc key), select the mode, and re-access Help.

Key Path	Mode
Example	INST:SEL DTMB INST:NSEL 236
Initial S/W Revision	A.02.00

1xEV-DO

Selects the 1xEV-DO mode for general purpose measurements of signals following this standard. There are several measurements available in this mode.

If you are using the Help feature, this mode must be currently active to access its detailed information. If it is not active, exit the Help feature (Esc key), select the mode, and re-access Help.

Key Path	Mode
Example	INST:SEL CDMA1XEV INST:NSEL 15
Initial S/W Revision	Prior to A.02.00

802.16 OFDMA (WiMAX/WiBro)

Selects the OFDMA mode for general purpose measurements of WiMAX signals. There are several measurements available in this mode.

If you are using the Help feature, this mode must be currently active to access its detailed information. If it is not active, exit the Help feature (Esc key), select the mode, and re-access Help.

Key Path	Mode
Example	INST:SEL WIMAXOFDMA INST:NSEL 75
Initial S/W Revision	Prior to A.02.00

89601 VSA

Selecting the 89601 VSA mode will start the 89600 VSA software. The 89600 VSA software is powerful, PC-based software, offering the industry's most sophisticated general purpose and standards specific signal evaluation and troubleshooting tools for R&D engineers. Even for proprietary and non-standard signals in SATCOM or MILCOM applications, you can make signal quality measurements with customized IQ constellation. Reach deeper into signals, gather more data on signal problems, and gain greater insight.

- Over 35 general-purpose analog and digital demodulators ranging from 2FSK to 4096QAM

- Flexible and custom IQ and OFDM signal analysis for single carrier
- Standards specific modulation analysis including:
 - Cellular: GSM/EDGE, cdma2000, W-CDMA, TD-SCDMA, LTE(FDD/TDD),
 - LTE-Advanced and more
 - Wireless networking: 802.11a/b/g, 802.11n, 802.ac, 802.16 WiMAX (fixed/mobile), WiSUN (MR-FSK PHY)
 - RFID
 - Digital satellite video and other satellite signals, radar, LMDS
 - Up to 400K bin FFT, for the highest resolution spectrum analysis
 - A full suite of time domain analysis tools, including signal capture and playback, time gating, and CCDF measurements
 - 20 simultaneous trace displays and the industry's most complete set of marker functions
 - Easy-to-use Microsoft ® Windows ® graphical user interface

For more information see the Agilent 89600 Series VSA web site at www.agilent.com/find/89600vsa

To learn more about how to use the 89600 VSA running in the X-Series, after the 89600 VSA software is running, open the 89600 VSA Help and open the "About Agilent X-Series Signal Analyzer with 89600 VSA Software" help topic.

Key Path	Mode
Example	INST:SEL VSA89601 INST:NSEL 101
Initial S/W Revision	Prior to A.02.00

MSR

Selects the MSR mode. The MSR mode makes several measurements for Cellular Communication devices that can be configured with multiple radio formats simultaneously following the 3GPP standard of Multi-Standard Radio, including GSM/EDGE, WCDMA/HSPA+ and LTE.

If you are using the Help feature, this mode must be currently active to access its detailed information. If it is not active, exit the Help feature (Esc key), select the mode, and re-access Help.

Key Path	Mode
Example	INST:SEL MSR INST:NSEL 106
Initial S/W Revision	A.09.491

Bluetooth

Selects the Bluetooth mode for Bluetooth specific measurements. There are several measurements available in this mode.

If you are using the Help feature, this mode must be currently active to access its detailed information. If it is not active, exit the Help feature (Esc key), select the mode, and re-access Help.

Key Path	Mode
Example	INST:SEL BT INST:NSEL 228
Initial S/W Revision	A.06.01

LTE

Selects the LTE mode for general purpose measurements of signals following the LTE FDD standard. There are several measurements available in this mode.

If you are using the Help feature, this mode must be currently active to access its detailed information. If it is not active, exit the Help feature (Esc key), select the mode, and re-access Help.

Key Path	Mode
Example	INST:SEL LTE INST:NSEL 102
Initial S/W Revision	Prior to A.02.00

SCPI Language Compatibility

The SCPI Language Compatibility mode provides remote language compatibility for SCPI-based instruments, such as the Rohde and Schwartz FSP and related series of spectrum analyzers.

NOTE After changing into or out of this mode, allow a 1 second delay before sending any subsequent commands.

If you are using the Help feature, this mode must be currently active to access its detailed information. If it is not active, exit the Help feature (Esc key), select the mode, and re-access Help.

Key Path	Mode
Example	INST:SEL SCPI LC Or INST:NSEL 270
Initial S/W Revision	A.06.00

Combined Fixed WiMAX

Selects the Combined Fixed WiMAX mode for general purpose measurements of signals following this standard. There are several measurements available in this mode.

If you are using the Help feature, this mode must be currently active to access its detailed information. If it is not active, exit the Help feature (Esc key), select the mode, and re-access Help.

Key Path	Mode
Example	INST:SEL CWIMAXOFDM INST:NSEL 81
Initial S/W Revision	A.02.00

ISDB-T

Selects the ISDB-T mode for measurements of digital video signals using this format. There are several power and demod measurements available in this mode.

If you are using the Help feature, this mode must be currently active to access its detailed information. If it is not active, exit the Help feature (Esc key), select the mode, and re-access Help.

Key Path	Mode
Example	INST:SEL ISDBT INST:NSEL 239
Initial S/W Revision	A.03.00

Digital Cable TV

Selects the Digital Cable TV mode for measurements of digital cable television systems. There are several power and demod measurements available in this mode.

If you are using the Help feature, this mode must be currently active to access its detailed information. If it is not active, exit the Help feature (Esc key), select the mode, and re-access Help.

Key Path	Mode
Example	INST:SEL DCATV INST:NSEL 238
Initial S/W Revision	A.07.00

LTE TDD

Selects the LTE TDD mode for general purpose measurements of signals following the LTE TDD standard. There are several measurements available in this mode.

If you are using the Help feature, this mode must be currently active to access its detailed information. If it is not active, exit the Help feature (Esc key), select the mode, and re-access Help.

Key Path	Mode
Example	INST:SEL LTETDD INST:NSEL 105
Initial S/W Revision	A.03.00

Remote Language Compatibility

The Remote Language Compatibility (RLC) mode provides remote command backwards compatibility for the 8560 series of spectrum analyzers, known as legacy spectrum analyzers.

NOTE After changing into or out of this mode, allow a 1 second delay before sending any subsequent commands.

If you are using the Help feature, this mode must be currently active to access its detailed information. If it is not active, exit the Help feature (Esc key), select the mode, and re-access Help.

Key Path	Mode
Example	INST:SEL RLC Or INST:NSEL 266
Initial S/W Revision	Prior to A.02.00

iDEN/WiDEN/MOTOTalk

Selects the iDEN/WiDEN/MOTOTalk mode for general purpose measurements of iDEN and iDEN-related signals. There are several measurements available in this mode.

If you are using the Help feature, this mode must be currently active to access its detailed information. If it is not active, exit the Help feature (Esc key), select the mode, and re-access Help.

Key Path	Mode
Example	INST:SEL IDEN INST:NSEL 103
Initial S/W Revision	A.02.00

Application Mode Number Selection (Remote Command Only)

Select the measurement mode by its mode number. The actual available choices depend upon which applications are installed in your instrument. The modes appear in this table in the same order they appear in the Mode menu (if the order is not changed by the Configure Applications utility found in the System, Power On menu). See "[Detailed List of Modes](#)" on page 303 for Mode details.

The Mode Number is the parameter for use with the :INSTrument:NSElect command. The Mode Parameter is the parameter for use with the :INSTrument[:SElect] command.

Mode	Mode Number	Mode Parameter
Spectrum Analyzer	1	SA
Real Time Spectrum Analyzer	107	RTSA
Sequence Analyzer	400	SEQAN
EMI Receiver	141	EMI
I/Q Analyzer (Basic)	8	BASIC
WCDMA with HSPA+	9	WCDMA
GSM/EDGE/EDGE Evo	13	EDGE GSM
802.16 OFDMA (WiMAX/WiBro)	75	WIMAX OFDMA
Vector Signal Analyzer (VXA)	100	VSA
Phase Noise	14	PNOISE
Noise Figure	219	NFIGure
Analog Demod	234	ADEM0D
Bluetooth	228	BT00th
TD-SCDMA with HSPA/8PSK	211	TDSCDMA
cdma2000	10	CDMA2K
1xEV-DO	15	CDMA1XEV
LTE	102	LTE
LTE TDD	105	LTETDD
LTE-Advanced FDD	107	LTEAFDD
LTE-Advanced TDD	108	LTEATDD
MSR	106	MSR
DVB-T/H with T2	235	DVB
DTMB (CTTB)	236	DTMB
Digital Cable TV	238	DCATV
ISDB-T	239	ISDBT
CMMB	240	CMMB
WLAN	217	WLAN
Combined WLAN	19	CWLAN
Combined Fixed WiMAX	81	CWIMAX OFDM
802.16 OFDM (Fixed WiMAX)	104	WIMAX FIXED
iDEN/WiDEN/MotoTalk	103	IDEN
Remote Language Compatibility	266	RLC
SCPI Language Compatibility	270	SCPILC
89601 VSA	101	VSA89601

Remote Command	:INSTrument:NSElect <integer> :INSTrument:NSElect?
Example	:INST:NSEL 1
Notes	SA mode is 1 The command must be sequential: i.e. continued parsing of commands cannot proceed until the instrument select is complete and the resultant SCPI trees are available.
Preset	Not affected by Preset. Set to default mode (1 for SA mode) following Restore System Defaults.
State Saved	Saved in instrument state
Initial S/W Revision	Prior to A.02.00

Application Mode Catalog Query (Remote Command Only)

Returns a string containing a comma separated list of names of all the installed and licensed measurement modes (applications). These names can only be used with the :INSTrument[:SElect] command.

Remote Command	:INSTrument:CATalog?
Example	:INST:CAT?
Notes	Query returns a quoted string of the installed and licensed modes separated with a comma. Example: "SA,PNOISE,WCDMA"
Backwards Compatibility Notes	VSA (E4406A) :INSTrument:CATalog? returned a list of installed INSTrument:SELECT items as a comma separated list of string values: "BASIC", "GSM", "EDGE GSM", "CDMA", "NADC", "PDC", "WCDMA", "CDMA2K", "CDMA1XEV", "IDEN", "WIDEN", "WLAN", "SERVICE" X-Series uses the ESA/PSA compatible query of a string contain comma separated values: "SA,PNOISE,NFIGURE,BASIC,CDMA,CDMA2K,WCDMA,CDMA1XEV,EDGE GSM,GSM,NADC,PDC,TDSCDMA,DMODULATION,WLAN"
Initial S/W Revision	Prior to A.02.00

Application Identification (Remote Commands Only)

Each entry in the Mode Menu will have a Model Number and associated information: Version, and Options. This information is displayed in the Show System screen. The corresponding SCPI remote commands are defined here.

"Current Application Model " on page 301

"Current Application Revision" on page 301

"Current Application Options" on page 301

Current Application Model

Returns a string that is the Model Number of the currently selected application (mode).

Remote Command	:SYSTem:APPLication[:CURRent][:NAME]?
Example	:SYST:APPL?
Notes	Query returns a quoted string that is the Model Number of the currently selected application (Mode). Example: "N9060A" String length is 6 characters.
Preset	Not affected by Preset
State Saved	Not saved in state, the value will be the selected application when a Save is done.
Initial S/W Revision	Prior to A.02.00

Current Application Revision

Returns a string that is the Revision of the currently selected application (mode).

Remote Command	:SYSTem:APPLication[:CURRent]:REVision?
Example	:SYST:APPL:REV?
Notes	Query returns a quoted string that is the Revision of the currently selected application (Mode). Example: "1.0.0.0" String length is a maximum of 23 characters. (each numeral can be an integer + 3 decimal points)
Preset	Not affected by a Preset
State Saved	Not saved in state, the value will be the selected application when a Save is done.
Initial S/W Revision	Prior to A.02.00

Current Application Options

Returns a string that is the Options list of the currently selected application (Mode).

Remote Command	:SYSTem:APPLication[:CURRent]:OPTion?
Example	:SYST:APPL:OPT?
Notes	Query returns a quoted string that is the Option list of the currently selected application (Mode). The format is the name as the *OPT? or SYSTem:OPTion command: a comma separated list of option identifiers. Example: "1FP,2FP" String length is a maximum of 255 characters.

Preset	Not affected by a Preset
State Saved	Not saved in state per se, the value will be the selected application when a Save is invoked.
Initial S/W Revision	Prior to A.02.00

Application Identification Catalog (Remote Commands Only)

A catalog of the installed and licensed applications (Modes) can be queried for their identification.

"Application Catalog Number of Entries" on page 302

"Application Catalog Model Numbers" on page 302

"Application Catalog Revision" on page 302

"Application Catalog Options" on page 303

Application Catalog Number of Entries

Returns the number of installed and licensed applications (Modes).

Remote Command	:SYSTem:APPLication:CATalog[:NAME]:COUNT?
Example	:SYST:APPL:CAT:COUN?
Preset	Not affected by Preset
State Saved	Not saved in instrument state.
Initial S/W Revision	Prior to A.02.00

Application Catalog Model Numbers

Returns a list of Model Numbers for the installed and licensed applications (Modes).

Remote Command	:SYSTem:APPLication:CATalog[:NAME]?
Example	:SYST:APPL:CAT?
Notes	Returned value is a quoted string of a comma separated list of Model Numbers. Example, if SAMS and Phase Noise are installed and licensed: "N9060A,N9068A" String length is COUNT * 7 - 1. (7 = Model Number length + 1 for comma. -1 = no comma for the 1st entry.)
Preset	Not affected by a Preset
State Saved	Not saved in instrument state.
Initial S/W Revision	Prior to A.02.00

Application Catalog Revision

Returns the Revision of the provided Model Number.

Remote Command	:SYSTem:APPLication:CATalog:REVision? <model>
Example	:SYST:APPL:CAT:REV? 'N9060A'
Notes	Returned value is a quoted string of revision for the provided Model Number. The revision will be a null-string ("") if the provided Model Number is not installed and licensed. Example, if SAMS is installed and licensed: "1.0.0.0"
Preset	Not affected by a Preset.
State Saved	Not saved in instrument state.
Initial S/W Revision	Prior to A.02.00

Application Catalog Options

Returns a list of Options for the provided Model Number

Remote Command	:SYSTem:APPLication:CATalog:OPTion? <model>
Example	:SYST:APPL:CAT:OPT? 'N9060A'
Notes	Returned value is a quoted string of a comma separated list of Options, in the same format as *OPT? or :SYSTem:OPTion?. If the provided Model Number is not installed and licensed a null-string ("") will be returned. Example, if SAMS is installed and licensed: "2FP" String length is a maximum of 255 characters.
Preset	Not affected by a Preset
State Saved	Not saved in instrument state.
Initial S/W Revision	Prior to A.02.00

Detailed List of Modes

This section contains an alphabetical list of Modes available in the X-Series, along with a brief description of each Mode.

Note that with the exception of the 89601 VSA, only licensed applications appear in the Mode menu. The 89601 will always appear, because it's licensing is handled differently.

1xEV-DO

Selects the 1xEV-DO mode for general purpose measurements of signals following this standard. There are several measurements available in this mode.

If you are using the Help feature, this mode must be currently active to access its detailed information. If it is not active, exit the Help feature (Esc key), select the mode, and re-access Help.

Key Path	Mode
----------	------

Example	INST:SEL CDMA1XEV INST:NSEL 15
Initial S/W Revision	Prior to A.02.00

802.16 OFDMA (WiMAX/WiBro)

Selects the OFDMA mode for general purpose measurements of WiMAX signals. There are several measurements available in this mode.

If you are using the Help feature, this mode must be currently active to access its detailed information. If it is not active, exit the Help feature (Esc key), select the mode, and re-access Help.

Key Path	Mode
Example	INST:SEL WIMAXOFDMA INST:NSEL 75
Initial S/W Revision	Prior to A.02.00

802.16 OFDM (Fixed WiMAX)

Selects the 802.16 OFDM (Fixed WiMAX) mode. This mode allows modulation quality measurements of signals that comply with IEEE 802.16a–2003 and IEEE 802.16–2004 standards, with flexibility to measure nonstandard OFDM formats. Along with the typical digital demodulation measurement results, several additional 802.16 OFDM unique trace data formats and numeric error data results provide enhanced data analysis.

If you are using the Help feature, this mode must be currently active to access its detailed information. If it is not active, exit the Help feature (Esc key), select the mode, and re-access Help.

Key Path	Mode
Example	INST:SEL WIMAXFIXED INST:NSEL 104
Initial S/W Revision	A.02.00

89601 VSA

Selecting the 89601 VSA mode will start the 89600 VSA software. The 89600 VSA software is powerful, PC-based software, offering the industry's most sophisticated general purpose and standards specific signal evaluation and troubleshooting tools for R&D engineers. Even for proprietary and non-standard signals in SATCOM or MILCOM applications, you can make signal quality measurements with customized IQ constellation. Reach deeper into signals, gather more data on signal problems, and gain greater insight.

- Over 35 general-purpose analog and digital demodulators ranging from 2FSK to 4096QAM
- Flexible and custom IQ and OFDM signal analysis for single carrier

- Standards specific modulation analysis including:
 - Cellular: GSM/EDGE, cdma2000, W-CDMA, TD-SCDMA, LTE(FDD/TDD),
 - LTE-Advanced and more
 - Wireless networking: 802.11a/b/g, 802.11n, 802.ac, 802.16 WiMAX (fixed/mobile), WiSUN (MR-FSK PHY)
 - RFID
 - Digital satellite video and other satellite signals, radar, LMDS
 - Up to 400K bin FFT, for the highest resolution spectrum analysis
 - A full suite of time domain analysis tools, including signal capture and playback, time gating, and CCDF measurements
 - 20 simultaneous trace displays and the industry's most complete set of marker functions
 - Easy-to-use Microsoft ® Windows ® graphical user interface

For more information see the Agilent 89600 Series VSA web site at www.agilent.com/find/89600vsa

To learn more about how to use the 89600 VSA running in the X-Series, after the 89600 VSA software is running, open the 89600 VSA Help and open the "About Agilent X-Series Signal Analyzer with 89600 VSA Software" help topic.

Key Path	Mode
Example	INST:SEL VSA89601 INST:NSEL 101
Initial S/W Revision	Prior to A.02.00

Analog Demod

Selects the Analog Demod mode for making measurements of AM, FM and phase modulated signals.

If you are using the Help feature, this mode must be currently active to access its detailed information. If it is not active, exit the Help feature (Esc key), select the mode, and re-access Help.

Key Path	Mode
Example	INST:SEL ADEMODO INST:NSEL 234
Initial S/W Revision	Prior to A.02.00

Bluetooth

Selects the Bluetooth mode for Bluetooth specific measurements. There are several measurements available in this mode.

If you are using the Help feature, this mode must be currently active to access its detailed information. If it is not active, exit the Help feature (Esc key), select the mode, and re-access Help.

Key Path	Mode
Example	INST:SEL BT INST:NSEL 228
Initial S/W Revision	A.06.01

cdma2000

Selects the cdma2000 mode for general purpose measurements of signals following this standard. There are several measurements available in this mode.

If you are using the Help feature, this mode must be currently active to access its detailed information. If it is not active, exit the Help feature (Esc key), select the mode, and re-access Help.

Key Path	Mode
Example	INST:SEL CDMA2K INST:NSEL 10
Initial S/W Revision	Prior to A.02.00

CMMB

Selects the CMMB mode for measurements of digital video signals using this format. There are several power and demod measurements available in this mode.

If you are using the Help feature, this mode must be currently active to access its detailed information. If it is not active, exit the Help feature (Esc key), select the mode, and re-access Help.

Key Path	Mode
Example	INST:SEL CMMB INST:NSEL 240
Initial S/W Revision	A.03.00

Combined WLAN

Selects the CWLAN mode for general purpose measurements of signals following this standard. There are several measurements available in this mode.

If you are using the Help feature, this mode must be currently active to access its detailed information. If it is not active, exit the Help feature (Esc key), select the mode, and re-access Help.

Key Path	Mode
Example	INST:SEL CWLAN

	INST:NSEL 19
Initial S/W Revision	A.02.00

Combined Fixed WiMAX

Selects the Combined Fixed WiMAX mode for general purpose measurements of signals following this standard. There are several measurements available in this mode.

If you are using the Help feature, this mode must be currently active to access its detailed information. If it is not active, exit the Help feature (Esc key), select the mode, and re-access Help.

Key Path	Mode
Example	INST:SEL CWIMAXOFDM INST:NSEL 81
Initial S/W Revision	A.02.00

Digital Cable TV

Selects the Digital Cable TV mode for measurements of digital cable television systems. There are several power and demod measurements available in this mode.

If you are using the Help feature, this mode must be currently active to access its detailed information. If it is not active, exit the Help feature (Esc key), select the mode, and re-access Help.

Key Path	Mode
Example	INST:SEL DCATV INST:NSEL 238
Initial S/W Revision	A.07.00

DTMB (CTTB)

Selects the DTMB (CTTB) mode for measurements of digital video signals using this format. There are several power and demod measurements available in this mode.

If you are using the Help feature, this mode must be currently active to access its detailed information. If it is not active, exit the Help feature (Esc key), select the mode, and re-access Help.

Key Path	Mode
Example	INST:SEL DTMB INST:NSEL 236
Initial S/W Revision	A.02.00

DVB-T/H with T2

Selects the DVB-T/H mode for measurements of digital video signals using this format. There are several power and demod measurements available in this mode.

If you are using the Help feature, this mode must be currently active to access its detailed information. If it is not active, exit the Help feature (Esc key), select the mode, and re-access Help.

Key Path	Mode
Example	INST:SEL DVB INST:NSEL 235
Initial S/W Revision	A.02.00
Modified at S/W Revision	A.07.00

EMI Receiver

The EMI Receiver Mode makes EMC measurements. Several measurements are provided to aid the user in characterizing EMC performance of their systems, including looking at signals with CISPR-16 compliant detectors, performing scans for interfering signals, and determining and charting interfering signals over time.

If you are using the Help feature, this mode must be currently active to access its detailed information. If it is not active, exit the Help feature (Esc key), select the mode, and re-access Help.

Key Path	Mode
Example	INST:SEL EMI INST:NSEL 141
Initial S/W Revision	A.07.01

GSM/EDGE/EDGE Evo

Selects the GSM with EDGE mode for general purpose measurements of signals following this standard. There are several measurements available in this mode.

If you are using the Help feature, this mode must be currently active to access its detailed information. If it is not active, exit the Help feature (Esc key), select the mode, and re-access Help.

Key Path	Mode
Example	INST:SEL EDGE GSM INST:NSEL 13
Initial S/W Revision	Prior to A.02.00
Modified at S/W Revision	A.02.00

iDEN/WiDEN/MOTOTalk

Selects the iDEN/WiDEN/MOTOTalk mode for general purpose measurements of iDEN and iDEN-related signals. There are several measurements available in this mode.

If you are using the Help feature, this mode must be currently active to access its detailed information. If it is not active, exit the Help feature (Esc key), select the mode, and re-access Help.

Key Path	Mode
Example	INST:SEL IDEN INST:NSEL 103
Initial S/W Revision	A.02.00

IQ Analyzer (Basic)

The IQ Analyzer Mode makes general purpose frequency domain and time domain measurements. These measurements often use alternate hardware signal paths when compared with a similar measurement in the Signal Analysis Mode using the Swept SA measurement. These frequency domain and time domain measurements can be used to output I/Q data results when measuring complex modulated digital signals.

If you are using the Help feature, this mode must be currently active to access its detailed information. If it is not active, exit the Help feature (Esc key), select the mode, and re-access Help.

Key Path	Mode
Example	INST:SEL BASIC INST:NSEL 8
Initial S/W Revision	Prior to A.02.00

ISDB-T

Selects the ISDB-T mode for measurements of digital video signals using this format. There are several power and demod measurements available in this mode.

If you are using the Help feature, this mode must be currently active to access its detailed information. If it is not active, exit the Help feature (Esc key), select the mode, and re-access Help.

Key Path	Mode
Example	INST:SEL ISDBT INST:NSEL 239
Initial S/W Revision	A.03.00

LTE

Selects the LTE mode for general purpose measurements of signals following the LTE FDD standard. There are several measurements available in this mode.

If you are using the Help feature, this mode must be currently active to access its detailed information. If it is not active, exit the Help feature (Esc key), select the mode, and re-access Help.

Key Path	Mode
Example	INST:SEL LTE INST:NSEL 102
Initial S/W Revision	Prior to A.02.00

LTE TDD

Selects the LTE TDD mode for general purpose measurements of signals following the LTE TDD standard. There are several measurements available in this mode.

If you are using the Help feature, this mode must be currently active to access its detailed information. If it is not active, exit the Help feature (Esc key), select the mode, and re-access Help.

Key Path	Mode
Example	INST:SEL LTETDD INST:NSEL 105
Initial S/W Revision	A.03.00

MSR

Selects the MSR mode. The MSR mode makes several measurements for Cellular Communication devices that can be configured with multiple radio formats simultaneously following the 3GPP standard of Multi-Standard Radio, including GSM/EDGE, WCDMA/HSPA+ and LTE.

If you are using the Help feature, this mode must be currently active to access its detailed information. If it is not active, exit the Help feature (Esc key), select the mode, and re-access Help.

Key Path	Mode
Example	INST:SEL MSR INST:NSEL 106
Initial S/W Revision	A.09.491

Noise Figure

The Noise Figure mode provides pre-configured measurements for making general purpose measurements of device noise figure.

If you are using the Help feature, this mode must be currently active to access its detailed information. If it is not active, exit the Help feature (Esc key), select the mode, and re-access Help.

Key Path	Mode
----------	------

Example	INST:SEL NFIGURE INST:NSEL 219
Initial S/W Revision	Prior to A.02.00

Phase Noise

The Phase Noise mode provides pre-configured measurements for making general purpose measurements of device phase noise.

If you are using the Help feature, this mode must be currently active to access its detailed information. If it is not active, exit the Help feature (Esc key), select the mode, and re-access Help.

Key Path	Mode
Example	INST:SEL PNOISE or INST:NSEL 14
Initial S/W Revision	Prior to A.02.00

Remote Language Compatibility

The Remote Language Compatibility (RLC) mode provides remote command backwards compatibility for the 8560 series of spectrum analyzers, known as legacy spectrum analyzers.

NOTE After changing into or out of this mode, allow a 1 second delay before sending any subsequent commands.

If you are using the Help feature, this mode must be currently active to access its detailed information. If it is not active, exit the Help feature (Esc key), select the mode, and re-access Help.

Key Path	Mode
Example	INST:SEL RLC Or INST:NSEL 266
Initial S/W Revision	Prior to A.02.00

SCPI Language Compatibility

The SCPI Language Compatibility mode provides remote language compatibility for SCPI-based instruments, such as the Rohde and Schwartz FSP and related series of spectrum analyzers.

NOTE After changing into or out of this mode, allow a 1 second delay before sending any subsequent commands.

If you are using the Help feature, this mode must be currently active to access its detailed information. If it is not active, exit the Help feature (Esc key), select the mode, and re-access Help.

Key Path	Mode
Example	INST:SEL SCPI LC Or INST:NSEL 270
Initial S/W Revision	A.06.00

Spectrum Analyzer

Selects the Spectrum Analyzer mode for general purpose measurements. There are several measurements available in this mode. General spectrum analysis measurements, in swept and zero span, can be done using the first key in the Meas menu, labeled Swept SA. Other measurements in the Meas Menu are designed to perform specialized measurement tasks, including power and demod measurements.

If you are using the Help feature, this mode must be currently active to access its detailed information. If it is not active, exit the Help feature (Esc key), select the mode, and re-access Help.

Key Path	Mode
Example	INST:SEL SA INST:NSEL 1
Initial S/W Revision	Prior to A.02.00

TD-SCDMA with HSPA/8PSK

Selects the TD-SCDMA mode for general purpose measurements of signals following this standard. There are several measurements available in this mode.

If you are using the Help feature, this mode must be currently active to access its detailed information. If it is not active, exit the Help feature (Esc key), select the mode, and re-access Help.

Key Path	Mode
Example	INST:SEL TDSCDMA INST:NSEL 211
Initial S/W Revision	Prior to A.02.00

Vector Signal Analyzer (VXA)

The N9064A (formerly 89601X) VXA Vector signal and WLAN modulation analysis application provides solutions for basic vector signal analysis, analog demodulation, and digital demodulation. The digital demodulation portion of N9064A allows you to perform measurements on standard-based formats such as cellular, wireless networking and digital video as well as general purpose flexible modulation analysis for wide range of digital formats, FSK to 1024QAM, with easy-to-use measurements and display tools such as

constellation and eye diagram, EVM traces and up to four simultaneous displays. Analog baseband analysis is available using the MXA and PXA with option BBA. Option 3FP WLAN has been discontinued.

N9064A honors existing 89601X licenses with all features and functionalities found on X-Series software versions prior to A.06.00. Specifically:

N9064A-1 is equivalent to 89601X-205

N9064A-2 is equivalent to 89601X-AYA

If you are using the Help feature, this mode must be currently active to access its detailed information. If it is not active, exit the Help feature (Esc key), select the mode, and re-access Help.

Key Path	Mode
Example	INST:SEL VSA INST:NSEL 100
Initial S/W Revision	Prior to A.02.00

W-CDMA with HSPA+

Selects the W-CDMA with HSPA+ mode for general purpose measurements of signals following this standard. There are several measurements available in this mode.

If you are using the Help feature, this mode must be currently active to access its detailed information. If it is not active, exit the Help feature (Esc key), select the mode, and re-access Help.

Key Path	Mode
Example	INST:SEL WCDMA INST:NSEL 9
Initial S/W Revision	Prior to A.02.00

WLAN

Selects the WLAN mode for general purpose measurements of signals following this standard. There are several measurements available in this mode.

If you are using the Help feature, this mode must be currently active to access its detailed information. If it is not active, exit the Help feature (Esc key), select the mode, and re-access Help.

Key Path	Mode
Example	INST:SEL WLAN INST:NSEL 217
Initial S/W Revision	A.09.491

Global Settings

Opens a menu that allows you to switch certain Meas Global parameters to a Mode Global state. These switches apply to all Modes that support global settings. No matter what Mode you are in when you set the “Global Center Frequency” switch to on, it applies to all Modes that support Global Settings.

Key Path	Mode Setup
Initial S/W Revision	Prior to A.02.00

Global Center Freq

The software maintains a Mode Global value called “Global Center Freq”.

When the Global Center Freq key is switched to On in any mode, the current mode’s center frequency is copied into the Global Center Frequency, and from then on all modes that support global settings use the Global Center Frequency. So you can switch between any of these modes and the Center Freq will remain unchanged.

Adjusting the Center Freq of any mode which supports Global Settings, while Global Center Freq is On, will modify the Global Center Frequency.

When Global Center Freq is turned Off, the Center Freq of the current mode is unchanged, but now the Center Freq of each mode is once again independent.

When Mode Preset is pressed while Global Center Freq is On, the Global Center Freq is preset to the preset Center Freq of the current mode.

This function is reset to Off when the Restore Defaults key is pressed in the Global Settings menu, or when System, Restore Defaults, All Modes is pressed.

Key Path	Mode Setup, Global Settings
Scope	Mode Global
Remote Command	:INSTRument:COUPle:FREQuency:CENTer ALL NONE :INSTRument:COUPle:FREQuency:CENTer?
Example	INST:COUP:FREQ:CENT ALL INST:COUP:FREQ:CENT?
Preset	Set to Off on Global Settings, Restore Defaults and System, Restore Defaults, All Modes
Range	On Off
Initial S/W Revision	Prior to A.02.00

Remote Command	:GLOBal:FREQuency:CENTer[:STATe] 1 0 ON OFF :GLOBal:FREQuency:CENTer[:STATe]?
Preset	Off
Initial S/W Revision	Prior to A.02.00

Restore Defaults

This key resets all of the functions in the Global Settings menu to Off. This also occurs when System, Restore Defaults, All Modes is pressed.

Key Path	Mode Setup, Global Settings
Remote Command	:INSTrument:COUPle:DEFault
Example	INST:COUP:DEF
Backwards Compatibility SCPI	:GLOBal:DEFault
Initial S/W Revision	Prior to A.02.00

Mode Setup

Enables you to select mode parameters. These settings are available for all measurements in the current mode.

Key Path	Front panel
----------	-------------

Radio Device

Allows you to specify the device to be used.

Key Path	Mode Setup
Mode	WIMAXOFDMA
Scope	Meas Global
Remote Command	<code>[:SENSe] :RADio:STANdard:DEVIce BTS MS</code> <code>[:SENSe] :RADio:STANdard:DEVIce?</code>
Example	<code>RAD:STAN:DEV BTS</code> <code>RAD:STAN:DEV?</code>
Notes	Radio device BTS is called BS in the WiMAX-OFDMA mode. BS is used in the front panel and BTS is used for the remote command.
Preset	BTS
State Saved	Saved in instrument state.
Range	BS MS
Initial S/W Revision	Prior to A.02.00

Radio Standard

The following standards are supported in the WiMAX-OFDMA Measurement Application:

IEEE 802.16e-2005

WiBro (Korean mobile WiMAX-OFDMA service)

Key Path	Mode Setup, Radio
Mode	WIMAXOFDMA
Scope	Meas Global
Remote Command	<code>[:SENSe] :RADio:STANdard WM80216E05 WIBRO</code> <code>[:SENSe] :RADio:STANdard?</code>
Example	<code>RAD:STAN WIBRO</code> <code>RAD:STAN?</code>
Preset	WM80216E05

State Saved	Saved in instrument state.
Range	IEEE 802.16e-2005 WiBro
Initial S/W Revision	Prior to A.02.00

802.16e-2005 mode

Key Path	Mode Setup, Radio Std
Mode	WIMAXOFDMA
Scope	Meas Global
Remote Command	[[:SENSe]:RADio:STANdard:Y05[:PROFile] B1M25 B3M5 B5M B7M B8M75 B10M B14M B15M B17M5 B20M B28M [:SENSe]:RADio:STANdard:Y05[:PROFile]?
Example	RAD:STAN:Y05 B10M RAD:STAN:Y05?
Preset	B10M
State Saved	Saved in instrument state.
Range	1.25MHz 3.5MHz 5MHz 7MHz 8.75MHz 10MHz 14MHz 15MHz 17.5MHz 20MHz 28MHz
Initial S/W Revision	Prior to A.02.00

FFT Size

OFDMA supports a scalable frame structure where the FFT size scales with the bandwidth to keep the subcarrier spacing fixed. Four FFT "NFFT" sizes are specified by the OFDMA standard: 128, 512, 1024 and 2048.

Key Path	Mode Setup, Radio Std
Mode	WIMAXOFDMA
Scope	Meas Global
Remote Command	[[:SENSe]:RADio:STANdard:BANDwidth[:CONFigure]:NFFT <integer> [:SENSe]:RADio:STANdard:BANDwidth[:CONFigure]:NFFT?
Example	RAD:STAN:BAND:NFFT 1024 RAD:STAN:BAND:NFFT?
Preset	1024
State Saved	Saved in instrument state.
Range	128 512 1024 2048
Min	128
Max	2048
Initial S/W Revision	Prior to A.02.00

BW Ratio

BW Ratio is defined as the ratio between the OFDMA FFT sample rate and the nominal channel bandwidth. The 802.16 Standard specifies that the BW Ratio be set to 8/7 or 28/25 depending on the nominal bandwidth of the test signal.

Key Path	Mode Setup, Radio, Radio Std
Mode	WIMAXOFDMA
Scope	Meas Global
Remote Command	[:SENSe]:RADio:STANdard:BANdwidth[:CONFIgure]:BWRatio R8BY7 R28BY25 [:SENSe]:RADio:STANdard:BANdwidth[:CONFIgure]:BWRatio?
Example	RAD:STAN:BAND:BWR R8BY7 RAD:STAN:BAND:BWR?
Notes	Force Restart is unavailable when WiBro is selected as the Radio Standard (described in " Radio Device " on page 316).
Preset	R28BY25
State Saved	Saved in instrument state.
Range	8/7 28/25
Initial S/W Revision	Prior to A.02.00

Guard Interval

IEEE 802.16 OFDMA supports multiple Guard Interval implementations. Each measurement changes its defaults according to the selected standard or device, if necessary.

Key Path	Mode Setup, Radio Std
Mode	WIMAXOFDMA
Scope	Meas Global
Remote Command	[:SENSe]:RADio:STANdard:GINTErval:RATio R1BY32 R1BY16 R1BY8 R1BY4 [:SENSe]:RADio:STANdard:GINTErval:RATio?
Example	RAD:STAN:GINT:RAT R1BY8 RAD:STAN:GINT:RAT?
Notes	Force Restart is unavailable when WiBro is selected as the Radio Standard (described in " Radio Device " on page 316).
Couplings	Radio Standard or Radio Device preset this to default.
Preset	R1BY8
State Saved	Saved in instrument state.
Range	1/32 1/16 1/8 1/4
Initial S/W Revision	Prior to A.02.00

Frame Duration

The Frame Duration parameter specifies OFDMA frame duration in units of time.

You can use the Radio Standard or Radio Device preset to set the Frame Duration to a value specified in the OFDMA standard or you can specify an arbitrary value manually in the Frame Duration parameter.

Key Path	Mode Setup, Radio Std
Mode	WIMAXOFDMA
Scope	Meas Global
Remote Command	<code>[:SENSe] :RADio:STANdard:FDURation <time></code> <code>[:SENSe] :RADio:STANdard:FDURation</code>
Example	<code>RAD:STAN:FDUR 5</code> <code>RAD:STAN:FDUR?</code>
Notes	The Actual Frame Duration value is selected that is closest in value to one of the following discrete numbers: 2, 2.5, 4, 5, 8, 10, 12.5, 20 ms.
Couplings	Radio Standard or Radio Device preset this parameter to the default length value.
Preset	5.0 ms
State Saved	Saved in instrument state.
Min	2 ms
Max	20 ms
Initial S/W Revision	Prior to A.02.00

Downlink Ratio

Downlink Ratio, expressed as a percentage, is the ratio of the downlink subframe length (including the TTG) to the frame length. Downlink Ratio defines where the uplink subframe starts relative to the start of the frame. A 30% Downlink Ratio means that 30% of the frame length is downlink subframe and 70% is uplink subframe.

Key Path	Mode Setup, Radio Std
Mode	WIMAXOFDMA
Scope	Meas Global
Remote Command	<code>[:SENSe] :RADio:STANdard:DRATio <real></code> <code>[:SENSe] :RADio:STANdard:DRATio</code>
Example	<code>RAD:STAN:DRAT 50.0</code> <code>RAD:STAN:DRAT?</code>
Couplings	Radio Standard or Radio Device preset this parameter to the default length value.
Preset	61.771 %
State Saved	Saved in instrument state.
Min	0 %
Max	100 %
Initial S/W Revision	Prior to A.02.00

WiBro mode

Key Path	Mode Setup, Radio Std, WiBro
Mode	WIMAXOFDMA
Scope	Meas Global
Remote Command	[:SENSe]:RADio:STANdard:WIBRo[:PROFile] B4M375 B8M75 B17M5 [:SENSe]:RADio:STANdard:WIBRo[:PROFile]?
Example	RAD:STAN:WIBR B8M75 RAD:STAN:WIBR?
Preset	B8M75
State Saved	Saved in instrument state.
Range	4.375MHz 8.75MHz 17.5MHz
Initial S/W Revision	Prior to A.02.00

FFT Size

OFDMA supports a scalable frame structure where the FFT size scales with the bandwidth to keep the subcarrier spacing fixed. Four FFT "NFFT" sizes are specified by the OFDMA standard: 128, 512, 1024 and 2048.

Key Path	Mode Setup, Radio Std
Mode	WIMAXOFDMA
Scope	Meas Global
Remote Command	[:SENSe]:RADio:STANdard:BANDwidth[:CONFigure]:NFFT <integer> [:SENSe]:RADio:STANdard:BANDwidth[:CONFigure]:NFFT?
Example	RAD:STAN:BAND:NFFT 1024 RAD:STAN:BAND:NFFT?
Preset	1024
State Saved	Saved in instrument state.
Range	128 512 1024 2048
Min	128
Max	2048
Initial S/W Revision	Prior to A.02.00

BW Ratio

BW Ratio is defined as the ratio between the OFDMA FFT sample rate and the nominal channel bandwidth. The 802.16 Standard specifies that the BW Ratio be set to 8/7 or 28/25 depending on the nominal bandwidth of the test signal.

Key Path	Mode Setup, Radio, Radio Std
Mode	WIMAXOFDMA
Scope	Meas Global
Remote Command	[:SENSE] :RADio:STANdard:BANDwidth[:CONFigure]:BWRatio R8BY7 R28BY25 [:SENSE] :RADio:STANdard:BANDwidth[:CONFigure]:BWRatio?
Example	RAD:STAN:BAND:BWR R8BY7 RAD:STAN:BAND:BWR?
Notes	Force Restart is unavailable when WiBro is selected as the Radio Standard (described in " Radio Device " on page 316).
Preset	R28BY25
State Saved	Saved in instrument state.
Range	8/7 28/25
Initial S/W Revision	Prior to A.02.00

Guard Interval

IEEE 802.16 OFDMA supports multiple Guard Interval implementations. Each measurement changes its defaults according to the selected standard or device, if necessary.

Key Path	Mode Setup, Radio Std
Mode	WIMAXOFDMA
Scope	Meas Global
Remote Command	[:SENSE] :RADio:STANdard:GINTerval:RATio R1BY32 R1BY16 R1BY8 R1BY4 [:SENSE] :RADio:STANdard:GINTerval:RATio?
Example	RAD:STAN:GINT:RAT R1BY8 RAD:STAN:GINT:RAT?
Notes	Force Restart is unavailable when WiBro is selected as the Radio Standard (described in " Radio Device " on page 316).
Couplings	Radio Standard or Radio Device preset this to default.
Preset	R1BY8
State Saved	Saved in instrument state.
Range	1/32 1/16 1/8 1/4
Initial S/W Revision	Prior to A.02.00

Frame Duration

The Frame Duration parameter specifies OFDMA frame duration in units of time.

You can use the Radio Standard or Radio Device preset to set the Frame Duration to a value specified in the OFDMA standard or you can specify an arbitrary value manually in the Frame Duration parameter.

Key Path	Mode Setup, Radio Std
Mode	WIMAXOFDMA
Scope	Meas Global
Remote Command	<code>[:SENSe] :RADio:STANdard:FDURation <time></code> <code>[:SENSe] :RADio:STANdard:FDURation</code>
Example	RAD:STAN:FDUR 5 RAD:STAN:FDUR?
Notes	The Actual Frame Duration value is selected that is closest in value to one of the following discrete numbers: 2, 2.5, 4, 5, 8, 10, 12.5, 20 ms.
Couplings	Radio Standard or Radio Device preset this parameter to the default length value.
Preset	5.0 ms
State Saved	Saved in instrument state.
Min	2 ms
Max	20 ms
Initial S/W Revision	Prior to A.02.00

Downlink Ratio

Downlink Ratio, expressed as a percentage, is the ratio of the downlink subframe length (including the TTG) to the frame length. Downlink Ratio defines where the uplink subframe starts relative to the start of the frame. A 30% Downlink Ratio means that 30% of the frame length is downlink subframe and 70% is uplink subframe.

Key Path	Mode Setup, Radio Std
Mode	WIMAXOFDMA
Scope	Meas Global
Remote Command	<code>[:SENSe] :RADio:STANdard:DRATio <real></code> <code>[:SENSe] :RADio:STANdard:DRATio</code>
Example	RAD:STAN:DRAT 50.0 RAD:STAN:DRAT?
Couplings	Radio Standard or Radio Device preset this parameter to the default length value.
Preset	61.771 %
State Saved	Saved in instrument state.
Min	0 %
Max	100 %
Initial S/W Revision	Prior to A.02.00

Preset Profile

IEEE 802.16 OFDMA supports multiple system profile (bandwidth) implementations. This selection changes parameters in each measurement according to the selected standard if necessary.

802.16e–2005 mode

Key Path	Mode Setup, Radio Std
Mode	WIMAXOFDMA
Scope	Meas Global
Remote Command	[:SENSe] :RADio:STANdard:Y05 [:PROFile] B1M25 B3M5 B5M B7M B8M75 B10M B14M B15M B17M5 B20M B28M [:SENSe] :RADio:STANdard:Y05 [:PROFile] ?
Example	RAD:STAN:Y05 B10M RAD:STAN:Y05?
Preset	B10M
State Saved	Saved in instrument state.
Range	1.25MHz 3.5MHz 5MHz 7MHz 8.75MHz 10MHz 14MHz 15MHz 17.5MHz 20MHz 28MHz
Initial S/W Revision	Prior to A.02.00

WiBro mode

Key Path	Mode Setup, Radio Std, WiBro
Mode	WIMAXOFDMA
Scope	Meas Global
Remote Command	[:SENSe] :RADio:STANdard:WIBro [:PROFile] B4M375 B8M75 B17M5 [:SENSe] :RADio:STANdard:WIBro [:PROFile] ?
Example	RAD:STAN:WIBR B8M75 RAD:STAN:WIBR?
Preset	B8M75
State Saved	Saved in instrument state.
Range	4.375MHz 8.75MHz 17.5MHz
Initial S/W Revision	Prior to A.02.00

Noise Reduction

Noise Reduction accesses a menu for configuring the noise compensation of the instrument. This menu only appears in models that support Noise Reduction.

Key Path	Mode Setup
Initial S/W Revision	A.04.00

Noise Floor Extension

Turns on the Noise Floor Extension function. When this function is On, the expected noise power of the analyzer (derived from a factory calibration) is subtracted from the trace data. This will usually reduce the apparent noise level by about 10 dB in low band, and 8 dB in high band (>~3.6 GHz).

Noise Floor Extension works with any RBW, VBW, detector, any setting of Average Type, any amount of trace averaging, and any signal type. It is ineffective when the trace is not smoothed (smoothing processes include narrow VBWs, trace averaging, and long sweep times with the detector set to Average or Peak). It works best with extreme amounts of smoothing, and with the average detector, with the Average Type set to Power.

NOTE

Noise Floor Extensions has no effect unless the RF Input is selected, therefore it does nothing when External Mixing is selected.

In those cases where the cancellation is ineffective, it nonetheless has no undesirable side-effects. There is no significant speed impact to having Noise Floor Extension on.

The best accuracy is achieved when substantial smoothing occurs in each point before trace averaging. Thus, when using the average detector, results are better with long sweep times and fewer trace averages. When using the sample detector, the VBW filter should be set narrow with less trace averaging, instead of a wide VBW filter with more trace averaging.

See "[More Information](#)" on page 324

Key Path	Mode Setup, Noise Reduction
Scope	Meas Global
Remote Command	<code>[:SENSe] :CORRection:NOISe:FLOor ON OFF 1 0</code> <code>[:SENSe] :CORRection:NOISe:FLOor?</code>
Example	<code>CORR:NOIS:FLO ON</code>
Dependencies	This key only appears in instruments with the NFE or NF2 license installed. In all others, the key does not appear, however the SCPI command will be accepted without error (but will have no effect).
Couplings	When NFE is enabled in any mode manually, a prompt will be displayed reminding you to perform the Characterize Noise Floor operation if it is needed. If NFE is enabled through SCPI and a Characterize Noise Floor operation is needed, an error will be entered in the system error queue.
Preset	Unaffected by Mode Preset. Turned off by Restore Mode Defaults.
State Saved	No
Initial S/W Revision	A.04.00

More Information

The analyzer is characterized in the factory (or during a field calibration) with a model of the noise, referred to the input mixer, versus frequency in each band and path combination. Bands are 0 (low band) and 1 through 4 (high band) in a 26.5 GHz instrument, for example. Paths include normal paths, preamp paths, the electronic attenuator, etc.

In most band/path combinations, the noise can be well characterized based on just two parameters and the analyzer frequency response before compensation for frequency-dependent losses.

After the noise density at the input mixer is estimated, the effects of the input attenuator, RBW, detector, etc. are computed to get the estimated input-port-referred noise level.

In the simplest case, the measured power (signal plus analyzer noise) in each display point (bucket) is compensated by subtracting the estimated noise power, leaving just the signal power. This is the operation when the detector is Average and the Average Type is set to Power.

In other cases, operation is often not quite as good but still highly effective. With peak detection, the noise floor is estimated based on the RBW and the duration of the bucket using the same equations used in the noise marker function. The voltage of the noise is subtracted from the voltage of the observed signal-plus-noise measurement to compute the estimated signal voltage. The peak detector is one example of processing that varies with detector to give good estimates of the signal level without the analyzer noise.

For best operation, the average detector and the power scale are recommended, as already stated. Peak detection for pulsed-RF can still give excellent effectiveness. FFT analysis does not work well, and does not do NFE well, with pulsed-RF signals, so this combination is not recommended. Negative peak detection is not very useful, either. Sample detection works well, but is never better than the average detector because it doesn't smooth as well. The Normal detector is a combination of peak and negative peak behaviors, and works about as well as these.

For best operation, extreme smoothing is desirable, as already stated. Using narrow VBWs works well, but using very long bucket durations and the average detector works best. Reducing the number of trace points will make the buckets longer.

For best operation, the power scale (Average Type = Power) is optimum. When making CW measurements in the presence of noise without NFE, averaging on the decibel scale has the advantage of reducing the effect of noise. When using NFE, the NFE does an even better job than using the log scale ever could. Using NFE with the log scale is not synergistic, though; NFE with the power scale works a little better than NFE with log averaging type.

The results from NFE with internal preamp can often be lower than the theoretical noise in a signal source at room temperature, a noise density of -174 dBm/Hz. This is expected and useful behavior, because NFE is designed to report the amount of input signal that is in excess of the thermal noise, not the amount that includes the thermal noise. This can be a useful behavior because thermal noise often interferes with what you want to measure, instead of being part of what you want to measure. Note that NFE is not adequately accurate to always be able to read below kTB.

On instruments with the NF2 license installed, the calibrated Noise Floor used by Noise Floor Extensions should be refreshed periodically. Agilent recommends that the Characterize Noise Floor operation be performed after the first 500 hours of operation, and once every calendar year. The key to perform this is located in the System, Alignments, Advanced menu. If you have not done this yourself at the recommended interval, then when you turn on Noise Floor Extensions, the analyzer will prompt you to do so with a dialog that says:

"This action will take several minutes to perform. Please disconnect all cables from the RF input and press Enter to proceed. Press ESC to cancel, or Postpone to postpone for a week."

If you Cancel, you will be prompted again the next time you turn NFE on. If you postpone, you will be prompted again after a week passes and you then turn NFE on.

Restore Mode Defaults

Resets the state for the currently active mode by resetting the mode persistent settings to their factory default values, clearing mode data and by performing a Mode Preset. This function will never cause a mode switch. This function performs a full preset for the currently active mode; whereas, Mode Preset performs a partial preset. Restore Mode Defaults does not affect any system settings. System settings are reset by the Restore System Defaults function. This function does reset mode data; as well as settings.

Key Path	Mode Setup
Remote Command	:INSTrument:DEFault
Example	:INST:DEF
Notes	Clears all pending OPC bits. The Status Byte is set to 0. A message comes up saying: "If you are sure, press key again".
Couplings	A Restore Mode Defaults will cause the currently running measurement to be aborted and causes the default measurement to be active. It gets the mode to a consistent state with all of the default couplings set.
Initial S/W Revision	Prior to A.02.00

Global Settings

Opens a menu that allows you to switch certain Meas Global parameters to a Mode Global state. These switches apply to all Modes that support global settings. No matter what Mode you are in when you set the "Global Center Frequency" switch to on, it applies to all Modes that support Global Settings.

Key Path	Mode Setup
Initial S/W Revision	Prior to A.02.00

Global Center Freq

The software maintains a Mode Global value called "Global Center Freq".

When the Global Center Freq key is switched to On in any mode, the current mode's center frequency is copied into the Global Center Frequency, and from then on all modes that support global settings use the Global Center Frequency. So you can switch between any of these modes and the Center Freq will remain unchanged.

Adjusting the Center Freq of any mode which supports Global Settings, while Global Center Freq is On, will modify the Global Center Frequency.

When Global Center Freq is turned Off, the Center Freq of the current mode is unchanged, but now the Center Freq of each mode is once again independent.

When Mode Preset is pressed while Global Center Freq is On, the Global Center Freq is preset to the preset Center Freq of the current mode.

This function is reset to Off when the Restore Defaults key is pressed in the Global Settings menu, or when System, Restore Defaults, All Modes is pressed.

Key Path	Mode Setup, Global Settings
Scope	Mode Global
Remote Command	:INSTrument:COUPle:FREQuency:CENTer ALL NONE :INSTrument:COUPle:FREQuency:CENTer?
Example	INST:COUP:FREQ:CENT ALL INST:COUP:FREQ:CENT?
Preset	Set to Off on Global Settings, Restore Defaults and System, Restore Defaults, All Modes
Range	On Off
Initial S/W Revision	Prior to A.02.00

Remote Command	:GLOBal:FREQuency:CENTer[:STATe] 1 0 ON OFF :GLOBal:FREQuency:CENTer[:STATe]?
Preset	Off
Initial S/W Revision	Prior to A.02.00

Restore Defaults

This key resets all of the functions in the Global Settings menu to Off. This also occurs when System, Restore Defaults, All Modes is pressed.

Key Path	Mode Setup, Global Settings
Remote Command	:INSTrument:COUPle:DEFault
Example	INST:COUP:DEF
Backwards Compatibility SCPI	:GLOBal:DEFault
Initial S/W Revision	Prior to A.02.00

SCPI Only Commands

This mode has the following additional mode-unique commands.

Nominal Bandwidth

The Nominal Bandwidth parameter specifies the nominal channel bandwidth. OFDMA supports a scalable frame structure where the FFT size scales according to the bandwidth to keep subcarrier spacing fixed. The OFDMA standard specifies four FFT "NFFT" sizes" (128, 512, 1024 and 2048) and, in addition, supports many nominal bandwidths. You can use the Preset to Standard to set the Nominal Bandwidth to a standard default value or you can specify an arbitrary value with this command.

How the analyzer determines Nominal Bandwidth:

The IEEE 802.16e-2005 standard defines the Sampling Frequency(F_s) as:

$$F_s = \text{floor}(BWRatio * BW / 8000) * 8000$$

This is the sample rate for a non-oversampled OFDMA signal. This equation restricts the sampling frequency to 8 kHz increments. To facilitate R&D development and debug-mode analysis of an OFDMA DUT, the analyzer allows arbitrary Sampling Frequency. To implement this capability, the analyzer does not use the "floor" function to compute the Sampling Frequency, but instead uses the following formula:

$$\text{Nominal BW (analyzer)} = F_s / BWRatio$$

NOTE This functionality is only available with SCPI control and is recommended only for the advanced user.

Mode	WIMAXOFDMA
Scope	Meas Global
Remote Command	<code>[:SENSe] :RADio:STANdard:BANDwidth[:CONFigure]:VALue <freq></code> <code>[:SENSe] :RADio:STANdard:BANDwidth[:CONFigure]:VALue?</code>
Example	<code>RAD:STAN:BAND:VAL 9.996 MHz</code> <code>RAD:STAN:BAND:VAL?</code>
Preset	10 MHz
State Saved	Saved in instrument state.
Min	31.25 kHz
Max	200 MHz
Initial S/W Revision	Prior to A.02.00

BW Ratio – Fractional Number

The BW Ratio is defined as the ratio between the OFDMA FFT sample rate and the nominal channel bandwidth.

This parameter is represented as a fractional number that contains two values; the first value is the numerator and the second is the denominator value of the BW Ratio.

NOTE This functionality is only available with SCPI control and is recommended only for the advanced user.

Mode	WIMAXOFDMA
Scope	Meas Global
Remote Command	<code>[:SENSe] :RADio:STANdard:BANDwidth[:CONFigure]:BWRatio:FRACTION</code> <code><integer>, <integer></code> <code>[:SENSe] :RADio:STANdard:BANDwidth[:CONFigure]:BWRatio:FRACTION?</code>
Example	<code>RAD:STAN:BAND:BWR:FRAC 11,10</code> <code>RAD:STAN:BAND:BWR:FRAC?</code>
Notes	SCPI Only. No Front Panel Access. The value of this fraction should be between 1.0 to 2.0
Preset	28,25
State Saved	Saved in instrument state.

Min	1
Max	1000
Initial S/W Revision	Prior to A.02.00

Guard Interval – Fractional Number

IEEE 802.16 OFDMA supports multiple Guard Interval implementations. Each measurement changes its defaults according to the selected standard or device, if necessary. For the advanced user, the Guard Interval can be set to a value other than the standard values (1/4, 1/8, 1/16 or 1/32).

This parameter is represented as a fractional number that contains two values; the first value is the numerator and the second is the denominator value of the Guard Interval.

NOTE

This functionality is only available with SCPI control and is recommended only for the advanced user.

Mode	WIMAXOFDMA
Scope	Meas Global
Remote Command	<code>[:SENSE] :RADio:STANdard:GINterval:RATio:FRACTioN <integer>, <integer></code> <code>[:SENSE] :RADio:STANdard:GINterval:RATio:FRACTioN?</code>
Example	<code>RAD:STAN:GINT:RAT:FRAC 3,18</code> <code>RAD:STAN:GINT:RAT:FRAC?</code>
Notes	SCPI Only. No Front Panel Access. The value of this fraction should be between 0.0 to 1.0
Preset	1, 8
State Saved	Saved in instrument state.
Min	0
Max	1000
Initial S/W Revision	Prior to A.02.00

Zone Map Data

Gets and sets the downlink and uplink zone definitions for a particular 802.16 OFDMA signal. Its parameter is a comma-separated string list which contains pairs of a key and a value. The key definition is basically equivalent to “.omf” originally created by the 89600, except the leading string “DemodOfdmaMap_” can be omitted. When only a partial change of the existent map is desired, the parameter must contain the pair of “[DemodOfdmaMap_]RefreshMap” and “FALSE”. A query returns all key-and-value pairs which is saved as the state in your X-Series Analyzer.

Mode	WIMAXOFDMA
Scope	Meas Global

Remote Command	:CALCulate:ZMAP:DATA <string>, ... :CALCulate:ZMAP:DATA?
Example	CALC:ZMAP:DATA "RefreshMap", "FALSE", "F1_DL_Z1_Len", "3" CALC:ZMAP:DATA?
Notes	SCPI Only. No Front Access. The SCPI parameter must be pairs of a key and a value.
Preset	"DemodOfdmaMap_AutoDetect", "FALSE", "DemodOfdmaMap_Count", "1", "DemodOfdmaMap_F1_DL_Count", "1", "DemodOfdmaMap_F1_DL_Z1_Active", "TRUE", "DemodOfdmaMap_F1_DL_Z1_AmcType", "1", "DemodOfdmaMap_F1_DL_Z1_B1_Active", "TRUE", "DemodOfdmaMap_F1_DL_Z1_B1_AllocType", "0", "DemodOfdmaMap_F1_DL_Z1_B1_Boost", "0", "DemodOfdmaMap_F1_DL_Z1_B1_BurstType", "1", "DemodOfdmaMap_F1_DL_Z1_B1_ColorIndex", "80", "DemodOfdmaMap_F1_DL_Z1_B1_ModType", "4", "DemodOfdmaMap_F1_DL_Z1_B1_Name", "<FCH>", "DemodOfdmaMap_F1_DL_Z1_B1_SubchannelInterval", "4", "DemodOfdmaMap_F1_DL_Z1_B1_SubchannelOffset", "0", "DemodOfdmaMap_F1_DL_Z1_B1_SymbolInterval", "2", "DemodOfdmaMap_F1_DL_Z1_B1_SymbolOffset", "0", "DemodOfdmaMap_F1_DL_Z1_Count", "1", "DemodOfdmaMap_F1_DL_Z1_DedicPilots", "FALSE", "DemodOfdmaMap_F1_DL_Z1_IDCell", "0", "DemodOfdmaMap_F1_DL_Z1_IDCellCouple", "FALSE", "DemodOfdmaMap_F1_DL_Z1_Len", "2", "DemodOfdmaMap_F1_DL_Z1_Locked", "FALSE", "DemodOfdmaMap_F1_DL_Z1_Name", "Zone01", "DemodOfdmaMap_F1_DL_Z1_PrbsID", "0", "DemodOfdmaMap_F1_DL_Z1_StcMatrix", "0", "DemodOfdmaMap_F1_DL_Z1_StcType", "0", "DemodOfdmaMap_F1_DL_Z1_SymOffset", "1", "DemodOfdmaMap_F1_DL_Z1_UseAllSC", "FALSE", "DemodOfdmaMap_F1_DL_Z1_WrapType", "0", "DemodOfdmaMap_F1_DL_Z1_ZoneType", "0", "DemodOfdmaMap_F1_UL_Count", "1", "DemodOfdmaMap_F1_UL_Z1_Active", "TRUE", "DemodOfdmaMap_F1_UL_Z1_AmcType", "1", "DemodOfdmaMap_F1_UL_Z1_B1_Active", "TRUE", "DemodOfdmaMap_F1_UL_Z1_B1_AllocType", "1", "DemodOfdmaMap_F1_UL_Z1_B1_Boost", "0", "DemodOfdmaMap_F1_UL_Z1_B1_BurstType", "0", "DemodOfdmaMap_F1_UL_Z1_B1_ColorIndex", "1", "DemodOfdmaMap_F1_UL_Z1_B1_ModType", "4", "DemodOfdmaMap_F1_UL_Z1_B1_Name", "Burst01", "DemodOfdmaMap_F1_UL_Z1_B1_PilotPattern", "0", "DemodOfdmaMap_F1_UL_Z1_B1_StcMode", "0", "DemodOfdmaMap_F1_UL_Z1_B1_SubchannelInterval", "1", "DemodOfdmaMap_F1_UL_Z1_B1_SubchannelOffset", "0", "DemodOfdmaMap_F1_UL_Z1_B1_SymbolInterval", "3", "DemodOfdmaMap_F1_UL_Z1_B1_SymbolOffset", "0", "DemodOfdmaMap_F1_UL_Z1_Count", "1", "DemodOfdmaMap_F1_UL_Z1_Gap", "0", "DemodOfdmaMap_F1_UL_Z1_IDCell", "0", "DemodOfdmaMap_F1_UL_Z1_Len", "3", "DemodOfdmaMap_F1_UL_Z1_Locked", "FALSE", "DemodOfdmaMap_F1_UL_Z1_Name", "unnamed", "DemodOfdmaMap_F1_UL_Z1_SymOffset", "0", "DemodOfdmaMap_F1_UL_Z1_WrapType", "1", "DemodOfdmaMap_F1_UL_Z1_ZoneType", "0", "DemodOfdmaMap_Name", "DefaultMap", "DemodOfdmaMap_RefreshMap", "TRUE"
State Saved	Saved in instrument state.
Initial S/W Revision	Prior to A.02.00

Key Definition

Basically a key requires the following syntax.

(1)Whole Map

(2)Optional header “DemodOfdmaMap” and keyname shown in the following table connected with an underscore.

(3)[DemodOfdmaMap_{MAPKEY}]

(4)Example:

(5)DemodOfdmaMap_Name

(6)RefreshMap

(7)Zone Count

(8)Optional header “DemodOfdmaMap”, a frame # preceded with “F”, “DL” or “UL” and keyname “Count” connected with an underscore.

(9)[DemodOfdmaMap_]Ff_DL_{MAPKEY}

(10)Example:

(11)DemodOfdmaMap_F1_DL_Count

(12)F1_UL_Count

(13)Zone Parameters

(14)Optional header “DemodOfdma”, a frame # preceded with “F”, “DL” or “UL”, a zone # preceded by “Z”, and a key name shown in the following table connected with underscores.

(15)[DemodOfdmaMap_]Ff_DL_Zz_{ZONEKEY}

(16)Example:

(17)DemodOfdmaMap_F1_DL_Z2_SymOffset

(18)F1_UL_Z1_ZoneType

(19)Burst Parameters

(20)Optional header “DemodOfdma”, a frame # preceded with “F”, “DL” or “UL”, a zone # preceded by “Z”, a burst # preceded by “B” and a key name shown in the following table connected with underscores.

(21)[DemodOfdmaMap_]Ff_DL_Zz_Bb_{ZONEKEY}

(22)Example:

(23)DemodOfdmaMap_F1_DL_Z2_B4_SymbolOffset

(24)F1_UL_Z1_B1_BurstType

Summary of Key Types

Whole Map			
Key	Type	Description	Remarks
AutoDetect	Boolean	Specifies if the map is auto detected or not. If this parameter is true, the measurement	

		engine will demodulate each burst while detecting its modulation scheme. If false, each burst is demodulated based on the ModType value of each burst.	
Count	Integer	Number of frames.	1
DownlinkRatio	Floating Point	Downlink ratio of the TDD frame.	Downlink Ratio is set by the mode parameter.
FrameLen	Floating Point	Frame length.	Frame length is set by the mode parameter.
Name	String	Map Name.	
Downlink/Uplink Zone Count			
Count	Integer	Number of zones.	
Downlink/Uplink Zone			
Active	Boolean	Denotes if the zone is active.	
AmcType	Integer (Enum)	AMC slot type for AMC zone. This is available only when ZoneType. 0 ... (2,3) 1 ... (1,6) 2 ... (4,2) 3 ... (3,2)	(2,3)
Count	Integer	Number of bursts.	
IDCell	Integer	Cell ID of the zone. If IDCellCouple is false, Cell ID is determined by this parameter.	Z1 (Zone# 1) ignores this parameter.
IDCellCouple	Boolean	Determines if Cell ID is calculated from Preamble Index. If false, ID Cell is determined by IDCell.	Z1 (Zone#1) ignores this parameter and regards this as always true.
Len	Integer	Zone length (in symbols).	
Locked	Boolean	If true, this zone is not editable in 89600.	This parameter is meaningful only on 89600. X-Series analyzers ignore this parameter.
Name	String	Zone Name.	This parameter is not used anywhere in X-Series analyzers.
PrbsID	Integer	PRBS ID.	
SymOffset	Integer	Symbol Offset from the start of the frame.	
UseAllSc	Boolean	Denotes if All Subcarrier is displayed or not. If false, inactive subcarriers' RCEs are returned as zero.	
WrapType	Integer (Enum)	Denotes Wrap Type (subchannel direction or symbol direction). 0 ... Subchannel 1 ... Symbol	

ZoneType	Integer (Enum)	Zone Type. Downlink: 0 ... PUSC 1 ... AMC 2 ... FUSC 3 ... OFUSC Uplink: 0 ... PUSC 1 ... OPUSC 2 ... AMC
Downlink/Uplink Burst		
Active	Boolean	Denotes if this burst is a target of measurement or not.
AllocType	Integer (Enum)	Burst allocation type. 0 ... Rectangle 1 ... Wrapped
Boost	Floating Point	Boosting level of the burst in dB.
BurstType	Integer (Enum)	Burst Type. Downlink 0 ... Normal 1 ... FCH 2 ... DLMAP Uplink 0 ... Normal 1 ... CDMA 2 ... PAPR 3 ... FFB
ColorIndex	Integer	An index for the color of the burst map view or measurement displays. 0 – 81.
ModType	Integer (Enum)	Modulation type of the burst. This is available only when DemodOfdmaMap_AutoDetected is false. 0 ... 16QAM 2 ... 64QAM 4 ... QPSK 8 ... BPSK
Name	String	Burst Name
SubchannelInterval	Integer	Subchannel Interval for the rectangular burst. This is meaningless for the wrapped burst.
SubchannelOffset	Integer	Subchannel offset from the start of the

		burst.
SymbolInterval	Integer	For the rectangular burst, symbol interval of the burst. For the wrapped burst, total length of the burst.
SymbolOffset	Integer	Symbol offset from the start of the burst.

6 System Functions

File

Opens a menu that enables you to access various standard and custom Windows functions. Press any other front-panel key to exit

Key Path	Front-panel key
Initial S/W Revision	Prior to A.02.00

File Explorer

Opens the standard Windows File Explorer. The File Explorer opens in the My Documents directory for the current user.

The File Explorer is a separate Windows application, so to return to the analyzer once you are in the File Explorer, you may either:

Exit the File Explorer by clicking on the red X in the upper right corner, with a mouse

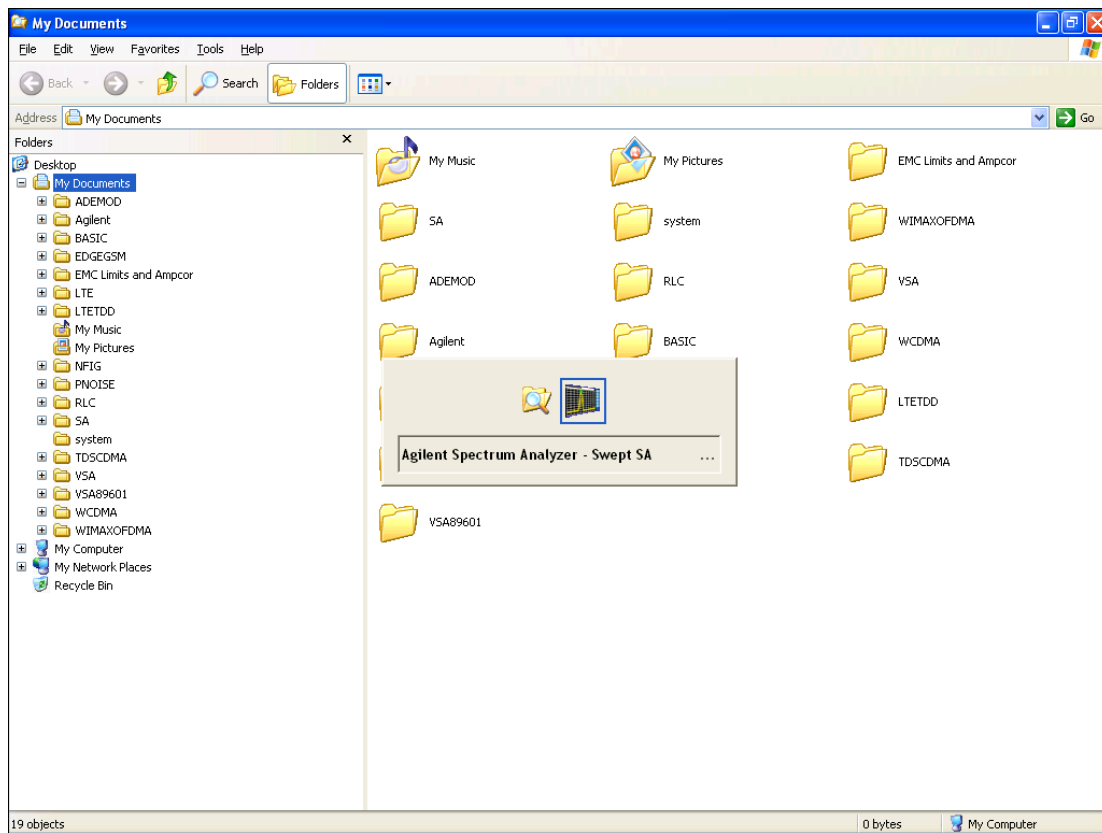

Or use Alt-Tab: press and hold the Alt key and press and release the Tab key until the Analyzer logo is showing in the window in the center of the screen, as shown above, then release the Alt key.

The ability to access File Explorer is not available if Option SF1 is installed.

Key Path	File
Initial S/W Revision	Prior to A.02.00

Page Setup

The Page Setup key brings up a Windows Page Setup dialog that allows you to control aspects of the pages sent to the printer when the PRINT hardkey is pressed.

Key Path	File
Initial S/W Revision	Prior to A.02.00

Paper size, the printer paper source, the page orientation and the margins are all settable. Just like any standard Windows dialog, you may navigate the dialog using the front-panel keys, or a mouse. There are no SCPI commands for controlling these parameters.

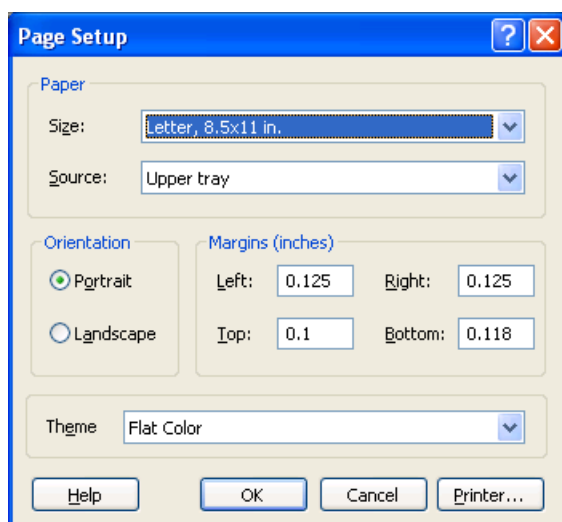

Also contained in this dialog is a drop-down control that lets you select the Theme to use when printing. For more on Themes, see information under View/Display, Display, System Display Settings, Theme. The Theme control has a corresponding SCPI command.

Parameter Name	Print Themes
Parameter Type	Enum
Mode	All
Remote Command	:SYSTem:PRINt:THEME TDCoLor TDMonochrome FCOLor FMONochrome :SYSTem:PRINt:THEME?
Example	:SYST:PRIN:THEM FCOL
Setup	:SYSTem:DEFault MISC
Preset	FCOL; not part of Preset, but is reset by Restore Misc Defaults or Restore System Defaults All and

	survives subsequent running of the modes.
State Saved	No
Initial S/W Revision	Prior to A.02.00

Print

This front-panel key is equivalent to performing a File, Print, OK. It immediately performs the currently configured Print to the Default printer.

The :HCOPY command is equivalent to pressing the PRINT key. The HCOpy:ABORt command can be used to abort a print which is already in progress. Sending HCOpy:ABORt will cause the analyzer to stop sending data to the printer, although the printer may continue or even complete the print, depending on how much data was sent to the printer before the user sent the ABORt command.

Key Path	Front-panel key
Remote Command	:HCOPY[:IMMEDIATE]
Initial S/W Revision	Prior to A.02.00

Key Path	SCPI command only
Remote Command	:HCOPY:ABORt
Initial S/W Revision	Prior to A.02.00

Restore Down

This key allows you to Restore Down the Instrument Application and reverses the action taken by Maximize. This key is only visible when the application has been maximized, and after the Restore Down action has been completed this key is replaced by the Maximize key.

Key Path	File
Mode	All
Notes	No equivalent remote command for this key.
State Saved	No
Initial S/W Revision	A.05.01

Minimize

The Minimize key causes the analyzer display to disappear down into the task bar, allowing you to see the Windows Desktop. You can use Alt-Tab (press and hold the Alt  key and press and release the Tab key) to restore the analyzer display.

Key Path	File
Mode	All
Notes	No equivalent remote command for this key.
State Saved	No
Initial S/W Revision	A.05.01

Exit

This key, when pressed, will exit the Instrument Application. A dialog box is used to confirm that you intended to exit the application:

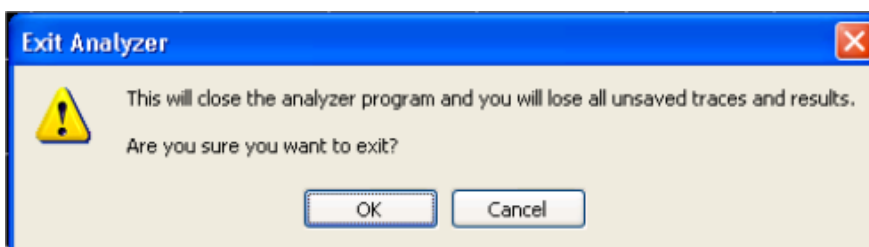

Key Path	File
Mode	All
Notes	The Instrument Application will close. No further SCPI commands can be sent. Use with caution!
Initial S/W Revision	Prior to A.02.00

Print

The Print key opens a Print dialog for configured printing (for example, to the printer of your choice). Refer to your Microsoft Windows Operating System manual for more information.

Maximize/Restore Down

These keys allow the Instrument Application to be maximized and then restored to its prior state. Only one of the two keys is visible at a time. When not already maximized the Maximize Application key is visible, and when maximized, the Restore Down Application key is visible and replaces the Maximize Application key.

Maximize

This key allows you to Maximize the Instrument Application, which causes the analyzer display to fill the screen. Once the application is maximized, this key is replaced by the Restore Down key.

Key Path	File
Mode	All

Notes	No equivalent remote command for this key.
State Saved	No
Initial S/W Revision	A.05.01

Restore Down

This key allows you to Restore Down the Instrument Application and reverses the action taken by Maximize. This key is only visible when the application has been maximized, and after the Restore Down action has been completed this key is replaced by the Maximize key.

Key Path	File
Mode	All
Notes	No equivalent remote command for this key.
State Saved	No
Initial S/W Revision	A.05.01

Print

This front-panel key is equivalent to performing a File, Print, OK. It immediately performs the currently configured Print to the Default printer.

The `:HCOPY` command is equivalent to pressing the PRINT key. The `HCOPY:ABORT` command can be used to abort a print which is already in progress. Sending `HCOPY:ABORT` will cause the analyzer to stop sending data to the printer, although the printer may continue or even complete the print, depending on how much data was sent to the printer before the user sent the `ABORT` command.

Key Path	Front-panel key
Remote Command	<code>:HCOPY[:IMMEDIATE]</code>
Initial S/W Revision	Prior to A.02.00

Key Path	SCPI command only
Remote Command	<code>:HCOPY:ABORT</code>
Initial S/W Revision	Prior to A.02.00

System

Opens a menu of keys that access various configuration menus and dialogs.

Key Path	Front-panel key
Notes	No remote command for this key specifically.
Initial S/W Revision	Prior to A.02.00

Show

Accesses a menu of choices that enable you to select the information window you want to view.

Key Path	System
Mode	All
Remote Command	:SYSTem:SHOW OFF ERRor SYSTem HARDware LXI HWSTatistics ALIGNment SOFTware CAPplication :SYSTem:SHOW?
Example	:SYST:SHOW SYST
Notes	This command displays (or exits) the various System information screens.
Preset	OFF
State Saved	No
Range	OFF ERRor SYSTem HARDware LXI HWSTatistics ALIGNment SOFTware CAPplication
Initial S/W Revision	Prior to A.02.00

Errors

There are two modes for the Errors selection, History and Status.

The list of errors displayed in the Errors screen does not automatically refresh. You must press the Refresh key or leave the screen and return to it to refresh it.

History brings up a screen displaying the event log in chronological order, with the newest event at the top. The history queue can hold up to 100 messages (if a message has a repeat count greater than 1 it only counts once against this number of 100). Note that this count bears no relation to the size of the SCPI queue. If the queue extends onto a second page, a scroll bar appears to allow scrolling with a mouse. Time is displayed to the second.

Status brings up a screen summarizing the status conditions currently in effect. Note that the time is displayed to the second.

The fields on the Errors display are:

Type (unlabeled) - Displays the icon identifying the event or condition as an error or warning.

ID - Displays the error number.

Message - Displays the message text.

Repeat (RPT) - This field shows the number of consecutive instances of the event, uninterrupted by other events. If an event occurs 5 times with no other intervening event, the value of repeat will be 5.

If the value of Repeat is 1 the field does not display. If the value of Repeat is >1, the time and date shown are those of the most recent occurrence. If the value of repeat reaches 999,999 it stops there.

Time - Shows the most recent time (including the date) at which the event occurred.

Key Path	System, Show
Mode	All
Remote Command	:SYSTem:ERRor[:NEXT]?
Example	:SYST:ERR?
Notes	The return string has the format: “<Error Number>,<Error>” Where <Error Number> and <Error> are those shown on the Show Errors screen
Backwards Compatibility Notes	In some legacy analyzers, the Repeat field shows the number of times the message has repeated since the last time the error queue was cleared. In the X-Series, the Repeat field shows the number of times the error has repeated since the last intervening error. So the count may very well be different than in the past even for identical signal conditions Unlike previous analyzers, in the X-Series all errors are reported through the Message or Status lines and are logged to the event queue. They never appear as text in the graticule area (as they sometimes do in previous analyzers) and they are never displayed in the settings panel at the top of the screen (as they sometimes do, by changing color, in previous analyzers). As a consequence of the above, the user can only see one status condition (the most recently generated) without looking at the queue. In the past, at least in the Spectrum Analyzer, multiple status conditions might display on the right side of the graticule. In general, there is no backwards compatibility specified or guaranteed between the error numbers in the X-Series and those of earlier products. Error, event, and status processing code in customers' software will probably need to be rewritten to work with X-Series. In the legacy analyzers, some conditions report as errors and others simply turn on status bits. Conditions that report as errors often report over and over as long as the condition exists. In the X-series, all conditions report as start and stop events. Consequently, software that repeatedly queries for a condition error until it stops reporting will have to be rewritten for the X-series.
Initial S/W Revision	Prior to A.02.00

Previous Page

See ["Next Page" on page 344.](#)

Key Path	System, Show, Errors
Initial S/W Revision	Prior to A.02.00

Next Page

Next Page and Previous Page menu keys move you between pages of the log, if it fills more than one page. These keys are grayed out in some cases:

- If on the last page of the log, the Next Page key is grayed-out
- If on the first page of the log, the Previous Page key is grayed-out.
- If there is only one page, both keys are grayed out.

Key Path	System, Show, Errors
Initial S/W Revision	Prior to A.02.00

History

The History and Status keys select the Errors view. The Status key has a second line that shows a number in [square brackets]. This is the number of currently open status items.

Key Path	System, Show, Errors
Initial S/W Revision	Prior to A.02.00

Verbose SCPI On/Off

When you turn Verbose SCPI on, additional information is returned when you send the :SYSTem:ERRor? query. The additional information consists of the characters that stimulated the error. This can aid you in debugging your test programs by indicating where in the parsing of a SCPI command the instrument encountered an invalid command or query.

Specifically, with Verbose SCPI on, the SYSTem:ERRor? query is expanded to show the SCPI data received, with the indicator <Err> at the point in the stream that the error occurred.

Verbose SCPI has no effect on the Show Errors screen or front panel Message Line; it only changes the response to the :SYST:ERR? query.

See the example below, where the invalid command "SENS:BOGUS" is sent:

Normal response to :SYST:ERR (using the Telnet window):

```
SCPI> SENS:BOGUS
```

```
SCPI> SYST:ERR?
```

```
-113,"Undefined header"
```

Now after turning on Verbose SCPI:

```
SCPI> SYST:BOGUS
```

```
SCPI> SYST:ERR?
```

```
-113,"Undefined header;SYST:BOGUS<Err>"
```

Key Path	System, Show, Errors
Mode	All
Remote Command	:SYSTem:ERRor:VERBose OFF ON 0 1 :SYSTem:ERRor:VERBose?
Example	:SYST:ERR:VERB ON
Preset	This is unaffected by Preset but is set to OFF on a “Restore System Defaults->Misc”
State Saved	No
Range	On Off
Initial S/W Revision	Prior to A.02.00

Refresh

When pressed, refreshes the Show Errors display.

Key Path	System, Show, Errors
Initial S/W Revision	Prior to A.02.00

Clear Error Queue

This clears all errors in all error queues.

Note the following:

- Clear Error Queue does not affect the current status conditions.
- Mode Preset does not clear the error queue.
- Restore System Defaults will clear all error queues.
- *CLS only clears the queue if it is sent remotely and *RST does not affect any error queue.
- Switching modes does not affect any error queues.

Key Path	System, Show, Errors
Initial S/W Revision	Prior to A.02.00

Input Overload Enable (Remote Command Only)

Input Overload errors are reported using the Input Overload status bit (bit 12 in the Measurement Integrity status register). Input Overloads (for example, ADC Overload errors) can come and go with great frequency, generating many error events (for example, for signals just on the verge of overload), and so are not put into the SCPI error queue by default. Normally the status bit is the only way for detecting these errors remotely.

It is possible to enable Input Overload reporting to the SCPI queue, by issuing the :SYSTem:ERRor:OVERload ON command. To return to the default state, issue the :SYSTem:ERRor:OVERload OFF command. In either case, Input Overloads always set the status bit.

NOTE

For versions of firmware before A.10.01, the Input Overload was only a Warning and so was never available in the SCPI queue, although it did set the status bit. For A.10.01 and later, the Input Overload is an error and can be enabled to the SCPI queue using this command.

Key Path	SCPI only
Remote Command	:SYSTem:ERRor:OVERload[:STATe] 0 1 OFF ON
Example	:SYST:ERR:OVER 1 Enable overload errors
Preset	Set to OFF by Restore Misc Defaults (no Overload errors go to SCPI)
State Saved	Saved in instrument state.
Initial S/W Revision	A.10.01

System

The System screen is formatted into three groupings: product descriptive information, options tied to the hardware, and software products:

```

<Product Name> <Product Description>
Product Number: N9020A
Serial Number: US46220924
Firmware Revision: A.01.01
Computer Name: <hostname>
Host ID: N9020A,US44220924

N9020A-503      Frequency Range to 3.6 GHz
N9020A-PFR     Precision Frequency Reference
N9020A-P03     Preamp 3.6 GHz

N9060A-2FP     Spectrum Analysis Measurement Suite 1.0.0.0
N9073A-1FP     WCDMA 1.0.0.0
N9073A-2FP     WCDMA with HSDPA 1.0.0.0
    
```

The Previous Page is grayed-out if the first page of information is presently displayed. The Next Page menu key is grayed-out if the last page of information is presently displayed.

Key Path	System, Show
Mode	All
Example	SYST:SHOW SYST

Backwards Compatibility Notes	The hardware statistics that are displayed in the PSA Show System screen have been moved to a dedicated Show Hardware Statistics screen in the Service Menu.
Initial S/W Revision	Prior to A.02.00

Show System contents (Remote Command Only)

A remote command is available to obtain the contents of the Show System screen (the entire contents, not just the currently displayed page).

Remote Command	:SYSTem:CONFigure[:SYSTem]?
Example	:SYST:CONF?
Notes	The output is an IEEE Block format of the Show System contents. Each line is separated with a new-line character.
Initial S/W Revision	Prior to A.02.00

Computer System description (Remote Command Only)

A remote command is available to obtain the Computer System description. The Computer System is the operating system and patch level as reported by operating system.

Remote Command	:SYSTem:CSYSem?
Example	:SYST:CSYS?
Notes	The return value is the Computer System name and service pack level.
Initial S/W Revision	Prior to A.12.00

Hardware

The show hardware screen is used to view details of the installed hardware. This information can be used to determine versions of hardware assemblies and field programmable devices, in the advent of future upgrades or potential repair needs.

The screen is formatted into two groupings: product descriptive information and hardware information. The hardware information is listed in a table format:

Hardware Information							
MXA Signal Analyzer							
Product Number: N9020A							
Serial Number: US46220107							
Firmware Revision: A.01.14							
Assembly Name	Part #	Serial #	Mat Rev	Rev	OF Rev	Hw Id	Misc
Analog IF	E441060104	78060200131	003	0	C	15	
YIG Tuned Filter	50877305	11061500550	005	0	A	11	
Digital IF	E441060105	78060100559	003	0	F	14	
Front End Controller	E441060101	78060100147	004	2	A	8	
Low Band Switch	E441060170	78060800346	005	1	A	10	
LO Synthesizer	E441060102	78060100226	003	3	G	2	
Reference	E441060108	78060300420	004	1	C	16	
Front End	E441060154	13062800820	010	2	B	9	

The Previous Page is grayed-out if the first page of information is presently displayed. The Next Page menu is grayed-out if the last page is information is presently displayed.

Key Path	System, Show
Mode	All
Example	SYST:SHOW HARD
Initial S/W Revision	Prior to A.02.00

LXI

This key shows you the product number, serial number, firmware revision, computer name, IP address, Host ID, LXI Class, LXI Version, MAC Address, and the Auto-MDIX Capability.

Key Path	System, Show
Initial S/W Revision	Prior to A.02.00

Power On

Enables you to select how the instrument should power on. The options are: Mode and Input/Output Defaults, User Preset and Last State.

Key Path	System
Mode	All
Remote Command	:SYSTem:PON:TYPE MODE USER LAST :SYSTem:PON:TYPE?
Example	:SYST:PON:TYPE MODE
Preset	This is unaffected by a Preset but is set to Mode on a “Restore System Defaults->All”
State Saved	No
Backwards Compatibility SCPI	:SYSTem:PON:TYPE PRESet the “PRESet” parameter is supported for backward compatibility only and behaves the same as MODE.
Backwards Compatibility Notes	The Preset Type key in legacy analyzers has been removed, and the Power On toggle key has been replaced by this 1-of-N key in the System menu.
Initial S/W Revision	Prior to A.02.00

Mode and Input/Output Defaults

When the analyzer is powered on in Mode and Input/Output Defaults, it performs a Restore Mode Defaults to all modes in the instrument and also performs a Restore Input/Output Defaults.

Persistent parameters (such as Amplitude Correction tables or Limit tables) are not affected at power on, even though they are normally cleared by Restore Input/Output Defaults and/or Restore Mode Defaults.

Key Path	System, Power On
Mode	All
Example	SYST:PON:TYPE MODE
Readback Text	Defaults
Initial S/W Revision	Prior to A.02.00

User Preset

Sets Power On to User Preset. When the analyzer is powered on in User Preset, it will User Preset each mode and switch to the power-on mode. Power On User Preset will not affect any settings beyond what a normal User Preset affects.

NOTE

An instrument could never power up for the first time in User Preset.

Key Path	System, Power On
Mode	All
Example	SYST:PON:TYPE USER
Readback Text	User Preset

Backwards Compatibility Notes	Power On User Preset will cause the instrument to power up in the power-on mode, not the last mode the instrument was in prior to shut down. Also, Power On User Preset will User Preset all modes. This does not exactly match legacy behavior.
Initial S/W Revision	Prior to A.02.00

Last State

Sets Power On to **Last**. When the analyzer is powered on, it will put all modes in the last state they were in prior to when the analyzer was put into Power Standby and it will wake up in the mode it was last in prior to powering off the instrument. The saving of the active mode prior to shutdown happens behind the scenes when a controlled shutdown is requested by using the front panel power Standby key or by using the remote command SYSTem:PDOWn. The non-active modes are saved as they are deactivated and recalled by Power On Last State.

NOTE

An instrument can never power up for the first time in Last.

If line power to the analyzer is interrupted, for example by pulling the line cord plug or by switching off power to a test rack, Power On Last State may not work properly. For proper operation, Power On Last State depends on you shutting down the instrument using the Standby key or the SYSTem:PDOWn SCPI command. This will ensure the last state of each mode is saved and can be recalled during a power up.

Key Path	System, Power On
Mode	All
Example	SYST:PON:TYPE LAST
Notes	Power on Last State only works if you have done a controlled shutdown prior to powering on in Last. If a controlled shutdown is not done when in Power On Last State, the instrument will power up in the last active mode, but it may not power up in the active mode's last state. If an invalid mode state is detected, a Mode Preset will occur. To control the shutdown under remote control use the :SYSTem:PDOWn command.
Readback Text	Last State
Backwards Compatibility Notes	It is no longer possible to power-up the analyzer in the last mode the analyzer was running with that mode in the preset state. (ESA/PSA SYST:PRESET:TYPE MODE with SYST:PON:PRESET) You can power-on the analyzer in the last mode the instrument was running in its last state (SYST:PON:TYPE LAST), or you can specify the mode to power-up in its preset state (SYST:PON:MODE <mode>).
Initial S/W Revision	Prior to A.02.00

Power On Application

Accesses a menu that lists the available Modes and lets you select which Mode is to be the power-on application.

This application is used for Power On Type “Mode and Input/Output Defaults” and Restore System Defaults All.

Key Path	System, Power On
Mode	All
Remote Command	:SYSTem:PON:MODE SA BASIC ADEMOD NFIGURE PNOISE CDMA2K TDSCDMA VSA VSA89601 WCDMA WIMAXOFDMA :SYSTem:PON:MODE?
Example	SYST:PON:MODE SA
Notes	The list of possible modes (and remote parameters) to choose from is dependent on which modes are installed in the instrument.
Preset	This is unaffected by a Preset but is set on a "Restore System Defaults->All" to: For N9038A: EMI For N8973B, N8974B, N8975B, or N8976B: NFIG For all other models: SA
State Saved	No
Initial S/W Revision	Prior to A.02.00

Configure Applications

The Configure Applications utility can be used to:

- select applications for preload
- determine how many applications can fit in memory at one time
- specify the order of the Modes in the Mode menu.

This utility consists of a window with instructions, a set of "Select Application" checkboxes, a "fuel bar" style memory gauge, and keys that help you set up your configuration.

For more information, see the following topics:

["Preloading Applications" on page 352](#)

["Access to Configure Applications utility" on page 352](#)

["Virtual memory usage" on page 352](#)

Key Path	System, Power On
Example	:SYST:SHOW CAPP Displays the Config Applications screen
Initial S/W Revision	A.02.00

Preloading Applications

During runtime, if a Mode that is not preloaded is selected using the Mode menu or sending SCPI commands, there will be a pause while the Application is loaded. During this pause a message that says “Loading application, please wait ...” is displayed. Once loaded, the application stays loaded, so the next time you select it during a session, there is no delay.

Preloading enables you to “preload” at startup, to eliminate the runtime delay. Preloading an application will cause it to be loaded into the analyzer’s memory when the analyzer program starts up. If you do this, the delay will increase the time it takes to start up the analyzer program, but this may be preferable to having to wait the first time you select an application. Note that, once an application is loaded into memory, it cannot be unloaded without exiting and restarting the analyzer program.

Note that there are more applications available for the X-Series than can fit into Windows Virtual Memory. By allowing you to choose which licensed applications to load at startup, the Configure Applications utility allows you to make optimal use of your memory.

Access to Configure Applications utility

A version of the utility runs the first time you power up the analyzer after purchasing it from Agilent. The utility automatically configures preloads so that as many licensed applications as possible are preloaded while keeping the total estimated virtual memory usage below the limit. This auto-configuration only takes place at the very first run, and after analyzer software upgrades.

You may, at any time, manually call up the Configure Applications utility by pressing System, Power On, Configure Applications, to find a configuration that works best for you, and then restart the analyzer program.

The utility may also be called if, during operation of the analyzer, you attempt to load more applications than can fit in memory at once.

Virtual memory usage

There are more applications available for the X-Series than can fit into memory at any one time, so the Configure Applications utility includes a memory tracker that serves two purposes:

1. It will not let you preload more applications than will fit into memory at once.
2. You can determine how many of your favorite applications can reside in memory at one time.

The utility provides a graphical representation of the amount of memory (note that the memory in question here is Virtual memory and is a limitation imposed by the operating system, not by the amount of physical memory you have in your analyzer). You select applications to preload by checking the boxes on the left. Checked applications preload at startup. The colored fuel bar indicates the total memory required when all the checked applications are loaded (either preloaded or selected during runtime).

Here is what the fuel bar colors mean:

RED: the applications you have selected cannot all fit into the analyzer’s memory. You must deselect applications until the fuel bar turns yellow.

YELLOW: the applications you have selected can all fit into the analyzer’s memory, but there is less than 10% of the memory left, probably not enough to load any other applications, either via preload or by selecting a Mode while the analyzer is running..

GREEN: The indicator is green when <90% of the memory limit is consumed. This means the applications you have selected can all fit into the analyzer's memory with room to spare. You will likely be able to load one or more other applications without running out of memory.

Select All

Marks all applications in the selection list. This allows you to enable all applications licensed on the instrument for pre-loading, or is a convenience for selecting all applications in one operation and then letting you deselect individual applications.

Key Path	System, Power On, Configure Applications
Initial S/W Revision	A.02.00

Deselect All

Clears the marks from all applications in the selection list, except the Power On application. The Power On application cannot be eliminated from the pre-load list.

Key Path	System, Power On, Configure Applications
Initial S/W Revision	A.02.00

Move Up

The application list is the order that applications appear in the Mode Menu. This key enables you to shift the selected application up in the list, thus moving the selected application earlier in the Mode Menu.

Key Path	System, Power On, Configure Applications
Initial S/W Revision	A.02.00

Move Down

The application list is the order that applications appear in the Mode Menu. This key enables you to shift the selected application down in the list, thus moving the selected application later in the Mode Menu.

Key Path	System, Power On, Configure Applications
Initial S/W Revision	A.02.00

Select/Deselect

Toggles the currently highlighted application in the list.

Key Path	System, Power On, Configure Applications
Initial S/W Revision	A.02.00

Save Changes and Exit

Applies the configuration of the applications list. The marked applications will be pre-loaded in memory the next time the instrument application is started, and the order of the applications in the list will be the order of the applications in the Mode Menu.

After saving your changes, the analyzer asks you if you would like it to restart so that your changes can take effect (see dialog box, below). If you choose not to restart, the changes will not take affect until the next time you shut down and restart the analyzer.

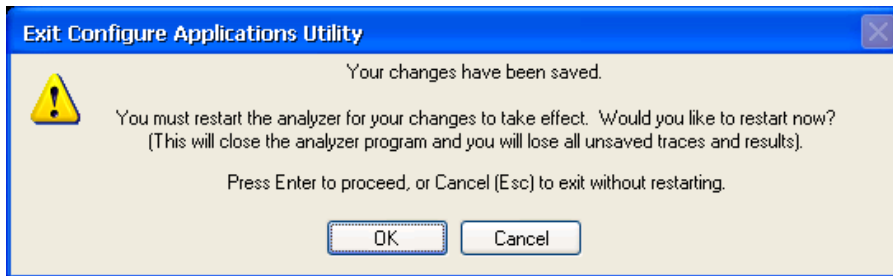

Key Path	System, Power On, Configure Applications
Remote Command	:SYSTem:PUP:PROcess
Example	:SYST:PUP:PROC This is the SCPI command for restarting the analyzer. You must Wait after this command for the instrument application to restart
Notes	The softkey will be grayed-out when the virtual memory of the selected applications exceeds 100% of the limit.
Notes	You cannot use *WAI or *OPC? to synchronize operation after a restart. This command stops and restarts the instrument application, thus the SCPI operation is terminated and restarted. A remote program must use fixed wait time to resume sending commands to the instrument. The wait time will be dependent upon which applications are pre-loaded.
Initial S/W Revision	A.02.00
Modified at S/W Revision	A.04.00

Exit Without Saving

Pressing this key will exit the Configure Applications utility without saving your changes.

Key Path	System, Power On, Configure Applications
Initial S/W Revision	A.02.00
Modified at S/W Revision	A.04.00

Restore Power On Defaults

This selection causes the Power On Type and Power On Application settings to be a reset to their default values. This level of Restore System Defaults does not affect any other system settings, mode settings and

does not cause a mode switch. The Power On key, under the Restore System Defaults menu, causes the same action.

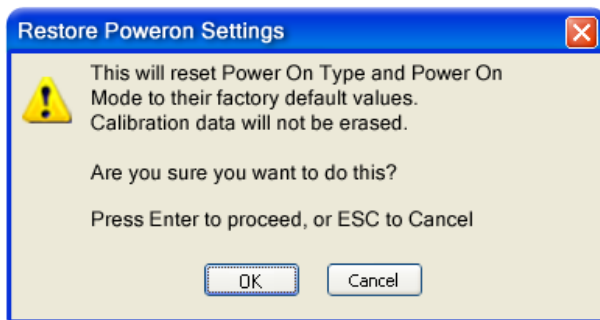

If you press any key other than OK or Enter, it is construed as a Cancel, because the only path that will actually cause the reset to be executed is through OK or Enter.

Key Path	System, Power On
Example	:SYST:DEF PON
Initial S/W Revision	Prior to A.02.00

Configure Applications - Instrument boot-up

At start-up of the analyzer program a dialog box similar to the one under the System, Power On, Configure Applications key will be displayed allowing you to choose which licensed applications are to be loaded. This dialog will only be displayed if the memory required to pre-load all of the licensed applications exceeds the Virtual Memory available.

Configure Applications - Windows desktop

The Configure Applications Utility may be run from the Windows Desktop. The utility is launched by double-



clicking the icon on the desktop, which brings-up a dialog box similar to the one under the System, Power On, Configure Applications key, allowing you to choose which licensed applications are to be loaded when the analyzer program starts up. This dialog box has mouse buttons on it that do the job the softkeys normally do in the System, Power On, Configure Applications menu.

Configure Applications - Remote Commands

The following topics provide details on using remote commands to configure the list of applications you want to load into the instrument memory or query the Virtual Memory utilization for your applications.

- ["Configuration list \(Remote Command Only\)" on page 356](#)
- ["Configuration Memory Available \(Remote Command Only\)" on page 356](#)
- ["Configuration Memory Total \(Remote Command Only\)" on page 356](#)
- ["Configuration Memory Used \(Remote Command Only\)" on page 356](#)

- "Configuration Application Memory (Remote Command Only)" on page 357

Configuration list (Remote Command Only)

This remote command is used to set or query the list of applications to be loaded in-memory.

Remote Command	:SYSTem:PON:APPLication:LLISt <string of INSTRument:SElect names> :SYSTem:PON:APPLication:LLISt?
Example	:SYST:PON:APPL:LLIS "SA,BASIC,WCDMA"
Notes	<string of INSTRument:SElect names> are from the enums of the :INSTRument:SElect command. The order of the <INSTRument:SElect names> is the order that the applications are loaded into memory, and the order that they appear in the Mode Menu. Error message -225 "Out of Memory" is reported when more applications are listed than can reside in Virtual Memory. When this occurs, the existing applications load list is unchanged.
Preset	Not affected by Preset
State Saved	Not saved in instrument state
Initial S/W Revision	A.02.00

Configuration Memory Available (Remote Command Only)

This remote command is used to query the amount of Virtual Memory remaining.

Remote Command	:SYSTem:PON:APPLication:VMEMory[:AVAIlable]?
Example	:SYST:PON:APPL:VMEM?
Preset	Not affected by Preset
Initial S/W Revision	A.02.00

Configuration Memory Total (Remote Command Only)

This remote command is used to query the limit of Virtual Memory allowed for applications.

Remote Command	:SYSTem:PON:APPLication:VMEMory:TOTal?
Example	:SYST:PON:APPL:VMEM:TOT?
Preset	Not affected by Preset
Initial S/W Revision	A.02.00

Configuration Memory Used (Remote Command Only)

This remote command is a query of the amount of Virtual Memory used by all measurement applications.

Remote Command	:SYSTem:PON:APPLication:VMEMory:USED?
Example	:SYST:PON:APPL:VMEM:USED?

Preset	Not affected by Preset
Initial S/W Revision	A.02.00

Configuration Application Memory (Remote Command Only)

This remote command is used to query the amount of Virtual Memory a particular application consumes.

Remote Command	:SYSTem:PON:APPLication:VMEMory:USED:NAME? <INSTRument:SElect name>
Example	:SYST:PON:APPL:VMEM:USED:NAME? CDMA2K
Notes	<INSTRument:SElect name> is from the enums of the :INSTRument:SElect command Value returned will be 0 (zero) if the name provided is invalid.
Preset	Not affected by Preset
Initial S/W Revision	Prior to A.02.00

Alignments

The Alignments Menu controls and displays the automatic alignment of the instrument, and provides the ability to restore the default alignment values.

The current setting of the alignment system is displayed in the system Settings Panel along the top of the display, including a warning icon for conditions that may cause specifications to be impacted.



Key Path	System
Initial S/W Revision	Prior to A.02.00

Auto Align

Configures the method for which the automatic background alignment is run.

Automatic background alignments are run periodically between measurement acquisitions. The instrument's software determines when alignments are to be performed to maintain warranted operation. The recommended setting for Auto Align is Normal.

An Auto Align execution cannot be aborted with the Cancel (ESC) key. To interrupt an Auto Align execution, select Auto Align Off.

Key Path	System, Alignments
Mode	All
Remote Command	:CALibration:AUTO ON PARTial OFF :CALibration:AUTO?
Example	:CAL:AUTO ON

Notes	While Auto Align is executing, bit 0 of Status Operation register is set.
Couplings	Auto Align is set to Off if Restore Align Data is invoked.
Preset	This is unaffected by Preset but is set to ON upon a “Restore System Defaults->Align”.
State Saved	No
Status Bits/OPC dependencies	When Auto Align is executing, bit 0 in the Status Operational register is set.
Backwards Compatibility SCPI	:CALibration:AUTO ALERt
	Parameter ALERt is for backward compatibility only and is mapped to PARTial
Backwards Compatibility Notes	<ol style="list-style-type: none"> 1. ESA SCPI for Auto Align is :CALibration:AUTO <Boolean>. The command for X-Series is an enumeration. Thus the parameters of “0” and “1” are not possible in X-Series. 2. Similarly, the ESA SCPI for :CALibration:AUTO? returned the Boolean value 1 or 0, in X-Series it is an Enumeration (string). Thus, queries by customer applications into numeric variables will result in an error 3. In PSA Auto Align OFF was not completely off, it is equivalent to PARTial in X-Series. In X-Series, OFF will be fully OFF. This means users of PSA SCPI who choose OFF may see degraded performance and should migrate their software to use PARTial.
Initial S/W Revision	Prior to A.02.00

Normal

Auto Align, Normal turns on the automatic alignment of all measurement systems. The Auto Align, Normal selection maintains the instrument in warranted operation across varying temperature and over time.

If the condition “Align Now, All required” is set, transition to Auto Align, Normal will perform the required alignments and clear the “Align Now, All required” condition and then continue with further alignments as required to maintain the instrument adequately aligned for warranted operation.

When Auto Align, Normal is selected the Auto Align Off time is set to zero.

When Auto Align, Normal is selected the Settings Panel indicates ALIGN AUTO.

Key Path	System, Alignments, Auto Align
Mode	All
Example	:CAL:AUTO ON
Notes	<p>Alignment processing as a result of the transition to Normal will be executed sequentially. Thus, *OPC? or *WAI following CAL:AUTO ON will return when the alignment processing is complete.</p> <p>The presence of an external signal may interfere with the RF portion of the alignment. If so, the Error Condition message “Align skipped: 50 MHz interference” or “Align skipped: 4.8 GHz interference” is reported, and bit 11 is set in the Status Questionable Calibration register. After the interfering signal is removed, subsequent alignment of the RF will clear the condition, and clear bit 11 in the Status Questionable Calibration register.</p>
Readback Text	Normal
Status Bits/OPC dependencies	An interfering user signal may prevent automatic alignment of the RF subsystem. If this occurs, the Error Condition message “Align skipped: 50 MHz interference” or “Align skipped: 4.8 GHz

interference” is reported, the Status Questionable Calibration bit 11 is set, and the alignment proceeds. When a subsequent alignment of the RF subsystem succeeds, either by the next cycle of automatic alignment or from an Align Now, RF, the Error Condition and Status Questionable Calibration bit 11 are cleared.

Initial S/W Revision	Prior to A.02.00
----------------------	------------------

Partial

Auto Align, Partial disables the full automatic alignment and the maintenance of warranted operation for the benefit of improved measurement throughput. Accuracy is retained for the Resolution Bandwidth filters and the IF Passband, which is critical to FFT accuracy, demodulation, and many measurement applications. With Auto Align set to Partial, you are now responsible for maintaining warranted operation by updating the alignments when they expire. The Auto Align, Alert mechanism will notify you when alignments have expired. One solution to expired alignments is to perform the Align All, Now operation. Another is to return the Auto Align selection to Normal.

Auto Align, Partial is recommended for measurements where the throughput is so important that a few percent of improvement is more valued than an increase in the accuracy errors of a few tenths of a decibel. One good application of Auto Align, Partial would be an automated environment where the alignments can be called during overhead time when the device-under-test is exchanged.

When Auto Align, Partial is selected the elapsed time counter begins for Auto Align Off time.

When Auto Align, Partial is selected the Settings Panel indicates ALIGN PARTIAL with a warning icon. The warning icon is to inform the operator that they are responsible for maintaining the warranted operation of the instrument

Key Path	System, Alignments, Auto Align
Mode	All
Example	:CAL:AUTO PART
Notes	Auto Align Partial begins the elapsed time counter for Auto Align Off time.
Readback Text	Partial
Initial S/W Revision	Prior to A.02.00

Off

Auto Align, Off disables automatic alignment and the maintenance of warranted operation, for the benefit of maximum measurement throughput. With Auto Align set to Off, you are now responsible for maintaining warranted operation by updating the alignments when they expire. The Auto Align, Alert mechanism will notify you when alignments have expired. One solution to expired alignments is to perform the Align All, Now operation. Another is to return the Auto Align selection to Normal.

The Auto Align, Off setting is rarely the best choice, because Partial gives almost the same improvement in throughput while maintaining the warranted performance for a much longer time. The choice is intended for unusual circumstances such as the measurement of radar pulses where you might like the revisit time to be as consistent as possible.

When Auto Align, Off is selected the Auto Align Off time is initialized and the elapsed time counter begins.

When Auto Align, Off is selected the Settings Panel indicates ALIGN OFF with a warning icon. The warning icon is to inform the operator that they are responsible for maintaining the warranted operation of the instrument:

Key Path	System, Alignments, Auto Align
Mode	All
Example	:CAL:AUTO OFF
Notes	Auto Align Off begins the elapsed time counter for Auto Align Off time.
Couplings	Auto Align is set to Off if Restore Align Data is invoked.
Readback Text	Off
Initial S/W Revision	Prior to A.02.00

All but RF

Auto Align, All but RF, configures automatic alignment to include or exclude the RF subsystem. (Eliminating the automatic alignment of the RF subsystem prevents the input impedance from changing. The normal input impedance of 50 ohms can change to an open circuit when alignments are being used. Some devices under test do not behave acceptably under such circumstances, for example by showing instability.) When Auto Align, All but RF ON is selected, the operator is responsible for performing an Align Now, RF when RF-related alignments expire. The Auto Align, Alert mechanism will notify the operator to perform an Align Now, All when the combination of time and temperature variation is exceeded.

When Auto Align, All but RF ON is selected the Settings Panel indicates ALIGN AUTO/NO RF with a warning icon (warning icon is intended to inform the operator they are responsible for the maintaining the RF alignment of the instrument):

Key Path	System, Alignments, Auto Align
Mode	All
Remote Command	:CALibration:AUTO:MODE ALL NRF :CALibration:AUTO:MODE?
Example	:CAL:AUTO:MODE NRF
Preset	This is unaffected by Preset but is set to ALL on a "Restore System Defaults->Align".
State Saved	No
Readback Text	RF or NRF
Initial S/W Revision	Prior to A.02.00

Alert

The instrument will signal an Alert when conditions exist such that you will need to perform a full alignment (for example, Align Now, All). The Alert can be configured in one of four settings; Time & Temperature, 24 hours, 7 days, or None. A confirmation is required when a selection other than Time & Temperature is chosen. This prevents accidental deactivation of alerts.

With Auto Align set to Normal, the configuration of Alert is not relevant because the instrument's software maintains the instrument in warranted operation.

Key Path	System, Alignments, Auto Align
Mode	All
Remote Command	:CALibration:AUTO:ALERT TTEMperature DAY WEEK NONE :CALibration:AUTO:ALERT?
Example	:CAL:AUTO:ALERT TEM
Notes	The alert that alignment is needed is the setting of bit 14 in the Status Questionable Calibration register.
Preset	This is unaffected by Preset but is set to TTEMperature on a "Restore System Defaults->Align".
State Saved	No
Status Bits/OPC dependencies	The alert is the Error Condition message "Align Now, All required" and bit 14 is set in the Status Questionable Calibration register.
Initial S/W Revision	Prior to A.02.00

Time & Temperature

With Auto Align Alert set to Time & Temperature the instrument will signal an alert when alignments expire due to the combination of the passage of time and changes in temperature. The alert is the Error Condition message "Align Now, All required". If this choice for Alert is selected, the absence of an alert means that the analyzer alignment is sufficiently up-to-date to maintain warranted accuracy.

Key Path	System, Alignments, Auto Align, Alert
Mode	All
Example	:CAL:AUTO:ALERT TEM
Readback Text	Time & Temp
Status Bits/OPC dependencies	Bit 14 is set in the Status Questionable Calibration register.
Initial S/W Revision	Prior to A.02.00

24 hours

With Auto Align Alert set to 24 Hours the instrument will signal an alert after a time span of 24 hours since the last successful full alignment (for example, Align Now, All or completion of a full Auto Align). You may choose this selection in an environment where the temperature is stable on a daily basis at a small risk of accuracy errors in excess of the warranted specifications. The alert is the Error Condition message "Align Now, All required".

For front-panel operation, confirmation is required to transition into this setting of Alert. The confirmation dialog is:

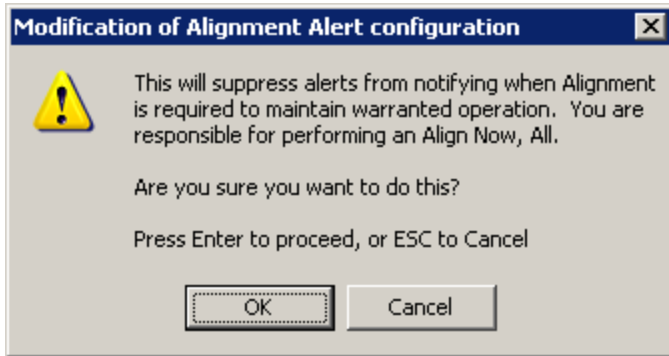

No confirmation is required when Alert is configured through a remote command.

Key Path	System, Alignments, Auto Align, Alert
Mode	All
Example	:CAL:AUTO:ALER DAY
Readback Text	24 hours
Status Bits/OPC dependencies	Bit 14 is set in the Status Questionable Calibration register.
Initial S/W Revision	Prior to A.02.00

7 days

With Auto Align Alert is set to 7 days the instrument will signal an alert after a time span of 168 hours since the last successful full alignment (for example, Align Now, All or completion of a full Auto Align). You may choose this selection in an environment where the temperature is stable on a weekly basis, at a modest risk of accuracy degradations in excess of warranted performance. The alert is the Error Condition message “Align Now, All required”.

For front panel operation, confirmation is required for the customer to transition into this setting of Alert. The confirmation dialog is:

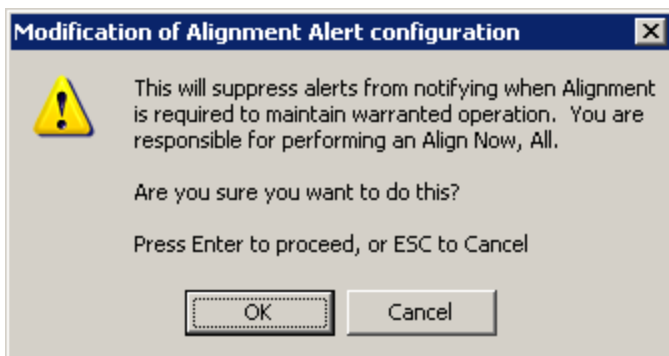

No confirmation is required when Alert is configured through a remote command.

Key Path	System, Alignments, Auto Align, Alert
Mode	All
Example	:CAL:AUTO:ALER WEEK
Readback Text	7 days
Status Bits/OPC dependencies	Bit 14 is set in the Status Questionable Calibration register.
Initial S/W Revision	Prior to A.02.00

None

With Auto Align Alert set to None the instrument will not signal an alert. This is provided for rare occasions where you are making a long measurement which cannot tolerate Auto Align interruptions, and must have the ability to capture a screen image at the end of the measurement without an alert posted to the display. Agilent does not recommends using this selection in any other circumstances, because of the risk of accuracy performance drifting well beyond expected levels without the operator being informed.

For front panel operation, confirmation is required to transition into this setting of Alert. The confirmation dialog is:

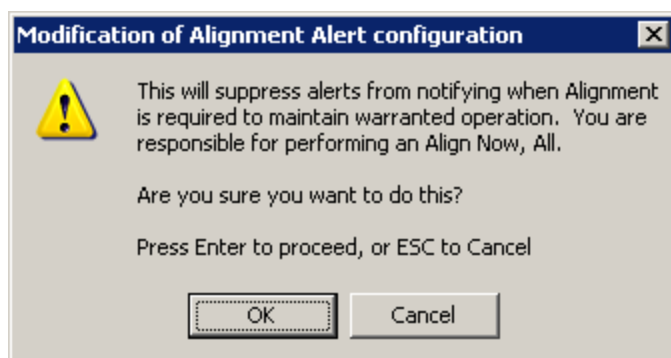

No confirmation is required when Alert is configured through a remote command.

Key Path	System, Alignments, Auto Align, Alert
Mode	All
Example	:CAL:AUTO:ALER NONE
Initial S/W Revision	Prior to A.02.00

Execute Expired Alignments (Remote Command Only)

Alignments can be expired in the situation where Auto Align is in the state of Partial or Off. This feature runs the alignments that have expired. This is different than performing an Align All, Now operation. Align All, Now performs an alignment of all subsystems regardless of whether they are needed or not, with Execute Expired Alignments, only the individual subsystems that have become due are aligned.

Mode	All
Remote Command	:CALibration:EXPIred?
Example	:CAL:EXP?
Notes	:CALibration:EXPIred? returns 0 if successful :CALibration:EXPIred? returns 1 if failed
Initial S/W Revision	Prior to A.02.00

Align Now

Accesses alignment processes that are immediate action operations. They perform complete operations and run until they are complete.

Key Path	System, Alignments
Initial S/W Revision	Prior to A.02.00

All

(In MXE the key label is “All (plus RF Presel 20 Hz – 3.6 GHz)”)Immediately executes an alignment of all subsystems In MXE, the Align Now All is followed by additionally aligning the RF Preselector section, so in MXE, the key label contains the parenthetical note “(plus RF Presel 20 Hz – 3.6 GHz)”. The instrument stops any measurement currently underway, performs the alignment, then restarts the measurement from the beginning (similar to pressing the Restart key).

If an interfering user signal is present at the RF Input, the alignment is performed on all subsystems except the RF. After completion, the Error Condition message “Align skipped: 50 MHz interference” or “Align skipped: 4.8 GHz interference” is generated. In addition the Error Condition message “Align Now, RF required” is generated, and bits 11 and 12 are set in the Status Questionable Calibration register.

The query form of the remote commands (:CALibration[:ALL]? or *CAL?) invokes the alignment of all subsystems and returns a success or failure value. An interfering user signal is not grounds for failure; if the alignment was able to succeed on all portions but unable to align the RF because of an interfering signal, the resultant will be the success value.

Successful completion of Align Now, All will clear the “Align Now, All required” Error Condition, and clear bit 14 in the Status Questionable Calibration register. It will also begin the elapsed time counter for Last Align Now, All Time, and capture the Last Align Now, All Temperature.

In the MXE, successful completion will also clear the “Align 20 Hz to 30 MHz required” Error Condition, the “Align 30 MHz to 3.6 GHz required” Error Condition, and the “Align 20 Hz to 3.6 GHz required” Error Condition, and clear bits 1 and bit 2 and clear the bit 1 in the Status Questionable Calibration Extended Needed register.

If the Align RF subsystem succeeded in aligning (no interfering signal present), the elapsed time counter begins for Last Align Now, RF Time, and the temperature is captured for the Last Align Now, RF Temperature. In addition the Error Conditions “Align skipped: 50 MHz interference” and “Align skipped: 4.8

GHz interference” are cleared, the Error Condition “Align Now, RF required” is cleared, and bits 11 and 12 are cleared in the Status Questionable Calibration register

Align Now, All can be interrupted by pressing the Cancel (ESC) front-panel key or remotely with Device Clear followed by the :ABORT SCPI command. When this occurs the Error Condition message “Align Now, All required” is generated, and bit 14 is set in the Status Questionable Condition register. This is because new alignment data may be employed for an individual subsystem, but not a cohesive set of data for all subsystems.

In many cases, you might find it more convenient to change alignments to Normal, instead of executing Align Now, All. When the Auto Align process transitions to Normal, the analyzer will immediately start to update only the alignments that have expired, thus efficiently restoring the alignment process.

Key Path	System, Alignments, Align Now
Mode	All
Remote Command	:CALibration[:ALL] :CALibration[:ALL]?
Example	:CAL
Notes	:CALibration[:ALL]? returns 0 if successful :CALibration[:ALL]? returns 1 if failed :CALibration[:ALL]? is the same as *CAL? While Align Now, All is performing the alignment, bit 0 in the Status Operation register is set. Completion, or termination, will clear bit 0 in the Status Operation register. This command is sequential; it must complete before further SCPI commands are processed. Interrupting the alignment from remote is accomplished by invoking Device Clear followed by the :ABORT command. Successful completion will clear bit 14 in the Status Questionable Calibration register. An interfering user signal is not grounds for failure of Align Now, All. However, bits 11 and 12 are set in the Status Questionable Calibration register to indicate Align Now, RF is required. An interfering user supplied signal will result in the instrument requiring an Align Now, RF with the interfering signal removed.
Couplings	Initializes the time for the Last Align Now, All Time. Records the temperature for the Last Align Now, All Temperature. If Align RF component succeeded, initializes the time for the Last Align Now, RF Time. If Align RF component succeeded, records the temperature for the Last Align Now, RF Temperature.
Status Bits/OPC dependencies	Bits 11, 12, or 14 may be set in the Status Questionable Calibration register.
Initial S/W Revision	Prior to A.02.00

Mode	All
Remote Command	*CAL?
Example	*CAL?
Notes	*CAL? returns 0 if successful

	<p>*CAL? returns 1 if failed :CALibration[:ALL]? is the same as *CAL? See additional remarks described with :CALibration[:ALL]? Everything about :CALibration[:ALL]? is synonymous with *CAL? including all conditions, status register bits, and couplings</p>
Initial S/W Revision	Prior to A.02.00

All but RF

(In MXE the key label is “All but RF (not including RF Presel)”)

Immediately executes an alignment of all subsystems except the RF subsystem . The instrument will stop any measurement currently underway, perform the alignment, and then restart the measurement from the beginning (similar to pressing the Restart key). This can be used to align portions of the instrument that are not impacted by an interfering user input signal.

This operation might be chosen instead of All if you do not want the device under test to experience a large change in input impedance, such as a temporary open circuit at the analyzer input.

The query form of the remote commands (:CALibration:NRF?) will invoke the alignment and return a success or failure value.

Successful completion of Align Now, All but RF will clear the “Align Now, All required” Error Condition, and clear bit 14 in the Status Questionable Calibration register. If “Align Now, All required” was in effect prior to executing the All but RF, the Error Condition message “Align Now, RF required” is generated and bit 12 in the Status Questionable Calibration register is set. It will also begin the elapsed time counter for Last Align Now, All Time, and capture the Last Align Now, All Temperature.

Align Now, All but RF can be interrupted by pressing the Cancel (ESC) front-panel key or remotely with Device Clear followed by the :ABORt SCPI command. When this occurs the Error Condition message “Align Now, All required” is generated, and bit 14 is set in the Status Questionable Condition register. This is because new alignment data may be used for an individual subsystem, but not a full new set of data for all subsystems.

In models with the RF Preselector, such as the N9038A, the “All but RF” alignment will execute an alignment of all subsystems except the RF subsystem of the Spectrum Analyzer, as well as the system gain of the RF Preselector.

Key Path	System, Alignments, Align Now
Mode	All
Remote Command	:CALibration:NRF :CALibration:NRF?
Example	:CAL:NRF
Notes	:CALibration:NRF? returns 0 if successful :CALibration:NRF? returns 1 if failed While Align Now, All but RF is performing the alignment, bit 0 in the Status Operation register is set. Completion, or termination, will clear bit 0 in the Status Operation register.

	<p>This command is sequential; it must complete before further SCPI commands are processed. Interrupting the alignment from remote is accomplished by invoking Device Clear followed by the :ABORt command.</p> <p>Successful completion will clear bit 14 in the Status Questionable Calibration register and set bit 12 if invoked with “Align Now, All required”.</p>
Couplings	<p>Initializes the time for the Last Align Now, All Time.</p> <p>Records the temperature for the Last Align Now, All Temperature.</p>
Status Bits/OPC dependencies	Bits 12 or 14 may be set in the Status Questionable Calibration register.
Initial S/W Revision	Prior to A.02.00

RF

(In MXE the key label is “RF Only”)

Immediately executes an alignment of the RF subsystem . The instrument stops any measurement currently underway, performs the alignment, then restarts the measurement from the beginning (similar to pressing the Restart key).

This operation might be desirable if the alignments had been set to not include RF alignments, or if previous RF alignments could not complete because of interference which has since been removed.

If an interfering user signal is present at the RF Input, the alignment will terminate and generate the Error Condition message “Align skipped: 50 MHz interference” or “Align skipped: 4.8 GHz interference”, and Error Condition “Align Now, RF required”. In addition, bits 11 and 12 will be set in the Status Questionable Calibration register.

The query form of the remote commands (:CALibration:RF?) will invoke the alignment of the RF subsystem and return a success or failure value. An interfering user signal is grounds for failure.

Successful completion of Align Now, RF will begin the elapsed time counter for Last Align Now, RF Time, and capture the Last Align Now, RF Temperature.

Align Now, RF can be interrupted by pressing the Cancel (ESC) front-panel key or remotely with Device Clear followed by the :ABORt SCPI command. When this occurs, the Error Condition message “Align Now, RF required” is generated, and bit 12 is set in the Status Questionable Condition register. None of the new alignment data is used.

In models with the RF Preselector, such as the N9038A, the RF alignment will execute an alignment of the RF subsystem of the Spectrum Analyzer, as well as the RF subsystem on RF Preselector path.

Key Path	System, Alignments, Align Now
Mode	All
Remote Command	:CALibration:RF :CALibration:RF?
Example	:CAL:RF
Notes	:CALibration:RF? returns 0 if successful

:CALibration:RF?	<p>returns 1 if failed (including interfering user signal)</p> <p>While Align Now, RF is performing the alignment, bit 0 in the Status Operation register is set. Completion, or termination, will clear bit 0 in the Status Operation register.</p> <p>This command is sequential; it must complete before further SCPI commands are processed. Interrupting the alignment from remote is accomplished by invoking Device Clear followed by the :ABORt command.</p> <p>Successful completion clears the Error Conditions “Align skipped: 50 MHz interference” and “Align skipped: 4800 MHz interference” and the Error Conditions “Align RF failed” and “Align Now, RF required”, and clears bits 3, 11, and 12 in the Status Questionable Calibration register.</p> <p>A failure encountered during alignment will generate the Error Condition message “Align RF failed” and set bit 3 in the Status Questionable Calibration register.</p> <p>An interfering user signal will result in bits 11 and 12 to be set in the Status Questionable Calibration register to indicate Align Now, RF is required.</p> <p>An interfering user supplied signal will result in the instrument requiring an Align Now, RF with the interfering signal removed.</p>
Couplings	<p>Initializes the time for the Last Align Now, RF Time.</p> <p>Records the temperature for the Last Align Now, RF Temperature.</p>
Status Bits/OPC dependencies	<p>Bits 11, 12, or 14 may be set in the Status Questionable Calibration register.</p>
Initial S/W Revision	<p>Prior to A.02.00</p>

External Mixer

Immediately executes an alignment of the External Mixer that is plugged into the USB port. The instrument stops any measurement currently underway, performs the alignment, then restarts the measurement from the beginning (similar to pressing the Restart key). As this alignment calibrates the LO power to the mixer, this is considered an LO alignment; and failure is classified as an LO alignment failure.

The query form of the remote commands (:CALibration:EMIXer?) will invoke the alignment of the External Mixer and return a success or failure value.

Key Path	System, Alignments, Align Now
Mode	All
Remote Command	:CALibration:EMIXer :CALibration:EMIXer?
Example	:CAL:EMIX
Notes	<p>:CAL:EMIX? returns 0 if successful</p> <p>:CAL:EMIX? returns 1 if failed</p> <p>While Align Now, Ext Mix is performing the alignment, bit 0 in the Status Operation register is set. Completion, or termination, will clear bit 0 in the Status Operation register.</p> <p>This command is sequential; it must complete before further SCPI commands are processed. Interrupting the alignment from remote is accomplished by invoking Device Clear followed by the :ABORt command.</p>

	A failure encountered during alignment will generate the Error Condition message “Align LO failed” and set bit 5 in the Status Questionable Calibration register. Successful completion will clear the “Align LO failed” message and bit 5 in the Status Questionable Calibration register.
Dependencies	This key does not appear unless option EXM is present and is grayed-out unless a USB mixer is plugged in to the USB.
Status Bits/OPC dependencies	Bit3 may be set in the Status Questionable Calibration Extended Failure register.
Initial S/W Revision	A.08.00

Show Alignment Statistics

Shows alignment information you can use to ensure that the instrument is operating in a specific manner. The Show Alignment Statistics screen is where you can view time and temperature information.

Values which are displayed are only updated when the Show Alignment Statistics screen is invoked, they are not updated while the Show Alignment Statistics screen is being displayed. The remote commands that access this information obtain current values.

An example of the Show Alignment Statistics screen would be similar to:

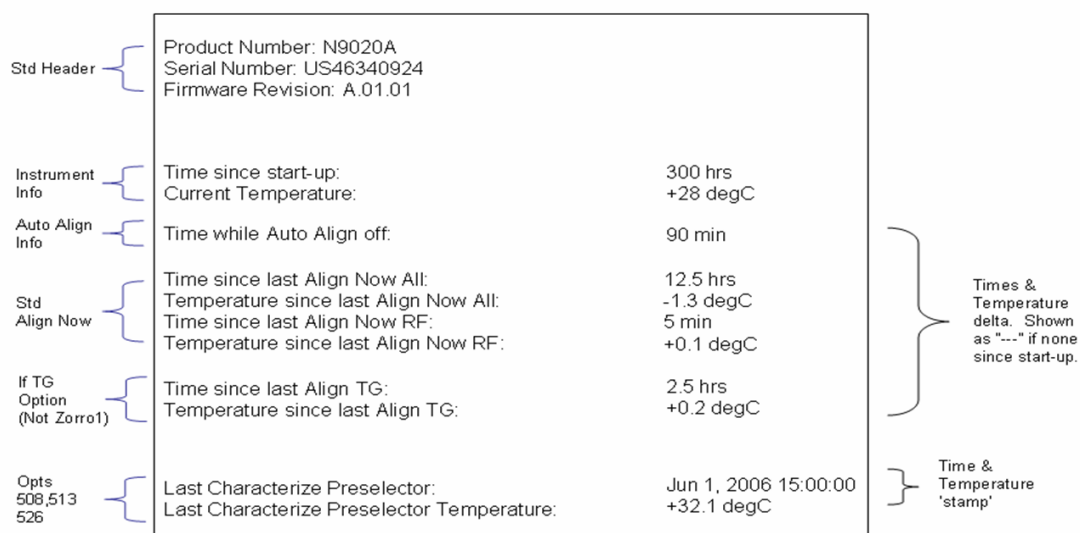

A successful Align Now, RF will set the Last Align RF temperature to the current temperature, and reset the Last Align RF time. A successful Align Now, All or Align Now, All but RF will set the Last Align Now All temperature to the current temperature, and reset the Last Align Now All time. A successful Align Now, All will also reset the Last Align RF items if the RF portion of the Align Now succeeded.

Key Path	System, Alignments
Mode	All

Notes	The values displayed on the screen are only updated upon entry to the screen and not updated while the screen is being displayed.
Initial S/W Revision	Prior to A.02.00

Key Path	Visual annotation in the Show Alignment Statistics screen
Mode	All
Remote Command	:SYSTem:PON:TIME?
Example	:SYST:PON:TIME?
Notes	Value is the time since the most recent start-up in seconds.
State Saved	No
Initial S/W Revision	Prior to A.02.00

Key Path	Visual annotation in the Show Alignment Statistics screen
Mode	All
Remote Command	:CALibration:TEMPerature:CURRent?
Example	:CAL:TEMP:CURR?
Notes	Value is in degrees Centigrade. Value is invalid if using default alignment data (Align Now, All required)
State Saved	No
Initial S/W Revision	Prior to A.02.00

Key Path	Visual annotation in the Show Alignment Statistics screen
Mode	All
Remote Command	:CALibration:TIME:LALL?
Example	:CAL:TIME:LALL?
Notes	Value is the elapsed time, in seconds, since the last successful Align Now, All or Align Now, All but RF was executed.
State Saved	No
Initial S/W Revision	Prior to A.02.00

Key Path	Visual annotation in the Show Alignment Statistics screen
Mode	All
Remote Command	:CALibration:TEMPerature:LALL?
Example	:CAL:TEMP:LALL?

Notes	Value is in degrees Centigrade at which the last successful Align Now, All or Align Now, All but RF was executed.
State Saved	No
Initial S/W Revision	Prior to A.02.00

Key Path	Visual annotation in the Show Alignment Statistics screen
Mode	All
Remote Command	:CALibration:TIME:LRF?
Example	:CAL:TIME:LRF?
Notes	Value is the elapsed time, in seconds, since the last successful Align Now, RF was executed, either individually or as a component of Align Now, All.
State Saved	No
Initial S/W Revision	Prior to A.02.00

Key Path	Visual annotation in the Show Alignment Statistics screen
Mode	All
Remote Command	:CALibration:TEMPerature:LRF?
Example	:CAL:TEMP:LRF?
Notes	Value is in degrees Centigrade at which the last successful Align Now, RF was executed, either individually or as a component of Align Now, All.
State Saved	No
Initial S/W Revision	Prior to A.02.00

Key Path	Visual annotation in the Show Alignment Statistics screen
Mode	All
Remote Command	:CALibration:TIME:LPreselector?
Example	:CAL:TIME:LPR?
Notes	Value is the date and time the last successful Characterize Preselector was executed. The date is separated from the time by a space character. Returns "" if no Characterize Preselector has ever been performed on the instrument.
Dependencies	In models that do not include preselectors, this command is not enabled and any attempt to set or query will yield an error.
State Saved	No
Initial S/W Revision	Prior to A.02.00

Key Path	Visual annotation in the Show Alignment Statistics screen
Mode	All
Remote Command	:CALibration:TEMPerature:LPreselector?
Example	:CAL:TEMP:LPR?
Notes	Value is in degrees Centigrade at which the last successful Characterize Preselector was executed.
Dependencies	In models that do not include preselectors, this command is not enabled and any attempt to set or query will yield an error.
State Saved	No
Initial S/W Revision	Prior to A.02.00

Key Path	Visual annotation in the Show Alignment Statistics screen
Mode	All
Remote Command	:CALibration:AUTO:TIME:OFF?
Example	:CAL:AUTO:TIME:OFF?
Notes	Value is the elapsed time, in seconds, since Auto Align has been set to Off or Off with Alert. The value is 0 if Auto Align is ALL or NORF.
State Saved	No
Initial S/W Revision	Prior to A.02.00

Key Path	Visual annotation in the Show Alignment Statistics screen
Mode	All
Remote Command	:CALibration:TIME:RFPSector:LCONducted?
Example	:CAL:TIME:RFPS:LCON?
Notes	Values are the date and time the last successful Align Now, 20 Hz – 30 MHz was executed. The date is separated from the time by a semi-colon character.
State Saved	No

Key Path	Visual annotation in the Show Alignment Statistics screen
Mode	All
Remote Command	:CALibration:TEMPerature:RFPSector:LCONducted?
Example	:CAL:TEMP:RFPS:LCON?
Notes	Value is in degrees Centigrade at which the last successful Align Now, 20 Hz – 30 MHz was executed.
State Saved	No

Key Path	Visual annotation in the Show Alignment Statistics screen
Mode	All
Remote Command	:CALibration:TIME:RFPSector:LRADiated?
Example	:CAL:TIME:RFPS:LRAD?
Notes	Value is the date and time the last successful Align Now, 30 MHz – 3.6 GHz was executed. The date is separated from the time by a semi-colon character.
State Saved	No

Key Path	Visual annotation in the Show Alignment Statistics screen
Mode	All
Remote Command	:CALibration:TEMPerature:RFPSector:LRADiated?
Example	:CAL:TEMP:RFPS:LRAD?
Notes	Value is in degrees Centigrade at which the last successful Align Now, 30 MHz – 3.6 GHz was executed.
State Saved	No

Key Path	Visual annotation in the Show Alignment Statistics screen
Mode	All
Remote Command	:CALibration:RFPSector:SCHeuler:TIME:NEXT? This query returns data using the following format “YYYY/MM/DD; HH:MM:SS”
Example	:CAL:RFPS:SCH:TIME:NEXT?
Notes	The next run time will be updated based on the start date/time and recurrence set by the users. “date” is representation of the date the task will run in the form of “YYYY/MM/DD” where: –YYYY is the four digit representation of year. (for example, 2009) –MM is the two digit representation of month. (for example, 01 to 12) –DD is the two digit representation of the day. (for example, 01 to 28, 29, 30 or 31 depending on the month and year) “time” is a representation of the time of day the task will run in the form of “HH:MM:SS” where: –HH is the two digit representation of the hour in 24 hour format –MM is the two digit representation of minute –SS is the two digit representation of seconds For model N9038A only.
State Saved	No

Restore Align Defaults

Initializes the alignment user interface settings, not alignment data, to the factory default values. Align Now, All must be executed if the value of the Timebase DAC results in a change.

For front panel operation, you are prompted to confirm action before setting the alignment parameters to factory defaults:

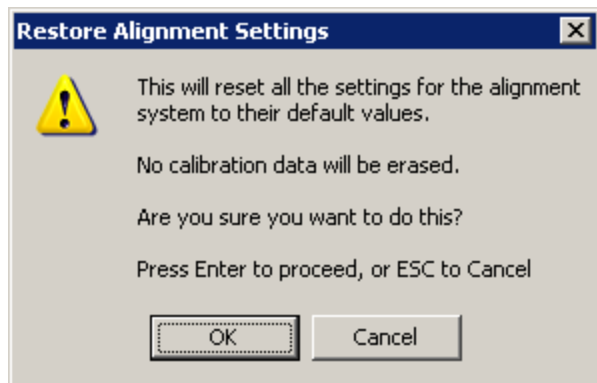

The parameters affected are:

Parameter	Setting
Timebase DAC	Calibrated
Timebase DAC setting	Calibrated value
Auto Align State	Normal (if the instrument is not operating with default alignment data, Off otherwise)
Auto Align All but RF	Off
Auto Align Alert	Time & Temperature

Key Path	System, Alignments
Mode	All
Example	:SYST:DEF ALIG
Notes	Alignment processing that results as the transition to Auto Alignment Normal will be executed sequentially; thus *OPC? or *WAI will wait until the alignment processing is complete.
Initial S/W Revision	Prior to A.02.00

Backup or Restore Align Data...

Opens the utility for backing-up or restoring the alignment data.

Alignment data for the instrument resides on the hard drive in a database. Agilent uses high quality hard drives; however it is highly recommended the alignment data be backed-up to storage outside of the instrument. Additionally, for customers who use multiple CPU Assemblies or multiple disk drives, the

alignment that pertains to the instrument must be transferred to the resident hard drive after a CPU or hard drive is replaced. This utility facilitates backing-up and restoring the alignment data.

NOTE

This utility allows the operator to navigate to any location of the Windows file system. It is intended that the operator use a USB memory device or Mapped Network Drive to back up the alignment data to storage outside of the instrument.

Key Path	System, Alignments
Initial S/W Revision	A.02.00
Key Path	System, Alignments
Mode	All
Remote Command	:CALibration:DATA:DEfault
Example	:CAL:DATA:DEF
Couplings	Sets Auto Align to Off. Sets bit 14 in the Status Questionable Calibration register. The Error Condition message "Align Now, All required" is generated.
Initial S/W Revision	Prior to A.02.00

Alignment Data Wizard

The Backup or Restore Alignment Data wizard guides you through the operation of backing-up or restoring the alignment data.

The following dialogue boxes operates without a mouse or external keyboard when you use the default file names.

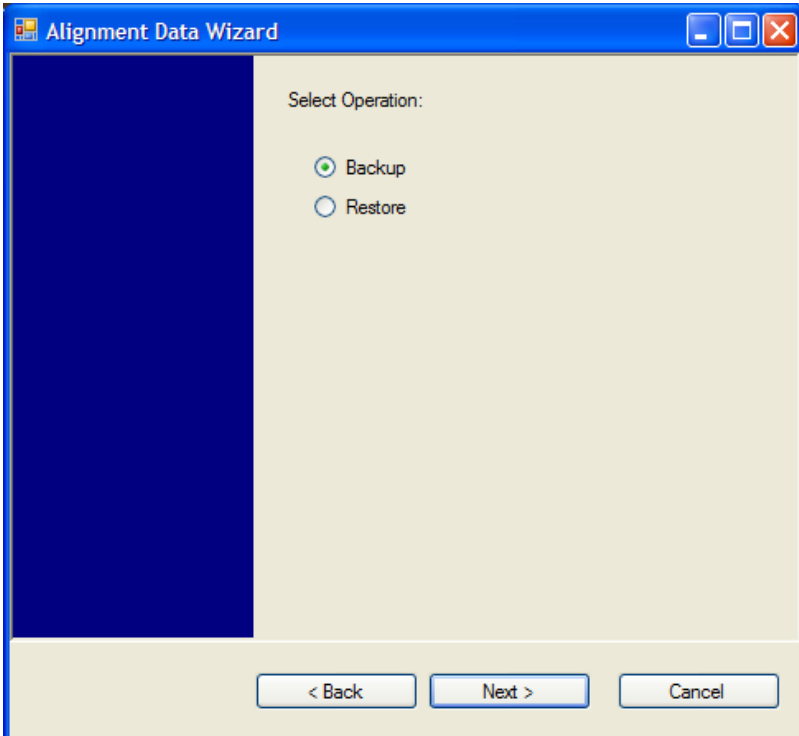
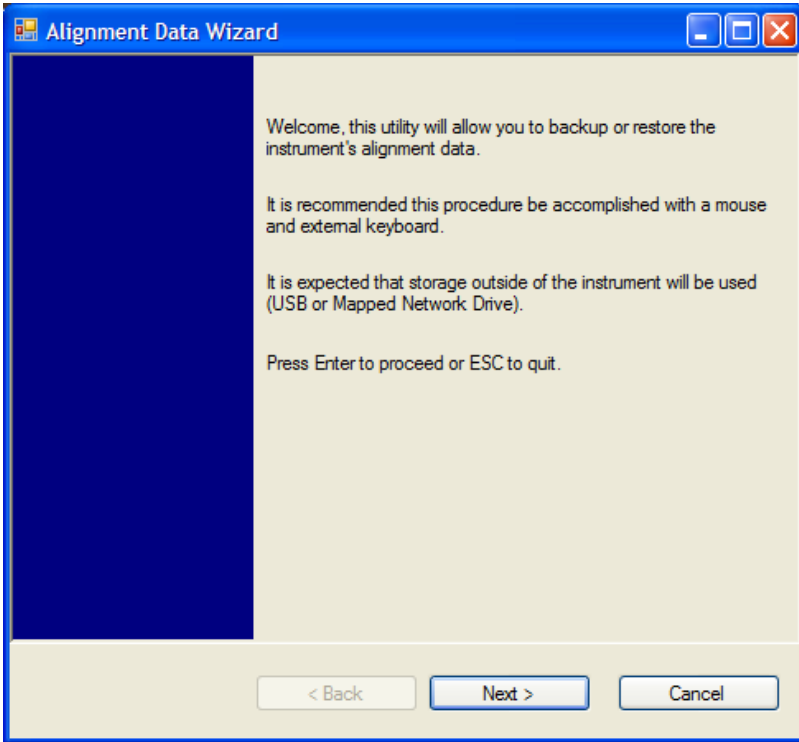

The backup screen indicates the approximate amount of space required to contain the backup file.

The default file name will be AlignDataBackup_<model number>_<serial number>_<date in YYYYMMDDHHMMSS>.bak.

The default backup location will be first drive identified as an external drive (USB or LAN) if such is available; if not, the internal D: partition will be selected.

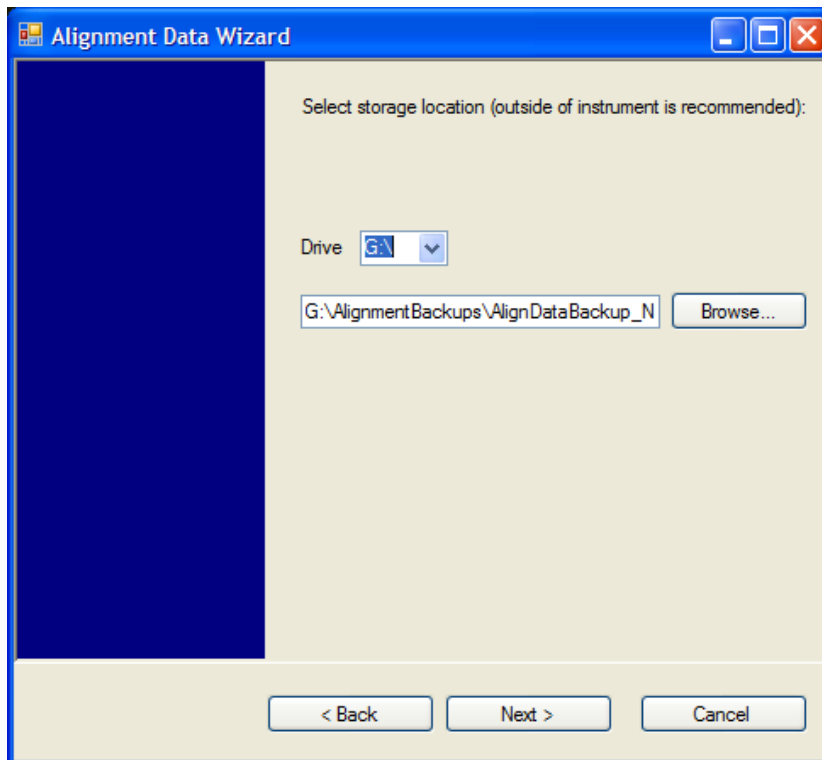

Changing the drive letter will also modify the path displayed in the box below. When this step is first loaded, the drive drop-down menu is populated with connected drives, which provide the user with write access. If there are many unreachable network drives connected to the instrument, this step can take a few seconds. If a USB drive is present, it will be selected by default. The path defaults to the AlignmentBackups folder, and a filename is automatically created in the form of AlignDataBackup_<model>_<serial number>_<date><time>. When the "Next >" button is pressed, you will be prompted to create a new folder if the chosen path does not yet exist.

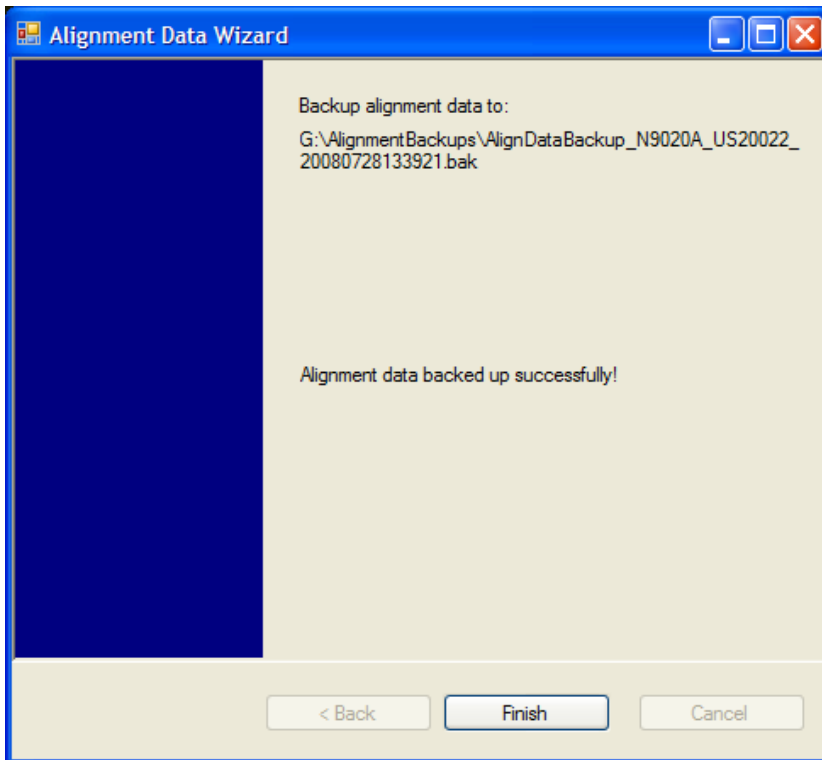
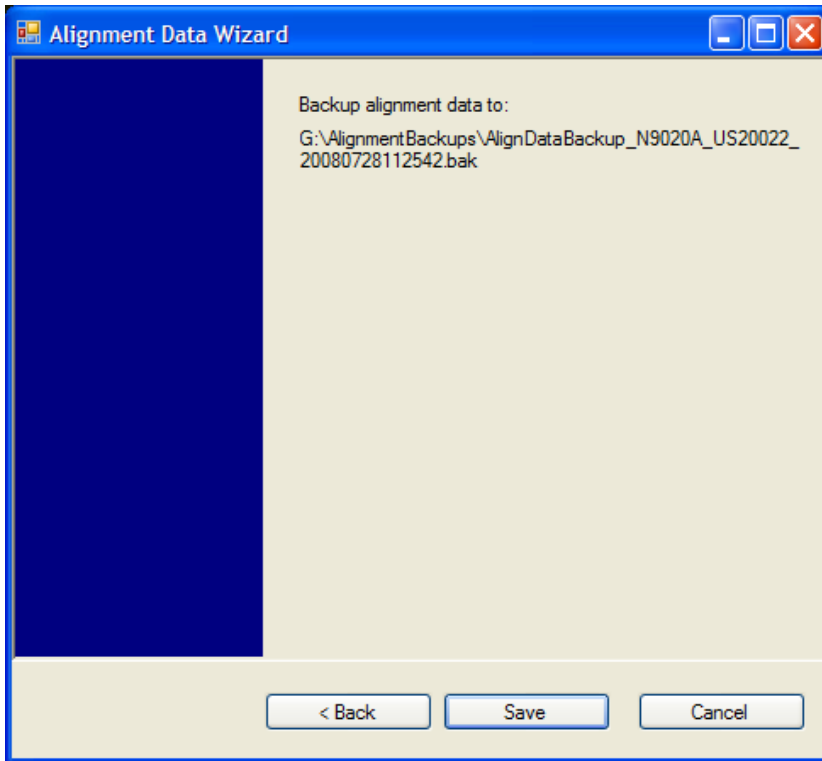

The restore operation checks the validity of the restore file using the database's built-in file validation. If the restore file is corrupt, the existing alignment data will remain in use.

If the serial number information in the backup file being restored is different from that of the instrument, the following message appears (the serial number shown are examples):

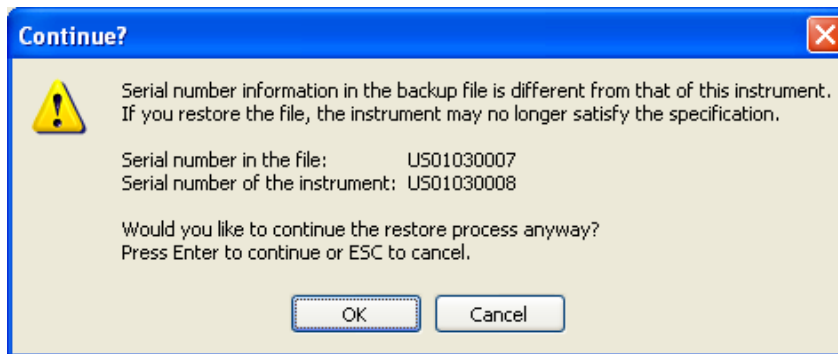

The default restore location will be first drive identified as an external drive (USB or LAN) if such is available; if not, the internal D: partition will be selected. The default restore file will be the most recent file that matches the default backup file name format: AlignDataBackup_<model number>_<serial number>_<date>.bak

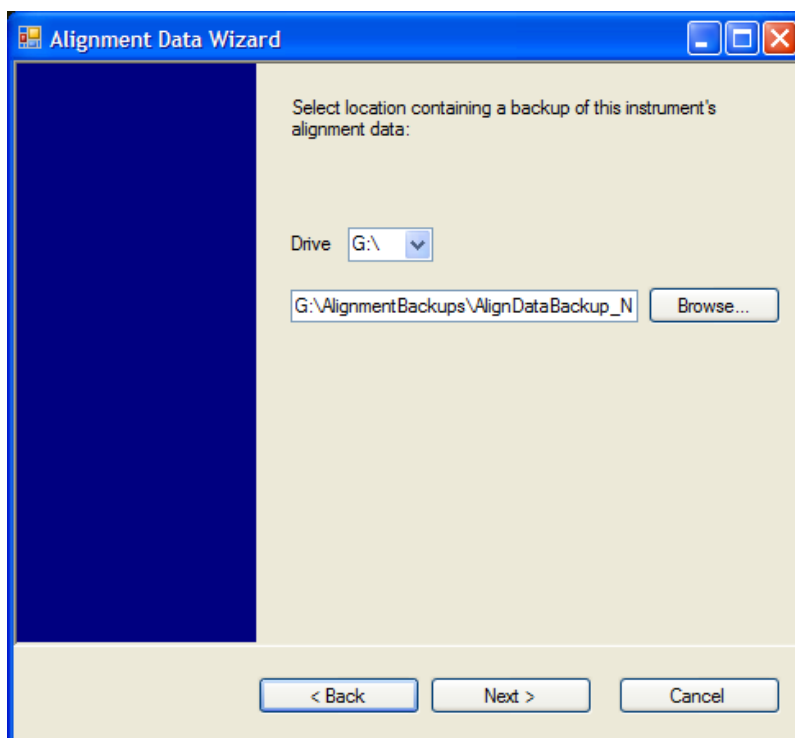

Changing the drive letter also modifies the path displayed in the box below. When this step is first loaded, the drive drop-down menu is populated with connected drives, which provide you with read access. The path defaults to the AlignBackups folder. The most recent *.bak file in the folder will also be selected by default.

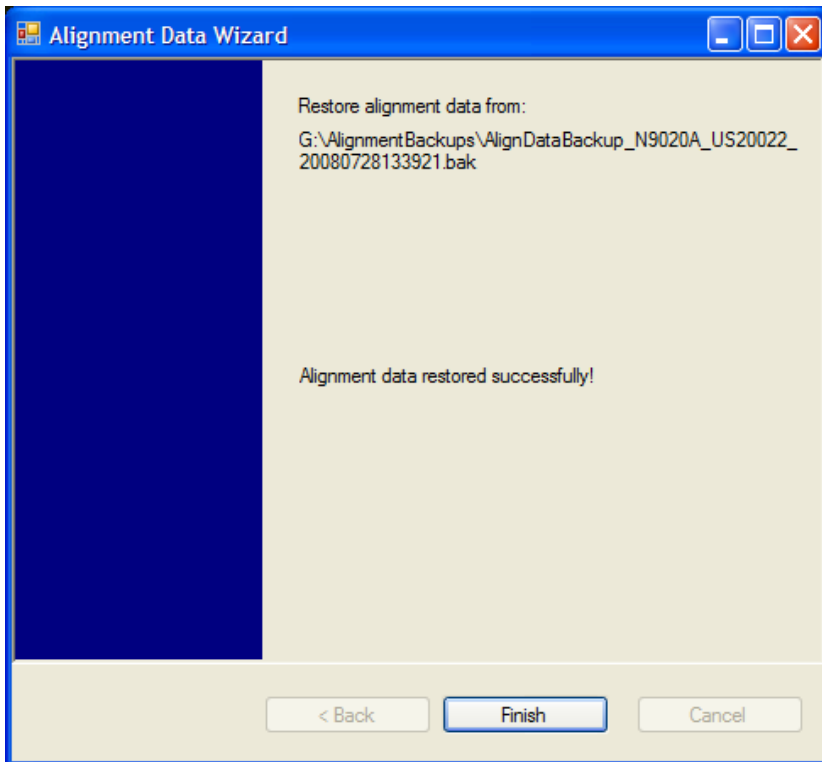
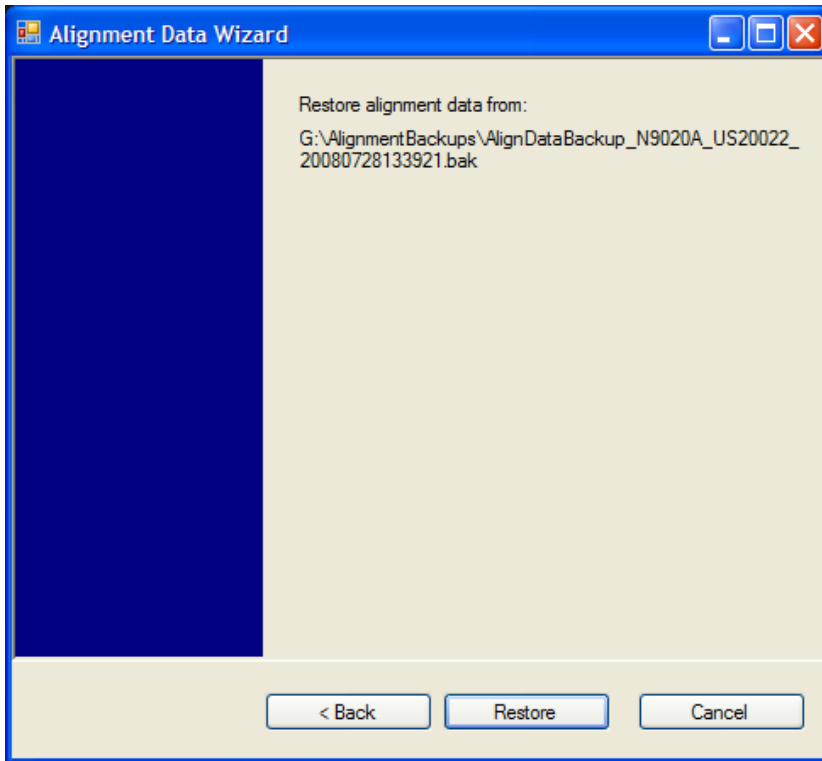

Perform Backup (Remote Command Only)

Invokes an alignment data backup operation to the provided Folder.

NOTE

It is recommended that the Folder provided is outside of the instrument (USB or Mapped Network Drive).

Remote Command	:CALibration:DATA:BACKup <filename>
Example	:CAL:DATA:BACK "F:\AlignDataBackup_N9020A_US00000001_2008140100.bak"
Initial S/W Revision	A.02.00

Perform Restore (Remote Command Only)

Invokes an alignment data restore operation from the provided filename.

Remote Command	:CALibration:DATA:RESTore <filename>
Example	:CAL:DATA:REST "F:\ AlignDataBackup_N9020A_US00000001_2008140100.bak "
Initial S/W Revision	A.02.00

Advanced

Accesses alignment processes that are immediate action operations that perform operations that run until complete. Advanced alignments are performed on an irregular basis, or require additional operator interaction

Key Path	System, Alignments
Initial S/W Revision	Prior to A.02.00

Characterize Preselector

The Preselector tuning curve drifts over temperature and time. Recognize that the Amplitude, Presel Center function adjusts the preselector for accurate amplitude measurements at an individual frequency. Characterize Preselector improves the amplitude accuracy by ensuring the Preselector is approximately centered at all frequencies without the use of the Amplitude, Presel Center function. Characterize Preselector can be useful in situations where absolute amplitude accuracy is not of utmost importance, and the throughput savings or convenience of not performing a Presel Center is desired. Presel Center is required prior to any measurement for best (and warranted) amplitude accuracy.

Agilent recommends that the Characterize Preselector operation be performed yearly as part of any calibration, but performing this operation every three months can be worthwhile.

Characterize Preselector immediately executes a characterization of the Preselector, which is a YIG-tuned filter (YTF). The instrument stops any measurement currently underway, performs the characterization, then restarts the measurement from the beginning (similar to pressing the Restart key).

The query form of the remote commands (:CALibration:YTF?) will invoke the alignment of the YTF subsystem and return a success or failure value.

A failure encountered during alignment will generate the Error Condition message "Characterize Preselector failure" and set bit 3 in the STATus:QUEStionable:CALibration:EXTended:FAILure status register. Successful completion of Characterize Preselector will clear this Condition. It will also begin the

elapsed time counter for Last Characterize Preselector Time, and capture the Last Characterize Preselector Temperature.

The last Characterize Preselector Time and Temperature survives across the power cycle as this operation is performed infrequently.

NOTE

The Characterize Preselector function can be interrupted by pressing the Cancel (ESC) front-panel key or remotely with Device Clear followed by the :ABORt SCPI command. None of the new characterization data is then used. However, since the old characterization data is purged at the beginning of the characterization, you now have an uncharacterized preselector. You should re-execute this function and allow it to finish before making any further preselected measurements.

Key Path	System, Alignments, Advanced
Mode	All
Remote Command	:CALibration:YTF :CALibration:YTF?
Example	:CAL:YTF
Notes	:CALibration:YTF? returns 0 if successful :CALibration:YTF? returns 1 if failed (including interfering user signal) While Advanced, Characterize Preselector is performing the alignment, bit 0 in the Status Operation register is set. Completion, or termination, will clear bit 0 in the Status Operation register. This command is sequential; it must complete before further SCPI commands are processed. Interrupting the alignment from remote is accomplished by invoking Device Clear followed by the :ABORt command. Successful completion will clear bit 9 in the Status Questionable Calibration register. A failure encountered during alignment will generate the Error Condition message "Characterize Preselector failed" and set bit 9 in the Status Questionable Calibration register. For Options that support frequencies > 3.6 GHz only.
Dependencies	This key does not appear in models that do not contain preselectors. In these models the SCPI command is accepted without error but no action is taken.
Couplings	Initializes the time for the Last Characterize Preselector Time. Records the temperature for the Last Characterize Preselector Temperature.
Initial S/W Revision	Prior to A.02.00

Characterize Reference Clock

Characterizing the reference clock is calibrating the Reference Input Phase with the External Reference Output. This feature is only available when either option DP2 or B40 is present. It requires connecting the 10 MHz OUT to the EXT REF IN port with a BNC cable before running the characterization.

See ["Front panel guided calibration sequence" on page 384](#)

Key Path	System, Alignments, Advanced
Mode	All

Remote Command	:CALibration:REFeRence:CLOCk?
Example	:CAL:REF:CLOC:INIT? //connect cable :CAL:REF:CLOC? //disconnect cable :CAL:REF:CLOC:END?
Notes	:CALibration:REFeRence:CLOCk? returns 0 if successful :CALibration:REFeRence:CLOCk? returns 1 if failed
Dependencies	Option DP2 or B40
Couplings	Initializes the time for the Last Characterize Reference Clock Time. Records the temperature for the Last Characterize Reference Clock Temperature. Expected to be run after :CAL:REF:CLOC:INIT, and before :CAL:REF:CLOC:END.
Initial S/W Revision	A.13.00

Parameter Name	Characterize Reference Clock Initialization
Mode	All
Remote Command	:CALibration:REFeRence:CLOCk:INITialize?
Example	:CAL:REF:CLOC:INIT?
Notes	:CALibration:REFeRence:CLOCk:INIT? returns 0 if successful :CALibration:REFeRence:CLOCk:INIT? returns 1 if failed
Dependencies	Option DP2 or B40
Couplings	Expected to be run before sending the :CAL:REF:CLOC? command. This will stop the current measurement when it has completed (does not abort the current data acquisition), and it will prepare the instrument for the expected cabling.
Force Restart	Yes
Initial S/W Revision	A.12.00

Parameter Name	Characterize Reference Clock End
Mode	All
Remote Command	:CALibration:REFeRence:CLOCk:END?
Example	:CAL:REF:CLOC:END?
Notes	:CALibration:REFeRence:CLOCk:END? returns 0 if successful :CALibration:REFeRence:CLOCk:END? returns 1 if failed
Dependencies	Option DP2 or B40
Couplings	Expected to be run after sending the :CAL:REF:CLOC? command, and after removing the cable used in that Characterize Reference Clock step. This will resume any queued measurements, and it concludes the reference clock characterization.
Force Restart	Yes
Initial S/W Revision	A.12.00

Parameter Name	Last Characterize Reference Clock
Key Path	Visual annotation in the Show Alignment Statistics screen
Parameter Type	String
Mode	All
Remote Command	:CALibration:TIME:REFeRence:CLOCK?
Example	:CAL:TIME:REFeRence:CLOCK?
Notes	Value is the date and time the last successful Characterize Reference Clock was executed. The date is separated from the time by a space character. Returns "" if Characterize Reference Clock has never been performed on the instrument.
Dependencies	Option DP2 or B40
State Saved	No
Initial S/W Revision	A.12.00

Front panel guided calibration sequence

When selecting "Characterize Reference Clock" through the front panel, the following form will be shown.

Step 1 of the guided calibration sequence:

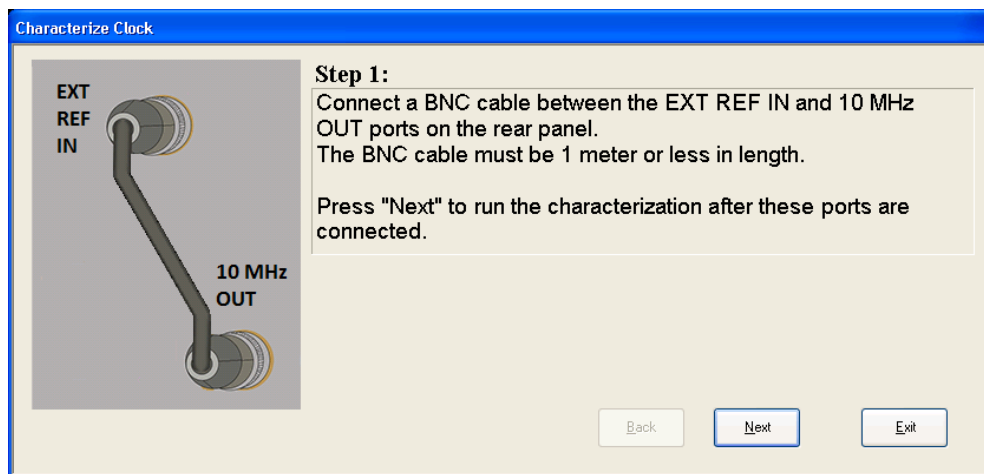

Step 2 of the guided calibration sequence:

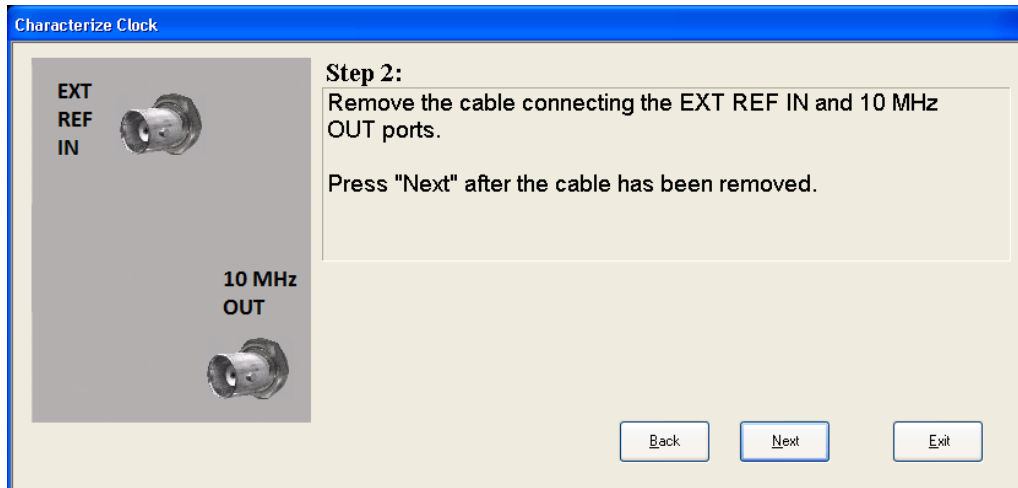

Step 3 of the guided calibration sequence:

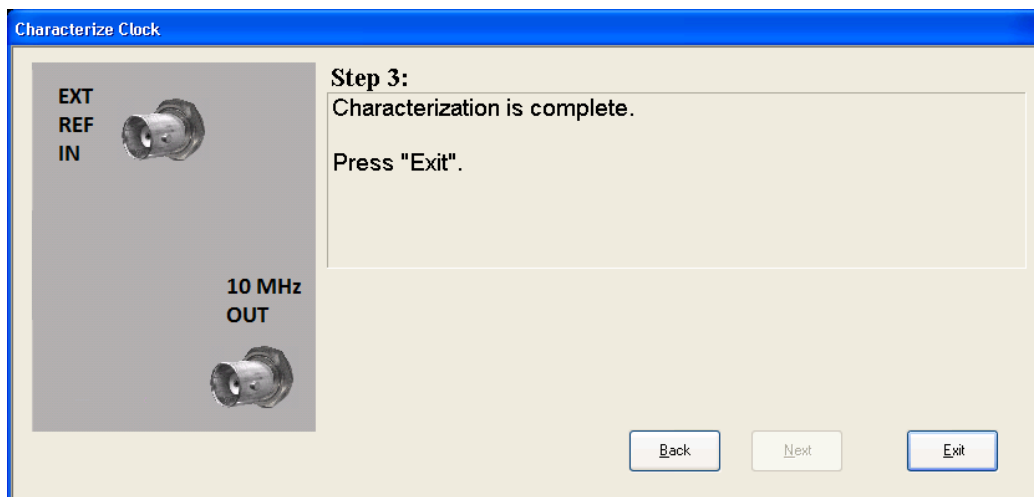

Timebase DAC

Allows control of the internal 10 MHz reference oscillator timebase. This may be used to adjust for minor frequency alignment between the signal and the internal frequency reference. This adjustment has no effect if the instrument is operating with an External Frequency Reference.

If the value of the Timebase DAC changes (by switching to Calibrated from User with User set to a different value, or in User with a new value entered) an alignment may be necessary. The alignment system will take appropriate action; which will either invoke an alignment or cause an Alert.

Key Path	System, Alignments
Mode	All
Remote Command	:CALibration:FREquency:REFerence:MODE CALibrated USER :CALibration:FREquency:REFerence:MODE?
Example	:CAL:FREQ:REF:MODE CAL
Notes	If the value of the timebase is changed the alignment system automatically performs an alignment or

	alerts that an alignment is due. If the value of the timebase is changed the alignment system automatically performs an alignment or alerts that an alignment is due.
Preset	This is unaffected by Preset but is set to CALibrated on a "Restore System Defaults->Align".
State Saved	No
Initial S/W Revision	Prior to A.02.00

Calibrated

Sets the Timebase DAC to the value established during factory or field calibration. The value displayed on the menu key is the calibrated value.

Key Path	System, Alignments, Timebase DAC
Mode	All
Example	:CAL:FREQ:REF:MODE CAL
Readback Text	[xxx] < where xxx is the calibrated value
Initial S/W Revision	Prior to A.02.00

User

Allows setting the Timebase DAC to a value other than the value established during the factory or field calibration. The value displayed on the menu key is the calibrated value.

Key Path	System, Alignments, Timebase DAC
Mode	All
Example	:CAL:FREQ:REF:MODE USER
Readback Text	xxx < where xxx is the Timebase DAC setting
Initial S/W Revision	Prior to A.02.00

Key Path	System, Alignments, Timebase DAC
Mode	All
Remote Command	:CALibration:FREQuency:REFerence:FINE <integer> :CALibration:FREQuency:REFerence:FINE?
Example	:CAL:FREQ:REF:FINE 8191
Notes	If the value of the timebase is changed the alignment system automatically performs an alignment or alerts that an alignment is due.
Couplings	Setting :CAL:FREQ:REF:FINE sets :CAL:FREQ:REF:MODE USER
Preset	This is unaffected by Preset but is set to the factory setting on a "Restore System Defaults->Align".

State Saved	No
Min	0
Max	16383
Backwards Compatibility SCPI	:CALibration:FREQuency:REFeRence:COARse ESA hardware contained two DAC controls for the Timebase. In X-Series the command :CALibration:FREQuency:REFeRence:FINE is the method for adjusting the timebase. The :COARse command is provided as an alias to :FINE.
Initial S/W Revision	Prior to A.02.00

Remote Command	:CALibration:FREQuency:REFeRence:COARse <integer> :CALibration:FREQuency:REFeRence:COARse?
Example	:CAL:FREQ:REF:COAR 8191
Notes	This is an alias for CAL:FREQ:REF:FINE any change to COARse is reflected in FINE and vice-versa. See CAL:FREQ:REF:FINE for description of functionality.
Couplings	Setting :CAL:FREQ:REF:COAR sets :CAL:FREQ:REF:MODE USER
Initial S/W Revision	Prior to A.02.00

I/O Config

Activates a menu for identifying and changing the I/O configuration for remote control.

Key Path	System
Initial S/W Revision	Prior to A.02.00

GPIB

Activates a menu for configuring the GPIB I/O port.

Key Path	System, I/O Config
Initial S/W Revision	A.02.00

GPIB Address

Select the GPIB remote address.

Key Path	System, I/O Config, GPIB
Mode	All
Remote Command	:SYSTem:COMMunicate:GPIB[1][:SELF]:ADDRess <integer> :SYSTem:COMMunicate:GPIB[1][:SELF]:ADDRess?

Example	:SYST:COMM:GPIB:ADDR 17
Notes	Changing the Address on the GPIB port requires all further communication to use the new address.
Preset	This is unaffected by Preset but is set to 18 on a “Restore System Defaults->Misc”
State Saved	No
Range	0 to 30
Min	0
Max	30
Initial S/W Revision	Prior to A.02.00

GPIB Controller

Sets the GPIB port into controller or device mode. In the normal state, GPIB controller is disabled, which allows the analyzer to be controlled by a remote computer. When GPIB Controller is enabled, the instrument can run software applications that use the instrument's computer as a GPIB controller; controlling devices connected to the instrument's GPIB port.

NOTE

When GPIB Controller is enabled, the analyzer application itself cannot be controlled over GPIB. In this case it can easily be controlled via LAN or USB. The GPIB port cannot be a controller and device at the same time. Only one controller can be active on the GPIB bus at any given time. If the analyzer is the controller, an external PC cannot be a controller.

To control the instrument from the software that is performing GPIB controller operation, you can use an internal TCP/IP connection to the analyzer application. Use the address TCPIP0:localhost:inst0:INSTR to send SCPI commands to the analyzer application.

Key Path	System, I/O Config, GPIB
Mode	All
Scope	Mode Global
Remote Command	:SYSTem:COMMunicate:GPIB[1][:SELF]:CONTroller[:ENABle] ON OFF 0 1 :SYSTem:COMMunicate:GPIB[1][:SELF]:CONTroller[:ENABle]?
Example	:SYST:COMM:GPIB:CONT ON Will set GPIB port to Controller
Notes	When the instrument becomes the Controller bit 0 in the Standard Event Status Register is set (and when the instrument relinquishes Controller capability bit 0 is cleared in the Standard Event Status Register).
Preset	This is unaffected by Preset but is set to OFF on a “Restore System Defaults->Misc”
State Saved	No
Range	Disabled Enabled
Initial S/W Revision	A.02.00

Disabled

Disables the GPIB Controller capability, this is the default (or normal) setting.

Key Path	System, I/O Config, GPIB, GPIB Controller	
Example	:SYST:COMM:GPIB:CONT OFF	Will set GPIB port to Device
Initial S/W Revision	A.02.00	

Enabled

Enables the GPIB Controller capability.

Key Path	System, I/O Config, GPIB, GPIB Controller	
Example	:SYST:COMM:GPIB:CONT ON	Will set GPIB port to Controller
Initial S/W Revision	A.02.00	

SCPI LAN

Activates a menu for identifying and changing the SCPI over a LAN configuration. There are a number of different ways to send SCPI remote commands to the instrument over LAN. It can be a problem to have multiple users simultaneously accessing the instrument over the LAN. These keys limit that somewhat by disabling the telnet, socket, and/or SiCL capability.

Key Path	System, I/O Config
Initial S/W Revision	Prior to A.02.00

SCPI Telnet

Turns the SCPI LAN telnet capability On or Off allowing you to limit SCPI access over LAN through telnet.

Key Path	System, I/O Config, SCPI LAN
Mode	All
Remote Command	:SYSTem:COMMunicate:LAN:SCPI:TELNet:ENABle OFF ON 0 1 :SYSTem:COMMunicate:LAN:SCPI:TELNet:ENABle?
Example	:SYST:COMM:LAN:SCPI:TELN:ENAB OFF
Preset	This is unaffected by Preset but is set to ON with a "Restore System Defaults->Misc"
State Saved	No
Range	On Off
Initial S/W Revision	Prior to A.02.00

SCPI Socket

Turns the capability of establishing Socket LAN sessions On or Off. This allows you to limit SCPI access over LAN through socket sessions.

Key Path	System, I/O Config, SCPI LAN
Mode	All
Remote Command	:SYSTem:COMMunicate:LAN:SCPI:SOCKet:ENABle OFF ON 0 1 :SYSTem:COMMunicate:LAN:SCPI:SOCKet:ENABle?
Example	:SYST:COMM:LAN:SCPI:SOCK:ENAB OFF
Preset	This is unaffected by a Preset but is set to ON with a "Restore System Defaults->Misc"
State Saved	No
Range	On Off
Initial S/W Revision	Prior to A.02.00

SICL Server

Turns the SICL server capability On or Off, enabling you to limit SCPI access over LAN through the SICL server. (SICL IEEE 488.2 protocol.)

Parameter	Description	Setting
Maximum Connections	The maximum number of connections that can be accessed simultaneously	5
Instrument Name	The name (same as the remote SICL address) of your analyzer	inst0
Instrument Logical Unit	The unique integer assigned to your analyzer when using SICL LAN	8
Emulated GPIB Name	The name (same as the remote SICL address) of the device used when communicating with your analyzer	gpib7
Emulated GPIB Logical Unit	The unique integer assigned to your device when it is being controlled using SICL LAN	8
Emulated GPIB Address	The emulated GPIB address assigned to your transmitter tester when it is a SICL server (the same as your GPIB address)	18

Key Path	System, I/O Config, SCPI LAN
Mode	All
Remote Command	:SYSTem:COMMunicate:LAN:SCPI:SICL:ENABle OFF ON 0 1 :SYSTem:COMMunicate:LAN:SCPI:SICL:ENABle?
Example	:SYST:COMM:LAN:SCPI:SICL:ENAB OFF
Preset	This is unaffected by Preset, but is set to ON with a "Restore System Defaults->Misc"
State Saved	No
Range	On Off
Initial S/W Revision	Prior to A.02.00

HiSLIP Server

Turns the HiSLIP server capability On or Off, enabling you to limit SCPI access over LAN through the HiSLIP server.

HiSLIP stands for High Speed LAN Instrument Protocol and is part of the IVI–6.1 specification.

Here is an example of a VISA connection string used to connect to the HiSLIP Server on an X-Series Spectrum Analyzer:

```
TCPIP0::a-n9030a-93016::hislip0::INSTR
```

In the example above, hislip0 is the HiSLIP device name that VISA users must include in their HiSLIP VISA Address strings. Your HiSLIP device name may be different depending on your VISA settings.

Key Path	System, I/O Config, SCPI LAN
Mode	All
Remote Command	:SYSTem:COMMunicate:LAN:SCPI:HISLip:ENABle OFF ON 0 1 :SYSTem:COMMunicate:LAN:SCPI:HISLip:ENABle?
Example	:SYST:COMM:LAN:SCPI:HISL:ENAB OFF
Preset	This is unaffected by Preset, but is set to ON with a “Restore System Defaults-> Misc”
State Saved	No
Range	On Off
Initial S/W Revision	A.11.00

SCPI Socket Control Port (Remote Command Only)

Returns the TCP/IP port number of the control socket associated with the SCPI socket session. This query enables you to obtain the unique port number to open when a device clear is to be sent to the instrument. Every time a connection is made to the SCPI socket, the instrument creates a peer control socket. The port number for this socket is random. The user must use this command to obtain the port number of the control socket. To force a device clear on this socket, open the port and send the string “DCL ” to the instrument.

If this SCPI command is sent to a non SCPI Socket interface, then 0 is returned.

Mode	All
Remote Command	:SYSTem:COMMunicate:LAN:SCPI:SOCKet:CONTRol?
Example	:SYST:COMM:LAN:SCPI:SOCK:CONT?
Preset	This is unaffected by Preset or “Restore System Defaults-> Misc”.
State Saved	No
Range	0 to 65534
Min	0
Max	65534
Initial S/W Revision	Prior to A.02.00

Reset Web Password

The embedded web server contains certain capability which are password protected; modifying the LAN configuration of the instrument, and access to web pages that can change the settings of the instrument. The default password from the factory is 'agilent' (without the quotes). The control provided here is the means to set the web password as the user desires, or to reset the password to the factory default.

Selecting Reset web password brings up a control for resetting the password as the user desires, or to the factory default. A keyboard is required to change the password from the factory default of 'agilent' or to set a new password that contains alphabetic characters. The control is:

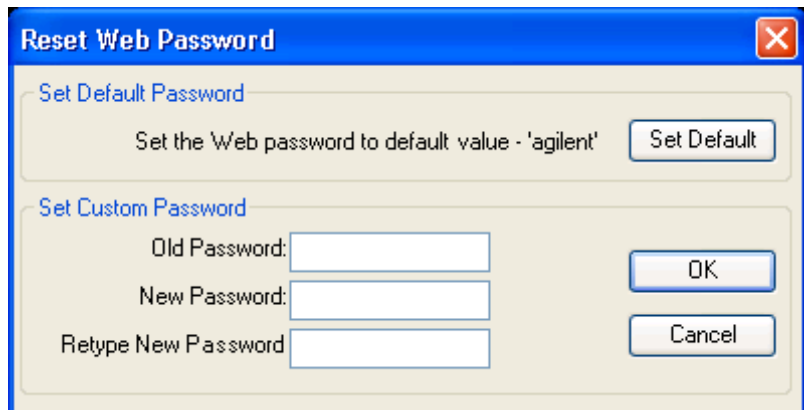

If this control is entered without an external keyboard or mouse connected, you can cancel the control by pressing the Cancel (ESC) front-panel key.

Key Path	System, I/O Config
Mode	All
Initial S/W Revision	Prior to A.02.00

LXI

Opens a menu that allows you to access the various LXI configuration properties.

Key Path	System, I/O Config
Initial S/W Revision	Prior to A.02.00

LAN Reset

Resets the LAN connection.

Key Path	System, I/O Config, LXI
Initial S/W Revision	Prior to A.02.00

Device Identification (Remote Command Only)

Enabling the LXI device identification will place the LXI Status Indicator to the 'Identify' state. Disabling the LXI device identification will place the LXI Status Indicator to the 'No Fault' state. The LXI Status indicator is in the upper left region of the instrument's graphical user interface (.

Mode	All
Remote Command	:LXI:IDENtify[:STATe] OFF ON 0 1 :LXI:IDENtify[:STATe]?
Example	:LXI:IDEN ON
Preset	Not part of Preset, but reset to OFF on Restore System Defaults All
State Saved	No
Range	On Off
Initial S/W Revision	A.12.50

System IDN Response

This key allows you to specify a response to the *IDN? query, or to return the analyzer to the Factory response if you have changed it.

To choose the factory-set response, press the Factory key.

To specify your own response, press the User key, and enter your desired response.

Key Path	System, I/O Config
Mode	All
Remote Command	:SYSTem:IDN <string> :SYSTem:IDN?
Notes	<ul style="list-style-type: none"> • This affects the response given in all Modes of the Analyzer, unless the current Mode has also specified a custom response, in which case the current Mode's custom IDN response takes precedence over the System's, but only while that Mode is the current Mode.. • It survives shutdown and restart of the software and therefore survives a power cycle • Null string as parameter restores the Factory setting
Preset	This is unaffected by Preset but is set to the original factory setting on a "Restore System Defaults->Misc"
State Saved	No
Initial S/W Revision	A.06.00

Factory

This key selects the factory setting, for example:

"Agilent Technologies,N9020A,MY00012345,A.05.01"

where the fields are manufacturer, model number, serial number, firmware revision.

Key Path	System, I/O Config, IDN Response
Example	:SYST:IDN "" null string, restores the factory setting
Initial S/W Revision	A.06.0

User

This key allows you to specify your own response to the *IDN? query. You may enter your desired response with the Alpha Editor or a plugin PC keyboard.

When you press this key, the active function becomes the current User string with the cursor at the end. This makes it easy to edit the existing string.

If you enter a null string (for example, by clearing the User String while editing and then pressing Done) the analyzer automatically reverts to the Factory setting.

Key Path	System, I/O Config, IDN Response
Example	:SYST:IDN "XYZ Corp, Model 12, 012345, A.01.01" user specified response
Initial S/W Revision	A.06.00

Query USB Connection (Remote Command Only)

Enables you to determine the speed of the USB connection.

Mode	All
Remote Command	:SYSTem:COMMunicate:USB:CONNectioN?
Example	:SYST:COMM:USB:CONN?
Notes	NONE - Indicates no USB connection has been made. LSPeed - Indicates a USB low speed connection (1.5 Mbps). This is reserved for future use, the T+M488 protocol is not supported on low speed connections. HSPeed - Indicates that a USB high speed connection (480 Mbps) has been negotiated. FSPeed - Indicates that a USB full speed connection (12 Mbps) has been negotiated.
State Saved	No
Range	NONE LSPeed HSPeed FSPeed
Initial S/W Revision	Prior to A.02.00

USB Connection Status (Remote Command Only)

Enables you to determine the current status of the USB connection.

Mode	All
Remote Command	:SYSTem:COMMunicate:USB:STATus?
Example	:SYST:COMM:USB:STAT?
Notes	<p>SUSPended – Indicates that the USB bus is currently in its suspended state. The bus is in the suspended state when:</p> <ul style="list-style-type: none"> • The bus is not connected to any controller • The controller is currently powered off • The controller has explicitly placed the USB device into the suspended state. <p>When in the suspended state, no USB activity, including start of frame packets are received.</p> <p>ACTive – Indicates that the USB device is in the active state. When the device is in the active state, it is receiving periodic start of frames but it isn't necessarily receiving or transmitting data.</p>
State Saved	No
Range	SUSPended ACTive
Initial S/W Revision	Prior to A.02.00

USB Packet Count (Remote Command Only)

Enables you to determine the number of packets received and transmitted on the USB bus.

Mode	All
Remote Command	:SYSTem:COMMunicate:USB:PACKets?
Example	:SYST:COMM:USB:PACK?
Notes	<p>Two integers are returned. The first is the number of packets received since application invocation, the second is the number of packets transmitted since application invocation. If no packets have been received or transmitted the response is 0,0.</p> <p>The packet count is initialized to 0,0 when the instrument application is started.</p>
State Saved	No
Initial S/W Revision	Prior to A.02.00

Restore Defaults

Provides incremental initialization of the system setting groups along with supporting a comprehensive reset of the entire instrument back to a factory default state. The menu selections are the groups of system settings and when one is selected, that particular group of system settings is reset back to their default values.

Key Path	System
Mode	All
Remote Command	:SYSTem:DEFault [ALL] ALIGn INPut MISC MODes PON
Example	SYST:DEF

State Saved	No
Initial S/W Revision	Prior to A.02.00

Restore Input/Output Defaults

Causes the group of settings and data associated with Input/Output front-panel key to be a reset to their default values. This level of Restore System Defaults does not affect any other system settings, mode settings and does not cause a mode switch. .

Confirmation is required to restore the Input/Output setting. The confirmation dialog is:

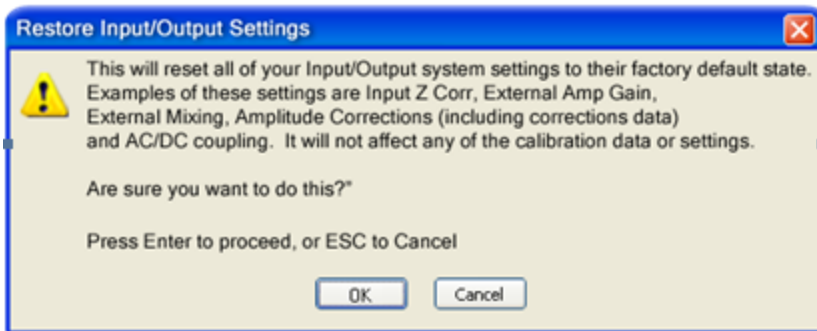

Key Path	System, Restore System Defaults
Example	:SYST:DEF INP
Initial S/W Revision	Prior to A.02.00

Restore Power On Defaults

This selection causes the Power On settings to be a reset to their default value. This level of Restore System Defaults does not affect any other system settings, mode settings and does not cause a mode switch. The Power On settings and their default values are Power On Type reset to Mode and Input/Output Defaults and Power On Application reset to whatever the factory set as its default value.

Confirmation is required to restore the factory default values. The confirmation dialog is:

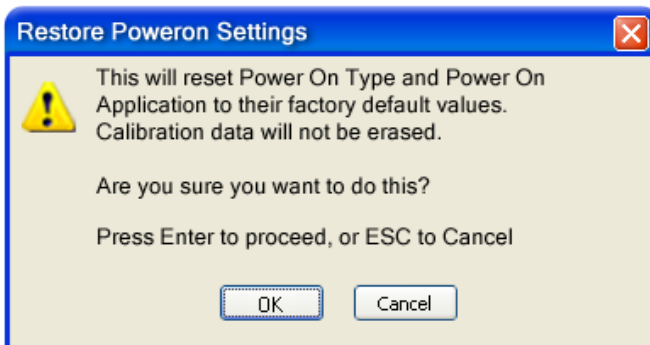

Key Path	System, Restore System Defaults
Example	:SYST:DEF PON
Initial S/W Revision	Prior to A.02.00

Restore Align Defaults

This selection causes the Alignment system settings to be a reset to their default values. This does not affect any Alignment data stored in the system. This level of Restore System Defaults does not affect any other system settings, mode settings and does not cause a mode switch.

After performing this function, it may impact the auto-alignment time of the instrument until a new alignment baseline has been established.

Confirmation is required to restore the factory default values. The confirmation dialog is:

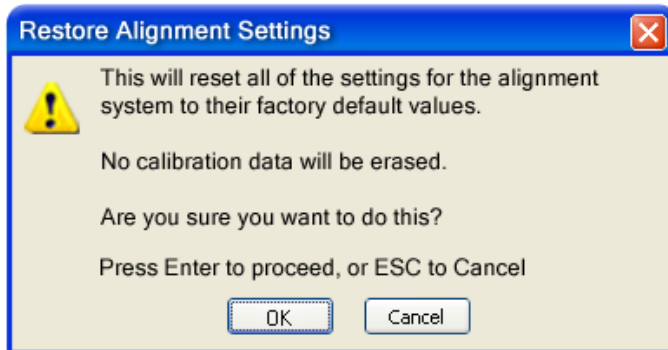

Key Path	System, Restore System Defaults
Example	:SYST:DEF ALIG
Initial S/W Revision	Prior to A.02.00

Restore Misc Defaults

This selection causes miscellaneous system settings to be reset to their default values. With this reset, you lose the GPIB address and it is reset to 18, so this should be used with caution. This level of Restore System Defaults does not affect any other system settings, mode settings and does not cause a mode switch. This miscellaneous group contains the rest of the settings that have not been part of the other Restore System Defaults groups. The following table is a complete list of settings associated with this group:

Miscellaneous Setting	Default Value
Verbose SCPI	Off
The SYST:PRES:TYPE	MODE
Auto File Name Number	000

Miscellaneous Setting	Default Value
Save Type	State
State Save To	Register 1
Screen Save To	SCREEN000.png
DISP:ENABle	ON
Full Screen	Off
SCPI Telnet	ON
SCPI Socket	ON
SICL Server	ON
Softkey Language	English
System Annotation	ON
Display Theme	TDColor
System IDN Response	Factory result of *IDN?
Display Intensity	100
Display Backlight	ON
GPIB Address	18

Confirmation is required to restore the factory default values. The confirmation dialog is:

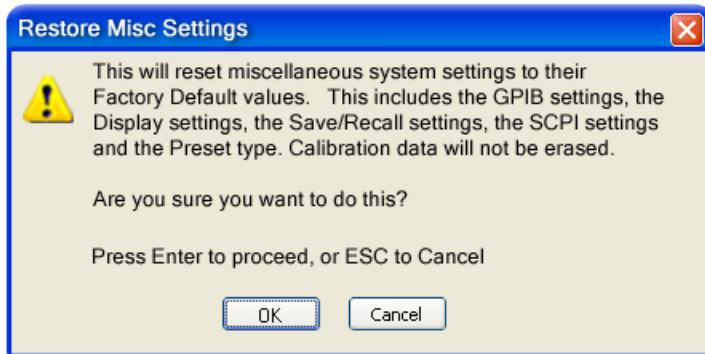

Key Path	System, Restore System Defaults
Example	:SYST:DEF MISC
Initial S/W Revision	Prior to A.02.00

Restore Mode Defaults (All Modes)

This selection resets all of the modes in the instrument back to their default state just as a Restore Mode Defaults does and it switches the instrument to the power-on mode and causes the default measurement

for the power-on mode to be active. This level of Restore System Defaults does not affect any system settings, but it does affect the state of all modes and does cause a mode switch unless the instrument was already in the power-on mode.

Confirmation is required to restore the factory default values. The confirmation dialog is:

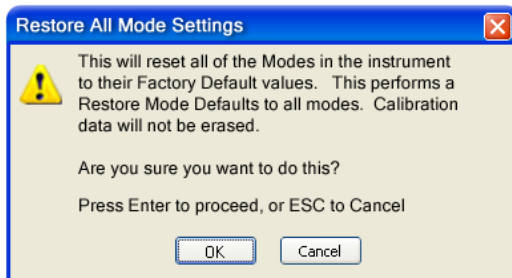

Key Path	System, Restore System Defaults
Example	:SYST:DEF MOD
Couplings	An All Mode will cause the currently running measurement to be aborted, mode switch to the power-on mode and activate the default measurement for the power-on mode.. It gets the mode to a consistent state with all of the default couplings set.
Initial S/W Revision	Prior to A.02.00

All

This performs a comprehensive reset of ALL analyzer settings to their factory default values. It resets all of the system setting groups, causes a Restore Mode Defaults for all modes in the instrument, and switches back to the power-on mode. It does not affect the User Preset file or any user saved files.

Confirmation is required to restore the factory default values. The confirmation dialog is:

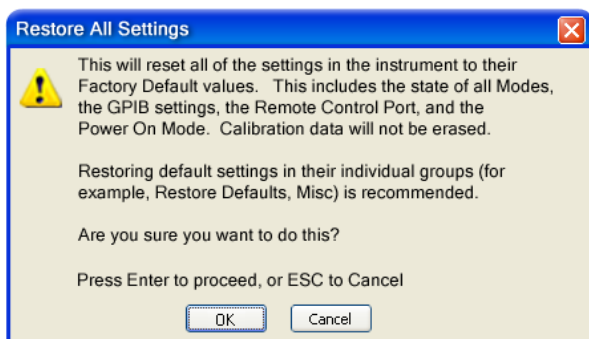

NOTE

If you are using an Agilent USB External Mixer, then you will need to perform a Refresh USB Mixer Connection after Restoring All Defaults.

Key Path	System, Restore System Defaults
Example	:SYST:DEF ALL
Notes	If using Agilent USB External Mixer, perform a Refresh USB Mixer Connection (SCPI command

	:MIX:BAND USB) following a Restore All Defaults.
Couplings	An All will cause the currently running measurement to be aborted and get all modes to a consistent state, so it is unnecessary to couple any settings.
Initial S/W Revision	Prior to A.02.00
Modified at S/W Revision	A.14.00

Control Panel...

Opens the Windows Control Panel. The Control Panel is used to configure certain elements of Windows that are not configured through the hardkey/softkey System menus.

NOTE This feature is not available if option SF1 is installed.

The Control Panel is a separate Windows application, so to return to the analyzer once you are in the Control Panel, you may either:

Exit the Control Panel by clicking on the red X in the upper right hand corner, with a mouse

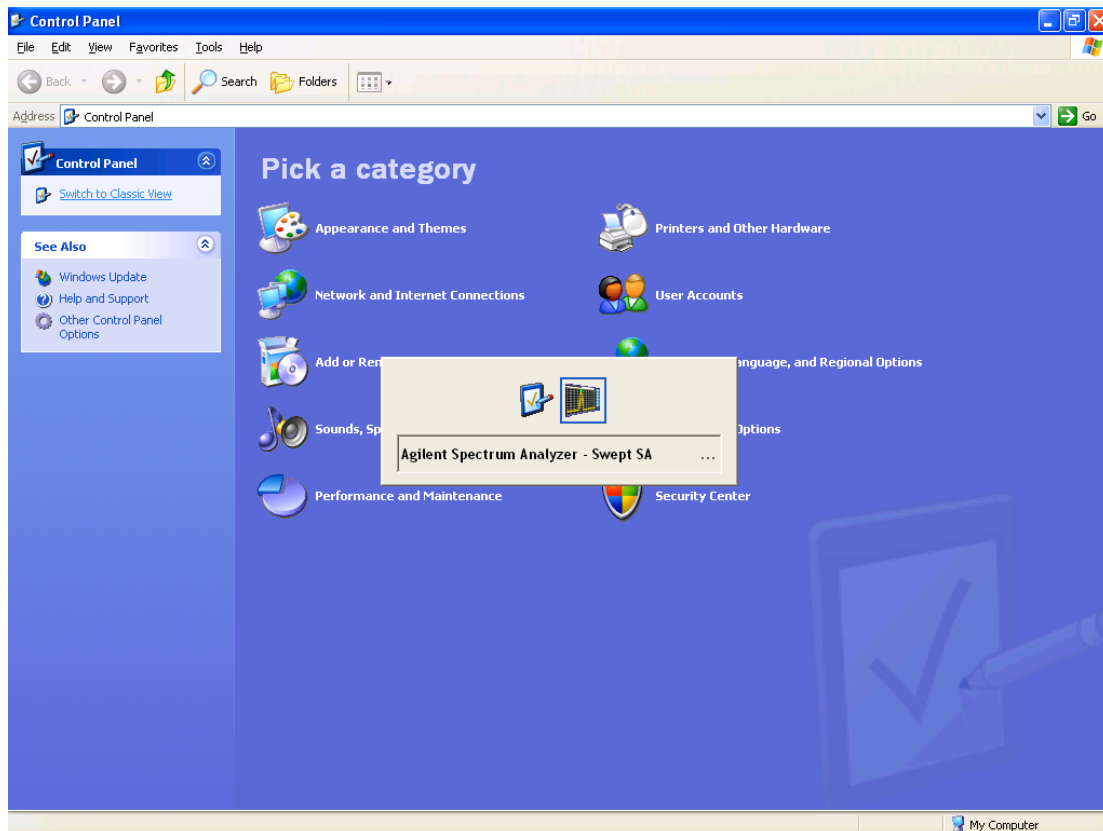

Or use Alt-Tab: press and hold the Alt key and press and release the Tab key until the Analyzer logo is showing in the window in the center of the screen, as above, then release the Alt key.

Key Path	System
Notes	No remote command for this key.
Initial S/W Revision	Prior to A.02.00

Licensing...

Opens the license explorer.

NOTE This feature is not available if option SF1 is installed.

For Help on this key, select Help in the menu bar at the top of the license explorer window.

Key Path	System
Notes	No equivalent remote command for this key.
Backwards Compatibility Notes	In ESA the SCPI command for displaying the Show Licenses screen is: :SYSTem:CONFigure:LKEY:STATe OFF ON 0 1:SYSTem:CONFigure:LKEY:STATe? There are no equivalent SCPI commands in the X-Series for displaying the License Explorer.
Initial S/W Revision	Prior to A.02.00

Remote Command	:SYSTem:LKEY <"OptionInfo">, <"LicenseInfo">
Example	SYST:LKEY "N9073A-1FP", "027253AD27F83CDA5673A9BA5F427FDA5E4F25AEB1017638211AC9F60D9C639FE539735909C551DE0A91"
Notes	The <"OptionInfo"> contains the feature and the version. You must specify the feature but can omit the version. If you omit the version, the system regards it as the latest one, since the system knows which version is supported for each feature. The <"LicenseInfo"> contains the signature, the expiration date, and serial number for transport if transportable. You must specify the signature, but you can omit the other information. If you omit the expiration date, the system regards it as permanent. If you omit the serial number, the system regards it as non-transportable. As a result, this supports reverse compatibility.
Initial S/W Revision	Prior to A.02.00

Remote Command	:SYSTem:LKEY:DELeTe <"OptionInfo">,<"LicenseInfo">
Example	SYST:LKEY:DEL "N9073A-1FP", "027253AD27F83CDA5673A9BA5F427FDA5E4F25AEB1017638211AC9F60D9C639FE539735909C551DE0A91"
Notes	The <"OptionInfo"> contains the feature and the version. You must specify the feature but can omit the version. If

you omit the version, the system regards it as the latest one, if more than one version is installed.

The <"LicenseInfo"> contains the signature, the expiration date, and whether or not be transportable. You must specify the signature, but you can omit the other information. If you omit the expiration date, the system regards it as permanent. If you omit the transportability, the system regards it as non-transportable. As a result, this supports reverse compatibility.

Initial S/W Revision Prior to A.02.00

Remote Command :SYSTem:LKEY:LIST?

Notes

Return Value:
 An <arbitrary block data> of all the installed instrument licenses.
 The format of each license is as follows.
 <Feature>,<Version>,<Signature>,<Expiration Date>,<Serial Number for Transport>
 Return Value Example:
 #3136
 N9073A-1FP,1.000,B043920A51CA
 N9060A-2FP,1.000,4D1D1164BE64
 N9020A-508,1.000,389BC042F920
 N9073A-1F1,1.000,5D71E9BA814C,13-aug-2005
 <arbitrary block data> is:
 #NMMM<data>
 Where:
 N is the number of digits that describes the number of MMM characters. For example if the data was 55 bytes, N would be 2.
 MMM would be the ASCII representation of the number of bytes. In the previous example, N would be 55.
 <data> ASCII contents of the data

Initial S/W Revision Prior to A.02.00

Remote Command :SYSTem:LKEY? <"OptionInfo">

Example SYST:LKEY? "N9073A-1FP"

Notes The <"OptionInfo"> contains the feature and the version. You must specify the feature but can omit the version. If you omit the version, the system regards it as the latest one.

Return Value:
 <"LicenseInfo"> if the license is valid, null otherwise.
 <"LicenseInfo"> contains the signature, the expiration date, and serial number if transportable.
 Return Value Example:
 "B043920A51CA"

Initial S/W Revision Prior to A.02.00

Remote Command	:SYSTem:HID?
Notes	Return value is the host ID as a string
Initial S/W Revision	Prior to A.02.00

Security

Accesses capabilities for operating the instrument in a security controlled environment.

Key Path	System
Initial S/W Revision	A.04.00

USB

The Windows operating system can be configured to disable write access to the USB ports for users who are in a secure environment where transferring data from the instrument is prohibited. This user interface is a convenient way for the customer to disable write access to USB.

Key Path	System, Security
Mode	All
Scope	Mode Global
Remote Command	:SYSTem:SECurity:USB:WPRotect[:ENABle] ON OFF 0 1 :SYSTem:SECurity:USB:WPRotect[:ENABle]?
Example	:SYST:SEC:USB:WPR ON Will set USB ports to Read-only
Notes	When the USB ports are in Read-only mode then no data can be stored to USB, including the internal USB memory used for a back-up location for the calibration data.
Dependencies	This key is grayed-out unless the current user has administrator privileges.
Preset	This is unaffected by Preset or any Restore System Defaults. An Agilent Recovery will set the USB to write protect OFF
State Saved	No
Range	Read-Write Read only
Initial S/W Revision	A.04.00

Read-Write

Selection for allowing full read-write access to the USB ports.

Key Path	System, Security, USB
Example	:SYST:SEC:USB:WPR OFF Will set USB ports to Read-Write
Initial S/W Revision	A.04.00

Read only

Selection for disabling write access to the USB ports.

Key Path	System, Security, USB	
Example	:SYST:SEC:USB:WPR ON	Will set USB ports to Read only
Initial S/W Revision	A.04.00	

Diagnostics

The Diagnostics key in the System menu gives you access to basic diagnostic capabilities of the instrument.

Key Path	System
Initial S/W Revision	Prior to A.02.00

Show Hardware Statistics

Provides a display of various hardware statistics. The statistics include the following:

- Mechanical relay cycles
- High and Low temperature extremes
- Elapsed time that the instrument has been powered-on (odometer)

The display should appear listing the statistics, product number, serial number, and firmware revision.

Hardware Statistical Information	
Agilent MXA Signal Analyzer	
Product Number: N9020A	
Serial Number: US00061145	
Instrument S/W Revision: A.12.00	
Revision Date: 7/11/2012 12:11:10 PM	
Component Name	Value
MechAtten #1 Count Total	457304
Calibrator Switch Cycles	105953
AC/DC Switch Cycles	114240
2 dB #1 Mechanical Atten Cycles	112655
2 dB #2 Mechanical Atten Cycles	124456
MechAtten #2 Count Total	472265
6 dB Mechanical Atten Cycles	115302
10 dB Mechanical Atten Cycles	93602
20 dB Mechanical Atten Cycles	144781
30 dB Mechanical Atten Cycles	118580
Low Noise Path Switch	45668
Preselector Bypass Cycles	31133
High temperature operating extreme	45.75
Low temperature operating extreme	-23.9375
Elapsed Time (On-Time)(hours)	134164

In some CXA models this field is called "Fixed Aten"

Some CXA models omit these fields

Only shown if LNP installed

Only shown if MPB installed

The CXA models in which the AC/DC Switch field is called Fixed Aten and that omit the mechanical attenuation fields are the N9000A–503/507 models.

Modular HWs only have time and temperature information in Show Hardware Statistics.

The data will be updated only when the Show Hardware Statistics menu key is pressed, it will not be updated while the screen is displayed.

The tabular data should be directly printable.

Key Path	System, Diagnostics
Mode	All
Notes	The values displayed on the screen are only updated upon entry to the screen and not updated while the screen is being displayed.
Initial S/W Revision	Prior to A.02.00

SCPI for Show Hardware Statistics (Remote Commands Only)

Each of the hardware statistic items can be queried via SCPI.

- "Query the Mechanical Relay Cycle Count" on page 406
- "Query the Operating Temperature Extremes" on page 406
- "Query the Elapsed Time since 1st power on" on page 406

Query the Mechanical Relay Cycle Count

Return the count of mechanical relay cycles. For N9038A model, there are additional 2 Mechanical Relays which are <N9038A Input2>, <N9038A Bypass>.

Remote Command	:SYSTem:MRELay:COUNT?
Example	:SYST:MREL:COUN?
Notes	<p>Query Only</p> <p>The return value is a comma separated list of the individual counts for each mechanical relay. The position of the relays in the list is:</p> <p>“<Cal Signal>,<AC/DC>,<2dB #1 Atten>,<2dB #2 Atten>,<6dB Atten>,<10dB Atten>,<20dB Atten>,<30dB Atten>,<Fixed Atten>,<Low Noise Path Switch>,<Presel Bypass>,<N9038A Input2>,<N9038A Bypass>”</p> <p>Items in the list not pertaining to your particular hardware configuration will return as -999 for those items.</p>
Initial S/W Revision	Prior to A.02.00
Modified at S/W Revision	A.08.00

Query the Operating Temperature Extremes

Returns the low operating temperature extreme value. The value survives a power-cycle and is the temperature extreme encountered since the value was reset by the factory or service center.

Mode	All
Remote Command	:SYSTem:TEMPerature:LEXTreme?
Example	:SYST:TEMP:LEXT?
Notes	Value is in degrees Celsius at which the lowest operating temperature has been recorded since 1st power-up.
State Saved	No
Initial S/W Revision	Prior to A.02.00

Mode	All
Remote Command	:SYSTem:TEMPerature:HEXTreme?
Example	:SYST:TEMP:HEXT?
Notes	Value is in degrees Celsius at which the highest operating temperature has been recorded since 1st power-up.
State Saved	No
Initial S/W Revision	Prior to A.02.00

Query the Elapsed Time since 1st power on

Returns the elapsed on-time in minutes since 1st power-on.

Remote Command	:SYSTem:PON:ETIMe?
Example	:SYST:PON:ETIM?
Notes	Query Only
Initial S/W Revision	Prior to A.02.00

Internet Explorer...

This key launches Microsoft Internet Explorer. A mouse and external keyboard are highly desired for using Internet Explorer. When Internet Explorer is running, close Internet Explorer to return focus to the Instrument Application (or use Alt-Tab).

NOTE This feature is not available if option SF1 is installed.

Key Path	System
Mode	All
Notes	No equivalent remote command for this key.
Initial S/W Revision	A.05.01

System Remote Commands (Remote Commands Only)

The commands in this section have no front-panel key equivalent.

["System Powerdown \(Remote Command Only\)" on page 407](#)

["List installed Options \(Remote Command Only\)" on page 408](#)

["Lock the Front-panel keys \(Remote Command Only\)" on page 408](#)

["List SCPI Commands \(Remote Command Only\)" on page 408](#)

["SCPI Version Query \(Remote Command Only\)" on page 409](#)

["Date \(Remote Command Only\)" on page 409](#)

["Time \(Remote Command Only\)" on page 409](#)

Initial S/W Revision	Prior to A.02.00
-----------------------------	------------------

System Powerdown (Remote Command Only)

Remote Command	SYSTem:PDOWn [NORMal FORCe]
Notes	Shuts down the instrument in the normal way (NORMal) or forced way (FORCe). In case there is another application with modified data pending for saving, the application prompt the user. The system waits until the user responds in the normal mode. It will go off after 20 seconds of wait in the force mode and all data will be lost.

List installed Options (Remote Command Only)

Lists the installed options that pertain to the instrument (signal analyzer).

Mode	All
Remote Command	:SYSTem:OPTions?
Example	:SYST:OPT?
Notes	The return string is a comma separated list of the installed options. For example: "503,P03,PFR" :SYSTem:OPTions? and *OPT? are the same.
State Saved	No
Initial S/W Revision	Prior to A.02.00

Lock the Front-panel keys (Remote Command Only)

Disables the instrument keyboard to prevent local input when the instrument is controlled remotely. Annunciation showing a "K" for 'Klock" (keyboard lock) alerts the local user that the keyboard is locked. Klock is similar to the GPIB Local Lockout function; namely that no front-panel keys are active with the exception of the Power Standby key. (The instrument is allowed to be turned-off if Klock is ON.) The Klock command is used in remote control situations where Local Lockout cannot be used.

Although primary intent of Klock is to lock-out the front panel, it will lock-out externally connected keyboards through USB. Klock has no effect on externally connected pointing devices (mice).

The front panel 'Local' key (Cancel/Esc) has no effect if Klock is ON.

Mode	All
Remote Command	:SYSTem:KLOCK OFF ON 0 1 :SYSTem:KLOCK?
Example	:SYST:KLOC ON
Notes	Keyboard lock remains in effect until turned-off or the instrument is power-cycled
Preset	Initialized to OFF at startup, unaffected by Preset
State Saved	No
Initial S/W Revision	Prior to A.02.00

List SCPI Commands (Remote Command Only)

Outputs a list of the valid SCPI commands for the currently selected Mode.

Remote Command	:SYSTem:HELP:HEADers?
Example	:SYST:HELP:HEAD?
Notes	The output is an IEEE Block format with each command separated with the New-Line character (hex

	0x0A)
Initial S/W Revision	Prior to A.02.00

SCPI Version Query (Remote Command Only)

Returns the SCPI version number with which the instrument complies. The SCPI industry standard changes regularly. This command indicates the version used when the instrument SCPI commands were defined.

Remote Command	:SYSTem:VERSion?
Example	:SYST:VERS?
Initial S/W Revision	Prior to A.02.00

Date (Remote Command Only)

The recommended access to the Date, Time, and Time zone of the instrument is through the Windows native control (Control Panel or accessing the Task Bar). You may also access this information remotely, as shown in this command and Time (below).

Sets or queries the date in the instrument.

Mode	All
Remote Command	:SYSTem:DATE "<year>,<month>,<day>" :SYSTem:DATE?
Example	:SYST:DATE "2006,05,26"
Notes	<year> is the four digit representation of year. (for example, 2006) <month> is the two digit representation of year. (for example. 01 to 12) <day> is the two digit representation of day. (for example, 01 to 28, 29, 30, or 31) depending on the month and year Unless the current account has Power User or Administrator privileges, an error will be generated by this command and no action will be taken.
Initial S/W Revision	Prior to A.02.00

Time (Remote Command Only)

Sets or queries the time in the instrument.

Mode	All
Remote Command	:SYSTem:TIME "<hour>,<minute>,<second>" :SYSTem:TIME?
Example	:SYST:TIME "13,05,26"

Notes	<hour> is the two digit representation of the hour in 24 hour format <minute> is the two digit representation of minute <second> is the two digit representation of second Unless the current account has Power User or Administrator privileges, an error will be generated by this command and no action will be taken.
Initial S/W Revision	Prior to A.02.00

7 Trigger Functions

Trigger

Accesses a menu of keys to control the selection of the trigger source and the setup of each of the trigger sources. The analyzer is designed to allow triggering from a number of different sources, for example, Free Run, Video, External, RF Burst, and so forth.

The TRIG:SOURCe command (below) will specify the trigger source for the currently selected input (RF or I/Q). If you change inputs, the new input remembers the trigger source it was last programmed to for the current measurement, and uses that trigger source. You can directly set the trigger source for each input using the TRIGger:RF:SOURce and TRIGger:IQ:SOURce commands (later in this section). When in External Mixing, the analyzer uses the RF trigger source.

Note the inclusion of the <measurement> parameter in the command below. Because each measurement remembers its own Trigger Source, the command must be qualified with the measurement name. Note that for the Swept SA measurement this is not the case; for backwards compatibility, no <measurement> parameter is used when setting the Trigger Source for the Swept SA measurement.

See ["Trigger Source Presets" on page 413](#)

See ["RF Trigger Source" on page 416](#)

See ["I/Q Trigger Source" on page 417](#)

See ["More Information" on page 418](#)

Key Path	Front-panel key
Remote Command	<pre>:TRIGger:<measurement>[:SEquence]:SOURce EXTernal1 EXTernal2 IMMediate LINE FRAMe RFBurst VIDeo IF ALARm LAN IQMag IDEMod QDEMod IINPut QINPut AIQMag TV :TRIGger:<measurement>[:SEquence]:SOURce?</pre> <p>where <measurement> is the measurement for which you wish to set the Source (blank for the Swept SA measurement)</p>
Example	<pre>TRIG:ACP:SOUR EXT1</pre> <p>Selects the external 1 trigger input for the ACP measurement and the selected input</p> <pre>TRIG:SOUR VID</pre> <p>Selects video triggering for the Swept SA (SANalyzer) measurement in the Spectrum Analyzer mode. For SAN, do not use the <measurement> keyword. Only send this form in the Spectrum Analyzer mode or you will get an Undefined Header error</p>
Notes	<p>Not all measurements have all the trigger sources available to them. Check the trigger source documentation for your specific measurement to see what sources are available.</p> <p>Not all trigger sources are available for each input. See the "RF Trigger Source" on page 416 and "I/Q Trigger Source" on page 417 commands for detailed information on which trigger sources are available for each input.</p> <p>Other trigger-related commands are found in the INITiate and ABORt SCPI command subsystems.</p> <p>*OPC should be used after requesting data. This will hold off any subsequent changes to the selected trigger source, until after the sweep is completed and the data is returned.</p> <p>Available ranges and presets can vary from mode to mode.</p>
Dependencies	<p>In some models, there is no second External input. In these models, the External 2 key is blanked and</p>

	the EXternal2 parameter will generate a "Hardware missing; Not available for this model number" message.
Preset	See table below
Status Bits/OPC dependencies	The Status Operation Register bit 5 "Waiting for Trigger" is set at the same time as the Sweeping or Measuring bit is set. It is cleared when the trigger actually occurs (that is, after the trigger event occurs and all the applicable trigger criteria have been met). A corresponding pop-up message ("Waiting for trigger") is generated if no trigger signal appears after approximately 2 sec. This message goes away when a trigger signal appears.
Backwards Compatibility SCPI	:TRIGger[:SEquence]:SOURce EXTernal For backward compatibility, the parameter EXTernal is mapped to EXTernal1
Backwards Compatibility SCPI	[:SENSe]:<measurement>:TRIGger:SOURce This backwards compatibility alias command is provided for ESA/PSA compatibility This backwards compatibility command does not apply to the Swept SA measurement, for that just use :TRIGger:SOURce This backwards compatibility command does not apply to the monitor spectrum, log plot and spot frequency measurements
Backwards Compatibility SCPI	[:SENSe]:<measurement>:TRIGger:SOURce IF In earlier instruments, the parameter IF was used by apps for the video trigger, so using the IF parameter selects VIDeo triggering. Sending IF in the command causes VID to be returned to a query.
Backwards Compatibility SCPI	[:SENSe]:ACPR:TRIGger:SOURce This backwards Compatibility SCPI command is provided to support the same functionality as [:SENSe]:ACPr:TRIGger:SOURce (PSA W-CDMA, PSA cdma2000 and PSA 1xEVDO) due to the fact that the ACPr node conflicts with the ACPower node.
Initial S/W Revision	Prior to A.02.00
Modified at S/W Revision	A.03.00

Trigger Source Presets

Here are the Trigger Source Presets for the various measurements:

Meas	Mode	Preset for RF	Preset for IQ	Notes
Swept SA	SA	IMM	IQ not supported	
CHP	SA, WCDMA, C2K, WIMAX OFDMA, 1xEVDO, DVB-T/H, DTMB, LTE, LTETDD, CMMB, ISDB-T, Digital Cable TV, MSR	IMM	IQ not supported	
OBW	SA, WCDMA, C2K, WIMAX OFDMA,	1xEVDO: EXT1 others: IMM	IQ not supported	For 1xEVDO mode, the trigger source is coupled with the gate state, as well as the gate

	TD-SCDMA, 1xEVDO, LTE, LTETDD, CMMB, ISDB-T, MSR			source. When the trigger source changes to RFBurst, External1 or External2, the gate state is set to on, and the gate source is set identically with the trigger source. When the trigger source changes to IMMEDIATE, VIDEO, LINE, FRAME or IF, the gate state is set to off.
CCDF	SA, WCDMA, C2K, WIMAX OFDMA, TD-SCDMA, 1xEV-DO, DVB-T/H, DTMB, LTE, LTETDD, CMMB, ISDB-T, Digital Cable TV, MSR	WIMAX OFDMA: RFBurst LTETDD: BTS: External 1 MS: Periodic Timer TD-SCDMA and 1xEV-DO: BTS: External 1 MS: RFBurst SA, WCDMA, C2K, LTE, CMMB, ISDB-T, DVB-T/H, DTMB, Digital Cable TV, MSR: IMMEDIATE	TD-SCDMA and 1xEV-DO: BTS: External 1 MS: IQMag LTETDD: BTS: External 1 MS: Periodic Timer Others: IMM	For TD-SCDMA: Trigger source is coupled with radio device. When radio device changes to BTS, trigger source will be changed to External1. When radio device changes to MS, trigger source will be set as RFBurst for RF or IQ Mag for BBIQ. When TriggerSource is RFBurst or IQ Mag, Measure Interval is grayed out.
ACP	SA, WCDMA, C2K, WIMAX OFDMA, TD-SCDMA, 1xEVDO, DVB-T/H, DTMB, LTE, LTETDD, CMMB, ISDB-T, Digital Cable TV, MSR	IMM	IQ not supported	
Tx Power	SA, GSM, TD-SCDMA	SA, GSM: RFBurst TD-SCDMA: External	IMM	TD-SCDMA doesn't support the Line and Periodic Timer parameters. When the mode is TD-SCDMA, if the Radio Device is switched to BTS, the value will be changed to External 1 and if the Radio device is switched to MS, the value will be changed to RFBurst
SPUR	SA, WCDMA, C2K, WIMAX OFDMA, TD-SCDMA, 1xEV-DO, DVB-T/H, LTE, LTETDD, MSR	IMM	IQ not supported	
SEM	SA, WCDMA, C2K, WIMAX OFDMA, TD-SCDMA, 1xEVDO, DVB-	1xEVDO(BTS): External1 All others: IMMEDIATE	IQ not supported	

	T/H, DTMB, LTE, LTETDD, CMMB, ISDB-T, Digital Cable TV, MSR			
CDP	WCDMA	IMM	IMM	
RHO	WCDMA	IMM	IMM	
PCON	WCDMA	IMM	IMM	
QPSK	WCDMA, C2K, 1xEVDO	All except CDMA1xEVDO: IMMediate CDMA1xEVDO: EXT1	IMM	
MON	All except SA and BASIC	IMM	IQ not supported	
WAV		LTETDD: BTS: External 1 MS: Periodic Timer GSM/EDGE: RFBurst All others: IMMediate	LTETDD: BTS: External 1 MS: Periodic Timer GSM/EDGE: IQMag All others: IMMMediate	
PVT	WIMAXOFDMA	RFB	IMM	
EVM	WIMAXOFDMA, DVB-T/H, DTMB, LTE, LTETDD, CMMB, ISDB-T, Digital Cable TV	All but CMMB: IMM CMMB: Periodic Timer	All but CMMB: IMM CMMB: External 1	LTE, LTETDD supports Free Run, Video and External 1 only.
SPEC	BASIC	IMM	IMM	
LOG Plot	PN	IMM	IQ not supported	
Spot Freq	PN	IMM	IQ not supported	
GMSK PVT	EDGE/GSM	RFB	IMM	
GMSK PFER	EDGE/GSM	RFB	IQMag	
GMSK ORFS	EDGE/GSM	RF Burst	IQ not supported	
EDGE PVT	EDGE/GSM	RFB	IMM	

EDGE EVM	EDGE/GSM	RFB	IQMag
EDGE ORFS	EDGE/GSM	Periodic Timer	IQ not supported
Combined WCDMA	WCDMA	IMM	IQ not supported
Combined GSM	EDGE/GSM	RFB	IQ not supported
List Power Step	WCDMA, EDGE/GSM	IMM	IQ not supported
Transmit On/Off Power	LTETDD	LTETDD: BTS: External 1 MS: Periodic Timer	LTETDD: BTS: External 1 MS: Periodic Timer
Transmit Analysis	BLUETOOTH	RFB	IQ not supported
Adjacent Channel Power	BLUETOOTH	IMM	IQ not supported
LE In-band Emissions	BLUETOOTH	IMM	IQ not supported
EDR In-band Spurious Emissions	BLUETOOTH	Periodic Timer	IQ not supported
Conformance EVM	LTE, LTETDD, MSR	IMM	IMM

RF Trigger Source

The RF Trigger Source command selects the trigger to be used for the specified measurement when RF is the selected input. The RF trigger source can be queried and changed even while another input is selected, but it is inactive until RF becomes the selected input.

Note the inclusion of the <measurement> parameter in the command below. Because each measurement remembers its own Trigger Source, the command must be qualified with the measurement name. Note that for the Swept SA measurement this is not the case; for backwards compatibility, no <measurement> parameter is used when setting the Trigger Source for the Swept SA measurement.

Remote Command	<code>:TRIGger:<measurement>[:SEquence]:RF:SOURce EXTernal1 EXTernal2 IMMEDIATE LINE FRAME RFBurst VIDEO IF ALARm LAN TV</code> <code>:TRIGger:<measurement>[:SEquence]:RF:SOURce?</code>
-----------------------	--

Example	<code>TRIG:ACP:RF:SOUR EXT1</code> Selects the external 1 trigger input for the ACP measurement and the RF input
----------------	---

	<p>TRIG:RF:SOUR VID</p> <p>Selects video triggering for the SANalyzer measurement and the RF input. For SAN, do not use the <measurement> keyword.</p>
Notes	<p>Not all measurements have all the trigger sources available to them. Check the trigger source documentation for your specific measurement to see what sources are available.</p> <p>Not all trigger sources are available for each input. For the RF Trigger Source, the following trigger sources are available:</p> <ul style="list-style-type: none"> –IMMediate - free run triggering –VIDeo - triggers on the video signal level –LINE - triggers on the power line signal –EXTernal1 (or EXTernal) - triggers on an externally connected trigger source marked “Trigger 1 In” on the rear panel –EXTernal2 - triggers on an externally connected trigger source marked “Trigger 2 In” on the front panel. In some models, there is no second External input. In these models, the External 2 key is blanked and the EXTernal2 parameter will generate a “Hardware missing; Not available for this model number” message –RFBurst - triggers on the bursted frame –FRAMe - triggers on the periodic timer –IF (video) - same as video, for backwards compatibility only <p>*OPC should be used after requesting data. This will hold off any subsequent changes to the selected trigger source, until after the sweep is completed and the data is returned.</p> <p>Available ranges, and presets can vary from mode to mode.</p>
Status Bits/OPC dependencies	<p>The Status Operation Register bit 5 "Waiting for Trigger" is set at the same time as the Sweeping or Measuring bit is set. It is cleared when the trigger actually occurs (that is, after the trigger event occurs and all the applicable trigger criteria have been met). A corresponding pop-up message ("Waiting for trigger") is generated if no trigger signal appears after approximately 2 sec. This message goes away when a trigger signal appears.</p>
Initial S/W Revision	Prior to A.02.00

I/Q Trigger Source

This command selects the trigger to be used for the specified measurement when I/Q (which requires option BBA) is the selected input. The I/Q trigger source can be queried and changed even while another input is selected, but it is inactive until I/Q becomes the selected input.

Remote Command	<pre>:TRIGger:<measurement>[:SEquence]:IQ:SOURce EXTernal1 EXTernal2 IMMediate IQMag IDEMod QDEMod IINPut QINPut AIQMag :TRIGger:<measurement>[:SEquence]:IQ:SOURce?</pre>
Example	<p>TRIG:WAVeform:SOUR IQM</p> <p>Selects I/Q magnitude triggering for the IQ Waveform measurement and the I/Q input</p>
Notes	<p>Not all measurements have all the trigger sources available to them. Check the trigger source documentation for your specific measurement to see what sources are available.</p> <p>Not all trigger sources are available for each input. For the I/Q Trigger Source, the following trigger sources are available:</p>

	<ul style="list-style-type: none"> –IMMediate - free run triggering –EXternal1 (or EXternal) - triggers on an externally connected trigger source on the rear panel –EXternal2 - triggers on an externally connected trigger source on the front panel –IQMag - triggers on the magnitude of the I/Q signal –IDEMod - triggers on the I/Q signal's demodulated I voltage –QDEMod - triggers on the I/Q signal's demodulated Q voltage –IINPut - triggers on the I channel's ADC voltage –QINPut - triggers on the Q channel's ADC voltage –AIQMag - triggers on the magnitude of the auxiliary receiver channel I/Q signal <p>*OPC should be used after requesting data. This will hold off any subsequent changes to the selected trigger source, until after the sweep is completed and the data is returned.</p> <p>Available ranges, and from mode to mode presets can vary</p>
Status Bits/OPC dependencies	The Status Operation Register bit 5 "Waiting for Trigger" is set at the same time as the Sweeping or Measuring bit is set. It is cleared when the trigger actually occurs (that is, after the trigger event occurs and all the applicable trigger criteria have been met). A corresponding pop-up message ("Waiting for trigger") is generated if no trigger signal appears after approximately 2 sec. This message goes away when a trigger signal appears.
Initial S/W Revision	Prior to A.02.00

More Information

The trigger menus let you select the trigger source and trigger settings for a sweep or measurement. In triggered operation (basically, any trigger source other than Free Run), the analyzer will begin a sweep or measurement only with the selected trigger conditions are met, generally when your trigger source signal meets the specified trigger level and polarity requirements. (In FFT measurements, the trigger controls when the data acquisition begins for FFT conversion.)

For each of the trigger sources, you may define a set of operational parameters or settings which will be applied when that source is selected as the current trigger source. Examples of these settings are Trigger Level, Trigger Delay, and Trigger Slope. You may apply different settings for each source; so, for example, you could have a Trigger Level of 1v for External 1 trigger and –10 dBm for Video trigger.

Once you have established the settings for a given trigger source, they generally will remain unchanged for that trigger source as you go from measurement to measurement within a Mode (although the settings do change as you go from Mode to Mode). Furthermore, the trigger settings within a Mode are the same for the **Trigger** menu, the **Gate Source** menu, and the **Sync Source** menu that is part of the **Periodic Timer Trigger Setup** menu. That is, if **Ext1** trigger level is set to 1v in the **Trigger** menu, it will appear as 1v in both the **Gate Source** and the **Sync Source** menus. For these reasons the trigger settings commands are not qualified with the measurement name, the way the trigger source commands are.

The settings setup menu can be accessed by pressing the key for the current trigger source a second time. For example, one press of Video selects the Video trigger as the source. The Video key becomes highlighted and the hollow arrow on the key turns black. Now a second press of the key takes you into the Video Trigger Setup menu.

Trigger Setup Parameters:

The following examples show trigger setup parameters using an external trigger source.

Example 1 illustrates the trigger conditions with negative slope and no trigger occurs during trigger Holdoff time.

Example 2 illustrates the trigger conditions with positive slope, trigger delay, and auto trigger time.

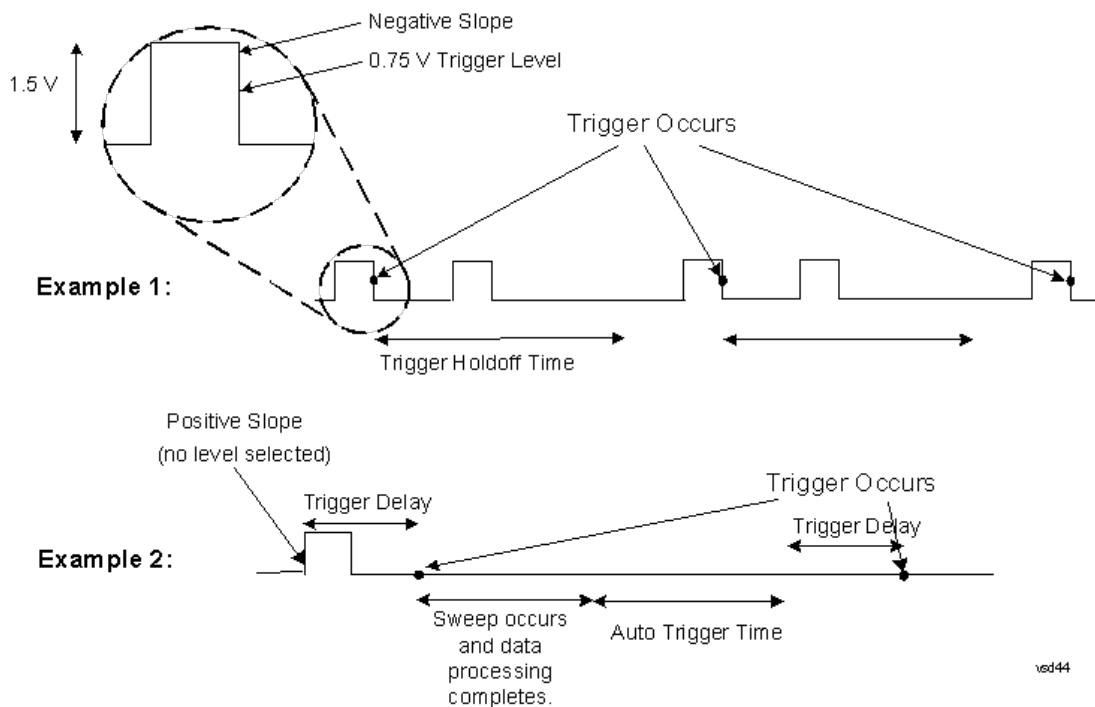

Free Run

Pressing this key, when it is not selected, selects free-run triggering. Free run triggering occurs immediately after the sweep/measurement is initiated.

Key Path	Trigger
Example	TRIG:SOUR IMM Swept SA measurement TRIG:<meas>:SOUR IMM Measurements other than Swept SA
State Saved	Saved in instrument state
Status Bits/OPC dependencies	The Status Operation Register bit 5 "Waiting for Trigger" is set at the same time as the Sweeping or Measuring bit is set. It is cleared when the trigger actually occurs (that is, after the trigger event occurs and all the applicable trigger criteria have been met). A corresponding pop-up message ("Waiting for trigger") is generated if no trigger signal appears after approximately 2 sec. This message goes away when a trigger signal appears.
Initial S/W Revision	Prior to A.02.00

Video (IF Envelope)

Pressing this key, when it is not selected, selects the video signal as the trigger. The Video trigger condition is met when the video signal (the filtered and detected version of the input signal, including both RBW and VBW filtering) crosses the video trigger level.

NOTE

When the detector selected for all active traces is the average detector, the video signal for triggering does not include any VBW filtering.

The video trigger level is shown as a labeled line on the display. The line is displayed as long as video is the selected trigger source.

Pressing this key, when it is already selected, accesses the video trigger setup functions.

Key Path	Trigger
Example	TRIG:SOUR VID Swept SA measurement TRIG:<meas>:SOUR VID Measurements other than Swept SA
Notes	Log Plot and Spot Frequency measurements do not support Video Trigger
Dependencies	Video trigger is allowed in average detector mode.
State Saved	Saved in instrument state
Status Bits/OPC dependencies	The Status Operation Register bit 5 "Waiting for Trigger" is set at the same time as the Sweeping or Measuring bit is set. It is cleared when the trigger actually occurs (that is, after the trigger event occurs and all the applicable trigger criteria have been met). A corresponding pop-up message ("Waiting for trigger") is generated if no trigger signal appears after approximately 2 sec. This message goes away when a trigger signal appears.
Backwards Compatibility Notes	In the past, the Average detector was not available when Video triggering was on, and consequently, functions that set the detector to average (such as Marker Noise or Band/Intvl Power) were not available when the video trigger was on. Similarly, Video triggering was not available when the detector was Average. In the X-Series, these restrictions are removed.
Initial S/W Revision	Prior to A.02.00

Trigger Level

Sets a level for the video signal trigger. When the video signal crosses this level, with the chosen slope, the trigger occurs. This level is displayed with a horizontal line only if **Video** is the selected trigger source.

Key Path	Trigger, Video
Remote Command	:TRIGger[:SEquence]:VIDeo:LEVel <ampl> :TRIGger[:SEquence]:VIDeo:LEVel?
Example	TRIG:VID:LEV -40 dBm
Notes	When sweep type = FFT, the video trigger uses the amplitude envelope in a bandwidth wider than the FFT width as a trigger source. This might often be useful, but does not have the same relationship between the displayed trace and the trigger level as in swept triggering. Amplitude Corrections are not taken into account by the Video Trig Level. For example, if you have

given yourself effective gain with an amplitude correction factor, the Video Trigger will not fire until you have dropped the trigger line that far below the displayed signal level, rather than simply dropping it down to the displayed signal level.

Note that other corrections, specifically External Gain and Ref Level Offset, modify the actual trace data as it is taken and therefore ARE taken into account by Trig Level.

Couplings	This same level is used for the Video trigger source in the Trigger menu and for the Video selection in the Gate Source menu.
Preset	Set the Video Trigger Level -25 dBm on Preset. When the Video Trigger Level becomes the active function, if the value is off screen, set it to either the top or bottom of screen, depending on which direction off screen it was.
State Saved	Saved in instrument state
Min	-170 dBm
Max	+30 dBm
Default Unit	Depends on the current selected Y axis unit
Backwards Compatibility SCPI	:TRIGger[:SEquence]:IF:LEVel :TRIGger[:SEquence]:IF:LEVel?
Backwards Compatibility Notes	This alias is provided for backward compatibility with VSA/PSA comms apps.
Initial S/W Revision	Prior to A.02.00

Trig Slope

Controls the trigger polarity. It is set positive to trigger on a rising edge and negative to trigger on a falling edge.

Key Path	Trigger, Video
Remote Command	:TRIGger[:SEquence]:VIDeo:SLOPe POSitive NEGative :TRIGger[:SEquence]:VIDeo:SLOPe?
Example	TRIG:VID:SLOP NEG
Preset	POSitive
State Saved	Saved in instrument state
Backwards Compatibility SCPI	:TRIGger[:SEquence]:IF:SLOPe NEGative POSitive :TRIGger[:SEquence]:IF:SLOPe? For backward compatibility with VSA/PSA comms apps
Backwards Compatibility Notes	The legacy :TRIGger[:SEquence]:SLOPe command affects the slopes for the VID, LINE, EXT1, EXT2, and RFB triggers.
Initial S/W Revision	Prior to A.02.00

Remote Command	:TRIGger[:SEquence]:SLOPe POSitive NEGative :TRIGger[:SEquence]:SLOPe?
Example	TRIG:SLOP NEG
Preset	POSitive
State Saved	Saved in instrument state
Backwards Compatibility Notes	In ESA/PSA, the Trigger Slope was global to all triggers. In the X-Series, the slope can be set individually for each Trigger Source. For backward compatibility, the global SLOPe command updates all instances of trigger slope (VID, LINE, EXT1, EXT2, TV, RFB). The query returns the trigger slope setting of the currently selected trigger source.
Initial S/W Revision	Prior to A.02.00

Trig Delay

Controls a time delay during that the analyzer will wait to begin a sweep after meeting the trigger criteria. You can use negative delay to pre-trigger the instrument in the time domain or FFT, but not in swept spans.

Key Path	Trigger, Video
Remote Command	:TRIGger[:SEquence]:VIDeo:DELaY <time> :TRIGger[:SEquence]:VIDeo:DELaY? :TRIGger[:SEquence]:VIDeo:DELaY:STATe OFF ON 0 1 :TRIGger[:SEquence]:VIDeo:DELaY:STATe?
Example	TRIG:VID:DEL:STAT ON TRIG:VID:DEL 100 ms
Notes	Video trigger delay may be set to negative values, in time domain, FFT and even swept. It makes intuitive sense in time domain and works well in FFT mode where the bandwidth of the filter before the video trigger is about 1.25 span. In swept spans, negative settings of Trig Delay are treated as a zero setting within the internal hardware and the advisory message "Neg. Trig Delay unavailable in Swept Mode, zero delay used." is generated when such a delay is set.
Preset	Off, 1 us
State Saved	Saved in instrument state
Min	-150 ms
Max	+500 ms
Default Unit	s
Backwards Compatibility Notes	! For backward compatibility with VSA/PSA comms apps :TRIGger[:SEquence]:IF:DELaY :TRIGger[:SEquence]:DELaY The legacy :TRIGger[:SEquence]:DELaY command affects the delay for the VID, LINE, EXT1, EXT2, and RFB triggers.
Initial S/W Revision	Prior to A.02.00

Remote Command	:TRIGger[:SEquence]:DELay <time> :TRIGger[:SEquence]:DELay? :TRIGger[:SEquence]:DELay:STATE OFF ON 0 1 :TRIGger[:SEquence]:DELay:STATE?
Example	TRIG:DEL 1 ms
Preset	1 us
State Saved	Saved in instrument state
Backwards Compatibility Notes	In ESA/PSA, the Trigger Delay was global to all triggers. In the X-Series, the delay can be set individually for each Trigger Source. For backward compatibility, the global DELay command updates all instances of trigger slope (VID, LINE, EXT1, EXT2) except TV and RFBurst. The query returns the trigger delay setting of the currently selected trigger source.
Initial S/W Revision	Prior to A.02.00

Remote Command	:TRIGger[:SEquence]:OFFSet <time> :TRIGger[:SEquence]:OFFSet? :TRIGger[:SEquence]:OFFSet:STATE OFF ON 0 1 :TRIGger[:SEquence]:OFFSet:STATE?
Example	TRIG:OFFS ON TRIG:OFFS -100 ms
Notes	These are ESA commands for trigger offset that allowed you to use a positive or negative delay when in zero span and in a Res BW \geq 1 kHz. For ESA compatibility, X-series analyzers keep track of this offset and adds it to the Trigger Delay for VIDEo, LINE, EXTernal1 or EXTernal2 whenever the value is sent to the hardware, if in Zero Span and RBW \geq 1 kHz.
Preset	Off, 0 s
State Saved	Saved in instrument state
Min	-11 s
Max	+11 s
Initial S/W Revision	Prior to A.02.00

Line

Pressing this key, when it is not selected, selects the line signal as the trigger. A new sweep/measurement will start synchronized with the next cycle of the line voltage. Pressing this key, when it is already selected, access the line trigger setup menu.

Key Path	Trigger
Example	TRIG:SOUR LINE Swept SA measurement TRIG:<meas>:SOUR LINE Measurements other than Swept SA
Dependencies	Line trigger is not available when operating from a "dc power source", for example, when the

	instrument is powered from batteries.
State Saved	Saved in instrument state
Status Bits/OPC dependencies	The Status Operation Register bit 5 "Waiting for Trigger" is set at the same time as the Sweeping or Measuring bit is set. It is cleared when the trigger actually occurs (that is, after the trigger event occurs and all the applicable trigger criteria have been met). A corresponding pop-up message ("Waiting for trigger") is generated if no trigger signal appears after approximately 2 sec. This message goes away when a trigger signal appears.
Initial S/W Revision	Prior to A.02.00

Trig Slope

Controls the trigger polarity. It is set positive to trigger on a rising edge and negative to trigger on a falling edge.

Key Path	Trigger, Line
Remote Command	:TRIGger[:SEquence]:LINE:SLOPe POSitive NEGative :TRIGger[:SEquence]:LINE:SLOPe?
Example	TRIG:LINE:SLOP NEG
Preset	POSitive
State Saved	Saved in instrument state
Backwards Compatibility Notes	The legacy :TRIGger[:SEquence]:SLOPe command affects the slopes for the VID, LINE, EXT1, EXT2, and RFB triggers.
Initial S/W Revision	Prior to A.02.00

Trig Delay

Controls a time delay during which the analyzer will wait to begin a sweep after meeting the trigger criteria. You can use negative delay to pre-trigger the instrument in time domain or FFT, but not in swept spans.

Key Path	Trigger, Line
Remote Command	:TRIGger[:SEquence]:LINE:DELay <time> :TRIGger[:SEquence]:LINE:DELay? :TRIGger[:SEquence]:LINE:DELay:STATe OFF ON 0 1 :TRIGger[:SEquence]:LINE:DELay:STATe?
Example	TRIG:LINE:DEL:STAT ON TRIG:LINE:DEL 100 ms
Notes	Video trigger delay may be set to negative values, in time domain, FFT and even swept. It makes intuitive sense in time domain and works well in FFT mode where the bandwidth of the filter before the video trigger is about 1.25 span. In swept spans, negative settings of Trig Delay are treated as a

	zero setting within the internal hardware and the advisory message "Neg. Trig Delay unavailable in Swept Mode, zero delay used." is generated when such a delay is set.
Preset	Off, 1.000 us
State Saved	Saved in instrument state
Min	-150 ms
Max	500 ms
Default Unit	S
Backwards Compatibility Notes	The legacy :TRIGger[:SEQuence]:DELAy command affects the delay for the VID, LINE, EXT1, EXT2, and RFB triggers. The legacy :TRIGger[:SEQuence]:OFFSet command is supported for the VIDeo, LINE, EXT1, and EXT2 triggers.
Initial S/W Revision	Prior to A.02.00

External 1

Pressing this key, when it is not selected, selects an external input signal as the trigger. A new sweep/measurement will start when the external trigger condition is met using the external 1 input connector on the rear panel.

Pressing this key, when it is already selected, accesses the external 1 trigger setup menu.

Key Path	Trigger
Example	TRIG:SOUR EXT1 Swept SA measurement TRIG:<meas>:SOUR EXT1 Measurements other than Swept SA
Dependencies	Grayed out if in use by Point Trigger in the Source Setup menu. Forced to Free Run if already selected and Point Trigger is set to External 1.
State Saved	Saved in instrument state
Status Bits/OPC dependencies	The Status Operation Register bit 5 "Waiting for Trigger" is set at the same time as the Sweeping or Measuring bit is set. It is cleared when the trigger actually occurs (that is, after the trigger event occurs and all the applicable trigger criteria have been met). A corresponding pop-up message ("Waiting for trigger") is generated if no trigger signal appears after approximately 2 sec. This message goes away when a trigger signal appears.
Initial S/W Revision	Prior to A.02.00

Trigger Level

Sets the value where the external 1 trigger input will trigger a new sweep/measurement.

Key Path	Trigger, External 1
Remote Command	:TRIGger[:SEQuence]:EXTernal1:LEVel <level>

	:TRIGger[:SEquence]:EXTernal1:LEVel?
Example	TRIG:EXT1:LEV 0.4 V
Couplings	This same level is used for the Ext1 trigger source in the Trigger menu, for the Ext1 selection in the Periodic Timer sync source (in the Trigger menu and in the Gate Source menu), and also for the Ext1 selection in the Gate Source menu.
Preset	1.2 V
State Saved	Saved in instrument state
Min	-5 V
Max	5 V
Default Unit	V
Backwards Compatibility SCPI	:TRIGger[:SEquence]:EXTernal:LEVel
Backwards Compatibility SCPI	For backward compatibility, the parameter EXTernal is mapped to EXTernal1
Backwards Compatibility SCPI	:TRIGger[:SEquence]:FRAMe:EXTernal1:LEVel
Initial S/W Revision	Prior to A.02.00

Trig Slope

Controls the trigger polarity. It is set positive to trigger on a rising edge and negative to trigger on a falling edge.

Key Path	Trigger, External 1
Remote Command	:TRIGger[:SEquence]:EXTernal1:SLOPe POSitive NEGative :TRIGger[:SEquence]:EXTernal1:SLOPe?
Example	TRIG:EXT1:SLOP NEG
Couplings	This same slope is used in the Ext1 selection for the trigger source in the Trigger menu and for the period timer sync source (in the Trigger menu and in the Gate Source menu).
Preset	POSitive
State Saved	Saved in instrument state
Backwards Compatibility SCPI	:TRIGger[:SEquence]:EXTernal:SLOPe
Backwards Compatibility SCPI	For backward compatibility, the parameter EXTernal is mapped to EXTernal1
Backwards Compatibility SCPI	:TRIGger[:SEquence]:FRAMe:EXTernal1:SLOPe
Backwards Compatibility Notes	The legacy :TRIGger[:SEquence]:SLOPe command affects the slopes for the VID, LINE, EXT1, EXT2, and RFB triggers.
Initial S/W Revision	Prior to A.02.00

Trig Delay

Controls a time delay during which the analyzer will wait to begin a sweep after meeting the trigger criteria. You can use negative delay to pre-trigger the instrument in time domain or FFT, but not in swept spans.

Key Path	Trigger, External 1
Remote Command	:TRIGger[:SEQuence]:EXTernal1:DELAy <time> :TRIGger[:SEQuence]:EXTernal1:DELAy? :TRIGger[:SEQuence]:EXTernal1:DELAy:STATe OFF ON 0 1 :TRIGger[:SEQuence]:EXTernal1:DELAy:STATe?
Example	TRIG:EXT1:DEL:STAT ON TRIG:EXT1:DEL 100 ms
Notes	Video trigger delay may be set to negative values, in time domain, FFT and even swept. It makes intuitive sense in time domain and works well in FFT mode where the bandwidth of the filter before the video trigger is about 1.25 span. In swept spans, negative settings of Trig Delay are treated as a zero setting within the internal hardware and the advisory message "Neg. Trig Delay unavailable in Swept Mode, zero delay used." is generated when such a delay is set.
Preset	Off, 1.000 us
State Saved	Saved in instrument state
Min	-150 ms
Max	+500 ms
Default Unit	s
Backwards Compatibility SCPI	:TRIGger[:SEQuence]:EXTernal:DELAy For backward compatibility, the parameter EXTernal is mapped to EXTernal1
Backwards Compatibility Notes	The legacy :TRIGger[:SEQuence]:DELAy command affects the delay for the VID, LINE, EXT1, EXT2, and RFB triggers. The legacy :TRIGger[:SEQuence]:OFFSet command is supported for the VIDeO, LINE, EXT1, and EXT2 triggers.
Initial S/W Revision	Prior to A.02.00

External 2

Pressing this key, when it is not selected, selects an external input signal as the trigger. A new sweep/measurement will start when the external trigger condition is met using the external 2 input connector. The external trigger 2 input connector is on the rear panel.

Pressing this key, when it is already selected, accesses the external 2 trigger setup menu.

Key Path	Trigger
Example	TRIG:SOUR EXT2 Swept SA measurement TRIG:<meas>:SOUR EXT2 Measurements other than Swept SA
Dependencies	In some models, there is no second External input. In these models, the External 2 key is blanked and

	<p>the EXTERNAL2 parameter will generate a "Hardware missing; Not available for this model number" message.</p> <p>Grayed out if in use by Point Trigger in the Source Setup menu.</p> <p>Forced to Free Run if already selected and Point Trigger is set to External 2.</p>
State Saved	Saved in instrument state
Status Bits/OPC dependencies	The Status Operation Register bit 5 "Waiting for Trigger" is set at the same time as the Sweeping or Measuring bit is set. It is cleared when the trigger actually occurs (that is, after the trigger event occurs and all the applicable trigger criteria have been met). A corresponding pop-up message ("Waiting for trigger") is generated if no trigger signal appears after approximately 2 sec. This message goes away when a trigger signal appears.
Initial S/W Revision	Prior to A.02.00
Modified at S/W Revision	A.03.00

Trigger Level

Sets the value where the external 2 trigger input will trigger a new sweep/measurement.

Key Path	Trigger, External 2
Remote Command	:TRIGger[:SEquence]:EXTernal2:LEVel :TRIGger[:SEquence]:EXTernal2:LEVel?
Example	TRIG:EXT2:LEV 1.1 V
Couplings	This same level is used for the Ext2 trigger source in the Trigger menu, for the Ext2 selection in the Periodic Timer sync source (in the Trigger menu and in the Gate Source menu), and also for the Ext2 selection in the Gate Source menu.
Preset	1.2 V
State Saved	Saved in instrument state
Min	-5 V
Max	5 V
Default Unit	V
Backwards Compatibility SCPI	:TRIGger[:SEquence]:FRAME:EXTernal2:LEVel
Initial S/W Revision	Prior to A.02.00

Trig Slope

Controls the trigger polarity. It is set positive to trigger on a rising edge and negative to trigger on a falling edge.

Key Path	Trigger, External 2
Remote Command	:TRIGger[:SEquence]:EXTernal2:SLOPe POSitive NEGative

	:TRIGger[:SEquence]:EXTernal2:SLOPe?
Example	TRIG:EXT2:SLOP NEG
Couplings	This same slope is used in the Ext2 selection for the trigger source in the Trigger menu and for the period timer sync source (in the Trigger menu and in the Gate Source menu).
Preset	POSitive
State Saved	Saved in instrument state
Backwards Compatibility SCPI	:TRIGger[:SEquence]:FRAMe:EXTernal2:SLOPe
Backwards Compatibility Notes	The legacy :TRIGger[:SEquence]:SLOPe command affects the slopes for the VID, LINE, EXT1, EXT2, and RFB triggers.
Initial S/W Revision	Prior to A.02.00

Trig Delay

Controls a time delay during which the analyzer will wait to begin a sweep after meeting the trigger criteria. You can use negative delay to pre-trigger the instrument in time domain or FFT, but not in swept spans.

Key Path	Trigger, External 2
Remote Command	:TRIGger[:SEquence]:EXTernal2:DELAy <time> :TRIGger[:SEquence]:EXTernal2:DELAy? :TRIGger[:SEquence]:EXTernal2:DELAy:STATe OFF ON 0 1 :TRIGger[:SEquence]:EXTernal2:DELAy:STATe?
Example	TRIG:EXT2:DEL:STAT ON TRIG:EXT2:DEL 100 ms
Notes	Video trigger delay may be set to negative values, in time domain, FFT and even swept. It makes intuitive sense in time domain and works well in FFT mode where the bandwidth of the filter before the video trigger is about 1.25 span. In swept spans, negative settings of Trig Delay are treated as a zero setting within the internal hardware and the advisory message "Neg. Trig Delay unavailable in Swept Mode, zero delay used." is generated when such a delay is set.
Preset	Off, 1.000 us
State Saved	Saved in instrument state
Min	-150 ms
Max	500 ms
Default Unit	s
Backwards Compatibility Notes	The legacy :TRIGger[:SEquence]:DELAy command affects the delay for the VID, LINE, EXT1, EXT2, and RFB triggers. The legacy :TRIGger[:SEquence]:OFFSet command is supported for the VIDeO, LINE, EXT1, and EXT2 triggers.
Initial S/W Revision	Prior to A.02.00

RF Burst

Pressing this key, when it is not selected, selects the RF Burst as the trigger. A new sweep/measurement will start when an RF burst envelope signal is identified from the signal at the RF Input connector. Pressing this key, when it is already selected, accesses the RF Burst trigger setup menu.

In some models, a variety of burst trigger circuitry is available, resulting in various available burst trigger bandwidths. The analyzer automatically chooses the appropriate trigger path based on the hardware configuration and other settings of the analyzer.

Key Path	Trigger
Example	TRIG:SOUR RFB Swept SA measurement TRIG:<meas>:SOUR RFB Measurements other than Swept SA
State Saved	Saved in instrument state
Status Bits/OPC dependencies	The Status Operation Register bit 5 "Waiting for Trigger" is set at the same time as the Sweeping or Measuring bit is set. It is cleared when the trigger actually occurs (that is, after the trigger event occurs and all the applicable trigger criteria have been met). A corresponding pop-up message ("Waiting for trigger") is generated if no trigger signal appears after approximately 2 sec. This message goes away when a trigger signal appears.
Backwards Compatibility Notes	The legacy command: :TRIGger[:SEQuence]:RFBurst:FSElectivity[:STATe] OFF ON 0 1 is not supported in the X-Series, as the hardware to do Frequency Selective burst triggers does not exist in X-Series.
Initial S/W Revision	Prior to A.02.00
Modified at S/W Revision	A.04.00

Absolute Trigger Level

Sets the absolute trigger level for the RF burst envelope.

When using the External Mixing path, the Absolute Trigger Level is uncalibrated because the factory default was set to accommodate the expected IF levels for the RF path.

Key Path	Trigger, RF Burst
Scope	Meas Global
Remote Command	:TRIGger[:SEQuence]:RFBurst:LEVel:ABSolute <ampl> :TRIGger[:SEQuence]:RFBurst:LEVel:ABSolute?
Example	TRIG:RFB:LEV:ABS 10 dBm sets the trigger level of the RF burst envelope signal to the absolute level of 10 dBm
Notes	Sending this command does not switch the setting from relative to absolute; to switch it you need to send the :TRIGger[:SEQuence]:RFBurst:LEVel:TYPE command, below. Amplitude Corrections are not taken into account by the Absolute Trigger Level. For example, if you have given yourself effective gain with an amplitude correction factor, the Absolute Trigger will not fire until you have set the trigger level that far below the displayed signal level, rather than simply to

	the displayed signal level. This is only true for Amplitude Corrections, not External Gain or Ref Level Offset functions. If mode is Bluetooth, the default value is -50 dBm.
Couplings	This same level is used for the RF Burst trigger source in the Trigger menu, for the RF Burst selection in the Periodic Timer sync source (in the Trigger menu and in the Gate Source menu), and also for the RF Burst selection in the Gate Source menu
Preset	-20 dBm
State Saved	Saved in instrument state
Min	-200 dBm
Max	100 dBm
Default Unit	depends on the current selected Y-Axis unit
Backwards Compatibility SCPI	:TRIGger[:SEquence]:FRAMe:RFBurst:LEVel:ABSolute
Initial S/W Revision	Prior to A.02.00
Modified at S/W Revision	A.04.00
<hr/>	
Key Path	Trigger, RF Burst
Remote Command	:TRIGger[:SEquence]:RFBurst:LEVel:TYPE ABSolute RELative :TRIGger[:SEquence]:RFBurst:LEVel:TYPE?
Example	TRIG:RFB:LEV:TYPE REL sets the trigger level type of the RF burst trigger to Relative.
Preset	ABSolute
State Saved	Saved in instrument state
Initial S/W Revision	Prior to A.02.00
Modified at S/W Revision	A.04.00

Relative Trigger Level

Sets the relative trigger level for the RF burst envelope.

In some models, the relative burst trigger function is implemented in hardware. In other models, without the advanced triggering hardware required, the relative burst trigger function is implemented in software in some measurements, and is unavailable in other measurements.

When implemented in software, the relative RF Burst trigger function is implemented as follows:

1. The measurement starts with the absolute RF Burst trigger setting. If it cannot get a trigger with that level, auto trigger fires and the acquisition starts anyway. After the acquisition, the measurement searches for the peak in the acquired waveform and saves it.

2. Now, in the next cycle of the measurement, the measurement determines a new absolute RF Burst level based on the peak value from the first measurement and the Relative RF Burst Trigger Level (always 0 or negative dB) set by the user. The following formula is used:
 3. absolute RF Burst level = peak level of the previous acquisition + relative RF Burst level
 4. If the new absolute RF Burst level differs from the previous by more than 0.5 dB, the new level is sent to the hardware; otherwise it is not updated (to avoid slowing down the acquisition)
- Steps 2 and 3 repeat for subsequent measurements.

Key Path	Trigger, RF Burst
Scope	Meas Global
Remote Command	:TRIGger[:SEquence]:RFBurst:LEVel:RELative <rel_ampl> :TRIGger[:SEquence]:RFBurst:LEVel:RELative?
Example	TRIG:RFB:LEV:REL -10 dB sets the trigger level of the RF burst envelope signal to the relative level of -10 dB
Notes	Sending this command does not switch the setting from absolute to relative; to switch it you need to send the :TRIGger[:SEquence]:RFBurst:LEVel:TYPE command, above. The relative trigger level is not available in some measurements. In those measurements the RELative parameter, and the :TRIGger[:SEquence]:RFBurst:LEVel:TYPE command (above), will generate an error if sent.
Dependencies	This key is grayed out and Absolute Trigger Level selected if the required hardware is not present in your analyzer and the current measurement does not support Relative triggering.
Preset	-6 dB GSM: -25 dB
State Saved	Saved in instrument state
Min	-45 dB
Max	0 dB
Default Unit	dB or dBc
Backwards Compatibility SCPI	:TRIGger[:SEquence]:RFBurst:LEVel This legacy command is aliased to :TRIGger[:SEquence]:RFBurst:LEVel:RELative because the PSA had ONLY relative burst triggering
Initial S/W Revision	Prior to A.02.00
Modified at S/W Revision	A.04.00

Trigger Slope

It is set positive to trigger on a rising edge and negative to trigger on a falling edge.

Key Path	Trigger, RF Burst
Remote Command	:TRIGger[:SEquence]:RFBurst:SLOPe POSitive NEGative :TRIGger[:SEquence]:RFBurst:SLOPe?

Example	TRIG:RFB:SLOP NEG
Couplings	This same slope is used in the RF Burst selection for the trigger source in the Trigger menu and for the period timer sync source (in the Trigger menu and in the Gate Source menu).
Preset	POSitive
State Saved	Saved in instrument state
Backwards Compatibility SCPI	:TRIGger[:SEQuence]:FRAMe:RFBurst:SLOPe
Backwards Compatibility Notes	The legacy :TRIGger[:SEQuence]:SLOPe command affects the slopes for the VID, LINE, EXT1, EXT2, and RFB triggers.
Initial S/W Revision	Prior to A.02.00

Trig Delay

Controls a time delay during which the analyzer will wait to begin a sweep after meeting the trigger criteria. You can use negative delay to pre-trigger the instrument in time domain or FFT, but not in swept spans.

Key Path	Trigger, RF Burst
Remote Command	:TRIGger[:SEQuence]:RFBurst:DELay <time> :TRIGger[:SEQuence]:RFBurst:DELay? :TRIGger[:SEQuence]:RFBurst:DELay:STATe OFF ON 0 1 :TRIGger[:SEQuence]:RFBurst:DELay:STATe?
Example	TRIG:RFB:DEL:STAT ON TRIG:RFB:DEL 100 ms
Notes	Video trigger delay may be set to negative values, in time domain, FFT and even swept. It makes intuitive sense in time domain and works well in FFT mode where the bandwidth of the filter before the video trigger is about 1.25 span. In swept spans, negative settings of Trig Delay are treated as a zero setting within the internal hardware and the advisory message "Neg. Trig Delay unavailable in Swept Mode, zero delay used." is generated when such a delay is set.
Preset	Off, 1.000 us
State Saved	Saved in instrument state
Min	-150 ms
Max	500 ms
Default Unit	s
Backwards Compatibility Notes	The legacy :TRIGger[:SEQuence]:DELay command affects the delay for the VID, LINE, EXT1, EXT2, and RFB triggers.
Initial S/W Revision	Prior to A.02.00

Periodic Timer (Frame Trigger)

Pressing this key, when it is not selected, selects the internal periodic timer signal as the trigger. Triggering occurrences are set by the **Period** parameter, which is modified by the **Sync Source** and **Offset**. Pressing this key, when it is already selected, accesses the periodic timer trigger setup functions.

If you do not have a sync source selected (it is Off), then the internal timer will not be synchronized with any external timing events.

Key Path	Trigger
Example	TRIG:SOUR FRAM Swept SA measurement
	TRIG:< meas>:SOUR FRAM Measurements other than Swept SA
State Saved	Saved in instrument state
Readback	[Sync: <value of Sync Source>], for example, [Sync: External 1]
Status Bits/OPC dependencies	The Status Operation Register bit 5 "Waiting for Trigger" is set at the same time as the Sweeping or Measuring bit is set. It is cleared when the trigger actually occurs (that is, after the trigger event occurs and all the applicable trigger criteria have been met). A corresponding pop-up message ("Waiting for trigger") is generated if no trigger signal appears after approximately 2 sec. This message goes away when a trigger signal appears.
Initial S/W Revision	Prior to A.02.00

Periodic Timer Triggering:

This feature selects the internal periodic timer signal as the trigger. Trigger occurrences are set by the **Periodic Timer** parameter, which is modified by the **Sync Source** and **Offset**.

The figure below shows the action of the periodic timer trigger. Before reviewing the figure, we'll explain some uses for the periodic trigger.

A common application is measuring periodic burst RF signals for which a trigger signal is not easily available. For example, we might be measuring a TDMA radio which bursts every 20 ms. Let's assume that the 20 ms period is very consistent. Let's also assume that we do not have an external trigger source available that is synchronized with the period, and that the signal-to-noise ratio of the signal is not high enough to provide a clean RF burst trigger at all of the analysis frequencies. For example, we might want to measure spurious transmissions at an offset from the carrier that is larger than the bandwidth of the RF burst trigger. In this application, we can set the Periodic Timer to a 20.00 ms period and adjust the offset from that timer to position our trigger just where we want it. If we find that the 20.00 ms is not exactly right, we can adjust the period slightly to minimize the drift between the period timer and the signal to be measured.

A second way to use this feature would be to use **Sync Source** temporarily, instead of **Offset**. In this case, we might tune to the signal in a narrow span and use the RF Burst trigger to synchronize the periodic timer. Then we would turn the sync source off so that it would not miss-trigger. Miss-triggering can occur when we are tuned so far away from the RF burst trigger that it is no longer reliable.

A third example would be to synchronize to a signal that has a reference time element of much longer period than the period of interest. In some CDMA applications, it is useful to look at signals with a short periodicity, by synchronizing that periodicity to the "even-second clock" edge that happens every two

seconds. Thus, we could connect the even-second clock trigger to Ext1 and use then Ext1 as the sync source for the periodic timer.

The figure below illustrates this third example. The top trace represents the even-second clock. It causes the periodic timer to synchronize with the leading edge shown. The analyzer trigger occurs at a time delayed by the accumulated offset from the period trigger event. The periodic timer continues to run, and triggers continue to occur, with a periodicity determined by the analyzer time base. The timer output (labeled "late event") will drift away from its ideal time due to imperfect matching between the time base of the signal being measured and the time base of the analyzer, and also because of imperfect setting of the period parameter. But the synchronization is restored on the next even-second clock event. ("Accumulated offset" is described in the in the **Offset** function section.)

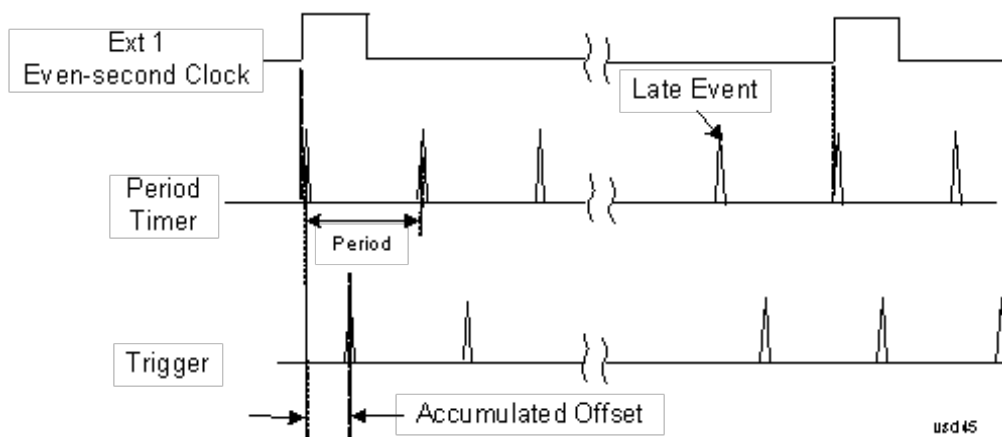

Period

Sets the period of the internal periodic timer clock. For digital communications signals, this is usually set to the frame period of your current input signal. In the case that sync source is not set to OFF, and the external sync source rate is changed for some reason, the periodic timer is synchronized at the every external synchronization pulse by resetting the internal state of the timer circuit.

Key Path	Trigger, Periodic Timer
Remote Command	:TRIGger[:SEquence]:FRAMe:PERiod <time> :TRIGger[:SEquence]:FRAMe:PERiod?
Example	TRIG:FRAM:PER 100 ms
Dependencies	The invalid data indicator turns on when the period is changed, until the next sweep/measurement completes.
Couplings	The same period is used in the Gate Source selection of the period timer.
Preset	20 ms GSM: 4.615383
State Saved	Saved in instrument state
Min	100.000 ns
Max	559.0000 ms
Default Unit	S
Initial S/W Revision	Prior to A.02.00

Offset

Adjusts the accumulated offset between the periodic timer events and the trigger event. Adjusting the accumulated offset is different than setting an offset, and requires explanation.

The periodic timer is usually not synchronized with any external events, so the timing of its output events has no absolute meaning. Since the timing relative to external events (RF signals) is important, you need to be able to adjust (offset) it. However, you have no direct way to see when the periodic timer events occur. All that you can see is the trigger timing. When you want to adjust the trigger timing, you will be changing the internal offset between the periodic timer events and the trigger event. Because the absolute value of that internal offset is unknown, we will just call that the accumulated offset. Whenever the Offset parameter is changed, you are changing that accumulated offset. You can reset the displayed offset using Reset Offset Display. Changing the display does not change the value of the accumulated offset, and you can still make additional changes to accumulated offset.

To avoid ambiguity, we define that an increase in the "offset" parameter, either from the knob or the SCPI adjust command, serves to delay the timing of the trigger event.

Key Path	Trigger, Periodic Timer
Remote Command	:TRIGger[:SEquence]:FRAMe:OFFSet <time> :TRIGger[:SEquence]:FRAMe:OFFSet?
Example	TRIG:FRAM:OFFS 1.2 ms
Notes	<p>The front panel interface (for example, the knob), and this command, adjust the accumulated offset, which is shown on the active function display. However, the actual amount sent to the hardware each time the offset is updated is the delta value, that is, the current accumulated offset value minus the previous accumulated offset value. Note that the accumulated offset value is essentially arbitrary; it represents the accumulated offset from the last time the offset was zeroed (with the Reset Offset Display key).</p> <p>Note that this command does not change the period of the trigger waveform. Note also that Offset is used only when the sync source is set to OFF, otherwise delay is used, see section "Trig Delay" on page 443.</p> <p>An increase in the "offset" parameter, either from the knob or the SCPI adjust command, serves to delay the timing of the trigger event.</p>
Notes	<p>When the SCPI command is sent the value shown on the key (and the Active Function, if this happens to be the active function) is updated with the new value. However, the actual amount sent to the hardware is the delta value, that is, the current accumulated offset value minus the previous accumulated offset value.</p> <p>The SCPI query simply returns the value currently showing on the key.</p>
Dependencies	The invalid data indicator turns on when the offset is changed, until the next sweep/measurement completes.
Couplings	The same offset is used in the Gate Source selection of the period timer.
Preset	0 s
State Saved	Saved in instrument state
Min	-10.000 s
Max	10.000 s

Default Unit	S
Initial S/W Revision	Prior to A.02.00

Reset Offset Display

Resets the value of the periodic trigger offset display setting to 0.0 seconds. The current displayed trigger location may include an offset value defined with the Offset key. Pressing this key redefines the currently displayed trigger location as the new trigger point that is 0.0 s offset. The Offset key can then be used to add offset relative to this new timing.

Key Path	Trigger, Periodic Timer
Remote Command	:TRIGger[:SEquence]:FRAMe:OFFSet:DISPlay:RESet
Example	TRIG:FRAM:OFFS:DISP:RES
Initial S/W Revision	Prior to A.02.00

Sync Source

Selects a signal source for you to synchronize your periodic timer trigger to, otherwise you are triggering at some arbitrary location in the frame. Synchronization reduces the precision requirements on the setting of the period.

For convenience you may adjust the level and slope of the selected sync source in a conditional branch setup menu accessed from the Sync Source menu. Note that these settings match those in the **Trigger** and **Gate Source** menus; that is, each trigger source has only one value of level and slope, regardless of which menu it is accessed from.

Key Path	Trigger, Periodic Timer
Remote Command	:TRIGger[:SEquence]:FRAMe:SYNC EXTernal1 EXTernal2 RFBurst OFF :TRIGger[:SEquence]:FRAMe:SYNC?
Example	TRIG:FRAM:SYNC EXT2
Dependencies	In some models, there is no second External input. In these models, the External 2 key is blanked and the EXTernal2 parameter will generate a "Hardware missing; Not available for this model number" message.
Preset	Off GSM/EDGE, MSR,LTE,LTETDD: RFBurst
State Saved	Saved in instrument state
Readback	The current setting is read back to this key and it is also Readback to the previous Periodic Timer trigger key.
Backwards Compatibility SCPI	:TRIGger[:SEquence]:FRAMe:SYNC EXTernal For backward compatibility, the parameter EXTernal is mapped to EXTernal1
Initial S/W Revision	Prior to A.02.00
Modified at S/W Revision	A.03.00, A.14.00

Off

Turns off the sync source for your periodic trigger. With the sync source off, the timing will drift unless the signal source frequency is locked to the analyzer frequency reference.

Key Path	Trigger, Periodic Timer, Sync Source
Example	TRIG:FRAM:SYNC OFF
Readback	Off
Initial S/W Revision	Prior to A.02.00

External 1

Pressing this key, when it is not selected, selects an external input signal as the trigger. A new sweep/measurement will start when the external trigger condition is met using the external 1 input connector on the rear panel.

Pressing this key, when it is already selected, accesses the external 1 trigger setup menu.

Key Path	Trigger
Example	TRIG:SOUR EXT1 Swept SA measurement TRIG:<meas>:SOUR EXT1 Measurements other than Swept SA
Dependencies	Grayed out if in use by Point Trigger in the Source Setup menu. Forced to Free Run if already selected and Point Trigger is set to External 1.
State Saved	Saved in instrument state
Status Bits/OPC dependencies	The Status Operation Register bit 5 "Waiting for Trigger" is set at the same time as the Sweeping or Measuring bit is set. It is cleared when the trigger actually occurs (that is, after the trigger event occurs and all the applicable trigger criteria have been met). A corresponding pop-up message ("Waiting for trigger") is generated if no trigger signal appears after approximately 2 sec. This message goes away when a trigger signal appears.
Initial S/W Revision	Prior to A.02.00

Trigger Level

Sets the value where the external 1 trigger input will trigger a new sweep/measurement.

Key Path	Trigger, External 1
Remote Command	:TRIGger[:SEquence]:EXTernal1:LEVel <level> :TRIGger[:SEquence]:EXTernal1:LEVel?
Example	TRIG:EXT1:LEV 0.4 V
Couplings	This same level is used for the Ext1 trigger source in the Trigger menu, for the Ext1 selection in the Periodic Timer sync source (in the Trigger menu and in the Gate Source menu), and also for the Ext1

	selection in the Gate Source menu.
Preset	1.2 V
State Saved	Saved in instrument state
Min	-5 V
Max	5 V
Default Unit	V
Backwards Compatibility SCPI	:TRIGger[:SEquence]:EXTernal:LEVel
	For backward compatibility, the parameter EXTernal is mapped to EXTernal1
Backwards Compatibility SCPI	:TRIGger[:SEquence]:FRAMe:EXTernal1:LEVel
Initial S/W Revision	Prior to A.02.00

Trig Slope

Controls the trigger polarity. It is set positive to trigger on a rising edge and negative to trigger on a falling edge.

Key Path	Trigger, External 1
Remote Command	:TRIGger[:SEquence]:EXTernal1:SLOPe POSitive NEGative :TRIGger[:SEquence]:EXTernal1:SLOPe?
Example	TRIG:EXT1:SLOP NEG
Couplings	This same slope is used in the Ext1 selection for the trigger source in the Trigger menu and for the period timer sync source (in the Trigger menu and in the Gate Source menu).
Preset	POSitive
State Saved	Saved in instrument state
Backwards Compatibility SCPI	:TRIGger[:SEquence]:EXTernal:SLOPe
	For backward compatibility, the parameter EXTernal is mapped to EXTernal1
Backwards Compatibility SCPI	:TRIGger[:SEquence]:FRAMe:EXTernal1:SLOPe
Backwards Compatibility Notes	The legacy :TRIGger[:SEquence]:SLOPe command affects the slopes for the VID, LINE, EXT1, EXT2, and RFB triggers.
Initial S/W Revision	Prior to A.02.00

External 2

Pressing this key, when it is not selected, selects an external input signal as the trigger. A new sweep/measurement will start when the external trigger condition is met using the external 2 input connector. The external trigger 2 input connector is on the rear panel.

Pressing this key, when it is already selected, accesses the external 2 trigger setup menu.

Key Path	Trigger
Example	TRIG:SOUR EXT2 Swept SA measurement TRIG:<meas>:SOUR EXT2 Measurements other than Swept SA
Dependencies	In some models, there is no second External input. In these models, the External 2 key is blanked and the EXTERNAL2 parameter will generate a "Hardware missing; Not available for this model number" message. Grayed out if in use by Point Trigger in the Source Setup menu. Forced to Free Run if already selected and Point Trigger is set to External 2.
State Saved	Saved in instrument state
Status Bits/OPC dependencies	The Status Operation Register bit 5 "Waiting for Trigger" is set at the same time as the Sweeping or Measuring bit is set. It is cleared when the trigger actually occurs (that is, after the trigger event occurs and all the applicable trigger criteria have been met). A corresponding pop-up message ("Waiting for trigger") is generated if no trigger signal appears after approximately 2 sec. This message goes away when a trigger signal appears.
Initial S/W Revision	Prior to A.02.00
Modified at S/W Revision	A.03.00

Trigger Level

Sets the value where the external 2 trigger input will trigger a new sweep/measurement.

Key Path	Trigger, External 2
Remote Command	:TRIGger[:SEquence]:EXTernal2:LEVel :TRIGger[:SEquence]:EXTernal2:LEVel?
Example	TRIG:EXT2:LEV 1.1 V
Couplings	This same level is used for the Ext2 trigger source in the Trigger menu, for the Ext2 selection in the Periodic Timer sync source (in the Trigger menu and in the Gate Source menu), and also for the Ext2 selection in the Gate Source menu.
Preset	1.2 V
State Saved	Saved in instrument state
Min	-5 V
Max	5 V
Default Unit	V
Backwards Compatibility SCPI	:TRIGger[:SEquence]:FRAMe:EXTernal2:LEVel
Initial S/W Revision	Prior to A.02.00

Trig Slope

Controls the trigger polarity. It is set positive to trigger on a rising edge and negative to trigger on a falling edge.

Key Path	Trigger, External 2
Remote Command	:TRIGger[:SEquence]:EXTernal2:SLOPe POSitive NEGative :TRIGger[:SEquence]:EXTernal2:SLOPe?
Example	TRIG:EXT2:SLOP NEG
Couplings	This same slope is used in the Ext2 selection for the trigger source in the Trigger menu and for the period timer sync source (in the Trigger menu and in the Gate Source menu).
Preset	POSitive
State Saved	Saved in instrument state
Backwards Compatibility SCPI	:TRIGger[:SEquence]:FRAMe:EXTernal2:SLOPe
Backwards Compatibility Notes	The legacy :TRIGger[:SEquence]:SLOPe command affects the slopes for the VID, LINE, EXT1, EXT2, and RFB triggers.
Initial S/W Revision	Prior to A.02.00

RF Burst

Pressing this key, when it is not selected, selects the RF Burst as the trigger. A new sweep/measurement will start when an RF burst envelope signal is identified from the signal at the RF Input connector. Pressing this key, when it is already selected, accesses the RF Burst trigger setup menu.

In some models, a variety of burst trigger circuitry is available, resulting in various available burst trigger bandwidths. The analyzer automatically chooses the appropriate trigger path based on the hardware configuration and other settings of the analyzer.

Key Path	Trigger
Example	TRIG:SOUR RFB Swept SA measurement TRIG:<meas>:SOUR RFB Measurements other than Swept SA
State Saved	Saved in instrument state
Status Bits/OPC dependencies	The Status Operation Register bit 5 "Waiting for Trigger" is set at the same time as the Sweeping or Measuring bit is set. It is cleared when the trigger actually occurs (that is, after the trigger event occurs and all the applicable trigger criteria have been met). A corresponding pop-up message ("Waiting for trigger") is generated if no trigger signal appears after approximately 2 sec. This message goes away when a trigger signal appears.
Backwards Compatibility Notes	The legacy command: :TRIGger[:SEquence]:RFBurst:FSElectivity[:STATe] OFF ON 0 1 is not supported in the X-Series, as the hardware to do Frequency Selective burst triggers does not exist in X-Series.
Initial S/W Revision	Prior to A.02.00
Modified at S/W Revision	A.04.00

Absolute Trigger Level

Sets the absolute trigger level for the RF burst envelope.

When using the External Mixing path, the Absolute Trigger Level is uncalibrated because the factory default was set to accommodate the expected IF levels for the RF path.

Key Path	Trigger, RF Burst
Scope	Meas Global
Remote Command	:TRIGger[:SEquence]:RFBurst:LEVel:ABSolute <ampl> :TRIGger[:SEquence]:RFBurst:LEVel:ABSolute?
Example	TRIG:RFB:LEV:ABS 10 dBm sets the trigger level of the RF burst envelope signal to the absolute level of 10 dBm
Notes	Sending this command does not switch the setting from relative to absolute; to switch it you need to send the :TRIGger[:SEquence]:RFBurst:LEVel:TYPE command, below. Amplitude Corrections are not taken into account by the Absolute Trigger Level. For example, if you have given yourself effective gain with an amplitude correction factor, the Absolute Trigger will not fire until you have set the trigger level that far below the displayed signal level, rather than simply to the displayed signal level. This is only true for Amplitude Corrections, not External Gain or Ref Level Offset functions. If mode is Bluetooth, the default value is -50 dBm.
Couplings	This same level is used for the RF Burst trigger source in the Trigger menu, for the RF Burst selection in the Periodic Timer sync source (in the Trigger menu and in the Gate Source menu), and also for the RF Burst selection in the Gate Source menu
Preset	-20 dBm
State Saved	Saved in instrument state
Min	-200 dBm
Max	100 dBm
Default Unit	depends on the current selected Y-Axis unit
Backwards Compatibility SCPI	:TRIGger[:SEquence]:FRAME:RFBurst:LEVel:ABSolute
Initial S/W Revision	Prior to A.02.00
Modified at S/W Revision	A.04.00

Key Path	Trigger, RF Burst
Remote Command	:TRIGger[:SEquence]:RFBurst:LEVel:TYPE ABSolute RELative :TRIGger[:SEquence]:RFBurst:LEVel:TYPE?
Example	TRIG:RFB:LEV:TYPE REL sets the trigger level type of the RF burst trigger to Relative.
Preset	ABSolute

State Saved	Saved in instrument state
Initial S/W Revision	Prior to A.02.00
Modified at S/W Revision	A.04.00

Trigger Slope

It is set positive to trigger on a rising edge and negative to trigger on a falling edge.

Key Path	Trigger, RF Burst
Remote Command	:TRIGger[:SEquence]:RFBurst:SLOPe POSitive NEGative :TRIGger[:SEquence]:RFBurst:SLOPe?
Example	TRIG:RFB:SLOP NEG
Couplings	This same slope is used in the RF Burst selection for the trigger source in the Trigger menu and for the period timer sync source (in the Trigger menu and in the Gate Source menu).
Preset	POSitive
State Saved	Saved in instrument state
Backwards Compatibility SCPI	:TRIGger[:SEquence]:FRAME:RFBurst:SLOPe
Backwards Compatibility Notes	The legacy :TRIGger[:SEquence]:SLOPe command affects the slopes for the VID, LINE, EXT1, EXT2, and RFB triggers.
Initial S/W Revision	Prior to A.02.00

Trig Delay

This setting delays the measurement timing relative to the Periodic Timer.

Key Path	Trigger, Periodic Timer
Remote Command	:TRIGger[:SEquence]:FRAME:DELAy <time> :TRIGger[:SEquence]:FRAME:DELAy? :TRIGger[:SEquence]:FRAME:DELAy:STATE OFF ON 0 1 :TRIGger[:SEquence]:FRAME:DELAy:STATE?
Notes	Note that delay is used when the sync source is not set to OFF. If the sync source is set to OFF, offset is used.
Preset	Off, 1.000 us
State Saved	Saved in instrument state
Min	-150 ms
Max	+500 ms
Default Unit	s
Initial S/W Revision	Prior to A.02.00

Auto/Holdoff

Opens up a menu that lets you adjust Auto Trigger and Trigger Holdoff parameters

Key Path	Trigger
Readback line	<p>Displays a summary of the Auto Trig and Holdoff settings, in square brackets</p> <p>First line: Auto Off or Auto On</p> <p>Second Line: "Hldf" followed by:</p> <ul style="list-style-type: none"> • If Holdoff is Off, readback Off • If Holdoff On and Type = Normal, readback value • If Holdoff On and Type = Above, readback value followed by AL • If Holdoff On and Type = Below, readback value followed by BL • If Holdoff Type selection is not supported by the current measurement, Holdoff Type is always Normal
Initial S/W Revision	A.02.00

Auto Trig

Sets the time that the analyzer will wait for the trigger conditions to be met. If they are not met after that much time, then the analyzer is triggered anyway.

Key Path	Trigger, Auto/Holdoff
Remote Command	<pre>:TRIGger[:SEquence]:ATRigger <time> :TRIGger[:SEquence]:ATRigger? :TRIGger[:SEquence]:ATRigger:STATe OFF ON 0 1 :TRIGger[:SEquence]:ATRigger:STATe?</pre>
Example	<pre>TRIG:ATR:STAT ON TRIG:ATR 100 ms</pre>
Notes	The "time that the analyzer will wait" starts when the analyzer is ready for a trigger, which may be hundreds of ms after the data acquisition for a sweep is done. The "time" ends when the trigger condition is satisfied, not when the delay ends.
Preset	Off, 100 ms
State Saved	Saved in instrument state
Min	1 ms
Max	100 s
Default Unit	s
Initial S/W Revision	Prior to A.02.00

Trig Holdoff

Sets the holdoff time between triggers. When the trigger condition is satisfied, the trigger occurs, the delay begins, and the holdoff time begins. New trigger conditions will be ignored until the holdoff time expires. For a free-running trigger, the holdoff value is the minimum time between triggers.

Key Path	Trigger, Auto/Holdoff
Remote Command	:TRIGger[:SEquence]:HOLDoff <time> :TRIGger[:SEquence]:HOLDoff? :TRIGger[:SEquence]:HOLDoff:STATe OFF ON 0 1 :TRIGger[:SEquence]:HOLDoff:STATe?
Example	TRIG:HOLD:STAT ON TRIG:HOLD 100 ms
Dependencies	Unavailable if the selected Input is BBIQ. If this is the case, the key is grayed out if it is pressed the informational message "Feature not supported for this Input" is displayed. If the SCPI command is sent, the error "Settings conflict; Feature not supported for this Input" is generated.
Preset	Off, 100 ms
State Saved	Saved in instrument state
Min	0 s
Max	0.5 s
Default Unit	s
Initial S/W Revision	Prior to A.02.00

8 Channel Power Measurement

The Channel Power measurement is used to find the total power present in a specified bandwidth. The power spectral density (the power in the signal normalized to 1 Hz) is also reported (In WLAN mode or WLAN radio standard in SA mode, the peak power spectral density for 1 MHz is reported). For measurement results and views, see ["View/Display" on page 615](#).

This topic contains the following sections:

["Measurement Commands for Channel Power" on page 448](#)

["Remote CommandResults for Channel Power Measurement" on page 449](#)

Measurement Commands for Channel Power

These commands are used to measure the total rms power in a specified integration bandwidth.

Use `:INSTrument:SElect` to set the mode.

```
:CONFigure:CHPower
:CONFigure:CHPower:NDEFault
:INITiate:CHPower
:FETCh:CHPower[n]?
:MEASure:CHPower[n]?
:READ:CHPower[n]?
:FETCh:CHPower:CHPower?
:MEASure:CHPower:CHPower?
:READ:CHPower:CHPower?
:FETCh:CHPower:DENSity?
:MEASure:CHPower:DENSity?
:READ:CHPower:DENSity
```

For more measurement related commands, see the SENSE subsystem, and the section "[Remote Measurement Functions](#)" on page 2205.

Remote Command Results for Channel Power Measurement

For DVB-T/H and DTMB (CTTB) mode, see ["DVB-T/H and DTMB \(CTTB\) Mode Remote Command Results" on page 450](#).

For ISDB-T and CMMB mode, see ["ISDB-T and CMMB mode Remote Command Results" on page 452](#).

For MSR, see ["Remote Command Results for WLAN Channel Power Measurement" on page 455](#)

For LTE-Advanced FDD/TDD, see ["LTE-Advanced FDD/TDD Mode Remote Command Results " on page 454](#)

For WLAN, see ["MSR Mode Remote Command Results" on page 453](#)

Command	Return Value
FETCh:CHPower[n]?	Refer to the table below.
MEASure:CHPower[n]?	
READ:CHPower[n]?	
FETCh:CHPower:CHPower?	Returns the Channel Power (dBm) (BW compatibility functionality)
MEASure:CHPower:CHPower?	
READ:CHPower:CHPower?	
FETCh:CHPower:DENSity?	Returns the Power Spectral Density (dBm/Hz) (BW compatibility functionality)
MEASure:CHPower:DENSity?	
READ:CHPower:DENSity?	

n	Results Returned
n=1 (or not specified)	Returns scalar results: <ol style="list-style-type: none"> 1. Channel Power is a floating point number representing the total channel power in the specified integration bandwidth. 2. PSD (Power Spectral Density) is the power in the specified unit bandwidth. The unit bandwidth is selected by the PSD Unit parameter in either dBm/Hz or dBm/MHz.
2	Returns floating point numbers that are the captured trace data of the power (in dBm/resolution BW) of the signal. The frequency span of the captured trace data is specified by the Span key.

DVB-T/H and DTMB (CTTB) Mode Remote Command Results

The following commands are available only for DVB-T/H and DTMB (CTTB) mode.

Condition	n	Results Returned
	n=1 (or not specified)	Returns scalar results: 1. Channel Power is a floating point number representing the total channel power in the specified integration bandwidth. 2. PSD (Power Spectral Density) is the power in the specified unit bandwidth. The unit bandwidth is selected by the PSD Unit parameter in either dBm/Hz or dBm/MHz.
	2	Returns floating point numbers that are the captured trace data of the power (in dBm/resolution BW) of the signal. The frequency span of the captured trace data is specified by the Span key.
Mode = DVB-T/H or Mode = DTMB (CTTB)	3	Returns 7 comma-separated scalar results, in the following order. 1. The shoulder attenuation result (dB) 2. Lower shoulder attenuation result (dB) 3. Upper shoulder attenuation result (dB) 4. Lower Offset - MAX shoulder point power (dBm) 5. Lower Offset - MAX shoulder point frequency (MHz) 6. Upper Offset - MAX shoulder point power (dBm) 7. Upper Offset - MAX shoulder point frequency (MHz) If the results are not available, -999.0 is returned. For example, if current view is RF spectrum or spectrum mask, -999.0 is returned.
Mode = DVB-T/H or Mode = DTMB (CTTB)	4	Returns floating point numbers that are the captured trace data of the power (in dBm/resolution BW) of the signal in the left graph of the shoulder attenuation view. If the results are not available, -999.0 is returned. For example, if current view is RF spectrum or spectrum mask, -999.0 is returned.
Mode = DVB-T/H or Mode = DTMB (CTTB)	5	Returns floating point numbers that are the captured trace data of the power (in dBm/resolution BW) of the signal in the right graph of the shoulder attenuation view. If the results are not available, -999.0 is returned. For example, if current view is RF spectrum or spectrum mask, -999.0 is returned.
Mode = DVB-T/H or Mode = DTMB (CTTB)	6	Returns floating point numbers that are the captured trace data of the power (in dBm/resolution BW) of the mask in the spectrum mask view. If the results are not available, -999.0 is returned. For example, if current view is RF spectrum or shoulder attenuation, -999.0 is returned.
Mode = DVB-T/H or Mode = DTMB (CTTB)	7	Returns the failed point information in the following order: 1. the 1st failed point frequency (MHz) 2. the 1st failed point absolute power (dBm) 3. the 1st failed point relative power (dB) 4. the 2nd failed point frequency (MHz) 5. the 2nd failed point absolute power (dBm)

6. the 2nd failed point relative power (dB)

...

$3*N-2$. the ($3*N-2$)th failed point frequency (MHz)

$3*N-1$. the ($3*N-1$)th failed point absolute power (dBm)

$3*N$. the ($3*N$)th failed point relative power (dB)

If the number of failed points is less than 20, it will show all of them (frequency, power and relative power), $N < 20$;

If the number of failed points is great than 20, the first ten failed points and the last ten failed points will be show, $N = 20$.

If the results are not available, -999.0 is returned.

For example, if current view is RF spectrum or shoulder attenuation, -999.0 is returned.

ISDB-T and CMMB mode Remote Command Results

The following commands are available only for ISDB-T and CMMB mode.

Condition	n	Results Returned
	n=1 (or not specified)	Returns scalar results: 1. Channel Power is a floating point number representing the total channel power in the specified integration bandwidth. 2. PSD (Power Spectral Density) is the power in the specified unit bandwidth. The unit bandwidth is selected by the PSD Unit parameter in either dBm/Hz or dBm/MHz.
	2	Returns floating point numbers that are the captured trace data of the power (in dBm/resolution BW) of the signal. The frequency span of the captured trace data is specified by the Span key.
Mode = ISDB-T or Mode = CMMB	3	Returns 7 comma-separated scalar results, in the following order. 1. The shoulder attenuation result (dB) 2. Lower shoulder attenuation result (dB) 3. Upper shoulder attenuation result (dB) 4. Lower Offset - MAX shoulder point power (dBm) 5. Lower Offset - MAX shoulder point frequency (MHz) 6. Upper Offset - MAX shoulder point power (dBm) 7. Upper Offset - MAX shoulder point frequency (MHz) If the results are not available, -999.0 is returned. For example, if current view is RF spectrum or spectrum mask, -999.0 is returned.
Mode = ISDB-T or Mode = CMMB	4	Returns floating point numbers that are the captured trace data of the power (in dBm/resolution BW) of the signal in the left window of the shoulder attenuation view. If the results are not available, -999.0 is returned. For example, if current view is RF spectrum or spectrum mask, -999.0 is returned.
Mode = ISDB-T or Mode = CMMB	5	Returns floating point numbers that are the captured trace data of the power (in dBm/resolution BW) of the signal in the right window of the shoulder attenuation view. If the results are not available, -999.0 is returned. For example, if current view is RF spectrum or spectrum mask, -999.0 is returned.

MSR Mode Remote Command Results

The following commands are available only for MSR mode.

Condition	n	Results Returned
	n=1 (or not specified)	Returns scalar results: 1. Channel Power is a floating point number representing the total channel power in the specified integration bandwidth. 2. PSD (Power Spectral Density) is the power in the specified unit bandwidth. The unit bandwidth is selected by the PSD Unit parameter in either dBm/Hz or dBm/MHz.
	2	Returns floating point numbers that are the captured trace data of the power (in dBm/resolution BW) of the signal. The frequency span of the captured trace data is specified by the Span key.
Mode = MSR	3	Returns [Carriers] comma-separated scalar results, in the following order. 1. Total Power of Carrier 1 (dBm) 2. Total Power of Carrier 2 (dBm) ... [Carriers]. Total Power of Carrier [Carriers] (dBm) If the result is not available, NaN (9.91E+37) is returned. Number of returned values might be changed in future releases.
Mode = MSR	4	Returns comma-separated scalar results, in the following order. 1. Total Power of LTE FDD carriers (dBm) 2. Total Power of W-CDMA carriers (dBm) 3. Total Power of GSM/EDGE carriers (dBm) 4. Total Power of cdma2000 carriers (dBm) 5. Total Power of 1xEV-DO carriers (dBm) ... The number of results is incremented by one when a new format is supported. If the result is not available, NaN (9.91E+37) is returned. Number of returned values will be changed in future releases if the number of supported radio format is increased.

LTE-Advanced FDD/TDD Mode Remote Command Results

The following commands are available only for LTE-Advanced FDD/TDD mode.

Condition	n	Results Returned
	n=1 (or not specified)	Returns scalar results: 1. Channel Power is a floating point number representing the total channel power in the specified integration bandwidth. 2. PSD (Power Spectral Density) is the power in the specified unit bandwidth. The unit bandwidth is selected by the PSD Unit parameter in either dBm/Hz or dBm/MHz.
	2	Returns floating point numbers that are the captured trace data of the power (in dBm/resolution BW) of the signal. The frequency span of the captured trace data is specified by the Span key.
Mode = LTEATDD/ LTEAFDD	3	Returns comma-separated scalar results, in the following order. 1. Total Power of Component Carrier 0 (dBm) 2. Total Power of Component Carrier 1 (dBm) 3. Total Power of Component Carrier 2 (dBm) 4. Total Power of Component Carrier 3 (dBm) 5. Total Power of Component Carrier 4 (dBm) If the result is not available, NaN (9.91E+37) is returned.
Mode = LTEATDD/ LTEAFDD	4	Returns comma-separated scalar results, in the following order. The unit bandwidth is selected by the PSD Unit parameter in either dBm/Hz or dBm/MHz. 1. Total Power Spectral Density of Component Carrier 0 (PSD Unit) 2. Total Power Spectral Density of Component Carrier 1 (PSD Unit) 3. Total Power Spectral Density of Component Carrier 2 (PSD Unit) 4. Total Power Spectral Density of Component Carrier 3 (PSD Unit) 5. Total Power Spectral Density of Component Carrier 4 (PSD Unit) If the result is not available, NaN (9.91E+37) is returned.

Remote Command Results for WLAN Channel Power Measurement

n	Results Returned
n=1 (or not specified)	<p>Returns scalar results:</p> <p>When the radio standard is NOT WLAN 802.11ac 80 + 80 MHz:</p> <ol style="list-style-type: none"> 1. Channel Power is a floating point number representing the total channel power in the specified integration bandwidth. 2. PSD (Power Spectral Density) is the power in the specified unit bandwidth. The unit bandwidth is selected by the PSD Unit parameter in either dBm/Hz or dBm/MHz. <p>When the radio standard is WLAN 802.11ac 80 + 80 MHz:</p> <ol style="list-style-type: none"> 1. Channel Power of the carrier of which the center frequency is indicated by Freq Segment 1 is a floating point number representing the total channel power of the first segment in the specified integration bandwidth. 2. PSD (Power Spectral Density) of the carrier of which the center frequency is indicated by Freq Segment 1 is the power in the specified unit bandwidth of the first segment. The unit bandwidth is selected by the PSD Unit parameter in either dBm/Hz or dBm/MHz. 3. Channel Power of the carrier of which the center frequency is indicated by Freq Segment 2 is a floating point number representing the total channel power of the second segment in the specified integration bandwidth. 4. PSD (Power Spectral Density) of the carrier of which the center frequency is indicated by Freq Segment 2 is the power in the specified unit bandwidth of the second segment. The unit bandwidth is selected by the PSD Unit parameter in either dBm/Hz or dBm/MHz.
2	Returns floating point numbers that are the captured trace data of the power (in dBm/resolution BW) of the signal. The frequency span of the captured trace data is specified by the Span key.
Key Path	Meas
Mode	SA, WCDMA, C2K, WIMAX OFDMA, 1xEVDO, DVB-T/H, DTMB (CTTB), ISDB-T, CMMB, LTE, LTETDD, Digital Cable TV, WLAN, MSR, LTEAFDD, LTEATDD
Initial S/W Revision	Prior to A.02.00
Modified at S/W Revision	A.03.00

AMPTD Y Scale

Accesses a menu of functions that enable you to set the vertical scale parameters. The parameter values are measurement independent, except all Attenuation values and the Internal Preamp selection, which are the same across all measurements.

Key Path	Front-panel key
Initial S/W Revision	Prior to A.02.00

Ref Value

Sets the value for the absolute power reference. However, since the Auto Scaling is defaulted to On, this value is automatically determined by the measurement result. When you set a value manually, Auto Scaling automatically changes to Off.

Key Path	AMPTD Y Scale
Mode	SA, WCDMA, C2K, WIMAX OFDMA, 1xEVDO, DVB-T/H, DTMB (CTTB), ISDB-T, CMMB, LTE, LTETDD, Digital Cable TV, WLAN, MSR, LTEAFDD, LTEATDD
Remote Command	:DISPlay:CHPower:VIEW[1]:WINDow[1]:TRACe:Y[:SCALe]:RLEVel <real> :DISPlay:CHPower:VIEW[1]:WINDow[1]:TRACe:Y[:SCALe]:RLEVel?
Example	DISP:CHP:VIEW:WIND:TRAC:Y:RLEV 10 dBm DISP:CHP:VIEW:WIND:TRAC:Y:RLEV?
Notes	You must be in the Spectrum Analysis mode, W-CDMA mode, cdma2000 mode, DVB-T/H mode, DTMB (CTTB) mode, ISDB-T mode, CMMB mode, Digital Cable TV mode, LTD mode, LTE TDD mode, WLAN mode, 1xEVDO mode, MSR, LTE-Advanced FDD/TDD mode or WIMAX OFDMA mode to use this command. Use :INSTrument:SElect to set the mode.
Couplings	When the Auto Scaling is On, this value is automatically determined by the measurement result. When you set a value manually, Auto Scaling automatically changes to Off.
Preset	10.00 dBm
State Saved	Saved in instrument state.
Min	-250.00 dBm
Max	250.00 dBm
Initial S/W Revision	Prior to A.02.00
Modified at S/W Revision	A.02.00, A.03.00

Attenuation

This menu controls the attenuator functions and interactions between the attenuation system components.

There are two attenuator configurations in the X-Series. One is a dual attenuator configuration consisting of a mechanical attenuator and an optional electronic attenuator. The other configuration uses a single

attenuator with combined mechanical and electronic sections that controls all the attenuation functions. Different models in the X-Series come with different configurations.

See "Dual Attenuator Configurations:" on page 457

See "Single Attenuator Configuration:" on page 458

Most Attenuation settings are the same for all measurements – they do not change as you change measurements. Settings like these are called “Meas Global” and are unaffected by Meas Preset.

Key Path	AMPTD Y Scale
Scope	Meas Global
Dependencies	In measurements that support the I/Q inputs, this key is unavailable when I/Q is the selected input, and is replaced by the Range key in that case.
Readback Line	Contains a summary in [] brackets of the current total attenuation. See the descriptions of the , " (Mech) Atten " on page 2141 , and "Enable Elec Atten" on page 2143 keys for more detail on the contributors to the total attenuation. Note that when "Pre-Adjust for Min Clip" is on, this value can change at the start of every measurement.
Initial S/W Revision	Prior to A.02.00
Modified at S/W Revision	A.03.00

Dual Attenuator Configurations:

Configuration 1: Mechanical attenuator + optional electronic attenuator

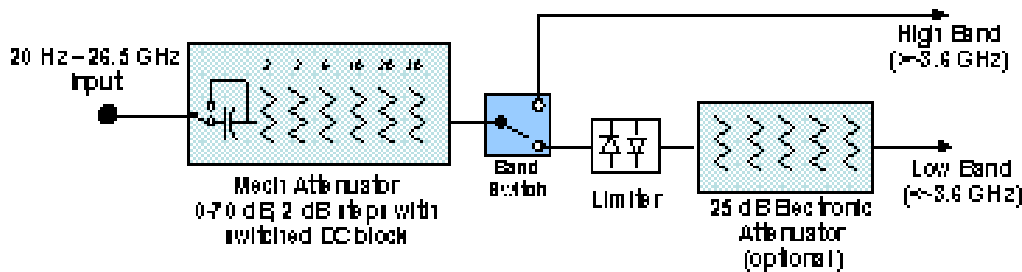

Configuration 2: Mechanical attenuator, no optional electronic attenuator

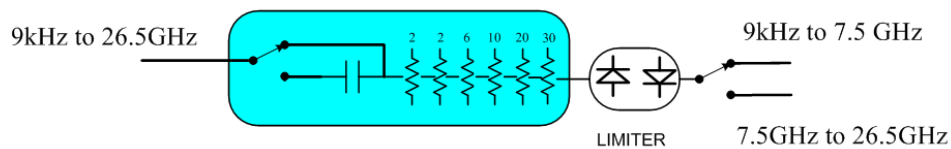

(note that Configuration 2 is not strictly speaking a dual-section attenuator, since there is no electronic section available. However, it behaves exactly like Configuration 1 without the Electronic Attenuator option EA3, therefore for the sake of this document it is grouped into the “Dual Attenuator” configuration)

Single Attenuator Configuration:

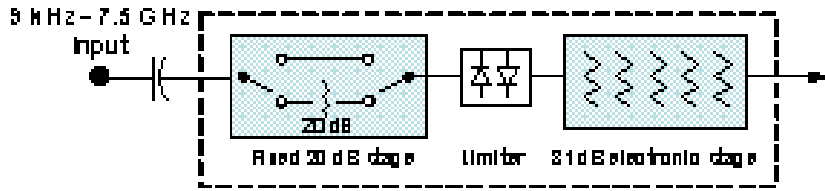

You can tell which attenuator configuration you have by pressing the Attenuation key, which (in most Modes) opens the Attenuation menu. If the first key in the Attenuation menu says Mech Atten you have the dual attenuator configuration. If the first key says Atten you have the single attenuator configuration.

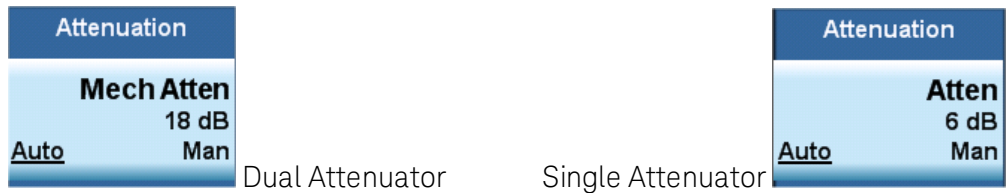

In the single attenuator configuration, you control the attenuation with a single control, as the fixed stage has only two states. In the dual attenuator configuration, both stages have significant range so you are given separate control of the mechanical and electronic attenuator stages.

When you have the dual attenuator configuration, you may still have only a single attenuator, because unless option EA3 (the Electronic Attenuator option) is available, and you purchase it, you will have only the mechanical attenuator.

(Mech) Atten

This key is labeled Mech Atten in dual attenuator models and Atten in single attenuator models. In the dual attenuator configuration, this key only affects the mechanical attenuator.

This key lets you modify the attenuation applied to the RF input signal path. This value is normally auto coupled to the Ref Level, the Internal Preamp Gain, any External Gain that is entered, and the Max Mixer Level, as described in the table below.

See "[Attenuator Configurations and Auto/Man](#)" on page 460

Key Path	AMPTD Y Scale, Attenuation
Remote Command	<pre>[:SENSE] : POWer [:RF] : ATTenuation <rel_ampl> [:SENSE] : POWer [:RF] : ATTenuation? [:SENSE] : POWer [:RF] : ATTenuation : AUTO OFF ON 0 1 [:SENSE] : POWer [:RF] : ATTenuation : AUTO?</pre>
Example	<p>POW:ATT 20</p> <p>Dual attenuator configuration: sets the mechanical attenuator to 20 dB</p> <p>Single attenuator mode: sets the main attenuation to 20 dB (see below for definition of “main” attenuation).</p> <p>If the attenuator was in Auto, it sets it to Manual.</p>
Dependencies	Some measurements do not support the Auto setting of (Mech) Atten. In these measurements, the

Auto/Man selection is not available, and the Auto/Man line on the key disappears.

In dual attenuator configurations, when the electronic attenuator is enabled, the mechanical attenuator has no auto setting and the Auto/Man line on the key disappears. The state of Auto/Man is remembered and restored when the electronic attenuator is once again disabled. This is described in more detail in the ["Enable Elec Atten" on page 2143](#) key description.

See ["Attenuator Configurations and Auto/Man" on page 460](#) for more information on the Auto/Man functionality of Attenuation.

Couplings

When (Mech) Atten is in Auto, it uses the following algorithm to determine a value:

If the USB Preamp is connected to USB, use 0 dB.

Otherwise, $Atten = ReferenceLevel + PreAmpGain + ExternalGain - RefLevelOffset - MaxMixerLevel + IF\ Gain$.

Limit this value to be between 6 dB and the Max value. No value below 6 dB can ever be chosen by Auto.

The resulting value is rounded up to the largest value possible given the attenuation step setting. That is, 50.01 dB would change to 60 dB (for a 10 dB attenuation step).

The "IF Gain" term in the equation above is either 0 dB or +10 dB, depending on the settings of FFT IF Gain, Swept IF Gain, max Ref Level and the Auto/Man setting of Mech Atten.

In External Mixing and BBIQ, where the Attenuator is not in the signal path, the Attenuator setting changes as described above when (Mech) Atten is in Auto, but no changes are made to the actual attenuator hardware setting until the input is changed back to the RF Input.

Preset The preset for Mech Attenuation is "Auto."
 The Auto value of attenuation is:
 CXA, EXA, MXA and PXA: 10 dB

State Saved Saved in instrument state

Min 0 dB

The attenuation set by this key cannot be decreased below 6 dB with the knob or step keys. To get to a value below 6 dB it has to be directly entered from the keypad or via SCPI. This protects from adjusting the attenuation to a dangerously small value which can put the instrument at risk of damage to input circuitry. However, if the current mechanical attenuation is below 6 dB it can be increased with the knob and step keys, but not decreased.

Max CXA N9000A-503/507: 50 dB
 CXA N9000A-513/526: 70dB
 EXA: 60 dB
 MXA and PXA: 70 dB

In the single attenuator configuration, the total of ATT and EATT cannot exceed 50 dB, so if the EATT is set to 24 dB first, the main attenuation cannot be greater than 26 dB and will be reduced accordingly; if the main attenuator is set to 40 dB first, EATT cannot be greater than 10 dB.

Initial S/W Revision Prior to A.02.00

Modified at S/W Revision A.03.00

Attenuator Configurations and Auto/Man

As described in the Attenuation key description, there are two distinct attenuator configurations available in the X-Series, the single attenuator and dual attenuator configurations. In dual attenuator configurations, we have the mechanical attenuation and the electronic attenuation, and the current total attenuation is the sum of the electronic + mechanical attenuation. In single attenuator configurations, we refer to the attenuation set using the (Mech) Atten key (or POW:ATT SCPI) as the “main” attenuation; and the attenuation that is set by the SCPI command POW:EATT as the “soft” attenuation (the POW:EATT command is honored even in the single attenuator configuration, for compatibility purposes). Then the current total attenuation is the sum of the main + soft attenuation. See the Elec Atten key description for more on “soft” attenuation.

In the dual attenuator configuration, when the electronic attenuator is enabled, there is no Auto/Man functionality for the mechanical attenuator, and the third line of the key label (the Auto/Man line) disappears:

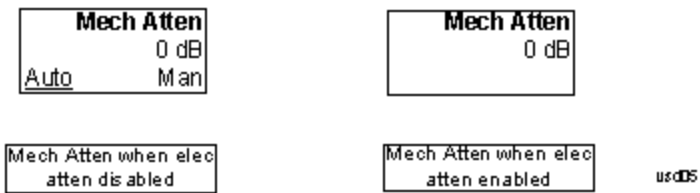

Enable Elec Atten

Enables the Electronic Attenuator.

The electronic attenuator offers finer steps than the mechanical attenuator, has no acoustical noise, is faster, and is less subject to wear. These advantages primarily aid in remote operation and are negligible for front panel use. See ["Using the Electronic Attenuator: Pros and Cons" on page 462](#) for a detailed discussion of the pros and cons of using the electronic attenuator.

For the single attenuator configuration, for SCPI backwards compatibility, the “soft” attenuation feature replaces the dual attenuator configuration’s electronic attenuator. All the same couplings and limitations apply. See ["Attenuator Configurations and Auto/Man" on page 2143](#)

See ["More Information" on page 461](#)

Key Path	AMPTD Y Scale, Attenuation
Remote Command	[:SENSe] :POWer [:RF] :EATTenuation :STATe OFF ON 0 1 [:SENSe] :POWer [:RF] :EATTenuation :STATe ?
Example	POW:EATT:STAT ON
Dependencies	This key only appears in Dual Attenuator models with an Electronic Attenuator installed. It does not appear in models with the Single Attenuator configuration, as in the single attenuator configuration there is no “electronic attenuator” there is only a single integrated attenuator (which has both a mechanical and electronic stage). However, in the single attenuator configuration, EATT SCPI commands are accepted for compatibility with other X-series instruments and set a “soft” attenuation as described in "Attenuator Configurations and Auto/Man" on page 2143 . The electronic attenuator (and the “soft” attenuation function provided in single attenuator configurations) is unavailable above 3.6 GHz. Therefore, if the Stop Frequency of the analyzer is > 3.6 GHz then the Enable Elec Atten key will be OFF and grayed out.

If the Internal Preamp is on, meaning it is set to Low Band or Full, the electronic attenuator (and the “soft” attenuation function provided in single attenuator configurations) is unavailable. In this case the Enable Elec Atten key will be OFF and grayed out.

If either of the above is true, if the SCPI command is sent, an error indicating that the electronic attenuator is unavailable will be sent.

If the electronic/soft Attenuator is enabled, then the Stop Freq of the analyzer is limited to 3.6 GHz and the Internal Preamp is unavailable.

The SCPI-only “soft” electronic attenuation for the single-attenuator configuration is not available in all measurements; in particular, it is not available in the Swept SA measurement.

Couplings	Enabling and disabling the Electronic Attenuator affects the setting of the Mechanical Attenuator (in dual attenuator configurations). This is described in more detail below this table.
Preset	OFF for Swept SA measurement; ON for all other measurements that support the electronic attenuator
State Saved	Saved in instrument state
Initial S/W Revision	Prior to A.02.00
Modified at S/W Revision	A.03.00

More Information

Mechanical Attenuator Transition Rules

When the Electronic Attenuator is enabled, the Mechanical Attenuator transitions to a state that has no Auto function. Below are the rules for transitioning the Mechanical Attenuator. NOTE that the information below ONLY applies to the dual attenuator configurations, and ONLY when the Electronic Attenuator is installed:

When the Electronic Attenuation is enabled from a disabled state:

- The Mechanical Attenuator is initialized to 10 dB (this is its optimal performance setting). You can then set it as desired with SCPI, numeric keypad, step keys, or knob, and it behaves as it normally would in manual mode
- The Auto/Man state of (Mech) Atten is saved
- The Auto/Man line on the (Mech) Atten key disappears and the auto rules are disabled
- The Electronic Attenuator is set to 10 dB less than the previous value of the Mechanical Attenuator, within the limitation that it must stay within the range of 0 to 24 dB of attenuation.

Examples in the dual attenuator configuration:

- Mech Atten at 20 dB. Elec Atten enabled, Mech Atten set to 10 dB, and Elec Atten set to 10 dB. New total attenuation equals the value before Elec Atten enabled.
- Mech Atten at 0 dB. Elec Atten enabled, Mech Atten set to 10 dB, and Elec Atten set to 0 dB. New total attenuation does not equal the value before Elec Atten enabled.
- Mech Atten at 40 dB. Elec Atten enabled, Mech Atten set to 10 dB, and Elec Atten set to 24 dB. New total attenuation does not equal the value before Elec Atten enabled.

When the Electronic Attenuation is disabled from an enabled state:

- The Elec Atten key is grayed out
- The Auto/Man state of (Mech) Atten is restored
- If now in Auto, (Mech) Atten recouples
- If now in Man, (Mech) Atten is set to the value of total attenuation that existed before the Elec Atten was disabled. The resulting value is rounded up to the smallest value possible given the (Mech) Atten Step setting - (That is, 57 dB changes to 58 dB when (Mech) Atten Step is 2 dB.)

Using the Electronic Attenuator: Pros and Cons

The electronic attenuator offers finer steps than the mechanical attenuator, has no acoustical noise, is faster, and is less subject to wear.

The “finer steps” advantage of the electronic attenuator is beneficial in optimizing the alignment of the analyzer dynamic range to the signal power in the front panel as well as remote use. Thus, you can achieve improved relative signal measurement accuracy. Compared to a mechanical attenuator with 2 dB steps, the 1 dB resolution of the electronic attenuator only gives better resolution when the odd-decibel steps are used. Those odd-decibel steps are less accurately calibrated than the even-decibel steps, so one tradeoff for this superior relative accuracy is reduced absolute amplitude accuracy.

Another disadvantage of the electronic attenuator is that the spectrum analyzer loses its “Auto” setting, making operation less convenient.

Also, the relationship between the dynamic range specifications (TOI, SHI, compression and noise) and instrument performance are less well-known with the electrical attenuator. With the mechanical attenuator, TOI, SHI and compression threshold levels increase dB-for-dB with increasing attenuation, and the noise floor does as well. With the electronic attenuator, there is an excess attenuation of about 1 to 3 dB between 0 and 3.6 GHz, making the effective TOI, SHI, and so forth, less well known. Excess attenuation is the actual attenuation relative to stated attenuation. Excess attenuation is accounted for in the analyzer calibration

Elec Atten

Controls the Electronic Attenuator in dual attenuator configurations. This key does not appear in single attenuator configurations, as the control of both the mechanical and electronic stages of the single attenuator is integrated into the single Atten key.

Key Path	AMPTD Y Scale, Attenuation
Remote Command	<code>[:SENSe] :POWer [:RF] :EATTenuation <rel_amp1></code> <code>[:SENSe] :POWer [:RF] :EATTenuation?</code>
Notes	Electronic Attenuation's specification is defined only when Mechanical Attenuation is 6 dB.
Dependencies	This key only appears in Dual Attenuator models with an Electronic Attenuator installed. It does not appear in models with the Single Attenuator configuration, as in the single attenuator configuration there is no “electronic attenuator” there is only a single integrated attenuator (which has both a mechanical and electronic stage). However, in the single attenuator configuration, EATT SCPI commands are accepted for compatibility with other X-series instruments and set a “soft” attenuation as described in "Attenuator Configurations and Auto/Man" on page 2143 . The “soft” attenuation is treated as an addition to the “main” attenuation value set by the Atten softkey or the

	POW:ATT SCPI command and affects the total attenuation displayed on the Attenuation key and the Meas Bar. When Enable Elec Atten is off or grayed out, the Elec Atten key is grayed out.
Preset	0 dB
State Saved	Saved in instrument state
Min	0 dB
Max	Dual attenuator configuration: 24 dB Single attenuator configuration: the total of ATT and EATT cannot exceed 50 dB, so if the EATT is set to 24 dB first, the main attenuation cannot be greater than 26 dB and will be reduced accordingly; if the main attenuator is set to 40 dB first, EATT cannot be greater than 10 dB
Initial S/W Revision	Prior to A.02.00
Modified at S/W Revision	A.03.00

Adjust Atten for Min Clip

Sets the combination of mechanical and electronic attenuation and gain based on the current measured signal level so that clipping will be at a minimum.

This is an "immediate action" function, that is, it executes once, when the key is pressed.

This key is grayed out in measurements that do not support this functionality. The spectrum analyzer measurement, Swept SA, does not support this functionality.

Key Path	AMPTD Y Scale, Attenuation
Remote Command	<code>[:SENSe] :POWer [:RF] :RANGe:OPTimize IMMEDIATE</code>
Initial S/W Revision	Prior to A.02.00
Modified at S/W Revision	A.03.00

Pre-Adjust for Min Clip

If this function is on, it does the adjustment described under ["Adjust Atten for Min Clip" on page 2146](#) each time a measurement restarts. Therefore, in Continuous measurement mode, it only executes before the first measurement.

In dual attenuator models, you can set Elec+Mech Atten, in which case both attenuators participate in the autoranging, or Elec Atten Only, in which case the mechanical attenuator does not participate in the autoranging. This latter case results in less wear on the mechanical attenuator and is usually faster.

This key is grayed out in measurements that do not support this functionality. The spectrum analyzer measurement, Swept SA, does not support this functionality.

Key Path	AMPTD Y Scale, Attenuation
Remote Command	<code>[:SENSe] :POWer [:RF] :RANGe:OPTimize:ATTenuation OFF ELECTRical COMBined</code>

	<code>[:SENSe] :POWer [:RF] :RANGe:OPTimize:ATTenuation?</code>
Notes	The SCPI parameter ELECtrical sets this function to On in single attenuator models. The SCPI parameter COMBined is mapped to ELECtrical in single attenuator models; if you send COMBined, it sets the function to On and returns ELEC to a query.
Dependencies	This key only appears in Dual Attenuator models with an Electronic Attenuator installed. In instruments with Dual Attenuator model, when Enable Elec Atten is off or grayed out, the Pre-Adjust for Min Clip key is grayed out.
Preset	OFF for Swept SA measurement; ON for all other measurements that support Pre-Adjust for Min Clip
State Saved	Saved in instrument state
Range	Dual attenuator models: Off Elec Atten Only Mech + Elec Atten Single attenuator models: Off On
Initial S/W Revision	Prior to A.02.00
Modified at S/W Revision	A.03.00

Remote Command	<code>[:SENSe] :POWer [:RF] :RANGe:AUTO ON OFF 1 0</code> <code>[:SENSe] :POWer [:RF] :RANGe:AUTO?</code>
Notes	ON aliases to "Elec Atten Only" (:POW:RANG:OPT:ATT ELEC) OFF aliases to "Off" (:POW:RANG:OPT:ATT OFF) The query :POW:RANG:AUTO? returns true if :POW:RANG:OPT:ATT is not "Off"
Initial S/W Revision	Prior to A.02.00

Off

Turns Pre-Adjust for Min Clip off. This is the default setting.

This key is grayed out in measurements that do not support this functionality. The spectrum analyzer measurement, Swept SA, does not support this functionality.

Key Path	AMPTD Y Scale, Attenuation, Pre-Adjust for Min Clip
Example	:POW:RANGe:OPT:ATT OFF
Initial S/W Revision	Prior to A.02.00

Elec Atten Only

Selects only the electric attenuator to participate in auto ranging. This offers less wear on the mechanical attenuator and is usually faster.

This key is grayed out in measurements that do not support this functionality. The spectrum analyzer measurement, Swept SA, does not support this functionality.

Key Path	AMPTD Y Scale, Attenuation, Pre-Adjust for Min Clip
Example	:POW:RANGe:OPT:ATT ELEC
Initial S/W Revision	Prior to A.02.00

Mech + Elec Atten

In dual attenuator models, this selects both attenuators participate in the autoranging.

This key is grayed out in measurements that do not support this functionality. The spectrum analyzer measurement, Swept SA, does not support this functionality.

Key Path	AMPTD Y Scale, Attenuation, Pre-Adjust for Min Clip
Example	:POW:RANGe:OPT:ATT COMB
Initial S/W Revision	Prior to A.02.00

(Mech) Atten Step

This controls the step size used when making adjustments to the input attenuation.

This key is labeled Mech Atten Step in dual attenuator models and Atten Step in single attenuator models. In the dual attenuator configuration, this key only affects the step size of the mechanical attenuator.

Key Path	AMPTD Y Scale, Attenuation
Remote Command	[:SENSe] :POWer [:RF] :ATTenuation :STEP [:INCRement] 10 dB 2 dB [:SENSe] :POWer [:RF] :ATTenuation :STEP [:INCRement] ?
Example	POW:ATT:STEP 2
Notes	Note this feature works like a 1-N choice from the front panel, but it takes a specific value (in dB) when used remotely. The only valid values are 2 and 10.
Dependencies	Blanked in CXA and EXA if option FSA (2 dB steps) is not present. If blanked, attempts to set it via SCPI will yield an error.
Couplings	When the attenuation step size changes, the current mechanical attenuation value is adjusted (if necessary) to be quantized to the new step size. That is, if step is set to 10 dB, mech atten is increased if necessary so it is a multiple of 10 dB
Preset	PXA and MXA: 2 dB EXA and CXA: 10 dB (2 dB with option FSA)
State Saved	Saved in instrument state
Initial S/W Revision	Prior to A.02.00
Modified at S/W Revision	A.03.00

Scale/Div

Sets the units per division of the vertical scale in the logarithmic display. However, since the Auto Scaling is defaulted to On, this value is automatically determined by the measurement result. When you set a value manually, Auto Scaling automatically changes to Off.

Key Path	AMPTD Y Scale
Mode	SA, WCDMA, C2K, WIMAX OFDMA, 1xEVDO, DVB-T/H, DTMB (CTTB), ISDB-T, CMMB, LTE, LTETDD, Digital Cable TV, WLAN, MSR, LTEAFDD, LTEATDD
Remote Command	:DISPlay:CHPower:VIEW[1]:WINDow[1]:TRACe:Y[:SCALe]:PDIVision <rel_amp1> :DISPlay:CHPower:VIEW[1]:WINDow[1]:TRACe:Y[:SCALe]:PDIVision?
Example	DISP:CHP:VIEW:WIND:TRAC:Y:PDIV 2 DISP:CHP:VIEW:WIND:TRAC:Y:PDIV?
Notes	You must be in the Spectrum Analysis mode, W-CDMA mode, cdma2000 mode, DVB-T/H mode, DTMB (CTTB) mode, ISDB-T mode, CMMB mode, Digital Cable TV mode, LTE mode, LTE TDD mode, WLAN mode, 1xEVDO mode, MSR, LTE-Advanced FDD/TDD mode or WIMAX OFDMA mode to use this command. Use :INSTrument:SElect to set the mode.
Couplings	When the Auto Scaling is On, this value is automatically determined by the measurement result. When you set a value manually, Auto Scaling automatically changes to Off.
Preset	10.00 dB
State Saved	Saved in instrument state.
Min	0.10 dB
Max	20.00 dB
Initial S/W Revision	Prior to A.02.00
Modified at S/W Revision	A.02.00, A.03.00

Presel Center

When this key is pressed, the centering of the preselector filter is adjusted to optimize the amplitude accuracy at the frequency of the selected marker. If the selected marker is not on when Presel Center is pressed, the analyzer will turn on the selected marker, perform a peak search, and then perform centering on the marker's center frequency. If the selected marker is already on and between the start and stop frequencies of the analyzer, the analyzer performs the preselector calibration on that marker's frequency. If the selected marker is already on, but outside the frequency range between Start Freq and Stop Freq, the analyzer will first perform a peak search, and then perform centering on the marker's center frequency.

The value displayed on the Presel Adjust key will change to reflect the new preselector tuning (see Presel Adjust).

A number of considerations should be observed to ensure proper operation. See ["Proper Preselector Operation" on page 467](#).

Key Path	AMPTD Y Scale
Remote Command	[:SENSE]:POWer[:RF]:PCENTER

Example	POW:PCEN
Notes	Note that the rules outlined above under the key description apply for the remote command as well as the key. The result of the command is dependent on marker position, and so forth. Any message shown by the key press is also shown in response to the remote command.
Dependencies	<ul style="list-style-type: none"> • Grayed out if the microwave preselector is off.) • If the selected marker's frequency is below Band 1, advisory message 0.5001 is generated and no action is taken. • Grayed out if entirely in Band 0. • Blank in models that do not include a preselector, such as option 503. If the SCPI is sent in these instruments, it is accepted without error, and the query always returns 0. • Grayed out in the Spectrogram View.
Couplings	<p>The active marker position determines where the centering will be attempted.</p> <p>If the analyzer is in a measurement such as averaging when centering is initiated, the act of centering the preselector will restart averaging but the first average trace will not be taken until the centering is completed.</p>
Status Bits/OPC dependencies	<p>When centering the preselector, *OPC will not return true until the process is complete and a subsequent measurement has completed, nor will results be returned to a READ or MEASURE command.</p> <p>The Measuring bit should remain set while this command is operating and should not go false until the subsequent sweep/measurement has completed.</p>
Initial S/W Revision	Prior to A.02.00
Modified at S/W Revision	A.03.00

Proper Preselector Operation

A number of considerations should be observed to ensure proper operation:

1. If the selected marker is off, the analyzer will turn on a marker, perform a peak search, and adjust the preselector using the selected marker's frequency. It uses the "highest peak" peak search method unqualified by threshold or excursion, so that there is no chance of a 'no peak found' error. It continues with that peak, even if it is the peak of just noise. Therefore, for this operation to work properly, there should be a signal on screen in a preselected range for the peak search to find.
2. If the selected marker is already on, the analyzer will attempt the centering at that marker's frequency. There is no preselector for signals below about 3.6 GHz, therefore if the marker is on a signal below 3.6 GHz, no centering will be attempted and an advisory message generated
3. In some models, the preselector can be bypassed. If it is bypassed, no centering will be attempted in that range and a message will be generated.

Preselector Adjust

Allows you to manually adjust the preselector filter frequency to optimize its response to the signal of interest. This function is only available when "[Presel Center](#)" on page 2149 is available.

For general purpose signal analysis, using Presel Center is recommended. Centering the filter minimizes the impact of long-term preselector drift. Presel Adjust can be used instead to manually optimize the preselector. One application of manual optimization would be to peak the preselector response, which both optimizes the signal-to-noise ratio and minimizes amplitude variations due to small (short-term) preselector drifting.

Key Path	AMPTD Y Scale
Scope	Meas Global
Remote Command	<code>[:SENSe] :POWer [:RF] :PADJust <freq></code> <code>[:SENSe] :POWer [:RF] :PADJust?</code>
Example	POW:PADJ 100KHz POW:PADJ?
Notes	The value on the key reads out to 0.1 MHz resolution.
Dependencies	<ul style="list-style-type: none"> • Grayed out if microwave preselector is off.) • Grayed out if entirely in Band 0. • Blank in models that do not include a preselector, such as option 503. If the SCPI is sent in these instruments, it is accepted without error, and the query always returns 0. • Grayed out in the Spectrogram View.
Preset	0 MHz
State Saved	The Presel Adjust value set by Presel Center, or by manually adjusting Presel Adjust, is not saved in instrument state, and does not survive a Preset or power cycle.
Min	-500 MHz
Max	500 MHz
Default Unit	Hz
Backwards Compatibility SCPI	<code>[:SENSe] :POWer [:RF] :MW :PADJust</code> <code>[:SENSe] :POWer [:RF] :MMW :PADJust</code> PSA had multiple preselectors, but the X-Series has only one. These commands simply alias to <code>[:SENSe] :POWer [:RF] :PADJust</code>
Initial S/W Revision	Prior to A.02.00
Modified at S/W Revision	A.03.00

Remote Command	<code>[:SENSe] :POWer [:RF] :PADJust :PRESelector MWAVE MMWave EXTERNAL</code> <code>[:SENSe] :POWer [:RF] :PADJust :PRESelector?</code>
Notes	PSA had multiple preselectors, and you could select which preselector to adjust. Since the X-Series has only one mm/uW preselector, the preselector selection softkey is no longer available. However, to provide backward compatibility, we accept the legacy remote commands. The command form has no effect, the query always returns MWAVE
Initial S/W Revision	Prior to A.02.00

μW Path Control

The μW Path Control functions include the μW Preselector Bypass (Option MPB) and Low Noise Path (Option LNP) controls in the High Band path circuits.

When the μW Preselector is bypassed, the user has better flatness, but will be subject to spurs from out of band interfering signals. When the Low Noise Path is enabled, the analyzer automatically switches around certain circuitry in the high frequency bands which can contribute to noise, when it is appropriate based on other analyzer settings.

For most applications, the preset state is Standard Path, which gives the best remote-control throughput, minimizes acoustic noise from switching and minimizes the risk of wear out in the hardware switches. For applications that utilize the wideband IF paths, the preset state is the μW Preselector Bypass path, if option MPB is present. This is because, when using a wideband IF such as the 140 MHz IF, the μW Preselector's bandwidth can be narrower than the available IF bandwidth, causing degraded amplitude flatness and phase linearity, so it is desirable to bypass the preselector in the default case.

Users may choose Low Noise Path Enable. It gives a lower noise floor, especially in the 21–26.5 GHz region, though without improving many measures of dynamic range, and without giving the best possible noise floor. The preamp, if purchased and used, gives better noise floor than does the Low Noise Path, however its compression threshold and third-order intercept are much poorer than that of the non-preamp Low Noise Path. There are some applications, typically for signals around –30 dBm, for which the third-order dynamic range of the standard path is good enough, but the noise floor is not low enough even with 0 dB input attenuation. When the third-order dynamic range of the preamp path is too little and the noise floor of the standard path is too high, the Low Noise Path can provide the best dynamic range.

Key Path	AMPTD Y Scale
Mode	SA, BASIC, PNOISE, VSA , LTE, LTETDD
Scope	Meas Global
Remote Command	[:SENSe] :POWer [:RF] :MW :PATH STD LNPath MPBypass FULL [:SENSe] :POWer [:RF] :MW :PATH?
Example	:POW:MW:PATH LNP Enables the Low Noise path
Notes	If a Presel Center is performed, the analyzer will momentarily switch to the Standard Path, regardless of the setting of μW Path Control The DC Block will always be switched in when the low noise path is switched in, to protect succeeding circuitry from DC. Note that this does not mean “when the low noise path is enabled” but when, based on the Low Noise Path rules, the path is actually switched in. This can happen when the selection is Low Noise Path Enable . In the case where the DC Block is switched in the analyzer is now AC coupled. However, if the user has selected DC coupling, the UI will still behave as though it were DC coupled, including all annunciation, warnings, status bits, and responses to SCPI queries. This is because, based on other settings, the analyzer could switch out the low noise path at any time and hence go back to being DC coupled. Alignment switching ignores the settings in this menu, and restores them when finished.
Dependencies	Unavailable in BBIQ and External Mixing
Preset	All modes other than IQ Analyzer mode and VXA: STD IQ Analyzer, VXA and WLAN mode:

	MPB option present and licensed: MPB MPB option not present and licensed: STD
State Saved	Save in instrument state
Readback	Value selected in the submenu
Initial S/W Revision	A.04.00
Modified at S/W Revision	A.10.00

Standard Path

This path gives the best remote-control throughput, minimizes acoustic noise from switching and minimizes the risk of wear in the hardware switches, particularly in remote test scenarios where both low band and high band setups will follow in rapid succession.

In this path, the bypass of the low band/high band switch and microwave preamp is never activated, which can cause some noise degradation but preserves the life of the bypass switch.

Key Path	AMPTD Y Scale, μ W Path Control
Example	:POW:MW:PATH STD
Readback Text	Standard Path
Initial S/W Revision	A.04.00

Low Noise Path Enable

You may choose Low Noise Path Enable, which gives a lower noise floor under some circumstances, particularly when operating in the 21–26.5 GHz region. With the Low Noise Path enabled, the low band/high band switch and microwave preamp are bypassed whenever all of the following are true:

- The analyzer is not in the Low Band, meaning:
- the start frequency is above 3.5 GHz and
- the stop frequency is above 3.6 GHz.
- the internal preamp is not installed or (if installed) is set to Off or Low Band

Note that this means that, when any part of a sweep is done in Low Band, the Low Noise Path is not used, whether or not the Low Noise Path Enable is selected in the user interface. Also, if the preamp is turned on, the Low Noise Path is not used, whether or not the Low Noise Path Enable is selected in the user interface. The only time the Low Noise Path is used is when Low Noise Path Enable is selected, the sweep is completely in High Band (> 3.6 GHz) and no preamp is in use.

See "[More Information](#)" on page 471

Key Path	AMPTD Y Scale, μ W Path Control
Measurement	Swept SA

Example	:POW:MW:PATH LNP
Notes	<p>For measurements that use IQ acquisition, the low noise path is used when the Center Frequency is in High Band (> 3.6 GHz) and no preamp is in use.</p> <p>In other words, the rules above are modified to use only the center frequency to qualify which path to switch in.</p> <p>This is not the case for FFT's in the Swept SA measurement; they use the same rules as swept measurements.</p>
Dependencies	<p>Key is blanked if current mode does not support it.</p> <p>Key is grayed out if mode supports it but current measurement does not support it.</p> <p>Unless Option LNP is present and licensed, key is blank and if SCPI command sent, error -241, "Hardware missing; Option not installed" is generated.</p>
Readback Text	Low Noise Path Enable
Initial S/W Revision	A.04.00

More Information

The user should understand that the Low Noise Path, while giving improved DANL, has the disadvantage of decreased TOI performance and decreased gain compression performance relative to the standard path.

The user should also understand that the bypass switch is a mechanical switch and has finite life, so if the Low Noise Path is enabled, it is possible to cause frequent cycling of this switch by frequently changing analyzer settings such that the above conditions hold true only some of the time. A user making tests of this nature should consider opting for the Standard Path, which will never throw the bypass switch, at the expense of some degraded noise performance.

The low noise path is useful for situations where the signal level is so low that the analyzer performance is dominated by noise even with 0 dB attenuation, but still high enough that the preamp option would have excessive third-order intermodulation or compression. The preamp, if purchased and used, gives better noise floor than does the "Low Noise Path." However, its compression threshold and third-order intercept are much poorer than that of the non-preamp path. There are some applications, typically for signals around -30 dBm, for which the third-order dynamic range of the standard path is good enough, but the noise floor is not low enough even with 0 dB input attenuation. When the third-order dynamic range of the preamp path is too little and the noise floor of the standard path is too high, the Low Noise Path can provide the best dynamic range

The graph below illustrates the concept. It shows, in red, the performance of an analyzer at different attenuation settings, both with the preamp on and off, in a measurement that is affected by both analyzer noise and analyzer TOI. The green shows the best available dynamic range, offset by 0.5 dB for clarity. The blue shows how the best available dynamic range improves for moderate signal levels with the low noise path switched in. In this illustration, the preamp improves the noise floor by 15 dB while degrading the third-order intercept by 30 dB, and the low noise path reduces loss by 8 dB. The attenuator step size is 2 dB.

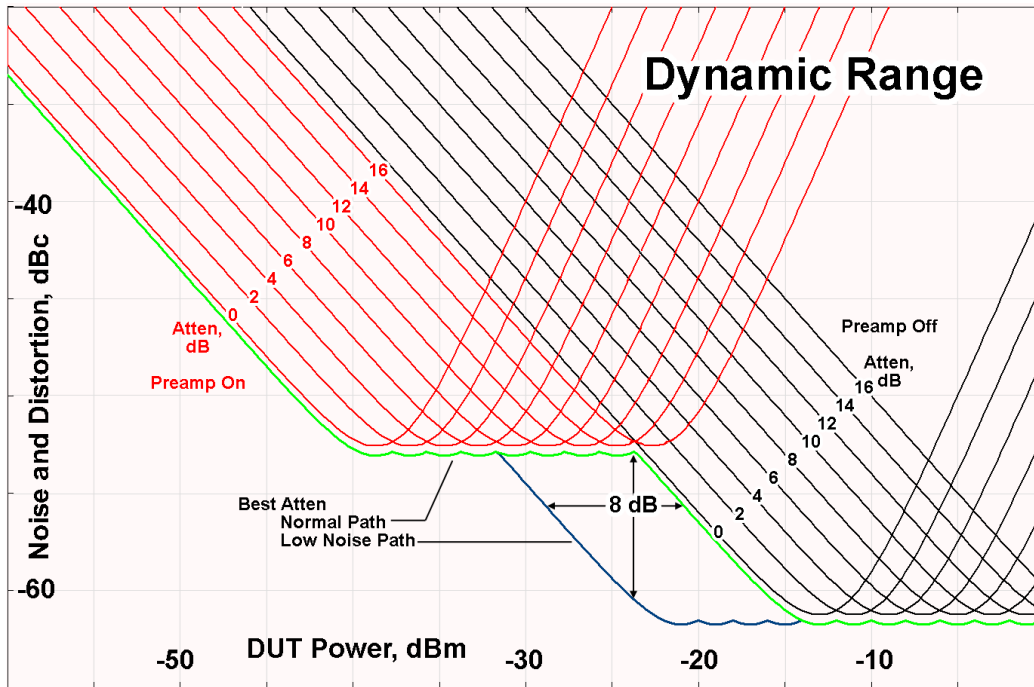

There are other times where selecting the low noise path improves performance, too. Compression-limited measurements such as finding the nulls in a pulsed-RF spectrum can profit from the low noise path in a way similar to the TOI-limited measurement illustrated. Accuracy can be improved when the low noise path allows the optimum attenuation to increase from a small amount like 0, 2 or 4 dB to a larger amount, giving better return loss at the analyzer input. Harmonic measurements, such as second and third harmonic levels, are much improved using the low noise path because of the superiority of that path for harmonic (though not intermodulation) distortion performance.

μW Preselector Bypass

This key toggles the preselector bypass switch for band 1 and higher. When the microwave preselector is on, the signal path is preselected. When the microwave preselector is off, the signal path is not preselected. The preselected path is the normal path for the analyzer.

The preselector is a tunable bandpass filter which prevents signals away from the frequency of interest from combining in the mixer to generate in-band spurious signals (images). The consequences of using a preselector filter are its limited bandwidth, the amplitude and phase ripple in its passband, and any amplitude and phase instability due to center frequency drift.

Option MPB or pre-selector bypass provides an unpreselected input mixer path for certain X-Series signal analyzers with frequency ranges above 3.6 GHz. This signal path allows a wider bandwidth and less amplitude variability, which is an advantage when doing modulation analysis and broadband signal analysis. The disadvantage is that, without the preselector, image signals will be displayed. Another disadvantage of bypassing the preselector is increased LO emission levels at the front panel input port.

Image responses are separated from the real signal by twice the 1st IF. For IF Paths of 10 MHz and 25 MHz, the 1st IF is 322.5 MHz, so the image response and the real signal will be separated by 645 MHz. The 1st IF will be different for other IF Path settings. When viewing a real signal and its corresponding image response in internal mixing, the image response will be to the left of the real signal.

Also, the image response and the real signal typically have the same amplitude and exhibit the same shape factor.

However, if Option FS1, Fast Sweep Capability, is enabled, the image response in the Swept SA measurement will appear lower in amplitude and have a much wider shape factor compared to the real signal.

Key Path	AMPTD Y Scale, μ W Path Control
Example	:POW:MW:PATH MPB
Dependencies	Key is blanked if current mode does not support it. Key is grayed out if mode supports it but current measurement does not support it. Key is blank unless Option MPB is present and licensed. If SCPI command sent when MPB not present, error -241, "Hardware missing; Option not installed" is generated.
Readback Text	μ W Preselector Bypass
Initial S/W Revision	A.04.00

Remote Command	[:SENSe] :POWer [:RF] :MW :PRESelector [:STATe] ON OFF 0 1 [:SENSe] :POWer [:RF] :MW :PRESelector [:STATe] ?
Example	:POW:MW:PRES OFF Bypasses the microwave preselector
Notes	The ON parameter sets the STD path (:POW:MW:PATH STD) The OFF parameter sets path MPB (:POW:MW:PATH MPB)
Preset	ON

Internal Preamp

Accesses a menu of keys that control the internal preamps. Turning on the preamp gives a better noise figure, but a poorer TOI to noise floor dynamic range. You can optimize this setting for your particular measurement.

The instrument takes the preamp gain into account as it sweeps. If you sweep outside of the range of the preamp the instrument will also account for that. The displayed result will always reflect the correct gain.

For some measurements, when the preamp is on and any part of the displayed frequency range is below the lowest frequency for which the preamp has specifications, a warning condition message appears in the status line. For example, for a preamp with a 9 kHz lowest specified frequency: "Preamp: Accy unspec'd below 9 kHz".

Key Path	AMPTD Y Scale
Scope	Meas Global
Remote Command	[:SENSe] :POWer [:RF] :GAIN [:STATe] OFF ON 0 1 [:SENSe] :POWer [:RF] :GAIN [:STATe] ?
Dependencies	Preamp is not available on all hardware platforms. If the preamp is not present or is unlicensed, the

	key is not shown. The preamp is not available when the electronic/soft attenuator is enabled.
--	--

Couplings	<p>The act of connecting the U7227A USB Preamplifier to one of the analyzer's USB ports will cause the Internal Preamp to be switched on. When this happens an informational message will be generated: "Internal Preamp turned on for optimal operation with USB Preamp." Note that if the Internal Preamp was already on, there will be no change to the setting, but if it was Off it will be switched On, to Full Range.</p> <p>Note that this same action occurs when the SA mode is selected while the USB Preamp is connected to one of the analyzer's USB ports, if it is the first time that the SA mode has run since powerup, or if the last time the SA mode was running the USB Preamp was NOT connected.</p> <p>Subsequently disconnecting the USB Preamp from USB does not change the Internal Preamp setting nor restore the previous setting.</p>
Preset	OFF
State Saved	Saved in instrument state
Initial S/W Revision	Prior to A.02.00
Modified at S/W Revision	A.14.00

Key Path	AMPTD Y Scale, Internal Preamp
Scope	Meas Global
Remote Command	[:SENSe]:POWer[:RF]:GAIN:BAND LOW FULL [:SENSe]:POWer[:RF]:GAIN:BAND?
Dependencies	<p>Preamp is not available on all hardware platforms. If the preamp is not present or is unlicensed, the key is not shown.</p> <p>If a POW:GAIN:BAND FULL command is sent when a low band preamp is available, the preamp band parameter is to LOW instead of FULL, and an "Option not installed" message is generated.</p>
Preset	LOW
State Saved	Saved in instrument state
Initial S/W Revision	Prior to A.02.00

Off

Turns the internal preamp off

Key Path	AMPTD Y Scale, Internal Preamp
Example	:POW:GAIN OFF
Readback	Off
Initial S/W Revision	Prior to A.02.00

Low Band

Sets the internal preamp to use only the low band.

The frequency range of the installed (optional) low-band preamp is displayed in square brackets on the Low Band key label.

Key Path	AMPTD Y Scale, Internal Preamp
Example	:POW:GAIN ON :POW:GAIN:BAND LOW
Readback	Low Band
Initial S/W Revision	Prior to A.02.00

Full Range

Sets the internal preamp to use its full range. The low band (0–3.6 GHz or 0–3GHz, depending on the model) is supplied by the low band preamp and the frequencies above low band are supplied by the high band preamp.

The frequency range of the installed (optional) preamp is displayed in square brackets on the Full Range key label. If the high band option is not installed the Full Range key does not appear.

Key Path	AMPTD Y Scale, Internal Preamp
Example	:POW:GAIN ON :POW:GAIN:BAND FULL
Readback	Full Range
Initial S/W Revision	Prior to A.02.00

Ref Position

Positions the reference level at the top, center, or bottom of the Y Scale display. Changing the reference position does not change the reference level value.

Key Path	AMPTD Y Scale
Mode	SA, WCDMA, C2K, WIMAX OFDMA, 1xEVDO, DVB-T/H, DTMB (CTTB), ISDB-T, CMMB, LTE, LTE-TDD, Digital Cable TV, WLAN, MSR, LTEAFDD, LTEATDD
Remote Command	:DISPlay:CHPower:VIEW[1]:WINDow[1]:TRACe:Y[:SCALE]:RPOSition TOP CENTER BOTTom :DISPlay:CHPower:VIEW[1]:WINDow[1]:TRACe:Y[:SCALE]:RPOSition?
Example	DISP:CHP:VIEW:WIND:TRAC:Y:RPOS CENT DISP:CHP:VIEW:WIND:TRAC:Y:RPOS?
Notes	You must be in the Spectrum Analysis mode, W-CDMA mode, cdma2000 mode, DVB-T/H mode, DTMB (CTTB) mode, ISDB-T mode, CMMB mode, Digital Cable TV mode, LTE mode, LTE TDD mode, WLAN mode, 1xEVDO mode, MSR, LTE-Advanced FDD/TDD mode or WIMAX OFDMA mode to use

	this command. Use :INSTrument:SElect to set the mode.
Preset	TOP
State Saved	Saved in instrument state.
Range	Top Ctr Bot
Initial S/W Revision	Prior to A.02.00
Modified at S/W Revision	A.02.00, A.03.00

Auto Scaling

Toggles the Auto Scaling function between On and Off.

Key Path	AMPTD Y Scale
Mode	SA, WCDMA, C2K, WIMAX OFDMA, 1xEVDO, DVB-T/H, DTMB (CTTB), ISDB-T, CMMB, LTE, LTETDD, Digital Cable TV, WLAN, MSR, LTEAFDD, LTEATDD
Remote Command	:DISPlay:CHPower:VIEW[1]:WINDow[1]:TRACe:Y[:SCALE]:COUPle 0 1 OFF ON :DISPlay:CHPower:VIEW[1]:WINDow[1]:TRACe:Y[:SCALE]:COUPle?
Example	DISP:CHP:VIEW:WIND:TRAC:Y:COUP OFF DISP:CHP:VIEW:WIND:TRAC:Y:COUP?
Couplings	When Auto Scaling is On, and the Restart front-panel key is pressed, this function automatically sets the scale per division to 10 dB and determines the reference values based on the measurement results. When you set a value to either Scale/Div or Ref Value manually, Auto Scaling automatically changes to Off.
Preset	1
State Saved	Saved in instrument state.
Range	On Off
Initial S/W Revision	Prior to A.02.00
Modified at S/W Revision	A.02.00, A.03.00

Auto Couple

The Auto Couple feature provides a quick and convenient way to automatically couple multiple instrument settings. This helps ensure accurate measurements and optimum dynamic range. When the Auto Couple feature is activated, either from the front panel or remotely, all parameters of the current measurement that have an Auto/Manual mode are set to Auto mode and all measurement settings dependent on (or coupled to) the Auto/Man parameters are automatically adjusted for optimal performance.

However, the Auto Couple key actions are confined to the current measurement only. It does not affect other measurements in the mode, and it does not affect markers, marker functions, or trace or display attributes.

See "[More Information](#)" on page 477

Key Path	Front-panel key
Remote Command	:COUPle ALL NONE
Example	:COUP ALL
Notes	:COUPle ALL puts all Auto/Man parameters in Auto mode (equivalent to pressing the Auto Couple key). :COUPLE NONE puts all Auto/Man parameters in manual mode. It decouples all the coupled instrument parameters and is not recommended for making measurements.
Initial S/W Revision	Prior to A.02.00

More Information

There are two types of functions that have Auto/Manual modes.

Auto/Man Active Function keys

An Auto/Man toggle key controls the binary state associated with an instrument parameter by toggling between Auto (where the parameter is automatically coupled to the other parameters it is dependent upon) and Man (where the parameter is controlled independent of the other parameters), as well as making the parameter the active function. The current mode is indicated on the softkey with either Auto or Man underlined as illustrated below.



Auto/Man 1-of-N keys

An Auto/Man 1-of-N key allows you to manually pick from a list of parameter values, or place the function in Auto, in which case the value is automatically selected (and indicated) as shown below. If in Auto, Auto is underlined on the calling key. If in manual operation, manual is indicated on the calling key. But the calling key does not actually toggle the function, it simply opens the menu.

8 Channel Power Measurement
Auto Couple

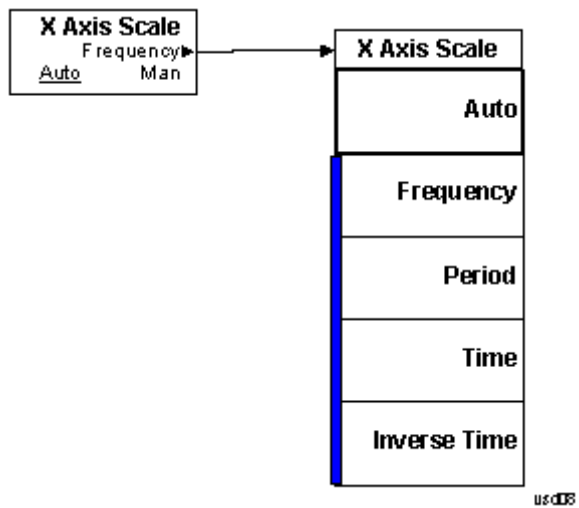

BW

Accesses a menu of functions that enable you to specify and control the video and resolution bandwidths. You can also select the type of filter for the measurement and set the filter bandwidth.

Key Path	Front-panel key
Initial S/W Revision	Prior to A.02.00

Res BW

Sets the value of the resolution bandwidth (RBW). If an unavailable bandwidth is entered with the numeric keypad, the closest available bandwidth is selected.

LTE-Advanced FDD/TDD Auto RBW:

Bandwidth	RBW (KHz)
1.4MHz	20
3MHz	43
5MHz	68
10MHz	150
15MHz	220
20MHz	270

the resolution bandwidth is predefined based on the corresponding bandwidth of the single LTE carrier, which is listed above. When ResBW mode is Auto, the narrowest RBW over the active carriers is selected for Multi-carriers.

Key Path	BW
Mode	SA, WCDMA, C2K, WIMAX OFDMA, 1xEVDO, DVB-T/H, DTMB (CTTB), ISDB-T, CMMB, LTE, LTE-TDD, Digital Cable TV, WLAN, MSR, LTEAFDD, LTEATDD
Remote Command	<pre>[:SENSe]:CHPower:BANDwidth[:RESolution] <bandwidth> [:SENSe]:CHPower:BANDwidth[:RESolution]? [:SENSe]:CHPower:BANDwidth[:RESolution]:AUTO ON OFF 1 0 [:SENSe]:CHPower:BANDwidth[:RESolution]:AUTO?</pre>
Example	<pre>CHP:BAND 5 MHz CHP:BAND? CHP:BAND:AUTO ON CHP:BAND:AUTO?</pre>
Notes	You must be in the Spectrum Analysis mode, W-CDMA mode, cdma2000 mode, DVB-T/H mode, DTMB (CTTB) mode, ISDB-T mode, CMMB mode, Digital Cable TV mode, LTE mode, LTE TDD mode, WLAN mode, 1xEVDO mode, MSR, LTE-Advanced FDD/TDD mode or WIMAX OFDMA mode to use this command. Use :INSTRument:SElect to set the mode.

Couplings	<p>Sweep time is coupled to the RBW. As the RBW changes, the sweep time (if set to Auto) is changed to maintain amplitude calibration.</p> <p>Video bandwidth (VBW) is coupled to the RBW. As the resolution bandwidth changes, the video bandwidth (if set to Auto) changes to maintain the ratio of VBW/RBW (10:1).</p> <p>When the Res BW is set to Auto, the resolution bandwidth is auto-coupled to the span. The ratio of Span/RBW is approximately 106:1 when auto coupled. When Res BW is set to Man, and the bandwidths are entered manually, these bandwidths are used regardless of other analyzer settings.</p>
Preset	<p>SA: Auto</p> <p>WCDMA: 240 kHz</p> <p>C2K: 24 kHz</p> <p>WIMAX OFDMA: 100kHz</p> <p>1xEVDO: 30kHz</p> <p>DVB-T/H: 3.9kHz</p> <p>DTMB (CTTB): 3.9kHz</p> <p>ISDB-T: 30kHz</p> <p>CMMB: 3.9kHz</p> <p>LTE: Auto</p> <p>LTETDD: Auto</p> <p>Digital Cable TV: 3.9kHz</p> <p>WLAN: 100 kHz</p> <p>MSR: 100kHz</p> <p>LTEAFDD/LTEATDD: Auto</p> <p>WCDMA, C2K, 1xEVDO, WIMAX OFDMA, DVB-T/H, DTMB (CTTB), ISDB-T, CMMB, Digital Cable TV, WLAN, MSR, LTEAFDD, LTEATDD: OFF</p> <p>SA, LTE, LTETDD: ON</p>
State Saved	Saved in instrument state.
Min	1 Hz
Max	8 MHz
Backwards Compatibility SCPI	<code>[:SENSe] :CHPower:BWIDth [:RESolution]</code>
Initial S/W Revision	Prior to A.02.00
Modified at S/W Revision	A.02.00, A.03.00

Video BW

Changes the analyzer post-detection filter (VBW).

Key Path	BW
Mode	SA, WCDMA, C2K, WIMAX OFDMA, 1xEVDO, DVB-T/H, DTMB (CTTB), ISDB-T, CMMB, LTE, LTETDD, Digital Cable TV, WLAN, MSR, LTEAFDD, LTEATDD
Remote Command	<code>[:SENSe] :CHPower:BANDwidth:VIDeo <bandwidth></code>

	<pre>[:SENSe] :CHPower :BANDwidth :VIDeo?</pre> <pre>[:SENSe] :CHPower :BANDwidth :VIDeo :AUTO ON OFF 1 0</pre> <pre>[:SENSe] :CHPower :BANDwidth :VIDeo :AUTO?</pre>
Example	<pre>CHP:BAND:VID 2.4 MHz</pre> <pre>CHP:BAND:VID?</pre> <pre>CHP:BAND:VID:AUTO OFF</pre> <pre>CHP:BAND:VID:AUTO?</pre>
Notes	You must be in the Spectrum Analysis mode, W-CDMA mode, cdma2000 mode, DVB-T/H mode, DTMB (CTTB) mode, ISDB-T mode, CMMB mode, Digital Cable TV mode, LTE mode, LTE TDD mode, WLAN mode, 1xEVDO mode, MSR, LTE-Advanced FDD/TDD mode or WIMAX OFDMA mode to use this command. Use :INSTRument:SElect to set the mode.
Dependencies	See Couplings
Couplings	<p>Video bandwidth (VBW) is coupled to the RBW. As the resolution bandwidth changes, the video bandwidth (if set to Auto) changes to maintain the ratio set by VBW/RBW.</p> <p>Sweep Time is coupled to the Video Bandwidth (VBW). As the VBW is changed, the sweep time (when set to Auto) is changed to maintain amplitude calibration. This occurs because of common hardware between the two circuits, even though the Video BW filter is not actually “in-circuit” when the detector is set to Average. Because the purpose of the average detector and the VBW filter are the same, either can be used to reduce the variance of the result.</p> <p>Although the VBW filter is not “in-circuit” when using the average detector, the Video BW key can have an effect on (Auto) sweep time, and is not disabled. In this case, reducing the VBW setting increases the sweep time, which increases the averaging time, producing a lower-variance trace.</p> <p>When using the average detector with either Sweep Time set to Man, or in zero span, the VBW setting has no effect and is disabled (grayed out).</p> <p>When the video bandwidth is AUTO coupled, the video bandwidth value is set to: Resolution Bandwidth * Video Bandwidth to Resolution Bandwidth Ratio</p>
Preset	<pre>SA: Auto</pre> <pre>WCDMA: 2.4MHz</pre> <pre>C2K: 240 kHz</pre> <pre>WIMAX OFDMA: Auto</pre> <pre>1xEVDO: 300 kHz</pre> <pre>DVB-T/H: 39kHz</pre> <pre>DTMB (CTTB): 39kHz</pre> <pre>ISDB-T: 300kHz</pre> <pre>CMMB: 39kHz</pre> <pre>LTE, MSR: Auto</pre> <pre>LTETDD: Auto</pre> <pre>LTEAFDD, LTEATDD: Auto</pre> <pre>Digital Cable TV: 39kHz</pre> <pre>WLAN: Auto</pre> <pre>ON</pre>

State Saved	Saved in instrument state.
Min	1 Hz
Max	50 MHz
Initial S/W Revision	Prior to A.02.00
Modified at S/W Revision	A.02.00, A.03.00

Filter Type

Selects the type of bandwidth filter that is used. The choices are Gaussian or Flat top.

Key Path	BW
Mode	SA, WCDMA, C2K, WIMAX OFDMA, 1xEVDO, DVB-T/H, DTMB (CTTB), ISDB-T, CMMB, LTE, LTE-TDD, Digital Cable TV, WLAN, MSR, LTEAFDD, LTEATDD
Remote Command	[:SENSe] :CHPower :BANDwidth :SHApe GAUSSian FLATtop [:SENSe] :CHPower :BANDwidth :SHApe?
Example	CHP:BAND:SHAP GAUS CHP:BAND:SHAP?
Preset	GAUSSian
State Saved	Saved in instrument state.
Range	Gaussian Flattop
Backwards Compatibility SCPI	[:SENSe] :CHPower :BWIDth :SHApe
Initial S/W Revision	Prior to A.02.00
Modified at S/W Revision	A.02.00, A.03.00

Cont (Continuous Measurement/Sweep)

Sets the analyzer for Continuous measurement operation. The single/continuous state is Meas Global so the setting will affect all measurements. If you are Paused, pressing Cont does a Resume.

Key Path	Front-panel key
Remote Command	:INITiate:CONTinuous OFF ON 0 1 :INITiate:CONTinuous?
Example	:INIT:CONT 0 puts analyzer in Single measurement operation. :INIT:CONT 1 puts analyzer in Continuous measurement operation
Preset	ON (Note that SYST:PRESet sets INIT:CONT to ON but *RST sets INIT:CONT to OFF)
State Saved	Saved in instrument state
Backwards Compatibility Notes	For Spectrum Analysis mode in ESA and PSA, there is no Cont hardkey, instead there is a Sweep Single/Cont key. In these analyzers, switching the Sweep Single/Cont key from Single to Cont restarts averages (displayed average count reset to 1), but does not restart Max Hold and Min Hold. The X-Series has Single and Cont keys in place of the SweepSingleCont key. In the X-Series, if in single measurement, the Cont key (and INIT:CONT ON) switches to continuous measurement, but never restarts a measurement and never resets a sweep.
Initial S/W Revision	Prior to A.02.00

In Swept SA Measurement (Spectrum Analysis Mode):

The analyzer takes repetitive sweeps, averages, measurements, etc., when in Continuous mode. When the average count reaches the Average/Hold Number the count stops incrementing, but the analyzer keeps sweeping. See the Trace/Detector section for the averaging formula used both before and after the Average/Hold Number is reached. The trigger condition must be met prior to each sweep. The type of trace processing for multiple sweeps, is set under the Trace/Detector key, with choices of Trace Average, Max Hold, or Min Hold.

In Other Measurements/Modes:

With Avg/Hold Num (in the Meas Setup menu) set to Off or set to On with a value of 1, a sweep is taken after the trigger condition is met; and the analyzer continues to take new sweeps after the current sweep has completed and the trigger condition is again met. However, with Avg/Hold Num set to On with a value >1, multiple sweeps (data acquisitions) are taken for the measurement. The trigger condition must be met prior to each sweep. The sweep is not stopped when the average count k equals the number N set for Avg/Hold Num is reached, but the number k stops incrementing. A measurement average usually applies to all traces, marker results, and numeric results. But sometimes it only applies to the numeric results.

If the analyzer is in Single measurement, pressing the Cont key does not change k and does not cause the sweep to be reset; the only action is to put the analyzer into Continuous measurement operation.

If it is already in continuous sweep:

the INIT:CONT 1 command has no effect

8 Channel Power Measurement Cont (Continuous Measurement/Sweep)

the INIT:CONT 0 command will place the analyzer in Single Sweep but will have no effect on the current sequence until $k = N$, at which point the current sequence will stop and the instrument will go to the idle state.

File

See "File" on page 336

FREQ Channel

Accesses a menu of keys that allow you to control the Frequency and Channel parameters of the instrument.

Some features in the Frequency menu are the same for all measurements – they do not change as you change measurements. Settings like these are called “Meas Global” and are unaffected by Meas Preset. For example, the Center Freq setting is the same for all measurements - it does not change as you change measurements.

Key Path	Front-panel key
Initial S/W Revision	Prior to A.02.00

Center Freq

Sets the frequency that corresponds to the horizontal center of the graticule (when frequency Scale Type is set to linear). While adjusting the Center Frequency the Span is held constant, which means that both Start Frequency and Stop Frequency will change.

Pressing Center Freq also sets the frequency entry mode to Center/Span. In Center/Span mode, the center frequency and span values are displayed below the graticule, and the default active function in the Frequency menu is Center Freq.

The center frequency setting is the same for all measurements within a mode, that is, it is Meas Global. Some modes are also able to share a Mode Global center frequency value. If this is the case, the Mode will have a Global Settings key in its Mode Setup menu.

The Center Freq function sets (and queries) the Center Frequency for the currently selected input. If your analyzer has multiple inputs, and you select another input, the Center Freq changes to the value for that input. SCPI commands are available to directly set the Center Freq for a specific input.

Center Freq is remembered as you go from input to input. Thus you can set a Center Freq of 10 GHz with the RF Input selected, change to BBIQ and set a Center Freq of 20 MHz, then switch to External Mixing and set a Center Freq of 60 GHz, and when you go back to the RF Input the Center Freq will go back to 10 GHz; back to BBIQ and it is 20 MHz; back to External Mixing and it is 60 GHz.

See ["RF Center Freq" on page 489](#)

See [Ext Mix Center Freq](#)

See ["I/Q Center Freq" on page 491](#)

See ["Center Frequency Presets" on page 487](#)

Key Path	FREQ Channel
Scope	Meas Global
Remote Command	<code>[:SENSe] :FREQuency:CENTer <freq></code> <code>[:SENSe] :FREQuency:CENTer?</code>

Example	FREQ:CENT 50 MHz FREQ:CENT UP changes the center frequency to 150 MHz if you use FREQ:CENT:STEP 100 MHz to set the center frequency step size to 100 MHz FREQ:CENT?
Notes	This command sets either the RF or I/Q Center Frequency depending on the selected input. For RF input it is equivalent to FREQ:RF:CENT For I/Q input it is equivalent to FREQ:IQ:CENT Preset and Max values are dependent on Hardware Options (5xx) If no terminator (e.g. MHz) is sent the terminator Hz is used. If a terminator with unit other than Frequency is used, an invalid suffix error message is generated.
Dependencies	The Center Frequency can be limited by Start or Stop Freq limits, if the Span is so large that Start or Stop reach their limit.
Couplings	When operating in "swept span", any value of the Center Frequency or Span that is within the frequency range of the analyzer is allowed when the value is being set through the front panel numeric key pad or the SCPI command. The other parameter is forced to a different value if needed, to keep the Start and the Stop Frequencies within the analyzer's frequency range
Preset	Depends on instrument maximum frequency, mode, measurement, and selected input. See "Center Frequency Presets" on page 487 and "RF Center Freq" on page 489 and Ext Mix Center Freq and "I/Q Center Freq" on page 491 .
State Saved	Saved in instrument state
Min	Depends on instrument maximum frequency, mode, measurement, and selected input.. See "Center Frequency Presets" on page 487 and "RF Center Freq" on page 489 and "I/Q Center Freq" on page 491 .
Max	Depends on instrument maximum frequency, mode, measurement, and selected input.. See "Center Frequency Presets" on page 487 and "RF Center Freq" on page 489 and "I/Q Center Freq" on page 491 .
Default Unit	Hz
Status Bits/OPC	Non-overlapped
Dependencies	
Initial S/W Revision	Prior to A.02.00

Center Frequency Presets

The following table provides the Center Frequency Presets for the Spectrum Analyzer mode, and the Max Freq, for the various frequency options:

Freq Option	CF after Mode Preset	Stop Freq after Mode Preset	Max Freq (can't tune)

8 Channel Power Measurement
FREQ Channel

			above)
503 (all but N9000A)	1.805 GHz	3.6 GHz	3.7 GHz
503 (N9000A)	1.505 GHz	3.0 GHz	3.08 GHz
507 (all but N9000A)	3.505 GHz	7.0 GHz	7.1 GHz
507 (N9000A)	3.755 GHz	7.5 GHz	7.58 GHz
508 (all but N9038A)	1.805 GHz	3.6 GHz	8.5 GHz
508 (N9038A)	4.205 GHz	8.4 GHz	8.5 GHz
513	6.805 GHz	13.6 GHz	13.8 GHz
526 (all but N9000A and N9038A)	13.255 GHz	26.5 GHz	27.0 GHz
526 (N9000A)	13.255 GHz	26.5 GHz	26.55 GHz
526 (N9038A)	1.805 GHz	3.6 GHz	27.0 GHz
532	16.005 GHz	32.0 GHz	32.5 GHz
543	21.505 GHz	43.0 GHz	TBD
544	22.005 GHz	44.0 GHz	44.5 GHz
550	25.005 GHz	50.0 GHz	51 GHz

Input 2:

Model	CF after Mode Preset	Stop Freq after Mode Preset	Max Freq (can't tune above)
N9000A opt C75	0.7505GHz	1.5 GHz	1.58 GHz
N9038A	505 MHz	1 GHz	1.000025 GHz

Tracking Generator Frequency Limits (N9000A only):

Tracking Generator Option	Min Freq (clips to this freq when turn TG on and	If above this Freq, Stop Freq clipped to this Freq when	Max Freq (can't tune above) while TG

	can't tune below while TG on)	TG turned on	on
T03	9 kHz	3.0 GHz	3.08 GHz
T06	9 kHz	6.0 GHz	6.05 GHz

The following table shows the Center Frequency Presets for modes other than Spectrum Analyzer:

Mode	CF Preset for RF
WCDMA	1 GHz
WIMAXOFDMA,	1 GHz
BASIC	1 GHz
ADEMOD	1 GHz
VSA	1 GHz
TDSCDMA	1 GHz
PNOISE	1 GHz
LTE	1 GHz
LTETDD	1 GHz
MSR	1 GHz
GSM	935.2 MHz
NFIGURE	1.505 GHz

RF Center Freq

SCPI command for specifying the RF Center Frequency. This command will set the Center Frequency to be used when the RF input is selected, even if the RF input is not the input that is selected at the time the command is sent. Note that the Center Freq function in the Frequency menu on the front panel always applies to the currently selected input.

Scope	Meas Global
Remote Command	<code>[:SENSe] :FREQuency:RF:CENTer <freq></code> <code>[:SENSe] :FREQuency:RF:CENTer?</code>
Example	FREQ:RF:CENT 30 MHz
Notes	This command is the same in all modes, but the parameter is Measurement Global. So the value is independent in each mode and common across all the measurements in the mode.
Dependencies	If the electronic/soft attenuator is enabled, any attempt to set Center Frequency such that the Stop Frequency would be >3.6 GHz fails and results in an advisory message. If the equivalent SCPI command is sent, this same message is generated as part of a “-221, Settings conflict” warning. If Source Mode is set to Tracking, and the Max or Min Center Freq is therefore limited by the limits of the source, a warning message is generated, “Data out of range;clipped to source max/min” if these limits are exceeded. Note that for an external source, these limits can be affected by the settings of

	Source Numerator, Source Denominator and Power Sweep.
Preset	See table above
State Saved	Saved in instrument state.
Min	-79.999995 MHz, unless Source Mode is set to Tracking, in which case it is limited by the minimum frequency of the Source
Max	See table above. Basically instrument maximum frequency – 5 Hz. Note that, if the Source Mode is set to Tracking, the effective instrument maximum frequency may be limited by the source maximum frequency. If the knob or step keys are being used, also depends on the value of the other three interdependent parameters Span, Start Frequency and Stop Frequency
Initial S/W Revision	Prior to A.02.00
Modified at S/W Revision	A.03.00

Ext Mix Center Freq

SCPI command for specifying the External Mixer Center Frequency. This command will set the Center Frequency to be used when the External Mixer is selected, even if the External Mixer input is not the input which is selected at the time the command is sent. Note that the Center Freq function in the Frequency menu on the front panel always applies to the currently selected input.

Scope	Meas Global
Remote Command	<code>[:SENSe] :FREQuency:EMIXer:CENTer <freq></code> <code>[:SENSe] :FREQuency:EMIXer:CENTer?</code>
Example	<code>:FREQ:EMIX:CENt 60 GHz</code> <code>:FREQ:EMIX:CENt?</code>
Notes	This command is the same in all modes, but the parameter is Measurement Global. So the value is independent in each mode and common across all the measurements in the mode.
Couplings	When returning to External Mixing after having been switched to one of the other inputs (e.g., RF), you will come back into the settings that you had when you left External Mixing. So you will come back to the band you were in with the Center Frequency that you had. However, Span is not an input-dependent parameter, therefore you will bring the span over from the other input. Therefore, the analyzer comes back with the span from the previous input, limited as necessary by the current mixer setup.
Preset	When a Mode Preset is performed while in External Mixing, the Start frequency of the current Mode is set to the nominal Min Freq of the lowest harmonic range in the Harmonic Table for the current mixer setup. Similarly, the Stop frequency of the current Mode is set to the nominal Max Freq of the highest harmonic range in the Harmonic Table. The Center Freq thus presets to the point arithmetically equidistant from these two frequencies. If the current measurement has a limited Span available to it, and cannot achieve the Span shown in the table (Span=Stop Freq – Start Freq), the analyzer uses the maximum Span the measurement allows, and still sets the Center Freq to the midpoint of the Start and Stop Freq values in the Harmonic Table.

	When Restore Input/Output Defaults is performed, the mixer presets to the 11970A, whose Start and Stop frequencies are 26.5 and 40 GHz respectively. The center of these two frequencies is 33.25 GHz. Therefore, after a Restore Input/Output Defaults, if you go into External Mixing and do a Mode Preset while in the Spectrum Analyzer Mode, the resulting Center Freq is 33.25 GHz.
State Saved	Saved in instrument state.
Min	The minimum frequency in the currently selected mixer band + 5 Hz
Max	The maximum frequency in the currently selected mixer band – 5 Hz If the knob or step keys are being used, also depends on the value of the other three interdependent parameters Span, Start Frequency and Stop Frequency
Initial S/W Revision	A.08.01

I/Q Center Freq

SCPI command for specifying the I/Q Center Frequency. This command will set the Center Frequency to be used when the I/Q input is selected, even if the I/Q input is not the input which is selected at the time the command is sent. Note that the Center Freq function in the Frequency menu on the front panel always applies to the currently selected input.

Scope	Meas Global
Remote Command	[:SENSe] :FREQuency:IQ:CENTer <freq> [:SENSe] :FREQuency:IQ:CENTer?
Example	FREQ:IQ:CENT: 30 MHz
Notes	This command is the same in all modes, but the parameter is Measurement Global. So the value is independent in each mode and common across all the measurements in the mode.
Preset	0 Hz
State Saved	Saved in instrument state.
Min	-40.049995 MHz
Max	40.049995 MHz
Initial S/W Revision	Prior to A.02.00

Input/Output

See "[Input/Output](#)" on page 196

Marker

Accesses a menu that enables you to select, set up and control the markers for the current measurement.

Key Path	Front-panel key
Initial S/W Revision	Prior to A.02.00

Select Marker

Displays 12 markers available for selection.

Key Path	Marker
Initial S/W Revision	Prior to A.02.00

Marker Type

Sets the marker control mode to Normal, Delta, Fixed or Off. All interactions and dependencies detailed under the key description are enforced when the remote command is sent. If the selected marker is Off, pressing Marker sets it to Normal and places it at the center of the screen on the trace determined by the Marker Trace rules. At the same time, Marker X Axis Value appears on the Active Function area.

The default active function is the active function for the currently selected marker control mode. If the current control mode is Off, there is no active function and the active function is turned off.

Key Path	Marker
Mode	SA, WCDMA, C2K, WIMAX OFDMA, 1xEVDO, DVB-T/H, DTMB (CTTB), ISDB-T, CMMB, LTE, LTE-TDD, Digital Cable TV, WLAN, MSR, LTEAFDD, LTEATDD
Remote Command	:CALCulate:CHPower:MARKer[1] 2 ... 12:MODE Position DELTa OFF :CALCulate:CHPower:MARKer[1] 2 ... 12:MODE?
Example	CALC:CHP:MARK3:MODE POS CALC:CHP:MARK3:MODE?
Notes	If the selected marker is Off, pressing Marker sets it to Normal and places it at the center of the screen on the trace determined by the Marker Trace rules. At the same time, Marker X Axis Value appears on the Active Function area. Default Active Function: the active function for the selected marker's current control mode. If the current control mode is Off, there is no active function and the active function is turned off. Active Function Display: the marker X axis value entered in the active function area displays the marker value to its full entered precision.
Preset	OFF
State Saved	Saved in instrument state.
Range	Normal Delta Off
Initial S/W Revision	Prior to A.02.00
Modified at S/W Revision	A.02.00, A.03.00

Properties

Accesses the marker properties menu.

Key Path	Marker
Initial S/W Revision	Prior to A.02.00

Select Marker

Displays 12 markers available for selection.

Key Path	Marker
Initial S/W Revision	Prior to A.02.00

Relative To

Sets the reference marker to which the selected marker is relative.

Key Path	Marker, Properties
Mode	SA, WCDMA, C2K, WIMAX OFDMA, 1xEVDO, DVB-T/H, DTMB (CTTB), ISDB-T, CMMB, LTE, LTETDD, Digital Cable TV, WLAN, MSR, LTEAFDD, LTEATDD
Remote Command	:CALCulate:CHPower:MARKer[1] 2 ... 12:REference <integer> :CALCulate:CHPower:MARKer[1] 2 ... 12:REference?
Example	CALC:CHP:MARK:REF 5 CALC:CHP:MARK:REF?
Notes	A marker cannot be relative to itself so that choice is grayed out, and if sent from SCPI generates error -221: "Settings conflict; marker cannot be relative to itself." When queried, a single value is returned (the specified marker numbers relative marker). You must be in the Spectrum Analysis or WCDMA mode to use this command. Use :INSTrument:SElect to set the mode.
Preset	2 3 4 5 6 7 8 9 10 11 12 1
State Saved	Saved in instrument state.
Min	1
Max	12
Initial S/W Revision	Prior to A.02.00
Modified at S/W Revision	A.02.00, A.03.00

All Markers Off

Turns off all markers.

Key Path	Marker
Mode	SA, WCDMA, C2K, WIMAX OFDMA, 1xEVDO, DVB-T/H, DTMB (CTTB), ISDB-T, CMMB, LTE, LTETDD, Digital Cable TV, WLAN, MSR, LTEAFDD, LTEATDD
Remote Command	:CALCulate:CHPower:MARKer:AOff
Example	CALC:CHP:MARK:AOff
Initial S/W Revision	Prior to A.02.00
Modified at S/W Revision	A.02.00, A.03.00

Marker X Axis Value (Remote Command Only)

Sets the marker X Axis value in the current marker X Axis Scale unit. It has no effect if the control mode is Off, but is the SCPI equivalent of entering an X value if the control mode is Normal, Delta, or Fixed.

Mode	SA, WCDMA, CDMA2K, WIMAXOFDMA, CDMA1XEV, DVB, DTMB, ISDBT, CMMB, LTE, LTETDD, DCATV, WLAN, MSR, LTEAFDD, LTEATDD
Remote Command	:CALCulate:CHPower:MARKer[1] 2 ... 12:X <real> :CALCulate:CHPower:MARKer[1] 2 ... 12:X?
Example	CALC:CHP:MARK3:X 0 CALC:CHP:MARK3:X?
Notes	The query returns the marker's absolute X Axis value if the control mode is Normal, or the offset from the marker's reference marker if the control mode is Delta. The query is returned in the fundamental units for the current marker X Axis scale: Hz for Frequency.
Preset	After a preset, all markers are turned OFF, so Marker X Axis Value query returns a not a number (NAN).
State Saved	Saved in instrument state.
Min	-9.9E+37
Max	9.9E+37
Initial S/W Revision	Prior to A.02.00
Modified at S/W Revision	A.02.00, A.03.00

Marker X Axis Position (Remote Command Only)

Sets the marker X Axis Scale position in trace points. This setting has no effect if the control mode is Off, but is the SCPI equivalent of entering a value if the control mode is Normal or Delta . The entered value is immediately translated into the current X Axis Scale units for setting the value of the marker.

Mode	SA, WCDMA, CDMA2K, WIMAXOFDMA, CDMA1XEV, DVB, DTMB, ISDBT, CMMB, LTE, LTETDD, DCATV, WLAN, MSR, LTEAFDD, LTEATDD
Remote Command	:CALCulate:CHPower:MARKer[1] 2 ... 12:X:POsition <real> :CALCulate:CHPower:MARKer[1] 2 ... 12:X:POsition?
Example	CALC:CHP:MARK10:X:POS 0

	CALC:CHP:MARK10:X:POS?
Notes	The query returns the marker's absolute X Axis value in trace points if the control mode is Normal, or the offset from the marker's reference marker in trace points if the control mode is Delta.
Preset	After a preset, all markers are turned OFF, so Marker X Axis Value query returns a not a number (NAN).
State Saved	Saved in instrument state.
Min	-9.9E+37
Max	9.9E+37
Initial S/W Revision	Prior to A.02.00
Modified at S/W Revision	A.02.00, A.03.00

Marker Y Axis Value (Remote Command only)

Returns the marker Y Axis value in the current marker Y Axis unit.

Mode	SA, WCDMA, CDMA2K, WIMAXOFDMA, CDMA1XEV, DVB, DTMB, ISDBT, CMMB, LTE, LTETDD, DCATV, WLAN, MSR, LTEAFDD, LTEATDD
Remote Command	:CALCulate:CHPower:MARKer[1] 2 ... 12:Y?
Example	CALC:CHP:MARK11:Y?
Preset	Result dependent on Markers setup and signal source.
State Saved	Saved in instrument state.
Initial S/W Revision	Prior to A.02.00
Modified at S/W Revision	A.02.00, A.03.00

Backward Compatibility SCPI Commands

Sets or queries the state of a marker. Setting a marker which is OFF to state ON or 1 puts it in Normal mode and places it at the center of the screen.

Mode	SA, WCDMA, CDMA2K, WIMAXOFDMA, CDMA1XEV, DVB, DTMB, ISDBT, CMMB, LTE, LTETDD, DCATV, WLAN, MSR, LTEAFDD, LTEATDD
Remote Command	:CALCulate:CHPower:MARKer[1] 2 ... 12:STATe OFF ON 0 1 :CALCulate:CHPower:MARKer[1] 2 ... 12:STATe?
Example	CALC:CHP:MARK3:STAT ON CALC:CHP:MARK3:STAT?
Preset	OFF
State Saved	Saved in instrument state.
Range	On Off
Initial S/W Revision	Prior to A.02.00
Modified at S/W Revision	A.02.00, A.03.00

Marker Function

There are no 'Marker Functions' supported in Channel Power, so this front-panel key displays a blank menu when pressed.

Key Path	Front-panel key
Initial S/W Revision	Prior to A.02.00

Marker To

There is no 'Marker To' functionality supported in Channel Power measurement, so this front-panel key displays a blank key menu when pressed.

Key Path	Front-panel key
Initial S/W Revision	Prior to A.02.00

Meas

The information in this section is common to all measurements. For key and remote command information for a specific measurement, refer to the section that describes the measurement of interest.

Measurements available under the Meas key are specific to the current Mode.

When viewing Help for measurements, note the following:

NOTE

Operation for some keys differs between measurements. The information displayed in Help pertains to the current measurement. To see how a key operates in a different measurement, exit Help (press the Cancel Esc key), select the measurement, then reenter Help (press the Help key) and press that key.

Key Path	Front-panel key
Initial S/W Revision	Prior to A.02.00

Remote Measurement Functions

This section contains the following topics:

["Measurement Group of Commands" on page 2206](#)

["Current Measurement Query \(Remote Command Only\)" on page 2208](#)

["Limit Test Current Results \(Remote Command Only\)" on page 2208](#)

["Data Query \(Remote Command Only\)" on page 2208](#)

["Calculate/Compress Trace Data Query \(Remote Command Only\)" on page 2209](#)

["Calculate Peaks of Trace Data \(Remote Command Only\)" on page 2214](#)

[Hardware-Accelerated Fast Power Measurement \(Remote Command Only\)](#)

["Format Data: Numeric Data \(Remote Command Only\)" on page 2215](#)

["Format Data: Byte Order \(Remote Command Only\)" on page 2216](#)

Initial S/W Revision	Prior to A.02.00
----------------------	------------------

Measurement Group of Commands

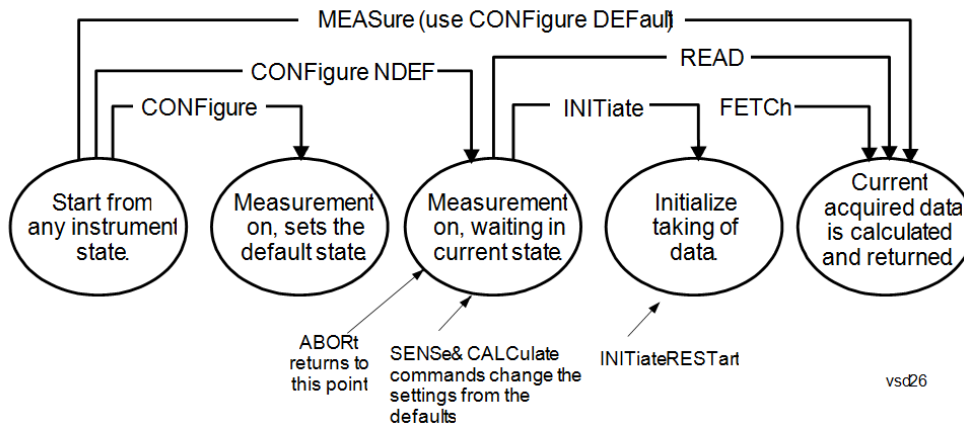

Measure Commands:

:MEASure:<measurement>[n]?

This is a fast single-command way to make a measurement using the factory default instrument settings. These are the settings and units that conform to the Mode Setup settings (e.g. radio standard) that you have currently selected.

- Stops the current measurement (if any) and sets up the instrument for the specified measurement using the factory defaults
- Initiates the data acquisition for the measurement
- Blocks other SCPI communication, waiting until the measurement is complete before returning results.
- If the function does averaging, it is turned on and the number of averages is set to 10.
- After the data is valid it returns the scalar results, or the trace data, for the specified measurement. The type of data returned may be defined by an [n] value that is sent with the command.
- The scalar measurement results will be returned if the optional [n] value is not included, or is set to 1. If the [n] value is set to a value other than 1, the selected trace data results will be returned. See each command for details of what types of scalar results or trace data results are available.
- ASCII is the default format for the data output. (Older versions of Spectrum Analysis and Phase Noise mode measurements only use ASCII.) The binary data formats should be used for handling large blocks of data since they are smaller and faster than the ASCII format. Refer to the FORMat:DATA command for more information.

If you need to change some of the measurement parameters from the factory default settings you can set up the measurement with the CONFIgure command. Use the commands in the SENSe:<measurement> and CALCulate:<measurement> subsystems to change the settings. Then you can use the READ? command to initiate the measurement and query the results.

If you need to repeatedly make a given measurement with settings other than the factory defaults, you can use the commands in the SENSe:<measurement> and CALCulate:<measurement> subsystems to set up the measurement. Then use the READ? command to initiate the measurement and query results.

Measurement settings persist if you initiate a different measurement and then return to a previous one. Use READ:<measurement>? if you want to use those persistent settings. If you want to go back to the default settings, use MEASure:<measurement>?.

Configure Commands:

:CONFIgure:<measurement>

This command stops the current measurement (if any) and sets up the instrument for the specified measurement using

the factory default instrument settings. It does not initiate the taking of measurement data unless INIT:CONTinuous is ON. If you change any measurement settings after using the CONFigure command, the READ command can be used to initiate a measurement without changing the settings back to their defaults.

In the Swept SA measurement in Spectrum Analyzer mode the CONFigure command also turns the averaging function on and sets the number of averages to 10 for all measurements.

:CONFigure: <measurement>: NDEFault stops the current measurement and changes to the specified measurement. It does not change the settings to the defaults. It does not initiate the taking of measurement data unless INIT:CONTinuous is ON.

The CONFigure? query returns the current measurement name.

The CONFigure:CATalog? query returns a quoted string of all licensed measurement names in the current mode. For example, "SAN, CHP, OBW, ACP, PST, TXP, SPUR, SEM, LIST".

Fetch Commands:

:FETCh:<measurement>[n]?

This command puts selected data from the most recent measurement into the output buffer. Use FETCh if you have already made a good measurement and you want to return several types of data (different [n] values, for example, both scalars and trace data) from a single measurement. FETCh saves you the time of re-making the measurement. You can only FETCh results from the measurement that is currently active, it will not change to a different measurement. An error message is reported if a measurement other than the current one is specified.

If you need to get new measurement data, use the READ command, which is equivalent to an INITiate followed by a FETCh.

The scalar measurement results will be returned if the optional [n] value is not included, or is set to 1. If the [n] value is set to a value other than 1, the selected trace data results will be returned. See each command for details of what types of scalar results or trace data results are available. The binary data formats should be used for handling large blocks of data since they are smaller and transfer faster than the ASCII format. (FORMat:DATA)

FETCh may be used to return results other than those specified with the original READ or MEASure command that you sent.

INITiate Commands:

:INITiate:<measurement>

This command is not available for measurements in all the instrument modes:

- Initiates a trigger cycle for the specified measurement, but does not output any data. You must then use the FETCh<meas> command to return data. If a measurement other than the current one is specified, the instrument will switch to that measurement and then initiate it.
 - For example, suppose you have previously initiated the ACP measurement, but now you are running the channel power measurement. If you send INIT:ACP? it will change from channel power to ACP and will initiate an ACP measurement.
 - Does not change any of the measurement settings. For example, if you have previously started the ACP measurement and you send INIT:ACP? it will initiate a new ACP measurement using the same instrument settings as the last time ACP was run.
 - If your selected measurement is currently active (in the idle state) it triggers the measurement, assuming the trigger conditions are met. Then it completes one trigger cycle. Depending upon the measurement and the number of averages, there may be multiple data acquisitions, with multiple trigger events, for one full trigger cycle. It also holds off additional commands on GPIB until the acquisition is complete.
-

READ Commands:

:READ:<measurement>[n]?

- Does not preset the measurement to the factory default settings. For example, if you have previously initiated the ACP
-

measurement and you send READ:ACP? it will initiate a new measurement using the same instrument settings.

- Initiates the measurement and puts valid data into the output buffer. If a measurement other than the current one is specified, the instrument will switch to that measurement before it initiates the measurement and returns results.
 - For example, suppose you have previously initiated the ACP measurement, but now you are running the channel power measurement. Then you send READ:ACP? It will change from channel power back to ACP and, using the previous ACP settings, will initiate the measurement and return results.
 - Blocks other SCPI communication, waiting until the measurement is complete before returning the results
 - If the optional [n] value is not included, or is set to 1, the scalar measurement results will be returned. If the [n] value is set to a value other than 1, the selected trace data results will be returned. See each command for details of what types of scalar results or trace data results are available. The binary data formats should be used when handling large blocks of data since they are smaller and faster than the ASCII format. (FORMat:DATA)
-

Initial S/W Revision	Prior to A.02.00
----------------------	------------------

Current Measurement Query (Remote Command Only)

This command returns the name of the measurement that is currently running.

Remote Command	:CONFigure?
-----------------------	-------------

Example	CONF?
----------------	-------

Initial S/W Revision	Prior to A.02.00
----------------------	------------------

Limit Test Current Results (Remote Command Only)

Queries the status of the current measurement limit testing. It returns a 0 if the measured results pass when compared with the current limits. It returns a 1 if the measured results fail any limit tests.

Remote Command	:CALCulate:CLIMits:FAIL?
-----------------------	--------------------------

Example	CALC:CLIM:FAIL? queries the current measurement to see if it fails the defined limits. Returns a 0 or 1: 0 it passes, 1 it fails.
----------------	--

Initial S/W Revision	Prior to A.02.00
----------------------	------------------

Data Query (Remote Command Only)

Returns the designated measurement data for the currently selected measurement and subopcode.

n = any valid subopcode for the current measurement. See the measurement command results table for your current measurement, for information about what data is returned for the subopcodes.

This command uses the data setting specified by the FORMat:BORDER and FORMat:DATA commands and can return real or ASCII data. (See the format command descriptions under Input/Output in the Analyzer Setup section.)

Remote Command	:CALCulate:DATA[n]?
Notes	The return trace depends on the measurement. In CALCulate:<meas>:DATA[n], n is any valid subopcode for the current measurement. It returns the same data as the FETCH:<measurement>? query where <measurement> is the current measurement.
Initial S/W Revision	Prior to A.02.00

Calculate/Compress Trace Data Query (Remote Command Only)

Returns compressed data for the currently selected measurement and sub-opcode [n].

n = any valid sub-opcode for that measurement. See the MEASure:<measurement>? command description of your specific measurement for information on the data that can be returned.

The data is returned in the current Y Axis Unit of the analyzer. The command is used with a sub-opcode <n> (default=1) to specify the trace. With trace queries, it is best if the analyzer is not sweeping during the query. Therefore, it is generally advisable to be in Single Sweep, or Update=Off.

This command is used to compress or decimate a long trace to extract and return only the desired data. A typical example would be to acquire N frames of GSM data and return the mean power of the first burst in each frame. The command can also be used to identify the best curve fit for the data.

Remote Command	:CALCulate:DATA<n>:COMPRESS? BLOCK CFIT MAXimum MINimum MEAN DMEan RMS RMSCubed SAMPLE SDEVIation PPHase [,<soffset> [,<length>[,<roffset>[,<rlimit>]]]]
Example	To query the mean power of a set of GSM bursts: Supply a signal that is a set of GSM bursts. Select the IQ Waveform measurement (in IQ Analyzer Mode). Set the sweep time to acquire at least one burst. Set the triggers such that acquisition happens at a known position relative to a burst. Then query the mean burst levels using, CALC:DATA2:COMP? MEAN, 24e-6, 526e-6 (These parameter values correspond to GSM signals, where 526e-6 is the length of the burst in the slot and you just want 1 burst.)
Notes	The command supports 5 parameters. Note that the last 4 (<soffset>, <length>, <roffset>, <rlimit>) are optional. But these optional parameters must be entered in the specified order. For example, if you want to specify <length>, then you must also specify <soffset>. See details below for a definition of each of these parameters. This command uses the data in the format specified by FORMat:DATA, returning either binary or ASCII data.
Initial S/W Revision	Prior to A.02.00

- BLOCK or block data - returns all the data points from the region of the trace data that you specify. For example, it could be used to return the data points of an input signal over several timeslots, excluding the portions of the trace data that you do not want. (This is x,y pairs for trace data and I,Q pairs for complex data.)

- CFIT or curve fit - applies curve fitting routines to the data. <soffset> and <length> are required to define the data that you want. <roffset> is an optional parameter for the desired order of the curve equation. The query will return the following values: the x-offset (in seconds) and the curve coefficients ((order + 1) values).

MIN, MAX, MEAN, DME, RMS, RMSC, SAMP, SDEV and PPH return one data value for each specified region (or <length>) of trace data, for as many regions as possible until you run out of trace data (using <roffset> to specify regions). Or they return the number of regions you specify (using <rlimit>) ignoring any data beyond that.

- MINimum - returns the minimum data point (y value) for the specified region(s) of trace data. For I/Q trace data, the minimum magnitude of the I/Q pairs is returned.
- MAXimum - returns the maximum data point (y value) for the specified region(s) of trace data. For I/Q trace data, the maximum magnitude of the I/Q pairs is returned.
- MEAN - returns a single value that is the arithmetic mean of the data point values (in dB/ dBm) for the specified region(s) of trace data. For I/Q trace data, the mean of the magnitudes of the I/Q pairs is returned. See the following equations.

-

NOTE

If the original trace data is in dB, this function returns the arithmetic mean of those log values, not log of the mean power which is a more useful value. The mean of the log is the better measurement technique when measuring CW signals in the presence of noise. The mean of the power, expressed in dB, is useful in power measurements such as Channel Power. To achieve the mean of the power, use the RMS option.

Equation 1

Mean Value of Data Points for Specified Region(s)

$$\text{MEAN} = \frac{1}{n} \sum_{X_i \in \text{region}(s)} X_i$$

where X_i is a data point value, and n is the number of data points in the specified region(s).

Equation 2

Mean Value of I/Q Data Pairs for Specified Region(s)

$$\text{MEAN} = \frac{1}{n} \sum_{X_i \in \text{region}(s)} |X_i|$$

where $|X_i|$ is the magnitude of an I/Q pair, and n is the number of I/Q pairs in the specified region(s).

- DMEan - returns a single value that is the mean power (in dB/ dBm) of the data point values for the specified region(s) of trace data. See the following equation:

Equation 3

DMEan Value of Data Points for Specified Region(s)

$$\text{DME} = 10 \times \log_{10} \left(\frac{1}{n} \sum_{X_i \in \text{region}(s)} 10^{\frac{X_i}{10}} \right)$$

- RMS - returns a single value that is the average power on a root-mean-squared voltage scale (arithmetic rms) of the data point values for the specified region(s) of trace data. See the following equation.

NOTE

For I/Q trace data, the rms of the magnitudes of the I/Q pairs is returned. See the following equation. This function is very useful for I/Q trace data. However, if the original trace data is in dB, this function returns the rms of the log values which is not usually needed.

Equation 4

RMS Value of Data Points for Specified Region(s)

$$\text{RMS} = \sqrt{\frac{1}{n} \sum_{X_i \in \text{region}(s)} X_i^2}$$

where X_i is a data point value, and n is the number of data points in the specified region(s).

Equation 5

RMS Value of I/Q Data Pairs for Specified Region(s)

$$\text{RMS} = \sqrt{\frac{1}{n} \sum_{X_i \in \text{region}(s)} X_i X_i^*}$$

where X_i is the complex value representation of an I/Q pair, X_i^* its conjugate complex number, and n is the number of I/Q pairs in the specified region(s).

Once you have the rms value for a region of trace data (linear or I/Q), you may want to calculate the mean power. You must convert this rms value (peak volts) to power in dBm:

$$10 \times \log[10 \times (\text{rms value})^2]$$

- SAMPLe - returns the first data value (x,y pair) for the specified region(s) of trace data. For I/Q trace data, the first I/Q pair is returned.
- SDEViation - returns a single value that is the arithmetic standard deviation for the data point values for the specified region(s) of trace data. See the following equation.
- For I/Q trace data, the standard deviation of the magnitudes of the I/Q pairs is returned. See the following equation.

Equation 6

Standard Deviation of Data Point Values for Specified Region(s)

$$\text{SDEV} = \sqrt{\frac{1}{n} \sum_{X_i \in \text{region}(s)} (X_i - \bar{X})^2}$$

where X_i is a data point value, \bar{X} is the arithmetic mean of the data point values for the specified region (s), and n is the number of data points in the specified region(s).

$$\text{SDEV} = \sqrt{\frac{1}{n} \sum_{X_i \in \text{region}(s)} (|X_i| - \bar{X})^2}$$

where $|X_i|$ is the magnitude of an I/Q pair, \bar{X} is the mean of the magnitudes for the specified region(s), and n is the number of data points in the specified region(s).

- PPHase - returns the x,y pairs of both rms power (dBm) and arithmetic mean phase (radian) for every specified region and frequency offset (Hz). The number of pairs is defined by the specified number of regions. This parameter can be used for I/Q vector ($n=0$) in Waveform (time domain) measurement and all parameters are specified by data point in PPHase.

The rms power of the specified region may be expressed as:

$$\text{Power} = 10 \times \log [10 \times (\text{RMS I/Q value})] + 10.$$

The RMS I/Q value (peak volts) is:

$$\sqrt{\frac{1}{n} \sum_{X_i \in \text{region}} X_i X_i^*}$$

where X_i is the complex value representation of an I/Q pair, X_i^* its conjugate complex number, and n is the number of I/Q pairs in the specified region.

The arithmetic mean phase of the specified region may be expressed as:

$$\frac{1}{n} \sum_{Y_i \in \text{region}} Y_i$$

where Y_i is the unwrapped phase of I/Q pair with applying frequency correction and n is the number of I/Q pairs in the specified region.

The frequency correction is made by the frequency offset calculated by the arithmetic mean of every specified region's frequency offset. Each frequency offset is calculated by the least square method against the unwrapped phase of I/Q pair.

Sample Trace Data - Constant Envelope

(See below for explanation of variables.)

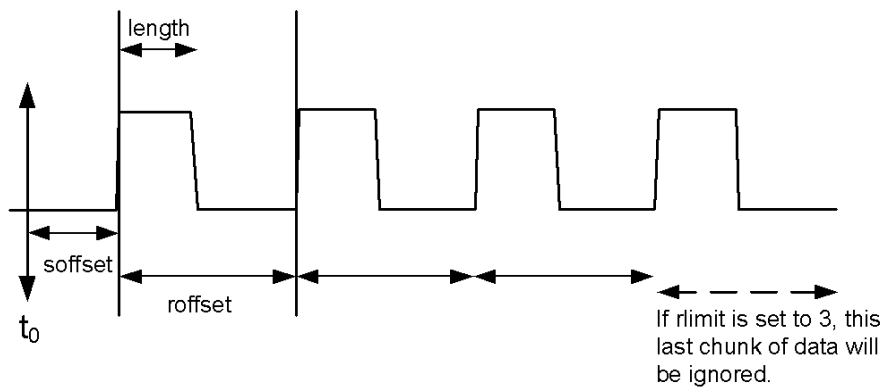

Sample Trace Data - Not Constant Envelope

(See below for explanation of variables.)

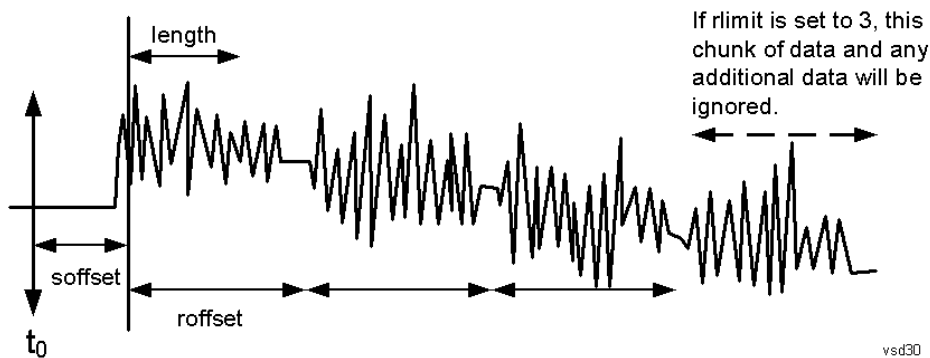

<soffset> - start offset is an optional real number. (It is in seconds for time-domain traces, and is a dimensionless index 0 to Npoints - 1, for frequency-domain traces). It specifies the amount of data at the beginning of the trace that will be ignored before the decimation process starts. It is the time or frequency change from the start of the trace to the point where you want to start using the data. The default value is zero.

<length> - is an optional real number. (It is in seconds for time-domain traces, and is a dimensionless index 0 to Npoints - 1, for frequency-domain traces). It defines how much data will be compressed into one value. This parameter has a default value equal to the current trace length.

<roffset> - repeat offset is an optional real number. (It is in seconds for time-domain traces, and is a dimensionless index 0 to Npoints - 1, for frequency-domain traces). It defines the beginning of the next field of trace elements to be compressed. This is relative to the beginning of the previous field. This parameter has a default value equal to the <length> variable. Note that this parameter is used for a completely different purpose when curve fitting (see CFIT above).

<rlimit> - repeat limit is an optional integer. It specifies the number of data items that you want returned. It will ignore any additional items beyond that number. You can use the Start offset and the Repeat limit to pick out exactly what part of the data you want to use. The default value is all the data.

Calculate Peaks of Trace Data (Remote Command Only)

Returns a list of all the peaks for the currently selected measurement and sub-opcode [n]. The peaks must meet the requirements of the peak threshold and excursion values.

n = any valid sub-opcode for the current measurement. See the MEASure:<measurement> command description of your specific measurement for information on the data that can be returned.

The command can only be used with specific sub-opcodes with measurement results that are trace data. Both real and complex traces can be searched, but complex traces are converted to magnitude in dBm. In many measurements the sub-opcode n=0, is the raw trace data which cannot be searched for peaks. And Sub-opcode n=1, is often calculated results values which also cannot be searched for peaks.

This command uses the data setting specified by the FORMat:BORDER and FORMat:DATA commands and can return real or ASCII data. If the format is set to INT,32, it returns REAL,32 data.

The command has four types of parameters:

- Threshold (in dBm)
- Excursion (in dB)
- Sorting order (amplitude, frequency, time)
- Optional in some measurements: Display line use (all, > display line, < display line)

Remote Command	<p>For Swept SA measurement:</p> <pre>:CALCulate:DATA[1] 2 ... 6:PEAKs? <threshold>,<excursion>[,AMPLitude FREQuency TIME[,ALL GTDLline LTDLine]]</pre> <p>For most other measurements:</p> <pre>:CALCulate:DATA[1] 2 ... 6:PEAKs? <threshold>,<excursion>[,AMPLitude FREQuency TIME]</pre>
-----------------------	---

Example	<p>Example for Swept SA measurement in Spectrum Analyzer Mode:</p> <p>CALC:DATA4:PEAK? -40, 10, FREQ, GTDL This will identify the peaks of trace 4 that are above -40 dBm, with excursions of at least 10 dB. The peaks are returned in order of increasing frequency, starting with the lowest frequency. Only the peaks that are above the display line are returned.</p> <p>Query Results 1:</p> <p>With FORMat:DATA REAL, 32 selected, it returns a list of floating-point numbers. The first value in the list is the number of peak points that are in the following list. A peak point consists of two values: a peak amplitude followed by its corresponding frequency (or time).</p> <p>If no peaks are found the peak list will consist of only the number of peaks, (0).</p>
----------------	---

Notes	<p><n> - is the trace that will be used</p> <p><threshold> - is the level below which trace data peaks are ignored. Note that the threshold value is required and is always used as a peak criterion. To effectively disable the threshold criterion for this command, provide a substantially low threshold value such as -200 dBm. Also note that the threshold value used in this command is independent of and has no effect on the threshold value stored under the Peak Criteria menu.</p> <p><excursion> - is the minimum amplitude variation (rise and fall) required for a signal to be identified as peak. Note that the excursion value is required and is always used as a peak criterion. To effectively disable the excursion criterion for this command, provide the minimum value of 0.0 dB. Also note that the excursion value used in this command is independent of and has no effect on the</p>
--------------	---

excursion value stored under the Peak Criteria menu.

Values must be provided for threshold and excursion. The sorting and display line parameters are optional (defaults are AMPLitude and ALL).

Note that there is always a Y-axis value for the display line, regardless of whether the display line state is on or off. It is the current Y-axis value of the display line which is used by this command to determine whether a peak should be reported

Sorting order:

AMPLitude - lists the peaks in order of descending amplitude, with the highest peak first (default if optional parameter not sent)

FREQuency - lists the peaks in order of occurrence, left to right across the x-axis.

TIME - lists the peaks in order of occurrence, left to right across the x-axis.

Peaks vs. Display Line:

ALL - lists all of the peaks found (default if optional parameter not sent).

GTDLine (greater than display line) - lists all of the peaks found above the display line.

LTDLine (less than display line) - lists all of the peaks found below the display line.

Initial S/W Revision Prior to A.02.00

Format Data: Numeric Data (Remote Command Only)

This command specifies the format of the trace data input and output. It specifies the formats used for trace data during data transfer across any remote port. It affects only the data format for setting and querying trace data for the :TRACe[:DATA], TRACe[:DATA]?, :CALCulate:DATA[n]? and FETCh:SANalyzer [n]? commands and queries.

Remote Command :FORMat [:TRACe] [:DATA] ASCii|INTeger,32|REAL,32 |REAL,64
:FORMat [:TRACe] [:DATA] ?

Notes The query response is:
ASCii: ASC,8
REAL,32: REAL,32
REAL,64: REAL,64
INTeger,32: INT,32

When the numeric data format is REAL or ASCii, data is output in the current Y Axis unit. When the data format is INTeger, data is output in units of m dBm (.001 dBm).

The INT,32 format returns binary 32-bit integer values in internal units (m dBm), in a definite length block.

Dependencies Sending a data format spec with an invalid number (for example, INT,48) generates no error. The analyzer simply uses the default (8 for ASCii, 32 for INTeger, 32 for REAL).

Sending data to the analyzer which does not conform to the current FORMat specified, results in an error. Sending ASCII data when a definite block is expected generates message -161 "Invalid Block Data" and sending a definite block when ASCII data is expected generates message -121 "Invalid Character in Number".

Preset ASCii

Backwards Compatibility Notes Note that the INT,32 format is only applicable to the command, TRACe:DATA. This preserves backwards compatibility for the Swept SA measurement. For all other commands/queries which honor FORMat:DATA, if INT,32 is sent the analyzer will behave as though it were set to REAL,32.

Initial S/W Revision Prior to A.02.00

The specs for each output type follow:

ASCIi - Amplitude values are in ASCII, in the current Y Axis Unit, one ASCII character per digit, values separated by commas, each value in the form:

SX.YYYYYEsZZ

Where:

S = sign (+ or -)

X = one digit to left of decimal point

Y = 5 digits to right of decimal point

E = E, exponent header

s = sign of exponent (+ or -)

ZZ = two digit exponent

REAL,32 - Binary 32-bit real values in the current Y Axis Unit, in a definite length block.

REAL,64 - Binary 64-bit real values in the current Y Axis Unit, in a definite length block.

Format Data: Byte Order (Remote Command Only)

This command selects the binary data byte order for data transfer and other queries. It controls whether binary data is transferred in normal or swapped mode. This command affects only the byte order for setting and querying trace data for the :TRACe[:DATA], TRACe[:DATA]? , :CALCulate:DATA[n]? and FETCh:SANalyzer[n]? commands and queries.

By definition any command that says it uses FORMat:DATA uses any format supported by FORMat:DATA.

The NORMal order is a byte sequence that begins with the most significant byte (MSB) first, and ends with the least significant byte (LSB) last in the sequence: 1|2|3|4. SWAPped order is when the byte sequence begins with the LSB first, and ends with the MSB last in the sequence: 4|3|2|1.

Remote Command	:FORMat:BORDER NORMal SWAPped :FORMat:BORDER?
Preset	NORMal
Initial S/W Revision	Prior to A.02.00

Meas Setup

Displays the setup menu for the currently selected measurement. The parameters included in this menu are as follows.

Averaging

IF Gain

Channel Power Span

Integrated Bandwidth

Filter Bandwidth

Root Raised Cosine (RRC) Filter

Key Path	Front-panel key
Initial S/W Revision	Prior to A.02.00

Avg/Hold Num

Specifies the number of measurement averages used to calculate the measurement result. The average is displayed at the end of each sweep. After the specified number of average counts, the averaging mode (terminal control) setting determines the averaging action.

Key Path	Meas Setup
Mode	SA, WCDMA, C2K, WIMAX OFDMA, 1xEVDO, DVB-T/H, DTMB (CTTB), ISDB-T, CMMB, LTE, LTETDD, Digital Cable TV, WLAN, MSR, LTEAFDD, LTEATDD
Remote Command	[:SENSe]:CHPower:AVERage:COUNT <integer> [:SENSe]:CHPower:AVERage:COUNT? [:SENSe]:CHPower:AVERage[:STATe] ON OFF 1 0 [:SENSe]:CHPower:AVERage[:STATe]?
Example	CHP:AVER:COUN 15 CHP:AVER:COUN? CHP:AVER ON CHP:AVER?
Notes	You must be in the Spectrum Analysis mode, W-CDMA mode, cdma2000 mode, DVB-T/H mode, DTMB (CTTB) mode, ISDB-T mode, CMMB mode, Digital Cable TV mode, LTE mode, LTE TDD mode 1xEVDO mode or WIMAX OFDMA mode to use this command. Use :INSTRument:SElect to set the mode.
Preset	SA: 10 WCDMA: 200 WIMAX OFDMA, LTE, LTETDD, MSR: 200 CDMA2K: 20 1xEVDO: 20

	DVB-T/H: 20 DTMB (CTTB): 20 ISDB-T: 10 CMMB: 10 Digital Cable TV: 10 WLAN: 10 LTEAFDD, LTEATDD:200 ON
State Saved	Saved in instrument state.
Min	1
Max	10000
Initial S/W Revision	Prior to A.02.00
Modified at S/W Revision	A.02.00, A.03.00

Avg Mode

Allows you to select the type of termination control used for the averaging function. This determines the averaging action after the specified number of data acquisitions (average count) is reached.

When set to Exponential (Exp) the measurement averaging continues using the specified number of averages to compute each exponentially-weighted averaged value. The average is displayed at the end of each sweep.

When set to Repeat, the measurement resets the average counter each time the specified number of averages is reached.

Key Path	Meas Setup
Mode	SA, WCDMA, C2K, WIMAX OFDMA, 1xEVDO, DVB-T/H, DTMB (CTTB), ISDB-T, CMMB, LTE, LTEATDD, Digital Cable TV, WLAN, MSR, LTEAFDD, LTEATDD
Remote Command	[:SENSe] :CHPower:AVERage:TCONtrol EXPonential REPeat [:SENSe] :CHPower:AVERage:TCONtrol?
Example	CHP:AVER:TCON EXP CHP:AVER:TCON?
Notes	You must be in the Spectrum Analysis mode, W-CDMA mode, cdma2000 mode, DVB-T/H mode, DTMB (CTTB) mode, ISDB-T mode, CMMB mode, Digital Cable TV mode, LTE mode, LTE TDD mode, WLAN mode, 1xEVDO mode or WIMAX OFDMA mode to use this command. Use :INSTRument:SElect to set the mode.
Preset	EXP
State Saved	Saved in instrument state.
Range	Exp Repeat
Initial S/W Revision	Prior to A.02.00
Modified at S/W Revision	A.02.00, A.03.00

Integ BW

Specifies the range of integration used in calculating the power in the channel. The integration bandwidth (IBW) is displayed on the trace as two markers connected by an arrow.

Key Path	Meas Setup
Mode	SA, WCDMA, C2K, WIMAX OFDMA, 1xEVDO, DVB-T/H, DTMB (CTTB), ISDB-T, CMMB, LTE, LTETDD, Digital Cable TV, WLAN
Remote Command	[:SENSe] :CHPower:BANDwidth:INTegration <bandwidth> [:SENSe] :CHPower:BANDwidth:INTegration?
Example	CHP:BAND:INT 10MHz CHP:BAND:INT?
Notes	You must be in the Spectrum Analysis mode, W-CDMA mode, cdma2000 mode, DVB-T/H mode, DTMB (CTTB) mode, ISDB-T mode, CMMB mode, Digital Cable TV mode, LTE mode, LTE TDD mode, WLAN mode, 1xEVDO mode or WIMAX OFDMA mode to use this command. Use :INSTrument:SElect to set the mode.
Dependencies	For MSR/LTE-Advanced FDD/TDD mode, this key is blank.
Couplings	The minimum value of the span is coupled with the integration bandwidth.
Preset	SA: 2 MHz WCDMA: 5 MHz C2K: 1.23 MHz WIMAX OFDMA: 10 MHz 1xEVDO: 1.23 MHz DVB-T/H: 7.61MHz DTMB (CTTB): 8MHz ISDB-T: 5.6MHz CMMB: 8MHz LTE: 5 MHz LTETDD: 5 MHz Digital Cable TV: 8MHz WLAN: if Radio Std is 802.11a/g(OFDM/DSSS-OFDM): 20 MHz if Radio Std is 802.11b: 25 MHz if Radio Std is 802.11n(20MHz): 20 MHz if Radio Std is 802.11n(40MHz): 40 MHz if Radio Std is 802.11ac (20 MHz): 20 MHz if Radio Std is 802.11ac (40 MHz): 40 MHz if Radio Std is 802.11ac (80 MHz): 80 MHz if Radio Std is 802.11ac (160 MHz): 160 MHz if Radio Std is 802.11ac (80 MHz + 80 MHz): 80 MHz

State Saved	Saved in instrument state.
Min	100 Hz
Max	Hardware Maximum Span
Initial S/W Revision	Prior to A.02.00
Modified at S/W Revision	A.02.00, A.03.00

PhNoise Opt

Selects the LO (local oscillator) phase noise behavior for various operating conditions. Refer to PhNoise Opt

in the Swept SA measurement for details.

Key Path	Meas Setup
Initial S/W Revision	A.04.20

PhNoise Opt Auto

Selects the LO (local oscillator) phase noise behavior to optimize dynamic range and speed for various instrument operating conditions. Refer to PhNoise Opt Auto State in the Swept SA measurement for details.

Key Path	Meas Setup
Remote Command	<code>[:SENSe] :CHPower:FREQuency:SYNThesis:AUTO [:STATe] OFF ON 0 1</code> <code>[:SENSe] :CHPower:FREQuency:SYNThesis:AUTO [:STATe] ?</code>
Example	CHP:FREQ:SYNT:AUTO 1 CHP:FREQ:SYNT:AUTO?
Preset	OFF
State Saved	Saved in instrument state.
Range	Auto Man
Readback Text	“Auto” is underlined when Auto is selected, otherwise Man is underlined.
Initial S/W Revision	A.04.20

PhNoise Opt State

Selects the LO (local oscillator) phase noise behavior for various operating conditions. Refer to PhNoise Opt in the Swept SA measurement for details.

Key Path	Meas Setup
----------	------------

Remote Command	<code>[:SENSe] :CHPower:FREQuency:SYNTHeSis [:STATe] 1 2 3</code> <code>[:SENSe] :CHPower:FREQuency:SYNTHeSis [:STATe] ?</code>
Example	CHP:FREQ:SYNT 1 CHP:FREQ:SYNT?
Notes	Parameter key: 1. optimizes phase noise for close-in from the carrier. 2. optimizes phase noise for wide-offset from the carrier. 3. optimizes LO for tuning speed.
Couplings	Best Close-in Φ Noise The frequency below which the phase noise is optimized is model dependent: PXA with option EP1: [offset <140 kHz] Models with option EP2: [offset <70 kHz] CXA with option EP4: [offset <90 kHz] CXA without option EP4: n/a All other models: [offset <20 kHz] Best Wide-offset Φ Noise The frequency below which the phase noise is optimized is model dependent: PXA with option EP1: [offset >160 kHz] Models with option EP2: [offset >100 kHz] CXA with option EP4: [offset >130 kHz] CXA without option EP4: n/a All other models: [offset >30 kHz] Fast Tuning The Fast Tuning details are model dependent: CXA without option EP4: n/a PXA with option EP1: [single loop] Models with option EP2: [medium loop bandwidth] All other models: [same as Close-in]
Preset	3
State Saved	Saved in instrument state.
Range	Best Close-in Φ Noise [offset < 140 kHz] Best Wide-offset Φ Noise [offset > 160 kHz] Fast Tuning [same as Close-in] [] is model dependent. See Couplings for details.
Initial S/W Revision	A.04.20

IF Gain

Sets the IF Gain function to Auto, Low Gain or High Gain. These settings affect sensitivity and IF overloads.

Key Path	Meas Setup
-----------------	------------

Dependencies	The IF Gain keys (FFT IF Gain and Swept IF Gain) have no effect when the U7227A USB Preamplifier is connected. This is not annotated or reflected on any softkey; there are no keys grayed out nor any SCPI locked out. The analyzer simply behaves as though both FFT IF Gain and Swept IF Gain are set to Low regardless of the setting on the keys.
Initial S/W Revision	Prior to A.02.00

IF Gain Auto

Activates the auto rules for IF Gain. When Auto is active, the IF Gain is set to High Gain under any of the following conditions:

- The input attenuator is set to 0 dB
- The preamp is turned On and the frequency range is under 3.6 GHz

For other settings, Auto sets the IF Gain to Low Gain.

Key Path	Meas Setup, IF Gain
Remote Command	[:SENSe] :CHPower : IF : GAIN : AUTO [: STATe] ON OFF 1 0 [:SENSe] :CHPower : IF : GAIN : AUTO [: STATe] ?
Example	CHP:IF:GAIN:AUTO ON CHP:IF:GAIN:AUTO?
Couplings	When the auto attenuation exists (for example, with an electrical attenuator), IF Gain State differs depending on the condition. Auto sets IF Gain to High Gain under any of the following conditions: The input attenuator is set to 0 dB, or the preamp is turned on and the frequency range is under 3.6 GHz. For other conditions, Auto sets IF Gain to Low Gain.
Preset	OFF
State Saved	Saved in instrument state.
Range	Off On
Initial S/W Revision	Prior to A.02.00

IF Gain State

Selects the range of the IF Gain.

Key Path	Meas Setup, IF Gain
Remote Command	[:SENSe] :CHPower : IF : GAIN [: STATe] ON OFF 1 0 [:SENSe] :CHPower : IF : GAIN [: STATe] ?
Example	CHP:IF:GAIN ON CHP:IF:GAIN?
Notes	ON = high gain OFF = low gain

Couplings	When the auto attenuation exists (for example, with an electrical attenuator), IF Gain State differs depending on the condition. Auto sets IF Gain to High Gain under any of the following conditions: The input attenuator is set to 0 dB, or the preamp is turned on and the frequency range is under 3.6 GHz. For other conditions, Auto sets IF Gain to Low Gain.
Preset	OFF
State Saved	Saved in instrument state.
Range	Low Gain High Gain
Initial S/W Revision	Prior to A.02.00

Method

Turns the Root Raised Cosine (RRC) filter On or Off. The α value (roll off) for the filter is set to the value of the Filter Alpha parameter, and the RRC filter bandwidth is set to the Filter BW parameter.

Key Path	Meas Setup
Mode	SA, WCDMA,WIMAX OFDMA, DVB-T/H, DTMB (CTTB), ISDB-T, CMMB, LTE, LTETDD, Digital Cable TV, WLAN
Remote Command	[:SENSe] :CHPower:FILTer [:RRC] [:STATe] OFF ON 0 1 [:SENSe] :CHPower:FILTer [:RRC] [:STATe] ?
Example	CHP:FILT OFF CHP:FILT?
Notes	This parameter is normally used when TETRA is selected as the Radio Std. You must be in the Spectrum Analysis mode, DVB-T/H mode, DTMB (CTTB) mode, ISDB-T mode, CMMB mode, LTE mode, LTE TDD mode, WLAN mode,WIMAX OFDMA mode or W-CDMA mode to use this command. Use :INSTrument:SElect to set the mode.
Dependencies	For CDMA2K mode, this key is blank. For 1xEVDO mode, this key is blank. For MSR mode, this key is blank. For LTE-Advanced FDD/TDD mode, this key is blank. For WLAN 802.11 ac (80 + 80 MHz), RRC Weighted is not supported .
Preset	OFF
State Saved	Saved in instrument state.
Range	Integ BW RRC Weighted
Initial S/W Revision	Prior to A.02.00
Modified at S/W Revision	A.02.00, A.03.00, A.10.00

Method

Turns the Root Raised Cosine (RRC) filter On or Off. The α value (roll off) for the filter is set to the value of the Filter Alpha parameter, and the RRC filter bandwidth is set to the Filter BW parameter.

Key Path	Meas Setup
Mode	SA, WCDMA,WIMAX OFDMA, DVB-T/H, DTMB (CTTB), ISDB-T, CMMB, LTE, LTETDD, Digital Cable TV, WLAN
Remote Command	[:SENSe] :CHPower:FILTer[:RRC] [:STATe] OFF ON 0 1 [:SENSe] :CHPower:FILTer[:RRC] [:STATe] ?
Example	CHP:FILT OFF CHP:FILT?
Notes	This parameter is normally used when TETRA is selected as the Radio Std. You must be in the Spectrum Analysis mode, DVB-T/H mode, DTMB (CTTB) mode, ISDB-T mode, CMMB mode, LTE mode, LTE TDD mode, WLAN mode,WIMAX OFMDA mode or W-CDMA mode to use this command. Use :INSTrument:SElect to set the mode.
Dependencies	For CDMA2K mode, this key is blank. For 1xEVDO mode, this key is blank. For MSR mode, this key is blank. For LTE-Advanced FDD/TDD mode, this key is blank. For WLAN 802.11 ac (80 + 80 MHz), RRC Weighted is not supported .
Preset	OFF
State Saved	Saved in instrument state.
Range	Integ BW RRC Weighted
Initial S/W Revision	Prior to A.02.00
Modified at S/W Revision	A.02.00, A.03.00, A.10.00

Filter Alpha

Inputs the alpha value for the Root Raised Cosine (RRC) filter.

Key Path	Meas Setup, Method
Mode	SA, WCDMA,WIMAX OFDMA, DVB-T/H, DTMB (CTTB), ISDB-T, CMMB, LTE, LTETDD, Digital Cable TV, WLAN
Remote Command	[:SENSe] :CHPower:FILTer[:RRC] :ALPHa <real> [:SENSe] :CHPower:FILTer[:RRC] :ALPHa?
Example	CHP:FILT:ALPH 0.5 CHP:FILT:ALPH?
Notes	This parameter is normally used when TETRA is selected as the Radio Std. You must be in the Spectrum Analysis mode, DVB-T/H mode, DTMB (CTTB) mode, ISDB-T mode, CMMB mode, LTE mode, LTE TDD mode, WLAN mode,WIMAX OFMDA mode or W-CDMA mode to use this command. Use :INSTrument:SElect to set the mode.

Dependencies	For CDMA2K mode, this key is blank. For 1xEVDO mode, this key is blank. For MSR mode, this key is blank. For LTE-Advanced FDD/TDD mode, this key is blank
Preset	SA, WCDMA, , WIMAX OFDMA, DVB-T/H, ISDB-T, CMMB, LTE, LTETDD, WLAN: 0.22 DTMB (CTTB): 0.05 Digital Cable TV: 0.15
State Saved	Saved in instrument state.
Min	0.01
Max	1.00
Initial S/W Revision	Prior to A.02.00
Modified at S/W Revision	A.02.00, A.03.00, A.10.00

Filter BW

Inputs the Root Raised Cosine (RRC) filter bandwidth. Normally, the filter bandwidth is the same as the symbol rate of the signal.

Key Path	Meas Setup, Method, RRC Weighted
Mode	SA, WCDMA,WIMAX OFDMA, DVB-T/H, DTMB (CTTB), ISDB-T, CMMB, LTE, LTETDD, Digital Cable TV, WLAN
Remote Command	<code>[:SENSe] :CHPower:FILTer [:RRC] :BANDwidth <real></code> <code>[:SENSe] :CHPower:FILTer [:RRC] :BANDwidth?</code>
Example	CHP:FILT:BAND 10MHz CHP:FILT:BAND?
Notes	This parameter is normally used when TETRA is selected as the Radio Std. You must be in the Spectrum Analysis mode, DVB-T/H mode, DTMB (CTTB) mode, ISDB-T mode, CMMB mode, LTE mode, LTE TDD mode, WLAN mode,WIMAX OFDMA mode or W-CDMA mode to use this command. Use :INSTRument:SElect to set the mode.
Dependencies	For CDMA2K mode, this key is blank. For 1xEVDO mode, this key is blank. For MSR mode, this key is blank. For LTE-Advanced FDD/TDD, this key is blank.
Preset	SA, LTE, LTETDD: 3.84MHz WCDMA: 3.84MHz WIMAX OFDMA: 10MHz DVB-T/H: 8MHz DTMB (CTTB): 7.56MHz ISDB-T: 5.6MHz CMMB: 7.512MHz

	Digital Cable TV: 6.9MHz WLAN: if Radio Std is 802.11a/g(OFDM/DSSS-OFDM): 16.6 MHz if Radio Std is 802.11b: 22 MHz if Radio Std is 802.11n(20MHz): 17.8 MHz if Radio Std is 802.11n(40MHz): 36.6 MHz
State Saved	Saved in instrument state.
Min	100 Hz
Max	100 MHz
Backwards Compatibility SCPI	[:SENSe] :CHPower :FILTer [:RRC] :BWIDth
Initial S/W Revision	Prior to A.02.00
Modified at S/W Revision	A.02.00, A.03.00, A.10.00

Limits

Accesses the Limits menu that allows you to set up the test limit for channel power or power spectral density.

When DVB-T/H mode or DTMB (CTTB) mode is selected or DVB-T radio standard is selected in SA mode, this functionality is disabled and input signal will be compared against pre-defined spectrum mask, instead. See 1.3.2 Limit Line Mask for DVB-T for more details.

In DVB-T/H, DTMB (CTTB), ISDB-T, CMMB mode, this key is blank. If DVB-T is selected as current Radio Std in SA Mode, this key is grayed out.

In MSR, LTE-Advanced FDD/TDD mode, this feature is not supported and the key is blank because the power of each carrier may be different.

Key Path	Meas Setup
Initial S/W Revision	A.10.00

Power Limit

If Power Limit is on, Power Limit is used as threshold which can judge whether the real measured channel power can be passed or not. If real measured channel power exceeds Power Limit, channel power test fails, otherwise, it passes. If Power Limit is off, channel power test is always passed.

Key Path	Meas Setup, Limits
Mode	SA, WCDMA, C2K, WIMAX OFDMA, 1xEVDO, LTE, LTETDD, Digital Cable TV, WLAN
Remote Command	:CALCulate:CHPower:LIMit:POWer <ampl> :CALCulate:CHPower:LIMit:POWer? :CALCulate:CHPower:LIMit:POWer:STATe OFF ON 0 1

	:CALCulate:CHPower:LIMit:POWer:STATe?
Example	CALC:CHP:LIM:POW 16.00 CALC:CHP:LIM:POW? CALC:CHP:LIM:POW:STAT ON CALC:CHP:LIM:POW:STAT?
Notes	This parameter and PSD Limit can determine Pass/Fail criteria. If ((power limit = On) and (PSD limit= Off)) Pass if (power test passes) Fail if (power test fails) If ((power limit = On) and (PSD limit= On)) Pass if (both power test and PSD test pass) Fail if (either of power test or PSD test fails) If ((power limit = Off) and (PSD limit= On)) Pass if (PSD test passes) Fail if (PSD test fails) If ((power limit = Off) and (PSD limit= Off)) Always Pass For MSR mode, this key is blank. For LTE-Advanced FDD/TDD mode, this key is blank. For WLAN 802.11 ac (80 MHz + 80 MHz), the power test and the PSD test are performed to both carriers. Which means the power (or PSD) readouts of both carriers should be compared with the power (or PSD) limit individually, and the test passes only when both values are lower than the limit.
Preset	16.00 SA, WCDMA, C2K, WIMAX OFDMA, 1xEVDO, DVB-T/H, DTMB (CTTB), LTE, LTETDD, Digital Cable TV: OFF WLAN: ON
State Saved	Saved in instrument state.
Min	-200.0
Max	200.0
Initial S/W Revision	A.10.00

PSD Limit

If PSD (power spectral density) Limit is ON, PSD Limit is used as threshold which can judge whether the real measured PSD can be passed or not. If real measured PSD exceeds PSD Limit, PSD test fails, otherwise, it passes. If PSD is off, PSD test is always passed.

Key Path	Meas Setup, Limits
Mode	SA, WCDMA, C2K, WIMAX OFDMA, 1xEVDO, LTE, LTETDD, Digital Cable TV, WLAN
Remote Command	:CALCulate:CHPower:LIMit:PSDeNsity <real> :CALCulate:CHPower:LIMit:PSDeNsity?

	:CALCulate:CHPower:LIMit:PSDensity:STATe OFF ON 0 1 :CALCulate:CHPower:LIMit:PSDensity:STATe?
Example	CALC:CHP:LIM:PSD 4.00 CALC:CHP:LIM:PSD? CALC:CHP:LIM:POW:STAT ON CALC:CHP:LIM:POW:STAT?
Notes	This parameter and Power Limit can determine Pass/Fail criteria. If ((power limit = On) and (PSD limit= Off)) Pass if (power test passes) Fail if (power test fails) If ((power limit = On) and (PSD limit= On)) Pass if (both power test and PSD test pass) Fail if (either of power test or PSD test fails) If ((power limit = Off) and (PSD limit= On)) Pass if (PSD test passes) Fail if (PSD test fails) If ((power limit = Off) and (PSD limit= Off)) Always Pass For MSR mode, this key is blank. For LTE-Advanced FDD/TDD mode, this key is blank. For WLAN 802.11ac (80 MHz + 80 MHz), the power test and the PSD test are performed to both carriers. Which means the PSD (or power) readouts of both carriers should be compared with the PSD (or power) limit individually, and the test passes only when both values are lower than the limit.
Couplings	The value is automatically converted when PSD Unit is changed.
Preset	4.00 SA, WCDMA, C2K, WIMAX OFDMA, 1Xevdo, LTE, LTETDD, Digital Cable TV: OFF WLAN: ON
State Saved	Saved in instrument state.
Min	-200.0
Max	200.0
Initial S/W Revision	A.10.00

Power Limit Fail (remote command only)

The command is query only and used to query if power test passes or fails. When DVB-T/H mode or DTMB (CTTB) mode is selected or DVB-T radio standard is selected in SA mode, this query SCPI command does not make any sense.

Remote Command	:CALCulate:CHPower:LIMit:POWer:FAIL?
-----------------------	--------------------------------------

Example	CALC:CHP:LIM:POW:FAIL?
Notes	This command is query only. When Power Limit is off, the returned value is always 0 (pass). When Power Limit is on, the returned value is 0(pass) while power test passes and 1(fail) while power test fails. In MSR, LTE-Advanced FDD/TDD mode, this feature is not supported.
Initial S/W Revision	A.10.00

PSD Limit Fail (remote command only)

The command is query only and used to query if PSD test passes or fails. When DVB-T/H mode or DTMB (CTTB) mode is selected or DVB-T radio standard is selected in SA mode, this query SCPI command does not make any sense.

Remote Command	:CALCulate:CHPower:LIMit:PSD:FAIL?
Example	CALC:CHP:LIM:PSD:FAIL?
Notes	This command is query only. When PSD Limit is off, the returned value is always 0 (pass). When PSD Limit is on, the returned value is 0(pass) while PSD test passes and 1(fail) while PSD test fails.
Initial S/W Revision	A.10.00

Meas Preset

Restores all the measurement parameters to their default values.

Key Path	Meas Setup
Mode	SA, WCDMA, C2K, WIMAX OFDMA, 1xEVDO, DVB-T/H, DTMB (CTTB), ISDB-T, CMMB, LTE, LTETDD, Digital Cable TV, WLAN, MSR, LTEAFDD, LTEATDD
Remote Command	:CONFigure:CHPower
Example	CONF:CHP
Initial S/W Revision	Prior to A.02.00
Modified at S/W Revision	A.02.00, A.03.00

PSD Unit

Sets the unit bandwidth for Power Spectral Density. The available units are dBm/Hz and dBm/MHz.

Key Path	Meas Setup
Mode	SA, WCDMA, WIMAX OFDMA, 1xEVDO, DVB-T/H, DTMB (CTTB), LTE, LTETDD, Digital Cable TV,

	WLAN, MSR, LTEAFDD, LTEATDD
Remote Command	:UNIT:CHPower:POWer:PSD DBMHZ DBMMHZ :UNIT:CHPower:POWer:PSD?
Example	UNIT:CHP:POW:PSD DBMMHZ UNIT:CHP:POW:PSD?
Couplings	When the PSD unit is changed, the PSD result of the “MEAS READ FETCH:CHP1?” is also changed by the PSD unit basis (in either dBm/Hz or dBm/MHz).
Preset	DBMHZ WLAN: DBMMHZ
State Saved	Saved in instrument state.
Range	dBm/Hz dBm/MHz
Initial S/W Revision	Prior to A.02.00
Modified at S/W Revision	A.02.00, A.03.00

8 Channel Power Measurement
Mode

Mode

See "[Mode](#)" on page 286

Mode Preset

Returns the active mode to a known state.

Mode Preset does the following for the currently active mode:

- Aborts the currently running measurement.
- Brings up the default menu for the mode, with no active function.
- Sets measurement Global settings to their preset values for the active mode only.
- Activates the default measurement.
- Brings up the default menu for the mode.
- Clears the input and output buffers.
- Sets Status Byte to 0.

Mode Preset does not:

- Cause a mode switch
- Affect mode persistent settings
- Affect system settings

See "[How-To Preset](#)" on page 528 for more information.

Key Path	Front-panel key
Remote Command	:SYSTem:PRESet
Example	:SYST:PRES
Notes	*RST is preferred over :SYST:PRES for remote operation. *RST does a Mode Preset, as done by the :SYST:PRES command, and it sets the measurement mode to Single measurement rather than Continuous for optimal remote control throughput. Clears all pending OPC bits. The Status Byte is set to 0.
Couplings	A Mode Preset aborts the currently running measurement, activates the default measurement, and gets the mode to a consistent state with all of the default couplings set.
Backwards Compatibility Notes	In the X-Series, the legacy "Factory Preset" has been replaced with Mode Preset, which only presets the currently active mode, not the entire instrument. In the X-Series, the way to preset the entire instrument is by using System, Restore System Defaults All, which behaves essentially the same way as restore System Defaults does on ESA and PSA. There is also no "Preset Type" as there is on the PSA. There is a green Mode Preset front-panel key that does a Mode Preset and a white-with-green-letters User Preset front-panel key that does a User Preset. The old PRESet:TYPE command is ignored (without generating an error), and SYST:PRES without a parameter does a Mode Preset, which should cover most backward code compatibility issues. The settings and correction data under the Input/Output front-panel key (examples: Input Z Corr, Ext Amp Gain, etc.) are no longer part of any Mode, so they will not be preset by a Mode Preset. They are preset using Restore Input/Output Defaults, Restore System Defaults All. Note that because User Preset does a Recall State, and all of these settings are saved in State, they ARE recalled when using

	User Preset.
Initial S/W Revision	Prior to A.02.00

How-To Preset

The table below shows all possible presets, their corresponding SCPI commands and front-panel access (key paths). Instrument settings depend on the current measurement context. Some settings are local to the current measurement, some are global (common) across all the measurements in the current mode, and some are global to all the available modes. In a similar way, restoring the settings to their preset state can be done within the different contexts.

Auto Couple - is a measurement local key. It sets all Auto/Man parameter couplings in the measurement to Auto. Any Auto/Man selection that is local to other measurements in the mode will not be affected.

Meas Preset - is a measurement local key. Meas Preset resets all the variables local to the current measurement except the persistent ones.

Mode Preset - resets all the current mode's measurement local and measurement global variables except the persistent ones.

Restore Mode Defaults - resets ALL the Mode variables (and all the Meas global and Meas local variables), including the persistent ones.

Type Of Preset	SCPI Command	Front Panel Access
Auto Couple	:COUPle ALL	Auto Couple front-panel key
Meas Preset	:CONFigure:<Measurement>	Meas Setup Menu
Mode Preset	:SYSTem:PRESet	Mode Preset (green key)
Restore Mode Defaults	:INSTrument:DEFault	Mode Setup Menu
Restore All Mode Defaults	:SYSTem:DEFault MODEs	System Menu; Restore System Default Menu
*RST	*RST	not possible (Mode Preset with Single)
Restore Input/Output Defaults	:SYSTem:DEFault INPUt	System Menu; Restore System Default Menu
Restore Power On Defaults	:SYSTem:DEFault PON	System Menu; Restore System Default Menu
Restore Alignment Defaults	:SYSTem:DEFault ALIGN	System Menu; Restore System Default Menu
Restore Miscellaneous Defaults	:SYSTem:DEFault MISC	System Menu; Restore System Default Menu
Restore All System Defaults	:SYSTem:DEFault [ALL] :SYSTem:PRESet:PERsistent	System Menu; Restore System Default Menu
User Preset	:SYSTem:PRESet:USER	User Preset Menu
User Preset All Modes	:SYSTem:PRESet:USER:ALL	User Preset Menu

Power On Mode Preset	:SYSTem:PON:TYPE MODE	System Menu
Power On User Preset	:SYSTem:PON:TYPE USER	System Menu
Power On Last State	:SYSTem:PON:TYPE LAST	System Menu

Preset Type (Remote Command Only)

As stated in the Backward Compatibility section, to be compatible with ESA/PSA the PRESet:TYPE command will be implemented as a no-op.

Mode	All
Remote Command	:SYSTem:PRESet:TYPE FACTory MODE USER :SYSTem:PRESet:TYPE?
Example	:SYST:PRESet:TYPE FACT
Notes	This command is supported for backward compatibility only. It is a no-op which does not change the behavior of any preset operation.
Preset	This is unaffected by Preset but is set to Mode on a "Restore System Defaults->All"
State Saved	No
Initial S/W Revision	Prior to A.02.00

Mode Setup

See "[Mode Setup](#)" on page 316

Peak Search

Places the selected marker on the trace point with the maximum y-axis value. Pressing Peak Search with the selected marker Off causes the selected marker to be set to Normal, then a peak search is immediately performed.

Key Path	Front panel key
Mode	SA, WCDMA, C2K, WIMAX OFDMA, 1xEVDO, DVB-T/H, DTMB (CTTB), ISDB-T, CMMB, LTE, LTETDD, Digital Cable TV, WLAN, MSR, LTEAFDD, LTEATDD
Remote Command	:CALCulate:CHPower:MARKer[1] 2 ... 12:MAXimum
Example	CALC:CHP:MARK2:MAX
Initial S/W Revision	Prior to A.02.00
Modified at S/W Revision	A.02.00, A.03.00

8 Channel Power Measurement
Print

Print

See ["Print" on page 341](#)

Quick Save

The Quick Save front-panel key repeats the most recent save that was performed from the Save menu, with the following exceptions:

- Register saves are not remembered as Saves for the purpose of the Quick Save function
- If the current measurement does not support the last non-register save that was performed, an informational message is generated, “File type not supported for this measurement”

Quick Save repeats the last type of qualified save (that is, a save qualified by the above criteria) in the last save directory by creating a unique filename using the Auto File Naming algorithm described below.

If Quick Save is pressed after startup and before any qualified Save has been performed, the Quick Save function performs a Screen Image save using the current settings for Screen Image saves (current theme, current directory), which then becomes the “last save” for the purpose of subsequent Quick Saves.

The Auto File Naming feature automatically generates a file name for use when saving a file. The filename consists of a prefix and suffix separated by a dot, as is standard for the Windows® file system. A default prefix exists for each of the available file types:

Type	Default Prefix	Menu
State	State_	(Save/Recall)
Trace + State	State_	(Save/Recall)
Screen	Screen_	(Save/Recall)
Amplitude Corrections	Ampcor_	(Import/Export)
Traces	Trace_	(Import/Export)
Limit Lines	LLine_	(Import/Export)
Measurement Result	MeasR_	(Import/Export)
Capture Buffer	CapBuf_	(Import/Export)

A four digit number is appended to the prefix to create a unique file name. The numbering sequence starts at 0000 within each Mode for each file type and updates incrementally to 9999, then wraps to 0000 again. It remembers where it was through a Mode Preset and when leaving and returning to the Mode. It is reset by Restore Misc Defaults and Restore System Defaults and subsequent running of the instrument application. So, for example, the first auto file name generated for State files is State_0000.state. The next is State_0001, and so forth.

One of the key features of Auto File Name is that we guarantee that the Auto File Name will never conflict with an existing file. The algorithm looks for the next available number. If it gets to 9999, then it looks for holes. If it find no holes, that is no more numbers are available, it gives an error.

For example, if when we get to State_0010.state there is already a State_0010.state file in the current directory, it advances the counter to State_0011.state to ensure that no conflict will exist (and then it verifies that State_0011.state also does not exist in the current directory and advances again if it does, and so forth).

If you enter a file name for a given file type, then the prefix becomes the filename you entered instead of the default prefix, followed by an underscore. The last four letters (the suffix) are the 4-digit number.

For example, if you save a measurement results file as “fred.csv”, then the next auto file name chosen for a measurement results save will be fred_0000.csv.

NOTE

Although 0000 is used in the example above, the number that is used is actually the current number in the Meas Results sequence, that is, the number that would have been used if you had not entered your own file name.

NOTE

If the filename you entered ends with _dddd, where d=any number, making it look just like an auto file name, then the next auto file name picks up where you left off with the suffix being dddd + 1.

Key Path	Front-panel key
Notes	No remote command for this key specifically.
Initial S/W Revision	Prior to A.02.00

Recall

The Recall menu lets you choose what you want to recall, and where you want to recall it from. Among the types of files you can recall are **States and Traces**. In addition, an Import (Data) option lets you recall a number of data types stored in CSV files (as used by Excel and other spreadsheet programs).

The default paths for Recall are data type dependent and are the same as for the Save key.

Key Path	Front-panel key
Notes	<p>No remote command for this key specifically, but the :MMEM:LOAD command is available for specific file types. An example is :MMEM:LOAD:STATe <filename>.</p> <p>If you try to recall a State file for a mode that is not licensed or not available in the instrument, an error message will occur and the state will not change.</p>
Backwards Compatibility Notes	<p>In legacy analyzers, it was possible to load a state without affecting the trace data, limit lines or correction data. Similarly (since User Preset is actually loading a state), it was possible to do a User Preset without affecting the trace data, limit lines or correction data.</p> <p>In the X-Series, “state” always includes all of this data; so whenever state is loaded, all of the traces, limit lines and corrections are affected. Although this differs from previous behavior, it is desirable behavior, and should not cause adverse issues for users.</p>
Backwards Compatibility Notes	<p>Recall for the X-Series supports backward compatibility in the sense that you can recall a state file from any X-Series model number and any version of X-Series software. This is only possible if part of the recalling process goes through a limiting step after recalling the mode settings, at least for settings that may vary with version number, model number, option and license differences. If you try to recall a state file onto an instrument with less capability than what was available on the instrument during the save, the recall will ignore the state it doesn't support and it will limit the recalled setting to what it allows.</p> <p>Example: if the saved state includes preamp ON, but the recalling instrument does not have a preamp; the preamp is limited to OFF. Conversely, if you save a state without a preamp, the preamp is OFF in the state file. When this saved file is recalled on an instrument with a licensed preamp, the preamp is changed to OFF. Another example is if the saved state has center frequency set to 20 GHz, but the instrument recalling the saved state is a different model and only supports 13.5 GHz. In this case, the center frequency is limited along with any other frequency based settings. Since the center frequency can't be preserved in this case, the recall limiting tries to at least preserve span to keep the measurement setup as intact as possible.</p> <p>It may be appropriate to issue a warning if the state is limited on the recall; warnings do not go out to SCPI so this would only affect the manual user.</p> <p>Note that there is no state file compatibility outside of the X-Series. For example, you cannot recall a state file from ESA or PSA.</p>
Initial S/W Revision	Prior to A.02.00

State

The Recall State menu lets you choose a register or file from which to recall the state.

The content of a state file includes all of the settings and data required to return the analyzer as closely as possible to the Mode it was in, with the exact settings that were in place, when the save occurred. The Mode settings in each state file include the settings that are affected by Mode Preset, as well as the

additional settings affected by Restore Mode Defaults; all of the Mode's settings. In addition, all of the settings of the Input/Output system are included, even though they are outside of the Mode's state, because they are needed to restore the complete setup. Persistent System settings (for example, GPIB address) are not affected by either a Mode Preset or Restore Mode Defaults, nor are they included in a saved State file.

Since each state file is only for one Mode, the settings for other Modes are unaffected when it is loaded. Recall State will cause a mode switch if the state being recalled is not from the current active mode.

After the recall completes, the message "File <filename> recalled" or "Recalled State Register <register number>" is displayed.

For rapid recalls, the State menu lists 16 registers that you can choose from to recall. Pressing a Register key initiates the recall. You can also select a file from which to recall.

The default path for all State Files is:

My Documents\<<mode name>\state

where <mode name> is the parameter used to select the mode with the INST:SEL command (for example, SA for the Spectrum Analyzer).

See "[More Information](#)" on page 537.

Key Path	Recall
Mode	All
Remote Command	:MMEMory:LOAD:STATe <filename>
Example	:MMEM:LOAD:STAT "myState.state" This recalls the file myState.state on the default path
Example	MMEM:LOAD:STAT "MyStateFile.state" This loads the state file data (on the default file directory path) into the instrument state.
Notes	<p>When you pick a file to recall, the analyzer first verifies that the file is recallable in the current instrument by checking the software version and model number of the instrument. If everything matches, a full recall proceeds by aborting the currently running measurement, clearing any pending operations, and then loading the State from the saved state file. You can open state files from any mode, so recalling a State file switches to the mode that was active when the save occurred. After switching to the mode of the saved state file, mode settings and data (if any for the mode) are loaded with values from the saved file. The saved measurement of the mode becomes the newly active measurement and the data relevant to the measurement (if there is any) is recalled.</p> <p>If there is a mismatch between file version or model number or instrument version or model number, the recall function tries to recall as much as possible and returns a warning message. It may limit settings that differ based on model number, licensing or version number.</p> <p>After recalling the state, the Recall State function does the following:</p> <ul style="list-style-type: none"> • Makes the saved measurement for the mode the active measurement. • Clears the input and output buffers. • Status Byte is set to 0. • Executes a *CLS <p>If the file specified is empty an error is generated. If the specified file does not exist, another error is generated. If there is a mismatch between the file and the proper file type, an error is generated. If</p>

	there is a mismatch between file version or model number or instrument version or model number, a warning is displayed. Then it returns to the State menu and File Open dialog goes away. After the Recall, the analyzer exits the Recall menu and returns to the previous menu.
Backwards Compatibility SCPI	:MMEMory:LOAD:STATe 1,<filename> For backwards compatibility, the above syntax is supported. The "1" is simply ignored.
Initial S/W Revision	Prior to A.02.00

More Information

In measurements that support saving Traces, for example, Swept SA, the Trace data is saved along with the State in the State file. When recalling the State, the Trace data is recalled as well. Traces are recalled exactly as they were stored, including the writing mode and update and display modes. If a Trace was updating and visible when the State was saved, it will come back updating and visible, and its data will be rewritten right away. When you use State to save and recall traces, any trace whose data must be preserved should be placed in View or Blank mode before saving.

The following table describes the Trace Save and Recall possibilities:

You want to recall state and one trace's data, leaving other traces unaffected.	Save Trace+State from 1 trace. Make sure that no other traces are updating (they should all be in View or Blank mode) when the save is performed.	On Recall, specify the trace you want to load the one trace's data into. This trace will load in View. All other traces' data will be unaffected, although their trace mode will be as it was when the state save was performed.
You want to recall all traces	Save Trace+State from ALL traces.	On Recall, all traces will come back in View (or Blank if they were in Blank or Background when saved)
You want all traces to load exactly as they were when saved.	Save State	On recall, all traces' mode and data will be exactly as they were when saved. Any traces that were updating will have their data immediately overwritten.

From File...

When you press "From File", the analyzer brings up a Windows dialog and a menu entitled "File Open." This menu allows you to navigate to the various fields in the Windows dialog without using a keyboard or mouse. The Tab and Arrow keys can also be used for dialog navigation.

8 Channel Power Measurement Recall

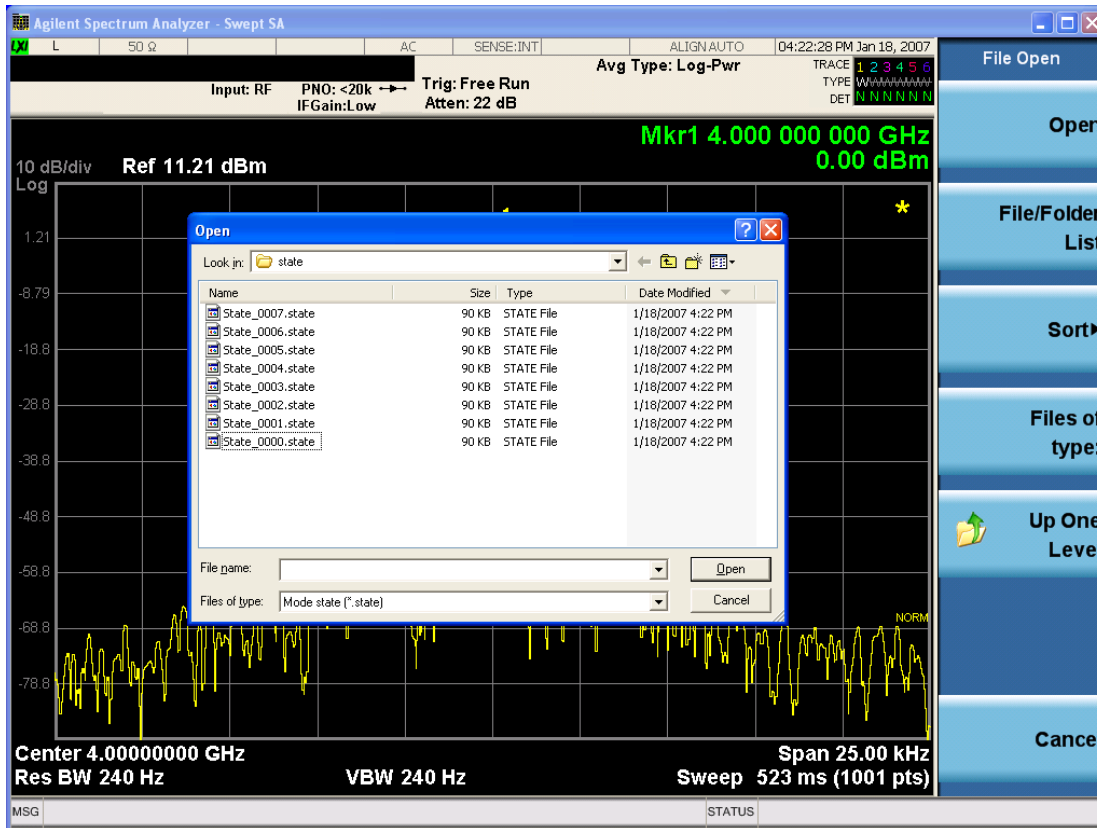

Listed below are the functions of the various fields in the dialog, and the corresponding softkeys:

Open

Performs the recall of the specified file. While the recall is being performed, the floppy icon appears briefly in the Meas bar.

File/Folder List

Enables you to navigate to the center of the dialog that contains the list of files and folders. Once here you can get information about the file and use the tab keys to navigate to the other fields in the dialog, such as Look In.

Look In

The Look In field shows the path from which the file will be recalled and allows you to change the path using the up and down arrow keys to navigate to other paths; the Enter key to open a directory; and the Backspace key to go back one directory. The **Look In field** first uses the last path from the Save As dialog **Save In:** path for that same file type. There is no softkey for directly navigating to the Look In field, but you can use the left tab to get here from the File/Folder List.

User specified paths are remembered when you leave and return to a Mode and are reset back to the default using Restore Mode Defaults.

Sort

Accesses a menu that enables you to sort the files within the File Open dialog. Only one sorting type can be selected at a time and the sorting happens immediately. The sorting types are By Date, By Name, By extension, and By Size.

Files of Type

This field shows the file suffix for the type of file you have selected to recall. For example, if you navigated here while recalling State, "Mode state (*.state)" is in the field. If you navigated here while recalling Trace, ""Mode state (*.trace)" is in the field. If you navigated here while importing a trace data file, "Trace Data (*.csv)" is in the field. For some file types, there is more than one choice in the dropdown menu, which you can select by using the up and down arrow keys and Enter.

Up One Level

This key corresponds to the icon of a folder with the up arrow that is in the tool bar of the dialog. When pressed, it causes the file and folder list to navigate up one level in the directory structure. The Backspace key does the same thing.

Cancel

This key corresponds to the Cancel selection in the dialog. It causes the current **Open** request to be cancelled. The ESC key does the same thing.

Key Path	Recall, State
Notes	Brings up the Open dialog for recalling a State Save Type
Initial S/W Revision	Prior to A.02.00

Edit Register Names

You may enter a custom name on any of the Register keys, to help you remember what you are using that state to save. To do this, press the Edit Register Names key, choose the register whose name you wish to edit, and then enter the desired label using the Alpha Editor or an external PC keyboard.

The maximum number of characters that can be added is 30. In most cases, 30 characters will fit on two lines of the key.

For more information and the SCPI command, see Edit Register Names under the Save, State function.

Key Path	Recall, State
Mode	All
Dependencies	N9060A-7FP or N9060B-2FP license required to edit the register names. When the feature is not licensed, sending the SCPI command generates an error, -221, "Settings conflict;Option not available"
Initial S/W Revision	A.11.00

Register 1 thru Register 16

Selecting any one of these register keys causes the State of the mode from the specified Register to be recalled. Each of the register keys annotates whether it is empty or at what date and time it was last

modified. In addition, you can use the Edit Register Names key under Save, State to enter custom names for each register.

Registers are shared by all modes, so recalling from any one of the registers will cause a mode switch to the mode that was active when the save to the Register occurred.

Although these 16 registers are the only registers available from the front panel, there are 128 state registers available in the instrument. Registers 17–128 are only available from the SCPI interface, using the *RCL command.

After the recall completes, the message "Register <register number> recalled" appears in the message bar. If you are in the Spectrum Analyzer Mode, and you are recalling a register that was saved in the Spectrum Analyzer Mode, then after the recall, you will still be in the Recall Register menu. If the Recall causes you to switch modes, then after the Recall, you will be in the Frequency menu.

If a requested register is empty an error is generated.

Key Path	Recall, State
Example	*RCL 1
Range	1–16 from front panel, 1–128 from SCPI
Readback	Date and time with seconds resolution are displayed on the key OR A custom name of up to 30 characters entered using the Save, State, Edit Register Names key OR “(empty)” if no prior save operation has been performed to this register.
Initial S/W Revision	Prior to A.02.00
Modified at S/W Revision	Prior to A.11.00

Register 1 thru Register 16

Selecting any one of these register keys causes the State of the mode from the specified Register to be recalled. Each of the register keys annotates whether it is empty or at what date and time it was last modified. In addition, you can use the Edit Register Names key under Save, State to enter custom names for each register.

Registers are shared by all modes, so recalling from any one of the registers will cause a mode switch to the mode that was active when the save to the Register occurred.

Although these 16 registers are the only registers available from the front panel, there are 128 state registers available in the instrument. Registers 17–128 are only available from the SCPI interface, using the *RCL command.

After the recall completes, the message "Register <register number> recalled" appears in the message bar. If you are in the Spectrum Analyzer Mode, and you are recalling a register that was saved in the Spectrum Analyzer Mode, then after the recall, you will still be in the Recall Register menu. If the Recall causes you to switch modes, then after the Recall, you will be in the Frequency menu.

If a requested register is empty an error is generated.

Key Path	Recall, State
Example	*RCL 1
Range	1–16 from front panel, 1–128 from SCPI
Readback	Date and time with seconds resolution are displayed on the key OR A custom name of up to 30 characters entered using the Save, State,Edit Register Names key OR “(empty)” if no prior save operation has been performed to this register.
Initial S/W Revision	Prior to A.02.00
Modified at S/W Revision	Prior to A.11.00

Data (Import)

Importing a data file loads data that was previously saved from the current measurement or from other measurements and/or modes that produce compatible data files. The Import Menu only contains Data Types that are supported by the current measurement.

Since the commonly exported data files are in .csv format, the data can be edited by the user prior to importing. This allows you to export a data file, manipulate the data in Excel (the most common PC Application for manipulating .csv files) and then import it.

Importing Data loads measurement data from the specified file into the specified or default destination, depending on the data type selected. Selecting an Import Data menu key will not actually cause the importing to occur, since the analyzer still needs to know from where to get the data. Pressing the Open key in this menu brings up the Open dialog and Open menu that provides you with the options from where to recall the data. Once a filename has been selected or entered in the Open menu, the recall occurs as soon as the Open button is pressed.

Key Path	Recall
Mode	All
Notes	The menu is built from whatever data types are available for the mode. Some keys will be missing completely, so the key locations in the sub-menu will vary. No SCPI command directly controls the Data Type that this key controls. The Data Type is included in the MMEM:LOAD commands.
Dependencies	If a file type is not used by a certain measurement, it is grayed out for that measurement. The key for a file type will not show at all if there are no measurements in the Mode that support it.
Preset	Is not affected by Preset or shutdown, but is reset during Restore Mode Defaults
Readback	The data type that is currently selected
Initial S/W Revision	Prior to A.02.00

Mask

Enables you to recall a preset mask file. This file type (.mask) differs from a normal “state” file because it contains the configuration for Carrier, Offset, and Limit for the specific preset profile BW. A brief description of the mask file is available in the properties view of each file. (Right-mouse-click on the file, select, "Properties" to view this information.) A detailed list of the mask parameter values is located in the .pdf file of the same name in the same directory. Blank values in the .pdf file are parameters that will not be overwritten when recalling the mask.

Key Path	Recall, Data
Mode	WIMAXOFDMA
Remote Command	:MMEMory:LOAD:MASK <string>
Example	:MMEM:LOAD:MASK "MyLimitFile.mask"
Notes	Set of parameters related to Limit, Carrier and Offset are overwritten by Preset Mask file.
Initial S/W Revision	A.02.00

This topic contains the following sections:

["File location and extension" on page 542](#)

["Example of Preset Mask file" on page 543](#)

File location and extension

File location: The preset mask file is located in “My Documents\WIMAXOFDMA\data\masks”.

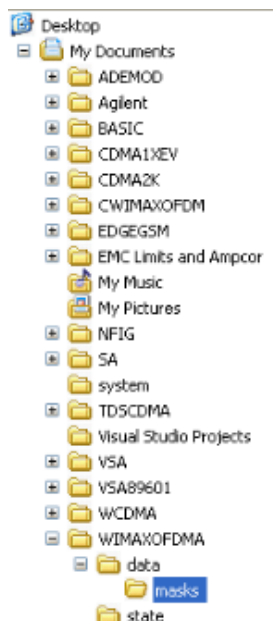

NOTE

When your X-Series analyzer starts, all mask files located in “My Documents\WIMAXOFDMA\data/masks” are overwritten, so any files you wish to save should be stored in another directory location.

File type: The file type is binary file.

File Name: The file name is decided by following naming rules. Each specific keyword is connected with underscore.

<Standard name>_<Radio device>_<Preset Profile BW>_<Measurement>.mask

<Standard name>: This term references the standard associated with each mask file.

<Radio device>: This term specifies to which radio device (BS or MS) the mask file pertains.

<Preset Profile BW>: This term specifies to which Preset Profile BW the mask file pertains.

<Measurement>: This term specifies the measurement to which the mask file is applied. Your selections are: SEM, ACP, or Mode. When selecting **Mode**, the values of some parameters in both the ACP and SEM measurement are overwritten.

File extension: The extension of preset mask file is “mask” to distinguish it from a “state” file.

When you press the open key under the Data menu, the “My Documents\WIMAXOFDMA\data\masks” folder is opened. Select one mask file.

NOTE

When you change the preset BW profile or Radio Device, all measurement parameters are reset to their original values. Thus you have to recall the appropriate preset mask file again after the change.

Example of Preset Mask file

When you import a preset mask file, it is a “Recall” function. Specific parameter values are overwritten by the contents of the preset mask file (see table below). Those values not specified by the preset mask file remain unchanged. Because the file format type is binary, you cannot view, change, or create the preset mask file. Here is an example of a preset mask file used for ACP measurements.

File Location: My Documents/WIMAXOFDMA/data/masks

File Name: ETSI-EN301-021-SysE_BS_10MHz_ACP.mask

The .pdf file that lists the parameters similarly to that shown below is named, "ETSI-EN301-021-SysE_BS_10MHz_ACP.pdf"

The set of parameters listed in the following table for the Preset Profile BW (10MHz) are imported into the ACP measurement.

Offset	Start Freq (MHz)	Stop Freq (MHz)	Sweep Time	Res BW (Hz)	Meas BW	Rel Start	Rel Stop	Fail Mask
A	5	7.14		30k	1	-8	-25	Rel
B	7.14	10.57		30k	1	-25	-27	Rel
C	10.57	20		30k	1	-27	-50	Rel
D	20	25		30k	1	-50	-50	Rel
E	25	30		30k	1	-50	-50	Rel

Zone Map

Pressing this key selects Zone Map as the data type to be imported.

The WiMAX-OFDMA application can load the Singal Studio Setup file, and the OFDMA Map file is compatible with the 89601A Mobile WiMAX omf file.

Key Path	Recall, Data
Remote Command	:MMEMory:LOAD:ZMAP <string>
Example	MMEM:LOAD:ZMAP "ZMap_0000.omf"
Notes	The SCPI parameter is a quoted string that specifies the filename. Both single and double quotes are supported for any filename parameter over SCPI.
Dependencies	You must be in the 802.16 OFDMA (WiMAX/WiBro) mode.
Status Bits/OPC dependencies	Sequential – waits for the previous measurement to complete.
Initial S/W Revision	Prior to A.02.00

Open...

When you press “Open”, the analyzer brings up a Windows dialog and a menu entitled “File Open.” This menu allows you to navigate to the various fields in the Windows dialog without using a keyboard or mouse. The Tab and Arrow keys can also be used for dialog navigation.

See "[From File...](#)" on page 2241 in Recall, State, for a full description of this dialog and menu.

Key Path	Recall, Data
Notes	The key location is mode-dependent and will vary. Brings up Open dialog for recalling a <mode specific> Save Type
Initial S/W Revision	Prior to A.02.00

Restart

The Restart function restarts the current sweep, or measurement, or set of averaged/held sweeps or measurements. If you are Paused, pressing Restart does a Resume.

The Restart function is accessed in several ways:

- Pressing the Restart key
- Sending the remote command INIT:IMMEDIATE
- Sending the remote command INIT:RESTART

See "[More Information](#)" on page 545

Key Path	Front-panel key
Remote Command	:INITiate[:IMMEDIATE] :INITiate:RESTART
Example	:INIT:IMM :INIT:REST
Notes	:INITiate:RESTART and :INITiate:IMMEDIATE perform exactly the same function.
Couplings	Resets average/hold count k. For the first sweep overwrites all active (update=on) traces with new current data. For application modes, it resets other parameters as required by the measurement.
Status Bits/OPC dependencies	This is an Overlapped command. The STATUS:OPERation register bits 0 through 8 are cleared. The STATUS:QUESTIONable register bit 9 (INTEgrity sum) is cleared. The SWEEPING bit is set. The MEASURING bit is set.
Backwards Compatibility Notes	For Spectrum Analysis mode in ESA and PSA, the Restart hardkey and the INITiate:RESTART command restart trace averages (displayed average count reset to 1) for a trace in Clear Write, but did not restart Max Hold and Min Hold. In the X-Series, the Restart hardkey and the INITiate:RESTART command restart not only Trace Average, but MaxHold and MinHold traces as well. For wireless comms modes in ESA and PSA, the Restart hardkey and the INITiate:RESTART command restart every measurement, which includes all traces and numeric results. There is no change to this operation.
Initial S/W Revision	Prior to A.02.00

More Information

The **Restart** function first aborts the current sweep/measurement as quickly as possible. It then resets the sweep and trigger systems, sets up the measurement and initiates a new data measurement sequence with a new data acquisition (sweep) taken once the trigger condition is met.

If the analyzer is in the process of aligning when **Restart** is executed, the alignment finishes before the restart function is performed.

Even when set for Single operation, multiple sweeps may be taken when Restart is pressed (for example, when averaging/holding is on). Thus when we say that **Restart** "restarts a measurement," we may mean:

- It restarts the current sweep
- It restarts the current measurement
- It restarts the current set of sweeps if any trace is in Trace Average, Max Hold or Min Hold
- It restarts the current set of measurements if Averaging, or Max Hold, or Min Hold is on for the measurement
- depending on the current settings.

With **Average/Hold Number** (in **Meas Setup** menu) set to 1, or Averaging off, or no trace in Trace Average or Hold, a single sweep is equivalent to a single measurement. A single sweep is taken after the trigger condition is met; and the analyzer stops sweeping once that sweep has completed. However, with **Average/Hold Number** >1 and at least one trace set to **Trace Average, Max Hold, or Min Hold (SA Measurement)** or **Averaging on (most other measurements)**, multiple sweeps/data acquisitions are taken for a single measurement. The trigger condition must be met prior to each sweep. The sweep is stopped when the average count k equals the number N set for **Average/Hold Number**. A measurement average usually applies to all traces, marker results, and numeric results; but sometimes it only applies to the numeric results.

Once the full set of sweeps has been taken, the analyzer will go to idle state. To take one more sweep without resetting the average count, increment the average count by 1, by pressing the step up key while **Average/Hold Number** is the active function, or sending the remote command CALC:AVER:TCON UP.

Save

The Save menu lets you choose what you want to save and where you want to save it. Among the types of files you can save are **States**, **Traces**, and **Screen Images**. In addition, an Export (Data) option lets you save a number of data types as CSV files for easy import into Excel and other spreadsheet programs.

Key Path	Front-panel key
Mode	All
Notes	No remote command for this key specifically, but the :MMEM:STORe command is available for specific file types. An example is :MMEM:STOR:STATe <filename>.
Initial S/W Revision	Prior to A.02.00

State

The Save State menu lets you choose a register or file for saving the state.

The content of a state file includes all of the settings and data required to return the analyzer as closely as possible to the Mode it was in, with the exact settings which were in place, when the save occurred. The Mode settings in each state file include the settings that are affected by Mode Preset, as well as the additional settings affected by Restore Mode Defaults; all of the Mode's settings. In addition, all of the settings of the Input/Output system are included, even though they are outside of the Mode's state, because they are needed to restore the complete setup. Persistent System settings (for example, Verbose SCPI) are not affected by either Mode Preset or Restore Mode Defaults, nor are they included in a saved State file.

After the save completes, the message "File <filename> saved" or "State Register <register number> saved" is displayed.

For rapid saving, the State menu lists 16 registers to save to. Pressing a Register key initiates the save. You can also select a file to save to.

The default path for all State Files is:

My Documents\<>mode name>\state

where <mode name> is the parameter used to select the mode with the INST:SEL command (for example, SA for the Spectrum Analyzer).

Key Path	Save
Mode	All
Remote Command	:MMEMory:STORe:STATe <filename>
Example	MMEM:STOR:STATe "MyStateFile.state" This stores the current instrument state data in the file MyStateFile.state in the default directory.
Notes	Both single and double quotes are supported for any filename parameter over remote. After saving to a register, that register's menu key is updated with the date the time, unless a custom label has been entered for that key. After saving to a register, you remain in the Save State menu, so that you can see the Register key

update. After saving to a file, the analyzer automatically returns to the previous menu and any Save As dialog goes away.

Backwards Compatibility SCPI	:MMEMory:STORe:STATe 1,<filename>
Initial S/W Revision	Prior to A.02.00

To File . . .

When you press “To File”, the analyzer brings up a Windows dialog and a menu entitled “Save As.” This menu allows you to navigate to the various fields in the Windows dialog without using a keyboard or mouse. The Tab and Arrow keys can also be used for dialog navigation.

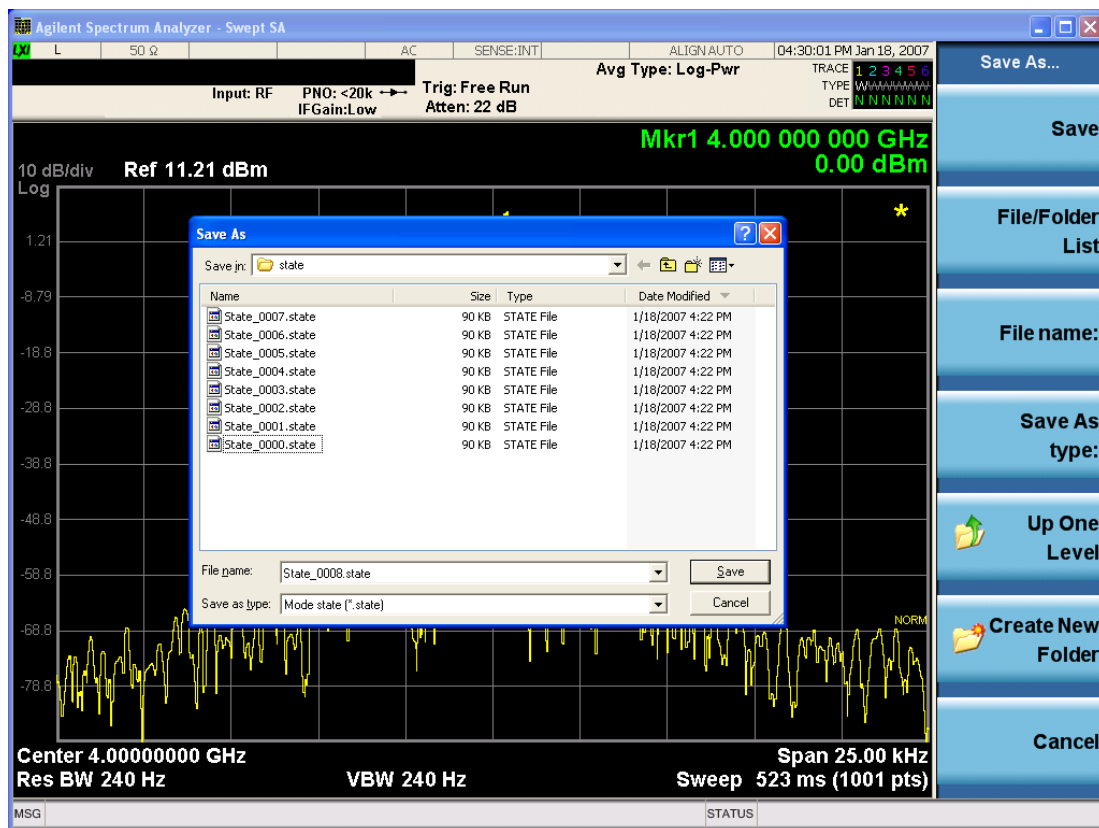

The Listed below

are the functions of the various fields in the dialog, and the corresponding softkeys:

Save

Performs the save to the specified file of the selected type. If the file already exists, a dialog will appear that allows you to replace the existing file by selecting OK, or you can Cancel the request. If you select OK, the file will be overwritten. Using the C: drive is strongly discouraged, since it runs the risk of being overwritten during an instrument software upgrade.

While the save is being performed, the floppy icon appears briefly in the Meas bar.

File/Folder List

Enables you to navigate to the center of the dialog that contains the list of files and folders. Once here you can get information about the file and use the tab keys to navigate to the other fields in the dialog, such as Save In.

Save In

The Save In field shows the path to which the file will be saved and allows you to change the path using the up and down arrow keys to navigate to other paths; the Enter key to open a directory; and the Backspace key to go back one directory. The **Save In field** defaults to the default path for this type of file and remembers the last path you used to save this type of file. There is no softkey for directly navigating to the Save In field but you can use left tab to get here from the File/Folder List.

User specified paths are remembered when you leave and return to a Mode and are reset back to the default using Restore Mode Defaults.

File Name

The File Name field is initially loaded with an automatically generated filename specific to the appropriate Save Type. The automatically generated filename is guaranteed not to conflict with any filename currently in the directory. You may replace or modify this filename using the File Name key. See the ["Quick Save " on page 2237](#) documentation for more on the automatic file naming algorithm.

When you press the File Name key the analyzer displays the Alpha Editor. Use the knob to choose the letter to add and the front-panel Enter key to add the letter to the file name. The BK character moves you back and the FW character moves you forward in the filename. The Select key on the front panel generates a space character. When you are done entering the filename press the Done softkey. This returns back to the **File Open** dialog and menu, but does not cause the save to occur.

Save As Type

This field shows the file suffix for the type of file you have selected to save. For example, if you navigated here while saving State, "Mode state (*.state)" is in the field. If you navigated here from saving Trace, ""Mode state (*.trace)" is in the field. If you navigated here while exporting a trace data file, "Trace Data (*.csv)" is in the field. For some file types, there is more than one choice in the dropdown, which you can select by using the up and down arrow keys and Enter.

Up One Level

This key corresponds to the icon of a folder with the up arrow that is in the tool bar of the dialog. When pressed, it causes the file and folder list to navigate up one level in the directory structure. The Backspace key does the same thing.

Create New Folder

This key corresponds to the icon of a folder with the "*" that is in the tool bar of the dialog. When pressed, a new folder is created in the current directory with the name **New Folder** and you can enter a new folder name using the Alpha Editor.

Cancel

This key corresponds to the Cancel selection in the dialog. It causes the current **Save As** request to be cancelled. The ESC key does the same thing.

Key Path	Save, State
Mode	All
Notes	Brings up Save As dialog for saving a State Save Type
Initial S/W Revision	Prior to A.02.00

Edit Register Names

You may enter a custom name on any of the Register keys, to help you remember what you are using that state to save. To do this, press the Edit Register Names key, choose the register whose name you wish to edit, and then enter the desired label using the Alpha Editor or an external PC keyboard.

The maximum number of characters that can be added is 30. In most cases, 30 characters will fit on two lines of the key.

See ["More Information" on page 550](#)

Key Path	Save, State
Mode	All
Remote Command	:MMEMory:REGister:STATe:LABel <reg number>,"label" :MMEMory:REGister:STATe:LABel? <reg number>
Example	:MMEM:REG:STAT:LAB 1,"my label"
Notes	<reg number> is an integer from 1 to 16. If the SCPI specifies an invalid register number an error message is generated, -222,"Data out of range;Invalid register label number" "label" is a string from 0 to 30 characters in length. If a label exceeds 30 characters, an error message is generated, -150,"String data error;Label clipped to 30 characters" "label" of length 0 erases the custom label and restores the default (time and date) label. E.g.: :MMEM:REG:STAT:LAB 1,""
Dependencies	N9060A-7FP or N9060B-2FP license required to edit the register names. When the feature is not licensed, sending this command generates an error, -221,"Settings conflict;Option not available"
Preset	The names are unaffected by Preset or power cycle but are set to the default label (time and date) on a "Restore System Defaults->Misc"
Initial S/W Revision	A.11.00

More Information

When you edit one of the register names, the time and date field will be replaced by the custom name.

If you delete all the characters in the custom name, it restores the default (time and date).

The register names are stored within the state files, but they are not part of the instrument state; that is, once you have edited a register name, loading a new state will not change that register name. Another consequence of this is that the names will be persistent through a power cycle. Also, if a named state file is transferred to another analyzer, it will bring its custom name along with it.

If you try to edit the name of an empty register, the analyzer will first save the state to have a file to put the name in. If you load a named state file into an analyzer with older firmware it will ignore the metadata.

The *SAV and *RCL commands will not be affected by the custom register names, nor will the MMEM commands.

Register 1 thru Register 16

Selecting any one of these register menu keys causes the State of the currently active mode to be saved to the specified Register. The registers are provided for rapid saving and recalling, since you do not need to specify a filename or navigate to a file. Each of the register menu keys annotates whether it is empty or at what date and time it was last modified. In addition, you can use the Edit Register Names key to enter custom names for each register.

Although these 16 registers are the only registers available from the front panel, there are 128 state registers available in the instrument. Registers 17–128 are only available from the SCPI interface, using the *SAV command.

There is one set of 128 state registers in the instrument, not one set for each Mode. When a state is saved, the Mode it was saved from is saved with it; then when it is recalled, the instrument switches to that Mode.

After the save completes, the corresponding register menu key annotation is updated with the date and time and the message "Register <register number> saved" is displayed.

Key Path	Save, State
Mode	All
Example	*SAV 1
Range	1–16 from front panel, 1–128 from SCPI
Readback	Date and time with seconds resolution are displayed on the key OR A custom name of up to 30 characters entered using the Edit Register Names key OR “(empty)” if no prior save operation has been performed to this register.
Initial S/W Revision	Prior to A.02.00
Modified at S/W Revision	A.11.00

Register 1 thru Register 16

Selecting any one of these register menu keys causes the State of the currently active mode to be saved to the specified Register. The registers are provided for rapid saving and recalling, since you do not need to specify a filename or navigate to a file. Each of the register menu keys annotates whether it is empty or at what date and time it was last modified. In addition, you can use the Edit Register Names key to enter custom names for each register.

Although these 16 registers are the only registers available from the front panel, there are 128 state registers available in the instrument. Registers 17–128 are only available from the SCPI interface, using the *SAV command.

There is one set of 128 state registers in the instrument, not one set for each Mode. When a state is saved, the Mode it was saved from is saved with it; then when it is recalled, the instrument switches to that Mode.

After the save completes, the corresponding register menu key annotation is updated with the date and time and the message "Register <register number> saved" is displayed.

Key Path	Save, State
Mode	All
Example	*SAV 1
Range	1-16 from front panel, 1-128 from SCPI
Readback	Date and time with seconds resolution are displayed on the key OR A custom name of up to 30 characters entered using the Edit Register Names key OR “(empty)” if no prior save operation has been performed to this register.
Initial S/W Revision	Prior to A.02.00
Modified at S/W Revision	A.11.00

Data (Export)

Exporting a data file stores data from the current measurement to mass storage files. The Export Menu only contains data types that are supported by the current measurement.

Since the commonly exported data files are in .csv format, the data can be edited by you prior to importing. This allows you to export a data file, manipulate the data in Excel (the most common PC Application for manipulating .csv files) and then import it.

Selecting an Export Data menu key will not actually cause the exporting to occur, since the analyzer still needs to know where you wish to save the data. Pressing the Save As key in this menu brings up the Save As dialog and Save As menu that allows you to specify the destination file and directory. Once a filename has been selected or entered in the Open menu, the export will occur as soon as the Save key is pressed.

Key Path	Save
Mode	All
Notes	The menu is built from whatever data types are available for the mode. So the key locations in the sub menu will vary. No SCPI command directly controls the Data Type that this key controls. The Data Type is included in the MMEM:STORe commands.
Dependencies	If a file type is not used by a certain measurement, that type is grayed out for that measurement. The key for a file type will not show at all if there are no measurements in the Mode that support it.
Preset	Is not affected by a Preset or shutdown, but is reset during Restore Mode Defaults
Readback	The data type that is currently selected
Initial S/W Revision	Prior to A.02.00

Measurement Results

Pressing this key selects Meas Results as the data type to be exported.

The Meas Results file contains information which describes the current state of the analyzer. It is detailed in Meas Result File Contents below.

Key Path	Save, Data
Remote Command	:MMEMory:STORe:RESults <string>
Example	:MMEM:STOR:RES "MeasR_0000.csv"
Notes	<p>If the save is initiated via SCPI and the file already exists, the file will be overwritten.</p> <p>The SCPI command exports Channel Power measurement results to the file specified as the parameter in the current path. The default path is My Documents\<current mode>\data\CHP\results.</p> <p>Using the C: drive is strongly discouraged, since it runs the risk of being overwritten during an instrument software upgrade.</p> <p>The SCPI parameter is a quoted string, which specifies the filename. Both single and double quotes are supported for any filename parameter over SCPI.</p>
Dependencies	The current active measurement must be the Channel Power measurement to use this command.
Status Bits/OPC dependencies	Sequential – waits for the previous measurement to complete.
Initial S/W Revision	Prior to A.02.00

Meas Results File Contents

A Meas Results File contains measurement results with the following information.

- File ID string, which is "MeasResult"
- Measurement ID following Mode ID, which is "SA:CHP" for example.
- Firmware rev and model number
- Option string
- Auto Sweep Time Rules
- Average Mode
- Average Number
- Average State
- Center Frequency
- Detector
- Electrical Atten
- Electrical Atten State
- IFGain

- IFGainAuto
- Impedance
- Integ BW
- Internal Preamp
- Internal Preamp Band
- Mechanical Atten
- MechanicalAttenStepEnum
- PSD Unit
- Resolution Band Width
- Resolution Bandwidth Shape
- RRC Filter Alpha
- RRC Filter BW
- RRC Filter State
- Span
- Sweep Points
- Sweep Time
- Sweep Time Auto
- TriggerSource
- Video Bandwidth
- Y Axis Unit

The file contains these data followed by MeasResult1 and MeasResult2 that flag the start of the measurement results. Each line of Measurement Results consists of two comma separated values, MeasResult1 value and MeasResult2 value. MeasResult1 contains the same results as MEAS/READ/FETCH:CHPower1; MeasResult2, MEAS/READ/FETCH:CHPower2.

Exported file is .csv file. The Meas Results file, when imported into Excel, will show the following data:

MeasResult	
SA:CHP	
A.10.53	N9030A
526 ALV ATP B1X B1Y B25 B40 BBA CR3 CRP DCF DDA DP2 DRD EA3 EDP EMC EP1 ERC ESC ESP EXM FSA LFE LNP MAT MPB NFE NUL P26 PFR PNC RTL RTS S40 SB1 SEC SM1 TVT YAS YAV	1
Auto Sweep Time Rules	Normal
Average Mode	Exponential

Average Number	10
Average State	TRUE
Center Frequency	13255000000
Detector	Average
IFGain	FALSE
IFGainAuto	FALSE
Impedance	50
Integ BW	2000000
Internal Preamp	FALSE
Internal Preamp Band	Low
PSD Unit	DbmHz
Resolution Band Width	27000
Resolution Bandwidth Shape	Gaussian
RRC Filter Alpha	0.22
RRC Filter BW	3840000
RRC Filter State	FALSE
Span	3000000
Sweep Points	1001
Sweep Time	0.004933333
Sweep Time Auto	TRUE
TriggerSource	Free
Video Bandwidth	270000
Y Axis Unit	DecibelMilliwatt
MeasResult1	MeasResult2
-76.8141133132837	-95.29174
-139.824413269924	-94.99601
	-94.95281
	-95.17146

Zone Map

Pressing this key selects Zone Map as the data type to be exported.

The Zone Map file contains information about current Zone Map configuration. Its format is compatible with the 89601A OFDMA map file. It is detailed in ["Zone Map File Contents" on page 556](#) below.

Key Path	Save, Data
Remote Command	:MMEMory:STORe:ZMAP <string>

Example	MMEM:STOR:ZMAP "ZMap_0000.omf"
Notes	<p>If the save is initiated via SCPI and the file already exists, the file will be overwritten.</p> <p>The SCPI command exports Zone Map information to the file specified as the parameter in the current path. The default path is My Documents\WIMAXOFDMA\.</p> <p>Using the C: drive is strongly discouraged, since it runs the risk of being overwritten during an instrument software upgrade.</p> <p>The SCPI parameter is a quoted string that specifies the filename. Both single and double quotes are supported for any filename parameter over SCPI.</p>
Dependencies	You must be in the 802.16 OFDMA (WiMAX/WiBro) mode.
Status Bits/OPC dependencies	Sequential – waits for the previous measurement to complete.
Initial S/W Revision	Prior to A.02.00

Zone Map File Contents

A Zone Map File contains the following information of the Zone Map configuration. See ["Zone Map Data" on page 329](#) for detailed definitions.

- DemodOfdmaMap_AutoDetect
- DemodOfdmaMap_Count
- DemodOfdmaMap_F1_DL_Count
- DemodOfdmaMap_F1_DL_Z1_Active
- DemodOfdmaMap_F1_DL_Z1_AmcType
- DemodOfdmaMap_F1_DL_Z1_B1_Active
- DemodOfdmaMap_F1_DL_Z1_B1_AllocType
- DemodOfdmaMap_F1_DL_Z1_B1_Boost
- DemodOfdmaMap_F1_DL_Z1_B1_BurstType
- DemodOfdmaMap_F1_DL_Z1_B1_ColorIndex
- DemodOfdmaMap_F1_DL_Z1_B1_ModType
- DemodOfdmaMap_F1_DL_Z1_B1_Name
- DemodOfdmaMap_F1_DL_Z1_B1_SubchannelInterval
- DemodOfdmaMap_F1_DL_Z1_B1_SubchannelOffset
- DemodOfdmaMap_F1_DL_Z1_B1_SymbolInterval
- DemodOfdmaMap_F1_DL_Z1_B1_SymbolOffset
- DemodOfdmaMap_F1_DL_Z1_Count
- DemodOfdmaMap_F1_DL_Z1_DedicPilots

- DemodOfdmaMap_F1_DL_Z1_IDCell
- DemodOfdmaMap_F1_DL_Z1_IDCellCouple
- DemodOfdmaMap_F1_DL_Z1_Len
- DemodOfdmaMap_F1_DL_Z1_Locked
- DemodOfdmaMap_F1_DL_Z1_Name
- DemodOfdmaMap_F1_DL_Z1_PrbsID
- DemodOfdmaMap_F1_DL_Z1_StcMatrix
- DemodOfdmaMap_F1_DL_Z1_StcType
- DemodOfdmaMap_F1_DL_Z1_SymOffset
- DemodOfdmaMap_F1_DL_Z1_UseAllSC
- DemodOfdmaMap_F1_DL_Z1_WrapType
- DemodOfdmaMap_F1_DL_Z1_ZoneType
- DemodOfdmaMap_F1_UL_Count
- DemodOfdmaMap_F1_UL_Z1_Active
- DemodOfdmaMap_F1_UL_Z1_AmcType
- DemodOfdmaMap_F1_UL_Z1_B1_Active
- DemodOfdmaMap_F1_UL_Z1_B1_AllocType
- DemodOfdmaMap_F1_UL_Z1_B1_Boost
- DemodOfdmaMap_F1_UL_Z1_B1_BurstType
- DemodOfdmaMap_F1_UL_Z1_B1_ColorIndex
- DemodOfdmaMap_F1_UL_Z1_B1_ModType
- DemodOfdmaMap_F1_UL_Z1_B1_Name
- DemodOfdmaMap_F1_UL_Z1_B1_PilotPattern
- DemodOfdmaMap_F1_UL_Z1_B1_StcMode
- DemodOfdmaMap_F1_UL_Z1_B1_SubchannelInterval
- DemodOfdmaMap_F1_UL_Z1_B1_SubchannelOffset
- DemodOfdmaMap_F1_UL_Z1_B1_SymbolInterval
- DemodOfdmaMap_F1_UL_Z1_B1_SymbolOffset
- DemodOfdmaMap_F1_UL_Z1_Count
- DemodOfdmaMap_F1_UL_Z1_Gap
- DemodOfdmaMap_F1_UL_Z1_IDCell

- DemodOfdmaMap_F1_UL_Z1_Len
- DemodOfdmaMap_F1_UL_Z1_Locked
- DemodOfdmaMap_F1_UL_Z1_Name
- DemodOfdmaMap_F1_UL_Z1_SymOffset
- DemodOfdmaMap_F1_UL_Z1_UseSubchRotate
- DemodOfdmaMap_F1_UL_Z1_WrapType
- DemodOfdmaMap_F1_UL_Z1_ZoneType
- DemodOfdmaMap_Name
- DemodOfdmaMap_RefreshMap

Save As . . .

When you press “Save As”, the analyzer brings up a Windows dialog and a menu entitled “**Save As.**” This menu allows you to navigate to the various fields in the Windows dialog without using a keyboard or mouse. The Tab and Arrow keys can also be used for dialog navigation.

See "[To File . . .](#)" on page 2252 in Save, State for a full description of this dialog and menu.

The default path for saving files is:

For all of the Trace Data Files:

My Documents\`<mode name>`\data\traces

For all of the Limit Data Files:

My Documents\`<mode name>`\data\limits

For all of the Measurement Results Data Files:

My Documents\`<mode name>`\data\`<measurement name>`\results

For all of the Capture Buffer Data Files:

My Documents\`<mode name>`\data\captureBuffer

Key Path	Save, Data
Mode	All
Notes	The key location is mode-dependent and will vary. Brings up the Save As dialog for saving a <code><mode specific></code> Save Type. The save is performed immediately and does not wait until the measurement is complete.
Initial S/W Revision	Prior to A.02.00

Screen Image

Pressing Screen Image accesses a menu of functions that enable you to specify a format and location for the saved screen image. It brings up a menu that allows you to specify the color scheme of the Screen

Image (Themes) or navigate to the Save As dialog to perform the actual save.

Screen Image files contain an exact representation of the analyzer display. They cannot be loaded back onto the analyzer, but they can be loaded into your PC for use in many popular applications.

The image to be saved is actually captured when the Save front panel key is pressed, and kept in temporary storage to be used if you ask for a Screen Image save. When the Screen Image key is pressed, a "thumbnail" of the captured image is displayed, as shown below:

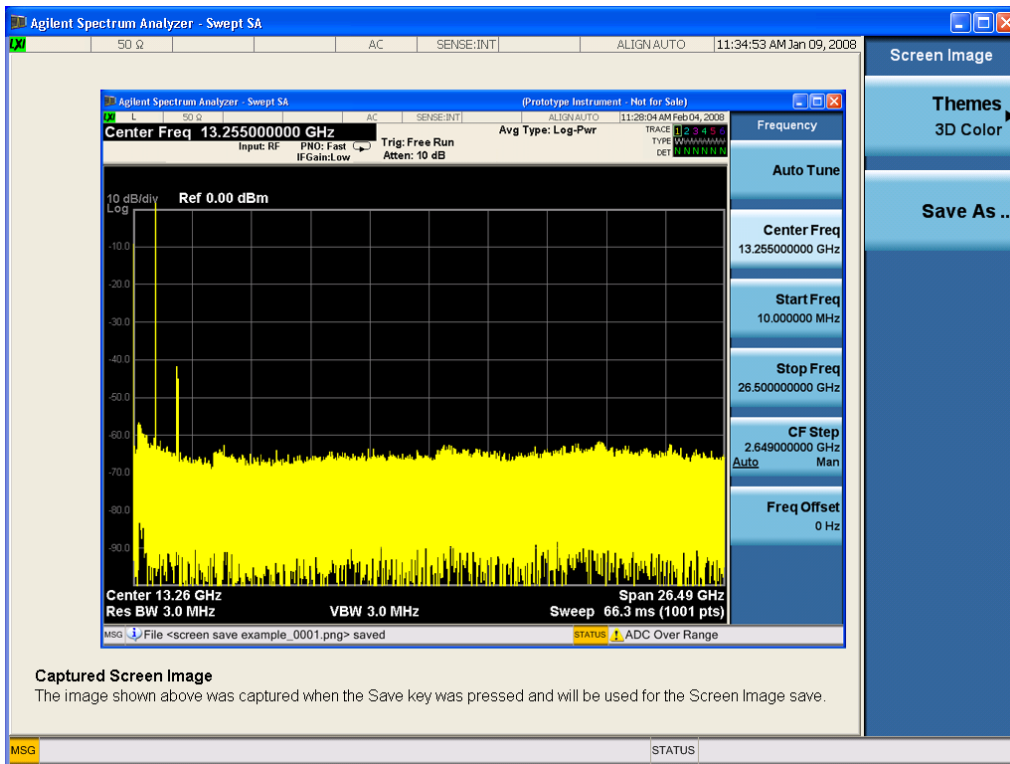

When you continue on into the Save As menu and complete the Screen Image save, the image depicted in the thumbnail is the one that gets saved, showing the menus that were on the screen before going into the Save menus. The save is performed immediately and does not wait until the measurement is complete.

After you have completed the save, the Quick Save front-panel key lets you quickly repeat the last save performed, using an auto-named file, with the current screen data.

NOTE

For versions previous to A.01.55, if you initiate a screen image save by navigating through the Save menus, the image that is saved will contain the Save menu softkeys, not the menus and the active function that were on the screen when you first pressed the Save front panel key.

Key Path	Save
Mode	All
Remote Command	:MMEMory:STORe:SCReen <filename>
Example	:MMEM:STOR:SCR "myScreen.png" This stores the current screen image in the file MyScreenFile.png in the default directory.
Initial S/W Revision	Prior to A.02.00

Themes

Accesses a menu of functions that enable you to choose the theme to be used when saving the screen image.

The **Themes** option is the same as the **Themes** option under the **Display** and **Page Setup** dialogs. It allows you to choose between themes to be used when saving the screen image.

Key Path	Save, Screen Image
Remote Command	:MMEMory:STORe:SCReen:THEMe TDColor TDMonochrome FCOLor FMONochrome :MMEMory:STORe:SCReen:THEMe?
Example	:MMEM:STOR:SCR:THEM TDM
Preset	3D Color; Is not part of Preset, but is reset by Restore Misc Defaults or Restore System Defaults All and survives subsequent running of the modes.
Readback	3D Color 3D Mono Flat Color Flat Mono
Backwards Compatibility Notes	In ESA and PSA we offer the choice of "Reverse Bitmap" or "Reverse Metafile" when saving screen images. This is much like the "Flat Color" theme available in X-Series. Also, if you selected Reverse Bitmap AND a black & white screen image, that would be much like "Flat Monochrome". In other words, each of the X-Series themes has a similar screen image type in ESA/PSA. But they are not identical.
Initial S/W Revision	Prior to A.02.00

3D Color

Selects a standard color theme with each object filled, shaded and colored as designed.

Key Path	Save, Screen Image, Themes
Example	MMEM:STOR:SCR:THEM TDC
Readback	3D Color
Initial S/W Revision	Prior to A.02.00

3D Monochrome

Selects a format that is like 3D color but shades of gray are used instead of colors.

Key Path	Save, Screen Image, Themes
Example	MMEM:STOR:SCR:THEM TDM
Readback	3D Mono
Initial S/W Revision	Prior to A.02.00

Flat Color

Selects a format that is best when the screen is to be printed on an ink printer.

Key Path	Save, Screen Image, Themes
Example	MMEM:STOR:SCR:THEM FCOL
Readback	Flat Color
Initial S/W Revision	Prior to A.02.00

Flat Monochrome

Selects a format that is like Flat Color. But only black is used (no colors, not even gray), and no fill.

Key Path	Save, Screen Image, Themes
Example	MMEM:STOR:SCR:THEM FMON
Readback	Flat Mono
Initial S/W Revision	Prior to A.02.00

Save As...

When you press “Save As”, the analyzer brings up a Windows dialog and a menu entitled “**Save As.**” This menu allows you to navigate to the various fields in the Windows dialog without using a keyboard or mouse. The Tab and Arrow keys can also be used for dialog navigation.

See ["To File ..." on page 2252](#) in Save, State for a full description of this dialog and menu.

The default path for Screen Images is

My Documents\`<mode name>`\screen.

where `<mode name>` is the parameter used to select the mode with the INST:SEL command (for example, SA for the Spectrum Analyzer).

Key Path	Save, Screen Image
Notes	Brings up Save As dialog for saving a Screen Image Save Type
Initial S/W Revision	Prior to A.02.00

Mass Storage Catalog (Remote Command Only)

Key path	SCPI Only
Remote Command	:MMEMory:CATalog? [<code><directory_name></code>]
Notes	The string must be a valid logical path. Queries disk usage information (drive capacity, free space available) and obtains a list of files and directories in a specified directory in the following format:

	<p><numeric_value>,<numeric_value>,{<file_entry>}</p> <p>It returns two numeric parameters and as many strings as there are files and directories. The first parameter indicates the total amount of storage currently used in bytes. The second parameter indicates the total amount of storage available, also in bytes. The <file_entry> is a string. Each <file_entry> indicates the name, type, and size of one file in the directory list:</p> <p><file_name>,<file_type>,<file_size></p> <p>As the windows file system has an extension that indicates file type, <file_type> is always empty. <file_size> provides the size of the file in bytes. For directories, <file_entry> is surrounded by square brackets and both <file_type> and <file_size> are empty</p>
Initial S/W Revision	Prior to A.02.00

Mass Storage Change Directory (Remote Command Only)

Key path	SCPI Only
Remote Command	:MMEMory:CDIRectory [<directory_name>] :MMEMory:CDIRectory?
Notes	<p>The string must be a valid logical path.</p> <p>Changes the default directory for a mass memory file system. The <directory_name> parameter is a string. If no parameter is specified, the directory is set to the *RST value.</p> <p>At *RST, this value is set to the default user data storage area, that is defined as System.Environment.SpecialFolder.Personal.</p> <p>Query returns full path of the default directory.</p>
Initial S/W Revision	Prior to A.02.00

Mass Storage Copy (Remote Command Only)

Key path	SCPI Only
Remote Command	:MMEMory:COPY <string>,<string>[,<string>,<string>]
Notes	<p>The string must be a valid logical path.</p> <p>Copies an existing file to a new file or an existing directory to a new directory.</p> <p>Two forms of parameters are allowed. The first form has two parameters. In this form, the first parameter specifies the source, and the second parameter specifies the destination.</p> <p>The second form has four parameters. In this form, the first and third parameters specify the source. The second and fourth parameters specify the directories. The first pair of parameters specifies the source. The second pair specifies the destination. An error is generated if the source doesn't exist or the destination file already exists.</p> <p>This command will generate an "access denied" error if the destination is a restricted folder (e.g., C:\Windows) and the current user does not have Power User or Administrator privileges.</p>

Mass Storage Device Copy (Remote Command Only)

This command transfers data to/from a file and a peripheral device.

Key path	SCPI Only
Remote Command	:MMEMory:COpy:DEvice <source_string>,<dest_string>
Notes	<p>The strings must be a valid logical path or a valid device keyword. If the dest_string is a device keyword, the data is copied from the source file to the device. If the source_string is a device keyword, the data is copied to the source file from the device.</p> <p>Valid device keywords are: SNS (smart noise source)</p> <p>An error is generated if the file or device is not found.</p>

Mass Storage Delete (Remote Command Only)

Key path	SCPI Only
Remote Command	:MMEMory:DElete <file_name>[,<directory_name>]
Notes	<p>The string must be a valid logical path.</p> <p>Removes a file from the specified directory. The <file_name> parameter specifies the file name to be removed. This command will generate an “access denied” error if the file is in a restricted folder (e.g., C:\Windows) and the current user does not have Power User or Administrator privileges.</p>
Initial S/W Revision	Prior to A.02.00

Mass Storage Data (Remote Command Only)

Creates a file containing the specified data OR queries the data from an existing file.

Key path	SCPI Only
Remote Command	:MMEMory:DATA <file_name>, <data> :MMEMory:DATA? <file_name>
Notes	<p>The string must be a valid logical path.</p> <p>The command form is MMEMory:DATA <file_name>,<data>. It loads <data> into the file <file_name>. <data> is in 488.2 block format. <file_name> is string data.</p> <p>The query form is MMEMory:DATA? <file_name> with the response being the associated <data> in block format.</p>
Initial S/W Revision	Prior to A.02.00

Mass Storage Make Directory (Remote Command Only)

Key path	SCPI Only
----------	-----------

Remote Command	:MMEMory:MDIRectory <directory_name>
Notes	The string must be a valid logical path. Creates a new directory. The <directory_name> parameter specifies the name to be created. This command will generate an “access denied” error if the new directory would be in a restricted folder (e.g., C:\Windows) and the current user does not have Power User or Administrator privileges.
Initial S/W Revision	Prior to A.02.00

Mass Storage Move (Remote Command Only)

Key path	SCPI Only
Remote Command	:MMEMory:MOVE <string>,<string>[,<string>,<string>]
Notes	The string must be a valid logical path. Moves an existing file to a new file or an existing directory to a new directory. Two forms of parameters are allowed. The first form has two parameters. In this form, the first parameter specifies the source, and the second parameter specifies the destination. The second form has four parameters. In this form, the first and third parameters specify the source. The second and fourth parameters specify the directories. The first pair of parameters specifies the source. The second pair specifies the destination. An error is generated if the source doesn't exist or the destination file already exists. This command will generate an “access denied” error if the destination is a restricted folder (e.g., C:\Windows) and the current user does not have Power User or Administrator privileges.
Initial S/W Revision	Prior to A.02.00

Mass Storage Remove Directory (Remote Command Only)

Key path	SCPI Only
Remote Command	:MMEMory:RDIRectory <directory_name>
Notes	The string must be a valid logical path. Removes a directory. The <directory_name> parameter specifies the directory name to be removed. All files and directories under the specified directory shall also be removed. This command will generate an “access denied” error if the folder is a restricted folder (e.g., C:\Windows) or is in a restricted folder and the current user does not have Power User or Administrator privileges.
Initial S/W Revision	Prior to A.02.00

Single (Single Measurement/Sweep)

Sets the analyzer for Single measurement operation. The single/continuous state is Meas Global, so the setting will affect all the measurements. If you are Paused, pressing Single does a Resume.

See "[More Information](#)" on page 565

Key Path	Front-panel key
Example	:INIT:CONT OFF
Notes	See Cont key description.
Backwards Compatibility Notes	<p>For Spectrum Analysis mode in ESA and PSA, the Single hardkey and the INITiate:IMM switched from continuous measurement to single measurement and restarted sweeps and averages (displayed average count reset to 1), but did not restart Max Hold and Min Hold. In the X-Series, the Single hardkey and the INITiate:IMM command initiate a sweep/ measurement/ average sequence/hold sequence including MaxHold and MinHold.</p> <p>For Spectrum Analysis mode in ESA and PSA, the Single hardkey restarted the sweep regardless of whether or not you were in an active sweep or sweep sequence. In the X-Series, Restart does this but Single only restarts the sweep or sweep sequence if you are in the idle state.</p> <p>INIT[:IMM] in ESA & PSA Spectrum Analysis Mode does an implied ABORT. In some other PSA Modes, INIT[:IMM] is ignored if not in the idle state. . The X-Series follows the ESA/PSA SA Mode model, which may cause some Modes to have compatibility problems.</p>
Initial S/W Revision	Prior to A.02.00

More Information

See "[Restart](#)" on page 2249 for details on the INIT:IMMEDIATE (Restart) function.

If you are already in single sweep, the INIT:CONT OFF command has no effect.

If you are already in Single Sweep, then pressing the Single key in the middle of a sweep does not restart the sweep or sequence. Similarly, pressing the Single key does not restart the sweep or sequence if the sweep is not in the idle state (for example, if you are taking a very slow sweep, or the analyzer is waiting for a trigger). Instead, it results in a message. "Already in Single, press Restart to initiate a new sweep or sequence". Even though pressing the Single key in the middle of a sweep does not restart the sweep, sending INIT:IMMEDIATE does reset it.

To take one more sweep without resetting the average count, increment the average count by 1, by pressing the step up key while **Average/Hold Number** is the active function, or sending the remote command CALC:AVER:TCON UP.

Source

There is no Source control functionality for this measurement. When this key is pressed, the screen either displays a blank menu, or the previously-selected menu remains unchanged.

Key Path	Front-panel key
----------	-----------------

Span X Scale

Accesses a menu of functions that enable you set the horizontal scale parameters.

Key Path	Front-panel key
Initial S/W Revision	Prior to A.02.00

Span

Changes the frequency range symmetrically about the center frequency.

The default (and minimum) Span is calculated using the number of carriers and the carrier width where;

$$\text{Span} = (\text{Upper Carrier Freq} + (\text{max offset IBW} * (1 + \alpha)) / 2) - (\text{Lower Carrier Freq} - (\text{max offset IBW} * (1 + \alpha)) / 2)$$

The span is increased by a factor of 1 + Filter Alpha if the RRC Filter is on.

Key Path	Span X Scale
Mode	SA, WCDMA, C2K, WIMAX OFDMA, 1xEVDO, DVB-T/H, DTMB (CTTB), ISDB-T, CMMB, LTE, LTETDD, Digital Cable TV, WLAN
Remote Command	[:SENSe] :CHPower:FREQuency:SPAN <freq> [:SENSe] :CHPower:FREQuency:SPAN?
Example	CHP:FREQ:SPAN 10 MHz CHP:FREQ:SPAN?
Notes	You must be in the Spectrum Analysis mode, W-CDMA mode, cdma2000 mode, DVB-T/H mode, DTMB (CTTB) mode, ISDB-T mode, CMMB mode, Digital Cable TV mode, LTE mode, LTE TDD mode, WLAN mode, 1xEVDO mode or WIMAX OFDMA mode to use this command. Use :INSTrument:SElect to set the mode.
Dependencies	For MSR mode, this key is blank. For LTE-Advanced FDD/TDD mode, this key is blank. For WLAN 802.11ac (80 MHz + 80 MHz), the key is not enabled and its value is coupled with the spacing between the center frequencies of the two carriers. Span = Center Frequency 1 - Center Frequency 2 + Integ BW + 40 MHz Margin. When the calculated span is over 1 GHz, it's still coupled to its maximum value, which is 1 GHz.
Couplings	When Res BW is set to Auto, the resolution bandwidth is auto-coupled to span. The ratio of span /RBW is approximately 106:1. When the Res BW is set to Man, bandwidths are entered by the user, and these bandwidths are used regardless of other analyzer settings. Since Span is coupled to Integ BW in the factory default condition, if you change the integration bandwidth setting, the span setting changes by a proportional amount until a limit value is reached. However, the span can be individually set. The minimum value of the span is coupled with the integration bandwidth.
Preset	SA: 3 MHz WCDMA: 7.5 MHz

	<p>C2K: 1.845 MHz WIMAX OFDMA: 20 MHz 1xEVDO: 2.0MHz DVB-T/H: 10MHz DTMB (CTTB): 10MHz ISDB-T: 10MHz CMMB: 10MHz LTE: 7.5 MHz LTETDD: 7.5 MHz Digital Cable TV: 10MHz WLAN: if Radio Std is 802.11a/g(OFDM/DSSS-OFDM): 30 MHz if Radio Std is 802.11b: 37.5MHz if Radio Std is 802.11n(20MHz): 30 MHz if Radio Std is 802.11n(40MHz): 60 MHz if Radio Std is 802.11ac (20 MHz): 30 MHz if Radio Std is 802.11ac (40 MHz): 60 MHz if Radio Std is 802.11ac (80 MHz): 120 MHz if Radio Std is 802.11ac (160 MHz): 240 MHz if Radio Std is 802.11ac (80 MHz + 80 MHz): 360 MHz</p>
State Saved	Saved in instrument state.
Min	100 Hz
Max	Hardware Maximum Span
Initial S/W Revision	Prior to A.02.00
Modified at S/W Revision	A.02.00, A.03.00

Full Span

Changes the span to show the full frequency range of the spectrum analyzer.

Key Path	Span X Scale
Mode	SA, WCDMA, C2K, WIMAX OFDMA, 1xEVDO, DVB-T/H, DTMB (CTTB), ISDB-T, CMMB, LTE, LTETDD, Digital Cable TV, WLAN
Remote Command	[[:SENSe]:CHPower:FREQuency:SPAN:FULL
Example	CHP:FREQ:SPAN:FULL
Notes	You must be in the Spectrum Analysis mode, W-CDMA mode, cdma2000 mode, DVB-T/H mode, DTMB (CTTB) mode, ISDB-T mode, CMMB mode, Digital Cable TV mode, LTE mode, LTE TDD mode, WLAN mode, 1xEVDO mode or WIMAX OFDMA mode to use this command. Use :INSTrument:SElect to set the mode.

Dependencies	For MSR mode, this key is blank. For LTE-Advanced FDD/TDD mode, this key is blank.
Couplings	Selecting full span changes the measurement span value.
Initial S/W Revision	Prior to A.02.00
Modified at S/W Revision	A.02.00, A.03.00

Last Span

Changes the span to the previous span setting. If no previous span value exists, then the span remains unchanged.

Key Path	Span X Scale
Mode	SA, WCDMA, C2K, WIMAX OFDMA, 1xEVDO, DVB-T/H, DTMB (CTTB), ISDB-T, CMMB, LTE, LTETDD, Digital Cable TV, WLAN
Remote Command	[:SENSe] :CHPower:FREQuency:SPAN:PREvious
Example	CHP:FREQ:SPAN:PREV
Notes	You must be in the Spectrum Analysis mode, W-CDMA mode, cdma2000 mode, DVB-T/H mode, DTMB (CTTB) mode, ISDB-T mode, CMMB mode, Digital Cable TV mode, LTE mode, LTE TDD mode, WLAN mode, 1xEVDO mode or WIMAX OFDMA mode to use this command. Use :INSTrument:SElect to set the mode.
Dependencies	For MSR mode, this key is blank. For LTE-Advanced FDD/TDD mode, this key is blank.
Couplings	Selecting last span changes the measurement span value.
Initial S/W Revision	Prior to A.02.00
Modified at S/W Revision	A.02.00, A.03.00

Sweep/Control

Accesses a menu of functions that enable you to set up and control the sweep time and source for the current measurement. See "[Sweep/Control](#)" on page 2282 for more information.

Key Path	Front-panel key
Initial S/W Revision	Prior to A.02.00

Sweep Time

Selects the length of time that the spectrum analyzer sweeps the displayed frequency span. Additional overhead time, which impacts the sweep rate, is not calculated as part of the sweep time. In fact:

$$\text{sweep rate} = \text{span} / \text{sweep time}$$

$$\text{update rate} = 1 / (\text{sweep time} + \text{overhead})$$

$$\text{sweep cycle time} = \text{sweep time} + \text{overhead}$$

Sweep time is coupled to RBW and VBW, and is impacted by the number of sweep points, so changing those parameters may change the sweep time.

Key Path	Sweep/Control
Mode	SA, WCDMA, C2K, WIMAX OFDMA, 1xEVDO, DVB-T/H, DTMB (CTTB), ISDB-T, CMMB, LTE, LTETDD, Digital Cable TV, WLAN, MSR, LTEAFDD, LTEATDD
Remote Command	[:SENSe]:CHPower:SWEep:TIME <time> [:SENSe]:CHPower:SWEep:TIME? [:SENSe]:CHPower:SWEep:TIME:AUTO OFF ON 0 1 [:SENSe]:CHPower:SWEep:TIME:AUTO?
Example	CHP:SWE:TIME 25ms CHP:SWE:TIME? CHP:SWE:TIME:AUTO OFF CHP:SWE:TIME:AUTO?
Preset	SA, WIMAX OFDMA: Automatically Calculated WCDMA: 1.0 ms CDMA2K: 9.4ms 1xEVDO: 2.66ms DVB-T/H: Automatically Calculated DTMB (CTTB): Automatically Calculated ISDB-T: Automatically Calculated CMMB: Automatically Calculated LTE, MSR: Automatically Calculated LTETDD: Automatically Calculated Digital Cable TV: Automatically Calculated

	WLAN: Automatically Calculated LTEAFDD,LTEATDD:Automatically Calculated
State Saved	Saved in instrument state.
Min	1 ms
Max	4000 s
Initial S/W Revision	Prior to A.02.00
Modified at S/W Revision	A.02.00, A.03.00

Sweep Setup

Accesses a menu that enables you to set the sweep state for the current measurement.

Key Path	Sweep/Control
Initial S/W Revision	Prior to A.02.00

Auto Sweep Time Rules

Switches the analyzer between normal and accuracy sweep states.

Setting Auto Sweep Time to Accy results in slower sweep times, usually about three times as long, but yields better amplitude accuracy for CW signals. The instrument amplitude accuracy specifications only apply when Auto Sweep Time is set to Accy.

Additional amplitude errors which occur when Auto Sweep Time is set to Norm are usually well under 0.1 dB, though this is not guaranteed. Because of the faster sweep times and still low errors, Norm is the preferred setting of Auto Sweep Time. Auto Sweep Time is set to Norm on a Preset or Auto Couple. This means that in the Preset or Auto Coupled state, instrument amplitude accuracy specifications do not apply.

Key Path	Sweep/Control, Sweep Setup
Mode	SA, WCDMA, C2K, WIMAX OFDMA, 1xEVDO, DVB-T/H, DTMB (CTTB), ISDB-T, CMMB, LTE, LTE-TDD, Digital Cable TV, WLAN, MSR, LTEAFDD, LTEATDD
Remote Command	[:SENSe] :CHPower:SWEep:TIME:AUTO:RULEs NORMal ACCuracy [:SENSe] :CHPower:SWEep:TIME:AUTO:RULEs?
Example	CHP:SWE:TIME:AUTO:RUL NORM CHP:SWE:TIME:AUTO:RUL?
Notes	In Zero Span, this key is irrelevant and inaccessible (because the whole Sweep Setup menu is grayed out in Zero Span), however its settings can be changed remotely with no error indication. Set to Norm when Auto Couple is pressed or sent remotely

Preset	NORMal
State Saved	Saved in instrument state.
Range	Norm Accy
Initial S/W Revision	Prior to A.02.00
Modified at S/W Revision	A.02.00, A.03.00

Pause

Pauses a measurement after the current data acquisition is complete. When Paused, the label on the key changes to Resume. Pressing the Resume key resumes the measurement at the point it was at when paused. See ["Pause/Resume" on page 2282](#) for more details.

Key Path	Sweep/Control
Initial S/W Revision	Prior to A.02.00

Gate

Accesses a menu that enables you to control the gating function. The Gate functionality is used to view signals best viewed by qualifying them with other events.

Gate setup parameters are the same for all measurements – they do not change as you change measurements. Settings like these are called “Meas Global” and are unaffected by Meas Preset.

Note that Sweep Time autocoupling rules and annotation are changed by Gate being on.

Key Path	Sweep/Control
Scope	Meas Global
Readback	The state and method of Gate, as [Off, LO] or [On, Video]. Note that for measurements that only support gated LO, the method is nonetheless read back, but always as LO.
Initial S/W Revision	Prior to A.02.00

Gate On/Off

Turns the gate function on and off.

When the Gate Function is on, the selected Gate Method is used along with the gate settings and the signal at the gate source to control the sweep and video system with the gate signal. Not all measurements allow every type of Gate Methods.

When Gate is on, the annunciation in the measurement bar reflects that it is on and what method is used, as seen in the following "Gate: LO" annunciator graphic.

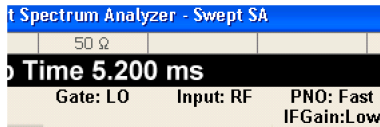

Key Path	Sweep/Control, Gate
Remote Command	[:SENSe] :SWEep:EGATe [:STATe] OFF ON 0 1 [:SENSe] :SWEep:EGATe [:STATe] ?
Example	SWE:EGAT ON SWE:EGAT?
Dependencies	<p>The function is unavailable (grayed out) and Off when:</p> <ul style="list-style-type: none"> • Gate Method is LO or Video and FFT Sweep Type is manually selected. • Gate Method is FFT and Swept Sweep Type is manually selected. • Marker Count is ON. <p>The following are unavailable whenever Gate is on:</p> <ul style="list-style-type: none"> • FFT under Sweep Type when Method=LO or Video or Swept under Sweep Type when Method=FFT • Marker Count <p>While Gate is on, the Auto Rules for Sweep Type are modified so that the choice agrees with the Gate Method: i.e., FFT for Method = FFT and Swept for Method = LO or Video.</p> <p>The Gate softkey and all SCPI under the [:SENSe]:SWEep:EGATe SCPI node are grayed out when Source Mode is Tracking with an external source. This is because the Gate circuitry is used to sync the external source. If the Tracking Source is turned on, the Gate is turned off.</p> <p>When in the ACP measurement:</p> <ul style="list-style-type: none"> • When Meas Method is RBW or FAST, this function is unavailable and the key is grayed out. • Whenever Gate is on, Meas Method, RBW or FAST is unavailable and keys for those are grayed out. • When Gate is on, Offset Res BW and Offset Video BW are ignored (if you set these values) and the measurement works as if all Offset Res BW and all Offset Video BW are coupled with the Res BW and the Video BW under the BW menu. When Gate is on, the Offset BW key in the Offset/Limit menu is grayed out.
Preset	Off LTETDD: On
State Saved	Saved in instrument state
Range	On Off
Backwards Compatibility SCPI	[:SENSe] :SWEep:TIME:GATE[:STATe] ESA compatibility
Backwards Compatibility Notes	In ESA, Trig Delay (On) and Gate (On) could not be active at the same time.. This dependency does not exist in PSA or in the X-Series.
Initial S/W Revision	Prior to A.02.00

Gate View On/Off

Turning on Gate View in the Swept SA measurement provides a single-window gate view display..

Turning on Gate View in other measurements shows the split-screen Gate View. In these measurements, when the Gate View is on, the regular view of the current measurement traces and results are reduced vertically to about 70% of the regular height. The Zero Span window, showing the positions of the Gate, is shown between the Measurement Bar and the reduced measurement window. By reducing the height of the measurement window, some of the annotation on the Data Display may not fit and is not shown.

Key Path	Sweep/Control, Gate
Remote Command	[:SENSe] :SWEep:EGATe:VIEW ON OFF 1 0 [:SENSe] :SWEep:EGATe:VIEW?
Example	SWE:EGAT:VIEW ON turns on the gate view.
Dependencies	In the Swept SA measurement: In Gate View, the regular Sweep Time key is grayed out . When pressed, the grayed out key puts up the informational message "Use Gate View Sweep Time in the Gate menu." In the other measurements: When you turn Gate View on, the lower window takes on the current state of the instrument. Upon leaving Gate View, the instrument takes on the state of the lower window. When you turn Gate View on, the upper window Sweep Time is set to the gate view sweep time.
Couplings	These couplings apply to the Swept SA measurement: <ul style="list-style-type: none"> • When Gate View is turned on, the instrument is set to Zero Span. • Gate View automatically turns off whenever a Span other than Zero is selected. • Gate View automatically turns off if you press the Last Span key while in Gate View, and the instrument returns to the Span it was in before entering Gate View (even if that is Zero Span). • When Gate View is turned on, the sweep time used is the gate view sweep time. This is set according to the rules in section "Gate View Setup" on page 2083 • When Gate View is turned off, Sweep Time is set to the normal Swept SA measurement sweep time. • If Gate View is on and Gate is off, then turning on Gate turns off Gate View.
Preset	OFF
State Saved	Saved in instrument state
Range	On Off
Initial S/W Revision	Prior to A.02.00

A sample of the Gate View screen in the Swept SA measurement is shown in the following graphic :

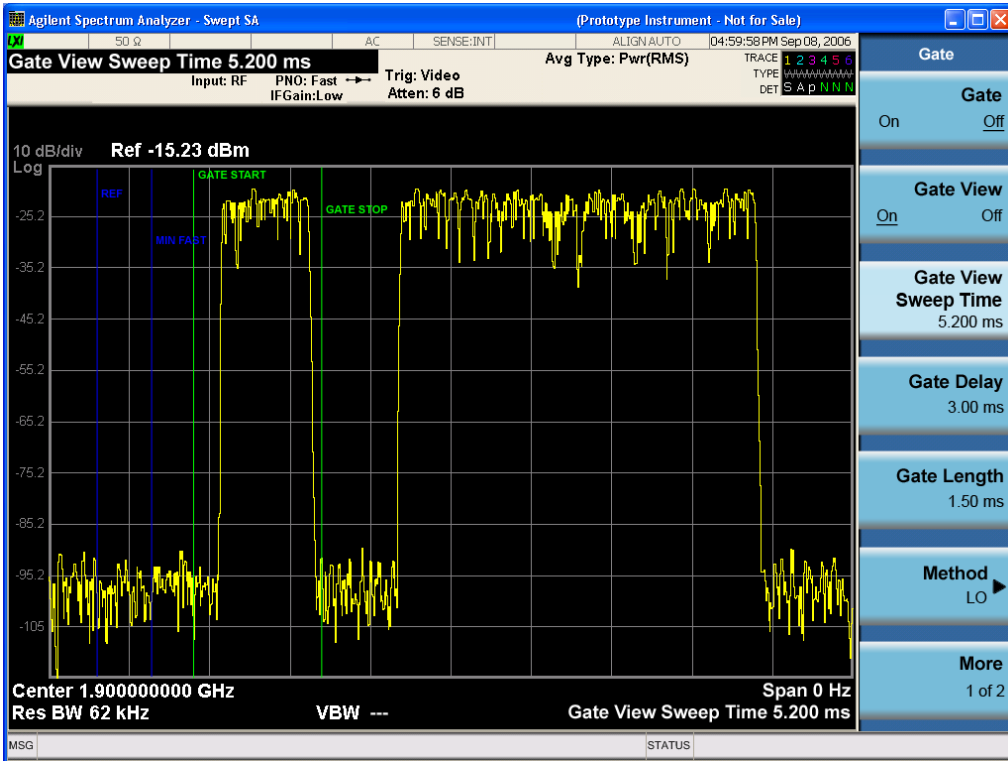

A sample of the Gate View screen in other measurements is shown in the following graphic. This example is for the ACP measurement:

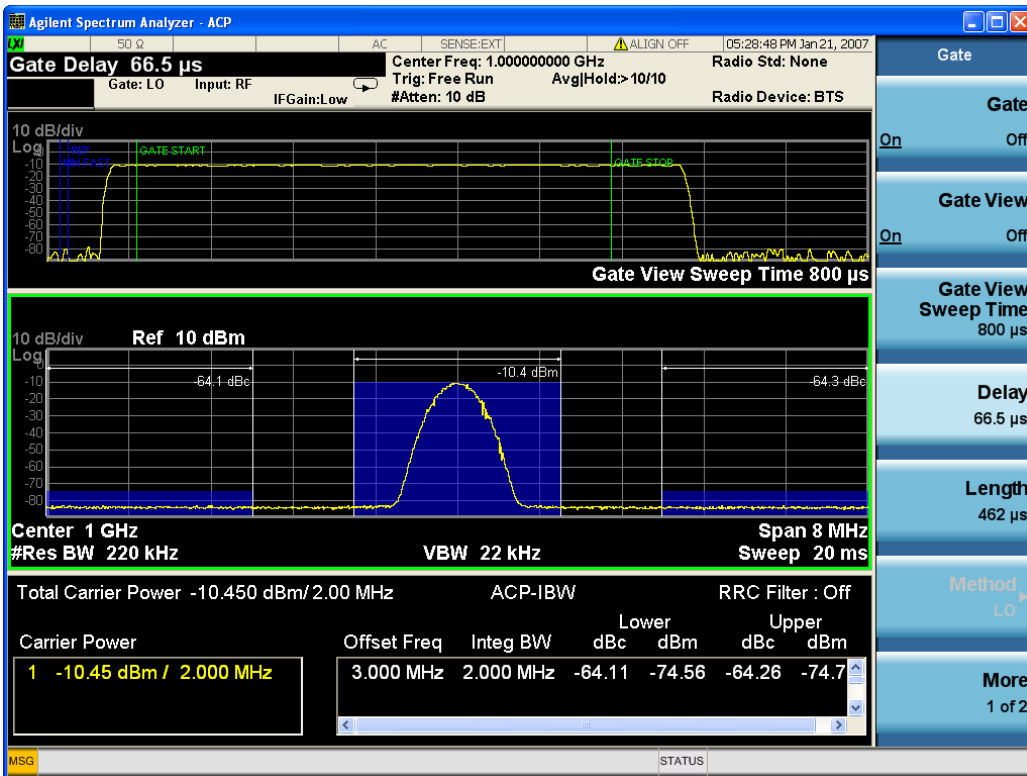

Turning Gate View off returns the analyzer to the Normal measurement view.

In the Swept SA, the normal measurement view is the single-window Swept SA view. When returning to this view, the Swept SA measurement returns to the Span it was in before entering **Gate View** (even if that is Zero Span).

The **Gate View** window is triggered from the Gate Source, with zero trigger delay. Also, when updating the **Gate View** window, the Gate itself must not operate. So it is internally shut off while the gate view window is being updated. For the Swept SA measurement, this means that the Gate is internally shut off whenever the gate view window is displayed. The measurement bar and softkeys continue to show the Trigger source for the main sweep window and give no indication that the Gate is shut off or that the Gate View window is triggered from the Gate Source.

When in **Gate View**, vertical lines are displayed in the Gate View window as follows:

- Green lines are displayed at the gate edges as follows: in Edge Gate, a line is shown for Delay and one for the end of the Gate period, defined by Length. In Level Gate a line is shown only for Delay. You can adjust the position of the green lines by adjusting the gate length and the gate delay. These lines update in the Gate View window as the active function changes, even if the window is not being updated. In Gated LO and Gated Video, these lines are positioned relative to the delay reference line (not relative to 0 time). In Gated FFT, their location is relative to the left edge of the screen.
- A blue line is displayed showing the delay reference, that is, the reference point for the Gate Delay within the Zero Span window. The blue line represents where (in time) the effective location of the gate start would be if the gate were programmed to zero delay.
-
- The second blue line is labeled "MIN FAST" as shown in the figure above because it represents the minimum Gate Delay for fast Gated LO operation. This line is only displayed in Gated LO. You cannot scroll (knob) or decrement (down key) the Gate Delay to less than that represented by the position of this line, it can only be set below this position manually, although once there it can be moved freely with the knob while below the line.
- A yellow line in the Gated Video case only, is displayed at Blength, where Blength is the display point (bucket) length for the swept trace, which is given by the sweep time for that trace divided by number of Points - 1. So it is referenced to 0 time, not to the delay reference. This line is labeled NEXT PT (it is not shown in the figure above because the figure above is for Gated LO).
- The yellow line represents the edge of a display point (bucket). Normally in Gated Video, the bucket length must be selected so that it exceeds the off time of the burst. There is another way to use the analyzer in Gated Video measurements, and that is to set the bucket width much shorter than the off time of the burst. Then use the Max Hold trace function to fill in "missing" buckets more slowly. This allows you to see some of the patterns of the Gated Video results earlier, though seeing a completely filled-in spectrum later.

Gate View Setup

Accesses a menu that enables you to setup parameters relevant to the Gate View

Key Path	Sweep/Control, Gate
Scope	Meas Global
Initial S/W Revision	A.10.00

Gate View Sweep Time

Controls the sweep time in the Gate View window. To provide an optimal view of the gate signal, the analyzer initializes Gate View Sweep Time based on the current settings of Gate Delay and Gate Length.

Key Path	Sweep/Control, Gate, Gate View Setup
Remote Command	[:SENSe] :SWEep:EGATe:TIME <time> [:SENSe] :SWEep:EGATe:TIME?
Example	SWE:EGAT:TIME 500 ms
Dependencies	Gate View Sweep Time is initialized: <ul style="list-style-type: none"> • On Preset (after initializing delay and length). • Every time the Gate Method is set/changed. <p>Additionally, in the Swept SA measurement, whenever you do a Preset, or leave Gate View, the analyzer remembers the Gate Delay and Gate Length settings. Then, when returning to Gate View, if the current Gate Delay and/or Gate Length do not match the remembered values Gate View Sweep Time is re-initialized.</p> <ol style="list-style-type: none"> 1. Compute the location of the "gate stop" line, which you know is at time $t = t_{min} + \text{GateDelay} + \text{GateLength}$.
Preset	519.3 μ s WiMAX OFDMA: 5 ms GSM/EDGE: 1 ms
State Saved	Saved in instrument state
Max	6000 s
Initial S/W Revision	Prior to A.02.00

Gate View Start Time

Controls the time at the left edge of the Gate View.

Key Path	Sweep/Control, Gate, Gate View Setup
Remote Command	[:SENSe] :SWEep:EGATe:VIEW:STARt <time> [:SENSe] :SWEep:EGATe:VIEW:STARt?
Example	SWE:EGAT:VIEW:STAR 10ms
Notes	Units of time are required or no units; otherwise an invalid suffix error message will be generated. See error -131.
Preset	0 ms
State Saved	Saved in instrument state
Min	0
Max	500 ms
Initial S/W Revision	A.10.00

Gate Delay

Controls the length of time from the time the gate condition goes True until the gate is turned on.

Key Path	Sweep/Control, Gate
Remote Command	[:SENSe] :SWEep:EGATe:DELay <time> [:SENSe] :SWEep:EGATe:DELay?
Example	SWE:EGAT:DELay 500ms SWE:EGAT:DELay?
Notes	Units of time are required or no units; otherwise an invalid suffix error message will be generated.
Preset	57.7 us WiMAX OFDMA: 71 us GSM/EDGE: 600 us WLAN: 500 us
State Saved	Saved in instrument state
Min	0.0 us
Max	100 s
Backwards Compatibility SCPI	[:SENSe] :SWEep:TIME:GATE:DELay ESA compatibility
Initial S/W Revision	Prior to A.02.00

Gate Length

Controls the length of time that the gate is on after it opens.

Key Path	Sweep/Control, Gate
Remote Command	[:SENSe] :SWEep:EGATe:LENGth <time> [:SENSe] :SWEep:EGATe:LENGth?
Example	SWE:EGAT:LENG 1 SWE:EGAT:LENG?
Notes	Units of time are required or no units; otherwise an invalid suffix error message will be generated.
Dependencies	<p>Grayed out when Gate Method is set to FFT in which case the label changes to that shown below.</p>  <p>The key is also grayed out if Gate Control = Level.</p>
Preset	461.6 us

	WiMAX OFDMA: 50 us GSM/EDGE: 200 us WLAN: 1.54 ms
State Saved	Saved in instrument state
Min	100 ns
Max	5 s
Backwards Compatibility SCPI	[:SENSe]:SWEep:TIME:GATE:LENGth ESA compatibility
Initial S/W Revision	Prior to A.02.00

Gate Source

The menus under the Gate Source key are the same as those under the Trigger key, with the exception that neither Free Run nor Video are available as Gate Source selections. However, a different SCPI command is used to select the Gate Source (see table below) because you may independently set the Gate Source and the Trigger Source.

Any changes to the settings in the setup menus under each Gate Source selection key (for example: Trigger Level, Trigger Delay, etc.) also affect the corresponding settings under the Trigger menu keys. The SCPI commands used for these are the same for Trigger and Gate, since there is only one setting which affects both Gate and Trigger. Example: to set the Trigger Level for External 1 you use the command :TRIG:EXT1:LEV regardless of whether you are using External 1 as a Trigger Source or a Gate Source.

Key Path	Sweep/Control, Gate
Remote Command	[:SENSe]:SWEep:EGATe:SOURce EXTernal1 EXTernal2 LINE FRAME RFBurst [:SENSe]:SWEep:EGATe:SOURce?
Dependencies	In some models, there is no second External input. In these models, the External 2 key is blanked and the EXTernal2 parameter will generate a "Hardware missing; Not available for this model number" error.
Preset	EXTernal 1 GSM/EDGE, MSR: FRAME LTETDD: EXTernal 1When Direction is Downlink, FRAME when Direction is Uplink.
Backwards Compatibility Notes	In ESA, there is a single Gate input port. In PSA, the Gate Source may be taken from one of two specified input ports. In the X-Series, any Trigger Source can be a Gate Source.
Initial S/W Revision	Prior to A.02.00
Modified at S/W Revision	A.03.00, A.14.00

Line

Pressing this key, when it is not selected, selects the line signal as the trigger. A new sweep/measurement will start synchronized with the next cycle of the line voltage. Pressing this key, when it is already selected, access the line trigger setup menu.

Key Path	Trigger
Example	TRIG:SOUR LINE Swept SA measurement TRIG:<meas>:SOUR LINE Measurements other than Swept SA
Dependencies	Line trigger is not available when operating from a "dc power source", for example, when the instrument is powered from batteries.
State Saved	Saved in instrument state
Status Bits/OPC dependencies	The Status Operation Register bit 5 "Waiting for Trigger" is set at the same time as the Sweeping or Measuring bit is set. It is cleared when the trigger actually occurs (that is, after the trigger event occurs and all the applicable trigger criteria have been met). A corresponding pop-up message ("Waiting for trigger") is generated if no trigger signal appears after approximately 2 sec. This message goes away when a trigger signal appears.
Initial S/W Revision	Prior to A.02.00

Trig Slope

Controls the trigger polarity. It is set positive to trigger on a rising edge and negative to trigger on a falling edge.

Key Path	Trigger, Line
Remote Command	:TRIGger[:SEquence]:LINE:SLOPe POSitive NEGative :TRIGger[:SEquence]:LINE:SLOPe?
Example	TRIG:LINE:SLOP NEG
Preset	POSitive
State Saved	Saved in instrument state
Backwards Compatibility Notes	The legacy :TRIGger[:SEquence]:SLOPe command affects the slopes for the VID, LINE, EXT1, EXT2, and RFB triggers.
Initial S/W Revision	Prior to A.02.00

External 1

Pressing this key, when it is not selected, selects an external input signal as the trigger. A new sweep/measurement will start when the external trigger condition is met using the external 1 input connector on the rear panel.

Pressing this key, when it is already selected, accesses the external 1 trigger setup menu.

Key Path	Trigger
Example	TRIG:SOUR EXT1 Swept SA measurement TRIG:<meas>:SOUR EXT1 Measurements other than Swept SA
Dependencies	Grayed out if in use by Point Trigger in the Source Setup menu. Forced to Free Run if already selected and Point Trigger is set to External 1.
State Saved	Saved in instrument state
Status Bits/OPC dependencies	The Status Operation Register bit 5 "Waiting for Trigger" is set at the same time as the Sweeping or Measuring bit is set. It is cleared when the trigger actually occurs (that is, after the trigger event occurs and all the applicable trigger criteria have been met). A corresponding pop-up message ("Waiting for trigger") is generated if no trigger signal appears after approximately 2 sec. This message goes away when a trigger signal appears.
Initial S/W Revision	Prior to A.02.00

Trigger Level

Sets the value where the external 1 trigger input will trigger a new sweep/measurement.

Key Path	Trigger, External 1
Remote Command	:TRIGger[:SEquence]:EXTernal1:LEVel <level> :TRIGger[:SEquence]:EXTernal1:LEVel?
Example	TRIG:EXT1:LEV 0.4 V
Couplings	This same level is used for the Ext1 trigger source in the Trigger menu, for the Ext1 selection in the Periodic Timer sync source (in the Trigger menu and in the Gate Source menu), and also for the Ext1 selection in the Gate Source menu.
Preset	1.2 V
State Saved	Saved in instrument state
Min	-5 V
Max	5 V
Default Unit	V
Backwards Compatibility SCPI	:TRIGger[:SEquence]:EXTernal:LEVel For backward compatibility, the parameter EXTernal is mapped to EXTernal1
Backwards Compatibility SCPI	:TRIGger[:SEquence]:FRAME:EXTernal1:LEVel
Initial S/W Revision	Prior to A.02.00

Trig Slope

Controls the trigger polarity. It is set positive to trigger on a rising edge and negative to trigger on a falling edge.

Key Path	Trigger, External 1
Remote Command	:TRIGger[:SEquence]:EXTErnal1:SLOPe POSitive NEGative :TRIGger[:SEquence]:EXTErnal1:SLOPe?
Example	TRIG:EXT1:SLOP NEG
Couplings	This same slope is used in the Ext1 selection for the trigger source in the Trigger menu and for the period timer sync source (in the Trigger menu and in the Gate Source menu).
Preset	POSitive
State Saved	Saved in instrument state
Backwards Compatibility SCPI	:TRIGger[:SEquence]:EXTErnal:SLOPe For backward compatibility, the parameter EXTErnal is mapped to EXTErnal1
Backwards Compatibility SCPI	:TRIGger[:SEquence]:FRAME:EXTErnal1:SLOPe
Backwards Compatibility Notes	The legacy :TRIGger[:SEquence]:SLOPe command affects the slopes for the VID, LINE, EXT1, EXT2, and RFB triggers.
Initial S/W Revision	Prior to A.02.00

External 2

Pressing this key, when it is not selected, selects an external input signal as the trigger. A new sweep/measurement will start when the external trigger condition is met using the external 2 input connector. The external trigger 2 input connector is on the rear panel.

Pressing this key, when it is already selected, accesses the external 2 trigger setup menu.

Key Path	Trigger
Example	TRIG:SOUR EXT2 Swept SA measurement TRIG:<meas>:SOUR EXT2 Measurements other than Swept SA
Dependencies	In some models, there is no second External input. In these models, the External 2 key is blanked and the EXTErnal2 parameter will generate a "Hardware missing; Not available for this model number" message. Grayed out if in use by Point Trigger in the Source Setup menu. Forced to Free Run if already selected and Point Trigger is set to External 2.
State Saved	Saved in instrument state
Status Bits/OPC dependencies	The Status Operation Register bit 5 "Waiting for Trigger" is set at the same time as the Sweeping or Measuring bit is set. It is cleared when the trigger actually occurs (that is, after the trigger event occurs and all the applicable trigger criteria have been met). A corresponding pop-up message ("Waiting for trigger") is generated if no trigger signal appears after approximately 2 sec. This message goes away when a trigger signal appears.
Initial S/W Revision	Prior to A.02.00
Modified at S/W Revision	A.03.00

Trigger Level

Sets the value where the external 2 trigger input will trigger a new sweep/measurement.

Key Path	Trigger, External 2
Remote Command	:TRIGger[:SEquence]:EXTernal2:LEVel :TRIGger[:SEquence]:EXTernal2:LEVel?
Example	TRIG:EXT2:LEV 1.1 V
Couplings	This same level is used for the Ext2 trigger source in the Trigger menu, for the Ext2 selection in the Periodic Timer sync source (in the Trigger menu and in the Gate Source menu), and also for the Ext2 selection in the Gate Source menu.
Preset	1.2 V
State Saved	Saved in instrument state
Min	-5 V
Max	5 V
Default Unit	V
Backwards Compatibility SCPI	:TRIGger[:SEquence]:FRAMe:EXTernal2:LEVel
Initial S/W Revision	Prior to A.02.00

Trig Slope

Controls the trigger polarity. It is set positive to trigger on a rising edge and negative to trigger on a falling edge.

Key Path	Trigger, External 2
Remote Command	:TRIGger[:SEquence]:EXTernal2:SLOPe POSitive NEGative :TRIGger[:SEquence]:EXTernal2:SLOPe?
Example	TRIG:EXT2:SLOP NEG
Couplings	This same slope is used in the Ext2 selection for the trigger source in the Trigger menu and for the period timer sync source (in the Trigger menu and in the Gate Source menu).
Preset	POSitive
State Saved	Saved in instrument state
Backwards Compatibility SCPI	:TRIGger[:SEquence]:FRAMe:EXTernal2:SLOPe
Backwards Compatibility Notes	The legacy :TRIGger[:SEquence]:SLOPe command affects the slopes for the VID, LINE, EXT1, EXT2, and RFB triggers.
Initial S/W Revision	Prior to A.02.00

RF Burst

Pressing this key, when it is not selected, selects the RF Burst as the trigger. A new sweep/measurement will start when an RF burst envelope signal is identified from the signal at the RF Input connector. Pressing this key, when it is already selected, accesses the RF Burst trigger setup menu.

In some models, a variety of burst trigger circuitry is available, resulting in various available burst trigger bandwidths. The analyzer automatically chooses the appropriate trigger path based on the hardware configuration and other settings of the analyzer.

Key Path	Trigger
Example	TRIG:SOUR RFB Swept SA measurement TRIG:< meas>:SOUR RFB Measurements other than Swept SA
State Saved	Saved in instrument state
Status Bits/OPC dependencies	The Status Operation Register bit 5 "Waiting for Trigger" is set at the same time as the Sweeping or Measuring bit is set. It is cleared when the trigger actually occurs (that is, after the trigger event occurs and all the applicable trigger criteria have been met). A corresponding pop-up message ("Waiting for trigger") is generated if no trigger signal appears after approximately 2 sec. This message goes away when a trigger signal appears.
Backwards Compatibility Notes	The legacy command: :TRIGger[:SEQuence]:RFBurst:FSElectivity[:STATe] OFF ON 0 1 is not supported in the X-Series, as the hardware to do Frequency Selective burst triggers does not exist in X-Series.
Initial S/W Revision	Prior to A.02.00
Modified at S/W Revision	A.04.00

Absolute Trigger Level

Sets the absolute trigger level for the RF burst envelope.

When using the External Mixing path, the Absolute Trigger Level is uncalibrated because the factory default was set to accommodate the expected IF levels for the RF path.

Key Path	Trigger, RF Burst
Scope	Meas Global
Remote Command	:TRIGger[:SEQuence]:RFBurst:LEVel:ABSolute <ampl> :TRIGger[:SEQuence]:RFBurst:LEVel:ABSolute?
Example	TRIG:RFB:LEV:ABS 10 dBm sets the trigger level of the RF burst envelope signal to the absolute level of 10 dBm
Notes	Sending this command does not switch the setting from relative to absolute; to switch it you need to send the :TRIGger[:SEQuence]:RFBurst:LEVel:TYPE command, below. Amplitude Corrections are not taken into account by the Absolute Trigger Level. For example, if you have given yourself effective gain with an amplitude correction factor, the Absolute Trigger will not fire until you have set the trigger level that far below the displayed signal level, rather than simply to

	the displayed signal level. This is only true for Amplitude Corrections, not External Gain or Ref Level Offset functions. If mode is Bluetooth, the default value is -50 dBm.
Couplings	This same level is used for the RF Burst trigger source in the Trigger menu, for the RF Burst selection in the Periodic Timer sync source (in the Trigger menu and in the Gate Source menu), and also for the RF Burst selection in the Gate Source menu
Preset	-20 dBm
State Saved	Saved in instrument state
Min	-200 dBm
Max	100 dBm
Default Unit	depends on the current selected Y-Axis unit
Backwards Compatibility SCPI	:TRIGger[:SEquence]:FRAMe:RFBurst:LEVel:ABSolute
Initial S/W Revision	Prior to A.02.00
Modified at S/W Revision	A.04.00

Key Path	Trigger, RF Burst
Remote Command	:TRIGger[:SEquence]:RFBurst:LEVel:TYPE ABSolute RELative :TRIGger[:SEquence]:RFBurst:LEVel:TYPE?
Example	TRIG:RFB:LEV:TYPE REL sets the trigger level type of the RF burst trigger to Relative.
Preset	ABSolute
State Saved	Saved in instrument state
Initial S/W Revision	Prior to A.02.00
Modified at S/W Revision	A.04.00

Relative Trigger Level

Sets the relative trigger level for the RF burst envelope.

In some models, the relative burst trigger function is implemented in hardware. In other models, without the advanced triggering hardware required, the relative burst trigger function is implemented in software in some measurements, and is unavailable in other measurements.

When implemented in software, the relative RF Burst trigger function is implemented as follows:

1. The measurement starts with the absolute RF Burst trigger setting. If it cannot get a trigger with that level, auto trigger fires and the acquisition starts anyway. After the acquisition, the measurement searches for the peak in the acquired waveform and saves it.

2. Now, in the next cycle of the measurement, the measurement determines a new absolute RF Burst level based on the peak value from the first measurement and the Relative RF Burst Trigger Level (always 0 or negative dB) set by the user. The following formula is used:
 3. absolute RF Burst level = peak level of the previous acquisition + relative RF Burst level
 4. If the new absolute RF Burst level differs from the previous by more than 0.5 dB, the new level is sent to the hardware; otherwise it is not updated (to avoid slowing down the acquisition)
- Steps 2 and 3 repeat for subsequent measurements.

Key Path	Trigger, RF Burst
Scope	Meas Global
Remote Command	:TRIGger[:SEquence]:RFBurst:LEVel:RELative <rel_ampl> :TRIGger[:SEquence]:RFBurst:LEVel:RELative?
Example	TRIG:RFB:LEV:REL -10 dB sets the trigger level of the RF burst envelope signal to the relative level of -10 dB
Notes	Sending this command does not switch the setting from absolute to relative; to switch it you need to send the :TRIGger[:SEquence]:RFBurst:LEVel:TYPE command, above. The relative trigger level is not available in some measurements. In those measurements the RELative parameter, and the :TRIGger[:SEquence]:RFBurst:LEVel:TYPE command (above), will generate an error if sent.
Dependencies	This key is grayed out and Absolute Trigger Level selected if the required hardware is not present in your analyzer and the current measurement does not support Relative triggering.
Preset	-6 dB GSM: -25 dB
State Saved	Saved in instrument state
Min	-45 dB
Max	0 dB
Default Unit	dB or dBc
Backwards Compatibility SCPI	:TRIGger[:SEquence]:RFBurst:LEVel This legacy command is aliased to :TRIGger[:SEquence]:RFBurst:LEVel:RELative because the PSA had ONLY relative burst triggering
Initial S/W Revision	Prior to A.02.00
Modified at S/W Revision	A.04.00

Trigger Slope

It is set positive to trigger on a rising edge and negative to trigger on a falling edge.

Key Path	Trigger, RF Burst
Remote Command	:TRIGger[:SEquence]:RFBurst:SLOPe POSitive NEGative :TRIGger[:SEquence]:RFBurst:SLOPe?

Example	TRIG:RFB:SLOP NEG
Couplings	This same slope is used in the RF Burst selection for the trigger source in the Trigger menu and for the period timer sync source (in the Trigger menu and in the Gate Source menu).
Preset	POSitive
State Saved	Saved in instrument state
Backwards Compatibility SCPI	:TRIGger[:SEQuence]:FRAMe:RFBurst:SLOPe
Backwards Compatibility Notes	The legacy :TRIGger[:SEQuence]:SLOPe command affects the slopes for the VID, LINE, EXT1, EXT2, and RFB triggers.
Initial S/W Revision	Prior to A.02.00

Periodic Timer (Frame Trigger)

Pressing this key, when it is not selected, selects the internal periodic timer signal as the trigger. Triggering occurrences are set by the **Period** parameter, which is modified by the **Sync Source** and **Offset**. Pressing this key, when it is already selected, accesses the periodic timer trigger setup functions.

If you do not have a sync source selected (it is Off), then the internal timer will not be synchronized with any external timing events.

Key Path	Trigger
Example	TRIG:SOUR FRAM Swept SA measurement TRIG:<meas>:SOUR FRAM Measurements other than Swept SA
State Saved	Saved in instrument state
Readback	[Sync: <value of Sync Source>], for example, [Sync: External 1]
Status Bits/OPC dependencies	The Status Operation Register bit 5 "Waiting for Trigger" is set at the same time as the Sweeping or Measuring bit is set. It is cleared when the trigger actually occurs (that is, after the trigger event occurs and all the applicable trigger criteria have been met). A corresponding pop-up message ("Waiting for trigger") is generated if no trigger signal appears after approximately 2 sec. This message goes away when a trigger signal appears.
Initial S/W Revision	Prior to A.02.00

Periodic Timer Triggering:

This feature selects the internal periodic timer signal as the trigger. Trigger occurrences are set by the **Periodic Timer** parameter, which is modified by the **Sync Source** and **Offset**.

The figure below shows the action of the periodic timer trigger. Before reviewing the figure, we'll explain some uses for the periodic trigger.

A common application is measuring periodic burst RF signals for which a trigger signal is not easily available. For example, we might be measuring a TDMA radio which bursts every 20 ms. Let's assume that the 20 ms period is very consistent. Let's also assume that we do not have an external trigger source

available that is synchronized with the period, and that the signal-to-noise ratio of the signal is not high enough to provide a clean RF burst trigger at all of the analysis frequencies. For example, we might want to measure spurious transmissions at an offset from the carrier that is larger than the bandwidth of the RF burst trigger. In this application, we can set the Periodic Timer to a 20.00 ms period and adjust the offset from that timer to position our trigger just where we want it. If we find that the 20.00 ms is not exactly right, we can adjust the period slightly to minimize the drift between the period timer and the signal to be measured.

A second way to use this feature would be to use **Sync Source** temporarily, instead of **Offset**. In this case, we might tune to the signal in a narrow span and use the RF Burst trigger to synchronize the periodic timer. Then we would turn the sync source off so that it would not miss-trigger. Miss-triggering can occur when we are tuned so far away from the RF burst trigger that it is no longer reliable.

A third example would be to synchronize to a signal that has a reference time element of much longer period than the period of interest. In some CDMA applications, it is useful to look at signals with a short periodicity, by synchronizing that periodicity to the "even-second clock" edge that happens every two seconds. Thus, we could connect the even-second clock trigger to Ext1 and use then Ext1 as the sync source for the periodic timer.

The figure below illustrates this third example. The top trace represents the even-second clock. It causes the periodic timer to synchronize with the leading edge shown. The analyzer trigger occurs at a time delayed by the accumulated offset from the period trigger event. The periodic timer continues to run, and triggers continue to occur, with a periodicity determined by the analyzer time base. The timer output (labeled "late event") will drift away from its ideal time due to imperfect matching between the time base of the signal being measured and the time base of the analyzer, and also because of imperfect setting of the period parameter. But the synchronization is restored on the next even-second clock event. ("Accumulated offset" is described in the in the **Offset** function section.)

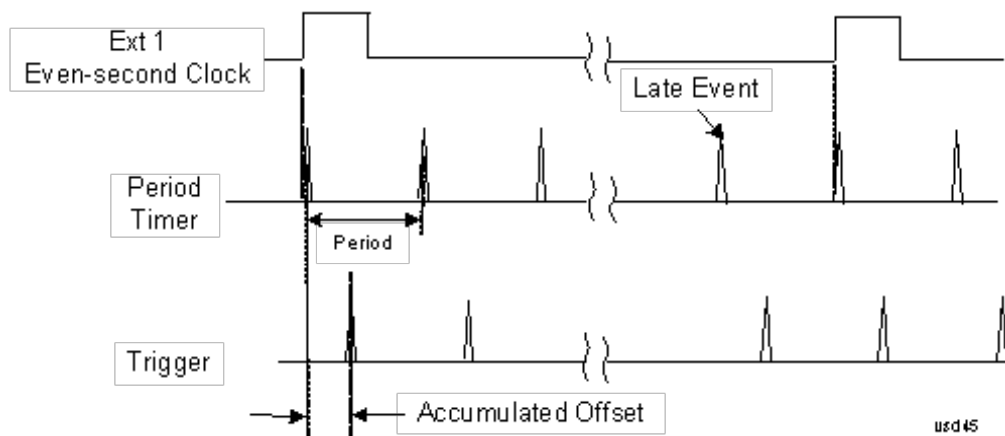

Period

Sets the period of the internal periodic timer clock. For digital communications signals, this is usually set to the frame period of your current input signal. In the case that sync source is not set to OFF, and the external sync source rate is changed for some reason, the periodic timer is synchronized at the every external synchronization pulse by resetting the internal state of the timer circuit.

Key Path	Trigger, Periodic Timer
Remote Command	:TRIGger[:SEquence]:FRAME:PERiod <time>

	:TRIGger[:SEquence]:FRAMe:PERiod?
Example	TRIG:FRAM:PER 100 ms
Dependencies	The invalid data indicator turns on when the period is changed, until the next sweep/measurement completes.
Couplings	The same period is used in the Gate Source selection of the period timer.
Preset	20 ms GSM: 4.615383
State Saved	Saved in instrument state
Min	100.000 ns
Max	559.0000 ms
Default Unit	S
Initial S/W Revision	Prior to A.02.00

Offset

Adjusts the accumulated offset between the periodic timer events and the trigger event. Adjusting the accumulated offset is different than setting an offset, and requires explanation.

The periodic timer is usually not synchronized with any external events, so the timing of its output events has no absolute meaning. Since the timing relative to external events (RF signals) is important, you need to be able to adjust (offset) it. However, you have no direct way to see when the periodic timer events occur. All that you can see is the trigger timing. When you want to adjust the trigger timing, you will be changing the internal offset between the periodic timer events and the trigger event. Because the absolute value of that internal offset is unknown, we will just call that the accumulated offset. Whenever the Offset parameter is changed, you are changing that accumulated offset. You can reset the displayed offset using Reset Offset Display. Changing the display does not change the value of the accumulated offset, and you can still make additional changes to accumulated offset.

To avoid ambiguity, we define that an increase in the "offset" parameter, either from the knob or the SCPI adjust command, serves to delay the timing of the trigger event.

Key Path	Trigger, Periodic Timer
Remote Command	:TRIGger[:SEquence]:FRAMe:OFFSet <time> :TRIGger[:SEquence]:FRAMe:OFFSet?
Example	TRIG:FRAM:OFFS 1.2 ms
Notes	The front panel interface (for example, the knob), and this command, adjust the accumulated offset, which is shown on the active function display. However, the actual amount sent to the hardware each time the offset is updated is the delta value, that is, the current accumulated offset value minus the previous accumulated offset value. Note that the accumulated offset value is essentially arbitrary; it represents the accumulated offset from the last time the offset was zeroed (with the Reset Offset Display key). Note that this command does not change the period of the trigger waveform. Note also that Offset is used only when the sync source is set to OFF, otherwise delay is used, see section "Trig Delay" on page 443.

	An increase in the "offset" parameter, either from the knob or the SCPI adjust command, serves to delay the timing of the trigger event.
Notes	When the SCPI command is sent the value shown on the key (and the Active Function, if this happens to be the active function) is updated with the new value. However, the actual amount sent to the hardware is the delta value, that is, the current accumulated offset value minus the previous accumulated offset value. The SCPI query simply returns the value currently showing on the key.
Dependencies	The invalid data indicator turns on when the offset is changed, until the next sweep/measurement completes.
Couplings	The same offset is used in the Gate Source selection of the period timer.
Preset	0 s
State Saved	Saved in instrument state
Min	-10.000 s
Max	10.000 s
Default Unit	S
Initial S/W Revision	Prior to A.02.00

Offset Adjust (Remote Command Only)

This remote command does not work at all like the related front panel keys. This command lets you advance the phase of the frame trigger by the amount you specify.

It does not change the period of the trigger waveform. If the command is sent multiple times, it advances the phase of the frame trigger an additional amount each time it is sent. Negative numbers are permitted.

Remote Command	:TRIGger[:SEquence]:FRAMe:ADJust <time>
Example	TRIG:FRAM:ADJ 1.2 ms
Notes	Note also that Offset is used only when the sync source is set to OFF, otherwise delay is used, see section "Trig Delay" on page 443 An increase in the "offset" parameter, either from the knob or the SCPI adjust command, serves to delay the timing of the trigger event.
Notes	The front panel interface (for example, the knob) and the :TRIG:FRAM:OFFS command adjust the accumulated offset, which is shown on the active function display. However, the actual amount sent to the hardware is the delta value, that is, the current offset value minus the previous offset value. When the SCPI command is sent the value shown on the key (and the Active Function, if this happens to be the active function) is updated by increasing it (or decreasing it if the value sent is negative) by the amount specified in the SCPI command. This is a "command only" SCPI command, with no query.
Dependencies	The invalid data indicator turns on when the offset is changed, until the next sweep/measurement completes.
Couplings	The same offset is used in the Gate Source selection of the period timer.
Preset	0 s

State Saved	Saved in instrument state
Min	-10.000 s
Max	10.000 s
Default Unit	S
Initial S/W Revision	Prior to A.02.00

Reset Offset Display

Resets the value of the periodic trigger offset display setting to 0.0 seconds. The current displayed trigger location may include an offset value defined with the Offset key. Pressing this key redefines the currently displayed trigger location as the new trigger point that is 0.0 s offset. The Offset key can then be used to add offset relative to this new timing.

Key Path	Trigger, Periodic Timer
Remote Command	:TRIGger[:SEquence]:FRAMe:OFFSet:DISPlay:RESet
Example	TRIG:FRAM:OFFS:DISP:RES
Initial S/W Revision	Prior to A.02.00

Sync Source

Selects a signal source for you to synchronize your periodic timer trigger to, otherwise you are triggering at some arbitrary location in the frame. Synchronization reduces the precision requirements on the setting of the period.

For convenience you may adjust the level and slope of the selected sync source in a conditional branch setup menu accessed from the Sync Source menu. Note that these settings match those in the **Trigger** and **Gate Source** menus; that is, each trigger source has only one value of level and slope, regardless of which menu it is accessed from.

Key Path	Trigger, Periodic Timer
Remote Command	:TRIGger[:SEquence]:FRAMe:SYNC EXTernal1 EXTernal2 RFBurst OFF :TRIGger[:SEquence]:FRAMe:SYNC?
Example	TRIG:FRAM:SYNC EXT2
Dependencies	In some models, there is no second External input. In these models, the External 2 key is blanked and the EXTernal2 parameter will generate a "Hardware missing; Not available for this model number" message.
Preset	Off GSM/EDGE, MSR,LTE,LTETDD: RFBurst
State Saved	Saved in instrument state
Readback	The current setting is read back to this key and it is also Readback to the previous Periodic Timer trigger key.

Backwards Compatibility SCPI	:TRIGger[:SEquence]:FRAMe:SYNC EXTernal
Initial S/W Revision	Prior to A.02.00
Modified at S/W Revision	A.03.00, A.14.00

Off

Turns off the sync source for your periodic trigger. With the sync source off, the timing will drift unless the signal source frequency is locked to the analyzer frequency reference.

Key Path	Trigger, Periodic Timer, Sync Source
Example	TRIG:FRAM:SYNC OFF
Readback	Off
Initial S/W Revision	Prior to A.02.00

External 1

Pressing this key, when it is not selected, selects an external input signal as the trigger. A new sweep/measurement will start when the external trigger condition is met using the external 1 input connector on the rear panel.

Pressing this key, when it is already selected, accesses the external 1 trigger setup menu.

Key Path	Trigger
Example	TRIG:SOUR EXT1 Swept SA measurement TRIG:<meas>:SOUR EXT1 Measurements other than Swept SA
Dependencies	Grayed out if in use by Point Trigger in the Source Setup menu. Forced to Free Run if already selected and Point Trigger is set to External 1.
State Saved	Saved in instrument state
Status Bits/OPC dependencies	The Status Operation Register bit 5 "Waiting for Trigger" is set at the same time as the Sweeping or Measuring bit is set. It is cleared when the trigger actually occurs (that is, after the trigger event occurs and all the applicable trigger criteria have been met). A corresponding pop-up message ("Waiting for trigger") is generated if no trigger signal appears after approximately 2 sec. This message goes away when a trigger signal appears.
Initial S/W Revision	Prior to A.02.00

Trigger Level

Sets the value where the external 1 trigger input will trigger a new sweep/measurement.

Key Path	Trigger, External 1
Remote Command	:TRIGger[:SEquence]:EXTernal1:LEVel <level> :TRIGger[:SEquence]:EXTernal1:LEVel?
Example	TRIG:EXT1:LEV 0.4 V
Couplings	This same level is used for the Ext1 trigger source in the Trigger menu, for the Ext1 selection in the Periodic Timer sync source (in the Trigger menu and in the Gate Source menu), and also for the Ext1 selection in the Gate Source menu.
Preset	1.2 V
State Saved	Saved in instrument state
Min	-5 V
Max	5 V
Default Unit	V
Backwards Compatibility SCPI	:TRIGger[:SEquence]:EXTernal:LEVel For backward compatibility, the parameter EXTernal is mapped to EXTernal1
Backwards Compatibility SCPI	:TRIGger[:SEquence]:FRAMe:EXTernal1:LEVel
Initial S/W Revision	Prior to A.02.00

Trig Slope

Controls the trigger polarity. It is set positive to trigger on a rising edge and negative to trigger on a falling edge.

Key Path	Trigger, External 1
Remote Command	:TRIGger[:SEquence]:EXTernal1:SLOPe POSitive NEGative :TRIGger[:SEquence]:EXTernal1:SLOPe?
Example	TRIG:EXT1:SLOP NEG
Couplings	This same slope is used in the Ext1 selection for the trigger source in the Trigger menu and for the period timer sync source (in the Trigger menu and in the Gate Source menu).
Preset	POSitive
State Saved	Saved in instrument state
Backwards Compatibility SCPI	:TRIGger[:SEquence]:EXTernal:SLOPe For backward compatibility, the parameter EXTernal is mapped to EXTernal1
Backwards Compatibility SCPI	:TRIGger[:SEquence]:FRAMe:EXTernal1:SLOPe
Backwards Compatibility Notes	The legacy :TRIGger[:SEquence]:SLOPe command affects the slopes for the VID, LINE, EXT1, EXT2, and RFB triggers.
Initial S/W Revision	Prior to A.02.00

External 2

Pressing this key, when it is not selected, selects an external input signal as the trigger. A new sweep/measurement will start when the external trigger condition is met using the external 2 input connector. The external trigger 2 input connector is on the rear panel.

Pressing this key, when it is already selected, accesses the external 2 trigger setup menu.

Key Path	Trigger
Example	TRIG:SOUR EXT2 Swept SA measurement TRIG:<meas>:SOUR EXT2 Measurements other than Swept SA
Dependencies	In some models, there is no second External input. In these models, the External 2 key is blanked and the EXTERNAL2 parameter will generate a "Hardware missing; Not available for this model number" message. Grayed out if in use by Point Trigger in the Source Setup menu. Forced to Free Run if already selected and Point Trigger is set to External 2.
State Saved	Saved in instrument state
Status Bits/OPC dependencies	The Status Operation Register bit 5 "Waiting for Trigger" is set at the same time as the Sweeping or Measuring bit is set. It is cleared when the trigger actually occurs (that is, after the trigger event occurs and all the applicable trigger criteria have been met). A corresponding pop-up message ("Waiting for trigger") is generated if no trigger signal appears after approximately 2 sec. This message goes away when a trigger signal appears.
Initial S/W Revision	Prior to A.02.00
Modified at S/W Revision	A.03.00

Trigger Level

Sets the value where the external 2 trigger input will trigger a new sweep/measurement.

Key Path	Trigger, External 2
Remote Command	:TRIGger[:SEquence]:EXTernal2:LEVel :TRIGger[:SEquence]:EXTernal2:LEVel?
Example	TRIG:EXT2:LEV 1.1 V
Couplings	This same level is used for the Ext2 trigger source in the Trigger menu, for the Ext2 selection in the Periodic Timer sync source (in the Trigger menu and in the Gate Source menu), and also for the Ext2 selection in the Gate Source menu.
Preset	1.2 V
State Saved	Saved in instrument state
Min	-5 V
Max	5 V
Default Unit	V
Backwards Compatibility SCPI	:TRIGger[:SEquence]:FRAME:EXTernal2:LEVel
Initial S/W Revision	Prior to A.02.00

Trig Slope

Controls the trigger polarity. It is set positive to trigger on a rising edge and negative to trigger on a falling edge.

Key Path	Trigger, External 2
Remote Command	:TRIGger[:SEquence]:EXTernal2:SLOPe POSitive NEGative :TRIGger[:SEquence]:EXTernal2:SLOPe?
Example	TRIG:EXT2:SLOP NEG
Couplings	This same slope is used in the Ext2 selection for the trigger source in the Trigger menu and for the period timer sync source (in the Trigger menu and in the Gate Source menu).
Preset	POSitive
State Saved	Saved in instrument state
Backwards Compatibility SCPI	:TRIGger[:SEquence]:FRAMe:EXTernal2:SLOPe
Backwards Compatibility Notes	The legacy :TRIGger[:SEquence]:SLOPe command affects the slopes for the VID, LINE, EXT1, EXT2, and RFB triggers.
Initial S/W Revision	Prior to A.02.00

RF Burst

Pressing this key, when it is not selected, selects the RF Burst as the trigger. A new sweep/measurement will start when an RF burst envelope signal is identified from the signal at the RF Input connector. Pressing this key, when it is already selected, accesses the RF Burst trigger setup menu.

In some models, a variety of burst trigger circuitry is available, resulting in various available burst trigger bandwidths. The analyzer automatically chooses the appropriate trigger path based on the hardware configuration and other settings of the analyzer.

Key Path	Trigger
Example	TRIG:SOUR RFB Swept SA measurement TRIG:<meas>:SOUR RFB Measurements other than Swept SA
State Saved	Saved in instrument state
Status Bits/OPC dependencies	The Status Operation Register bit 5 "Waiting for Trigger" is set at the same time as the Sweeping or Measuring bit is set. It is cleared when the trigger actually occurs (that is, after the trigger event occurs and all the applicable trigger criteria have been met). A corresponding pop-up message ("Waiting for trigger") is generated if no trigger signal appears after approximately 2 sec. This message goes away when a trigger signal appears.
Backwards Compatibility Notes	The legacy command: :TRIGger[:SEquence]:RFBurst:FSElectivity[:STATe] OFF ON 0 1 is not supported in the X-Series, as the hardware to do Frequency Selective burst triggers does not exist in X-Series.

Initial S/W Revision	Prior to A.02.00
Modified at S/W Revision	A.04.00

Absolute Trigger Level

Sets the absolute trigger level for the RF burst envelope.

When using the External Mixing path, the Absolute Trigger Level is uncalibrated because the factory default was set to accommodate the expected IF levels for the RF path.

Key Path	Trigger, RF Burst
Scope	Meas Global
Remote Command	:TRIGger[:SEquence]:RFBurst:LEVel:ABSolute <ampl> :TRIGger[:SEquence]:RFBurst:LEVel:ABSolute?
Example	TRIG:RFB:LEV:ABS 10 dBm sets the trigger level of the RF burst envelope signal to the absolute level of 10 dBm
Notes	Sending this command does not switch the setting from relative to absolute; to switch it you need to send the :TRIGger[:SEquence]:RFBurst:LEVel:TYPE command, below. Amplitude Corrections are not taken into account by the Absolute Trigger Level. For example, if you have given yourself effective gain with an amplitude correction factor, the Absolute Trigger will not fire until you have set the trigger level that far below the displayed signal level, rather than simply to the displayed signal level. This is only true for Amplitude Corrections, not External Gain or Ref Level Offset functions. If mode is Bluetooth, the default value is -50 dBm.
Couplings	This same level is used for the RF Burst trigger source in the Trigger menu, for the RF Burst selection in the Periodic Timer sync source (in the Trigger menu and in the Gate Source menu), and also for the RF Burst selection in the Gate Source menu
Preset	-20 dBm
State Saved	Saved in instrument state
Min	-200 dBm
Max	100 dBm
Default Unit	depends on the current selected Y-Axis unit
Backwards Compatibility SCPI	:TRIGger[:SEquence]:FRAME:RFBurst:LEVel:ABSolute
Initial S/W Revision	Prior to A.02.00
Modified at S/W Revision	A.04.00

Key Path	Trigger, RF Burst
Remote Command	:TRIGger[:SEquence]:RFBurst:LEVel:TYPE ABSolute RELative :TRIGger[:SEquence]:RFBurst:LEVel:TYPE?

Example	TRIG:RFB:LEV:TYPE REL sets the trigger level type of the RF burst trigger to Relative.
Preset	ABSolute
State Saved	Saved in instrument state
Initial S/W Revision	Prior to A.02.00
Modified at S/W Revision	A.04.00

Trigger Slope

It is set positive to trigger on a rising edge and negative to trigger on a falling edge.

Key Path	Trigger, RF Burst
Remote Command	:TRIGger[:SEQuence]:RFBurst:SLOPe POSitive NEGative :TRIGger[:SEQuence]:RFBurst:SLOPe?
Example	TRIG:RFB:SLOP NEG
Couplings	This same slope is used in the RF Burst selection for the trigger source in the Trigger menu and for the period timer sync source (in the Trigger menu and in the Gate Source menu).
Preset	POSitive
State Saved	Saved in instrument state
Backwards Compatibility SCPI	:TRIGger[:SEQuence]:FRAME:RFBurst:SLOPe
Backwards Compatibility Notes	The legacy :TRIGger[:SEQuence]:SLOPe command affects the slopes for the VID, LINE, EXT1, EXT2, and RFB triggers.
Initial S/W Revision	Prior to A.02.00

Sync Holdoff

Sync Holdoff specifies the duration that the sync source signal must be kept false before the transition to true to be recognized as the sync timing. The periodic timer phase is aligned when the sync source signal becomes true, after the Holdoff time is satisfied.

A holdoff of 2 ms will work with most WiMAX signals, but there may be cases where the burst off duration is less than 1 ms and this value will need to be changed.

Key Path	Trigger, Periodic Timer
Remote Command	:TRIGger[:SEQuence]:FRAME:SYNC:HOLDoff <time> :TRIGger[:SEQuence]:FRAME:SYNC:HOLDoff? :TRIGger[:SEQuence]:FRAME:SYNC:HOLDoff:STATe OFF ON 0 1 :TRIGger[:SEQuence]:FRAME:SYNC:HOLDoff:STATe?
Preset	On, 1.000 ms

State Saved	Saved in instrument state
Min	0 ms
Max	+500 ms
Default Unit	s
Initial S/W Revision	Prior to A.02.00

Control Edge/Level

Sets the method of controlling the gating function from the gating signal.

Edge

In Edge triggering, the gate opens (after the Delay) on the selected edge (for example, positive) of the gate signal and closes on the alternate edge (for example, negative).

Level

In Level triggering, the gate opens (after the Delay) when the gate signal has achieved a certain level and stays open as long as that level is maintained.

Key Path	Sweep/Control, Gate
Remote Command	[:SENSe] :SWEep:EGATe:CONTRol EDGE LEVeL [:SENSe] :SWEep:EGATe:CONTRol?
Example	SWE:EGAT:CONT EDGE
Dependencies	If the Gate Method is FFT the Control key is grayed out and Edge is selected. If the Gate Source is TV, Frame or Line, the Control key is grayed out and Edge is selected.
Preset	EDGE
State Saved	Saved in instrument state
Backwards Compatibility SCPI	[:SENSe] :SWEep:TIME:GATE:TYPE ESA Compatibility
Initial S/W Revision	Prior to A.02.00

Gate Holdoff

Lets you increase or decrease the wait time after a gate event ends before the analyzer will respond to the next gate signal.

After any Gate event finishes, the analyzer must wait for the sweep system to settle before it can respond to another Gate signal. The analyzer calculates a "wait time," taking into account a number of factors, including RBW and Phase Noise Optimization settings. The goal is to achieve the same accuracy when gated as in ungated operation. The figure below illustrates this concept:

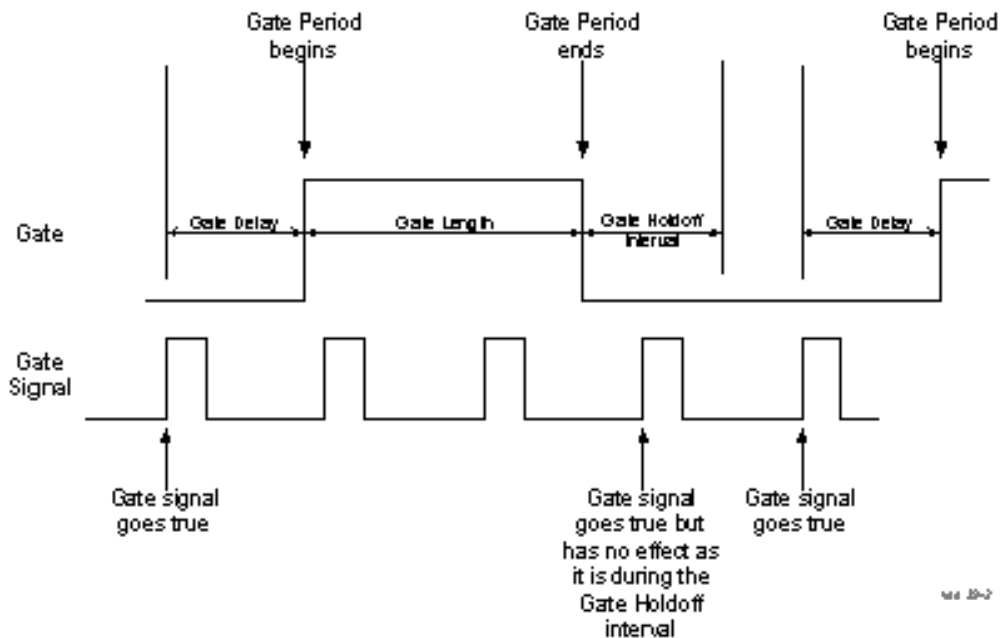

When Gate Holdoff is in Auto, the wait time calculated by the analyzer is used. When Gate Time is in Manual, the user may adjust the wait time, usually decreasing it in order to achieve greater speed, but at the risk of decreasing accuracy.

When the Method key is set to Video or FFT, the Gate Holdoff function has no effect.

In measurements that do not support Auto, the value shown when Auto is selected is “---” and the manually set holdoff is returned to a query.

Key Path	Sweep/Control, Gate
Remote Command	<pre>[:SENSe] :SWEep:EGATe:HOLDoff <time> [:SENSe] :SWEep:EGATe:HOLDoff? [:SENSe] :SWEep:EGATe:HOLDoff:AUTO OFF ON 0 1 [:SENSe] :SWEep:EGATe:HOLDoff:AUTO?</pre>
Example	<pre>SWE:EGAT:HOLD 0.0002 SWE:EGAT:HOLD? SWE:EGAT:HOLD:AUTO ON SWE:EGAT:HOLD:AUTO?</pre>
Couplings	<p>When Gate Holdoff is Auto, the Gate Holdoff key shows the value calculated by the analyzer for the wait time.</p> <p>Pressing the Gate Holdoff key while it is in Auto and not selected, causes the key to become selected and allows the user to adjust the value. If the value is adjusted, the setting changes to Man.</p> <p>Pressing the Gate Holdoff key, while it is in Auto and selected, does not change the value of Gate Holdoff, but causes the setting to change to Man. Now the user can adjust the value.</p> <p>Pressing the key while it is in Man and selected, cause the value to change back to Auto.</p> <p>Pressing the key while it is in Man and not selected, causes the key to become selected and allows the user to adjust the value.</p>

	When Method is set to Video or FFT, the Gate Holdoff function has no effect.
Preset	Auto Auto/On
State Saved	Saved in instrument state
Min	1 µsec
Max	1 sec
Initial S/W Revision	Prior to A.02.00

Gate Delay Compensation

This function allows you to select an RBW-dependent value by which to adjust the gate delay, to compensate for changes in the delay caused by RBW effects.

You can select between uncompensated operation and two types of compensation, Delay Until RBW Settled and Compensate for RBW Group Delay.

See "[More Information](#)" on page 601

Key Path	Sweep/Control, Gate
Scope	Meas Global
Remote Command	[:SENSe] :SWEep:EGATe:DELay:COMPensation:TYPE OFF SETTled GDELay [:SENSe] :SWEep:EGATe:DELay:COMPensation:TYPE?
Example	SWE:EGAT:DEL:COMP:TYPE SETT SWE:EGAT:DEL:COMP:TYPE?
Notes	Although this function is Meas Global, there are some measurements that do not support this function. In those measurements the operation will be Uncompensated. Going into one of those measurements will not change the Meas Global selection; it will simply display the grayed-out menu key with "Uncompensated" showing as the selection. This is a non-forceful grayout, so the SCPI command is still accepted. If Gate Delay Compensation is not supported at all within a particular mode, the key is not displayed, and if the SCPI command is sent while in a measurement within that mode, an "Undefined Header" message is generated. Measurements that do not support this function include: Swept SA
Preset	TD-SCDMA mode: Compensate for RBW Group Delay All other modes: Delay Until RBW Settled
State Saved	Saved in instrument state
Range	Uncompensated Delay Until RBW Settled Compensate for RBW Group Delay
Readback text	Uncompensated Settled Group Delay
Initial S/W Revision	Prior to A.02.00
Modified at S/W Revision	A.11.0

More Information

Selecting Uncompensated means that the actual gate delay is as you sets it.

Selecting Delay Until RBW Settled causes the gate delay to be increased above the user setting by an amount equal to $3.06/\text{RBW}$. This compensated delay causes the GATE START and GATE STOP lines on the display to move by the compensation amount, and the actual hardware gate delay to be increased by the same amount. All the other gate lines (for example, MIN FAST) are unaffected. If the RBW subsequently changes, the compensation is readjusted for the new RBW. The value shown on the Gate Delay key does NOT change.

Delay Until RBW Settled allows excellent measurements of gated signals, by allowing the IF to settle following any transient that affects the burst. Excellent measurements also require that the analysis region not extend into the region affected by the falling edge of the burst. Thus, excellent measurements can only be made over a width that declines with narrowing RBWs, which is achieved by decreasing the gate length below the user setting by an amount equal to $2.53/\text{RBW}$. Therefore, for general purpose compensation, you will still want to change the gate length with changes in RBW even if the gate delay is compensated. The compensated Gate Length is limited by the analyzer so that it will never go below 10% of the value shown on the Gate Length key, as otherwise the sweep times could get very long. Anytime the Gate Length and RBW values combine in such a way that this limiting takes place, a warning is displayed. For measurements which contain multiple sweeps with different RBW like SEM and SPUR, the smallest RBW is used for this limiting.

Selecting Compensate for RBW Group Delay causes the gate delay to be increased above the user setting by an amount equal to $1.81/\text{RBW}$. This compensated delay causes the GATE START, GATE STOP lines on the display to move by the compensation amount, and the actual hardware gate delay to be increased by the same amount. All the other gate lines (for example, MIN FAST) are unaffected. If the RBW subsequently changes, the compensation is readjusted for the new RBW. The value shown on the Gate Delay key does NOT change. Compensate for RBW Group Delay also includes gate length compensation; the gate length itself is adjusted as necessary to attempt to compensate for delay effects imposed by the RBW.

Compensate for RBW Group Delay is similar to Delay Until RBW Settled, but compensates for the group delay of the RBW filter, rather than the filter settling time. As the RBW gets narrow, this can allow the settling tail of the RBW to affect the beginning part of the gated measurement, and allow the beginning of the RBW settling transient to affect the end of the gated measurement. These two effects are symmetric because the RBW response is symmetric. Because the gate length is not automatically compensated, some users might find this compensation to be more intuitive than compensation for RBW settling.

Min Fast Position Query (Remote Command Only)

This command queries the position of the MIN FAST line, relative to the delay reference (REF) line. See section "[Gate View On/Off](#)" on page 2080. If this query is sent while not in gate view, the MinFast calculation is performed based on the current values of the appropriate parameters and the result is returned. Knowing this value lets you set an optimal gate delay value for the current measurement setup.

Remote Command	[:SENSe] :SWEep:EGATe:MINFast?
Example	SWE:EGAT:MIN?
Initial S/W Revision	Prior to A.02.00

Gate Preset (Remote Command Only)

Presets the time-gated spectrum analysis capability.

This command sets gate parameter values to the ESA preset values, as follows:

Gate trigger type = edge

Gate polarity = positive

Gate delay = 1 us

Gate length = 1 us

Remote Command	<code>[:SENSe]:SWEep:TIME:GATE:PRESet</code> ESA Compatibility
Initial S/W Revision	Prior to A.02.00

Gate Level (Remote Command Only)

Sets the gate input transition point level for the external TRIGGER inputs on the front and rear panel. This is a legacy command for PSA compatibility. It is simply an alias to the equivalent trigger level command.

Remote Command	<code>[:SENSe]:SWEep:EGATE:EXTeRnal[1] 2:LEVel <voltage></code> <code>[:SENSe]:SWEep:EGATE:EXTeRnal[1] 2:LEVel?</code>
Notes	This command is simply an alias to <code>:TRIGger[:SEQuence]:EXTeRnal[1] 2:LEVel</code> For details refer
Initial S/W Revision	Prior to A.02.00

Gate Polarity (Remote Command Only)

Sets the polarity for the gate signal. This setup is now done using the gate trigger's slope setting.

When Positive (Pos) is selected, a positive-going edge (Edge) or a high voltage (Level) will satisfy the gate condition, after the delay set with the Gate Delay key. When Negative (Neg) is selected, a negative-going edge (Edge) or a low voltage (Level) will satisfy the gate condition after the delay.

Remote Command	<code>[:SENSe]:SWEep:EGATE:POLarity</code> NEGative POSitive <code>[:SENSe]:SWEep:EGATE:POLarity?</code>
Example	<code>SWE:EGAT:POL</code> NEG <code>SWE:EGAT:POL?</code>
Preset	POSitive
State Saved	Saved in instrument state
Backwards Compatibility SCPI	<code>[:SENSe]:SWEep:TIME:GATE:POLarity</code> ESA compatibility
Initial S/W Revision	Prior to A.02.00

Remote Command	[:SENSe] :SWEep:TIME:GATE:LEVel HIGH LOW [:SENSe] :SWEep:TIME:GATE:LEVel? ESA compatibility
Preset	HIGH
Initial S/W Revision	Prior to A.02.00

Points

Sets the number of points per sweep. The resolution of setting the sweep time depends on the number of points selected. If Preset is selected, the number of points per sweep defaults to 1001. The current value of points is displayed parenthetically, next to the sweep time in the lower-right corner of the display.

Changing the number of points has several effects on the analyzer. Since markers are read at the point location, the marker reading may change. All trace data is cleared.

Key Path	Sweep/Control
Mode	SA, WCDMA, C2K, WIMAX OFDMA, 1xEVDO, DVB-T/H, DTMB (CTTB), ISDB-T, CMMB, LTE, LTEFDD, Digital Cable TV, WLAN, MSR, LTEAFDD, LTEATDD
Remote Command	[:SENSe] :CHPower:SWEep:POINts <integer> [:SENSe] :CHPower:SWEep:POINts?
Example	CHP:SWE:POIN 501 CHP:SWE:POIN?
Notes	Whenever the number of sweep points changes: All trace data is erased Any traces with Update Off also go to Display Off (like going from View to Blank in the older analyzers) Sweep time is re-quantized Any limit lines that are on are updated If averaging/hold is on, averaging/hold starts over
Couplings	Whenever the number of sweep points changes, the sweep time is re-quantized.
Preset	DVB-T/H: 2001 DTMB (CTTB): 2001 Other: 1001 ISDB-T: 2001 CMMB: 2001 1xEVDO: 512 Digital Cable TV: 2001
State Saved	Saved in instrument state.
Min	101

8 Channel Power Measurement
Sweep/Control

Max	20001
Initial S/W Revision	Prior to A.02.00
Modified at S/W Revision	A.02.00, A.03.00

System

See "System" on page 342

Trace/Detector

Accesses a menu of functions that enable you to control the detectors for the current measurement.

Key Path	Front-panel key
Initial S/W Revision	Prior to A.02.00

Trace Type

Allows you to select the type of trace you want to use for the current measurement. The first page of this menu contains a 1-of-N selection of the trace type (Clear Write, Average, Max Hold, Min Hold) for the selected trace.

Key Path	Trace/Detector
Mode	SA, WCDMA, C2K, WIMAX OFDMA, 1xEVDO, DVB-T/H, DTMB (CTTB), ISDB-T, CMMB, LTE, LTETDD, Digital Cable TV, WLAN, MSR, LTEAFDD, LTEATDD
Remote Command	:TRACe:CHPower:TYPE WRITe AVERAge MAXHold MINHold :TRACe:CHPower:TYPE?
Example	TRAC:CHP:TYPE WRIT TRAC:CHP:TYPE?
Notes	WRITe = Clear Write AVERAge = Average MAXHold = Maximum Hold MINHold = Minimum Hold
Couplings	When Detector setting is "Auto" ([:SENSe]:CHPower:DETEctor:AUTO?), Detector ([:SENSe]:CHPower:DETEctor[:FUNCTION]?) switches aligning with the switch of this parameter: "NORMal" with WRITe (Clear Write), "AVERAge" with AVERAge, "POSitive (peak)" with MAXHold, and "NEGative (peak)" with MINHold.
Preset	AVERAge
State Saved	Saved in instrument state.
Range	ClearWrite Average MaxHold MinHold
Initial S/W Revision	Prior to A.02.00
Modified at S/W Revision	A.02.00, A.03.00

Detector

Accesses a menu of functions that enable you to control the detectors for the current measurement. The following choices are available:

- Auto– the detector selected depends on marker functions, trace functions, average type, and the trace averaging function.

- Normal—the detector determines the peak of the CW-like signals, and it yields alternating maximums and minimums of noise-like signals. This is also referred to as Rosenfell detection.
- Average—the detector determines the average of the signal within the sweep points. The averaging method depends upon the Average Type selection (voltage, power or log scales).
- Peak—the detector determines the maximum of the signal within the sweep points.
- Sample—the detector indicates the instantaneous level of the signal at the center of the sweep points represented by each display point.
- Negative Peak—the detector determines the minimum of the signal within the sweep points.

Key Path	Detector
Initial S/W Revision	Prior to A.02.00

Auto

Sets the detector for the currently selected trace to Auto.

Key Path	Trace/Detector
Mode	SA, WCDMA, C2K, WIMAX OFDMA, 1xEVDO, DVB-T/H, DTMB (CTTB), ISDB-T, CMMB, LTE, LTETDD, Digital Cable TV, WLAN, MSR, LTEAFDD, LTEATDD
Remote Command	[[:SENSe]:CHPower:DETEctor:AUTO ON OFF 1 0 [:SENSe]:CHPower:DETEctor:AUTO?
Example	CHP:DET:AUTO ON CHP:DET:AUTO?
Couplings	When Detector setting is “Auto” ([:SENSe]:CHPower:DETEctor:AUTO?), Detector ([:SENSe]:CHPower:DETEctor[:FUNCTION]?) switches aligning with the switch of this parameter: “NORMal” with Clear Write, “AVERage” with AVERage, “POSitive (peak)” with MAXHold, and “NEGative (peak)” with MINHold.
Preset	Others: ON DVB-T/H, DTMB (CTTB), ISDB-T, CMMB, Digital Cable TV: OFF
State Saved	Saved in instrument state.
Initial S/W Revision	Prior to A.02.00
Modified at S/W Revision	A.02.00, A.03.00

Detector Selection

Selects a detector to be used by the analyzer for the current measurement.

Key Path	Trace/Detector
Mode	SA, WCDMA, C2K, WIMAX OFDMA, 1xEVDO, DVB-T/H, DTMB (CTTB), ISDB-T, CMMB, LTE, LTETDD, Digital Cable TV, WLAN, MSR, LTEAFDD, LTEATDD

Remote Command	<code>[[:SENSe]:CHPower:DETEctor[:FUNction] NORMal AVERage POSitive SAMPlE NEGative [:SENSe]:CHPower:DETEctor[:FUNction]?</code>
Example	CHP:DET NORM CHP:DET?
Notes	<p>When you manually select a detector (instead of selecting Auto), that detector is used regardless of other analyzer settings.</p> <p>The Normal detector determines the peak of CW-like signals, and it yields alternating maximums and minimums of noise-like signals. This method of detection is also referred to as Rosenfell detection.</p> <p>The Average detector determines the average of the signal within the sweep points. The averaging method is Power Average (RMS).</p> <p>The Peak detector determines the maximum of the signal within the sweep points.</p> <p>The Sample detector indicates the instantaneous level of the signal at the center of the sweep points represented by each display point.</p> <p>The Negative Peak detector determines the minimum of the signal within the sweep points.</p>
Couplings	When Detector setting is "Auto" (<code>[[:SENSe]:CHPower:DETEctor:AUTO?</code>), Detector (<code>[[:SENSe]:CHPower:DETEctor[:FUNction]?</code>) switches aligning with the switch of this parameter: "NORMal" with Clear Write, "AVERage" with AVERage, "POSitive (peak)" with MAXHold, and "NEGative (peak)" with MINHold.
Preset	AVERage
State Saved	Saved in instrument state.
Range	Normal Average Peak Sample Negative Peak
Initial S/W Revision	Prior to A.02.00
Modified at S/W Revision	A.02.00, A.03.00

Trigger

See ["Trigger" on page 412](#)

Free Run

See ["Free Run " on page 419](#)

Video

See ["Video \(IF Envelope\) " on page 420](#)

Trigger Level

See ["Trigger Level " on page 420](#)

Trig Slope

See ["Trig Slope " on page 421](#)

Trig Delay

See ["Trig Delay " on page 422](#)

Line

See ["Line " on page 2087](#)

Trig Slope

See ["Trig Slope " on page 2087](#)

Trig Delay

See ["Trig Delay " on page 424](#)

External 1

See ["External 1 " on page 2099](#)

Trigger Level

See ["Trigger Level " on page 2099](#)

Trig Slope

See ["Trig Slope " on page 2100](#)

Trig Delay

See ["Trig Delay " on page 427](#)

External 2

See ["External 2 " on page 2101](#)

Trigger Level

See ["Trigger Level "](#) on page 2101

Trig Slope

See ["Trig Slope "](#) on page 2102

Trig Delay

See ["Trig Delay "](#) on page 429

RF Burst

See ["RF Burst "](#) on page 2102

Absolute Trigger

See ["Absolute Trigger Level"](#) on page 2103

Relative Trigger

See ["Relative Trigger Level"](#) on page 2092

Trig Slope

See ["Trigger Slope "](#) on page 2104

Trig Delay

See ["Trig Delay "](#) on page 433

Periodic Timer

See ["Periodic Timer \(Frame Trigger\) "](#) on page 2094

Period

See ["Period "](#) on page 2095

Offset

See ["Offset "](#) on page 2096

Reset Offset Display

See ["Reset Offset Display "](#) on page 2098

Sync Source

See ["Sync Source "](#) on page 2098

Off

See ["Off "](#) on page 2099

External 1

See ["External 1 "](#) on page 2099

Trigger Level

See ["Trigger Level "](#) on page 2099

Trig Slope

See ["Trig Slope "](#) on page 2100

External 2

See ["External 2 "](#) on page 2101

Trigger Level

See ["Trigger Level "](#) on page 2101

Trig Slope

See ["Trig Slope "](#) on page 2102

RF Burst

See ["RF Burst "](#) on page 2102

Absolute Trigger

See ["Absolute Trigger Level"](#) on page 2103

Trig Slope

See ["Trigger Slope "](#) on page 2104

Trig Delay

See ["Trig Delay"](#) on page 443

Auto/Holdoff

See ["Auto/Holdoff "](#) on page 444

Auto Trig

See ["Auto Trig "](#) on page 444

Trig Holdoff

See ["Trig Holdoff "](#) on page 445

User Preset

Accesses a menu that gives you the following three choices:

- User Preset – recalls a state previously saved using the Save User Preset function.
- User Preset All Modes – presets all of the modes in the analyzer
- Save User Preset– saves the current state for the current mode

Key Path	Front-panel key
Backwards Compatibility Notes	<p>User Preset is actually loading a state, and in legacy analyzers, it was possible to load a state without affecting the trace data, limit lines or correction data. Similarly it was possible to do a User Preset without affecting the trace data, limit lines or correction data.</p> <p>In the X-Series, “state” always includes all of this data; so whenever state is loaded, or User Preset is executed, all of the traces, limit lines and corrections are affected. Although this differs from previous behavior, it is desirable behavior, and should not cause adverse issues for users.</p> <p>On ESA and PSA, User Preset affected the entire instrument’s state. In the X-Series, User Preset only recalls the state for the active mode. There is a User Preset file for each mode. User Preset can never cause a mode switch as it can in legacy analyzers. If you want to recall all modes to their user preset file state, you will need to do a User Preset after mode switching into each mode.</p> <p>User Preset recalls mode state which can now include data like traces; whereas on ESA and PSA, User Preset did not affect data.</p>
Initial S/W Revision	Prior to A.02.00

User Preset

User Preset sets the state of the currently active mode back to the state that was previously saved for this mode using the Save User Preset menu key or the SCPI command, SYST:PRES:USER:SAV. It not only recalls the Mode Preset settings, but it also recalls all of the mode persistent settings, and the Input/Output system setting that existed at the time Save User Preset was executed.

If a Save User Preset has not been done at any time, User Preset recalls the default user preset file for the currently active mode. The default user preset files are created if, at power-on, a mode detects there is no user preset file. There will never be a scenario when there is no user preset file to restore. For each mode, the default user preset state is the same state that would be saved if a Save User Preset is performed in each mode right after doing a Restore Mode Default and after a Restore Input/Output Defaults.

The User Preset function does the following:

- Aborts the currently running measurement.
- Sets the mode State to the values defined by Save User Preset.
- Makes the saved measurement for the currently running mode the active measurement.
- Brings up the saved menu for the power-on mode.
- Clears the input and output buffers.
- Sets the Status Byte to 0.

Key Path	User Preset
Remote Command	:SYSTem:PRESet:USER
Example	:SYST:PRES:USER:SAVE:SYST:PRES:USER
Notes	:SYST:PRES:USER:SAVE is used to save the current state as the user preset state. Clears all pending OPC bits. The Status Byte is set to 0. Pressing the User Preset front-panel key while already in the User Preset menu will cause the User Preset to get executed
Couplings	A user preset will cause the currently running measurement to be aborted and cause the saved measurement to be active. Recalling a User Preset file has the same issues that recalling a Save State file has. Some settings may need to be limited and therefore re-coupled, since the capabilities of the mode may have changes when the User Preset file was last saved.
Initial S/W Revision	Prior to A.02.00

User Preset All Modes

Recalls all of the User Preset files for each mode, switches to the power-on mode, and activates the saved measurement from the power-on mode User Preset file.

NOTE

When the instrument is secured, all of the user preset files are converted back to their default user preset files.

The User Preset function does the following:

- Aborts the currently running measurement.
- Switches the Mode to the power-on mode.
- Restores the User Preset files for each mode.
- Makes the saved measurement for the power-on mode the active measurement.
- Brings up the saved menu for the power-on mode.
- Clears the input and output buffers.
- Sets the Status Byte to 0.

Key Path	User Preset
Remote Command	:SYSTem:PRESet:USER:ALL
Example	:SYST:PRES:USER:SAVE:SYST:PRES:USER:ALL
Notes	Clears all pending OPC bits. The Status Byte is set to 0. :SYST:PRES:USER:SAVE is used to save the current state as the user preset state.
Couplings	A user preset will cause the currently running measurement to be aborted, cause a mode switch to the power-on mode, and cause the saved measurement to be active in the power-on mode. Recalling a User Preset file has the same issues that recalling a Save State file has. Some settings may need to be limited and therefore re-coupled, since the capabilities of the mode may have changes when the User Preset file was last saved.
Initial S/W Revision	Prior to A.02.00

Save User Preset

Saves the currently active mode and its State. You can recall this User Preset file by pressing the User Preset menu key or sending the SYST:PRES:USER remote command. This same state is also saved by the Save State function.

Key Path	User Preset
Remote Command	:SYSTem:PRESet:USER:SAVE
Example	:SYST:PRES:USER:SAVE
Notes	:SYST:PRES:SAVE creates the same file as if the user requested a *SAV or a MMEM:STOR:STAT, except User Preset Save does not allow the user to specify the filename or the location of the file.
Initial S/W Revision	Prior to A.02.00

View/Display

Accesses a menu of functions that enable you to control the instrument display as well as turn the bar graph On and Off.

If current mode is NOT DVB-T/H, DTMB (CTTB), ISDB-T, MSR, LTE-Advanced FDD/TDD or CMMB mode, the front panel views only contain one view: Spectrum View. The results of the measurement can be displayed as a single spectrum trace view or displayed with a Bar Graph trace on the spectrum trace.

Spectrum View with Bar Graph off

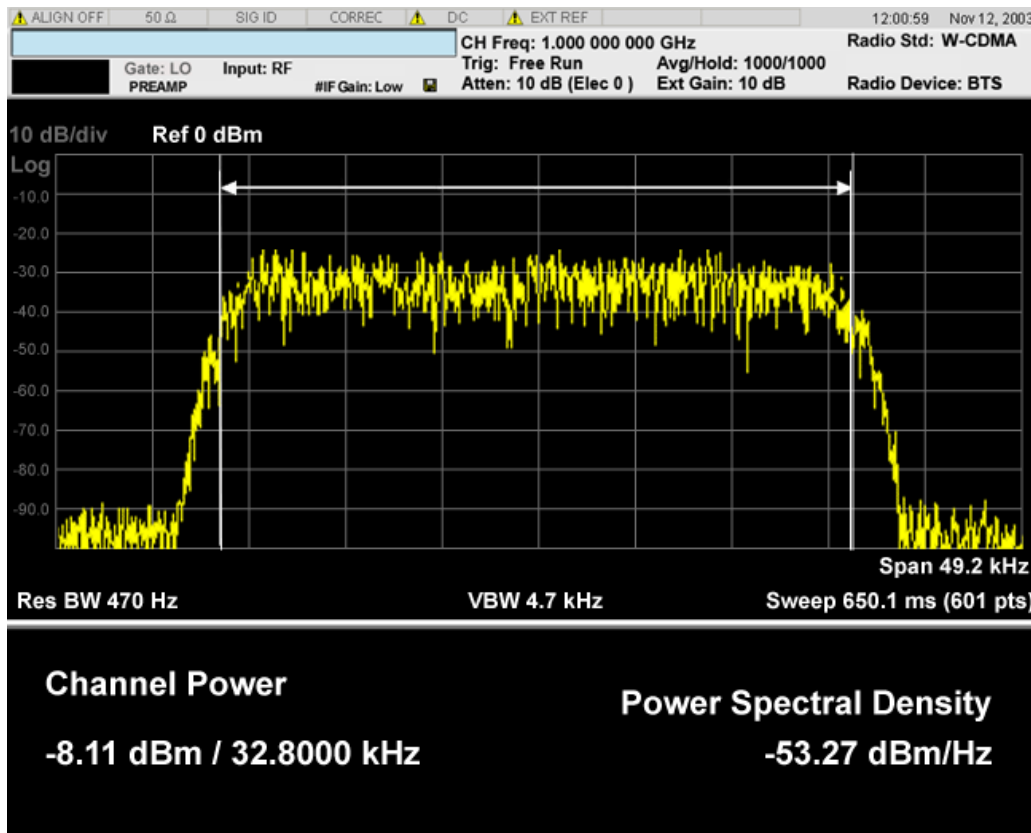

Spectrum View with Bar Graph on

This View is the same as the 'Spectrum' view, but has a blue bar between the markers that indicates the measured output power level. The bar graph is activated when the "Bar Graph" Soft Key is set to ON under the View/Display menu. The actual measured output power level is displayed on the display at the bottom of the bar.

8 Channel Power Measurement
View/Display

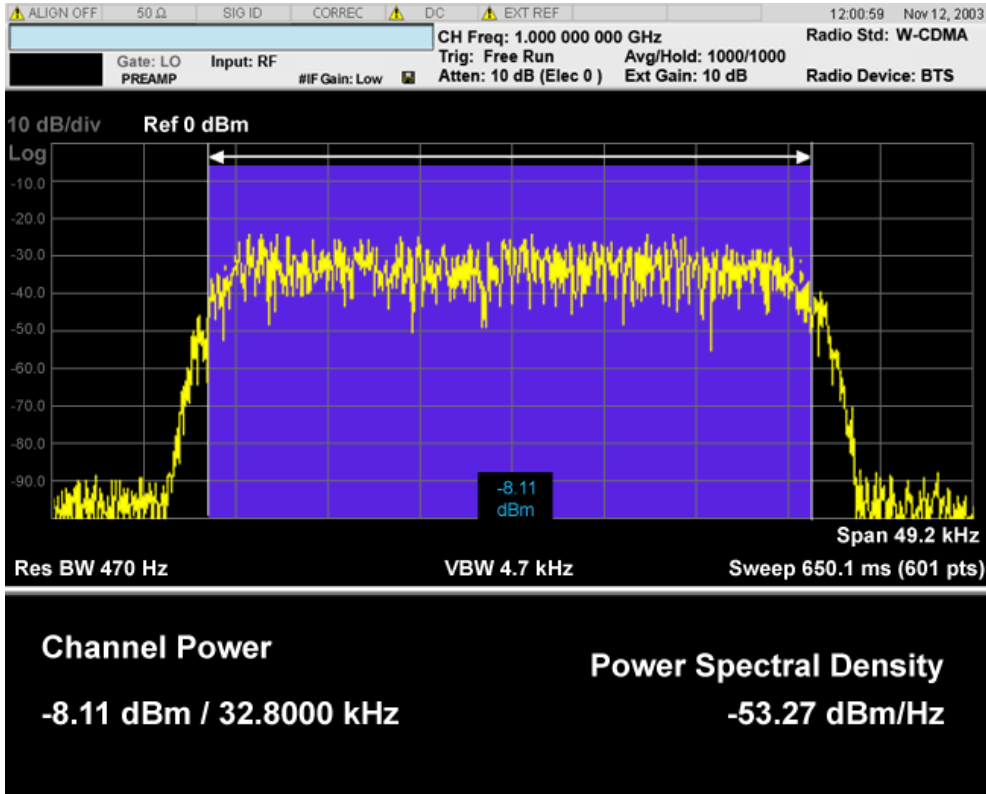

If current mode is MSR and LTE-Advanced FDD/TDD, there are two views, Power Results and Carrier Info. Power Results view is almost the same as the common CHP view.

If the current mode is WLAN and the format is WLAN 802.11ac 80+80 MHz, the spectrum view is changed a little so that the results of both carrier segments can be displayed.

Spectrum View with Bar Graph off for WLAN 802.11ac (80 + 80 MHz):

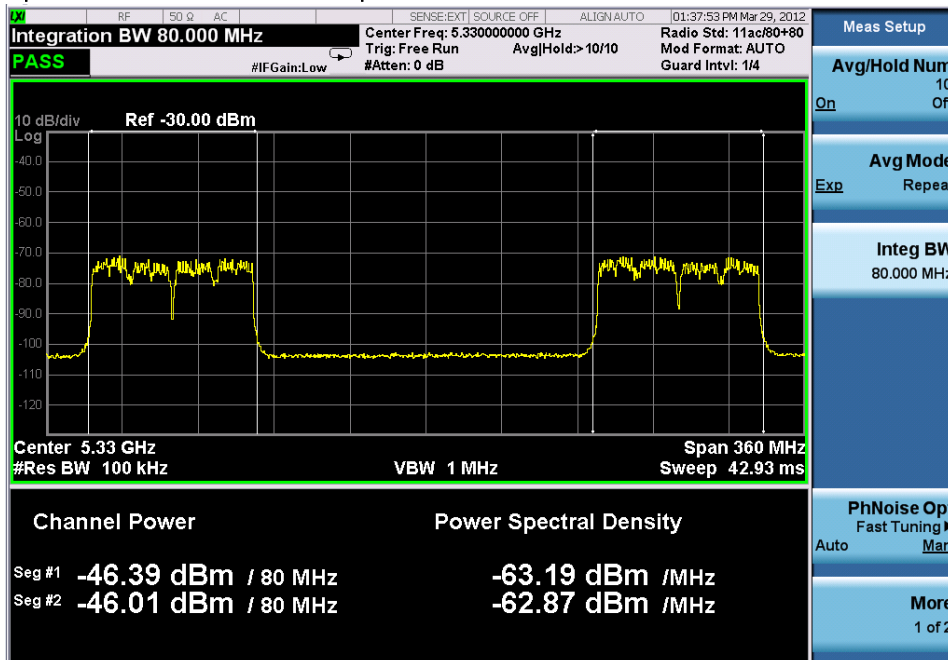

Spectrum View with Bar Graph on for WLAN 802.11ac (80 + 80 MHz):

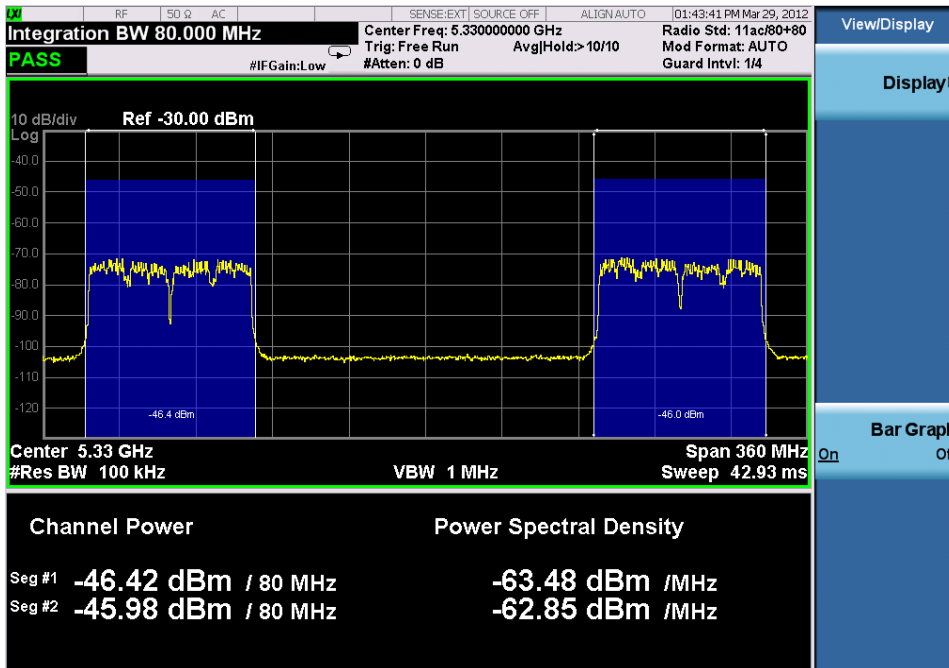

Power Results:

The spectrum trace and power bars are displayed in the upper window. Total carrier power, total PSD and total format carrier power are displayed in the lower window. Total format carrier power is total power of carriers of the same Radio Format. If there is no carrier of the corresponding format, it is not displayed. Thus items in the total format power table changes depending on the carrier configuration. Since the metrics window of MSR and LTE-Advanced FDD/TDD is a bit denser than the common CHP, vertical positions of total power and power spectral density goes up a little bit.

Carrier Info:

The lower window of Power Results view is replaced by the carrier info table in this view. Carrier center frequency can be displayed in either offset or absolute frequency depending on Carrier Freq. The table can be scrolled by Carrier Result on Meas Setup menu or by Select Carrier on Config Carriers menu. The highlighted row changes as either Carrier Result or Select Carrier is changed. The highlighted row and these keys are not coupled.

View selection by name (MSR and LTE-Advanced FDD/TDD only)

Selects the results view. The following SCPI command allows you to select the desired measurement view by enumeration.

Key Path	No equivalent front-panel key
Mode	MSR, LTEAFDD, LTEATDD
Remote Command	:DISPlay:CHPower:VIEW[:SElect] PRESult CINformation :DISPlay:CHPower:VIEW[:SElect]?
Example	:DISP:CHP:VIEW PRES :DISP:CHP:VIEW?

Preset	PRESult
State Saved	Saved in instrument state
Range	Power Results Carrier Info
Initial S/W Revision	A.10.00

Selects the results view. The following SCPI command allows you to select the desired measurement view by enumeration.

Key Path	No equivalent front-panel key
Mode	MSR, LTEAFDD, LTEATDD
Remote Command	:DISPlay:CHPower:VIEW:NSElect <integer> :DISPlay:CHPower:VIEW:NSElect?
Example	DISP:CHP:VIEW:NSEL 1 DISP:CHP:VIEW:NSEL?
Preset	1
State Saved	Saved in instrument state
Min	1
Max	2
Initial S/W Revision	A.10.00

View selection by name (DTMB (CTTB), DVB-T/H only)

Selects the results view. The following SCPI command allows you to select the desired measurement view by enumeration.

Key Path	No equivalent front-panel key
Mode	DVB-T/H, DTMB (CTTB)
Remote Command	:DISPlay:CHPower:VIEW[:SElect] RFSpectrum SHOULder MASK :DISPlay:CHPower:VIEW[:SElect]?
Example	DISP:CHP:VIEW RFSP DISP:CHP:VIEW?
Preset	RFSpectrum
State Saved	Saved in instrument state.
Range	RF Spectrum Shoulder Attenuation Spectrum Mask
Initial S/W Revision	A.02.00

View selection by name (ISDB-T, CMMB only)

Selects the results view. The following SCPI command allows you to select the desired measurement view by enumeration.

Key Path	No equivalent front-panel key
Mode	ISDB-T, CMMB
Remote Command	:DISPlay:CHPower:VIEW[:SElect] RFSpectrum SHOUlder :DISPlay:CHPower:VIEW[:SElect]?
Example	DISP:CHP:VIEW RFSP DISP:CHP:VIEW?
Preset	RFSpectrum
State Saved	Saved in instrument state.
Range	RF Spectrum Shoulder Attenuation
Initial S/W Revision	A.03.00

Key Path	Front-panel key
Initial S/W Revision	Prior to A.02.00

Display

The Display menu is common to most measurements, and is used for configuring items on the display. Some Display menu settings apply to all the measurements in a mode, and some only to the current measurement. Those under the System Display Settings key apply to all measurements in all modes.

Key Path	Display
Key Path	View/Display
Initial S/W Revision	Prior to A.02.00

Annotation

Turns on and off various parts of the display annotation. The annotation is divided up into four categories:

1. Meas Bar: This is the measurement bar at the top of the screen. It does not include the settings panel or the Active Function. Turning off the Meas Bar turns off the settings panel and the Active Function. When the Meas Bar is off, the graticule area expands to fill the area formerly occupied by the Meas Bar.
2. Screen Annotation: this is the annotation and annunciation around the graticule, including any annotation on lines (such as the display line, the threshold line, etc.) This does NOT include the marker number or the N dB result. When off, the graticule expands to fill the entire graticule area.
3. Trace annotation: these are the labels on the traces, showing their detector (or their math mode).

8 Channel Power Measurement
View/Display

4. Active Function annotation: this is the active function display in the meas bar, and all of the active function values displayed on softkeys.

See the figure below. Each type of annotation can be turned on and off individually.

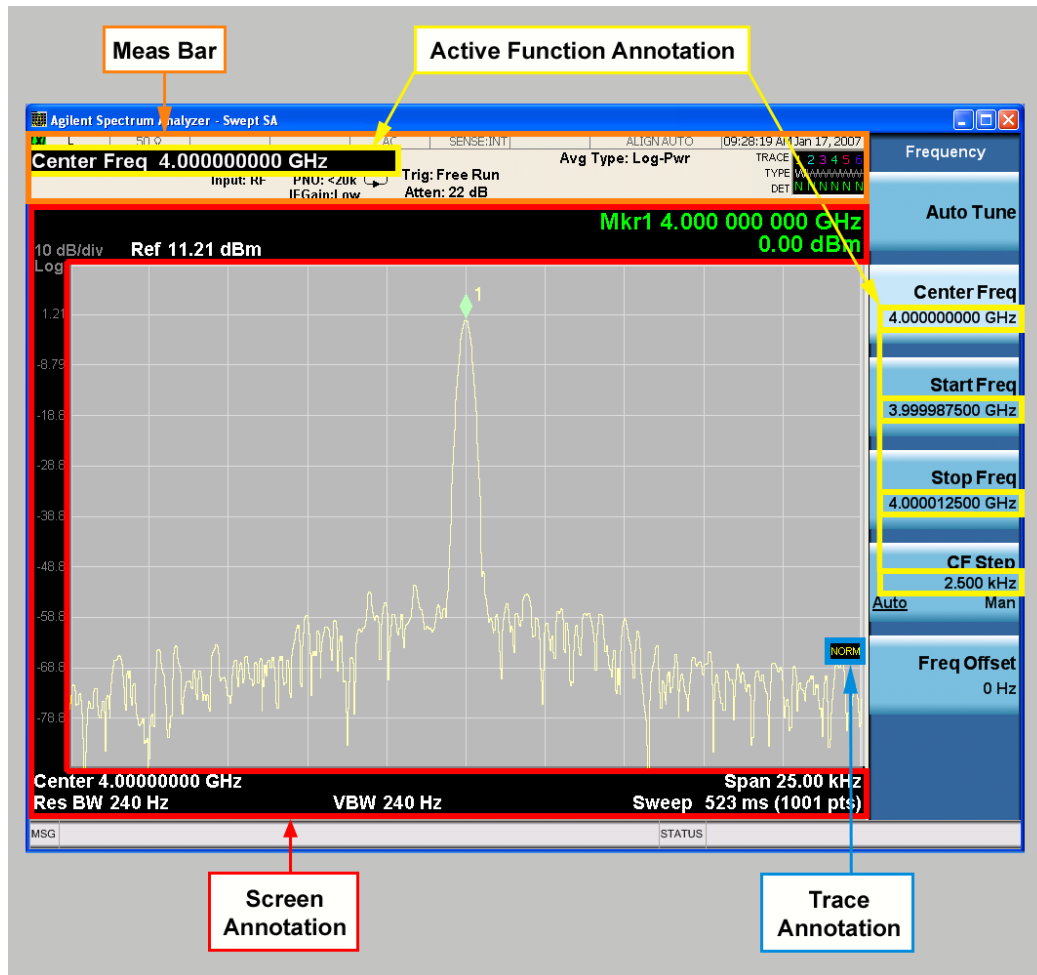

Key Path	View/Display, Display
Initial S/W Revision	Prior to A.02.00

Meas Bar On/Off

This function turns the Measurement Bar on and off, including the settings panel. When off, the graticule area expands to fill the area formerly occupied by the Measurement Bar.

Key Path	View/Display, Display, Annotation
Remote Command	:DISPlay:ANNotation:MBAR[:STATe] OFF ON 0 1 :DISPlay:ANNotation:MBAR[:STATe]?
Example	DISP:ANN:MBAR OFF

Dependencies	Grayed out and forced to OFF when System Display Settings, Annotation is set to Off.
Preset	On This should remain Off through a Preset when System DisplaySettings, Annotation is set to Off.
State Saved	Saved in instrument state.
Initial S/W Revision	Prior to A.02.00

Screen

This controls the display of the annunciation and annotation around the graticule, including any annotation on lines (such as the display line, the threshold line, etc.) and the y-axis annotation. This does NOT include marker annotation (or the N dB result). When off, the graticule expands to fill the entire graticule area, leaving only the 1.5% gap above the graticule as described in the Trace/Detector chapter.

Key Path	View/Display, Display, Annotation
Remote Command	:DISPlay:ANNotation:SCReen[:STATe] OFF ON 0 1 :DISPlay:ANNotation:SCReen[:STATe]?
Example	DISP:ANN:SCR OFF
Dependencies	Grayed-out and forced to OFF when System Display Settings, Annotation is set to Off.
Preset	On This should remain Off through a Preset when System DisplaySettings, Annotation is set to Off
State Saved	Saved in instrument state.
Initial S/W Revision	Prior to A.02.00

Active Function Values On/Off

Turns on and off the active function display in the Meas Bar, and all of the active function values displayed on the softkeys.

Note that all of the softkeys that have active functions have these numeric values blanked when this function is on. This is a security feature..

8 Channel Power Measurement
View/Display

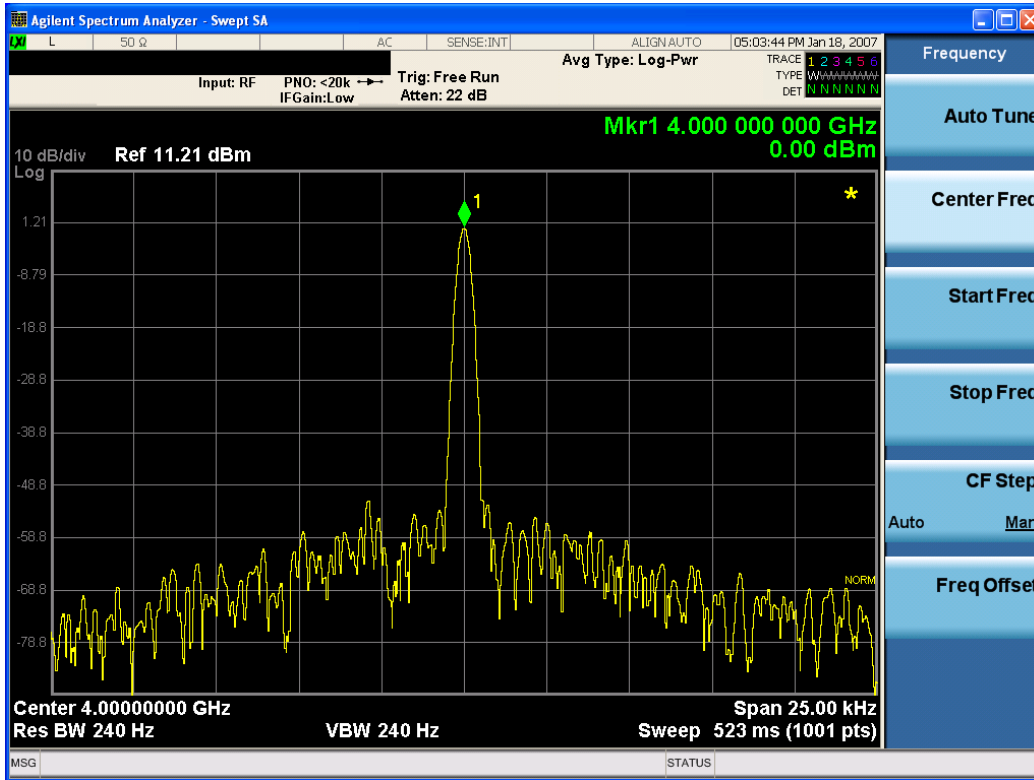

Key Path	View/Display, Display, Annotation
Remote Command	:DISPlay:ACTivefunc[:STATE] ON OFF 1 0 :DISPlay:ACTivefunc[:STATE]?
Example	DISP:ACT OFF
Dependencies	Grayed out and forced to OFF when System Display Settings, Annotation is set to Off.
Preset	On This should remain Off through a Preset when System DisplaySettings, Annotation is set to Off
State Saved	Saved in instrument state.
Initial S/W Revision	Prior to A.02.00

Title

Displays menu keys that enable you to change or clear a title on your display.

Key Path	View/Display, Display
Initial S/W Revision	Prior to A.02.00

Change Title

Writes a title into the "measurement name" field in the banner, for example, "Swept SA".

Press Change Title to enter a new title through the alpha editor. Press Enter or Return to complete the entry. Press ESC to cancel the entry and preserve your existing title.

The display title will replace the measurement name. It remains for this measurement until you press Change Title again, or you recall a state, or a Preset is performed. A title can also be cleared by pressing Title, Clear Title.

NOTE

Notice the inclusion of the <measurement> parameter in the command below. Because each measurement remembers the Display Title, the command must be qualified with the measurement name. For the Swept SA measurement this is not the case; no <measurement> parameter is used when changing the Display Title for the Swept SA measurement.

Key Path	View/Display, Display, Title
Mode	All
Remote Command	:DISPlay:<measurement>:ANNotation:TITLe:DATA <string> :DISPlay:<measurement>:ANNotation:TITLe:DATA?
Example	DISP:ANN:TITL:DATA "This Is My Title" This example is for the Swept SA measurement in the Spectrum Analyzer mode. The SANalyzer <measurement> name is not used. DISP:ACP:ANN:TITL:DATA "This Is My Title" This example is for Measurements other than Swept SA. Both set the title to: This Is My Title
Notes	Pressing this key cancels any active function. When a title is edited the previous title remains intact (it is not cleared) and the cursor goes at the end so that characters can be added or BKSP can be used to go back over previous characters.
Preset	No title (measurement name instead)
State Saved	Saved in instrument state.
Initial S/W Revision	Prior to A.02.00

Clear Title

Clears a title from the front-panel display. Once cleared, the title cannot be retrieved. After the title is cleared, the current Measurement Name replaces it in the title bar.

Key Path	View/Display, Display, Title
Example	The following commands clear the title and restore the measurement's original title: DISP:ANN:TITL:DATA "" This example is for the Swept SA measurement in the Spectrum Analyzer mode. The SANalyzer <measurement> name is not used. DISP:ACP:ANN:TITL:DATA "" This example is for ACP; in measurements other than Swept SA the measurement name is required.
Notes	Uses the :DISPlay:<measurement>:ANNotation:TITLe:DATA <string> command with an empty string (in the Swept SA, the <measurement> is omitted).
Preset	Performed on Preset.
Initial S/W Revision	Prior to A.02.00

Graticule

Pressing Graticule turns the display graticule On or Off. It also turns the graticule y-axis annotation on and off.

Key Path	View/Display, Display
Remote Command	:DISPlay:WINDow[1]:TRACe:GRATicule:GRID[:STATe] OFF ON 0 1 :DISPlay:WINDow[1]:TRACe:GRATicule:GRID[:STATe]?
Example	DISP:WIND:TRAC:GRAT:GRID OFF
Notes	The graticule is the set of horizontal and vertical lines that make up the grid/divisions for the x-axis and y-axis.
Preset	On
State Saved	Saved in instrument state
Initial S/W Revision	Prior to A.02.00

System Display Settings

These settings are "Mode Global" – they affect all modes and measurements and are reset only by Restore Misc Defaults or Restore System Defaults under System.

Key Path	View/Display, Display
Initial S/W Revision	Prior to A.02.00

Annotation Local Settings

This is a Mode Global override of the meas local annotation settings. When it is All Off, it forces ScreenAnnotation, Meas Bar, Trace, and Active Function Values settings to be OFF for all measurements in all modes. This provides the security based "annotation off" function of previous analyzers; hence it uses the legacy SCPI command.

When it is All Off, the Screen, Meas Bar, Trace, and Active Function Values keys under the Display, Annotation menu are grayed out and forced to Off. When Local Settings is selected, you are able to set the local annotation settings on a measurement by measurement basis.

Key Path	View/Display, Display, System Display Settings
Remote Command	:DISPlay:WINDow[1]:ANNotation[:ALL] OFF ON 0 1 :DISPlay:WINDow[1]:ANNotation[:ALL]?
Example	:DISP:WIND:ANN OFF
Preset	On (Set by Restore Misc Defaults)
State Saved	Not saved in instrument state.
Backwards Compatibility Notes	The WINDow parameter and optional subopcode is included for backwards compatibility but ignored – all windows are equally affected.
Initial S/W Revision	Prior to A.02.00

Themes

Accesses a menu of functions that enable you to choose the theme to be used when saving the screen image.

The **Themes** option is the same as the **Themes** option under the **Display** and **Page Setup** dialogs. It allows you to choose between themes to be used when saving the screen image.

Key Path	Save, Screen Image
Remote Command	:MMEMory:STORe:SCReen:THEMe TDColor TDMonochrome FCOLOR FMONochrome :MMEMory:STORe:SCReen:THEMe?
Example	:MMEM:STOR:SCR:THEM TDM
Preset	3D Color; Is not part of Preset, but is reset by Restore Misc Defaults or Restore System Defaults All and survives subsequent running of the modes.
Readback	3D Color 3D Mono Flat Color Flat Mono
Backwards Compatibility Notes	In ESA and PSA we offer the choice of "Reverse Bitmap" or "Reverse Metafile" when saving screen images. This is much like the "Flat Color" theme available in X-Series. Also, if you selected Reverse Bitmap AND a black & white screen image, that would be much like "Flat Monochrome". In other words, each of the X-Series themes has a similar screen image type in ESA/PSA. But they are not identical.
Initial S/W Revision	Prior to A.02.00

3D Color

Selects a standard color theme with each object filled, shaded and colored as designed.

Key Path	Save, Screen Image, Themes
Example	MMEM:STOR:SCR:THEM TDC
Readback	3D Color
Initial S/W Revision	Prior to A.02.00

3D Monochrome

Selects a format that is like 3D color but shades of gray are used instead of colors.

Key Path	Save, Screen Image, Themes
Example	MMEM:STOR:SCR:THEM TDM
Readback	3D Mono
Initial S/W Revision	Prior to A.02.00

Flat Color

Selects a format that is best when the screen is to be printed on an ink printer.

Key Path	Save, Screen Image, Themes
Example	MMEM:STOR:SCR:THEM FCOL
Readback	Flat Color
Initial S/W Revision	Prior to A.02.00

Flat Monochrome

Selects a format that is like Flat Color. But only black is used (no colors, not even gray), and no fill.

Key Path	Save, Screen Image, Themes
Example	MMEM:STOR:SCR:THEM FMON
Readback	Flat Mono
Initial S/W Revision	Prior to A.02.00

Backlight

Accesses the display backlight on/off keys. This setting may interact with settings under the Windows "Power" menu.

When the backlight is off, pressing ESC, TAB, SPACE, ENTER, UP, DOWN, LEFT, RIGHT, DEL, BKSP, CTRL, or ALT turns the backlight on without affecting the application. Pressing any other key will turn backlight on and could potentially perform the action as well.

Key Path	View/Display, Display, System Display Settings
Remote Command	:DISPlay:BACKlight ON OFF :DISPlay:BACKlight?
Preset	ON (Set by Restore Misc Defaults)
Initial S/W Revision	Prior to A.02.00

Backlight Intensity

An active function used to set the backlight intensity. It goes from 0 to 100 where 100 is full on and 0 is off. This value is independent of the values set under the Backlight on/off key.

Key Path	View/Display, Display, System Display Settings
Remote Command	:DISPlay:BACKlight:INTensity <integer> :DISPlay:BACKlight:INTensity?
Example	DISP:BACK:INT 50

Preset	100 (Set by Restore Misc Defaults)
Min	0
Max	100
Initial S/W Revision	Prior to A.02.00

Bar Graph

Turns the Bar Graph On and Off.

Key Path	DVB-T/H, DTMB (CTTB), ISDB-T, CMMB: View/Display, RF SpectrumOthers: View/Display
Mode	SA, WCDMA, C2K, WIMAX OFDMA, 1xEVDO, DVB-T/H, DTMB (CTTB), ISDB-T, CMMB, LTE, LTE-TDD, Digital Cable TV, WLAN, MSR, LTE-Advanced FDD, LTE-TDD
Remote Command	:DISPlay:CHPower:VIEW[1]:WINDow[1]:BGRaph ON OFF 1 0 :DISPlay:CHPower:VIEW[1]:WINDow[1]:BGRaph?
Example	DISP:CHP:VIEW:WIND:BGR ON DISP:CHP:VIEW:WIND:BGR?
Notes	You must be in the Spectrum Analysis mode, W-CDMA mode, cdma2000 mode, DVB-T/H mode, DTMB (CTTB) mode, ISDB-T mode, CMMB mode, Digital Cable TV mode, LTE mode, LTE TDD mode, WLAN mode, 1xEVDO mode, MSR, LTE-Advanced FDD/TDD mode or WIMAX OFDMA mode to use this command. Use :INSTrument:SElect to set the mode.
Preset	OFF
State Saved	Saved in instrument state.
Range	On Off
Initial S/W Revision	Prior to A.02.00
Modified at S/W Revision	A.02.00, A.03.00

9 ACP Measurement

ACP is a measurement of the amount of interference, or power, in an adjacent frequency channel. The results are displayed as a bar graph or as spectrum data, with measurement data at specified offsets. For measurement results and views, see ["View/Display" on page 838](#).

This topic contains the following sections:

["Measurement Commands for ACP" on page 630](#)

["Remote Command Results for ACP Measurement" on page 631](#)

Measurement Commands for ACP

The following commands are used to retrieve the measurement results:

```
:CONFigure:ACP  
:CONFigure:ACP:NDEFault  
:INITiate:ACP  
:FETCh:ACP[n]?  
:READ:ACP[n]?  
:MEASure:ACP[n]?
```

For more measurement related commands, see the SENSE subsystem, and the section "[Remote Measurement Functions](#)" on page 2205.

Remote Command Results for ACP Measurement

Condition	N	Results Returned
Mode = SA mode, Radio Std = None, Number of carriers = 1 and only offset A is on	Not specified or n = 1	Returns 3 comma-separated values that correspond to: Reference carrier power, lower-adjacent channel power (dBc), and upper-adjacent channel power (dBc).
Mode = DTMB (CTTB) or CMMB, Radio BW = 8 MHz, Number of carriers = 1 and Meas Type = Total power reference	Not specified or n = 1	Returns 32 comma-separated scalar results, in the following order. 1. 0.0 2. Total carrier power (dBm) 3. 0.0 4. Reference carrier power (dBm) 5. Lower offset A - relative power (dB) 6. Lower offset A - absolute power (dBm) 7. Upper offset A - relative power (dB) 8. Upper offset A - absolute power (dBm) 9. Lower offset B - relative power (dB) 10. Lower offset B - absolute power (dBm) 11. Upper offset B - relative power (dB) 12. Upper offset B - absolute power (dBm) ... 25. Lower offset F - relative power (dB) 26. Lower offset F - absolute power (dBm) 27. Upper offset F - relative power (dB) 28. Upper offset F - absolute power (dBm) 29. Inside Adjacent Channel - relative power (dB) 30. Inside Adjacent Channel - absolute power (dBm) 31. Outside Adjacent Channel - relative power (dB) 32. Outside Adjacent Channel - absolute power (dBm) If Radio Device = Exciter, the last four (29, 30, 31 and 32) results returned -999.0. If the results are not available, -999.0 is returned. Note: * Inside Adjacent Channel - absolute power: the maximum of the Lower offset A - absolute power and the Upper offset A - absolute power; ** Inside Adjacent Channel - relative power: the result of Reference carrier power subtracted from Inside Adjacent Channel - absolute power; *** Outside Adjacent Channel - absolute power: the root mean square of the absolute power of the offset B upper/lower, the offset C upper/lower and the offset D upper/lower; **** Outside Adjacent Channel - relative power: the result of Reference carrier power subtracted from Outside Adjacent Channel - absolute power;
Mode = DTMB (CTTB) or	not specified	Returns 32 comma-separated scalar results, in the following order.

Condition	N	Results Returned
CMMB, Radio BW = 8 MHz, Number of carriers = 1 and Meas Type = Power spectral density reference	or n = 1	<ol style="list-style-type: none"> 1. 0.0 2. Total carrier power (dBm/Hz or dBm/MHz) 3. 0.0 4. Reference carrier power (dBm/Hz or dBm/MHz) 5. Lower offset A - relative power (dB) 6. Lower offset A - absolute power (dBm/Hz or dBm/MHz) 7. Upper offset A - relative power (dB) 8. Upper offset A - absolute power (dBm/Hz or dBm/MHz) 9. Lower offset B - relative power (dB) 10. Lower offset B - absolute power (dBm/Hz or dBm/MHz) 11. Upper offset B - relative power (dB) 12. Upper offset B - absolute power (dBm/Hz or dBm/MHz) ... 25. Lower offset F - relative power (dB) 26. Lower offset F - absolute power (dBm/Hz or dBm/MHz) 27. Upper offset F - relative power (dB) 28. Upper offset F - absolute power (dBm/Hz or dBm/MHz) 29. -999.0 30. -999.0 31. -999.0 32. -999.0 <p>The last four (29, 30, 31 and 32) results always returned -999.0. If the results are not available, -999.0 is returned.</p>
Meas Type = Total power reference	Not specified or n = 1	<p>Returns 28 comma-separated scalar results, in the following order.</p> <ol style="list-style-type: none"> 1. 0.0 2. Total carrier power (dBm) 3. 0.0 4. Reference carrier power (dBm) 5. Lower offset A - relative power (dB) 6. Lower offset A - absolute power (dBm) 7. Upper offset A - relative power (dB) 8. Upper offset A - absolute power (dBm) 9. Lower offset B - relative power (dB) 10. Lower offset B - absolute power (dBm) 11. Upper offset B - relative power (dB) 12. Upper offset B - absolute power (dBm) ... 25. Lower offset F - relative power (dB) 26. Lower offset F - absolute power (dBm)

Condition	N	Results Returned
		27. Upper offset F - relative power (dB) 28. Upper offset F - absolute power (dBm) If the results are not available, -999.0 is returned. When in MSR and LTE-Advanced FDD/TDD, this trace includes only outer offset results and their reference value(s).
Meas Type = Power spectral density reference	not specified or n = 1	Returns 28 comma-separated scalar results, in the following order. 1. 0.0 2. Total carrier power (dBm/Hz or dBm/MHz) 3. 0.0 4. Reference carrier power (dBm/Hz or dBm/MHz) 5. Lower offset A - relative power (dB) 6. Lower offset A - absolute power (dBm/Hz or dBm/MHz) 7. Upper offset A - relative power (dB) 8. Upper offset A - absolute power (dBm/Hz or dBm/MHz) 9. Lower offset B - relative power (dB) 10. Lower offset B - absolute power (dBm/Hz or dBm/MHz) 11. Upper offset B - relative power (dB) 12. Upper offset B - absolute power (dBm/Hz or dBm/MHz) ... 25. Lower offset F - relative power (dB) 26. Lower offset F - absolute power (dBm/Hz or dBm/MHz) 27. Upper offset F - relative power (dB) 28. Upper offset F - absolute power (dBm/Hz or dBm/MHz) If the results are not available, -999.0 is returned. When in MSR and LTE-Advanced FDD/TDD, this trace includes only outer offset results and their reference value(s).
Meas Method = FAST	not specified or n = 1	Returns 5 comma-separated results, in the following order: 1. Reference carrier - absolute power (dBm) 2. Lower offset A - absolute power (dBm) 3. Upper offset A - absolute power (dBm) 4. Lower offset B - absolute power (dBm) 5. Upper offset B - absolute power (dBm)
Mode = MSR , LTEAFDD, LTEATDD, Meas Type = Total power reference and Power Ref = Left & Right Carriers	Not specified or n = 1	Returns 28 comma-separated scalar results, in the following order. 1. 0.0 2. Total carrier power (dBm) 3. Left Reference carrier power (dBm) 4. Right Reference carrier power (dBm) 5. Lower offset A - relative power (dB) 6. Lower offset A - absolute power (dBm) 7. Upper offset A - relative power (dB)

Condition	N	Results Returned
		8. Upper offset A - absolute power (dBm) 9. Lower offset B - relative power (dB) 10. Lower offset B - absolute power (dBm) 11. Upper offset B - relative power (dB) 12. Upper offset B - absolute power (dBm) ... 25. Lower offset F - relative power (dB) 26. Lower offset F - absolute power (dBm) 27. Upper offset F - relative power (dB) 28. Upper offset F - absolute power (dBm) If the results are not available, -999.0 is returned.
Mode = MSR , LTEAFDD, LTEATDD, Meas Type = Power spectral density reference and Power Ref = Left & Right Carriers	not specified or n = 1	Returns 28 comma-separated scalar results, in the following order. 1. 0.0 2. Total carrier power (dBm/Hz or dBm/MHz) 3. Left reference carrier power (dBm/Hz or dBm/MHz) 4. Right reference carrier power (dBm/Hz or dBm/MHz) 5. Lower offset A - relative power (dB) 6. Lower offset A - absolute power (dBm/Hz or dBm/MHz) 7. Upper offset A - relative power (dB) 8. Upper offset A - absolute power (dBm/Hz or dBm/MHz) 9. Lower offset B - relative power (dB) 10. Lower offset B - absolute power (dBm/Hz or dBm/MHz) 11. Upper offset B - relative power (dB) 12. Upper offset B - absolute power (dBm/Hz or dBm/MHz) ... 25. Lower offset F - relative power (dB) 26. Lower offset F - absolute power (dBm/Hz or dBm/MHz) 27. Upper offset F - relative power (dB) 28. Upper offset F - absolute power (dBm/Hz or dBm/MHz) If the results are not available, -999.0 is returned. When in MSR and LTE-Advanced FDD/TDD, this trace includes only outer offset results and their reference value(s).
Meas Type = Total power reference	n = 2	Returns 48 scalar results, in the following order: 1. Channel (1) - relative power (dB) 2. Channel (1) - absolute power (dBm) 3. Channel (2) - relative power (dB) 4. Channel (2) - absolute power (dBm) ... 23. Channel (12) - relative power (dB) 24. Channel (12) - absolute power (dBm)

Condition	N	Results Returned
		25. Lower offset A - relative power (dB) 26. Lower offset A - absolute power (dBm) 27. Upper offset A - relative power (dB) 28. Upper offset A - absolute power (dBm) 29. Lower offset B - relative power (dB) 30. Lower offset B - absolute power (dBm) 31. Upper offset B - relative power (dB) 32. Upper offset B - absolute power (dBm) ... 45. Lower offset F - relative power (dB) 46. Lower offset F - absolute power (dBm) 47. Upper offset F - relative power (dB) 48. Upper offset F - absolute power (dBm) If the results are not available, -999.0 is returned. When in MSR and LTE-Advanced FDD/TDD, this trace includes only outer offset results and their reference value(s).
Meas Type = Power spectral density reference	n = 2	Returns 48 scalar results, in the following order: 1. Channel (1) - relative power (dB) 2. Channel (1) - absolute power (dBm/Hz or dBm/MHz) 3. Channel (2) - relative power (dB) 4. Channel (2) - absolute power (dBm/Hz or dBm/MHz) ... 23. Channel (12) - relative power (dB) 24. Channel (12) - absolute power (dBm/Hz or dBm/MHz) 25. Lower offset A - relative power (dB) 26. Lower offset A - absolute power (dBm/Hz or dBm/MHz) 27. Upper offset A - relative power (dB) 28. Upper offset A - absolute power (dBm/Hz or dBm/MHz) 29. Lower offset B - relative power (dB) 30. Lower offset B - absolute power (dBm/Hz or dBm/MHz) 31. Upper offset B - relative power (dB) 32. Upper offset B - absolute power (dBm/Hz or dBm/MHz) ... 45. Lower offset F - relative power (dB) 46. Lower offset F - absolute power (dBm/Hz or dBm/MHz) 47. Upper offset F - relative power (dB) 48. Upper offset F - absolute power (dBm/Hz or dBm/MHz) If the results are not available, -999.0 is returned. When in MSR and LTE-Advanced FDD/TDD, this trace includes only outer offset

Condition	N	Results Returned
Mode = DTMB (CTTB) or CMMB, Radio BW = 8 MHz and Meas Type = Total power reference	n = 3	<p>results.</p> <hr/> <p>Returns 28 scalar values of the pass/fail (0 = passed, or 1 = failed) determined by testing the relative to the reference carrier and by testing the absolute power limit of the offset frequencies (measured as total power in dB):</p> <ol style="list-style-type: none"> 1. Lower offset A - relative limit result 2. Lower offset A - absolute limit result 3. Upper offset A - relative limit result 4. Upper offset A - absolute limit result 5. Lower offset B - relative limit result 6. Lower offset B - absolute limit result 7. Upper offset B - relative limit result 8. Upper offset B - absolute limit result <p>...</p> <ol style="list-style-type: none"> 21. Lower offset F - relative limit result 22. Lower offset F - absolute limit result 23. Upper offset F - relative limit result 24. Upper offset F - absolute limit result 25. Inside Adjacent Channel - relative limit result 26. Inside Adjacent Channel - absolute limit result 27. Outside Adjacent Channel - relative limit result 28. Outside Adjacent Channel - absolute limit result <p>If Radio Device = Exciter, the last four (25, 26, 27 and 28) results returned -999.0.</p>
Mode = DTMB (CTTB) or CMMB, Radio BW = 8 MHz and Meas Type = Power spectral density reference	n = 3	<p>Returns 28 scalar values of the pass/fail (0 = passed, or 1 = failed) determined by testing the relative to the reference carrier and by testing the absolute power limit of the offset frequencies (measured as power spectral density in dB):</p> <ol style="list-style-type: none"> 1. Lower offset A - relative limit result 2. Lower offset A - absolute limit result 3. Upper offset A - relative limit result 4. Upper offset A - absolute limit result 5. Lower offset B - relative limit result 6. Lower offset B - absolute limit result 7. Upper offset B - relative limit result 8. Upper offset B - absolute limit result <p>...</p> <ol style="list-style-type: none"> 21. Lower offset F - relative limit result 22. Lower offset F - absolute limit result 23. Upper offset F - relative limit result 24. Upper offset F - absolute limit result 25. -999.0

Condition	N	Results Returned
		26. -999.0 27. -999.0 28. -999.0 The last four results always returned -999.0.
Meas Type = Total power reference	n = 3	Returns 24 scalar values of the pass/fail (0 = passed, or 1 = failed) determined by testing the relative to the reference carrier and by testing the absolute power limit of the offset frequencies (measured as total power in dB): <ol style="list-style-type: none"> 1. Lower offset A - relative limit result 2. Lower offset A - absolute limit result 3. Upper offset A - relative limit result 4. Upper offset A - absolute limit result 5. Lower offset B - relative limit result 6. Lower offset B - absolute limit result 7. Upper offset B - relative limit result 8. Upper offset B - absolute limit result ... <ol style="list-style-type: none"> 21 Lower offset F - relative limit result 22 Lower offset F - absolute limit result 23 Upper offset F - relative limit result 24 Upper offset F - absolute limit result When in MSR and LTE-Advanced FDD/TDD, this trace includes only outer offset results.
Meas Type = Power spectral density reference	n = 3	Returns 24 scalar values of the pass/fail (0 = passed, or 1 = failed) determined by testing the relative to the reference carrier and by testing the absolute power limit of the offset frequencies (measured as power spectral density in dB): <ol style="list-style-type: none"> 1. Lower offset A - relative limit result 2. Lower offset A - absolute limit result 3. Upper offset A - relative limit result 4. Upper offset A - absolute limit result 5. Lower offset B - relative limit result 6. Lower offset B - absolute limit result 7. Upper offset B - relative limit result 8. Upper offset B - absolute limit result ... <ol style="list-style-type: none"> 21 Lower offset F - relative limit result 22 Lower offset F - absolute limit result 23 Upper offset F - relative limit result 24 Upper offset F - absolute limit result When in MSR and LTE-Advanced FDD/TDD, this trace includes only outer offset results.

Condition	N	Results Returned
	n = 4	Returns <Num Pts> comma-separated scalar values representing the Y values in Trace 1
	n = 5	Returns <Num Pts> comma-separated scalar values representing the Y values in Trace 2
	n = 6	Returns <Num Pts> comma-separated scalar values representing the Y values in Trace 3
Meas Type = Total power reference	n = 7	<p>Returns (2 * Number of Carriers) scalar results, in the following order:</p> <p>The Number of Carriers is the value filled in Carriers under Carrier Setup menu. If license N9060A-5FP is enabled, max value of Number of Carriers is 18, otherwise, max value of Number of Carriers is 12. In MSR mode, max value of Number of Carriers is 100. In LTE-Advanced FDD/TDD mode, max value of number of carriers is 5.</p> <ol style="list-style-type: none"> 1. Channel (1) - relative power (dB) 2. Channel (1) - absolute power (dBm) 3. Channel (2) - relative power (dB) 4. Channel (2) - absolute power (dBm) <p>...</p> <p>2 * Number of Carriers -1. Channel (Number of Carriers) - relative power (dB)</p> <p>2 * Number of Carriers. Channel (Number of Carriers) - absolute power (dBm)</p> <p>If the results are not available, 9.91E+37 is returned.</p>
Meas Type = Power spectral density reference	n = 7	<p>Returns (2 * Number of Carriers) scalar results, in the following order: The Number of Carriers is the value filled in Carriers under Carrier Setup menu.</p> <p>If license N9060A-5FP is enabled, max value of Number of Carriers is 18, otherwise, max value of Number of Carriers is 12. In MSR mode, max value of Number of Carriers is 100. In LTE-Advanced FDD/TDD mode, max value of number of carriers is 5.</p> <ol style="list-style-type: none"> 1. Channel (1) - relative power (dB) 2. Channel (1) - absolute power (dBm/Hz or dBm/MHz) 3. Channel (2) - relative power (dB) 4. Channel (2) - absolute power (dBm/Hz or dBm/MHz) <p>...</p> <p>2 * Number of Carriers -1. Channel (Number of Carriers) - relative power (dB)</p> <p>2 * Number of Carriers. Channel (Number of Carriers) - absolute power (dBm/Hz or dBm/MHz)</p> <p>If the results are not available, 9.91E+37 is returned</p>
Mode = MSR,LTEAFDD,LTEATDD	n = 8	<p>Returns scalar results, in the following order:</p> <ol style="list-style-type: none"> 1. 0.0 2. Total carrier power (dBm) 3. 0.0

Condition	N	Results Returned
		<p>4. Reference carrier power (dBm, dBm/Hz or dBm/MHz)</p> <p>5. Inner Lower offset A - relative power (dB)</p> <p>6. Inner Lower offset A - absolute power (dBm, dBm/Hz or dBm/MHz)</p> <p>7. Inner Upper offset A - relative power (dB)</p> <p>8. Inner Upper offset A - absolute power (dBm, dBm/Hz or dBm/MHz)</p> <p>9. Inner Lower offset B - relative power (dB)</p> <p>10. Inner Lower offset B - absolute power (dBm, dBm/Hz or dBm/MHz)</p> <p>11. Inner Upper offset B - relative power (dB)</p> <p>12. Inner Upper offset B - absolute power (dBm, dBm/Hz or dBm/MHz)</p> <p>...</p> <p>25. Inner Lower offset F - relative power (dB)</p> <p>26. Inner Lower offset F - absolute power (dBm, dBm/Hz or dBm/MHz)</p> <p>27. Inner Upper offset F - relative power (dB)</p> <p>28. Inner Upper offset F - absolute power (dBm, dBm/Hz or dBm/MHz)</p> <p>When Power Ref is either Left & Right Carriers or Max Power Carrier in Sub-block, the first four values are</p> <p>1. 0.0</p> <p>2. Total carrier power (dBm)</p> <p>3. Reference carrier in the lower sub-block (dBm, dBm/Hz or dBm/MHz)</p> <p>4. Reference carrier in the upper sub-block (dBm, dBm/Hz or dBm/MHz)</p> <p>Unit of absolute power results.</p> <p>dBm: Meas Type = Total Pwr Ref</p> <p>dBm/Hz: Meas Type = PSD Ref, PSD Unit = dBm/Hz</p> <p>dBm/MHz: Meas Type = PSD Ref, PSD Unit = dBm/MHz</p> <p>If the results are not available, 9.91E+37 is returned.</p>
Mode = MSR, LTEAFDD,LTEATDD	n = 9	<p>Returns scalar values of the pass/fail (0 = passed, or 1 = failed) determined by testing the relative to the reference carrier and by testing the absolute power limit of the offset frequencies.</p> <p>1. Inner Lower offset A - relative limit result</p> <p>2. Inner Lower offset A - absolute limit result</p> <p>3. Inner Upper offset A - relative limit result</p> <p>4. Inner Upper offset A - absolute limit result</p> <p>5. Inner Lower offset B - relative limit result</p> <p>6. Inner Lower offset B - absolute limit result</p> <p>7. Inner Upper offset B - relative limit result</p> <p>8. Inner Upper offset B - absolute limit result</p> <p>...</p> <p>21. Inner Lower offset F - relative limit result</p> <p>22. Inner Lower offset F - absolute limit result</p> <p>23. Inner Upper offset F - relative limit result</p>

Condition	N	Results Returned
		24. Inner Upper offset F - absolute limit result
Mode = MSR, LTEAFDD,LTEATDD	n = 10	<p>Returns scalar values of offset results. Numbers returned in this trace is 10 x actually measured offsets. Note that upper and lower sides of an offset are returned separately. For example, when only outer offset A is measured with offset side both, $10 \times 2 = 20$ values are returned.</p> <ol style="list-style-type: none"> 1. Inner = 1 or Outer = 2. 2. Offset A~F. (A=1, B=2, ... F=6) 3. Offset Side. Lower=1 or Upper=2 4. Relative power or relative PSD (dBc or dB) 5. Absolute power (dBm) or absolute PSD (dBm/Hz or dBm/MHz) 6. Reference power (dBm) or reference PSD (dBm/Hz or dBm/MHz) 7. Reference Index 1 8. Reference Index 2 9. 0 (Reserved) 10. 0 (Reserved) <p>...</p> <ol style="list-style-type: none"> $10(n-1)+1$. Inner = 1 or Outer = 2. $10(n-1)+2$. Offset A~F. (A=1, B=2, ... F=6) $10(n-1)+3$. Offset Side. Lower=1 or Upper=2 $10(n-1)+4$. Relative power or relative PSD (dBc or dB) $10(n-1)+5$. Absolute power (dBm) or absolute PSD (dBm/Hz or dBm/MHz) $10(n-1)+6$. Reference power (dBm) or reference PSD (dBm/Hz or dBm/MHz) $10(n-1)+7$. Reference Index 1 $10(n-1)+8$. Reference Index 2 $10(n-1)+9$. 0 (Reserved) $10(n-1)+10$. 0 (Reserved) <p>Where n is number of offsets.</p> <p>Meas Type determines which type of power result is returned, i.e. power or PSD. Unit for PSD results is determined by PSD Unit.</p> <p>If result is not available, 9.91E+37 is returned.</p>
Key Path	Front-panel key	
Initial S/W Revision	Prior to A.02.00	
Modified at S/W Revision	A.13.00	

AMPTD Y Scale

Accesses a menu of functions that enable you to set the vertical scale parameters. The parameter values are measurement independent, except all Attenuation values and the Internal Preamp selections, which are the same across all measurements.

Key Path	Front-panel key
Initial S/W Revision	Prior to A.02.00

Ref Value

Sets the value for the absolute power reference. However, since the Auto Scaling is defaulted to On, this value is automatically determined by the measurement result. When you set a value manually, Auto Scaling automatically changes to Off.

Key Path	AMPTD Y Scale
Mode	SA, WCDMA, C2K, WIMAX OFDMA, TD-SCDMA, 1xEVDO, DVB-T/H, DTMB (CTTB), ISDB-T, CMMB, LTE, LTE-TDD, Digital Cable TV, MSR, LTEAFDD, LTEATDD
Remote Command	:DISPlay:ACPower:VIEW[1]:WINDow[1]:TRACe:Y[:SCALe]:RLEVel <real> :DISPlay:ACPower:VIEW[1]:WINDow[1]:TRACe:Y[:SCALe]:RLEVel?
Example	DISP:ACP:VIEW:WIND:TRAC:Y:RLEV 100 DISP:ACP:VIEW:WIND:TRAC:Y:RLEV?
Notes	You must be in the mode that includes ACP measurements to use this command. Use :INSTrument:SElect to set the mode.
Couplings	When the Auto Scaling is On, this value is automatically determined by the measurement result. When you set a value manually, Auto Scaling automatically changes to Off.
Preset	10dBm
State Saved	Saved in instrument state.
Min	-250.00 dBm
Max	250.00 dBm
Initial S/W Revision	Prior to A.02.00
Modified at S/W Revision	A.02.00, A.03.00

Attenuation

This menu controls the attenuator functions and interactions between the attenuation system components.

There are two attenuator configurations in the X-Series. One is a dual attenuator configuration consisting of a mechanical attenuator and an optional electronic attenuator. The other configuration uses a single attenuator with combined mechanical and electronic sections that controls all the attenuation functions. Different models in the X-Series come with different configurations.

See "Dual Attenuator Configurations:" on page 642

See "Single Attenuator Configuration:" on page 643

Most Attenuation settings are the same for all measurements – they do not change as you change measurements. Settings like these are called “Meas Global” and are unaffected by Meas Preset.

Key Path	AMPTD Y Scale
Scope	Meas Global
Dependencies	In measurements that support the I/Q inputs, this key is unavailable when I/Q is the selected input, and is replaced by the Range key in that case.
Readback Line	Contains a summary in [] brackets of the current total attenuation. See the descriptions of the , " (Mech) Atten " on page 2141, and " Enable Elec Atten " on page 2143 keys for more detail on the contributors to the total attenuation. Note that when "Pre-Adjust for Min Clip" is on, this value can change at the start of every measurement.
Initial S/W Revision	Prior to A.02.00
Modified at S/W Revision	A.03.00

Dual Attenuator Configurations:

Configuration 1: Mechanical attenuator + optional electronic attenuator

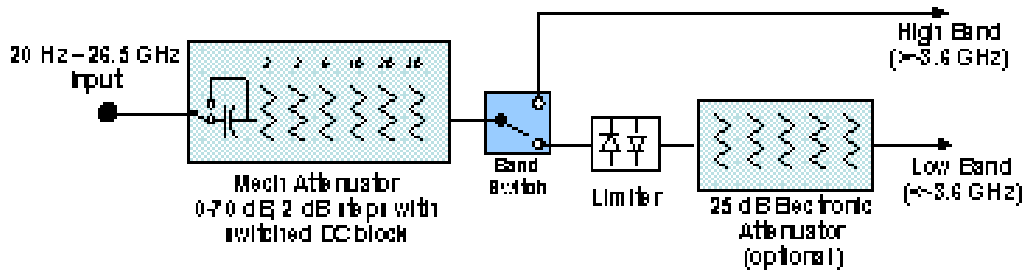

Configuration 2: Mechanical attenuator, no optional electronic attenuator

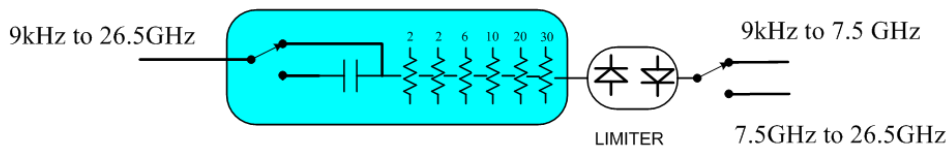

(note that Configuration 2 is not strictly speaking a dual-section attenuator, since there is no electronic section available. However, it behaves exactly like Configuration 1 without the Electronic Attenuator option EA3, therefore for the sake of this document it is grouped into the “Dual Attenuator” configuration)

Single Attenuator Configuration:

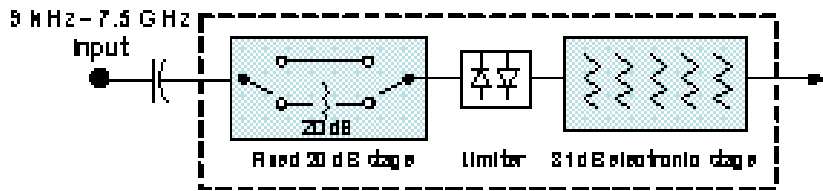

You can tell which attenuator configuration you have by pressing the Attenuation key, which (in most Modes) opens the Attenuation menu. If the first key in the Attenuation menu says Mech Atten you have the dual attenuator configuration. If the first key says Atten you have the single attenuator configuration.

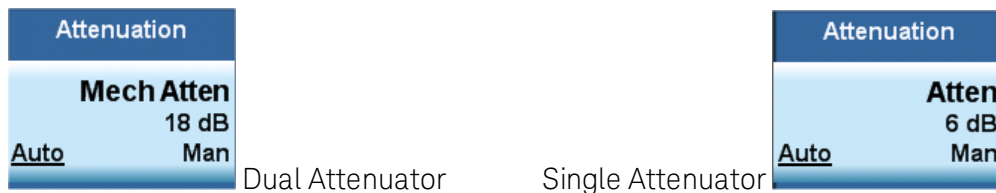

In the single attenuator configuration, you control the attenuation with a single control, as the fixed stage has only two states. In the dual attenuator configuration, both stages have significant range so you are given separate control of the mechanical and electronic attenuator stages.

When you have the dual attenuator configuration, you may still have only a single attenuator, because unless option EA3 (the Electronic Attenuator option) is available, and you purchase it, you will have only the mechanical attenuator.

(Mech) Atten

This key is labeled Mech Atten in dual attenuator models and Atten in single attenuator models. In the dual attenuator configuration, this key only affects the mechanical attenuator.

This key lets you modify the attenuation applied to the RF input signal path. This value is normally auto coupled to the Ref Level, the Internal Preamp Gain, any External Gain that is entered, and the Max Mixer Level, as described in the table below.

See "[Attenuator Configurations and Auto/Man](#)" on page 645

Key Path	AMPTD Y Scale, Attenuation
Remote Command	<pre>[:SENSe]:POWer[:RF]:ATTenuation <rel_amp1> [:SENSe]:POWer[:RF]:ATTenuation? [:SENSe]:POWer[:RF]:ATTenuation:AUTO OFF ON 0 1 [:SENSe]:POWer[:RF]:ATTenuation:AUTO?</pre>
Example	<p>POW:ATT 20</p> <p>Dual attenuator configuration: sets the mechanical attenuator to 20 dB</p> <p>Single attenuator mode: sets the main attenuation to 20 dB (see below for definition of "main" attenuation).</p> <p>If the attenuator was in Auto, it sets it to Manual.</p>
Dependencies	Some measurements do not support the Auto setting of (Mech) Atten. In these measurements, the

Auto/Man selection is not available, and the Auto/Man line on the key disappears.

In dual attenuator configurations, when the electronic attenuator is enabled, the mechanical attenuator has no auto setting and the Auto/Man line on the key disappears. The state of Auto/Man is remembered and restored when the electronic attenuator is once again disabled. This is described in more detail in the ["Enable Elec Atten" on page 2143](#) key description.

See ["Attenuator Configurations and Auto/Man" on page 645](#) for more information on the Auto/Man functionality of Attenuation.

Couplings

When (Mech) Atten is in Auto, it uses the following algorithm to determine a value:

If the USB Preamp is connected to USB, use 0 dB.

Otherwise, $Atten = ReferenceLevel + PreAmpGain + ExternalGain - RefLevelOffset - MaxMixerLevel + IF\ Gain$.

Limit this value to be between 6 dB and the Max value. No value below 6 dB can ever be chosen by Auto.

The resulting value is rounded up to the largest value possible given the attenuation step setting. That is, 50.01 dB would change to 60 dB (for a 10 dB attenuation step).

The "IF Gain" term in the equation above is either 0 dB or +10 dB, depending on the settings of FFT IF Gain, Swept IF Gain, max Ref Level and the Auto/Man setting of Mech Atten.

In External Mixing and BBIQ, where the Attenuator is not in the signal path, the Attenuator setting changes as described above when (Mech) Atten is in Auto, but no changes are made to the actual attenuator hardware setting until the input is changed back to the RF Input.

Preset

The preset for Mech Attenuation is "Auto."

The Auto value of attenuation is:

CXA, EXA, MXA and PXA: 10 dB

State Saved

Saved in instrument state

Min

0 dB

The attenuation set by this key cannot be decreased below 6 dB with the knob or step keys. To get to a value below 6 dB it has to be directly entered from the keypad or via SCPI. This protects from adjusting the attenuation to a dangerously small value which can put the instrument at risk of damage to input circuitry. However, if the current mechanical attenuation is below 6 dB it can be increased with the knob and step keys, but not decreased.

Max

CXA N9000A-503/507: 50 dB

CXA N9000A-513/526: 70dB

EXA: 60 dB

MXA and PXA: 70 dB

In the single attenuator configuration, the total of ATT and EATT cannot exceed 50 dB, so if the EATT is set to 24 dB first, the main attenuation cannot be greater than 26 dB and will be reduced accordingly; if the main attenuator is set to 40 dB first, EATT cannot be greater than 10 dB.

Initial S/W Revision

Prior to A.02.00

Modified at S/W Revision

A.03.00

Attenuator Configurations and Auto/Man

As described in the Attenuation key description, there are two distinct attenuator configurations available in the X-Series, the single attenuator and dual attenuator configurations. In dual attenuator configurations, we have the mechanical attenuation and the electronic attenuation, and the current total attenuation is the sum of the electronic + mechanical attenuation. In single attenuator configurations, we refer to the attenuation set using the (Mech) Atten key (or POW:ATT SCPI) as the “main” attenuation; and the attenuation that is set by the SCPI command POW:EATT as the “soft” attenuation (the POW:EATT command is honored even in the single attenuator configuration, for compatibility purposes). Then the current total attenuation is the sum of the main + soft attenuation. See the Elec Atten key description for more on “soft” attenuation.

In the dual attenuator configuration, when the electronic attenuator is enabled, there is no Auto/Man functionality for the mechanical attenuator, and the third line of the key label (the Auto/Man line) disappears:

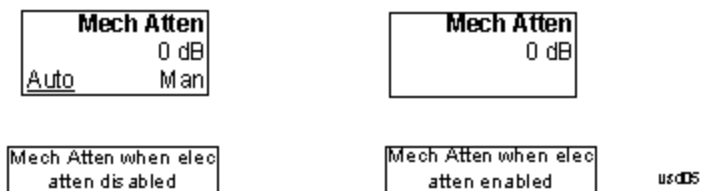

Enable Elec Atten

Enables the Electronic Attenuator.

The electronic attenuator offers finer steps than the mechanical attenuator, has no acoustical noise, is faster, and is less subject to wear. These advantages primarily aid in remote operation and are negligible for front panel use. See ["Using the Electronic Attenuator: Pros and Cons" on page 647](#) for a detailed discussion of the pros and cons of using the electronic attenuator.

For the single attenuator configuration, for SCPI backwards compatibility, the “soft” attenuation feature replaces the dual attenuator configuration’s electronic attenuator. All the same couplings and limitations apply. See ["Attenuator Configurations and Auto/Man" on page 2143](#)

See ["More Information" on page 646](#)

Key Path	AMPTD Y Scale, Attenuation
Remote Command	[:SENSe] :POWer [:RF] :EATTenuation :STATE OFF ON 0 1 [:SENSe] :POWer [:RF] :EATTenuation :STATE ?
Example	POW:EATT:STAT ON
Dependencies	This key only appears in Dual Attenuator models with an Electronic Attenuator installed. It does not appear in models with the Single Attenuator configuration, as in the single attenuator configuration there is no “electronic attenuator” there is only a single integrated attenuator (which has both a mechanical and electronic stage). However, in the single attenuator configuration, EATT SCPI commands are accepted for compatibility with other X-series instruments and set a “soft” attenuation as described in "Attenuator Configurations and Auto/Man" on page 2143 . The electronic attenuator (and the “soft” attenuation function provided in single attenuator configurations) is unavailable above 3.6 GHz. Therefore, if the Stop Frequency of the analyzer is > 3.6 GHz then the Enable Elec Atten key will be OFF and grayed out.

	<p>If the Internal Preamp is on, meaning it is set to Low Band or Full, the electronic attenuator (and the “soft” attenuation function provided in single attenuator configurations) is unavailable. In this case the Enable Elec Atten key will be OFF and grayed out.</p> <p>If either of the above is true, if the SCPI command is sent, an error indicating that the electronic attenuator is unavailable will be sent.</p> <p>If the electronic/soft Attenuator is enabled, then the Stop Freq of the analyzer is limited to 3.6 GHz and the Internal Preamp is unavailable.</p> <p>The SCPI-only “soft” electronic attenuation for the single-attenuator configuration is not available in all measurements; in particular, it is not available in the Swept SA measurement.</p>
Couplings	Enabling and disabling the Electronic Attenuator affects the setting of the Mechanical Attenuator (in dual attenuator configurations). This is described in more detail below this table.
Preset	OFF for Swept SA measurement; ON for all other measurements that support the electronic attenuator
State Saved	Saved in instrument state
Initial S/W Revision	Prior to A.02.00
Modified at S/W Revision	A.03.00

More Information

Mechanical Attenuator Transition Rules

When the Electronic Attenuator is enabled, the Mechanical Attenuator transitions to a state that has no Auto function. Below are the rules for transitioning the Mechanical Attenuator. NOTE that the information below ONLY applies to the dual attenuator configurations, and ONLY when the Electronic Attenuator is installed:

When the Electronic Attenuation is enabled from a disabled state:

- The Mechanical Attenuator is initialized to 10 dB (this is its optimal performance setting). You can then set it as desired with SCPI, numeric keypad, step keys, or knob, and it behaves as it normally would in manual mode
- The Auto/Man state of (Mech) Atten is saved
- The Auto/Man line on the (Mech) Atten key disappears and the auto rules are disabled
- The Electronic Attenuator is set to 10 dB less than the previous value of the Mechanical Attenuator, within the limitation that it must stay within the range of 0 to 24 dB of attenuation.

Examples in the dual attenuator configuration:

- Mech Atten at 20 dB. Elec Atten enabled, Mech Atten set to 10 dB, and Elec Atten set to 10 dB. New total attenuation equals the value before Elec Atten enabled.
- Mech Atten at 0 dB. Elec Atten enabled, Mech Atten set to 10 dB, and Elec Atten set to 0 dB. New total attenuation does not equal the value before Elec Atten enabled.
- Mech Atten at 40 dB. Elec Atten enabled, Mech Atten set to 10 dB, and Elec Atten set to 24 dB. New total attenuation does not equal the value before Elec Atten enabled.

When the Electronic Attenuation is disabled from an enabled state:

- The Elec Atten key is grayed out
- The Auto/Man state of (Mech) Atten is restored
- If now in Auto, (Mech) Atten recouples
- If now in Man, (Mech) Atten is set to the value of total attenuation that existed before the Elec Atten was disabled. The resulting value is rounded up to the smallest value possible given the (Mech) Atten Step setting - (That is, 57 dB changes to 58 dB when (Mech) Atten Step is 2 dB.)

Using the Electronic Attenuator: Pros and Cons

The electronic attenuator offers finer steps than the mechanical attenuator, has no acoustical noise, is faster, and is less subject to wear.

The “finer steps” advantage of the electronic attenuator is beneficial in optimizing the alignment of the analyzer dynamic range to the signal power in the front panel as well as remote use. Thus, you can achieve improved relative signal measurement accuracy. Compared to a mechanical attenuator with 2 dB steps, the 1 dB resolution of the electronic attenuator only gives better resolution when the odd-decibel steps are used. Those odd-decibel steps are less accurately calibrated than the even-decibel steps, so one tradeoff for this superior relative accuracy is reduced absolute amplitude accuracy.

Another disadvantage of the electronic attenuator is that the spectrum analyzer loses its “Auto” setting, making operation less convenient.

Also, the relationship between the dynamic range specifications (TOI, SHI, compression and noise) and instrument performance are less well-known with the electrical attenuator. With the mechanical attenuator, TOI, SHI and compression threshold levels increase dB-for-dB with increasing attenuation, and the noise floor does as well. With the electronic attenuator, there is an excess attenuation of about 1 to 3 dB between 0 and 3.6 GHz, making the effective TOI, SHI, and so forth, less well known. Excess attenuation is the actual attenuation relative to stated attenuation. Excess attenuation is accounted for in the analyzer calibration

Elec Atten

Controls the Electronic Attenuator in dual attenuator configurations. This key does not appear in single attenuator configurations, as the control of both the mechanical and electronic stages of the single attenuator is integrated into the single Atten key.

Key Path	AMPTD Y Scale, Attenuation
Remote Command	<code>[:SENSe] :POWer [:RF] :EATTenuation <rel_ampl></code> <code>[:SENSe] :POWer [:RF] :EATTenuation?</code>
Notes	Electronic Attenuation's specification is defined only when Mechanical Attenuation is 6 dB.
Dependencies	This key only appears in Dual Attenuator models with an Electronic Attenuator installed. It does not appear in models with the Single Attenuator configuration, as in the single attenuator configuration there is no “electronic attenuator” there is only a single integrated attenuator (which has both a mechanical and electronic stage). However, in the single attenuator configuration, EATT SCPI commands are accepted for compatibility with other X-series instruments and set a “soft” attenuation as described in "Attenuator Configurations and Auto/Man" on page 2143 . The “soft” attenuation is treated as an addition to the “main” attenuation value set by the Atten softkey or the

	POW:ATT SCPI command and affects the total attenuation displayed on the Attenuation key and the Meas Bar. When Enable Elec Atten is off or grayed out, the Elec Atten key is grayed out.
Preset	0 dB
State Saved	Saved in instrument state
Min	0 dB
Max	Dual attenuator configuration: 24 dB Single attenuator configuration: the total of ATT and EATT cannot exceed 50 dB, so if the EATT is set to 24 dB first, the main attenuation cannot be greater than 26 dB and will be reduced accordingly; if the main attenuator is set to 40 dB first, EATT cannot be greater than 10 dB
Initial S/W Revision	Prior to A.02.00
Modified at S/W Revision	A.03.00

Adjust Atten for Min Clip

Sets the combination of mechanical and electronic attenuation and gain based on the current measured signal level so that clipping will be at a minimum.

This is an "immediate action" function, that is, it executes once, when the key is pressed.

This key is grayed out in measurements that do not support this functionality. The spectrum analyzer measurement, Swept SA, does not support this functionality.

Key Path	AMPTD Y Scale, Attenuation
Remote Command	<code>[:SENSe] :POWer [:RF] :RANGe:OPTimize IMMEDIATE</code>
Initial S/W Revision	Prior to A.02.00
Modified at S/W Revision	A.03.00

Pre-Adjust for Min Clip

If this function is on, it does the adjustment described under ["Adjust Atten for Min Clip" on page 2146](#) each time a measurement restarts. Therefore, in Continuous measurement mode, it only executes before the first measurement.

In dual attenuator models, you can set Elec+Mech Atten, in which case both attenuators participate in the autoranging, or Elec Atten Only, in which case the mechanical attenuator does not participate in the autoranging. This latter case results in less wear on the mechanical attenuator and is usually faster.

This key is grayed out in measurements that do not support this functionality. The spectrum analyzer measurement, Swept SA, does not support this functionality.

Key Path	AMPTD Y Scale, Attenuation
Remote Command	<code>[:SENSe] :POWer [:RF] :RANGe:OPTimize:ATTenuation OFF ELECTRical COMBined</code>

	<code>[:SENSe] :POWer [:RF] :RANGe:OPTimize:ATTenuation?</code>
Notes	The SCPI parameter ELECTrical sets this function to On in single attenuator models. The SCPI parameter COMBined is mapped to ELECTrical in single attenuator models; if you send COMBined, it sets the function to On and returns ELEC to a query.
Dependencies	This key only appears in Dual Attenuator models with an Electronic Attenuator installed. In instruments with Dual Attenuator model, when Enable Elec Atten is off or grayed out, the Pre-Adjust for Min Clip key is grayed out.
Preset	OFF for Swept SA measurement; ON for all other measurements that support Pre-Adjust for Min Clip
State Saved	Saved in instrument state
Range	Dual attenuator models: Off Elec Atten Only Mech + Elec Atten Single attenuator models: Off On
Initial S/W Revision	Prior to A.02.00
Modified at S/W Revision	A.03.00

Remote Command	<code>[:SENSe] :POWer [:RF] :RANGe:AUTO ON OFF 1 0</code> <code>[:SENSe] :POWer [:RF] :RANGe:AUTO?</code>
Notes	ON aliases to "Elec Atten Only" (:POW:RANG:OPT:ATT ELEC) OFF aliases to "Off" (:POW:RANG:OPT:ATT OFF) The query :POW:RANG:AUTO? returns true if :POW:RANG:OPT:ATT is not "Off"
Initial S/W Revision	Prior to A.02.00

Off

Turns Pre-Adjust for Min Clip off. This is the default setting.

This key is grayed out in measurements that do not support this functionality. The spectrum analyzer measurement, Swept SA, does not support this functionality.

Key Path	AMPTD Y Scale, Attenuation, Pre-Adjust for Min Clip
Example	:POW:RANGe:OPT:ATT OFF
Initial S/W Revision	Prior to A.02.00

Elec Atten Only

Selects only the electric attenuator to participate in auto ranging. This offers less wear on the mechanical attenuator and is usually faster.

This key is grayed out in measurements that do not support this functionality. The spectrum analyzer measurement, Swept SA, does not support this functionality.

Key Path	AMPTD Y Scale, Attenuation, Pre-Adjust for Min Clip
Example	:POW:RANGe:OPT:ATT ELEC
Initial S/W Revision	Prior to A.02.00

Mech + Elec Atten

In dual attenuator models, this selects both attenuators participate in the autoranging.

This key is grayed out in measurements that do not support this functionality. The spectrum analyzer measurement, Swept SA, does not support this functionality.

Key Path	AMPTD Y Scale, Attenuation, Pre-Adjust for Min Clip
Example	:POW:RANGe:OPT:ATT COMB
Initial S/W Revision	Prior to A.02.00

(Mech) Atten Step

This controls the step size used when making adjustments to the input attenuation.

This key is labeled Mech Atten Step in dual attenuator models and Atten Step in single attenuator models. In the dual attenuator configuration, this key only affects the step size of the mechanical attenuator.

Key Path	AMPTD Y Scale, Attenuation
Remote Command	[[:SENSe]:POWer[:RF]:ATTenuation:STEP[:INCRement] 10 dB 2 dB [:SENSe]:POWer[:RF]:ATTenuation:STEP[:INCRement]?
Example	POW:ATT:STEP 2
Notes	Note this feature works like a 1-N choice from the front panel, but it takes a specific value (in dB) when used remotely. The only valid values are 2 and 10.
Dependencies	Blanked in CXA and EXA if option FSA (2 dB steps) is not present. If blanked, attempts to set it via SCPI will yield an error.
Couplings	When the attenuation step size changes, the current mechanical attenuation value is adjusted (if necessary) to be quantized to the new step size. That is, if step is set to 10 dB, mech atten is increased if necessary so it is a multiple of 10 dB
Preset	PXA and MXA: 2 dB EXA and CXA: 10 dB (2 dB with option FSA)
State Saved	Saved in instrument state
Initial S/W Revision	Prior to A.02.00
Modified at S/W Revision	A.03.00

Scale/Div

Sets the units-per-division of the vertical scale in the logarithmic display. However, since the Auto Scaling is defaulted to On, this value is automatically determined by the measurement result. When you set a value manually, Auto Scaling automatically changes to Off.

Key Path	AMPTD Y Scale
Mode	SA, WCDMA, C2K, WIMAX OFDMA, TD-SCDMA, 1xEVDO, DVB-T/H, DTMB (CTTB), ISDB-T, CMMB, LTE, LTE-TDD, Digital Cable TV, MSR, LTEAFDD, LTEATDD
Remote Command	:DISPlay:ACPower:VIEW[1]:WINDow[1]:TRACe:Y[:SCALe]:PDIVision <rel_ampl> :DISPlay:ACPower:VIEW[1]:WINDow[1]:TRACe:Y[:SCALe]:PDIVision?
Example	DISP:ACP:VIEW:WIND:TRAC:Y:PDIV 5 DISP:ACP:VIEW:WIND:TRAC:Y:PDIV?
Notes	You must be in the mode that includes ACP measurements to use this command. Use :INSTrument:SElect to set the mode.
Couplings	When the Auto Scaling is On, this value is automatically determined by the measurement result. When you set a value manually, Auto Scaling automatically changes to Off.
Preset	10.00 dB
State Saved	Saved in instrument state.
Min	0.10 dB
Max	20.00 dB
Initial S/W Revision	Prior to A.02.00
Modified at S/W Revision	A.02.00, A.03.00

Presel Center

When this key is pressed, the centering of the preselector filter is adjusted to optimize the amplitude accuracy at the frequency of the selected marker. If the selected marker is not on when Presel Center is pressed, the analyzer will turn on the selected marker, perform a peak search, and then perform centering on the marker's center frequency. If the selected marker is already on and between the start and stop frequencies of the analyzer, the analyzer performs the preselector calibration on that marker's frequency. If the selected marker is already on, but outside the frequency range between Start Freq and Stop Freq, the analyzer will first perform a peak search, and then perform centering on the marker's center frequency.

The value displayed on the Presel Adjust key will change to reflect the new preselector tuning (see Presel Adjust).

A number of considerations should be observed to ensure proper operation. See ["Proper Preselector Operation" on page 652](#).

Key Path	AMPTD Y Scale
Remote Command	[:SENSe]:POWer[:RF]:PCENter
Example	POW:PCEN
Notes	Note that the rules outlined above under the key description apply for the remote command as well

	as the key. The result of the command is dependent on marker position, and so forth. Any message shown by the key press is also shown in response to the remote command.
Dependencies	<ul style="list-style-type: none"> • Grayed out if the microwave preselector is off.) • If the selected marker's frequency is below Band 1, advisory message 0.5001 is generated and no action is taken. • Grayed out if entirely in Band 0. • Blank in models that do not include a preselector, such as option 503. If the SCPI is sent in these instruments, it is accepted without error, and the query always returns 0. • Grayed out in the Spectrogram View.
Couplings	<p>The active marker position determines where the centering will be attempted.</p> <p>If the analyzer is in a measurement such as averaging when centering is initiated, the act of centering the preselector will restart averaging but the first average trace will not be taken until the centering is completed.</p>
Status Bits/OPC dependencies	<p>When centering the preselector, *OPC will not return true until the process is complete and a subsequent measurement has completed, nor will results be returned to a READ or MEASURE command.</p> <p>The Measuring bit should remain set while this command is operating and should not go false until the subsequent sweep/measurement has completed.</p>
Initial S/W Revision	Prior to A.02.00
Modified at S/W Revision	A.03.00

Proper Preselector Operation

A number of considerations should be observed to ensure proper operation:

1. If the selected marker is off, the analyzer will turn on a marker, perform a peak search, and adjust the preselector using the selected marker's frequency. It uses the "highest peak" peak search method unqualified by threshold or excursion, so that there is no chance of a 'no peak found' error. It continues with that peak, even if it is the peak of just noise. Therefore, for this operation to work properly, there should be a signal on screen in a preselected range for the peak search to find.
2. If the selected marker is already on, the analyzer will attempt the centering at that marker's frequency. There is no preselector for signals below about 3.6 GHz, therefore if the marker is on a signal below 3.6 GHz, no centering will be attempted and an advisory message generated
3. In some models, the preselector can be bypassed. If it is bypassed, no centering will be attempted in that range and a message will be generated.

Preselector Adjust

Allows you to manually adjust the preselector filter frequency to optimize its response to the signal of interest. This function is only available when "[Presel Center](#)" on page 2149 is available.

For general purpose signal analysis, using Presel Center is recommended. Centering the filter minimizes the impact of long-term preselector drift. Presel Adjust can be used instead to manually optimize the

preselector. One application of manual optimization would be to peak the preselector response, which both optimizes the signal-to-noise ratio and minimizes amplitude variations due to small (short-term) preselector drifting.

Key Path	AMPTD Y Scale
Scope	Meas Global
Remote Command	<code>[:SENSe] :POWer [:RF] :PADJust <freq></code> <code>[:SENSe] :POWer [:RF] :PADJust?</code>
Example	POW:PADJ 100KHz POW:PADJ?
Notes	The value on the key reads out to 0.1 MHz resolution.
Dependencies	<ul style="list-style-type: none"> • Grayed out if microwave preselector is off.) • Grayed out if entirely in Band 0. • Blank in models that do not include a preselector, such as option 503. If the SCPI is sent in these instruments, it is accepted without error, and the query always returns 0. • Grayed out in the Spectrogram View.
Preset	0 MHz
State Saved	The Presel Adjust value set by Presel Center, or by manually adjusting Presel Adjust, is not saved in instrument state, and does not survive a Preset or power cycle.
Min	-500 MHz
Max	500 MHz
Default Unit	Hz
Backwards Compatibility SCPI	<code>[:SENSe] :POWer [:RF] :MW:PADJust</code> <code>[:SENSe] :POWer [:RF] :MMW:PADJust</code> PSA had multiple preselectors, but the X-Series has only one. These commands simply alias to <code>[:SENSe] :POWer [:RF] :PADJust</code>
Initial S/W Revision	Prior to A.02.00
Modified at S/W Revision	A.03.00

Remote Command	<code>[:SENSe] :POWer [:RF] :PADJust:PRESelector MWAVE MMWave EXternal</code> <code>[:SENSe] :POWer [:RF] :PADJust:PRESelector?</code>
Notes	PSA had multiple preselectors, and you could select which preselector to adjust. Since the X-Series has only one mm/uW preselector, the preselector selection softkey is no longer available. However, to provide backward compatibility, we accept the legacy remote commands. The command form has no effect, the query always returns MWAVE
Initial S/W Revision	Prior to A.02.00

μW Path Control

The μW Path Control functions include the μW Preselector Bypass (Option MPB) and Low Noise Path (Option LNP) controls in the High Band path circuits.

When the μW Preselector is bypassed, the user has better flatness, but will be subject to spurs from out of band interfering signals. When the Low Noise Path is enabled, the analyzer automatically switches around certain circuitry in the high frequency bands which can contribute to noise, when it is appropriate based on other analyzer settings.

For most applications, the preset state is Standard Path, which gives the best remote-control throughput, minimizes acoustic noise from switching and minimizes the risk of wear out in the hardware switches. For applications that utilize the wideband IF paths, the preset state is the μW Preselector Bypass path, if option MPB is present. This is because, when using a wideband IF such as the 140 MHz IF, the μW Preselector's bandwidth can be narrower than the available IF bandwidth, causing degraded amplitude flatness and phase linearity, so it is desirable to bypass the preselector in the default case.

Users may choose Low Noise Path Enable. It gives a lower noise floor, especially in the 21–26.5 GHz region, though without improving many measures of dynamic range, and without giving the best possible noise floor. The preamp, if purchased and used, gives better noise floor than does the Low Noise Path, however its compression threshold and third-order intercept are much poorer than that of the non-preamp Low Noise Path. There are some applications, typically for signals around –30 dBm, for which the third-order dynamic range of the standard path is good enough, but the noise floor is not low enough even with 0 dB input attenuation. When the third-order dynamic range of the preamp path is too little and the noise floor of the standard path is too high, the Low Noise Path can provide the best dynamic range.

Key Path	AMPTD Y Scale
Mode	SA, BASIC, PNOISE, VSA , LTE, LTETDD
Scope	Meas Global
Remote Command	[:SENSe] :POWer [:RF] :MW:PATH STD LNPath MPBypass FULL [:SENSe] :POWer [:RF] :MW:PATH?
Example	:POW:MW:PATH LNP Enables the Low Noise path
Notes	If a Presel Center is performed, the analyzer will momentarily switch to the Standard Path, regardless of the setting of μW Path Control The DC Block will always be switched in when the low noise path is switched in, to protect succeeding circuitry from DC. Note that this does not mean “when the low noise path is enabled” but when, based on the Low Noise Path rules, the path is actually switched in. This can happen when the selection is Low Noise Path Enable . In the case where the DC Block is switched in the analyzer is now AC coupled. However, if the user has selected DC coupling, the UI will still behave as though it were DC coupled, including all annunciation, warnings, status bits, and responses to SCPI queries. This is because, based on other settings, the analyzer could switch out the low noise path at any time and hence go back to being DC coupled. Alignment switching ignores the settings in this menu, and restores them when finished.
Dependencies	Unavailable in BBIQ and External Mixing
Preset	All modes other than IQ Analyzer mode and VXA: STD IQ Analyzer, VXA and WLAN mode: MPB option present and licensed: MPB

	MPB option not present and licensed: STD
State Saved	Save in instrument state
Readback	Value selected in the submenu
Initial S/W Revision	A.04.00
Modified at S/W Revision	A.10.00

Standard Path

This path gives the best remote-control throughput, minimizes acoustic noise from switching and minimizes the risk of wear in the hardware switches, particularly in remote test scenarios where both low band and high band setups will follow in rapid succession.

In this path, the bypass of the low band/high band switch and microwave preamp is never activated, which can cause some noise degradation but preserves the life of the bypass switch.

Key Path	AMPTD Y Scale, μ W Path Control
Example	:POW:MW:PATH STD
Readback Text	Standard Path
Initial S/W Revision	A.04.00

Low Noise Path Enable

You may choose Low Noise Path Enable, which gives a lower noise floor under some circumstances, particularly when operating in the 21–26.5 GHz region. With the Low Noise Path enabled, the low band/high band switch and microwave preamp are bypassed whenever all of the following are true:

- The analyzer is not in the Low Band, meaning:
- the start frequency is above 3.5 GHz and
- the stop frequency is above 3.6 GHz.
- the internal preamp is not installed or (if installed) is set to Off or Low Band

Note that this means that, when any part of a sweep is done in Low Band, the Low Noise Path is not used, whether or not the Low Noise Path Enable is selected in the user interface. Also, if the preamp is turned on, the Low Noise Path is not used, whether or not the Low Noise Path Enable is selected in the user interface. The only time the Low Noise Path is used is when Low Noise Path Enable is selected, the sweep is completely in High Band (> 3.6 GHz) and no preamp is in use.

See "[More Information](#)" on page 656

Key Path	AMPTD Y Scale, μ W Path Control
Measurement	Swept SA
Example	:POW:MW:PATH LNP

Notes	<p>For measurements that use IQ acquisition, the low noise path is used when the Center Frequency is in High Band (> 3.6 GHz) and no preamp is in use.</p> <p>In other words, the rules above are modified to use only the center frequency to qualify which path to switch in.</p> <p>This is not the case for FFT's in the Swept SA measurement; they use the same rules as swept measurements.</p>
Dependencies	<p>Key is blanked if current mode does not support it.</p> <p>Key is grayed out if mode supports it but current measurement does not support it.</p> <p>Unless Option LNP is present and licensed, key is blank and if SCPI command sent, error -241, "Hardware missing; Option not installed" is generated.</p>
Readback Text	Low Noise Path Enable
Initial S/W Revision	A.04.00

More Information

The user should understand that the Low Noise Path, while giving improved DANL, has the disadvantage of decreased TOI performance and decreased gain compression performance relative to the standard path.

The user should also understand that the bypass switch is a mechanical switch and has finite life, so if the Low Noise Path is enabled, it is possible to cause frequent cycling of this switch by frequently changing analyzer settings such that the above conditions hold true only some of the time. A user making tests of this nature should consider opting for the Standard Path, which will never throw the bypass switch, at the expense of some degraded noise performance.

The low noise path is useful for situations where the signal level is so low that the analyzer performance is dominated by noise even with 0 dB attenuation, but still high enough that the preamp option would have excessive third-order intermodulation or compression. The preamp, if purchased and used, gives better noise floor than does the "Low Noise Path." However, its compression threshold and third-order intercept are much poorer than that of the non-preamp path. There are some applications, typically for signals around -30 dBm, for which the third-order dynamic range of the standard path is good enough, but the noise floor is not low enough even with 0 dB input attenuation. When the third-order dynamic range of the preamp path is too little and the noise floor of the standard path is too high, the Low Noise Path can provide the best dynamic range

The graph below illustrates the concept. It shows, in red, the performance of an analyzer at different attenuation settings, both with the preamp on and off, in a measurement that is affected by both analyzer noise and analyzer TOI. The green shows the best available dynamic range, offset by 0.5 dB for clarity. The blue shows how the best available dynamic range improves for moderate signal levels with the low noise path switched in. In this illustration, the preamp improves the noise floor by 15 dB while degrading the third-order intercept by 30 dB, and the low noise path reduces loss by 8 dB. The attenuator step size is 2 dB.

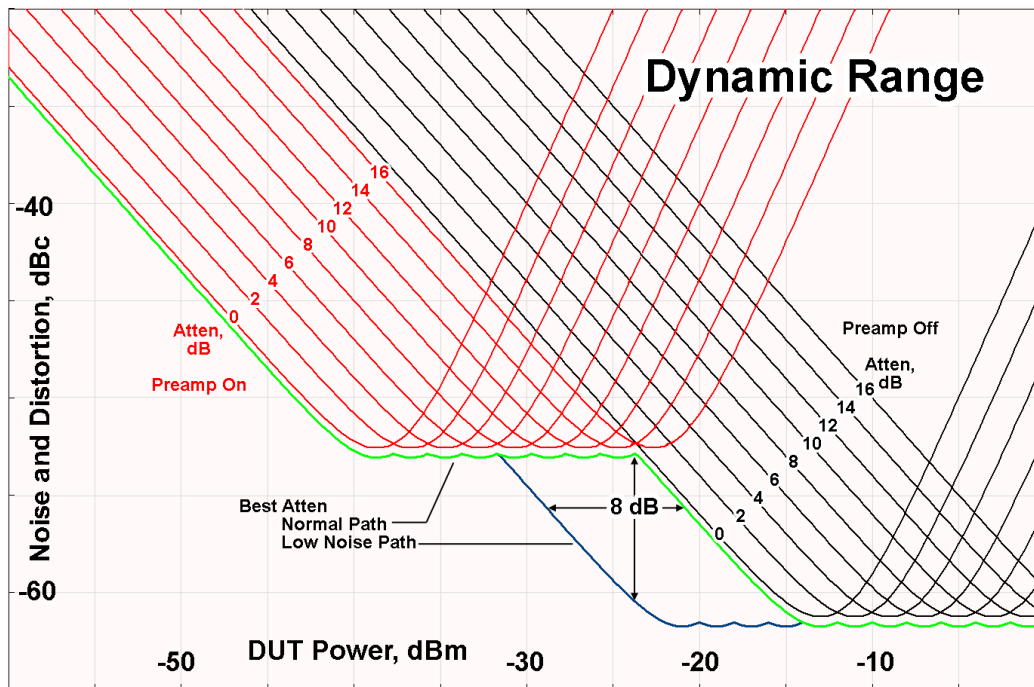

There are other times where selecting the low noise path improves performance, too. Compression-limited measurements such as finding the nulls in a pulsed-RF spectrum can profit from the low noise path in a way similar to the TOI-limited measurement illustrated. Accuracy can be improved when the low noise path allows the optimum attenuation to increase from a small amount like 0, 2 or 4 dB to a larger amount, giving better return loss at the analyzer input. Harmonic measurements, such as second and third harmonic levels, are much improved using the low noise path because of the superiority of that path for harmonic (though not intermodulation) distortion performance.

μ W Preselector Bypass

This key toggles the preselector bypass switch for band 1 and higher. When the microwave preselector is on, the signal path is preselected. When the microwave preselector is off, the signal path is not preselected. The preselected path is the normal path for the analyzer.

The preselector is a tunable bandpass filter which prevents signals away from the frequency of interest from combining in the mixer to generate in-band spurious signals (images). The consequences of using a preselector filter are its limited bandwidth, the amplitude and phase ripple in its passband, and any amplitude and phase instability due to center frequency drift.

Option MPB or pre-selector bypass provides an unpreselected input mixer path for certain X-Series signal analyzers with frequency ranges above 3.6 GHz. This signal path allows a wider bandwidth and less amplitude variability, which is an advantage when doing modulation analysis and broadband signal analysis. The disadvantage is that, without the preselector, image signals will be displayed. Another disadvantage of bypassing the preselector is increased LO emission levels at the front panel input port.

Image responses are separated from the real signal by twice the 1st IF. For IF Paths of 10 MHz and 25 MHz, the 1st IF is 322.5 MHz, so the image response and the real signal will be separated by 645 MHz. The 1st IF will be different for other IF Path settings. When viewing a real signal and its corresponding image response in internal mixing, the image response will be to the left of the real signal.

Also, the image response and the real signal typically have the same amplitude and exhibit the same shape factor.

However, if Option FS1, Fast Sweep Capability, is enabled, the image response in the Swept SA measurement will appear lower in amplitude and have a much wider shape factor compared to the real signal.

Key Path	AMPTD Y Scale, μ W Path Control
Example	:POW:MW:PATH MPB
Dependencies	Key is blanked if current mode does not support it. Key is grayed out if mode supports it but current measurement does not support it. Key is blank unless Option MPB is present and licensed. If SCPI command sent when MPB not present, error -241, "Hardware missing; Option not installed" is generated.
Readback Text	μ W Preselector Bypass
Initial S/W Revision	A.04.00

Remote Command	[:SENSe] :POWer [:RF] :MW:PRESelector [:STATe] ON OFF 0 1 [:SENSe] :POWer [:RF] :MW:PRESelector [:STATe] ?
Example	:POW:MW:PRES OFF Bypasses the microwave preselector
Notes	The ON parameter sets the STD path (:POW:MW:PATH STD) The OFF parameter sets path MPB (:POW:MW:PATH MPB)
Preset	ON

Internal Preamp

Accesses a menu of keys that control the internal preamps. Turning on the preamp gives a better noise figure, but a poorer TOI to noise floor dynamic range. You can optimize this setting for your particular measurement.

The instrument takes the preamp gain into account as it sweeps. If you sweep outside of the range of the preamp the instrument will also account for that. The displayed result will always reflect the correct gain.

For some measurements, when the preamp is on and any part of the displayed frequency range is below the lowest frequency for which the preamp has specifications, a warning condition message appears in the status line. For example, for a preamp with a 9 kHz lowest specified frequency: "Preamp: Accy unspec'd below 9 kHz".

Key Path	AMPTD Y Scale
Scope	Meas Global
Remote Command	[:SENSe] :POWer [:RF] :GAIN [:STATe] OFF ON 0 1 [:SENSe] :POWer [:RF] :GAIN [:STATe] ?
Dependencies	Preamp is not available on all hardware platforms. If the preamp is not present or is unlicensed, the

key is not shown.
The preamp is not available when the electronic/soft attenuator is enabled.

Couplings	<p>The act of connecting the U7227A USB Preamplifier to one of the analyzer's USB ports will cause the Internal Preamp to be switched on. When this happens an informational message will be generated: "Internal Preamp turned on for optimal operation with USB Preamp." Note that if the Internal Preamp was already on, there will be no change to the setting, but if it was Off it will be switched On, to Full Range.</p> <p>Note that this same action occurs when the SA mode is selected while the USB Preamp is connected to one of the analyzer's USB ports, if it is the first time that the SA mode has run since powerup, or if the last time the SA mode was running the USB Preamp was NOT connected.</p> <p>Subsequently disconnecting the USB Preamp from USB does not change the Internal Preamp setting nor restore the previous setting.</p>
Preset	OFF
State Saved	Saved in instrument state
Initial S/W Revision	Prior to A.02.00
Modified at S/W Revision	A.14.00

Key Path	AMPTD Y Scale, Internal Preamp
Scope	Meas Global
Remote Command	<pre>[:SENSe] :POWer [:RF] :GAIN: BAND LOW FULL [:SENSe] :POWer [:RF] :GAIN: BAND?</pre>
Dependencies	<p>Preamp is not available on all hardware platforms. If the preamp is not present or is unlicensed, the key is not shown.</p> <p>If a POW:GAIN: BAND FULL command is sent when a low band preamp is available, the preamp band parameter is to LOW instead of FULL, and an "Option not installed" message is generated.</p>
Preset	LOW
State Saved	Saved in instrument state
Initial S/W Revision	Prior to A.02.00

Off

Turns the internal preamp off

Key Path	AMPTD Y Scale, Internal Preamp
Example	:POW:GAIN OFF
Readback	Off
Initial S/W Revision	Prior to A.02.00

Low Band

Sets the internal preamp to use only the low band.

The frequency range of the installed (optional) low-band preamp is displayed in square brackets on the Low Band key label.

Key Path	AMPTD Y Scale, Internal Preamp
Example	:POW:GAIN ON :POW:GAIN:BAND LOW
Readback	Low Band
Initial S/W Revision	Prior to A.02.00

Full Range

Sets the internal preamp to use its full range. The low band (0–3.6 GHz or 0–3GHz, depending on the model) is supplied by the low band preamp and the frequencies above low band are supplied by the high band preamp.

The frequency range of the installed (optional) preamp is displayed in square brackets on the Full Range key label. If the high band option is not installed the Full Range key does not appear.

Key Path	AMPTD Y Scale, Internal Preamp
Example	:POW:GAIN ON :POW:GAIN:BAND FULL
Readback	Full Range
Initial S/W Revision	Prior to A.02.00

Ref Position

Positions the reference level at the top, center, or bottom of the Y- scale display. Changing the reference position does not change the reference level value.

Key Path	AMPTD Y Scale
Mode	SA, WCDMA, C2K, WIMAX OFDMA, TD-SCDMA, 1xEVDO, DVB-T/H, DTMB (CTTB), ISDB-T, CMMB, LTE, LTETDD, Digital Cable TV, MSR, LTEAFDD,LTEATDD
Remote Command	:DISPlay:ACP:Power:VIEW[1]:WINDow[1]:TRACe:Y[:SCALe]:RPOSition TOP CENTer BOTTom :DISPlay:ACP:Power:VIEW[1]:WINDow[1]:TRACe:Y[:SCALe]:RPOSition?
Example	DISP:ACP:VIEW:WIND:TRAC:Y:RPOS CENT DISP:ACP:VIEW:WIND:TRAC:Y:RPOS?
Notes	You must be in the mode that includes ACP measurements to use this command. Use :INSTRument:SElect to set the mode.
Preset	TOP

State Saved	Saved in instrument state.
Range	Top Ctr Bot
Initial S/W Revision	Prior to A.02.00
Modified at S/W Revision	A.02.00, A.03.00

Auto Scaling

Toggles the Auto Scaling function between On and Off.

Key Path	AMPTD Y Scale
Mode	SA, WCDMA, C2K, WIMAX OFDMA, TD-SCDMA, 1xEVDO, DVB-T/H, DTMB (CTTB), ISDB-T, CMMB, LTE, LTE-TDD, Digital Cable TV, MSR, LTEAFDD, LTEATDD
Remote Command	:DISPlay:ACPower:VIEW[1]:WINDow[1]:TRACe:Y[:SCALe]:COUPLe 0 1 OFF ON :DISPlay:ACPower:VIEW[1]:WINDow[1]:TRACe:Y[:SCALe]:COUPLe?
Example	DISP:ACP:VIEW:WIND:TRAC:Y:COUP ON DISP:ACP:VIEW:WIND:TRAC:Y:COUP?
Notes	You must be in the mode that includes ACP measurements to use this command. Use :INSTrument:SElect to set the mode.
Couplings	When Auto Scaling is On and the Restart front-panel key is pressed, this function automatically determines the scale per division and reference values based on the measurement results. When you set a value to either Scale/Div or Ref Value manually, Auto Scaling automatically changes to Off.
Preset	ON
State Saved	Saved in instrument state.
Range	On Off
Initial S/W Revision	Prior to A.02.00
Modified at S/W Revision	A.02.00, A.03.00

Auto Couple

The Auto Couple feature provides a quick and convenient way to automatically couple multiple instrument settings. This helps ensure accurate measurements and optimum dynamic range. When the Auto Couple feature is activated, either from the front panel or remotely, all parameters of the current measurement that have an Auto/Manual mode are set to Auto mode and all measurement settings dependent on (or coupled to) the Auto/Man parameters are automatically adjusted for optimal performance.

However, the Auto Couple key actions are confined to the current measurement only. It does not affect other measurements in the mode, and it does not affect markers, marker functions, or trace or display attributes.

See ["More Information" on page 662](#)

Key Path	Front-panel key
Remote Command	:COUPLe ALL NONE
Example	:COUP ALL
Notes	:COUPLe ALL puts all Auto/Man parameters in Auto mode (equivalent to pressing the Auto Couple key). :COUPLE NONE puts all Auto/Man parameters in manual mode. It decouples all the coupled instrument parameters and is not recommended for making measurements.
Initial S/W Revision	Prior to A.02.00

More Information

There are two types of functions that have Auto/Manual modes.

Auto/Man Active Function keys

An Auto/Man toggle key controls the binary state associated with an instrument parameter by toggling between Auto (where the parameter is automatically coupled to the other parameters it is dependent upon) and Man (where the parameter is controlled independent of the other parameters), as well as making the parameter the active function. The current mode is indicated on the softkey with either Auto or Man underlined as illustrated below.

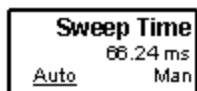

usd07

Auto/Man 1-of-N keys

An Auto/Man 1-of-N key allows you to manually pick from a list of parameter values, or place the function in Auto, in which case the value is automatically selected (and indicated) as shown below. If in Auto, Auto is underlined on the calling key. If in manual operation, manual is indicated on the calling key. But the calling key does not actually toggle the function, it simply opens the menu.

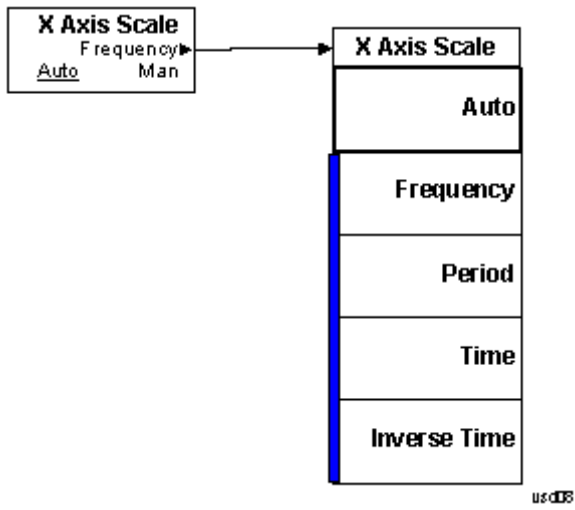

BW

Accesses a menu of functions that enable you to specify and control the video and resolution bandwidths. You can also select the type of filter for the measurement and set the filter bandwidth.

Key Path	Front-panel key
Initial S/W Revision	Prior to A.02.00

Res BW

Sets the value of the resolution bandwidth. If an unavailable bandwidth is entered with the numeric keypad, the closest available bandwidth is selected.

LTE-Advanced FDD/TDD Auto RBW:

Bandwidth	RBW (KHz)
1.4MHz	51KHz
3MHz	
5MHz	100 KHz
10MHz	
15MHz	
20MHz	

the resolution bandwidth is predefined based on the corresponding bandwidth of the single LTE carrier, which is listed above. When ResBW mode is Auto, the narrowest RBW over the active carriers is selected for Multi-carriers.

Key Path	BW
Mode	SA, WCDMA, C2K, WIMAX OFDMA, TD-SCDMA, 1xEVDO, DVB-T/H, DTMB (CTTB), ISDB-T, CMMB, LTE, LTE-TDD, Digital Cable TV, MSR, LTEAFDD, LTEATDD
Remote Command	[:SENSe]:ACPower:BANDwidth[:RESolution] <freq> [:SENSe]:ACPower:BANDwidth[:RESolution]? [:SENSe]:ACPower:BANDwidth[:RESolution]:AUTO ON OFF 1 0 [:SENSe]:ACPower:BANDwidth[:RESolution]:AUTO?
Example	ACP:BAND 25kHz ACP:BAND? ACP:BAND:AUTO ON ACP:BAND:AUTO?
Notes	This key is available only in IBW mode. This parameter is preset by the Meas Method selection. Preset values are as follows: IBW: 100 kHz

	IBWR: 27 kHz FAST (WCDMA): 390 kHz You must be in the mode that includes ACP measurements to use this command. Use :INSTrument:SElect to set the mode.
Dependencies	When Meas Method is RBW or FAST, this key is grayed out and disabled. If the key is pressed, an advisory message is generated. If the equivalent remote command is sent, a "Setting conflict" warning is generated.
Couplings	The resolution bandwidth is coupled to the video bandwidth based on the video to resolution bandwidth ratio setting if AUTO is selected.
Preset	SA: 220 kHz WCDMA: 100 kHz WIMAX OFDMA: 100 kHz C2K: 15 kHz TD-SCDMA: 30 kHz 1xEVDO: 30 kHz DVB-T/H: 39 kHz DTMB (CTTB): 39 kHz ISDB-T: 39 kHz CMMB: 39 kHz LTE: 100 kHz LTETDD: 100 kHz Digital Cable TV: 39 kHz MSR: 100 kHz LTEAFDD, LTEATDD: 100kHz LTEAFDD, LTEATDD: 1 Others:0
State Saved	Saved in instrument state.
Min	1 Hz
Max	8 MHz
Backwards Compatibility SCPI	[:SENSe] :ACPpower:BWIDth[:RESolution] [:SENSe] :ACP:SWEep:BWIDth BWIDth[:RESolution] (PSA W-CDMA, PSA cdma2000)
Initial S/W Revision	Prior to A.02.00
Modified at S/W Revision	A.02.00, A.03.00

Video BW

Changes the analyzer post-detection filter (VBW).

Key Path	BW
Mode	SA, WCDMA, C2K, WIMAX OFDMA, TD-SCDMA, 1xEVDO, DVB-T/H, DTMB (CTTB), ISDB-T, CMMB,

	LTE, LTETDD, Digital Cable TV, MSR, LTEAFDD, LTEATDD
Remote Command	[:SENSe]:ACPower:BANDwidth:VIDeo <freq> [:SENSe]:ACPower:BANDwidth:VIDeo? [:SENSe]:ACPower:BANDwidth:VIDeo:AUTO OFF ON 0 1 [:SENSe]:ACPower:BANDwidth:VIDeo:AUTO?
Example	ACP:BAND:VID 1kHz ACP:BAND:VID? ACP:BWID:VID:AUTO ON ACP:BWID:VID:AUTO?
Notes	The values shown in this table reflect the conditions after a Mode Preset.
Dependencies	When Meas Method is RBW or FAST, this key is grayed out and disabled. If the key is pressed, an advisory message is generated. If the equivalent remote command is sent, a "Setting conflict" warning is generated.
Preset	SA: 22 kHz WCDMA, WIMAX OFDMA: 1 MHz C2K: Method RBW: grayed out (1.2 MHz) Method IBW: 150 kHz TD-SCDMA: 300 kHz 1xEVDO: 300 kHz DVB-T/H: 390 kHz DTMB (CTTB): 390 kHz ISDB-T: 390 kHz CMMB: 390 kHz LTE, LTETDD, MSR: Auto LTETDD: 1 MHz Digital Cable TV: 390 kHz LTEAFDD, LTEATDD: Auto SA: ON WCDMA: OFF WIMAX OFDMA: OFF TD-SCDMA: OFF DVB-T/H: OFF DTMB (CTTB): OFF CDMA1xEVDO: OFF ISDB-T: OFF CMMB: OFF LTE, MSR: ON LTETDD: ON Digital Cable TV: OFF

	LTEAFDD, LTEATDD: ON
State Saved	Saved in instrument state.
Min	1 Hz
Max	50 MHz
Backwards Compatibility SCPI	[:SENSe] :ACPower :BWIDth :VIDeo
Initial S/W Revision	Prior to A.02.00
Modified at S/W Revision	A.02.00, A.03.00

RBW Control

Accesses a menu that enables you to select the filter bandwidth and type.

Key Path	BW
Initial S/W Revision	Prior to A.02.00

Filter Type

Selects the type of bandwidth filter that is used. The choices are Gaussian or Flat top.

Key Path	BW, RBW Control
Mode	SA, WCDMA, C2K, WIMAX OFDMA, TD-SCDMA, 1xEVDO, DVB-T/H, DTMB (CTTB), ISDB-T, CMMB, LTE, LTE-TDD, Digital Cable TV, MSR, LTEAFDD, LTEATDD
Remote Command	[:SENSe] :ACPower :BANDwidth :SHAPE GAUSSian FLATtop [:SENSe] :ACPower :BANDwidth :SHAPE?
Example	ACP:BAND:SHAP GAUS ACP:BAND:SHAP?
Dependencies	When Meas Method is FAST, this key is grayed out and disabled. If the key is pressed, an advisory message is generated. If the equivalent remote command is sent, a "Setting conflict" warning is generated.
Preset	GAUSSian C2K: FLATtop
State Saved	Saved in instrument state.
Range	Gaussian (Normal) Flattop
Backwards Compatibility SCPI	[:SENSe] :ACPower :BWIDth :SHAPE
Initial S/W Revision	Prior to A.02.00
Modified at S/W Revision	A.02.00, A.03.00

Filter BW

Selects a Gaussian filter based on its -3 dB (Normal) bandwidth or its -6 dB bandwidth.

Key Path	BW, RBW Control
Mode	SA, WCDMA, C2K, WIMAX OFDMA, TD-SCDMA, 1xEVDO, DVB-T/H, DTMB (CTTB), ISDB-T, CMMB, LTE, LTE-TDD, Digital Cable TV, MSR, LTEAFDD, LTEATDD
Remote Command	<code>[:SENSe] :ACPower :BANDwidth :TYPE DB3 DB6</code> <code>[:SENSe] :ACPower :BANDwidth :TYPE ?</code>
Example	ACP:BAND:TYPE DB3 ACP:BAND:TYPE?
Dependencies	When Filter Type is Flattop or Meas Method is RBW or FAST, this key is grayed out and disabled. If the key is pressed, an advisory message is generated. If the equivalent remote command is sent, a "Setting conflict" warning is generated.
Preset	DB3
State Saved	Saved in instrument state.
Range	-3 dB (Normal) -6 dB
Backwards Compatibility SCPI	<code>[:SENSe] :ACPower :BWIDth :TYPE</code>
Initial S/W Revision	Prior to A.02.00
Modified at S/W Revision	A.02.00, A.03.00

Cont (Continuous Measurement/Sweep)

Sets the analyzer for Continuous measurement operation. The single/continuous state is Meas Global so the setting will affect all measurements. If you are Paused, pressing Cont does a Resume.

Key Path	Front-panel key
Remote Command	:INITiate:CONTinuous OFF ON 0 1 :INITiate:CONTinuous?
Example	:INIT:CONT 0 puts analyzer in Single measurement operation. :INIT:CONT 1 puts analyzer in Continuous measurement operation
Preset	ON (Note that SYST:PRESet sets INIT:CONT to ON but *RST sets INIT:CONT to OFF)
State Saved	Saved in instrument state
Backwards Compatibility Notes	For Spectrum Analysis mode in ESA and PSA, there is no Cont hardkey, instead there is a Sweep Single/Cont key. In these analyzers, switching the Sweep Single/Cont key from Single to Cont restarts averages (displayed average count reset to 1), but does not restart Max Hold and Min Hold. The X-Series has Single and Cont keys in place of the SweepSingleCont key. In the X-Series, if in single measurement, the Cont key (and INIT:CONT ON) switches to continuous measurement, but never restarts a measurement and never resets a sweep.
Initial S/W Revision	Prior to A.02.00

In Swept SA Measurement (Spectrum Analysis Mode):

The analyzer takes repetitive sweeps, averages, measurements, etc., when in Continuous mode. When the average count reaches the Average/Hold Number the count stops incrementing, but the analyzer keeps sweeping. See the Trace/Detector section for the averaging formula used both before and after the Average/Hold Number is reached. The trigger condition must be met prior to each sweep. The type of trace processing for multiple sweeps, is set under the Trace/Detector key, with choices of Trace Average, Max Hold, or Min Hold.

In Other Measurements/Modes:

With Avg/Hold Num (in the Meas Setup menu) set to Off or set to On with a value of 1, a sweep is taken after the trigger condition is met; and the analyzer continues to take new sweeps after the current sweep has completed and the trigger condition is again met. However, with Avg/Hold Num set to On with a value >1, multiple sweeps (data acquisitions) are taken for the measurement. The trigger condition must be met prior to each sweep. The sweep is not stopped when the average count k equals the number N set for Avg/Hold Num is reached, but the number k stops incrementing. A measurement average usually applies to all traces, marker results, and numeric results. But sometimes it only applies to the numeric results.

If the analyzer is in Single measurement, pressing the Cont key does not change k and does not cause the sweep to be reset; the only action is to put the analyzer into Continuous measurement operation.

If it is already in continuous sweep:

the INIT:CONT 1 command has no effect

9 ACP Measurement
Cont (Continuous Measurement/Sweep)

the INIT:CONT 0 command will place the analyzer in Single Sweep but will have no effect on the current sequence until $k = N$, at which point the current sequence will stop and the instrument will go to the idle state.

File

See "File" on page 336

FREQ Channel

Accesses a menu of keys that allow you to control the Frequency and Channel parameters of the instrument.

Some features in the Frequency menu are the same for all measurements – they do not change as you change measurements. Settings like these are called “Meas Global” and are unaffected by Meas Preset. For example, the Center Freq setting is the same for all measurements - it does not change as you change measurements.

Key Path	Front-panel key
Initial S/W Revision	Prior to A.02.00

Center Freq

Sets the frequency that corresponds to the horizontal center of the graticule (when frequency Scale Type is set to linear). While adjusting the Center Frequency the Span is held constant, which means that both Start Frequency and Stop Frequency will change.

Pressing Center Freq also sets the frequency entry mode to Center/Span. In Center/Span mode, the center frequency and span values are displayed below the graticule, and the default active function in the Frequency menu is Center Freq.

The center frequency setting is the same for all measurements within a mode, that is, it is Meas Global. Some modes are also able to share a Mode Global center frequency value. If this is the case, the Mode will have a Global Settings key in its Mode Setup menu.

The Center Freq function sets (and queries) the Center Frequency for the currently selected input. If your analyzer has multiple inputs, and you select another input, the Center Freq changes to the value for that input. SCPI commands are available to directly set the Center Freq for a specific input.

Center Freq is remembered as you go from input to input. Thus you can set a Center Freq of 10 GHz with the RF Input selected, change to BBIQ and set a Center Freq of 20 MHz, then switch to External Mixing and set a Center Freq of 60 GHz, and when you go back to the RF Input the Center Freq will go back to 10 GHz; back to BBIQ and it is 20 MHz; back to External Mixing and it is 60 GHz.

See ["RF Center Freq" on page 675](#)

See [Ext Mix Center Freq](#)

See ["I/Q Center Freq" on page 677](#)

See ["Center Frequency Presets" on page 673](#)

Key Path	FREQ Channel
Scope	Meas Global
Remote Command	<code>[:SENSe] :FREQuency:CENTer <freq></code> <code>[:SENSe] :FREQuency:CENTer?</code>

Example	<p>FREQ:CENT 50 MHz</p> <p>FREQ:CENT UP changes the center frequency to 150 MHz if you use FREQ:CENT:STEP 100 MHz to set the center frequency step size to 100 MHz</p> <p>FREQ:CENT?</p>
Notes	<p>This command sets either the RF or I/Q Center Frequency depending on the selected input.</p> <p>For RF input it is equivalent to FREQ:RF:CENT</p> <p>For I/Q input it is equivalent to FREQ:IQ:CENT</p> <p>Preset and Max values are dependent on Hardware Options (5xx)</p> <p>If no terminator (e.g. MHz) is sent the terminator Hz is used. If a terminator with unit other than Frequency is used, an invalid suffix error message is generated.</p>
Dependencies	<p>The Center Frequency can be limited by Start or Stop Freq limits, if the Span is so large that Start or Stop reach their limit.</p>
Couplings	<p>When operating in “swept span”, any value of the Center Frequency or Span that is within the frequency range of the analyzer is allowed when the value is being set through the front panel numeric key pad or the SCPI command. The other parameter is forced to a different value if needed, to keep the Start and the Stop Frequencies within the analyzer’s frequency range</p>
Preset	<p>Depends on instrument maximum frequency, mode, measurement, and selected input.</p> <p>See "Center Frequency Presets" on page 673 and "RF Center Freq" on page 675 and Ext Mix Center Freq and "I/Q Center Freq" on page 677.</p>
State Saved	<p>Saved in instrument state</p>
Min	<p>Depends on instrument maximum frequency, mode, measurement, and selected input..</p> <p>See "Center Frequency Presets" on page 673 and "RF Center Freq" on page 675 and "I/Q Center Freq" on page 677.</p>
Max	<p>Depends on instrument maximum frequency, mode, measurement, and selected input..</p> <p>See "Center Frequency Presets" on page 673 and "RF Center Freq" on page 675 and "I/Q Center Freq" on page 677.</p>
Default Unit	<p>Hz</p>
Status Bits/OPC	<p>Non-overlapped</p>
Dependencies	
Initial S/W Revision	<p>Prior to A.02.00</p>

Center Frequency Presets

The following table provides the Center Frequency Presets for the Spectrum Analyzer mode, and the Max Freq, for the various frequency options:

Freq Option	CF after Mode Preset	Stop Freq after Mode Preset	Max Freq (can't tune)

9 ACP Measurement
FREQ Channel

			above)
503 (all but N9000A)	1.805 GHz	3.6 GHz	3.7 GHz
503 (N9000A)	1.505 GHz	3.0 GHz	3.08 GHz
507 (all but N9000A)	3.505 GHz	7.0 GHz	7.1 GHz
507 (N9000A)	3.755 GHz	7.5 GHz	7.58 GHz
508 (all but N9038A)	1.805 GHz	3.6 GHz	8.5 GHz
508 (N9038A)	4.205 GHz	8.4 GHz	8.5 GHz
513	6.805 GHz	13.6 GHz	13.8 GHz
526 (all but N9000A and N9038A)	13.255 GHz	26.5 GHz	27.0 GHz
526 (N9000A)	13.255 GHz	26.5 GHz	26.55 GHz
526 (N9038A)	1.805 GHz	3.6 GHz	27.0 GHz
532	16.005 GHz	32.0 GHz	32.5 GHz
543	21.505 GHz	43.0 GHz	TBD
544	22.005 GHz	44.0 GHz	44.5 GHz
550	25.005 GHz	50.0 GHz	51 GHz

Input 2:

Model	CF after Mode Preset	Stop Freq after Mode Preset	Max Freq (can't tune above)
N9000A opt C75	0.7505GHz	1.5 GHz	1.58 GHz
N9038A	505 MHz	1 GHz	1.000025 GHz

Tracking Generator Frequency Limits (N9000A only):

Tracking Generator Option	Min Freq (clips to this freq when turn TG on and	If above this Freq, Stop Freq clipped to this Freq when	Max Freq (can't tune above) while TG

	can't tune below while TG on)	TG turned on	on
T03	9 kHz	3.0 GHz	3.08 GHz
T06	9 kHz	6.0 GHz	6.05 GHz

The following table shows the Center Frequency Presets for modes other than Spectrum Analyzer:

Mode	CF Preset for RF
WCDMA	1 GHz
WIMAXOFDMA,	1 GHz
BASIC	1 GHz
ADEMOD	1 GHz
VSA	1 GHz
TDSCDMA	1 GHz
PNOISE	1 GHz
LTE	1 GHz
LTETDD	1 GHz
MSR	1 GHz
GSM	935.2 MHz
NFIGURE	1.505 GHz

RF Center Freq

SCPI command for specifying the RF Center Frequency. This command will set the Center Frequency to be used when the RF input is selected, even if the RF input is not the input that is selected at the time the command is sent. Note that the Center Freq function in the Frequency menu on the front panel always applies to the currently selected input.

Scope	Meas Global
Remote Command	<code>[:SENSe] :FREQuency:RF:CENTer <freq></code> <code>[:SENSe] :FREQuency:RF:CENTer?</code>
Example	FREQ:RF:CENT 30 MHz
Notes	This command is the same in all modes, but the parameter is Measurement Global. So the value is independent in each mode and common across all the measurements in the mode.
Dependencies	If the electronic/soft attenuator is enabled, any attempt to set Center Frequency such that the Stop Frequency would be >3.6 GHz fails and results in an advisory message. If the equivalent SCPI command is sent, this same message is generated as part of a “-221, Settings conflict” warning. If Source Mode is set to Tracking, and the Max or Min Center Freq is therefore limited by the limits of the source, a warning message is generated, “Data out of range;clipped to source max/min” if these limits are exceeded. Note that for an external source, these limits can be affected by the settings of

	Source Numerator, Source Denominator and Power Sweep.
Preset	See table above
State Saved	Saved in instrument state.
Min	-79.999995 MHz, unless Source Mode is set to Tracking, in which case it is limited by the minimum frequency of the Source
Max	See table above. Basically instrument maximum frequency – 5 Hz. Note that, if the Source Mode is set to Tracking, the effective instrument maximum frequency may be limited by the source maximum frequency. If the knob or step keys are being used, also depends on the value of the other three interdependent parameters Span, Start Frequency and Stop Frequency
Initial S/W Revision	Prior to A.02.00
Modified at S/W Revision	A.03.00

Ext Mix Center Freq

SCPI command for specifying the External Mixer Center Frequency. This command will set the Center Frequency to be used when the External Mixer is selected, even if the External Mixer input is not the input which is selected at the time the command is sent. Note that the Center Freq function in the Frequency menu on the front panel always applies to the currently selected input.

Scope	Meas Global
Remote Command	<code>[:SENSe] :FREQuency:EMIXer:CENTer <freq></code> <code>[:SENSe] :FREQuency:EMIXer:CENTer?</code>
Example	<code>:FREQ:EMIX:CENt 60 GHz</code> <code>:FREQ:EMIX:CENt?</code>
Notes	This command is the same in all modes, but the parameter is Measurement Global. So the value is independent in each mode and common across all the measurements in the mode.
Couplings	When returning to External Mixing after having been switched to one of the other inputs (e.g., RF), you will come back into the settings that you had when you left External Mixing. So you will come back to the band you were in with the Center Frequency that you had. However, Span is not an input-dependent parameter, therefore you will bring the span over from the other input. Therefore, the analyzer comes back with the span from the previous input, limited as necessary by the current mixer setup.
Preset	When a Mode Preset is performed while in External Mixing, the Start frequency of the current Mode is set to the nominal Min Freq of the lowest harmonic range in the Harmonic Table for the current mixer setup. Similarly, the Stop frequency of the current Mode is set to the nominal Max Freq of the highest harmonic range in the Harmonic Table. The Center Freq thus presets to the point arithmetically equidistant from these two frequencies. If the current measurement has a limited Span available to it, and cannot achieve the Span shown in the table (Span=Stop Freq – Start Freq), the analyzer uses the maximum Span the measurement allows, and still sets the Center Freq to the midpoint of the Start and Stop Freq values in the Harmonic Table.

	When Restore Input/Output Defaults is performed, the mixer presets to the 11970A, whose Start and Stop frequencies are 26.5 and 40 GHz respectively. The center of these two frequencies is 33.25 GHz. Therefore, after a Restore Input/Output Defaults, if you go into External Mixing and do a Mode Preset while in the Spectrum Analyzer Mode, the resulting Center Freq is 33.25 GHz.
State Saved	Saved in instrument state.
Min	The minimum frequency in the currently selected mixer band + 5 Hz
Max	The maximum frequency in the currently selected mixer band – 5 Hz If the knob or step keys are being used, also depends on the value of the other three interdependent parameters Span, Start Frequency and Stop Frequency
Initial S/W Revision	A.08.01

I/Q Center Freq

SCPI command for specifying the I/Q Center Frequency. This command will set the Center Frequency to be used when the I/Q input is selected, even if the I/Q input is not the input which is selected at the time the command is sent. Note that the Center Freq function in the Frequency menu on the front panel always applies to the currently selected input.

Scope	Meas Global
Remote Command	[:SENSe] :FREQuency:IQ:CENTer <freq> [:SENSe] :FREQuency:IQ:CENTer?
Example	FREQ:IQ:CENT: 30 MHz
Notes	This command is the same in all modes, but the parameter is Measurement Global. So the value is independent in each mode and common across all the measurements in the mode.
Preset	0 Hz
State Saved	Saved in instrument state.
Min	-40.049995 MHz
Max	40.049995 MHz
Initial S/W Revision	Prior to A.02.00

Input/Output

See "[Input/Output](#)" on page 196

Marker

Accesses a menu that enables you to select, set up and control the markers for the current measurement. Note that this hard key and all sub keys are unavailable when "Meas Method" on page 731 is set to RBW.

Key Path	Front-panel key
Initial S/W Revision	Prior to A.02.00

Select Marker

Displays 12 markers available for selection. Note that this key is unavailable when "Meas Method" on page 731 is set to RBW.

Key Path	Marker
Initial S/W Revision	Prior to A.02.00

Marker Type

Sets the marker control mode to Normal, Delta, Fixed or Off. All interactions and dependencies detailed under the key description are enforced when the remote command is sent. If the selected marker is Off, pressing Marker sets it to Normal and places it at the center of the screen on the trace determined by the Marker Trace rules. At the same time, Marker X Axis Value appears on the Active Function area.

The default active function is the active function for the currently selected marker control mode. If the current control mode is Off, there is no active function and the active function is turned off.

Key Path	Marker
Mode	SA, WCDMA, C2K, WIMAX OFDMA, TD-SCDMA, 1xEVDO, DVB-T/H, DTMB (CTTB), ISDB-T, CMMB, LTE, LTE-TDD, Digital Cable TV, MSR, LTEAFDD, LTEATDD
Remote Command	:CALCulate:ACPower:MARKer[1] 2 ... 12:MODE POSITION DELTa OFF :CALCulate:ACPower:MARKer[1] 2 ... 12:MODE?
Example	CALC:ACP:MARK2:MODE DELT CALC:ACP:MARK2:MODE?
Notes	If the selected marker is Off, pressing Marker sets it to Normal and places it at the center of the screen on the trace determined by the Marker Trace rules. At the same time, Marker X Axis Value appears on the Active Function area. Default Active Function: the active function for the selected marker's current control mode. If the current control mode is Off, there is no active function and the active function is turned off. Active Function Display: the marker X axis value entered in the active function area will display the marker value to its full entered precision. You must be in the mode that includes ACP measurements to use this command. Use :INSTrument:SElect to set the mode.
Dependencies	This key is unavailable when "Meas Method" on page 731 is set to RBW.

Preset	OFF OFF OFF OFF OFF OFF OFF OFF OFF OFF OFF OFF
State Saved	Saved in instrument state.
Range	Normal Delta Off
Initial S/W Revision	Prior to A.02.00
Modified at S/W Revision	A.02.00, A.03.00

Properties

Accesses the marker properties menu. Note that this key is unavailable when "Meas Method" on page 731 is set to RBW.

Key Path	Marker
Initial S/W Revision	Prior to A.02.00

Select Marker

Displays 12 markers available for selection. Note that this key is unavailable when "Meas Method" on page 731 is set to RBW.

Key Path	Marker
Initial S/W Revision	Prior to A.02.00

Relative To

Selects the desired marker. The selected marker will be relative to its reference marker.

Key Path	Marker, Properties
Mode	SA, WCDMA, C2K, WIMAX OFDMA, TD-SCDMA, 1xEVDO, DVB-T/H, DTMB (CTTB), ISDB-T, CMMB, LTE, LTETDD, Digital Cable TV, MSR, LTEAFDD, LTEATDD
Remote Command	:CALCulate:ACPpower:MARKer[1] 2 ... 12:REFerence <integer> :CALCulate:ACPpower:MARKer[1] 2 ... 12:REFerence?
Example	CALC:ACP:MARK2:REF 6 CALC:ACP:MARK2:REF?
Notes	A marker cannot be relative to itself so that choice is grayed out, and if sent from a remote command, generates error -221: "Settings conflict; marker cannot be relative to itself." When queried a single value will be returned (the specified marker numbers relative marker). You must be in the mode that includes ACP measurements to use this command. Use :INSTrument:SElect to set the mode.
Dependencies	This key is unavailable when "Meas Method" on page 731 is set to RBW.

Preset	2 3 4 5 6 7 8 9 10 11 12 1
State Saved	Saved in instrument state.
Min	1
Max	12
Initial S/W Revision	Prior to A.02.00
Modified at S/W Revision	A.02.00, A.03.00

Marker Trace

Selects the trace that you want your marker to be placed on. A marker is associated with one and only one trace. This trace is used to determine the placement, result, and X Axis Scale of the marker. All markers have an associated trace, even Fixed markers; it is from that trace that they determine their attributes and behaviors, and it is to that trace that they go when they become Normal or Delta markers.

Key Path	Marker, Properties
Mode	SA, WCDMA, C2K, WIMAX OFDMA, TD-SCDMA, 1xEVDO, DVB-T/H, DTMB (CTTB), ISDB-T, CMMB, LTE, LTE-TDD, Digital Cable TV, MSR, LTEAFDD, LTEATDD
Remote Command	:CALCulate:ACPower:MARKer[1] 2 ... 12:TRACe 1 2 3 :CALCulate:ACPower:MARKer[1] 2 ... 12:TRACe?
Example	CALC:ACP:MARK2:TRAC 2 CALC:ACP:MARK2:TRAC?
Notes	If the selected marker is Off, pressing Marker sets it to Normal and places it at the center of the screen on the trace determined by the Marker Trace rules. At the same time, Marker X Axis Value appears on the Active Function area. Default Active Function: the active function for the selected marker's current control mode. If the current control mode is Off, there is no active function and the active function is turned off. Active Function Display: the marker X axis value entered in the active function area will display the marker value to its full entered precision.
Dependencies	This key is unavailable when " Meas Method " on page 731 is set to RBW.
Couplings	This is not affected by Auto Coupling. Sending the remote command causes the addressed marker to become selected.
Preset	All Markers Off
State Saved	Saved in instrument state.
Range	1 2 3
Initial S/W Revision	Prior to A.02.00
Modified at S/W Revision	A.02.00, A.03.00

Couple Markers

When this function is On, moving any marker causes an equal X axis movement of every other marker which is not Off. By “equal X axis movement” we mean that we preserve the difference between each marker’s X axis value (in the fundamental x-axis units of the trace that marker is on) and the X axis value of the marker being moved (in the same fundamental x-axis units).

Key Path	Marker
Mode	SA, WCDMA, C2K, WIMAX OFDMA, TD-SCDMA, 1xEVDO, DVB-T/H, DTMB (CTTB), ISDB-T, CMMB, LTE, LTETDD, Digital Cable TV, MSR, LTEAFDD,LTEATDD
Remote Command	:CALCulate:ACPower:MARKer:COUPle[:STATe] ON OFF 1 0 :CALCulate:ACPower:MARKer:COUPle[:STATe]?
Example	CALC:ACP:MARK:COUP ON
Dependencies	This key is unavailable when "Meas Method" on page 731 is set to RBW.
Preset	OFF
State Saved	Saved in instrument state.
Range	On Off
Initial S/W Revision	Prior to A.02.00
Modified at S/W Revision	A.02.00, A.03.00

Marker All Off

Turns all active markers off.

Key Path	Marker
Mode	SA, WCDMA, C2K, WIMAX OFDMA, TD-SCDMA, 1xEVDO, DVB-T/H, DTMB (CTTB), ISDB-T, CMMB, LTE, LTETDD, Digital Cable TV, MSR, LTEAFDD,LTEATDD
Remote Command	:CALCulate:ACPower:MARKer:AOFF
Example	CALC:ACP:MARK:AOFF
Dependencies	This key is unavailable when "Meas Method" on page 731 is set to RBW.
Initial S/W Revision	Prior to A.02.00
Modified at S/W Revision	A.02.00, A.03.00

Marker X Axis Value (Remote Command only)

Sets the marker X axis value in the current marker X Axis Scale unit. This value has no effect if the control mode is Off, but is the SCPI equivalent of entering an X value if the control mode is Normal,Delta or Fixed.

Mode	SA, WCDMA, C2K, WIMAX OFDMA, TD-SCDMA, 1xEVDO, DVB-T/H, DTMB (CTTB), ISDB-T, CMMB, LTE, LTETDD, Digital Cable TV, MSR, LTEAFDD,LTEATDD
Remote Command	:CALCulate:ACPower:MARKer[1] 2 ... 12:X <freq> :CALCulate:ACPower:MARKer[1] 2 ... 12:X?

Example	CALC:ACP:MARK3:X 0 CALC:ACP:MARK3:X?
Notes	The query returns the marker's absolute X Axis value if the control mode is Normal, or the offset from the marker's reference marker if the control mode is Delta. If the marker is Off the response is not a number.
Dependencies	Unavailable when " Meas Method " on page 731 is set to RBW.
Preset	After a preset, all Markers are turned OFF, so Marker X Axis Value query will return a not a number (NAN).
State Saved	No
Min	-9.9E+37
Max	9.9E+37
Initial S/W Revision	Prior to A.02.00
Modified at S/W Revision	A.02.00, A.03.00

Marker X Axis Position (Remote Command only)

Sets the marker X position in trace points. It has no effect if the control mode is Off, but is the SCPI equivalent of entering a value if the control mode is Normal, Delta or Fixed. The entered value is immediately translated into the current X Axis Scale units for setting the value of the marker.

Mode	SA, WCDMA, C2K, WIMAX OFDMA, TD-SCDMA, 1xEVDO, DVB-T/H, DTMB (CTTB), ISDB-T, CMMB, LTE, LTE-TDD, Digital Cable TV, MSR, LTEAFDD, LTEATDD
Remote Command	:CALCulate:ACPower:MARKer[1] 2 ... 12:X:POSition <real> :CALCulate:ACPower:MARKer[1] 2 ... 12:X:POSition?
Example	CALC:ACP:MARK10:X:POS 0 CALC:ACP:MARK10:X:POS?
Notes	The query returns the marker's absolute X Axis value in trace points if the control mode is Normal, or the offset from the marker's reference marker in trace points if the control mode is Delta. The value is returned as a real number, not an integer, corresponding to the translation from X Axis Scale units to trace points (see "Fractional Trace Points"). If the marker is Off the response is not a number. When a Marker is turned on, it is placed center of the screen on the trace. Therefore the default value depends on instrument condition, although the Preset/Default is defined as 500 (this value might be expected value when all offset is on).
Dependencies	Unavailable when " Meas Method " on page 731 is set to RBW.
Preset	After a preset, all Markers are turned OFF, so Marker X Axis Value query will return a not a number (NAN).
State Saved	No
Min	-9.9E+37
Max	9.9E+37
Initial S/W Revision	Prior to A.02.00
Modified at S/W Revision	A.02.00, A.03.00

Marker Y Axis Value (Remote Command only)

Returns the marker Y axis value in the current marker Y axis unit.

Mode	SA, WCDMA, C2K, WIMAX OFDMA, TD-SCDMA, 1xEVDO, DVB-T/H, DTMB (CTTB), ISDB-T, CMMB, LTE, LTEFDD, Digital Cable TV, MSR, LTEAFDD, LTEATDD
Remote Command	:CALCulate:ACPower:MARKer[1] 2 ... 12:Y?
Example	CALC:ACP:MARK11:Y?
Notes	Since the result value is always calculated from acquisition data, the default value is arbitrary. Although the Preset/Default values are defined.
Dependencies	Unavailable when " Meas Method " on page 731 is set to RBW.
Preset	Result dependent on markers setup and signal source.
State Saved	No
Backwards Compatibility SCPI	:CALCulate:ACPower:MARKer[1] 2 ... 12:FUNCTION:RESULT?
Initial S/W Revision	Prior to A.02.00
Modified at S/W Revision	A.02.00, A.03.00

Backward Compatibility Remote Commands

Sets or queries the state of a marker. Setting a marker which is off to the on state or 1 puts it in Normal mode and places it at the center of the screen.

Mode	SA, WCDMA, WIMAXOFDMA, CDMA2K, TDSCDMA, CDMA1XEV, DVB, DTMB, ISDBT, CMMB, LTE, LTEFDD, DCATV, MSR, LTEAFDD, LTEATDD
Remote Command	:CALCulate:ACPower:MARKer[1] 2 ... 12:STATe OFF ON 0 1 :CALCulate:ACPower:MARKer[1] 2 ... 12:STATe?
Example	CALC:ACP:MARK2:STAT ON CALC:ACP:MARK2:STAT?
Notes	This parameter is also accessed from Marker, Properties, 1 You must be in the mode that includes ACP measurements to use this command. Use :INSTrument:SElect to set the mode.
Preset	OFF OFF OFF OFF OFF OFF OFF OFF OFF OFF OFF OFF
State Saved	Saved in instrument state.
Range	On Off
Initial S/W Revision	Prior to A.02.00
Modified at S/W Revision	A.02.00, A.03.00

Marker Function

There are no Marker Functions supported in the ACP measurement. The front-panel key will display a blank key menu when pressed.

Key Path	Front-panel key
Initial S/W Revision	Prior to A.02.00

Marker To

There is no Marker To functionality supported in ACP. The front-panel key will display a blank key menu when pressed.

Key Path	Front-panel key
Initial S/W Revision	Prior to A.02.00

Meas

The information in this section is common to all measurements. For key and remote command information for a specific measurement, refer to the section that describes the measurement of interest.

Measurements available under the Meas key are specific to the current Mode.

When viewing Help for measurements, note the following:

NOTE

Operation for some keys differs between measurements. The information displayed in Help pertains to the current measurement. To see how a key operates in a different measurement, exit Help (press the Cancel Esc key), select the measurement, then reenter Help (press the Help key) and press that key.

Key Path	Front-panel key
Initial S/W Revision	Prior to A.02.00

Remote Measurement Functions

This section contains the following topics:

"Measurement Group of Commands" on page 2206

"Current Measurement Query (Remote Command Only)" on page 2208

"Limit Test Current Results (Remote Command Only)" on page 2208

"Data Query (Remote Command Only)" on page 2208

"Calculate/Compress Trace Data Query (Remote Command Only)" on page 2209

"Calculate Peaks of Trace Data (Remote Command Only)" on page 2214

Hardware-Accelerated Fast Power Measurement (Remote Command Only)

"Format Data: Numeric Data (Remote Command Only)" on page 2215

"Format Data: Byte Order (Remote Command Only)" on page 2216

Initial S/W Revision	Prior to A.02.00
----------------------	------------------

Measurement Group of Commands

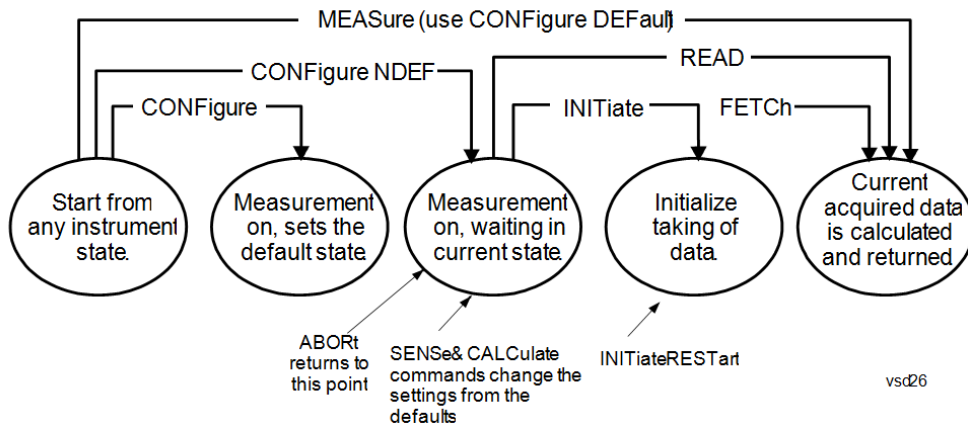

Measure Commands:

:MEASure:<measurement>[n]?

This is a fast single-command way to make a measurement using the factory default instrument settings. These are the settings and units that conform to the Mode Setup settings (e.g. radio standard) that you have currently selected.

- Stops the current measurement (if any) and sets up the instrument for the specified measurement using the factory defaults
- Initiates the data acquisition for the measurement
- Blocks other SCPI communication, waiting until the measurement is complete before returning results.
- If the function does averaging, it is turned on and the number of averages is set to 10.
- After the data is valid it returns the scalar results, or the trace data, for the specified measurement. The type of data returned may be defined by an [n] value that is sent with the command.
- The scalar measurement results will be returned if the optional [n] value is not included, or is set to 1. If the [n] value is set to a value other than 1, the selected trace data results will be returned. See each command for details of what types of scalar results or trace data results are available.
- ASCII is the default format for the data output. (Older versions of Spectrum Analysis and Phase Noise mode measurements only use ASCII.) The binary data formats should be used for handling large blocks of data since they are smaller and faster than the ASCII format. Refer to the FORMat:DATA command for more information.

If you need to change some of the measurement parameters from the factory default settings you can set up the measurement with the CONFIgure command. Use the commands in the SENSe:<measurement> and CALCulate:<measurement> subsystems to change the settings. Then you can use the READ? command to initiate the measurement and query the results.

If you need to repeatedly make a given measurement with settings other than the factory defaults, you can use the commands in the SENSe:<measurement> and CALCulate:<measurement> subsystems to set up the measurement. Then use the READ? command to initiate the measurement and query results.

Measurement settings persist if you initiate a different measurement and then return to a previous one. Use READ:<measurement>? if you want to use those persistent settings. If you want to go back to the default settings, use MEASure:<measurement>?.

Configure Commands:

:CONFIgure:<measurement>

This command stops the current measurement (if any) and sets up the instrument for the specified measurement using

the factory default instrument settings. It does not initiate the taking of measurement data unless INIT:CONTInuous is ON. If you change any measurement settings after using the CONFigure command, the READ command can be used to initiate a measurement without changing the settings back to their defaults.

In the Swept SA measurement in Spectrum Analyzer mode the CONFigure command also turns the averaging function on and sets the number of averages to 10 for all measurements.

:CONFigure: <measurement>: NDEFault stops the current measurement and changes to the specified measurement. It does not change the settings to the defaults. It does not initiate the taking of measurement data unless INIT:CONTInuous is ON.

The CONFigure? query returns the current measurement name.

The CONFigure:CATalog? query returns a quoted string of all licensed measurement names in the current mode. For example, "SAN, CHP, OBW, ACP, PST, TXP, SPUR, SEM, LIST".

Fetch Commands:

:FETCh:<measurement>[n]?

This command puts selected data from the most recent measurement into the output buffer. Use FETCh if you have already made a good measurement and you want to return several types of data (different [n] values, for example, both scalars and trace data) from a single measurement. FETCh saves you the time of re-making the measurement. You can only FETCh results from the measurement that is currently active, it will not change to a different measurement. An error message is reported if a measurement other than the current one is specified.

If you need to get new measurement data, use the READ command, which is equivalent to an INITiate followed by a FETCh.

The scalar measurement results will be returned if the optional [n] value is not included, or is set to 1. If the [n] value is set to a value other than 1, the selected trace data results will be returned. See each command for details of what types of scalar results or trace data results are available. The binary data formats should be used for handling large blocks of data since they are smaller and transfer faster than the ASCII format. (FORMat:DATA)

FETCh may be used to return results other than those specified with the original READ or MEASure command that you sent.

INITiate Commands:

:INITiate:<measurement>

This command is not available for measurements in all the instrument modes:

- Initiates a trigger cycle for the specified measurement, but does not output any data. You must then use the FETCh<meas> command to return data. If a measurement other than the current one is specified, the instrument will switch to that measurement and then initiate it.
- For example, suppose you have previously initiated the ACP measurement, but now you are running the channel power measurement. If you send INIT:ACP? it will change from channel power to ACP and will initiate an ACP measurement.
- Does not change any of the measurement settings. For example, if you have previously started the ACP measurement and you send INIT:ACP? it will initiate a new ACP measurement using the same instrument settings as the last time ACP was run.
- If your selected measurement is currently active (in the idle state) it triggers the measurement, assuming the trigger conditions are met. Then it completes one trigger cycle. Depending upon the measurement and the number of averages, there may be multiple data acquisitions, with multiple trigger events, for one full trigger cycle. It also holds off additional commands on GPIB until the acquisition is complete.

READ Commands:

:READ:<measurement>[n]?

- Does not preset the measurement to the factory default settings. For example, if you have previously initiated the ACP
-

measurement and you send READ:ACP? it will initiate a new measurement using the same instrument settings.

- Initiates the measurement and puts valid data into the output buffer. If a measurement other than the current one is specified, the instrument will switch to that measurement before it initiates the measurement and returns results.
 - For example, suppose you have previously initiated the ACP measurement, but now you are running the channel power measurement. Then you send READ:ACP? It will change from channel power back to ACP and, using the previous ACP settings, will initiate the measurement and return results.
 - Blocks other SCPI communication, waiting until the measurement is complete before returning the results
 - If the optional [n] value is not included, or is set to 1, the scalar measurement results will be returned. If the [n] value is set to a value other than 1, the selected trace data results will be returned. See each command for details of what types of scalar results or trace data results are available. The binary data formats should be used when handling large blocks of data since they are smaller and faster than the ASCII format. (FORMat:DATA)
-

Initial S/W Revision	Prior to A.02.00
----------------------	------------------

Current Measurement Query (Remote Command Only)

This command returns the name of the measurement that is currently running.

Remote Command	:CONFigure?
-----------------------	-------------

Example	CONF?
----------------	-------

Initial S/W Revision	Prior to A.02.00
----------------------	------------------

Limit Test Current Results (Remote Command Only)

Queries the status of the current measurement limit testing. It returns a 0 if the measured results pass when compared with the current limits. It returns a 1 if the measured results fail any limit tests.

Remote Command	:CALCulate:CLIMits:FAIL?
-----------------------	--------------------------

Example	CALC:CLIM:FAIL? queries the current measurement to see if it fails the defined limits. Returns a 0 or 1: 0 it passes, 1 it fails.
----------------	--

Initial S/W Revision	Prior to A.02.00
----------------------	------------------

Data Query (Remote Command Only)

Returns the designated measurement data for the currently selected measurement and subopcode.

n = any valid subopcode for the current measurement. See the measurement command results table for your current measurement, for information about what data is returned for the subopcodes.

This command uses the data setting specified by the FORMat:BORDER and FORMat:DATA commands and can return real or ASCII data. (See the format command descriptions under Input/Output in the Analyzer Setup section.)

Remote Command	:CALCulate:DATA[n]?
Notes	The return trace depends on the measurement. In CALCulate:<meas>:DATA[n], n is any valid subopcode for the current measurement. It returns the same data as the FETCH:<measurement>? query where <measurement> is the current measurement.
Initial S/W Revision	Prior to A.02.00

Calculate/Compress Trace Data Query (Remote Command Only)

Returns compressed data for the currently selected measurement and sub-opcode [n].

n = any valid sub-opcode for that measurement. See the MEASure:<measurement>? command description of your specific measurement for information on the data that can be returned.

The data is returned in the current Y Axis Unit of the analyzer. The command is used with a sub-opcode <n> (default=1) to specify the trace. With trace queries, it is best if the analyzer is not sweeping during the query. Therefore, it is generally advisable to be in Single Sweep, or Update=Off.

This command is used to compress or decimate a long trace to extract and return only the desired data. A typical example would be to acquire N frames of GSM data and return the mean power of the first burst in each frame. The command can also be used to identify the best curve fit for the data.

Remote Command	:CALCulate:DATA<n>:COMPRESS? BLOCK CFIT MAXimum MINimum MEAN DMEan RMS RMSCubed SAMPLE SDEVIation PPHase [,<soffset> [,<length>[,<roffset>[,<rlimit>]]]]
Example	To query the mean power of a set of GSM bursts: Supply a signal that is a set of GSM bursts. Select the IQ Waveform measurement (in IQ Analyzer Mode). Set the sweep time to acquire at least one burst. Set the triggers such that acquisition happens at a known position relative to a burst. Then query the mean burst levels using, CALC:DATA2:COMP? MEAN, 24e-6, 526e-6 (These parameter values correspond to GSM signals, where 526e-6 is the length of the burst in the slot and you just want 1 burst.)
Notes	The command supports 5 parameters. Note that the last 4 (<soffset>, <length>, <roffset>, <rlimit>) are optional. But these optional parameters must be entered in the specified order. For example, if you want to specify <length>, then you must also specify <soffset>. See details below for a definition of each of these parameters. This command uses the data in the format specified by FORMat:DATA, returning either binary or ASCII data.
Initial S/W Revision	Prior to A.02.00

- BLOCK or block data - returns all the data points from the region of the trace data that you specify. For example, it could be used to return the data points of an input signal over several timeslots, excluding the portions of the trace data that you do not want. (This is x,y pairs for trace data and I,Q pairs for complex data.)

- CFIT or curve fit - applies curve fitting routines to the data. <soffset> and <length> are required to define the data that you want. <roffset> is an optional parameter for the desired order of the curve equation. The query will return the following values: the x-offset (in seconds) and the curve coefficients ((order + 1) values).

MIN, MAX, MEAN, DME, RMS, RMSC, SAMP, SDEV and PPH return one data value for each specified region (or <length>) of trace data, for as many regions as possible until you run out of trace data (using <roffset> to specify regions). Or they return the number of regions you specify (using <rlimit>) ignoring any data beyond that.

- MINimum - returns the minimum data point (y value) for the specified region(s) of trace data. For I/Q trace data, the minimum magnitude of the I/Q pairs is returned.
- MAXimum - returns the maximum data point (y value) for the specified region(s) of trace data. For I/Q trace data, the maximum magnitude of the I/Q pairs is returned.
- MEAN - returns a single value that is the arithmetic mean of the data point values (in dB/ dBm) for the specified region(s) of trace data. For I/Q trace data, the mean of the magnitudes of the I/Q pairs is returned. See the following equations.

•

NOTE If the original trace data is in dB, this function returns the arithmetic mean of those log values, not log of the mean power which is a more useful value. The mean of the log is the better measurement technique when measuring CW signals in the presence of noise. The mean of the power, expressed in dB, is useful in power measurements such as Channel Power. To achieve the mean of the power, use the RMS option.

Equation 1

Mean Value of Data Points for Specified Region(s)

$$\text{MEAN} = \frac{1}{n} \sum_{X_i \in \text{region}(s)} X_i$$

where X_i is a data point value, and n is the number of data points in the specified region(s).

Equation 2

Mean Value of I/Q Data Pairs for Specified Region(s)

$$\text{MEAN} = \frac{1}{n} \sum_{X_i \in \text{region}(s)} |X_i|$$

where $|X_i|$ is the magnitude of an I/Q pair, and n is the number of I/Q pairs in the specified region(s).

- DMEan - returns a single value that is the mean power (in dB/ dBm) of the data point values for the specified region(s) of trace data. See the following equation:

Equation 3

DMEan Value of Data Points for Specified Region(s)

$$\text{DME} = 10 \times \log_{10} \left(\frac{1}{n} \sum_{X_i \in \text{region}(s)} 10^{\frac{X_i}{10}} \right)$$

- RMS - returns a single value that is the average power on a root-mean-squared voltage scale (arithmetic rms) of the data point values for the specified region(s) of trace data. See the following equation.

NOTE

For I/Q trace data, the rms of the magnitudes of the I/Q pairs is returned. See the following equation. This function is very useful for I/Q trace data. However, if the original trace data is in dB, this function returns the rms of the log values which is not usually needed.

Equation 4

RMS Value of Data Points for Specified Region(s)

$$\text{RMS} = \sqrt{\frac{1}{n} \sum_{X_i \in \text{region}(s)} X_i^2}$$

where X_i is a data point value, and n is the number of data points in the specified region(s).

Equation 5

RMS Value of I/Q Data Pairs for Specified Region(s)

$$\text{RMS} = \sqrt{\frac{1}{n} \sum_{X_i \in \text{region}(s)} X_i X_i^*}$$

where X_i is the complex value representation of an I/Q pair, X_i^* its conjugate complex number, and n is the number of I/Q pairs in the specified region(s).

Once you have the rms value for a region of trace data (linear or I/Q), you may want to calculate the mean power. You must convert this rms value (peak volts) to power in dBm:

$$10 \times \log[10 \times (\text{rms value})^2]$$

- SAMPLe - returns the first data value (x,y pair) for the specified region(s) of trace data. For I/Q trace data, the first I/Q pair is returned.
- SDEViation - returns a single value that is the arithmetic standard deviation for the data point values for the specified region(s) of trace data. See the following equation.
- For I/Q trace data, the standard deviation of the magnitudes of the I/Q pairs is returned. See the following equation.

Equation 6

Standard Deviation of Data Point Values for Specified Region(s)

$$\text{SDEV} = \sqrt{\frac{1}{n} \sum_{X_i \in \text{region}(s)} (X_i - \bar{X})^2}$$

where X_i is a data point value, \bar{X} is the arithmetic mean of the data point values for the specified region (s), and n is the number of data points in the specified region(s).

$$\text{SDEV} = \sqrt{\frac{1}{n} \sum_{X_i \in \text{region}(s)} (|X_i| - \bar{X})^2}$$

where $|X_i|$ is the magnitude of an I/Q pair, \bar{X} is the mean of the magnitudes for the specified region(s), and n is the number of data points in the specified region(s).

- PPHase - returns the x,y pairs of both rms power (dBm) and arithmetic mean phase (radian) for every specified region and frequency offset (Hz). The number of pairs is defined by the specified number of regions. This parameter can be used for I/Q vector ($n=0$) in Waveform (time domain) measurement and all parameters are specified by data point in PPHase.

The rms power of the specified region may be expressed as:

$$\text{Power} = 10 \times \log [10 \times (\text{RMS I/Q value})] + 10.$$

The RMS I/Q value (peak volts) is:

$$\sqrt{\frac{1}{n} \sum_{X_i \in \text{region}} X_i X_i^*}$$

where X_i is the complex value representation of an I/Q pair, X_i^* its conjugate complex number, and n is the number of I/Q pairs in the specified region.

The arithmetic mean phase of the specified region may be expressed as:

$$\frac{1}{n} \sum_{Y_i \in \text{region}} Y_i$$

where Y_i is the unwrapped phase of I/Q pair with applying frequency correction and n is the number of I/Q pairs in the specified region.

The frequency correction is made by the frequency offset calculated by the arithmetic mean of every specified region's frequency offset. Each frequency offset is calculated by the least square method against the unwrapped phase of I/Q pair.

Sample Trace Data - Constant Envelope

(See below for explanation of variables.)

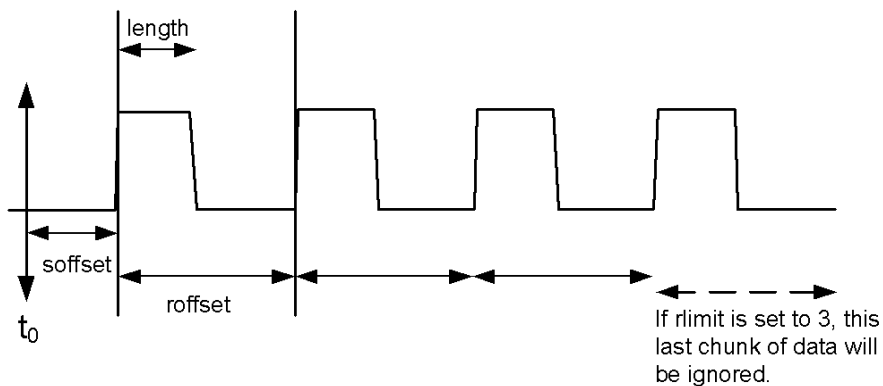

Sample Trace Data - Not Constant Envelope

(See below for explanation of variables.)

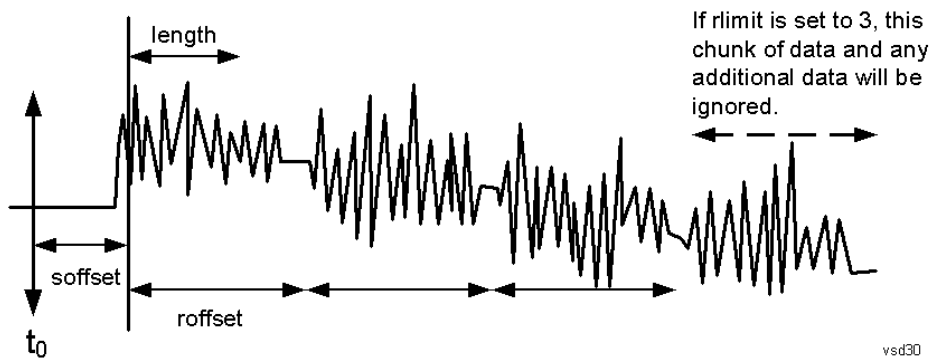

<soffset> - start offset is an optional real number. (It is in seconds for time-domain traces, and is a dimensionless index 0 to Npoints - 1, for frequency-domain traces). It specifies the amount of data at the beginning of the trace that will be ignored before the decimation process starts. It is the time or frequency change from the start of the trace to the point where you want to start using the data. The default value is zero.

<length> - is an optional real number. (It is in seconds for time-domain traces, and is a dimensionless index 0 to Npoints - 1, for frequency-domain traces). It defines how much data will be compressed into one value. This parameter has a default value equal to the current trace length.

<roffset> - repeat offset is an optional real number. (It is in seconds for time-domain traces, and is a dimensionless index 0 to Npoints - 1, for frequency-domain traces). It defines the beginning of the next field of trace elements to be compressed. This is relative to the beginning of the previous field. This parameter has a default value equal to the <length> variable. Note that this parameter is used for a completely different purpose when curve fitting (see CFIT above).

<rlimit> - repeat limit is an optional integer. It specifies the number of data items that you want returned. It will ignore any additional items beyond that number. You can use the Start offset and the Repeat limit to pick out exactly what part of the data you want to use. The default value is all the data.

Calculate Peaks of Trace Data (Remote Command Only)

Returns a list of all the peaks for the currently selected measurement and sub-opcode [n]. The peaks must meet the requirements of the peak threshold and excursion values.

n = any valid sub-opcode for the current measurement. See the MEASure:<measurement> command description of your specific measurement for information on the data that can be returned.

The command can only be used with specific sub-opcodes with measurement results that are trace data. Both real and complex traces can be searched, but complex traces are converted to magnitude in dBm. In many measurements the sub-opcode n=0, is the raw trace data which cannot be searched for peaks. And Sub-opcode n=1, is often calculated results values which also cannot be searched for peaks.

This command uses the data setting specified by the FORMat:BORDER and FORMat:DATA commands and can return real or ASCII data. If the format is set to INT,32, it returns REAL,32 data.

The command has four types of parameters:

- Threshold (in dBm)
- Excursion (in dB)
- Sorting order (amplitude, frequency, time)
- Optional in some measurements: Display line use (all, > display line, < display line)

Remote Command	<p>For Swept SA measurement:</p> <pre>:CALCulate:DATA[1] 2 ... 6:PEAKs? <threshold>,<excursion>[,AMPLitude FREQuency TIME[,ALL GTDLine LTDLine]]</pre> <p>For most other measurements:</p> <pre>:CALCulate:DATA[1] 2 ... 6:PEAKs? <threshold>,<excursion>[,AMPLitude FREQuency TIME]</pre>
-----------------------	--

Example	<p>Example for Swept SA measurement in Spectrum Analyzer Mode:</p> <p>CALC:DATA4:PEAK? -40, 10, FREQ, GTDL This will identify the peaks of trace 4 that are above -40 dBm, with excursions of at least 10 dB. The peaks are returned in order of increasing frequency, starting with the lowest frequency. Only the peaks that are above the display line are returned.</p> <p>Query Results 1:</p> <p>With FORMat:DATA REAL, 32 selected, it returns a list of floating-point numbers. The first value in the list is the number of peak points that are in the following list. A peak point consists of two values: a peak amplitude followed by its corresponding frequency (or time).</p> <p>If no peaks are found the peak list will consist of only the number of peaks, (0).</p>
----------------	---

Notes	<p><n> - is the trace that will be used</p> <p><threshold> - is the level below which trace data peaks are ignored. Note that the threshold value is required and is always used as a peak criterion. To effectively disable the threshold criterion for this command, provide a substantially low threshold value such as -200 dBm. Also note that the threshold value used in this command is independent of and has no effect on the threshold value stored under the Peak Criteria menu.</p> <p><excursion> - is the minimum amplitude variation (rise and fall) required for a signal to be identified as peak. Note that the excursion value is required and is always used as a peak criterion. To effectively disable the excursion criterion for this command, provide the minimum value of 0.0 dB. Also note that the excursion value used in this command is independent of and has no effect on the</p>
--------------	---

excursion value stored under the Peak Criteria menu.

Values must be provided for threshold and excursion. The sorting and display line parameters are optional (defaults are AMPLitude and ALL).

Note that there is always a Y-axis value for the display line, regardless of whether the display line state is on or off. It is the current Y-axis value of the display line which is used by this command to determine whether a peak should be reported. Sorting order:

AMPLitude - lists the peaks in order of descending amplitude, with the highest peak first (default if optional parameter not sent)

FREQUency - lists the peaks in order of occurrence, left to right across the x-axis.

TIME - lists the peaks in order of occurrence, left to right across the x-axis.

Peaks vs. Display Line:

ALL - lists all of the peaks found (default if optional parameter not sent).

GTDLine (greater than display line) - lists all of the peaks found above the display line.

LTDLine (less than display line) - lists all of the peaks found below the display line.

Initial S/W Revision Prior to A.02.00

Format Data: Numeric Data (Remote Command Only)

This command specifies the format of the trace data input and output. It specifies the formats used for trace data during data transfer across any remote port. It affects only the data format for setting and querying trace data for the :TRACe[:DATA], TRACe[:DATA]?, :CALCulate:DATA[n]? and FETCh:SANalyzer [n]? commands and queries.

Remote Command :FORMat[:TRACe][:DATA] ASCii|INTeger,32|REAL,32 |REAL,64
:FORMat[:TRACe][:DATA]?

Notes The query response is:
ASCii: ASC,8
REAL,32: REAL,32
REAL,64: REAL,64
INTeger,32: INT,32
When the numeric data format is REAL or ASCii, data is output in the current Y Axis unit. When the data format is INTeger, data is output in units of m dBm (.001 dBm).
The INT,32 format returns binary 32-bit integer values in internal units (m dBm), in a definite length block.

Dependencies Sending a data format spec with an invalid number (for example, INT,48) generates no error. The analyzer simply uses the default (8 for ASCii, 32 for INTeger, 32 for REAL).
Sending data to the analyzer which does not conform to the current FORMat specified, results in an error. Sending ASCII data when a definite block is expected generates message -161 "Invalid Block Data" and sending a definite block when ASCII data is expected generates message -121 "Invalid Character in Number".

Preset ASCii

Backwards Compatibility Notes Note that the INT,32 format is only applicable to the command, TRACe:DATA. This preserves backwards compatibility for the Swept SA measurement. For all other commands/queries which honor FORMat:DATA, if INT,32 is sent the analyzer will behave as though it were set to REAL,32.

Initial S/W Revision Prior to A.02.00

The specs for each output type follow:

ASCIi - Amplitude values are in ASCII, in the current Y Axis Unit, one ASCII character per digit, values separated by commas, each value in the form:

SX.YYYYYEsZZ

Where:

S = sign (+ or -)

X = one digit to left of decimal point

Y = 5 digits to right of decimal point

E = E, exponent header

s = sign of exponent (+ or -)

ZZ = two digit exponent

REAL,32 - Binary 32-bit real values in the current Y Axis Unit, in a definite length block.

REAL,64 - Binary 64-bit real values in the current Y Axis Unit, in a definite length block.

Format Data: Byte Order (Remote Command Only)

This command selects the binary data byte order for data transfer and other queries. It controls whether binary data is transferred in normal or swapped mode. This command affects only the byte order for setting and querying trace data for the :TRACe[:DATA], TRACe[:DATA]? , :CALCulate:DATA[n]? and FETCh:SANalyzer[n]? commands and queries.

By definition any command that says it uses FORMat:DATA uses any format supported by FORMat:DATA.

The NORMal order is a byte sequence that begins with the most significant byte (MSB) first, and ends with the least significant byte (LSB) last in the sequence: 1|2|3|4. SWAPped order is when the byte sequence begins with the LSB first, and ends with the MSB last in the sequence: 4|3|2|1.

Remote Command	:FORMat:BORDER NORMal SWAPped :FORMat:BORDER?
Preset	NORMal
Initial S/W Revision	Prior to A.02.00

Meas Setup

Displays the setup menu for the currently selected measurement. The functions included in the measurement setup menu include setting the parameters for the carriers, offsets, bandwidths, measurement methods and types. This menu also allows you to turn noise correction on and off.

Key Path	Front-panel key
Initial S/W Revision	Prior to A.02.00

Average/Hold Number

Specifies the number of measurement averages used to calculate the measurement result. The average will be displayed at the end of each sweep. After the specified number of average counts, the average mode (termination control) setting determines the average action.

Key Path	Meas Setup
Mode	SA, WCDMA, C2K, WIMAX OFDMA, TD-SCDMA, 1xEVDO, DVB-T/H, DTMB (CTTB), ISDB-T, CMMB, LTE, LTE-TDD, Digital Cable TV, MSR, LTEAFDD, LTEATDD
Remote Command	[:SENSe]:ACPower:AVERage:COUNT <integer> [:SENSe]:ACPower:AVERage:COUNT? [:SENSe]:ACPower:AVERage[:STATe] OFF ON 0 1 [:SENSe]:ACPower:AVERage[:STATe]?
Example	ACP:AVER:COUN 250 ACP:AVER:COUN? ACP:AVER OFF ACP:AVER?
Notes	You must be in the mode that includes ACP measurements to use this command. Use :INSTRument:SElect to set the mode.
Preset	10 ON
State Saved	Saved in instrument state.
Min	1
Max	1000
Backwards Compatibility SCPI	[:SENSe]:ACPR:AVERage:COUNT [:SENSe]:MCPower:AVERage:COUNT (PSA Power Suite, PSA W-CDMA, PSA cdma2000)
Initial S/W Revision	Prior to A.02.00
Modified at S/W Revision	A.02.00, A.03.00

Avg Mode

Enables you to set the averaging mode. This determines the averaging action after the specified number of data acquisitions (average count) is reached.

When set to Exponential (Exp) the measurement averaging continues using the specified number of averages to compute each averaged value. The average will be displayed at the end of each sweep.

When set to Repeat, the measurement resets the average counter each time the specified number of averages is reached.

Key Path	Meas Setup
Mode	SA, WCDMA, C2K, WIMAX OFDMA, TD-SCDMA, 1xEVDO, DVB-T/H, DTMB (CTTB), ISDB-T, CMMB, LTE, LTETDD, Digital Cable TV, MSR, LTEAFDD, LTEATDD
Remote Command	[:SENSe] :ACPower:AVERage:TCONtrol EXPonential REPEAT [:SENSe] :ACPower:AVERage:TCONtrol ?
Example	ACP:AVER:TCON EXP ACP:AVER:TCON ?
Notes	You must be in the mode that includes ACP measurements to use this command. Use :INSTRument:SElect to set the mode.
Preset	EXPonential
State Saved	Saved in instrument state.
Range	Exp Repeat
Backwards Compatibility SCPI	[:SENSe] :ACPR:AVERage:TCONtrol
Initial S/W Revision	Prior to A.02.00
Modified at S/W Revision	A.02.00, A.03.00

Carrier Setup (This menu is unavailable in MSR and LTE-Advanced FDD/TDD)

Accesses a menu that contains Carriers, Ref Carrier, Ref Car Freq, Ref Car Pwr and Configure Carriers.

Key Path	Meas Setup
Initial S/W Revision	Prior to A.02.00

Carriers

Specifies the number of carriers to be measured.

Key Path	Meas Setup, Carrier Setup, Configure Carriers
Mode	SA, WCDMA, C2K, WIMAX OFDMA, 1xEVDO, TD-SCDMA, DVB-T/H, DTMB (CTTB), ISDB-T, CMMB, LTE, LTETDD, Digital Cable TV

Remote Command	<code>[:SENSe]:ACPower:CARRier[1] 2:COUNT <integer></code> <code>[:SENSe]:ACPower:CARRier[1] 2:COUNT?</code>
Example	ACP:CARR:COUN 1 ACP:CARR:COUN?
Notes	Carrier sub op code. 1 for BTS, 2 for MS. Default is BTS. Note that Carrier sub op code 2 is supported only in Non-SA modes. In the SA mode, Carrier sub op code 1 is used for both BTS and MS. You must be in the mode that includes ACP measurements to use this command. Use :INSTrument:SElect to set the mode.
Dependencies	When Number of Carriers is 1, Ref Carrier is grayed out. If N9060A-5FP license is enabled, Max of Carrier is 18, otherwise, Max of Carrier is 12.
Couplings	Changing this parameter might affect the Span.
Preset	1
State Saved	Saved in instrument state.
Min	1
Max	Refer to Dependencies item.
Initial S/W Revision	Prior to A.02.00
Modified at S/W Revision	A.02.00, A.03.00

Ref Carrier

Sets the reference carrier. Relative power measurements are made from the reference carrier.

If set to Auto, the measurement selects the carrier with the highest power as the reference carrier and the Ref Carrier parameter is updated. If a value is entered when Ref Carrier Mode is set to Auto, the mode changes to Man.

If set to Man, the value that you enter for the Ref Carrier is used as the reference carrier.

Key Path	Meas Setup, Carrier Setup
Mode	SA, WCDMA, C2K, WIMAX OFDMA, 1xEVDO, TD-SCDMA, DVB-T/H, DTMB (CTTB), ISDB-T, CMMB, LTE, LTETDD, Digital Cable TV
Remote Command	<code>[:SENSe]:ACPower:CARRier[1] 2:RCARrier <integer></code> <code>[:SENSe]:ACPower:CARRier[1] 2:RCARrier?</code> <code>[:SENSe]:ACPower:CARRier[1] 2:RCARrier:AUTO OFF ON 0 1</code> <code>[:SENSe]:ACPower:CARRier[1] 2:RCARrier:AUTO?</code>
Example	ACP:CARR:RCAR 1 ACP:CARR:RCAR? ACP:CARR:RCAR:AUTO OFF ACP:CARR:RCAR:AUTO?

Notes	Carrier sub op code. 1 for BTS, 2 for MS. Default is BTS. Note that Carrier sub op code 2 is supported only in Non-SA modes. In the SA mode, Carrier sub op code 1 is used for both BTS and MS. You must be in the mode that includes ACP measurements to use this command. Use :INSTrument:SElect to set the mode.
Dependencies	If there is only one carrier, this key will be grayed out.
Couplings	If you enter a carrier value that is currently configured as having no power present, that carrier will be changed to having power present. If you enter a ref carrier this parameter will be set to manual.
Preset	Auto determined
State Saved	Saved in instrument state.
Min	1
Max	Number of available carriers
Backwards Compatibility SCPI	[:SENSe] :MCPower :RCARrier [1] 2 (PSA Power Suite)
Initial S/W Revision	Prior to A.02.00
Modified at S/W Revision	A.02.00, A.03.00

Ref Car Freq

Sets the reference carrier frequency.

Key Path	Meas Setup, Carrier Setup
Mode	SA, WCDMA, C2K, WIMAX OFDMA, 1xEVDO, TD-SCDMA, DVB-T/H, DTMB (CTTB), ISDB-T, CMMB, LTE, LTETDD, Digital Cable TV
Remote Command	[:SENSe] :ACPpower :CARRier [1] 2 :RCFRrequency <freq> [:SENSe] :ACPpower :CARRier [1] 2 :RCFRrequency? [:SENSe] :ACPpower :CARRier [1] 2 :RCFRrequency :AUTO OFF ON 0 1 [:SENSe] :ACPpower :CARRier [1] 2 :RCFRrequency :AUTO?
Example	ACP:CARR:RCFR 250 MHz ACP:CARR:RCFR? ACP:CARR:RCFR:AUTO OFF ACP:CARR:RCFR:AUTO?
Notes	Carrier sub op code. 1 for BTS, 2 for MS. Default is BTS. Note that Carrier sub op code 2 is supported only in Non-SA modes. In the SA mode, Carrier sub op code 1 is used for both BTS and MS. You must be in the mode that includes ACP measurements to use this command. Use :INSTrument:SElect to set the mode.

Couplings	<p>Coupled to the Center Frequency.</p> <p>If the center frequency changes, the Ref Carrier Frequency is calculated using the following three steps;</p> $\text{Ref Freq1} = \text{Ctr Freq} - (\text{Total of all Carrier Widths} / 2)$ $\text{Ref Freq2} = \text{Ref Freq1} + (\text{Total of all Carrier Widths up to Ref Carrier})$ $\text{Ref Freq} = \text{Ref Freq2} + (0.5 * \text{Carrier Width of Ref Carrier})$ <p>If reference carrier frequency changes the Center Frequency is calculated using the following three steps;</p> $\text{Ctr Freq1} = \text{Ref Freq} - (0.5 * \text{Carrier Width of Ref Carrier})$ $\text{Ctr Freq2} = \text{Ctr Freq1} - (\text{Total of all Carrier Widths up to Ref Carrier})$ $\text{Ctr Freq} = \text{Ctr Freq2} + (\text{Total of all Carrier Widths} / 2)$ <p>This ensures that the carriers are always centered on the screen.</p> <p>If there is only one carrier present the Reference Carrier Frequency will be the same as the Center Frequency.</p>
Preset	Calculated based on the current Center Frequency
State Saved	Saved in instrument state.
Min	-79.999995 MHz
Max	<p>Hardware Dependent:</p> <p>Option 503 = 3.699999995 GHz</p> <p>Option 508 = 8.499999995 GHz</p> <p>Option 513 = 13.799999995 GHz</p> <p>Option 526 = 26.999999995 GHz</p>
Initial S/W Revision	Prior to A.02.00
Modified at S/W Revision	A.02.00, A.03.00

Power Ref

Sets the power reference in the carrier that will be used to compute the relative values for the offsets.

Key Path	Meas Setup, Carrier Setup
Initial S/W Revision	Prior to A.02.00
Modified at S/W Revision	A.03.00, A.04.00

Total Power

Sets the multi-carrier power reference.

When set to Auto, the carrier power result reflects the measured power value in the selected reference carrier.

When set to Man, the result is referenced to the last measured value, or you may specify the reference for the multi-carrier power measurement. Relative values are displayed, referenced to the “Power Reference” value.

Key Path	Meas Setup, Carrier Setup, Power Ref
Mode	SA, WCDMA, C2K, WIMAX OFDMA, TD-SCDMA, DVB-T/H, DTMB (CTTB), ISDB-T, CMMB, LTE, LTETDD, Digital Cable TV, MSR
Remote Command	[:SENSe]:ACPowEr:CARRier[1] 2[:POWer] <real> [:SENSe]:ACPowEr:CARRier[1] 2[:POWer]? [:SENSe]:ACPowEr:CARRier[1] 2:AUTO[:STATe] OFF ON 0 1 [:SENSe]:ACPowEr:CARRier[1] 2:AUTO[:STATe]?
Example	ACP:CARR 10 ACP:CARR? ACP:CARR:AUTO OFF ACP:CARR:AUTO?
Notes	Although the default value is defined, the value is recalculated by the measurement result just after measurement. Carrier sub op code: 1 for BTS, 2 for MS. Default is BTS. Carrier sub op code 2 is supported only in Non-SA modes. MS is not supported in MSR. In the SA mode, Carrier sub op code 1 is used for both BTS and MS. The Unit Terminator keys differ depending on whether or not the mode supports Y Axis Unit and also which Y Axis Unit is selected. You must be in the mode that includes ACP measurements to use this command. Use :INSTrument:SElect to set the mode. Power Ref State ([:SENSe]:ACPowEr:CARRier[1] 2:AUTO[:STATe]) is not available in MSR mode.
Dependencies	This key is available only when the Meas Type is TPreF. If the Meas Type is not TPreF, this key is grayed out.
Preset	0.0 ON
State Saved	Saved in instrument state.
Min	-200 dBm
Max	200 dBm
Backwards Compatibility SCPI	[:SENSe]:MCPowEr:CARRier[1] 2[:POWer]
Initial S/W Revision	Prior to A.02.00
Modified at S/W Revision	A.02.00, A.03.00, A.04.00, A.10.00

PSD

Sets the power spectral density in the carrier (main channel) that is used to compute the relative power spectral density values for the offsets when Meas Type is set to PSD Ref. When the PSD Ref state is set to Auto, this will be set to the measured carrier power spectral density.

Key Path	Meas Setup, Carrier Setup, Power Ref
Mode	SA, WCDMA, C2K, WIMAX OFDMA, TD-SCDMA, DVB-T/H, DTMB (CTTB), ISDB-T, CMMB, LTE, LTETDD, Digital Cable TV, MSR
Remote Command	<code>[:SENSe] :ACPower:CARRier [1] 2:CPSD <real></code> <code>[:SENSe] :ACPower:CARRier [1] 2:CPSD?</code>
Example	ACP:CARR:CPSD 25 ACP:CARR:CPSD?
Notes	Although the default value is defined, the value is recalculated by the measurement result just after measurement. Carrier sub op code. 1 for BTS, 2 for MS. Default is BTS. MS is not supported in MSR. Note that Carrier sub op code 2 is supported only in Non-SA modes. In the SA mode, Carrier sub op code 1 is used for both BTS and MS. You must be in the mode that includes ACP measurements to use this command. Use :INSTrument:SElect to set the mode.
Dependencies	This key is available only when the Meas Type is PSDRef. If the Meas Type is not PSDRef, this key is grayed out.
Couplings	The value of PSD is automatically converted when PSD Unit is changed.
Preset	0.0
State Saved	Saved in instrument state.
Min	-999
Max	999
Initial S/W Revision	Prior to A.02.00
Modified at S/W Revision	A.02.00, A.03.00, A.04.00, A.10.00

Configure Carriers

Accesses a menu that contains Carrier, Carrier Pwr Present, Carrier Width and Carrier Integ BW parameters.

Key Path	Meas Setup, Carrier Setup
Initial S/W Revision	Prior to A.02.00

Carrier

Selects the carrier to configure for the current measurement.

Key Path	Meas Setup, Carrier Setup, Configure Carriers
Mode	SA, WCDMA, C2K, WIMAX OFDMA, 1xEVDO, TD-SCDMA, DVB-T/H, DTMB (CTTB), ISDB-T, CMMB, LTE, LTETDD, Digital Cable TV

Couplings	Max value is the number of available carriers, so this value might change when the number of carriers is changed.
Preset	1
State Saved	No
Min	1
Max	Number of available carriers
Initial S/W Revision	Prior to A.02.00
Modified at S/W Revision	A.02.00, A.03.00

Carrier Pwr Present

Configures the carriers for this measurement. It allows spaces to be inserted between carriers. Carriers with the power present parameter set to Yes are carriers, and those with the power present parameter set to No are spaces. Each carrier power present is set to Yes or No. The individual carriers can be set by selecting the desired carrier on the carrier menu key using the up down arrows, the knob, or numeric keypad, then toggling the carrier power present using the carrier power present menu key.

The query for this parameter returns the current values for all of the carriers. If a carrier is defined as having no power present, the power displayed will be relative to the reference carrier, otherwise the absolute power will be displayed.

If you change the carrier power present to no and that carrier is currently configured as the reference carrier, the next carrier to the left (or the right if there are no carriers to the left) will be assigned as the reference carrier. This also applies to the scenario where there are only two carriers configured as having power present and you configure only one carrier to have no power present.

Key Path	Meas Setup, Carrier Setup, Configure Carriers
Mode	SA, WCDMA, C2K, WIMAX OFDMA, 1xEVDO, TD-SCDMA, DVB-T/H, DTMB (CTTB), ISDB-T, CMMB, LTE, LTETDD, Digital Cable TV
Remote Command	<code>[:SENSe] :ACPpower :CARRier [1] 2 :LIST :PPresent YES NO, YES NO, YES NO, YES NO, YES NO, YES NO, YES NO</code> <code>[:SENSe] :ACPpower :CARRier [1] 2 :LIST :PPresent ?</code>
Example	ACP:CARR2:LIST:PPR YES ACP:CARR2:LIST:PPR?
Notes	Carrier sub op code. 1 for BTS, 2 for MS. Default is BTS. Note that Carrier sub op code 2 is supported only in Non-SA modes. In the SA mode, Carrier sub op code 1 is used for both BTS and MS. When setting these values remotely, the position in the list sent corresponds to the carrier. Missing values are not permitted, therefore if you want to change values 2 and 6 you must send all values up to 6. Subsequent values will remain unchanged, unless the number of values sent is greater than the number of carriers, then subsequent values will be ignored.
Dependencies	If there is only one carrier, this key will be grayed out.
Couplings	Coupled to the number of carriers. When the SCPI command is sent, the number of carriers will be set to the number of entries in the parameter list.

Preset	YES
State Saved	Saved in instrument state.
Range	Yes No
Backwards Compatibility SCPI	<code>[:SENSE] :MCPower:CARRIER[1] 2 :LIST:PPResent (PSA Power Suite)</code>
Initial S/W Revision	Prior to A.02.00
Modified at S/W Revision	A.02.00, A.03.00

Carrier Spacing

Sets the width of the carrier spacing. This will be the value applied to all the current slots, whether they are carriers or spaces.

Enter each carrier spacing value individually by selecting the desired carrier on the carrier menu key using the up down arrows, the knob, or the numeric keypad, then enter the carrier width using the carrier spacing menu key.

Key Path	Meas Setup, Carrier Setup, Configure Carriers
Mode	SA, WCDMA, C2K, WIMAX OFDMA, 1xEVDO, TD-SCDMA, DVB-T/H, DTMB (CTTB), ISDB-T, CMMB, LTE, LTE-TDD, Digital Cable TV
Remote Command	<code>[:SENSE] :ACPPower:CARRIER[1] 2 :LIST:WIDTH <freq>, <freq>, <freq>, <freq>, <freq>, <freq></code> <code>[:SENSE] :ACPPower:CARRIER[1] 2 :LIST:WIDTH?</code>
Example	ACP:CARR2:LIST:WIDT 25kHz ACP:CARR2:LIST:WIDT?
Notes	Carrier sub op code. 1 for BTS, 2 for MS. Default is BTS. Note that Carrier sub op code 2 is supported only in Non-SA modes. In the SA mode, Carrier sub op code 1 is used for both BTS and MS. When setting these values remotely, the position in the list sent corresponds to the carrier. Missing values are not permitted, therefore if you want to change values 2 and 6 you must send all values up to 6. Subsequent values will remain unchanged, unless the number of values sent is greater than the number of carriers, then subsequent values will be ignored. You must be in the mode that includes ACP measurements to use this command. Use :INSTRument:SElect to set the mode.
Couplings	Coupled to the number of carriers. When the SCPI command is sent, the number of carriers will be set to the number of entries in the parameter list. Changing Carrier Spacing might affect the Span.
Preset	SA, WCDMA: 5 MHz WIMAX OFDMA: 10 MHz C2K: 1.25 MHz 1xEVDO: 1.25 MHz

	TD-SCDMA: 1.6 MHz DVB-T/H: 8 MHz DTMB (CTTB): 8 MHz ISDB-T: 6 MHz CMMB: 8 MHz LTE: 5 MHz LTETDD: 5 MHz Digital Cable TV: 8 MHz
State Saved	Saved in instrument state.
Min	0 Hz
Max	1 GHz
Backwards Compatibility SCPI	<code>[[:SENSe]:MCPower:CARRier[1] 2:LIST:WIDTh (PSA Power Suite)</code>
Initial S/W Revision	Prior to A.02.00
Modified at S/W Revision	A.02.00, A.03.00

Measurement Noise Bandwidth

Specifies the Measurement Noise Bandwidth used to calculate the power in the carriers.

Each Measurement Noise Bandwidth value is entered individually by selecting the desired carrier on the carrier menu key using the up down arrows, the knob, or the numeric keypad. Then enter the measurement noise bandwidth using the measurement noise bandwidth key.

Key Path	Meas Setup, Carrier Setup, Configure Carriers
Mode	SA, WCDMA, C2K, WIMAX OFDMA, TD-SCDMA, 1xEVDO, DVB-T/H, DTMB (CTTB), ISDB-T, CMMB, LTE, LTETDD, Digital Cable TV
Remote Command	<code>[[:SENSe]:ACPPower:CARRier[1] 2:LIST:BANDwidth[:INTEgration] <freq>, <freq>, <freq>, <freq>, <freq></code> <code>[[:SENSe]:ACPPower:CARRier[1] 2:LIST:BANDwidth[:INTEgration]?</code>
Example	ACP:CARR2:LIST:BAND 25kHz ACP:CARR2:LIST:BAND?
Notes	In the WCDMA mode, the preset/default value is defined as 3.84 MHz. But internally, 4.6848 MHz is used as the default value. Carrier sub op code. 1 for BTS, 2 for MS. Default is BTS. Note that Carrier sub op code 2 is supported only in Non-SA modes. In the SA mode, Carrier sub op code 1 is used for both BTS and MS. When setting these values remotely, the position in the list sent corresponds to the carrier. Missing values are not permitted, therefore if you want to change values 2 and 6 you must send all values up to 6. Subsequent values will remain unchanged, unless the number of values sent is greater than the number of carriers, then subsequent values will be ignored. You must be in the mode that includes ACP measurements to use this command. Use

	:INSTrument:SElect to set the mode.
Couplings	Coupled to the number of carriers. When the SCPI command is sent, the number of carriers is set to the number of entries in the parameter list.
Preset	SA: 2 MHz WCDMA: 3.84 MHz WIMAX OFDMA: 10 MHz C2K: 1.23MHz TD-SCDMA: 1.28 MHz 1xEVDO: 1.23 MHz DVB-T/H: 7.61 MHz DTMB (CTTB): 7.56 MHz ISDB-T: 5.6 MHz CMMB: 7.512 MHz LTE, LTE-TDD: 4.515 MHz 4.5 MHz Digital Cable TV: 8.0 MHz
State Saved	Saved in instrument state.
Min	10 Hz
Max	1 GHz
Backwards Compatibility SCPI	[:SENSe] :ACPower :BANDwidth :INTEgration [:SENSe] :ACPower :BWIDth :INTEgration [:SENSe] :ACPower :CARRier [1] 2 :LIST :BWIDth [:INTEgration] [:SENSe] :MCPower :CARRier [1] 2 :LIST :BANDwidth [:INTEgration] (PSA Power Suite) [:SENSe] :MCPower :CARRier [1] 2 :LIST :BWIDth [:INTEgration] (PSA Power Suite)
Initial S/W Revision	Prior to A.02.00
Modified at S/W Revision	A.02.00, A.03.00

Method for Carrier

Accesses the carrier configuration method settings.

Key Path	Meas Setup, Carrier Setup, Configure Carriers
Mode	SA, WCDMA, WIMAX OFDMA, TD-SCDMA, DVB-T/H, DTMB (CTTB), ISDB-T, CMMB, LTE, LTE-TDD, Digital Cable TV
Remote Command	[:SENSe] :ACPower :CARRier [1] 2 :LIST :FILTEr [:RRC] [:STATE] ON OFF 1 0, ON OFF 1 0, ON OFF 1 0, ON OFF 1 0, ON OFF 1 0 [:SENSe] :ACPower :CARRier [1] 2 :LIST :FILTEr [:RRC] [:STATE] ?
Example	ACP:CARR:LIST:FILT 0,0,0,0 ACP:CARR:LIST:FILT?

Notes	The binary values translate as follows: 1 ON = RRC Weighted 0 OFF = Integ BW Maximum of Array length depends on the number of carriers. You must be in the mode that includes ACP measurements to use this command. Use :INSTrument:SElect to set the mode.
Preset	SA, LTE, LTETDD: OFF WCDMA: ON WIMAX OFDMA: OFF TD-SCDMA: ON DVB-T/H: OFF DTMB (CTTB): ON ISDB-T, CMMB: OFF Digital Cable TV: OFF
State Saved	Saved in instrument state.
Range	IntegBW RRC Weight
Initial S/W Revision	Prior to A.02.00
Modified at S/W Revision	A.02.00, A.03.00

Filter Alpha for Carrier

Inputs the alpha value for the filter used in the current carrier configuration.

Key Path	Meas Setup, Carrier Setup, Configure Carriers, Method, RRC Weighted
Mode	SA, WCDMA, WIMAX OFDMA, TD-SCDMA, DVB-T/H, DTMB (CTTB), ISDB-T, CMMB, LTE, LTETDD, Digital Cable TV
Remote Command	[[:SENSE]:ACPpower:CARRier[1] 2:LIST:FILTer:ALPHA <real>, <real>, <real>, <real>, <real>, <real> [:SENSE]:ACPpower:CARRier[1] 2:LIST:FILTer:ALPHA?
Example	ACP:CARR2:LIST:FILT:ALPH 0.5 ACP:CARR2:LIST:FILT:ALPH?
Notes	You must be in the mode that includes ACP measurements to use this command. Use :INSTrument:SElect to set the mode.
Preset	0.22 C2K: No DTMB (CTTB): 0.05 Digital Cable TV: 0.15
State Saved	Saved in instrument state.
Min	0.01
Max	1.0

Initial S/W Revision	Prior to A.02.00
Modified at S/W Revision	A.02.00, A.03.00

Offset/Limits

Accesses a menu of functions that contains Offset, Offset Freq/Offset To Edge, Offset Integ BW, Upper Offset Limit and Lower Offset parameters. When in the MSR and LTE-Advanced FDD/TDD mode, the softkey label changes to Outer Offset/Limits.

Key Path	Meas Setup
Initial S/W Revision	Prior to A.02.00
Modified at S/W Revision	A.13.00

Select Offset

Selects the offset to configure.

Key Path	Meas Setup, Offset/Limits, Limits
Mode	SA, WCDMA, C2K, WIMAX OFDMA, TD-SCDMA, 1xEVDO, DVB-T/H, DTMB (CTTB), ISDB-T, CMMB, LTE, LTE-TDD, Digital Cable TV, MSR, LTEAFDD, LTEATDD
Preset	A
State Saved	Saved in instrument state.
Range	Offset A Offset B Offset C Offset D Offset E Offset F
Initial S/W Revision	Prior to A.02.00
Modified at S/W Revision	A.02.00, A.03.00, A.13.00

Offset Freq

This parameter determines the frequency difference between the center of the main channel and the center of the carrier.

Each Offset Freq state value is entered individually by selecting the desired carrier on the carrier menu key using the up down arrows, RPG or numeric keypad. Then enter the Offset Freq State using the Offset Frequency key.

The list contains up to six (6) entries, depending on the mode selected, for offset frequencies. Each offset frequency in the list corresponds to a reference bandwidth in the bandwidth list.

An offset frequency of zero turns the display of the measurement for that offset off, but the measurement is still made and reported. You can turn off (not use) specific offsets with the [:SENSe]:ACP:OFFSet:LIST:STATe command.

Turning the offset off has the same effect as setting the frequency of the offset to 0 Hz and will cause it to be removed from the results screen.

Key Path	Meas Setup, Offset/Limits
Mode	SA, WCDMA, C2K, WIMAX OFDMA, TD-SCDMA, 1xEVDO, DVB-T/H, DTMB (CTTB), ISDB-T, CMMB, LTE, LTETDD, Digital Cable TV, MSR, LTEAFDD, LTEATDD
Remote Command	<pre>[:SENSE]:ACPpower:OFFSet [1] 2[:OUTer]:LIST[:FREQuency] <freq>, <freq>, <freq>, <freq>, <freq>, <freq> [:SENSE]:ACPpower:OFFSet [1] 2[:OUTer]:LIST[:FREQuency]? [:SENSE]:ACPpower:OFFSet [1] 2[:OUTer]:LIST:STATe OFF ON 0 1, OFF ON 0 1, OFF ON 0 1, OFF ON 0 1, OFF ON 0 1, OFF ON 0 1 [:SENSE]:ACPpower:OFFSet [1] 2[:OUTer]:LIST:STATe?</pre>
Example	<pre>ACP:OFFS1:LIST 0,0,0,0,0 ACP:OFFS1:LIST? ACP:OFFS2:LIST:STAT 1,1,0,0,0 ACP:OFFS2:LIST:STAT?</pre>
Notes	<p>The label for this menu key will change depending on the currently selected radio standard or mode. For cdma2000 the label for the menu key will be Offset to Edge. For all other supported standards the label will be Offset Freq.</p> <p>When setting these values remotely, the position in the list sent corresponds to the offset. Missing values are not permitted, unless the number of values sent is greater than the number of carriers, then subsequent values will be ignored.</p> <p>Offset sub op code. 1 for BTS, 2 for MS. Default is BTS.</p> <p>Note that Offset sub op code 2 is supported only in Non-SA modes.</p> <p>In the SA mode, Offset sub op code 1 is used for both BTS and MS.</p> <p>You must be in the mode that includes ACP measurements to use this command. Use :INSTrument:SElect to set the mode.</p>
Couplings	Changing Offset Frequency might affect the Span. See the Span key section for details.
Preset	<pre>SA: 3 MHz, 0 Hz, 0 Hz, 0 Hz, 0 Hz, 0 Hz 3 MHz, 0 Hz, 0 Hz, 0 Hz, 0 Hz, 0 Hz WCDMA: 5.0 MHz, 10.0 MHz, 0 Hz, 0 Hz, 0 Hz, 0 Hz 5.0 MHz, 10.0 MHz, 0 Hz, 0 Hz, 0 Hz, 0 Hz WIMAX OFDMA: 10 MHz, 20 MHz, 0 Hz, 0 Hz, 0 Hz, 0 Hz 10 MHz, 20 MHz, 0 Hz, 0 Hz, 0 Hz, 0 Hz C2K:750KHz, 1.980 MHz, 0 Hz, 0 Hz, 0 Hz, 0 Hz 885 kHz, 1.980 MHz, 0 Hz, 0 Hz, 0 Hz, 0 Hz TD-SCDMA: 1.6 MHz, 3.2 MHz, 0 Hz, 0 Hz, 0 Hz, 0 Hz 1.6 MHz, 3.2 MHz, 0 Hz, 0 Hz, 0 Hz, 0 Hz 1xEVDO: 750KHz, 1.98MHz, 3.125MHz, 4.000MHz, 7.500MHz, 7.500MHz 885KHz, 1.98MHz, 3.125MHz, 4.000MHz, 7.500MHz, 7.500MHz DVB-T/H: 8 MHz, 16 MHz, 0 Hz, 0 Hz, 0 Hz, 0 Hz 8 MHz, 16 MHz, 0 Hz, 0 Hz, 0 Hz, 0 Hz DTMB (CTTB): 8 MHz, 16 MHz, 24 MHz, 32 MHz, 0 Hz, 0 Hz 8 MHz, 16 MHz, 24 MHz, 32 MHz, 0 Hz, 0 Hz ISDB-T: 6 MHz, 12 MHz, 0 Hz, 0 Hz, 0 Hz, 0 Hz 6 MHz, 12 MHz, 0 Hz, 0 Hz, 0 Hz, 0 Hz CMMB: 8 MHz, 16 MHz, 24 MHz, 32 MHz, 0 Hz, 0 Hz 8 MHz, 16 MHz, 24 MHz, 32 MHz, 0 Hz, 0 Hz LTE, LTETDD, MSR, LTEAFDD, LTEATDD: 5 MHz, 10 MHz, 0, 0, 0, 0 5 MHz, 10 MHz, 0, 0, 0, 0 Digital Cable TV: 8 MHz, 16 MHz, 0 Hz, 0 Hz, 0 Hz, 0 Hz 8 MHz, 16 MHz, 0 Hz, 0 Hz, 0 Hz, 0 Hz</pre>

	SA: ON, OFF, OFF, OFF, OFF, OFF ON, OFF, OFF, OFF, OFF, OFF WCDMA: ON, ON, OFF, OFF, OFF, OFF ON, ON, OFF, OFF, OFF, OFF WIMAX OFDMA: ON, ON, OFF, OFF, OFF, OFF ON, ON, OFF, OFF, OFF, OFF TD-SCDMA: ON, ON, OFF, OFF, OFF, OFF ON, ON, OFF, OFF, OFF, OFF DVB-T/H: ON, ON, OFF, OFF, OFF, OFF ON, ON, OFF, OFF, OFF, OFF DTMB (CTTB): ON, ON, OFF, OFF, OFF, OFF ON, ON, OFF, OFF, OFF, OFF CDMA1xEVDO: ON, ON, OFF, OFF, OFF, OFF ON, ON, OFF, OFF, OFF, OFF ISDB-T: ON, ON, OFF, OFF, OFF, OFF ON, ON, OFF, OFF, OFF, OFF CMMB: ON, ON, ON, ON, OFF, OFF ON, ON, ON, ON, OFF, OFF LTE, LTEFDD, MSR, LTEAFDD, LTEATDD: ON, ON, OFF, OFF, OFF, OFF ON, OFF, OFF, OFF, OFF, OFF Digital Cable TV: ON, ON, OFF, OFF, OFF, OFF ON, ON, OFF, OFF, OFF, OFF
State Saved	Saved in instrument state.
Min	0 Hz
Max	500 MHz
Backwards Compatibility SCPI	<code>[[:SENSe]:MCPower:OFFSet[1] 2:LIST[:FREQuency] (PSA Power Suite)</code>
Initial S/W Revision	Prior to A.02.00
Modified at S/W Revision	A.02.00, A.03.00, A.13.00

Integ BW

Sets the Integration Bandwidth for the offsets. Each resolution bandwidth in the list corresponds to an offset frequency in the list defined by `[[:SENSe]:ACP:OFFSet[n]::OUTer]:LIST[:FREQuency]`.

Enter each value individually by selecting the desired offset on the offset menu key using the up down arrows, the knob, or the numeric keypad, then enter the Offset Integration Bandwidth using the Offset Integration Bandwidth menu key.

You can turn off (not use) specific offsets with the `[[:SENSe]:ACP:OFFSet[n]::OUTer]:LIST:STATe` command.

Key Path	Meas Setup, Offset/Limits
Mode	SA, WCDMA, C2K, WIMAX OFDMA, TD-SCDMA, 1xEVDO, DVB-T/H, DTMB (CTTB), ISDB-T, CMMB, LTE, LTEFDD, Digital Cable TV, MSR, LTEAFDD, LTEATDD
Remote Command	<code>[[:SENSe]:ACP:OFFSet[1] 2[:OUTer]:LIST:BANDwidth[:INTegration]</code> <code><freq>, <freq>, <freq>, <freq>, <freq>, <freq></code> <code>[[:SENSe]:ACP:OFFSet[1] 2[:OUTer]:LIST:BANDwidth[:INTegration]?</code>
Example	ACP:OFFS2:LIST:BAND 2MHz, 2MHz, 2MHz, 2MHz, 2MHz, 2MHz ACP:OFFS2:LIST:BAND?
Notes	When setting these values remotely, the position in the list sent corresponds to the offset. Missing values are not permitted i.e. if you want to change the second value, you must send all values up to it. Subsequent values will remain unchanged, unless the number of values sent is greater than the number of carriers, then subsequent values will be ignored.

	<p>Offset sub op code. 1 for BTS, 2 for MS. Default is BTS.</p> <p>Note that Offset sub op code 2 is supported only in Non-SA modes.</p> <p>In the SA mode, Offset sub op code 1 is used for both BTS and MS.</p> <p>You must be in the mode that includes ACP measurements to use this command. Use :INSTRument:SElect to set the mode.</p>
Couplings	Changing Integ BW might affect the Span. See Span section for details.
Preset	<p>SA: 2 MHz, 2 MHz, 2 MHz, 2 MHz, 2 MHz, 2 MHz 2 MHz, 2 MHz, 2 MHz, 2 MHz, 2 MHz, 2 MHz</p> <p>WCDMA: 3.84 MHz, 3.84 MHz, 3.84 MHz, 3.84 MHz, 3.84 MHz, 3.84 MHz 3.84 MHz, 3.84 MHz, 3.84 MHz, 3.84 MHz, 3.84 MHz, 3.84 MHz</p> <p>WIMAX OFDMA: 10 MHz, 10 MHz, 10 MHz, 10 MHz, 10 MHz, 10 MHz 10 MHz, 10 MHz, 10 MHz, 10 MHz, 10 MHz, 10 MHz</p> <p>C2K: 30 kHz, 30 kHz, 30 kHz, 30 kHz, 30 kHz, 30 kHz 30 kHz, 30 kHz, 30 kHz, 30 kHz, 30 kHz, 30 kHz</p> <p>TD-SCDMA: 1.28 MHz, 1.28 MHz, 1.28 MHz, 1.28 MHz, 1.28 MHz, 1.28 MHz</p> <p>1xEVDO: C2K: 30 kHz, 30 kHz, 30 kHz, 30 kHz, 30 kHz, 30 kHz 30 kHz, 30 kHz, 30 kHz, 30 kHz, 30 kHz, 30 kHz</p> <p>DVB-T/H: 7.61 MHz, 7.61 MHz, 7.61 MHz, 7.61 MHz, 7.61 MHz, 7.61 MHz 7.61 MHz, 7.61 MHz, 7.61 MHz, 7.61 MHz, 7.61 MHz, 7.61 MHz</p> <p>DTMB (CTTB): 7.56 MHz, 7.56 MHz, 7.56 MHz, 7.56 MHz, 7.56 MHz, 7.56 MHz 7.56 MHz, 7.56 MHz, 7.56 MHz, 7.56 MHz, 7.56 MHz, 7.56 MHz</p> <p>ISDB-T: 5.6 MHz, 5.6 MHz, 5.6 MHz, 5.6 MHz, 5.6 MHz, 5.6 MHz 5.6 MHz, 5.6 MHz, 5.6 MHz, 5.6 MHz, 5.6 MHz, 5.6 MHz</p> <p>CMMB: 7.512 MHz, 7.512 MHz, 7.512 MHz, 7.512 MHz, 7.512 MHz, 7.512 MHz 7.512 MHz, 7.512 MHz, 7.512 MHz, 7.512 MHz, 7.512 MHz, 7.512 MHz</p> <p>LTE, LTE-TDD, MSR, LTEAFDD, LTEATDD: 4.515 MHz, 4.515 MHz, 4.515 MHz, 4.515 MHz, 4.515 MHz, 4.515 MHz 4.5 MHz, 4.5 MHz, 4.5 MHz, 4.5 MHz, 4.5 MHz, 4.5 MHz</p> <p>Digital Cable TV: 8.0 MHz, 8.0 MHz, 8.0 MHz, 8.0 MHz, 8.0 MHz, 8.0 MHz 8.0 MHz, 8.0 MHz, 8.0 MHz, 8.0 MHz, 8.0 MHz, 8.0 MHz</p>
State Saved	Saved in instrument state.
Min	10 Hz
Max	1 GHz
Backwards Compatibility SCPI	<pre>[:SENSe]:ACPower:OFFSet [1] 2:LIST:BWIDth[:INTEgration]</pre> <pre>[:SENSe]:ACPR:OFFSet [1] 2:LIST:BANDwidth</pre> <pre>[:SENSe]:ACPR:OFFSet [1] 2:LIST:BWIDth</pre> <pre>[:SENSe]:MCPower:OFFSet [1] 2:LIST:BANDwidth[:INTEgration] (PSA Power Suite)</pre> <pre>[:SENSe]:MCPower:OFFSet [1] 2:LIST:BWIDth[:INTEgration] (PSA Power Suite)</pre>
Initial S/W Revision	Prior to A.02.00
Modified at S/W Revision	A.02.00, A.03.00, A.13.00

Offset BW

Accesses the offset bandwidth menu.

Key Path	Meas Setup, Offset/Limits
Initial S/W Revision	Prior to A.02.00

Res BW

Sets the resolution bandwidth. If an unavailable bandwidth is entered with the numeric keypad, the closest available bandwidth is selected.

Key Path	Meas Setup, Offset/Limits
Mode	SA, WCDMA, C2K, WIMAX OFDMA, TD-SCDMA, 1xEVDO, DVB-T/H, DTMB (CTTB), ISDB-T, CMMB, LTE, LTE-TDD, Digital Cable TV, MSR, LTEAFDD, LTEATDD
Remote Command	<pre>[:SENSe]:ACPower:OFFSet [1] 2[:OUTer]:LIST:BANDwidth:RESolution <freq>, <freq>, <freq>, <freq>, <freq> [:SENSe]:ACPower:OFFSet [1] 2[:OUTer]:LIST:BANDwidth:RESolution? [:SENSe]:ACPower:OFFSet [1] 2[:OUTer]:LIST:BANDwidth:RESolution:AUTO ON OFF 1 0, ON OFF 1 0, ON OFF 1 0, ON OFF 1 0, ON OFF 1 0, ON OFF 1 0 [:SENSe]:ACPower:OFFSet [1] 2[:OUTer]:LIST:BANDwidth:RESolution:AUTO?</pre>
Example	<pre>ACP:OFFS2:LIST:BAND:RES 220kHz, 220kHz, 220kHz, 220kHz, 220kHz, 220kHz ACP:OFFS2:LIST:BAND:RES? ACP:OFFS2:LIST:BAND:RES:AUTO 1,1,1,1,1,1 ACP:OFFS2:LIST:BAND:RES:AUTO?</pre>
Notes	<p>Offset sub op code. 1 for BTS, 2 for MS. Default is BTS.</p> <p>Note that Offset sub op code 2 is supported only in Non-SA modes.</p> <p>In the SA mode, Offset sub op code 1 is used for both BTS and MS.</p> <p>You must be in the mode that includes ACP measurements to use this command. Use :INSTrument:SElect to set the mode.</p>
Dependencies	When Meas Method is RBW or FAST, this key is grayed out and disabled. If the key is pressed, an advisory message is generated. If the equivalent remote command is sent, a "Setting conflict" warning is generated.
Couplings	When Res BW Mode is AUTO, this value is exactly same as Res BW under BW key. And when this value is changed by user, Res BW Mode is also changed to Man.
Preset	<pre>SA: 220 kHz, 220 kHz, 220 kHz, 220 kHz, 220 kHz, 220 kHz WCDMA: 100 kHz, 100 kHz, 100 kHz, 100 kHz, 100 kHz, 100 kHz WIMAX OFDMA: 100 kHz, 100 kHz, 100 kHz, 100 kHz, 100 kHz, 100 kHz C2K: Method:RBW 30 kHz</pre>

	<p>Method: IBW C2K: 15 kHz, 15 kHz, 15 kHz, 15 kHz, 15 kHz, 15 kHz 15 kHz, 15 kHz, 15 kHz, 15 kHz, 15 kHz, 15 kHz TD-SCDMA: 30 kHz, 30 kHz, 30 kHz, 30 kHz, 30 kHz, 30 kHz 1xEVDO: 30KHz, 30KHz, 30KHz, 30KHz, 30KHz, 30KHz 30KHz, 30KHz, 30KHz, 30KHz, 30KHz, 30KHz DVB-T/H: 39 kHz, 39 kHz, 39 kHz, 39 kHz, 39 kHz, 39 kHz 39 kHz, 39 kHz, 39 kHz, 39 kHz, 39 kHz, 39 kHz DTMB (CTTB): 39 kHz, 39 kHz, 39 kHz, 39 kHz, 39 kHz, 39 kHz 39 kHz, 39 kHz, 39 kHz, 39 kHz, 39 kHz, 39 kHz ISDB-T: 39 kHz, 39 kHz, 39 kHz, 39 kHz, 39 kHz, 39 kHz 39 kHz, 39 kHz, 39 kHz, 39 kHz, 39 kHz, 39 kHz CMMB: 39 kHz, 39 kHz, 39 kHz, 39 kHz, 39 kHz, 39 kHz 39 kHz, 39 kHz, 39 kHz, 39 kHz, 39 kHz, 39 kHz LTE, LTE-TDD, MSR, LTEAFDD, LTEATDD: 100 kHz, 100 kHz, 100 kHz, 100 kHz, 100kHz, 100 kHz 100 kHz, 100 kHz, 100 kHz, 100 kHz, 100 kHz, 100 kHz Digital Cable TV: 39 kHz, 39 kHz, 39 kHz, 39 kHz, 39 kHz, 39 kHz 39 kHz, 39 kHz, 39 kHz, 39 kHz, 39 kHz, 39 kHz 1, 1, 1, 1, 1, 1</p>
State Saved	Saved in instrument state.
Min	1 Hz
Max	8 MHz
Backwards Compatibility SCPI	<code>[:SENSe] :ACPower:OFFSet [1] 2 :LIST:BWIDth:RESolution</code>
Initial S/W Revision	Prior to A.02.00
Modified at S/W Revision	A.02.00, A.03.00, A.13.00

Video BW

Enables you to change the analyzer post-detection filter (VBW).

Key Path	Meas Setup, Offset/Limits, Offset BW
Mode	SA, WCDMA, C2K, WIMAX OFDMA, TD-SCDMA, 1xEVDO, DVB-T/H, DTMB (CTTB), ISDB-T, CMMB, LTE, LTE-TDD, Digital Cable TV, MSR, LTEAFDD, LTEATDD
Remote Command	<pre>[:SENSe] :ACPower:OFFSet [1] 2 [:OUTer] :LIST:BAWdwidth:VIDeo <freq>, <freq>, <freq>, <freq>, <freq> [:SENSe] :ACPower:OFFSet [1] 2 [:OUTer] :LIST:BAWdwidth:VIDeo? [:SENSe] :ACPower:OFFSet [1] 2 [:OUTer] :LIST:BAWdwidth:VIDeo:AUTO OFF ON 0 1, OFF ON 0 1, OFF ON 0 1, OFF ON 0 1, OFF ON 0 1, OFF ON 0 1 [:SENSe] :ACPower:OFFSet [1] 2 [:OUTer] :LIST:BAWdwidth:VIDeo:AUTO?</pre>
Example	ACP:OFFS2:LIST:BAW:VID 5MHz, 5MHz, 5MHz, 5MHz, 5MHz, 5MHz

	<p>ACP:OFFS2:LIST:BAND:VID?</p> <p>ACP:OFFS2:LIST:BAND:VID:AUTO 0,0,0,0,1,1</p> <p>ACP:OFFS2:LIST:BAND:VID:AUTO?</p>
Notes	<p>The values shown in this table reflect the conditions after a Mode Preset.</p> <p>Offset sub op code. 1 for BTS, 2 for MS. Default is BTS.</p> <p>Note that Offset sub op code 2 is supported only in Non-SA modes.</p> <p>In the SA mode, Offset sub op code 1 is used for both BTS and MS.</p> <p>You must be in the mode that includes ACP measurements to use this command. Use :INSTrument:SElect to set the mode.</p> <p>.</p>
Dependencies	<p>When Meas Method is RBW or FAST, this key is grayed out and disabled. If the key is pressed, an advisory message is generated. If the equivalent remote command is sent, a "Setting conflict" warning is generated.</p>
Preset	<p>SA: 22 kHz, 22 kHz, 22 kHz, 22 kHz, 22 kHz, 22 kHz</p> <p>WCDMA, WIMAX OFDMA: 1 MHz, 1 MHz, 1 MHz, 1 MHz, 1 MHz, 1 MHz</p> <p>C2K: 150 kHz, 150 kHz, 150 kHz, 150 kHz, 150 kHz, 150 kHz 150 kHz, 150 kHz, 150 kHz, 1150 kHz, 1150 kHz, 150 kHz</p> <p>TD-SCDMA: 300 kHz, 300 kHz, 300 kHz, 300 kHz, 300 kHz, 300 kHz</p> <p>1xEVDO: 300KHz, 300KHz, 300KHz, 300KHz, 300KHz, 300KHz 300KHz, 300KHz, 300KHz, 300KHz, 300KHz, 300KHz</p> <p>DVB-T/H: 390 kHz, 390 kHz, 390 kHz, 390 kHz, 390 kHz, 390 kHz 390 kHz, 390 kHz, 390 kHz, 390 kHz, 390 kHz, 390 kHz</p> <p>DTMB (CTTB): 390 kHz, 390 kHz, 390 kHz, 390 kHz, 390 kHz, 390 kHz 390 kHz, 390 kHz, 390 kHz, 390 kHz, 390 kHz, 390 kHz</p> <p>ISDB-T: 390 kHz, 390 kHz, 390 kHz, 390 kHz, 390 kHz, 390 kHz 390 kHz, 390 kHz, 390 kHz, 390 kHz, 390 kHz, 390 kHz</p> <p>CMMB: 390 kHz, 390 kHz, 390 kHz, 390 kHz, 390 kHz, 390 kHz 390 kHz, 390 kHz, 390 kHz, 390 kHz, 390 kHz, 390 kHz</p> <p>LTE, LTEFDD, MSR, LTEAFDD, LTEATDD: 1 MHz, 1 MHz, 1 MHz, 1 MHz, 1 MHz, 1 MHz</p> <p>Digital Cable TV: 390 kHz, 390 kHz, 390 kHz, 390 kHz, 390 kHz, 390 kHz 390 kHz, 390 kHz, 390 kHz, 390 kHz, 390 kHz, 390 kHz</p> <p>ON, ON, ON, ON, ON, ON</p>
State Saved	<p>Saved in instrument state.</p>
Min	<p>1 Hz</p>
Max	<p>50 MHz</p>
Backwards Compatibility SCPI	<p>[:SENSe] :ACPowEr:OFFSet [1] 2 :LIST:BWIDth:VIDeo</p>
Initial S/W Revision	<p>Prior to A.02.00</p>
Modified at S/W Revision	<p>A.02.00, A.03.00, A.13.00</p>

RBW Control

Accesses the resolution bandwidth control menu.

Key Path	Meas Setup, Offset/Limits, Offset BW
Initial S/W Revision	Prior to A.02.00

Filter Type

Selects the type of bandwidth filter that is used.

Key Path	Meas Setup, Offset/Limits, Offset BW, RBW Control
Mode	SA, WCDMA, C2K, WIMAX OFDMA, TD-SCDMA, 1xEVDO, DVB-T/H, DTMB (CTTB), ISDB-T, CMMB, LTE, LTEFDD, Digital Cable TV, MSR, LTEAFDD, LTEATDD
Remote Command	[:SENSe]:ACPower:OFFSet[1] 2[:OUTer]:LIST:BANDwidth:SHAPE GAUSSian FLATtop, GAUSSian FLATtop, GAUSSian FLATtop, GAUSSian FLATtop, GAUSSian FLATtop, GAUSSian FLATtop [:SENSe]:ACPower:OFFSet[1] 2[:OUTer]:LIST:BANDwidth:SHAPE?
Example	ACP:OFFS2:LIST:BAND:SHAP FLAT, GAUS, GAUS, GAUS, GAUS, GAUS ACP:OFFS2:LIST:BAND:SHAP?
Notes	Offset sub op code. 1 for BTS, 2 for MS. Default is BTS. Note that Offset sub op code 2 is supported only in Non-SA modes. In the SA mode, Offset sub op code 1 is used for both BTS and MS. You must be in the mode that includes ACP measurements to use this command. Use :INSTrument:SElect to set the mode.
Dependencies	When Res BW Mode for the offset is Auto, this key is grayed out and disabled. Since Res BW Mode for the offset is preset to Auto on changing Meas Method to RBW or FAST, this key is grayed out and disabled too. If the key is pressed, an advisory message is generated. If the equivalent remote command is sent, a "Setting conflict" warning is generated.
Couplings	See the description above
Preset	GAUSSian, GAUSSian, GAUSSian, GAUSSian, GAUSSian, GAUSSian
State Saved	Saved in instrument state.
Range	GAUSSian FLATtop
Backwards Compatibility SCPI	[:SENSe]:ACPower:OFFSet[1] 2:LIST:BWIDth:SHAPE
Initial S/W Revision	Prior to A.02.00
Modified at S/W Revision	A.02.00, A.03.00, A.13.00

Filter BW

Selects a Gaussian filter based on its -3 dB (Normal) bandwidth or its -6 dB bandwidth.

Key Path	Meas Setup, Offset/Limits, Offset BW, RBW Control
Mode	SA, WCDMA, C2K, WIMAX OFDMA, TD-SCDMA, 1xEVDO, DVB-T/H, DTMB (CTTB), ISDB-T, CMMB, LTE, LTE-TDD, Digital Cable TV, MSR, LTEAFDD, LTEATDD
Remote Command	<code>[:SENSe] :ACPower:OFFSet [1] 2 [:OUTer] :LIST:BANDwidth:TYPE DB3 DB6, DB3 DB6, DB3 DB6, DB3 DB6, DB3 DB6, DB3 DB6</code> <code>[:SENSe] :ACPower:OFFSet [1] 2 [:OUTer] :LIST:BANDwidth:TYPE?</code>
Example	ACP:OFFS2:LIST:BAND:TYPE DB3, DB3, DB3, DB3, DB3, DB3 ACP:OFFS2:LIST:BAND:TYPE?
Notes	Offset sub op code. 1 for BTS, 2 for MS. Default is BTS. Note that Offset sub op code 2 is supported only in Non-SA modes. In the SA mode, Offset sub op code 1 is used for both BTS and MS. You must be in the mode that includes ACP measurements to use this command. Use :INSTrument:SElect to set the mode.
Dependencies	When Filter Type if Flattop or Res BW Mode for the offset is Auto, this key is grayed out and disabled. Since Res BW Mode for the offset is preset to Auto on changing Meas Method to RBW or FAST, this key is grayed out and disabled too. If the key is pressed, an advisory message is generated. If the equivalent remote command is sent, a "Setting conflict" warning is generated.
Preset	DB3, DB3, DB3, DB3, DB3, DB3
State Saved	Saved in instrument state.
Range	-3 dB (Normal) -6 dB
Backwards Compatibility SCPI	<code>[:SENSe] :ACPower:OFFSet [1] 2 :LIST:BWIDth:TYPE</code>
Initial S/W Revision	Prior to A.02.00
Modified at S/W Revision	A.02.00, A.03.00, A.13.00

Limits

Limits key accesses a menu of functions that contains Select Offset, Abs Limit, Rel Limit and Fail Mask parameters.

Key Path	Meas Setup, Offset/Limits
Initial S/W Revision	A.03.00

Select Offset

Selects the offset to configure.

Key Path	Meas Setup, Offset/Limits, Limits
Mode	SA, WCDMA, C2K, WIMAX OFDMA, TD-SCDMA, 1xEVDO, DVB-T/H, DTMB (CTTB), ISDB-T, CMMB, LTE, LTE-TDD, Digital Cable TV, MSR, LTEAFDD, LTEATDD

Preset	A
State Saved	Saved in instrument state.
Range	Offset A Offset B Offset C Offset D Offset E Offset F
Initial S/W Revision	Prior to A.02.00
Modified at S/W Revision	A.02.00, A.03.00, A.13.00

Abs Limit

Enters an absolute limit value, which sets the absolute amplitude levels to test against for each of the custom offsets. The list must contain six (6) entries. If there is more than one offset, the offset closest to the carrier channel is the first one in the list. [:SENSe]:ACP:OFFSet[n][:OUTer]:LIST:TEST selects the type of testing to be done at each offset.

You can turn off (not use) specific offsets with the [:SENSe]:ACP:OFFSet[n][:OUTer]:LIST:STATe command.

The query returns the six (6) sets of real numbers that are the current absolute amplitude test limits.

Key Path	Meas Setup, Offset/Limits, Limits
Mode	SA, WCDMA, C2K, WIMAX OFDMA, TD-SCDMA, 1xEVDO, DVB-T/H, DTMB (CTTB), ISDB-T, CMMB, LTE, LTETDD, Digital Cable TV, MSR,LTEAFDD,LTEATDD
Remote Command	[:SENSe]:ACP:Power:OFFSet[1] 2[:OUTer]:LIST:ABSolute <real>, <real>, <real>, <real>, <real>, <real> [:SENSe]:ACP:Power:OFFSet[1] 2[:OUTer]:LIST:ABSolute?
Example	ACP:OFFS2:LIST:ABS -10, -10, -10, -10, -10, -10 ACP:OFFS2:LIST:ABS?
Notes	Offset sub op code. 1 for BTS, 2 for MS. Default is BTS. Note that Offset sub op code 2 is supported only in Non-SA modes. In the SA mode, Offset sub op code 1 is used for both BTS and MS. You must be in the mode that includes ACP measurements to use this command. Use :INSTrument:SElect to set the mode.
Couplings	None If current mode is DTMB (CTTB) or CMMB and current device type is Transmitter, the value from position 2 to position 4 are coupled, changing any one will change the others.
Preset	SA: 0dBm, 0 dBm, 0 dBm, 0 dBm, 0 dBm, 0 dBm 0dBm, 0 dBm, 0 dBm, 0 dBm, 0 dBm, 0 dBm WCDMA: 50 dBm, 50 dBm, 50 dBm, 50 dBm, 50 dBm, 50 dBm 50 dBm, 50 dBm, 50 dBm, 50 dBm, 50 dBm, 50 dBm C2K: 50 dBm, 50 dBm, 50 dBm, 50 dBm, 50 dBm, 50 dBm 50 dBm, 50 dBm, 50 dBm, 50 dBm, 50 dBm, 50 dBm WIMAX OFDMA: 50,50,50,50,50,50 TD-SCDMA: 50 dBm, 50 dBm, 50 dBm, 50 dBm, 50 dBm, 50 dBm 50 dBm, 50 dBm, 50 dBm, 50 dBm, 50 dBm, 50 dBm 1xEVDO: -27dBm, -27dBm, -13dBm, -13dBm, -13dBm, -13dBm -27dBm, -27dBm, -13dBm, -13dBm, -13dBm, -13dBm

	DVB-T/H: 50 dBm, 50 dBm, 50 dBm, 50 dBm, 50 dBm, 50 dBm 50 dBm, 50 dBm, 50 dBm, 50 dBm, 50 dBm, 50 dBm
	DTMB (CTTB): 11.14 dBm, 11.14dBm, 11.14 dBm, 11.14 dBm, 50 dBm, 50 dBm 11.14 dBm, 11.14 dBm, 11.14 dBm, 11.14 dBm, 50 dBm, 50 dBm
	ISDB-T: 50 dBm, 50 dBm, 50 dBm, 50 dBm, 50 dBm, 50 dBm 50 dBm, 50 dBm, 50 dBm, 50 dBm, 50 dBm, 50 dBm
	CMMB: 11.14 dBm, 11.14dBm, 11.14 dBm, 11.14 dBm, 50 dBm, 50 dBm 11.14 dBm, 11.14 dBm, 11.14 dBm, 11.14 dBm, 50 dBm, 50 dBm
	LTE, LTE-TDD, MSR, LTEAFDD, LTEATDD: -8.45, -8.45, -8.45, -8.45, -8.45, -8.45 -50.0, -50.0, -50.0, -50.0, -50.0, -50.0
	Digital Cable TV: 50 dBm, 50 dBm, 50 dBm, 50 dBm, 50 dBm, 50 dBm 50 dBm, 50 dBm, 50 dBm, 50 dBm, 50 dBm, 50 dBm
State Saved	Saved in instrument state.
Min	-200.0 dBm
Max	50.0 dBm
Backwards Compatibility SCPI	<code>[[:SENSE]:ACPR:OFFSet[1] 2:LIST:ABSolute (PSA W-CDMA, PSA cdma2000)</code> <code>[[:SENSE]:MCPower:OFFSet[1] 2:LIST:ABSolute (PSA W-CDMA)</code>
Initial S/W Revision	Prior to A.02.00
Modified at S/W Revision	A.02.00, A.03.00, A.13.00

Rel Lim (Car)

Enters a relative limit value for the carrier level. This sets the amplitude levels to test against for the specified offsets.

The amplitude level is relative to the carrier amplitude. If multiple offsets are available, the list contains six (6) entries. The offset closest to the carrier channel is the first one in the list.

`[[:SENSE]:ACP:OFFSet[n]:OUTer]:LIST:TEST` selects the type of testing to be done at each offset.

You can turn off (not use) specific offsets with the `[[:SENSE]:ACP:OFFSet[n]:OUTer]:LIST:STATe` command.

The query returns the six (6) sets of real numbers that are the current amplitude test limits, relative to the carrier, for each offset.

Offset[n] n = 1 is base station and n = 2 is mobiles. The default is base station (1).

Key Path	Meas Setup, Offset/Limits, Limits,
Mode	SA, WCDMA, C2K, WIMAX OFDMA, TD-SCDMA, 1xEVDO, DVB-T/H, DTMB (CTTB), ISDB-T, CMMB, LTE, LTE-TDD, Digital Cable TV, MSR, LTEAFDD, LTEATDD
Remote Command	<code>[[:SENSE]:ACPower:OFFSet[1] 2[:OUTer]:LIST:RCARrier <real>, <real>, <real>, <real>, <real>, <real></code> <code>[[:SENSE]:ACPower:OFFSet[1] 2[:OUTer]:LIST:RCARrier?</code>
Example	<code>ACP:OFFS2:LIST:RCAR 0,0,0,0,0,0</code> <code>ACP:OFFS2:LIST:RCAR?</code>

Notes	<p>Offset sub op code. 1 for BTS, 2 for MS. Default is BTS.</p> <p>Note that Offset sub op code 2 is supported only in Non-SA modes.</p> <p>In the SA mode, Offset sub op code 1 is used for both BTS and MS.</p> <p>You must be in the mode that includes ACP measurements to use this command. Use :INSTrument:SElect to set the mode.</p>
Couplings	<p>None</p> <p>If current mode is DTMB (CTTB) or CMMB and current device type is Transmitter, the value from position 2 to position 4 are coupled, changing any one will change the others.</p>
Preset	<p>SA: -45, -60, 0, 0, 0, 0 -45, -60, 0, 0, 0, 0</p> <p>WCDMA: -44.2, -49.2, -49.2, -49.2, -49.2, -49.2 -32.2, -42.2, -42.2, -42.2, -42.2, -42.2</p> <p>C2K: 0, 0, 0, 0, 0, 0 0, 0, 0, 0, 0, 0</p> <p>WIMAX OFDMA: -50,-60,0,0,0,0</p> <p>TD-SCDMA: -40, -45, -45, -45, -45, -45 -33, -43, -43, -43, -43, -43</p> <p>1xEVDO: -45, -55, -55, -55, -55, -55 -45, -55, -55, -55, -55, -55</p> <p>DVB-T/H: -60, -60, 0, 0, 0, 0 -60, -60, 0, 0, 0, 0</p> <p>DTMB (CTTB): -45, -60, -60, -60, 50, 50 -45, -60, -60, -60, 50, 50</p> <p>ISDB-T: -60, -60, 0, 0, 0, 0 -60, -60, 0, 0, 0, 0</p> <p>CMMB: -45, -60, -60, -60, 50, 50 -45, -60, -60, -60, 50, 50</p> <p>LTE, LTEFDD, MSR, LTEAFDD, LTEATDD: -44.2, -44.2, -44.2, -44.2, -44.2, -44.2 -29.2, -29.2, -29.2, -29.2, -29.2, -29.2</p> <p>Digital Cable TV: -58, -62, -65, -73, -73, -73 -58, -62, -65, -73, -73, -73</p>
State Saved	Saved in instrument state.
Min	-150
Max	50.0
Backwards Compatibility SCPI	[[:SENSE]:MCPower:OFFSet[1] 2:LIST:RCARrier (PSA WCDMA)
Initial S/W Revision	Prior to A.02.00
Modified at S/W Revision	A.02.00, A.03.00, A.04.00, A.13.00

Positive Offset Limit (SCPI only)

Enables you to set the upper limit for the upper segment of the specified offset pair.

Mode	SA, WCDMA, CDMA2K, WIMAXOFDMA, TDSCDMA, CDMA1XEV, DVB, DTMB, LTE, LTEFDD, DCATV, MSR, LTEAFDD,LTEATDD
Remote Command	:CALCulate:ACPower:OFFSet[:OUTer]:LIST:LIMit:POSitive[:UPPer]:DATA <real>, <real>, <real>, <real>, <real>, <real> :CALCulate:ACPower:OFFSet[:OUTer]:LIST:LIMit:POSitive[:UPPer]:DATA?
Example	CALC:ACP:OFFS:LIST:LIM:POS:DATA 0, 0, 0, 0, 0, 0 CALC:ACP:OFFS:LIST:LIM:POS:DATA?

Notes	SCPI only command
Preset	SA: -45, -60, 0, 0, 0, 0 -45, -60, 0, 0, 0, 0 WCDMA: -44.2, -49.2, -49.2, -49.2, -49.2, -49.2 -32.2, -42.2, -42.2, -42.2, -42.2 C2K: 0, 0, 0, 0, 0, 0 0, 0, 0, 0, 0, 0 WIMAX OFDMA: -50, -60, 0, 0, 0, 0 TD-SCDMA: -40, -45, -45, -45, -45, -45 -33, -43, -43, -43, -43, -43 1xEVDO: -45, -55, -55, -55, -55, -55 -45, -55, -55, -55, -55, -55 DVB-T/H: -60, -60, 0, 0, 0, 0 -60, -60, 0, 0, 0, 0 DTMB (CTTB): -45, -60, -60, -60, 0, 0 -45, -60, -60, -60, 0, 0 Digital Cable TV: -58, -62, -65, -73, -73, -73 -58, -62, -65, -73, -73, -73 LTE, LTETDD, MSR, LTEAFDD, LTEATDD: -44.2, -44.2, -44.2, -44.2, -44.2, -44.2 -29.2, -29.2, -29.2, -29.2, -29.2, -29.2
State Saved	Saved in instrument state.
Min	-150.0
Max	50.0
Backwards Compatibility SCPI	:CALCulate:MCPower:OFFSet:LIST:LIMit:POSitive[:UPPer]:DATA (PSA Power Suite)
Initial S/W Revision	A.04.00
Modified at S/W Revision	A.13.00

Negative Offset Limit

Enables you to set the upper limit for the lower segment of the specified offset pair.

Mode	SA, WCDMA, CDMA2K, WIMAXOFDMA, TDSCDMA, CDMA1XEV, DVB, DTMB, LTE, LTETDD, DCATV, MSR, LTEAFDD, LTEATDD
Remote Command	:CALCulate:ACPower:OFFSet[:OUTer]:LIST:LIMit:NEGative[:UPPer]:DATA <real>, <real>, <real>, <real>, <real>, <real> :CALCulate:ACPower:OFFSet[:OUTer]:LIST:LIMit:NEGative[:UPPer]:DATA?
Example	CALC:ACP:OFFS:LIST:LIM:NEG:DATA 0, 0, 0, 0, 0, 0 CALC:ACP:OFFS:LIST:LIM:NEG:DATA?
Notes	SCPI only command
Preset	SA: -45, -60, 0, 0, 0, 0 -45, -60, 0, 0, 0, 0 WCDMA: -44.2, -49.2, -49.2, -49.2, -49.2, -49.2 -32.2, -42.2, -42.2, -42.2, -42.2 C2K: 0, 0, 0, 0, 0, 0 0, 0, 0, 0, 0, 0 WIMAX OFDMA: -50, -60, 0, 0, 0, 0 TD-SCDMA: -40, -45, -45, -45, -45, -45 -33, -43, -43, -43, -43, -43 1xEVDO: -45, -55, -55, -55, -55, -55 -45, -55, -55, -55, -55, -55 DVB-T/H: -60, -60, 0, 0, 0, 0 -60, -60, 0, 0, 0, 0 DTMB (CTTB): -45, -60, -60, -60, 0, 0 -45, -60, -60, -60, 0, 0 Digital Cable TV: -58, -62, -65, -73, -73, -73 -58, -62, -65, -73, -73, -73

	LTE, LTE_TDD, MSR, LTEAFDD, LTEATDD: -44.2, -44.2, -44.2, -44.2, -44.2, -44.2 -29.2, -29.2, -29.2, -29.2, -29.2, -29.2
State Saved	Saved in instrument state.
Min	-150.0
Max	50.0
Backwards Compatibility SCPI	:CALCulate:MCPower:OFFSet:LIST:LIMit:NEGative[:UPPer]:DATA (PSA Power Suite)
Initial S/W Revision	A.04.00
Modified at S/W Revision	A.13.00

Rel Limit (PSD)

Enters a relative limit value for the level of the power spectral density. This sets the amplitude levels to test against for any custom offsets. The amplitude level is relative to the power spectral density. If multiple offsets are available, the list contains six (6) entries. The offset closest to the carrier channel is the first one in the list.

[[:SENSE]:ACP:OFFSet[n]:OUTer]:LIST:TEST selects the type of testing to be done at each offset.

You can turn off (not use) specific offsets with the [[:SENSE]:ACP:OFFSet[n]:OUTer]:LIST:STATE command.

The query returns the six (6) sets of real numbers that are the current amplitude test limits, relative to the power spectral density, for each offset.

Offset[n] n = 1 is base station and n = 2 is mobiles. The default is base station (1).

Key Path	Meas Setup, Offset/Limits, Limits
Mode	SA, WCDMA, C2K, WIMAX OFDMA, TD-SCDMA, 1xEVDO, DVB-T/H, DTMB (CTTB), ISDB-T, CMMB, LTE, LTE_TDD, Digital Cable TV, MSR, LTEAFDD, LTEATDD
Remote Command	[[:SENSE]:ACP:OFFSet[1] 2[:OUTer]:LIST:RPSDensity <rel_ampl>, <rel_ampl>, <rel_ampl>, <rel_ampl>, <rel_ampl> [[:SENSE]:ACP:OFFSet[1] 2[:OUTer]:LIST:RPSDensity?
Example	ACP:OFFS2:LIST:RPSD 10,10,10,10,10,10 ACP:OFFS2:LIST:RPSD?
Notes	Offset sub op code. 1 for BTS, 2 for MS. Default is BTS. Note that Offset sub op code 2 is supported only in Non-SA modes. In the SA mode, Offset sub op code 1 is used for both BTS and MS. You must be in the mode that includes ACP measurements to use this command. Use :INSTrument:SElect to set the mode.
Preset	SA: -28.87 dB, -43.87 dB, 0 dB, 0 dB, 0 dB, 0 dB -28.87 dB, -43.87 dB, 0 dB, 0 dB, 0 dB, 0 dB WCDMA: -44.2 dB, -49.2 dB, -49.2 dB, -49.2 dB, -49.2 dB, -49.2 dB -32.2 dB, -42.2 dB, -42.2 dB, -42.2 dB C2K: 0 dB, 0 dB, 0 dB, 0 dB, 0 dB, 0 dB 0 dB, 0 dB, 0 dB, 0 dB, 0 dB, 0 dB WIMAX OFDMA: -25,-35,0,0,0,0

	TD-SCDMA: -40 dB, -45 dB, -45 dB, -45 dB, -45 dB, -45 dB -33 dB, -43 dB, -43 dB, -43 dB, -43 dB, -43 dB 1xEVDO: -45, -55, -55, -55, -55, -55 -45, -55, -55, -55, -55, -55 DVB-T/H: -60 dB, -60 dB, 0 dB, 0 dB, 0 dB, 0 dB -60 dB, -60 dB, 0 dB, 0 dB, 0 dB, 0 dB DTMB (CTTB): 50 dB, 50 dB, 50 dB, 50 dB, 50 dB, 50 dB 50 dB, 50 dB, 50 dB, 50 dB, 50 dB, 50 dB ISDB-T: -60 dB, -60 dB, 0 dB, 0 dB, 0 dB, 0 dB -60 dB, -60 dB, 0 dB, 0 dB, 0 dB, 0 dB CMMB: 50 dB, 50 dB, 50 dB, 50 dB, 50 dB, 50 dB 50 dB, 50 dB, 50 dB, 50 dB, 50 dB, 50 dB LTE, LTE-TDD, MSR, LTEAFDD, LTEATDD: 0, 0, 0, 0, 0, 0 0, 0, 0, 0, 0, 0 Digital Cable TV: 50 dB, 50 dB, 50 dB, 50 dB, 50 dB, 50 dB 50 dB, 50 dB, 50 dB, 50 dB, 50 dB, 50 dB
State Saved	Saved in instrument state.
Min	-150.0 dB
Max	50.0 dB
Initial S/W Revision	Prior to A.02.00
Modified at S/W Revision	A.02.00, A.03.00, A.13.00

Fail Mask

Accesses a menu that enables you to select one of the logic keys for the fail conditions between the measurement results and the test limits. The setting defines the type of testing to be done at any custom offset frequencies. The measured powers are tested against the absolute values defined with [:SENSe]:ACP:OFFSet[n][:OUTer]:LIST:ABSolute, or the relative values defined with [:SENSe]:ACP:OFFSet[n][:OUTer]:LIST:RPSDensity and [:SENSe]:ACP:OFFSet[n][:OUTer]:LIST:RCARrier.

You can turn off (not use) specific offsets with the [:SENSe]:ACP:OFFSet[n][:OUTer]:LIST:STATe command.

- Absolute – Fail is shown if one of the absolute ACP measurement results is larger than the limit for Abs Limit.
- Relative – Fail is shown if one of the relative ACP measurement results is larger than the limit for Rel Lim (Car) or Rel Lim (PSD).
- Abs AND Rel – Fail is shown if one of the absolute ACP measurement results is larger than the limit for Abs Limit AND one of the relative ACP measurement results is larger than the limit for Rel Lim (Car) or Rel Lim (PSD).
- Abs OR Rel – Fail is shown if one of the absolute ACP measurement results is larger than the limit for Abs Limit OR one of the relative ACP measurement results is larger than the limit for Rel Lim (Car) or Rel Lim (PSD).

Key Path	Meas Setup, Offset/Limits, Limits
Mode	SA, WCDMA, C2K, WIMAX OFDMA, TD-SCDMA, 1xEVDO, DVB-T/H, DTMB (CTTB), ISDB-T, CMMB, LTE, LTE-TDD, Digital Cable TV, MSR, LTEAFDD, LTEATDD
Remote Command	[:SENSe]:ACPower:OFFSet[1] 2[:OUTer]:LIST:TEST ABSolute AND OR RELative, ABSolute AND OR RELative, ABSolute AND OR RELative, ABSolute AND OR RELative, ABSolute AND OR

	RELative, ABSolute AND OR RELative [:SENSe]:ACPpower:OFFSet [1] 2 [:OUTer]:LIST:TEST?
Example	ACP:OFFS2:LIST:TEST ABS, ABS, ABS, ABS, ABS, ABS ACP:OFFS2:LIST:TEST?
Notes	Offset sub op code. 1 for BTS, 2 for MS. Default is BTS. Note that Offset sub op code 2 is supported only in Non-SA modes. In the SA mode, Offset sub op code 1 is used for both BTS and MS. You must be in the mode that includes ACP measurements to use this command. Use :INSTRument:SElect to set the mode.
Couplings	None If current mode is DTMB (CTTB) or CMMB and current device type is Transmitter, the value from position 2 to position 4 are coupled, changing any one will change the others.
Preset	SA, WCDMA, C2K, TD-SCDMA: REL, REL, REL, REL, REL, REL REL, REL, REL, REL, REL, REL WIMAX OFDMA: REL, REL, REL, REL, REL, REL DVB-T/H: REL, REL, REL, REL, REL, REL DTMB (CTTB): OR,AND, AND,AND, REL, REL CDMA1xEVDO: REL, REL, ABS, REL, REL, REL REL, REL, ABS, REL, REL, REL ISDB-T : REL, REL, REL, REL, REL, REL CMMB : OR,AND, AND,AND, REL, REL LTE, LTETDD, MSR, LTEAFDD, LTEATDD: AND, AND, AND, AND, AND, AND AND, AND, AND, AND, AND, AND Digital Cable TV: REL, REL, REL, REL, REL, REL
State Saved	Saved in instrument state.
Range	Absolute Relative Abs AND Rel (fail if both fail) Abs OR Rel (fail if either fails)
Backwards Compatibility SCPI	[:SENSe]:MCPower:OFFSet [1] 2 :LIST:TEST
Initial S/W Revision	Prior to A.02.00
Modified at S/W Revision	A.02.00, A.03.00, A.04.00, A13.00

Offset Side

Enables you to turn off (not use) specific offsets with [:SENSe]:ACPpower:OFFSet[1]|2[:Outer]:LIST:SIDE.

- NEGative - Negative (lower) sideband only
- BOTH - Both of the negative (lower) and positive (upper) sidebands
- POSitive - Positive (upper) sideband only

The figure below shows the relation between the negative/positive offset side setups and the upper/lower results in the MSR and LTE-Advanced FDD/TDD.

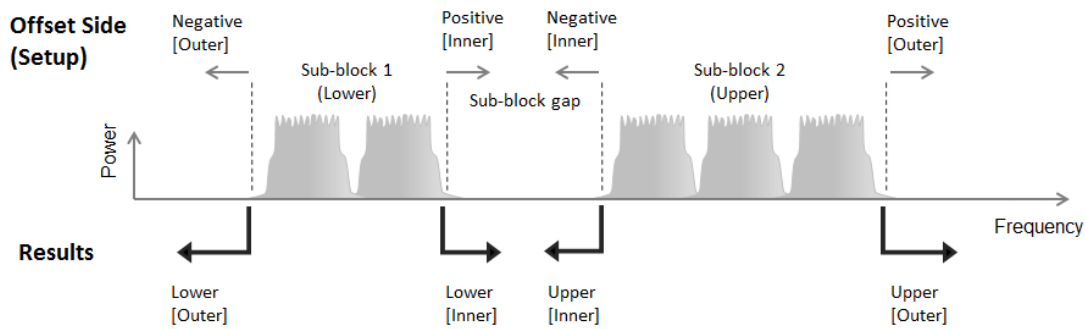

Key Path	Meas Setup, Offset/Limits
Mode	SA, WCDMA, C2K, WIMAX OFDMA, TD-SCDMA, 1xEVDO, DTMB (CTTB), DVB-T/H, LTE, LTETDD, Digital Cable TV, MSR,LTEAFDD,LTEATDD
Remote Command	<code>[[:SENSE]:ACPower:OFFSet[1] 2[:OUTer]:LIST:SIDE NEGative BOTH POSitive,NEGative BOTH POSitive,NEGative BOTH POSitive,NEGative BOTH POSitive,NEGative BOTH POSitive</code> <code>[[:SENSe]:ACPower:OFFSet[1] 2[:OUTer]:LIST:SIDE?</code>
Example	ACP:OFFS:LIST:SIDE BOTH ACP:OFFS:LIST:SIDE?
Notes	OFFSet1 is for BTS, 2 for MS. Default is BTS. You must be in the Spectrum Analysis mode, W-CDMA mode, cdma2000 mode, TD-SCDMA mode, DTMB (CTTB) mode, DVB-T/H mode, ISDB-T mode, CMMB mode, Digital Cable TV mode, 1xEVDO mode, WIMAX OFDMA mode, LTE mode, LTETDD ,LTEAFDD,LTEATDD or MSR mode to use this command. Use :INSTRument:SElect to set the mode. If you set POS or NEG in an offset, result of the inactive side will return -999.
Preset	BOTH, BOTH, BOTH, BOTH, BOTH, BOTH BOTH, BOTH, BOTH, BOTH, BOTH, BOTH
State Saved	Saved in instrument state.
Range	Neg Both Pos
Initial S/W Revision	A.03.00
Modified at S/W Revision	A.13.00

Method for Offset

This key allows you to turn RRC filtering of each offset on or off. The value (roll off) for the filter will be set to the value of the Filter Alpha parameter.

Key Path	Meas Setup, Offset/Limits
Mode	SA, WCDMA, WIMAX OFDMA,TD-SCDMA, DVB-T/H, DTMB (CTTB), ISDB-T, CMMB, LTE, LTETDD, Digital Cable TV, MSR, LTEAFDD,LTEATDD
Remote Command	<code>[[:SENSe]:ACPower:OFFSet[1] 2[:OUTer]:LIST:FILTer[:RRC][:STATe] ON OFF</code> <code> 1 0, ON OFF 1 0, ON OFF 1 0, ON OFF 1 0, ON OFF</code> <code> 1 0, ON OFF 1 0</code> <code>[[:SENSe]:ACPower:OFFSet[1] 2[:OUTer]:LIST:FILTer[:RRC][:STATe]?</code>

Example	ACP:OFFS:LIST:FILT 1,0,0 ACP:OFFS:LIST:FILT?
Notes	1 ON = RRC Weighted, 0 OFF = Integ BW This parameter is not available for cdma2000 and 1xEVDO. You must be in the mode that includes ACP measurements to use this command. Use :INSTrument:SElect to set the mode.
Preset	SA: 0, 0, 0, 0, 0, 0 0, 0, 0, 0, 0, 0 WCDMA:1, 1, 1, 1, 1, 1 1, 1, 1, 1, 1, 1 C2K: NO WIMAX OFDMA: 0, 0, 0, 0, 0, 0 0, 0, 0, 0, 0, 0 TD-SCDMA: 1, 1, 1, 1, 1, 1 1, 1, 1, 1, 1, 1 DVB-T/H: 0, 0, 0, 0, 0, 0 0, 0, 0, 0, 0, 0 DTMB (CTTB): 1, 1, 1, 1, 1, 1 1, 1, 1, 1, 1, 1 ISDB-T: 0, 0, 0, 0, 0, 0 0, 0, 0, 0, 0, 0 CMMB: 1, 1, 1, 1, 1, 1 1, 1, 1, 1, 1, 1 LTE: 0, 0, 0, 0, 0, 0 0, 0, 0, 0, 0, 0 LTETDD: 0, 0, 0, 0, 0, 0 0, 0, 0, 0, 0, 0 Digital Cable TV: 0, 0, 0, 0, 0, 0 0, 0, 0, 0, 0, 0 MSR, LTEAFDD, LTEATDD: 0, 0, 0, 0, 0, 0 0, 0, 0, 0, 0, 0
State Saved	Saved in instrument state.
Range	Integ BW RRC Weighted
Initial S/W Revision	A.03.00
Modified at S/W Revision	A.13.00

Method for Offset

This key allows you to turn RRC filtering of each offset on or off. The value (roll off) for the filter will be set to the value of the Filter Alpha parameter.

Key Path	Meas Setup, Offset/Limits
Mode	SA, WCDMA, WIMAX OFDMA, TD-SCDMA, DVB-T/H, DTMB (CTTB), ISDB-T, CMMB, LTE, LTETDD, Digital Cable TV, MSR, LTEAFDD, LTEATDD
Remote Command	[:SENSe] :ACPpower:OFFSet [1] 2 [:OUTer] :LIST:FiLTeR [:RRC] [:STATe] ON OFF 1 0, ON OFF 1 0, ON OFF 1 0, ON OFF 1 0, ON OFF 1 0, ON OFF 1 0 [:SENSe] :ACPpower:OFFSet [1] 2 [:OUTer] :LIST:FiLTeR [:RRC] [:STATe] ?
Example	ACP:OFFS:LIST:FILT 1,0,0 ACP:OFFS:LIST:FILT?
Notes	1 ON = RRC Weighted, 0 OFF = Integ BW This parameter is not available for cdma2000 and 1xEVDO. You must be in the mode that includes ACP measurements to use this command. Use

	:INSTrument:SElect to set the mode.
Preset	SA: 0, 0, 0, 0, 0, 0 0, 0, 0, 0, 0, 0 WCDMA:1, 1, 1, 1, 1, 1 1, 1, 1, 1, 1, 1 C2K: NO WIMAX OFDMA: 0, 0, 0, 0, 0, 0 0, 0, 0, 0, 0, 0 TD-SCDMA: 1, 1, 1, 1, 1, 1 1, 1, 1, 1, 1, 1 DVB-T/H: 0, 0, 0, 0, 0, 0 0, 0, 0, 0, 0, 0 DTMB (CTTB): 1, 1, 1, 1, 1, 1 1, 1, 1, 1, 1, 1 ISDB-T: 0, 0, 0, 0, 0, 0 0, 0, 0, 0, 0, 0 CMMB: 1, 1, 1, 1, 1, 1 1, 1, 1, 1, 1, 1 LTE: 0, 0, 0, 0, 0, 0 0, 0, 0, 0, 0, 0 LTETDD: 0, 0, 0, 0, 0, 0 0, 0, 0, 0, 0, 0 Digital Cable TV: 0, 0, 0, 0, 0, 0 0, 0, 0, 0, 0, 0 MSR, LTEAFDD, LTEATDD: 0, 0, 0, 0, 0, 0 0, 0, 0, 0, 0, 0
State Saved	Saved in instrument state.
Range	Integ BW RRC Weighted
Initial S/W Revision	A.03.00
Modified at S/W Revision	A.13.00

Filter Alpha for Offset

Sets the alpha value for the RRC Filter for each offset.

Key Path	Meas Setup, Offset/Limits, Method, RRC Weighted
Mode	SA, WCDMA, WIMAX OFDMA,TD-SCDMA, DVB-T/H, DTMB (CTTB), ISDB-T, CMMB, LTE, LTETDD, Digital Cable TV, MSR, LTEAFDD,LTEATDD
Remote Command	[:SENSe] :ACPoweR:OFFSet [1] 2 [:OUTer] :LIST:FILTer:ALPHa <real>, <real>, <real>, <real>, <real> [:SENSe] :ACPoweR:OFFSet [1] 2 [:OUTer] :LIST:FILTer:ALPHa?
Example	ACP:OFFS:LIST:FILT:ALPH 0.5, 0.5, 0.5, 0.5, 0.5, 0.5 ACP:OFFS:LIST:FILT:ALPH?
Notes	This parameter is not available for cdma2000 and 1xEVDO. You must be in the mode that includes ACP measurements to use this command. Use :INSTrument:SElect to set the mode.
Preset	SA: 0.22, 0.22, 0.22, 0.22, 0.22, 0.22 0.22, 0.22, 0.22, 0.22, 0.22, 0.22 WCDMA: 0.22, 0.22, 0.22, 0.22, 0.22, 0.22 0.22, 0.22, 0.22, 0.22, 0.22, 0.22 WIMAX OFDMA: 0.22, 0.22, 0.22, 0.22, 0.22, 0.22 0.22, 0.22, 0.22, 0.22, 0.22, 0.22 C2K: NO TD-SCDMA: 0.22, 0.22, 0.22, 0.22, 0.22, 0.22 0.22, 0.22, 0.22, 0.22, 0.22, 0.22 DVB-T/H: 0.22, 0.22, 0.22, 0.22, 0.22, 0.22 0.22, 0.22, 0.22, 0.22, 0.22, 0.22

	DTMB (CTTB): 0.05, 0.05, 0.05, 0.05, 0.05, 0.05 0.05, 0.05, 0.05, 0.05, 0.05, 0.05
	ISDB-T : 0.22, 0.22, 0.22, 0.22, 0.22, 0.22 0.22, 0.22, 0.22, 0.22, 0.22, 0.22
	CMMB : 0.22, 0.22, 0.22, 0.22, 0.22, 0.22 0.22, 0.22, 0.22, 0.22, 0.22, 0.22
	LTE: 0.22, 0.22, 0.22, 0.22, 0.22, 0.22 0.22, 0.22, 0.22, 0.22, 0.22, 0.22
	LTETDD: 0.22, 0.22, 0.22, 0.22, 0.22, 0.22 0.22, 0.22, 0.22, 0.22, 0.22, 0.22
	Digital Cable TV: 0.15, 0.15, 0.15, 0.15, 0.15, 0.15 0.15, 0.15, 0.15, 0.15, 0.15, 0.15
	MSR, LTEAFDD, LTEATDD: 0.22, 0.22, 0.22, 0.22, 0.22, 0.22 0.22, 0.22, 0.22, 0.22, 0.22, 0.22
State Saved	Saved in instrument state.
Min	0.01
Max	1.00
Initial S/W Revision	A.03.00
Modified at S/W Revision	A.13.00

Offset Frequency Define

This key allows you to select “Offset” definition. Each standard defines each “Offset” from Carrier.

3GPP2 requires the “From Carrier Center to MeasBW Closer Edge” definition. LTE conformance test requires “From Carrier Edge to MeasBW Center” and/or “From Carrier Edge to MeasBW Closer Edge” definition.

- CTOCenter – From the center of the carrier closest to the adjacent channel to the center of the adjacent channel Offset Integ BW
- CTOEdge - From the center of the carrier closest to the adjacent channel to the edge of the closest adjacent channel Offset Integ BW
- ETOCenter – From Center Frequency - Carrier Spacing / 2 (for lower offset), Center Frequency + Carrier Spacing / 2 (for upper offset) of the carrier closest to the adjacent channel's to the center of the adjacent channel Offset Integ BW
- ETOEdge - From Center Frequency - Carrier Spacing / 2 (for lower offset), Center Frequency + Carrier Spacing / 2 (for upper offset) of the carrier closest to the adjacent channel's to the edge of the closest adjacent channel Offset Integ BW

Key Path	Meas Setup, Offset/Limits
Mode	SA, WCDMA, C2K, WIMAX OFDMA, TD-SCDMA, 1xEVDO, DVB-T/H, DTMB (CTTB), ISDB-T, CMMB, LTE, LTETDD, Digital Cable TV, MSR,LTEAFDD,LTEATDD
Remote Command	[[:SENSe]:ACPpower:OFFSet[1] 2[:OUTer]:TYPE CTOCenter CTOEdge ETOCenter ETOEdge [:SENSe]:ACPpower:OFFSet[1] 2[:OUTer]:TYPE?
Example	ACP:OFFS:TYPE ETOC ACP:OFFS:TYPE?
Notes	You must be in the mode that includes ACP measurements to use this command. Use :INSTrument:SElect to set the mode.

Preset	All Except C2K and 1xEVDO: CTOCenter C2K and 1xEVDO: CTOEdge
State Saved	Saved in instrument state.
Range	Carrier Center To Meas BW Center Carrier Center To Meas BW Edge Carrier Edge To Meas BW Center Carrier Edge To Meas BW Edge
Initial S/W Revision	A.03.00
Modified at S/W Revision	A.13.00

Carrier Result

Allows you to view and scroll through the carrier power results.

Key Path	Meas Setup
Mode	SA, WCDMA, C2K, WIMAX OFDMA, TD-SCDMA, 1xEVDO, DVB-T/H, DTMB (CTTB), ISDB-T, CMMB, LTE, LTE-TDD, Digital Cable TV, MSR, LTEAFDD, LTEATDD
Couplings	This key will be grayed out if there is only one carrier.
Preset	1
State Saved	No
Min	1
Max	Number of carriers.
Initial S/W Revision	Prior to A.02.00
Modified at S/W Revision	A.02.00, A.03.00

Meas Method

Sets the desired method to measure ACP.

Integration BW – one sweep of the trace is taken, and the band power for each offset is computed. Depending on the status of the Meas Type parameter (Total Power Reference or PSD Reference), results are displayed relative to the total power or the power spectral density. The display reflects either the current trace or a bar graph view.

Filtered IBW (max dynamic range) – the ACP Path is used to compute ACP when an ACP path is available. This method increases dynamic range, but increases measurement time as it limits the resolution bandwidth. This method is useful for improving dynamic range on a W-CDMA signal because a sharp cutoff bandpass filter is used. The accuracy of the adjacent channel power ratio is not degraded by this method, but the absolute accuracy of both adjacent channel power and carrier power are degraded by up to about 0.5 dB.

RBW – the algorithm uses zero-span and an appropriate RBW setting to capture all of the power in the carrier channel and the offsets. The zero-span algorithm (RBW method) is slower than the IBW method, but greatly improves repeatability.

Fast (in WCDMA mode or SA mode with 3GPP WCDMA radio standard selected) – this provides the same method as the Integration BW method, but is optimized for speed to measure a W-CDMA signal.

Fast (in CDMA2K mode or SA mode with CDMA2K radio standard selected) – this provides faster measurement using the FFT method with a limited parameter flexibility. When this is selected, CDMA2K preset offsets are given and control of the following are grayed out:

BW menu, Sweep/Control menu except Pause/Resume, Trace/Detector menu, Carrier Setup, Offset Limit, RRC Weighting, Filter Alpha, and Noise Correction softkeys in Meas Setup menu.

Key Path	Meas Setup
Mode	SA, WCDMA, C2K, WIMAX OFDMA, 1xEVDO, DVB-T/H, DTMB (CTTB), ISDB-T, CMMB, LTE, LTETDD, Digital Cable TV, MSR,, LTEAFDD, LTEATDD
Remote Command	[:SENSe] :ACPower:METhod IBW IBWRange FAST RBW [:SENSe] :ACPower:METhod?
Example	ACP:METH IBW ACP:METH?
Notes	<p>FAST mode is only supported for WCDMA and C2K signal. You must be in the WCDMA or C2K mode or SA mode with 3GPP WCDMA or CDMA2K radio standard. Otherwise a setting conflict error message will be reported.</p> <p>In the TDSCDMA mode, only the IBW method is available to use. Therefore, the measure method key is not displayed in the TD-SCDMA mode.</p> <p>CDMA1xEVDO mode only supports RBW and Integration BW method.</p> <p>C2K mode only supports RBW, Integration BW and FAST method.</p> <p>LTETDD mode only supports Integration BW and Filtered IBW method.</p> <p>MSR mode only supports Integration BW and Filtered IBW method.</p> <p>LTE-Advanced FDD/TDD mode only support IBW and Filtered IBW method.</p> <p>You must be in the mode that includes ACP measurements to use this command. Use :INSTRument:SElect to set the mode.</p>
Dependencies	<p>When RBW or FAST is selected, Gate function is not available. If you try to turn Gate On while Meas Method is RBW or FAST, an error is generated.</p> <p>When Gate function is ON, RBW and FAST method is not available. If you try to change Meas Method to RBW or FAST, an error is generated.</p>
Couplings	IBW (Range) restricts the Res BW available for making this measurement to 30 kHz. When selected, the Res BW is clipped to this value if required and an error number displayed.
Preset	SA, LTE, LTETDD, MSR, LTEAFDD, LTEATDD: IBW WCDMA: IBW C2K: RBW WIMAX OFDMA: IBW 1xEVDO: IBW DVB-T/H: IBW DTMB (CTTB): IBW ISDB-T: IBW CMMB: IBW

	Digital Cable TV: IBW
State Saved	Saved in instrument state.
Range	Integration BW Filtered IBW (max dynamic range) RBW Fast
Readback Text	IBW Filtered IBW RBW Fast
Backwards Compatibility SCPI	[:SENSe] :ACPR :SWEp :TYPE [:SENSe] :MCPower :METHod (PSA Power Suite)
Initial S/W Revision	Prior to A.02.00
Modified at S/W Revision	A.02.00, A.03.00

Meas Type

Changes the reference used for the measurement. This allows you to make absolute and relative power measurements of either total power or the power normalized to the measurement bandwidth.

Total Pwr Ref (TPR) sets the reference to the total carrier power. PSD Ref (PSDR) sets the reference to the power spectral density of the carrier.

Key Path	Meas Setup
Mode	SA, WCDMA, C2K, WIMAX OFDMA, TD-SCDMA, 1xEVDO, DVB-T/H, DTMB (CTTB), ISDB-T, CMMB, LTE, LTE-TDD, Digital Cable TV, MSR, LTEAFDD, LTEATDD
Remote Command	[:SENSe] :ACPower :TYPE TPRef PSDRef [:SENSe] :ACPower :TYPE?
Example	ACP:TYPE PSDR ACP:TYPE?
Notes	You must be in the mode that includes ACP measurements to use this command. Use :INSTrument:SElect to set the mode.
Preset	TPRef
State Saved	Saved in instrument state.
Range	Total Power Ref PSD Ref
Initial S/W Revision	Prior to A.02.00
Modified at S/W Revision	A.02.00, A.03.00

PSD Ref

Sets the unit bandwidth for Power Spectral Density. The available units are dBm/Hz and dBm/MHz.

Key Path	Meas Setup
Mode	A, WCDMA, C2K, WIMAX OFDMA, TD-SCDMA, 1xEVDO, DVB-T/H, DTMB (CTTB), ISDB-T, CMMB, LTE, LTE-TDD, Digital Cable TV, MSR, LTEAFDD, LTEATDD
Remote Command	:UNIT:ACPower:POWer:PSD DBMHZ DBMMHZ

	:UNIT:ACPower:POW:PSD?
Example	UNIT:ACP:POW:PSD DBMMHZ UNIT:ACP:POW:PSD?
Couplings	When the PSD unit is changed, the PSD reference result of the “MEAS READ FETCH:ACP[n]?” is also changed by the PSD unit basis (in either dBm/Hz or dBm/MHz).
Preset	DBMMHZ
State Saved	Saved in instrument state.
Range	dBm/Hz dBm/MHz
Initial S/W Revision	Prior to A.02.00
Modified at S/W Revision	A.02.00, A.03.00

Limit Test

Turns limit checking for each offset On or Off. The limits may be specified within the Offset menu, for each offset, both sides of the carrier. For results that fail the limit, a red F is appended. In the Combined view, the bar turns red.

Key Path	Meas Setup
Mode	SA, WCDMA, C2K, WIMAX OFDMA, TD-SCDMA, 1xEVDO, DVB-T/H, DTMB (CTTB), ISDB-T, CMMB, LTE, LTETDD, Digital Cable TV, MSR, LTEAFDD, LTEATDD
Remote Command	:CALCulate:ACPower:LIMit:STATe OFF ON 0 1 :CALCulate:ACPower:LIMit:STATe?
Example	CALC:ACP:LIM:STAT OFF CALC:ACP:LIM:STAT?
Notes	You must be in the mode that includes ACP measurements to use this command. Use :INSTrument:SElect to set the mode.
Preset	SA: OFF WCDMA: ON C2K: ON WIMAX OFDMA: OFF TD-SCDMA: ON 1xEVDO: ON DVB-T/H: OFF DTMB (CTTB): ON ISDB-T: OFF CMMB: ON LTE, LTETDD, MSR, LTEAFDD, LTEATDD: ON Digital Cable TV: OFF
State Saved	Saved in instrument state.
Range	On Off

Backwards Compatibility SCPI	<code>[:SENSe] :MCPower :LIMit [:STATe]</code>
	<code>[:SENSe] :ACPower :LIMit [:STATe]</code>
Initial S/W Revision	Prior to A.02.00
Modified at S/W Revision	A.02.00, A.03.00

Noise Correction

Sets the measurement noise floor correction function to On or Off. On enables measurement noise correction when the measured power in the reference channel or any offset is close to the noise floor of the analyzer. Off turns these corrections off.

In analyzers with the noise floor extensions option (option NFE) enabled, there are two ways to compensate for the analyzer noise floor: through the NFE and through this noise corrections key. The techniques are results are similar but not identical. NFE uses a model of the analyzer noise floor, adapted to the current conditions such as center frequency, RBW and ambient temperature. The parameters of this model are measured in the factory or field calibration in a highly averaged measurement. So they are consistent. However, because the model is imperfect, the corrections are imperfect. Using NFE is very convenient; the user need not wait for the ACP noise corrections calibration to occur. The ACP NC calibration, though, has advantages of being measured very recently, at the current ambient, and the exact center frequency, with no requirement that the model be perfect. So it will often (but not always) have slightly better dynamic range. If both ACP NC is turned on and NFE is turned on, the analyzer uses only the ACP NC. When ACP NC is turned off but NFE is on, NFE is used and performance should still be excellent.

Key Path	Meas Setup
Mode	SA, WCDMA, C2K, WiMAX OFDMA, TD-SCDMA, 1xEVDO, DVB-T/H, DTMB (CTTB), ISDB-T, CMMB, LTE, LTE-TDD, Digital Cable TV, MSR, LTEAFDD, LTEATDD
Remote Command	<code>[:SENSe] :ACPower :CORRection :NOISe [:AUTO] OFF ON 0 1</code> <code>[:SENSe] :ACPower :CORRection :NOISe [:AUTO] ?</code>
Example	ACP:CORR:NOIS OFF ACP:CORR:NOIS?
Notes	You must be in the mode that includes ACP measurements to use this command. Use <code>:INSTrument:SElect</code> to set the mode.
Dependencies	This parameter is unavailable when Meas Method is set to RBW or Fast.
Preset	0
State Saved	Saved in instrument state.
Range	On Off
Initial S/W Revision	Prior to A.02.00
Modified at S/W Revision	A.02.00, A.03.00, A.04.00

Meas Preset

Restores all the measurement parameters to their default values.

Key Path	Meas Setup
Mode	SA, WCDMA, C2K, WIMAX OFDMA, TD-SCDMA, 1xEVDO, DVB-T/H, DTMB (CTTB), ISDB-T, CMMB, LTE, LTETDD, Digital Cable TV, MSR, LTEAFDD,LTEATDD
Remote Command	:CONFigure:ACPover
Example	CONF:ACP
Notes	You must be in the mode that includes ACP measurements to use this command. Use :INSTrument:SElect to set the mode.
Couplings	Selecting Meas Preset will restore all measurement parameters to their default values.
Initial S/W Revision	Prior to A.02.00
Modified at S/W Revision	A.02.00, A.03.00

Offset RRC Weighting (Backward Compatibility SCPI)

Mode	SA, WCDMA, TD-SCDMA, WIMAX OFDMA, DVB-T/H, DTMB (CTTB), ISDB-T, CMMB, LTE, LTETDD, Digital Cable TV, MSR, LTEAFDD,LTEATDD
Remote Command	[:SENSe] :ACPover:FILTer [:RRC] [:STATe] OFF ON 0 1 [:SENSe] :ACPover:FILTer [:RRC] [:STATe] ?
Example	ACP:FILT OFF ACP:FILT?
Notes	This parameter is not available for cdma2000 and 1xEVDO The backwards Compatibility SCPI command, [:SENSe]:ACPr:FILTer[:RRC][:STATe], is provided to support same functionality as [:SENSe]:ACPr:FILTer[:RRC][:STATe] (PSA W-CDMA, PSA cdma2000 and PSA 1xEVDO) due to ACPr node conflicts with ACPover node. You must be in the mode that includes ACP measurements to use this command. Use :INSTrument:SElect to set the mode.
Couplings	This command is an alias to [:SENSe]:ACPover:OFFSet[1]2:LIST:FILTer[:RRC][:STATe] Sending the commands to set values of all offsets for BS and MS, however, sending the query always return a value of BS Offset A.
Preset	SA, WIMAX OFDMA, LTE, LTETDD, MSR: OFF WCDMA: ON C2K: NO TD-SCDMA: ON DVB-T/H: OFF DTMB (CTTB):ON ISDB-T: OFF CMMB: OFF Digital Cable TV: ON LTEAFDD,LTEATDD: OFF

State Saved	Saved in instrument state.
Backwards Compatibility SCPI	[:SENSe] :ACPR:FILTer [:RRC] [:STATe]
	[:SENSe] :MCPower:FILTer [:RRC] [:STATe]
Initial S/W Revision	Prior to A.02.00
Modified at S/W Revision	A.03.00

Offset Filter Alpha (Backward Compatibility SCPI)

Mode	SA, WCDMA, WIMAX OFDMA, TD-SCDMA, DVB-T/H, DTMB (CTTB), ISDB-T, CMMB, LTE, LTEATDD, Digital Cable TV, MSR, LTEAFDD, LTEATDD
Remote Command	[:SENSe] :ACPower:FILTer [:RRC] :ALPHa <real> [:SENSe] :ACPower:FILTer [:RRC] :ALPHa?
Example	ACP:FILT:ALPH 0.5 ACP:FILT:ALPH?
Notes	This parameter is not available for cdma2000 and 1xEVDO The backwards Compatibility SCPI command, [:SENSe] :ACPR:FILTer [:RRC] :ALPHa, is provided to support same functionality as [:SENSe] :ACPr:FILTer [:RRC] :ALPHa (PSA W-CDMA, PSA cdma2000 and PSA 1xEVDO) due to ACPr node conflicts with ACPower node. You must be in the mode that includes ACP measurements to use this command. Use :INSTrument:SElect to set the mode.
Couplings	This command is an alias to [:SENSe] :ACPower:OFFSet [1] 2 :LIST:FILTer:ALPHa Sending the commands to set values of all offsets for BS and MS, however, sending the query always return a value of BS Offset A.
Preset	SA, WCDMA, WIMAX OFDMA, TD-SCDMA, DVB-T/H, ISDB-T, CMMB, LTE, LTEATDD, MSR: 0.22 C2K: NO DTMB (CTTB): 0.05 Digital Cable TV: 0.15 LTEAFDD, LTEATDD: 0.22
State Saved	Saved in instrument state.
Min	0.01
Max	1.00
Backwards Compatibility SCPI	[:SENSe] :ACPR:FILTer [:RRC] :ALPHa
	[:SENSe] :MCPower:FILTer [:RRC] :ALPHa
Initial S/W Revision	Prior to A.02.00
Modified at S/W Revision	A.03.00

Method for Carrier (Backward Compatibility SCPI)

Mode	SA, WCDMA, WIMAX OFDMA, TD-SCDMA, DVB-T/H, DTMB (CTTB), ISDB-T, CMMB, LTE, LTETDD, Digital Cable TV, MSR
Remote Command	[[:SENSe]:ACPower:CARRier[1] 2:LIST:METhod IBW RRC, ... [:SENSe]:ACPower:CARRier[1] 2:LIST:METhod?
Example	ACP:CARR2:LIST:METh RRC ACP:CARR2:LIST:METh?
Notes	You must be in the mode that includes ACP measurements to use this command. Use :INSTrument:SElect to set the mode. Maximum of Array length depends on the number of carriers.
Couplings	This command is an alias to [:SENSe]:ACPower:CARRier[1] 2:LIST:FiLTer[:RRC][:STATe] The enum value translates as follows: RRC Weighted = 1 ON Integ BW = 0 OFF Maximum of Array length depends on the number of carriers.
Preset	SA: IBW WCDMA: RRC WIMAX OFDMA: IBW TD-SCDMA: RRC DVB-T/H: IBW DTMB (CTTB): RRC ISDB-T: IBW CMMB: IBW LTE, MSR: IBW LTETDD: IBW Digital Cable TV: RRC
State Saved	Saved in instrument state.
Initial S/W Revision	Prior to A.02.00
Modified at S/W Revision	A.03.00

Mode

See "Mode" on page 286

Mode Preset

Returns the active mode to a known state.

Mode Preset does the following for the currently active mode:

- Aborts the currently running measurement.
- Brings up the default menu for the mode, with no active function.
- Sets measurement Global settings to their preset values for the active mode only.
- Activates the default measurement.
- Brings up the default menu for the mode.
- Clears the input and output buffers.
- Sets Status Byte to 0.

Mode Preset does not:

- Cause a mode switch
- Affect mode persistent settings
- Affect system settings

See "[How-To Preset](#)" on page 741 for more information.

Key Path	Front-panel key
Remote Command	:SYSTem:PRESet
Example	:SYST:PRES
Notes	*RST is preferred over :SYST:PRES for remote operation. *RST does a Mode Preset, as done by the :SYST:PRES command, and it sets the measurement mode to Single measurement rather than Continuous for optimal remote control throughput. Clears all pending OPC bits. The Status Byte is set to 0.
Couplings	A Mode Preset aborts the currently running measurement, activates the default measurement, and gets the mode to a consistent state with all of the default couplings set.
Backwards Compatibility Notes	In the X-Series, the legacy "Factory Preset" has been replaced with Mode Preset, which only presets the currently active mode, not the entire instrument. In the X-Series, the way to preset the entire instrument is by using System, Restore System Defaults All, which behaves essentially the same way as restore System Defaults does on ESA and PSA. There is also no "Preset Type" as there is on the PSA. There is a green Mode Preset front-panel key that does a Mode Preset and a white-with-green-letters User Preset front-panel key that does a User Preset. The old PRESet:TYPE command is ignored (without generating an error), and SYST:PRES without a parameter does a Mode Preset, which should cover most backward code compatibility issues. The settings and correction data under the Input/Output front-panel key (examples: Input Z Corr, Ext Amp Gain, etc.) are no longer part of any Mode, so they will not be preset by a Mode Preset. They are preset using Restore Input/Output Defaults, Restore System Defaults All. Note that because User Preset does a Recall State, and all of these settings are saved in State, they ARE recalled when using

	User Preset.
Initial S/W Revision	Prior to A.02.00

How-To Preset

The table below shows all possible presets, their corresponding SCPI commands and front-panel access (key paths). Instrument settings depend on the current measurement context. Some settings are local to the current measurement, some are global (common) across all the measurements in the current mode, and some are global to all the available modes. In a similar way, restoring the settings to their preset state can be done within the different contexts.

Auto Couple - is a measurement local key. It sets all Auto/Man parameter couplings in the measurement to Auto. Any Auto/Man selection that is local to other measurements in the mode will not be affected.

Meas Preset - is a measurement local key. Meas Preset resets all the variables local to the current measurement except the persistent ones.

Mode Preset - resets all the current mode's measurement local and measurement global variables except the persistent ones.

Restore Mode Defaults - resets ALL the Mode variables (and all the Meas global and Meas local variables), including the persistent ones.

Type Of Preset	SCPI Command	Front Panel Access
Auto Couple	:COUPlE ALL	Auto Couple front-panel key
Meas Preset	:CONFIgure:<Measurement>	Meas Setup Menu
Mode Preset	:SYSTem:PRESet	Mode Preset (green key)
Restore Mode Defaults	:INSTrument:DEFault	Mode Setup Menu
Restore All Mode Defaults	:SYSTem:DEFault MODEs	System Menu; Restore System Default Menu
*RST	*RST	not possible (Mode Preset with Single)
Restore Input/Output Defaults	:SYSTem:DEFault INPut	System Menu; Restore System Default Menu
Restore Power On Defaults	:SYSTem:DEFault PON	System Menu; Restore System Default Menu
Restore Alignment Defaults	:SYSTem:DEFault ALIGn	System Menu; Restore System Default Menu
Restore Miscellaneous Defaults	:SYSTem:DEFault MISC	System Menu; Restore System Default Menu
Restore All System Defaults	:SYSTem:DEFault [ALL] :SYSTem:PRESet:PERSistent	System Menu; Restore System Default Menu
User Preset	:SYSTem:PRESet:USER	User Preset Menu
User Preset All Modes	:SYSTem:PRESet:USER:ALL	User Preset Menu

Power On Mode Preset	:SYSTem:PON:TYPE MODE	System Menu
Power On User Preset	:SYSTem:PON:TYPE USER	System Menu
Power On Last State	:SYSTem:PON:TYPE LAST	System Menu

Preset Type (Remote Command Only)

As stated in the Backward Compatibility section, to be compatible with ESA/PSA the PRESet:TYPE command will be implemented as a no-op.

Mode	All
Remote Command	:SYSTem:PRESet:TYPE FACTory MODE USER :SYSTem:PRESet:TYPE?
Example	:SYST:PRESet:TYPE FACT
Notes	This command is supported for backward compatibility only. It is a no-op which does not change the behavior of any preset operation.
Preset	This is unaffected by Preset but is set to Mode on a "Restore System Defaults->All"
State Saved	No
Initial S/W Revision	Prior to A.02.00

Mode Setup

See "[Mode Setup](#)" on page 316

Peak Search

Places the selected marker on the trace point with the maximum y-axis value.

Key Path	Peak Search
Mode	SA, WCDMA, C2K, WIMAX OFDMA, TD-SCDMA, 1xEVDO, DVB-T/H, DTMB (CTTB), ISDB-T, CMMB, LTE, LTETDD, Digital Cable TV, MSR, LTEAFDD, LTEATDD
Remote Command	:CALCulate:ACPower:MARKer[1] 2 ... 12:MAXimum
Example	CALC:ACP:MARK2:MAX
Initial S/W Revision	Prior to A.02.00
Modified at S/W Revision	A.02.00, A.03.00

Next Peak

Moves the selected marker to the peak that has the next highest amplitude.

Key Path	Peak Search
Mode	SA, WCDMA, C2K, WIMAX OFDMA, TD-SCDMA, 1xEVDO, DVB-T/H, DTMB (CTTB), ISDB-T, CMMB, LTE, LTETDD, Digital Cable TV, MSR, LTEAFDD, LTEATDD
Remote Command	:CALCulate:ACPower:MARKer[1] 2 ... 12:MAXimum:NEXT
Example	CALC:ACP:MARK2:MAX:NEXT
Initial S/W Revision	Prior to A.02.00
Modified at S/W Revision	A.02.00, A.03.00

Next Pk Right

Moves the selected marker to the nearest peak to the right of the current marker that meets all enabled peak criteria.

Key Path	Peak Search
Mode	SA, WCDMA, C2K, WIMAX OFDMA, TD-SCDMA, 1xEVDO, DVB-T/H, DTMB (CTTB), ISDB-T, CMMB, LTE, LTETDD, Digital Cable TV, MSR, LTEAFDD, LTEATDD
Remote Command	:CALCulate:ACPower:MARKer[1] 2 ... 12:MAXimum:RIGHT
Example	CALC:ACP:MARK2:MAX:RIGH
Initial S/W Revision	Prior to A.02.00
Modified at S/W Revision	A.02.00, A.03.00

Next Pk Left

Moves the selected marker to the nearest peak to the left of the current marker that meets all enabled peak criteria.

Key Path	Peak Search
Mode	SA, WCDMA, C2K, WIMAX OFDMA, TD-SCDMA, 1xEVDO, DVB-T/H, DTMB (CTTB), ISDB-T, CMMB, LTE, LTE-TDD, Digital Cable TV, MSR, LTEAFDD, LTEATDD
Remote Command	:CALCulate:ACPower:MARKer [1] 2 . . . 12:MAXimum:LEFT
Example	CALC:ACP:MARK2:MAX:LEFT
Initial S/W Revision	Prior to A.02.00
Modified at S/W Revision	A.02.00, A.03.00

Marker Delta

Sets the control mode for the selected marker to Delta mode.

See Marker Delta in the "Marker Functions" section for more information.

Key Path	Peak Search
Initial S/W Revision	Prior to A.02.00

Pk-Pk Search

Finds and displays the amplitude and frequency (or time, if in zero span) differences between the highest and lowest y-axis value.

Key Path	Peak Search
Mode	SA, WCDMA, C2K, WIMAX OFDMA, TD-SCDMA, 1xEVDO, DVB-T/H, DTMB (CTTB), ISDB-T, CMMB, LTE, LTE-TDD, Digital Cable TV, MSR, LTEAFDD, LTEATDD
Remote Command	:CALCulate:ACPower:MARKer [1] 2 . . . 12:PTPeak
Example	CALC:ACP:MARK:PTP
Notes	Turns on the Marker Δ active function.
Couplings	This key is not available (key is grayed out) when Coupled Markers is on.
Initial S/W Revision	Prior to A.02.00
Modified at S/W Revision	A.02.00, A.03.00

Min Search

Moves the selected marker to the minimum y-axis value on the current trace.

Key Path	Peak Search
Mode	SA, WCDMA, C2K, WIMAX OFDMA, TD-SCDMA, 1xEVDO, DVB-T/H, DTMB (CTTB), ISDB-T, CMMB, LTE, LTEFDD, Digital Cable TV, MSR, LTEAFDD, LTEATDD
Remote Command	:CALCulate:ACPower:MARKer[1] 2 ... 12:MINimum
Example	CALC:ACP:MARK:MIN
Initial S/W Revision	Prior to A.02.00
Modified at S/W Revision	A.02.00, A.03.00

Print

See "Print" on page 341

Quick Save

The Quick Save front-panel key repeats the most recent save that was performed from the Save menu, with the following exceptions:

- Register saves are not remembered as Saves for the purpose of the Quick Save function
- If the current measurement does not support the last non-register save that was performed, an informational message is generated, “File type not supported for this measurement”

Quick Save repeats the last type of qualified save (that is, a save qualified by the above criteria) in the last save directory by creating a unique filename using the Auto File Naming algorithm described below.

If Quick Save is pressed after startup and before any qualified Save has been performed, the Quick Save function performs a Screen Image save using the current settings for Screen Image saves (current theme, current directory), which then becomes the “last save” for the purpose of subsequent Quick Saves.

The Auto File Naming feature automatically generates a file name for use when saving a file. The filename consists of a prefix and suffix separated by a dot, as is standard for the Windows® file system. A default prefix exists for each of the available file types:

Type	Default Prefix	Menu
State	State_	(Save/Recall)
Trace + State	State_	(Save/Recall)
Screen	Screen_	(Save/Recall)
Amplitude Corrections	Ampcor_	(Import/Export)
Traces	Trace_	(Import/Export)
Limit Lines	LLine_	(Import/Export)
Measurement Result	MeasR_	(Import/Export)
Capture Buffer	CapBuf_	(Import/Export)

A four digit number is appended to the prefix to create a unique file name. The numbering sequence starts at 0000 within each Mode for each file type and updates incrementally to 9999, then wraps to 0000 again. It remembers where it was through a Mode Preset and when leaving and returning to the Mode. It is reset by Restore Misc Defaults and Restore System Defaults and subsequent running of the instrument application. So, for example, the first auto file name generated for State files is State_0000.state. The next is State_0001, and so forth.

One of the key features of Auto File Name is that we guarantee that the Auto File Name will never conflict with an existing file. The algorithm looks for the next available number. If it gets to 9999, then it looks for holes. If it find no holes, that is no more numbers are available, it gives an error.

For example, if when we get to State_0010.state there is already a State_0010.state file in the current directory, it advances the counter to State_0011.state to ensure that no conflict will exist (and then it verifies that State_0011.state also does not exist in the current directory and advances again if it does, and so forth).

If you enter a file name for a given file type, then the prefix becomes the filename you entered instead of the default prefix, followed by an underscore. The last four letters (the suffix) are the 4-digit number.

For example, if you save a measurement results file as “fred.csv”, then the next auto file name chosen for a measurement results save will be fred_0000.csv.

NOTE

Although 0000 is used in the example above, the number that is used is actually the current number in the Meas Results sequence, that is, the number that would have been used if you had not entered your own file name.

NOTE

If the filename you entered ends with _dddd, where d=any number, making it look just like an auto file name, then the next auto file name picks up where you left off with the suffix being dddd + 1.

Key Path	Front-panel key
Notes	No remote command for this key specifically.
Initial S/W Revision	Prior to A.02.00

Recall

The Recall menu lets you choose what you want to recall, and where you want to recall it from. Among the types of files you can recall are **States and Traces**. In addition, an Import (Data) option lets you recall a number of data types stored in CSV files (as used by Excel and other spreadsheet programs).

The default paths for Recall are data type dependent and are the same as for the Save key.

Key Path	Front-panel key
Notes	<p>No remote command for this key specifically, but the :MMEM:LOAD command is available for specific file types. An example is :MMEM:LOAD:STATE <filename>.</p> <p>If you try to recall a State file for a mode that is not licensed or not available in the instrument, an error message will occur and the state will not change.</p>
Backwards Compatibility Notes	<p>In legacy analyzers, it was possible to load a state without affecting the trace data, limit lines or correction data. Similarly (since User Preset is actually loading a state), it was possible to do a User Preset without affecting the trace data, limit lines or correction data.</p> <p>In the X-Series, “state” always includes all of this data; so whenever state is loaded, all of the traces, limit lines and corrections are affected. Although this differs from previous behavior, it is desirable behavior, and should not cause adverse issues for users.</p>
Backwards Compatibility Notes	<p>Recall for the X-Series supports backward compatibility in the sense that you can recall a state file from any X-Series model number and any version of X-Series software. This is only possible if part of the recalling process goes through a limiting step after recalling the mode settings, at least for settings that may vary with version number, model number, option and license differences. If you try to recall a state file onto an instrument with less capability than what was available on the instrument during the save, the recall will ignore the state it doesn't support and it will limit the recalled setting to what it allows.</p> <p>Example: if the saved state includes preamp ON, but the recalling instrument does not have a preamp; the preamp is limited to OFF. Conversely, if you save a state without a preamp, the preamp is OFF in the state file. When this saved file is recalled on an instrument with a licensed preamp, the preamp is changed to OFF. Another example is if the saved state has center frequency set to 20 GHz, but the instrument recalling the saved state is a different model and only supports 13.5 GHz. In this case, the center frequency is limited along with any other frequency based settings. Since the center frequency can't be preserved in this case, the recall limiting tries to at least preserve span to keep the measurement setup as intact as possible.</p> <p>It may be appropriate to issue a warning if the state is limited on the recall; warnings do not go out to SCPI so this would only affect the manual user.</p> <p>Note that there is no state file compatibility outside of the X-Series. For example, you cannot recall a state file from ESA or PSA.</p>
Initial S/W Revision	Prior to A.02.00

State

The Recall State menu lets you choose a register or file from which to recall the state.

The content of a state file includes all of the settings and data required to return the analyzer as closely as possible to the Mode it was in, with the exact settings that were in place, when the save occurred. The Mode settings in each state file include the settings that are affected by Mode Preset, as well as the

additional settings affected by Restore Mode Defaults; all of the Mode's settings. In addition, all of the settings of the Input/Output system are included, even though they are outside of the Mode's state, because they are needed to restore the complete setup. Persistent System settings (for example, GPIB address) are not affected by either a Mode Preset or Restore Mode Defaults, nor are they included in a saved State file.

Since each state file is only for one Mode, the settings for other Modes are unaffected when it is loaded. Recall State will cause a mode switch if the state being recalled is not from the current active mode.

After the recall completes, the message "File <filename> recalled" or "Recalled State Register <register number>" is displayed.

For rapid recalls, the State menu lists 16 registers that you can choose from to recall. Pressing a Register key initiates the recall. You can also select a file from which to recall.

The default path for all State Files is:

My Documents\<>mode name>\state

where <mode name> is the parameter used to select the mode with the INST:SEL command (for example, SA for the Spectrum Analyzer).

See "[More Information](#)" on page 752.

Key Path	Recall
Mode	All
Remote Command	:MMEMory:LOAD:STATe <filename>
Example	:MMEM:LOAD:STAT "myState.state" This recalls the file myState.state on the default path
Example	MMEM:LOAD:STAT "MyStateFile.state" This loads the state file data (on the default file directory path) into the instrument state.
Notes	<p>When you pick a file to recall, the analyzer first verifies that the file is recallable in the current instrument by checking the software version and model number of the instrument. If everything matches, a full recall proceeds by aborting the currently running measurement, clearing any pending operations, and then loading the State from the saved state file. You can open state files from any mode, so recalling a State file switches to the mode that was active when the save occurred. After switching to the mode of the saved state file, mode settings and data (if any for the mode) are loaded with values from the saved file. The saved measurement of the mode becomes the newly active measurement and the data relevant to the measurement (if there is any) is recalled.</p> <p>If there is a mismatch between file version or model number or instrument version or model number, the recall function tries to recall as much as possible and returns a warning message. It may limit settings that differ based on model number, licensing or version number.</p> <p>After recalling the state, the Recall State function does the following:</p> <ul style="list-style-type: none"> • Makes the saved measurement for the mode the active measurement. • Clears the input and output buffers. • Status Byte is set to 0. • Executes a *CLS <p>If the file specified is empty an error is generated. If the specified file does not exist, another error is generated. If there is a mismatch between the file and the proper file type, an error is generated. If</p>

	there is a mismatch between file version or model number or instrument version or model number, a warning is displayed. Then it returns to the State menu and File Open dialog goes away. After the Recall, the analyzer exits the Recall menu and returns to the previous menu.
Backwards Compatibility SCPI	:MMEMory:LOAD:STATe 1,<filename> For backwards compatibility, the above syntax is supported. The "1" is simply ignored.
Initial S/W Revision	Prior to A.02.00

More Information

In measurements that support saving Traces, for example, Swept SA, the Trace data is saved along with the State in the State file. When recalling the State, the Trace data is recalled as well. Traces are recalled exactly as they were stored, including the writing mode and update and display modes. If a Trace was updating and visible when the State was saved, it will come back updating and visible, and its data will be rewritten right away. When you use State to save and recall traces, any trace whose data must be preserved should be placed in View or Blank mode before saving.

The following table describes the Trace Save and Recall possibilities:

You want to recall state and one trace's data, leaving other traces unaffected.	Save Trace+State from 1 trace. Make sure that no other traces are updating (they should all be in View or Blank mode) when the save is performed.	On Recall, specify the trace you want to load the one trace's data into. This trace will load in View. All other traces' data will be unaffected, although their trace mode will be as it was when the state save was performed.
You want to recall all traces	Save Trace+State from ALL traces.	On Recall, all traces will come back in View (or Blank if they were in Blank or Background when saved)
You want all traces to load exactly as they were when saved.	Save State	On recall, all traces' mode and data will be exactly as they were when saved. Any traces that were updating will have their data immediately overwritten.

From File...

When you press "From File", the analyzer brings up a Windows dialog and a menu entitled "File Open." This menu allows you to navigate to the various fields in the Windows dialog without using a keyboard or mouse. The Tab and Arrow keys can also be used for dialog navigation.

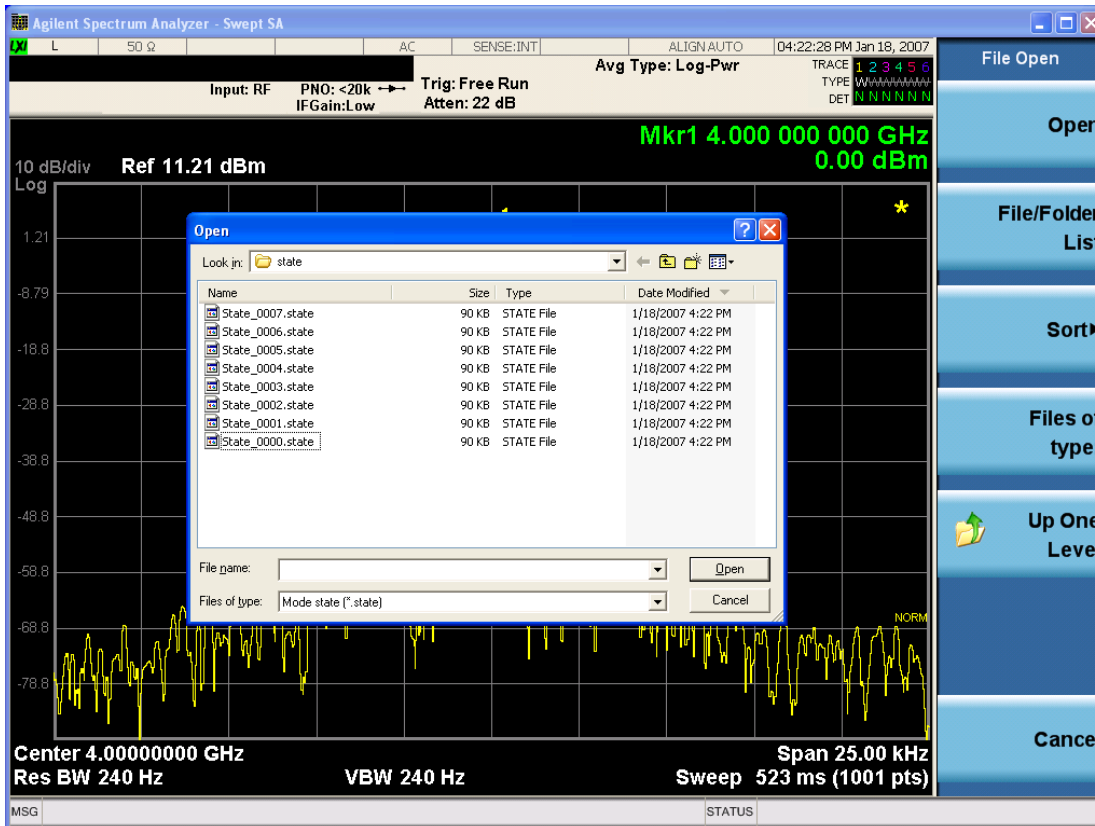

Listed below are the functions of the various fields in the dialog, and the corresponding softkeys:

Open

Performs the recall of the specified file. While the recall is being performed, the floppy icon appears briefly in the Meas bar.

File/Folder List

Enables you to navigate to the center of the dialog that contains the list of files and folders. Once here you can get information about the file and use the tab keys to navigate to the other fields in the dialog, such as Look In.

Look In

The Look In field shows the path from which the file will be recalled and allows you to change the path using the up and down arrow keys to navigate to other paths; the Enter key to open a directory; and the Backspace key to go back one directory. The **Look In field** first uses the last path from the Save As dialog **Save In**; path for that same file type. There is no softkey for directly navigating to the Look In field, but you can use the left tab to get here from the File/Folder List.

User specified paths are remembered when you leave and return to a Mode and are reset back to the default using Restore Mode Defaults.

Sort

Accesses a menu that enables you to sort the files within the File Open dialog. Only one sorting type can be selected at a time and the sorting happens immediately. The sorting types are By Date, By Name, By extension, and By Size.

Files of Type

This field shows the file suffix for the type of file you have selected to recall. For example, if you navigated here while recalling State, "Mode state (*.state)" is in the field. If you navigated here while recalling Trace, ""Mode state (*.trace)" is in the field. If you navigated here while importing a trace data file, "Trace Data (*.csv)" is in the field. For some file types, there is more than one choice in the dropdown menu, which you can select by using the up and down arrow keys and Enter.

Up One Level

This key corresponds to the icon of a folder with the up arrow that is in the tool bar of the dialog. When pressed, it causes the file and folder list to navigate up one level in the directory structure. The Backspace key does the same thing.

Cancel

This key corresponds to the Cancel selection in the dialog. It causes the current **Open** request to be cancelled. The ESC key does the same thing.

Key Path	Recall, State
Notes	Brings up the Open dialog for recalling a State Save Type
Initial S/W Revision	Prior to A.02.00

Edit Register Names

You may enter a custom name on any of the Register keys, to help you remember what you are using that state to save. To do this, press the Edit Register Names key, choose the register whose name you wish to edit, and then enter the desired label using the Alpha Editor or an external PC keyboard.

The maximum number of characters that can be added is 30. In most cases, 30 characters will fit on two lines of the key.

For more information and the SCPI command, see Edit Register Names under the Save, State function.

Key Path	Recall, State
Mode	All
Dependencies	N9060A-7FP or N9060B-2FP license required to edit the register names. When the feature is not licensed, sending the SCPI command generates an error, -221, "Settings conflict;Option not available"
Initial S/W Revision	A.11.00

Register 1 thru Register 16

Selecting any one of these register keys causes the State of the mode from the specified Register to be recalled. Each of the register keys annotates whether it is empty or at what date and time it was last

modified. In addition, you can use the Edit Register Names key under Save, State to enter custom names for each register.

Registers are shared by all modes, so recalling from any one of the registers will cause a mode switch to the mode that was active when the save to the Register occurred.

Although these 16 registers are the only registers available from the front panel, there are 128 state registers available in the instrument. Registers 17–128 are only available from the SCPI interface, using the *RCL command.

After the recall completes, the message "Register <register number> recalled" appears in the message bar. If you are in the Spectrum Analyzer Mode, and you are recalling a register that was saved in the Spectrum Analyzer Mode, then after the recall, you will still be in the Recall Register menu. If the Recall causes you to switch modes, then after the Recall, you will be in the Frequency menu.

If a requested register is empty an error is generated.

Key Path	Recall, State
Example	*RCL 1
Range	1–16 from front panel, 1–128 from SCPI
Readback	Date and time with seconds resolution are displayed on the key OR A custom name of up to 30 characters entered using the Save, State, Edit Register Names key OR “(empty)” if no prior save operation has been performed to this register.
Initial S/W Revision	Prior to A.02.00
Modified at S/W Revision	Prior to A.11.00

Register 1 thru Register 16

Selecting any one of these register keys causes the State of the mode from the specified Register to be recalled. Each of the register keys annotates whether it is empty or at what date and time it was last modified. In addition, you can use the Edit Register Names key under Save, State to enter custom names for each register.

Registers are shared by all modes, so recalling from any one of the registers will cause a mode switch to the mode that was active when the save to the Register occurred.

Although these 16 registers are the only registers available from the front panel, there are 128 state registers available in the instrument. Registers 17–128 are only available from the SCPI interface, using the *RCL command.

After the recall completes, the message "Register <register number> recalled" appears in the message bar. If you are in the Spectrum Analyzer Mode, and you are recalling a register that was saved in the Spectrum Analyzer Mode, then after the recall, you will still be in the Recall Register menu. If the Recall causes you to switch modes, then after the Recall, you will be in the Frequency menu.

If a requested register is empty an error is generated.

Key Path	Recall, State
Example	*RCL 1
Range	1-16 from front panel, 1-128 from SCPI
Readback	Date and time with seconds resolution are displayed on the key OR A custom name of up to 30 characters entered using the Save, State, Edit Register Names key OR “(empty)” if no prior save operation has been performed to this register.
Initial S/W Revision	Prior to A.02.00
Modified at S/W Revision	Prior to A.11.00

Data (Import)

Importing a data file loads data that was previously saved from the current measurement or from other measurements and/or modes that produce compatible data files. The Import Menu only contains Data Types that are supported by the current measurement.

Since the commonly exported data files are in .csv format, the data can be edited by the user prior to importing. This allows you to export a data file, manipulate the data in Excel (the most common PC Application for manipulating .csv files) and then import it.

Importing Data loads measurement data from the specified file into the specified or default destination, depending on the data type selected. Selecting an Import Data menu key will not actually cause the importing to occur, since the analyzer still needs to know from where to get the data. Pressing the Open key in this menu brings up the Open dialog and Open menu that provides you with the options from where to recall the data. Once a filename has been selected or entered in the Open menu, the recall occurs as soon as the Open button is pressed.

Key Path	Recall
Mode	All
Notes	The menu is built from whatever data types are available for the mode. Some keys will be missing completely, so the key locations in the sub-menu will vary. No SCPI command directly controls the Data Type that this key controls. The Data Type is included in the MMEM:LOAD commands.
Dependencies	If a file type is not used by a certain measurement, it is grayed out for that measurement. The key for a file type will not show at all if there are no measurements in the Mode that support it.
Preset	Is not affected by Preset or shutdown, but is reset during Restore Mode Defaults
Readback	The data type that is currently selected
Initial S/W Revision	Prior to A.02.00

Mask

Enables you to recall a preset mask file. This file type (.mask) differs from a normal “state” file because it contains the configuration for Carrier, Offset, and Limit for the specific preset profile BW. A brief description of the mask file is available in the properties view of each file. (Right-mouse-click on the file, select, "Properties" to view this information.) A detailed list of the mask parameter values is located in the .pdf file of the same name in the same directory. Blank values in the .pdf file are parameters that will not be overwritten when recalling the mask.

Key Path	Recall, Data
Mode	WIMAXOFDMA
Remote Command	:MMEMory:LOAD:MASK <string>
Example	:MMEM:LOAD:MASK "MyLimitFile.mask"
Notes	Set of parameters related to Limit, Carrier and Offset are overwritten by Preset Mask file.
Initial S/W Revision	A.02.00

This topic contains the following sections:

["File location and extension" on page 757](#)

["Example of Preset Mask file" on page 758](#)

File location and extension

File location: The preset mask file is located in “My Documents\WIMAXOFDMA\data\masks”.

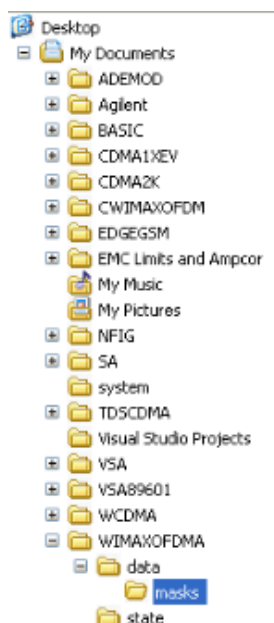

NOTE

When your X-Series analyzer starts, all mask files located in “My Documents\WIMAXOFDMA\data/masks” are overwritten, so any files you wish to save should be stored in another directory location.

File type: The file type is binary file.

File Name: The file name is decided by following naming rules. Each specific keyword is connected with underscore.

<Standard name>_<Radio device>_<Preset Profile BW>_<Measurement>.mask

<Standard name>: This term references the standard associated with each mask file.

<Radio device>: This term specifies to which radio device (BS or MS) the mask file pertains.

<Preset Profile BW>: This term specifies to which Preset Profile BW the mask file pertains.

<Measurement>: This term specifies the measurement to which the mask file is applied. Your selections are: SEM, ACP, or Mode. When selecting **Mode**, the values of some parameters in both the ACP and SEM measurement are overwritten.

File extension: The extension of preset mask file is “mask” to distinguish it from a “state” file.

When you press the open key under the Data menu, the “My Documents\WIMAXOFDMA\data\masks” folder is opened. Select one mask file.

NOTE

When you change the preset BW profile or Radio Device, all measurement parameters are reset to their original values. Thus you have to recall the appropriate preset mask file again after the change.

Example of Preset Mask file

When you import a preset mask file, it is a “Recall” function. Specific parameter values are overwritten by the contents of the preset mask file (see table below). Those values not specified by the preset mask file remain unchanged. Because the file format type is binary, you cannot view, change, or create the preset mask file. Here is an example of a preset mask file used for ACP measurements.

File Location: My Documents/WIMAXOFDMA/data/masks

File Name: ETSI-EN301-021-SysE_BS_10MHz_ACP.mask

The .pdf file that lists the parameters similarly to that shown below is named, "ETSI-EN301-021-SysE_BS_10MHz_ACP.pdf"

The set of parameters listed in the following table for the Preset Profile BW (10MHz) are imported into the ACP measurement.

Offset	Start Freq (MHz)	Stop Freq (MHz)	Sweep Time	Res BW (Hz)	Meas BW	Rel Start	Rel Stop	Fail Mask
A	5	7.14		30k	1	-8	-25	Rel
B	7.14	10.57		30k	1	-25	-27	Rel
C	10.57	20		30k	1	-27	-50	Rel
D	20	25		30k	1	-50	-50	Rel
E	25	30		30k	1	-50	-50	Rel

Zone Map

Pressing this key selects Zone Map as the data type to be imported.

The WiMAX-OFDMA application can load the Singal Studio Setup file, and the OFDMA Map file is compatible with the 89601A Mobile WiMAX omf file.

Key Path	Recall, Data
Remote Command	:MMEMory:LOAD:ZMAP <string>
Example	MMEM:LOAD:ZMAP "ZMap_0000.omf"
Notes	The SCPI parameter is a quoted string that specifies the filename. Both single and double quotes are supported for any filename parameter over SCPI.
Dependencies	You must be in the 802.16 OFDMA (WiMAX/WiBro) mode.
Status Bits/OPC dependencies	Sequential - waits for the previous measurement to complete.
Initial S/W Revision	Prior to A.02.00

Open...

When you press "Open", the analyzer brings up a Windows dialog and a menu entitled "**File Open.**" This menu allows you to navigate to the various fields in the Windows dialog without using a keyboard or mouse. The Tab and Arrow keys can also be used for dialog navigation.

See "[From File...](#)" on page 2241 in Recall, State, for a full description of this dialog and menu.

Key Path	Recall, Data
Notes	The key location is mode-dependent and will vary. Brings up Open dialog for recalling a <mode specific> Save Type
Initial S/W Revision	Prior to A.02.00

Restart

The Restart function restarts the current sweep, or measurement, or set of averaged/held sweeps or measurements. If you are Paused, pressing Restart does a Resume.

The Restart function is accessed in several ways:

- Pressing the Restart key
- Sending the remote command INIT:IMMediate
- Sending the remote command INIT:REStart

See "[More Information](#)" on page 760

Key Path	Front-panel key
Remote Command	:INITiate[:IMMediate] :INITiate:REStart
Example	:INIT:IMM :INIT:REST
Notes	:INITiate:REStart and :INITiate:IMMediate perform exactly the same function.
Couplings	Resets average/hold count k. For the first sweep overwrites all active (update=on) traces with new current data. For application modes, it resets other parameters as required by the measurement.
Status Bits/OPC dependencies	This is an Overlapped command. The STATus:OPERation register bits 0 through 8 are cleared. The STATus:QUESTionable register bit 9 (INTegrity sum) is cleared. The SWEEPING bit is set. The MEASURING bit is set.
Backwards Compatibility Notes	For Spectrum Analysis mode in ESA and PSA, the Restart hardkey and the INITiate:REStart command restart trace averages (displayed average count reset to 1) for a trace in Clear Write, but did not restart Max Hold and Min Hold. In the X-Series, the Restart hardkey and the INITiate:REStart command restart not only Trace Average, but MaxHold and MinHold traces as well. For wireless comms modes in ESA and PSA, the Restart hardkey and the INITiate:REStart command restart every measurement, which includes all traces and numeric results. There is no change to this operation.
Initial S/W Revision	Prior to A.02.00

More Information

The **Restart** function first aborts the current sweep/measurement as quickly as possible. It then resets the sweep and trigger systems, sets up the measurement and initiates a new data measurement sequence with a new data acquisition (sweep) taken once the trigger condition is met.

If the analyzer is in the process of aligning when **Restart** is executed, the alignment finishes before the restart function is performed.

Even when set for Single operation, multiple sweeps may be taken when Restart is pressed (for example, when averaging/holding is on). Thus when we say that **Restart** "restarts a measurement," we may mean:

- It restarts the current sweep
- It restarts the current measurement
- It restarts the current set of sweeps if any trace is in Trace Average, Max Hold or Min Hold
- It restarts the current set of measurements if Averaging, or Max Hold, or Min Hold is on for the measurement
- depending on the current settings.

With **Average/Hold Number** (in **Meas Setup** menu) set to 1, or Averaging off, or no trace in Trace Average or Hold, a single sweep is equivalent to a single measurement. A single sweep is taken after the trigger condition is met; and the analyzer stops sweeping once that sweep has completed. However, with **Average/Hold Number** >1 and at least one trace set to **Trace Average, Max Hold, or Min Hold (SA Measurement)** or **Averaging on (most other measurements)**, multiple sweeps/data acquisitions are taken for a single measurement. The trigger condition must be met prior to each sweep. The sweep is stopped when the average count k equals the number N set for **Average/Hold Number**. A measurement average usually applies to all traces, marker results, and numeric results; but sometimes it only applies to the numeric results.

Once the full set of sweeps has been taken, the analyzer will go to idle state. To take one more sweep without resetting the average count, increment the average count by 1, by pressing the step up key while **Average/Hold Number** is the active function, or sending the remote command `CALC:AVER:TCON UP`.

Save

The Save menu lets you choose what you want to save and where you want to save it. Among the types of files you can save are **States**, **Traces**, and **Screen Images**. In addition, an Export (Data) option lets you save a number of data types as CSV files for easy import into Excel and other spreadsheet programs.

Key Path	Front-panel key
Mode	All
Notes	No remote command for this key specifically, but the :MMEM:STOR:STATe <filename> command is available for specific file types. An example is :MMEM:STOR:STATe <filename>.
Initial S/W Revision	Prior to A.02.00

State

The Save State menu lets you choose a register or file for saving the state.

The content of a state file includes all of the settings and data required to return the analyzer as closely as possible to the Mode it was in, with the exact settings which were in place, when the save occurred. The Mode settings in each state file include the settings that are affected by Mode Preset, as well as the additional settings affected by Restore Mode Defaults; all of the Mode's settings. In addition, all of the settings of the Input/Output system are included, even though they are outside of the Mode's state, because they are needed to restore the complete setup. Persistent System settings (for example, Verbose SCPI) are not affected by either Mode Preset or Restore Mode Defaults, nor are they included in a saved State file.

After the save completes, the message "File <filename> saved" or "State Register <register number> saved" is displayed.

For rapid saving, the State menu lists 16 registers to save to. Pressing a Register key initiates the save. You can also select a file to save to.

The default path for all State Files is:

My Documents\<<mode name>\state

where <mode name> is the parameter used to select the mode with the INST:SEL command (for example, SA for the Spectrum Analyzer).

Key Path	Save
Mode	All
Remote Command	:MMEMory:STORe:STATe <filename>
Example	MMEM:STOR:STATe "MyStateFile.state" This stores the current instrument state data in the file MyStateFile.state in the default directory.
Notes	Both single and double quotes are supported for any filename parameter over remote. After saving to a register, that register's menu key is updated with the date the time, unless a custom label has been entered for that key. After saving to a register, you remain in the Save State menu, so that you can see the Register key

update. After saving to a file, the analyzer automatically returns to the previous menu and any Save As dialog goes away.

Backwards Compatibility SCPI	:MMEMory:STORe:STATe 1,<filename>
Initial S/W Revision	Prior to A.02.00

To File . . .

When you press “To File”, the analyzer brings up a Windows dialog and a menu entitled “**Save As.**” This menu allows you to navigate to the various fields in the Windows dialog without using a keyboard or mouse. The Tab and Arrow keys can also be used for dialog navigation.

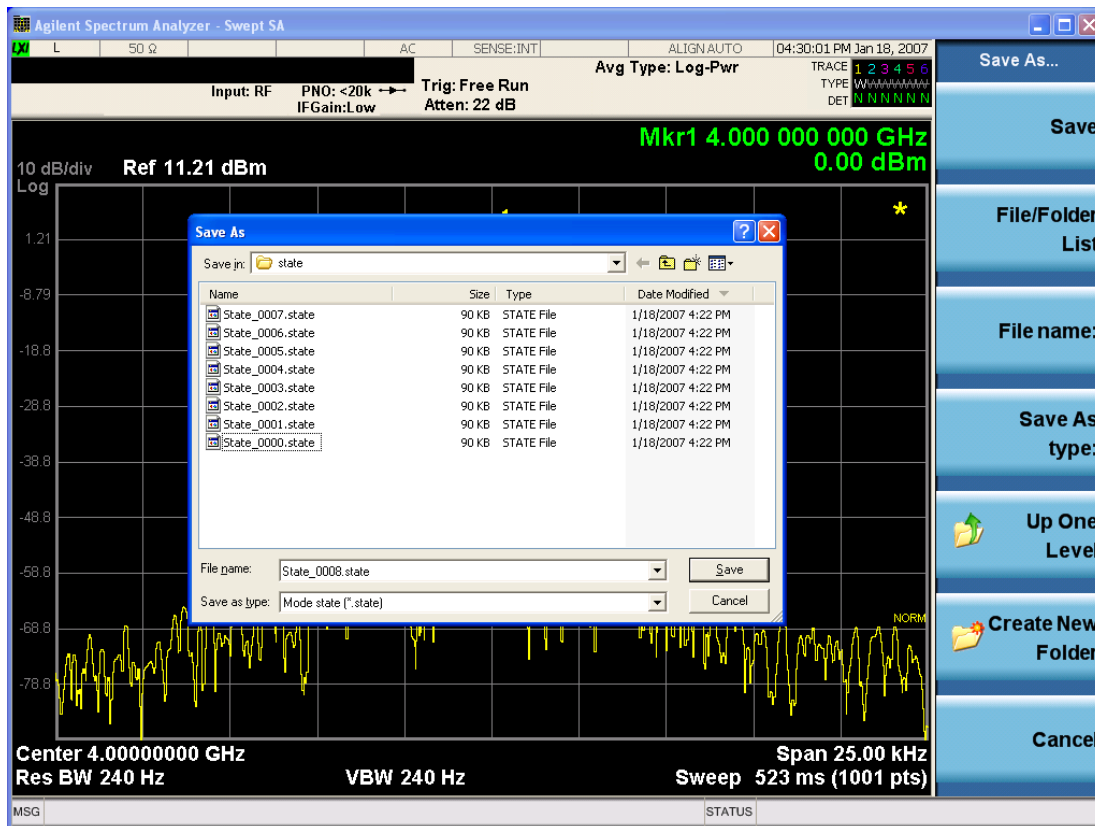

The Listed below

are the functions of the various fields in the dialog, and the corresponding softkeys:

Save

Performs the save to the specified file of the selected type. If the file already exists, a dialog will appear that allows you to replace the existing file by selecting OK, or you can Cancel the request. If you select OK, the file will be overwritten. Using the C: drive is strongly discouraged, since it runs the risk of being overwritten during an instrument software upgrade.

While the save is being performed, the floppy icon appears briefly in the Meas bar.

File/Folder List

Enables you to navigate to the center of the dialog that contains the list of files and folders. Once here you can get information about the file and use the tab keys to navigate to the other fields in the dialog, such as Save In.

Save In

The Save In field shows the path to which the file will be saved and allows you to change the path using the up and down arrow keys to navigate to other paths; the Enter key to open a directory; and the Backspace key to go back one directory. The **Save In field** defaults to the default path for this type of file and remembers the last path you used to save this type of file. There is no softkey for directly navigating to the Save In field but you can use left tab to get here from the File/Folder List.

User specified paths are remembered when you leave and return to a Mode and are reset back to the default using Restore Mode Defaults.

File Name

The File Name field is initially loaded with an automatically generated filename specific to the appropriate Save Type. The automatically generated filename is guaranteed not to conflict with any filename currently in the directory. You may replace or modify this filename using the File Name key. See the ["Quick Save " on page 2237](#) documentation for more on the automatic file naming algorithm.

When you press the File Name key the analyzer displays the Alpha Editor. Use the knob to choose the letter to add and the front-panel Enter key to add the letter to the file name. The BK character moves you back and the FW character moves you forward in the filename. The Select key on the front panel generates a space character. When you are done entering the filename press the Done softkey. This returns back to the **File Open** dialog and menu, but does not cause the save to occur.

Save As Type

This field shows the file suffix for the type of file you have selected to save. For example, if you navigated here while saving State, "Mode state (*.state)" is in the field. If you navigated here from saving Trace, ""Mode state (*.trace)" is in the field. If you navigated here while exporting a trace data file, "Trace Data (*.csv)" is in the field. For some file types, there is more than one choice in the dropdown, which you can select by using the up and down arrow keys and Enter.

Up One Level

This key corresponds to the icon of a folder with the up arrow that is in the tool bar of the dialog. When pressed, it causes the file and folder list to navigate up one level in the directory structure. The Backspace key does the same thing.

Create New Folder

This key corresponds to the icon of a folder with the "*" that is in the tool bar of the dialog. When pressed, a new folder is created in the current directory with the name **New Folder** and you can enter a new folder name using the Alpha Editor.

Cancel

This key corresponds to the Cancel selection in the dialog. It causes the current **Save As** request to be cancelled. The ESC key does the same thing.

Key Path	Save, State
Mode	All
Notes	Brings up Save As dialog for saving a State Save Type
Initial S/W Revision	Prior to A.02.00

Edit Register Names

You may enter a custom name on any of the Register keys, to help you remember what you are using that state to save. To do this, press the Edit Register Names key, choose the register whose name you wish to edit, and then enter the desired label using the Alpha Editor or an external PC keyboard.

The maximum number of characters that can be added is 30. In most cases, 30 characters will fit on two lines of the key.

See ["More Information" on page 765](#)

Key Path	Save, State
Mode	All
Remote Command	:MMEMory:REGister:STATe:LABel <reg number>,"label" :MMEMory:REGister:STATe:LABel? <reg number>
Example	:MMEM:REG:STAT:LAB 1,"my label"
Notes	<reg number> is an integer from 1 to 16. If the SCPI specifies an invalid register number an error message is generated, -222,"Data out of range;Invalid register label number" "label" is a string from 0 to 30 characters in length. If a label exceeds 30 characters, an error message is generated, -150,"String data error;Label clipped to 30 characters" "label" of length 0 erases the custom label and restores the default (time and date) label. E.g.: :MMEM:REG:STAT:LAB 1,""
Dependencies	N9060A-7FP or N9060B-2FP license required to edit the register names. When the feature is not licensed, sending this command generates an error, -221,"Settings conflict;Option not available"
Preset	The names are unaffected by Preset or power cycle but are set to the default label (time and date) on a "Restore System Defaults->Misc"
Initial S/W Revision	A.11.00

More Information

When you edit one of the register names, the time and date field will be replaced by the custom name.

If you delete all the characters in the custom name, it restores the default (time and date).

The register names are stored within the state files, but they are not part of the instrument state; that is, once you have edited a register name, loading a new state will not change that register name. Another consequence of this is that the names will be persistent through a power cycle. Also, if a named state file is transferred to another analyzer, it will bring its custom name along with it.

If you try to edit the name of an empty register, the analyzer will first save the state to have a file to put the name in. If you load a named state file into an analyzer with older firmware it will ignore the metadata.

The *SAV and *RCL commands will not be affected by the custom register names, nor will the MMEM commands.

Register 1 thru Register 16

Selecting any one of these register menu keys causes the State of the currently active mode to be saved to the specified Register. The registers are provided for rapid saving and recalling, since you do not need to specify a filename or navigate to a file. Each of the register menu keys annotates whether it is empty or at what date and time it was last modified. In addition, you can use the Edit Register Names key to enter custom names for each register.

Although these 16 registers are the only registers available from the front panel, there are 128 state registers available in the instrument. Registers 17–128 are only available from the SCPI interface, using the *SAV command.

There is one set of 128 state registers in the instrument, not one set for each Mode. When a state is saved, the Mode it was saved from is saved with it; then when it is recalled, the instrument switches to that Mode.

After the save completes, the corresponding register menu key annotation is updated with the date and time and the message "Register <register number> saved" is displayed.

Key Path	Save, State
Mode	All
Example	*SAV 1
Range	1–16 from front panel, 1–128 from SCPI
Readback	Date and time with seconds resolution are displayed on the key OR A custom name of up to 30 characters entered using the Edit Register Names key OR “(empty)” if no prior save operation has been performed to this register.
Initial S/W Revision	Prior to A.02.00
Modified at S/W Revision	A.11.00

Register 1 thru Register 16

Selecting any one of these register menu keys causes the State of the currently active mode to be saved to the specified Register. The registers are provided for rapid saving and recalling, since you do not need to specify a filename or navigate to a file. Each of the register menu keys annotates whether it is empty or at what date and time it was last modified. In addition, you can use the Edit Register Names key to enter custom names for each register.

Although these 16 registers are the only registers available from the front panel, there are 128 state registers available in the instrument. Registers 17–128 are only available from the SCPI interface, using the *SAV command.

There is one set of 128 state registers in the instrument, not one set for each Mode. When a state is saved, the Mode it was saved from is saved with it; then when it is recalled, the instrument switches to that Mode.

After the save completes, the corresponding register menu key annotation is updated with the date and time and the message "Register <register number> saved" is displayed.

Key Path	Save, State
Mode	All
Example	*SAV 1
Range	1–16 from front panel, 1–128 from SCPI
Readback	Date and time with seconds resolution are displayed on the key OR A custom name of up to 30 characters entered using the Edit Register Names key OR “(empty)” if no prior save operation has been performed to this register.
Initial S/W Revision	Prior to A.02.00
Modified at S/W Revision	A.11.00

Data (Export)

Exporting a data file stores data from the current measurement to mass storage files. The Export Menu only contains data types that are supported by the current measurement.

Since the commonly exported data files are in .csv format, the data can be edited by you prior to importing. This allows you to export a data file, manipulate the data in Excel (the most common PC Application for manipulating .csv files) and then import it.

Selecting an Export Data menu key will not actually cause the exporting to occur, since the analyzer still needs to know where you wish to save the data. Pressing the Save As key in this menu brings up the Save As dialog and Save As menu that allows you to specify the destination file and directory. Once a filename has been selected or entered in the Open menu, the export will occur as soon as the Save key is pressed.

Key Path	Save
Mode	All
Notes	The menu is built from whatever data types are available for the mode. So the key locations in the sub menu will vary. No SCPI command directly controls the Data Type that this key controls. The Data Type is included in the MMEM:STORe commands.
Dependencies	If a file type is not used by a certain measurement, that type is grayed out for that measurement. The key for a file type will not show at all if there are no measurements in the Mode that support it.
Preset	Is not affected by a Preset or shutdown, but is reset during Restore Mode Defaults
Readback	The data type that is currently selected
Initial S/W Revision	Prior to A.02.00

Measurement Results

Pressing this key selects Meas Results as the data type to be exported.

The Meas Results file contains information which describes the current state of the analyzer. It is detailed in Meas Result File Contents below.

Key Path	Save, Data
Remote Command	:MMEMory:STORe:RESults <string>
Example	:MMEM:STOR:RES "MeasR_0000.csv"
Notes	<p>If the save is initiated via SCPI and the file already exists, the file will be overwritten.</p> <p>The SCPI command exports ACP measurement results to the file specified as the parameter in the current path. The default path is My Documents\<current mode>\data\ACP\results.</p> <p>Using the C: drive is strongly discouraged, since it runs the risk of being overwritten during an instrument software upgrade.</p> <p>The SCPI parameter is a quoted string that specifies the filename. Both single and double quotes are supported for any filename parameter over SCPI.</p>
Dependencies	The current active measurement must be the ACP measurement to use this command.
Status Bits/OPC dependencies	Sequential – waits for the previous measurement to complete
Initial S/W Revision	Prior to A.02.00

Meas Results File Contents

A Meas Results File contains measurement results with the following information.

- File ID string, which is "MeasResult"
- Measurement ID following Mode ID, which is "SA:ACP" for example.
- Firmware rev and model number
- Option string
- Auto Scaling
- Auto Sweep Time Rules
- Automatic Trigger Time
- Automatic Trigger Time State
- Average Mode
- Average Number
- Average State
- Bar Graph
- Carrier Coupling
- Carrier Pwr Present

- Carrier Spacing
- Carriers
- Center Frequency
- Center Frequency Step
- Center Frequency Step State
- Detector Auto
- Detector Selection
- Electrical Atten
- Electrical Atten State
- External Array Trigger Delay
- External Array Trigger Delay State
- External Array Trigger Level
- External Array Trigger Slope
- Filter Alpha
- Filter BW
- Filter Type
- Internal Preamp
- Internal Preamp Band
- Limit Test
- Line Trigger Delay
- Line Trigger Delay State
- Line Trigger Slope
- Meas Method
- Meas Type
- Measurement Noise Bandwidth
- Mechanical Atten
- MechanicalAttenStepEnum
- Method
- Noise Correction
- Offset Abs Limit
- Offset Fail

- Offset Filter Alpha
- Offset Filter BW
- Offset Filter Type
- Offset Freq
- Offset Freq State
- Offset Integ BW
- Offset Method
- Offset Rel Lim (Car)
- Offset Rel Lim (PSD)
- Offset Res BW
- Offset Res BW Mode
- Offset Video BW
- Offset Video BW Mode
- Periodic Timer Period
- Periodic Timer Sync Source
- Periodic Timer Trigger Delay
- Periodic Timer Trigger Delay State
- Points
- Power Ref
- Power Ref State
- Preselector Adjust
- PSD Ref
- PSD Unit
- Ref Car Freq
- Ref Car Freq State
- Ref Carrier
- Ref Carrier Mode
- Ref Position
- Ref Value
- Res BW
- Res BW Mode

- RFBurst Trigger Delay
- RFBurst Trigger Delay State
- RFBurst Trigger Level Abs
- RFBurst Trigger Level Rel
- RFBurst Trigger Level Type
- RFBurst Trigger Slope
- Scale/Div
- Span
- Sweep Time
- Sweep Time Auto
- Trigger Holdoff
- Trigger Holdoff State
- Trigger Source
- Video BW
- Video BW Auto

The file contains these data followed by MeasResult1, MeasResult2, and MeasResult3 that flag the start of the measurement results. Each line of Measurement Results consists of three comma separated values, MeasResult1 value, MeasResult2 value, and MeasResult3 value. MeasResult1 contains the same result as MEAS/READ/FETCH:ACPower1; MeasResult2, MEAS/READ/FETCH:ACPower2; MeasResult3, MEAS/READ/FETCH:ACPower3.

Exported file is .csv file. The Meas Results file, when imported into Excel, will show the following data:

MeasResult	
SA:ACP	
A.10.53	N9030A
526 ALV ATP	1
B1X B1Y B25	
B40 BBA CR3	
CRP DCF DDA	
DP2 DRD EA3	
EDP EMC EP1	
ERC ESC ESP	
EXM FSA LFE	
LNP MAT MPB	
NFE NUL P26	
PFR PNC RTL	
RTS S40 SB1	
SEC SM1 TVT	
YAS YAV	

Auto Scaling	TRUE												
Auto Sweep Time Rules	Accy												
Automatic Trigger Time	0.1												
Automatic Trigger Time State	FALSE												
Average Mode	Exponential												
Average Number	10												
Average State	TRUE												
Bar Graph	TRUE												
Carrier Coupling	TRUE	TRUE	TRUE	TRUE	TRUE	TRUE	TRUE	TRUE	TRUE	TRUE	TRUE	TRUE	TRUE
Carrier Pwr Present	Yes	Yes	Yes	Yes	Yes	Yes	Yes	Yes	Yes	Yes	Yes	Yes	Yes
Carrier Spacing	5000000	500000	50000	50000	50000	50000	50000	50000	50000	50000	50000	50000	50000
			0	0	0	0	0	0	0	0	0	0	0
Carriers	1												
Center Frequency	1.33E+10												
Center Frequency Step	800000												
Center Frequency Step State	TRUE												
Detector Auto	TRUE												
Detector Selection	Average												
Electrical Atten	0												
Electrical Atten State	FALSE												
External Array Trigger Delay	1.00E-06	1.00E-06											
External Array Trigger Delay State	FALSE	FALSE											
External Array Trigger Level	1.2	1.2											

External Array Trigger Slope	Positive	Positive										
Filter Alpha	0.22	0.22	0.22	0.22	0.22	0.22	0.22	0.22	0.22	0.22	0.22	0.22
Filter BW	Minus3dB											
Filter Type	Gaussian											
Internal Preamp	FALSE											
Internal Preamp Band	Low											
Limit Test	FALSE											
Line Trigger Delay	1.00E-06											
Line Trigger Delay State	FALSE											
Line Trigger Slope	Positive											
Meas Method	IbwSpeed											
Meas Type	TPRef											
Measurement Noise Bandwidth	2000000	2000000	200000	200000	200000	200000	200000	200000	200000	200000	200000	200000
Mechanical Atten	10											
MechanicalAttenStepEnum	S2dB											
Method	IBW	IBW	IBW	IBW	IBW	IBW	IBW	IBW	IBW	IBW	IBW	IBW
Noise Correction	FALSE											
Offset Abs Limit	0	0	0	0	0	0						
Offset Fail	Relative	Relative	Relative	Relative	Relative	Relative						
Offset Filter Alpha	0.22											
Offset Filter BW	Minus3dB	Minus3dB	Minus3dB	Minus3dB	Minus3dB	Minus3dB						
Offset Filter Type	Gaussian	Gaussian	Gaussian	Gaussian	Gaussian	Gaussian						
Offset Freq	3000000	0	0	0	0	0						

Offset Freq State	TRUE	FALSE	FAL SE	FAL SE	FAL SE	FAL SE
Offset Integ BW	2000000	2000 000	200 000	200 000	200 000	200 000
Offset Method	FALSE					
Offset Rel Lim (Car)	-45	-60	0	0	0	0
Offset Rel Lim (PSD)	-28.87	- 43.87	0	0	0	0
Offset Res BW	220000	2200 00	220 000	220 000	220 000	220 000
Offset Res BW Mode	TRUE	TRUE	TRU E	TRU E	TRU E	TRU E
Offset Video BW	22000	2200 0	220 00	220 00	220 00	220 00
Offset Video BW Mode	TRUE	TRUE	TRU E	TRU E	TRU E	TRU E
Periodic Timer Period	0.02					
Periodic Timer Sync Source	None					
Periodic Timer Trigger Delay	1.00E-06					
Periodic Timer Trigger Delay State	FALSE					
Points	1001					
Power Ref	-76.81 dBm					
Power Ref State	On					
Preselector Adjust	0					
PSD Ref	-139.82 dBm/Hz					
PSD Unit	DbmHz					
Ref Car Freq	13.25500 0000 GHz					
Ref Car Freq State	On					
Ref Carrier	1					

Ref Carrier Mode	On	
Ref Position	Top	
Ref Value	-30	
Res BW	220000	
Res BW Mode	FALSE	
RFBurst Trigger Delay	1.00E-06	
RFBurst Trigger Delay State	FALSE	
RFBurst Trigger Level Abs	-20	
RFBurst Trigger Level Rel	-6	
RFBurst Trigger Level Type	Absolute	
RFBurst Trigger Slope	Positive	
Scale/Div	10	
Span	8000000	
Sweep Time	0.02	
Sweep Time Auto	TRUE	
Trigger Holdoff	0.1	
Trigger Holdoff State	FALSE	
Trigger Source	Free	
Video BW	22000	
Video BW Auto	TRUE	
MeasResult1	MeasResult 2	Meas Result 3
- 76.80585177 44559	0	1
0.084790019 950006	- 76.80585 17744559	0

0.028392912 8313787	-999	1
	-999	0
	-999	1

Zone Map

Pressing this key selects Zone Map as the data type to be exported.

The Zone Map file contains information about current Zone Map configuration. Its format is compatible with the 89601A OFDMA map file. It is detailed in ["Zone Map File Contents" on page 776](#) below.

Key Path	Save, Data
Remote Command	:MMEMory:STORe:ZMAP <string>
Example	MMEM:STOR:ZMAP "ZMap_0000.omf"
Notes	<p>If the save is initiated via SCPI and the file already exists, the file will be overwritten.</p> <p>The SCPI command exports Zone Map information to the file specified as the parameter in the current path. The default path is My Documents\WIMAXOFDMA\.</p> <p>Using the C: drive is strongly discouraged, since it runs the risk of being overwritten during an instrument software upgrade.</p> <p>The SCPI parameter is a quoted string that specifies the filename. Both single and double quotes are supported for any filename parameter over SCPI.</p>
Dependencies	You must be in the 802.16 OFDMA (WiMAX/WiBro) mode.
Status Bits/OPC dependencies	Sequential - waits for the previous measurement to complete.
Initial S/W Revision	Prior to A.02.00

Zone Map File Contents

A Zone Map File contains the following information of the Zone Map configuration. See ["Zone Map Data" on page 329](#) for detailed definitions.

- DemodOfdmaMap_AutoDetect
- DemodOfdmaMap_Count
- DemodOfdmaMap_F1_DL_Count
- DemodOfdmaMap_F1_DL_Z1_Active
- DemodOfdmaMap_F1_DL_Z1_AmcType
- DemodOfdmaMap_F1_DL_Z1_B1_Active
- DemodOfdmaMap_F1_DL_Z1_B1_AllocType
- DemodOfdmaMap_F1_DL_Z1_B1_Boost

- DemodOfdmaMap_F1_DL_Z1_B1_BurstType
- DemodOfdmaMap_F1_DL_Z1_B1_ColorIndex
- DemodOfdmaMap_F1_DL_Z1_B1_ModType
- DemodOfdmaMap_F1_DL_Z1_B1_Name
- DemodOfdmaMap_F1_DL_Z1_B1_SubchannelInterval
- DemodOfdmaMap_F1_DL_Z1_B1_SubchannelOffset
- DemodOfdmaMap_F1_DL_Z1_B1_SymbolInterval
- DemodOfdmaMap_F1_DL_Z1_B1_SymbolOffset
- DemodOfdmaMap_F1_DL_Z1_Count
- DemodOfdmaMap_F1_DL_Z1_DedicPilots
- DemodOfdmaMap_F1_DL_Z1_IDCell
- DemodOfdmaMap_F1_DL_Z1_IDCellCouple
- DemodOfdmaMap_F1_DL_Z1_Len
- DemodOfdmaMap_F1_DL_Z1_Locked
- DemodOfdmaMap_F1_DL_Z1_Name
- DemodOfdmaMap_F1_DL_Z1_PrbsID
- DemodOfdmaMap_F1_DL_Z1_StcMatrix
- DemodOfdmaMap_F1_DL_Z1_StcType
- DemodOfdmaMap_F1_DL_Z1_SymOffset
- DemodOfdmaMap_F1_DL_Z1_UseAllSC
- DemodOfdmaMap_F1_DL_Z1_WrapType
- DemodOfdmaMap_F1_DL_Z1_ZoneType
- DemodOfdmaMap_F1_UL_Count
- DemodOfdmaMap_F1_UL_Z1_Active
- DemodOfdmaMap_F1_UL_Z1_AmcType
- DemodOfdmaMap_F1_UL_Z1_B1_Active
- DemodOfdmaMap_F1_UL_Z1_B1_AllocType
- DemodOfdmaMap_F1_UL_Z1_B1_Boost
- DemodOfdmaMap_F1_UL_Z1_B1_BurstType
- DemodOfdmaMap_F1_UL_Z1_B1_ColorIndex
- DemodOfdmaMap_F1_UL_Z1_B1_ModType

- DemodOfdmaMap_F1_UL_Z1_B1_Name
- DemodOfdmaMap_F1_UL_Z1_B1_PilotPattern
- DemodOfdmaMap_F1_UL_Z1_B1_StcMode
- DemodOfdmaMap_F1_UL_Z1_B1_SubchannelInterval
- DemodOfdmaMap_F1_UL_Z1_B1_SubchannelOffset
- DemodOfdmaMap_F1_UL_Z1_B1_SymbolInterval
- DemodOfdmaMap_F1_UL_Z1_B1_SymbolOffset
- DemodOfdmaMap_F1_UL_Z1_Count
- DemodOfdmaMap_F1_UL_Z1_Gap
- DemodOfdmaMap_F1_UL_Z1_IDCell
- DemodOfdmaMap_F1_UL_Z1_Len
- DemodOfdmaMap_F1_UL_Z1_Locked
- DemodOfdmaMap_F1_UL_Z1_Name
- DemodOfdmaMap_F1_UL_Z1_SymOffset
- DemodOfdmaMap_F1_UL_Z1_UseSubchRotate
- DemodOfdmaMap_F1_UL_Z1_WrapType
- DemodOfdmaMap_F1_UL_Z1_ZoneType
- DemodOfdmaMap_Name
- DemodOfdmaMap_RefreshMap

Save As . . .

When you press “Save As”, the analyzer brings up a Windows dialog and a menu entitled “**Save As.**” This menu allows you to navigate to the various fields in the Windows dialog without using a keyboard or mouse. The Tab and Arrow keys can also be used for dialog navigation.

See "[To File . . .](#)" on page 2252 in Save, State for a full description of this dialog and menu.

The default path for saving files is:

For all of the Trace Data Files:

My Documents\`<mode name>`\data\traces

For all of the Limit Data Files:

My Documents\`<mode name>`\data\limits

For all of the Measurement Results Data Files:

My Documents\`<mode name>`\data\`<measurement name>`\results

For all of the Capture Buffer Data Files:

My Documents\

Key Path	Save, Data
Mode	All
Notes	The key location is mode-dependent and will vary. Brings up the Save As dialog for saving a <mode specific> Save Type. The save is performed immediately and does not wait until the measurement is complete.
Initial S/W Revision	Prior to A.02.00

Screen Image

Pressing Screen Image accesses a menu of functions that enable you to specify a format and location for the saved screen image. It brings up a menu that allows you to specify the color scheme of the Screen Image (Themes) or navigate to the Save As dialog to perform the actual save.

Screen Image files contain an exact representation of the analyzer display. They cannot be loaded back onto the analyzer, but they can be loaded into your PC for use in many popular applications.

The image to be saved is actually captured when the Save front panel key is pressed, and kept in temporary storage to be used if you ask for a Screen Image save. When the Screen Image key is pressed, a "thumbnail" of the captured image is displayed, as shown below:

The screenshot displays the Agilent Spectrum Analyzer interface. The main window shows a spectrum plot with a center frequency of 13.25500000 GHz and a reference level of 0.00 dBm. The plot shows a signal with a peak at approximately -10 dBm and a noise floor around -70 dBm. The 'Screen Image' menu is open on the right side of the screen, showing options like 'Themes', '3D Color', 'Auto Tune', and 'Save As ...'. The 'Save As ...' option is highlighted. Below the plot, a message indicates that the screen image was successfully saved as 'example_0001.png'.

When you continue on into the Save As menu and complete the Screen Image save, the image depicted in the thumbnail is the one that gets saved, showing the menus that were on the screen before going into the Save menus. The save is performed immediately and does not wait until the measurement is complete.

OFDMA (WiMAX/WiBro) Measurement Application Reference

779

After you have completed the save, the Quick Save front-panel key lets you quickly repeat the last save performed, using an auto-named file, with the current screen data.

NOTE

For versions previous to A.01.55, if you initiate a screen image save by navigating through the Save menus, the image that is saved will contain the Save menu softkeys, not the menus and the active function that were on the screen when you first pressed the Save front panel key.

Key Path	Save
Mode	All
Remote Command	:MMEMory:STORe:SCReem <filename>
Example	:MMEM:STOR:SCR "myScreen.png" This stores the current screen image in the file MyScreenFile.png in the default directory.
Initial S/W Revision	Prior to A.02.00

Themes

Accesses a menu of functions that enable you to choose the theme to be used when saving the screen image.

The **Themes** option is the same as the **Themes** option under the **Display** and **Page Setup** dialogs. It allows you to choose between themes to be used when saving the screen image.

Key Path	Save, Screen Image
Remote Command	:MMEMory:STORe:SCReem:THEMe TDColor TDMonochrome FCOLor FMONochrome :MMEMory:STORe:SCReem:THEMe?
Example	:MMEM:STOR:SCR:THEM TDM
Preset	3D Color; Is not part of Preset, but is reset by Restore Misc Defaults or Restore System Defaults All and survives subsequent running of the modes.
Readback	3D Color 3D Mono Flat Color Flat Mono
Backwards Compatibility Notes	In ESA and PSA we offer the choice of "Reverse Bitmap" or "Reverse Metafile" when saving screen images. This is much like the "Flat Color" theme available in X-Series. Also, if you selected Reverse Bitmap AND a black & white screen image, that would be much like "Flat Monochrome". In other words, each of the X-Series themes has a similar screen image type in ESA/PSA. But they are not identical.
Initial S/W Revision	Prior to A.02.00

3D Color

Selects a standard color theme with each object filled, shaded and colored as designed.

Key Path	Save, Screen Image, Themes
Example	MMEM:STOR:SCR:THEM TDC

Readback	3D Color
Initial S/W Revision	Prior to A.02.00

3D Monochrome

Selects a format that is like 3D color but shades of gray are used instead of colors.

Key Path	Save, Screen Image, Themes
Example	MMEM:STOR:SCR:THEM TDM
Readback	3D Mono
Initial S/W Revision	Prior to A.02.00

Flat Color

Selects a format that is best when the screen is to be printed on an ink printer.

Key Path	Save, Screen Image, Themes
Example	MMEM:STOR:SCR:THEM FCOL
Readback	Flat Color
Initial S/W Revision	Prior to A.02.00

Flat Monochrome

Selects a format that is like Flat Color. But only black is used (no colors, not even gray), and no fill.

Key Path	Save, Screen Image, Themes
Example	MMEM:STOR:SCR:THEM FMON
Readback	Flat Mono
Initial S/W Revision	Prior to A.02.00

Save As...

When you press "Save As", the analyzer brings up a Windows dialog and a menu entitled "**Save As.**" This menu allows you to navigate to the various fields in the Windows dialog without using a keyboard or mouse. The Tab and Arrow keys can also be used for dialog navigation.

See "[To File . . .](#)" on page 2252 in Save, State for a full description of this dialog and menu.

The default path for Screen Images is

My Documents\`<mode name>`\screen.

where <mode name> is the parameter used to select the mode with the INST:SEL command (for example, SA for the Spectrum Analyzer).

Key Path	Save, Screen Image
Notes	Brings up Save As dialog for saving a Screen Image Save Type
Initial S/W Revision	Prior to A.02.00

Mass Storage Catalog (Remote Command Only)

Key path	SCPI Only
Remote Command	:MMEMory:CATalog? [<directory_name>]
Notes	<p>The string must be a valid logical path.</p> <p>Queries disk usage information (drive capacity, free space available) and obtains a list of files and directories in a specified directory in the following format:</p> <p><numeric_value>,<numeric_value>,{<file_entry>}</p> <p>It returns two numeric parameters and as many strings as there are files and directories. The first parameter indicates the total amount of storage currently used in bytes. The second parameter indicates the total amount of storage available, also in bytes. The <file_entry> is a string. Each <file_entry> indicates the name, type, and size of one file in the directory list:</p> <p><file_name>,<file_type>,<file_size></p> <p>As the windows file system has an extension that indicates file type, <file_type> is always empty. <file_size> provides the size of the file in bytes. For directories, <file_entry> is surrounded by square brackets and both <file_type> and <file_size> are empty</p>
Initial S/W Revision	Prior to A.02.00

Mass Storage Change Directory (Remote Command Only)

Key path	SCPI Only
Remote Command	:MMEMory:CDIRectory [<directory_name>] :MMEMory:CDIRectory?
Notes	<p>The string must be a valid logical path.</p> <p>Changes the default directory for a mass memory file system. The <directory_name> parameter is a string. If no parameter is specified, the directory is set to the *RST value.</p> <p>At *RST, this value is set to the default user data storage area, that is defined as System.Environment.SpecialFolder.Personal.</p> <p>Query returns full path of the default directory.</p>
Initial S/W Revision	Prior to A.02.00

Mass Storage Copy (Remote Command Only)

Key path	SCPI Only
Remote Command	:MMEMory:COpy <string>,<string>[,<string>,<string>]
Notes	<p>The string must be a valid logical path.</p> <p>Copies an existing file to a new file or an existing directory to a new directory.</p> <p>Two forms of parameters are allowed. The first form has two parameters. In this form, the first parameter specifies the source, and the second parameter specifies the destination.</p> <p>The second form has four parameters. In this form, the first and third parameters specify the source. The second and fourth parameters specify the directories. The first pair of parameters specifies the source. The second pair specifies the destination. An error is generated if the source doesn't exist or the destination file already exists.</p> <p>This command will generate an "access denied" error if the destination is a restricted folder (e.g., C:\Windows) and the current user does not have Power User or Administrator privileges.</p>

Mass Storage Device Copy (Remote Command Only)

This command transfers data to/from a file and a peripheral device.

Key path	SCPI Only
Remote Command	:MMEMory:COpy:DEvice <source_string>,<dest_string>
Notes	<p>The strings must be a valid logical path or a valid device keyword. If the dest_string is a device keyword, the data is copied from the source file to the device. If the source_string is a device keyword, the data is copied to the source file from the device.</p> <p>Valid device keywords are:</p> <p>SNS (smart noise source)</p> <p>An error is generated if the file or device is not found.</p>

Mass Storage Delete (Remote Command Only)

Key path	SCPI Only
Remote Command	:MMEMory:DElete <file_name>[,<directory_name>]
Notes	<p>The string must be a valid logical path.</p> <p>Removes a file from the specified directory. The <file_name> parameter specifies the file name to be removed. This command will generate an "access denied" error if the file is in a restricted folder (e.g., C:\Windows) and the current user does not have Power User or Administrator privileges.</p>
Initial S/W Revision	Prior to A.02.00

Mass Storage Data (Remote Command Only)

Creates a file containing the specified data OR queries the data from an existing file.

Key path	SCPI Only
Remote Command	:MMEMory:DATA <file_name>, <data> :MMEMory:DATA? <file_name>
Notes	The string must be a valid logical path. The command form is MMEMory:DATA <file_name>,<data>. It loads <data> into the file <file_name>. <data> is in 488.2 block format. <file_name> is string data. The query form is MMEMory:DATA? <file_name> with the response being the associated <data> in block format.
Initial S/W Revision	Prior to A.02.00

Mass Storage Make Directory (Remote Command Only)

Key path	SCPI Only
Remote Command	:MMEMory:MDIRectory <directory_name>
Notes	The string must be a valid logical path. Creates a new directory. The <directory_name> parameter specifies the name to be created. This command will generate an “access denied” error if the new directory would be in a restricted folder (e.g., C:\Windows) and the current user does not have Power User or Administrator privileges.
Initial S/W Revision	Prior to A.02.00

Mass Storage Move (Remote Command Only)

Key path	SCPI Only
Remote Command	:MMEMory:MOVE <string>,<string>[,<string>,<string>]
Notes	The string must be a valid logical path. Moves an existing file to a new file or an existing directory to a new directory. Two forms of parameters are allowed. The first form has two parameters. In this form, the first parameter specifies the source, and the second parameter specifies the destination. The second form has four parameters. In this form, the first and third parameters specify the source. The second and fourth parameters specify the directories. The first pair of parameters specifies the source. The second pair specifies the destination. An error is generated if the source doesn't exist or the destination file already exists. This command will generate an “access denied” error if the destination is a restricted folder (e.g., C:\Windows) and the current user does not have Power User or Administrator privileges.
Initial S/W Revision	Prior to A.02.00

Mass Storage Remove Directory (Remote Command Only)

Key path	SCPI Only
Remote Command	:MMEMory:RDIRECTory <directory_name>
Notes	<p>The string must be a valid logical path.</p> <p>Removes a directory. The <directory_name> parameter specifies the directory name to be removed. All files and directories under the specified directory shall also be removed.</p> <p>This command will generate an “access denied” error if the folder is a restricted folder (e.g., C:\Windows) or is in a restricted folder and the current user does not have Power User or Administrator privileges.</p>
Initial S/W Revision	Prior to A.02.00

Single (Single Measurement/Sweep)

Sets the analyzer for Single measurement operation. The single/continuous state is Meas Global, so the setting will affect all the measurements. If you are Paused, pressing Single does a Resume.

See ["More Information" on page 786](#)

Key Path	Front-panel key
Example	:INIT:CONT OFF
Notes	See Cont key description.
Backwards Compatibility Notes	<p>For Spectrum Analysis mode in ESA and PSA, the Single hardkey and the INITiate:IMM switched from continuous measurement to single measurement and restarted sweeps and averages (displayed average count reset to 1), but did not restart Max Hold and Min Hold. In the X-Series, the Single hardkey and the INITiate:IMM command initiate a sweep/ measurement/ average sequence/hold sequence including MaxHold and MinHold.</p> <p>For Spectrum Analysis mode in ESA and PSA, the Single hardkey restarted the sweep regardless of whether or not you were in an active sweep or sweep sequence. In the X-Series, Restart does this but Single only restarts the sweep or sweep sequence if you are in the idle state.</p> <p>INIT[:IMM] in ESA & PSA Spectrum Analysis Mode does an implied ABORT. In some other PSA Modes, INIT[:IMM] is ignored if not in the idle state. . The X-Series follows the ESA/PSA SA Mode model, which may cause some Modes to have compatibility problems.</p>
Initial S/W Revision	Prior to A.02.00

More Information

See ["Restart" on page 2249](#) for details on the INIT:IMMEDIATE (Restart) function.

If you are already in single sweep, the INIT:CONT OFF command has no effect.

If you are already in Single Sweep, then pressing the Single key in the middle of a sweep does not restart the sweep or sequence. Similarly, pressing the Single key does not restart the sweep or sequence if the sweep is not in the idle state (for example, if you are taking a very slow sweep, or the analyzer is waiting for a trigger). Instead, it results in a message. "Already in Single, press Restart to initiate a new sweep or sequence". Even though pressing the Single key in the middle of a sweep does not restart the sweep, sending INIT:IMMEDIATE does reset it.

To take one more sweep without resetting the average count, increment the average count by 1, by pressing the step up key while **Average/Hold Number** is the active function, or sending the remote command CALC:AVER:TCON UP.

Source

There is no Source control functionality for this measurement. When this key is pressed, the screen either displays a blank menu, or the previously-selected menu remains unchanged.

Key Path	Front-panel key
----------	-----------------

SPAN X Scale

Accesses a menu of functions that enable you set the horizontal scale parameters.

Key Path	Front-panel key
Initial S/W Revision	Prior to A.02.00

Span

Changes the frequency range symmetrically about the center frequency.

The default (and minimum) span is calculated using the number of carriers and the carrier width where;

$$\text{Span} = (\text{Upper Carrier Freq} + (\text{max offset IBW} * (1 + \alpha)) / 2) - (\text{Lower Carrier Freq} - (\text{max offset IBW} * (1 + \alpha)) / 2)$$

The span is increased by a factor of 1 + Filter Alpha if the RRC Filter is on.

Key Path	SPAN X Scale
Mode	SA, WCDMA, C2K, WIMAX OFDMA, TD-SCDMA, 1xEVDO, DVB-T/H, DTMB (CTTB), ISDB-T, CMMB, LTE, LTE-TDD, Digital Cable TV, MSR, LTEAFDD, LTEATDD
Remote Command	[:SENSe] :ACPpower:FREQuency:SPAN <freq> [:SENSe] :ACPpower:FREQuency:SPAN?
Example	ACP:FREQ:SPAN 25MHz ACP:FREQ:SPAN?
Notes	You must be in the mode that includes ACP measurements to use this command. Use :INSTrument:SElect to set the mode.
Couplings	The span value is clipped when the carrier settings and/or the offset settings are changed. The value is changed to satisfy following formula: $\text{Span} = (\text{Upper Carrier Freq} + (\text{max offset IBW} * (1 + \alpha)) / 2) - (\text{Lower Carrier Freq} - (\text{max offset IBW} * (1 + \alpha)) / 2)$
Preset	SA: 8 MHz WCDMA: 24.6848 MHz WIMAX OFDMA: 50 MHz C2K: 4.5 MHz TD-SCDMA: 8 MHz 1xEVDO: 4.05 MHz DVB-T/H: 40 MHz DTMB (CTTB): 72 MHz ISDB-T: 30 MHz CMMB: 72 MHz LTE, LTE-TDD, MSR: 25 MHz Digital Cable TV: 40 MHz LTEAFDD, LTEATDD: 25MHz

State Saved	Saved in instrument state.
Min	10 Hz
Max	Hardware Dependent: Option 503 = 3.7 GHz Option 507 = 7.1 GHz Option 508 = 8.5 GHz Option 513 = 13.8 GHz Option 526 = 27.0 GHz
Initial S/W Revision	Prior to A.02.00
Modified at S/W Revision	A.02.00, A.03.00

Full Span

Changes the span to show the full frequency range of the spectrum analyzer.

Key Path	SPAN X Scale
Mode	SA, WCDMA, C2K, WiMAX OFDMA, TD-SCDMA, 1xEVDO, DVB-T/H, DTMB (CTTB), ISDB-T, CMMB, LTE, LTETDD, Digital Cable TV
Remote Command	[:SENSe] :ACPowEr :FREQuency :SPAN :FULL
Example	ACP:FREQ:SPAN:FULL
Notes	You must be in the mode that includes ACP measurements to use this command. Use :INSTrument:SElect to set the mode.
Dependencies	For MSR and LTE-Advanced FDD/TDD mode, this key is blank.
Initial S/W Revision	Prior to A.02.00
Modified at S/W Revision	A.02.00, A.03.00

Last Span

Changes the span to the previous span setting. If no previous span value exists, then the span will remain unchanged.

Key Path	SPAN X Scale
Mode	SA, WCDMA, C2K, WIMAX OFDMA, TD-SCDMA, 1xEVDO, DVB-T/H, DTMB (CTTB), ISDB-T, CMMB, LTE, LTETDD, Digital Cable TV, MSR, LTEAFDD,LTEATDD
Remote Command	[:SENSe] :ACPowEr :FREQuency :SPAN :PREVious
Example	ACP:FREQ:SPAN:PREV
Notes	You must be in the mode that includes ACP measurements to use this command. Use :INSTrument:SElect to set the mode.
Initial S/W Revision	Prior to A.02.00
Modified at S/W Revision	A.02.00, A.03.00

Sweep/Control

Accesses a menu of functions that enable you to set up and control the sweep time, and source.

See "[Sweep/Control](#)" on page 2282 for more information.

Key Path	Front-panel key
Initial S/W Revision	Prior to A.02.00

Sweep Time

Selects the length of time in which the spectrum analyzer sweeps the displayed frequency span. In swept spans, the sweep time varies from 1 millisecond to 2000 seconds. Additional overhead time, which impacts the sweep rate, is not calculated as part of the sweep time. In fact:

sweep rate = span/sweep time

update rate = 1/(sweep time + overhead)

sweep cycle time = sweep time + overhead

Sweep time is coupled to RBW and VBW, and is impacted by the number of sweep points, so changing those parameters may change the sweep time.

If you increase the sweep time, you increase the length of the time data captured and the number of points measured. You might need to specify a specific sweep speed to accommodate a specific condition in your transmitter. For example, you may have a burst signal and need to measure an exact portion of the burst.

Selecting a specific sweep time may result in a long measurement time since the resulting number of data points may not be the optimum 2n. Use [:SENSe]:ACP:OFFSet:LIST:SWEep:TIME to set the number of points used for measuring the offset channels for Basic and cdmaOne.

For cdma2000 and W-CDMA, this command sets the sweep time when using the sweep mode. See [:SENSe]:ACP:SWEep:TYPE

Key Path	Sweep/Control
Mode	SA, WCDMA, C2K, WIMAX OFDMA, TD-SCDMA, 1xEVDO, DVB-T/H, DTMB (CTTB), ISDB-T, CMMB, LTE, LTE-TDD, Digital Cable TV, MSR, LTEAFDD, LTE-TDD
Remote Command	[:SENSe]:ACP:Power:SWEep:TIME <time> [:SENSe]:ACP:Power:SWEep:TIME? [:SENSe]:ACP:Power:SWEep:TIME:AUTO OFF ON 0 1 [:SENSe]:ACP:Power:SWEep:TIME:AUTO?
Example	ACP:SWE:TIME 50ms ACP:SWE:TIME? ACP:SWE:TIME:AUTO OFF ACP:SWE:TIME:AUTO?
Notes	This parameter is preset by Meas Method selection. Preset values are as follows:

	IBW: 29 ms IBWR: 108 ms FAST (WCDMA): 7.5 ms
Preset	SA, LTE, LTETDD, MSR: Automatically calculated WCDMA: 29 ms WIMAX OFDMA: Automatically calculated C2K: Automatically calculated TD-SCDMA: Automatically calculated 1xEVDO: Automatically calculated DVB-T/H: Automatically calculated DTMB (CTTB): Automatically calculated ISDB-T: Automatically calculated CMMB: Automatically calculated Digital Cable TV: Automatically calculated LTEAFDD, LTEATDD: Automatically calculated SA, LTE, LTETDD, MSR, LTEAFDD, LTEATDD: ON WCDMA: OFF C2K: OFF (method IBW) WIMAX OFDMA: ON TD-SCDMA: ON DVB-T/H: ON DTMB (CTTB): ON ISDB-T: ON CMMB: ON Digital Cable TV: ON
State Saved	Saved in instrument state.
Min	1 ms
Max	4000 s
Initial S/W Revision	Prior to A.02.00
Modified at S/W Revision	A.02.00, A.03.00

Sweep Setup

Accesses the sweep setup menu.

Key Path	Sweep/Control
Initial S/W Revision	Prior to A.02.00

Auto Sweep Time Rules

Switches the analyzer between normal and accuracy sweep states.

Key Path	Sweep/Control, Sweep Setup
Mode	SA, WCDMA, C2K, WIMAX OFDMA, TD-SCDMA, 1xEVDO, DVB-T/H, DTMB (CTTB), ISDB-T, CMMB, LTE, LTE-TDD, Digital Cable TV, MSR, LTEAFDD, LTEATDD
Remote Command	[:SENSe] :ACPoweR :SWEep :TIME :AUTO :RULes NORMal ACCuracy [:SENSe] :ACPoweR :SWEep :TIME :AUTO :RULes ?
Example	ACP:SWE:TIME:AUTO:RUL NORM ACP:SWE:TIME:AUTO:RUL?
Notes	Set to Norm when Auto Couple is pressed or sent remotely.
Preset	SA, WCDMA, C2K, TD-SCDMA, 1xEVDO, DTMB (CTTB), LTE, LTE-TDD, MSR, LTEAFDD, LTEATDD: ACCuracy WIMAX OFDMA, DVB-T/H: NORMal ISDB-T, CMMB: NORMal Digital Cable TV: NORMal
State Saved	Saved in instrument state.
Range	Norm Accy
Initial S/W Revision	Prior to A.02.00
Modified at S/W Revision	A.02.00, A.03.00

Pause

Pauses a measurement after the current data acquisition is complete. When Paused, the label on the key changes to Resume. Pressing the Resume key resumes the measurement at the point where it was paused. When Paused, pressing Restart, Single, or Cont does a Resume

See "[Pause/Resume](#)" on page 2282 for more details.

Key Path	Sweep/Control
Initial S/W Revision	Prior to A.02.00

Gate

Accesses a menu that enables you to control the gating function. The Gate functionality is used to view signals best viewed by qualifying them with other events.

Gate setup parameters are the same for all measurements – they do not change as you change measurements. Settings like these are called “Meas Global” and are unaffected by Meas Preset.

Note that Sweep Time autocoupling rules and annotation are changed by Gate being on.

Key Path	Sweep/Control
Scope	Meas Global
Readback	The state and method of Gate, as [Off, LO] or [On, Video]. Note that for measurements that only support gated LO, the method is nonetheless read back, but always as LO.
Initial S/W Revision	Prior to A.02.00

Gate On/Off

Turns the gate function on and off.

When the Gate Function is on, the selected Gate Method is used along with the gate settings and the signal at the gate source to control the sweep and video system with the gate signal. Not all measurements allow every type of Gate Methods.

When Gate is on, the annunciation in the measurement bar reflects that it is on and what method is used, as seen in the following "Gate: LO" annunciator graphic.

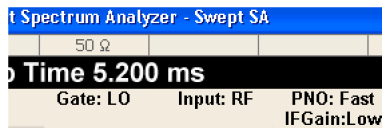

Key Path	Sweep/Control, Gate
Remote Command	[:SENSe] :SWEep:EGATe [:STATe] OFF ON 0 1 [:SENSe] :SWEep:EGATe [:STATe] ?
Example	SWE:EGAT ON SWE:EGAT?

Dependencies

The function is unavailable (grayed out) and Off when:

- Gate Method is LO or Video and FFT Sweep Type is manually selected.
- Gate Method is FFT and Swept Sweep Type is manually selected.
- Marker Count is ON.

The following are unavailable whenever Gate is on:

- FFT under Sweep Type when Method=LO or Video or Swept under Sweep Type when Method=FFT
- Marker Count

While Gate is on, the Auto Rules for Sweep Type are modified so that the choice agrees with the Gate Method: i.e., FFT for Method = FFT and Swept for Method = LO or Video.

The Gate softkey and all SCPI under the [:SENSe]:SWEep:EGATe SCPI node are grayed out when Source Mode is Tracking with an external source. This is because the Gate circuitry is used to sync the external source. If the Tracking Source is turned on, the Gate is turned off.

When in the ACP measurement:

- When Meas Method is RBW or FAST, this function is unavailable and the key is grayed out.

	<ul style="list-style-type: none"> • Whenever Gate is on, Meas Method, RBW or FAST is unavailable and keys for those are grayed out. • When Gate is on, Offset Res BW and Offset Video BW are ignored (if you set these values) and the measurement works as if all Offset Res BW and all Offset Video BW are coupled with the Res BW and the Video BW under the BW menu. When Gate is on, the Offset BW key in the Offset/Limit menu is grayed out.
Preset	Off LTETDD: On
State Saved	Saved in instrument state
Range	On Off
Backwards Compatibility SCPI	[:SENSe]:SWEep:TIME:GATE[:STATe] ESA compatibility
Backwards Compatibility Notes	In ESA, Trig Delay (On) and Gate (On) could not be active at the same time.. This dependency does not exist in PSA or in the X-Series.
Initial S/W Revision	Prior to A.02.00

Gate View On/Off

Turning on Gate View in the Swept SA measurement provides a single-window gate view display..

Turning on Gate View in other measurements shows the split-screen Gate View. In these measurements, when the Gate View is on, the regular view of the current measurement traces and results are reduced vertically to about 70% of the regular height. The Zero Span window, showing the positions of the Gate, is shown between the Measurement Bar and the reduced measurement window. By reducing the height of the measurement window, some of the annotation on the Data Display may not fit and is not shown.

Key Path	Sweep/Control, Gate
Remote Command	[:SENSe]:SWEep:EGATe:VIEW ON OFF 1 0 [:SENSe]:SWEep:EGATe:VIEW?
Example	SWE:EGAT:VIEW ON turns on the gate view.
Dependencies	<p>In the Swept SA measurement:</p> <p>In Gate View, the regular Sweep Time key is grayed out . When pressed, the grayed out key puts up the informational message "Use Gate View Sweep Time in the Gate menu."</p> <p>In the other measurements:</p> <p>When you turn Gate View on, the lower window takes on the current state of the instrument. Upon leaving Gate View, the instrument takes on the state of the lower window.</p> <p>When you turn Gate View on, the upper window Sweep Time is set to the gate view sweep time.</p>
Couplings	<p>These couplings apply to the Swept SA measurement:</p> <ul style="list-style-type: none"> • When Gate View is turned on, the instrument is set to Zero Span. • Gate View automatically turns off whenever a Span other than Zero is selected. • Gate View automatically turns off if you press the Last Span key while in Gate View, and the instrument returns to the Span it was in before entering Gate View (even if that is Zero Span). • When Gate View is turned on, the sweep time used is the gate view sweep time. This is set

according to the rules in section "Gate View Setup " on page 2083

- When Gate View is turned off, Sweep Time is set to the normal Swept SA measurement sweep time.
- If Gate View is on and Gate is off, then turning on Gate turns off Gate View.

Preset	OFF
State Saved	Saved in instrument state
Range	On Off
Initial S/W Revision	Prior to A.02.00

A sample of the Gate View screen in the Swept SA measurement is shown in the following graphic :

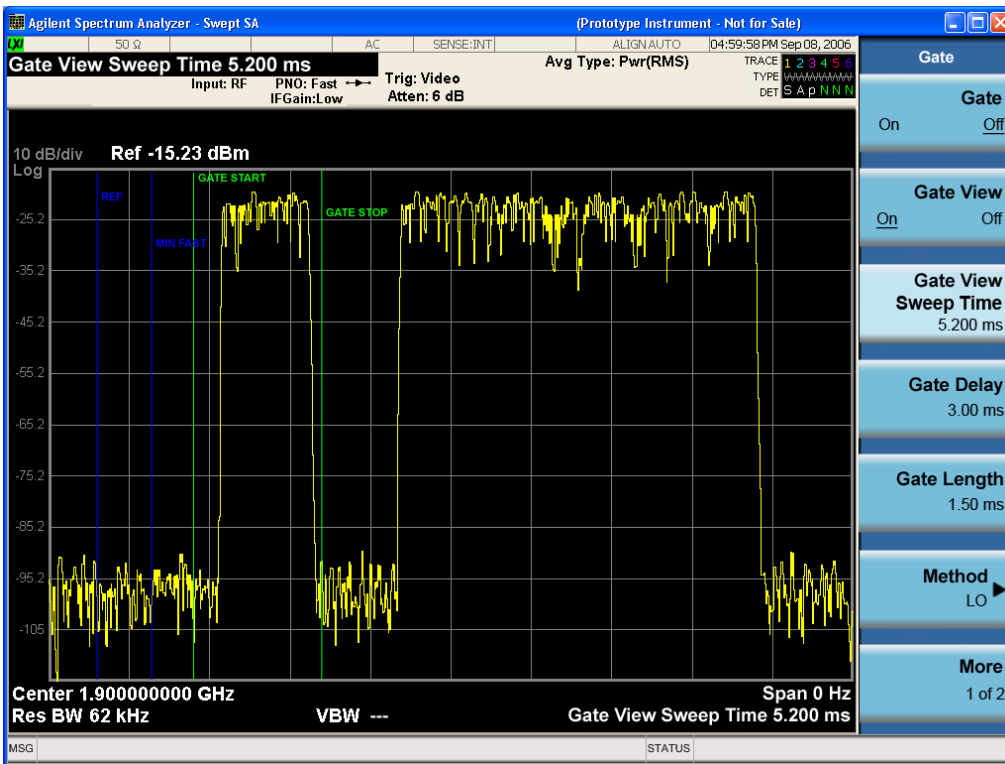

A sample of the Gate View screen in other measurements is shown in the following graphic . This example is for the ACP measurement:



Turning Gate View off returns the analyzer to the Normal measurement view.

In the Swept SA, the normal measurement view is the single-window Swept SA view. When returning to this view, the Swept SA measurement returns to the Span it was in before entering **Gate View** (even if that is Zero Span).

The **Gate View** window is triggered from the Gate Source, with zero trigger delay. Also, when updating the **Gate View** window, the Gate itself must not operate. So it is internally shut off while the gate view window is being updated. For the Swept SA measurement, this means that the Gate is internally shut off whenever the gate view window is displayed. The measurement bar and softkeys continue to show the Trigger source for the main sweep window and give no indication that the Gate is shut off or that the Gate View window is triggered from the Gate Source.

When in **Gate View**, vertical lines are displayed in the Gate View window as follows:

- Green lines are displayed at the gate edges as follows: in Edge Gate, a line is shown for Delay and one for the end of the Gate period, defined by Length. In Level Gate a line is shown only for Delay. You can adjust the position of the green lines by adjusting the gate length and the gate delay. These lines update in the Gate View window as the active function changes, even if the window is not being updated. In Gated LO and Gated Video, these lines are positioned relative to the delay reference line (not relative to 0 time). In Gated FFT, their location is relative to the left edge of the screen.
- A blue line is displayed showing the delay reference, that is, the reference point for the Gate Delay within the Zero Span window. The blue line represents where (in time) the effective location of the gate start would be if the gate were programmed to zero delay.

-

- The second blue line is labeled "MIN FAST" as shown in the figure above because it represents the minimum Gate Delay for fast Gated LO operation. This line is only displayed in Gated LO. You cannot scroll (knob) or decrement (down key) the Gate Delay to less than that represented by the position of this line, it can only be set below this position manually, although once there it can be moved freely with the knob while below the line.
- A yellow line in the Gated Video case only, is displayed at Blength, where Blength is the display point (bucket) length for the swept trace, which is given by the sweep time for that trace divided by number of Points – 1. So it is referenced to 0 time, not to the delay reference. This line is labeled NEXT PT (it is not shown in the figure above because the figure above is for Gated LO).
- The yellow line represents the edge of a display point (bucket). Normally in Gated Video, the bucket length must be selected so that it exceeds the off time of the burst. There is another way to use the analyzer in Gated Video measurements, and that is to set the bucket width much shorter than the off time of the burst. Then use the Max Hold trace function to fill in "missing" buckets more slowly. This allows you to see some of the patterns of the Gated Video results earlier, though seeing a completely filled-in spectrum later.

Gate View Setup

Accesses a menu that enables you to setup parameters relevant to the Gate View

Key Path	Sweep/Control, Gate
Scope	Meas Global
Initial S/W Revision	A.10.00

Gate View Sweep Time

Controls the sweep time in the Gate View window. To provide an optimal view of the gate signal, the analyzer initializes Gate View Sweep Time based on the current settings of Gate Delay and Gate Length.

Key Path	Sweep/Control, Gate, Gate View Setup
Remote Command	[:SENSe] :SWEep:EGATe:TIME <time> [:SENSe] :SWEep:EGATe:TIME?
Example	SWE:EGAT:TIME 500 ms
Dependencies	Gate View Sweep Time is initialized: <ul style="list-style-type: none"> • On Preset (after initializing delay and length). • Every time the Gate Method is set/changed. <p>Additionally, in the Swept SA measurement, whenever you do a Preset, or leave Gate View, the analyzer remembers the Gate Delay and Gate Length settings. Then, when returning to Gate View, if the current Gate Delay and/or Gate Length do not match the remembered values Gate View Sweep Time is re-initialized.</p> <ol style="list-style-type: none"> 1. Compute the location of the "gate stop" line, which you know is at time $t = t_{min} + GateDelay + GateLength$.
Preset	519.3 μ s

	WiMAX OFDMA: 5 ms GSM/EDGE: 1 ms
State Saved	Saved in instrument state
Max	6000 s
Initial S/W Revision	Prior to A.02.00

Gate View Start Time

Controls the time at the left edge of the Gate View.

Key Path	Sweep/Control, Gate, Gate View Setup
Remote Command	[:SENSe] :SWEep:EGATe:VIEW:STARt <time> [:SENSe] :SWEep:EGATe:VIEW:STARt?
Example	SWE:EGAT:VIEW:STAR 10ms
Notes	Units of time are required or no units; otherwise an invalid suffix error message will be generated. See error -131.
Preset	0 ms
State Saved	Saved in instrument state
Min	0
Max	500 ms
Initial S/W Revision	A.10.00

Gate Delay

Controls the length of time from the time the gate condition goes True until the gate is turned on.

Key Path	Sweep/Control, Gate
Remote Command	[:SENSe] :SWEep:EGATe:DELay <time> [:SENSe] :SWEep:EGATe:DELay?
Example	SWE:EGAT:DELay 500ms SWE:EGAT:DELay?
Notes	Units of time are required or no units; otherwise an invalid suffix error message will be generated.
Preset	57.7 us WiMAX OFDMA: 71 us GSM/EDGE: 600 us WLAN: 500 us
State Saved	Saved in instrument state

Min	0.0 us
Max	100 s
Backwards Compatibility SCPI	[:SENSe]:SWEep:TIME:GATE:DELay ESA compatibility
Initial S/W Revision	Prior to A.02.00

Gate Length

Controls the length of time that the gate is on after it opens.

Key Path	Sweep/Control, Gate
Remote Command	[:SENSe]:SWEep:EGATe:LENGth <time> [:SENSe]:SWEep:EGATe:LENGth?
Example	SWE:EGAT:LENG 1 SWE:EGAT:LENG?
Notes	Units of time are required or no units; otherwise an invalid suffix error message will be generated.

Dependencies

Grayed out when Gate Method is set to FFT in which case the label changes to that shown below.



The key is also grayed out if Gate Control = Level.

Preset	461.6 us WiMAX OFDMA: 50 us GSM/EDGE: 200 us WLAN: 1.54 ms
State Saved	Saved in instrument state
Min	100 ns
Max	5 s
Backwards Compatibility SCPI	[:SENSe]:SWEep:TIME:GATE:LENGth ESA compatibility
Initial S/W Revision	Prior to A.02.00

Gate Source

The menus under the Gate Source key are the same as those under the Trigger key, with the exception that neither Free Run nor Video are available as Gate Source selections. However, a different SCPI command

is used to select the Gate Source (see table below) because you may independently set the Gate Source and the Trigger Source.

Any changes to the settings in the setup menus under each Gate Source selection key (for example: Trigger Level, Trigger Delay, etc.) also affect the corresponding settings under the Trigger menu keys. The SCPI commands used for these are the same for Trigger and Gate, since there is only one setting which affects both Gate and Trigger. Example: to set the Trigger Level for External 1 you use the command :TRIG:EXT1:LEV regardless of whether you are using External 1 as a Trigger Source or a Gate Source.

Key Path	Sweep/Control, Gate
Remote Command	[:SENSe] :SWEep:EGATe:SOURce EXTernal1 EXTernal2 LINE FRAME RFBurst [:SENSe] :SWEep:EGATe:SOURce?
Dependencies	In some models, there is no second External input. In these models, the External 2 key is blanked and the EXTernal2 parameter will generate a "Hardware missing; Not available for this model number" error.
Preset	EXTernal 1 GSM/EDGE, MSR: FRAME LTETDD: EXTernal 1When Direction is Downlink, FRAME when Direction is Uplink.
Backwards Compatibility Notes	In ESA, there is a single Gate input port. In PSA, the Gate Source may be taken from one of two specified input ports. In the X-Series, any Trigger Source can be a Gate Source.
Initial S/W Revision	Prior to A.02.00
Modified at S/W Revision	A.03.00, A.14.00

Line

Pressing this key, when it is not selected, selects the line signal as the trigger. A new sweep/measurement will start synchronized with the next cycle of the line voltage. Pressing this key, when it is already selected, access the line trigger setup menu.

Key Path	Trigger
Example	TRIG:SOUR LINE Swept SA measurement TRIG:<meas>:SOUR LINE Measurements other than Swept SA
Dependencies	Line trigger is not available when operating from a "dc power source", for example, when the instrument is powered from batteries.
State Saved	Saved in instrument state
Status Bits/OPC dependencies	The Status Operation Register bit 5 "Waiting for Trigger" is set at the same time as the Sweeping or Measuring bit is set. It is cleared when the trigger actually occurs (that is, after the trigger event occurs and all the applicable trigger criteria have been met). A corresponding pop-up message ("Waiting for trigger") is generated if no trigger signal appears after approximately 2 sec. This message goes away when a trigger signal appears.
Initial S/W Revision	Prior to A.02.00

Trig Slope

Controls the trigger polarity. It is set positive to trigger on a rising edge and negative to trigger on a falling edge.

Key Path	Trigger, Line
Remote Command	:TRIGger[:SEquence]:LINE:SLOPe POSitive NEGative :TRIGger[:SEquence]:LINE:SLOPe?
Example	TRIG:LINE:SLOP NEG
Preset	POSitive
State Saved	Saved in instrument state
Backwards Compatibility Notes	The legacy :TRIGger[:SEquence]:SLOPe command affects the slopes for the VID, LINE, EXT1, EXT2, and RFB triggers.
Initial S/W Revision	Prior to A.02.00

External 1

Pressing this key, when it is not selected, selects an external input signal as the trigger. A new sweep/measurement will start when the external trigger condition is met using the external 1 input connector on the rear panel.

Pressing this key, when it is already selected, accesses the external 1 trigger setup menu.

Key Path	Trigger
Example	TRIG:SOUR EXT1 Swept SA measurement TRIG:<meas>:SOUR EXT1 Measurements other than Swept SA
Dependencies	Grayed out if in use by Point Trigger in the Source Setup menu. Forced to Free Run if already selected and Point Trigger is set to External 1.
State Saved	Saved in instrument state
Status Bits/OPC dependencies	The Status Operation Register bit 5 "Waiting for Trigger" is set at the same time as the Sweeping or Measuring bit is set. It is cleared when the trigger actually occurs (that is, after the trigger event occurs and all the applicable trigger criteria have been met). A corresponding pop-up message ("Waiting for trigger") is generated if no trigger signal appears after approximately 2 sec. This message goes away when a trigger signal appears.
Initial S/W Revision	Prior to A.02.00

Trigger Level

Sets the value where the external 1 trigger input will trigger a new sweep/measurement.

Key Path	Trigger, External 1
Remote Command	:TRIGger[:SEquence]:EXTernal1:LEVel <level>

	:TRIGger[:SEquence]:EXTernal1:LEVel?
Example	TRIG:EXT1:LEV 0.4 V
Couplings	This same level is used for the Ext1 trigger source in the Trigger menu, for the Ext1 selection in the Periodic Timer sync source (in the Trigger menu and in the Gate Source menu), and also for the Ext1 selection in the Gate Source menu.
Preset	1.2 V
State Saved	Saved in instrument state
Min	-5 V
Max	5 V
Default Unit	V
Backwards Compatibility SCPI	:TRIGger[:SEquence]:EXTernal:LEVel
Backwards Compatibility SCPI	For backward compatibility, the parameter EXTernal is mapped to EXTernal1
Backwards Compatibility SCPI	:TRIGger[:SEquence]:FRAMe:EXTernal1:LEVel
Initial S/W Revision	Prior to A.02.00

Trig Slope

Controls the trigger polarity. It is set positive to trigger on a rising edge and negative to trigger on a falling edge.

Key Path	Trigger, External 1
Remote Command	:TRIGger[:SEquence]:EXTernal1:SLOPe POSitive NEGative :TRIGger[:SEquence]:EXTernal1:SLOPe?
Example	TRIG:EXT1:SLOP NEG
Couplings	This same slope is used in the Ext1 selection for the trigger source in the Trigger menu and for the period timer sync source (in the Trigger menu and in the Gate Source menu).
Preset	POSitive
State Saved	Saved in instrument state
Backwards Compatibility SCPI	:TRIGger[:SEquence]:EXTernal:SLOPe
Backwards Compatibility SCPI	For backward compatibility, the parameter EXTernal is mapped to EXTernal1
Backwards Compatibility SCPI	:TRIGger[:SEquence]:FRAMe:EXTernal1:SLOPe
Backwards Compatibility Notes	The legacy :TRIGger[:SEquence]:SLOPe command affects the slopes for the VID, LINE, EXT1, EXT2, and RFB triggers.
Initial S/W Revision	Prior to A.02.00

External 2

Pressing this key, when it is not selected, selects an external input signal as the trigger. A new sweep/measurement will start when the external trigger condition is met using the external 2 input connector. The external trigger 2 input connector is on the rear panel.

Pressing this key, when it is already selected, accesses the external 2 trigger setup menu.

Key Path	Trigger
Example	TRIG:SOUR EXT2 Swept SA measurement TRIG:<meas>:SOUR EXT2 Measurements other than Swept SA
Dependencies	In some models, there is no second External input. In these models, the External 2 key is blanked and the EXTernal2 parameter will generate a "Hardware missing; Not available for this model number" message. Grayed out if in use by Point Trigger in the Source Setup menu. Forced to Free Run if already selected and Point Trigger is set to External 2.
State Saved	Saved in instrument state
Status Bits/OPC dependencies	The Status Operation Register bit 5 "Waiting for Trigger" is set at the same time as the Sweeping or Measuring bit is set. It is cleared when the trigger actually occurs (that is, after the trigger event occurs and all the applicable trigger criteria have been met). A corresponding pop-up message ("Waiting for trigger") is generated if no trigger signal appears after approximately 2 sec. This message goes away when a trigger signal appears.
Initial S/W Revision	Prior to A.02.00
Modified at S/W Revision	A.03.00

Trigger Level

Sets the value where the external 2 trigger input will trigger a new sweep/measurement.

Key Path	Trigger, External 2
Remote Command	:TRIGger[:SEquence]:EXTernal2:LEVel :TRIGger[:SEquence]:EXTernal2:LEVel?
Example	TRIG:EXT2:LEV 1.1 V
Couplings	This same level is used for the Ext2 trigger source in the Trigger menu, for the Ext2 selection in the Periodic Timer sync source (in the Trigger menu and in the Gate Source menu), and also for the Ext2 selection in the Gate Source menu.
Preset	1.2 V
State Saved	Saved in instrument state
Min	-5 V
Max	5 V
Default Unit	V
Backwards Compatibility SCPI	:TRIGger[:SEquence]:FRAMe:EXTernal2:LEVel
Initial S/W Revision	Prior to A.02.00

Trig Slope

Controls the trigger polarity. It is set positive to trigger on a rising edge and negative to trigger on a falling edge.

Key Path	Trigger, External 2
Remote Command	:TRIGger[:SEquence]:EXTernal2:SLOPe POSitive NEGative :TRIGger[:SEquence]:EXTernal2:SLOPe?
Example	TRIG:EXT2:SLOP NEG
Couplings	This same slope is used in the Ext2 selection for the trigger source in the Trigger menu and for the period timer sync source (in the Trigger menu and in the Gate Source menu).
Preset	POSitive
State Saved	Saved in instrument state
Backwards Compatibility SCPI	:TRIGger[:SEquence]:FRAMe:EXTernal2:SLOPe
Backwards Compatibility Notes	The legacy :TRIGger[:SEquence]:SLOPe command affects the slopes for the VID, LINE, EXT1, EXT2, and RFB triggers.
Initial S/W Revision	Prior to A.02.00

RF Burst

Pressing this key, when it is not selected, selects the RF Burst as the trigger. A new sweep/measurement will start when an RF burst envelope signal is identified from the signal at the RF Input connector. Pressing this key, when it is already selected, accesses the RF Burst trigger setup menu.

In some models, a variety of burst trigger circuitry is available, resulting in various available burst trigger bandwidths. The analyzer automatically chooses the appropriate trigger path based on the hardware configuration and other settings of the analyzer.

Key Path	Trigger
Example	TRIG:SOUR RFB Swept SA measurement TRIG:<meas>:SOUR RFB Measurements other than Swept SA
State Saved	Saved in instrument state
Status Bits/OPC dependencies	The Status Operation Register bit 5 "Waiting for Trigger" is set at the same time as the Sweeping or Measuring bit is set. It is cleared when the trigger actually occurs (that is, after the trigger event occurs and all the applicable trigger criteria have been met). A corresponding pop-up message ("Waiting for trigger") is generated if no trigger signal appears after approximately 2 sec. This message goes away when a trigger signal appears.
Backwards Compatibility Notes	The legacy command: :TRIGger[:SEquence]:RFBurst:FSElectivity[:STATe] OFF ON 0 1 is not supported in the X-Series, as the hardware to do Frequency Selective burst triggers does not exist in X-Series.

Initial S/W Revision	Prior to A.02.00
Modified at S/W Revision	A.04.00

Absolute Trigger Level

Sets the absolute trigger level for the RF burst envelope.

When using the External Mixing path, the Absolute Trigger Level is uncalibrated because the factory default was set to accommodate the expected IF levels for the RF path.

Key Path	Trigger, RF Burst
Scope	Meas Global
Remote Command	:TRIGger[:SEquence]:RFBurst:LEVel:ABSolute <ampl> :TRIGger[:SEquence]:RFBurst:LEVel:ABSolute?
Example	TRIG:RFB:LEV:ABS 10 dBm sets the trigger level of the RF burst envelope signal to the absolute level of 10 dBm
Notes	Sending this command does not switch the setting from relative to absolute; to switch it you need to send the :TRIGger[:SEquence]:RFBurst:LEVel:TYPE command, below. Amplitude Corrections are not taken into account by the Absolute Trigger Level. For example, if you have given yourself effective gain with an amplitude correction factor, the Absolute Trigger will not fire until you have set the trigger level that far below the displayed signal level, rather than simply to the displayed signal level. This is only true for Amplitude Corrections, not External Gain or Ref Level Offset functions. If mode is Bluetooth, the default value is -50 dBm.
Couplings	This same level is used for the RF Burst trigger source in the Trigger menu, for the RF Burst selection in the Periodic Timer sync source (in the Trigger menu and in the Gate Source menu), and also for the RF Burst selection in the Gate Source menu
Preset	-20 dBm
State Saved	Saved in instrument state
Min	-200 dBm
Max	100 dBm
Default Unit	depends on the current selected Y-Axis unit
Backwards Compatibility SCPI	:TRIGger[:SEquence]:FRAME:RFBurst:LEVel:ABSolute
Initial S/W Revision	Prior to A.02.00
Modified at S/W Revision	A.04.00

Key Path	Trigger, RF Burst
Remote Command	:TRIGger[:SEquence]:RFBurst:LEVel:TYPE ABSolute RELative :TRIGger[:SEquence]:RFBurst:LEVel:TYPE?

Example	TRIG:RFB:LEV:TYPE REL sets the trigger level type of the RF burst trigger to Relative.
Preset	ABSolute
State Saved	Saved in instrument state
Initial S/W Revision	Prior to A.02.00
Modified at S/W Revision	A.04.00

Relative Trigger Level

Sets the relative trigger level for the RF burst envelope.

In some models, the relative burst trigger function is implemented in hardware. In other models, without the advanced triggering hardware required, the relative burst trigger function is implemented in software in some measurements, and is unavailable in other measurements.

When implemented in software, the relative RF Burst trigger function is implemented as follows:

1. The measurement starts with the absolute RF Burst trigger setting. If it cannot get a trigger with that level, auto trigger fires and the acquisition starts anyway. After the acquisition, the measurement searches for the peak in the acquired waveform and saves it.
2. Now, in the next cycle of the measurement, the measurement determines a new absolute RF Burst level based on the peak value from the first measurement and the Relative RF Burst Trigger Level (always 0 or negative dB) set by the user. The following formula is used:
3. absolute RF Burst level = peak level of the previous acquisition + relative RF Burst level
4. If the new absolute RF Burst level differs from the previous by more than 0.5 dB, the new level is sent to the hardware; otherwise it is not updated (to avoid slowing down the acquisition)

Steps 2 and 3 repeat for subsequent measurements.

Key Path	Trigger, RF Burst
Scope	Meas Global
Remote Command	:TRIGger[:SEquence]:RFBurst:LEVel:RELative <rel_ampl> :TRIGger[:SEquence]:RFBurst:LEVel:RELative?
Example	TRIG:RFB:LEV:REL -10 dB sets the trigger level of the RF burst envelope signal to the relative level of -10 dB
Notes	Sending this command does not switch the setting from absolute to relative; to switch it you need to send the :TRIGger[:SEquence]:RFBurst:LEVel:TYPE command, above. The relative trigger level is not available in some measurements. In those measurements the RELative parameter, and the :TRIGger[:SEquence]:RFBurst:LEVel:TYPE command (above), will generate an error if sent.
Dependencies	This key is grayed out and Absolute Trigger Level selected if the required hardware is not present in your analyzer and the current measurement does not support Relative triggering.
Preset	-6 dB

	GSM: -25 dB
State Saved	Saved in instrument state
Min	-45 dB
Max	0 dB
Default Unit	dB or dBc
Backwards Compatibility SCPI	:TRIGger[:SEquence]:RFBurst:LEVel
	This legacy command is aliased to :TRIGger[:SEquence]:RFBurst:LEVel:RELative because the PSA had ONLY relative burst triggering
Initial S/W Revision	Prior to A.02.00
Modified at S/W Revision	A.04.00

Trigger Slope

It is set positive to trigger on a rising edge and negative to trigger on a falling edge.

Key Path	Trigger, RF Burst
Remote Command	:TRIGger[:SEquence]:RFBurst:SLOPe POSitive NEGative :TRIGger[:SEquence]:RFBurst:SLOPe?
Example	TRIG:RFB:SLOP NEG
Couplings	This same slope is used in the RF Burst selection for the trigger source in the Trigger menu and for the period timer sync source (in the Trigger menu and in the Gate Source menu).
Preset	POSitive
State Saved	Saved in instrument state
Backwards Compatibility SCPI	:TRIGger[:SEquence]:FRAMe:RFBurst:SLOPe
Backwards Compatibility Notes	The legacy :TRIGger[:SEquence]:SLOPe command affects the slopes for the VID, LINE, EXT1, EXT2, and RFB triggers.
Initial S/W Revision	Prior to A.02.00

Periodic Timer (Frame Trigger)

Pressing this key, when it is not selected, selects the internal periodic timer signal as the trigger. Triggering occurrences are set by the **Period** parameter, which is modified by the **Sync Source** and **Offset**. Pressing this key, when it is already selected, accesses the periodic timer trigger setup functions.

If you do not have a sync source selected (it is Off), then the internal timer will not be synchronized with any external timing events.

Key Path	Trigger
Example	TRIG:SOUR FRAM Swept SA measurement TRIG:<meas>:SOUR FRAM Measurements other than Swept SA

State Saved	Saved in instrument state
Readback	[Sync: <value of Sync Source>], for example, [Sync: External 1]
Status Bits/OPC dependencies	The Status Operation Register bit 5 "Waiting for Trigger" is set at the same time as the Sweeping or Measuring bit is set. It is cleared when the trigger actually occurs (that is, after the trigger event occurs and all the applicable trigger criteria have been met). A corresponding pop-up message ("Waiting for trigger") is generated if no trigger signal appears after approximately 2 sec. This message goes away when a trigger signal appears.
Initial S/W Revision	Prior to A.02.00

Periodic Timer Triggering:

This feature selects the internal periodic timer signal as the trigger. Trigger occurrences are set by the **Periodic Timer** parameter, which is modified by the **Sync Source** and **Offset**.

The figure below shows the action of the periodic timer trigger. Before reviewing the figure, we'll explain some uses for the periodic trigger.

A common application is measuring periodic burst RF signals for which a trigger signal is not easily available. For example, we might be measuring a TDMA radio which bursts every 20 ms. Let's assume that the 20 ms period is very consistent. Let's also assume that we do not have an external trigger source available that is synchronized with the period, and that the signal-to-noise ratio of the signal is not high enough to provide a clean RF burst trigger at all of the analysis frequencies. For example, we might want to measure spurious transmissions at an offset from the carrier that is larger than the bandwidth of the RF burst trigger. In this application, we can set the Periodic Timer to a 20.00 ms period and adjust the offset from that timer to position our trigger just where we want it. If we find that the 20.00 ms is not exactly right, we can adjust the period slightly to minimize the drift between the period timer and the signal to be measured.

A second way to use this feature would be to use **Sync Source** temporarily, instead of **Offset**. In this case, we might tune to the signal in a narrow span and use the RF Burst trigger to synchronize the periodic timer. Then we would turn the sync source off so that it would not miss-trigger. Miss-triggering can occur when we are tuned so far away from the RF burst trigger that it is no longer reliable.

A third example would be to synchronize to a signal that has a reference time element of much longer period than the period of interest. In some CDMA applications, it is useful to look at signals with a short periodicity, by synchronizing that periodicity to the "even-second clock" edge that happens every two seconds. Thus, we could connect the even-second clock trigger to Ext1 and use then Ext1 as the sync source for the periodic timer.

The figure below illustrates this third example. The top trace represents the even-second clock. It causes the periodic timer to synchronize with the leading edge shown. The analyzer trigger occurs at a time delayed by the accumulated offset from the period trigger event. The periodic timer continues to run, and triggers continue to occur, with a periodicity determined by the analyzer time base. The timer output (labeled "late event") will drift away from its ideal time due to imperfect matching between the time base of the signal being measured and the time base of the analyzer, and also because of imperfect setting of the period parameter. But the synchronization is restored on the next even-second clock event. ("Accumulated offset" is described in the in the **Offset** function section.)

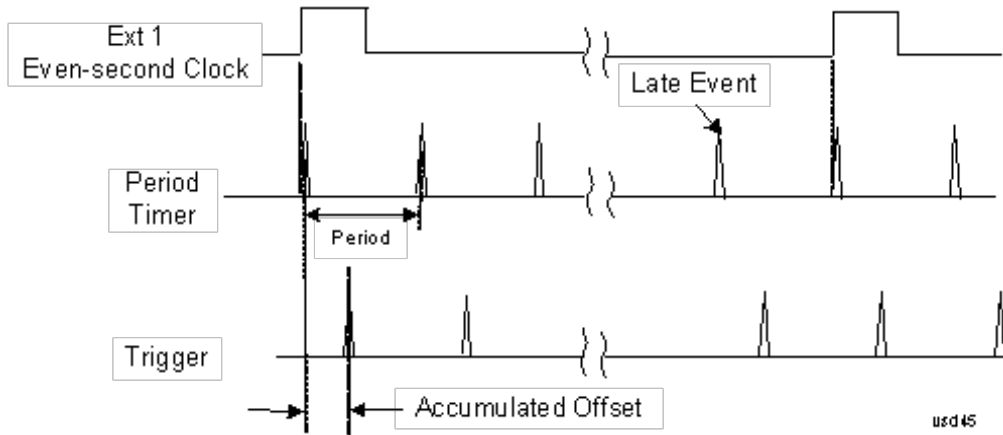

Period

Sets the period of the internal periodic timer clock. For digital communications signals, this is usually set to the frame period of your current input signal. In the case that sync source is not set to OFF, and the external sync source rate is changed for some reason, the periodic timer is synchronized at the every external synchronization pulse by resetting the internal state of the timer circuit.

Key Path	Trigger, Periodic Timer
Remote Command	:TRIGger[:SEquence]:FRAMe:PERiod <time> :TRIGger[:SEquence]:FRAMe:PERiod?
Example	TRIG:FRAM:PER 100 ms
Dependencies	The invalid data indicator turns on when the period is changed, until the next sweep/measurement completes.
Couplings	The same period is used in the Gate Source selection of the period timer.
Preset	20 ms GSM: 4.615383
State Saved	Saved in instrument state
Min	100.000 ns
Max	559.0000 ms
Default Unit	S
Initial S/W Revision	Prior to A.02.00

Offset

Adjusts the accumulated offset between the periodic timer events and the trigger event. Adjusting the accumulated offset is different than setting an offset, and requires explanation.

The periodic timer is usually not synchronized with any external events, so the timing of its output events has no absolute meaning. Since the timing relative to external events (RF signals) is important, you need to be able to adjust (offset) it. However, you have no direct way to see when the periodic timer events occur. All that you can see is the trigger timing. When you want to adjust the trigger timing, you will be changing the internal offset between the periodic timer events and the trigger event. Because the absolute value of

that internal offset is unknown, we will just call that the accumulated offset. Whenever the Offset parameter is changed, you are changing that accumulated offset. You can reset the displayed offset using Reset Offset Display. Changing the display does not change the value of the accumulated offset, and you can still make additional changes to accumulated offset.

To avoid ambiguity, we define that an increase in the "offset" parameter, either from the knob or the SCPI adjust command, serves to delay the timing of the trigger event.

Key Path	Trigger, Periodic Timer
Remote Command	:TRIGger[:SEquence]:FRAMe:OFFSet <time> :TRIGger[:SEquence]:FRAMe:OFFSet?
Example	TRIG:FRAM:OFFS 1.2 ms
Notes	<p>The front panel interface (for example, the knob), and this command, adjust the accumulated offset, which is shown on the active function display. However, the actual amount sent to the hardware each time the offset is updated is the delta value, that is, the current accumulated offset value minus the previous accumulated offset value. Note that the accumulated offset value is essentially arbitrary; it represents the accumulated offset from the last time the offset was zeroed (with the Reset Offset Display key).</p> <p>Note that this command does not change the period of the trigger waveform. Note also that Offset is used only when the sync source is set to OFF, otherwise delay is used, see section "Trig Delay" on page 443.</p> <p>An increase in the "offset" parameter, either from the knob or the SCPI adjust command, serves to delay the timing of the trigger event.</p>
Notes	<p>When the SCPI command is sent the value shown on the key (and the Active Function, if this happens to be the active function) is updated with the new value. However, the actual amount sent to the hardware is the delta value, that is, the current accumulated offset value minus the previous accumulated offset value.</p> <p>The SCPI query simply returns the value currently showing on the key.</p>
Dependencies	The invalid data indicator turns on when the offset is changed, until the next sweep/measurement completes.
Couplings	The same offset is used in the Gate Source selection of the period timer.
Preset	0 s
State Saved	Saved in instrument state
Min	-10.000 s
Max	10.000 s
Default Unit	S
Initial S/W Revision	Prior to A.02.00

Offset Adjust (Remote Command Only)

This remote command does not work at all like the related front panel keys. This command lets you advance the phase of the frame trigger by the amount you specify.

It does not change the period of the trigger waveform. If the command is sent multiple times, it advances the phase of the frame trigger an additional amount each time it is sent. Negative numbers are permitted.

Remote Command	:TRIGger[:SEquence]:FRAMe:ADJust <time>
Example	TRIG:FRAM:ADJ 1.2 ms
Notes	Note also that Offset is used only when the sync source is set to OFF, otherwise delay is used, see section "Trig Delay" on page 443 An increase in the "offset" parameter, either from the knob or the SCPI adjust command, serves to delay the timing of the trigger event.
Notes	The front panel interface (for example, the knob) and the :TRIG:FRAM:OFFS command adjust the accumulated offset, which is shown on the active function display. However, the actual amount sent to the hardware is the delta value, that is, the current offset value minus the previous offset value. When the SCPI command is sent the value shown on the key (and the Active Function, if this happens to be the active function) is updated by increasing it (or decreasing it if the value sent is negative) by the amount specified in the SCPI command. This is a "command only" SCPI command, with no query.
Dependencies	The invalid data indicator turns on when the offset is changed, until the next sweep/measurement completes.
Couplings	The same offset is used in the Gate Source selection of the period timer.
Preset	0 s
State Saved	Saved in instrument state
Min	-10.000 s
Max	10.000 s
Default Unit	S
Initial S/W Revision	Prior to A.02.00

Reset Offset Display

Resets the value of the periodic trigger offset display setting to 0.0 seconds. The current displayed trigger location may include an offset value defined with the Offset key. Pressing this key redefines the currently displayed trigger location as the new trigger point that is 0.0 s offset. The Offset key can then be used to add offset relative to this new timing.

Key Path	Trigger, Periodic Timer
Remote Command	:TRIGger[:SEquence]:FRAMe:OFFSet:DISPlay:RESet
Example	TRIG:FRAM:OFFS:DISP:RES
Initial S/W Revision	Prior to A.02.00

Sync Source

Selects a signal source for you to synchronize your periodic timer trigger to, otherwise you are triggering at some arbitrary location in the frame. Synchronization reduces the precision requirements on the setting of the period.

For convenience you may adjust the level and slope of the selected sync source in a conditional branch setup menu accessed from the Sync Source menu. Note that these settings match those in the **Trigger** and **Gate Source** menus; that is, each trigger source has only one value of level and slope, regardless of which menu it is accessed from.

Key Path	Trigger, Periodic Timer
Remote Command	:TRIGger[:SEQuence]:FRAMe:SYNC EXTernal1 EXTernal2 RFBurst OFF :TRIGger[:SEQuence]:FRAMe:SYNC?
Example	TRIG:FRAM:SYNC EXT2
Dependencies	In some models, there is no second External input. In these models, the External 2 key is blanked and the EXTernal2 parameter will generate a "Hardware missing; Not available for this model number" message.
Preset	Off GSM/EDGE, MSR,LTE,LTETDD: RFBurst
State Saved	Saved in instrument state
Readback	The current setting is read back to this key and it is also Readback to the previous Periodic Timer trigger key.
Backwards Compatibility SCPI	:TRIGger[:SEQuence]:FRAMe:SYNC EXTernal For backward compatibility, the parameter EXTernal is mapped to EXTernal1
Initial S/W Revision	Prior to A.02.00
Modified at S/W Revision	A.03.00, A.14.00

Off

Turns off the sync source for your periodic trigger. With the sync source off, the timing will drift unless the signal source frequency is locked to the analyzer frequency reference.

Key Path	Trigger, Periodic Timer, Sync Source
Example	TRIG:FRAM:SYNC OFF
Readback	Off
Initial S/W Revision	Prior to A.02.00

External 1

Pressing this key, when it is not selected, selects an external input signal as the trigger. A new sweep/measurement will start when the external trigger condition is met using the external 1 input connector on the rear panel.

Pressing this key, when it is already selected, accesses the external 1 trigger setup menu.

Key Path	Trigger
Example	TRIG:SOUR EXT1 Swept SA measurement

	TRIG:<meas>:SOUR EXT1 Measurements other than Swept SA
Dependencies	Grayed out if in use by Point Trigger in the Source Setup menu. Forced to Free Run if already selected and Point Trigger is set to External 1.
State Saved	Saved in instrument state
Status Bits/OPC dependencies	The Status Operation Register bit 5 "Waiting for Trigger" is set at the same time as the Sweeping or Measuring bit is set. It is cleared when the trigger actually occurs (that is, after the trigger event occurs and all the applicable trigger criteria have been met). A corresponding pop-up message ("Waiting for trigger") is generated if no trigger signal appears after approximately 2 sec. This message goes away when a trigger signal appears.
Initial S/W Revision	Prior to A.02.00

Trigger Level

Sets the value where the external 1 trigger input will trigger a new sweep/measurement.

Key Path	Trigger, External 1
Remote Command	:TRIGger[:SEquence]:EXTernal:LEVel <level> :TRIGger[:SEquence]:EXTernal:LEVel?
Example	TRIG:EXT1:LEV 0.4 V
Couplings	This same level is used for the Ext1 trigger source in the Trigger menu, for the Ext1 selection in the Periodic Timer sync source (in the Trigger menu and in the Gate Source menu), and also for the Ext1 selection in the Gate Source menu.
Preset	1.2 V
State Saved	Saved in instrument state
Min	-5 V
Max	5 V
Default Unit	V
Backwards Compatibility SCPI	:TRIGger[:SEquence]:EXTernal:LEVel For backward compatibility, the parameter EXTernal is mapped to EXTernal1
Backwards Compatibility SCPI	:TRIGger[:SEquence]:FRAMe:EXTernal1:LEVel
Initial S/W Revision	Prior to A.02.00

Trig Slope

Controls the trigger polarity. It is set positive to trigger on a rising edge and negative to trigger on a falling edge.

Key Path	Trigger, External 1
Remote Command	:TRIGger[:SEquence]:EXTernal:SLOPe POSitive NEGative

	:TRIGger[:SEQuence]:EXTernal1:SLOPe?
Example	TRIG:EXT1:SLOP NEG
Couplings	This same slope is used in the Ext1 selection for the trigger source in the Trigger menu and for the period timer sync source (in the Trigger menu and in the Gate Source menu).
Preset	POSitive
State Saved	Saved in instrument state
Backwards Compatibility SCPI	:TRIGger[:SEQuence]:EXTernal:SLOPe For backward compatibility, the parameter EXTernal is mapped to EXTernal1
Backwards Compatibility SCPI	:TRIGger[:SEQuence]:FRAMe:EXTernal1:SLOPe
Backwards Compatibility Notes	The legacy :TRIGger[:SEQuence]:SLOPe command affects the slopes for the VID, LINE, EXT1, EXT2, and RFB triggers.
Initial S/W Revision	Prior to A.02.00

External 2

Pressing this key, when it is not selected, selects an external input signal as the trigger. A new sweep/measurement will start when the external trigger condition is met using the external 2 input connector. The external trigger 2 input connector is on the rear panel.

Pressing this key, when it is already selected, accesses the external 2 trigger setup menu.

Key Path	Trigger
Example	TRIG:SOUR EXT2 Swept SA measurement TRIG:<meas>:SOUR EXT2 Measurements other than Swept SA
Dependencies	In some models, there is no second External input. In these models, the External 2 key is blanked and the EXTernal2 parameter will generate a "Hardware missing; Not available for this model number" message. Grayed out if in use by Point Trigger in the Source Setup menu. Forced to Free Run if already selected and Point Trigger is set to External 2.
State Saved	Saved in instrument state
Status Bits/OPC dependencies	The Status Operation Register bit 5 "Waiting for Trigger" is set at the same time as the Sweeping or Measuring bit is set. It is cleared when the trigger actually occurs (that is, after the trigger event occurs and all the applicable trigger criteria have been met). A corresponding pop-up message ("Waiting for trigger") is generated if no trigger signal appears after approximately 2 sec. This message goes away when a trigger signal appears.
Initial S/W Revision	Prior to A.02.00
Modified at S/W Revision	A.03.00

Trigger Level

Sets the value where the external 2 trigger input will trigger a new sweep/measurement.

Key Path	Trigger, External 2
Remote Command	:TRIGger[:SEquence]:EXTernal2:LEVel :TRIGger[:SEquence]:EXTernal2:LEVel?
Example	TRIG:EXT2:LEV 1.1 V
Couplings	This same level is used for the Ext2 trigger source in the Trigger menu, for the Ext2 selection in the Periodic Timer sync source (in the Trigger menu and in the Gate Source menu), and also for the Ext2 selection in the Gate Source menu.
Preset	1.2 V
State Saved	Saved in instrument state
Min	-5 V
Max	5 V
Default Unit	V
Backwards Compatibility SCPI	:TRIGger[:SEquence]:FRAMe:EXTernal2:LEVel
Initial S/W Revision	Prior to A.02.00

Trig Slope

Controls the trigger polarity. It is set positive to trigger on a rising edge and negative to trigger on a falling edge.

Key Path	Trigger, External 2
Remote Command	:TRIGger[:SEquence]:EXTernal2:SLOPe POSitive NEGative :TRIGger[:SEquence]:EXTernal2:SLOPe?
Example	TRIG:EXT2:SLOP NEG
Couplings	This same slope is used in the Ext2 selection for the trigger source in the Trigger menu and for the period timer sync source (in the Trigger menu and in the Gate Source menu).
Preset	POSitive
State Saved	Saved in instrument state
Backwards Compatibility SCPI	:TRIGger[:SEquence]:FRAMe:EXTernal2:SLOPe
Backwards Compatibility Notes	The legacy :TRIGger[:SEquence]:SLOPe command affects the slopes for the VID, LINE, EXT1, EXT2, and RFB triggers.
Initial S/W Revision	Prior to A.02.00

RF Burst

Pressing this key, when it is not selected, selects the RF Burst as the trigger. A new sweep/measurement will start when an RF burst envelope signal is identified from the signal at the RF Input connector. Pressing this key, when it is already selected, accesses the RF Burst trigger setup menu.

In some models, a variety of burst trigger circuitry is available, resulting in various available burst trigger bandwidths. The analyzer automatically chooses the appropriate trigger path based on the hardware configuration and other settings of the analyzer.

Key Path	Trigger
Example	TRIG:SOUR RFB Swept SA measurement TRIG:<meas>:SOUR RFB Measurements other than Swept SA
State Saved	Saved in instrument state
Status Bits/OPC dependencies	The Status Operation Register bit 5 "Waiting for Trigger" is set at the same time as the Sweeping or Measuring bit is set. It is cleared when the trigger actually occurs (that is, after the trigger event occurs and all the applicable trigger criteria have been met). A corresponding pop-up message ("Waiting for trigger") is generated if no trigger signal appears after approximately 2 sec. This message goes away when a trigger signal appears.
Backwards Compatibility Notes	The legacy command: :TRIGger[:SEquence]:RFBurst:FSElectivity[:STATe] OFF ON 0 1 is not supported in the X-Series, as the hardware to do Frequency Selective burst triggers does not exist in X-Series.
Initial S/W Revision	Prior to A.02.00
Modified at S/W Revision	A.04.00

Absolute Trigger Level

Sets the absolute trigger level for the RF burst envelope.

When using the External Mixing path, the Absolute Trigger Level is uncalibrated because the factory default was set to accommodate the expected IF levels for the RF path.

Key Path	Trigger, RF Burst
Scope	Meas Global
Remote Command	:TRIGger[:SEquence]:RFBurst:LEVel:ABSolute <ampl> :TRIGger[:SEquence]:RFBurst:LEVel:ABSolute?
Example	TRIG:RFB:LEV:ABS 10 dBm sets the trigger level of the RF burst envelope signal to the absolute level of 10 dBm
Notes	Sending this command does not switch the setting from relative to absolute; to switch it you need to send the :TRIGger[:SEquence]:RFBurst:LEVel:TYPE command, below. Amplitude Corrections are not taken into account by the Absolute Trigger Level. For example, if you have given yourself effective gain with an amplitude correction factor, the Absolute Trigger will not fire until you have set the trigger level that far below the displayed signal level, rather than simply to the displayed signal level. This is only true for Amplitude Corrections, not External Gain or Ref Level Offset functions. If mode is Bluetooth, the default value is -50 dBm.
Couplings	This same level is used for the RF Burst trigger source in the Trigger menu, for the RF Burst selection in the Periodic Timer sync source (in the Trigger menu and in the Gate Source menu), and also for the

	RF Burst selection in the Gate Source menu
Preset	-20 dBm
State Saved	Saved in instrument state
Min	-200 dBm
Max	100 dBm
Default Unit	depends on the current selected Y-Axis unit
Backwards Compatibility SCPI	:TRIGger[:SEquence]:FRAMe:RFBurst:LEVel:ABSolute
Initial S/W Revision	Prior to A.02.00
Modified at S/W Revision	A.04.00

Key Path	Trigger, RF Burst
Remote Command	:TRIGger[:SEquence]:RFBurst:LEVel:TYPE ABSolute RELative :TRIGger[:SEquence]:RFBurst:LEVel:TYPE?
Example	TRIG:RFB:LEV:TYPE REL sets the trigger level type of the RF burst trigger to Relative.
Preset	ABSolute
State Saved	Saved in instrument state
Initial S/W Revision	Prior to A.02.00
Modified at S/W Revision	A.04.00

Trigger Slope

It is set positive to trigger on a rising edge and negative to trigger on a falling edge.

Key Path	Trigger, RF Burst
Remote Command	:TRIGger[:SEquence]:RFBurst:SLOPe POSitive NEGative :TRIGger[:SEquence]:RFBurst:SLOPe?
Example	TRIG:RFB:SLOP NEG
Couplings	This same slope is used in the RF Burst selection for the trigger source in the Trigger menu and for the period timer sync source (in the Trigger menu and in the Gate Source menu).
Preset	POSitive
State Saved	Saved in instrument state
Backwards Compatibility SCPI	:TRIGger[:SEquence]:FRAMe:RFBurst:SLOPe
Backwards Compatibility Notes	The legacy :TRIGger[:SEquence]:SLOPe command affects the slopes for the VID, LINE, EXT1, EXT2, and RFB triggers.
Initial S/W Revision	Prior to A.02.00

Sync Holdoff

Sync Holdoff specifies the duration that the sync source signal must be kept false before the transition to true to be recognized as the sync timing. The periodic timer phase is aligned when the sync source signal becomes true, after the Holdoff time is satisfied.

A holdoff of 2 ms will work with most WiMAX signals, but there may be cases where the burst off duration is less than 1 ms and this value will need to be changed.

Key Path	Trigger, Periodic Timer
Remote Command	:TRIGger[:SEQuence]:FRAMe:SYNC:HOLDoff <time> :TRIGger[:SEQuence]:FRAMe:SYNC:HOLDoff? :TRIGger[:SEQuence]:FRAMe:SYNC:HOLDoff:STATe OFF ON 0 1 :TRIGger[:SEQuence]:FRAMe:SYNC:HOLDoff:STATe?
Preset	On, 1.000 ms
State Saved	Saved in instrument state
Min	0 ms
Max	+500 ms
Default Unit	s
Initial S/W Revision	Prior to A.02.00

Control Edge/Level

Sets the method of controlling the gating function from the gating signal.

Edge

In Edge triggering, the gate opens (after the Delay) on the selected edge (for example, positive) of the gate signal and closes on the alternate edge (for example, negative).

Level

In Level triggering, the gate opens (after the Delay) when the gate signal has achieved a certain level and stays open as long as that level is maintained.

Key Path	Sweep/Control, Gate
Remote Command	[:SENSe]:SWEep:EGATe:CONTRol EDGE LEVEl [:SENSe]:SWEep:EGATe:CONTRol?
Example	SWE:EGAT:CONT EDGE
Dependencies	If the Gate Method is FFT the Control key is grayed out and Edge is selected. If the Gate Source is TV, Frame or Line, the Control key is grayed out and Edge is selected.
Preset	EDGE
State Saved	Saved in instrument state
Backwards Compatibility SCPI	[:SENSe]:SWEep:TIME:GATE:TYPE ESA Compatibility
Initial S/W Revision	Prior to A.02.00

Gate Holdoff

Lets you increase or decrease the wait time after a gate event ends before the analyzer will respond to the next gate signal.

After any Gate event finishes, the analyzer must wait for the sweep system to settle before it can respond to another Gate signal. The analyzer calculates a "wait time," taking into account a number of factors, including RBW and Phase Noise Optimization settings. The goal is to achieve the same accuracy when gated as in ungated operation. The figure below illustrates this concept:

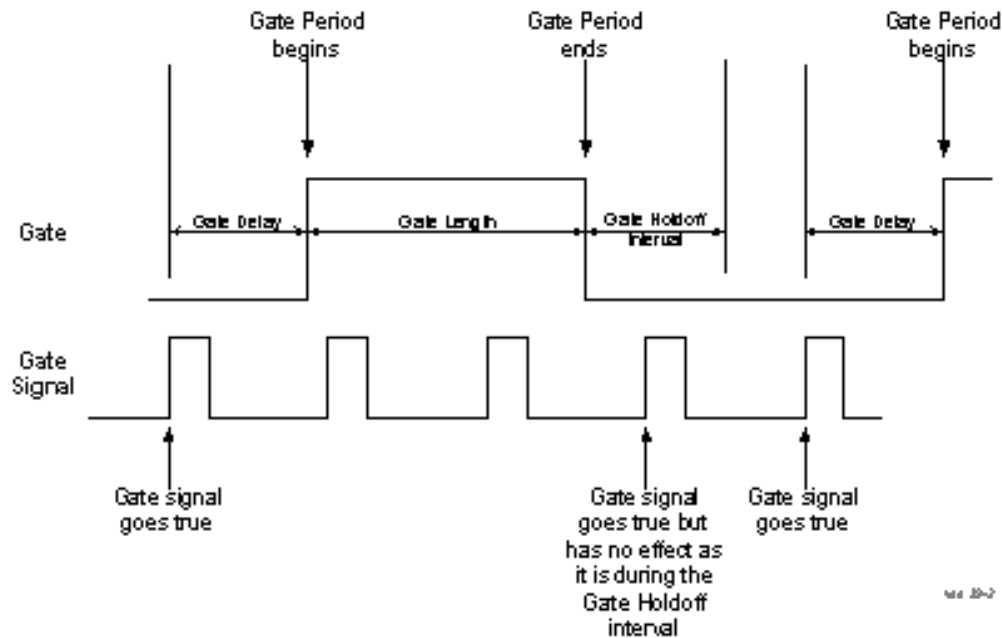

When Gate Holdoff is in Auto, the wait time calculated by the analyzer is used. When Gate Time is in Manual, the user may adjust the wait time, usually decreasing it in order to achieve greater speed, but at the risk of decreasing accuracy.

When the Method key is set to Video or FFT, the Gate Holdoff function has no effect.

In measurements that do not support Auto, the value shown when Auto is selected is “---” and the manually set holdoff is returned to a query.

Key Path	Sweep/Control, Gate
Remote Command	<pre>[:SENSe]:SWEep:EGATe:HOLDoff <time> [:SENSe]:SWEep:EGATe:HOLDoff? [:SENSe]:SWEep:EGATe:HOLDoff:AUTO OFF ON 0 1 [:SENSe]:SWEep:EGATe:HOLDoff:AUTO?</pre>
Example	<pre>SWE:EGAT:HOLD 0.0002 SWE:EGAT:HOLD? SWE:EGAT:HOLD:AUTO ON</pre>

SWE:EGAT:HOLD:AUTO?	
Couplings	<p>When Gate Holdoff is Auto, the Gate Holdoff key shows the value calculated by the analyzer for the wait time.</p> <p>Pressing the Gate Holdoff key while it is in Auto and not selected, causes the key to become selected and allows the user to adjust the value. If the value is adjusted, the setting changes to Man.</p> <p>Pressing the Gate Holdoff key, while it is in Auto and selected, does not change the value of Gate Holdoff, but causes the setting to change to Man. Now the user can adjust the value.</p> <p>Pressing the key while it is in Man and selected, cause the value to change back to Auto.</p> <p>Pressing the key while it is in Man and not selected, causes the key to become selected and allows the user to adjust the value.</p> <p>When Method is set to Video or FFT, the Gate Holdoff function has no effect.</p>
Preset	<p>Auto</p> <p>Auto/On</p>
State Saved	Saved in instrument state
Min	1 μ sec
Max	1 sec
Initial S/W Revision	Prior to A.02.00

Gate Delay Compensation

This function allows you to select an RBW-dependent value by which to adjust the gate delay, to compensate for changes in the delay caused by RBW effects.

You can select between uncompensated operation and two types of compensation, Delay Until RBW Settled and Compensate for RBW Group Delay.

See ["More Information" on page 822](#)

Key Path	Sweep/Control, Gate
Scope	Meas Global
Remote Command	<pre>[:SENSe] :SWEep:EGATe:DELAy:COMPensation:TYPE OFF SETTled GDELAy [:SENSe] :SWEep:EGATe:DELAy:COMPensation:TYPE?</pre>
Example	<pre>SWE:EGAT:DEL:COMP:TYPE SETT SWE:EGAT:DEL:COMP:TYPE?</pre>
Notes	<p>Although this function is Meas Global, there are some measurements that do not support this function. In those measurements the operation will be Uncompensated. Going into one of those measurements will not change the Meas Global selection; it will simply display the grayed-out menu key with "Uncompensated" showing as the selection. This is a non-forceful grayout, so the SCPI command is still accepted.</p> <p>If Gate Delay Compensation is not supported at all within a particular mode, the key is not displayed, and if the SCPI command is sent while in a measurement within that mode, an "Undefined Header" message is generated.</p> <p>Measurements that do not support this function include:</p>

Swept SA	
Preset	TD-SCDMA mode: Compensate for RBW Group Delay All other modes: Delay Until RBW Settled
State Saved	Saved in instrument state
Range	Uncompensated Delay Until RBW Settled Compensate for RBW Group Delay
Readback text	Uncompensated Settled Group Delay
Initial S/W Revision	Prior to A.02.00
Modified at S/W Revision	A.11.0

More Information

Selecting Uncompensated means that the actual gate delay is as you sets it.

Selecting Delay Until RBW Settled causes the gate delay to be increased above the user setting by an amount equal to $3.06/\text{RBW}$. This compensated delay causes the GATE START and GATE STOP lines on the display to move by the compensation amount, and the actual hardware gate delay to be increased by the same amount. All the other gate lines (for example, MIN FAST) are unaffected. If the RBW subsequently changes, the compensation is readjusted for the new RBW. The value shown on the Gate Delay key does NOT change.

Delay Until RBW Settled allows excellent measurements of gated signals, by allowing the IF to settle following any transient that affects the burst. Excellent measurements also require that the analysis region not extend into the region affected by the falling edge of the burst. Thus, excellent measurements can only be made over a width that declines with narrowing RBWs, which is achieved by decreasing the gate length below the user setting by an amount equal to $2.53/\text{RBW}$. Therefore, for general purpose compensation, you will still want to change the gate length with changes in RBW even if the gate delay is compensated. The compensated Gate Length is limited by the analyzer so that it will never go below 10% of the value shown on the Gate Length key, as otherwise the sweep times could get very long. Anytime the Gate Length and RBW values combine in such a way that this limiting takes place, a warning is displayed. For measurements which contain multiple sweeps with different RBW like SEM and SPUR, the smallest RBW is used for this limiting.

Selecting Compensate for RBW Group Delay causes the gate delay to be increased above the user setting by an amount equal to $1.81/\text{RBW}$. This compensated delay causes the GATE START, GATE STOP lines on the display to move by the compensation amount, and the actual hardware gate delay to be increased by the same amount. All the other gate lines (for example, MIN FAST) are unaffected. If the RBW subsequently changes, the compensation is readjusted for the new RBW. The value shown on the Gate Delay key does NOT change. Compensate for RBW Group Delay also includes gate length compensation; the gate length itself is adjusted as necessary to attempt to compensate for delay effects imposed by the RBW.

Compensate for RBW Group Delay is similar to Delay Until RBW Settled, but compensates for the group delay of the RBW filter, rather than the filter settling time. As the RBW gets narrow, this can allow the settling tail of the RBW to affect the beginning part of the gated measurement, and allow the beginning of the RBW settling transient to affect the end of the gated measurement. These two effects are symmetric

because the RBW response is symmetric. Because the gate length is not automatically compensated, some users might find this compensation to be more intuitive than compensation for RBW settling.

Min Fast Position Query (Remote Command Only)

This command queries the position of the MIN FAST line, relative to the delay reference (REF) line. See section "[Gate View On/Off](#)" on page 2080. If this query is sent while not in gate view, the MinFast calculation is performed based on the current values of the appropriate parameters and the result is returned. Knowing this value lets you set an optimal gate delay value for the current measurement setup.

Remote Command	<code>[:SENSe] :SWEep:EGATe:MINFast?</code>
Example	<code>SWE:EGAT:MIN?</code>
Initial S/W Revision	Prior to A.02.00

Gate Preset (Remote Command Only)

Presets the time-gated spectrum analysis capability.

This command sets gate parameter values to the ESA preset values, as follows:

Gate trigger type = edge

Gate polarity = positive

Gate delay = 1 us

Gate length = 1 us

Remote Command	<code>[:SENSe] :SWEep:TIME:GATE:PRESet</code> ESA Compatibility
Initial S/W Revision	Prior to A.02.00

Gate Level (Remote Command Only)

Sets the gate input transition point level for the external TRIGGER inputs on the front and rear panel. This is a legacy command for PSA compatibility. It is simply an alias to the equivalent trigger level command.

Remote Command	<code>[:SENSe] :SWEep:EGATe:EXTernal [1] 2 :LEVel <voltage></code> <code>[:SENSe] :SWEep:EGATe:EXTernal [1] 2 :LEVel?</code>
Notes	This command is simply an alias to <code>:TRIGger[:SEQUence]:EXTernal[1] 2:LEVel</code> For details refer
Initial S/W Revision	Prior to A.02.00

Gate Polarity (Remote Command Only)

Sets the polarity for the gate signal. This setup is now done using the gate trigger's slope setting.

When Positive (Pos) is selected, a positive-going edge (Edge) or a high voltage (Level) will satisfy the gate condition, after the delay set with the Gate Delay key. When Negative (Neg) is selected, a negative-going edge (Edge) or a low voltage (Level) will satisfy the gate condition after the delay.

Remote Command	<code>[:SENSe] :SWEep:EGATe:POLarity NEGative POSitive</code> <code>[:SENSe] :SWEep:EGATe:POLarity?</code>
Example	<code>SWE:EGAT:POL NEG</code> <code>SWE:EGAT:POL?</code>
Preset	POSitive
State Saved	Saved in instrument state
Backwards Compatibility SCPI	<code>[:SENSe] :SWEep:TIME:GATE:POLarity</code> ESA compatibility
Initial S/W Revision	Prior to A.02.00

Remote Command	<code>[:SENSe] :SWEep:TIME:GATE:LEVel HIGH LOW</code> <code>[:SENSe] :SWEep:TIME:GATE:LEVel?</code> ESA compatibility
Preset	HIGH
Initial S/W Revision	Prior to A.02.00

Points

Sets the number of points per sweep, from 1 to 20001. The sweep time resolution setting will depend on the number of points selected.

Key Path	Sweep/Control
Mode	SA, WCDMA, C2K, WIMAX OFDMA, TD-SCDMA, 1xEVDO, DVB-T/H, DTMB (CTTB), ISDB-T, CMMB, LTE, LTE-TDD, Digital Cable TV, MSR, LTEAFDD, LTEATDD
Remote Command	<code>[:SENSe] :ACPowe:r:SWEep:POINts <integer></code> <code>[:SENSe] :ACPowe:r:SWEep:POINts?</code>
Example	<code>ACP:SWE:POIN 500</code> <code>ACP:SWE:POIN?</code>
Notes	Whenever the number of sweep points changes: <ul style="list-style-type: none"> • All trace data is erased • Any traces with Update Off will also go to Display Off (like going from View to Blank in the older analyzers) • Sweep time is re-quantized • Any limit lines that are on will be updated • If averaging/hold is on, averaging/hold starts over
Couplings	Whenever the number of sweep points changes, the sweep time is re-quantized.

Preset	Others: 1001 DVB-T/H:2001 DTMB (CTTB): 2001 ISDB-T: 2001 CMMB: 2001 Digital Cable TV: 2001
State Saved	Saved in instrument state.
Min	1
Max	20001
Initial S/W Revision	Prior to A.02.00
Modified at S/W Revision	A.02.00, A.03.00

System

See ["System" on page 342](#)

Trace/Detector

Accesses a menu of functions that enable you to control the detectors for the current measurement.

Key Path	Front-panel key
Initial S/W Revision	Prior to A.02.00

Select Trace (Front-panel Only)

This key selects which trace the other parameters under the Trace/Detector menu will apply to.

Key Path	Trace/Detector
Notes	Front-panel only.
Couplings	When Meas Method is RBW or FAST, Select Trace is disabled.
Preset	1
State Saved	Saved in instrument state.
Range	1 2 3
Initial S/W Revision	Prior to A.02.00

Trace Type

Allows you to select the type of trace for the current measurement. The first page of this menu contains a selection of the trace type (Clear Write, Trace Average, Max Hold, Min Hold) for the selected trace.

Key Path	Trace/Detector
Mode	SA, WCDMA, C2K, WIMAX OFDMA, TD-SCDMA, 1xEVDO, DVB-T/H, DTMB (CTTB), ISDB-T, CMMB, LTE, LTE-TDD, Digital Cable TV, MSR, LTEAFDD, LTEATDD
Remote Command	:TRACe [1] 2 3 :ACPoweR :TYPE WRITe AVERAge MAXHold MINHold :TRACe [1] 2 3 :ACPoweR :TYPE?
Example	TRAC:ACP:TYPE MINH TRAC:ACP:TYPE?
Notes	WRITe = Clear Write AVERAge = Average MAXHold = Maximum Hold MINHold = Minimum Hold
Couplings	When Detector setting is "Auto" (:SENSe]:ACPoweR:DETEctor:AUTO?), Detector is set to what the Radio Standard defaults states (see detector section below) for all conditions of Trace Type and for all traces. When set to Manual, all Traces use the same detector type. When Average State = Off then Trace Types AVERAge, MaxHold and MinHold will not function, since Averaging is required to be 'on' for them to operate.

	When Meas Method is RBW or FAST, Trace Type is disabled.
Preset	AVERage
State Saved	Saved in instrument state.
Initial S/W Revision	Prior to A.02.00
Modified at S/W Revision	A.02.00, A.03.00

View/Blank

Enables you to select how to view the displayed trace.

Key Path	Trace/Detector
Mode	SA,WCDMA, C2K, WIMAX OFDMA, TD-SCDMA, 1xEVDO, DVB-T/H, DTMB (CTTB), ISDB-T, CMMB, LTE, LTETDD, Digital Cable TV, MSR, LTEAFDD,LTEATDD
Notes	No remote control. Front panel only.
Couplings	The four states of this 1-of-N actually set two variables, Update and Display, to their four possible combinations. Trace On: Update and Display both On View: Update Off and Display On (Not implemented) Blank: Update Off and Display Off Background: Update On, Display Off (Not implemented) See tables below for detail on remote commands to control these two variables. Selecting a trace type (Clear Write, Trace Average, Max Hold, Min Hold) for a trace (pressing the key or sending the equivalent remote command) puts the trace in 'Trace On' state (Update On and Display On), even if that trace type was already selected. When Meas Method is RBW or FAST, this key is grayed out.
Preset	Trace On
State Saved	Saved in instrument state.
Range	Trace On Blank
Initial S/W Revision	Prior to A.02.00
Modified at S/W Revision	A.03.00

Key Path	Trace/Detector
Mode	WCDMA, C2K, WIMAX OFDMA, TD-SCDMA, 1xEVDO, DVB-T/H, DTMB (CTTB), ISDB-T, CMMB, LTE, LTETDD, Digital Cable TV, MSR, LTEAFDD,LTEATDD
Remote Command	:TRACe [1] 2 3 :ACPoweR:UPDate [:STATe] ON OFF 0 1 :TRACe [1] 2 3 :ACPoweR:UPDate [:STATe] ?
Example	TRAC:ACP:UPD ON TRAC:ACP:UPD?
Couplings	Whenever you set Update to On for any trace, the Display is set to On for that trace. When Meas Method is RBW or FAST, Trace Update is disabled.
Preset	1 0 0 (On for Trace 1; Off for 2 &3)

State Saved	Saved in instrument state.
Range	0 1
Initial S/W Revision	Prior to A.02.00
Modified at S/W Revision	A.03.00
<hr/>	
Key Path	Trace/Detector
Mode	WCDMA, C2K, WIMAX OFDMA, TD-SCDMA, 1xEVDO, DVB-T/H, DTMB (CTTB), ISDB-T, CMMB, LTE, LTETDD, Digital Cable TV, MSR, LTEAFDD,LTEATDD
Remote Command	:TRACe[1] 2 3:ACPover:DISPlay[:STATe] ON OFF 0 1 :TRACe[1] 2 3:ACPover:DISPlay[:STATe]?
Example	TRAC:ACP:DISP ON TRAC:ACP:DISP?
Couplings	Whenever you set Update to On for any trace, the Display is set to On for that trace. When Meas Method is RBW or FAST, Trace Display is disabled.
Preset	1 0 0 (On for Trace 1; Off for 2 &3)
State Saved	Saved in instrument state.
Range	0 1
Initial S/W Revision	Prior to A.02.00
Modified at S/W Revision	A.03.00

Detector

Accesses a menu of functions that enables you to control the detectors for the current measurement. Allows up to three (3) traces, but each use the same detector type choice. The following choices are available:

- Auto– the detector selected is set to AVERage, unless the Radio Standard defaults state otherwise e.g. it is set to Peak for Radio Standard = PDC when Device = both MS and BTS, and when Radio Standard = NADC and Device = MS.
- Normal–the detector determines the peak of the CW-like signals, and it yields alternating maximums and minimums of noise-like signals. This is also referred to as Rosenfell detection.
- Average–the detector determines the average of the signal within the sweep points. The averaging method is Power (RMS).
- Peak–the detector determines the maximum of the signal within the sweep points.
- Sample–the detector indicates the instantaneous level of the signal at the center of the sweep points represented by each display point.
- Negative Peak–the detector determines the minimum of the signal within the sweep points.

In swept analysis, the time interval of the data collection for the display sweep points also represents a frequency interval. In FFT analysis, the sweep points represents just a frequency interval. The detector

determines the relationship between the spectrum computed by the FFT and the single data point displayed for the sweep points.

Key Path	Trace/Detector
Initial S/W Revision	Prior to A.02.00

Auto

Sets the detector for the currently selected trace to auto.

Key Path	Trace/Detector
Mode	SA, WCDMA, C2K, WIMAX OFDMA, TD-SCDMA, 1xEVDO, DVB-T/H, DTMB (CTTB), ISDB-T, CMMB, LTE, LTE-TDD, Digital Cable TV, MSR, LTEAFDD, LTEATDD
Remote Command	<code>[:SENSe] :ACPower:DETECTOR:AUTO ON OFF 1 0</code> <code>[:SENSe] :ACPower:DETECTOR:AUTO?</code>
Example	ACP:DET:AUTO 1 ACP:DET?
Couplings	When Detector setting is "Auto" (<code>[:SENSe] :ACPower:DETECTOR:AUTO?</code>), Detector is set to what the Radio Standard defaults states (see detector section) for all conditions of Trace Type and for all traces. When set to Manual, all Traces use the same detector type. When Average State = Off then Trace Types AVERage, MaxHold and MinHold will not function, since Averaging is required to be 'on' for them to operate.
Preset	ON
State Saved	Saved in instrument state.
Range	ON OFF
Initial S/W Revision	Prior to A.02.00
Modified at S/W Revision	A.02.00, A.03.00

Detector Selection

Selects a detector to be used by the analyzer for the current measurement. All traces will use the same detector type, similar to Monitor Spectrum measurement

Key Path	Trace/Detector
Mode	SA, WCDMA, C2K, WIMAX OFDMA, TD-SCDMA, 1xEVDO, DVB-T/H, DTMB (CTTB), ISDB-T, CMMB, LTE, LTE-TDD, Digital Cable TV, MSR, LTEAFDD, LTEATDD
Remote Command	<code>[:SENSe] :ACPower:DETECTOR[:FUNCTION] AVERage NEGative NORMal POSitive SAMPlE</code> <code>[:SENSe] :ACPower:DETECTOR[:FUNCTION] ?</code>
Example	ACP:DET NORM ACP:DET?
Notes	When you manually select a detector (instead of selecting Auto), that detector is used regardless of

other analyzer settings.

The detector choices are:

- The Normal detector determines the peak of CW-like signals, and it yields alternating maximums and minimums of noise-like signals. This is also referred to as Rosenfell detection.
- The Average detector determines the average of the signal within the data range. The averaging method is Power (RMS).
- The Peak detector determines the maximum of the signal within the data range.
- The Sample detector indicates the instantaneous level of the signal at the center of the data represented by each display point.
- The Negative Peak detector determines the minimum of the signal within the data range.

Because they may not find a spectral component's true peak, neither average nor sample detectors measure amplitudes of CW signals as accurately as peak or normal, but they do measure noise without the biases of peak detection.

When a detector selection is made, the menu returns to the previous menu.

Couplings	<p>When Detector setting is "Auto" (:SENSe]:ACPower:DETECTOR:AUTO?), Detector is set to what the Radio Standard defaults states (see detector section) for all conditions of Trace Type and for all traces. When set to Manual, all Traces use the same detector type. When Average State = Off then Trace Types AVERage, MaxHold and MinHold will not function, since Averaging is required to be 'on' for them to operate.</p> <p>Only one detector type for all 3 traces is allowed.</p> <p>When Meas Method is RBW or FAST, Detector is disabled.</p>
Preset	AVERage
State Saved	Saved in instrument state.
Range	Normal Average Peak Sample Negative Peak
Backwards Compatibility SCPI	[:SENSe] :ACPR :SWEep :DETECTOR [:FUNction]
Initial S/W Revision	Prior to A.02.00
Modified at S/W Revision	A.02.00, A.03.00

Trigger

See ["Trigger" on page 412](#)

Free Run

See ["Free Run " on page 419](#)

Video

See ["Video \(IF Envelope\) " on page 420](#)

Trigger Level

See ["Trigger Level " on page 420](#)

Trig Slope

See ["Trig Slope " on page 421](#)

Trig Delay

See ["Trig Delay " on page 422](#)

Line

See ["Line " on page 2087](#)

Trig Slope

See ["Trig Slope " on page 2087](#)

Trig Delay

See ["Trig Delay " on page 424](#)

External 1

See ["External 1 " on page 2099](#)

Trigger Level

See ["Trigger Level " on page 2099](#)

Trig Slope

See ["Trig Slope " on page 2100](#)

Trig Delay

See ["Trig Delay " on page 427](#)

External 2

See ["External 2 " on page 2101](#)

Trigger Level

See ["Trigger Level "](#) on page 2101

Trig Slope

See ["Trig Slope "](#) on page 2102

Trig Delay

See ["Trig Delay "](#) on page 429

RF Burst

See ["RF Burst "](#) on page 2102

Absolute Trigger

See ["Absolute Trigger Level"](#) on page 2103

Relative Trigger

See ["Relative Trigger Level"](#) on page 2092

Trig Slope

See ["Trigger Slope "](#) on page 2104

Trig Delay

See ["Trig Delay "](#) on page 433

Periodic Timer

See ["Periodic Timer \(Frame Trigger\) "](#) on page 2094

Period

See ["Period "](#) on page 2095

Offset

See ["Offset "](#) on page 2096

Reset Offset Display

See ["Reset Offset Display "](#) on page 2098

Sync Source

See ["Sync Source "](#) on page 2098

Off

See ["Off "](#) on page 2099

External 1

See ["External 1 "](#) on page 2099

Trigger Level

See ["Trigger Level "](#) on page 2099

Trig Slope

See ["Trig Slope "](#) on page 2100

External 2

See ["External 2 "](#) on page 2101

Trigger Level

See ["Trigger Level "](#) on page 2101

Trig Slope

See ["Trig Slope "](#) on page 2102

RF Burst

See ["RF Burst "](#) on page 2102

Absolute Trigger

See ["Absolute Trigger Level"](#) on page 2103

Trig Slope

See ["Trigger Slope "](#) on page 2104

Trig Delay

See ["Trig Delay"](#) on page 443

Auto/Holdoff

See ["Auto/Holdoff "](#) on page 444

Auto Trig

See ["Auto Trig "](#) on page 444

Trig Holdoff

See ["Trig Holdoff "](#) on page 445

User Preset

Accesses a menu that gives you the following three choices:

- User Preset – recalls a state previously saved using the Save User Preset function.
- User Preset All Modes – presets all of the modes in the analyzer
- Save User Preset– saves the current state for the current mode

Key Path	Front-panel key
Backwards Compatibility Notes	<p>User Preset is actually loading a state, and in legacy analyzers, it was possible to load a state without affecting the trace data, limit lines or correction data. Similarly it was possible to do a User Preset without affecting the trace data, limit lines or correction data.</p> <p>In the X-Series, “state” always includes all of this data; so whenever state is loaded, or User Preset is executed, all of the traces, limit lines and corrections are affected. Although this differs from previous behavior, it is desirable behavior, and should not cause adverse issues for users.</p> <p>On ESA and PSA, User Preset affected the entire instrument’s state. In the X-Series, User Preset only recalls the state for the active mode. There is a User Preset file for each mode. User Preset can never cause a mode switch as it can in legacy analyzers. If you want to recall all modes to their user preset file state, you will need to do a User Preset after mode switching into each mode.</p> <p>User Preset recalls mode state which can now include data like traces; whereas on ESA and PSA, User Preset did not affect data.</p>
Initial S/W Revision	Prior to A.02.00

User Preset

User Preset sets the state of the currently active mode back to the state that was previously saved for this mode using the Save User Preset menu key or the SCPI command, SYST:PRES:USER:SAV. It not only recalls the Mode Preset settings, but it also recalls all of the mode persistent settings, and the Input/Output system setting that existed at the time Save User Preset was executed.

If a Save User Preset has not been done at any time, User Preset recalls the default user preset file for the currently active mode. The default user preset files are created if, at power-on, a mode detects there is no user preset file. There will never be a scenario when there is no user preset file to restore. For each mode, the default user preset state is the same state that would be saved if a Save User Preset is performed in each mode right after doing a Restore Mode Default and after a Restore Input/Output Defaults.

The User Preset function does the following:

- Aborts the currently running measurement.
- Sets the mode State to the values defined by Save User Preset.
- Makes the saved measurement for the currently running mode the active measurement.
- Brings up the saved menu for the power-on mode.
- Clears the input and output buffers.
- Sets the Status Byte to 0.

Key Path	User Preset
Remote Command	:SYSTem:PRESet:USER
Example	:SYST:PRES:USER:SAVE:SYST:PRES:USER
Notes	:SYST:PRES:USER:SAVE is used to save the current state as the user preset state. Clears all pending OPC bits. The Status Byte is set to 0. Pressing the User Preset front-panel key while already in the User Preset menu will cause the User Preset to get executed
Couplings	A user preset will cause the currently running measurement to be aborted and cause the saved measurement to be active. Recalling a User Preset file has the same issues that recalling a Save State file has. Some settings may need to be limited and therefore re-coupled, since the capabilities of the mode may have changes when the User Preset file was last saved.
Initial S/W Revision	Prior to A.02.00

User Preset All Modes

Recalls all of the User Preset files for each mode, switches to the power-on mode, and activates the saved measurement from the power-on mode User Preset file.

NOTE

When the instrument is secured, all of the user preset files are converted back to their default user preset files.

The User Preset function does the following:

- Aborts the currently running measurement.
- Switches the Mode to the power-on mode.
- Restores the User Preset files for each mode.
- Makes the saved measurement for the power-on mode the active measurement.
- Brings up the saved menu for the power-on mode.
- Clears the input and output buffers.
- Sets the Status Byte to 0.

Key Path	User Preset
Remote Command	:SYSTem:PRESet:USER:ALL
Example	:SYST:PRES:USER:SAVE:SYST:PRES:USER:ALL
Notes	Clears all pending OPC bits. The Status Byte is set to 0. :SYST:PRES:USER:SAVE is used to save the current state as the user preset state.
Couplings	A user preset will cause the currently running measurement to be aborted, cause a mode switch to the power-on mode, and cause the saved measurement to be active in the power-on mode. Recalling a User Preset file has the same issues that recalling a Save State file has. Some settings may need to be limited and therefore re-coupled, since the capabilities of the mode may have changes when the User Preset file was last saved.
Initial S/W Revision	Prior to A.02.00

Save User Preset

Saves the currently active mode and its State. You can recall this User Preset file by pressing the User Preset menu key or sending the SYST:PRES:USER remote command. This same state is also saved by the Save State function.

Key Path	User Preset
Remote Command	:SYSTem:PRESet:USER:SAVE
Example	:SYST:PRES:USER:SAVE
Notes	:SYST:PRES:SAVE creates the same file as if the user requested a *SAV or a MMEM:STOR:STAT, except User Preset Save does not allow the user to specify the filename or the location of the file.
Initial S/W Revision	Prior to A.02.00

View/Display

Accesses a menu of functions that enable you to control the instrument display as well as turn the bar graph On and Off.

If current mode is NOT MSR and LTE-Advanced FDD/TDD mode, the front panel views only contain one view: Spectrum View.

The results of the measurement can be displayed as a single spectrum trace view or displayed with a Bar Graph trace on the spectrum trace.

The display consists of the following two windows:

"Spectrum Window" on page 840

"Results Window" on page 840



The following two views are only for DTMB (CTTB) and CMMB:

DTMB and CMMB Transmitter:

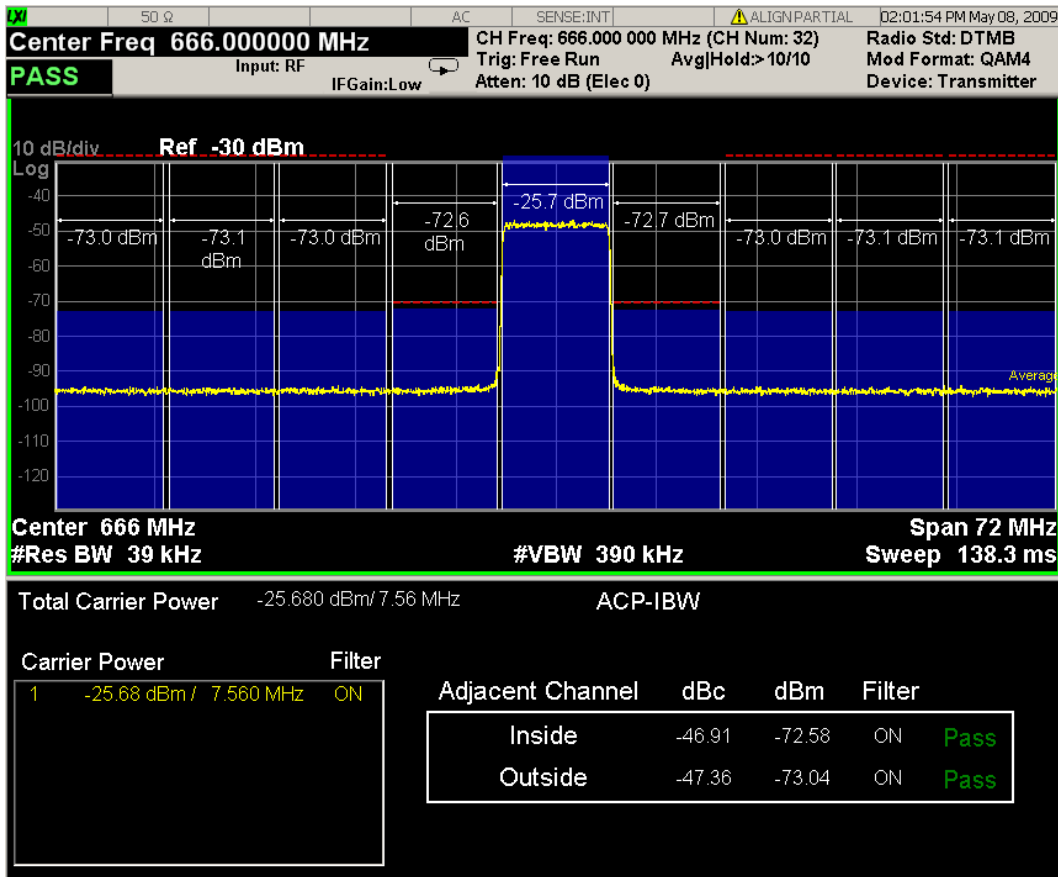

DTMB and CMMB Exciter:

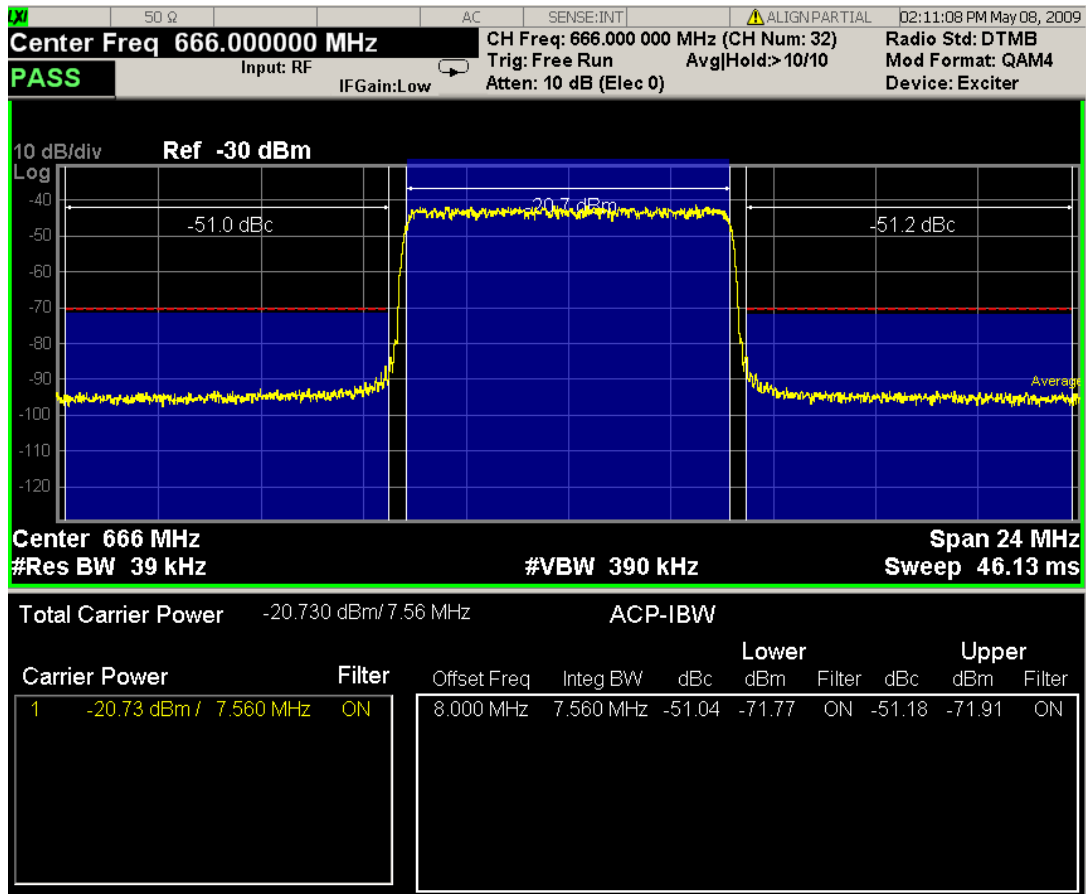

Spectrum Window

When the Bar Graph is On and Limit Test is On, the color of each bar graph reflects the limit test result. When the limit test fails, the bar color is red, and when limit test passes, the bar color is blue.

When RBW is selected as the measurement method, the spectrum trace is not displayed, only the bar graph is displayed. In addition, the Bar Graph key (under the View/Display front-panel key) is set to ON and is grayed out.

The RRC Filter display item is only displayed when RRC filter is on.

Results Window

The text window displays the following results:

Total Carrier Power

This is the total power of all the carriers with carrier power present set to yes. The power is calculated by integrating across the bandwidth declared by the Carrier Integ Bw parameter for each carrier and then totaling the sums. The total integration bandwidth is shown as part of the result. This will be the total of the Carrier Integ Bw of the carriers used in calculating the total carrier power. If the RRC Filter is on, then the integration bandwidth used is $(1 + \alpha)/T$ where $T = 1/(\text{Carrier Integ Bw})$ multiplied by the number of carriers with carrier power present set to yes.

Ref Carrier Power

This is the power in the reference carrier. The power is calculated by integrating across the bandwidth declared by the Carrier Integ Bw parameter for that carrier. The integration bandwidth is shown as part of the result. This is the value of the Carrier Integ Bw for that carrier unless the RRC Filter is on, then the integration bandwidth used is the displayed value, which is $(1 + \alpha)/T$ where $T = 1/(\text{Carrier Integ Bw})$.

Carrier Power

This is the power in all the currently defined carriers. If the carrier has carrier power present, the power will be absolute. If the carrier is defined as not having power present, the power will be relative to the reference carrier. The power is calculated by integrating across the bandwidth declared by the Carrier Integ Bw parameter. The integration bandwidth is shown as part of the result. This is the value of the Carrier Integ Bw for the carrier unless the RRC Filter is on, then the integration bandwidth used is the displayed value, which is $(1 + \alpha)/T$ where $T = 1/(\text{Carrier Integ Bw})$.

As there are potentially more results than can be easily viewed on the display, a scrollable list is used to display all results. The Carrier Results menu key is used to index the carrier amplitude results. This key is grayed out unless the measurement is in single mode (as in continual measurement mode). The display is continuously updating and will not need to be accessed. The currently selected Carrier Result is displayed on the last line of the carrier power result list unless:

- The selected Carrier Result is 4 or less in normal multi carrier power results view. In this case the first 4 carrier power results will be displayed.
- The selected Carrier Result is 9 or greater in normal multi carrier power results view. In this case the last 4 carrier power results will be displayed.
- The zoom mode is selected. In this case all carrier power ranges can be displayed.

Offset Relative Power

This is the power in the offsets relative to the reference carrier. The power is calculated by integrating across the bandwidth declared by the Offset Integ Bw parameter. The offset integration bandwidth is shown as part of the result. This is the value on the Offset Integ Bw menu key unless the RRC Filter is on, then the integration bandwidth used is the displayed value, which is $(1 + \alpha)/T$ where $T = 1/(\text{Offset Integ Bw})$.

Offset Absolute Power

This is the absolute power in the offsets. The power is calculated by integrating across the bandwidth declared by the Offset Integ Bw parameter. The offset integration bandwidth is shown as part of the result. This is the value on the Offset Integ Bw menu key unless the RRC Filter is on, then the integration bandwidth used is the displayed value, which is $(1 + \alpha)/T$ where $T = 1/(\text{Offset Integ Bw})$.

Inside Adjacent Channel Power (DTMB (CTTB) and CMMB only)

This result is only valid for DTMB (CTTB) transmitter and CMMB transmitter. It contains two parts: Relative Power and Absolute Power. The power is calculated by integrating across the bandwidth (Integ Bw) at the frequency Offset A.

Inside Absolute Power = $\text{MAX}(P_{\text{Lower Offset A}}, P_{\text{Upper Offset A}})$;

Inside Relative Power = Inside Absolute Power – Carrier Power;

Outside Adjacent Channel Absolute Power (DTMB (CTTB) and CMMB only)

This result is only valid for DTMB (CTTB) transmitter and CMMB transmitter. It contains two parts: Relative Power and Absolute Power. The power is the Root-Mean-Square of the power calculated by integrating across the bandwidth (Integ Bw) at frequency Offset B, C and D.

$$\text{Outside Absolute Power} = \sqrt{\frac{P_{\text{Lower OffsetB}}^2 + P_{\text{Upper OffsetB}}^2 + P_{\text{Lower OffsetC}}^2 + P_{\text{Upper OffsetC}}^2 + P_{\text{Lower OffsetD}}^2 + P_{\text{Upper OffsetD}}^2}{6}}$$

Outside Relative Power = Outside Absolute Power – Carrier Power;

If current mode is MSR, there are two views, Result Trace and Carrier Info.

NOTE Y Scale/Div, Y Ref Position, Y Auto Scale, Y Ref Value and Bar Graph affect both views. For example, power bars on the traces in both views appear or disappear when Bar Graph is toggled.

View Selection by Name (MSR and LTE-Advanced FDD/TDD Only)

Selects the results view. The following SCPI command allows you to select the desired measurement view by enumeration.

Key Path	No equivalent front-panel key
Mode	MSR, LTEAFDD,LTEATDD
Remote Command	:DISPlay:ACPower:VIEW[:SElect] PRESult CINformation :DISPlay:ACPower:VIEW[:SElect]?
Example	DISP:ACP:VIEW PRES DISP:ACP:VIEW?
Notes	This SCPI is only available in MSR and LTE-Advanced FDD/TDD.
Preset	PRESult
State Saved	Saved in instrument state
Range	Power Results Carrier Info
Initial S/W Revision	A.10.00

Key Path	No equivalent front-panel key
Mode	MSR, LTEAFDD,LTEATDD
Remote Command	:DISPlay:ACPower:VIEW:NSElect <integer> :DISPlay:ACPower:VIEW:NSElect?
Example	DISP:ACP:VIEW:NSEL 1 DISP:ACP:VIEW:NSEL?
Notes	This SCPI is only available in MSR and LTE-Advanced FDD/TDD.
Preset	1
State Saved	Saved in instrument state
Min	1
Max	2
Initial S/W Revision	A.10.00

Key Path	Front-panel key
Initial S/W Revision	Prior to A.02.00

Display

The Display menu is common to most measurements, and is used for configuring items on the display. Some Display menu settings apply to all the measurements in a mode, and some only to the current measurement. Those under the System Display Settings key apply to all measurements in all modes.

Key Path	Display
Key Path	View/Display
Initial S/W Revision	Prior to A.02.00

Annotation

Turns on and off various parts of the display annotation. The annotation is divided up into four categories:

1. Meas Bar: This is the measurement bar at the top of the screen. It does not include the settings panel or the Active Function. Turning off the Meas Bar turns off the settings panel and the Active Function. When the Meas Bar is off, the graticule area expands to fill the area formerly occupied by the Meas Bar.
2. Screen Annotation: this is the annotation and annunciation around the graticule, including any annotation on lines (such as the display line, the threshold line, etc.) This does NOT include the marker number or the N dB result. When off, the graticule expands to fill the entire graticule area.
3. Trace annotation: these are the labels on the traces, showing their detector (or their math mode).
4. Active Function annotation: this is the active function display in the meas bar, and all of the active function values displayed on softkeys.

See the figure below. Each type of annotation can be turned on and off individually.

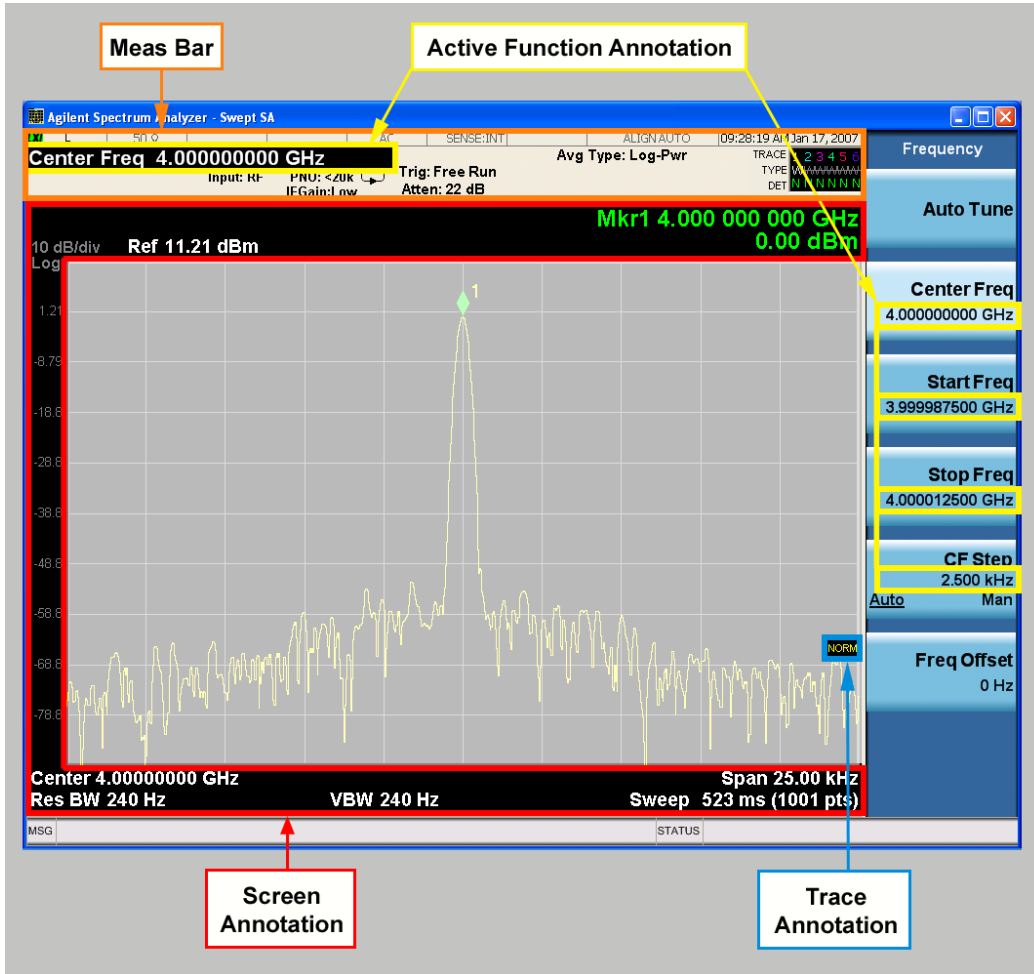

Key Path	View/Display, Display
Initial S/W Revision	Prior to A.02.00

Meas Bar On/Off

This function turns the Measurement Bar on and off, including the settings panel. When off, the graticule area expands to fill the area formerly occupied by the Measurement Bar.

Key Path	View/Display, Display, Annotation
Remote Command	:DISPlay:ANNOtation:MBAR[:STATe] OFF ON 0 1 :DISPlay:ANNOtation:MBAR[:STATe]?
Example	DISP:ANN:MBAR OFF
Dependencies	Grayed out and forced to OFF when System Display Settings, Annotation is set to Off.
Preset	On This should remain Off through a Preset when System DisplaySettings, Annotation is set to Off.
State Saved	Saved in instrument state.
Initial S/W Revision	Prior to A.02.00

Screen

This controls the display of the annunciation and annotation around the graticule, including any annotation on lines (such as the display line, the threshold line, etc.) and the y-axis annotation. This does NOT include marker annotation (or the N dB result). When off, the graticule expands to fill the entire graticule area, leaving only the 1.5% gap above the graticule as described in the Trace/Detector chapter.

Key Path	View/Display, Display, Annotation
Remote Command	:DISPlay:ANNotation:SCReen[:STATe] OFF ON 0 1 :DISPlay:ANNotation:SCReen[:STATe]?
Example	DISP:ANN:SCR OFF
Dependencies	Grayed-out and forced to OFF when System Display Settings, Annotation is set to Off.
Preset	On This should remain Off through a Preset when System DisplaySettings, Annotation is set to Off
State Saved	Saved in instrument state.
Initial S/W Revision	Prior to A.02.00

Active Function Values On/Off

Turns on and off the active function display in the Meas Bar, and all of the active function values displayed on the softkeys.

Note that all of the softkeys that have active functions have these numeric values blanked when this function is on. This is a security feature..

9 ACP Measurement
View/Display

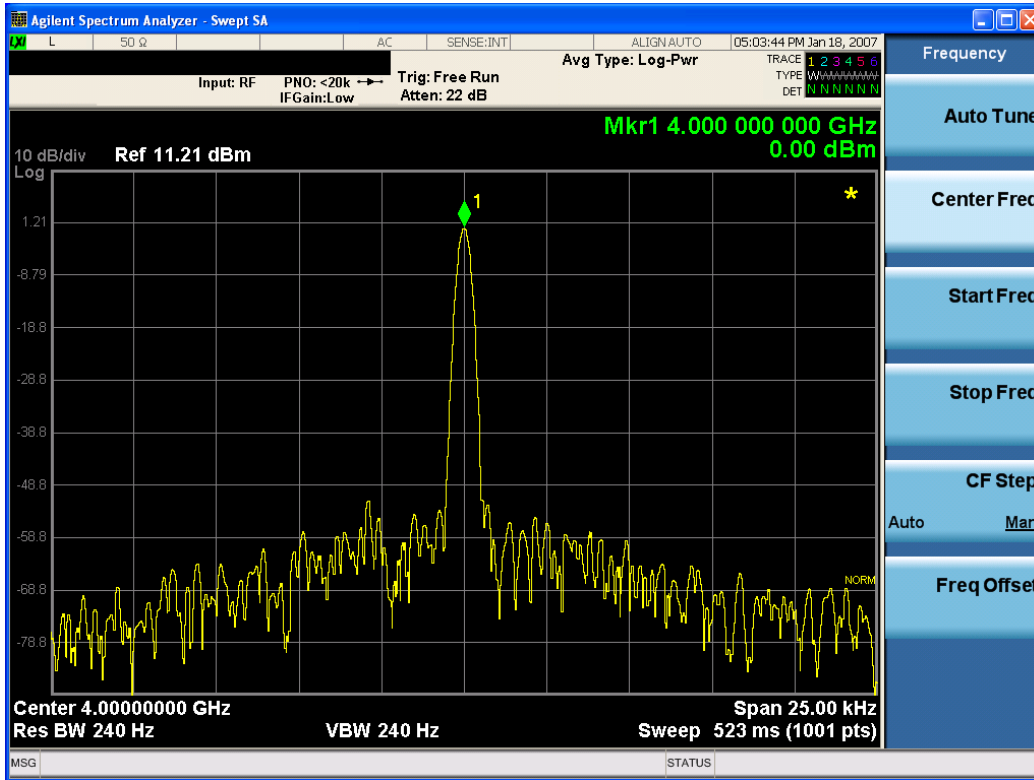

Key Path	View/Display, Display, Annotation
Remote Command	:DISPlay:ACTivefunc[:STATE] ON OFF 1 0 :DISPlay:ACTivefunc[:STATE]?
Example	DISP:ACT OFF
Dependencies	Grayed out and forced to OFF when System Display Settings, Annotation is set to Off.
Preset	On This should remain Off through a Preset when System DisplaySettings, Annotation is set to Off
State Saved	Saved in instrument state.
Initial S/W Revision	Prior to A.02.00

Title

Displays menu keys that enable you to change or clear a title on your display.

Key Path	View/Display, Display
Initial S/W Revision	Prior to A.02.00

Change Title

Writes a title into the "measurement name" field in the banner, for example, "Swept SA".

Press Change Title to enter a new title through the alpha editor. Press Enter or Return to complete the entry. Press ESC to cancel the entry and preserve your existing title.

The display title will replace the measurement name. It remains for this measurement until you press Change Title again, or you recall a state, or a Preset is performed. A title can also be cleared by pressing Title, Clear Title.

NOTE

Notice the inclusion of the <measurement> parameter in the command below. Because each measurement remembers the Display Title, the command must be qualified with the measurement name. For the Swept SA measurement this is not the case; no <measurement> parameter is used when changing the Display Title for the Swept SA measurement.

Key Path	View/Display, Display, Title
Mode	All
Remote Command	:DISPlay:<measurement>:ANNotation:TITLe:DATA <string> :DISPlay:<measurement>:ANNotation:TITLe:DATA?
Example	DISP:ANN:TITL:DATA "This Is My Title" This example is for the Swept SA measurement in the Spectrum Analyzer mode. The SANalyzer <measurement> name is not used. DISP:ACP:ANN:TITL:DATA "This Is My Title" This example is for Measurements other than Swept SA. Both set the title to: This Is My Title
Notes	Pressing this key cancels any active function. When a title is edited the previous title remains intact (it is not cleared) and the cursor goes at the end so that characters can be added or BKSP can be used to go back over previous characters.
Preset	No title (measurement name instead)
State Saved	Saved in instrument state.
Initial S/W Revision	Prior to A.02.00

Clear Title

Clears a title from the front-panel display. Once cleared, the title cannot be retrieved. After the title is cleared, the current Measurement Name replaces it in the title bar.

Key Path	View/Display, Display, Title
Example	The following commands clear the title and restore the measurement's original title: DISP:ANN:TITL:DATA "" This example is for the Swept SA measurement in the Spectrum Analyzer mode. The SANalyzer <measurement> name is not used. DISP:ACP:ANN:TITL:DATA "" This example is for ACP; in measurements other than Swept SA the measurement name is required.
Notes	Uses the :DISPlay:<measurement>:ANNotation:TITLe:DATA <string> command with an empty string (in the Swept SA, the <measurement> is omitted).
Preset	Performed on Preset.
Initial S/W Revision	Prior to A.02.00

Graticule

Pressing Graticule turns the display graticule On or Off. It also turns the graticule y-axis annotation on and off.

Key Path	View/Display, Display
Remote Command	:DISPlay:WINDow[1]:TRACe:GRATicule:GRID[:STATe] OFF ON 0 1 :DISPlay:WINDow[1]:TRACe:GRATicule:GRID[:STATe]?
Example	DISP:WIND:TRAC:GRAT:GRID OFF
Notes	The graticule is the set of horizontal and vertical lines that make up the grid/divisions for the x-axis and y-axis.
Preset	On
State Saved	Saved in instrument state
Initial S/W Revision	Prior to A.02.00

System Display Settings

These settings are "Mode Global" – they affect all modes and measurements and are reset only by Restore Misc Defaults or Restore System Defaults under System.

Key Path	View/Display, Display
Initial S/W Revision	Prior to A.02.00

Annotation Local Settings

This is a Mode Global override of the meas local annotation settings. When it is All Off, it forces ScreenAnnotation, Meas Bar, Trace, and Active Function Values settings to be OFF for all measurements in all modes. This provides the security based "annotation off" function of previous analyzers; hence it uses the legacy SCPI command.

When it is All Off, the Screen, Meas Bar, Trace, and Active Function Values keys under the Display, Annotation menu are grayed out and forced to Off. When Local Settings is selected, you are able to set the local annotation settings on a measurement by measurement basis.

Key Path	View/Display, Display, System Display Settings
Remote Command	:DISPlay:WINDow[1]:ANNOtation[:ALL] OFF ON 0 1 :DISPlay:WINDow[1]:ANNOtation[:ALL]?
Example	:DISP:WIND:ANN OFF
Preset	On (Set by Restore Misc Defaults)
State Saved	Not saved in instrument state.
Backwards Compatibility Notes	The WINDow parameter and optional subopcode is included for backwards compatibility but ignored – all windows are equally affected.
Initial S/W Revision	Prior to A.02.00

Themes

Accesses a menu of functions that enable you to choose the theme to be used when saving the screen image.

The **Themes** option is the same as the **Themes** option under the **Display** and **Page Setup** dialogs. It allows you to choose between themes to be used when saving the screen image.

Key Path	Save, Screen Image
Remote Command	:MMEMory:STORe:SCReen:THEMe TDColor TDMonochrome FCOlor FMONochrome :MMEMory:STORe:SCReen:THEMe?
Example	:MMEM:STOR:SCR:THEM TDM
Preset	3D Color; Is not part of Preset, but is reset by Restore Misc Defaults or Restore System Defaults All and survives subsequent running of the modes.
Readback	3D Color 3D Mono Flat Color Flat Mono
Backwards Compatibility Notes	In ESA and PSA we offer the choice of "Reverse Bitmap" or "Reverse Metafile" when saving screen images. This is much like the "Flat Color" theme available in X-Series. Also, if you selected Reverse Bitmap AND a black & white screen image, that would be much like "Flat Monochrome". In other words, each of the X-Series themes has a similar screen image type in ESA/PSA. But they are not identical.
Initial S/W Revision	Prior to A.02.00

3D Color

Selects a standard color theme with each object filled, shaded and colored as designed.

Key Path	Save, Screen Image, Themes
Example	MMEM:STOR:SCR:THEM TDC
Readback	3D Color
Initial S/W Revision	Prior to A.02.00

3D Monochrome

Selects a format that is like 3D color but shades of gray are used instead of colors.

Key Path	Save, Screen Image, Themes
Example	MMEM:STOR:SCR:THEM TDM
Readback	3D Mono
Initial S/W Revision	Prior to A.02.00

Flat Color

Selects a format that is best when the screen is to be printed on an ink printer.

Key Path	Save, Screen Image, Themes
Example	MMEM:STOR:SCR:THEM FCOL
Readback	Flat Color
Initial S/W Revision	Prior to A.02.00

Flat Monochrome

Selects a format that is like Flat Color. But only black is used (no colors, not even gray), and no fill.

Key Path	Save, Screen Image, Themes
Example	MMEM:STOR:SCR:THEM FMON
Readback	Flat Mono
Initial S/W Revision	Prior to A.02.00

Backlight

Accesses the display backlight on/off keys. This setting may interact with settings under the Windows "Power" menu.

When the backlight is off, pressing ESC, TAB, SPACE, ENTER, UP, DOWN, LEFT, RIGHT, DEL, BKSP, CTRL, or ALT turns the backlight on without affecting the application. Pressing any other key will turn backlight on and could potentially perform the action as well.

Key Path	View/Display, Display, System Display Settings
Remote Command	:DISPlay:BACKlight ON OFF :DISPlay:BACKlight?
Preset	ON (Set by Restore Misc Defaults)
Initial S/W Revision	Prior to A.02.00

Backlight Intensity

An active function used to set the backlight intensity. It goes from 0 to 100 where 100 is full on and 0 is off. This value is independent of the values set under the Backlight on/off key.

Key Path	View/Display, Display, System Display Settings
Remote Command	:DISPlay:BACKlight:INTensity <integer> :DISPlay:BACKlight:INTensity?
Example	DISP:BACK:INT 50

Preset	100 (Set by Restore Misc Defaults)
Min	0
Max	100
Initial S/W Revision	Prior to A.02.00

Bar Graph

Turns the Bar Graph On and Off.

Key Path	View/Display
Mode	SA, WCDMA, C2K, WIMAX OFDMA, TD-SCDMA, 1xEVDO, DVB-T/H, DTMB (CTTB), ISDB-T, CMMB, LTE, LTE-TDD, Digital Cable TV, MSR, LTEAFDD, LTEATDD
Remote Command	:DISPlay:ACPower:VIEW[1]:WINDow[1]:BGRaph OFF ON 0 1 :DISPlay:ACPower:VIEW[1]:WINDow[1]:BGRaph?
Example	DISP:ACP:VIEW:WIND:BGR OFF DISP:ACP:VIEW:WIND:BGR?
Notes	You must be in the mode that includes ACP measurements to use this command. Use :INSTrument:SElect to set the mode.
Dependencies	When the method is RBW, this key is always set to On and grayed out.
Preset	ON
State Saved	Saved in instrument state.
Range	On Off
Initial S/W Revision	Prior to A.02.00
Modified at S/W Revision	A.02.00, A.03.00

10 Spectrum Emission Mask Measurement

The spectrum emission mask measures spurious signal levels in up to six pairs of offset frequencies and relates them to the carrier power. For measurement results and views, see ["View/Display" on page 1062](#).

This topic contains the following sections:

["Measurement Commands for Spectrum Emission Mask" on page 854](#)

["Remote Command Results for Spectrum Emission Mask Measurement" on page 855](#)

["Number of Offsets" on page 875](#)

Measurement Commands for Spectrum Emission Mask

Offsets that are turned off (inactive) return -999.0 when their results are queried via SCPI.

```
:CONFigure:SEMask  
:CONFigure:SEMask:NDEFault  
:INITiate:SEMask  
:FETCh:SEMask[n]?  
:MEASure:SEMask[n]?  
:READ:SEMask[n]?
```

For more measurement related commands, see the SENSE subsystem, and the section "[Remote Measurement Functions](#)" on page 2205.

Remote Command Results for Spectrum Emission Mask Measurement

The following table describes the results returned by the FETCh, MEASure, and READ queries listed above, according to the index value n:

Modes	n	Return Value
All except MSR, WLAN, LTEAFDD, LTEATDD	1	<p>Meas Type: Total Power Reference</p> <p>Returns 82 comma-separated scalar results, in the following order:</p> <ol style="list-style-type: none"> 1. Reserved for the future use, returns -999.0 2. Absolute power at the center frequency (reference) area (dBm) 3. Reserved for the future use, returns -999.0 4. Reserved for the future use, returns -999.0 5. Peak frequency in the center frequency (reference) area (Hz) 6. Reserved for the future use, returns -999.0 7. Reserved for the future use, returns -999.0 8. Reserved for the future use, returns -999.0 9. Reserved for the future use, returns -999.0 10. Reserved for the future use, returns -999.0 11. Relative integrated power on the negative offset A (dBc) 12. Absolute integrated power on the negative offset A (dBm) 13. Relative peak power on the negative offset A (dBc) 14. Absolute peak power on the negative offset A (dBm) 15. Peak power offset frequency from the center or carrier edge frequency in the negative offset A, depending on Offset Frequency Define settings (Hz) 16. Relative integrated power on the positive offset A (dBc) 17. Absolute integrated power on the positive offset A (dBm) 18. Relative peak power on the positive offset A (dBc) 19. Absolute peak power on the positive offset A (dBm) 20. Peak power offset frequency from the center or carrier edge frequency in the positive offset A, depending on Offset Frequency Define settings (Hz) 21. Relative integrated power on the negative offset B (dBc) --- 69. Absolute peak power on the positive offset F (dBm) 70. Peak power offset frequency from the center or carrier edge frequency in the positive offset F, depending on Offset Frequency Define settings (Hz) 71. Minimum margin from limit line on the negative offset A (dB) 72. Minimum margin from limit line on the positive offset A (dB) 73. Minimum margin from limit line on the negative offset B (dB) 74. Minimum margin from limit line on the positive offset B (dB) 75. Minimum margin from limit line on the negative offset C (dB) 76. Minimum margin from limit line on the positive offset C (dB)

Modes	n	Return Value
		77. Minimum margin from limit line on the negative offset D (dB) 78. Minimum margin from limit line on the positive offset D (dB) 79. Minimum margin from limit line on the negative offset E (dB) 80. Minimum margin from limit line on the positive offset E (dB) 81. Minimum margin from limit line on the negative offset F (dB) 82. Minimum margin from limit line on the positive offset F (dB)
All except MSR, WLAN, LTEAFDD, LTEATDD	1	Meas Type: Power Spectral Density Reference Returns 82 comma-separated scalar results, in the following order: 1. Reserved for the future use, returns -999.0 2. Absolute power at the center frequency (reference) area (dBm/Hz) 3. Reserved for the future use, returns -999.0 4. Reserved for the future use, returns -999.0 5. Peak frequency in the center frequency (reference) area (Hz) 6. Reserved for the future use, returns -999.0 7. Reserved for the future use, returns -999.0 8. Reserved for the future use, returns -999.0 9. Reserved for the future use, returns -999.0 10. Reserved for the future use, returns -999.0 11. Relative integrated power on the negative offset A (dB) 12. Absolute integrated power on the negative offset A (dBm/Hz) 13. Relative peak power on the negative offset A (dB) 14. Absolute peak power on the negative offset A (dBm/Hz) 15. Peak power offset frequency from the center or carrier edge frequency in the negative offset A, depending on Offset Frequency Define settings (Hz) 16. Relative integrated power on the positive offset A (dB) 17. Absolute integrated power on the positive offset A (dBm/Hz) 18. Relative peak power on the positive offset A (dB) 19. Absolute peak power on the positive offset A (dBm/Hz) 20. Peak power offset frequency from the center or carrier edge frequency in the positive offset A, depending on Offset Frequency Define settings (Hz) 21. Relative integrated power on the negative offset B (dB) --- 69. Absolute peak power on the positive offset F (dBm/Hz) 70. Peak power offset frequency from the center or carrier edge frequency in the positive offset F, depending on Offset Frequency Define settings (Hz) 71. Minimum margin from limit line on the negative offset A (dB) 72. Minimum margin from limit line on the positive offset A (dB) 73. Minimum margin from limit line on the negative offset B (dB) 74. Minimum margin from limit line on the positive offset B (dB)

Modes	n	Return Value
		75. Minimum margin from limit line on the negative offset C (dB)
		76. Minimum margin from limit line on the positive offset C (dB)
		77. Minimum margin from limit line on the negative offset D (dB)
		78. Minimum margin from limit line on the positive offset D (dB)
		79. Minimum margin from limit line on the negative offset E (dB)
		80. Minimum margin from limit line on the positive offset E (dB)
		81. Minimum margin from limit line on the negative offset F (dB)
		82. Minimum margin from limit line on the positive offset F (dB)
All except MSR, WLAN, LTEAFDD, LTEATDD	1	<p>Meas Type: Spectrum Peak Reference Returns 82 comma-separated scalar results, in the following order:</p> <ol style="list-style-type: none"> 1. Reserved for the future use, returns -999.0 2. Peak power at the center frequency (reference) area (dBm) 3. Reserved for the future use, returns -999.0 4. Reserved for the future use, returns -999.0 5. Peak frequency in the center frequency (reference) area (Hz) 6. Reserved for the future use, returns -999.0 7. Reserved for the future use, returns -999.0 8. Reserved for the future use, returns -999.0 9. Reserved for the future use, returns -999.0 10. Reserved for the future use, returns -999.0 11. Reserved for the future use, returns -999.0 12. Reserved for the future use, returns -999.0 13. Relative peak power on the negative offset A (dB) 14. Absolute peak power on the negative offset A (dBm) 15. Peak power offset frequency from the center or carrier edge frequency in the negative offset A, depending on Offset Frequency Define settings (Hz) 16. Reserved for the future use, returns -999.0 17. Reserved for the future use, returns -999.0 18. Relative peak power on the positive offset A (dB) 19. Absolute peak power on the positive offset A (dBm) 20. Peak power offset frequency from the center or carrier edge frequency in the positive offset A, depending on Offset Frequency Define settings (Hz) 21. Reserved for the future use, returns -999.0 --- 69. Absolute peak power on the positive offset F (dBm) 70. Peak power offset frequency from the center or carrier edge frequency in the positive offset F, depending on Offset Frequency Define settings (Hz) 71. Minimum margin from limit line on the negative offset A (dB) 72. Minimum margin from limit line on the positive offset A (dB)

Modes	n	Return Value
		73. Minimum margin from limit line on the negative offset B (dB) 74. Minimum margin from limit line on the positive offset B (dB) 75. Minimum margin from limit line on the negative offset C (dB) 76. Minimum margin from limit line on the positive offset C (dB) 77. Minimum margin from limit line on the negative offset D (dB) 78. Minimum margin from limit line on the positive offset D (dB) 79. Minimum margin from limit line on the negative offset E (dB) 80. Minimum margin from limit line on the positive offset E (dB) 81. Minimum margin from limit line on the negative offset F (dB) 82. Minimum margin from limit line on the positive offset F (dB)
MSR, LTEAFDD, LTEATDD	1	<p data-bbox="467 730 818 758">Meas Type: Total Power Reference</p> <p data-bbox="467 758 1419 821">Returns outer offset results when Non-Contiguous Meas Region is set to Outer, and returns inner offset results when it is set to Inner, in the following order.</p> <ol data-bbox="467 831 1419 1843" style="list-style-type: none"> <li data-bbox="467 831 1360 894">1. Total Absolute power of carriers of Measure Carrier On if available. Otherwise -999.0 is returned. <li data-bbox="467 905 1419 999">2. Absolute reference power. Absolute power at the left reference carrier if Power Ref type is "Left & Right Carriers." Absolute power at the reference carrier of the left sub-block if Power Ref type is "Max Power Carrier in Sub-block." (dBm) <li data-bbox="467 1010 1419 1104">3. Absolute power at the right reference carrier if Power Ref type is "Left & Right Carriers." Absolute power at the reference carrier of the right sub-block if Power Ref type is "Max Power Carrier in Sub-block." Otherwise -999.0 is returned. (dBm) <li data-bbox="467 1115 919 1142">4. Reserved for the future use, returns -999.0 <li data-bbox="467 1152 1419 1268">5. Peak frequency in the ref carrier channel spacing frequency range. Peak frequency in the left ref carrier frequency range if Power Ref Type is "Left & Right Carriers." Peak frequency in the ref carrier frequency range of the left sub-block if Power Ref type is "Max Power Carrier in Sub-block." <li data-bbox="467 1278 1419 1373">6. Peak frequency in the right ref carrier channel spacing frequency range if Power Ref type is "Left & Right Carriers." Peak frequency in the ref carrier frequency range of the right sub-block if Power Ref type is "Max Power Carrier in Sub-block." Otherwise -999.0 is returned. <li data-bbox="467 1383 919 1411">7. Reserved for the future use, returns -999.0 <li data-bbox="467 1421 919 1449">8. Reserved for the future use, returns -999.0 <li data-bbox="467 1459 919 1486">9. Reserved for the future use, returns -999.0 <li data-bbox="467 1497 932 1524">10. Reserved for the future use, returns -999.0 <li data-bbox="467 1535 1057 1562">11. Relative integrated power on the negative offset A (dBc) <li data-bbox="467 1572 1070 1600">12. Absolute integrated power on the negative offset A (dBm) <li data-bbox="467 1610 1003 1638">13. Relative peak power on the negative offset A (dBc) <li data-bbox="467 1648 1016 1675">14. Absolute peak power on the negative offset A (dBm) <li data-bbox="467 1686 1419 1749">15. Peak power offset frequency from the center or carrier edge frequency in the negative offset A, depending on Offset Frequency Define settings (Hz) <li data-bbox="467 1759 1049 1787">16. Relative integrated power on the positive offset A (dBc) <li data-bbox="467 1797 1062 1824">17. Absolute integrated power on the positive offset A (dBm)

Modes	n	Return Value
		18. Relative peak power on the positive offset A (dBc)
		19. Absolute peak power on the positive offset A (dBm)
		20. Peak power offset frequency from the center or carrier edge frequency in the positive offset A, depending on Offset Frequency Define settings (Hz)
		21. Relative integrated power on the negative offset B (dBc)

		69. Absolute peak power on the positive offset F (dBm)
		70. Peak power offset frequency from the center or carrier edge frequency in the positive offset F, depending on Offset Frequency Define settings (Hz)
		71. Minimum margin from limit line on the negative offset A (dB)
		72. Minimum margin from limit line on the positive offset A (dB)
		73. Minimum margin from limit line on the negative offset B (dB)
		74. Minimum margin from limit line on the positive offset B (dB)
		75. Minimum margin from limit line on the negative offset C (dB)
		76. Minimum margin from limit line on the positive offset C (dB)
		77. Minimum margin from limit line on the negative offset D (dB)
		78. Minimum margin from limit line on the positive offset D (dB)
		79. Minimum margin from limit line on the negative offset E (dB)
		80. Minimum margin from limit line on the positive offset E (dB)
		81. Minimum margin from limit line on the negative offset F (dB)
		82. Minimum margin from limit line on the positive offset F (dB)
MSR , LTEAFDD, LTEATDD	1	<p>Meas Type: Power Spectral Density Reference Returns outer offset results when Non-Contiguous Meas Region is set to Outer, and returns inner offset results when it is set to Inner, in the following order.</p> <ol style="list-style-type: none"> 1. Total Absolute power of carriers of Measure Carrier On if available. Otherwise -999.0 is returned. (dBm) 2. Absolute reference power. Absolute power at the left reference carrier if Power Ref type is "Left & Right Carriers." Absolute power at the reference carrier of the left sub-block if Power Ref type is "Max Power Carrier in Sub-block." (dBm/Hz) 3. Absolute power at the right reference carrier if Power Ref type is "Left & Right Carriers." Absolute power at the reference carrier of the right sub-block if Power Ref type is "Max Power Carrier in Sub-block." Otherwise -999.0 is returned. (dBm/Hz) 4. Reserved for the future use, returns -999.0 5. Peak frequency in the ref carrier channel spacing frequency range . Peak frequency in the left ref carrier frequency range if Power Ref type is "Left & Right Carriers." Peak frequency in the ref carrier frequency range of the left sub-block if Power Ref type is "Max Power Carrier in Sub-block." 6. Peak frequency in the right ref carrier channel spacing frequency range if Power Ref type is "Left & Right Carriers." Peak frequency in the ref carrier frequency range of the right sub-block if Power Ref type is "Max Power Carrier in Sub-block." Otherwise -999.0 is returned. 7. Reserved for the future use, returns -999.0

Modes	n	Return Value
		8. Reserved for the future use, returns -999.0
		9. Reserved for the future use, returns -999.0
		10. Reserved for the future use, returns -999.0
		11. Relative integrated power on the negative offset A (dBc)
		12. Absolute integrated power on the negative offset A (dBm/Hz)
		13. Relative peak power on the negative offset A (dBc)
		14. Absolute peak power on the negative offset A (dBm/Hz)
		15. Peak power offset frequency from the center or carrier edge frequency in the negative offset A, depending on Offset Frequency Define settings (Hz)
		16. Relative integrated power on the positive offset A (dBc)
		17. Absolute integrated power on the positive offset A (dBm/Hz)
		18. Relative peak power on the positive offset A (dBc)
		19. Absolute peak power on the positive offset A (dBm/Hz)
		20. Peak power offset frequency from the center or carrier edge frequency in the positive offset A, depending on Offset Frequency Define settings (Hz)
		21. Relative integrated power on the negative offset B (dBc)

		69. Absolute peak power on the positive offset F (dBm/Hz)
		70. Peak power offset frequency from the center or carrier edge frequency in the positive offset F, depending on Offset Frequency Define settings (Hz)
		71. Minimum margin from limit line on the negative offset A (dB)
		72. Minimum margin from limit line on the positive offset A (dB)
		73. Minimum margin from limit line on the negative offset B (dB)
		74. Minimum margin from limit line on the positive offset B (dB)
		75. Minimum margin from limit line on the negative offset C (dB)
		76. Minimum margin from limit line on the positive offset C (dB)
		77. Minimum margin from limit line on the negative offset D (dB)
		78. Minimum margin from limit line on the positive offset D (dB)
		79. Minimum margin from limit line on the negative offset E (dB)
		80. Minimum margin from limit line on the positive offset E (dB)
		81. Minimum margin from limit line on the negative offset F (dB)
		82. Minimum margin from limit line on the positive offset F (dB)
MSR, LTEAFDD, LTEATDD	1	<p>Meas Type: Spectrum Peak Reference</p> <p>Returns outer offset results when Non-Contiguous Meas Region is set to Outer, and returns inner offset results when it is set to Inner, in the following order.</p> <ol style="list-style-type: none"> 1. Total Absolute power of carriers of Measure Carrier On if available. Otherwise -999.0 is returned. (dBm) 2. Peak reference power. Peak power at the left reference carrier if Power Ref type is "Left & Right Carriers." Peak power at the reference carrier of the left sub-block if Power Ref type is "Max Power Carrier in Sub-block." (dBm)

Modes	n	Return Value
		3. Peak power at the right reference carrier if Power Ref type is "Left & Right Carriers." Peak power at the reference carrier of the right sub-block if Power Ref type is "Max Power Carrier in Sub-block." Otherwise -999.0 is returned. (dBm)
		4. Reserved for the future use, returns -999.0
		5. Peak frequency in the ref carrier channel spacing frequency range. Peak frequency in the left ref carrier frequency range if Power Ref type is "Left & Right Carriers." Peak frequency in the ref carrier frequency range of the left sub-block if Power Ref type is "Max Power Carrier in Sub-block."
		6. Peak frequency in the right ref carrier channel spacing frequency range if Power Ref type is "Left & Right Carriers." Peak frequency in the ref carrier frequency range of the right sub-block if Power Ref type is "Max Power Carrier in Sub-block." Otherwise -999.0 is returned.
		7. Reserved for the future use, returns -999.0
		8. Reserved for the future use, returns -999.0
		9. Reserved for the future use, returns -999.0
		10. Reserved for the future use, returns -999.0
		11. Relative integrated power on the negative offset A (dBc)
		12. Absolute integrated power on the negative offset A (dBm)
		13. Relative peak power on the negative offset A (dBc)
		14. Absolute peak power on the negative offset A (dBm)
		15. Peak power offset frequency from the center or carrier edge frequency in the negative offset A, depending on Offset Frequency Define settings (Hz)
		16. Relative integrated power on the positive offset A (dBc)
		17. Absolute integrated power on the positive offset A (dBm)
		18. Relative peak power on the positive offset A (dBc)
		19. Absolute peak power on the positive offset A (dBm)
		20. Peak power offset frequency from the center or carrier edge frequency in the positive offset A, depending on Offset Frequency Define settings (Hz)
		21. Relative integrated power on the negative offset B (dBc)

		69. Absolute peak power on the positive offset F (dBm)
		70. Peak power offset frequency from the center or carrier edge frequency in the positive offset F, depending on Offset Frequency Define settings (Hz)
		71. Minimum margin from limit line on the negative offset A (dB)
		72. Minimum margin from limit line on the positive offset A (dB)
		73. Minimum margin from limit line on the negative offset B (dB)
		74. Minimum margin from limit line on the positive offset B (dB)
		75. Minimum margin from limit line on the negative offset C (dB)
		76. Minimum margin from limit line on the positive offset C (dB)
		77. Minimum margin from limit line on the negative offset D (dB)
		78. Minimum margin from limit line on the positive offset D (dB)
		79. Minimum margin from limit line on the negative offset E (dB)
		80. Minimum margin from limit line on the positive offset E (dB)

Modes	n	Return Value
		81. Minimum margin from limit line on the negative offset F (dB)
		82. Minimum margin from limit line on the positive offset F (dB)
WLAN, with radio standard 802.11 ac (80 MHz + 80 MHz)	1	<p>Meas Type: Total Power Reference Returns 82 comma-separated scalar results, in the following order:</p> <ol style="list-style-type: none"> 1. Reserved for the future use, returns -999.0 2. Absolute reference power (dBm) 3. Absolute power of the carrier of which the frequency is indicated by Freq Segment 1 (dBm) 4. Absolute power of the carrier of which the frequency is indicated by Freq Segment 2 (dBm) 5. Peak frequency in the center frequency (reference) area (Hz) 6. Reserved for the future use, returns -999.0 7. Reserved for the future use, returns -999.0 8. Reserved for the future use, returns -999.0 9. Reserved for the future use, returns -999.0 10. Reserved for the future use, returns -999.0 11. Relative integrated power on the negative offset A (dBc) 12. Absolute integrated power on the negative offset A (dBm) 13. Relative peak power on the negative offset A (dBc) 14. Absolute peak power on the negative offset A (dBm) 15. Peak power offset frequency from the center or carrier edge frequency in the negative offset A, depending on Offset Frequency Define settings (Hz) 16. Relative integrated power on the positive offset A (dBc) 17. Absolute integrated power on the positive offset A (dBm) 18. Relative peak power on the positive offset A (dBc) 19. Absolute peak power on the positive offset A (dBm) 20. Peak power offset frequency from the center or carrier edge frequency in the positive offset A, depending on Offset Frequency Define settings (Hz) 21. Relative integrated power on the negative offset B (dBc) <p>---</p> <ol style="list-style-type: none"> 69. Absolute peak power on the positive offset F (dBm) 70. Peak power offset frequency from the center or carrier edge frequency in the positive offset F, depending on Offset Frequency Define settings (Hz) 71. Minimum margin from limit line on the negative offset A (dB) 72. Minimum margin from limit line on the positive offset A (dB) 73. Minimum margin from limit line on the negative offset B (dB) 74. Minimum margin from limit line on the positive offset B (dB) 75. Minimum margin from limit line on the negative offset C (dB) 76. Minimum margin from limit line on the positive offset C (dB) 77. Minimum margin from limit line on the negative offset D (dB) 78. Minimum margin from limit line on the positive offset D (dB)

Modes	n	Return Value
		79. Minimum margin from limit line on the negative offset E (dB)
		80. Minimum margin from limit line on the positive offset E (dB)
		81. Minimum margin from limit line on the negative offset F (dB)
		82. Minimum margin from limit line on the positive offset F (dB)
WLAN, with radio standard 802.11 ac (80 MHz + 80 MHz)	1	<p>Meas Type: Power Spectral Density Reference Returns 82 comma-separated scalar results, in the following order:</p> <ol style="list-style-type: none"> 1. Reserved for the future use, returns -999.0 2. Absolute reference power (dBm/Hz) 3. Absolute power of the carrier of which the frequency is indicated by Freq Segment 1 (dBm/Hz) 4. Absolute power of the carrier of which the frequency is indicated by Freq Segment 2 (dBm/Hz) 5. Peak frequency in the center frequency (reference) area (Hz) 6. Reserved for the future use, returns -999.0 7. Reserved for the future use, returns -999.0 8. Reserved for the future use, returns -999.0 9. Reserved for the future use, returns -999.0 10. Reserved for the future use, returns -999.0 11. Relative integrated power on the negative offset A (dB) 12. Absolute integrated power on the negative offset A (dBm/Hz) 13. Relative peak power on the negative offset A (dB) 14. Absolute peak power on the negative offset A (dBm/Hz) 15. Peak power offset frequency from the center or carrier edge frequency in the negative offset A, depending on Offset Frequency Define settings (Hz) 16. Relative integrated power on the positive offset A (dB) 17. Absolute integrated power on the positive offset A (dBm/Hz) 18. Relative peak power on the positive offset A (dB) 19. Absolute peak power on the positive offset A (dBm/Hz) 20. Peak power offset frequency from the center or carrier edge frequency in the positive offset A, depending on Offset Frequency Define settings (Hz) 21. Relative integrated power on the negative offset B (dB) --- 69. Absolute peak power on the positive offset F (dBm/Hz) 70. Peak power offset frequency from the center or carrier edge frequency in the positive offset F, depending on Offset Frequency Define settings (Hz) 71. Minimum margin from limit line on the negative offset A (dB) 72. Minimum margin from limit line on the positive offset A (dB) 73. Minimum margin from limit line on the negative offset B (dB) 74. Minimum margin from limit line on the positive offset B (dB) 75. Minimum margin from limit line on the negative offset C (dB) 76. Minimum margin from limit line on the positive offset C (dB)

Modes	n	Return Value
		77. Minimum margin from limit line on the negative offset D (dB) 78. Minimum margin from limit line on the positive offset D (dB) 79. Minimum margin from limit line on the negative offset E (dB) 80. Minimum margin from limit line on the positive offset E (dB) 81. Minimum margin from limit line on the negative offset F (dB) 82. Minimum margin from limit line on the positive offset F (dB)
All	2	Returns the displayed frequency domain spectrum trace data separated by comma. The number of data points is 2001.
All	3	Returns the displayed frequency domain absolute limit trace data separated by comma. The number of data points is 2001.
All	4	Returns the displayed frequency domain relative limit trace data separated by comma. The number of data points is 2001.
All (see details)	5	<p>Meas Type: Total Power Reference Returns comma-separated scalar values (in dBm) of the absolute integrated power of the segment frequencies. The length of the result depends on the number of available offset (See "Number of Offsets" on page 875).</p> <ol style="list-style-type: none"> 1. Total power reference (dBm) 2. Reserved for the future use, returns -999.0 3. Absolute integrated power at negative offset frequency (A) 4. Absolute integrated power at positive offset frequency (A) <p>---</p> <ol style="list-style-type: none"> 25. Absolute integrated power at negative offset frequency (L) 26. Absolute integrated power at positive offset frequency (L) <p>In MSR and LTE-Advanced FDD/TDD mode. Returns outer offset results when Non-Contiguous Meas Region is set to Outer, and returns inner offset results when it is set to Inner, in the following order.</p> <ol style="list-style-type: none"> 1. Ref carrier power. Left ref carrier power if Power Ref type is "Left & Right Carriers." Ref carrier power of the left sub-block if Power Ref type is "Max Power Carrier in Sub-block." (dBm) 2. Right ref carrier power if Ref channel type is "Left & Right Carriers." Ref carrier power of the right sub-block if Power Ref type is "Max Power Carrier in Sub-block." Otherwise -999.0 is returned. (dBm) 3. Absolute integrated power at negative offset frequency (A) 4. Absolute integrated power at positive offset frequency (A) <p>---</p> <ol style="list-style-type: none"> 25. Absolute integrated power at negative offset frequency (L) 26. Absolute integrated power at positive offset frequency (L) <p>In WLAN mode. Returns 26 comma-separated scalar values (in dBm) of the absolute integrated power of the segment frequencies:</p> <ol style="list-style-type: none"> 1. Ref carrier power (dBm) 2. Reserved for the future use, returns -999.0

Modes	n	Return Value
		3. Absolute integrated power at negative offset frequency (A) 4. Absolute integrated power at positive offset frequency (A) --- 25. Absolute integrated power at negative offset frequency (L) 26. Absolute integrated power at positive offset frequency (L) If the result is not available, -999.0 is returned. The number of values returned is subject to change in future releases.
All (see details)	5	<p data-bbox="488 611 959 638">Meas Type: Power Spectral Density Reference</p> <p data-bbox="488 642 1398 732">Returns comma-separated scalar values (in dBm/Hz) of the absolute integrated power of the segment frequencies. The length of the result depends on the number of available offset (See "Number of Offsets" on page 875).</p> <p data-bbox="488 743 1084 890">1. Power spectral density reference (dBm/Hz) 2. Reserved for the future use, returns -999.0 3. Absolute integrated power at negative offset frequency (A) 4. Absolute integrated power at positive offset frequency (A) ---</p> <p data-bbox="488 942 1094 1010">25. Absolute integrated power at negative offset frequency (L) 26. Absolute integrated power at positive offset frequency (L)</p> <p data-bbox="488 1020 919 1047">In MSR and LTE-Advanced FDD/TDD mode.</p> <p data-bbox="488 1058 1438 1125">Returns outer offset results when Non-Contiguous Meas Region is set to Outer, and returns inner offset results when it is set to Inner, in the following order.</p> <p data-bbox="488 1136 1433 1297">1. Ref carrier power. Left ref carrier power if Power Ref type is "Left & Right Carriers" Ref carrier power of the left sub-block if Power Ref type is "Max Power Carrier in Sub-block." (dBm/Hz) 2. Right ref carrier power if Power Ref type is "Left & Right Carriers." Ref carrier power of the right sub-block if Power Ref type is "Max Power Carrier in Sub-block." Otherwise -999.0 is returned. (dBm/Hz) 3. Absolute integrated power at negative offset frequency (A) 4. Absolute integrated power at positive offset frequency (A) ---</p> <p data-bbox="488 1430 1094 1497">25. Absolute integrated power at negative offset frequency (L) 26. Absolute integrated power at positive offset frequency (L)</p> <p data-bbox="488 1507 643 1535">In WLAN mode.</p> <p data-bbox="488 1545 1433 1612">Returns 26 comma-separated scalar values (in dBm/Hz) of the absolute integrated power of the segment frequencies:</p> <p data-bbox="488 1623 1084 1770">1. Ref carrier power (dBm/Hz) 2. Reserved for the future use, returns -999.0 3. Absolute integrated power at negative offset frequency (A) 4. Absolute integrated power at positive offset frequency (A) ---</p> <p data-bbox="488 1818 1094 1845">25. Absolute integrated power at negative offset frequency (L)</p>

Modes	n	Return Value
		<p>26. Absolute integrated power at positive offset frequency (L)</p> <p>If the result is not available, -999.0 is returned.</p> <p>The number of values returned is subject to change in future releases.</p>
All (see details)	5	<p>Meas Type: Spectrum Peak Reference</p> <p>Returns comma-separated scalar values (in dBm) of the absolute peak power of the segment frequencies. The length of the result depends on the number of available offset (See "Number of Offsets" on page 875).</p> <ol style="list-style-type: none"> 1. Spectrum Peak Power reference (dBm) 2. Reserved for the future use, returns -999.0 3. Absolute peak power at negative offset frequency (A) 4. Absolute peak power at positive offset frequency (A) <p>---</p> <p>25. Absolute peak power at negative offset frequency (L)</p> <p>26. Absolute peak power at positive offset frequency (L)</p> <p>In MSR and LTE-Advanced FDD/TDD mode.</p> <p>Returns outer offset results when Non-Contiguous Meas Region is set to Outer, and returns inner offset results when it is set to Inner, in the following order.</p> <ol style="list-style-type: none"> 1. Spectrum Peak Power reference of ref carrier. Spectrum Peak Power reference of left ref carrier if Power Ref type is "Left & Right Carriers." Spectrum Peak Power reference of the left sub-block if Power Ref type is "Max Power Carrier in Sub-block." (dBm) 2. Spectrum Peak Power reference of right ref carrier power if Power Ref type is "Left & Right carriers." Spectrum Peak Power reference of the right sub-block if Power Ref type is "Max Power Carrier in Sub-block." Otherwise -999.0 is returned. (dBm) 3. Absolute peak power at negative offset frequency (A) 4. Absolute peak power at positive offset frequency (A) <p>---</p> <p>25. Absolute peak power at negative offset frequency (L)</p> <p>26. Absolute peak power at positive offset frequency (L)</p> <p>If the result is not available, -999.0 is returned.</p> <p>The number of values returned is subject to change in future releases.</p>
All	6	<p>Meas Type: Total Power Reference</p> <p>Returns comma-separated scalar values (in dBc) of the integrated power relative to the carrier at the segment frequencies. The length of the result depends on the number of available offset (See "Number of Offsets" on page 875).</p> <p>When in the MSR and LTE-Advanced FDD/TDD mode, returns outer offset results when Non-Contiguous Meas Region is set to Outer, and returns inner offset results when it is set to Inner, in the following order.</p> <ol style="list-style-type: none"> 1. Reserved for the future use, returns -999.0 2. Reserved for the future use, returns -999.0 3. Relative integrated power at negative offset frequency (A)

Modes	n	Return Value
		<p>4. Relative integrated power at positive offset frequency (A)</p> <p>---</p> <p>25. Relative integrated power at negative offset frequency (L)</p> <p>26. Relative integrated power at positive offset frequency (L)</p> <p>If the result is not available, -999.0 is returned.</p> <p>The number of values returned is subject to change in future releases.</p>
All	6	<p>Meas Type: Power Spectral Density Reference</p> <p>Returns comma-separated scalar values (in dBc/Hz) of the integrated power relative to the carrier at the segment frequencies. The length of the result depends on the number of available offset (See "Number of Offsets" on page 875).</p> <p>When in the MSR and LTE-Advanced FDD/TDD mode, returns outer offset results when Non-Contiguous Meas Region is set to Outer, and returns inner offset results when it is set to Inner, in the following order.</p> <p>Returns -999.0 for the offsets if in WLAN:</p> <ol style="list-style-type: none"> 1. Reserved for the future use, returns -999.0 2. Reserved for the future use, returns -999.0 3. Relative integrated power at negative offset frequency (A) 4. Relative integrated power at positive offset frequency (A) <p>---</p> <p>25. Relative integrated power at negative offset frequency (L)</p> <p>26. Relative integrated power at positive offset frequency (L)</p> <p>If the result is not available, -999.0 is returned.</p> <p>The number of values returned is subject to change in future releases.</p>
All	6	<p>Meas Type: Spectrum Peak Reference</p> <p>Returns comma-separated scalar values (in dB) of the integrated power relative to the carrier at the segment frequencies. The length of the result depends on the number of available offset (See "Number of Offsets" on page 875).</p> <p>When in the MSR and LTE-Advanced FDD/TDD mode, returns outer offset results when Non-Contiguous Meas Region is set to Outer, and returns inner offset results when it is set to Inner, in the following order.</p> <ol style="list-style-type: none"> 1. Reserved for the future use, returns -999.0 2. Reserved for the future use, returns -999.0 3. Relative peak power at negative offset frequency (A) 4. Relative peak power at positive offset frequency (A) <p>---</p> <p>25. Relative peak power at negative offset frequency (L)</p> <p>26. Relative peak power at positive offset frequency (L)</p> <p>If the result is not available, -999.0 is returned.</p> <p>The number of values returned is subject to change in future releases.</p>
All	7	

Modes	n	Return Value
		<p>Returns comma-separated pass/fail test results (0=passed, or 1=failed) determined by testing the minimum margin point from the limit line that is determined each offset's Limits setting. The length of the result depends on the number of available offset (See "Number of Offsets" on page 875).</p> <p>When in the MSR and LTE-Advanced FDD/TDD mode, returns outer offset results when Non-Contiguous Meas Region is set to Outer, and returns inner offset results when it is set to Inner, in the following order.</p> <ol style="list-style-type: none"> 1. Reserved for the future use, returns -999.0 2. Reserved for the future use, returns -999.0 3. At negative offset frequency (A) 4. At positive offset frequency (A) --- 25. At negative offset frequency (L) 26. At positive offset frequency (L) <p>The number of values returned is subject to change in future releases.</p>
All	8	<p>Offset Pass/Fail.</p> <p>Returns comma-separated pass/fail test results (0=passed, or 1=failed) determined by testing the minimum margin point from the limit line that is determined each offset's Limits setting. The length of the result depends on the number of available offset (See "Number of Offsets" on page 875).</p> <p>When in the MSR and LTE-Advanced FDD/TDD mode, returns outer offset results when Non-Contiguous Meas Region is set to Outer, and returns inner offset results when it is set to Inner, in the following order.</p> <p>Note: These results (n=8) are the same as n=7 result.</p> <ol style="list-style-type: none"> 1. Reserved for the future use, returns -999.0 2. Reserved for the future use, returns -999.0 3. At negative offset frequency (A) 4. At positive offset frequency (A) --- 25. At negative offset frequency (L) 26. At positive offset frequency (L) <p>The number of values returned is subject to change in future releases.</p>
All	9	<p>Offset Peak Power Freq.</p> <p>Returns comma-separated scalar values of frequency (in Hz) that have peak power from center or carrier edge frequency in each offset, depending on Offset Frequency Define settings. The length of the result depends on the number of available offset (See "Number of Offsets" on page 875).</p> <p>When in the MSR and LTE-Advanced FDD/TDD mode, returns outer offset results when Non-Contiguous Meas Region is set to Outer, and returns inner offset results when it is set to Inner, in the following order.</p> <ol style="list-style-type: none"> 1. Reserved for the future use, returns -999.0 2. Reserved for the future use, returns -999.0 3. Negative offset frequency (A)

Modes	n	Return Value
		<p>4. Positive offset frequency (A)</p> <p>---</p> <p>25. Negative offset frequency (L)</p> <p>26. Positive offset frequency (L)</p> <p>If the result is not available, -999.0 is returned.</p> <p>The number of values returned is subject to change in future releases.</p>
All	10	<p>Offset Abs Peak Power.</p> <p>Returns comma-separated scalar values (in dBm) of the absolute peak power of the segment frequencies. The length of the result depends on the number of available offset (See "Number of Offsets" on page 875).</p> <p>When in the MSR and LTE-Advanced FDD/TDD mode, returns outer offset results when Non-Contiguous Meas Region is set to Outer, and returns inner offset results when it is set to Inner, in the following order.</p> <ol style="list-style-type: none"> 1. Reserved for the future use, returns -999.0 2. Reserved for the future use, returns -999.0 3. At negative offset frequency (A) 4. At positive offset frequency (A) <p>---</p> <ol style="list-style-type: none"> 25. At negative offset frequency (L) 26. At positive offset frequency (L) <p>If the result is not available, -999.0 is returned.</p> <p>The number of values returned is subject to change in future releases.</p>
All	11	<p>Offset Rel Peak Power.</p> <p>Returns comma-separated scalar values in dBc (dB if MeasType = PSD) of the peak power relative to the carrier at the segment frequencies. The length of the result depends on the number of available offset (See "Number of Offsets" on page 875).</p> <p>When in the MSR and LTE-Advanced FDD/TDD mode, returns outer offset results when Non-Contiguous Meas Region is set to Outer, and returns inner offset results when it is set to Inner, in the following order.</p> <ol style="list-style-type: none"> 1. Reserved for the future use, returns -999.0 2. Reserved for the future use, returns -999.0 3. At negative offset frequency (A) 4. At positive offset frequency (A) <p>---</p> <ol style="list-style-type: none"> 25. At negative offset frequency (L) 26. At positive offset frequency (L) <p>If the result is not available, -999.0 is returned.</p> <p>The number of values returned is subject to change in future releases.</p>
All	12	<p>Returns the power result (the peak power of the signal in the ref channel) when Meas Type is Spectrum Peak reference. Otherwise, the value returned will be -999.0.</p> <p>When in the MSR and LTE-Advanced FDD/TDD mode, returns outer offset results when Non-</p>

Modes	n	Return Value
		Contiguous Meas Region is set to Outer, and returns inner offset results when it is set to Inner, in the following order.
MSR, LTEAFDD, LTEATDD only	13	<p>Meas Type: Total Power Reference Returns outer offset results when Non-Contiguous Meas Region is set to Outer, and returns inner offset results when it is set to Inner, in the following order.</p> <ol style="list-style-type: none"> 1. Total Absolute power of carriers of Measure Carrier On if Power Ref Type is "Max Power Carrier," "Max Power Carrier in Sub-block," or "RF Bandwidth." Otherwise NaN (9.91E+37) is returned. (dBm) 2. Absolute reference power. Absolute power at the left reference carrier if Power Ref type is "Left & Right Carriers." Absolute power at the reference carrier of the left sub-block if Power Ref type is "Max Power Carrier in Sub-block." (dBm) 3. Absolute power at the right reference carrier if Power Ref type is "Left & Right Carriers." Absolute power at the reference carrier of the right sub-block if Power Ref type is "Max Power Carrier in Sub-block." Otherwise NaN (9.91E+37) is returned. (dBm) 4. Peak frequency in the measured ref carrier frequency range. Peak frequency in the left ref carrier frequency range if Power Ref type is "Left & Right Carriers." Peak frequency in the ref carrier frequency range of the left sub-block if Power Ref type is "Max Power Carrier in Sub-block." (Hz) 5. Peak frequency in the right ref carrier frequency range if Power Ref type is "Left & Right Carriers." Peak frequency in the ref carrier frequency range of the right sub-block if Power Ref type is "Max Power Carrier in Sub-block." Otherwise NaN (9.91E+37) is returned. (Hz) <p>If the result is not available, NaN (9.91E+37) is returned. The number of values returned is subject to change in future releases.</p>
MSR, LTEAFDD, LTEATDD only	13	<p>Meas Type: Power Spectral Density Reference Returns outer offset results when Non-Contiguous Meas Region is set to Outer, and returns inner offset results when it is set to Inner, in the following order.</p> <ol style="list-style-type: none"> 1. Total Absolute power of carriers of Measure Carrier On if Power Ref Type is "Max Power Carrier," "Max Power Carrier in Sub-block," or "RF Bandwidth." Otherwise NaN (9.91E+37) is returned. (dBm) 2. Absolute reference power. Absolute power at the left reference carrier if Power Ref type is "Left & Right Carriers." Absolute power at the reference carrier of the left sub-block if Power Ref type is "Max Power Carrier in Sub-block." (dBm/Hz) 3. Absolute power at the right reference carrier if Power Ref type is "Left & Right Carriers." Absolute power at the reference carrier of the right sub-block if Power Ref type is "Max Power Carrier in Sub-block." Otherwise NaN (9.91E+37) is returned. (dBm/Hz) 4. Peak frequency in the measured ref carrier frequency range. Peak frequency in the left ref carrier frequency range if Power Ref type is "Left & Right Carriers." Peak frequency in the ref carrier frequency range of the left sub-block if Power Ref type is "Max Power Carrier in Sub-block." (Hz) 5. Peak frequency in the right ref carrier frequency range if Power Ref type is "Left & Right Carriers." Peak frequency in the ref carrier frequency range of the right sub-block if Power Ref

Modes	n	Return Value
		<p>type is "Max Power Carrier in Sub-block." Otherwise NaN (9.91E+37) is returned. (Hz)</p> <p>If the result is not available, NaN (9.91E+37) is returned.</p> <p>The number of values returned is subject to change in future releases.</p>
MSR, LTEAFDD, LTEATDD only	13	<p>Meas Type: Power Spectrum Peak Reference</p> <p>Returns outer offset results when Non-Contiguous Meas Region is set to Outer, and returns inner offset results when it is set to Inner, in the following order.</p> <ol style="list-style-type: none"> 1. Total Absolute power of carriers of Measure Carrier On if Power Ref Type is "Max Power Carrier," "Max Power Carrier in Sub-block," or "RF Bandwidth." Otherwise NaN (9.91E+37) is returned. (dBm) 2. Peak reference power. Peak power at the left reference carrier if Power Ref type is "Left & Right Carriers." Peak power at the reference carrier of the left sub-block if Power Ref type is "Max Power Carrier in Sub-block." (dBm) 3. Peak power at the right reference carrier if Power Ref type is "Left & Right Carriers." Peak power at the reference carrier of the right sub-block if Power Ref type is "Max Power Carrier in Sub-block." Otherwise NaN (9.91E+37) is returned. (dBm) 4. Peak frequency in the measured ref carrier frequency range. Peak frequency in the left ref carrier frequency range if Power Ref type is "Left & Right Carriers." Peak frequency in the ref carrier frequency range of the left sub-block if Power Ref type is "Max Power Carrier in Sub-block." (Hz) 5. Peak frequency in the right ref carrier frequency range if Power Ref type is "Left & Right Carriers." Peak frequency in the ref carrier frequency range of the right sub-block if Power Ref type is "Max Power Carrier in Sub-block." Otherwise NaN (9.91E+37) is returned. (Hz) <p>If the result is not available, NaN (9.91E+37) is returned.</p> <p>The number of values returned is subject to change in future releases.</p>
All	14	<p>Meas Type: Total Power Reference</p> <p>Returns comma-separated scalar results, in the following order:</p> <p>When in the MSR and LTE-Advanced FDD/TDD mode, returns outer offset results when Non-Contiguous Meas Region is set to Outer, and returns inner offset results when it is set to Inner, in the following order.</p> <ol style="list-style-type: none"> 1. Relative integrated power on the negative offset A (dBc) 2. Absolute integrated power on the negative offset A (dBm) 3. Relative peak power on the negative offset A (dBc) 4. Absolute peak power on the negative offset A (dBm) 5. Peak power offset frequency from the center or carrier edge frequency in the negative offset A, depending on Offset Frequency Define settings (Hz) 6. Relative integrated power on the positive offset A (dBc) 7. Absolute integrated power on the positive offset A (dBm) 8. Relative peak power on the positive offset A (dBc) 9. Absolute peak power on the positive offset A (dBm)

Modes	n	Return Value
		<p>10. Peak power offset frequency from the center or carrier edge frequency in the positive offset A, depending on Offset Frequency Define settings (Hz)</p> <p>11. Relative integrated power on the negative offset B (dBc)</p> <p>---</p> <p>119. Absolute peak power on the positive offset L (dBm)</p> <p>120. Peak power offset frequency from the center or carrier edge frequency in the positive offset L, depending on Offset Frequency Define settings (Hz)</p> <p>If the result is not available, NaN (9.91 E+37) is returned.</p> <p>The length of the result depends on the number of available offset (See "Number of Offsets" on page 875).</p> <p>The number of values returned is subject to change in future releases.</p>
All	14	<p>Meas Type: Power Spectral Density Reference</p> <p>Returns comma-separated scalar results, in the following order:</p> <p>When in the MSR and LTE-Advanced FDD/TDD mode, returns outer offset results when Non-Contiguous Meas Region is set to Outer, and returns inner offset results when it is set to Inner, in the following order.</p> <ol style="list-style-type: none"> 1. Relative integrated power on the negative offset A (dB) 2. Absolute integrated power on the negative offset A (dBm/Hz) 3. Relative peak power on the negative offset A (dB) 4. Absolute peak power on the negative offset A (dBm/Hz) 5. Peak power offset frequency from the center or carrier edge frequency in the negative offset A, depending on Offset Frequency Define settings (Hz) 6. Relative integrated power on the positive offset A (dB) 7. Absolute integrated power on the positive offset A (dBm/Hz) 8. Relative peak power on the positive offset A (dB) 9. Absolute peak power on the positive offset A (dBm/Hz) 10. Peak power offset frequency from the center or carrier edge frequency in the positive offset A, depending on Offset Frequency Define settings (Hz) 11. Relative integrated power on the negative offset B (dB) <p>---</p> <p>119. Absolute peak power on the positive offset L (dBm/Hz)</p> <p>120. Peak power offset frequency from the center or carrier edge frequency in the positive offset L, depending on Offset Frequency Define settings (Hz)</p> <p>If the result is not available, NaN (9.91 E+37) is returned.</p> <p>The length of the result depends on the number of available offset (See "Number of Offsets" on page 875).</p> <p>The number of values returned is subject to change in future releases.</p>
All	14	<p>Meas Type: Spectrum Peak Reference</p> <p>Returns comma-separated scalar results, in the following order:</p>

Modes	n	Return Value
		<p>When in the MSR and LTE-Advanced FDD/TDD mode, returns outer offset results when Non-Contiguous Meas Region is set to Outer, and returns inner offset results when it is set to Inner, in the following order.</p> <ol style="list-style-type: none"> 1. Reserved for the future use, returns NaN (9.91E+37) 2. Reserved for the future use, returns NaN (9.91E+37) 3. Relative peak power on the negative offset A (dB) 4. Absolute peak power on the negative offset A (dBm) 5. Peak power offset frequency from the center or carrier edge frequency in the negative offset A, depending on Offset Frequency Define settings (Hz) 6. Reserved for the future use, returns NaN (9.91E+37) 7. Reserved for the future use, returns NaN (9.91E+37) 8. Relative peak power on the positive offset A (dB) 9. Absolute peak power on the positive offset A (dBm) 10. Peak power offset frequency from the center or carrier edge frequency in the positive offset A, depending on Offset Frequency Define settings (Hz) 11. Relative integrated power on the negative offset B (dB) <p>---</p> <ol style="list-style-type: none"> 119. Absolute peak power on the positive offset L (dBm) 120. Peak power offset frequency from the center or carrier edge frequency in the positive offset L, depending on Offset Frequency Define settings (Hz) <p>If the result is not available, NaN (9.91E+37) is returned.</p> <p>The length of the result depends on the number of available offset (See "Number of Offsets" on page 875).</p> <p>The number of values returned is subject to change in future releases.</p>
All	15	<p>Meas Type: Total Power Reference</p> <p>Returns comma-separated scalar results, in the following order:</p> <p>When in the MSR and LTE-Advanced FDD/TDD mode, returns outer offset results when Non-Contiguous Meas Region is set to Outer, and returns inner offset results when it is set to Inner, in the following order.</p> <ol style="list-style-type: none"> 1. Minimum margin from limit line on the negative offset A (dB) 2. Minimum margin from limit line on the positive offset A (dB) 3. Minimum margin from limit line on the negative offset B (dB) 4. Minimum margin from limit line on the positive offset B (dB) <p>---</p> <ol style="list-style-type: none"> 23. Minimum margin from limit line on the negative offset L (dB) 24. Minimum margin from limit line on the positive offset L (dB) <p>If the result is not available, NaN (9.91E+37) is returned.</p> <p>The length of the result depends on the number of available offset (See "Number of Offsets" on page 875).</p> <p>The number of values returned is subject to change in future releases.</p>
MSR, LTEAFDD,	16	

Modes	n	Return Value
LTEATDD only		Returns number of carriers comma-separated scalar results, in the following order: 1. Absolute power of carrier 1 (dBm) 2. Absolute power of carrier 2 (dBm) --- number of carriers-1. Absolute power of carrier (number of carriers)-1 (dBm) number of carriers. Absolute power of carrier (number of carriers)-1 (dBm) If Measure Carrier of the corresponding carrier is no, NaN (9.91E+37) is returned.
WLAN only	16	Returns two carriers comma-separated scalar results when the radio standard is 802.11 ac 80+80 MHz. And returns NaN otherwise. 1. Absolute power of carrier segment 1 (dBm) 2. Absolute power of carrier segment 2 (dBm)
MSR, LTEAFDD, LTEATDD only	17	Returns the displayed frequency domain combined limit trace data separated by comma. Combined trace is a mixed trace of both absolute limit trace and relative limit trace according to the fail mask condition. The number of data points is 2001.

Number of Offsets

The number of available offsets varies depending on the mode and option as below.

Mode	The number of available offsets
MSR, LTEAFDD, LTEATDD	12 (Offset A to L)
WLAN	12 (Offset A to L)
Other modes with option N9060A-7FP	12 (Offset A to L)
Other modes without option N9060A-7FP	6 (Offset A to F)

Key Path	Meas
Initial S/W Revision	Prior to A.02.00
Modified at S/W Revision	A.11.00, A.14.00

AMPTD Y Scale

Accesses a menu of functions that enable you to set the vertical scale parameters. The parameter values are measurement independent except all Attenuation values and Internal Preamp selections that are measurement global.

Key Path	Front-panel key
Initial S/W Revision	Prior to A.02.00

Ref Value

Sets the value for the absolute power reference. However, since Auto Scaling defaults to On, this value is automatically determined by the measurement result. When you set a value manually, Auto Scaling automatically changes to Off.

Key Path	AMPTD Y Scale
Mode	SA, WCDMA, C2K, WIMAX OFDMA, TD-SCDMA, 1xEVDO, DTMB (CTTB), DVB-T/H, ISDB-T, CMMB, LTE, LTETDD, Digital Cable TV, WLAN, MSR, LTEAFDD, LTEATDD
Remote Command	:DISPlay:SEMAsk:VIEW[1]:WINDow[1]:TRACe:Y[:SCALe]:RLEVel <real> :DISPlay:SEMAsk:VIEW[1]:WINDow[1]:TRACe:Y[:SCALe]:RLEVel?
Example	DISP:SEM:VIEW:WIND:TRAC:Y:RLEV 100 DISP:SEM:VIEW:WIND:TRAC:Y:RLEV?
Notes	You must be in the mode that includes SEM measurement to use this command. Use :INSTrument:SElect to set the mode.
Couplings	When the Auto Scaling is On, this value is automatically determined by the measurement result. When you set a value manually, Auto Scaling automatically changed to Off.
Preset	10.0 dBm
State Saved	Saved in instrument state.
Min	-250 dBm
Max	250 dBm
Initial S/W Revision	Prior to A.02.00
Modified at S/W Revision	A.02.00, A.03.00

Attenuation

This menu controls the attenuator functions and interactions between the attenuation system components.

There are two attenuator configurations in the X-Series. One is a dual attenuator configuration consisting of a mechanical attenuator and an optional electronic attenuator. The other configuration uses a single attenuator with combined mechanical and electronic sections that controls all the attenuation functions. Different models in the X-Series come with different configurations.

See "Dual Attenuator Configurations:" on page 877

See "Single Attenuator Configuration:" on page 878

Most Attenuation settings are the same for all measurements – they do not change as you change measurements. Settings like these are called “Meas Global” and are unaffected by Meas Preset.

Key Path	AMPTD Y Scale
Scope	Meas Global
Dependencies	In measurements that support the I/Q inputs, this key is unavailable when I/Q is the selected input, and is replaced by the Range key in that case.
Readback Line	Contains a summary in [] brackets of the current total attenuation. See the descriptions of the , " (Mech) Atten " on page 2141, and " Enable Elec Atten " on page 2143 keys for more detail on the contributors to the total attenuation. Note that when "Pre-Adjust for Min Clip" is on, this value can change at the start of every measurement.
Initial S/W Revision	Prior to A.02.00
Modified at S/W Revision	A.03.00

Dual Attenuator Configurations:

Configuration 1: Mechanical attenuator + optional electronic attenuator

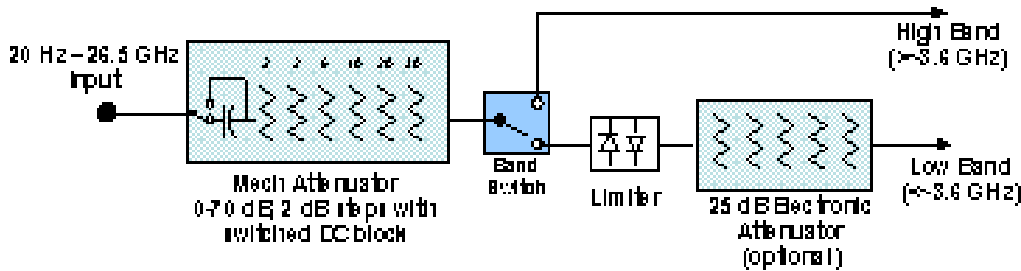

Configuration 2: Mechanical attenuator, no optional electronic attenuator

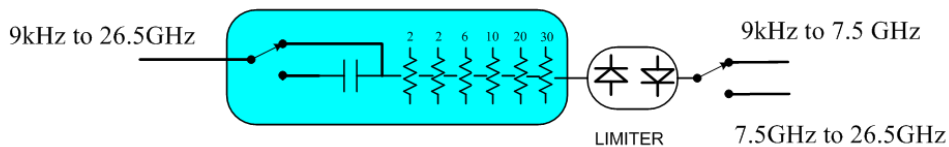

(note that Configuration 2 is not strictly speaking a dual-section attenuator, since there is no electronic section available. However, it behaves exactly like Configuration 1 without the Electronic Attenuator option EA3, therefore for the sake of this document it is grouped into the “Dual Attenuator” configuration)

Single Attenuator Configuration:

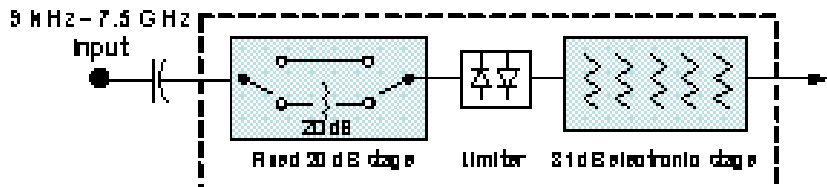

You can tell which attenuator configuration you have by pressing the Attenuation key, which (in most Modes) opens the Attenuation menu. If the first key in the Attenuation menu says Mech Atten you have the dual attenuator configuration. If the first key says Atten you have the single attenuator configuration.

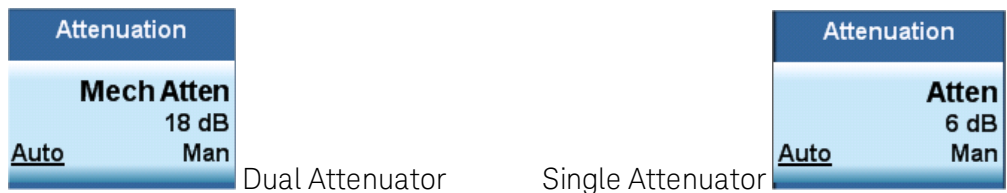

In the single attenuator configuration, you control the attenuation with a single control, as the fixed stage has only two states. In the dual attenuator configuration, both stages have significant range so you are given separate control of the mechanical and electronic attenuator stages.

When you have the dual attenuator configuration, you may still have only a single attenuator, because unless option EA3 (the Electronic Attenuator option) is available, and you purchase it, you will have only the mechanical attenuator.

(Mech) Atten

This key is labeled Mech Atten in dual attenuator models and Atten in single attenuator models. In the dual attenuator configuration, this key only affects the mechanical attenuator.

This key lets you modify the attenuation applied to the RF input signal path. This value is normally auto coupled to the Ref Level, the Internal Preamp Gain, any External Gain that is entered, and the Max Mixer Level, as described in the table below.

See ["Attenuator Configurations and Auto/Man" on page 880](#)

Key Path	AMPTD Y Scale, Attenuation
Remote Command	<pre>[:SENSe]:POWer[:RF]:ATTenuation <rel_ampl> [:SENSe]:POWer[:RF]:ATTenuation? [:SENSe]:POWer[:RF]:ATTenuation:AUTO OFF ON 0 1 [:SENSe]:POWer[:RF]:ATTenuation:AUTO?</pre>
Example	<p>POW:ATT 20</p> <p>Dual attenuator configuration: sets the mechanical attenuator to 20 dB</p> <p>Single attenuator mode: sets the main attenuation to 20 dB (see below for definition of “main” attenuation).</p> <p>If the attenuator was in Auto, it sets it to Manual.</p>
Dependencies	Some measurements do not support the Auto setting of (Mech) Atten. In these measurements, the

Auto/Man selection is not available, and the Auto/Man line on the key disappears.

In dual attenuator configurations, when the electronic attenuator is enabled, the mechanical attenuator has no auto setting and the Auto/Man line on the key disappears. The state of Auto/Man is remembered and restored when the electronic attenuator is once again disabled. This is described in more detail in the ["Enable Elec Atten" on page 2143](#) key description.

See ["Attenuator Configurations and Auto/Man" on page 880](#) for more information on the Auto/Man functionality of Attenuation.

Couplings

When (Mech) Atten is in Auto, it uses the following algorithm to determine a value:
 If the USB Preamp is connected to USB, use 0 dB.
 Otherwise, $Atten = ReferenceLevel + PreAmpGain + ExternalGain - RefLevelOffset - MaxMixerLevel + IF\ Gain$.
 Limit this value to be between 6 dB and the Max value. No value below 6 dB can ever be chosen by Auto.
 The resulting value is rounded up to the largest value possible given the attenuation step setting. That is, 50.01 dB would change to 60 dB (for a 10 dB attenuation step).
 The "IF Gain" term in the equation above is either 0 dB or +10 dB, depending on the settings of FFT IF Gain, Swept IF Gain, max Ref Level and the Auto/Man setting of Mech Atten.
 In External Mixing and BBIQ, where the Attenuator is not in the signal path, the Attenuator setting changes as described above when (Mech) Atten is in Auto, but no changes are made to the actual attenuator hardware setting until the input is changed back to the RF Input.

Preset The preset for Mech Attenuation is "Auto."
 The Auto value of attenuation is:
 CXA, EXA, MXA and PXA: 10 dB

State Saved Saved in instrument state

Min 0 dB
 The attenuation set by this key cannot be decreased below 6 dB with the knob or step keys. To get to a value below 6 dB it has to be directly entered from the keypad or via SCPI. This protects from adjusting the attenuation to a dangerously small value which can put the instrument at risk of damage to input circuitry. However, if the current mechanical attenuation is below 6 dB it can be increased with the knob and step keys, but not decreased.

Max CXA N9000A-503/507: 50 dB
 CXA N9000A-513/526: 70dB
 EXA: 60 dB
 MXA and PXA: 70 dB
 In the single attenuator configuration, the total of ATT and EATT cannot exceed 50 dB, so if the EATT is set to 24 dB first, the main attenuation cannot be greater than 26 dB and will be reduced accordingly; if the main attenuator is set to 40 dB first, EATT cannot be greater than 10 dB.

Initial S/W Revision Prior to A.02.00

Modified at S/W Revision A.03.00

Attenuator Configurations and Auto/Man

As described in the Attenuation key description, there are two distinct attenuator configurations available in the X-Series, the single attenuator and dual attenuator configurations. In dual attenuator configurations, we have the mechanical attenuation and the electronic attenuation, and the current total attenuation is the sum of the electronic + mechanical attenuation. In single attenuator configurations, we refer to the attenuation set using the (Mech) Atten key (or POW:ATT SCPI) as the “main” attenuation; and the attenuation that is set by the SCPI command POW:EATT as the “soft” attenuation (the POW:EATT command is honored even in the single attenuator configuration, for compatibility purposes). Then the current total attenuation is the sum of the main + soft attenuation. See the Elec Atten key description for more on “soft” attenuation.

In the dual attenuator configuration, when the electronic attenuator is enabled, there is no Auto/Man functionality for the mechanical attenuator, and the third line of the key label (the Auto/Man line) disappears:

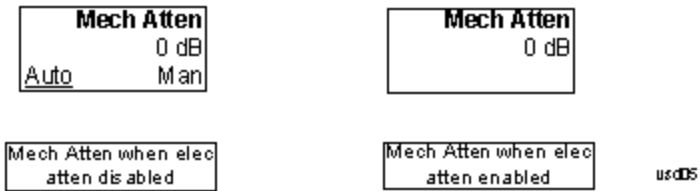

Enable Elec Atten

Enables the Electronic Attenuator.

The electronic attenuator offers finer steps than the mechanical attenuator, has no acoustical noise, is faster, and is less subject to wear. These advantages primarily aid in remote operation and are negligible for front panel use. See ["Using the Electronic Attenuator: Pros and Cons" on page 882](#) for a detailed discussion of the pros and cons of using the electronic attenuator.

For the single attenuator configuration, for SCPI backwards compatibility, the “soft” attenuation feature replaces the dual attenuator configuration’s electronic attenuator. All the same couplings and limitations apply. See ["Attenuator Configurations and Auto/Man" on page 2143](#)

See ["More Information" on page 881](#)

Key Path	AMPTD Y Scale, Attenuation
Remote Command	[:SENSe] : POWer [:RF] : EATTenuation : STATE OFF ON 0 1 [:SENSe] : POWer [:RF] : EATTenuation : STATE ?
Example	POW:EATT:STAT ON
Dependencies	This key only appears in Dual Attenuator models with an Electronic Attenuator installed. It does not appear in models with the Single Attenuator configuration, as in the single attenuator configuration there is no “electronic attenuator” there is only a single integrated attenuator (which has both a mechanical and electronic stage). However, in the single attenuator configuration, EATT SCPI commands are accepted for compatibility with other X-series instruments and set a “soft” attenuation as described in "Attenuator Configurations and Auto/Man" on page 2143 . The electronic attenuator (and the “soft” attenuation function provided in single attenuator configurations) is unavailable above 3.6 GHz. Therefore, if the Stop Frequency of the analyzer is > 3.6 GHz then the Enable Elec Atten key will be OFF and grayed out.

	<p>If the Internal Preamp is on, meaning it is set to Low Band or Full, the electronic attenuator (and the “soft” attenuation function provided in single attenuator configurations) is unavailable. In this case the Enable Elec Atten key will be OFF and grayed out.</p> <p>If either of the above is true, if the SCPI command is sent, an error indicating that the electronic attenuator is unavailable will be sent.</p> <p>If the electronic/soft Attenuator is enabled, then the Stop Freq of the analyzer is limited to 3.6 GHz and the Internal Preamp is unavailable.</p> <p>The SCPI-only “soft” electronic attenuation for the single-attenuator configuration is not available in all measurements; in particular, it is not available in the Swept SA measurement.</p>
Couplings	Enabling and disabling the Electronic Attenuator affects the setting of the Mechanical Attenuator (in dual attenuator configurations). This is described in more detail below this table.
Preset	OFF for Swept SA measurement; ON for all other measurements that support the electronic attenuator
State Saved	Saved in instrument state
Initial S/W Revision	Prior to A.02.00
Modified at S/W Revision	A.03.00

More Information

Mechanical Attenuator Transition Rules

When the Electronic Attenuator is enabled, the Mechanical Attenuator transitions to a state that has no Auto function. Below are the rules for transitioning the Mechanical Attenuator. NOTE that the information below ONLY applies to the dual attenuator configurations, and ONLY when the Electronic Attenuator is installed:

When the Electronic Attenuation is enabled from a disabled state:

- The Mechanical Attenuator is initialized to 10 dB (this is its optimal performance setting). You can then set it as desired with SCPI, numeric keypad, step keys, or knob, and it behaves as it normally would in manual mode
- The Auto/Man state of (Mech) Atten is saved
- The Auto/Man line on the (Mech) Atten key disappears and the auto rules are disabled
- The Electronic Attenuator is set to 10 dB less than the previous value of the Mechanical Attenuator, within the limitation that it must stay within the range of 0 to 24 dB of attenuation.

Examples in the dual attenuator configuration:

- Mech Atten at 20 dB. Elec Atten enabled, Mech Atten set to 10 dB, and Elec Atten set to 10 dB. New total attenuation equals the value before Elec Atten enabled.
- Mech Atten at 0 dB. Elec Atten enabled, Mech Atten set to 10 dB, and Elec Atten set to 0 dB. New total attenuation does not equal the value before Elec Atten enabled.
- Mech Atten at 40 dB. Elec Atten enabled, Mech Atten set to 10 dB, and Elec Atten set to 24 dB. New total attenuation does not equal the value before Elec Atten enabled.

When the Electronic Attenuation is disabled from an enabled state:

- The Elec Atten key is grayed out
- The Auto/Man state of (Mech) Atten is restored
- If now in Auto, (Mech) Atten recouples
- If now in Man, (Mech) Atten is set to the value of total attenuation that existed before the Elec Atten was disabled. The resulting value is rounded up to the smallest value possible given the (Mech) Atten Step setting - (That is, 57 dB changes to 58 dB when (Mech) Atten Step is 2 dB.)

Using the Electronic Attenuator: Pros and Cons

The electronic attenuator offers finer steps than the mechanical attenuator, has no acoustical noise, is faster, and is less subject to wear.

The “finer steps” advantage of the electronic attenuator is beneficial in optimizing the alignment of the analyzer dynamic range to the signal power in the front panel as well as remote use. Thus, you can achieve improved relative signal measurement accuracy. Compared to a mechanical attenuator with 2 dB steps, the 1 dB resolution of the electronic attenuator only gives better resolution when the odd-decibel steps are used. Those odd-decibel steps are less accurately calibrated than the even-decibel steps, so one tradeoff for this superior relative accuracy is reduced absolute amplitude accuracy.

Another disadvantage of the electronic attenuator is that the spectrum analyzer loses its “Auto” setting, making operation less convenient.

Also, the relationship between the dynamic range specifications (TOI, SHI, compression and noise) and instrument performance are less well-known with the electrical attenuator. With the mechanical attenuator, TOI, SHI and compression threshold levels increase dB-for-dB with increasing attenuation, and the noise floor does as well. With the electronic attenuator, there is an excess attenuation of about 1 to 3 dB between 0 and 3.6 GHz, making the effective TOI, SHI, and so forth, less well known. Excess attenuation is the actual attenuation relative to stated attenuation. Excess attenuation is accounted for in the analyzer calibration

Elec Atten

Controls the Electronic Attenuator in dual attenuator configurations. This key does not appear in single attenuator configurations, as the control of both the mechanical and electronic stages of the single attenuator is integrated into the single Atten key.

Key Path	AMPTD Y Scale, Attenuation
Remote Command	[:SENSe] :POWer [:RF] :EATTenuation <rel_amp1> [:SENSe] :POWer [:RF] :EATTenuation?
Notes	Electronic Attenuation’s specification is defined only when Mechanical Attenuation is 6 dB.
Dependencies	This key only appears in Dual Attenuator models with an Electronic Attenuator installed. It does not appear in models with the Single Attenuator configuration, as in the single attenuator configuration there is no “electronic attenuator” there is only a single integrated attenuator (which has both a mechanical and electronic stage). However, in the single attenuator configuration, EATT SCPI commands are accepted for compatibility with other X-series instruments and set a “soft” attenuation as described in "Attenuator Configurations and Auto/Man" on page 2143 . The “soft” attenuation is treated as an addition to the “main” attenuation value set by the Atten softkey or the

	POW:ATT SCPI command and affects the total attenuation displayed on the Attenuation key and the Meas Bar. When Enable Elec Atten is off or grayed out, the Elec Atten key is grayed out.
Preset	0 dB
State Saved	Saved in instrument state
Min	0 dB
Max	Dual attenuator configuration: 24 dB Single attenuator configuration: the total of ATT and EATT cannot exceed 50 dB, so if the EATT is set to 24 dB first, the main attenuation cannot be greater than 26 dB and will be reduced accordingly; if the main attenuator is set to 40 dB first, EATT cannot be greater than 10 dB
Initial S/W Revision	Prior to A.02.00
Modified at S/W Revision	A.03.00

Adjust Atten for Min Clip

Sets the combination of mechanical and electronic attenuation and gain based on the current measured signal level so that clipping will be at a minimum.

This is an "immediate action" function, that is, it executes once, when the key is pressed.

This key is grayed out in measurements that do not support this functionality. The spectrum analyzer measurement, Swept SA, does not support this functionality.

Key Path	AMPTD Y Scale, Attenuation
Remote Command	<code>[:SENSe] :POWer [:RF] :RANGe:OPTimize IMMEDIATE</code>
Initial S/W Revision	Prior to A.02.00
Modified at S/W Revision	A.03.00

Pre-Adjust for Min Clip

If this function is on, it does the adjustment described under "[Adjust Atten for Min Clip](#)" on page 2146 each time a measurement restarts. Therefore, in Continuous measurement mode, it only executes before the first measurement.

In dual attenuator models, you can set Elec+Mech Atten, in which case both attenuators participate in the autoranging, or Elec Atten Only, in which case the mechanical attenuator does not participate in the autoranging. This latter case results in less wear on the mechanical attenuator and is usually faster.

This key is grayed out in measurements that do not support this functionality. The spectrum analyzer measurement, Swept SA, does not support this functionality.

Key Path	AMPTD Y Scale, Attenuation
Remote Command	<code>[:SENSe] :POWer [:RF] :RANGe:OPTimize:ATTenuation OFF ELECTRical COMBined</code>

	<code>[:SENSe] :POWer [:RF] :RANGe:OPTimize:ATTenuation?</code>
Notes	The SCPI parameter ELECtrical sets this function to On in single attenuator models. The SCPI parameter COMBined is mapped to ELECtrical in single attenuator models; if you send COMBined, it sets the function to On and returns ELEC to a query.
Dependencies	This key only appears in Dual Attenuator models with an Electronic Attenuator installed. In instruments with Dual Attenuator model, when Enable Elec Atten is off or grayed out, the Pre-Adjust for Min Clip key is grayed out.
Preset	OFF for Swept SA measurement; ON for all other measurements that support Pre-Adjust for Min Clip
State Saved	Saved in instrument state
Range	Dual attenuator models: Off Elec Atten Only Mech + Elec Atten Single attenuator models: Off On
Initial S/W Revision	Prior to A.02.00
Modified at S/W Revision	A.03.00

Remote Command	<code>[:SENSe] :POWer [:RF] :RANGe:AUTO ON OFF 1 0</code> <code>[:SENSe] :POWer [:RF] :RANGe:AUTO?</code>
Notes	ON aliases to "Elec Atten Only" (:POW:RANG:OPT:ATT ELEC) OFF aliases to "Off" (:POW:RANG:OPT:ATT OFF) The query :POW:RANG:AUTO? returns true if :POW:RANG:OPT:ATT is not "Off"
Initial S/W Revision	Prior to A.02.00

Off

Turns Pre-Adjust for Min Clip off. This is the default setting.

This key is grayed out in measurements that do not support this functionality. The spectrum analyzer measurement, Swept SA, does not support this functionality.

Key Path	AMPTD Y Scale, Attenuation, Pre-Adjust for Min Clip
Example	:POW:RANGe:OPT:ATT OFF
Initial S/W Revision	Prior to A.02.00

Elec Atten Only

Selects only the electric attenuator to participate in auto ranging. This offers less wear on the mechanical attenuator and is usually faster.

This key is grayed out in measurements that do not support this functionality. The spectrum analyzer measurement, Swept SA, does not support this functionality.

Key Path	AMPTD Y Scale, Attenuation, Pre-Adjust for Min Clip
Example	:POW:RANGe:OPT:ATT ELEC
Initial S/W Revision	Prior to A.02.00

Mech + Elec Atten

In dual attenuator models, this selects both attenuators participate in the autoranging.

This key is grayed out in measurements that do not support this functionality. The spectrum analyzer measurement, Swept SA, does not support this functionality.

Key Path	AMPTD Y Scale, Attenuation, Pre-Adjust for Min Clip
Example	:POW:RANGe:OPT:ATT COMB
Initial S/W Revision	Prior to A.02.00

(Mech) Atten Step

This controls the step size used when making adjustments to the input attenuation.

This key is labeled Mech Atten Step in dual attenuator models and Atten Step in single attenuator models. In the dual attenuator configuration, this key only affects the step size of the mechanical attenuator.

Key Path	AMPTD Y Scale, Attenuation
Remote Command	[[:SENSe]:POWer[:RF]:ATTenuation:STEP[:INCRement] 10 dB 2 dB [:SENSe]:POWer[:RF]:ATTenuation:STEP[:INCRement]?
Example	POW:ATT:STEP 2
Notes	Note this feature works like a 1-N choice from the front panel, but it takes a specific value (in dB) when used remotely. The only valid values are 2 and 10.
Dependencies	Blanked in CXA and EXA if option FSA (2 dB steps) is not present. If blanked, attempts to set it via SCPI will yield an error.
Couplings	When the attenuation step size changes, the current mechanical attenuation value is adjusted (if necessary) to be quantized to the new step size. That is, if step is set to 10 dB, mech atten is increased if necessary so it is a multiple of 10 dB
Preset	PXA and MXA: 2 dB EXA and CXA: 10 dB (2 dB with option FSA)
State Saved	Saved in instrument state
Initial S/W Revision	Prior to A.02.00
Modified at S/W Revision	A.03.00

Scale/Div

Sets the units-per-division of the vertical scale in the logarithmic display. When Auto Scaling is On, the scale per division value is automatically determined by the measurement result. When you set a value manually, Auto Scaling automatically changes to Off.

Key Path	AMPTD Y Scale
Mode	SA, WCDMA, C2K, WIMAX OFDMA, TD-SCDMA, 1xEVDO, DTMB (CTTB), DVB-T/H, ISDB-T, CMMB, LTE, LTE-TDD, Digital Cable TV, WLAN, MSR, LTEAFDD, LTEATDD
Remote Command	:DISPlay:SEMAsk:VIEW[1]:WINDow[1]:TRACe:Y[:SCALe]:PDIVision <rel_ampl> :DISPlay:SEMAsk:VIEW[1]:WINDow[1]:TRACe:Y[:SCALe]:PDIVision?
Example	DISP:SEM:VIEW:WIND:TRAC:Y:PDIV 15dB DISP:SEM:VIEW:WIND:TRAC:Y:PDIV?
Notes	You must be in the mode that includes SEM measurement to use this command. Use :INSTrument:SElect to set the mode.
Couplings	When the Auto Scaling is On, this value is automatically determined by the measurement result. When you set a value manually, Auto Scaling automatically changes to Off.
Preset	10 dB
State Saved	Saved in instrument state
Min	0.10 dB
Max	20.00 dB
Initial S/W Revision	Prior to A.02.00
Modified at S/W Revision	A.02.00, A.03.00

Presel Center

When this key is pressed, the centering of the preselector filter is adjusted to optimize the amplitude accuracy at the frequency of the selected marker. If the selected marker is not on when Presel Center is pressed, the analyzer will turn on the selected marker, perform a peak search, and then perform centering on the marker's center frequency. If the selected marker is already on and between the start and stop frequencies of the analyzer, the analyzer performs the preselector calibration on that marker's frequency. If the selected marker is already on, but outside the frequency range between Start Freq and Stop Freq, the analyzer will first perform a peak search, and then perform centering on the marker's center frequency.

The value displayed on the Presel Adjust key will change to reflect the new preselector tuning (see Presel Adjust).

A number of considerations should be observed to ensure proper operation. See ["Proper Preselector Operation" on page 887](#).

Key Path	AMPTD Y Scale
Remote Command	[:SENSe]:POWer[:RF]:PCENter
Example	POW:PCEN
Notes	Note that the rules outlined above under the key description apply for the remote command as well

	as the key. The result of the command is dependent on marker position, and so forth. Any message shown by the key press is also shown in response to the remote command.
Dependencies	<ul style="list-style-type: none"> • Grayed out if the microwave preselector is off.) • If the selected marker's frequency is below Band 1, advisory message 0.5001 is generated and no action is taken. • Grayed out if entirely in Band 0. • Blank in models that do not include a preselector, such as option 503. If the SCPI is sent in these instruments, it is accepted without error, and the query always returns 0. • Grayed out in the Spectrogram View.
Couplings	<p>The active marker position determines where the centering will be attempted.</p> <p>If the analyzer is in a measurement such as averaging when centering is initiated, the act of centering the preselector will restart averaging but the first average trace will not be taken until the centering is completed.</p>
Status Bits/OPC dependencies	<p>When centering the preselector, *OPC will not return true until the process is complete and a subsequent measurement has completed, nor will results be returned to a READ or MEASure command.</p> <p>The Measuring bit should remain set while this command is operating and should not go false until the subsequent sweep/measurement has completed.</p>
Initial S/W Revision	Prior to A.02.00
Modified at S/W Revision	A.03.00

Proper Preselector Operation

A number of considerations should be observed to ensure proper operation:

1. If the selected marker is off, the analyzer will turn on a marker, perform a peak search, and adjust the preselector using the selected marker's frequency. It uses the "highest peak" peak search method unqualified by threshold or excursion, so that there is no chance of a 'no peak found' error. It continues with that peak, even if it is the peak of just noise. Therefore, for this operation to work properly, there should be a signal on screen in a preselected range for the peak search to find.
2. If the selected marker is already on, the analyzer will attempt the centering at that marker's frequency. There is no preselector for signals below about 3.6 GHz, therefore if the marker is on a signal below 3.6 GHz, no centering will be attempted and an advisory message generated
3. In some models, the preselector can be bypassed. If it is bypassed, no centering will be attempted in that range and a message will be generated.

Preselector Adjust

Allows you to manually adjust the preselector filter frequency to optimize its response to the signal of interest. This function is only available when **"Presel Center" on page 2149** is available.

For general purpose signal analysis, using Presel Center is recommended. Centering the filter minimizes the impact of long-term preselector drift. Presel Adjust can be used instead to manually optimize the

preselector. One application of manual optimization would be to peak the preselector response, which both optimizes the signal-to-noise ratio and minimizes amplitude variations due to small (short-term) preselector drifting.

Key Path	AMPTD Y Scale
Scope	Meas Global
Remote Command	[:SENSe] :POWeR [:RF] :PADJust <freq> [:SENSe] :POWeR [:RF] :PADJust?
Example	POW:PADJ 100KHz POW:PADJ?
Notes	The value on the key reads out to 0.1 MHz resolution.
Dependencies	<ul style="list-style-type: none"> • Grayed out if microwave preselector is off.) • Grayed out if entirely in Band 0. • Blank in models that do not include a preselector, such as option 503. If the SCPI is sent in these instruments, it is accepted without error, and the query always returns 0. • Grayed out in the Spectrogram View.
Preset	0 MHz
State Saved	The Presel Adjust value set by Presel Center, or by manually adjusting Presel Adjust, is not saved in instrument state, and does not survive a Preset or power cycle.
Min	-500 MHz
Max	500 MHz
Default Unit	Hz
Backwards Compatibility SCPI	[:SENSe] :POWeR [:RF] :MW:PADJust [:SENSe] :POWeR [:RF] :MMW:PADJust PSA had multiple preselectors, but the X-Series has only one. These commands simply alias to [:SENSe] :POWeR [:RF] :PADJust
Initial S/W Revision	Prior to A.02.00
Modified at S/W Revision	A.03.00

Remote Command	[:SENSe] :POWeR [:RF] :PADJust:PRESelector MWAVE MMWave EXTeRnal [:SENSe] :POWeR [:RF] :PADJust:PRESelector?
Notes	PSA had multiple preselectors, and you could select which preselector to adjust. Since the X-Series has only one mm/uW preselector, the preselector selection softkey is no longer available. However, to provide backward compatibility, we accept the legacy remote commands. The command form has no effect, the query always returns MWAVE
Initial S/W Revision	Prior to A.02.00

μW Path Control

The μW Path Control functions include the μW Preselector Bypass (Option MPB) and Low Noise Path (Option LNP) controls in the High Band path circuits.

When the μW Preselector is bypassed, the user has better flatness, but will be subject to spurs from out of band interfering signals. When the Low Noise Path is enabled, the analyzer automatically switches around certain circuitry in the high frequency bands which can contribute to noise, when it is appropriate based on other analyzer settings.

For most applications, the preset state is Standard Path, which gives the best remote-control throughput, minimizes acoustic noise from switching and minimizes the risk of wear out in the hardware switches. For applications that utilize the wideband IF paths, the preset state is the μW Preselector Bypass path, if option MPB is present. This is because, when using a wideband IF such as the 140 MHz IF, the μW Preselector's bandwidth can be narrower than the available IF bandwidth, causing degraded amplitude flatness and phase linearity, so it is desirable to bypass the preselector in the default case.

Users may choose Low Noise Path Enable. It gives a lower noise floor, especially in the 21–26.5 GHz region, though without improving many measures of dynamic range, and without giving the best possible noise floor. The preamp, if purchased and used, gives better noise floor than does the Low Noise Path, however its compression threshold and third-order intercept are much poorer than that of the non-preamp Low Noise Path. There are some applications, typically for signals around –30 dBm, for which the third-order dynamic range of the standard path is good enough, but the noise floor is not low enough even with 0 dB input attenuation. When the third-order dynamic range of the preamp path is too little and the noise floor of the standard path is too high, the Low Noise Path can provide the best dynamic range.

Key Path	AMPTD Y Scale
Mode	SA, BASIC, PNOISE, VSA , LTE, LTETDD
Scope	Meas Global
Remote Command	[:SENSe] :POWer [:RF] :MW:PATH STD LNPath MPBypass FULL [:SENSe] :POWer [:RF] :MW:PATH?
Example	:POW:MW:PATH LNP Enables the Low Noise path
Notes	If a Presel Center is performed, the analyzer will momentarily switch to the Standard Path, regardless of the setting of μW Path Control The DC Block will always be switched in when the low noise path is switched in, to protect succeeding circuitry from DC. Note that this does not mean “when the low noise path is enabled” but when, based on the Low Noise Path rules, the path is actually switched in. This can happen when the selection is Low Noise Path Enable . In the case where the DC Block is switched in the analyzer is now AC coupled. However, if the user has selected DC coupling, the UI will still behave as though it were DC coupled, including all annunciation, warnings, status bits, and responses to SCPI queries. This is because, based on other settings, the analyzer could switch out the low noise path at any time and hence go back to being DC coupled. Alignment switching ignores the settings in this menu, and restores them when finished.
Dependencies	Unavailable in BBIQ and External Mixing
Preset	All modes other than IQ Analyzer mode and VXA: STD IQ Analyzer, VXA and WLAN mode: MPB option present and licensed: MPB

	MPB option not present and licensed: STD
State Saved	Save in instrument state
Readback	Value selected in the submenu
Initial S/W Revision	A.04.00
Modified at S/W Revision	A.10.00

Standard Path

This path gives the best remote-control throughput, minimizes acoustic noise from switching and minimizes the risk of wear in the hardware switches, particularly in remote test scenarios where both low band and high band setups will follow in rapid succession.

In this path, the bypass of the low band/high band switch and microwave preamp is never activated, which can cause some noise degradation but preserves the life of the bypass switch.

Key Path	AMPTD Y Scale, μ W Path Control
Example	:POW:MW:PATH STD
Readback Text	Standard Path
Initial S/W Revision	A.04.00

Low Noise Path Enable

You may choose Low Noise Path Enable, which gives a lower noise floor under some circumstances, particularly when operating in the 21–26.5 GHz region. With the Low Noise Path enabled, the low band/high band switch and microwave preamp are bypassed whenever all of the following are true:

- The analyzer is not in the Low Band, meaning:
- the start frequency is above 3.5 GHz and
- the stop frequency is above 3.6 GHz.
- the internal preamp is not installed or (if installed) is set to Off or Low Band

Note that this means that, when any part of a sweep is done in Low Band, the Low Noise Path is not used, whether or not the Low Noise Path Enable is selected in the user interface. Also, if the preamp is turned on, the Low Noise Path is not used, whether or not the Low Noise Path Enable is selected in the user interface. The only time the Low Noise Path is used is when Low Noise Path Enable is selected, the sweep is completely in High Band (> 3.6 GHz) and no preamp is in use.

See "[More Information](#)" on page 891

Key Path	AMPTD Y Scale, μ W Path Control
Measurement	Swept SA
Example	:POW:MW:PATH LNP

Notes	<p>For measurements that use IQ acquisition, the low noise path is used when the Center Frequency is in High Band (> 3.6 GHz) and no preamp is in use.</p> <p>In other words, the rules above are modified to use only the center frequency to qualify which path to switch in.</p> <p>This is not the case for FFT's in the Swept SA measurement; they use the same rules as swept measurements.</p>
Dependencies	<p>Key is blanked if current mode does not support it.</p> <p>Key is grayed out if mode supports it but current measurement does not support it.</p> <p>Unless Option LNP is present and licensed, key is blank and if SCPI command sent, error -241, "Hardware missing; Option not installed" is generated.</p>
Readback Text	Low Noise Path Enable
Initial S/W Revision	A.04.00

More Information

The user should understand that the Low Noise Path, while giving improved DANL, has the disadvantage of decreased TOI performance and decreased gain compression performance relative to the standard path.

The user should also understand that the bypass switch is a mechanical switch and has finite life, so if the Low Noise Path is enabled, it is possible to cause frequent cycling of this switch by frequently changing analyzer settings such that the above conditions hold true only some of the time. A user making tests of this nature should consider opting for the Standard Path, which will never throw the bypass switch, at the expense of some degraded noise performance.

The low noise path is useful for situations where the signal level is so low that the analyzer performance is dominated by noise even with 0 dB attenuation, but still high enough that the preamp option would have excessive third-order intermodulation or compression. The preamp, if purchased and used, gives better noise floor than does the "Low Noise Path." However, its compression threshold and third-order intercept are much poorer than that of the non-preamp path. There are some applications, typically for signals around -30 dBm, for which the third-order dynamic range of the standard path is good enough, but the noise floor is not low enough even with 0 dB input attenuation. When the third-order dynamic range of the preamp path is too little and the noise floor of the standard path is too high, the Low Noise Path can provide the best dynamic range

The graph below illustrates the concept. It shows, in red, the performance of an analyzer at different attenuation settings, both with the preamp on and off, in a measurement that is affected by both analyzer noise and analyzer TOI. The green shows the best available dynamic range, offset by 0.5 dB for clarity. The blue shows how the best available dynamic range improves for moderate signal levels with the low noise path switched in. In this illustration, the preamp improves the noise floor by 15 dB while degrading the third-order intercept by 30 dB, and the low noise path reduces loss by 8 dB. The attenuator step size is 2 dB.

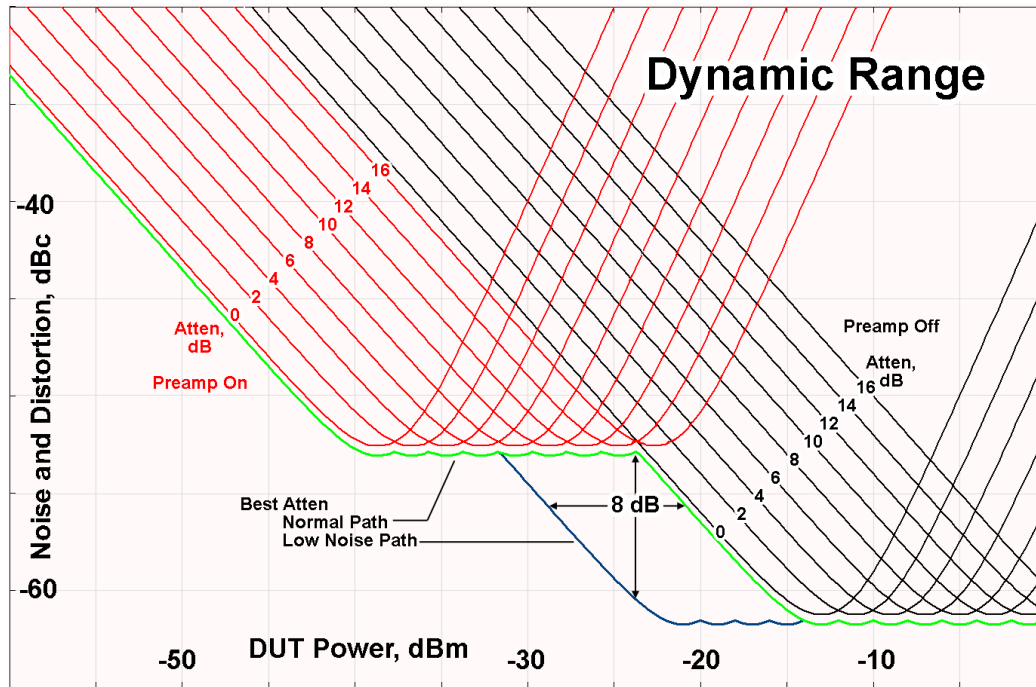

There are other times where selecting the low noise path improves performance, too. Compression-limited measurements such as finding the nulls in a pulsed-RF spectrum can profit from the low noise path in a way similar to the TOI-limited measurement illustrated. Accuracy can be improved when the low noise path allows the optimum attenuation to increase from a small amount like 0, 2 or 4 dB to a larger amount, giving better return loss at the analyzer input. Harmonic measurements, such as second and third harmonic levels, are much improved using the low noise path because of the superiority of that path for harmonic (though not intermodulation) distortion performance.

μW Preselector Bypass

This key toggles the preselector bypass switch for band 1 and higher. When the microwave preselector is on, the signal path is preselected. When the microwave preselector is off, the signal path is not preselected. The preselected path is the normal path for the analyzer.

The preselector is a tunable bandpass filter which prevents signals away from the frequency of interest from combining in the mixer to generate in-band spurious signals (images). The consequences of using a preselector filter are its limited bandwidth, the amplitude and phase ripple in its passband, and any amplitude and phase instability due to center frequency drift.

Option MPB or pre-selector bypass provides an unpreselected input mixer path for certain X-Series signal analyzers with frequency ranges above 3.6 GHz. This signal path allows a wider bandwidth and less amplitude variability, which is an advantage when doing modulation analysis and broadband signal analysis. The disadvantage is that, without the preselector, image signals will be displayed. Another disadvantage of bypassing the preselector is increased LO emission levels at the front panel input port.

Image responses are separated from the real signal by twice the 1st IF. For IF Paths of 10 MHz and 25 MHz, the 1st IF is 322.5 MHz, so the image response and the real signal will be separated by 645 MHz. The 1st IF will be different for other IF Path settings. When viewing a real signal and its corresponding image response in internal mixing, the image response will be to the left of the real signal.

Also, the image response and the real signal typically have the same amplitude and exhibit the same shape factor.

However, if Option FS1, Fast Sweep Capability, is enabled, the image response in the Swept SA measurement will appear lower in amplitude and have a much wider shape factor compared to the real signal.

Key Path	AMPTD Y Scale, μ W Path Control
Example	:POW:MW:PATH MPB
Dependencies	Key is blanked if current mode does not support it. Key is grayed out if mode supports it but current measurement does not support it. Key is blank unless Option MPB is present and licensed. If SCPI command sent when MPB not present, error -241, "Hardware missing; Option not installed" is generated.
Readback Text	μ W Preselector Bypass
Initial S/W Revision	A.04.00

Remote Command	[:SENSe] :POWer [:RF] :MW :PRESelector [:STATe] ON OFF 0 1 [:SENSe] :POWer [:RF] :MW :PRESelector [:STATe] ?
Example	:POW:MW:PRES OFF Bypasses the microwave preselector
Notes	The ON parameter sets the STD path (:POW:MW:PATH STD) The OFF parameter sets path MPB (:POW:MW:PATH MPB)
Preset	ON

Internal Preamp

Accesses a menu of keys that control the internal preamps. Turning on the preamp gives a better noise figure, but a poorer TOI to noise floor dynamic range. You can optimize this setting for your particular measurement.

The instrument takes the preamp gain into account as it sweeps. If you sweep outside of the range of the preamp the instrument will also account for that. The displayed result will always reflect the correct gain.

For some measurements, when the preamp is on and any part of the displayed frequency range is below the lowest frequency for which the preamp has specifications, a warning condition message appears in the status line. For example ,for a preamp with a 9 kHz lowest specified frequency: "Preamp: Accy unspec'd below 9 kHz".

Key Path	AMPTD Y Scale
Scope	Meas Global
Remote Command	[:SENSe] :POWer [:RF] :GAIN [:STATe] OFF ON 0 1 [:SENSe] :POWer [:RF] :GAIN [:STATe] ?
Dependencies	Preamp is not available on all hardware platforms. If the preamp is not present or is unlicensed, the

	key is not shown. The preamp is not available when the electronic/soft attenuator is enabled.
--	--

Couplings	The act of connecting the U7227A USB Preamplifier to one of the analyzer's USB ports will cause the Internal Preamp to be switched on. When this happens an informational message will be generated: "Internal Preamp turned on for optimal operation with USB Preamp." Note that if the Internal Preamp was already on, there will be no change to the setting, but if it was Off it will be switched On, to Full Range. Note that this same action occurs when the SA mode is selected while the USB Preamp is connected to one of the analyzer's USB ports, if it is the first time that the SA mode has run since powerup, or if the last time the SA mode was running the USB Preamp was NOT connected. Subsequently disconnecting the USB Preamp from USB does not change the Internal Preamp setting nor restore the previous setting.
Preset	OFF
State Saved	Saved in instrument state
Initial S/W Revision	Prior to A.02.00
Modified at S/W Revision	A.14.00

Key Path	AMPTD Y Scale, Internal Preamp
Scope	Meas Global
Remote Command	[:SENSe] : POWer [:RF] : GAIN : BAND LOW FULL [:SENSe] : POWer [:RF] : GAIN : BAND ?
Dependencies	Preamp is not available on all hardware platforms. If the preamp is not present or is unlicensed, the key is not shown. If a POW:GAIN:BAND FULL command is sent when a low band preamp is available, the preamp band parameter is to LOW instead of FULL, and an "Option not installed" message is generated.
Preset	LOW
State Saved	Saved in instrument state
Initial S/W Revision	Prior to A.02.00

Off

Turns the internal preamp off

Key Path	AMPTD Y Scale, Internal Preamp
Example	:POW:GAIN OFF
Readback	Off
Initial S/W Revision	Prior to A.02.00

Low Band

Sets the internal preamp to use only the low band.

The frequency range of the installed (optional) low-band preamp is displayed in square brackets on the Low Band key label.

Key Path	AMPTD Y Scale, Internal Preamp
Example	:POW:GAIN ON :POW:GAIN:BAND LOW
Readback	Low Band
Initial S/W Revision	Prior to A.02.00

Full Range

Sets the internal preamp to use its full range. The low band (0–3.6 GHz or 0–3GHz, depending on the model) is supplied by the low band preamp and the frequencies above low band are supplied by the high band preamp.

The frequency range of the installed (optional) preamp is displayed in square brackets on the Full Range key label. If the high band option is not installed the Full Range key does not appear.

Key Path	AMPTD Y Scale, Internal Preamp
Example	:POW:GAIN ON :POW:GAIN:BAND FULL
Readback	Full Range
Initial S/W Revision	Prior to A.02.00

Ref Position

Positions the reference level at the top, center or bottom of the Y scale display. Changing the reference position does not affect the reference level value.

Key Path	AMPTD Y Scale
Mode	SA, WCDMA, C2K, WIMAX OFDMA, TD-SCDMA, 1xEVDO, DTMB (CTTB), DVB-T/H, ISDB-T, CMMB, LTE, LTE-TDD, Digital Cable TV, WLAN, MSR, LTEAFDD, LTEATDD
Remote Command	:DISPlay:SEMask:VIEW[1]:WINDow[1]:TRACe:Y[:SCALe]:RPOSition TOP CENTer BOTTom :DISPlay:SEMask:VIEW[1]:WINDow[1]:TRACe:Y[:SCALe]:RPOSition?
Example	DISP:SEM:VIEW:WIND:TRAC:Y:RPOS BOTT DISP:SEM:VIEW:WIND:TRAC:Y:RPOS?
Notes	You must be in the mode that includes SEM measurement to use this command. Use :INSTrument:SElect to set the mode.
Preset	TOP

State Saved	Saved in instrument state
Range	Top Ctr Bot
Initial S/W Revision	Prior to A.02.00
Modified at S/W Revision	A.02.00, A.03.00

Auto Scaling

Toggles the Auto Scaling function between On and Off.

When Auto Scaling is On and the Restart front-panel key is pressed, the analyzer automatically determines the scale per division and reference values based on the measurement results. When you set a value to either Scale/Div or Ref Value manually, Auto Scaling automatically changes to Off.

Key Path	AMPTD Y Scale
Mode	SA, WCDMA, C2K, WIMAX OFDMA, TD-SCDMA, 1xEVDO, DTMB (CTTB), DVB-T/H, ISDB-T, CMMB, LTE, LTEFDD, Digital Cable TV, WLAN, MSR, LTEAFDD, LTEATDD
Remote Command	:DISPlay:SEMask:VIEW[1]:WINDow[1]:TRACe:Y[:SCALe]:COUPle 0 1 ON OFF :DISPlay:SEMask:VIEW[1]:WINDow[1]:TRACe:Y[:SCALe]:COUPle?
Example	DISP:SEM:VIEW:WIND:TRAC:Y:COUP OFF DISP:SEM:VIEW:WIND:TRAC:Y:COUP?
Notes	You must be in the mode that includes SEM measurement to use this command. Use :INSTrument:SElect to set the mode.
Couplings	When Auto Scaling is On, upon pressing the Restart front-panel key, this function automatically determines the scale per division and reference values based on the measurement results. When you set a value to either Scale/Div or Ref Value manually, Auto Scaling automatically changes to Off.
Preset	ON
State Saved	Saved in instrument state
Range	On Off
Initial S/W Revision	Prior to A.02.00
Modified at S/W Revision	A.02.00, A.03.00

Auto Couple

The Auto Couple feature provides a quick and convenient way to automatically couple multiple instrument settings. This helps ensure accurate measurements and optimum dynamic range. When the Auto Couple feature is activated, either from the front panel or remotely, all parameters of the current measurement that have an Auto/Manual mode are set to Auto mode and all measurement settings dependent on (or coupled to) the Auto/Man parameters are automatically adjusted for optimal performance.

However, the Auto Couple key actions are confined to the current measurement only. It does not affect other measurements in the mode, and it does not affect markers, marker functions, or trace or display attributes.

See "[More Information](#)" on page 897

Key Path	Front-panel key
Remote Command	:COUPle ALL NONE
Example	:COUP ALL
Notes	:COUPle ALL puts all Auto/Man parameters in Auto mode (equivalent to pressing the Auto Couple key). :COUPLE NONE puts all Auto/Man parameters in manual mode. It decouples all the coupled instrument parameters and is not recommended for making measurements.
Initial S/W Revision	Prior to A.02.00

More Information

There are two types of functions that have Auto/Manual modes.

Auto/Man Active Function keys

An Auto/Man toggle key controls the binary state associated with an instrument parameter by toggling between Auto (where the parameter is automatically coupled to the other parameters it is dependent upon) and Man (where the parameter is controlled independent of the other parameters), as well as making the parameter the active function. The current mode is indicated on the softkey with either Auto or Man underlined as illustrated below.



Auto/Man 1-of-N keys

An Auto/Man 1-of-N key allows you to manually pick from a list of parameter values, or place the function in Auto, in which case the value is automatically selected (and indicated) as shown below. If in Auto, Auto is underlined on the calling key. If in manual operation, manual is indicated on the calling key. But the calling key does not actually toggle the function, it simply opens the menu.

10 Spectrum Emission Mask Measurement
Auto Couple

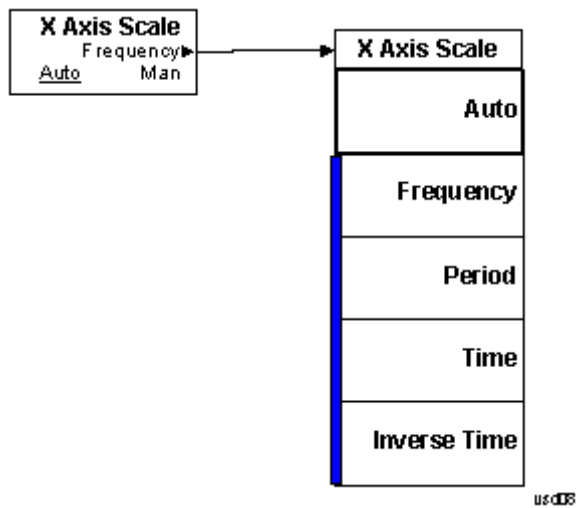

BW

Accesses a menu of functions that enable you to select the type of filter for the measurement.

Key Path	Front-panel key
Initial S/W Revision	Prior to A.02.00
Modified at S/W Revision	A.03.00

Filter Type

Selects the type of bandwidth filter that is used in Carrier and Offsets.

When Gaussian or Flattop is selected, selected filter is applied to carriers and all offsets.

When Auto Sense is selected, filter type is automatically selected for each carriers and offsets, so that measurement speed and accuracy is optimized.

Key Path	BW
Mode	SA, WCDMA, C2K, WIMAX OFDMA, TD-SCDMA, 1xEVDO, DVB-T/H, DTMB (CTTB), ISDB-T, CMMB, LTE, LTE-TDD, Digital Cable TV, WLAN, MSR, LTEAFDD, LTEATDD
Remote Command	[:SENSe] :SEMAsk:BA NDwidth:SHAPE ASENse GAUSsian FLATtop [:SENSe] :SEMAsk:BA NDwidth:SHAPE?
Example	SEM:BA ND:SHA P GAUS SEM:BA ND:SHA P?
Couplings	See the description above
Preset	ASENse
State Saved	Saved in instrument state
Range	Auto Sense (each offset and carrier) Gaussian (all offsets and carriers) Flattop (all offsets and carriers)
Initial S/W Revision	A.03.00

Cont (Continuous Measurement/Sweep)

Sets the analyzer for Continuous measurement operation. The single/continuous state is Meas Global so the setting will affect all measurements. If you are Paused, pressing Cont does a Resume.

Key Path	Front-panel key
Remote Command	:INITiate:CONTinuous OFF ON 0 1 :INITiate:CONTinuous?
Example	:INIT:CONT 0 puts analyzer in Single measurement operation. :INIT:CONT 1 puts analyzer in Continuous measurement operation
Preset	ON (Note that SYST:PRESet sets INIT:CONT to ON but *RST sets INIT:CONT to OFF)
State Saved	Saved in instrument state
Backwards Compatibility Notes	For Spectrum Analysis mode in ESA and PSA, there is no Cont hardkey, instead there is a Sweep Single/Cont key. In these analyzers, switching the Sweep Single/Cont key from Single to Cont restarts averages (displayed average count reset to 1), but does not restart Max Hold and Min Hold. The X-Series has Single and Cont keys in place of the SweepSingleCont key. In the X-Series, if in single measurement, the Cont key (and INIT:CONT ON) switches to continuous measurement, but never restarts a measurement and never resets a sweep.
Initial S/W Revision	Prior to A.02.00

In Swept SA Measurement (Spectrum Analysis Mode):

The analyzer takes repetitive sweeps, averages, measurements, etc., when in Continuous mode. When the average count reaches the Average/Hold Number the count stops incrementing, but the analyzer keeps sweeping. See the Trace/Detector section for the averaging formula used both before and after the Average/Hold Number is reached. The trigger condition must be met prior to each sweep. The type of trace processing for multiple sweeps, is set under the Trace/Detector key, with choices of Trace Average, Max Hold, or Min Hold.

In Other Measurements/Modes:

With Avg/Hold Num (in the Meas Setup menu) set to Off or set to On with a value of 1, a sweep is taken after the trigger condition is met; and the analyzer continues to take new sweeps after the current sweep has completed and the trigger condition is again met. However, with Avg/Hold Num set to On with a value >1, multiple sweeps (data acquisitions) are taken for the measurement. The trigger condition must be met prior to each sweep. The sweep is not stopped when the average count k equals the number N set for Avg/Hold Num is reached, but the number k stops incrementing. A measurement average usually applies to all traces, marker results, and numeric results. But sometimes it only applies to the numeric results.

If the analyzer is in Single measurement, pressing the Cont key does not change k and does not cause the sweep to be reset; the only action is to put the analyzer into Continuous measurement operation.

If it is already in continuous sweep:

the INIT:CONT 1 command has no effect

the INIT:CONT 0 command will place the analyzer in Single Sweep but will have no effect on the current sequence until $k = N$, at which point the current sequence will stop and the instrument will go to the idle state.

10 Spectrum Emission Mask Measurement
File

File

See "File" on page 336

FREQ Channel

Accesses a menu of keys that allow you to control the Frequency and Channel parameters of the instrument.

Some features in the Frequency menu are the same for all measurements – they do not change as you change measurements. Settings like these are called “Meas Global” and are unaffected by Meas Preset. For example, the Center Freq setting is the same for all measurements – it does not change as you change measurements.

Key Path	Front-panel key
Initial S/W Revision	Prior to A.02.00

Center Freq

Sets the frequency that corresponds to the horizontal center of the graticule (when frequency Scale Type is set to linear). While adjusting the Center Frequency the Span is held constant, which means that both Start Frequency and Stop Frequency will change.

Pressing Center Freq also sets the frequency entry mode to Center/Span. In Center/Span mode, the center frequency and span values are displayed below the graticule, and the default active function in the Frequency menu is Center Freq.

The center frequency setting is the same for all measurements within a mode, that is, it is Meas Global. Some modes are also able to share a Mode Global center frequency value. If this is the case, the Mode will have a Global Settings key in its Mode Setup menu.

The Center Freq function sets (and queries) the Center Frequency for the currently selected input. If your analyzer has multiple inputs, and you select another input, the Center Freq changes to the value for that input. SCPI commands are available to directly set the Center Freq for a specific input.

Center Freq is remembered as you go from input to input. Thus you can set a Center Freq of 10 GHz with the RF Input selected, change to BBIQ and set a Center Freq of 20 MHz, then switch to External Mixing and set a Center Freq of 60 GHz, and when you go back to the RF Input the Center Freq will go back to 10 GHz; back to BBIQ and it is 20 MHz; back to External Mixing and it is 60 GHz.

See ["RF Center Freq" on page 906](#)

See [Ext Mix Center Freq](#)

See ["I/Q Center Freq" on page 908](#)

See ["Center Frequency Presets" on page 904](#)

Key Path	FREQ Channel
Scope	Meas Global
Remote Command	[:SENSe] :FREQuency :CENTer <freq> [:SENSe] :FREQuency :CENTer?

Example	FREQ:CENT 50 MHz FREQ:CENT UP changes the center frequency to 150 MHz if you use FREQ:CENT:STEP 100 MHz to set the center frequency step size to 100 MHz FREQ:CENT?
Notes	This command sets either the RF or I/Q Center Frequency depending on the selected input. For RF input it is equivalent to FREQ:RF:CENT For I/Q input it is equivalent to FREQ:IQ:CENT Preset and Max values are dependent on Hardware Options (5xx) If no terminator (e.g. MHz) is sent the terminator Hz is used. If a terminator with unit other than Frequency is used, an invalid suffix error message is generated.
Dependencies	The Center Frequency can be limited by Start or Stop Freq limits, if the Span is so large that Start or Stop reach their limit.
Couplings	When operating in "swept span", any value of the Center Frequency or Span that is within the frequency range of the analyzer is allowed when the value is being set through the front panel numeric key pad or the SCPI command. The other parameter is forced to a different value if needed, to keep the Start and the Stop Frequencies within the analyzer's frequency range
Preset	Depends on instrument maximum frequency, mode, measurement, and selected input. See "Center Frequency Presets" on page 904 and "RF Center Freq" on page 906 and Ext Mix Center Freq and "I/Q Center Freq" on page 908 .
State Saved	Saved in instrument state
Min	Depends on instrument maximum frequency, mode, measurement, and selected input.. See "Center Frequency Presets" on page 904 and "RF Center Freq" on page 906 and "I/Q Center Freq" on page 908 .
Max	Depends on instrument maximum frequency, mode, measurement, and selected input.. See "Center Frequency Presets" on page 904 and "RF Center Freq" on page 906 and "I/Q Center Freq" on page 908 .
Default Unit	Hz
Status Bits/OPC	Non-overlapped
Dependencies	
Initial S/W Revision	Prior to A.02.00

Center Frequency Presets

The following table provides the Center Frequency Presets for the Spectrum Analyzer mode, and the Max Freq, for the various frequency options:

Freq Option	CF after Mode Preset	Stop Freq after Mode Preset	Max Freq (can't tune)

			above)
503 (all but N9000A)	1.805 GHz	3.6 GHz	3.7 GHz
503 (N9000A)	1.505 GHz	3.0 GHz	3.08 GHz
507 (all but N9000A)	3.505 GHz	7.0 GHz	7.1 GHz
507 (N9000A)	3.755 GHz	7.5 GHz	7.58 GHz
508 (all but N9038A)	1.805 GHz	3.6 GHz	8.5 GHz
508 (N9038A)	4.205 GHz	8.4 GHz	8.5 GHz
513	6.805 GHz	13.6 GHz	13.8 GHz
526 (all but N9000A and N9038A)	13.255 GHz	26.5 GHz	27.0 GHz
526 (N9000A)	13.255 GHz	26.5 GHz	26.55 GHz
526 (N9038A)	1.805 GHz	3.6 GHz	27.0 GHz
532	16.005 GHz	32.0 GHz	32.5 GHz
543	21.505 GHz	43.0 GHz	TBD
544	22.005 GHz	44.0 GHz	44.5 GHz
550	25.005 GHz	50.0 GHz	51 GHz

Input 2:

Model	CF after Mode Preset	Stop Freq after Mode Preset	Max Freq (can't tune above)
N9000A opt C75	0.7505GHz	1.5 GHz	1.58 GHz
N9038A	505 MHz	1 GHz	1.000025 GHz

Tracking Generator Frequency Limits (N9000A only):

Tracking Generator Option	Min Freq (clips to this freq when turn TG on and	If above this Freq, Stop Freq clipped to this Freq when	Max Freq (can't tune above) while TG

	can't tune below while TG on)	TG turned on	on
T03	9 kHz	3.0 GHz	3.08 GHz
T06	9 kHz	6.0 GHz	6.05 GHz

The following table shows the Center Frequency Presets for modes other than Spectrum Analyzer:

Mode	CF Preset for RF
WCDMA	1 GHz
WIMAXOFDMA,	1 GHz
BASIC	1 GHz
ADEMOD	1 GHz
VSA	1 GHz
TDSCDMA	1 GHz
PNOISE	1 GHz
LTE	1 GHz
LTETDD	1 GHz
MSR	1 GHz
GSM	935.2 MHz
NFIGURE	1.505 GHz

RF Center Freq

SCPI command for specifying the RF Center Frequency. This command will set the Center Frequency to be used when the RF input is selected, even if the RF input is not the input that is selected at the time the command is sent. Note that the Center Freq function in the Frequency menu on the front panel always applies to the currently selected input.

Scope	Meas Global
Remote Command	<code>[:SENSe] :FREQuency:RF:CENTer <freq></code> <code>[:SENSe] :FREQuency:RF:CENTer?</code>
Example	FREQ:RF:CENT 30 MHz
Notes	This command is the same in all modes, but the parameter is Measurement Global. So the value is independent in each mode and common across all the measurements in the mode.
Dependencies	If the electronic/soft attenuator is enabled, any attempt to set Center Frequency such that the Stop Frequency would be >3.6 GHz fails and results in an advisory message. If the equivalent SCPI command is sent, this same message is generated as part of a “-221, Settings conflict” warning. If Source Mode is set to Tracking, and the Max or Min Center Freq is therefore limited by the limits of the source, a warning message is generated, “Data out of range;clipped to source max/min” if these limits are exceeded. Note that for an external source, these limits can be affected by the settings of

	Source Numerator, Source Denominator and Power Sweep.
Preset	See table above
State Saved	Saved in instrument state.
Min	-79.999995 MHz, unless Source Mode is set to Tracking, in which case it is limited by the minimum frequency of the Source
Max	See table above. Basically instrument maximum frequency - 5 Hz. Note that, if the Source Mode is set to Tracking, the effective instrument maximum frequency may be limited by the source maximum frequency. If the knob or step keys are being used, also depends on the value of the other three interdependent parameters Span, Start Frequency and Stop Frequency
Initial S/W Revision	Prior to A.02.00
Modified at S/W Revision	A.03.00

Ext Mix Center Freq

SCPI command for specifying the External Mixer Center Frequency. This command will set the Center Frequency to be used when the External Mixer is selected, even if the External Mixer input is not the input which is selected at the time the command is sent. Note that the Center Freq function in the Frequency menu on the front panel always applies to the currently selected input.

Scope	Meas Global
Remote Command	<code>[:SENSe] :FREQuency:EMIXer:CENTer <freq></code> <code>[:SENSe] :FREQuency:EMIXer:CENTer?</code>
Example	<code>:FREQ:EMIX:CENT 60 GHz</code> <code>:FREQ:EMIX:CENT?</code>
Notes	This command is the same in all modes, but the parameter is Measurement Global. So the value is independent in each mode and common across all the measurements in the mode.
Couplings	When returning to External Mixing after having been switched to one of the other inputs (e.g., RF), you will come back into the settings that you had when you left External Mixing. So you will come back to the band you were in with the Center Frequency that you had. However, Span is not an input-dependent parameter, therefore you will bring the span over from the other input. Therefore, the analyzer comes back with the span from the previous input, limited as necessary by the current mixer setup.
Preset	When a Mode Preset is performed while in External Mixing, the Start frequency of the current Mode is set to the nominal Min Freq of the lowest harmonic range in the Harmonic Table for the current mixer setup. Similarly, the Stop frequency of the current Mode is set to the nominal Max Freq of the highest harmonic range in the Harmonic Table. The Center Freq thus presets to the point arithmetically equidistant from these two frequencies. If the current measurement has a limited Span available to it, and cannot achieve the Span shown in the table (Span=Stop Freq - Start Freq), the analyzer uses the maximum Span the measurement allows, and still sets the Center Freq to the midpoint of the Start and Stop Freq values in the Harmonic Table.

	<p>When Restore Input/Output Defaults is performed, the mixer presets to the 11970A, whose Start and Stop frequencies are 26.5 and 40 GHz respectively. The center of these two frequencies is 33.25 GHz.</p> <p>Therefore, after a Restore Input/Output Defaults, if you go into External Mixing and do a Mode Preset while in the Spectrum Analyzer Mode, the resulting Center Freq is 33.25 GHz.</p>
State Saved	Saved in instrument state.
Min	The minimum frequency in the currently selected mixer band + 5 Hz
Max	<p>The maximum frequency in the currently selected mixer band – 5 Hz</p> <p>If the knob or step keys are being used, also depends on the value of the other three interdependent parameters Span, Start Frequency and Stop Frequency</p>
Initial S/W Revision	A.08.01

I/Q Center Freq

SCPI command for specifying the I/Q Center Frequency. This command will set the Center Frequency to be used when the I/Q input is selected, even if the I/Q input is not the input which is selected at the time the command is sent. Note that the Center Freq function in the Frequency menu on the front panel always applies to the currently selected input.

Scope	Meas Global
Remote Command	<pre>[:SENSe] :FREQuency:IQ:CENTer <freq></pre> <pre>[:SENSe] :FREQuency:IQ:CENTer?</pre>
Example	FREQ:IQ:CENT: 30 MHz
Notes	This command is the same in all modes, but the parameter is Measurement Global. So the value is independent in each mode and common across all the measurements in the mode.
Preset	0 Hz
State Saved	Saved in instrument state.
Min	-40.049995 MHz
Max	40.049995 MHz
Initial S/W Revision	Prior to A.02.00

Input/Output

See "Input/Output" on page 196

Marker

Accesses a menu that enables you to select, set up and control the markers for the current measurement. If there are no active markers, Marker selects marker 1, sets it to Normal and places it at the center of the display. You can turn on and control up to 12 markers.

Key Path	Front-panel key
Initial S/W Revision	Prior to A.02.00

Select Marker

Displays 12 markers available for selection.

Key Path	Marker
Initial S/W Revision	Prior to A.02.00

Marker Type

Sets the marker control mode to Normal and Off. If the selected marker is Off, pressing Marker sets it to Normal and places it at the center of the screen on the trace determined by the Marker Trace rules. At the same time, Marker X Axis Value appears on the Active Function area. The marker X axis value entered in the active function area will display the marker value to its full entered precision. If the current control mode for the measurement is Off, there is no active function and the active function is turned off.

Key Path	Marker
Mode	SA, WCDMA, C2K, WIMAX OFDMA, TD-SCDMA, 1xEVDO, DTMB (CTTB), DVB-T/H, ISDB-T, CMMB, LTE, LTE-TDD, Digital Cable TV, WLAN, MSR, LTEAFDD, LTEATDD
Remote Command	:CALCulate:SEMask:MARKer[1] 2 ... 12:MODE POSITION OFF :CALCulate:SEMask:MARKer[1] 2 ... 12:MODE?
Example	CALC:SEM:MARK:MODE POS CALC:SEM:MARK:MODE?
Notes	If the selected marker is Off, pressing Marker sets it to Normal and places it at the center of the screen on the trace determined by the Marker Trace rules. At the same time, Marker X Axis Value appears on the Active Function area. Default Active Function: the active function for the selected marker's current control mode. Note that if the current control mode is Off, there is no active function and the active function is turned off. Active Function Display: the marker X axis value entered in the active function area will display the marker value to its full entered precision.
Preset	OFF OFF OFF OFF OFF OFF OFF OFF OFF OFF OFF OFF
State Saved	Saved in instrument state
Range	Normal Off
Initial S/W Revision	Prior to A.02.00
Modified at S/W Revision	A.02.00, A.03.00

Couple Markers

When this function is true, moving any marker causes an equal X Axis movement of every other marker that is not Off. By “equal X Axis movement” we mean that we preserve the difference between each marker’s X Axis value (in the fundamental x-axis units of the trace that marker is on) and the X Axis value of the marker being moved (in the same fundamental x-axis units).

Key Path	Marker
Mode	SA, WCDMA, C2K, WIMAX OFDMA, TD-SCDMA, 1xEVDO, DTMB (CTTB), DVB-T/H, ISDB-T, CMMB, LTE, LTEFDD, Digital Cable TV, WLAN, MSR, LTEAFDD, LTEATDD
Remote Command	:CALCulate:SEMask:MARKer:COUPle[:STATe] ON OFF 1 0 :CALCulate:SEMask:MARKer:COUPle[:STATe]?
Example	CALC:SEM:MARK:COUP ON CALC:SEM:MARK:COUP?
Preset	OFF
State Saved	Saved in instrument state
Range	On Off
Initial S/W Revision	Prior to A.02.00
Modified at S/W Revision	A.02.00, A.03.00

All Markers Off

Turns all active markers off in all views.

Key Path	Marker
Mode	SA, WCDMA, C2K, WIMAX OFDMA, TD-SCDMA, 1xEVDO, DTMB (CTTB), DVB-T/H, ISDB-T, CMMB, LTE, LTEFDD, Digital Cable TV, WLAN, MSR, LTEAFDD, LTEATDD
Remote Command	:CALCulate:SEMask:MARKer:AOff
Example	CALC:SEM:MARK:AOff
Initial S/W Revision	Prior to A.02.00
Modified at S/W Revision	A.02.00, A.03.00

Marker X Axis Value (Remote Command Only)

Sets the marker X Axis value in the current marker X Axis Scale unit. It has no effect if the control mode is Off, but is the SCPI equivalent of entering an X value if the control mode is Normal.

Mode	SA, WCDMA, C2K, WIMAX OFDMA, TD-SCDMA, 1xEVDO, DTMB (CTTB), DVB-T/H ISDB-T, CMMB, LTE, LTEFDD, Digital Cable TV, WLAN, MSR, LTEAFDD, LTEATDD
Remote Command	:CALCulate:SEMask:MARKer[1] 2 ... 12:X <freq>

	:CALCulate:SEMask:MARKer[1] 2 ... 12:X?
Example	CALC:SEM:MARK3:X 1.0 GHz CALC:SEM:MARK3:X?
Notes	<p>If no suffix is sent it will use the fundamental units for the current marker X Axis Scale. If a suffix is sent that does not match the current marker X Axis Scale unit, an error "Invalid suffix" will be generated.</p> <p>The query returns the marker's absolute X Axis value if the control mode is Normal. The query is returned in the fundamental units for the current marker X Axis scale. If the marker is Off the response is not a number.</p> <p>When a Marker is turned on, it is placed center of the screen on the trace. Therefore the default value depends on instrument condition, although the Preset/Default is defined as 1.5 GHz.</p>
Preset	After a preset, , all Markers are turned OFF, , so a Marker X Axis Value query will return a not a number (NAN).
State Saved	No
Min	-9.9E+37
Max	9.9E+37
Initial S/W Revision	Prior to A.02.00
Modified at S/W Revision	A.02.00, A.03.00

Marker X Axis Position (Remote Command Only)

Sets the marker X position in trace points. It has no effect if the control mode is Off, but is the SCPI equivalent of entering a value if the control mode is Normal, except in trace points rather than X Axis Scale units. The entered value is immediately translated into the current X Axis Scale units for setting the value of the marker.

Mode	SA, WCDMA, C2K, WIMAX OFDMA, TD-SCDMA, 1xEVDO, DTMB (CTTB), DVB-T/H, ISDB-T, CMMB, LTE, LTETDD, Digital Cable TV, WLAN, MSR, LTEAFDD, LTEATDD
Remote Command	:CALCulate:SEMask:MARKer[1] 2 ... 12:X:POSition <real> :CALCulate:SEMask:MARKer[1] 2 ... 12:X:POSition?
Example	CALC:SEM:MARK10:X:POS 1001 CALC:SEM:MARK10:X:POS?
Notes	<p>The query returns the marker's absolute X Axis value in trace points if the control mode is Normal. The value is returned as a real number, not an integer, corresponding to the translation from X Axis Scale units to trace points . If the marker is Off the response is not a number.</p> <p>When a Marker is turned on, it is placed center of the screen on the trace. Therefore the default value depends on the instrument condition although the Preset/Default is defined as 6507 (this value might be the expected value when all the offsets are on).</p>
Preset	After a preset, , all Markers are turned OFF, , so a Marker X Axis Value query will return a not a number (NAN).
State Saved	No

Min	-9.9E+37
Max	9.9E+37
Initial S/W Revision	Prior to A.02.00
Modified at S/W Revision	A.02.00, A.03.00

Marker Y Axis Value (Remote Command Only)

Returns the marker Y Axis value in the current marker Y Axis unit.

Mode	SA, WCDMA, C2K, WIMAX OFDMA, TD-SCDMA, 1xEVDO, DTMB (CTTB), DVB-T/H, ISDB-T, CMMB, LTE, LTE-TDD, Digital Cable TV, WLAN, MSR, LTEAFDD, LTEATDD
Remote Command	:CALCulate:SEMask:MARKer[1] 2 ... 12:Y?
Example	CALC:SEM:MARK11:Y 10 dBm CALC:SEM:MARK11:Y?
Notes	Since the result value is always calculated from acquisition data, the default value is arbitrary, although the Preset/Default values is defined.
Preset	Result dependent on markers setup and signal source
State Saved	No
Backwards Compatibility SCPI	:CALCulate:SEMask:MARKer[1] 2 ... 12:FUNctIon:RESult?
Initial S/W Revision	Prior to A.02.00
Modified at S/W Revision	A.02.00, A.03.00

Marker Function

There are no 'Marker Functions' supported in Spectrum Emission Mask so this front-panel key displays a blank menu when pressed.

Key Path	Front-panel key
Initial S/W Revision	Prior to A.02.00

Marker To

There is no 'Marker To' functionality supported in Spectrum Emission Mask so this front-panel key displays a blank menu when pressed.

Key Path	Front-panel key
Initial S/W Revision	Prior to A.02.00

Meas

The information in this section is common to all measurements. For key and remote command information for a specific measurement, refer to the section that describes the measurement of interest.

Measurements available under the Meas key are specific to the current Mode.

When viewing Help for measurements, note the following:

NOTE

Operation for some keys differs between measurements. The information displayed in Help pertains to the current measurement. To see how a key operates in a different measurement, exit Help (press the Cancel Esc key), select the measurement, then reenter Help (press the Help key) and press that key.

Key Path	Front-panel key
Initial S/W Revision	Prior to A.02.00

Remote Measurement Functions

This section contains the following topics:

["Measurement Group of Commands" on page 2206](#)

["Current Measurement Query \(Remote Command Only\)" on page 2208](#)

["Limit Test Current Results \(Remote Command Only\)" on page 2208](#)

["Data Query \(Remote Command Only\)" on page 2208](#)

["Calculate/Compress Trace Data Query \(Remote Command Only\)" on page 2209](#)

["Calculate Peaks of Trace Data \(Remote Command Only\)" on page 2214](#)

[Hardware-Accelerated Fast Power Measurement \(Remote Command Only\)](#)

["Format Data: Numeric Data \(Remote Command Only\)" on page 2215](#)

["Format Data: Byte Order \(Remote Command Only\)" on page 2216](#)

Initial S/W Revision	Prior to A.02.00
----------------------	------------------

Measurement Group of Commands

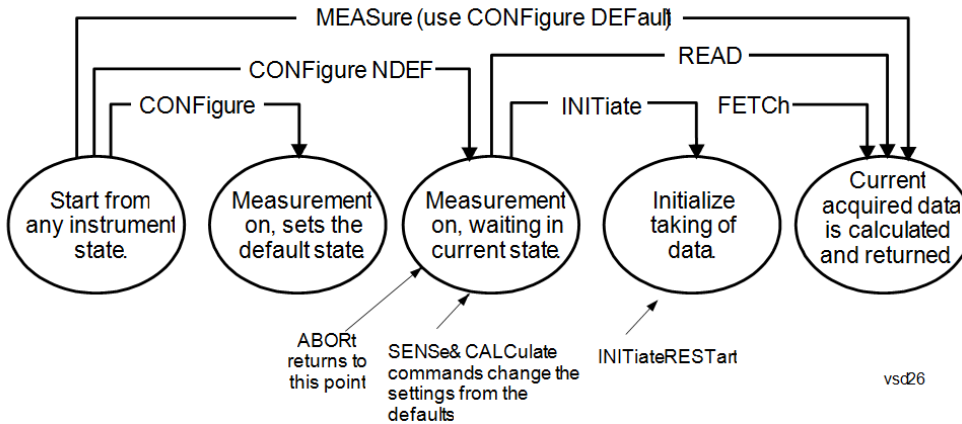

Measure Commands:

:MEASure:<measurement>[n]?

This is a fast single-command way to make a measurement using the factory default instrument settings. These are the settings and units that conform to the Mode Setup settings (e.g. radio standard) that you have currently selected.

- Stops the current measurement (if any) and sets up the instrument for the specified measurement using the factory defaults
- Initiates the data acquisition for the measurement
- Blocks other SCPI communication, waiting until the measurement is complete before returning results.
- If the function does averaging, it is turned on and the number of averages is set to 10.
- After the data is valid it returns the scalar results, or the trace data, for the specified measurement. The type of data returned may be defined by an [n] value that is sent with the command.
- The scalar measurement results will be returned if the optional [n] value is not included, or is set to 1. If the [n] value is set to a value other than 1, the selected trace data results will be returned. See each command for details of what types of scalar results or trace data results are available.
- ASCII is the default format for the data output. (Older versions of Spectrum Analysis and Phase Noise mode measurements only use ASCII.) The binary data formats should be used for handling large blocks of data since they are smaller and faster than the ASCII format. Refer to the FORMat:DATA command for more information.

If you need to change some of the measurement parameters from the factory default settings you can set up the measurement with the CONFIGure command. Use the commands in the SENSe:<measurement> and CALCulate:<measurement> subsystems to change the settings. Then you can use the READ? command to initiate the measurement and query the results.

If you need to repeatedly make a given measurement with settings other than the factory defaults, you can use the commands in the SENSe:<measurement> and CALCulate:<measurement> subsystems to set up the measurement. Then use the READ? command to initiate the measurement and query results.

Measurement settings persist if you initiate a different measurement and then return to a previous one. Use READ:<measurement>? if you want to use those persistent settings. If you want to go back to the default settings, use MEASure:<measurement>?.

Configure Commands:

:CONFigure:<measurement>

This command stops the current measurement (if any) and sets up the instrument for the specified measurement using

the factory default instrument settings. It does not initiate the taking of measurement data unless INIT:CONTinuous is ON. If you change any measurement settings after using the CONFigure command, the READ command can be used to initiate a measurement without changing the settings back to their defaults.

In the Swept SA measurement in Spectrum Analyzer mode the CONFigure command also turns the averaging function on and sets the number of averages to 10 for all measurements.

:CONFigure: <measurement>: NDEFault stops the current measurement and changes to the specified measurement. It does not change the settings to the defaults. It does not initiate the taking of measurement data unless INIT:CONTinuous is ON.

The CONFigure? query returns the current measurement name.

The CONFigure:CATalog? query returns a quoted string of all licensed measurement names in the current mode. For example, "SAN, CHP, OBW, ACP, PST, TXP, SPUR, SEM, LIST".

Fetch Commands:

:FETCh:<measurement>[n]?

This command puts selected data from the most recent measurement into the output buffer. Use FETCh if you have already made a good measurement and you want to return several types of data (different [n] values, for example, both scalars and trace data) from a single measurement. FETCh saves you the time of re-making the measurement. You can only FETCh results from the measurement that is currently active, it will not change to a different measurement. An error message is reported if a measurement other than the current one is specified.

If you need to get new measurement data, use the READ command, which is equivalent to an INITiate followed by a FETCh.

The scalar measurement results will be returned if the optional [n] value is not included, or is set to 1. If the [n] value is set to a value other than 1, the selected trace data results will be returned. See each command for details of what types of scalar results or trace data results are available. The binary data formats should be used for handling large blocks of data since they are smaller and transfer faster than the ASCII format. (FORMat:DATA)

FETCh may be used to return results other than those specified with the original READ or MEASure command that you sent.

INITiate Commands:

:INITiate:<measurement>

This command is not available for measurements in all the instrument modes:

- Initiates a trigger cycle for the specified measurement, but does not output any data. You must then use the FETCh<meas> command to return data. If a measurement other than the current one is specified, the instrument will switch to that measurement and then initiate it.
 - For example, suppose you have previously initiated the ACP measurement, but now you are running the channel power measurement. If you send INIT:ACP? it will change from channel power to ACP and will initiate an ACP measurement.
 - Does not change any of the measurement settings. For example, if you have previously started the ACP measurement and you send INIT:ACP? it will initiate a new ACP measurement using the same instrument settings as the last time ACP was run.
 - If your selected measurement is currently active (in the idle state) it triggers the measurement, assuming the trigger conditions are met. Then it completes one trigger cycle. Depending upon the measurement and the number of averages, there may be multiple data acquisitions, with multiple trigger events, for one full trigger cycle. It also holds off additional commands on GPIB until the acquisition is complete.
-

READ Commands:

:READ:<measurement>[n]?

- Does not preset the measurement to the factory default settings. For example, if you have previously initiated the ACP
-

measurement and you send READ:ACP? it will initiate a new measurement using the same instrument settings.

- Initiates the measurement and puts valid data into the output buffer. If a measurement other than the current one is specified, the instrument will switch to that measurement before it initiates the measurement and returns results.
 - For example, suppose you have previously initiated the ACP measurement, but now you are running the channel power measurement. Then you send READ:ACP? It will change from channel power back to ACP and, using the previous ACP settings, will initiate the measurement and return results.
 - Blocks other SCPI communication, waiting until the measurement is complete before returning the results
 - If the optional [n] value is not included, or is set to 1, the scalar measurement results will be returned. If the [n] value is set to a value other than 1, the selected trace data results will be returned. See each command for details of what types of scalar results or trace data results are available. The binary data formats should be used when handling large blocks of data since they are smaller and faster than the ASCII format. (FORMat:DATA)
-

Initial S/W Revision	Prior to A.02.00
----------------------	------------------

Current Measurement Query (Remote Command Only)

This command returns the name of the measurement that is currently running.

Remote Command	:CONFigure?
-----------------------	-------------

Example	CONF?
----------------	-------

Initial S/W Revision	Prior to A.02.00
----------------------	------------------

Limit Test Current Results (Remote Command Only)

Queries the status of the current measurement limit testing. It returns a 0 if the measured results pass when compared with the current limits. It returns a 1 if the measured results fail any limit tests.

Remote Command	:CALCulate:CLIMits:FAIL?
-----------------------	--------------------------

Example	CALC:CLIM:FAIL? queries the current measurement to see if it fails the defined limits. Returns a 0 or 1: 0 it passes, 1 it fails.
----------------	--

Initial S/W Revision	Prior to A.02.00
----------------------	------------------

Data Query (Remote Command Only)

Returns the designated measurement data for the currently selected measurement and subopcode.

n = any valid subopcode for the current measurement. See the measurement command results table for your current measurement, for information about what data is returned for the subopcodes.

This command uses the data setting specified by the FORMat:BORDER and FORMat:DATA commands and can return real or ASCII data. (See the format command descriptions under Input/Output in the Analyzer Setup section.)

Remote Command	:CALCulate:DATA[n]?
Notes	The return trace depends on the measurement. In CALCulate:<meas>:DATA[n], n is any valid subopcode for the current measurement. It returns the same data as the FETCH:<measurement>? query where <measurement> is the current measurement.
Initial S/W Revision	Prior to A.02.00

Calculate/Compress Trace Data Query (Remote Command Only)

Returns compressed data for the currently selected measurement and sub-opcode [n].

n = any valid sub-opcode for that measurement. See the MEASure:<measurement>? command description of your specific measurement for information on the data that can be returned.

The data is returned in the current Y Axis Unit of the analyzer. The command is used with a sub-opcode <n> (default=1) to specify the trace. With trace queries, it is best if the analyzer is not sweeping during the query. Therefore, it is generally advisable to be in Single Sweep, or Update=Off.

This command is used to compress or decimate a long trace to extract and return only the desired data. A typical example would be to acquire N frames of GSM data and return the mean power of the first burst in each frame. The command can also be used to identify the best curve fit for the data.

Remote Command	:CALCulate:DATA<n>:COMPRESS? BLOCK CFIT MAXimum MINimum MEAN DMEan RMS RMSCubed SAMPLE SDEVIation PPHase [,<soffset> [,<length>[,<roffset>[,<rlimit>]]]]
Example	To query the mean power of a set of GSM bursts: Supply a signal that is a set of GSM bursts. Select the IQ Waveform measurement (in IQ Analyzer Mode). Set the sweep time to acquire at least one burst. Set the triggers such that acquisition happens at a known position relative to a burst. Then query the mean burst levels using, CALC:DATA2:COMP? MEAN, 24e-6, 526e-6 (These parameter values correspond to GSM signals, where 526e-6 is the length of the burst in the slot and you just want 1 burst.)
Notes	The command supports 5 parameters. Note that the last 4 (<soffset>, <length>, <roffset>, <rlimit>) are optional. But these optional parameters must be entered in the specified order. For example, if you want to specify <length>, then you must also specify <soffset>. See details below for a definition of each of these parameters. This command uses the data in the format specified by FORMat:DATA, returning either binary or ASCII data.
Initial S/W Revision	Prior to A.02.00

- BLOCK or block data - returns all the data points from the region of the trace data that you specify. For example, it could be used to return the data points of an input signal over several timeslots, excluding the portions of the trace data that you do not want. (This is x,y pairs for trace data and I,Q pairs for complex data.)

- CFIT or curve fit - applies curve fitting routines to the data. <soffset> and <length> are required to define the data that you want. <roffset> is an optional parameter for the desired order of the curve equation. The query will return the following values: the x-offset (in seconds) and the curve coefficients ((order + 1) values).

MIN, MAX, MEAN, DME, RMS, RMSC, SAMP, SDEV and PPH return one data value for each specified region (or <length>) of trace data, for as many regions as possible until you run out of trace data (using <roffset> to specify regions). Or they return the number of regions you specify (using <rlimit>) ignoring any data beyond that.

- MINimum - returns the minimum data point (y value) for the specified region(s) of trace data. For I/Q trace data, the minimum magnitude of the I/Q pairs is returned.
- MAXimum - returns the maximum data point (y value) for the specified region(s) of trace data. For I/Q trace data, the maximum magnitude of the I/Q pairs is returned.
- MEAN - returns a single value that is the arithmetic mean of the data point values (in dB/ dBm) for the specified region(s) of trace data. For I/Q trace data, the mean of the magnitudes of the I/Q pairs is returned. See the following equations.

•

NOTE

If the original trace data is in dB, this function returns the arithmetic mean of those log values, not log of the mean power which is a more useful value. The mean of the log is the better measurement technique when measuring CW signals in the presence of noise. The mean of the power, expressed in dB, is useful in power measurements such as Channel Power. To achieve the mean of the power, use the RMS option.

Equation 1

Mean Value of Data Points for Specified Region(s)

$$\text{MEAN} = \frac{1}{n} \sum_{X_i \in \text{region}(s)} X_i$$

where X_i is a data point value, and n is the number of data points in the specified region(s).

Equation 2

Mean Value of I/Q Data Pairs for Specified Region(s)

$$\text{MEAN} = \frac{1}{n} \sum_{X_i \in \text{region}(s)} |X_i|$$

where $|X_i|$ is the magnitude of an I/Q pair, and n is the number of I/Q pairs in the specified region(s).

- DMEan - returns a single value that is the mean power (in dB/ dBm) of the data point values for the specified region(s) of trace data. See the following equation:

Equation 3

DMEan Value of Data Points for Specified Region(s)

$$\text{DME} = 10 \times \log_{10} \left(\frac{1}{n} \sum_{X_i \in \text{region}(s)} 10^{\frac{X_i}{10}} \right)$$

- RMS - returns a single value that is the average power on a root-mean-squared voltage scale (arithmetic rms) of the data point values for the specified region(s) of trace data. See the following equation.

NOTE For I/Q trace data, the rms of the magnitudes of the I/Q pairs is returned. See the following equation. This function is very useful for I/Q trace data. However, if the original trace data is in dB, this function returns the rms of the log values which is not usually needed.

Equation 4

RMS Value of Data Points for Specified Region(s)

$$\text{RMS} = \sqrt{\frac{1}{n} \sum_{X_i \in \text{region}(s)} X_i^2}$$

where X_i is a data point value, and n is the number of data points in the specified region(s).

Equation 5

RMS Value of I/Q Data Pairs for Specified Region(s)

$$\text{RMS} = \sqrt{\frac{1}{n} \sum_{X_i \in \text{region}(s)} X_i X_i^*}$$

where X_i is the complex value representation of an I/Q pair, X_i^* its conjugate complex number, and n is the number of I/Q pairs in the specified region(s).

Once you have the rms value for a region of trace data (linear or I/Q), you may want to calculate the mean power. You must convert this rms value (peak volts) to power in dBm:

$$10 \times \log[10 \times (\text{rms value})^2]$$

- SAMPLe - returns the first data value (x,y pair) for the specified region(s) of trace data. For I/Q trace data, the first I/Q pair is returned.
- SDEViation - returns a single value that is the arithmetic standard deviation for the data point values for the specified region(s) of trace data. See the following equation.
- For I/Q trace data, the standard deviation of the magnitudes of the I/Q pairs is returned. See the following equation.

Equation 6

Standard Deviation of Data Point Values for Specified Region(s)

$$\text{SDEV} = \sqrt{\frac{1}{n} \sum_{X_i \in \text{region}(s)} (X_i - \bar{X})^2}$$

where X_i is a data point value, \bar{X} is the arithmetic mean of the data point values for the specified region (s), and n is the number of data points in the specified region(s).

$$\text{SDEV} = \sqrt{\frac{1}{n} \sum_{X_i \in \text{region}(s)} (|X_i| - \bar{X})^2}$$

where $|X_i|$ is the magnitude of an I/Q pair, \bar{X} is the mean of the magnitudes for the specified region(s), and n is the number of data points in the specified region(s).

- PPHase - returns the x,y pairs of both rms power (dBm) and arithmetic mean phase (radian) for every specified region and frequency offset (Hz). The number of pairs is defined by the specified number of regions. This parameter can be used for I/Q vector ($n=0$) in Waveform (time domain) measurement and all parameters are specified by data point in PPHase.

The rms power of the specified region may be expressed as:

$$\text{Power} = 10 \times \log [10 \times (\text{RMS I/Q value})] + 10.$$

The RMS I/Q value (peak volts) is:

$$\sqrt{\frac{1}{n} \sum_{X_i \in \text{region}} X_i X_i^*}$$

where X_i is the complex value representation of an I/Q pair, X_i^* its conjugate complex number, and n is the number of I/Q pairs in the specified region.

The arithmetic mean phase of the specified region may be expressed as:

$$\frac{1}{n} \sum_{Y_i \in \text{region}} Y_i$$

where Y_i is the unwrapped phase of I/Q pair with applying frequency correction and n is the number of I/Q pairs in the specified region.

The frequency correction is made by the frequency offset calculated by the arithmetic mean of every specified region's frequency offset. Each frequency offset is calculated by the least square method against the unwrapped phase of I/Q pair.

Sample Trace Data - Constant Envelope

(See below for explanation of variables.)

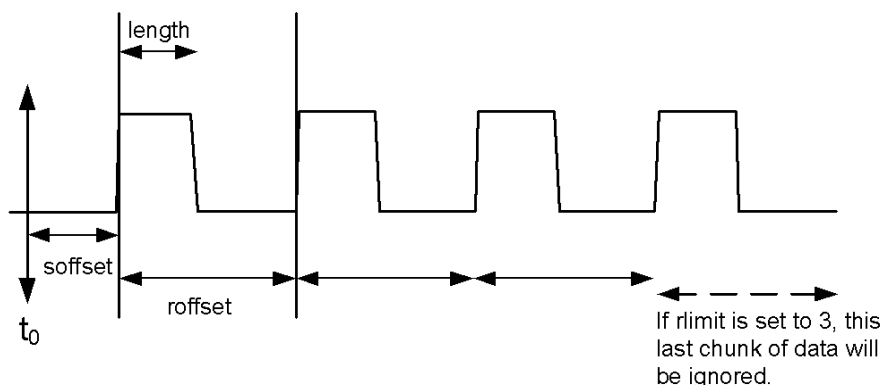

Sample Trace Data - Not Constant Envelope

(See below for explanation of variables.)

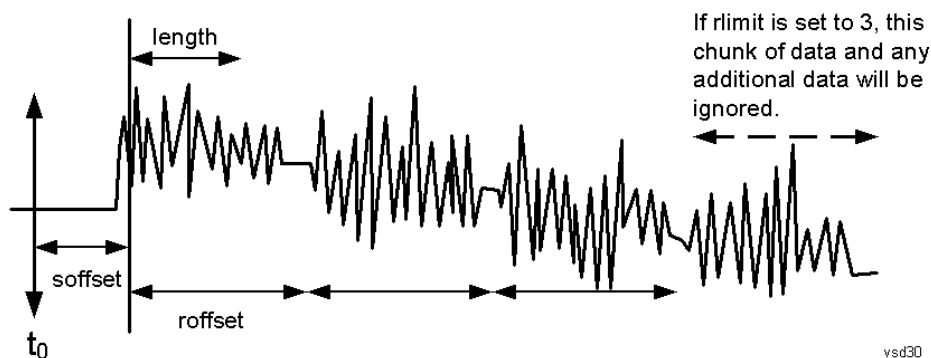

<soffset> - start offset is an optional real number. (It is in seconds for time-domain traces, and is a dimensionless index 0 to Npoints - 1, for frequency-domain traces). It specifies the amount of data at the beginning of the trace that will be ignored before the decimation process starts. It is the time or frequency change from the start of the trace to the point where you want to start using the data. The default value is zero.

<length> - is an optional real number. (It is in seconds for time-domain traces, and is a dimensionless index 0 to Npoints - 1, for frequency-domain traces). It defines how much data will be compressed into one value. This parameter has a default value equal to the current trace length.

<roffset> - repeat offset is an optional real number. (It is in seconds for time-domain traces, and is a dimensionless index 0 to Npoints - 1, for frequency-domain traces). It defines the beginning of the next field of trace elements to be compressed. This is relative to the beginning of the previous field. This parameter has a default value equal to the <length> variable. Note that this parameter is used for a completely different purpose when curve fitting (see CFIT above).

<rlimit> - repeat limit is an optional integer. It specifies the number of data items that you want returned. It will ignore any additional items beyond that number. You can use the Start offset and the Repeat limit to pick out exactly what part of the data you want to use. The default value is all the data.

Calculate Peaks of Trace Data (Remote Command Only)

Returns a list of all the peaks for the currently selected measurement and sub-opcode [n]. The peaks must meet the requirements of the peak threshold and excursion values.

n = any valid sub-opcode for the current measurement. See the MEASure:<measurement> command description of your specific measurement for information on the data that can be returned.

The command can only be used with specific sub-opcodes with measurement results that are trace data. Both real and complex traces can be searched, but complex traces are converted to magnitude in dBm. In many measurements the sub-opcode n=0, is the raw trace data which cannot be searched for peaks. And Sub-opcode n=1, is often calculated results values which also cannot be searched for peaks.

This command uses the data setting specified by the FORMat:BORDER and FORMat:DATA commands and can return real or ASCII data. If the format is set to INT,32, it returns REAL,32 data.

The command has four types of parameters:

- Threshold (in dBm)
- Excursion (in dB)
- Sorting order (amplitude, frequency, time)
- Optional in some measurements: Display line use (all, > display line, < display line)

Remote Command	<p>For Swept SA measurement:</p> <pre>:CALCulate:DATA[1] 2 ... 6:PEAKs? <threshold>,<excursion>[,AMPLitude FREQuency TIME[,ALL GTDLline LTDLine]]</pre> <p>For most other measurements:</p> <pre>:CALCulate:DATA[1] 2 ... 6:PEAKs? <threshold>,<excursion>[,AMPLitude FREQuency TIME]</pre>
-----------------------	---

Example	<p>Example for Swept SA measurement in Spectrum Analyzer Mode:</p> <p>CALC:DATA4:PEAK? -40, 10, FREQ, GTDL This will identify the peaks of trace 4 that are above -40 dBm, with excursions of at least 10 dB. The peaks are returned in order of increasing frequency, starting with the lowest frequency. Only the peaks that are above the display line are returned.</p> <p>Query Results 1:</p> <p>With FORMat:DATA REAL, 32 selected, it returns a list of floating-point numbers. The first value in the list is the number of peak points that are in the following list. A peak point consists of two values: a peak amplitude followed by its corresponding frequency (or time).</p> <p>If no peaks are found the peak list will consist of only the number of peaks, (0).</p>
----------------	---

Notes	<p><n> - is the trace that will be used</p> <p><threshold> - is the level below which trace data peaks are ignored. Note that the threshold value is required and is always used as a peak criterion. To effectively disable the threshold criterion for this command, provide a substantially low threshold value such as -200 dBm. Also note that the threshold value used in this command is independent of and has no effect on the threshold value stored under the Peak Criteria menu.</p> <p><excursion> - is the minimum amplitude variation (rise and fall) required for a signal to be identified as peak. Note that the excursion value is required and is always used as a peak criterion. To effectively disable the excursion criterion for this command, provide the minimum value of 0.0 dB. Also note that the excursion value used in this command is independent of and has no effect on the</p>
--------------	---

excursion value stored under the Peak Criteria menu.

Values must be provided for threshold and excursion. The sorting and display line parameters are optional (defaults are AMPLitude and ALL).

Note that there is always a Y-axis value for the display line, regardless of whether the display line state is on or off. It is the current Y-axis value of the display line which is used by this command to determine whether a peak should be reported

Sorting order:

AMPLitude - lists the peaks in order of descending amplitude, with the highest peak first (default if optional parameter not sent)

FREQuency - lists the peaks in order of occurrence, left to right across the x-axis.

TIME - lists the peaks in order of occurrence, left to right across the x-axis.

Peaks vs. Display Line:

ALL - lists all of the peaks found (default if optional parameter not sent).

GTDLine (greater than display line) - lists all of the peaks found above the display line.

LTDLine (less than display line) - lists all of the peaks found below the display line.

Initial S/W Revision Prior to A.02.00

Format Data: Numeric Data (Remote Command Only)

This command specifies the format of the trace data input and output. It specifies the formats used for trace data during data transfer across any remote port. It affects only the data format for setting and querying trace data for the :TRACe[:DATA], TRACe[:DATA]?, :CALCulate:DATA[n]? and FETCh:SANalyzer [n]? commands and queries.

Remote Command :FORMat [:TRACe] [:DATA] ASCii | INTeger, 32 | REAL, 32 | REAL, 64
:FORMat [:TRACe] [:DATA] ?

Notes The query response is:
ASCii: ASC,8
REAL,32: REAL,32
REAL,64: REAL,64
INTeger,32: INT,32

When the numeric data format is REAL or ASCii, data is output in the current Y Axis unit. When the data format is INTeger, data is output in units of m dBm (.001 dBm).

The INT,32 format returns binary 32-bit integer values in internal units (m dBm), in a definite length block.

Dependencies Sending a data format spec with an invalid number (for example, INT,48) generates no error. The analyzer simply uses the default (8 for ASCii, 32 for INTeger, 32 for REAL).

Sending data to the analyzer which does not conform to the current FORMat specified, results in an error. Sending ASCII data when a definite block is expected generates message -161 "Invalid Block Data" and sending a definite block when ASCII data is expected generates message -121 "Invalid Character in Number".

Preset ASCii

Backwards Compatibility Notes Note that the INT,32 format is only applicable to the command, TRACe:DATA. This preserves backwards compatibility for the Swept SA measurement. For all other commands/queries which honor FORMat:DATA, if INT,32 is sent the analyzer will behave as though it were set to REAL,32.

Initial S/W Revision Prior to A.02.00

The specs for each output type follow:

ASCIi - Amplitude values are in ASCII, in the current Y Axis Unit, one ASCII character per digit, values separated by commas, each value in the form:

SX.YYYYYEsZZ

Where:

S = sign (+ or -)

X = one digit to left of decimal point

Y = 5 digits to right of decimal point

E = E, exponent header

s = sign of exponent (+ or -)

ZZ = two digit exponent

REAL,32 - Binary 32-bit real values in the current Y Axis Unit, in a definite length block.

REAL,64 - Binary 64-bit real values in the current Y Axis Unit, in a definite length block.

Format Data: Byte Order (Remote Command Only)

This command selects the binary data byte order for data transfer and other queries. It controls whether binary data is transferred in normal or swapped mode. This command affects only the byte order for setting and querying trace data for the :TRACe[:DATA], TRACe[:DATA]? , :CALCulate:DATA[n]? and FETCh:SANalyzer[n]? commands and queries.

By definition any command that says it uses FORMat:DATA uses any format supported by FORMat:DATA.

The NORMal order is a byte sequence that begins with the most significant byte (MSB) first, and ends with the least significant byte (LSB) last in the sequence: 1|2|3|4. SWAPPed order is when the byte sequence begins with the LSB first, and ends with the MSB last in the sequence: 4|3|2|1.

Remote Command	:FORMat:BORDER NORMal SWAPPed :FORMat:BORDER?
Preset	NORMal
Initial S/W Revision	Prior to A.02.00

Meas Setup

Displays the setup menu for the currently selected measurement.

Key Path	Front-panel key
Initial S/W Revision	Prior to A.02.00

Avg/Hold Num

Toggles averaging On or Off in addition to enabling you to set the number of measurement averages used to calculate the measurement result. The average is displayed at the end of each sweep. After the specified number of average counts, the average mode (termination control) setting determines the average action.

In the remote mode, use the Average State command to turn averaging on or off.

Key Path	Meas Setup
Mode	SA, WCDMA, C2K, WIMAX OFDMA, TD-SCDMA, 1xEVDO, DTMB (CTTB), DVB-T/H, ISDB-T, CMMB, LTE, LTE-TDD, Digital Cable TV, WLAN, MSR, LTEAFDD, LTEATDD
Remote Command	[:SENSe]:SEMAsk:AVERAge:COUNT <integer> [:SENSe]:SEMAsk:AVERAge:COUNT? [:SENSe]:SEMAsk:AVERAge[:STATe] ON OFF 1 0 [:SENSe]:SEMAsk:AVERAge[:STATe]?
Example	SEM:AVER:COUN 100 SEM:AVER:COUN? SEM:AVER ON SEM:AVER?
Notes	You must be in the mode that includes SEM measurement to use this command. Use :INSTrument:SElect to set the mode.
Preset	10 OFF
State Saved	Saved in instrument state.
Min	1
Max	10000
Initial S/W Revision	Prior to A.02.00
Modified at S/W Revision	A.02.00, A.03.00

Meas Type

Accesses a menu that enables you to select one of the following measurement reference types:

- Total Pwr Ref – Sets the reference to the total carrier power and the measured data is shown in dBc and dBm.
- PSD Ref – Sets the reference to the mean power spectral density of the carrier and the measured data is shown in dB and dBm/Hz.
- Spectrum Peak Ref – Sets the reference to the spectrum peak power of the carrier and the measured data is shown in dB and dBm.

Key Path	Meas Setup
Mode	SA, WCDMA, C2K, WIMAX OFDMA, TD-SCDMA, 1xEVDO, DTMB (CTTB), DVB-T/H, ISDB-T, CMMB, LTE, LTE-TDD, Digital Cable TV, WLAN, MSR, LTEAFDD, LTEATDD
Remote Command	[:SENSe] :SEMask:TYPE PSDRef TPRef SPRef [:SENSe] :SEMask:TYPE?
Example	SEM:TYPE PSDR SEM:TYPE?
Notes	You must be in the mode that includes SEM measurement to use this command. Use :INSTrument:SElect to set the mode.
Preset	SA, , WCDMA, , C2K, , TD-SCDMA, , 1xEVDO, , DTMB (CTTB), , DVB-T/H, , ISDB-T, , CMMB, , LTE, , LTE-TDD, , Digital Cable TV, , MSR, , LTEAFDD, , LTEATDD: TPRef WIMAX OFDMA, WLAN: SPRef
State Saved	Saved in instrument state.
Range	Total Pwr Ref PSD Ref Spectrum Peak Ref
Initial S/W Revision	Prior to A.02.00
Modified at S/W Revision	A.02.00, A.03.00

Ref Channel

Accesses a menu that enables you to set up the measurement parameters used to calculate the power in the reference channel.

Key Path	Meas Setup
Initial S/W Revision	Prior to A.02.00

Integ BW

Specifies the integration bandwidth used to calculate the power in the reference channel.

Key Path	Meas Setup, Ref Channel
Mode	SA, WCDMA, C2K, WIMAX OFDMA, TD-SCDMA, 1xEVDO, DTMB (CTTB), DVB-T/H, ISDB-T, CMMB, LTE, LTE-TDD, Digital Cable TV, WLAN
Remote Command	[:SENSe] :SEMask:BANDwidth[1] 2:INTEgration <bandwidth> [:SENSe] :SEMask:BANDwidth[1] 2:INTEgration?

Example	SEM:BAND:INT 10 MHz SEM:BAND:INT?
Notes	10% . 100% of Channel Span Parameter Value Bandwidth sub op code, 1 is for BTS, 2 for MS. Default is BTS. You must be in the mode that includes SEM measurement to use this command. Use :INSTrument:SElect to set the mode.
Dependencies	For MSR and LTE-Advanced FDD/TDD mode, this key is blank.
Couplings	Cannot be higher than the channel Span. If lower than 1/10 of channel Span, then the channel Span is reduced to be 10 times the Integ BW.
Preset	SA: 3.84 MHz WCDMA: 3.84 MHz 3.84 MHz C2K: 1.23 MHz 1.23 MHz WIMAX OFDMA: 10 MHz 10 MHz TD-SCDMA: 1.28 MHz 1.28 MHz 1xEVDO: 1.23MHz DTMB (CTTB): 7.56MHz DVB-T/H: 7.61MHz ISDB-T: 5.6MHz CMMB: 7.512MHz LTE: 4.515MHz 4.5MHz LTETDD: 4.515MHz 4.5MHz Digital Cable TV: 6.9MHz WLAN: if Radio Std is 802.11a/g(OFDM/DSSS-OFDM)/802.11n(20 MHz)/ 802.11ac (20 MHz): 18 MHz if Radio Std is 802.11b/g(DSSS/CCK/PBCC): 22 MHz if Radio Std is 802.11n(40MHz)/ 802.11ac (40 MHz): 38 MHz if Radio Std is 802.11ac (80 MHz): 78 MHz if Radio Std is 802.11ac (160 MHz): 158 MHz if Radio Std is 802.11ac (80 MHz + 80 MHz): 78 MHz
State Saved	Saved in instrument state.
Min	1 kHz
Max	645 MHz
Initial S/W Revision	Prior to A.02.00
Modified at S/W Revision	A.02.00, A.03.00

Span

Specifies the span used to calculate the power in the reference channel.

Key Path	Meas Setup, Ref Channel
-----------------	-------------------------

Mode	SA, WCDMA, C2K, WIMAX OFDMA, TD-SCDMA, 1xEVDO, DTMB (CTTB), DVB-T/H, ISDB-T, LTE, LTETDD, CMMB, Digital Cable TV, WLAN
Remote Command	[:SENSe] :SEMAsk:FREQuency[1] 2:SPAN <freq> [:SENSe] :SEMAsk:FREQuency[1] 2:SPAN?
Example	SEM:FREQ:SPAN 3MHz SEM:FREQ:SPAN?
Notes	Frequency sub op code, 1 is for BTS, 2 for MS. Default is BTS. You must be in the mode that includes SEM measurement to use this command. Use :INSTrument:SElect to set the mode.
Dependencies	For MSR and LTE-Advanced FDD/TDD mode, this key is blank.
Couplings	Range 1 kHz to 50 MHz (although restricted by Integ BW). If you set the channel Span lower than channel Integ BW, they will both track each other. As you increase the channel Span, the Integ BW will also increase if it is less than 1/10 of the channel Span. For WLAN 802.11ac (80 + 80 MHz), the channel span is coupled with the difference between the center frequencies of the two carriers. When the difference is either less than 80 MHz or greater than 565 MHz, a “setting conflict” error message is displayed. Chan Span = Carrier Spacing + Chan IntegBW;
Preset	SA: 5.0 MHz WCDMA: 5.0 MHz 5.0 MHz C2K: 1.25 MHz 1.25 MHz WIMAX OFDMA: 10 MHz 10 MHz TD-SCDMA: 1.6 MHz 1.6 MHz 1xEVDO: 1.25 MHz DTMB (CTTB): 10 MHz DVB-T/H: 10 MHz ISDB-T: 8 MHz CMMB: 10 MHz LTE: 5 MHz LTETDD: 5 MHz Digital Cable TV: 10 MHz WLAN: if Radio Std is 802.11a/g(OFDM/DSSS-OFDM)/802.11n(20 MHz)/ 802.11ac (20 MHz): 18 MHz if Radio Std is 802.11b/g(DSSS/CCK/PBCC): 22 MHz if Radio Std is 802.11n(40MHz)/ 802.11ac (40 MHz): 38 MHz if Radio Std is 802.11ac (80 MHz): 78 MHz if Radio Std is 802.11ac (160 MHz): 158 MHz if Radio Std is 802.11ac (80 MHz + 80 MHz): 240 MHz
State Saved	Saved in instrument state.
Min	1 kHz
Max	645 MHz
Initial S/W Revision	Prior to A.02.00
Modified at S/W Revision	A.02.00, A.03.00

Sweep Time

Sets the sweep time used to calculate the power in the reference channel. Sweep Time can be set manually or put in auto mode.

Key Path	Meas Setup, Ref Channel
Mode	SA, WCDMA, C2K, WIMAX OFDMA, TD-SCDMA, 1xEVDO, DTMB (CTTB), DVB-T/H, ISDB-T, CMMB, LTE, LTETDD, Digital Cable TV, WLAN, MSR, LTEAFDD, LTEATDD
Remote Command	[:SENSe]:SEMAsk:SWEep[1] 2:TIME <time> [:SENSe]:SEMAsk:SWEep[1] 2:TIME? [:SENSe]:SEMAsk:SWEep[1] 2:TIME:AUTO OFF 0 ON 1 [:SENSe]:SEMAsk:SWEep[1] 2:TIME:AUTO?
Example	SEM:SWE:TIME 9ms SEM:SWE:TIME? SEM:SWE:TIME:AUTO OFF SEM:SWE:TIME:AUTO?
Notes	Sub op code, 1 is for BTS, 2 for MS. Default is BTS. You must be in the mode that includes SEM measurement to use this command. Use :INSTrument:SElect to set the mode.
Couplings	When the time is set manually, Auto is set to OFF. Value is coupled with Channel Detector selection, Channel Resolution BW, Channel Video BW if the state is Auto. When set to Auto, the Sweep Time is automatically calculated
Preset	Automatically calculated ON
State Saved	Saved in instrument state.
Min	1 ms
Max	4000 s
Initial S/W Revision	Prior to A.02.00
Modified at S/W Revision	A.02.00, A.03.00

Res BW

Sets the resolution bandwidth used to calculate the power in the reference channel. The Channel Resolution BW can be set manually or put in to auto mode.

MSR Auto RBW:

In the MSR resolution bandwidth is predefined for each radio format. When carriers are configured with multiple radio formats, the narrowest RBW is selected.

LTE	1.4 MHz	13
	3 MHz	27
	5 MHz	47
	10 MHz	91
	15 MHz	150
	20 MHz	180
W-CDMA		75
GSM		30

In LTE-Advanced FDD/TDD, the resolution bandwidth is predefined based on the corresponding bandwidth of the single LTE carrier, which is listed above. When ResBW mode is Auto, the narrowest RBW is selected.

Key Path	Meas Setup, Ref Channel
Mode	SA, WCDMA, C2K, WIMAX OFDMA, TD-SCDMA, 1xEVDO, DTMB (CTTB), DVB-T/H, ISDB-T, CMMB, LTE, LTE-TDD, Digital Cable TV, WLAN, MSR, LTEAFDD, LTEATDD
Remote Command	<pre>[:SENSe]:SEMask:BANDwidth[1] 2[:RESolution] <bandwidth> [:SENSe]:SEMask:BANDwidth[1] 2[:RESolution]? [:SENSe]:SEMask:BANDwidth[1] 2[:RESolution]:AUTO OFF ON 1 0 [:SENSe]:SEMask:BANDwidth[1] 2[:RESolution]:AUTO?</pre>
Example	<pre>SEM:BAND 100 kHz SEM:BAND? SEM:BAND:AUTO ON SEM:BAND:AUTO?</pre>
Notes	<p>Bandwidth sub op code, 1 is for BTS, 2 for MS. Default is BTS.</p> <p>You must be in the mode that includes SEM measurement to use this command. Use :INSTrument:SElect to set the mode.</p>
Couplings	<p>When Res BW is set manually, Channel Resolution BW Mode is set to MANual.</p> <p>Value is coupled with Channel Detector selection, Channel Sweep Time, Channel Video BW.</p> <p>When set to Auto, the resolution bandwidth is automatically calculated.</p>
Preset	<pre>SA: 100 kHz WCDMA: 75 kHz C2K: 24 kHz WIMAX OFDMA: 100 kHz TD-SCDMA: 30 kHz 1xEVDO: 30.0 KHz DTMB (CTTB): 3.9 kHz DVB-T/H: 3.9 kHz ISDB-T: 10 kHz CMMB: 3.9 kHz</pre>

	LTE, , LTETDD, , MSR, , LTEAFDD, , LTEATDD:Auto (47 kHz) Digital Cable TV: 3.9 kHz WLAN: 100 kHz ON
State Saved	Saved in instrument state.
Min	1 Hz
Max	8 MHz
Backwards Compatibility SCPI	[:SENSe] :SEMAsk :BWIDth [1] 2 [:RESolution]
Initial S/W Revision	Prior to A.02.00
Modified at S/W Revision	A.02.00, A.03.00

Video BW

Sets the video bandwidth used to calculate the power in the reference channel. The Channel Video BW can be set manually or put in to auto mode.

Key Path	Meas Setup, Ref Channel
Mode	SA, WCDMA, C2K, WIMAX OFDMA, TD-SCDMA, 1xEVDO, DTMB (CTTB), DVB-T/H, ISDB-T, CMMB, LTE, LTETDD, Digital Cable TV, WLAN, MSR, LTEAFDD, LTEATDD
Remote Command	[:SENSe] :SEMAsk :BANDwidth [1] 2 :VIDeo <bandwidth> [:SENSe] :SEMAsk :BANDwidth [1] 2 :VIDeo? [:SENSe] :SEMAsk :BANDwidth [1] 2 :VIDeo :AUTO OFF ON 1 0 [:SENSe] :SEMAsk :BANDwidth [1] 2 :VIDeo :AUTO?
Example	SEM:BAND:VID 100 kHz SEM:BAND:VID? SEM:BAND:VID:AUTO ON SEM:BAND:VID:AUTO?
Notes	Bandwidth sub op code, 1 is for BTS, 2 for MS. Default is BTS. You must be in the mode that includes SEM measurement to use this command. Use :INSTrument:SElect to set the mode.
Couplings	When Video BW is set manually, Channel Video BW Mode is set to MANual Value is coupled with Channel Detector selection, Channel Sweep Time, Channel Resolution BW. When set to Auto, the video bandwidth is automatically calculated.
Preset	SA: 100 kHz WCDMA: 75 kHz C2K: 24 kHz WIMAX OFDMA: 30 kHz TD-SCDMA: 300 kHz 1xEVDO: 300.0 kHz

	DTMB (CTTB): 39 kHz DVB-T/H: 39 kHz ISDB-T: 1 kHz CMMB: 39 kHz LTE, MSR, LTEAFDD, LTEATDD: Auto LTETDD: Auto Digital Cable TV: 39 kHz WLAN: Auto ON
State Saved	Saved in instrument state.
Min	1 Hz
Max	50 MHz
Backwards Compatibility SCPI	[:SENSe] :SEMAsk:BWIDth [1] 2 :VIDeo
Initial S/W Revision	Prior to A.02.00
Modified at S/W Revision	A.02.00, A.03.00

VBW/RBW

Sets the Video BW/Resolution BW Ratio to calculate the Channel Resolution BW and Channel Video BW. The VBW/RBW Ratio can be set manually or put in to auto mode.

Key Path	Meas Setup, Ref Channel
Mode	SA, WCDMA, C2K, WIMAX OFDMA, TD-SCDMA mode, 1xEVDO, DTMB (CTTB), DVB-T/H, ISDB-T, CMMB, LTE, LTETDD, Digital Cable TV, WLAN, MSR, LTEAFDD, LTEATDD
Remote Command	[:SENSe] :SEMAsk:BA NDwidth [1] 2 :VIDeo:RATio <real> [:SENSe] :SEMAsk:BA NDwidth [1] 2 :VIDeo:RATio [:SENSe] :SEMAsk:BA NDwidth [1] 2 :VIDeo:RATio:AUTO OFF ON 1 0 [:SENSe] :SEMAsk:BA NDwidth [1] 2 :VIDeo:RATio:AUTO?
Example	SEM:BA ND:VID:RAT 0.1 SEM:BA ND:VID:RAT? SEM:BA ND:VID:RAT:AUTO ON SEM:BA ND:VID:RAT:AUTO?
Notes	Bandwidth sub op code, 1 is for BTS, 2 for MS. Default is BTS. You must be in the mode that includes SEM measurement to use this command. Use :INSTrument:SElect to set the mode.
Couplings	When Video BW/Res BW is set manually, Channel VBW/RBW Ratio Mode is set to MANual When set to Auto, the VBW/RBW Ratio is automatically calculated.
Preset	SA, WCDMA, C2K: 1.0 WIMAX OFDMA: 0.3

	TD-SCDMA: 10 1xEVDO: 10.0 DTMB (CTTB): 10 DVB-T/H: 10 ISDB-T: 0.1 CMMB: 10 LTE, MSR: Auto LTEAFDD,LTEATDD:Auto LTETDD: Auto Digital Cable TV: 10 WLAN: Auto ON
State Saved	Saved in instrument state.
Min	0.00001
Max	3000000
Backwards Compatibility SCPI	[:SENSe] :SEMAsk:BWIDth [1] 2 :VIDeo:RATio
Initial S/W Revision	Prior to A.02.00
Modified at S/W Revision	A.02.00, A.03.00

Power Ref (for the modes except MSR and LTE-Advanced FDD/TDD)

Sets the power reference in the carrier that will be used to compute the relative values for the offsets.

Key Path	Meas Setup, Ref Channel
Initial S/W Revision	Prior to A.02.00

Total Power

Sets the power in the carrier (ref channel) that is used to compute the relative power values for the offsets. When the state is set to auto, this value is set to the measured carrier reference power. When set to manual, the result takes on the last measured value, or can be manually entered.

For WLAN 802.11ac (80 MHz + 80 MHz), the higher of the power readouts of the two carriers is used for computing the relative power values for the offset.

Key Path	Meas Setup, Ref Channel, Power Ref
Mode	SA, WCDMA, C2K, WIMAX OFDMA, TD-SCDMA, 1xEVDO, DTMB (CTTB), DVB-T/H, ISDB-T, CMMB, LTE, LTETDD, Digital Cable TV, WLAN, MSR, LTEAFDD, LTEATDD
Remote Command	[:SENSe] :SEMAsk:CARRier [:POWer] <real> [:SENSe] :SEMAsk:CARRier [:POWer] ?

	<code>[:SENSe] :SEMask:CARRier:AUTO[:STATe] OFF ON 1 0</code> <code>[:SENSe] :SEMask:CARRier:AUTO[:STATe] ?</code>
Example	SEM:CARR 100dBm SEM:CARR? SEM:CARR:AUTO OFF SEM:CARR:AUTO?
Notes	The min and max values given are for Meas Type = Total Pwr Ref. You must be in the mode that includes SEM measurement to use this command. Use :INSTrument:SElect to set the mode.. This BAF SCPI command is available in all the Meas Type case. This BAF SCPI command is not available in MSR and LTE-Advanced FDD/TDD mode.
Dependencies	This "Total Power Ref" parameter is coupled with the "Meas Type" parameter. The softkey is active when Meas Type is set to Total Power Ref. Otherwise, it is grayed out.
Preset	Measured carrier reference power
State Saved	Saved in instrument state.
Min	-200 dBm
Max	200 dBm
Initial S/W Revision	Prior to A.02.00
Modified at S/W Revision	A.02.00, A.03.00

PSD

Sets the power spectral density in the carrier that is used to compute the relative power spectral density values for the offsets when Meas Type is set to PSD Ref. When the state is set to auto, this will be set to the measured carrier power spectral density.

For WLAN 802.11ac (80 MHz + 80 MHz), the higher of the power density readouts of the two carriers is used for computing the relative PSD values for the offset.

Key Path	Meas Setup, Ref Chan, Power Ref
Mode	SA, WCDMA, C2K , WIMAX OFDMA, TD-SCDMA, 1xEVDO, DTMB (CTTB), DVB-T/H, ISDB-T, CMMB, LTE, LTE-TDD, Digital Cable TV, WLAN, MSR, LTEAFDD, LTEATDD
Remote Command	<code>[:SENSe] :SEMask:CARRier:CPSD <real></code> <code>[:SENSe] :SEMask:CARRier:CPSD?</code>
Example	SEM:CARR:CPSD -80 SEM:CARR:CPSD?
Notes	Although the default value is defined, the value is recalculated by the measurement result just after completing the measurement. Carrier sub op code. 1 for BTS, 2 for MS. Default is BTS. You must be in the mode that includes SEM measurement to use this command. Use :INSTrument:SElect to set the mode.

Dependencies	See Couplings
Couplings	This "PSD" parameter is coupled with the "Meas Type" parameter. The key will be active if the Meas Type is set to PSD. Otherwise, it is grayed out.
Preset	Measured carrier PSD reference power
State Saved	Saved in instrument state.
Min	-200
Max	200
Initial S/W Revision	Prior to A.02.00
Modified at S/W Revision	A.02.00, A.03.00

Spectrum Peak

Sets the spectrum peak power in the carrier that is used to compute the relative power spectral density values for the offsets when Meas Type is set to Spectrum Peak. When the state is set to auto, this is set to the measured carrier spectrum peak power. When set to manual, the result takes on the last measured value, or can be manually entered

Key Path	Meas Setup, Ref Channel, Power Ref
Mode	SA, WCDMA, C2K, WIMAX OFDMA, TD-SCDMA, 1xEVDO, DTMB (CTTB), DVB-T/H, ISDB-T, CMMB, LTE, LTETDD, Digital Cable TV, WLAN
Remote Command	[:SENSe] :SEMAsk :CARRier :PEAK [:POWer] <real> [:SENSe] :SEMAsk :CARRier :PEAK [:POWer] ?
Example	SEM:CARR:PEAK -80 SEM:CARR:PEAK:POWER?
Notes	Although the default value is defined, the value is recalculated by the measurement result just after completing the measurement. Carrier sub op code. 1 for BTS, 2 for MS. Default is BTS. You must be in the mode that includes SEM measurement to use this command. Use :INSTRument:SElect to set the mode.
Dependencies	See Couplings
Couplings	This "Spectrum Peak Ref" parameter is coupled with the "Meas Type" parameter. This softkey is active when the "Meas Type" is set to "Spectrum Peak Ref". Otherwise, grayout.
Preset	Measured carrier Spectrum Peak reference power
State Saved	Saved in instrument state.
Min	-200
Max	200
Initial S/W Revision	Prior to A.02.00
Modified at S/W Revision	A.02.00, A.03.00

Offset/Limits

Accesses a menu that enables you to set up the measurement parameters for offset pairs. For example, you can assign the start and stop frequencies, select the resolution bandwidth, and set the sweep time. When in the MSR and LTE-Advanced FDD/TDD mode, the softkey label changes to Outer Offset/Limits.

Key Path	Meas Setup
Initial S/W Revision	Prior to A.02.00
Modified at S/W Revision	A.14.00

Select Offset

Selects the offset (upper and lower) and displays the memory selection menu that enables you to store a set of parameter values for the offset, such as Start Freq, Stop Freq, Sweep Time, Res BW, Meas BW, Abs Start, and Abs Stop. Only one selection at a time is shown on this menu key label.

Key Path	Meas Setup, Offset/Limits
Mode	SA, WCDMA, C2K, WIMAX OFDMA, TD-SCDMA, 1xEVDO, DTMB (CTTB), DVB-T/H, ISDB-T, CMMB, LTE, LTE-TDD, Digital Cable TV, WLAN, MSR, LTEAFDD, LTEATDD
Preset	A
Range	MSR, LTEATDD, LTEAFDD, WLAN: A B C D E F G H J K L Other modes without option N9060A-7FP: A B C D E F Other modes with option N9060A-7FP: A B C D E F G H J K L
Initial S/W Revision	Prior to A.02.00
Modified at S/W Revision	A.02.00, A.03.00, A.10.00, A.11.00, A.14.00

Start Freq

Specifies the start frequency for the currently selected offset. Also enables you to toggle that offset between On and Off.

Missing values are not permitted; that is, if you want to change values 2 and 6, you must send all values up to 6. Subsequent values will remain as they were. The query for this parameter always returns 12 values.

Key Path	Meas Setup, Offset/Limits
Mode	SA, WCDMA, C2K, WIMAX OFDMA, TD-SCDMA, 1xEVDO, DTMB (CTTB), DVB-T/H, ISDB-T, CMMB, LTE, LTE-TDD, Digital Cable TV, WLAN, MSR, LTEAFDD, LTEATDD
Remote Command	[:SENSe] :SEMAsk:OFFSet [1] 2 [:OUTer] :LIST:FREQuency:STARt <freq>, ... [:SENSe] :SEMAsk:OFFSet [1] 2 [:OUTer] :LIST:FREQuency:STARt? [:SENSe] :SEMAsk:OFFSet [1] 2 [:OUTer] :LIST:STATe ON OFF 1 0, ... [:SENSe] :SEMAsk:OFFSet [1] 2 [:OUTer] :LIST:STATe?
Example	SEM:OFFS2:LIST:FREQ:STAR 2.515 MHz, , 2.715 MHz, , 3.515 MHz, , 4.00 MHz, , 8.00 MHz, , 12.50 MHz

	<p>SEM:OFFS2:LIST:FREQ:STAR? SEM:OFFS:LIST:STAT ON, , ON, , ON, , OFF, , OFF, , OFF SEM:OFFS:LIST:STAT?</p>
Notes	<p>Comma separated list of values. OFFSet1 is for BTS, 2 for MS. Default is BTS. You must be in the mode that includes SEM measurement to use this command. Use :INSTrument:SElect to set the mode.</p>
Couplings	<p>Coupled to Stop Freq. When the start freq goes above the stop freq, the stop freq is automatically adjusted to the start freq plus 100 Hz. If the current mode is DVB-T/H, this value will be modified automatically according to the limit type and the output power of the transmitter which is less or more than 25 W. If the current mode is ISDB-T, this value will be modified automatically according to the limit type.</p>
Preset	<p>For modes (except MSR, , LTEAFDD, , LTEATDD and WLAN) without option N9060A-7FP, , the preset value is as follows. SA: 2.515 MHz, , 2.715 MHz, , 3.515 MHz, , 4.00 MHz, , 8.00 MHz, , 12.50 MHz WCDMA: 2.515 MHz, , 2.715 MHz, , 3.515 MHz, , 4.000 MHz, , 8.000 MHz, , 12.50 MHz 2.515MHz, , 4.000 MHz, , 7.500 MHz, , 8.500 MHz, , 12.5 MHz, , 15 MHz C2K: 750.0 kHz, , 780.0 kHz, , 1.980 MHz, , 3.25 MHz, , 7.0 MHz, , 7.0 MHz 885 kHz, , 1.980 MHz, , 2.250 MHz, , 8.0 MHz, , 12.0 MHz, , 12.0 MHz WIMAX OFDMA: 4.75 MHz, 5.45 MHz, 9.75 MHz, 14.75 MHz, 19.75 MHz, 24.75 MHz 4.75 MHz, 5.45 MHz, 9.75 MHz, 14.75 MHz, 19.75 MHz, 24.75 MHz TD-SCDMA: 81 5kHz, 1015 kHz, 1815 kHz, 2.3 MHz, , , 2.3 MHz, , 2.3 MHz 815 kHz, 1.8 MHz, 2.9 MHz, , 2.9 MHz, 2.9 MHz, , 2.9 MHz 1xEVDO: 750.0 kHz, , 780.0 kHz, , 1.98 MHz, , 3.25 MHz, , 7 MHz, , 7 MHz 885.0 kHz, , 1.98 MHz, , 1.98 MHz, , 1.98 MHz, , 1.98 MHz DTMB (CTTB): 3.8 MHz, , 4.2 MHz, , 6 MHz, , 6 MHz, , 6 MHz, 6 MHz 6MHz, , 6MHz, , 6MHz, , 6MHz, , 6MHz, , 6MHz DVB-T/H: 3.81 MHz, , 4.2 MHz, , 6 MHz, , 6 MHz, , 6 MHz, , 6 MHz 6MHz, , 6MHz, , 6MHz, , 6MHz, , 6MHz ISDB-T: 2.79 MHz, , 2.86 MHz, , 3.0 MHz, , 4.36 MHz, , 6 MHz, , 6 MHz 6MHz, , 6MHz, , 6MHz, , 6MHz, , 6MHz, , 6MHz CMMB: 3.8 MHz, , 4.2 MHz, , 8.0 MHz, , 6 MHz, , 6 MHz, , 6 MHz 6MHz, , 6MHz, , 6MHz, , 6MHz, , 6MHz LTE, , LTETDD: 50 kHz, , 5.05 MHz, , 10.5 MHz, , 15.00 MHz, , 30 MHz, , 40 MHz 15.00 kHz, 1.5 MHz, 5.5 MHz, 6.5 MHz, 10 MHz, 20MHz Digital Cable TV: 3.8 MHz, , 4.2 MHz, , 6 MHz, , 6 MHz, , 6 MHz, , 6 MHz 6MHz, , 6MHz, , 6MHz, , 6MHz, , 6MHz When option N9060A-7FP is installed in these modes, , the preset value of Offset G ~ L is the same as the Offset F value. ----- WLAN: if Radio Std is 802.11a/g(OFDM/DSSS-OFDM)/802.11n(20MHz): 9 MHz, , 11 MHz, , 20 MHz, , 30</p>

MHz, 50 MHz, 216 MHz, 216 MHz, 216 MHz, 216 MHz, 216 MHz, 216 MHz, 216 MHz

if Radio Std is 802.11b/g(DSSS/CCK/PBCC): 11 MHz, 22 MHz, 50 MHz, 70 MHz, 90 MHz, 100 MHz, 100 MHz, 100 MHz, 100 MHz, 100 MHz, 100 MHz, 100 MHz

if Radio Std is 802.11n(20MHz): 9 MHz, 11 MHz, 20 MHz, 30 MHz, 50 MHz, 100 MHz, 100 MHz, 100 MHz, 100 MHz, 100 MHz, 100 MHz

if Radio Std is 802.11n(40MHz): 19 MHz, 21 MHz, 40 MHz, 60 MHz, 100 MHz, 200 MHz, 200 MHz, 200 MHz, 200 MHz, 200 MHz, 200 MHz

if Radio Std is 802.11ac(20MHz): 9 MHz, 11 MHz, 20 MHz, 30 MHz, 30 MHz, 30 MHz, 30 MHz, 30 MHz, 30 MHz, 30 MHz, 30 MHz, 30 MHz

if Radio Std is 802.11ac(40MHz): 19 MHz, 21 MHz, 40 MHz, 60 MHz, 60 MHz, 60 MHz, 60 MHz, 60 MHz, 60 MHz, 60 MHz, 60 MHz, 60 MHz

if Radio Std is 802.11ac(80MHz): 39 MHz, 41 MHz, 80 MHz, 120 MHz, 120 MHz, 120 MHz, 120 MHz, 120 MHz, 120 MHz, 120 MHz, 120 MHz, 120 MHz

if Radio Std is 802.11ac(160MHz): 79 MHz, 81 MHz, 160 MHz, 240 MHz, 240 MHz, 240 MHz, 240 MHz, 240 MHz, 240 MHz, 240 MHz, 240 MHz, 240 MHz

if Radio Std is 802.11ac(80 MHz + 80MHz): 0 MHz, 40 MHz, 79 MHz, 159 MHz, 161 MHz, 200 MHz, 240 MHz, 240 MHz, 240 MHz, 240 MHz, 240 MHz, 240 MHz, 240 MHz

MSR:15 kHz, 215kHz, 1.015MHz, 1.5MHz, 10.5MHz, 15.00MHz, 30MHz, 30MHz, 30MHz, 30MHz, 30MHz | 15kHz, 215kHz, 1.015MHz, 1.5MHz, 10.5MHz, 15.00MHz, 30MHz, 30MHz, 30MHz, 30MHz, 30MHz, 30MHz, 30MHz

LTEAFDD, LTEATDD: 50 kHz, 5.05 MHz, 10.5 MHz, 15.00 MHz, 30 MHz, 40 MHz, 40 MHz, 40 MHz, 40 MHz, 40 MHz | 15.00 kHz, 1.5 MHz, 5.5 MHz, 6.5 MHz, 10 MHz, 20MHz, 20MHz, 20MHz, 20MHz, 20MHz, 20MHz, 20MHz

For modes (except MSR, LTEAFDD, LTEATDD and WLAN) without option N9060A-7FP, the preset value is as follows.

SA: ON, ON, ON, ON, ON, OFF

WCDMA: ON, ON, ON, ON, ON, OFF|ON, ON, ON, ON, OFF, OFF

C2K: ON, ON, ON, OFF, OFF, OFF|ON, ON, OFF, OFF, OFF, OFF

WIMAX OFDMA: ON, ON, ON, OFF, OFF, OFF|ON, ON, ON, OFF, OFF, OFF

TD-SCDMA: ON, ON, ON, ON, OFF, OFF|ON, ON, ON, OFF, OFF, OFF

1xEVDO: ON, ON, ON, OFF, OFF, OFF|ON, ON, OFF, OFF, OFF, OFF

DTMB (CTTB), DVB-T/H, CMMB, Digital Cable TV: ON, ON, ON, OFF, OFF, OFF

ISDB-T: ON, ON, ON, ON, OFF, OFF

LTE, LTE-TDD: ON, ON, ON, OFF, OFF, OFF|ON, ON, ON, ON, OFF, OFF

When option N9060A-7FP is installed in these modes, the preset value of Offset G ~ L is the same as the Offset F value.

WLAN:

if Radio Std is 802.11b/g(DSSS/CCK/PBCC): ON, ON, OFF, OFF, OFF, OFF, OFF, OFF, OFF, OFF, OFF, OFF

if Radio Std is 802.11a/g(OFDM/DSSS-OFDM)/802.11n(20MHz/40MHz): ON, ON, ON, ON, OFF, OFF, OFF, OFF, OFF, OFF, OFF, OFF

if Radio Std is 802.11ac (20 MHz/ 40 MHz/ 80 MHz/ 160 MHz): ON, ON, ON, ON, OFF, OFF, OFF, OFF, OFF, OFF, OFF, OFF

	if Radio Std is 802.11ac (80 MHz + 80 MHz): ON, , ON, , ON, , ON, , ON, , ON, , OFF, , OFF, , OFF, , OFF, , OFF MSR:ON, , ON, , ON, , ON, , ON, , OFF, , OFF, , OFF, , OFF, , OFF, , OFF, , OFF ON, , ON, , ON, , ON, , ON, , OFF, , OFF, , OFF, , OFF, , OFF, , OFF, , OFF LTEAFDD, , LTEATDD: ON, , ON, , ON, , OFF, , OFF, , OFF, OFF, , OFF, , OFF, , OFF, OFF, OFF ON, , ON, , ON, , ON, , OFF, , OFF, , OFF, , OFF, , OFF, , OFF, , OFF, , OFF, , OFF
State Saved	Saved in instrument state.
Min	0 Hz
Max	499.9999 MHz
Initial S/W Revision	Prior to A.02.00
Modified at S/W Revision	A.02.00, A.03.00, A.10.00, A.11.00, A.14.00

Stop Freq

Specifies the stop frequency for the currently selected offset.

Missing values are not permitted; that is, if you want to change values 2 and 6, you must send all values up to 6. Subsequent values will remain as they were. The query for this parameter always returns 12 values.

Key Path	Meas Setup, Offset/Limits
Mode	SA, WCDMA, C2K, WIMAX OFDMA, TD-SCDMA, 1xEVDO, DTMB (CTTB), DVB-T/H, ISDB-T, CMMB, LTE, LTE-TDD, Digital Cable TV, WLAN, MSR, LTEAFDD, LTEATDD
Remote Command	[:SENSE] :SEMAsk:OFFSet [1] 2 [:OUTer] :LIST:FREQuency:STOP <freq>, ... [:SENSE] :SEMAsk:OFFSet [1] 2 [:OUTer] :LIST:FREQuency:STOP?
Example	SEM:OFFS:LIST:FREQ:STOP 2.715 MHz, , 3.515 MHz, , 4.00 MHz, , 8.00 MHz, , 12.50 MHz, , 15.0 MHz SEM:OFFS:LIST:FREQ:STOP?
Notes	Comma separated list of values. OFFSet1 is for BTS, 2 for MS. Default is BTS. You must be in the mode that includes SEM measurement to use this command. Use :INSTrument:SElect to set the mode.
Couplings	Coupled to Start Freq. When the stop freq goes below the start freq, the start freq is automatically adjusted to the stop freq minus 100 Hz. If the current mode is DVB-T/H, this value will be modified automatically according to the limit type and the output power of the transmitter which is less or more than 25 W. If the current mode is ISDB-T, this value will be modified automatically according to the limit type.
Preset	For modes (except MSR, , LTEAFDD, , LTEATDD and WLAN) without option N9060A-7FP, , the preset value is as follows. SA: 2.715 MHz, , 3.515 MHz, , 4.00 MHz, , 8.00 MHz, , 12.50 MHz, , 15.0 MHz WCDMA:2.715 MHz, , 3.515 MHz, , 4.000 MHz, , 8.000 MHz, , 12.50 MHz, , 15.0 MHz 3.485 MHz, , 7.500 MHz, , 8.500 MHz, , 12.00 MHz, , 15.00 MHz, , 18.0 MHz

C2K: 780.0kHz , 1.980 MHz , 4.0 MHz , 4.0 MHz , 12.0 MHz , 12.0 MHz | 1.980 MHz , 4.0 MHz , 4.0 MHz , 11.5 MHz , 14.5 MHz , 14.5 MHz

WiMAX OFDMA: 5.45 MHz , 9.75 MHz , 14.75 MHz , 19.75 MHz , 24.75 MHz , 29.75 MHz | 5.45 MHz , 9.75 MHz , 14.75 MHz , 19.75 MHz , 24.75 MHz , 29.75 MHz

TD-SCDMA:

1015 kHz , 1815kHz , 2.3 MHz , 4 MHz , 4 MHz , 4 MHz | 1.8 MHz , 2385 kHz , 3.5 MHz , 3.5 MHz , 3.5 MHz , 3.5 MHz

1xEVDO: 780.0 kHz , 1.98 MHz , 4.0 MHz , 4.0 MHz , 12 MHz , 12 MHz | 1.98 MHz , 4.0 MHz , 4.0 MHz , 4.0 MHz , 4.0 MHz , 4.0 MHz

DTMB (CTTB): 4.2 MHz , 6 MHz , 12 MHz , 12 MHz , 12 MHz , 12 MHz | 12 MHz , 12 MHz , 12 MHz , 12 MHz , 12 MHz , 12 MHz

DVB-T/H: 4.2 MHz , 6 MHz , 12 MHz , 12 MHz , 12 MHz , 12 MHz | 12 MHz , 12 MHz , 12 MHz , 12 MHz , 12 MHz , 12 MHz

ISDB-T: 2.86 MHz , 3.0 MHz , 4.36 MHz , 15.0 MHz , 15.0 MHz , 15.0 MHz | 15MHz , 15MHz , 15MHz , 15MHz , 15MHz , 15MHz

CMMB: 4.2 MHz , 8.0 MHz , 12.0 MHz , 12.0 MHz , 12.0 MHz , 12.0 MHz | 12 MHz , 12 MHz , 12 MHz , 12 MHz , 12 MHz , 12 MHz

LTE , LTE-TDD: 5.05 MHz , 10.05 MHz , 15 MHz , 30 MHz , 40 MHz , 50 MHz | 985.0 kHz , 4.50 MHz , 5.5001 MHz , 9.50 MHz , 20 MHz , 40 MHz

Digital Cable TV: 4.2 MHz , 6.0 MHz , 12.0 MHz , 12.0 MHz , 12.0 MHz , 12.0 MHz , 12 MHz , 12 MHz , 12 MHz , 12 MHz , 12 MHz , 12 MHz

When option N9060A-7FP is installed in these modes , the preset value of Offset G ~ L is the same as the Offset F value.

WLAN:

if Radio Std is 802.11a/g(OFDM/DSSS-OFDM)/802.11n(20MHz): 11 MHz , 20 MHz , 30 MHz , 50 MHz , 100 MHz , 250 MHz , 250 MHz , 250 MHz , 250 MHz , 250 MHz , 250 MHz , 250 MHz

if Radio Std is 802.11b/g(DSSS/CCK/PBCC): 22 MHz , 50 MHz , 70 MHz , 90 MHz , 100 MHz , 120 MHz , 120 MHz , 120 MHz , 120 MHz , 120 MHz , 120 MHz , 120 MHz

if Radio Std is 802.11n(20MHz): 11 MHz , 20 MHz , 30 MHz , 50 MHz , 100 MHz , 200 MHz , 200 MHz , 200 MHz , 200 MHz , 200 MHz , 200 MHz , 200 MHz

if Radio Std is 802.11n(40MHz): 21 MHz , 40 MHz , 60 MHz , 100 MHz , 200 MHz , 300 MHz , 300 MHz , 300 MHz , 300 MHz , 300 MHz , 300 MHz , 300 MHz

if Radio Std is 802.11ac(20MHz): 11 MHz , 20 MHz , 30 MHz , 50 MHz , 50 MHz , 50 MHz , 50 MHz , 50 MHz , 50 MHz , 50 MHz , 50 MHz , 50 MHz

if Radio Std is 802.11ac(40MHz): 21 MHz , 40 MHz , 60 MHz , 100 MHz , 100 MHz , 100 MHz , 100 MHz , 100 MHz , 100 MHz , 100 MHz , 100 MHz , 100 MHz

if Radio Std is 802.11ac(80MHz): 41 MHz , 80 MHz , 120 MHz , 200 MHz , 200 MHz , 200 MHz , 200 MHz , 200 MHz , 200 MHz , 200 MHz , 200 MHz , 200 MHz

if Radio Std is 802.11ac(160MHz): 81 MHz , 160 MHz , 240 MHz , 400 MHz , 400 MHz , 400 MHz , 400 MHz , 400 MHz , 400 MHz , 400 MHz , 400 MHz , 400 MHz

if Radio Std is 802.11ac(80 MHz + 80MHz): 40 MHz , 79 MHz , 81 MHz , 161 MHz , 200 MHz , 240 MHz , 260 MHz , 260 MHz , 260 MHz , 260 MHz , 260 MHz , 260 MHz

MSR: 215kHz , 1.015MHz , 1.5MHz , 10.5MHz , 50MHz , 50MHz , 50MHz , 50MHz , 50MHz ,

	50MHz, , 50MHz, , 50MHz LTEAFDD, , LTEATDD: 5.05 MHz, , 10.05 MHz, , 15 MHz, , 30 MHz, , 40 MHz, , 50 MHz, , 50 MHz, , 50 MHz, , 50 MHz, , 50 MHz, , 50 MHz 985.0 kHz, , 4.50 MHz, , 5.5001 MHz, , 9.50 MHz, 20 MHz, , 40 MHz, , 40 MHz, , 40 MHz, , 40 MHz, , 40 MHz, , 40 MHz, , 40 MHz
State Saved	Saved in instrument state.
Min	100 Hz
Max	500 MHz
Initial S/W Revision	Prior to A.02.00
Modified at S/W Revision	A.02.00, A.03.00, A.10.00, A.11.00, A.14.00

Sweep Time

Specifies the sweep time for the currently selected offset and enables you to toggle the Sweep Time mode between Auto and Man.

Missing values are not permitted; that is, if you want to change values 2 and 6, you must send all values up to 6. Subsequent values will remain as they were. The query for this parameter always returns 12 values.

Key Path	Meas Setup, Offset/Limits
Mode	SA, WCDMA, C2K, WIMAX OFDMA, TD-SCDMA, 1xEVDO, DTMB (CTTB), DVB-T/H, ISDB-T, CMMB, LTE, LTETDD, Digital Cable TV, WLAN, MSR, LTEAFDD, LTEATDD
Remote Command	[:SENSE] :SEMAsk:OFFSet [1] 2 [:OUTer] :LIST:SWEep:TIME <time>, ... [:SENSE] :SEMAsk:OFFSet [1] 2 [:OUTer] :LIST:SWEep:TIME? [:SENSE] :SEMAsk:OFFSet [1] 2 [:OUTer] :LIST:SWEep:TIME:AUTO ON OFF 1 0, ... [:SENSE] :SEMAsk:OFFSet [1] 2 [:OUTer] :LIST:SWEep:TIME:AUTO?
Example	SEM:OFFS2:LIST:SWE:TIME 1.0 ms, , 3.4 ms, , 2.08 ms, , 1.0 ms, , 1.0 ms, , 1.0 ms SEM:OFFS2:LIST:SWE:TIME? SEM:OFFS2:LIST:SWE:TIME:AUTO ON, , ON, , ON, , ON, , OFF, , OFF SEM:OFFS2:LIST:SWE:TIME:AUTO?
Notes	Comma separated list of values. OFFSet1 is for BTS, 2 for MS. Default is BTS. You must be in the mode that includes SEM measurement to use this command. Use :INSTrument:SElect to set the mode.
Couplings	When the sweep time is set manually, Sweep Time Mode is set to MANual. If the current mode is DVB-T/H, this value will be modified automatically according to the output power of the transmitter which is less or more than 25W. If the current mode is ISDB-T, this value will be modified automatically according to the limit type.
Preset	Automatically calculated Modes (except MSR, , LTEAFDD, , LTEATDD and WLAN) without option N9060A-7FP: ON, ON, ON, ON, ON, ON

	Modes (except MSR, , LTEAFDD, , LTEATDD and WLAN) with option N9060A-7FP: ON, ON, ON, ON, ON, ON, ON, ON, ON, ON, ON, ON, ON, ON, ON, ON WLAN: ON, ON, ON, ON, ON, ON, ON, ON, ON, ON, ON, ON, ON, ON, ON, ON MSR: ON,ON,ON,ON,ON,ON,ON,ON,ON,ON,ON,ON,ON,ON,ON,ON LTEAFDD, , LTEATDD: ON, ON, ON, ON, ON, ON, ON, ON, ON, ON, ON, ON, ON, ON, ON ON, ON, ON, ON, ON, ON, ON, ON, ON, ON, ON, ON, ON, ON, ON, ON
State Saved	Saved in instrument state.
Min	1 ms
Max	4000 s
Backwards Compatibility SCPI	[:SENSe] :SEMAsk :OFFSet [1] 2 :LIST :SWEEp [:TIME]
Initial S/W Revision	Prior to A.02.00
Modified at S/W Revision	A.02.00, A.03.00, A.10.00, A.11.00, A.14.00

Offset Side

Specifies which offset side to measure.

You can turn off (not use) specific offsets with [:SENSe]:SEMAsk:OFFSet[n][:OUTer]:LIST:STATe.

- **BOTH** – Both of the negative (lower) and positive (upper) sidebands
- **NEGative** – Negative (lower) sideband only
- **POSitive** – Positive (upper) sideband only

Missing values are not permitted; that is, if you want to change values 2 and 6, you must send all values up to 6. Subsequent values will remain as they were. The query for this parameter always returns 12 values.

The figure below shows the relation between the negative/positive offset side setups and the upper/lower results in the MSR and LTE-Advanced FDD/TDD.

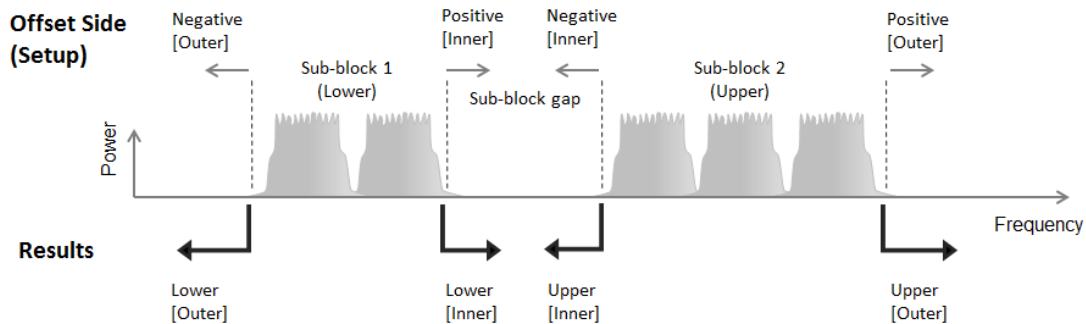

Key Path	Meas Setup, Offset/Limits
Mode	SA, WCDMA, C2K, WIMAX OFDMA, TD-SCDMA, 1xEVDO, DTMB (CTTB), DVB-T/H, ISDB-T, CMMB, LTE, LTEATDD, Digital Cable TV, WLAN, MSR, LTEAFDD, LTEATDD
Remote Command	[:SENSe] :SEMAsk :OFFSet [1] 2 [:OUTer] :LIST :SIDE BOTH NEGative

	POSitive, ... [:SENSe]:SEMAsk:OFFSet[1] 2[:OUTer]:LIST:SIDE?
Example	SEM:OFFS:LIST:SIDE BOTH, , NEG, , NEG, , POS, , POS, , POS SEM:OFFS:LIST:SIDE?
Notes	Comma separated list of values. OFFSet1 is for BTS, 2 for MS. Default is BTS. You must be in the mode that includes SEM measurement to use this command. Use :INSTrument:SElect to set the mode.
Preset	Modes (except MSR, , LTEAFDD, , LTEATDD and WLAN) without option N9060A-7FP: BOTH, , BOTH, , BOTH, , BOTH, , BOTH, , BOTH Modes (except MSR, , LTEAFDD, , LTEATDD and WLAN) with option N9060A-7FP: BOTH, , BOTH, , BOTH, , BOTH, , BOTH, , BOTH, , BOTH, , BOTH, , BOTH, , BOTH, , BOTH, , BOTH MSR: BOTH, , BOTH, , BOTH, , BOTH, , BOTH, , BOTH, , BOTH, , BOTH, , BOTH, , BOTH, , BOTH, , BOTH LTEAFDD, LTEATDD: BOTH, , BOTH, , BOTH, , BOTH, , BOTH, , BOTH, , BOTH, , BOTH, , BOTH, , BOTH, , BOTH, , BOTH BOTH, , BOTH, , BOTH, , BOTH, , BOTH, , BOTH, , BOTH, , BOTH, , BOTH, , BOTH, , BOTH, , BOTH WLAN: BOTH, , BOTH, , BOTH, , BOTH, , BOTH, , BOTH, , BOTH, , BOTH, , BOTH, , BOTH, , BOTH, , BOTH, , BOTH
State Saved	Saved in instrument state.
Range	Neg Both Pos
Initial S/W Revision	Prior to A.02.00
Modified at S/W Revision	A.02.00, A.03.00, A.10.00, A.11.00, A.14.00

Res BW

Specifies which Resolution BW filter to use when measuring the currently selected offset.

Offset Res BW Mode allows the instrument to determine the optimum Resolution BW filter to use when measuring the currently selected offset.. When changing the Meas BW parameter, if the Res BW needs to be changed to adhere to the rule

$$(N \times \text{Res BW}) \leq (\text{Stop freq of the offset} - \text{Start freq of the offset}),$$

where N is the multiplier, this setting will automatically be changed to manual.

Missing values are not permitted; that is, if you want to change values 2 and 6, you must send all values up to 6. Subsequent values will remain as they were. The query for this parameter always returns 12 values.

Key Path	Meas Setup, Offset/Limits
Mode	SA, WCDMA, C2K, WIMAX OFDMA, TD-SCDMA, 1xEVDO mode, DTMB (CTTB), DVB-T/H, ISDB-T, CMMB, LTE, LTE-TDD, Digital Cable TV, WLAN, MSR, LTEAFDD, LTEATDD
Remote Command	[:SENSe]:SEMAsk:OFFSet[1] 2[:OUTer]:LIST:BANDwidth[:RESolution] <bandwidth>, ... [:SENSe]:SEMAsk:OFFSet[1] 2[:OUTer]:LIST:BANDwidth[:RESolution]?

	<pre>[:SENSe] :SEMask:OFFSet [1] 2 [:OUTer] :LIST:BANDwidth [:RESolution] :AUTO OFF ON 1 0, ... [:SENSe] :SEMask:OFFSet [1] 2 [:OUTer] :LIST:BANDwidth [:RESolution] :AUTO?</pre>
Example	<pre>SEM:OFFS2:LIST:BAND 30.0 kHz , 30.0 kHz , 30.0 kHz , 1.00 MHz, 1.00 MHz , 1.00 MHz SEM:OFFS2:LIST:BAND? SEM:OFFS:LIST:BAND:AUTO 1,1,1,1,1,1 SEM:OFFS:LIST:BAND:AUTO?</pre>
Notes	<p>Comma separated list of values.</p> <p>OFFSet1 is for BTS, 2 for MS. Default is BTS.</p> <p>You must be in the mode that includes SEM measurement to use this command. Use :INSTrument:SElect to set the mode.</p>
Couplings	<p>Coupled to Start and Stop offset and Meas BW multiplier. This parameter must adhere to the rule (N x Res BW) <= (Stop freq of the offset - Start freq of the offset), where N is the multiplier. If the multiplier is changed, the Res BW will be changed to ensure this. When set manually, Res BW Coupling is set to manual.</p> <p>The resolution bandwidth is coupled to the offset width determined by the start frequency and stop frequency.</p>
Preset	<p>For modes (except MSR, LTEAFDD, , LTEATDD and WLAN) without option N9060A-7FP, , the preset value is as follows.</p> <p>SA: 30.0 kHz, , 30.0 kHz, , 30.0 kHz, , 1.00 MHz, 1.00 MHz, , 1.00 MHz</p> <p>WCDMA: 30.00 kHz, , 30.00 kHz, , 30.00 kHz, , 100.00 kHz, , 1.000 MHz, , 1.00 MHz 30.00 kHz, , 1.000 MHz, , 1.000 MHz, , 1.000 MHz, , 1.000 MHz, , 1.00 MHz</p> <p>C2K: 3.00 kHz, , 30.00 kHz, , 30.00 kHz, , 6.2 kHz, , 1.000 MHz, , 1.00 MHz 30.00 kHz, , 30.00 kHz, , 6.2 kHz, , 1.000 MHz, , 1.000 MHz, , 1.00 MHz</p> <p>WIMAX OFDMA: 100 KHz, , 100 KHz, , 100 KHz, , 100 KHz, , 100 KHz, , 100 KHz 100 KHz, , 100 KHz, , 100 KHz, , 100 KHz, , 100 KHz, , 100 KHz</p> <p>TD-SCDMA: 30 kHz, , 30 kHz, , 30 kHz, , 50 kHz, , 1 MHz, , 1 MHz 30 kHz, , 30 kHz, , 50 kHz, , 1 MHz, , 1 MHz, , 1 MHz</p> <p>1xEVDO: 30.00 kHz, , 30.00 kHz, , 30.00 kHz, , 6.2 kHz, , 1.000 MHz, , 1.000 MHz 30.00 kHz, , 30.00 kHz, , 30.00 kHz, , 30.00 kHz, , 30.00 kHz</p> <p>DTMB (CTTB), , DVB-T/H, , CMMB, , Digital Cable TV: 3.9 kHz, , 3.9 kHz, , 3.9 kHz, , 3.9 kHz, , 3.9 kHz, , 3.9 kHz 30.00 kHz, , 1.000 MHz, , 1.000 MHz, , 1.000 MHz, , 1.000 MHz, , 1.00 MHz</p> <p>ISDB-T: 10.0 kHz, , 10.0 kHz, , 10.0 kHz, , 10.0 kHz, , 10. kHz, , 10.0 kHz 30.00 kHz, , 1.000 MHz, , 1.000 MHz, , 1.000 MHz, , 1.000 MHz, , 1.00 MHz</p> <p>LTE, , LTETDD: 51 kHz, , 100 kHz, , 1.0 MHz, , 1.0 MHz, 1.0 MHz, , 1.0 MHz 15.0 kHz, , 510 kHz, 1.0 MHz, 1.0 MHz, 1.0 MHz, 1.0 MHz</p> <p>When option N9060A-7FP is installed in these modes, , the preset value of Offset G ~ L is the same as the Offset F value.</p> <p>-----</p> <p>WLAN: 100 KHz, , 100 KHz, , 100 KHz, , 100 KHz, , 100 KHz, , 100 KHz, , 100 KHz, , 100 KHz, , 100 KHz, , 100 KHz, , 100 KHz</p> <p>MSR: 30kHz, , 30kHz, , 30kHz, , 1.0MHz, 1.0MHz, , 1.0MHz, , 1.0MHz, , 1.0MHz, , 1.0MHz, , 1.0MHz, , 1.0MHz 30kHz, , 30kHz, , 30kHz, , 1.0MHz, 1.0MHz, , 1.0MHz, , 1.0MHz, , 1.0MHz, , 1.0MHz, , 1.0MHz</p>

	<p>LTEAFDD, , LTEATDD: 51 kHz, , 100 kHz, , 1.0 MHz, , 1.0 MHz, 1.0 MHz, , 1.0 MHz, 1.0 MHz, 1.0 MHz, 1.0 MHz, 1.0 MHz, 1.0 MHz, 1.0 MHz 15.0 kHz, , 510 kHz, 1.0 MHz, 1.0 MHz, 1.0 MHz, 1.0 MHz, 1.0 MHz, 1.0 MHz, 1.0 MHz, 1.0 MHz, 1.0 MHz, 1.0 MHz</p> <p>Modes (except MSR, , LTEAFDD, , LTEATDD and WLAN) without option N9060A-7FP: OFF, , OFF, , OFF, , OFF, , OFF, , OFF OFF, , OFF, , OFF, , OFF, , OFF, , OFF</p> <p>Modes (except MSR, , LTEAFDD, , LTEATDD and WLAN) with option N9060A-7FP: OFF, , OFF, , OFF, , OFF, , OFF, , OFF, , OFF, , OFF, , OFF OFF, , OFF, , OFF, , OFF, , OFF, , OFF, , OFF, , OFF, , OFF, , OFF</p> <p>MSR: OFF, , OFF, , OFF, , OFF, , OFF, , OFF, , OFF, , OFF, , OFF, , OFF OFF, , OFF, , OFF, , OFF, , OFF, , OFF, , OFF, , OFF, , OFF, , OFF</p> <p>LTEAFDD, , LTEATDD: OFF, , OFF, , OFF, , OFF, , OFF, , OFF, , OFF, , OFF, , OFF, , OFF, , OFF, , OFF OFF, , OFF, , OFF, , OFF, , OFF, , OFF, , OFF, , OFF, , OFF, , OFF</p> <p>WLAN: OFF, , OFF, , OFF, , OFF, , OFF, , OFF, , OFF, , OFF, , OFF, , OFF, , OFF OFF, , OFF, , OFF, , OFF, , OFF, , OFF, , OFF, , OFF, , OFF, , OFF</p>
State Saved	Saved in instrument state.
Min	1 Hz
Max	8 MHz
Backwards Compatibility SCPI	[:SENSE] :SEMAsk:OFFSet [1] 2 :LIST:BWIDth [:RESolution]
Initial S/W Revision	Prior to A.02.00
Modified at S/W Revision	A.02.00, A.03.00, A.10.00, A.11.00, A.14.00

Meas BW

Allows you to specify a multiplier of Res BW for the measurement integration bandwidth.

Meas BW is multiplier integer number. It shows a ratio between Integration BW and Resolution BW of the measurement result.

$$\text{Integ BW} = \text{Meas BW} * \text{Resolution BW}$$

Integration BW is desired resolution bandwidth and Resolution BW is actual bandwidth for sweep. Measurement sweeps with Resolution BW and Meas BW compensates sweep resolution bandwidth to Integration BW.

If you set this parameter greater than 1, you can set Resolution BW narrower to avoid carrier power leakage effect to the offset power integration.

Missing values are not permitted; that is, if you want to change values 2 and 6, you must send all values up to 6. Subsequent values will remain as they were. The query for this parameter always returns 12 values.

Key Path	Meas Setup, Offset/Limits
Mode	SA, WCDMA, C2K, WIMAX OFDMA, TD-SCDMA, 1xEVDO, DTMB (CTTB), DVB-T/HISDB-T, CMMB, LTE, LTETDD, Digital Cable TV, WLAN
Remote Command	[:SENSE] :SEMAsk:OFFSet [1] 2 [:OUTer] :LIST:BWIDth:IMULti <integer>, ... [:SENSE] :SEMAsk:OFFSet [1] 2 [:OUTer] :LIST:BWIDth:IMULti?

Example	SEM:OFFS2:LIST:BAND:IMUL 1,1,1,1,1 SEM:OFFS2:LIST:BAND:IMUL?
Notes	Comma separated list of values. OFFSet1 is for BTS, 2 for MS. Default is BTS. You must be in the mode that includes SEM measurement to use this command. Use :INSTrument:SElect to set the mode.
Couplings	This parameter must adhere to the rule (N x Res BW) <= (Stop freq of the offset - Start freq of the offset), where N is the multiplier. If the Res Bw is changed, the multiplier will be changed to ensure this.
Preset	For modes (except MSR, , LTEAFDD, , LTEATDD and WLAN) without option N9060A-7FP, , the preset value is as follows. SA: 1, 1, 1, 1, 1, 1 WCDMA: 1, , 1, , 1, , 10, , 1, , 1 1, , 1, , 1, , 1, , 1 C2K: 10, 1, 1, 1, 1, 1 1, 1, 1, 1, 1, 1 WIMAX OFDMA, , 1xEVDO: 1, , 1, , 1, , 1, , 1 1, , 1, , 1, , 1, , 1 TD-SCDMA:1, , 1, , 1, , 20, , 1, , 1 1, , 1, , 20, , 1, , 1, , 1 DTMB (CTTB), , DVB-T/H, , ISDB-T, , CMMB, , Digital Cable TV: 1, , 1, , 1, , 1, , 1 1, , 1, , 1, , 1, , 1 LTE, , LTETDD: 2, , 1, , 1, , 1, , 1 2, , 2, , 1, , 1, , 1, 1 When option N9060A-7FP is installed in these modes, , the preset value of Offset G ~ L is the same as the Offset F value. ----- WLAN: 1, 1, 1, 1, 1, 1, 1, 1, 1, 1, 1, 1 MSR: 1, , 1, , 1, , 1, , 1, , 1, , 1, , 1, , 1, , 1 1, , 1, , 1, , 1, , 1, , 1, , 1, , 1, , 1, , 1 LTEAFDD, , LTEATDD: 2, , 1, , 1, , 1, , 1, , 1, , 1, , 1, , 1, , 1 2, , 2, , 1, , 1, , 1, , 1, , 1, , 1, , 1, , 1, , 1
State Saved	Saved in instrument state.
Min	1
Max	1000
Backwards Compatibility SCPI	[:SENSe] :SEMAsk:OFFSet [1] 2 :LIST:BWIDth:IMULti
Initial S/W Revision	Prior to A.02.00
Modified at S/W Revision	A.02.00, A.03.00, A.10.00, A.11.00, A.14.00

Video BW

Changes the analyzer post-detection filter.

Missing values are not permitted; that is, if you want to change values 2 and 6, you must send all values up to 6. Subsequent values will remain as they were. The query for this parameter always returns 12 values.

Key Path	Meas Setup, Offset/Limits
-----------------	---------------------------

Mode	SA, WCDMA, C2K, WIMAXOFDMA, TD-SCDMA, 1xEVDO, DTMB (CTTB), DVB-T/H, ISDB-T, CMMB, LTE, LTEFDD, Digital Cable TV, WLAN, MSR, LTEAFDD, LTEATDD
Remote Command	[:SENSe]:SEMAsk:OFFSet[1] 2[:OUTer]:LIST:BAWdwidth:VIDeo <freq>, ... [:SENSe]:SEMAsk:OFFSet[1] 2[:OUTer]:LIST:BAWdwidth:VIDeo? [:SENSe]:SEMAsk:OFFSet[1] 2[:OUTer]:LIST:BAWdwidth:VIDeo:AUTO OFF ON 0 1, ... [:SENSe]:SEMAsk:OFFSet[1] 2[:OUTer]:LIST:BAWdwidth:VIDeo:AUTO?
Example	SEM:OFFS2:LIST:BAWd:VID 3.00 kHz, , 3.00 kHz, , 3.00 kHz, , 100.0 kHz, 100.0 kHz, , 100.0 kHz SEM:OFFS2:LIST:BAWd:VID? SEM:OFFS2:LIST:BAWd:VID:AUTO ON, , ON, , ON, , ON, , ON SEM:OFFS2:LIST:BAWd:VID:AUTO?
Notes	Comma separated list of values. OFFSet1 is for BTS, 2 for MS. Default is BTS. You must be in the mode that includes SEM measurement to use this command. Use :INSTrument:SElect to set the mode.
Preset	ISDB-T: 1.0kHz, , 1.0kHz, , 1.0kHz, , 1.0kHz, , 1.0kHz, , 1.0kHz Other than ISDB-T: Automatically Calculated Modes (except MSR, , LTEAFDD, , LTEATDD, , WLAN, , ISDB-T) without option N9060A-7FP: ON, , ON, , ON, , ON, , ON ON, , ON, , ON, , ON, , ON Modes (except MSR, , LTEAFDD, , LTEATDD, , WLAN, , ISDB-T) with option N9060A-7FP:ON, , ON, , ON, , ON, , ON, , ON, , ON, , ON, , ON, , ON, , ON ON, , ON, , ON, , ON, , ON, , ON, , ON, , ON, , ON ----- MSR, , LTEAFDD, , LTEATDD: ON, , ON, , ON, , ON, , ON, , ON, , ON, , ON, , ON, , ON, , ON ON, , ON, , ON, , ON, , ON, , ON, , ON, , ON, , ON, , ON WLAN: ON, , ON, , ON, , ON, , ON, , ON, , ON, , ON, , ON, , ON, , ON ON, , ON, , ON, , ON, , ON, , ON, , ON, , ON, , ON, , ON ISDB-T: OFF, , OFF, , OFF, , OFF, , OFF OFF, , OFF, , OFF, , OFF, , OFF, , OFF
State Saved	Saved in instrument state.
Min	1 Hz
Max	50 MHz
Backwards Compatibility SCPI	[:SENSe]:SEMAsk:OFFSet[1] 2:LIST:BWIDth:VIDeo
Initial S/W Revision	Prior to A.02.00
Modified at S/W Revision	A.02.00, A.03.00, A.10.00, A.11.00, A.14.00

VBW/RBW

Selects the ratio between the video and resolution bandwidths.

Missing values are not permitted; that is, if you want to change values 2 and 6, you must send all values up to 6. Subsequent values will remain as they were. The query for this parameter always returns 12 values.

Key Path	Meas Setup, Offset/Limits
Mode	SA, WCDMA, C2K, WIMAX OFDMA, TD-SCDMA, 1xEVDO, DTMB (CTTB), DVB-T/H, ISDB-T, CMMB, LTE, LTEFDD, Digital Cable TV, WLAN, MSR, LTEAFDD, LTEATDD
Remote Command	<pre>[:SENSe]:SEMask:OFFSet[1] 2[:OUTer]:LIST:BANDwidth:VIDeo:RATio <real>, ... [:SENSe]:SEMask:OFFSet[1] 2[:OUTer]:LIST:BANDwidth:VIDeo:RATio? [:SENSe]:SEMask:OFFSet[1] 2[:OUTer]:LIST:BANDwidth:VIDeo:RATio:AUTO OFF ON 0 1, ... [:SENSe]:SEMask:OFFSet[1] 2[:OUTer]:LIST:BANDwidth:VIDeo:RATio:AUTO?</pre>
Example	<pre>SEM:OFFS2:LIST:BAND:VID:RAT 0.1, , 0.1, , 0.1, , 0.1, , 0.1, , 0.1 SEM:OFFS2:LIST:BAND:VID:RAT? SEM:OFFS2:LIST:BAND:VID:RAT:AUTO ON, , ON, , ON, , ON, , ON SEM:OFFS2:LIST:BAND:VID:RAT:AUTO?</pre>
Notes	<p>Comma separated list of values.</p> <p>OFFSet1 is for BTS, 2 for MS. Default is BTS.</p> <p>You must be in the mode that includes SEM measurement to use this command. Use :INSTrument:SElect to set the mode.</p>
Preset	<p>For modes (except MSR, , LTEAFDD, , LTEATDD and WLAN) without option N9060A-7FP, , the preset value is as follows.</p> <p>SA, , WCDMA, , C2K, , LTE, , LTEFDD: 0.01, , 0.01, , 0.01, , 0.01, , 0.01, , 0.01 0.01, , 0.01, , 0.01, , 0.01, , 0.01, , 0.01</p> <p>WIMAX OFDMA: 0.3, , 0.3, , 0.3, , 0.3, , 0.3, , 0.3</p> <p>TD-SCDMA: 10, , 10, , 10, , 10, , 1, , 1 10, , 10, , 10, , 1, , 1, , 1</p> <p>1xEVDO: 10, , 10, , 10, , 10, , 10 10, , 10, , 10, , 10, , 10</p> <p>DTMB (CTTB), , DVB-T/H, , CMMB, , Digital Cable TV: 10, , 10, , 10, , 10, , 10 10, , 10, , 10, , 10, , 10, , 10</p> <p>ISDB-T: 0.1, , 0.1, , 0.1, , 0.1, , 0.1, , 0.1 10, , 10, , 10, , 10, , 10</p> <p>When option N9060A-7FP is installed in these modes, , the preset value of Offset G ~ L is the same as the Offset F value.</p> <p>-----</p> <p>WLAN: 0.3, , 0.3, , 0.3, , 0.3, , 0.3, , 0.3, , 0.3, , 0.3, , 0.3, , 0.3</p> <p>MSR, , LTEAFDD, , LTEATDD: 0.01, , 0.01, , 0.01, , 0.01, , 0.01, , 0.01, , 0.01, , 0.01, , 0.01, , 0.01, , 0.01, , 0.01, , 0.01 0.01, , 0.01, , 0.01, , 0.01, , 0.01, , 0.01, , 0.01, , 0.01, , 0.01, , 0.01, , 0.01, , 0.01</p> <p>Modes (except MSR, , LTEAFDD, , LTEATDD and WLAN) without option N9060A-7FP: OFF, , OFF, , OFF, , OFF, , OFF, , OFF OFF, , OFF, , OFF, , OFF, , OFF, , OFF</p> <p>Modes (except MSR, , LTEAFDD, , LTEATDD and WLAN) with option N9060A-7FP: OFF, , OFF, , OFF, , OFF, , OFF, , OFF, , OFF, , OFF, , OFF, , OFF, , OFF, , OFF OFF, , OFF, , OFF, , OFF, , OFF, , OFF, , OFF, , OFF, , OFF, , OFF, , OFF, , OFF, , OFF, , OFF, , OFF</p> <p>MSR, , LTEAFDD, , LTEATDD: OFF, , OFF, , OFF, , OFF, , OFF, , OFF, , OFF, , OFF, , OFF, , OFF, , OFF, , OFF, , OFF OFF, , OFF, , OFF, , OFF, , OFF, , OFF, , OFF, , OFF, , OFF, , OFF, , OFF</p> <p>WLAN: OFF, , OFF, , OFF, , OFF, , OFF, , OFF, , OFF, , OFF, , OFF, , OFF, , OFF, , OFF, , OFF OFF, , OFF, , OFF, , OFF, , OFF, , OFF, , OFF, , OFF, , OFF, , OFF, , OFF, , OFF, , OFF</p>

State Saved	Saved in instrument state.
Min	0.00001
Max	3000000
Initial S/W Revision	Prior to A.02.00
Modified at S/W Revision	A.02.00, A.03.00, A.10.00, A.11.00, A.14.00

Limits

Accesses a menu that enables you to set the power limits for start and stop frequencies of the selected offsets.

Key Path	Meas Setup
Initial S/W Revision	Prior to A.02.00

Select Offset

Selects the offset (upper and lower) and displays the memory selection menu that enables you to store a set of parameter values for the offset, such as Start Freq, Stop Freq, Sweep Time, Res BW, Meas BW, Abs Start, and Abs Stop. Only one selection at a time is shown on this menu key label.

Key Path	Meas Setup, Offset/Limits
Mode	SA, WCDMA, C2K, WIMAX OFDMA, TD-SCDMA, 1xEVDO, DTMB (CTTB), DVB-T/H, ISDB-T, CMMB, LTE, LTE-TDD, Digital Cable TV, WLAN, MSR, LTEAFDD, LTEATDD
Preset	A
Range	MSR, LTEATDD, LTEAFDD, WLAN: A B C D E F G H I J K L Other modes without option N9060A-7FP: A B C D E F Other modes with option N9060A-7FP: A B C D E F G H I J K L
Initial S/W Revision	Prior to A.02.00
Modified at S/W Revision	A.02.00, A.03.00, A.10.00, A.11.00, A.14.00

Abs Start

Sets the absolute power level limit at the start frequency for the selected offset. The absolute power level limit ranges from -200 to +50 dBm.

The fail condition for each offset channel is set remotely by [:SENSe]:SEMAsk:OFFSet[n]
[:OUTer]:LIST:TEST.

You can turn off (not use) specific offset channels remotely with [:SENSe]:SEMAsk:OFFSet[n]
[:OUTer]:LIST:STATe.

The SCPI query returns values currently set to the absolute power test limits.

Missing values are not permitted; that is, if you want to change values 2 and 6, you must send all values up to 6. Subsequent values will remain as they were. The query for this parameter always returns 12 values.

Key Path	Meas Setup, Offset/Limit, Limits
Mode	SA, WCDMA, C2K, WIMAX OFDMA, TD-SCDMA, 1xEVDO, DTMB (CTTB), DVB-T/H, ISDB-T, CMMB, LTE, LTEFDD, Digital Cable TV, WLAN, MSR, LTEAFDD, LTEATDD
Remote Command	[:SENSe] :SEMAsk:OFFSet [1] 2 [:OUTer] :LIST:STARt:ABSolute <real>, ... [:SENSe] :SEMAsk:OFFSet [1] 2 [:OUTer] :LIST:STARt:ABSolute?
Example	SEM:OFFS2:LIST:STAR:ABS -12.50 dBm, , -12.50 dBm, , -24.50 dBm, , -11.50 dBm, , -11.50 dBm, , -11.50 dBm SEM:OFFS2:LIST:STAR:ABS?
Notes	Comma separated list of values. OFFSet1 is for BTS, 2 for MS. Default is BTS. You must be in the mode that includes SEM measurement to use this command. Use :INSTrument:SElect to set the mode.
Couplings	If the current mode is DVB-T/H, this value will be modified automatically according to the limit type and the output power of the transmitter which is less or more than 25W. If the current mode is ISDB-T, this value will be modified automatically according to the limit type.
Preset	For modes (except MSR, LTEAFDD, LTEATDD and WLAN) without option N9060A-7FP, the preset value is as follows. SA, WIMAX OFDMA: -14.00 dBm, , -14.00 dBm, , -26.00 dBm, , -13.00 dBm, , -13.00 dBm, , -13.00 dBm WCDMA: -12.50 dBm, , -12.50 dBm, , -24.50 dBm, , -11.50 dBm, , -11.50 dBm, , -11.50 dBm -69.6 dBm, , -54.3 dBm, , -54.3 dBm, , -54.3 dBm, , -54.3 dBm, , -54.3 dBm C2K: -27.00 dBm, , -27.00 dBm, , -27.00 dBm, , -46.00 dBm, , -13.00 dBm, , -13.00 dBm -70.13 dBm, , -70.13 dBm, , -35.00 dBm, , -13.00 dBm, , -13.00 dBm, , -13.00 dBm TD-SCDMA: -28 dBm, , -28 dBm, , -36 dBm, , -21 dBm, , -21 dBm, , -21 dBm -71.3 dBm, , -71.3 dBm, , -56.07 dBm, , -56.07 dBm, , -56.07 dBm, , -56.07 dBm 1xEVDO: -27.0dBm, , -27.00 dBm, , -27.00 dBm, , -46.00 dBm, , -13.00 dBm, , -13.00 dBm -70.13 dBm, , -70.13 dBm, , -70.13 dBm, , -70.13 dBm, , -70.13 dBm, , -70.13 dBm DTMB (CTTB): -14.0 dBm, , -14.0 dBm, , -26.0 dBm, , -13.0 dBm, , -13.0 dBm, , -13.0 dBm -13.0 dBm, , -13.0 dBm, , -13.0 dBm, , -13.0 dBm, , -13.0 dBm DVB-T/H: 11.2 dBm, , -29 dBm, , -41 dBm, , -66 dBm, , -82 dBm, , -82 dBm -82 dBm, , -82 dBm, , -82 dBm, , -82 dBm, , -82 dBm ISDB-T, CMMB, Digital Cable TV: 50.0 dBm, , 50.0 dBm, , 50.0 dBm, , 50.0 dBm, , 50.0 dBm, , 50.0 dBm 50.0 dBm, , 50.0 dBm, , 50.0 dBm, , 50.0 dBm, , 50.0 dBm, , 50.0 dBm LTE, LTEFDD: -5.5 dBm, , -12.5 dBm, , -15.0 dBm, , -15.0 dBm, , -15.0 dBm, , -15.0 dBm -13.5 dBm, , -8.5 dBm, , -11.5 dBm, , -23.5 dBm, , -23.5 dBm, , -23.5 dBm When option N9060A-7FP is installed in these modes, the preset value of Offset G ~ L is the same as the Offset F value. ----- WLAN: if Radio Std is 802.11a/g(OFDM/DSSS-OFDM): 16.00 dBm, , -4.00 dBm, , -12.00 dBm, , -

	<p>24.00 dBm , -24.00 dBm , -24.00 dBm , -24.00 dBm , -24.00 dBm , -24.00 dBm , -24.00 dBm , -24.00 dBm</p> <p>if Radio Std is 802.11b/g(DSSS/CCK/PBCC): -10 dBm , -30 dBm , -30 dBm , -30 dBm , -30 dBm , -30 dBm , -30 dBm , -30 dBm , -30 dBm , -30 dBm , -30 dBm , -30 dBm , -30 dBm</p> <p>if Radio Std is 802.11n(20MHz) or 802.11ac(20MHz): 16.00 dBm , -4.00 dBm , -12.00 dBm , -63.00 dBm , -63.00 dBm , -63.00 dBm , -63.00 dBm , -63.00 dBm , -63.00 dBm , -63.00 dBm , -63.00 dBm , -63.00 dBm</p> <p>if Radio Std is 802.11n(40MHz) or 802.11ac(40MHz): 16.00 dBm , -4.00 dBm , -12.00 dBm , -66.00 dBm , -66.00 dBm , -66.00 dBm , -66.00 dBm , -66.00 dBm , -66.00 dBm , -66.00 dBm , -66.00 dBm , -66.00 dBm</p> <p>if Radio Std is 802.11ac(80MHz/160MHz): 16.00 dBm , -4.00 dBm , -12.00 dBm , -69.00 dBm , -69.00 dBm , -69.00 dBm , -69.00 dBm , -69.00 dBm , -69.00 dBm , -69.00 dBm , -69.00 dBm , -69.00 dBm</p> <p>if Radio Std is 802.11ac (80 MHz + 80 MHz): -69.00 dBm , -69.00 dBm , -69.00 dBm , -69.00 dBm , -69.00 dBm , -69.00 dBm , -69.00 dBm , -69.00 dBm , -69.00 dBm , -69.00 dBm</p> <p>MSR: -12.5 dBm , -12.5 dBm , -24.5 dBm , -11.5 dBm , -15.0 dBm , -15.0 dBm , -15.0 dBm , -15.0 dBm , -15.0 dBm , -15.0 dBm -12.5 dBm , -12.5 dBm , -24.5 dBm , -11.5 dBm , -15.0 dBm , -15.0 dBm , -15.0 dBm , -15.0 dBm , -15.0 dBm , -15.0 dBm , -15.0 dBm</p> <p>LTEAFDD , LTEATDD: -5.5 dBm , -12.5 dBm , -15.0 dBm , -15.0 dBm , -15.0 dBm , -15.0 dBm , -15.0 dBm , -15.0 dBm , -15.0 dBm , -15.0 dBm -13.5 dBm , -8.5 dBm , -11.5 dBm , -23.5 dBm , -23.5 dBm , -23.5 dBm , -23.5 dBm , -23.5 dBm , -23.5 dBm , -23.5 dBm , -23.5 dBm</p>
State Saved	Saved in instrument state.
Min	-200 dBm
Max	50 dBm
Initial S/W Revision	Prior to A.02.00
Modified at S/W Revision	A.02.00, A.03.00, A.10.00, A.11.00, A.14.00

Abs Stop

Sets the absolute power level limit at the stop frequency for the selected offset. The absolute power level limit ranges from -200 to +50 dBm. You can also toggle this function between couple and manual. If set to Couple, the Abs Stop power level limit is coupled to Abs Start to result in a flat limit line. If set to Man, Abs Start and Abs Stop take different values to result in a sloped limit line.

The SCPI query returns values currently set to the offset stop absolute power limits.

Missing values are not permitted; that is, if you want to change values 2 and 6, you must send all values up to 6. Subsequent values will remain as they were. The query for this parameter always returns 12 values.

Key Path	Meas Setup, Offset/Limits, Limits
Mode	SA, WCDMA, C2K, WIMAX OFDMA, TD-SCDMA, 1xEVDO, DTMB (CTTB), DVB-T/H, ISDB-T, CMCC, LTE, LTE-TDD, Digital Cable TV, WLAN, MSR, LTEAFDD, LTEATDD

Remote Command	<pre>[:SENSe] :SEMAsk:OFFSet [1] 2 [:OUTer] :LIST:STOP:ABSolute <real>, ... [:SENSe] :SEMAsk:OFFSet [1] 2 [:OUTer] :LIST:STOP:ABSolute? [:SENSe] :SEMAsk:OFFSet [1] 2 [:OUTer] :LIST:STOP:ABSolute:COUPle ON OFF 1 0, ... [:SENSe] :SEMAsk:OFFSet [1] 2 [:OUTer] :LIST:STOP:ABSolute:COUPle?</pre>
Example	<pre>SEM:OFFS:LIST:STOP:ABS -12.50 dBm, , -24.50 dBm, , -24.50 dBm, , -11.50 dBm, , -11.50 dBm, , -11.50 dBm SEM:OFFS1:LIST:STOP:ABS? SEM:OFFS:LIST:STOP:ABS:COUP ON, , OFF, , ON, , ON, , ON, , ON SEM:OFFS:LIST:STOP:ABS:COUP?</pre>
Notes	<p>Comma separated list of values. OFFSet1 is for BTS, 2 for MS. Default is BTS. You must be in the mode that includes SEM measurement to use this command. Use :INSTrument:SElect to set the mode.</p>
Couplings	<p>Coupled to Abs Start if "Auto" is selected, that is, the Stop value is equal to the Start value. If the current mode is DVB-T/H, this value will be modified automatically according to the limit type and the output power of the transmitter which is less or more than 25W. If the current mode is ISDB-T, this value will be modified automatically according to the limit type.</p>
Preset	<p>For modes (except MSR, LTEAFDD, , LTEATDD and WLAN) without option N9060A-7FP, , the preset value is as follows.</p> <pre>SA, , WIMAX OFDMA: -14.00 dBm, , -26.00 dBm, , -26.00 dBm, , -13.00 dBm, , -13.00 dBm, , - 13.00 dBm WCDMA: -12.50 dBm, , -24.50 dBm, , -24.50 dBm, , -11.50 dBm, , -11.50 dBm, , -11.50 dBm -69.6 dBm, , -54.3 dBm, , -54.3 dBm, , -54.3 dBm, , -54.3 dBm, , -54.3 dBm C2K: -27.00 dBm, , -27.00 dBm, , -27.00 dBm, , -46.00 dBm, , -13.00 dBm, , -13.00 dBm -70.13 dBm, , -70.13 dBm, , -35.00 dBm, , -13.00 dBm, , -13.00 dBm, , -13.00 dBm TD-SCDMA: -28 dBm, , -36 dBm, , -36 dBm, , -21 dBm, , -21 dBm, , -21 dBm -71.3 dBm, , -71.3 dBm, , -56.07 dBm, , -56.07 dBm, , -56.07 dBm, , -56.07 dBm 1xEVDO: -27dBm, , -27.00 dBm, , -27.00 dBm, , -46.00 dBm, , -13.00 dBm, , -13.00 dBm -70.13 dBm, , -70.13 dBm, , -70.13 dBm, , -70.13 dBm, , -70.13 dBm, , -70.13 dBm DTMB (CTTB): -14.0 dBm, , -26.0 dBm, , -26.0 dBm, , -13.0 dBm, , -13.0 dBm, , -13.0 dBm -13.0 dBm, , -13.0 dBm, , -13.0 dBm, , -13.0 dBm, , -13.0 dBm DVB-T/H: -29 dBm, , -41 dBm, , -66 dBm, , -82 dBm, , -82 dBm, , -82 dBm -82 dBm, , -82 dBm, , -82 dBm, , -82 dBm, , -82 dBm, , -82 dBm ISDB-TCMMB, , Digital Cable TV: 50.0 dBm, , 50.0 dBm, , 50.0 dBm, , 50.0 dBm, , 50.0 dBm 50.0 dBm, , 50.0 dBm, , 50.0 dBm, , 50.0 dBm, , 50.0 dBm, , 50.0 dBm LTE, , LTETDD: -12.5 dBm, , -12.5 dBm, , -15.0 dBm, , -15.0 dBm, , -15.0 dBm, , -15.0 dBm - 13.5 dBm, , -8.5 dBm, , -11.5 dBm, , -23.5 dBm, , -23.5 dBm, , -23.5 dBm When option N9060A-7FP is installed in these modes, , the preset value of Offset G ~ L is the same as the Offset F value. ----- WLAN:</pre>

if Radio Std is 802.11a/g(OFDM/DSSS-OFDM): -4.00 dBm, , -12.00 dBm, , -24.00 dBm, , -24.00 dBm, , -24.00 dBm, , -24.00 dBm, , -24.00 dBm, , -24.00 dBm, , -24.00 dBm, , -24.00 dBm, , -24.00 dBm

if Radio Std is 802.11b/g(DSSS/CCK/PBCC): -10 dBm, , -30 dBm, , -30 dBm, , -30 dBm, , -30 dBm, , -30 dBm, , -30 dBm, , -30 dBm, , -30 dBm, , -30 dBm

if Radio Std is 802.11n(20MHz) or 802.11ac(20MHz): -4.00 dBm, , -12.00 dBm, , -24.00 dBm, , -63.00 dBm, , -63.00 dBm, , -63.00 dBm, , -63.00 dBm, , -63.00 dBm, , -63.00 dBm, , -63.00 dBm

if Radio Std is 802.11n(40MHz) or 802.11ac(40MHz): -4.00 dBm, , -12.00 dBm, , -24.00 dBm, , -66.00 dBm, , -66.00 dBm, , -66.00 dBm, , -66.00 dBm, , -66.00 dBm, , -66.00 dBm, , -66.00 dBm

if Radio Std is 802.11ac(80MHz/160MHz): -4.00 dBm, , -12.00 dBm, , -24.00 dBm, , -69.00 dBm, , -69.00 dBm, , -69.00 dBm, , -69.00 dBm, , -69.00 dBm, , -69.00 dBm, , -69.00 dBm

if Radio Std is 802.11ac (80 + 80 MHz): -69.00 dBm, , -69.00 dBm, , -69.00 dBm, , -69.00 dBm, , -69.00 dBm, , -69.00 dBm, , -69.00 dBm, , -69.00 dBm, , -69.00 dBm

MSR:-12.5 dBm, , -24.5 dBm, , -11.5 dBm, , -15.0 dBm, , -15.0 dBm, , -15.0 dBm, , -15.0 dBm, , -15.0 dBm, , -15.0 dBm, , -15.0 dBm, , -15.0 dBm, , -15.0 dBm, , -15.0 dBm, , -15.0 dBm, , -15.0 dBm, , -15.0 dBm, , -15.0 dBm, , -15.0 dBm

LTEAFDD, , LTEATDD:-12.5 dBm, , -12.5 dBm, , -15.0 dBm, , -15.0 dBm, , -15.0 dBm, , -15.0 dBm, , -15.0 dBm, , -15.0 dBm, , -15.0 dBm, , -15.0 dBm, , -15.0 dBm, , -15.0 dBm, , -13.5 dBm, , -8.5 dBm, , -11.5 dBm, , -23.5 dBm, , -23.5 dBm, , -23.5 dBm, , -23.5 dBm, , -23.5 dBm, , -23.5 dBm, , -23.5 dBm, , -23.5 dBm

For modes (except MSR, , LTEAFDD, , LTEATDD and WLAN) without option N9060A-7FP, , the preset value is as follows.

SA,WIMAX OFDMA: ON, OFF, ON, ON, ON, ON

WCDMA: ON, , OFF, , ON, , ON, , ON, , ON|ON, , ON, , ON, , ON, , ON

C2K: ON, , ON, , ON, , ON, , ON, , OFF|ON, , ON, , ON, , ON, , OFF

TD-SCDMA: ON, , OFF, , ON, , ON, , ON, , ON|ON, , ON, , ON, , ON, , ON

1xEVDO: ON, , ON, , ON, , ON, , ON, , OFF|ON, , ON, , ON, , ON, , OFF

DTMB (CTTB): ON, OFF, ON, ON, ON, ON

DVB-T/H, , ISDB-T, , CMMB, , Digital Cable TV: OFF, , OFF, , OFF, , OFF, , OFF, , OFF

LTE, , LTETDD: OFF, , ON, , ON, , ON, , ON, , ON|ON, , ON, , ON, , ON, , ON

When option N9060A-7FP is installed in these modes, , the preset value of Offset G ~ L is the same as the Offset F value.

WLAN:

if Radio Std is 802.11a/g(OFDM/DSSS-OFDM)/802.11n(20MHz/40MHz)/802.11 ac (20MHz/40MHz/80MHz/160MHz): OFF, , OFF, , OFF, , ON, , ON, , ON, , ON, , ON, , ON, , ON, , ON

if Radio Std is 802.11 ac(80+80 MHz): ON, , ON, , ON, , ON, , ON, , ON, , ON, , ON, , ON, , ON, , ON

if Radio Std is 802.11b/g(DSSS/CCK/PBCC): ON, , ON, , ON, , ON, , ON, , ON, , ON, , ON, , ON, , ON, , ON

	, ON, , ON MSR: ON, , OFF, , OFF, , OFF, , ON, , OFF, , OFF, , OFF, , OFF, , OFF, , OFF, ON, , OFF, , OFF, , OFF, , ON, , OFF, , OFF, , OFF, , OFF, , OFF, , OFF, , OFF, , OFF, , OFF, , OFF LTEAFDD, , LTEATDD: OFF, , ON, , ON, , ON, , ON, , ON, , ON, , ON, , ON, , ON, , ON, ON, ON, , ON, , ON, , ON, , ON, , ON, , ON, , ON, , ON, , ON, , ON, , ON
State Saved	Saved in instrument state.
Min	-200 dBm
Max	50 dBm
Initial S/W Revision	Prior to A.02.00
Modified at S/W Revision	A.02.00, A.03.00, A.10.00, A.11.00, A.14.00

Rel Start

Sets a relative power level limit at the start frequency for the selected offset. The relative power level limit ranges from -200 to +50 dBc.

The fail condition is set remotely by [:SENSe]:SEMask:OFFSet[n][:OUTer]:LIST:TEST for each offset channel test.

You can turn off (not use) specific offset channels remotely with [:SENSe]:SEMask:OFFSet[n][:OUTer]:LIST:STATe.

The SCPI query returns values currently set to the relative power test limits.

Missing values are not permitted; that is, if you want to change values 2 and 6, you must send all values up to 6. Subsequent values will remain as they were. The query for this parameter always returns 12 values.

Key Path	Meas Setup, Offset/Limits, Limits
Mode	SA, WCDMA, C2K, WIMAX OFDMA, TD-SCDMA, 1xEVDO, DTMB (CTTB), DVB-T/H, ISDB-T, CMMB, LTE, LTE-TDD, Digital Cable TV, WLAN, MSR, LTEAFDD, LTEATDD
Remote Command	[:SENSe]:SEMask:OFFSet[1] 2[:OUTer]:LIST:STARt:RCARrier <rel_ampl>, ... [:SENSe]:SEMask:OFFSet[1] 2[:OUTer]:LIST:STARt:RCARrier?
Example	SEM:OFFS:LIST:STAR:RCAR -30, , -30, , -30, , -30, , -30, , -30 SEM:OFFS:LIST:STAR:RCAR?

Notes	Comma separated list of values. OFFSet1 is for BTS, 2 for MS. Default is BTS. You must be in the mode that includes SEM measurement to use this command. Use :INSTRUMENT:SElect to set the mode.
-------	--

Couplings	If the current mode is DVB-T/H, this value will be modified automatically according to the limit type the output power of the transmitter which is less or more than 25W. If the current mode is ISDB-T, this value will be modified automatically according to the limit type. If the current mode is WLAN and radio std is 802.11n, Rel Start limits will be set to following values
-----------	--

when frequency changed to above 5GHz:
0 dB, -20.00 dB, -28.00 dB, -40.00 dB, -40.00 dB, -40.00 dB, -40.00 dB, -40.00 dB, -40.00 dB,
-40.00 dB, -40.00 dB, -40.00 dB

Preset For modes (except MSR, LTEAFDD, LTEATDD and WLAN) without option N9060A-7FP, the preset value is as follows.
SA: -30.00 dB, -30.00 dB, -30.00 dB, -30.00 dB, -30.00 dB, -30.00 dB
WCDMA: -30.00 dB, -30.00 dB, -30.00 dB, -30.00 dB, -30.00 dB, -30.00 dB|-33.73 dB, -34.00 dB, -37.50 dB, -47.50 dB, -47.50 dB, -47.50 dB
C2K: -45.00 dB, -45.00 dB, -55.00 dB, -55.00 dB, -55.00 dB, -55.00 dB|-42.00 dB, -54.00 dB, -54.00 dB, -54.00 dB, -54.00 dB, -54.00 dB
WIMAX OFDMA: 0 dB, -25 dB, -32 dB, -50 dB, -50 dB, -50 dB
TD-SCDMA: -54.00 dB, -54.00 dB, -62.00 dB, -47.00 dB, -47.00 dB, -47.00 dB|-35.21 dB, -49.00 dB, -44.00 dB, -44.00 dB, -44.00 dB, -44.00 dB
1xEVDO: -45dBc, -45.00 dB, -55.00 dB, -55.00 dB, -55.00 dB, -55.00 dB|-42dBc, -54.00 dB, -54.00 dB, -54.00 dB, -54.00 dB
DTMB (CTTB): -32.8 dB, -83 dB, -95 dB, -120 dB, -120 dB, -120 dB|-120 dB, -120 dB, -120 dB
DVB-T/H: -30 dB, -30 dB, -30 dB, -30 dB, -30 dB, -30 dB|-30 dB, -30 dB, -30 dB, -30 dB, -30 dB, -30 dB
ISDB-T: -27.4 dB, -47.4 dB, -54.4 dB, XXX, 50 dB, 50 dB | 50 dB, 50 dB, 50 dB, 50 dB, 50 dB, 50 dB; XXX is coupled with the total power reference, it is -57.4 dB when $P \leq 0.025$ W, -67.4 dB when $P = 0.25$ W, $-(73.4 + 10 \log P)$ dB when 0.25 W $< P \leq 2.5$ W or 0.025 W $< P < 0.25$ W, -77.4 dB when $P > 2.5$ W.
CMMB: -37 dB, -72 dB, -84 dB, -90 dB, -90 dB, -90 dB|-90 dB, -90 dB, -90 dB, -90 dB, -90 dB, -90 dB
LTE, LTEATDD: 0 dB, 0 dB, 0 dB, 0 dB, 0 dB, 0 dB|0 dB, 0 dB, 0 dB, 0 dB, 0 dB, 0 dB
Digital Cable TV: 0 dB, 0 dB, 0 dB, 0 dB, 0 dB, 0 dB | 0 dB, 0 dB, 0 dB, 0 dB, 0 dB, 0 dB
When option N9060A-7FP is installed in these modes, the preset value of Offset G ~ L is the same as the Offset F value.

WLAN:
if Radio Std is 802.11a/g(OFDM/DSSS-OFDM): 0 dB, -20.00 dB, -28.00 dB, -40.00 dB, -40.00 dB, -47.00 dB, -47.00 dB, -47.00 dB, -47.00 dB, -47.00 dB, -47.00 dB, -47.00 dB
if Radio Std is 802.11b/g(DSSS/CCK/PBCC): -30 dB, -50 dB, -50 dB, -50 dB, -50 dB, -50 dB, -50 dB, -50 dB, -50 dB, -50 dB, -50 dB, -50 dB
if Radio Std is 802.11n(20MHz/40MHz): 0 dB, -20.00 dB, -28.00 dB, -45.00 dB, -45.00 dB, -45.00 dB, -45.00 dB, -45.00 dB, -45.00 dB, -45.00 dB, -45.00 dB, -45.00 dB
if Radio Std is 802.11ac (20 MHz/ 40 MHz/ 80 MHz/ 160 MHz): 0 dB, -20.00 dB, -28.00 dB, -40.00 dB, -40.00 dB, -40.00 dB, -40.00 dB, -40.00 dB, -40.00 dB, -40.00 dB, -40.00 dB, -40.00 dB
if Radio Std is 802.11ac(80 MHz + 80MHz): -40.00 dB, -28.00 dB, -20 dB, 0 dB, - 20 dB, -28 dB, -40 dB, -40 dB, -40.00 dB, -40.00 dB, -40.00 dB, -40.00 dB
MSR, LTEAFDD, LTEATDD: 0 dB, 0 dB, 0 dB, 0 dB, 0 dB, 0 dB, 0 dB, 0 dB, 0 dB, 0 dB, 0 dB, 0 dB,

	0 dB, , 0 dB 0 dB, , 0 dB, , 0 dB, , 0 dB, , 0 dB, , 0 dB, , 0 dB, , 0 dB, , 0 dB, , 0 dB
State Saved	Saved in instrument state.
Min	-200 dB
Max	50 dB
Initial S/W Revision	Prior to A.02.00
Modified at S/W Revision	A.02.00, A.03.00, A.10.00, A.11.00, A.14.00

Rel Stop

Sets a relative power level limit at the stop frequency for the selected offset. The relative power level limit ranges from -200 to +50 dBc.

The fail condition is set remotely by [:SENSe]:SEMAsk:OFFSet[n][:OUTer]:LIST:TEST for each offset channel.

You can turn off (not use) specific offset channels remotely with [:SENSe]:SEMAsk:OFFSet[n][:OUTer]:LIST:STATe.

The SCPI query returns values currently set to the offset stop relative power limits.

Missing values are not permitted; that is, if you want to change values 2 and 6, you must send all values up to 6. Subsequent values will remain as they were. The query for this parameter always returns 12 values.

Key Path	Meas Setup, Offset/Limits, Limits
Mode	SA, WCDMA, C2K, WIMAX OFDMA, TD-SCDMA, 1xEVDO, DTMB (CTTB), DVB-T/H, ISDB-T, CMMB, LTE, LTEFDD, Digital Cable TV, WLAN, MSR, LTEAFDD, LTEATDD
Remote Command	[:SENSe]:SEMAsk:OFFSet[1] 2[:OUTer]:LIST:STOP:RCARrier <rel_ampl>, ... [:SENSe]:SEMAsk:OFFSet[1] 2[:OUTer]:LIST:STOP:RCARrier? [:SENSe]:SEMAsk:OFFSet[1] 2[:OUTer]:LIST:STOP:RCARrier:COUPle ON OFF 1 0, ... [:SENSe]:SEMAsk:OFFSet[1] 2[:OUTer]:LIST:STOP:RCARrier:COUPle?
Example	SEM:OFFS:LIST:STOP:RCAR -30, , -30, , -30, , -30, , -30, , -30 SEM:OFFS:LIST:STOP:RCAR? SEM:OFFS:LIST:STOP:RCAR:COUP ON, , ON, , ON, , ON, , ON SEM:OFFS:LIST:STOP:RCAR:COUP?
Notes	Comma separated list of values. OFFSet1 is for BTS, 2 for MS. Default is BTS. You must be in the mode that includes SEM measurement to use this command. Use :INSTrument:SElect to set the mode.
Couplings	Coupled to Rel Start if "Auto" is selected, that is, Start is made the same as Stop. If the current mode is DVB-T/H, this value will be modified automatically according to the limit type and the output power of the transmitter which is less or more than 25W. If the current mode is ISDB-T, this value will be modified automatically according to the limit type.

If the current mode is WLAN and radio std is 802.11n, Rel Stop limits will be set to following values when frequency changed to above 5GHz:

-20.00 dB, -28.00 dB, -40.00 dB, -40.00 dB, -40.00 dB, -40.00 dB, -40.00 dB, -40.00 dB, -40.00 dB, -40.00 dB, -40.00 dB, -40.00 dB

Preset

For modes (except MSR, LTEAFDD, LTEATDD and WLAN) without option N9060A-7FP, the preset value is as follows.

SA: -30.00 dB, -30.00 dB, -30.00 dB, -30.00 dB, -30.00 dB, -30.00 dB

WCDMA: -30.00 dB, -30.00 dB, -30.00 dB, -30.00 dB, -30.00 dB, -30.00 dB|-48.28 dB, -37.50 dB, -47.50 dB, -47.50 dB, -47.50 dB, -47.50 dB

C2K: -45.00 dB, -45.00 dB, -55.00 dB, -55.00 dB, -55.00 dB, -55.00 dB|-42.00 dB, -54.00 dB, -54.00 dB, -54.00 dB, -54.00 dB, -54.00 dB

WIMAX OFDMA: -25 dB, -32 dB, -50 dB, -50 dB, -50 dB, -50 dB

TD-SCDMA: -54.00 dB, -62.00 dB, -62.00 dB, -47.00 dB, -47.00 dB, -47.00 dB|-49.00 dB, -58.945 dB, -44.00 dB, -44.00 dB, -44.00 dB, -44.00 dB

1xEVDO: -45dB, -45.00 dB, -55.00 dB, -55.00 dB, -55.00 dB, -55.00 dB|-42dB, -54.00 dB, -54.00 dB, -54.00 dB, -54.00 dB, -54.00 dB

DTMB (CTTB): -83 dB, -95 dB, -120 dB, -120 dB, -120 dB, -120 dB|-120 dB, -120 dB, -120 dB, -120 dB, -120 dB, -120 dB

DVB-T/H: -73 dB, -85 dB, -110 dB, -126 dB, -126 dB, -126 dB|-126 dB, -126 dB, -126 dB, -126 dB, -126 dB, -126 dB

ISDB-T: -47.4 dB, -54.4 dB, XXX, 50 dB, 50 dB, 50 dB|50 dB, 50 dB, 50 dB, 50 dB, 50 dB, 50 dB, 50 dB; XXX is coupled with the total power reference P, it is -57.4 dB when $P < 0.025$ W, -67.4 dB when $P = 0.25$ W, $-(73.4 + 10\log P)$ dB when 0.25 W $< P < 2.5$ W or 0.025 W $< P < 0.25$ W, -77.4 dB when $P > 2.5$ W.

CMMB: -72 dB, -84 dB, -90 dB, -90 dB, -90 dB, -90 dB|-90 dB, -90 dB, -90 dB, -90 dB, -90 dB, -90 dB

LTE, LTETDD: 0 dB, 0 dB, 0 dB, 0 dB, 0 dB, 0 dB

Digital Cable TV: 0 dB, 0 dB, 0 dB, 0 dB, 0 dB, 0 dB|0 dB, 0 dB, 0 dB, 0 dB, 0 dB, 0 dB

When option N9060A-7FP is installed in these modes, the preset value of Offset G ~ L is the same as the Offset F value.

WLAN:

if Radio Std is 802.11a/g(OFDM/DSSS-OFDM): -20.00 dB, -28.00 dB, -40.00 dB, -40.00 dB, -47.00 dB, -47.00 dB, -47.00 dB, -47.00 dB, -47.00 dB, -47.00 dB, -47.00 dB, -47.00 dB

if Radio Std is 802.11b/g(DSSS/CCK/PBCC): -30 dB, -50 dB, -50 dB, -50 dB, -50 dB, -50 dB, -50 dB, -50 dB, -50 dB, -50 dB, -50 dB, -50 dB

if Radio Std is 802.11n(20MHz/40MHz): -20.00 dB, -28.00 dB, -45.00 dB, -45.00 dB, -45.00 dB, -45.00 dB, -45.00 dB, -45.00 dB, -45.00 dB, -45.00 dB, -45.00 dB, -45.00 dB

if Radio Std is 802.11ac (20 MHz/ 40 MHz/ 80 MHz/ 160 MHz): -20.00 dB, -28.00 dB, -40.00 dB, -40.00 dB, -40.00 dB, -40.00 dB, -40.00 dB, -40.00 dB, -40.00 dB, -40.00 dB, -40.00 dB, -40.00 dB

if Radio Std is 802.11ac(80 MHz + 80MHz): -28.00 dB, -20.00 dB, 0 dB, -20.00 dB, -28.00

- OR checks against both limits, failing if either of the limits is broken.
- AND will only display a fail if both of the limits are broken.

The absolute or relative power limit value for each offset channel can be set remotely with [:SENSe]:SEMAsk:OFFSet[n][:OUTer]:LIST:ABSolute or [:SENSe]:SEMAsk:OFFSet[n][:OUTer]:LIST:RCARrier.

You can turn off (not use) specific offset channels remotely with [:SENSe]:SEMAsk:OFFSet[n][:OUTer]:LIST:STATe.

Missing values are not permitted; that is, if you want to change values 2 and 6, you must send all values up to 6. Subsequent values will remain as they were. The query for this parameter always returns 12 values.

Key Path	Meas Setup, Offset/Limits, Limits
Mode	SA, WCDMA, C2K, WIMAX OFDMA, TD-SCDMA, 1xEVDO, DTMB (CTTB), DVB-T/H, ISDB-T, CMMB, LTE, LTETDD, Digital Cable TV, WLAN, MSR, LTEAFDD, LTEATDD
Remote Command	[:SENSe]:SEMAsk:OFFSet[1] 2[:OUTer]:LIST:TEST ABSolute AND OR RELative, ... [:SENSe]:SEMAsk:OFFSet[1] 2[:OUTer]:LIST:TEST?
Example	SEM:OFFS:LIST:TEST ABS, , ABS, , ABS, , ABS, , ABS, , ABS SEM:OFFS:LIST:TEST?
Notes	Comma separated list of values. You must be in the mode that includes SEM measurement to use this command. Use :INSTrument:SElect to set the mode.
Couplings	None If the current mode is DVB-T/H, this value will be modified automatically according to the limit type and the output power of the transmitter which is less or more than 25W.
Preset	For modes (except MSR, LTEAFDD, LTEATDD and WLAN) without option N9060A-7FP, the preset value is as follows. SA: ABS, ABS, ABS, ABS, ABS, ABS WCDMA: ABS, , ABS, , ABS, , ABS, , ABS AND, , AND, , AND, , AND, , AND, , AND C2K: REL, , REL, , REL, , ABS, , REL, , REL AND, , AND, , ABS, , REL, , REL, , REL WIMAX OFDMA: REL, , REL, , REL, , REL, , REL REL, , REL, , REL, , REL, , REL, , REL TD-SCDMA: ABS, , ABS, , ABS, , ABS, , ABS AND, , AND, , AND, , AND, , AND, , AND 1xEVDO: REL, , REL, , REL, , ABS, , REL, , REL AND, , AND, , AND, , OR, , AND, , AND DTMB (CTTB), ISDB-T, CMMB: REL, , REL, , REL, , REL, , REL, , REL REL, , REL, , REL, , REL, , REL, , REL DVB-T/H: ABS, , ABS, , ABS, , ABS, , ABS ABS, , ABS, , ABS, , ABS, , ABS, , ABS LTE, , LTETDD: ABS, , ABS, , ABS, , ABS, , ABS, , ABS Digital Cable TV: REL, , REL, , REL, , REL, , REL, , REL REL, , REL, , REL, , REL, , REL, , REL When option N9060A-7FP is installed in these modes, the preset value of Offset G ~ L is the same as the Offset F value. ----- WLAN:

	if Radio Std is 802.11a/g(OFDM/DSSS-OFDM) or 802.11b/g(DSSS/CCK/PBCC): REL, , REL, , REL, , REL, , REL, , REL, , REL, , REL, , REL, , REL if Radio Std is 802.11n(20MHz/40MHz): REL, , REL, , REL, , AND, , AND, , AND, , AND, , AND, , AND, , AND, , AND, , AND, , AND if Radio Std is 802.11ac (20 MHz/ 40 MHz/ 80 MHz/ 160 MHz): REL, , REL, , REL, , AND, , AND, , AND, , AND, , AND, , AND, , AND, , AND if Radio Std is 802.11ac (80 MHz + 80MHz): REL, , REL, , REL, , REL, , REL, , REL, , AND, , AND, , AND, , AND, , AND, , AND MSR, LTEAFDD, , LTEATDD: ABS, , ABS, , ABS, , ABS, , ABS, , ABS, , ABS, , ABS, , ABS, , ABS, , ABS, , ABS, , ABS, , ABS
State Saved	Saved in instrument state.
Range	Absolute Relative Abs AND Rel Abs OR Rel
Initial S/W Revision	Prior to A.02.00
Modified at S/W Revision	A.02.00, A.03.00, A.10.00, A.11.00, A.14.00

Offset Freq Define

This key enables you to select “Offset” definition. Each standard defines each “Offset” from Carrier.

Meas BW Edge means the edge of resolution band width that is represented by Meas BW and Res BW settings. Actual center frequency of Meas BW and the limit line have ½ Meas BW offset when the Meas BW Edge is selected.

3GPP2 requires the “Carrier Center to Meas BW Edge” definition. LTE conformance test requires “Carrier Edge to Meas BW Center” and/or “Carrier Edge to Meas BW Edge” definition

- **CTOCenter** – From carrier center to the center of offset measuring filter*
- **CTOEdge** – From carrier center to the nominal –3 dB point of the offset measuring filter* closer to the carrier
- **ETOCenter** – From Center Frequency – Span of Ref Channel / 2 (for lower offset), Center Frequency + Span of Ref Channel / 2 (for upper offset) of the carrier closest to each offset to the center of offset measuring filter*
- **ETOEdge** – From Center Frequency – Span of Ref Channel / 2 (for lower offset), Center Frequency + Span of Ref Channel / 2 (for upper offset) of the carrier closest to each offset to the nominal –3 dB point of the offset measuring filter* closer to the carrier

*Measuring filter = Meas BW (N) x Res BW

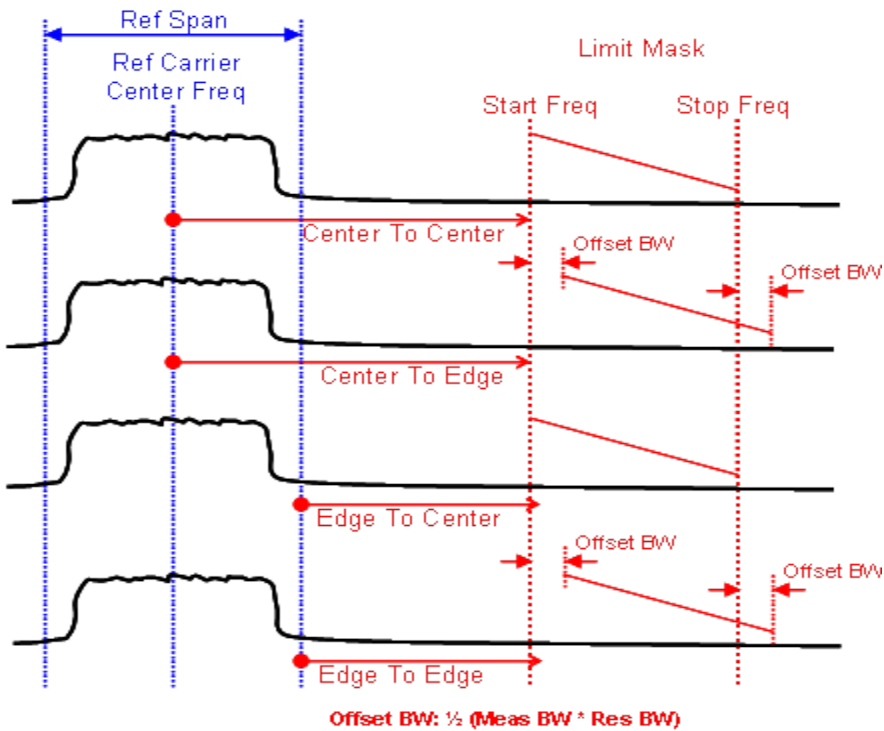
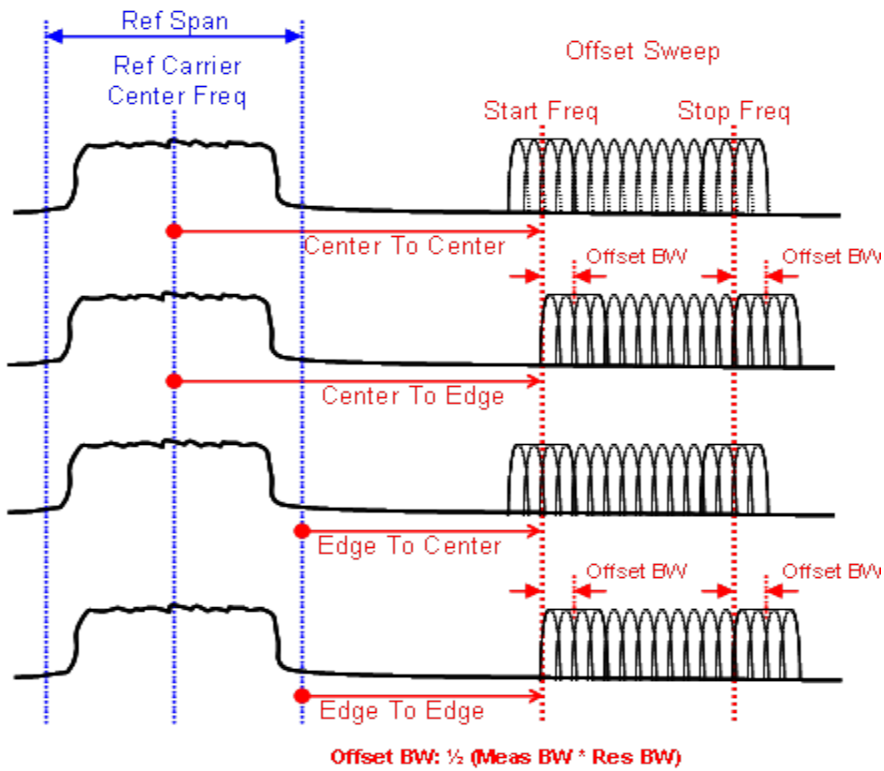

Key Path	Meas Setup, Offset/Limits
Mode	SA, WCDMA, C2K, WIMAX OFDMA, TD-SCDMA, 1xEVDO, DVB-T/H, DTMB (CTTB), ISDB-T, CMMB, LTE, LTETDD, Digital Cable TV, WLAN
Remote Command	<code>[:SENSE] :SEMask:OFFSet [1] 2 :TYPE CTOCenter CTOEdge ETOCenter ETOEdge</code> <code>[:SENSE] :SEMask:OFFSet [1] 2 :TYPE ?</code>
Example	SEM:OFFS:TYPE ETOC SEM:OFFS:TYPE?
Notes	You must be in the mode that includes SEM measurements to use this command. Use <code>:INSTRument:SElect</code> to set the mode. For the MSR and LTE-Advanced FDD/TDD mode, see Offset Freq Define (Only for MSR and LTE-Advanced FDD/TDD) .
Preset	SA, , WCDMA, , WIMAX OFDMA, , TD-SCDMA, , DVB-T/H, , DTMB (CTTB), , ISDB-T, , CMMB, , Digital Cable TV: CTOC C2K: CTOE 1xEVDO: CTOE LTE: ETOC LTETDD: ETOC
State Saved	Saved in instrument state.
Range	Carrier Center To Meas BW Center Carrier Center To Meas BW Edge Carrier Edge To Meas BW Center Carrier Edge To Meas BW Edge
Initial S/W Revision	A.03.00

Method

Sets the measurement method:

- **Integ BW**—enables you to set the channel integration bandwidth.
- **RRC Weight**—selects Root Raised Cosine (RRC) filtering of the carriers. The α value (rolloff) for the filter is set to the value of the Filter Alpha parameter.

Key Path	Meas Setup
Mode	SA, WCDMA, WIMAX OFDMA, TD-SCDMA, DTMB (CTTB), DVB-T/H, ISDB-T, CMMB, LTE, LTETDD, Digital Cable TV, WLAN, MSR, LTEAFDD, LTEATDD
Remote Command	<code>[:SENSE] :SEMask:FILTer [:RRC] [:STATe] OFF ON 0 1</code> <code>[:SENSE] :SEMask:FILTer [:RRC] [:STATe] ?</code>
Example	SEM:FILT ON SEM:FILT?
Notes	For the C2K and 1xEVDO mode, this key is not available. 1 ON = RRC Weight, 0 OFF = IntegBW You must be in the mode that includes SEM measurement to use this command. Use

	:INSTrument:SElect to set the mode.
Dependencies	WLAN: RRC Weight is not supported when the radio standard is WLAN 802.11ac (80+80MHz).
Preset	SA, , WIMAX OFDMA, , DVB-T/H, , ISDB-T, , CMMB, , LTE, , LTETDD, , WLAN, , MSR, , LTEAFDD, , LTEATDD: OFF WCDMA, , TD-SCDMA, , DTMB (CTTB), , Digital Cable TV: ON
State Saved	Saved in instrument state.
Range	RRCWeight IntegBW
Initial S/W Revision	Prior to A.02.00
Modified at S/W Revision	A.02.00, A.03.00

Filter Alpha

Sets the alpha value for the RRC Filter.

Key Path	Meas Setup
Mode	SA, WCDMA, WIMAX OFDMA, TD-SCDMA, DTMB (CTTB), DVB-T/H, ISDB-T, CMMB, LTE, LTETDD, Digital Cable TV, MSR, LTEAFDD, LTEATDD
Remote Command	[:SENSe] :SEMAsk:FILTEr [:RRC] :ALPHa <real> [:SENSe] :SEMAsk:FILTEr [:RRC] :ALPHa?
Example	SEM:FILT:ALPH 0.3 SEM:FILT:ALPH?
Notes	For the C2K and 1xEVDO mode, this key is not available. You must be in the mode that includes SEM measurement to use this command. Use :INSTrument:SElect to set the mode.
Preset	0.22 DTMB (CTTB): 0.05 Digital Cable TV: 0.15
State Saved	Saved in instrument state.
Min	0.01
Max	1.0
Initial S/W Revision	Prior to A.02.00
Modified at S/W Revision	A.02.00, A.03.00

Meas Preset

Restores all the measurement parameters to their default values.

Key Path	Meas Setup
Mode	SA, WCDMA, C2K, WIMAX OFDMA, TD-SCDMA, 1xEVDO, DTMB (CTTB), DVB-T/H, ISDB-T, CMMB,

	LTE, LTE-TDD, Digital Cable TV, WLAN, MSR, LTE-A-FDD, LTE-A-TDD
Remote Command	:CONFigure:SEMask
Example	CONF:SEM
Notes	You must be in the mode that includes SEM measurement to use this command. Use :INSTrument:SElect to set the mode.
Couplings	Selecting Meas Preset will restore all measurement parameters to their default values.
Initial S/W Revision	Prior to A.02.00
Modified at S/W Revision	A.02.00, A.03.00

Mode

See "[Mode](#)" on page 286

Mode Preset

Returns the active mode to a known state.

Mode Preset does the following for the currently active mode:

- Aborts the currently running measurement.
- Brings up the default menu for the mode, with no active function.
- Sets measurement Global settings to their preset values for the active mode only.
- Activates the default measurement.
- Brings up the default menu for the mode.
- Clears the input and output buffers.
- Sets Status Byte to 0.

Mode Preset does not:

- Cause a mode switch
- Affect mode persistent settings
- Affect system settings

See "[How-To Preset](#)" on page 970 for more information.

Key Path	Front-panel key
Remote Command	:SYSTem:PRESet
Example	:SYST:PRES
Notes	*RST is preferred over :SYST:PRES for remote operation. *RST does a Mode Preset, as done by the :SYST:PRES command, and it sets the measurement mode to Single measurement rather than Continuous for optimal remote control throughput. Clears all pending OPC bits. The Status Byte is set to 0.
Couplings	A Mode Preset aborts the currently running measurement, activates the default measurement, and gets the mode to a consistent state with all of the default couplings set.
Backwards Compatibility Notes	In the X-Series, the legacy "Factory Preset" has been replaced with Mode Preset, which only presets the currently active mode, not the entire instrument. In the X-Series, the way to preset the entire instrument is by using System, Restore System Defaults All, which behaves essentially the same way as restore System Defaults does on ESA and PSA. There is also no "Preset Type" as there is on the PSA. There is a green Mode Preset front-panel key that does a Mode Preset and a white-with-green-letters User Preset front-panel key that does a User Preset. The old PRESet:TYPE command is ignored (without generating an error), and SYST:PRES without a parameter does a Mode Preset, which should cover most backward code compatibility issues. The settings and correction data under the Input/Output front-panel key (examples: Input Z Corr, Ext Amp Gain, etc.) are no longer part of any Mode, so they will not be preset by a Mode Preset. They are preset using Restore Input/Output Defaults, Restore System Defaults All. Note that because User Preset does a Recall State, and all of these settings are saved in State, they ARE recalled when using

	User Preset.
Initial S/W Revision	Prior to A.02.00

How-To Preset

The table below shows all possible presets, their corresponding SCPI commands and front-panel access (key paths). Instrument settings depend on the current measurement context. Some settings are local to the current measurement, some are global (common) across all the measurements in the current mode, and some are global to all the available modes. In a similar way, restoring the settings to their preset state can be done within the different contexts.

Auto Couple - is a measurement local key. It sets all Auto/Man parameter couplings in the measurement to Auto. Any Auto/Man selection that is local to other measurements in the mode will not be affected.

Meas Preset - is a measurement local key. Meas Preset resets all the variables local to the current measurement except the persistent ones.

Mode Preset - resets all the current mode's measurement local and measurement global variables except the persistent ones.

Restore Mode Defaults - resets ALL the Mode variables (and all the Meas global and Meas local variables), including the persistent ones.

Type Of Preset	SCPI Command	Front Panel Access
Auto Couple	:COUPle ALL	Auto Couple front-panel key
Meas Preset	:CONFigure:<Measurement>	Meas Setup Menu
Mode Preset	:SYSTem:PRESet	Mode Preset (green key)
Restore Mode Defaults	:INSTrument:DEFault	Mode Setup Menu
Restore All Mode Defaults	:SYSTem:DEFault MODes	System Menu; Restore System Default Menu
*RST	*RST	not possible (Mode Preset with Single)
Restore Input/Output Defaults	:SYSTem:DEFault INPUt	System Menu; Restore System Default Menu
Restore Power On Defaults	:SYSTem:DEFault PON	System Menu; Restore System Default Menu
Restore Alignment Defaults	:SYSTem:DEFault ALIGN	System Menu; Restore System Default Menu
Restore Miscellaneous Defaults	:SYSTem:DEFault MISC	System Menu; Restore System Default Menu
Restore All System Defaults	:SYSTem:DEFault [ALL] :SYSTem:PRESet:PERsistent	System Menu; Restore System Default Menu
User Preset	:SYSTem:PRESet:USER	User Preset Menu
User Preset All Modes	:SYSTem:PRESet:USER:ALL	User Preset Menu

Power On Mode Preset	:SYSTem:PON:TYPE MODE	System Menu
Power On User Preset	:SYSTem:PON:TYPE USER	System Menu
Power On Last State	:SYSTem:PON:TYPE LAST	System Menu

Preset Type (Remote Command Only)

As stated in the Backward Compatibility section, to be compatible with ESA/PSA the PRESet:TYPE command will be implemented as a no-op.

Mode	All
Remote Command	:SYSTem:PRESet:TYPE FACTory MODE USER :SYSTem:PRESet:TYPE?
Example	:SYST:PRESet:TYPE FACT
Notes	This command is supported for backward compatibility only. It is a no-op which does not change the behavior of any preset operation.
Preset	This is unaffected by Preset but is set to Mode on a “Restore System Defaults->All”
State Saved	No
Initial S/W Revision	Prior to A.02.00

Mode Setup

See "[Mode Setup](#)" on page 316

Peak Search

There is no 'Peak Search' supported in Spectrum Emission Mask so this front-panel key displays a blank menu when pressed.

Key Path	Front-panel key
Initial S/W Revision	Prior to A.02.00

10 Spectrum Emission Mask Measurement
Print

Print

See "Print" on page 341

Quick Save

The Quick Save front-panel key repeats the most recent save that was performed from the Save menu, with the following exceptions:

- Register saves are not remembered as Saves for the purpose of the Quick Save function
- If the current measurement does not support the last non-register save that was performed, an informational message is generated, “File type not supported for this measurement”

Quick Save repeats the last type of qualified save (that is, a save qualified by the above criteria) in the last save directory by creating a unique filename using the Auto File Naming algorithm described below.

If Quick Save is pressed after startup and before any qualified Save has been performed, the Quick Save function performs a Screen Image save using the current settings for Screen Image saves (current theme, current directory), which then becomes the “last save” for the purpose of subsequent Quick Saves.

The Auto File Naming feature automatically generates a file name for use when saving a file. The filename consists of a prefix and suffix separated by a dot, as is standard for the Windows® file system. A default prefix exists for each of the available file types:

Type	Default Prefix	Menu
State	State_	(Save/Recall)
Trace + State	State_	(Save/Recall)
Screen	Screen_	(Save/Recall)
Amplitude Corrections	Ampcor_	(Import/Export)
Traces	Trace_	(Import/Export)
Limit Lines	LLine_	(Import/Export)
Measurement Result	MeasR_	(Import/Export)
Capture Buffer	CapBuf_	(Import/Export)

A four digit number is appended to the prefix to create a unique file name. The numbering sequence starts at 0000 within each Mode for each file type and updates incrementally to 9999, then wraps to 0000 again. It remembers where it was through a Mode Preset and when leaving and returning to the Mode. It is reset by Restore Misc Defaults and Restore System Defaults and subsequent running of the instrument application. So, for example, the first auto file name generated for State files is State_0000.state. The next is State_0001, and so forth.

One of the key features of Auto File Name is that we guarantee that the Auto File Name will never conflict with an existing file. The algorithm looks for the next available number. If it gets to 9999, then it looks for holes. If it find no holes, that is no more numbers are available, it gives an error.

For example, if when we get to State_0010.state there is already a State_0010.state file in the current directory, it advances the counter to State_0011.state to ensure that no conflict will exist (and then it verifies that State_0011.state also does not exist in the current directory and advances again if it does, and so forth).

If you enter a file name for a given file type, then the prefix becomes the filename you entered instead of the default prefix, followed by an underscore. The last four letters (the suffix) are the 4-digit number.

For example, if you save a measurement results file as “fred.csv”, then the next auto file name chosen for a measurement results save will be fred_0000.csv.

NOTE

Although 0000 is used in the example above, the number that is used is actually the current number in the Meas Results sequence, that is, the number that would have been used if you had not entered your own file name.

NOTE

If the filename you entered ends with _dddd, where d=any number, making it look just like an auto file name, then the next auto file name picks up where you left off with the suffix being dddd + 1.

Key Path	Front-panel key
Notes	No remote command for this key specifically.
Initial S/W Revision	Prior to A.02.00

Recall

The Recall menu lets you choose what you want to recall, and where you want to recall it from. Among the types of files you can recall are **States and Traces**. In addition, an Import (Data) option lets you recall a number of data types stored in CSV files (as used by Excel and other spreadsheet programs).

The default paths for Recall are data type dependent and are the same as for the Save key.

Key Path	Front-panel key
Notes	<p>No remote command for this key specifically, but the :MMEM:LOAD command is available for specific file types. An example is :MMEM:LOAD:STATe <filename>.</p> <p>If you try to recall a State file for a mode that is not licensed or not available in the instrument, an error message will occur and the state will not change.</p>
Backwards Compatibility Notes	<p>In legacy analyzers, it was possible to load a state without affecting the trace data, limit lines or correction data. Similarly (since User Preset is actually loading a state), it was possible to do a User Preset without affecting the trace data, limit lines or correction data.</p> <p>In the X-Series, “state” always includes all of this data; so whenever state is loaded, all of the traces, limit lines and corrections are affected. Although this differs from previous behavior, it is desirable behavior, and should not cause adverse issues for users.</p>
Backwards Compatibility Notes	<p>Recall for the X-Series supports backward compatibility in the sense that you can recall a state file from any X-Series model number and any version of X-Series software. This is only possible if part of the recalling process goes through a limiting step after recalling the mode settings, at least for settings that may vary with version number, model number, option and license differences. If you try to recall a state file onto an instrument with less capability than what was available on the instrument during the save, the recall will ignore the state it doesn't support and it will limit the recalled setting to what it allows.</p> <p>Example: if the saved state includes preamp ON, but the recalling instrument does not have a preamp; the preamp is limited to OFF. Conversely, if you save a state without a preamp, the preamp is OFF in the state file. When this saved file is recalled on an instrument with a licensed preamp, the preamp is changed to OFF. Another example is if the saved state has center frequency set to 20 GHz, but the instrument recalling the saved state is a different model and only supports 13.5 GHz. In this case, the center frequency is limited along with any other frequency based settings. Since the center frequency can't be preserved in this case, the recall limiting tries to at least preserve span to keep the measurement setup as intact as possible.</p> <p>It may be appropriate to issue a warning if the state is limited on the recall; warnings do not go out to SCPI so this would only affect the manual user.</p> <p>Note that there is no state file compatibility outside of the X-Series. For example, you cannot recall a state file from ESA or PSA.</p>
Initial S/W Revision	Prior to A.02.00

State

The Recall State menu lets you choose a register or file from which to recall the state.

The content of a state file includes all of the settings and data required to return the analyzer as closely as possible to the Mode it was in, with the exact settings that were in place, when the save occurred. The Mode settings in each state file include the settings that are affected by Mode Preset, as well as the

additional settings affected by Restore Mode Defaults; all of the Mode's settings. In addition, all of the settings of the Input/Output system are included, even though they are outside of the Mode's state, because they are needed to restore the complete setup. Persistent System settings (for example, GPIB address) are not affected by either a Mode Preset or Restore Mode Defaults, nor are they included in a saved State file.

Since each state file is only for one Mode, the settings for other Modes are unaffected when it is loaded. Recall State will cause a mode switch if the state being recalled is not from the current active mode.

After the recall completes, the message "File <filename> recalled" or "Recalled State Register <register number>" is displayed.

For rapid recalls, the State menu lists 16 registers that you can choose from to recall. Pressing a Register key initiates the recall. You can also select a file from which to recall.

The default path for all State Files is:

My Documents\<<mode name>\state

where <mode name> is the parameter used to select the mode with the INST:SEL command (for example, SA for the Spectrum Analyzer).

See "[More Information](#)" on page 979.

Key Path	Recall
Mode	All
Remote Command	:MMEMory:LOAD:STATe <filename>
Example	:MMEM:LOAD:STAT "myState.state" This recalls the file myState.state on the default path
Example	MMEM:LOAD:STAT "MyStateFile.state" This loads the state file data (on the default file directory path) into the instrument state.
Notes	<p>When you pick a file to recall, the analyzer first verifies that the file is recallable in the current instrument by checking the software version and model number of the instrument. If everything matches, a full recall proceeds by aborting the currently running measurement, clearing any pending operations, and then loading the State from the saved state file. You can open state files from any mode, so recalling a State file switches to the mode that was active when the save occurred. After switching to the mode of the saved state file, mode settings and data (if any for the mode) are loaded with values from the saved file. The saved measurement of the mode becomes the newly active measurement and the data relevant to the measurement (if there is any) is recalled.</p> <p>If there is a mismatch between file version or model number or instrument version or model number, the recall function tries to recall as much as possible and returns a warning message. It may limit settings that differ based on model number, licensing or version number.</p> <p>After recalling the state, the Recall State function does the following:</p> <ul style="list-style-type: none"> • Makes the saved measurement for the mode the active measurement. • Clears the input and output buffers. • Status Byte is set to 0. • Executes a *CLS <p>If the file specified is empty an error is generated. If the specified file does not exist, another error is generated. If there is a mismatch between the file and the proper file type, an error is generated. If</p>

	there is a mismatch between file version or model number or instrument version or model number, a warning is displayed. Then it returns to the State menu and File Open dialog goes away. After the Recall, the analyzer exits the Recall menu and returns to the previous menu.
Backwards Compatibility SCPI	:MMEMory:LOAD:STATe 1,<filename> For backwards compatibility, the above syntax is supported. The "1" is simply ignored.
Initial S/W Revision	Prior to A.02.00

More Information

In measurements that support saving Traces, for example, Swept SA, the Trace data is saved along with the State in the State file. When recalling the State, the Trace data is recalled as well. Traces are recalled exactly as they were stored, including the writing mode and update and display modes. If a Trace was updating and visible when the State was saved, it will come back updating and visible, and its data will be rewritten right away. When you use State to save and recall traces, any trace whose data must be preserved should be placed in View or Blank mode before saving.

The following table describes the Trace Save and Recall possibilities:

You want to recall state and one trace's data, leaving other traces unaffected.	Save Trace+State from 1 trace. Make sure that no other traces are updating (they should all be in View or Blank mode) when the save is performed.	On Recall, specify the trace you want to load the one trace's data into. This trace will load in View. All other traces' data will be unaffected, although their trace mode will be as it was when the state save was performed.
You want to recall all traces	Save Trace+State from ALL traces.	On Recall, all traces will come back in View (or Blank if they were in Blank or Background when saved)
You want all traces to load exactly as they were when saved.	Save State	On recall, all traces' mode and data will be exactly as they were when saved. Any traces that were updating will have their data immediately overwritten.

From File...

When you press "From File", the analyzer brings up a Windows dialog and a menu entitled "File Open." This menu allows you to navigate to the various fields in the Windows dialog without using a keyboard or mouse. The Tab and Arrow keys can also be used for dialog navigation.

10 Spectrum Emission Mask Measurement Recall

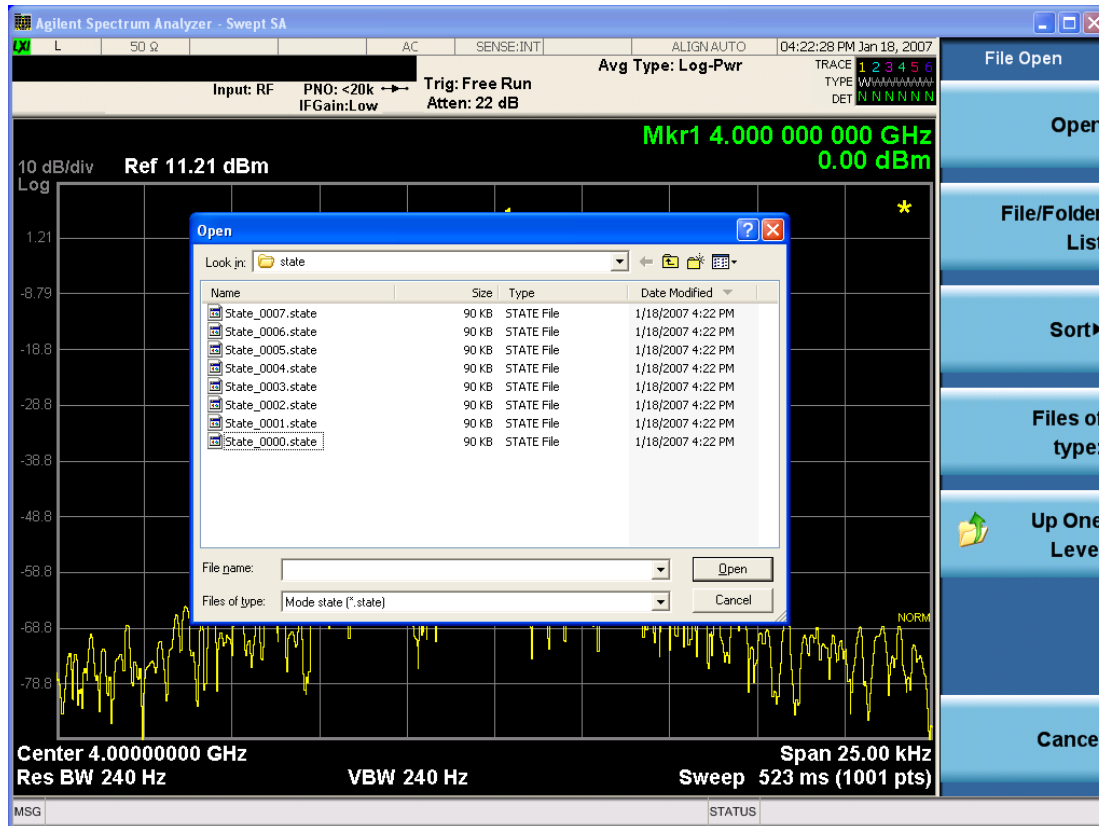

Listed below are the functions of the various fields in the dialog, and the corresponding softkeys:

Open

Performs the recall of the specified file. While the recall is being performed, the floppy icon appears briefly in the Meas bar.

File/Folder List

Enables you to navigate to the center of the dialog that contains the list of files and folders. Once here you can get information about the file and use the tab keys to navigate to the other fields in the dialog, such as Look In.

Look In

The Look In field shows the path from which the file will be recalled and allows you to change the path using the up and down arrow keys to navigate to other paths; the Enter key to open a directory; and the Backspace key to go back one directory. The **Look In field** first uses the last path from the Save As dialog **Save In:** path for that same file type. There is no softkey for directly navigating to the Look In field, but you can use the left tab to get here from the File/Folder List.

User specified paths are remembered when you leave and return to a Mode and are reset back to the default using Restore Mode Defaults.

Sort

Accesses a menu that enables you to sort the files within the File Open dialog. Only one sorting type can be selected at a time and the sorting happens immediately. The sorting types are By Date, By Name, By extension, and By Size.

Files of Type

This field shows the file suffix for the type of file you have selected to recall. For example, if you navigated here while recalling State, "Mode state (*.state)" is in the field. If you navigated here while recalling Trace, ""Mode state (*.trace)" is in the field. If you navigated here while importing a trace data file, "Trace Data (*.csv)" is in the field. For some file types, there is more than one choice in the dropdown menu, which you can select by using the up and down arrow keys and Enter.

Up One Level

This key corresponds to the icon of a folder with the up arrow that is in the tool bar of the dialog. When pressed, it causes the file and folder list to navigate up one level in the directory structure. The Backspace key does the same thing.

Cancel

This key corresponds to the Cancel selection in the dialog. It causes the current **Open** request to be cancelled. The ESC key does the same thing.

Key Path	Recall, State
Notes	Brings up the Open dialog for recalling a State Save Type
Initial S/W Revision	Prior to A.02.00

Edit Register Names

You may enter a custom name on any of the Register keys, to help you remember what you are using that state to save. To do this, press the Edit Register Names key, choose the register whose name you wish to edit, and then enter the desired label using the Alpha Editor or an external PC keyboard.

The maximum number of characters that can be added is 30. In most cases, 30 characters will fit on two lines of the key.

For more information and the SCPI command, see Edit Register Names under the Save, State function.

Key Path	Recall, State
Mode	All
Dependencies	N9060A-7FP or N9060B-2FP license required to edit the register names. When the feature is not licensed, sending the SCPI command generates an error, -221, "Settings conflict;Option not available"
Initial S/W Revision	A.11.00

Register 1 thru Register 16

Selecting any one of these register keys causes the State of the mode from the specified Register to be recalled. Each of the register keys annotates whether it is empty or at what date and time it was last

modified. In addition, you can use the Edit Register Names key under Save, State to enter custom names for each register.

Registers are shared by all modes, so recalling from any one of the registers will cause a mode switch to the mode that was active when the save to the Register occurred.

Although these 16 registers are the only registers available from the front panel, there are 128 state registers available in the instrument. Registers 17–128 are only available from the SCPI interface, using the *RCL command.

After the recall completes, the message "Register <register number> recalled" appears in the message bar. If you are in the Spectrum Analyzer Mode, and you are recalling a register that was saved in the Spectrum Analyzer Mode, then after the recall, you will still be in the Recall Register menu. If the Recall causes you to switch modes, then after the Recall, you will be in the Frequency menu.

If a requested register is empty an error is generated.

Key Path	Recall, State
Example	*RCL 1
Range	1–16 from front panel, 1–128 from SCPI
Readback	Date and time with seconds resolution are displayed on the key OR A custom name of up to 30 characters entered using the Save, State, Edit Register Names key OR “(empty)” if no prior save operation has been performed to this register.
Initial S/W Revision	Prior to A.02.00
Modified at S/W Revision	Prior to A.11.00

Register 1 thru Register 16

Selecting any one of these register keys causes the State of the mode from the specified Register to be recalled. Each of the register keys annotates whether it is empty or at what date and time it was last modified. In addition, you can use the Edit Register Names key under Save, State to enter custom names for each register.

Registers are shared by all modes, so recalling from any one of the registers will cause a mode switch to the mode that was active when the save to the Register occurred.

Although these 16 registers are the only registers available from the front panel, there are 128 state registers available in the instrument. Registers 17–128 are only available from the SCPI interface, using the *RCL command.

After the recall completes, the message "Register <register number> recalled" appears in the message bar. If you are in the Spectrum Analyzer Mode, and you are recalling a register that was saved in the Spectrum Analyzer Mode, then after the recall, you will still be in the Recall Register menu. If the Recall causes you to switch modes, then after the Recall, you will be in the Frequency menu.

If a requested register is empty an error is generated.

Key Path	Recall, State
Example	*RCL 1
Range	1–16 from front panel, 1–128 from SCPI
Readback	Date and time with seconds resolution are displayed on the key OR A custom name of up to 30 characters entered using the Save, State,Edit Register Names key OR “(empty)” if no prior save operation has been performed to this register.
Initial S/W Revision	Prior to A.02.00
Modified at S/W Revision	Prior to A.11.00

Data (Import)

Importing a data file loads data that was previously saved from the current measurement or from other measurements and/or modes that produce compatible data files. The Import Menu only contains Data Types that are supported by the current measurement.

Since the commonly exported data files are in .csv format, the data can be edited by the user prior to importing. This allows you to export a data file, manipulate the data in Excel (the most common PC Application for manipulating .csv files) and then import it.

Importing Data loads measurement data from the specified file into the specified or default destination, depending on the data type selected. Selecting an Import Data menu key will not actually cause the importing to occur, since the analyzer still needs to know from where to get the data. Pressing the Open key in this menu brings up the Open dialog and Open menu that provides you with the options from where to recall the data. Once a filename has been selected or entered in the Open menu, the recall occurs as soon as the Open button is pressed.

Key Path	Recall
Mode	All
Notes	The menu is built from whatever data types are available for the mode. Some keys will be missing completely, so the key locations in the sub-menu will vary. No SCPI command directly controls the Data Type that this key controls. The Data Type is included in the MMEM:LOAD commands.
Dependencies	If a file type is not used by a certain measurement, it is grayed out for that measurement. The key for a file type will not show at all if there are no measurements in the Mode that support it.
Preset	Is not affected by Preset or shutdown, but is reset during Restore Mode Defaults
Readback	The data type that is currently selected
Initial S/W Revision	Prior to A.02.00

Mask

Enables you to recall a preset mask file. This file type (.mask) differs from a normal “state” file because it contains the configuration for Carrier, Offset, and Limit for the specific preset profile BW. A brief description of the mask file is available in the properties view of each file. (Right-mouse-click on the file, select, "Properties" to view this information.) A detailed list of the mask parameter values is located in the .pdf file of the same name in the same directory. Blank values in the .pdf file are parameters that will not be overwritten when recalling the mask.

Key Path	Recall, Data
Mode	WIMAXOFDMA
Remote Command	:MMEMory:LOAD:MASK <string>
Example	:MMEM:LOAD:MASK "MyLimitFile.mask"
Notes	Set of parameters related to Limit, Carrier and Offset are overwritten by Preset Mask file.
Initial S/W Revision	A.02.00

This topic contains the following sections:

["File location and extension" on page 984](#)

["Example of Preset Mask file" on page 985](#)

File location and extension

File location: The preset mask file is located in “My Documents\WIMAXOFDMA\data\masks”.

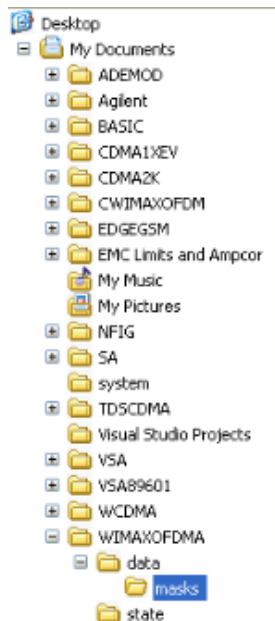

NOTE

When your X-Series analyzer starts, all mask files located in “My Documents\WIMAXOFDMA\data/masks” are overwritten, so any files you wish to save should be stored in another directory location.

File type: The file type is binary file.

File Name: The file name is decided by following naming rules. Each specific keyword is connected with underscore.

<Standard name>_<Radio device>_<Preset Profile BW>_<Measurement>.mask

<Standard name>: This term references the standard associated with each mask file.

<Radio device>: This term specifies to which radio device (BS or MS) the mask file pertains.

<Preset Profile BW>: This term specifies to which Preset Profile BW the mask file pertains.

<Measurement>: This term specifies the measurement to which the mask file is applied. Your selections are: SEM, ACP, or Mode. When selecting **Mode**, the values of some parameters in both the ACP and SEM measurement are overwritten.

File extension: The extension of preset mask file is “mask” to distinguish it from a “state” file.

When you press the open key under the Data menu, the “My Documents\WIMAXOFDMA\data\masks” folder is opened. Select one mask file.

NOTE

When you change the preset BW profile or Radio Device, all measurement parameters are reset to their original values. Thus you have to recall the appropriate preset mask file again after the change.

Example of Preset Mask file

When you import a preset mask file, it is a “Recall” function. Specific parameter values are overwritten by the contents of the preset mask file (see table below). Those values not specified by the preset mask file remain unchanged. Because the file format type is binary, you cannot view, change, or create the preset mask file. Here is an example of a preset mask file used for ACP measurements.

File Location: My Documents/WIMAXOFDMA/data/masks

File Name: ETSI-EN301-021-SysE_BS_10MHz_ACP.mask

The .pdf file that lists the parameters similarly to that shown below is named, "ETSI-EN301-021-SysE_BS_10MHz_ACP.pdf"

The set of parameters listed in the following table for the Preset Profile BW (10MHz) are imported into the ACP measurement.

Offset	Start Freq (MHz)	Stop Freq (MHz)	Sweep Time	Res BW (Hz)	Meas BW	Rel Start	Rel Stop	Fail Mask
A	5	7.14		30k	1	-8	-25	Rel
B	7.14	10.57		30k	1	-25	-27	Rel
C	10.57	20		30k	1	-27	-50	Rel
D	20	25		30k	1	-50	-50	Rel
E	25	30		30k	1	-50	-50	Rel

Zone Map

Pressing this key selects Zone Map as the data type to be imported.

The WiMAX-OFDMA application can load the Singal Studio Setup file, and the OFDMA Map file is compatible with the 89601A Mobile WiMAX omf file.

Key Path	Recall, Data
Remote Command	:MMEMory:LOAD:ZMAP <string>
Example	MMEM:LOAD:ZMAP "ZMap_0000.omf"
Notes	The SCPI parameter is a quoted string that specifies the filename. Both single and double quotes are supported for any filename parameter over SCPI.
Dependencies	You must be in the 802.16 OFDMA (WiMAX/WiBro) mode.
Status Bits/OPC dependencies	Sequential – waits for the previous measurement to complete.
Initial S/W Revision	Prior to A.02.00

Open...

When you press “Open”, the analyzer brings up a Windows dialog and a menu entitled “File Open.” This menu allows you to navigate to the various fields in the Windows dialog without using a keyboard or mouse. The Tab and Arrow keys can also be used for dialog navigation.

See "[From File...](#)" on page 2241 in Recall, State, for a full description of this dialog and menu.

Key Path	Recall, Data
Notes	The key location is mode-dependent and will vary. Brings up Open dialog for recalling a <mode specific> Save Type
Initial S/W Revision	Prior to A.02.00

Restart

The Restart function restarts the current sweep, or measurement, or set of averaged/held sweeps or measurements. If you are Paused, pressing Restart does a Resume.

The Restart function is accessed in several ways:

- Pressing the Restart key
- Sending the remote command INIT:IMMEDIATE
- Sending the remote command INIT:RESTART

See "[More Information](#)" on page 987

Key Path	Front-panel key
Remote Command	:INITiate[:IMMEDIATE] :INITiate:RESTART
Example	:INIT:IMM :INIT:REST
Notes	:INITiate:RESTART and :INITiate:IMMEDIATE perform exactly the same function.
Couplings	Resets average/hold count k. For the first sweep overwrites all active (update=on) traces with new current data. For application modes, it resets other parameters as required by the measurement.
Status Bits/OPC dependencies	This is an Overlapped command. The STATUS:OPERation register bits 0 through 8 are cleared. The STATUS:QUESTIONable register bit 9 (INTEgrity sum) is cleared. The SWEEPING bit is set. The MEASURING bit is set.
Backwards Compatibility Notes	For Spectrum Analysis mode in ESA and PSA, the Restart hardkey and the INITiate:RESTART command restart trace averages (displayed average count reset to 1) for a trace in Clear Write, but did not restart Max Hold and Min Hold. In the X-Series, the Restart hardkey and the INITiate:RESTART command restart not only Trace Average, but MaxHold and MinHold traces as well. For wireless comms modes in ESA and PSA, the Restart hardkey and the INITiate:RESTART command restart every measurement, which includes all traces and numeric results. There is no change to this operation.
Initial S/W Revision	Prior to A.02.00

More Information

The **Restart** function first aborts the current sweep/measurement as quickly as possible. It then resets the sweep and trigger systems, sets up the measurement and initiates a new data measurement sequence with a new data acquisition (sweep) taken once the trigger condition is met.

If the analyzer is in the process of aligning when **Restart** is executed, the alignment finishes before the restart function is performed.

Even when set for Single operation, multiple sweeps may be taken when Restart is pressed (for example, when averaging/holding is on). Thus when we say that **Restart** "restarts a measurement," we may mean:

- It restarts the current sweep
- It restarts the current measurement
- It restarts the current set of sweeps if any trace is in Trace Average, Max Hold or Min Hold
- It restarts the current set of measurements if Averaging, or Max Hold, or Min Hold is on for the measurement
- depending on the current settings.

With **Average/Hold Number** (in **Meas Setup** menu) set to 1, or Averaging off, or no trace in Trace Average or Hold, a single sweep is equivalent to a single measurement. A single sweep is taken after the trigger condition is met; and the analyzer stops sweeping once that sweep has completed. However, with **Average/Hold Number** >1 and at least one trace set to **Trace Average, Max Hold, or Min Hold (SA Measurement)** or **Averaging on (most other measurements)**, multiple sweeps/data acquisitions are taken for a single measurement. The trigger condition must be met prior to each sweep. The sweep is stopped when the average count k equals the number N set for **Average/Hold Number**. A measurement average usually applies to all traces, marker results, and numeric results; but sometimes it only applies to the numeric results.

Once the full set of sweeps has been taken, the analyzer will go to idle state. To take one more sweep without resetting the average count, increment the average count by 1, by pressing the step up key while **Average/Hold Number** is the active function, or sending the remote command CALC:AVER:TCON UP.

Save

The Save menu lets you choose what you want to save and where you want to save it. Among the types of files you can save are **States**, **Traces**, and **Screen Images**. In addition, an Export (Data) option lets you save a number of data types as CSV files for easy import into Excel and other spreadsheet programs.

Key Path	Front-panel key
Mode	All
Notes	No remote command for this key specifically, but the :MMEM:STORe command is available for specific file types. An example is :MMEM:STOR:STATe <filename>.
Initial S/W Revision	Prior to A.02.00

State

The Save State menu lets you choose a register or file for saving the state.

The content of a state file includes all of the settings and data required to return the analyzer as closely as possible to the Mode it was in, with the exact settings which were in place, when the save occurred. The Mode settings in each state file include the settings that are affected by Mode Preset, as well as the additional settings affected by Restore Mode Defaults; all of the Mode's settings. In addition, all of the settings of the Input/Output system are included, even though they are outside of the Mode's state, because they are needed to restore the complete setup. Persistent System settings (for example, Verbose SCPI) are not affected by either Mode Preset or Restore Mode Defaults, nor are they included in a saved State file.

After the save completes, the message "File <filename> saved" or "State Register <register number> saved" is displayed.

For rapid saving, the State menu lists 16 registers to save to. Pressing a Register key initiates the save. You can also select a file to save to.

The default path for all State Files is:

My Documents\<<mode name>\state

where <mode name> is the parameter used to select the mode with the INST:SEL command (for example, SA for the Spectrum Analyzer).

Key Path	Save
Mode	All
Remote Command	:MMEMory:STORe:STATe <filename>
Example	MMEM:STOR:STATe "MyStateFile.state" This stores the current instrument state data in the file MyStateFile.state in the default directory.
Notes	Both single and double quotes are supported for any filename parameter over remote. After saving to a register, that register's menu key is updated with the date the time, unless a custom label has been entered for that key. After saving to a register, you remain in the Save State menu, so that you can see the Register key

update. After saving to a file, the analyzer automatically returns to the previous menu and any Save As dialog goes away.

Backwards Compatibility SCPI :MMEMory:STORe:STATe 1,<filename>

For backwards compatibility, the above syntax is supported. The "1" is simply ignored. The command is sequential.

Initial S/W Revision Prior to A.02.00

To File . . .

When you press “To File”, the analyzer brings up a Windows dialog and a menu entitled “Save As.” This menu allows you to navigate to the various fields in the Windows dialog without using a keyboard or mouse. The Tab and Arrow keys can also be used for dialog navigation.

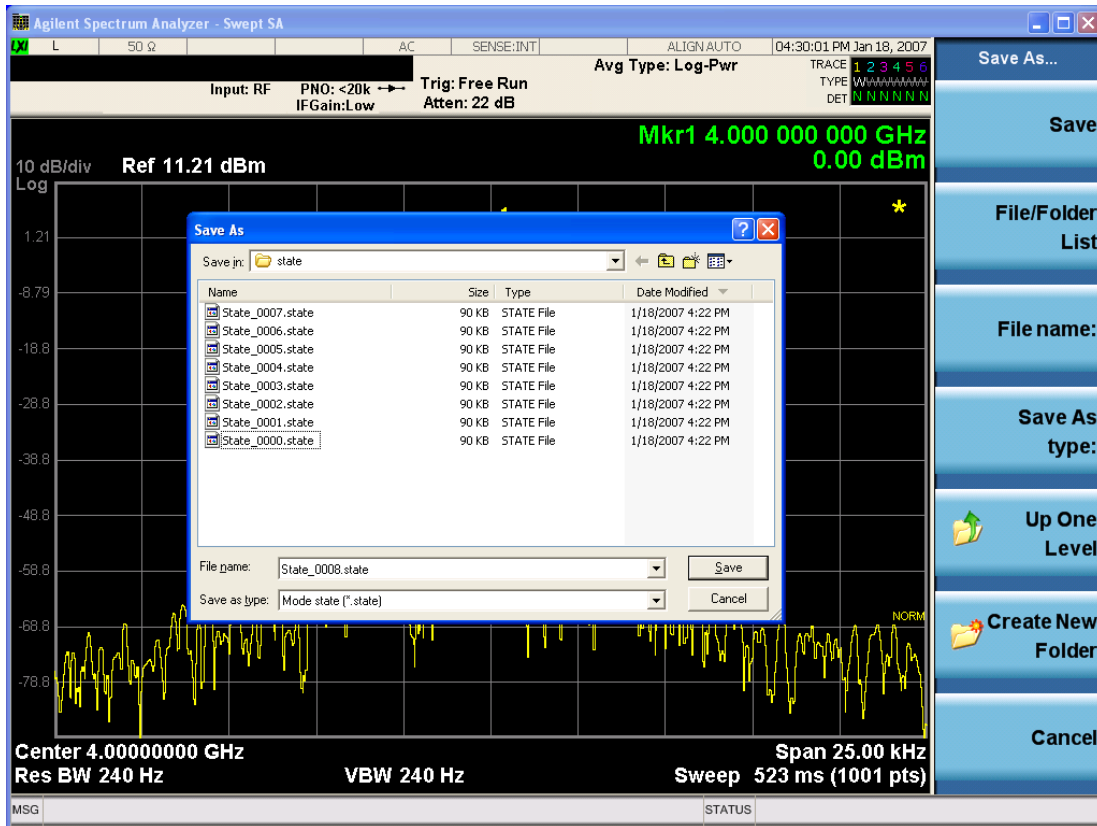

The Listed below

are the functions of the various fields in the dialog, and the corresponding softkeys:

Save

Performs the save to the specified file of the selected type. If the file already exists, a dialog will appear that allows you to replace the existing file by selecting OK, or you can Cancel the request. If you select OK, the file will be overwritten. Using the C: drive is strongly discouraged, since it runs the risk of being overwritten during an instrument software upgrade.

While the save is being performed, the floppy icon appears briefly in the Meas bar.

File/Folder List

Enables you to navigate to the center of the dialog that contains the list of files and folders. Once here you can get information about the file and use the tab keys to navigate to the other fields in the dialog, such as Save In.

Save In

The Save In field shows the path to which the file will be saved and allows you to change the path using the up and down arrow keys to navigate to other paths; the Enter key to open a directory; and the Backspace key to go back one directory. The **Save In field** defaults to the default path for this type of file and remembers the last path you used to save this type of file. There is no softkey for directly navigating to the Save In field but you can use left tab to get here from the File/Folder List.

User specified paths are remembered when you leave and return to a Mode and are reset back to the default using Restore Mode Defaults.

File Name

The File Name field is initially loaded with an automatically generated filename specific to the appropriate Save Type. The automatically generated filename is guaranteed not to conflict with any filename currently in the directory. You may replace or modify this filename using the File Name key. See the ["Quick Save " on page 2237](#) documentation for more on the automatic file naming algorithm.

When you press the File Name key the analyzer displays the Alpha Editor. Use the knob to choose the letter to add and the front-panel Enter key to add the letter to the file name. The BK character moves you back and the FW character moves you forward in the filename. The Select key on the front panel generates a space character. When you are done entering the filename press the Done softkey. This returns back to the **File Open** dialog and menu, but does not cause the save to occur.

Save As Type

This field shows the file suffix for the type of file you have selected to save. For example, if you navigated here while saving State, "Mode state (*.state)" is in the field. If you navigated here from saving Trace, ""Mode state (*.trace)" is in the field. If you navigated here while exporting a trace data file, "Trace Data (*.csv)" is in the field. For some file types, there is more than one choice in the dropdown, which you can select by using the up and down arrow keys and Enter.

Up One Level

This key corresponds to the icon of a folder with the up arrow that is in the tool bar of the dialog. When pressed, it causes the file and folder list to navigate up one level in the directory structure. The Backspace key does the same thing.

Create New Folder

This key corresponds to the icon of a folder with the "*" that is in the tool bar of the dialog. When pressed, a new folder is created in the current directory with the name **New Folder** and you can enter a new folder name using the Alpha Editor.

Cancel

This key corresponds to the Cancel selection in the dialog. It causes the current **Save As** request to be cancelled. The ESC key does the same thing.

Key Path	Save, State
Mode	All
Notes	Brings up Save As dialog for saving a State Save Type
Initial S/W Revision	Prior to A.02.00

Edit Register Names

You may enter a custom name on any of the Register keys, to help you remember what you are using that state to save. To do this, press the Edit Register Names key, choose the register whose name you wish to edit, and then enter the desired label using the Alpha Editor or an external PC keyboard.

The maximum number of characters that can be added is 30. In most cases, 30 characters will fit on two lines of the key.

See ["More Information" on page 992](#)

Key Path	Save, State
Mode	All
Remote Command	:MMEMory:REGister:STATe:LABel <reg number>,"label" :MMEMory:REGister:STATe:LABel? <reg number>
Example	:MMEM:REG:STAT:LAB 1,"my label"
Notes	<reg number> is an integer from 1 to 16. If the SCPI specifies an invalid register number an error message is generated, -222,"Data out of range;Invalid register label number" "label" is a string from 0 to 30 characters in length. If a label exceeds 30 characters, an error message is generated, -150,"String data error;Label clipped to 30 characters" "label" of length 0 erases the custom label and restores the default (time and date) label. E.g.: :MMEM:REG:STAT:LAB 1,""
Dependencies	N9060A-7FP or N9060B-2FP license required to edit the register names. When the feature is not licensed, sending this command generates an error, -221,"Settings conflict;Option not available"
Preset	The names are unaffected by Preset or power cycle but are set to the default label (time and date) on a "Restore System Defaults->Misc"
Initial S/W Revision	A.11.00

More Information

When you edit one of the register names, the time and date field will be replaced by the custom name.

If you delete all the characters in the custom name, it restores the default (time and date).

The register names are stored within the state files, but they are not part of the instrument state; that is, once you have edited a register name, loading a new state will not change that register name. Another consequence of this is that the names will be persistent through a power cycle. Also, if a named state file is transferred to another analyzer, it will bring its custom name along with it.

If you try to edit the name of an empty register, the analyzer will first save the state to have a file to put the name in. If you load a named state file into an analyzer with older firmware it will ignore the metadata.

The *SAV and *RCL commands will not be affected by the custom register names, nor will the MMEM commands.

Register 1 thru Register 16

Selecting any one of these register menu keys causes the State of the currently active mode to be saved to the specified Register. The registers are provided for rapid saving and recalling, since you do not need to specify a filename or navigate to a file. Each of the register menu keys annotates whether it is empty or at what date and time it was last modified. In addition, you can use the Edit Register Names key to enter custom names for each register.

Although these 16 registers are the only registers available from the front panel, there are 128 state registers available in the instrument. Registers 17–128 are only available from the SCPI interface, using the *SAV command.

There is one set of 128 state registers in the instrument, not one set for each Mode. When a state is saved, the Mode it was saved from is saved with it; then when it is recalled, the instrument switches to that Mode.

After the save completes, the corresponding register menu key annotation is updated with the date and time and the message "Register <register number> saved" is displayed.

Key Path	Save, State
Mode	All
Example	*SAV 1
Range	1–16 from front panel, 1–128 from SCPI
Readback	Date and time with seconds resolution are displayed on the key OR A custom name of up to 30 characters entered using the Edit Register Names key OR “(empty)” if no prior save operation has been performed to this register.
Initial S/W Revision	Prior to A.02.00
Modified at S/W Revision	A.11.00

Register 1 thru Register 16

Selecting any one of these register menu keys causes the State of the currently active mode to be saved to the specified Register. The registers are provided for rapid saving and recalling, since you do not need to specify a filename or navigate to a file. Each of the register menu keys annotates whether it is empty or at what date and time it was last modified. In addition, you can use the Edit Register Names key to enter custom names for each register.

Although these 16 registers are the only registers available from the front panel, there are 128 state registers available in the instrument. Registers 17–128 are only available from the SCPI interface, using the *SAV command.

There is one set of 128 state registers in the instrument, not one set for each Mode. When a state is saved, the Mode it was saved from is saved with it; then when it is recalled, the instrument switches to that Mode.

After the save completes, the corresponding register menu key annotation is updated with the date and time and the message "Register <register number> saved" is displayed.

Key Path	Save, State
Mode	All
Example	*SAV 1
Range	1-16 from front panel, 1-128 from SCPI
Readback	Date and time with seconds resolution are displayed on the key OR A custom name of up to 30 characters entered using the Edit Register Names key OR “(empty)” if no prior save operation has been performed to this register.
Initial S/W Revision	Prior to A.02.00
Modified at S/W Revision	A.11.00

Data (Export)

Exporting a data file stores data from the current measurement to mass storage files. The Export Menu only contains data types that are supported by the current measurement.

Since the commonly exported data files are in .csv format, the data can be edited by you prior to importing. This allows you to export a data file, manipulate the data in Excel (the most common PC Application for manipulating .csv files) and then import it.

Selecting an Export Data menu key will not actually cause the exporting to occur, since the analyzer still needs to know where you wish to save the data. Pressing the Save As key in this menu brings up the Save As dialog and Save As menu that allows you to specify the destination file and directory. Once a filename has been selected or entered in the Open menu, the export will occur as soon as the Save key is pressed.

Key Path	Save
Mode	All
Notes	The menu is built from whatever data types are available for the mode. So the key locations in the sub menu will vary. No SCPI command directly controls the Data Type that this key controls. The Data Type is included in the MMEM:STORe commands.
Dependencies	If a file type is not used by a certain measurement, that type is grayed out for that measurement. The key for a file type will not show at all if there are no measurements in the Mode that support it.
Preset	Is not affected by a Preset or shutdown, but is reset during Restore Mode Defaults
Readback	The data type that is currently selected
Initial S/W Revision	Prior to A.02.00

Measurement Results

Pressing this key selects Meas Results as the data type to be exported.

The Meas Results file contains information that describes the current state of the analyzer. It is detailed in ["Meas Results File Contents" on page 995](#) below.

Key Path	Save, Data
Remote Command	:MMEMory:STORe:RESults <string>
Example	:MMEM:STOR:RES "MeasR_0000.csv"
Notes	<p>If the save is initiated via SCPI and the file already exists, the file will be overwritten.</p> <p>The SCPI command exports Spectrum Emission Mask measurement results to the file specified as the parameter in the current path. The default path is My Documents\<current mode>\data\sem\results.<="" p=""> <p>Using the C: drive is strongly discouraged, since it runs the risk of being overwritten during an instrument software upgrade.</p> <p>The SCPI parameter is a quoted string that specifies the filename. Both single and double quotes are supported for any filename parameter over SCPI.</p> </current></p>
Dependencies	The current active measurement must be the Spectrum Emission Mask measurement to use this command.
Status Bits/OPC dependencies	Sequential – waits for the previous measurement to complete
Initial S/W Revision	Prior to A.02.00

Meas Results File Contents

A Meas Results File contains measurement results with the following information.

- File ID string, which is "MeasResult"
- Measurement ID following Mode ID, which is "SA:SEM" for example.
- Firmware rev and model number
- Option string
- Automatic Trigger Time
- Automatic Trigger Time State
- Center Frequency
- ChanIntegBW
- ChannelDetector
- ChannelDetectorState
- ChanPwrRefAuto
- ChanResBW

- ChanResBWAuto
- ChanSpan
- ChanSweepTime
- ChanSweepTimeAuto
- ChanVbwRbwRatio
- ChanVbwRbwRatioAuto
- ChanVideoBW
- ChanVideoBWAuto
- Electrical Atten
- Electrical Atten Bypass
- Electrical Atten State
- External1 Trigger Delay
- External1 Trigger Delay State
- External1 Trigger Level
- External1 Trigger Slope
- External2 Trigger Delay
- External2 Trigger Delay State
- External2 Trigger Level
- External2 Trigger Slope
- FilterAlpha
- Internal Preamp
- Internal Preamp Band
- Line Trigger Delay
- Line Trigger Delay State
- Line Trigger Slope
- Mechanical Atten
- Mechanical Atten Auto
- OffsetDetector
- OffsetDetectorState
- OffsetLimitAbsStartBTS
- OffsetLimitAbsStartMS

- OffsetLimitAbsStopBTS
- OffsetLimitAbsStopMS
- OffsetLimitFailMaskBTS
- OffsetLimitFailMaskMS
- OffsetLimitRelStartBTS
- OffsetLimitRelStartMS
- OffsetLimitRelStopBTS
- OffsetLimitRelStopMS
- OffsetMeasBWBTS
- OffsetMeasBWMS
- OffsetResolutionBWAutoBTS
- OffsetResolutionBWAutoMS
- OffsetResolutionBWBTS
- OffsetResolutionBWMS
- OffsetSideBTS
- OffsetSideMS
- OffsetStartFrequencyBTS
- OffsetStartFrequencyMS
- OffsetStateBTS
- OffsetStateMS
- OffsetStopFrequencyBTS
- OffsetStopFrequencyMS
- OffsetSweepTimeAutoBTS
- OffsetSweepTimeAutoMS
- OffsetSweepTimeBTS
- OffsetSweepTimeMS
- OffsetVbwRbwRatioAutoBTS
- OffsetVbwRbwRatioAutoMS
- OffsetVbwRbwRatioBTS
- OffsetVbwRbwRatioMS
- OffsetVideoBWAutoBTS

- OffsetVideoBWAutoMS
- OffsetVideoBW BTS
- OffsetVideoBW MS
- PeakReference
- Periodic Timer Period
- Periodic Timer Sync Source
- Periodic Timer Trigger Delay
- Periodic Timer Trigger Delay State
- PowerReference
- PSDReference
- Radio Device
- RFBurst Trigger Delay
- RFBurst Trigger Delay State
- RFBurst Trigger Level Abs
- RFBurst Trigger Level Rel
- RFBurst Trigger Level Type
- RFBurst Trigger Slope
- RrcFilter
- SemAverageNumber
- SemAverageState
- TotalAtten
- Trigger Holdoff
- Trigger Holdoff State
- TriggerSource
- Video Trigger Delay
- Video Trigger Delay State
- Video Trigger Level
- Video Trigger Slope
- ViewSelection

The file contains these data followed by MeasResult1 to MeasResult12 that flag the start of the measurement results. Each line of Measurement Results consists of twelve comma separated values from MeasResult1 value to MeasResult12 value. MeasResult1 contains the same results as

MEAS/READ/FETCH:SEMask1; MeasResult2, MEAS/READ/FETCH:SEMask2; MeasResult3,
MEAS/READ/FETCH:SEMask3;... (continues in the same manner)

The exported file is in CSV format, with a.csv extension. The Meas Results file, when imported into Excel, shows the following data:

MeasResult		
SA:SEM		
A.10.53	N90	
	30A	
526 ALV ATP	1	
B1X B1Y B25		
B40 BBA CR3		
CRP DCF DDA		
DP2 DRD EA3		
EDP EMC EP1		
ERC ESC ESP		
EXM FSA LFE		
LNP MAT		
MPB NFE		
NUL P26 PFR		
PNC RTL RTS		
S40 SB1 SEC		
SM1 TVT YAS		
YAV		
Automatic Trigger Time	0.1	
Automatic Trigger Time State	FALS	E
Center Frequency	1.33	E+10
ChanIntegBW	384 000 0	384 000 0
ChannelDetector	Average	
ChannelDetectorState	TRUE	
ChanPwrRefAuto	TRUE	
ChanResBW	100 000	100 000
ChanResBWAuto	FALS E	FALS E
ChanSpan	500 000	500 000

10 Spectrum Emission Mask Measurement
Save

	0	0
ChanSweepTime	0.00 250 7	0.00 250 7
ChanSweepTimeAuto	TRUE	TRUE
ChanVbwRbwRatio	1	1
ChanVbwRbwRatioAuto	FALSE	FALSE
ChanVideoBW	100 000	100 000
ChanVideoBWAuto	TRUE	TRUE
Electrical Atten	0	
Electrical Atten Bypass	TRUE	
Electrical Atten State	FALSE	
External1 Trigger Delay	1.00 E-06	
External1 Trigger Delay State	FALSE	
External1 Trigger Level	1.2	
External1 Trigger Slope	Positive	
External2 Trigger Delay	1.00 E-06	
External2 Trigger Delay State	FALSE	
External2 Trigger Level	1.2	
External2 Trigger Slope	Positive	
FilterAlpha	0.22	
Internal Preamp	FALSE	
Internal Preamp Band	Low	

Line Trigger Delay	1.00 E-06					
Line Trigger Delay State	FALSE					
Line Trigger Slope	Positive					
Mechanical Atten	10					
Mechanical Atten Auto	TRUE					
OffsetDetector	Peak					
OffsetDetectorState	TRUE					
OffsetLimitAbsStartBTS	-14	-14	-26	-13	-13	-13
OffsetLimitAbsStartMS	-14	-14	-26	-13	-13	-13
OffsetLimitAbsStopBTS	-14	-26	-26	-13	-13	-13
OffsetLimitAbsStopMS	-14	-26	-26	-13	-13	-13
OffsetLimitFailMaskBTS	ABSolute	ABSolute	ABSolute	ABSolute	ABSolute	ABSolute
OffsetLimitFailMaskMS	ABSolute	ABSolute	ABSolute	ABSolute	ABSolute	ABSolute
OffsetLimitRelStartBTS	-30	-30	-30	-30	-30	-30
OffsetLimitRelStartMS	-30	-30	-30	-30	-30	-30
OffsetLimitRelStopBTS	-30	-30	-30	-30	-30	-30
OffsetLimitRelStopMS	-30	-30	-30	-30	-30	-30
OffsetMeasBWBTS	1	1	1	1	1	1
OffsetMeasBWS	1	1	1	1	1	1
OffsetResolutionBWAutoBTS	FALSE	FALSE	FALSE	FALSE	FALSE	FALSE
OffsetResolutionBWAutoMS	FALSE	FALSE	FALSE	FALSE	FALSE	FALSE

OffsetResolutionBWBTS	30000	30000	30000	1000000	1000000	1000000
OffsetResolutionBWS	30000	30000	30000	1000000	1000000	1000000
OffsetSideBTS	Both	Both	Both	Both	Both	Both
OffsetSideMS	Both	Both	Both	Both	Both	Both
OffsetStartFrequencyBTS	2515000	2715000	3515000	4000000	800000	125000
OffsetStartFrequencyMS	2515000	2715000	3515000	4000000	800000	125000
OffsetStateBTS	TRUE	TRUE	TRUE	TRUE	TRUE	FALSE
OffsetStateMS	TRUE	TRUE	TRUE	TRUE	TRUE	FALSE
OffsetStopFrequencyBTS	2715000	3515000	4000000	8000000	125000	150000
OffsetStopFrequencyMS	2715000	3515000	4000000	8000000	125000	150000
OffsetSweepTimeAutoBTS	TRUE	TRUE	TRUE	TRUE	TRUE	TRUE
OffsetSweepTimeAutoMS	TRUE	TRUE	TRUE	TRUE	TRUE	TRUE
OffsetSweepTimeBTS	0.01733	0.06932	0.04202	0.002053	0.00225	0.00125
OffsetSweepTimeMS	0.01733	0.06932	0.04202	0.002053	0.00225	0.00125
OffsetVbwRbwRatioAutoBTS	FALSE	FALSE	FALSE	FALSE	FALSE	FALSE
OffsetVbwRbwRatioAutoMS	FALSE	FALSE	FALSE	FALSE	FALSE	FALSE
OffsetVbwRbwRatioBTS	0.01	0.01	0.01	0.01	0.01	0.01
OffsetVbwRbwRatioMS	0.01	0.01	0.01	0.01	0.01	0.01

OffsetVideoB WAutoBTS	TRUE	TRUE	TRUE	TRUE	TRUE	TRUE
OffsetVideoB WAutoMS	TRUE	TRUE	TRUE	TRUE	TRUE	TRUE
OffsetVideoB WBTS	300	300	300	10000	100 00	100 00
OffsetVideoB WMS	300	300	300	10000	100 00	100 00
PeakReferenc e	- 82.9 957					
Periodic Timer Period	0.02					
Periodic Timer Sync Source	None					
Periodic Timer Trigger Delay	1.00 E-06					
Periodic Timer Trigger Delay State	FALS E					
PowerReferen ce	- 73.6 966					
PSDReferenc e	- 139. 54					
Radio Device	Bts					
RFBurst Trigger Delay	1.00 E-06					
RFBurst Trigger Delay State	FALS E					
RFBurst Trigger Level Abs	-20					
RFBurst Trigger Level Rel	-6					
RFBurst Trigger Level Type	Absol ute					
RFBurst Trigger Slope	Posit ive					

RrcFilter	FALSE											
SemAverageNumber	10											
SemAverageState	FALSE											
TotalAtten	10											
Trigger Holdoff	0.1											
Trigger Holdoff State	FALSE											
TriggerSource	Free											
Video Trigger Delay	1.00E-06											
Video Trigger Delay State	FALSE											
Video Trigger Level	-25											
Video Trigger Slope	Positive											
Video Selection	AbsPwrFreq											
MeasResult1	Meas Result t2	Meas Result t3	Meas Result t4	MeasResult5	Meas Result t6	Meas Result t7	Meas Result t8	Meas Result t9	Meas Result 10	Meas Result 11	Meas Result 12	
-999	-78.89359	-13	999	-73.6966334099879	-999	-999	-999	-999	-999	-999	-999	
-73.6966334099879	-78.95235	-13	999	-999	-999	-999	-999	-999	-999	-999	-999	

Zone Map

Pressing this key selects Zone Map as the data type to be exported.

The Zone Map file contains information about current Zone Map configuration. Its format is compatible with the 89601A OFDMA map file. It is detailed in ["Zone Map File Contents" on page 1005](#) below.

Key Path	Save, Data
----------	------------

Remote Command	:MMEMory:STORe:ZMAP <string>
Example	MMEM:STOR:ZMAP "ZMap_0000.omf"
Notes	<p>If the save is initiated via SCPI and the file already exists, the file will be overwritten.</p> <p>The SCPI command exports Zone Map information to the file specified as the parameter in the current path. The default path is My Documents\WIMAXOFDMA\.</p> <p>Using the C: drive is strongly discouraged, since it runs the risk of being overwritten during an instrument software upgrade.</p> <p>The SCPI parameter is a quoted string that specifies the filename. Both single and double quotes are supported for any filename parameter over SCPI.</p>
Dependencies	You must be in the 802.16 OFDMA (WiMAX/WiBro) mode.
Status Bits/OPC dependencies	Sequential - waits for the previous measurement to complete.
Initial S/W Revision	Prior to A.02.00

Zone Map File Contents

A Zone Map File contains the following information of the Zone Map configuration. See ["Zone Map Data" on page 329](#) for detailed definitions.

- DemodOfdmaMap_AutoDetect
- DemodOfdmaMap_Count
- DemodOfdmaMap_F1_DL_Count
- DemodOfdmaMap_F1_DL_Z1_Active
- DemodOfdmaMap_F1_DL_Z1_AmcType
- DemodOfdmaMap_F1_DL_Z1_B1_Active
- DemodOfdmaMap_F1_DL_Z1_B1_AllocType
- DemodOfdmaMap_F1_DL_Z1_B1_Boost
- DemodOfdmaMap_F1_DL_Z1_B1_BurstType
- DemodOfdmaMap_F1_DL_Z1_B1_ColorIndex
- DemodOfdmaMap_F1_DL_Z1_B1_ModType
- DemodOfdmaMap_F1_DL_Z1_B1_Name
- DemodOfdmaMap_F1_DL_Z1_B1_SubchannelInterval
- DemodOfdmaMap_F1_DL_Z1_B1_SubchannelOffset
- DemodOfdmaMap_F1_DL_Z1_B1_SymbolInterval
- DemodOfdmaMap_F1_DL_Z1_B1_SymbolOffset
- DemodOfdmaMap_F1_DL_Z1_Count

- DemodOfdmaMap_F1_DL_Z1_DedicPilots
- DemodOfdmaMap_F1_DL_Z1_IDCell
- DemodOfdmaMap_F1_DL_Z1_IDCellCouple
- DemodOfdmaMap_F1_DL_Z1_Len
- DemodOfdmaMap_F1_DL_Z1_Locked
- DemodOfdmaMap_F1_DL_Z1_Name
- DemodOfdmaMap_F1_DL_Z1_PrbsID
- DemodOfdmaMap_F1_DL_Z1_StcMatrix
- DemodOfdmaMap_F1_DL_Z1_StcType
- DemodOfdmaMap_F1_DL_Z1_SymOffset
- DemodOfdmaMap_F1_DL_Z1_UseAllSC
- DemodOfdmaMap_F1_DL_Z1_WrapType
- DemodOfdmaMap_F1_DL_Z1_ZoneType
- DemodOfdmaMap_F1_UL_Count
- DemodOfdmaMap_F1_UL_Z1_Active
- DemodOfdmaMap_F1_UL_Z1_AmcType
- DemodOfdmaMap_F1_UL_Z1_B1_Active
- DemodOfdmaMap_F1_UL_Z1_B1_AllocType
- DemodOfdmaMap_F1_UL_Z1_B1_Boost
- DemodOfdmaMap_F1_UL_Z1_B1_BurstType
- DemodOfdmaMap_F1_UL_Z1_B1_ColorIndex
- DemodOfdmaMap_F1_UL_Z1_B1_ModType
- DemodOfdmaMap_F1_UL_Z1_B1_Name
- DemodOfdmaMap_F1_UL_Z1_B1_PilotPattern
- DemodOfdmaMap_F1_UL_Z1_B1_StcMode
- DemodOfdmaMap_F1_UL_Z1_B1_SubchannelInterval
- DemodOfdmaMap_F1_UL_Z1_B1_SubchannelOffset
- DemodOfdmaMap_F1_UL_Z1_B1_SymbolInterval
- DemodOfdmaMap_F1_UL_Z1_B1_SymbolOffset
- DemodOfdmaMap_F1_UL_Z1_Count
- DemodOfdmaMap_F1_UL_Z1_Gap

- DemodOfdmaMap_F1_UL_Z1_IDCell
- DemodOfdmaMap_F1_UL_Z1_Len
- DemodOfdmaMap_F1_UL_Z1_Locked
- DemodOfdmaMap_F1_UL_Z1_Name
- DemodOfdmaMap_F1_UL_Z1_SymOffset
- DemodOfdmaMap_F1_UL_Z1_UseSubchRotate
- DemodOfdmaMap_F1_UL_Z1_WrapType
- DemodOfdmaMap_F1_UL_Z1_ZoneType
- DemodOfdmaMap_Name
- DemodOfdmaMap_RefreshMap

Save As . . .

When you press “Save As”, the analyzer brings up a Windows dialog and a menu entitled “**Save As.**” This menu allows you to navigate to the various fields in the Windows dialog without using a keyboard or mouse. The Tab and Arrow keys can also be used for dialog navigation.

See "[To File . . .](#)" on page 2252 in Save, State for a full description of this dialog and menu.

The default path for saving files is:

For all of the Trace Data Files:

My Documents\`<mode name>`\data\traces

For all of the Limit Data Files:

My Documents\`<mode name>`\data\limits

For all of the Measurement Results Data Files:

My Documents\`<mode name>`\data\`<measurement name>`\results

For all of the Capture Buffer Data Files:

My Documents\`<mode name>`\data\captureBuffer

Key Path	Save, Data
Mode	All
Notes	The key location is mode-dependent and will vary. Brings up the Save As dialog for saving a <code><mode specific></code> Save Type. The save is performed immediately and does not wait until the measurement is complete.
Initial S/W Revision	Prior to A.02.00

Screen Image

Pressing Screen Image accesses a menu of functions that enable you to specify a format and location for the saved screen image. It brings up a menu that allows you to specify the color scheme of the Screen Image (Themes) or navigate to the Save As dialog to perform the actual save.

Screen Image files contain an exact representation of the analyzer display. They cannot be loaded back onto the analyzer, but they can be loaded into your PC for use in many popular applications.

The image to be saved is actually captured when the Save front panel key is pressed, and kept in temporary storage to be used if you ask for a Screen Image save. When the Screen Image key is pressed, a "thumbnail" of the captured image is displayed, as shown below:

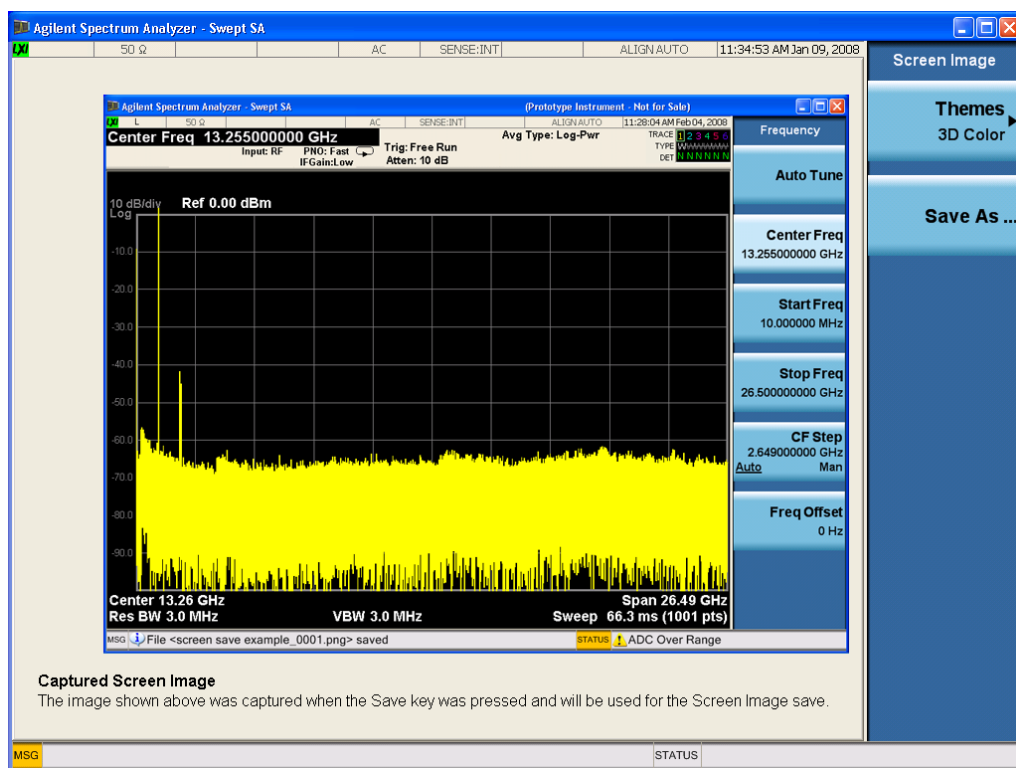

When you continue on into the Save As menu and complete the Screen Image save, the image depicted in the thumbnail is the one that gets saved, showing the menus that were on the screen before going into the Save menus. The save is performed immediately and does not wait until the measurement is complete.

After you have completed the save, the Quick Save front-panel key lets you quickly repeat the last save performed, using an auto-named file, with the current screen data.

NOTE

For versions previous to A.01.55, if you initiate a screen image save by navigating through the Save menus, the image that is saved will contain the Save menu softkeys, not the menus and the active function that were on the screen when you first pressed the Save front panel key.

Key Path	Save
Mode	All

Remote Command	:MMEMory:STORe:SCReen <filename>
Example	:MMEM:STOR:SCR "myScreen.png" This stores the current screen image in the file MyScreenFile.png in the default directory.
Initial S/W Revision	Prior to A.02.00

Themes

Accesses a menu of functions that enable you to choose the theme to be used when saving the screen image.

The **Themes** option is the same as the **Themes** option under the **Display** and **Page Setup** dialogs. It allows you to choose between themes to be used when saving the screen image.

Key Path	Save, Screen Image
Remote Command	:MMEMory:STORe:SCReen:THEMe TDColor TDMonochrome FCOLOR FMONochrome :MMEMory:STORe:SCReen:THEMe?
Example	:MMEM:STOR:SCR:THEM TDM
Preset	3D Color; Is not part of Preset, but is reset by Restore Misc Defaults or Restore System Defaults All and survives subsequent running of the modes.
Readback	3D Color 3D Mono Flat Color Flat Mono
Backwards Compatibility Notes	In ESA and PSA we offer the choice of "Reverse Bitmap" or "Reverse Metafile" when saving screen images. This is much like the "Flat Color" theme available in X-Series. Also, if you selected Reverse Bitmap AND a black & white screen image, that would be much like "Flat Monochrome". In other words, each of the X-Series themes has a similar screen image type in ESA/PSA. But they are not identical.
Initial S/W Revision	Prior to A.02.00

3D Color

Selects a standard color theme with each object filled, shaded and colored as designed.

Key Path	Save, Screen Image, Themes
Example	MMEM:STOR:SCR:THEM TDC
Readback	3D Color
Initial S/W Revision	Prior to A.02.00

3D Monochrome

Selects a format that is like 3D color but shades of gray are used instead of colors.

Key Path	Save, Screen Image, Themes
Example	MMEM:STOR:SCR:THEM TDM
Readback	3D Mono
Initial S/W Revision	Prior to A.02.00

Flat Color

Selects a format that is best when the screen is to be printed on an ink printer.

Key Path	Save, Screen Image, Themes
Example	MMEM:STOR:SCR:THEM FCOL
Readback	Flat Color
Initial S/W Revision	Prior to A.02.00

Flat Monochrome

Selects a format that is like Flat Color. But only black is used (no colors, not even gray), and no fill.

Key Path	Save, Screen Image, Themes
Example	MMEM:STOR:SCR:THEM FMON
Readback	Flat Mono
Initial S/W Revision	Prior to A.02.00

Save As...

When you press "Save As", the analyzer brings up a Windows dialog and a menu entitled "**Save As.**" This menu allows you to navigate to the various fields in the Windows dialog without using a keyboard or mouse. The Tab and Arrow keys can also be used for dialog navigation.

See "[To File . . .](#)" on page 2252 in Save, State for a full description of this dialog and menu.

The default path for Screen Images is

My Documents\`<mode name>`\screen.

where `<mode name>` is the parameter used to select the mode with the INST:SEL command (for example, SA for the Spectrum Analyzer).

Key Path	Save, Screen Image
Notes	Brings up Save As dialog for saving a Screen Image Save Type
Initial S/W Revision	Prior to A.02.00

Mass Storage Catalog (Remote Command Only)

Key path	SCPI Only
Remote Command	:MMEMory:CATalog? [<directory_name>]
Notes	<p>The string must be a valid logical path.</p> <p>Queries disk usage information (drive capacity, free space available) and obtains a list of files and directories in a specified directory in the following format: <numeric_value>,<numeric_value>,{<file_entry>}</p> <p>It returns two numeric parameters and as many strings as there are files and directories. The first parameter indicates the total amount of storage currently used in bytes. The second parameter indicates the total amount of storage available, also in bytes. The <file_entry> is a string. Each <file_entry> indicates the name, type, and size of one file in the directory list: <file_name>,<file_type>,<file_size></p> <p>As the windows file system has an extension that indicates file type, <file_type> is always empty. <file_size> provides the size of the file in bytes. For directories, <file_entry> is surrounded by square brackets and both <file_type> and <file_size> are empty</p>
Initial S/W Revision	Prior to A.02.00

Mass Storage Change Directory (Remote Command Only)

Key path	SCPI Only
Remote Command	:MMEMory:CDIRectory [<directory_name>] :MMEMory:CDIRectory?
Notes	<p>The string must be a valid logical path.</p> <p>Changes the default directory for a mass memory file system. The <directory_name> parameter is a string. If no parameter is specified, the directory is set to the *RST value.</p> <p>At *RST, this value is set to the default user data storage area, that is defined as System.Environment.SpecialFolder.Personal.</p> <p>Query returns full path of the default directory.</p>
Initial S/W Revision	Prior to A.02.00

Mass Storage Copy (Remote Command Only)

Key path	SCPI Only
Remote Command	:MMEMory:COPY <string>,<string>[,<string>,<string>]
Notes	<p>The string must be a valid logical path.</p> <p>Copies an existing file to a new file or an existing directory to a new directory.</p> <p>Two forms of parameters are allowed. The first form has two parameters. In this form, the first parameter specifies the source, and the second parameter specifies the destination.</p> <p>The second form has four parameters. In this form, the first and third parameters specify the source. The second and fourth parameters specify the directories. The first pair of parameters specifies the</p>

source. The second pair specifies the destination. An error is generated if the source doesn't exist or the destination file already exists.

This command will generate an "access denied" error if the destination is a restricted folder (e.g., C:\Windows) and the current user does not have Power User or Administrator privileges.

Mass Storage Device Copy (Remote Command Only)

This command transfers data to/from a file and a peripheral device.

Key path	SCPI Only
Remote Command	:MMEMory:COpy:DEvice <source_string>,<dest_string>
Notes	<p>The strings must be a valid logical path or a valid device keyword. If the dest_string is a device keyword, the data is copied from the source file to the device. If the source_string is a device keyword, the data is copied to the source file from the device.</p> <p>Valid device keywords are:</p> <p>SNS (smart noise source)</p> <p>An error is generated if the file or device is not found.</p>

Mass Storage Delete (Remote Command Only)

Key path	SCPI Only
Remote Command	:MMEMory:DELeTe <file_name>[,<directory_name>]
Notes	<p>The string must be a valid logical path.</p> <p>Removes a file from the specified directory. The <file_name> parameter specifies the file name to be removed. This command will generate an "access denied" error if the file is in a restricted folder (e.g., C:\Windows) and the current user does not have Power User or Administrator privileges.</p>
Initial S/W Revision	Prior to A.02.00

Mass Storage Data (Remote Command Only)

Creates a file containing the specified data OR queries the data from an existing file.

Key path	SCPI Only
Remote Command	<p>:MMEMory:DATA <file_name>,<data></p> <p>:MMEMory:DATA? <file_name></p>
Notes	<p>The string must be a valid logical path.</p> <p>The command form is MMEMory:DATA <file_name>,<data>. It loads <data> into the file <file_name>. <data> is in 488.2 block format. <file_name> is string data.</p> <p>The query form is MMEMory:DATA? <file_name> with the response being the associated <data> in block format.</p>
Initial S/W Revision	Prior to A.02.00

Mass Storage Make Directory (Remote Command Only)

Key path	SCPI Only
Remote Command	:MMEMory:MDIRectory <directory_name>
Notes	<p>The string must be a valid logical path.</p> <p>Creates a new directory. The <directory_name> parameter specifies the name to be created.</p> <p>This command will generate an “access denied” error if the new directory would be in a restricted folder (e.g., C:\Windows) and the current user does not have Power User or Administrator privileges.</p>
Initial S/W Revision	Prior to A.02.00

Mass Storage Move (Remote Command Only)

Key path	SCPI Only
Remote Command	:MMEMory:MOVE <string>,<string>[,<string>,<string>]
Notes	<p>The string must be a valid logical path.</p> <p>Moves an existing file to a new file or an existing directory to a new directory.</p> <p>Two forms of parameters are allowed. The first form has two parameters. In this form, the first parameter specifies the source, and the second parameter specifies the destination.</p> <p>The second form has four parameters. In this form, the first and third parameters specify the source. The second and fourth parameters specify the directories. The first pair of parameters specifies the source. The second pair specifies the destination. An error is generated if the source doesn't exist or the destination file already exists.</p> <p>This command will generate an “access denied” error if the destination is a restricted folder (e.g., C:\Windows) and the current user does not have Power User or Administrator privileges.</p>
Initial S/W Revision	Prior to A.02.00

Mass Storage Remove Directory (Remote Command Only)

Key path	SCPI Only
Remote Command	:MMEMory:RDIRectory <directory_name>
Notes	<p>The string must be a valid logical path.</p> <p>Removes a directory. The <directory_name> parameter specifies the directory name to be removed. All files and directories under the specified directory shall also be removed.</p> <p>This command will generate an “access denied” error if the folder is a restricted folder (e.g., C:\Windows) or is in a restricted folder and the current user does not have Power User or Administrator privileges.</p>
Initial S/W Revision	Prior to A.02.00

Single (Single Measurement/Sweep)

Sets the analyzer for Single measurement operation. The single/continuous state is Meas Global, so the setting will affect all the measurements. If you are Paused, pressing Single does a Resume.

See ["More Information" on page 1014](#)

Key Path	Front-panel key
Example	:INIT:CONT OFF
Notes	See Cont key description.
Backwards Compatibility Notes	<p>For Spectrum Analysis mode in ESA and PSA, the Single hardkey and the INITiate:IMM switched from continuous measurement to single measurement and restarted sweeps and averages (displayed average count reset to 1), but did not restart Max Hold and Min Hold. In the X-Series, the Single hardkey and the INITiate:IMM command initiate a sweep/ measurement/ average sequence/hold sequence including MaxHold and MinHold.</p> <p>For Spectrum Analysis mode in ESA and PSA, the Single hardkey restarted the sweep regardless of whether or not you were in an active sweep or sweep sequence. In the X-Series, Restart does this but Single only restarts the sweep or sweep sequence if you are in the idle state.</p> <p>INIT[:IMM] in ESA & PSA Spectrum Analysis Mode does an implied ABORT. In some other PSA Modes, INIT[:IMM] is ignored if not in the idle state. . The X-Series follows the ESA/PSA SA Mode model, which may cause some Modes to have compatibility problems.</p>
Initial S/W Revision	Prior to A.02.00

More Information

See ["Restart" on page 2249](#) for details on the INIT:IMMEDIATE (Restart) function.

If you are already in single sweep, the INIT:CONT OFF command has no effect.

If you are already in Single Sweep, then pressing the Single key in the middle of a sweep does not restart the sweep or sequence. Similarly, pressing the Single key does not restart the sweep or sequence if the sweep is not in the idle state (for example, if you are taking a very slow sweep, or the analyzer is waiting for a trigger). Instead, it results in a message. "Already in Single, press Restart to initiate a new sweep or sequence". Even though pressing the Single key in the middle of a sweep does not restart the sweep, sending INIT:IMMEDIATE does reset it.

To take one more sweep without resetting the average count, increment the average count by 1, by pressing the step up key while **Average/Hold Number** is the active function, or sending the remote command CALC:AVER:TCON UP.

Source

There is no Source control functionality for this measurement. When this key is pressed, the screen either displays a blank menu, or the previously-selected menu remains unchanged.

Key Path	Front-panel key
----------	-----------------

Span X Scale

Accesses a menu of functions that enable you to set the horizontal scale parameters.

Key Path	Front-panel key
Initial S/W Revision	A.11.00

Ref Value

Sets the X reference value.

Key Path	SPAN X Scale
Mode	BASIC, PNOISE, WCDMA, C2K, GSM, WIMAXOFDMA, TDSCDMA, 1XEVDO, DVB, DTMB, ISDBT, CMMB, LTE, LTETDD, DCTV, WLAN, MSR, LTEAFDD, LTEATDD
Remote Command	:DISPlay:SEMask:VIEW[1]:WINDow[1]:TRACe:X[:SCALe]:RLEVel <freq> :DISPlay:SEMask:VIEW[1]:WINDow[1]:TRACe:X[:SCALe]:RLEVel?
Example	DISP:SEM:VIEW:WIND:TRAC:X:RLEV 10 DISP:SEM:VIEW:WIND:TRAC:X:RLEV?
Notes	You must be in the mode that includes SEM measurement to use this command. Use :INSTrument:SElect to set the mode.
Couplings	If Auto Scaling is set to On, this value is automatically determined by the measurement result. When you set this value manually, Auto Scaling automatically changes to Off.
Preset	1.0 GHz
State Saved	Saved in instrument state.
Min	-1000 GHz
Max	1000 GHz
Default Unit	Hz
Initial S/W Revision	A.11.00

Scale/Div

Sets the horizontal scale.

Key Path	SPAN X Scale
Mode	BASIC, PNOISE, WCDMA, C2K, GSM, WIMAXOFDMA, TDSCDMA, 1XEVDO, DVB, DTMB, ISDBT, CMMB, LTE, LTETDD, DCTV, WLAN, MSR, LTEAFDD, LTEATDD
Remote Command	:DISPlay:SEMask:VIEW[1]:WINDow[1]:TRACe:X[:SCALe]:PDIVision <freq> :DISPlay:SEMask:VIEW[1]:WINDow[1]:TRACe:X[:SCALe]:PDIVision ?
Example	DISP:SEM:VIEW:WIND:TRAC:X:PDIV 500 DISP:SEM:VIEW:WIND:TRAC:X:PDIV?

Notes	You must be in a mode that includes the SEM measurement to use this command. Use INSTRUMENT:SElect to set the mode.
Couplings	If Auto Scaling is set to On, this value is automatically determined by the measurement result. When you set this value manually, Auto Scaling automatically changes to Off.
Preset	Automatically Calculated
State Saved	Yes Saved in instrument state.
Min	1 Hz
Max	10.0 GHz
Initial S/W Revision	A.11.00

Ref Position

Sets the reference position for the X axis to Left, Center or Right.

Key Path	SPAN X Scale
Mode	BASIC, PNOISE, WCDMA, C2K, GSM, WIMAXOFDMA, TDSCDMA, 1XEVD0, DVB, DTMB, ISDBT, CMMB, LTE, LTETDD, DCTV, WLAN, MSR, LTEAFDD, LTEATDD
Remote Command	:DISPlay:SEMask:VIEW[1]:WINDow[1]:TRACe:X[:SCALE]:RPOStion LEFT CENTER RIGHT :DISPlay:SEMask:VIEW[1]:WINDow[1]:TRACe:X[:SCALE]:RPOStion?
Example	DISP:SEM:VIEW:WIND:TRAC:X:RPOS LEFT DISP:SEM:VIEW:WIND:TRAC:X:RPOS?
Notes	You must be in a mode that includes the SEM measurement to use this command. Use INSTRUMENT:SElect to set the mode.
Preset	CENTER
State Saved	Yes Saved in instrument state.
Range	Left Ctr Right
Initial S/W Revision	A.11.00

Auto Scaling

Toggles the scale coupling function between On and Off.

Key Path	SPAN X Scale
Mode	BASIC, PNOISE, WCDMA, C2K, GSM, WIMAXOFDMA, TDSCDMA, 1XEVD0, DVB, DTMB, ISDBT, CMMB, LTE, LTETDD, DCTV, WLAN, MSR, LTEAFDD, LTEATDD
Remote Command	:DISPlay:SEMask:VIEW[1]:WINDow[1]:TRACe:X[:SCALE]:COUPle 0 1 OFF ON :DISPlay:SEMask:VIEW[1]:WINDow[1]:TRACe:X[:SCALE]:COUPle?
Example	DISP:SEM:VIEW:WIND:TRAC:X:COUP ON

DISP:SEM:VIEW:WIND:TRAC:X:COUP?	
Notes	You must be in a mode that includes the SEM measurement to use this command. Use INSTRUMENT:SElect to set the mode.
Couplings	When Auto Scaling is On and the Restart front-panel key is pressed, this function automatically determines the scale per division and reference values based on the measurement results. When you set a value to either Scale/Div or Ref Value manually, Auto Scaling automatically changes to Off.
Preset	1
State Saved	Yes Saved in instrument state.
Range	On Off
Initial S/W Revision	A.11.00

Sweep/Control

Displays a menu that enables you to set up and control the sweep time, gate method, and source of the current measurement. See "[Sweep/Control](#)" on page 2282 for more information.

Key Path	Front-panel key
Initial S/W Revision	Prior to A.02.00

Pause

Pauses a measurement after the current data acquisition is complete. When Paused, the label on the key changes to Resume. Pressing the Resume key resumes the measurement at the point it was at when paused. See "[Pause/Resume](#)" on page 2282 for more details.

Key Path	Sweep/Control
Initial S/W Revision	Prior to A.02.00

Gate

Accesses a menu that enables you to control the gating function. The Gate functionality is used to view signals best viewed by qualifying them with other events.

Gate setup parameters are the same for all measurements – they do not change as you change measurements. Settings like these are called “Meas Global” and are unaffected by Meas Preset.

Note that Sweep Time autocoupling rules and annotation are changed by Gate being on.

Key Path	Sweep/Control
Scope	Meas Global
Readback	The state and method of Gate, as [Off, LO] or [On, Video]. Note that for measurements that only support gated LO, the method is nonetheless read back, but always as LO.
Initial S/W Revision	Prior to A.02.00

Gate On/Off

Turns the gate function on and off.

When the Gate Function is on, the selected Gate Method is used along with the gate settings and the signal at the gate source to control the sweep and video system with the gate signal. Not all measurements allow every type of Gate Methods.

When Gate is on, the annunciation in the measurement bar reflects that it is on and what method is used, as seen in the following "Gate: LO" annunciator graphic.

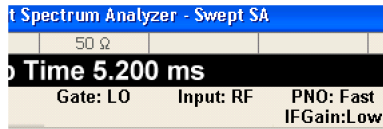

Key Path	Sweep/Control, Gate
Remote Command	[:SENSe] :SWEep:EGATe [:STATe] OFF ON 0 1 [:SENSe] :SWEep:EGATe [:STATe] ?
Example	SWE:EGAT ON SWE:EGAT?
Dependencies	<p>The function is unavailable (grayed out) and Off when:</p> <ul style="list-style-type: none"> • Gate Method is LO or Video and FFT Sweep Type is manually selected. • Gate Method is FFT and Swept Sweep Type is manually selected. • Marker Count is ON. <p>The following are unavailable whenever Gate is on:</p> <ul style="list-style-type: none"> • FFT under Sweep Type when Method=LO or Video or Swept under Sweep Type when Method=FFT • Marker Count <p>While Gate is on, the Auto Rules for Sweep Type are modified so that the choice agrees with the Gate Method: i.e., FFT for Method = FFT and Swept for Method = LO or Video.</p> <p>The Gate softkey and all SCPI under the [:SENSe]:SWEep:EGATe SCPI node are grayed out when Source Mode is Tracking with an external source. This is because the Gate circuitry is used to sync the external source. If the Tracking Source is turned on, the Gate is turned off.</p> <p>When in the ACP measurement:</p> <ul style="list-style-type: none"> • When Meas Method is RBW or FAST, this function is unavailable and the key is grayed out. • Whenever Gate is on, Meas Method, RBW or FAST is unavailable and keys for those are grayed out. • When Gate is on, Offset Res BW and Offset Video BW are ignored (if you set these values) and the measurement works as if all Offset Res BW and all Offset Video BW are coupled with the Res BW and the Video BW under the BW menu. When Gate is on, the Offset BW key in the Offset/Limit menu is grayed out.
Preset	Off LTETDD: On
State Saved	Saved in instrument state
Range	On Off
Backwards Compatibility SCPI	[:SENSe] :SWEep:TIME:GATE [:STATe] ESA compatibility
Backwards Compatibility Notes	In ESA, Trig Delay (On) and Gate (On) could not be active at the same time.. This dependency does not exist in PSA or in the X-Series.
Initial S/W Revision	Prior to A.02.00

Gate View On/Off

Turning on Gate View in the Swept SA measurement provides a single-window gate view display..

Turning on Gate View in other measurements shows the split-screen Gate View. In these measurements, when the Gate View is on, the regular view of the current measurement traces and results are reduced vertically to about 70% of the regular height. The Zero Span window, showing the positions of the Gate, is shown between the Measurement Bar and the reduced measurement window. By reducing the height of the measurement window, some of the annotation on the Data Display may not fit and is not shown.

Key Path	Sweep/Control, Gate
Remote Command	[:SENSe] :SWEep:EGATe:VIEW ON OFF 1 0 [:SENSe] :SWEep:EGATe:VIEW?
Example	SWE:EGAT:VIEW ON turns on the gate view.
Dependencies	In the Swept SA measurement: In Gate View, the regular Sweep Time key is grayed out . When pressed, the grayed out key puts up the informational message "Use Gate View Sweep Time in the Gate menu." In the other measurements: When you turn Gate View on, the lower window takes on the current state of the instrument. Upon leaving Gate View, the instrument takes on the state of the lower window. When you turn Gate View on, the upper window Sweep Time is set to the gate view sweep time.
Couplings	These couplings apply to the Swept SA measurement: <ul style="list-style-type: none"> • When Gate View is turned on, the instrument is set to Zero Span. • Gate View automatically turns off whenever a Span other than Zero is selected. • Gate View automatically turns off if you press the Last Span key while in Gate View, and the instrument returns to the Span it was in before entering Gate View (even if that is Zero Span). • When Gate View is turned on, the sweep time used is the gate view sweep time. This is set according to the rules in section "Gate View Setup" on page 2083 • When Gate View is turned off, Sweep Time is set to the normal Swept SA measurement sweep time. • If Gate View is on and Gate is off, then turning on Gate turns off Gate View.
Preset	OFF
State Saved	Saved in instrument state
Range	On Off
Initial S/W Revision	Prior to A.02.00

A sample of the Gate View screen in the Swept SA measurement is shown in the following graphic :

10 Spectrum Emission Mask Measurement Sweep/Control

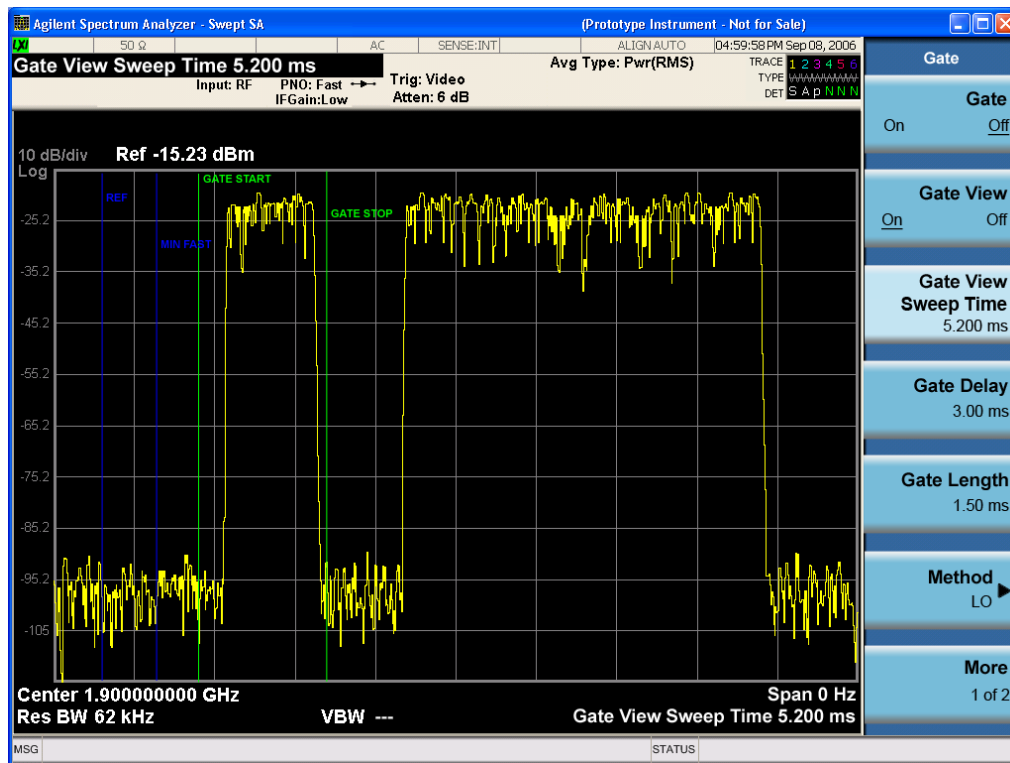

A sample of the Gate View screen in other measurements is shown in the following graphic. This example is for the ACP measurement:

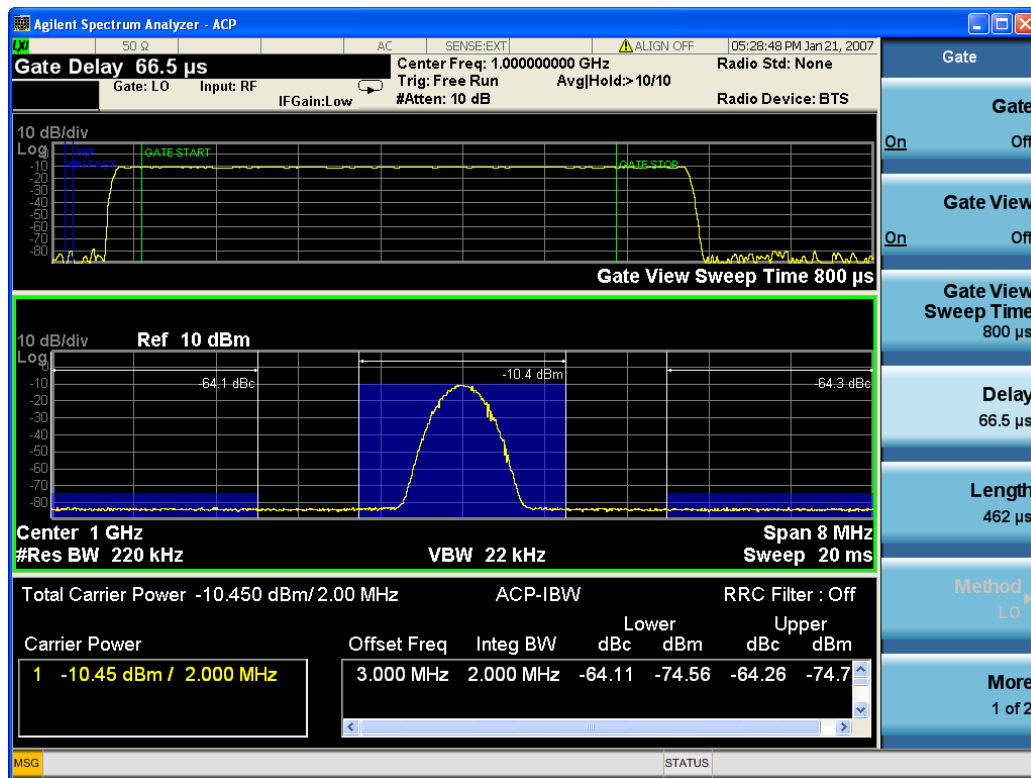

Turning Gate View off returns the analyzer to the Normal measurement view.

In the Swept SA, the normal measurement view is the single-window Swept SA view. When returning to this view, the Swept SA measurement returns to the Span it was in before entering **Gate View** (even if that is Zero Span).

The **Gate View** window is triggered from the Gate Source, with zero trigger delay. Also, when updating the **Gate View** window, the Gate itself must not operate. So it is internally shut off while the gate view window is being updated. For the Swept SA measurement, this means that the Gate is internally shut off whenever the gate view window is displayed. The measurement bar and softkeys continue to show the Trigger source for the main sweep window and give no indication that the Gate is shut off or that the Gate View window is triggered from the Gate Source.

When in **Gate View**, vertical lines are displayed in the Gate View window as follows:

- Green lines are displayed at the gate edges as follows: in Edge Gate, a line is shown for Delay and one for the end of the Gate period, defined by Length. In Level Gate a line is shown only for Delay. You can adjust the position of the green lines by adjusting the gate length and the gate delay. These lines update in the Gate View window as the active function changes, even if the window is not being updated. In Gated LO and Gated Video, these lines are positioned relative to the delay reference line (not relative to 0 time). In Gated FFT, their location is relative to the left edge of the screen.
- A blue line is displayed showing the delay reference, that is, the reference point for the Gate Delay within the Zero Span window. The blue line represents where (in time) the effective location of the gate start would be if the gate were programmed to zero delay.
-
- The second blue line is labeled "MIN FAST" as shown in the figure above because it represents the minimum Gate Delay for fast Gated LO operation. This line is only displayed in Gated LO. You cannot scroll (knob) or decrement (down key) the Gate Delay to less than that represented by the position of this line, it can only be set below this position manually, although once there it can be moved freely with the knob while below the line.
- A yellow line in the Gated Video case only, is displayed at Blength, where Blength is the display point (bucket) length for the swept trace, which is given by the sweep time for that trace divided by number of Points – 1. So it is referenced to 0 time, not to the delay reference. This line is labeled NEXT PT (it is not shown in the figure above because the figure above is for Gated LO).
- The yellow line represents the edge of a display point (bucket). Normally in Gated Video, the bucket length must be selected so that it exceeds the off time of the burst. There is another way to use the analyzer in Gated Video measurements, and that is to set the bucket width much shorter than the off time of the burst. Then use the Max Hold trace function to fill in "missing" buckets more slowly. This allows you to see some of the patterns of the Gated Video results earlier, though seeing a completely filled-in spectrum later.

Gate View Setup

Accesses a menu that enables you to setup parameters relevant to the Gate View

Key Path	Sweep/Control, Gate
Scope	Meas Global
Initial S/W Revision	A.10.00

Gate View Sweep Time

Controls the sweep time in the Gate View window. To provide an optimal view of the gate signal, the analyzer initializes Gate View Sweep Time based on the current settings of Gate Delay and Gate Length.

Key Path	Sweep/Control, Gate, Gate View Setup
Remote Command	[:SENSe] :SWEep:EGATe:TIME <time> [:SENSe] :SWEep:EGATe:TIME?
Example	SWE:EGAT:TIME 500 ms
Dependencies	Gate View Sweep Time is initialized: <ul style="list-style-type: none"> • On Preset (after initializing delay and length). • Every time the Gate Method is set/changed. <p>Additionally, in the Swept SA measurement, whenever you do a Preset, or leave Gate View, the analyzer remembers the Gate Delay and Gate Length settings. Then, when returning to Gate View, if the current Gate Delay and/or Gate Length do not match the remembered values Gate View Sweep Time is re-initialized.</p> <ol style="list-style-type: none"> 1. Compute the location of the "gate stop" line, which you know is at time $t = t_{min} + GateDelay + GateLength$.
Preset	519.3 μ s WiMAX OFDMA: 5 ms GSM/EDGE: 1 ms
State Saved	Saved in instrument state
Max	6000 s
Initial S/W Revision	Prior to A.02.00

Gate View Start Time

Controls the time at the left edge of the Gate View.

Key Path	Sweep/Control, Gate, Gate View Setup
Remote Command	[:SENSe] :SWEep:EGATe:VIEW:START <time> [:SENSe] :SWEep:EGATe:VIEW:START?
Example	SWE:EGAT:VIEW:STAR 10ms
Notes	Units of time are required or no units; otherwise an invalid suffix error message will be generated. See error -131.
Preset	0 ms
State Saved	Saved in instrument state
Min	0
Max	500 ms
Initial S/W Revision	A.10.00

Gate Delay

Controls the length of time from the time the gate condition goes True until the gate is turned on.

Key Path	Sweep/Control, Gate
Remote Command	[:SENSe] :SWEep:EGATe:DELay <time> [:SENSe] :SWEep:EGATe:DELay?
Example	SWE:EGAT:DELay 500ms SWE:EGAT:DELay?
Notes	Units of time are required or no units; otherwise an invalid suffix error message will be generated.
Preset	57.7 us WiMAX OFDMA: 71 us GSM/EDGE: 600 us WLAN: 500 us
State Saved	Saved in instrument state
Min	0.0 us
Max	100 s
Backwards Compatibility SCPI	[:SENSe] :SWEep:TIME:GATE:DELay ESA compatibility
Initial S/W Revision	Prior to A.02.00

Gate Length

Controls the length of time that the gate is on after it opens.

Key Path	Sweep/Control, Gate
Remote Command	[:SENSe] :SWEep:EGATe:LENGth <time> [:SENSe] :SWEep:EGATe:LENGth?
Example	SWE:EGAT:LENG 1 SWE:EGAT:LENG?
Notes	Units of time are required or no units; otherwise an invalid suffix error message will be generated.
Dependencies	<p>Grayed out when Gate Method is set to FFT in which case the label changes to that shown below.</p> <div style="border: 1px solid black; padding: 5px; display: inline-block;"> <p>Gate Length (=1.83/RBW) 2.8 ms</p> </div> <p style="margin-left: 20px;">vsd 39-1</p> <p>The key is also grayed out if Gate Control = Level.</p>
Preset	461.6 us

	WiMAX OFDMA: 50 us GSM/EDGE: 200 us WLAN: 1.54 ms
State Saved	Saved in instrument state
Min	100 ns
Max	5 s
Backwards Compatibility SCPI	[:SENSe] :SWEep:TIME:GATE:LENGth ESA compatibility
Initial S/W Revision	Prior to A.02.00

Gate Source

The menus under the Gate Source key are the same as those under the Trigger key, with the exception that neither Free Run nor Video are available as Gate Source selections. However, a different SCPI command is used to select the Gate Source (see table below) because you may independently set the Gate Source and the Trigger Source.

Any changes to the settings in the setup menus under each Gate Source selection key (for example: Trigger Level, Trigger Delay, etc.) also affect the corresponding settings under the Trigger menu keys. The SCPI commands used for these are the same for Trigger and Gate, since there is only one setting which affects both Gate and Trigger. Example: to set the Trigger Level for External 1 you use the command :TRIG:EXT1:LEV regardless of whether you are using External 1 as a Trigger Source or a Gate Source.

Key Path	Sweep/Control, Gate
Remote Command	[:SENSe] :SWEep:EGATE:SOURce EXTernal1 EXTernal2 LINE FRAME RFBurst [:SENSe] :SWEep:EGATE:SOURce?
Dependencies	In some models, there is no second External input. In these models, the External 2 key is blanked and the EXTernal2 parameter will generate a "Hardware missing; Not available for this model number" error.
Preset	EXTernal 1 GSM/EDGE, MSR: FRAME LTETDD: EXTernal 1When Direction is Downlink, FRAME when Direction is Uplink.
Backwards Compatibility Notes	In ESA, there is a single Gate input port. In PSA, the Gate Source may be taken from one of two specified input ports. In the X-Series, any Trigger Source can be a Gate Source.
Initial S/W Revision	Prior to A.02.00
Modified at S/W Revision	A.03.00, A.14.00

Line

Pressing this key, when it is not selected, selects the line signal as the trigger. A new sweep/measurement will start synchronized with the next cycle of the line voltage. Pressing this key, when it is already selected, access the line trigger setup menu.

Key Path	Trigger
Example	TRIG:SOUR LINE Swept SA measurement TRIG:<meas>:SOUR LINE Measurements other than Swept SA
Dependencies	Line trigger is not available when operating from a "dc power source", for example, when the instrument is powered from batteries.
State Saved	Saved in instrument state
Status Bits/OPC dependencies	The Status Operation Register bit 5 "Waiting for Trigger" is set at the same time as the Sweeping or Measuring bit is set. It is cleared when the trigger actually occurs (that is, after the trigger event occurs and all the applicable trigger criteria have been met). A corresponding pop-up message ("Waiting for trigger") is generated if no trigger signal appears after approximately 2 sec. This message goes away when a trigger signal appears.
Initial S/W Revision	Prior to A.02.00

Trig Slope

Controls the trigger polarity. It is set positive to trigger on a rising edge and negative to trigger on a falling edge.

Key Path	Trigger, Line
Remote Command	:TRIGger[:SEQuence]:LINE:SLOPe POSitive NEGative :TRIGger[:SEQuence]:LINE:SLOPe?
Example	TRIG:LINE:SLOP NEG
Preset	POSitive
State Saved	Saved in instrument state
Backwards Compatibility Notes	The legacy :TRIGger[:SEQuence]:SLOPe command affects the slopes for the VID, LINE, EXT1, EXT2, and RFB triggers.
Initial S/W Revision	Prior to A.02.00

External 1

Pressing this key, when it is not selected, selects an external input signal as the trigger. A new sweep/measurement will start when the external trigger condition is met using the external 1 input connector on the rear panel.

Pressing this key, when it is already selected, accesses the external 1 trigger setup menu.

Key Path	Trigger
Example	TRIG:SOUR EXT1 Swept SA measurement TRIG:<meas>:SOUR EXT1 Measurements other than Swept SA
Dependencies	Grayed out if in use by Point Trigger in the Source Setup menu. Forced to Free Run if already selected and Point Trigger is set to External 1.
State Saved	Saved in instrument state
Status Bits/OPC dependencies	The Status Operation Register bit 5 "Waiting for Trigger" is set at the same time as the Sweeping or Measuring bit is set. It is cleared when the trigger actually occurs (that is, after the trigger event occurs and all the applicable trigger criteria have been met). A corresponding pop-up message ("Waiting for trigger") is generated if no trigger signal appears after approximately 2 sec. This message goes away when a trigger signal appears.
Initial S/W Revision	Prior to A.02.00

Trigger Level

Sets the value where the external 1 trigger input will trigger a new sweep/measurement.

Key Path	Trigger, External 1
Remote Command	:TRIGger[:SEquence]:EXTernal1:LEVel <level> :TRIGger[:SEquence]:EXTernal1:LEVel?
Example	TRIG:EXT1:LEV 0.4 V
Couplings	This same level is used for the Ext1 trigger source in the Trigger menu, for the Ext1 selection in the Periodic Timer sync source (in the Trigger menu and in the Gate Source menu), and also for the Ext1 selection in the Gate Source menu.
Preset	1.2 V
State Saved	Saved in instrument state
Min	-5 V
Max	5 V
Default Unit	V
Backwards Compatibility SCPI	:TRIGger[:SEquence]:EXTernal:LEVel For backward compatibility, the parameter EXTernal is mapped to EXTernal1
Backwards Compatibility SCPI	:TRIGger[:SEquence]:FRAME:EXTernal1:LEVel
Initial S/W Revision	Prior to A.02.00

Trig Slope

Controls the trigger polarity. It is set positive to trigger on a rising edge and negative to trigger on a falling edge.

Key Path	Trigger, External 1
Remote Command	:TRIGger[:SEquence]:EXTernal1:SLOPe POSitive NEGative :TRIGger[:SEquence]:EXTernal1:SLOPe?
Example	TRIG:EXT1:SLOP NEG
Couplings	This same slope is used in the Ext1 selection for the trigger source in the Trigger menu and for the period timer sync source (in the Trigger menu and in the Gate Source menu).
Preset	POSitive
State Saved	Saved in instrument state
Backwards Compatibility SCPI	:TRIGger[:SEquence]:EXTernal:SLOPe For backward compatibility, the parameter EXTernal is mapped to EXTernal1
Backwards Compatibility SCPI	:TRIGger[:SEquence]:FRAMe:EXTernal1:SLOPe
Backwards Compatibility Notes	The legacy :TRIGger[:SEquence]:SLOPe command affects the slopes for the VID, LINE, EXT1, EXT2, and RFB triggers.
Initial S/W Revision	Prior to A.02.00

External 2

Pressing this key, when it is not selected, selects an external input signal as the trigger. A new sweep/measurement will start when the external trigger condition is met using the external 2 input connector. The external trigger 2 input connector is on the rear panel.

Pressing this key, when it is already selected, accesses the external 2 trigger setup menu.

Key Path	Trigger
Example	TRIG:SOUR EXT2 Swept SA measurement TRIG:<meas>:SOUR EXT2 Measurements other than Swept SA
Dependencies	In some models, there is no second External input. In these models, the External 2 key is blanked and the EXTernal2 parameter will generate a "Hardware missing; Not available for this model number" message. Grayed out if in use by Point Trigger in the Source Setup menu. Forced to Free Run if already selected and Point Trigger is set to External 2.
State Saved	Saved in instrument state
Status Bits/OPC dependencies	The Status Operation Register bit 5 "Waiting for Trigger" is set at the same time as the Sweeping or Measuring bit is set. It is cleared when the trigger actually occurs (that is, after the trigger event occurs and all the applicable trigger criteria have been met). A corresponding pop-up message ("Waiting for trigger") is generated if no trigger signal appears after approximately 2 sec. This message goes away when a trigger signal appears.
Initial S/W Revision	Prior to A.02.00
Modified at S/W Revision	A.03.00

Trigger Level

Sets the value where the external 2 trigger input will trigger a new sweep/measurement.

Key Path	Trigger, External 2
Remote Command	:TRIGger[:SEquence]:EXTernal2:LEVel :TRIGger[:SEquence]:EXTernal2:LEVel?
Example	TRIG:EXT2:LEV 1.1 V
Couplings	This same level is used for the Ext2 trigger source in the Trigger menu, for the Ext2 selection in the Periodic Timer sync source (in the Trigger menu and in the Gate Source menu), and also for the Ext2 selection in the Gate Source menu.
Preset	1.2 V
State Saved	Saved in instrument state
Min	-5 V
Max	5 V
Default Unit	V
Backwards Compatibility SCPI	:TRIGger[:SEquence]:FRAMe:EXTernal2:LEVel
Initial S/W Revision	Prior to A.02.00

Trig Slope

Controls the trigger polarity. It is set positive to trigger on a rising edge and negative to trigger on a falling edge.

Key Path	Trigger, External 2
Remote Command	:TRIGger[:SEquence]:EXTernal2:SLOPe POSitive NEGative :TRIGger[:SEquence]:EXTernal2:SLOPe?
Example	TRIG:EXT2:SLOP NEG
Couplings	This same slope is used in the Ext2 selection for the trigger source in the Trigger menu and for the period timer sync source (in the Trigger menu and in the Gate Source menu).
Preset	POSitive
State Saved	Saved in instrument state
Backwards Compatibility SCPI	:TRIGger[:SEquence]:FRAMe:EXTernal2:SLOPe
Backwards Compatibility Notes	The legacy :TRIGger[:SEquence]:SLOPe command affects the slopes for the VID, LINE, EXT1, EXT2, and RFB triggers.
Initial S/W Revision	Prior to A.02.00

RF Burst

Pressing this key, when it is not selected, selects the RF Burst as the trigger. A new sweep/measurement will start when an RF burst envelope signal is identified from the signal at the RF Input connector. Pressing this key, when it is already selected, accesses the RF Burst trigger setup menu.

In some models, a variety of burst trigger circuitry is available, resulting in various available burst trigger bandwidths. The analyzer automatically chooses the appropriate trigger path based on the hardware configuration and other settings of the analyzer.

Key Path	Trigger
Example	TRIG:SOUR RFB Swept SA measurement TRIG:<meas>:SOUR RFB Measurements other than Swept SA
State Saved	Saved in instrument state
Status Bits/OPC dependencies	The Status Operation Register bit 5 "Waiting for Trigger" is set at the same time as the Sweeping or Measuring bit is set. It is cleared when the trigger actually occurs (that is, after the trigger event occurs and all the applicable trigger criteria have been met). A corresponding pop-up message ("Waiting for trigger") is generated if no trigger signal appears after approximately 2 sec. This message goes away when a trigger signal appears.
Backwards Compatibility Notes	The legacy command: :TRIGger[:SEQuence]:RFBurst:FSElectivity[:STATe] OFF ON 0 1 is not supported in the X-Series, as the hardware to do Frequency Selective burst triggers does not exist in X-Series.
Initial S/W Revision	Prior to A.02.00
Modified at S/W Revision	A.04.00

Absolute Trigger Level

Sets the absolute trigger level for the RF burst envelope.

When using the External Mixing path, the Absolute Trigger Level is uncalibrated because the factory default was set to accommodate the expected IF levels for the RF path.

Key Path	Trigger, RF Burst
Scope	Meas Global
Remote Command	:TRIGger[:SEQuence]:RFBurst:LEVel:ABSolute <amp1> :TRIGger[:SEQuence]:RFBurst:LEVel:ABSolute?
Example	TRIG:RFB:LEV:ABS 10 dBm sets the trigger level of the RF burst envelope signal to the absolute level of 10 dBm
Notes	Sending this command does not switch the setting from relative to absolute; to switch it you need to send the :TRIGger[:SEQuence]:RFBurst:LEVel:TYPE command, below. Amplitude Corrections are not taken into account by the Absolute Trigger Level. For example, if you have given yourself effective gain with an amplitude correction factor, the Absolute Trigger will not fire until you have set the trigger level that far below the displayed signal level, rather than simply to

	the displayed signal level. This is only true for Amplitude Corrections, not External Gain or Ref Level Offset functions. If mode is Bluetooth, the default value is -50 dBm.
Couplings	This same level is used for the RF Burst trigger source in the Trigger menu, for the RF Burst selection in the Periodic Timer sync source (in the Trigger menu and in the Gate Source menu), and also for the RF Burst selection in the Gate Source menu
Preset	-20 dBm
State Saved	Saved in instrument state
Min	-200 dBm
Max	100 dBm
Default Unit	depends on the current selected Y-Axis unit
Backwards Compatibility SCPI	:TRIGger[:SEquence]:FRAME:RFBurst:LEVel:ABSolute
Initial S/W Revision	Prior to A.02.00
Modified at S/W Revision	A.04.00

Key Path	Trigger, RF Burst
Remote Command	:TRIGger[:SEquence]:RFBurst:LEVel:TYPE ABSolute RELative :TRIGger[:SEquence]:RFBurst:LEVel:TYPE?
Example	TRIG:RFB:LEV:TYPE REL sets the trigger level type of the RF burst trigger to Relative.
Preset	ABSolute
State Saved	Saved in instrument state
Initial S/W Revision	Prior to A.02.00
Modified at S/W Revision	A.04.00

Relative Trigger Level

Sets the relative trigger level for the RF burst envelope.

In some models, the relative burst trigger function is implemented in hardware. In other models, without the advanced triggering hardware required, the relative burst trigger function is implemented in software in some measurements, and is unavailable in other measurements.

When implemented in software, the relative RF Burst trigger function is implemented as follows:

1. The measurement starts with the absolute RF Burst trigger setting. If it cannot get a trigger with that level, auto trigger fires and the acquisition starts anyway. After the acquisition, the measurement searches for the peak in the acquired waveform and saves it.

2. Now, in the next cycle of the measurement, the measurement determines a new absolute RF Burst level based on the peak value from the first measurement and the Relative RF Burst Trigger Level (always 0 or negative dB) set by the user. The following formula is used:
 3. absolute RF Burst level = peak level of the previous acquisition + relative RF Burst level
 4. If the new absolute RF Burst level differs from the previous by more than 0.5 dB, the new level is sent to the hardware; otherwise it is not updated (to avoid slowing down the acquisition)
- Steps 2 and 3 repeat for subsequent measurements.

Key Path	Trigger, RF Burst
Scope	Meas Global
Remote Command	:TRIGger[:SEquence]:RFBurst:LEVel:RELative <rel_ampl> :TRIGger[:SEquence]:RFBurst:LEVel:RELative?
Example	TRIG:RFB:LEV:REL -10 dB sets the trigger level of the RF burst envelope signal to the relative level of -10 dB
Notes	Sending this command does not switch the setting from absolute to relative; to switch it you need to send the :TRIGger[:SEquence]:RFBurst:LEVel:TYPE command, above. The relative trigger level is not available in some measurements. In those measurements the RELative parameter, and the :TRIGger[:SEquence]:RFBurst:LEVel:TYPE command (above), will generate an error if sent.
Dependencies	This key is grayed out and Absolute Trigger Level selected if the required hardware is not present in your analyzer and the current measurement does not support Relative triggering.
Preset	-6 dB GSM: -25 dB
State Saved	Saved in instrument state
Min	-45 dB
Max	0 dB
Default Unit	dB or dBc
Backwards Compatibility SCPI	:TRIGger[:SEquence]:RFBurst:LEVel This legacy command is aliased to :TRIGger[:SEquence]:RFBurst:LEVel:RELative because the PSA had ONLY relative burst triggering
Initial S/W Revision	Prior to A.02.00
Modified at S/W Revision	A.04.00

Trigger Slope

It is set positive to trigger on a rising edge and negative to trigger on a falling edge.

Key Path	Trigger, RF Burst
Remote Command	:TRIGger[:SEquence]:RFBurst:SLOPe Positive NEGative :TRIGger[:SEquence]:RFBurst:SLOPe?

Example	TRIG:RFB:SLOP NEG
Couplings	This same slope is used in the RF Burst selection for the trigger source in the Trigger menu and for the period timer sync source (in the Trigger menu and in the Gate Source menu).
Preset	POSitive
State Saved	Saved in instrument state
Backwards Compatibility SCPI	:TRIGger[:SEQuence]:FRAMe:RFBurst:SLOPe
Backwards Compatibility Notes	The legacy :TRIGger[:SEQuence]:SLOPe command affects the slopes for the VID, LINE, EXT1, EXT2, and RFB triggers.
Initial S/W Revision	Prior to A.02.00

Periodic Timer (Frame Trigger)

Pressing this key, when it is not selected, selects the internal periodic timer signal as the trigger. Triggering occurrences are set by the **Period** parameter, which is modified by the **Sync Source** and **Offset**. Pressing this key, when it is already selected, accesses the periodic timer trigger setup functions.

If you do not have a sync source selected (it is Off), then the internal timer will not be synchronized with any external timing events.

Key Path	Trigger
Example	TRIG:SOUR FRAM Swept SA measurement TRIG:<meas>:SOUR FRAM Measurements other than Swept SA
State Saved	Saved in instrument state
Readback	[Sync: <value of Sync Source>], for example, [Sync: External 1]
Status Bits/OPC dependencies	The Status Operation Register bit 5 "Waiting for Trigger" is set at the same time as the Sweeping or Measuring bit is set. It is cleared when the trigger actually occurs (that is, after the trigger event occurs and all the applicable trigger criteria have been met). A corresponding pop-up message ("Waiting for trigger") is generated if no trigger signal appears after approximately 2 sec. This message goes away when a trigger signal appears.
Initial S/W Revision	Prior to A.02.00

Periodic Timer Triggering:

This feature selects the internal periodic timer signal as the trigger. Trigger occurrences are set by the **Periodic Timer** parameter, which is modified by the **Sync Source** and **Offset**.

The figure below shows the action of the periodic timer trigger. Before reviewing the figure, we'll explain some uses for the periodic trigger.

A common application is measuring periodic burst RF signals for which a trigger signal is not easily available. For example, we might be measuring a TDMA radio which bursts every 20 ms. Let's assume that the 20 ms period is very consistent. Let's also assume that we do not have an external trigger source

available that is synchronized with the period, and that the signal-to-noise ratio of the signal is not high enough to provide a clean RF burst trigger at all of the analysis frequencies. For example, we might want to measure spurious transmissions at an offset from the carrier that is larger than the bandwidth of the RF burst trigger. In this application, we can set the Periodic Timer to a 20.00 ms period and adjust the offset from that timer to position our trigger just where we want it. If we find that the 20.00 ms is not exactly right, we can adjust the period slightly to minimize the drift between the period timer and the signal to be measured.

A second way to use this feature would be to use **Sync Source** temporarily, instead of **Offset**. In this case, we might tune to the signal in a narrow span and use the RF Burst trigger to synchronize the periodic timer. Then we would turn the sync source off so that it would not miss-trigger. Miss-triggering can occur when we are tuned so far away from the RF burst trigger that it is no longer reliable.

A third example would be to synchronize to a signal that has a reference time element of much longer period than the period of interest. In some CDMA applications, it is useful to look at signals with a short periodicity, by synchronizing that periodicity to the "even-second clock" edge that happens every two seconds. Thus, we could connect the even-second clock trigger to Ext1 and use then Ext1 as the sync source for the periodic timer.

The figure below illustrates this third example. The top trace represents the even-second clock. It causes the periodic timer to synchronize with the leading edge shown. The analyzer trigger occurs at a time delayed by the accumulated offset from the period trigger event. The periodic timer continues to run, and triggers continue to occur, with a periodicity determined by the analyzer time base. The timer output (labeled "late event") will drift away from its ideal time due to imperfect matching between the time base of the signal being measured and the time base of the analyzer, and also because of imperfect setting of the period parameter. But the synchronization is restored on the next even-second clock event. ("Accumulated offset" is described in the in the **Offset** function section.)

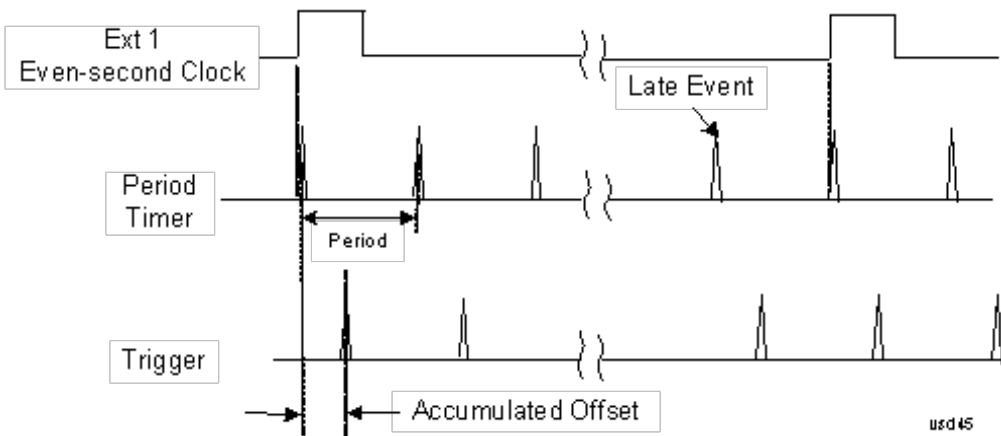

Period

Sets the period of the internal periodic timer clock. For digital communications signals, this is usually set to the frame period of your current input signal. In the case that sync source is not set to OFF, and the external sync source rate is changed for some reason, the periodic timer is synchronized at the every external synchronization pulse by resetting the internal state of the timer circuit.

Key Path	Trigger, Periodic Timer
Remote Command	:TRIGger[:SEquence]:FRAMe:PERIOD <time>

	:TRIGger[:SEquence]:FRAMe:PERiod?
Example	TRIG:FRAM:PER 100 ms
Dependencies	The invalid data indicator turns on when the period is changed, until the next sweep/measurement completes.
Couplings	The same period is used in the Gate Source selection of the period timer.
Preset	20 ms GSM: 4.615383
State Saved	Saved in instrument state
Min	100.000 ns
Max	559.0000 ms
Default Unit	S
Initial S/W Revision	Prior to A.02.00

Offset

Adjusts the accumulated offset between the periodic timer events and the trigger event. Adjusting the accumulated offset is different than setting an offset, and requires explanation.

The periodic timer is usually not synchronized with any external events, so the timing of its output events has no absolute meaning. Since the timing relative to external events (RF signals) is important, you need to be able to adjust (offset) it. However, you have no direct way to see when the periodic timer events occur. All that you can see is the trigger timing. When you want to adjust the trigger timing, you will be changing the internal offset between the periodic timer events and the trigger event. Because the absolute value of that internal offset is unknown, we will just call that the accumulated offset. Whenever the Offset parameter is changed, you are changing that accumulated offset. You can reset the displayed offset using Reset Offset Display. Changing the display does not change the value of the accumulated offset, and you can still make additional changes to accumulated offset.

To avoid ambiguity, we define that an increase in the "offset" parameter, either from the knob or the SCPI adjust command, serves to delay the timing of the trigger event.

Key Path	Trigger, Periodic Timer
Remote Command	:TRIGger[:SEquence]:FRAMe:OFFSet <time> :TRIGger[:SEquence]:FRAMe:OFFSet?
Example	TRIG:FRAM:OFFS 1.2 ms
Notes	The front panel interface (for example, the knob), and this command, adjust the accumulated offset, which is shown on the active function display. However, the actual amount sent to the hardware each time the offset is updated is the delta value, that is, the current accumulated offset value minus the previous accumulated offset value. Note that the accumulated offset value is essentially arbitrary; it represents the accumulated offset from the last time the offset was zeroed (with the Reset Offset Display key). Note that this command does not change the period of the trigger waveform. Note also that Offset is used only when the sync source is set to OFF, otherwise delay is used, see section "Trig Delay" on page 443.

	An increase in the "offset" parameter, either from the knob or the SCPI adjust command, serves to delay the timing of the trigger event.
Notes	When the SCPI command is sent the value shown on the key (and the Active Function, if this happens to be the active function) is updated with the new value. However, the actual amount sent to the hardware is the delta value, that is, the current accumulated offset value minus the previous accumulated offset value. The SCPI query simply returns the value currently showing on the key.
Dependencies	The invalid data indicator turns on when the offset is changed, until the next sweep/measurement completes.
Couplings	The same offset is used in the Gate Source selection of the period timer.
Preset	0 s
State Saved	Saved in instrument state
Min	-10.000 s
Max	10.000 s
Default Unit	S
Initial S/W Revision	Prior to A.02.00

Offset Adjust (Remote Command Only)

This remote command does not work at all like the related front panel keys. This command lets you advance the phase of the frame trigger by the amount you specify.

It does not change the period of the trigger waveform. If the command is sent multiple times, it advances the phase of the frame trigger an additional amount each time it is sent. Negative numbers are permitted.

Remote Command	:TRIGger[:SEquence]:FRAMe:ADJust <time>
Example	TRIG:FRAM:ADJ 1.2 ms
Notes	Note also that Offset is used only when the sync source is set to OFF, otherwise delay is used, see section "Trig Delay" on page 443 An increase in the "offset" parameter, either from the knob or the SCPI adjust command, serves to delay the timing of the trigger event.
Notes	The front panel interface (for example, the knob) and the :TRIG:FRAM:OFFS command adjust the accumulated offset, which is shown on the active function display. However, the actual amount sent to the hardware is the delta value, that is, the current offset value minus the previous offset value. When the SCPI command is sent the value shown on the key (and the Active Function, if this happens to be the active function) is updated by increasing it (or decreasing it if the value sent is negative) by the amount specified in the SCPI command. This is a "command only" SCPI command, with no query.
Dependencies	The invalid data indicator turns on when the offset is changed, until the next sweep/measurement completes.
Couplings	The same offset is used in the Gate Source selection of the period timer.
Preset	0 s

State Saved	Saved in instrument state
Min	-10.000 s
Max	10.000 s
Default Unit	S
Initial S/W Revision	Prior to A.02.00

Reset Offset Display

Resets the value of the periodic trigger offset display setting to 0.0 seconds. The current displayed trigger location may include an offset value defined with the Offset key. Pressing this key redefines the currently displayed trigger location as the new trigger point that is 0.0 s offset. The Offset key can then be used to add offset relative to this new timing.

Key Path	Trigger, Periodic Timer
Remote Command	:TRIGger[:SEquence]:FRAMe:OFFSet:DISPlay:RESet
Example	TRIG:FRAM:OFFS:DISP:RES
Initial S/W Revision	Prior to A.02.00

Sync Source

Selects a signal source for you to synchronize your periodic timer trigger to, otherwise you are triggering at some arbitrary location in the frame. Synchronization reduces the precision requirements on the setting of the period.

For convenience you may adjust the level and slope of the selected sync source in a conditional branch setup menu accessed from the Sync Source menu. Note that these settings match those in the **Trigger** and **Gate Source** menus; that is, each trigger source has only one value of level and slope, regardless of which menu it is accessed from.

Key Path	Trigger, Periodic Timer
Remote Command	:TRIGger[:SEquence]:FRAMe:SYNC EXTernal1 EXTernal2 RFBurst OFF :TRIGger[:SEquence]:FRAMe:SYNC?
Example	TRIG:FRAM:SYNC EXT2
Dependencies	In some models, there is no second External input. In these models, the External 2 key is blanked and the EXTernal2 parameter will generate a "Hardware missing; Not available for this model number" message.
Preset	Off GSM/EDGE, MSR,LTE,LTETDD: RFBurst
State Saved	Saved in instrument state
Readback	The current setting is read back to this key and it is also Readback to the previous Periodic Timer trigger key.

Backwards Compatibility SCPI	:TRIGger[:SEquence]:FRAMe:SYNC EXTernal
Initial S/W Revision	Prior to A.02.00
Modified at S/W Revision	A.03.00, A.14.00

Off

Turns off the sync source for your periodic trigger. With the sync source off, the timing will drift unless the signal source frequency is locked to the analyzer frequency reference.

Key Path	Trigger, Periodic Timer, Sync Source
Example	TRIG:FRAM:SYNC OFF
Readback	Off
Initial S/W Revision	Prior to A.02.00

External 1

Pressing this key, when it is not selected, selects an external input signal as the trigger. A new sweep/measurement will start when the external trigger condition is met using the external 1 input connector on the rear panel.

Pressing this key, when it is already selected, accesses the external 1 trigger setup menu.

Key Path	Trigger
Example	TRIG:SOUR EXT1 Swept SA measurement TRIG:<meas>:SOUR EXT1 Measurements other than Swept SA
Dependencies	Grayed out if in use by Point Trigger in the Source Setup menu. Forced to Free Run if already selected and Point Trigger is set to External 1.
State Saved	Saved in instrument state
Status Bits/OPC dependencies	The Status Operation Register bit 5 "Waiting for Trigger" is set at the same time as the Sweeping or Measuring bit is set. It is cleared when the trigger actually occurs (that is, after the trigger event occurs and all the applicable trigger criteria have been met). A corresponding pop-up message ("Waiting for trigger") is generated if no trigger signal appears after approximately 2 sec. This message goes away when a trigger signal appears.
Initial S/W Revision	Prior to A.02.00

Trigger Level

Sets the value where the external 1 trigger input will trigger a new sweep/measurement.

Key Path	Trigger, External 1
Remote Command	:TRIGger[:SEquence]:EXTErnal1:LEVel <level> :TRIGger[:SEquence]:EXTErnal1:LEVel?
Example	TRIG:EXT1:LEV 0.4 V
Couplings	This same level is used for the Ext1 trigger source in the Trigger menu, for the Ext1 selection in the Periodic Timer sync source (in the Trigger menu and in the Gate Source menu), and also for the Ext1 selection in the Gate Source menu.
Preset	1.2 V
State Saved	Saved in instrument state
Min	-5 V
Max	5 V
Default Unit	V
Backwards Compatibility SCPI	:TRIGger[:SEquence]:EXTErnal:LEVel For backward compatibility, the parameter EXTErnal is mapped to EXTErnal1
Backwards Compatibility SCPI	:TRIGger[:SEquence]:FRAME:EXTErnal1:LEVel
Initial S/W Revision	Prior to A.02.00

Trig Slope

Controls the trigger polarity. It is set positive to trigger on a rising edge and negative to trigger on a falling edge.

Key Path	Trigger, External 1
Remote Command	:TRIGger[:SEquence]:EXTErnal1:SLOPe POSitive NEGative :TRIGger[:SEquence]:EXTErnal1:SLOPe?
Example	TRIG:EXT1:SLOP NEG
Couplings	This same slope is used in the Ext1 selection for the trigger source in the Trigger menu and for the period timer sync source (in the Trigger menu and in the Gate Source menu).
Preset	POSitive
State Saved	Saved in instrument state
Backwards Compatibility SCPI	:TRIGger[:SEquence]:EXTErnal:SLOPe For backward compatibility, the parameter EXTErnal is mapped to EXTErnal1
Backwards Compatibility SCPI	:TRIGger[:SEquence]:FRAME:EXTErnal1:SLOPe
Backwards Compatibility Notes	The legacy :TRIGger[:SEquence]:SLOPe command affects the slopes for the VID, LINE, EXT1, EXT2, and RFB triggers.
Initial S/W Revision	Prior to A.02.00

External 2

Pressing this key, when it is not selected, selects an external input signal as the trigger. A new sweep/measurement will start when the external trigger condition is met using the external 2 input connector. The external trigger 2 input connector is on the rear panel.

Pressing this key, when it is already selected, accesses the external 2 trigger setup menu.

Key Path	Trigger
Example	TRIG:SOUR EXT2 Swept SA measurement TRIG:<meas>:SOUR EXT2 Measurements other than Swept SA
Dependencies	In some models, there is no second External input. In these models, the External 2 key is blanked and the EXTernal2 parameter will generate a "Hardware missing; Not available for this model number" message. Grayed out if in use by Point Trigger in the Source Setup menu. Forced to Free Run if already selected and Point Trigger is set to External 2.
State Saved	Saved in instrument state
Status Bits/OPC dependencies	The Status Operation Register bit 5 "Waiting for Trigger" is set at the same time as the Sweeping or Measuring bit is set. It is cleared when the trigger actually occurs (that is, after the trigger event occurs and all the applicable trigger criteria have been met). A corresponding pop-up message ("Waiting for trigger") is generated if no trigger signal appears after approximately 2 sec. This message goes away when a trigger signal appears.
Initial S/W Revision	Prior to A.02.00
Modified at S/W Revision	A.03.00

Trigger Level

Sets the value where the external 2 trigger input will trigger a new sweep/measurement.

Key Path	Trigger, External 2
Remote Command	:TRIGger[:SEquence]:EXTernal2:LEVel :TRIGger[:SEquence]:EXTernal2:LEVel?
Example	TRIG:EXT2:LEV 1.1 V
Couplings	This same level is used for the Ext2 trigger source in the Trigger menu, for the Ext2 selection in the Periodic Timer sync source (in the Trigger menu and in the Gate Source menu), and also for the Ext2 selection in the Gate Source menu.
Preset	1.2 V
State Saved	Saved in instrument state
Min	-5 V
Max	5 V
Default Unit	V
Backwards Compatibility SCPI	:TRIGger[:SEquence]:FRAMe:EXTernal2:LEVel
Initial S/W Revision	Prior to A.02.00

Trig Slope

Controls the trigger polarity. It is set positive to trigger on a rising edge and negative to trigger on a falling edge.

Key Path	Trigger, External 2
Remote Command	:TRIGger[:SEQuence]:EXTernal2:SLOPe POSitive NEGative :TRIGger[:SEQuence]:EXTernal2:SLOPe?
Example	TRIG:EXT2:SLOP NEG
Couplings	This same slope is used in the Ext2 selection for the trigger source in the Trigger menu and for the period timer sync source (in the Trigger menu and in the Gate Source menu).
Preset	POSitive
State Saved	Saved in instrument state
Backwards Compatibility SCPI	:TRIGger[:SEQuence]:FRAMe:EXTernal2:SLOPe
Backwards Compatibility Notes	The legacy :TRIGger[:SEQuence]:SLOPe command affects the slopes for the VID, LINE, EXT1, EXT2, and RFB triggers.
Initial S/W Revision	Prior to A.02.00

RF Burst

Pressing this key, when it is not selected, selects the RF Burst as the trigger. A new sweep/measurement will start when an RF burst envelope signal is identified from the signal at the RF Input connector. Pressing this key, when it is already selected, accesses the RF Burst trigger setup menu.

In some models, a variety of burst trigger circuitry is available, resulting in various available burst trigger bandwidths. The analyzer automatically chooses the appropriate trigger path based on the hardware configuration and other settings of the analyzer.

Key Path	Trigger
Example	TRIG:SOUR RFB Swept SA measurement TRIG:< meas>:SOUR RFB Measurements other than Swept SA
State Saved	Saved in instrument state
Status Bits/OPC dependencies	The Status Operation Register bit 5 "Waiting for Trigger" is set at the same time as the Sweeping or Measuring bit is set. It is cleared when the trigger actually occurs (that is, after the trigger event occurs and all the applicable trigger criteria have been met). A corresponding pop-up message ("Waiting for trigger") is generated if no trigger signal appears after approximately 2 sec. This message goes away when a trigger signal appears.
Backwards Compatibility Notes	The legacy command: :TRIGger[:SEQuence]:RFBurst:FSElectivity[:STATe] OFF ON 0 1 is not supported in the X-Series, as the hardware to do Frequency Selective burst triggers does not exist in X-Series.

Initial S/W Revision	Prior to A.02.00
Modified at S/W Revision	A.04.00

Absolute Trigger Level

Sets the absolute trigger level for the RF burst envelope.

When using the External Mixing path, the Absolute Trigger Level is uncalibrated because the factory default was set to accommodate the expected IF levels for the RF path.

Key Path	Trigger, RF Burst
Scope	Meas Global
Remote Command	:TRIGger[:SEquence]:RFBurst:LEVel:ABSolute <ampl> :TRIGger[:SEquence]:RFBurst:LEVel:ABSolute?
Example	TRIG:RFB:LEV:ABS 10 dBm sets the trigger level of the RF burst envelope signal to the absolute level of 10 dBm
Notes	Sending this command does not switch the setting from relative to absolute; to switch it you need to send the :TRIGger[:SEquence]:RFBurst:LEVel:TYPE command, below. Amplitude Corrections are not taken into account by the Absolute Trigger Level. For example, if you have given yourself effective gain with an amplitude correction factor, the Absolute Trigger will not fire until you have set the trigger level that far below the displayed signal level, rather than simply to the displayed signal level. This is only true for Amplitude Corrections, not External Gain or Ref Level Offset functions. If mode is Bluetooth, the default value is -50 dBm.
Couplings	This same level is used for the RF Burst trigger source in the Trigger menu, for the RF Burst selection in the Periodic Timer sync source (in the Trigger menu and in the Gate Source menu), and also for the RF Burst selection in the Gate Source menu
Preset	-20 dBm
State Saved	Saved in instrument state
Min	-200 dBm
Max	100 dBm
Default Unit	depends on the current selected Y-Axis unit
Backwards Compatibility SCPI	:TRIGger[:SEquence]:FRAME:RFBurst:LEVel:ABSolute
Initial S/W Revision	Prior to A.02.00
Modified at S/W Revision	A.04.00

Key Path	Trigger, RF Burst
Remote Command	:TRIGger[:SEquence]:RFBurst:LEVel:TYPE ABSolute RELative :TRIGger[:SEquence]:RFBurst:LEVel:TYPE?

Example	TRIG:RFB:LEV:TYPE REL sets the trigger level type of the RF burst trigger to Relative.
Preset	ABSolute
State Saved	Saved in instrument state
Initial S/W Revision	Prior to A.02.00
Modified at S/W Revision	A.04.00

Trigger Slope

It is set positive to trigger on a rising edge and negative to trigger on a falling edge.

Key Path	Trigger, RF Burst
Remote Command	:TRIGger[:SEquence]:RFBurst:SLOPe POSitive NEGative :TRIGger[:SEquence]:RFBurst:SLOPe?
Example	TRIG:RFB:SLOP NEG
Couplings	This same slope is used in the RF Burst selection for the trigger source in the Trigger menu and for the period timer sync source (in the Trigger menu and in the Gate Source menu).
Preset	POSitive
State Saved	Saved in instrument state
Backwards Compatibility SCPI	:TRIGger[:SEquence]:FRAME:RFBurst:SLOPe
Backwards Compatibility Notes	The legacy :TRIGger[:SEquence]:SLOPe command affects the slopes for the VID, LINE, EXT1, EXT2, and RFB triggers.
Initial S/W Revision	Prior to A.02.00

Sync Holdoff

Sync Holdoff specifies the duration that the sync source signal must be kept false before the transition to true to be recognized as the sync timing. The periodic timer phase is aligned when the sync source signal becomes true, after the Holdoff time is satisfied.

A holdoff of 2 ms will work with most WiMAX signals, but there may be cases where the burst off duration is less than 1 ms and this value will need to be changed.

Key Path	Trigger, Periodic Timer
Remote Command	:TRIGger[:SEquence]:FRAME:SYNC:HOLDoff <time> :TRIGger[:SEquence]:FRAME:SYNC:HOLDoff? :TRIGger[:SEquence]:FRAME:SYNC:HOLDoff:STATe OFF ON 0 1 :TRIGger[:SEquence]:FRAME:SYNC:HOLDoff:STATe?
Preset	On, 1.000 ms

State Saved	Saved in instrument state
Min	0 ms
Max	+500 ms
Default Unit	s
Initial S/W Revision	Prior to A.02.00

Control Edge/Level

Sets the method of controlling the gating function from the gating signal.

Edge

In Edge triggering, the gate opens (after the Delay) on the selected edge (for example, positive) of the gate signal and closes on the alternate edge (for example, negative).

Level

In Level triggering, the gate opens (after the Delay) when the gate signal has achieved a certain level and stays open as long as that level is maintained.

Key Path	Sweep/Control, Gate
Remote Command	[:SENSE] :SWEep:EGATe:CONTRol EDGE LEVel [:SENSE] :SWEep:EGATe:CONTRol?
Example	SWE:EGAT:CONT EDGE
Dependencies	If the Gate Method is FFT the Control key is grayed out and Edge is selected. If the Gate Source is TV, Frame or Line, the Control key is grayed out and Edge is selected.
Preset	EDGE
State Saved	Saved in instrument state
Backwards Compatibility SCPI	[:SENSE] :SWEep:TIME:GATE:TYPE ESA Compatibility
Initial S/W Revision	Prior to A.02.00

Gate Holdoff

Lets you increase or decrease the wait time after a gate event ends before the analyzer will respond to the next gate signal.

After any Gate event finishes, the analyzer must wait for the sweep system to settle before it can respond to another Gate signal. The analyzer calculates a "wait time," taking into account a number of factors, including RBW and Phase Noise Optimization settings. The goal is to achieve the same accuracy when gated as in ungated operation. The figure below illustrates this concept:

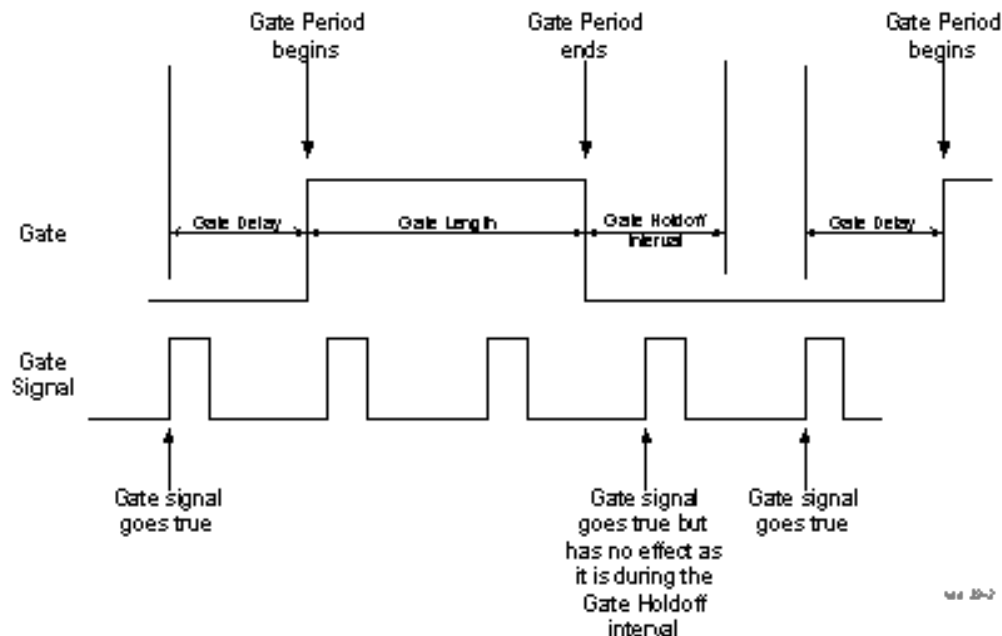

When Gate Holdoff is in Auto, the wait time calculated by the analyzer is used. When Gate Time is in Manual, the user may adjust the wait time, usually decreasing it in order to achieve greater speed, but at the risk of decreasing accuracy.

When the Method key is set to Video or FFT, the Gate Holdoff function has no effect.

In measurements that do not support Auto, the value shown when Auto is selected is “---” and the manually set holdoff is returned to a query.

Key Path	Sweep/Control, Gate
Remote Command	<pre>[:SENSe] :SWEep:EGATe:HOLDoff <time> [:SENSe] :SWEep:EGATe:HOLDoff? [:SENSe] :SWEep:EGATe:HOLDoff:AUTO OFF ON 0 1 [:SENSe] :SWEep:EGATe:HOLDoff:AUTO?</pre>
Example	<pre>SWE:EGAT:HOLD 0.0002 SWE:EGAT:HOLD? SWE:EGAT:HOLD:AUTO ON SWE:EGAT:HOLD:AUTO?</pre>
Couplings	<p>When Gate Holdoff is Auto, the Gate Holdoff key shows the value calculated by the analyzer for the wait time.</p> <p>Pressing the Gate Holdoff key while it is in Auto and not selected, causes the key to become selected and allows the user to adjust the value. If the value is adjusted, the setting changes to Man.</p> <p>Pressing the Gate Holdoff key, while it is in Auto and selected, does not change the value of Gate Holdoff, but causes the setting to change to Man. Now the user can adjust the value.</p> <p>Pressing the key while it is in Man and selected, cause the value to change back to Auto.</p> <p>Pressing the key while it is in Man and not selected, causes the key to become selected and allows the user to adjust the value.</p>

	When Method is set to Video or FFT, the Gate Holdoff function has no effect.
Preset	Auto Auto/On
State Saved	Saved in instrument state
Min	1 μ sec
Max	1 sec
Initial S/W Revision	Prior to A.02.00

Gate Delay Compensation

This function allows you to select an RBW-dependent value by which to adjust the gate delay, to compensate for changes in the delay caused by RBW effects.

You can select between uncompensated operation and two types of compensation, Delay Until RBW Settled and Compensate for RBW Group Delay.

See ["More Information" on page 1048](#)

Key Path	Sweep/Control, Gate
Scope	Meas Global
Remote Command	[:SENSe] :SWEep:EGATe:DELaY:COMPensation:TYPE OFF SETTled GDELaY [:SENSe] :SWEep:EGATe:DELaY:COMPensation:TYPE?
Example	SWE:EGAT:DEL:COMP:TYPE SETT SWE:EGAT:DEL:COMP:TYPE?
Notes	Although this function is Meas Global, there are some measurements that do not support this function. In those measurements the operation will be Uncompensated. Going into one of those measurements will not change the Meas Global selection; it will simply display the grayed-out menu key with "Uncompensated" showing as the selection. This is a non-forceful grayout, so the SCPI command is still accepted. If Gate Delay Compensation is not supported at all within a particular mode, the key is not displayed, and if the SCPI command is sent while in a measurement within that mode, an "Undefined Header" message is generated. Measurements that do not support this function include: Swept SA
Preset	TD-SCDMA mode: Compensate for RBW Group Delay All other modes: Delay Until RBW Settled
State Saved	Saved in instrument state
Range	Uncompensated Delay Until RBW Settled Compensate for RBW Group Delay
Readback text	Uncompensated Settled Group Delay
Initial S/W Revision	Prior to A.02.00
Modified at S/W Revision	A.11.0

More Information

Selecting Uncompensated means that the actual gate delay is as you sets it.

Selecting Delay Until RBW Settled causes the gate delay to be increased above the user setting by an amount equal to $3.06/\text{RBW}$. This compensated delay causes the GATE START and GATE STOP lines on the display to move by the compensation amount, and the actual hardware gate delay to be increased by the same amount. All the other gate lines (for example, MIN FAST) are unaffected. If the RBW subsequently changes, the compensation is readjusted for the new RBW. The value shown on the Gate Delay key does NOT change.

Delay Until RBW Settled allows excellent measurements of gated signals, by allowing the IF to settle following any transient that affects the burst. Excellent measurements also require that the analysis region not extend into the region affected by the falling edge of the burst. Thus, excellent measurements can only be made over a width that declines with narrowing RBWs, which is achieved by decreasing the gate length below the user setting by an amount equal to $2.53/\text{RBW}$. Therefore, for general purpose compensation, you will still want to change the gate length with changes in RBW even if the gate delay is compensated. The compensated Gate Length is limited by the analyzer so that it will never go below 10% of the value shown on the Gate Length key, as otherwise the sweep times could get very long. Anytime the Gate Length and RBW values combine in such a way that this limiting takes place, a warning is displayed. For measurements which contain multiple sweeps with different RBW like SEM and SPUR, the smallest RBW is used for this limiting.

Selecting Compensate for RBW Group Delay causes the gate delay to be increased above the user setting by an amount equal to $1.81/\text{RBW}$. This compensated delay causes the GATE START, GATE STOP lines on the display to move by the compensation amount, and the actual hardware gate delay to be increased by the same amount. All the other gate lines (for example, MIN FAST) are unaffected. If the RBW subsequently changes, the compensation is readjusted for the new RBW. The value shown on the Gate Delay key does NOT change. Compensate for RBW Group Delay also includes gate length compensation; the gate length itself is adjusted as necessary to attempt to compensate for delay effects imposed by the RBW.

Compensate for RBW Group Delay is similar to Delay Until RBW Settled, but compensates for the group delay of the RBW filter, rather than the filter settling time. As the RBW gets narrow, this can allow the settling tail of the RBW to affect the beginning part of the gated measurement, and allow the beginning of the RBW settling transient to affect the end of the gated measurement. These two effects are symmetric because the RBW response is symmetric. Because the gate length is not automatically compensated, some users might find this compensation to be more intuitive than compensation for RBW settling.

Min Fast Position Query (Remote Command Only)

This command queries the position of the MIN FAST line, relative to the delay reference (REF) line. See section ["Gate View On/Off" on page 2080](#). If this query is sent while not in gate view, the MinFast calculation is performed based on the current values of the appropriate parameters and the result is returned. Knowing this value lets you set an optimal gate delay value for the current measurement setup.

Remote Command	<code>[:SENSe] :SWEep:EGATe:MINFast?</code>
Example	<code>SWE:EGAT:MIN?</code>
Initial S/W Revision	Prior to A.02.00

Gate Preset (Remote Command Only)

Presets the time-gated spectrum analysis capability.

This command sets gate parameter values to the ESA preset values, as follows:

Gate trigger type = edge

Gate polarity = positive

Gate delay = 1 us

Gate length = 1 us

Remote Command	<code>[:SENSe]:SWEep:TIME:GATE:PRESet</code> ESA Compatibility
Initial S/W Revision	Prior to A.02.00

Gate Level (Remote Command Only)

Sets the gate input transition point level for the external TRIGGER inputs on the front and rear panel. This is a legacy command for PSA compatibility. It is simply an alias to the equivalent trigger level command.

Remote Command	<code>[:SENSe]:SWEep:EGATE:EXTernal[1] 2:LEVel <voltage></code> <code>[:SENSe]:SWEep:EGATE:EXTernal[1] 2:LEVel?</code>
Notes	This command is simply an alias to <code>:TRIGger[:SEQUence]:EXTernal[1] 2:LEVel</code> For details refer
Initial S/W Revision	Prior to A.02.00

Gate Polarity (Remote Command Only)

Sets the polarity for the gate signal. This setup is now done using the gate trigger's slope setting.

When Positive (Pos) is selected, a positive-going edge (Edge) or a high voltage (Level) will satisfy the gate condition, after the delay set with the Gate Delay key. When Negative (Neg) is selected, a negative-going edge (Edge) or a low voltage (Level) will satisfy the gate condition after the delay.

Remote Command	<code>[:SENSe]:SWEep:EGATE:POLarity</code> NEGative POSitive <code>[:SENSe]:SWEep:EGATE:POLarity?</code>
Example	<code>SWE:EGAT:POL NEG</code> <code>SWE:EGAT:POL?</code>
Preset	POSitive
State Saved	Saved in instrument state
Backwards Compatibility SCPI	<code>[:SENSe]:SWEep:TIME:GATE:POLarity</code> ESA compatibility
Initial S/W Revision	Prior to A.02.00

10 Spectrum Emission Mask Measurement
Sweep/Control

Remote Command	<code>[:SENSe] :SWEep:TIME:GATE:LEVel HIGH LOW</code> <code>[:SENSe] :SWEep:TIME:GATE:LEVel?</code> ESA compatibility
Preset	HIGH
Initial S/W Revision	Prior to A.02.00

System

See "System" on page 342

Trace/Detector

Accesses a menu of functions that enable you to control trace and detector for the current measurement.

Key Path	Front-panel key
Initial S/W Revision	Prior to A.02.00

Trace Type

Allows you to select the type of trace for the current measurement. The menu contains a 1-of-N selection of the trace type (Clear Write, Average, Max Hold, Min Hold).

Key Path	Trace/Detector
Mode	SA, WCDMA, C2K, WIMAX OFDMA, TD-SCDMA, 1xEVDO, DTMB (CTTB), DVB-T/H, ISDB-T, CMMB, LTE, LTEFDD, Digital Cable TV, WLAN, MSR, LTEAFDD, LTEATDD
Remote Command	:TRACe:SEMask:TYPE WRITe AVERAge MAXHold MINHold :TRACe:SEMask:TYPE?
Example	TRAC:SEM:TYPE MINH TRAC:SEM:TYPE?
Notes	WRITe = Clear Write AVERAge = Average MAXHold = Maximum Hold MINHold = Minimum Hold
Couplings	When Detector setting is "Auto" ([:SENSe]:SEMask:DETEctor:AUTO?), Detector ([:SENSe]:SEMask:DETEctor[:FUNCTion]?) switches aligning with the switch of this parameter: "NORMal" with WRITe (Clear Write), "AVERAge" with AVERAge, "POSitive (peak)" with MAXHold, and "NEGative (peak)" with MINHold.
Preset	AVERAge
State Saved	Saved in instrument state.
Range	WRITe AVERAge MAXHold MINHold
Initial S/W Revision	Prior to A.02.00
Modified at S/W Revision	A.02.00, A.03.00

Chan Detector

Accesses a menu of functions that enable you to control the detectors for reference channel. The following choices are available:

- Auto—the detector selected depends on marker functions, trace functions, average type, and the trace averaging function.
- Normal—the detector determines the peak of the CW-like signals, and it yields alternating maximums and minimums of noise-like signals. This is also referred to as Rosenfell detection.

- Average—the detector determines the average of the signal within the sweep points. The averaging method depends upon the Average Type selection (voltage, power or log scales).
- Peak—the detector determines the maximum of the signal within the sweep points.
- Sample—the detector indicates the instantaneous level of the signal at the center of the sweep points represented by each display point.
- Negative Peak—the detector determines the minimum of the signal within the sweep points.

Key Path	Trace/Detector
Initial S/W Revision	Prior to A.02.00

Chan Detector Auto

Sets the detector to the default detection mode for the reference channel. This mode is dependent upon the current reference channel conditions.

Key Path	Trace/Detector
Mode	SA, WCDMA, C2K, WIMAX OFDMA, TD-SCDMA, 1xEVDO, DTMB (CTTB), DVB-T/H, ISDB-T, CMMB, LTE, LTE-TDD, Digital Cable TV, WLAN, MSR, LTEAFDD, LTEATDD
Remote Command	[:SENSe] :SEMAsk:DETEctor:CARRier:AUTO ON OFF 1 0 [:SENSe] :SEMAsk:DETEctor:CARRier:AUTO?
Example	SEM:DET:CARR:AUTO OFF SEM:DET:CARR:AUTO?
Notes	See Couplings in the Trace Type section. You must be in the mode that includes SEM measurement to use this command. Use :INSTrument:SElect to set the mode.
Preset	ON
State Saved	Saved in instrument state
Range	On Off
Initial S/W Revision	Prior to A.02.00
Modified at S/W Revision	A.02.00, A.03.00

Chan Detector Selection

Selects the detector mode for the reference channel.

Key Path	Trace/Detector
Mode	SA, WCDMA, C2K, WIMAX OFDMA, TD-SCDMA, 1xEVDO, DTMB (CTTB), DVB-T/H, ISDB-T, CMMB, LTE, LTE-TDD, Digital Cable TV, WLAN, MSR, LTEAFDD, LTEATDD
Remote Command	[:SENSe] :SEMAsk:DETEctor:CARRier[:FUNction] AVERAge NEGAtive NORMAl POSitive SAMPlE [:SENSe] :SEMAsk:DETEctor:CARRier[:FUNction]?

Example	SEM:DET:CARR NEG SEM:DET:CARR?
Notes	When you manually select a detector (instead of selecting Auto), that detector is used regardless of other analyzer settings. Note: This detector setting affects the reference channel. There is not a per trace detector. You must be in the mode that includes SEM measurement to use this command. Use :INSTrument:SElect to set the mode.
Couplings	See Couplings in the Trace Type section.
Preset	AVERage
State Saved	Saved in instrument state.
Range	Normal Average Peak Sample Negative Peak
Initial S/W Revision	Prior to A.02.00
Modified at S/W Revision	A.02.00, A.03.00

Offset Detector

Accesses a menu of functions that enable you to control the detector for offsets. The following choices are available.

- Auto– the detector selected depends on marker functions, trace functions, average type, and the trace averaging function.
- Normal–the detector determines the peak of the CW-like signals, and it yields alternating maximums and minimums of noise-like signals. This is also referred to as Rosenfell detection.
- Average–the detector determines the average of the signal within the sweep points. The averaging method depends upon the Average Type selection (voltage, power or log scales).
- Peak–the detector determines the maximum of the signal within the sweep points.
- Sample–the detector indicates the instantaneous level of the signal at the center of the sweep points represented by each display point.
- Negative Peak–the detector determines the minimum of the signal within the sweep points.

Key Path	Trace/Detector
Initial S/W Revision	Prior to A.02.00

Offset Detector Auto

Sets the detector to the default detection mode for the offsets. This mode is dependent upon the current signal conditions of the offsets.

Key Path	Trace/Detector
Mode	SA, WCDMA, C2K, WIMAX OFDMA, TD-SCDMA, 1xEVDO, DTMB (CTTB), DVB-T/H, ISDB-T, CMMB,

	LTE, LTE-TDD, Digital Cable TV, WLAN, MSR, LTEAFDD, LTEATDD
Remote Command	[:SENSe] :SEMAsk:DETEctor:OFFSet:AUTO ON OFF 1 0 [:SENSe] :SEMAsk:DETEctor:OFFSet:AUTO?
Example	SEM:DET:OFFS:AUTO OFF SEM:DET:OFFS:AUTO?
Notes	See Couplings in the Trace Type section. You must be in the mode that includes SEM measurement to use this command. Use :INSTrument:SElect to set the mode.
Preset	ON
State Saved	Saved in instrument state.
Range	On Off
Initial S/W Revision	Prior to A.02.00
Modified at S/W Revision	A.02.00, A.03.00

Offset Detector Selection

Selects the detector mode for the offsets.

Key Path	Trace/Detector
Mode	SA, WCDMA, C2K, WIMAX OFDMA, TD-SCDMA, 1xEVDO, DTMB (CTTB), DVB-T/H, ISDB-T, CMMB, LTE, LTE-TDD, Digital Cable TV, WLAN, MSR, LTEAFDD, LTEATDD
Remote Command	[:SENSe] :SEMAsk:DETEctor:OFFSet[:FUNction] AVERAge NEGAtive NORMAl POSitive SAMPlE [:SENSe] :SEMAsk:DETEctor:OFFSet[:FUNction]?
Example	SEM:DET:OFFS AVER SEM:DET:OFFS?
Notes	When you manually select a detector (instead of selecting Auto), that detector is used regardless of other analyzer settings. Note: This detector setting has effects all offsets. There is not a per trace detector. You must be in the mode that includes SEM measurement to use this command. Use :INSTrument:SElect to set the mode.
Couplings	See Couplings in the Trace Type section.
Preset	POSitive
State Saved	Saved in instrument state.
Range	Normal Average Peak Sample Negative Peak
Initial S/W Revision	Prior to A.02.00
Modified at S/W Revision	A.02.00, A.03.00

Trigger

See ["Trigger" on page 412](#)

Free Run

See ["Free Run " on page 419](#)

Video

See ["Video \(IF Envelope\) " on page 420](#)

Trigger Level

See ["Trigger Level " on page 420](#)

Trig Slope

See ["Trig Slope " on page 421](#)

Trig Delay

See ["Trig Delay " on page 422](#)

Line

See ["Line " on page 2087](#)

Trig Slope

See ["Trig Slope " on page 2087](#)

Trig Delay

See ["Trig Delay " on page 424](#)

External 1

See ["External 1 " on page 2099](#)

Trigger Level

See ["Trigger Level " on page 2099](#)

Trig Slope

See ["Trig Slope " on page 2100](#)

Trig Delay

See ["Trig Delay " on page 427](#)

External 2

See ["External 2 " on page 2101](#)

Trigger Level

See ["Trigger Level "](#) on page 2101

Trig Slope

See ["Trig Slope "](#) on page 2102

Trig Delay

See ["Trig Delay "](#) on page 429

RF Burst

See ["RF Burst "](#) on page 2102

Absolute Trigger

See ["Absolute Trigger Level"](#) on page 2103

Relative Trigger

See ["Relative Trigger Level"](#) on page 2092

Trig Slope

See ["Trigger Slope "](#) on page 2104

Trig Delay

See ["Trig Delay "](#) on page 433

Periodic Timer

See ["Periodic Timer \(Frame Trigger\) "](#) on page 2094

Period

See ["Period "](#) on page 2095

Offset

See ["Offset "](#) on page 2096

Reset Offset Display

See ["Reset Offset Display "](#) on page 2098

Sync Source

See ["Sync Source "](#) on page 2098

Off

See ["Off "](#) on page 2099

External 1

See ["External 1 "](#) on page 2099

Trigger Level

See ["Trigger Level "](#) on page 2099

Trig Slope

See ["Trig Slope "](#) on page 2100

External 2

See ["External 2 "](#) on page 2101

Trigger Level

See ["Trigger Level "](#) on page 2101

Trig Slope

See ["Trig Slope "](#) on page 2102

RF Burst

See ["RF Burst "](#) on page 2102

Absolute Trigger

See ["Absolute Trigger Level"](#) on page 2103

Trig Slope

See ["Trigger Slope "](#) on page 2104

Trig Delay

See ["Trig Delay"](#) on page 443

Auto/Holdoff

See ["Auto/Holdoff "](#) on page 444

Auto Trig

See ["Auto Trig "](#) on page 444

Trig Holdoff

See ["Trig Holdoff "](#) on page 445

User Preset

Accesses a menu that gives you the following three choices:

- User Preset – recalls a state previously saved using the Save User Preset function.
- User Preset All Modes – presets all of the modes in the analyzer
- Save User Preset– saves the current state for the current mode

Key Path	Front-panel key
Backwards Compatibility Notes	<p>User Preset is actually loading a state, and in legacy analyzers, it was possible to load a state without affecting the trace data, limit lines or correction data. Similarly it was possible to do a User Preset without affecting the trace data, limit lines or correction data.</p> <p>In the X-Series, “state” always includes all of this data; so whenever state is loaded, or User Preset is executed, all of the traces, limit lines and corrections are affected. Although this differs from previous behavior, it is desirable behavior, and should not cause adverse issues for users.</p> <p>On ESA and PSA, User Preset affected the entire instrument’s state. In the X-Series, User Preset only recalls the state for the active mode. There is a User Preset file for each mode. User Preset can never cause a mode switch as it can in legacy analyzers. If you want to recall all modes to their user preset file state, you will need to do a User Preset after mode switching into each mode.</p> <p>User Preset recalls mode state which can now include data like traces; whereas on ESA and PSA, User Preset did not affect data.</p>
Initial S/W Revision	Prior to A.02.00

User Preset

User Preset sets the state of the currently active mode back to the state that was previously saved for this mode using the Save User Preset menu key or the SCPI command, SYST:PRES:USER:SAV. It not only recalls the Mode Preset settings, but it also recalls all of the mode persistent settings, and the Input/Output system setting that existed at the time Save User Preset was executed.

If a Save User Preset has not been done at any time, User Preset recalls the default user preset file for the currently active mode. The default user preset files are created if, at power-on, a mode detects there is no user preset file. There will never be a scenario when there is no user preset file to restore. For each mode, the default user preset state is the same state that would be saved if a Save User Preset is performed in each mode right after doing a Restore Mode Default and after a Restore Input/Output Defaults.

The User Preset function does the following:

- Aborts the currently running measurement.
- Sets the mode State to the values defined by Save User Preset.
- Makes the saved measurement for the currently running mode the active measurement.
- Brings up the saved menu for the power-on mode.
- Clears the input and output buffers.
- Sets the Status Byte to 0.

Key Path	User Preset
Remote Command	:SYSTem:PRESet:USER
Example	:SYST:PRES:USER:SAVE:SYST:PRES:USER
Notes	:SYST:PRES:USER:SAVE is used to save the current state as the user preset state. Clears all pending OPC bits. The Status Byte is set to 0. Pressing the User Preset front-panel key while already in the User Preset menu will cause the User Preset to get executed
Couplings	A user preset will cause the currently running measurement to be aborted and cause the saved measurement to be active. Recalling a User Preset file has the same issues that recalling a Save State file has. Some settings may need to be limited and therefore re-coupled, since the capabilities of the mode may have changes when the User Preset file was last saved.
Initial S/W Revision	Prior to A.02.00

User Preset All Modes

Recalls all of the User Preset files for each mode, switches to the power-on mode, and activates the saved measurement from the power-on mode User Preset file.

NOTE

When the instrument is secured, all of the user preset files are converted back to their default user preset files.

The User Preset function does the following:

- Aborts the currently running measurement.
- Switches the Mode to the power-on mode.
- Restores the User Preset files for each mode.
- Makes the saved measurement for the power-on mode the active measurement.
- Brings up the saved menu for the power-on mode.
- Clears the input and output buffers.
- Sets the Status Byte to 0.

Key Path	User Preset
Remote Command	:SYSTem:PRESet:USER:ALL
Example	:SYST:PRES:USER:SAVE:SYST:PRES:USER:ALL
Notes	Clears all pending OPC bits. The Status Byte is set to 0. :SYST:PRES:USER:SAVE is used to save the current state as the user preset state.
Couplings	A user preset will cause the currently running measurement to be aborted, cause a mode switch to the power-on mode, and cause the saved measurement to be active in the power-on mode. Recalling a User Preset file has the same issues that recalling a Save State file has. Some settings may need to be limited and therefore re-coupled, since the capabilities of the mode may have changes when the User Preset file was last saved.
Initial S/W Revision	Prior to A.02.00

Save User Preset

Saves the currently active mode and its State. You can recall this User Preset file by pressing the User Preset menu key or sending the SYST:PRES:USER remote command. This same state is also saved by the Save State function.

Key Path	User Preset
Remote Command	:SYSTem:PRESet:USER:SAVE
Example	:SYST:PRES:USER:SAVE
Notes	:SYST:PRES:SAVE creates the same file as if the user requested a *SAV or a MMEM:STOR:STAT, except User Preset Save does not allow the user to specify the filename or the location of the file.
Initial S/W Revision	Prior to A.02.00

View/Display

Accesses a menu of functions that enable you to control the instrument display.

The following keys select how the results are displayed:

- **Abs Pwr Freq**—displays the absolute power levels in dBm and the corresponding frequencies in the text window.
- **Rel Pwr Freq**—displays the relative power levels in dBc and the corresponding frequencies in the text window.
- **Integrated Power**—displays the absolute and relative power levels integrated throughout the bandwidths between the start and stop frequencies in the text window.
- **Carrier Info**—displays the carrier configuration information with measure powers. (Only available in MSR and LTE-Advanced FDD/TDD)

["View Selection by Name \(Remote Command Only\)" on page 1062](#)

["Views Selection by Number \(Remote Command only\)" on page 1063](#)

View Selection by Name (Remote Command Only)

Key Path	View/Display
Mode	SA, WCDMA, C2K, WIMAX OFDMA, TD-SCDMA, 1xEVDO, DTMB (CTTB), DVB-T/H, ISDB-T, CMMB, LTE, LTETDD, Digital Cable TV, WLAN, MSR, LTEAFDD, LTEATDD
Remote Command	:DISPlay:SEMask:VIEW[:SElect] APFReq RPFReq IPOWer CINformation :DISPlay:SEMask:VIEW[:SElect]?
Example	DISP:SEM:VIEW IPOW DISP:SEM:VIEW?
Notes	You must be in the mode that includes SEM measurement to use this command. Use :INSTrument:SElect to set the mode.
Dependencies	In the SA mode, when "Radio Standard" is set to WLAN, IPOWer is not available and the key is grayed out. CINformation is available only in MSR and LTE-Advanced FDD/TDD mode, otherwise the key is blank.
Presets	SA, , WCDMA, , C2K, , TD-SCDMA, , 1xEVDO, , DTMB (CTTB), , DVB-T/H, , ISDB-T, , CMMB, , LTE, , LTETDD, , Digital Cable TV, , MSR, , LTEAFDD, , LTEATDD: APFReq WIMAX OFDMA, WLAN: RPFReq
State Saved	Saved in instrument state.
Range	Abs Pwr & Freq Rel Pwr & Freq Integrated Power Carrier Info
Initial S/W Revision	Prior to A.02.00
Modified at S/W Revision	A.02.00, A.03.00, A.10.00

Views Selection by Number (Remote Command only)

The following numerical selections determine how the results are displayed:

1. displays the absolute power levels in dBm and the corresponding frequencies in the text window.
2. displays the relative power levels in dBc and the corresponding frequencies in the text window.
3. displays the absolute and relative power levels integrated throughout the bandwidths between the start and stop frequencies in the text window.
4. displays the carrier info table. (Only available in MSR and LTE-Advanced FDD/TDD)

Mode	SA, WCDMA, C2K, WIMAX OFDMA, TD-SCDMA, 1xEVDO, DTMB (CTTB), DVB-T/H, ISDB-T, CMMB, LTE, LTE-TDD, Digital Cable TV, WLAN, MSR, LTEAFDD, LTEATDD
Remote Command	:DISPlay:SEMask:VIEW:NSElect <integer> :DISPlay:SEMask:VIEW:NSElect?
Example	DISP:SEM:VIEW:NSEL 2 DISP:SEM:VIEW:NSEL?
Notes	In the SA mode, when "Radio Standard" is set to WLAN, Option 3 is not available. Option 4 is available only in MSR and LTE-Advanced FDD/TDD mode. You must be in the mode that includes SEM measurement to use this command. Use :INSTrument:SElect to set the mode.
Preset	SA, , WCDMA, , C2K, , TD-SCDMA, , 1xEVDO, , DTMB (CTTB), , DVB-T/H, , ISDB-T, , CMMB, , LTE, , LTE-TDD, , Digital Cable TV, , MSR, , LTEAFDD, , LTEATDD: 1 WIMAX OFDMA, WLAN: 2
State Saved	Saved in instrument state.
Min	1
Max	MSR, LTEAFDD, LTEATDD: 4 Other modes: 3
Initial S/W Revision	Prior to A.02.00
Modified at S/W Revision	A.02.00, A.03.00, A.10.00

Key Path	Front-panel key
Initial S/W Revision	Prior to A.02.00

Display

The Display menu is common to most measurements, and is used for configuring items on the display. Some Display menu settings apply to all the measurements in a mode, and some only to the current measurement. Those under the System Display Settings key apply to all measurements in all modes.

Key Path	Display
-----------------	---------

Key Path	View/Display
Initial S/W Revision	Prior to A.02.00

Annotation

Turns on and off various parts of the display annotation. The annotation is divided up into four categories:

1. Meas Bar: This is the measurement bar at the top of the screen. It does not include the settings panel or the Active Function. Turning off the Meas Bar turns off the settings panel and the Active Function. When the Meas Bar is off, the graticule area expands to fill the area formerly occupied by the Meas Bar.
2. Screen Annotation: this is the annotation and annunciation around the graticule, including any annotation on lines (such as the display line, the threshold line, etc.) This does NOT include the marker number or the N dB result. When off, the graticule expands to fill the entire graticule area.
3. Trace annotation: these are the labels on the traces, showing their detector (or their math mode).
4. Active Function annotation: this is the active function display in the meas bar, and all of the active function values displayed on softkeys.

See the figure below. Each type of annotation can be turned on and off individually.

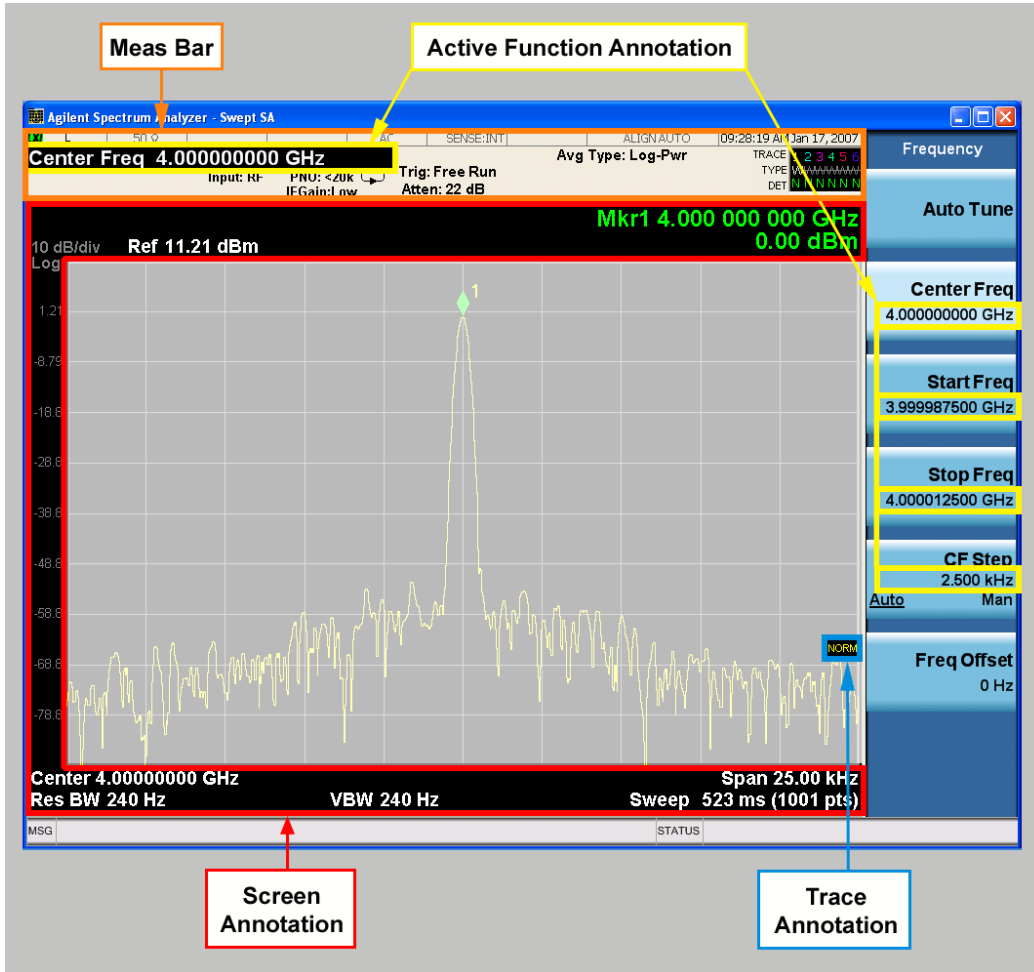

Key Path	View/Display, Display
Initial S/W Revision	Prior to A.02.00

Meas Bar On/Off

This function turns the Measurement Bar on and off, including the settings panel. When off, the graticule area expands to fill the area formerly occupied by the Measurement Bar.

Key Path	View/Display, Display, Annotation
Remote Command	:DISPlay:ANNotation:MBAR[:STATE] OFF ON 0 1 :DISPlay:ANNotation:MBAR[:STATE]?
Example	DISP:ANN:MBAR OFF
Dependencies	Grayed out and forced to OFF when System Display Settings, Annotation is set to Off.
Preset	On This should remain Off through a Preset when System DisplaySettings, Annotation is set to Off.
State Saved	Saved in instrument state.
Initial S/W Revision	Prior to A.02.00

Screen

This controls the display of the annunciation and annotation around the graticule, including any annotation on lines (such as the display line, the threshold line, etc.) and the y-axis annotation. This does NOT include marker annotation (or the N dB result). When off, the graticule expands to fill the entire graticule area, leaving only the 1.5% gap above the graticule as described in the Trace/Detector chapter.

Key Path	View/Display, Display, Annotation
Remote Command	:DISPlay:ANNotation:SCReen[:STATe] OFF ON 0 1 :DISPlay:ANNotation:SCReen[:STATe]?
Example	DISP:ANN:SCR OFF
Dependencies	Grayed-out and forced to OFF when System Display Settings, Annotation is set to Off.
Preset	On This should remain Off through a Preset when System DisplaySettings, Annotation is set to Off
State Saved	Saved in instrument state.
Initial S/W Revision	Prior to A.02.00

Active Function Values On/Off

Turns on and off the active function display in the Meas Bar, and all of the active function values displayed on the softkeys.

Note that all of the softkeys that have active functions have these numeric values blanked when this function is on. This is a security feature..

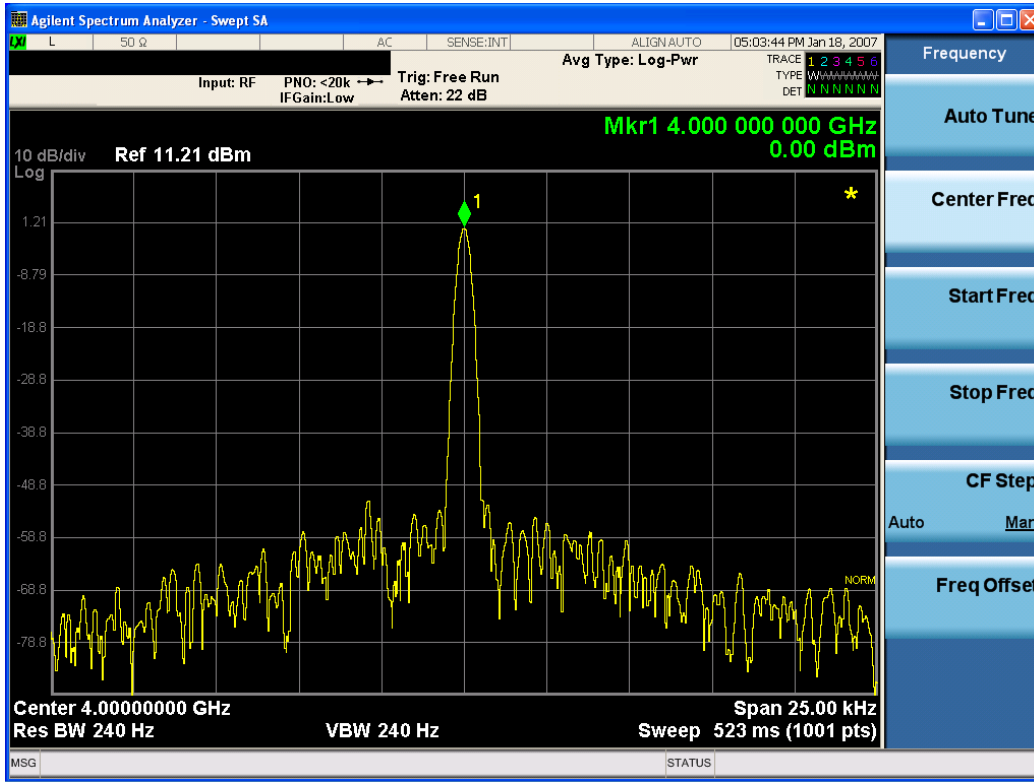

Key Path	View/Display, Display, Annotation
Remote Command	:DISPlay:ACTivefunc[:STATE] ON OFF 1 0 :DISPlay:ACTivefunc[:STATE]?
Example	DISP:ACT OFF
Dependencies	Grayed out and forced to OFF when System Display Settings, Annotation is set to Off.
Preset	On This should remain Off through a Preset when System DisplaySettings, Annotation is set to Off
State Saved	Saved in instrument state.
Initial S/W Revision	Prior to A.02.00

Title

Displays menu keys that enable you to change or clear a title on your display.

Key Path	View/Display, Display
Initial S/W Revision	Prior to A.02.00

Change Title

Writes a title into the "measurement name" field in the banner, for example, "Swept SA".

Press Change Title to enter a new title through the alpha editor. Press Enter or Return to complete the entry. Press ESC to cancel the entry and preserve your existing title.

The display title will replace the measurement name. It remains for this measurement until you press Change Title again, or you recall a state, or a Preset is performed. A title can also be cleared by pressing Title, Clear Title.

NOTE

Notice the inclusion of the <measurement> parameter in the command below. Because each measurement remembers the Display Title, the command must be qualified with the measurement name. For the Swept SA measurement this is not the case; no <measurement> parameter is used when changing the Display Title for the Swept SA measurement.

Key Path	View/Display, Display, Title
Mode	All
Remote Command	:DISPlay:<measurement>:ANNotation:TITLe:DATA <string> :DISPlay:<measurement>:ANNotation:TITLe:DATA?
Example	DISP:ANN:TITL:DATA "This Is My Title" This example is for the Swept SA measurement in the Spectrum Analyzer mode. The SANalyzer <measurement> name is not used. DISP:ACP:ANN:TITL:DATA "This Is My Title" This example is for Measurements other than Swept SA. Both set the title to: This Is My Title
Notes	Pressing this key cancels any active function. When a title is edited the previous title remains intact (it is not cleared) and the cursor goes at the end so that characters can be added or BKSP can be used to go back over previous characters.
Preset	No title (measurement name instead)
State Saved	Saved in instrument state.
Initial S/W Revision	Prior to A.02.00

Clear Title

Clears a title from the front-panel display. Once cleared, the title cannot be retrieved. After the title is cleared, the current Measurement Name replaces it in the title bar.

Key Path	View/Display, Display, Title
Example	The following commands clear the title and restore the measurement's original title: DISP:ANN:TITL:DATA "" This example is for the Swept SA measurement in the Spectrum Analyzer mode. The SANalyzer <measurement> name is not used. DISP:ACP:ANN:TITL:DATA "" This example is for ACP; in measurements other than Swept SA the measurement name is required.
Notes	Uses the :DISPlay:<measurement>:ANNotation:TITLe:DATA <string> command with an empty string (in the Swept SA, the <measurement> is omitted).
Preset	Performed on Preset.
Initial S/W Revision	Prior to A.02.00

Graticule

Pressing Graticule turns the display graticule On or Off. It also turns the graticule y-axis annotation on and off.

Key Path	View/Display, Display
Remote Command	:DISPlay:WINDow[1]:TRACe:GRATicule:GRID[:STATe] OFF ON 0 1 :DISPlay:WINDow[1]:TRACe:GRATicule:GRID[:STATe]?
Example	DISP:WIND:TRAC:GRAT:GRID OFF
Notes	The graticule is the set of horizontal and vertical lines that make up the grid/divisions for the x-axis and y-axis.
Preset	On
State Saved	Saved in instrument state
Initial S/W Revision	Prior to A.02.00

System Display Settings

These settings are "Mode Global" – they affect all modes and measurements and are reset only by Restore Misc Defaults or Restore System Defaults under System.

Key Path	View/Display, Display
Initial S/W Revision	Prior to A.02.00

Annotation Local Settings

This is a Mode Global override of the meas local annotation settings. When it is All Off, it forces ScreenAnnotation, Meas Bar, Trace, and Active Function Values settings to be OFF for all measurements in all modes. This provides the security based "annotation off" function of previous analyzers; hence it uses the legacy SCPI command.

When it is All Off, the Screen, Meas Bar, Trace, and Active Function Values keys under the Display, Annotation menu are grayed out and forced to Off. When Local Settings is selected, you are able to set the local annotation settings on a measurement by measurement basis.

Key Path	View/Display, Display, System Display Settings
Remote Command	:DISPlay:WINDow[1]:ANNOtation[:ALL] OFF ON 0 1 :DISPlay:WINDow[1]:ANNOtation[:ALL]?
Example	:DISP:WIND:ANN OFF
Preset	On (Set by Restore Misc Defaults)
State Saved	Not saved in instrument state.
Backwards Compatibility Notes	The WINDow parameter and optional subopcode is included for backwards compatibility but ignored – all windows are equally affected.
Initial S/W Revision	Prior to A.02.00

Themes

Accesses a menu of functions that enable you to choose the theme to be used when saving the screen image.

The **Themes** option is the same as the **Themes** option under the **Display** and **Page Setup** dialogs. It allows you to choose between themes to be used when saving the screen image.

Key Path	Save, Screen Image
Remote Command	:MMEMory:STORe:SCReen:THEMe TDColor TDMonochrome FCOLor FMONochrome :MMEMory:STORe:SCReen:THEMe?
Example	:MMEM:STOR:SCR:THEM TDM
Preset	3D Color; Is not part of Preset, but is reset by Restore Misc Defaults or Restore System Defaults All and survives subsequent running of the modes.
Readback	3D Color 3D Mono Flat Color Flat Mono
Backwards Compatibility Notes	In ESA and PSA we offer the choice of "Reverse Bitmap" or "Reverse Metafile" when saving screen images. This is much like the "Flat Color" theme available in X-Series. Also, if you selected Reverse Bitmap AND a black & white screen image, that would be much like "Flat Monochrome". In other words, each of the X-Series themes has a similar screen image type in ESA/PSA. But they are not identical.
Initial S/W Revision	Prior to A.02.00

3D Color

Selects a standard color theme with each object filled, shaded and colored as designed.

Key Path	Save, Screen Image, Themes
Example	MMEM:STOR:SCR:THEM TDC
Readback	3D Color
Initial S/W Revision	Prior to A.02.00

3D Monochrome

Selects a format that is like 3D color but shades of gray are used instead of colors.

Key Path	Save, Screen Image, Themes
Example	MMEM:STOR:SCR:THEM TDM
Readback	3D Mono
Initial S/W Revision	Prior to A.02.00

Flat Color

Selects a format that is best when the screen is to be printed on an ink printer.

Key Path	Save, Screen Image, Themes
Example	MMEM:STOR:SCR:THEM FCOL
Readback	Flat Color
Initial S/W Revision	Prior to A.02.00

Flat Monochrome

Selects a format that is like Flat Color. But only black is used (no colors, not even gray), and no fill.

Key Path	Save, Screen Image, Themes
Example	MMEM:STOR:SCR:THEM FMON
Readback	Flat Mono
Initial S/W Revision	Prior to A.02.00

Backlight

Accesses the display backlight on/off keys. This setting may interact with settings under the Windows "Power" menu.

When the backlight is off, pressing ESC, TAB, SPACE, ENTER, UP, DOWN, LEFT, RIGHT, DEL, BKSP, CTRL, or ALT turns the backlight on without affecting the application. Pressing any other key will turn backlight on and could potentially perform the action as well.

Key Path	View/Display, Display, System Display Settings
Remote Command	:DISPlay:BACKlight ON OFF :DISPlay:BACKlight?
Preset	ON (Set by Restore Misc Defaults)
Initial S/W Revision	Prior to A.02.00

Backlight Intensity

An active function used to set the backlight intensity. It goes from 0 to 100 where 100 is full on and 0 is off. This value is independent of the values set under the Backlight on/off key.

Key Path	View/Display, Display, System Display Settings
Remote Command	:DISPlay:BACKlight:INTensity <integer> :DISPlay:BACKlight:INTensity?
Example	DISP:BACK:INT 50

Preset	100 (Set by Restore Misc Defaults)
Min	0
Max	100
Initial S/W Revision	Prior to A.02.00

Abs Pwr Freq

Sets the display to the Absolute Peak Power and Frequency view. The views differ depending on the setting of the measurement type (Meas Type) under the Measurement Setup menu.

"Abs Peak Pwr & Freq (Total Pwr Ref)" on page 1072

"Abs Peak Pwr & Freq (PSD Ref)" on page 1074

"Abs Peak Pwr & Freq (Spectrum Pk Ref)" on page 1076

Abs Peak Pwr & Freq (Total Pwr Ref)

This view consists of the following two windows:

"Trace Window" on page 1074

"Results Window " on page 1074

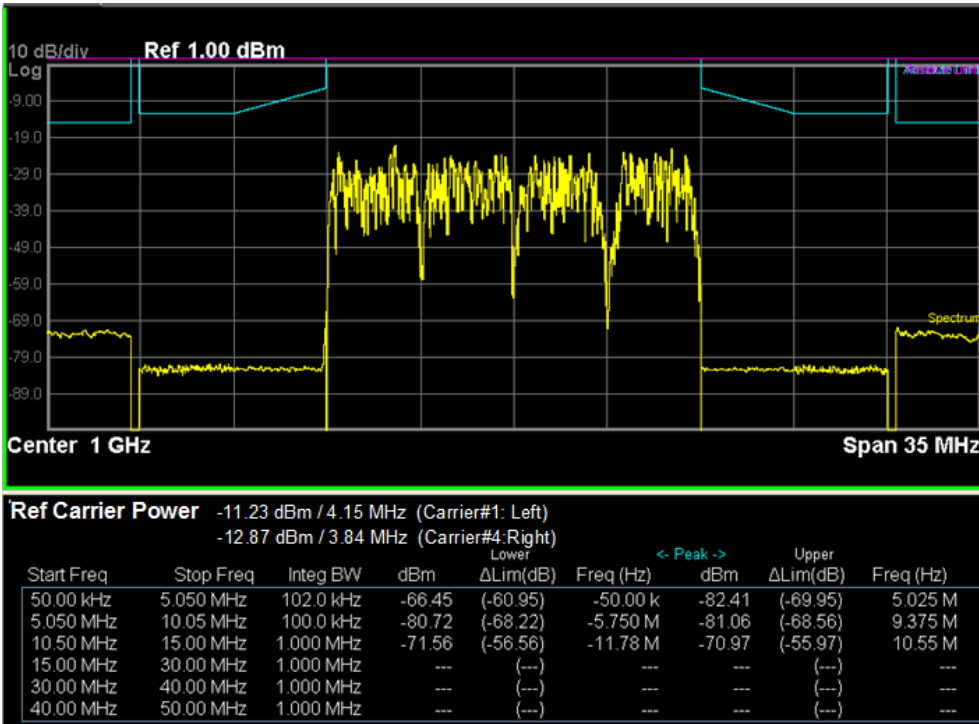
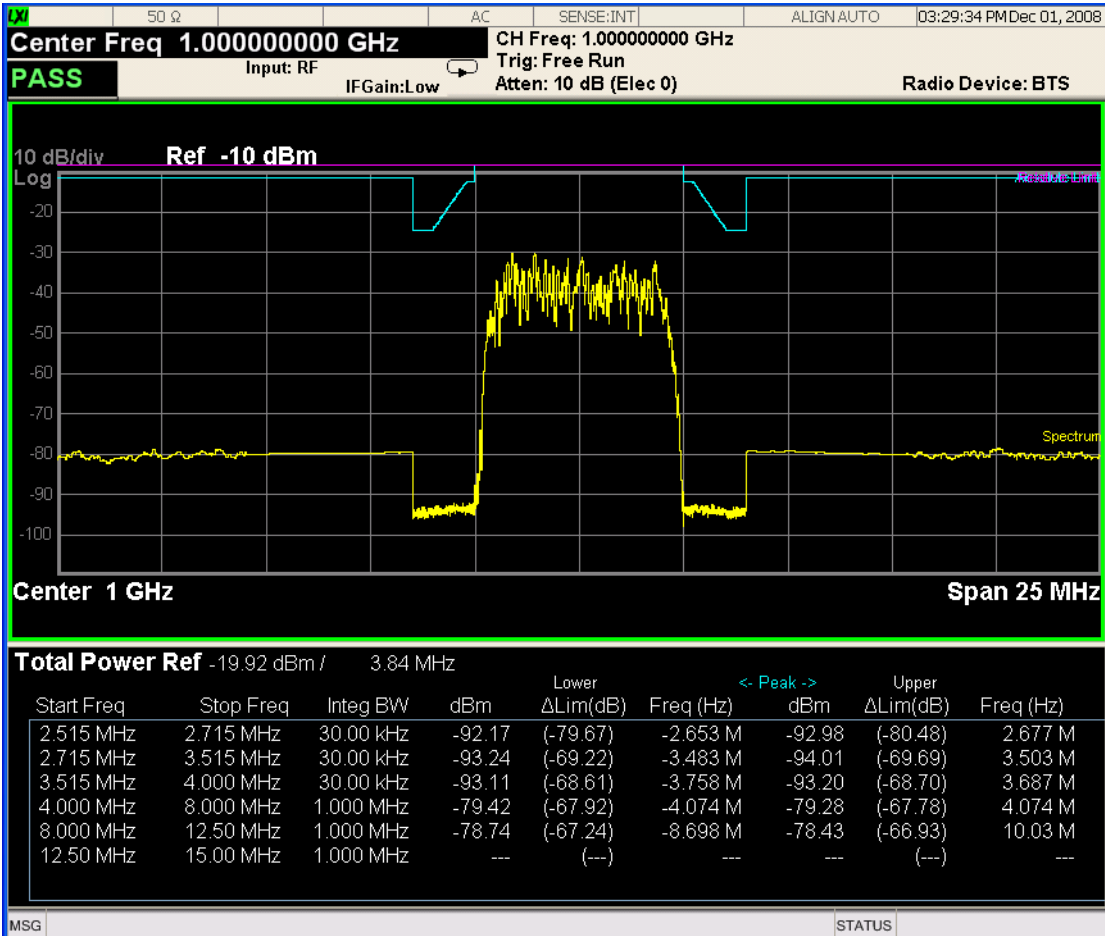

Trace Window

Corresponding Trace	yellow - Combined trace from carrier and each offset
---------------------	--

Results Window

Name	Corresponding Results
Total Pwr Ref	n=1 2nd element Absolute power at the reference area. Channel Integration Bandwidth
Start (Hz)	Start frequency for offset
Stop (Hz)	Stop frequency for offset
Meas BW (Hz)	Measurement bandwidth for offset
Lower Peak (dBm)	Absolute peak power on minimum margin point of the negative offset
Lower Δ lim (dB)	Minimum margin from limit line which is decided by Fail Mask setting on the negative offset
Lower Freq (Hz)	Frequency on minimum margin point of the negative offset
Upper Peak (dBm)	Absolute peak power on minimum margin point of the positive offset
Upper Δ lim (dB)	Minimum margin from limit line which is decided by Fail Mask setting on the positive offset
Upper Freq (Hz)	Frequency on minimum margin point of the positive offset

Abs Peak Pwr & Freq (PSD Ref)

This view consists of the following two windows:

["Trace Window" on page 1076](#)

["Results Window " on page 1076](#)

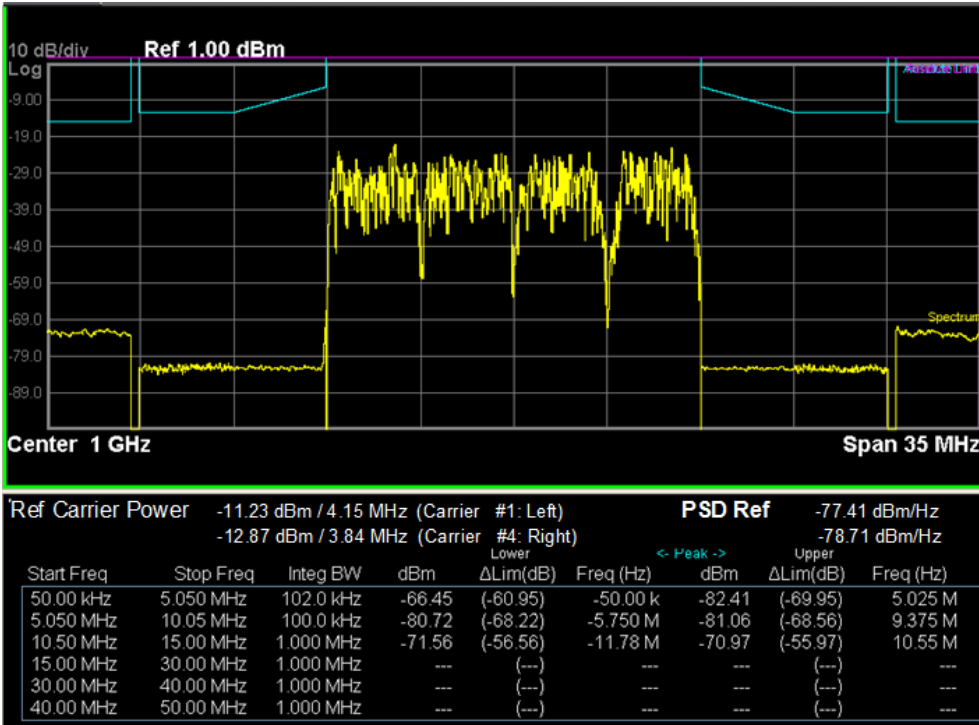
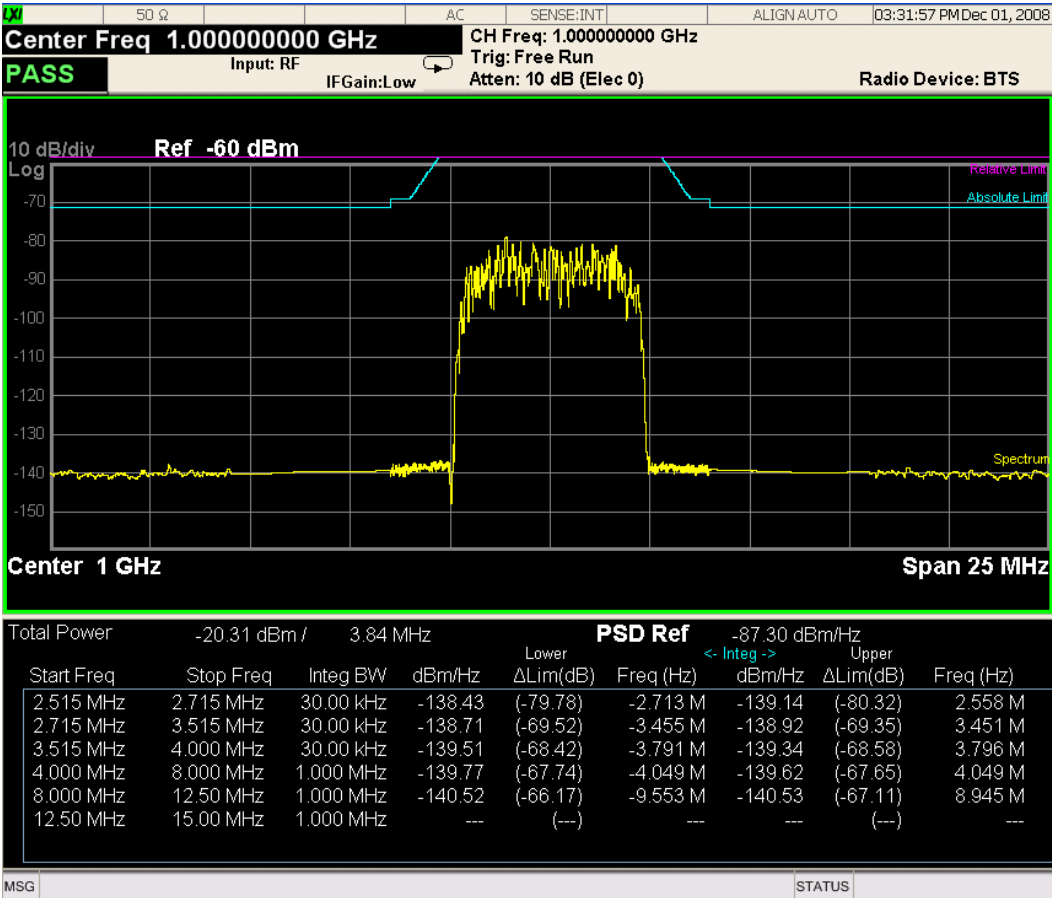

Trace Window

Corresponding Trace	yellow - Combined trace from carrier and each offset
---------------------	--

Results Window

Name	Corresponding Results
Total Pwr	n=1 2nd element Absolute power at the reference area. Channel Integration Bandwidth
PSD Ref	n=5 1st element Power spectral density reference at the reference area
Start (Hz)	Start frequency for offset
Stop (Hz)	Stop frequency for offset
Meas BW (Hz)	Measurement bandwidth for offset
Lower (dBm/Hz)	Absolute power spectrum density of the negative offset
Lower Δ lim (dB)	Minimum margin from limit line which is decided by Fail Mask setting on the negative offset
Lower Freq (Hz)	Frequency on minimum margin point of the negative offset
Upper (dBm/Hz)	Absolute power spectrum density of the positive offset
Upper Δ lim (dB)	Minimum margin from limit line which is decided by Fail Mask setting on the positive offset
Upper Freq (Hz)	Frequency on minimum margin point of the positive offset

Abs Peak Pwr & Freq (Spectrum Pk Ref)

This view consists of the following two windows:

["Trace Window" on page 1076](#)

["Results Window " on page 1076](#)

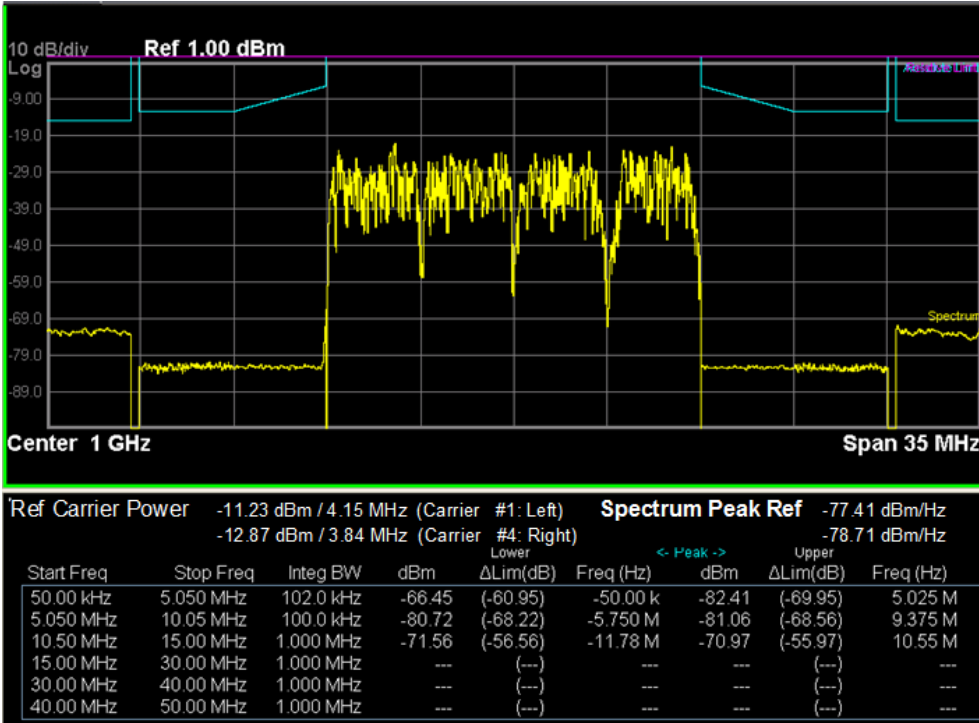
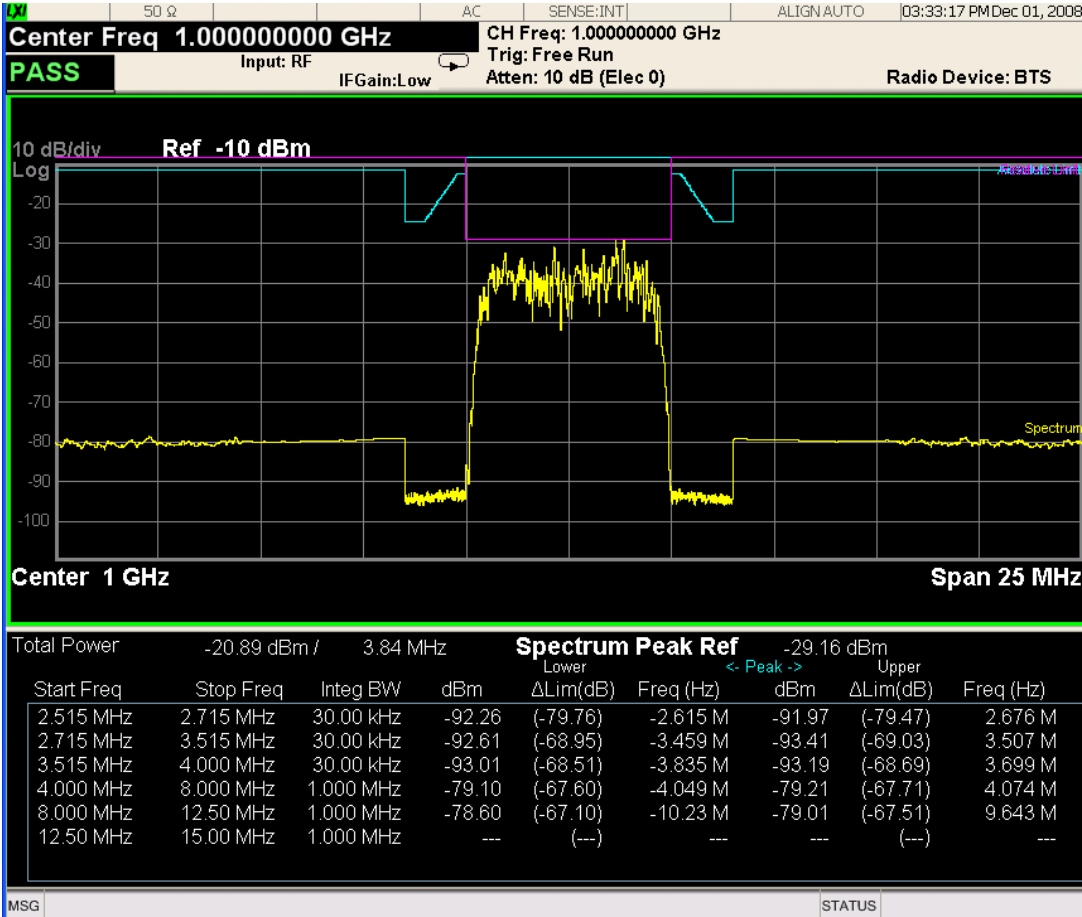

Trace Window

Corresponding Trace	yellow - Combined trace from carrier and each offset
---------------------	--

Results Window

Name	Corresponding Results
Total Pwr	Absolute power at the reference area. Channel Integration Bandwidth
Spectrum Peak Ref	n=5 1st element Spectrum peak power reference at the reference area
Start (Hz)	Start frequency for offset
Stop (Hz)	Stop frequency for offset
Meas BW (Hz)	Measurement bandwidth for offset
Lower(dBm)	Absolute peak power on minimum margin point of the negative offset
Lower Δ lim (dB)	Minimum margin from limit line which is decided by Fail Mask setting on the negative offset
Lower Freq (Hz)	Frequency on minimum margin point of the negative offset
Upper (dBm)	Absolute peak power on minimum margin point of the positive offset
Upper Δ lim (dB)	Minimum margin from limit line which is decided by Fail Mask setting on the positive offset
Upper Freq (Hz)	Frequency on minimum margin point of the positive offset

Key Path	View/Display
Initial S/W Revision	Prior to A.02.00

Rel Pwr Freq

Sets the display to the Relative Peak Power and Frequency view. The views differ depending on the setting of the measurement type (Meas Type) under the Measurement Setup menu.

"Rel Peak Pwr & Freq (Total Pwr Ref)" on page 1078

"Rel Peak Pwr & Freq (PSD Ref)" on page 1080

"Rel Peak Pwr & Freq (Spectrum Pk Ref)" on page 1081

Rel Peak Pwr & Freq (Total Pwr Ref)

This view consists of the following two windows:

"Trace Window" on page 1079

"Results Window" on page 1079

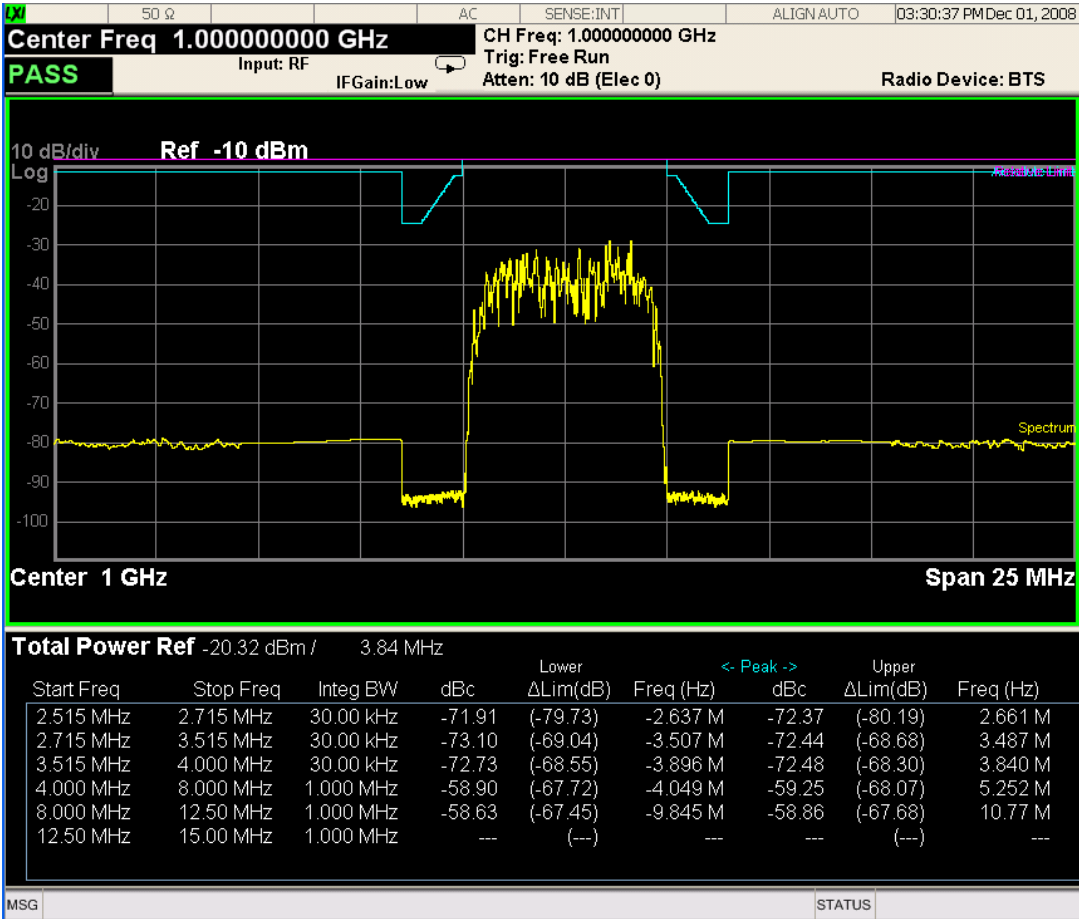

Trace Window

Corresponding Trace	yellow - Combined trace from carrier and each offset
---------------------	--

Results Window

Name	Corresponding Results
Total Pwr Ref	n=1 2nd element Absolute power at the reference area.
	Channel Integration Bandwidth
Start (Hz)	Start frequency for offset
Stop (Hz)	Stop frequency for offset
Meas BW (Hz)	Measurement bandwidth for offset
Lower Peak (dBc)	Relative peak power on minimum margin point of the negative offset
Lower ΔLim (dB)	Minimum margin from limit line which is decided by Fail Mask setting on the negative offset

Name	Corresponding Results
Lower Freq (Hz)	Frequency on minimum margin point of the negative offset
Upper Peak (dBc)	Relative peak power on minimum margin point of the positive offset
Upper ΔLim (dB)	Minimum margin from limit line which is decided by Fail Mask setting on the positive offset
Upper Freq (Hz)	Frequency on minimum margin point of the positive offset

Rel Peak Pwr & Freq (PSD Ref)

This view consists of the following two windows:

"Trace Window" on page 1080

"Results Window" on page 1081

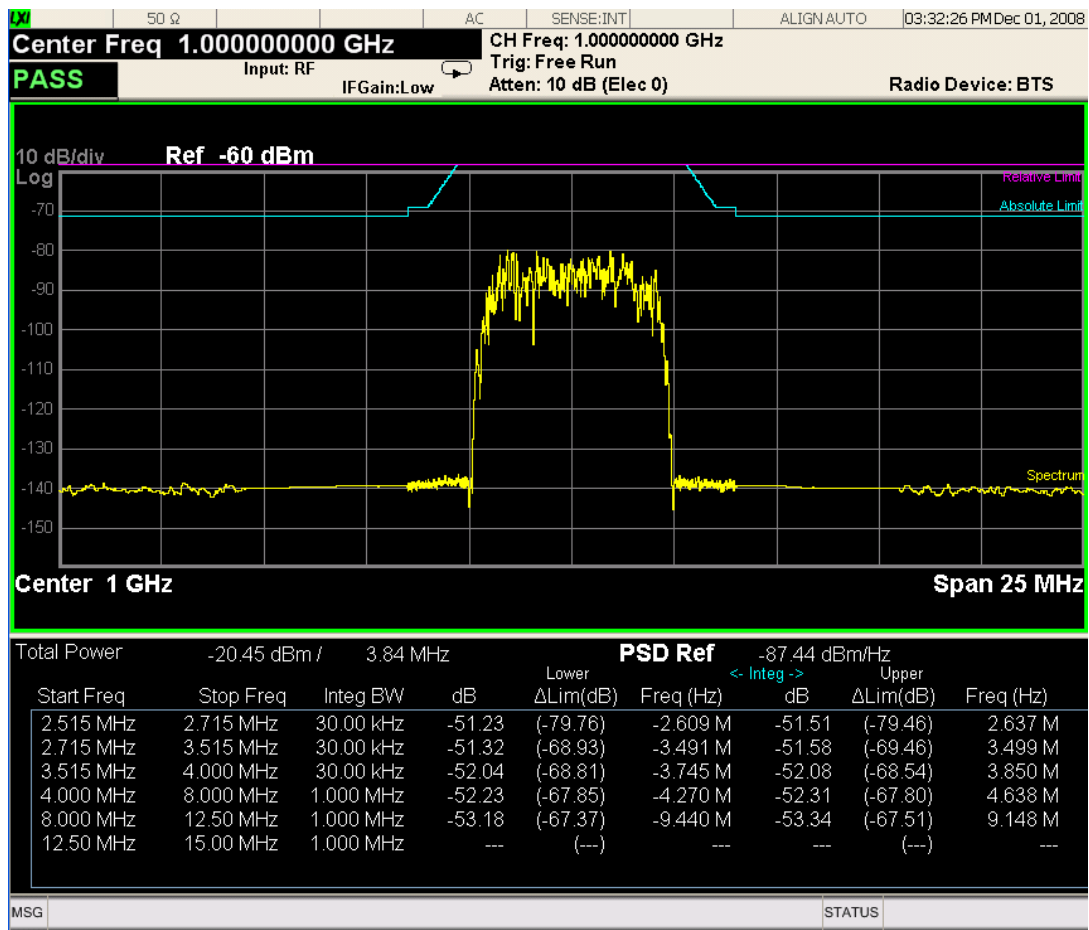

Trace Window

Corresponding Trace	yellow - Combined trace from carrier and each offset
---------------------	--

Results Window

Name	Corresponding Results
Total Pwr	n=1 2nd element Absolute power at the reference area.
	Channel Integration Bandwidth
PSD Ref	n=5 1st element Power spectral density reference at the reference area
Start (Hz)	Start frequency for offset
Stop (Hz)	Stop frequency for offset
Meas BW (Hz)	Measurement bandwidth for offset
Lower (dB)	Relative power spectrum density of the negative offset
Lower ΔLim (dB)	Minimum margin from limit line which is decided by Fail Mask setting on the negative offset
Lower Freq (Hz)	Frequency on minimum margin point of the negative offset
Upper (dB)	Relative power spectrum density of the positive offset
Upper ΔLim (dB)	Minimum margin from limit line which is decided by Fail Mask setting on the positive offset
Upper Freq (Hz)	Frequency on minimum margin point of the positive offset

Rel Peak Pwr & Freq (Spectrum Pk Ref)

This view consists of the following two windows:

"Trace Window" on page 1079

"Results Window" on page 1079

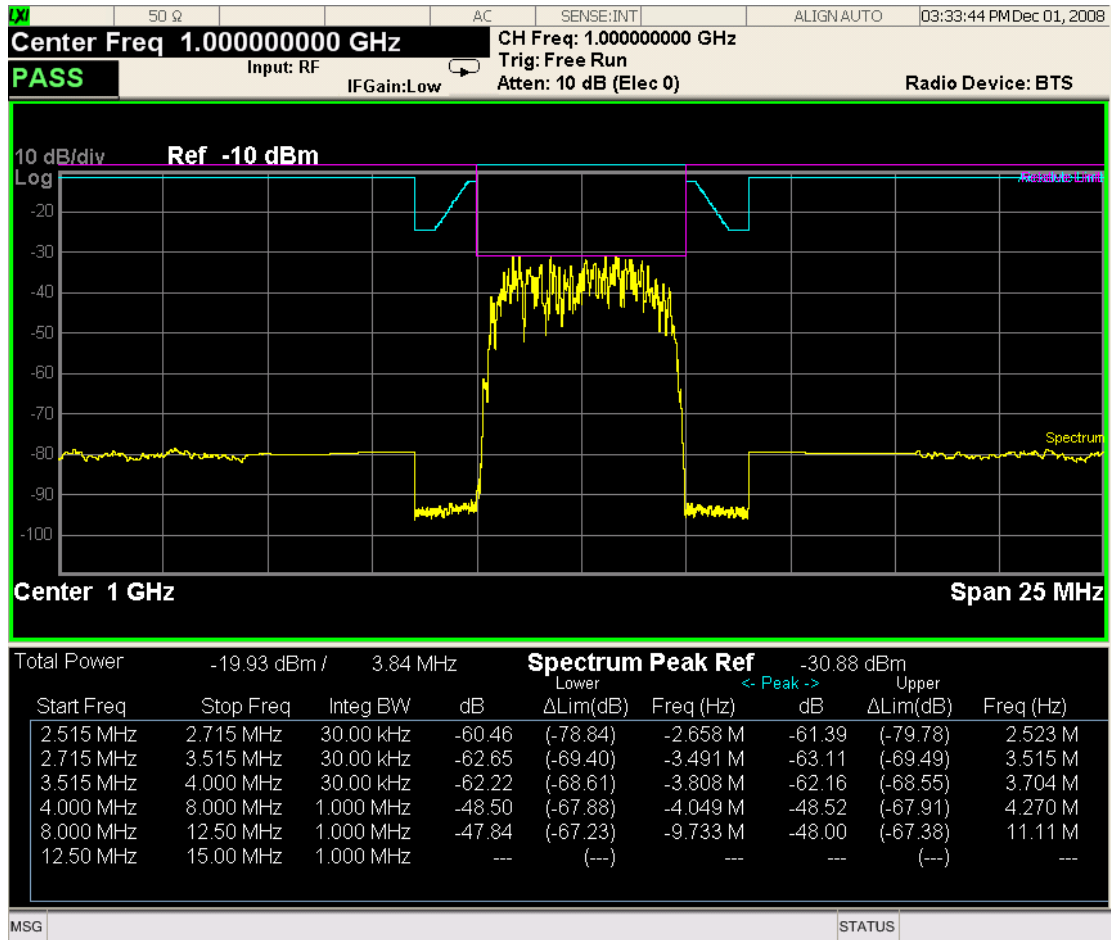

Trace Window

Corresponding Trace	yellow - Combined trace from carrier and each offset
---------------------	--

Results Window

Name	Corresponding Results
Total Pwr	Absolute power at the reference area.
	Channel Integration Bandwidth
Spectrum Peak Ref	n=5 1st element Spectrum peak power reference at the reference area
Start (Hz)	Start frequency for offset
Stop (Hz)	Stop frequency for offset
Meas BW (Hz)	Measurement bandwidth for offset
Lower Peak (dB)	Relative peak power on minimum margin point of the negative offset
Lower ΔLim (dB)	Minimum margin from limit line which is decided by Fail Mask setting

Name	Corresponding Results
	on the negative offset
Lower Freq (Hz)	Frequency on minimum margin point of the negative offset
Upper Peak (dB)	Relative peak power on minimum margin point of the positive offset
Upper Δ Lim (dB)	Minimum margin from limit line which is decided by Fail Mask setting on the positive offset
Upper Freq (Hz)	Frequency on minimum margin point of the positive offset

Key Path	View/Display
Initial S/W Revision	Prior to A.02.00

Integrated Power

Sets the display to the Integrated Power view. The views differ depending on the setting of the measurement type (Meas Type) under the Measurement Setup menu.

"Integrated Power (Total Pwr Ref)" on page 1083

"Integrated Power (PSD Ref)" on page 1086

"Integrated Power (Spectrum Pk Ref)" on page 1089

Integrated Power (Total Pwr Ref)

"Trace Window" on page 1085

"Results Window" on page 1085

10 Spectrum Emission Mask Measurement
View/Display

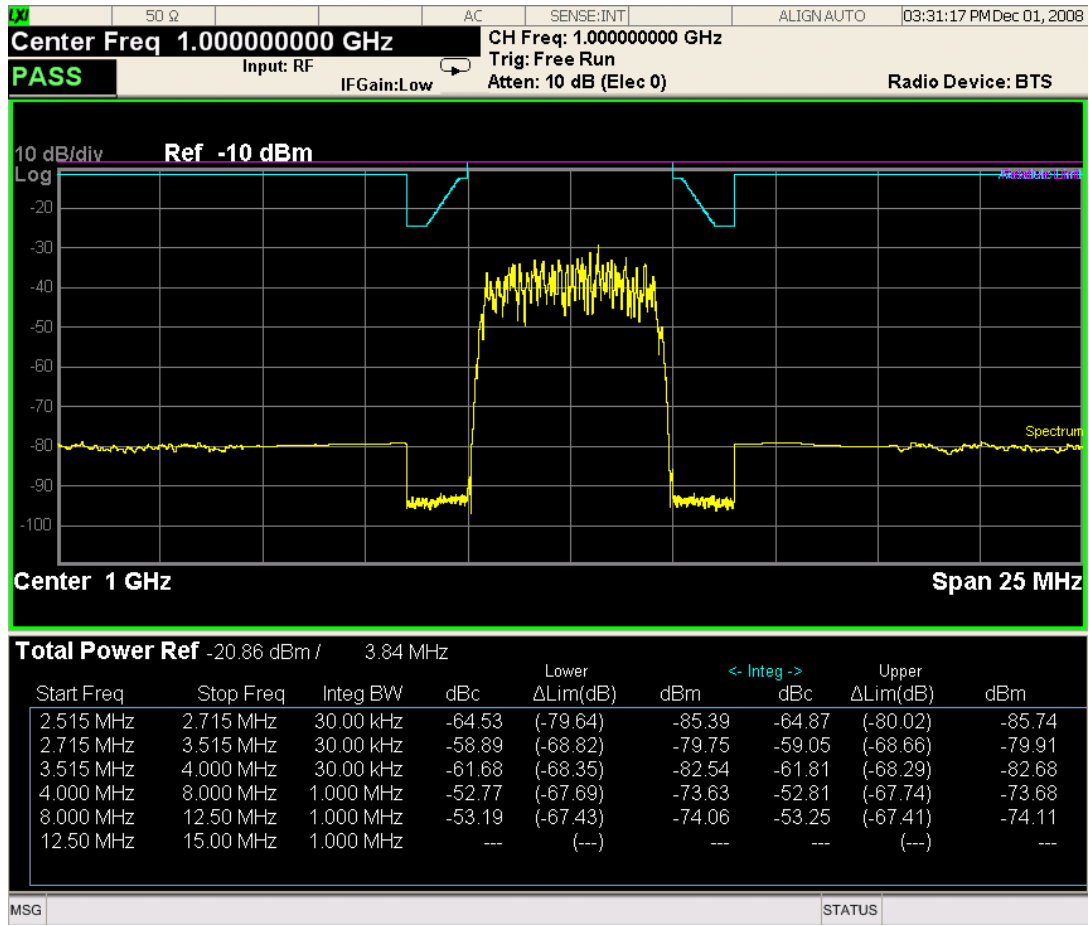

For WLAN 802.11ac (80 + 80 MHz), power readouts of both of the carriers are displayed in the lower result window.

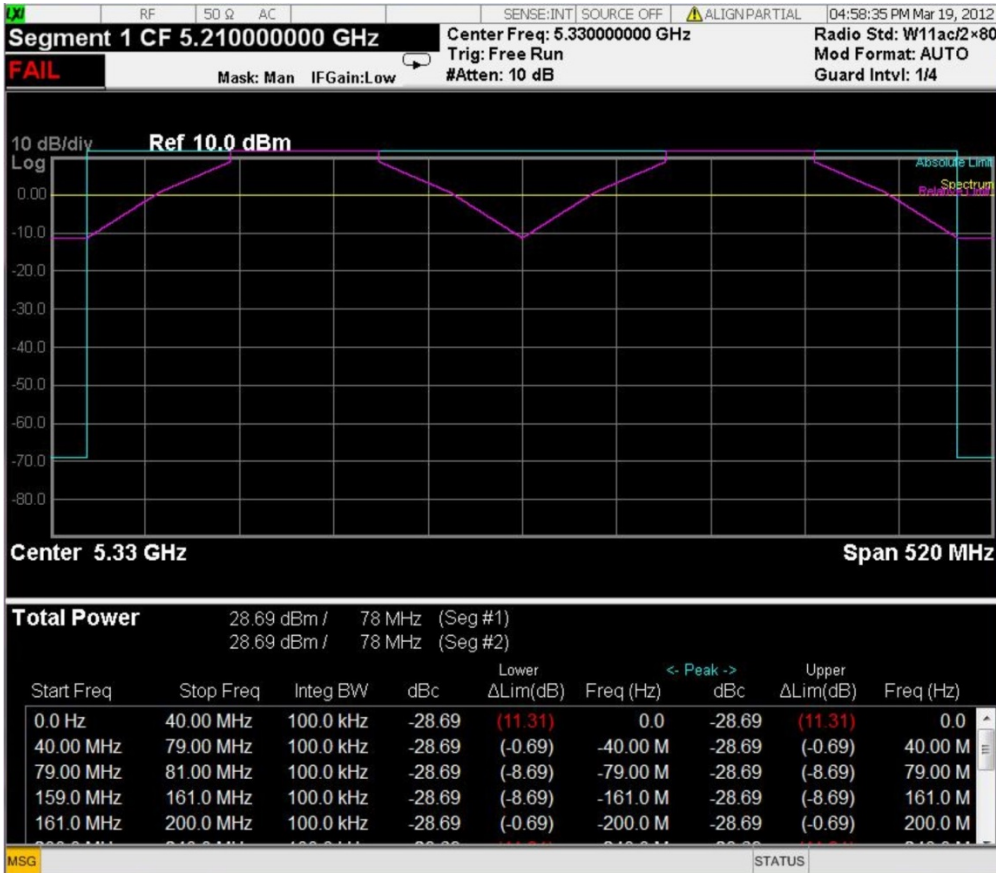

Trace Window

Corresponding Trace yellow - Combined trace from carrier and each offset

Results Window

Name	Corresponding Results
Total Pwr Ref	n=1 2nd element Absolute power at the reference area.
	Channel Integration Bandwidth
Start (Hz)	Start frequency for offset
Stop (Hz)	Stop frequency for offset
Meas BW (Hz)	Measurement bandwidth for offset
Lower Integ (dBc)	Relative integrated power on the negative offset
Lower ΔLim (dB)	Minimum margin from limit line which is decided by Fail Mask setting on the negative offset
Lower Integ (dBm)	Absolute integrated power on the negative offset

Name	Corresponding Results
Upper Integ (dBc)	Relative integrated power on the positive offset
Upper ΔLim (dB)	Minimum margin from limit line which is decided by Fail Mask setting on the positive offset
Upper Integ (dBm)	Absolute integrated power on the positive offset

Integrated Power (PSD Ref)

"Trace Window" on page 1088

"Results Window" on page 1088

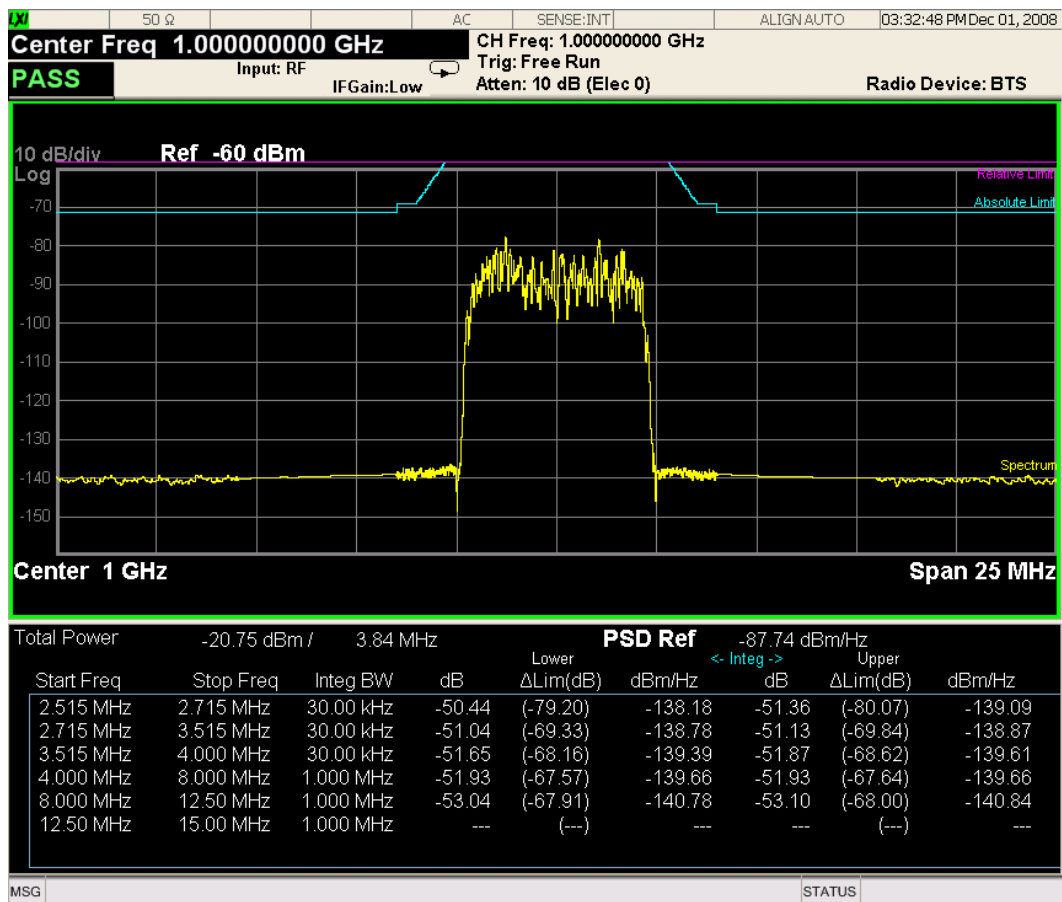

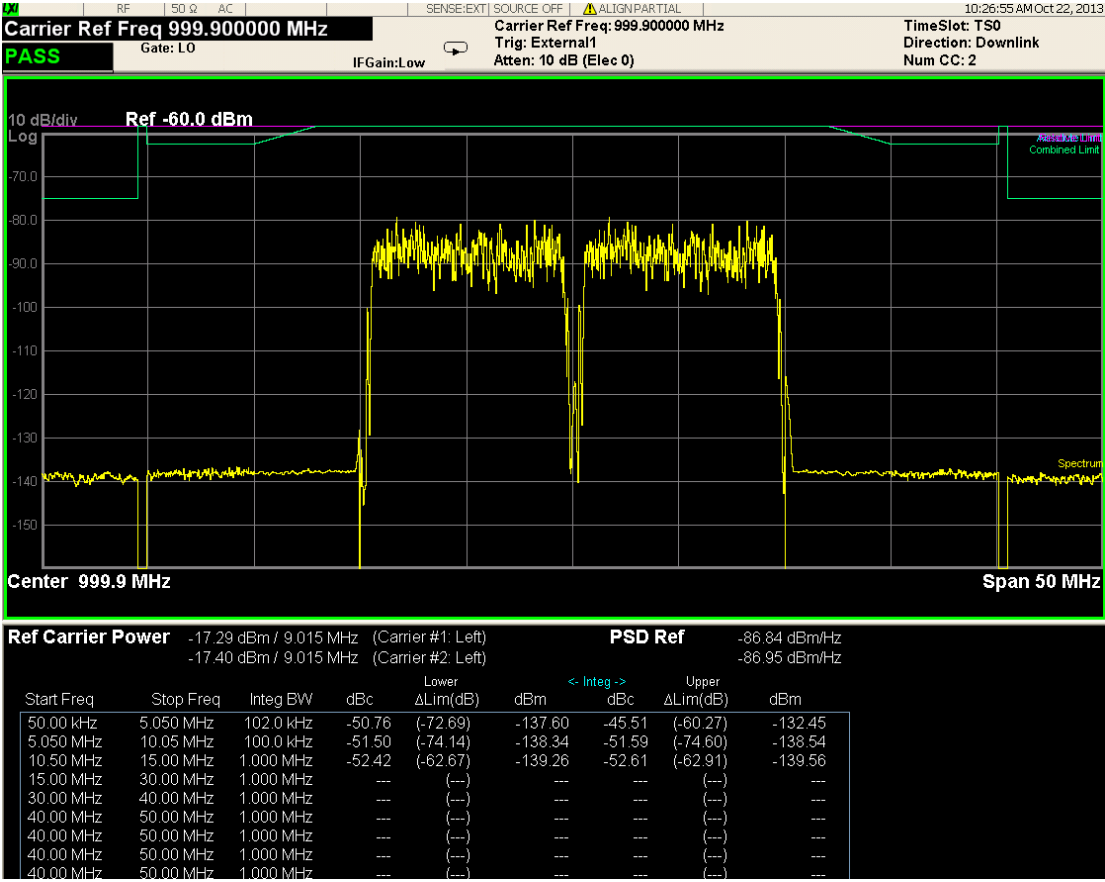

For WLAN 802.11ac (80 + 80 MHz), power readouts of both of the carriers are displayed in the lower result window.

10 Spectrum Emission Mask Measurement
View/Display

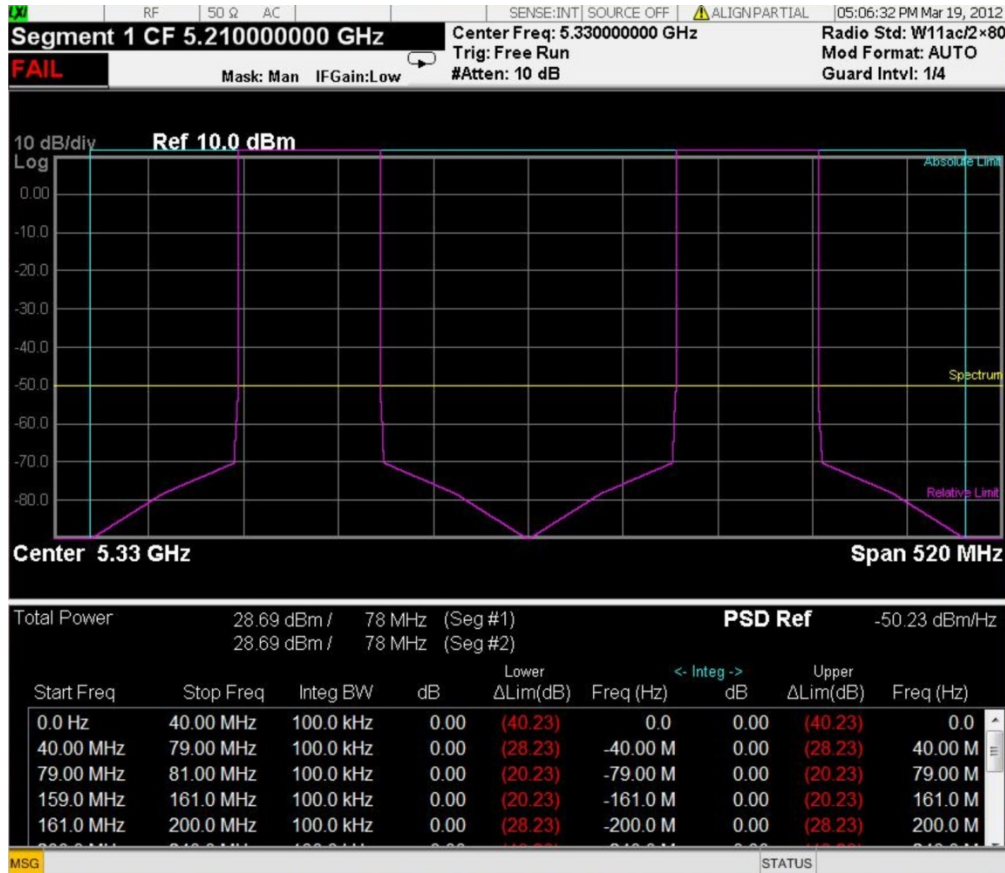

Trace Window

Corresponding Trace yellow - Combined trace from carrier and each offset

Results Window

Name	Corresponding Results
Total Pwr	n=1 2nd element Absolute power at the reference area.
	Channel Integration Bandwidth
PSD Ref	n=5 1st element Power spectral density reference at the reference area
Start (Hz)	Start frequency for offset
Stop (Hz)	Stop frequency for offset
Meas BW (Hz)	Measurement bandwidth for offset
Lower (dB)	Relative power spectrum density of the negative offset
Lower ΔLim (dB)	Minimum margin from limit line which is decided by Fail Mask setting on the negative offset

Name	Corresponding Results
Lower (dBm/Hz)	Absolute power spectrum density of the negative offset
Upper (dB)	Relative power spectrum density of the positive offset
Upper ΔLim (dB)	Minimum margin from limit line which is decided by Fail Mask setting on the positive offset
Upper (dBm/Hz)	Absolute power spectrum density of the negative offset

Integrated Power (Spectrum Pk Ref)

"Trace Window" on page 1085

"Results Window" on page 1085

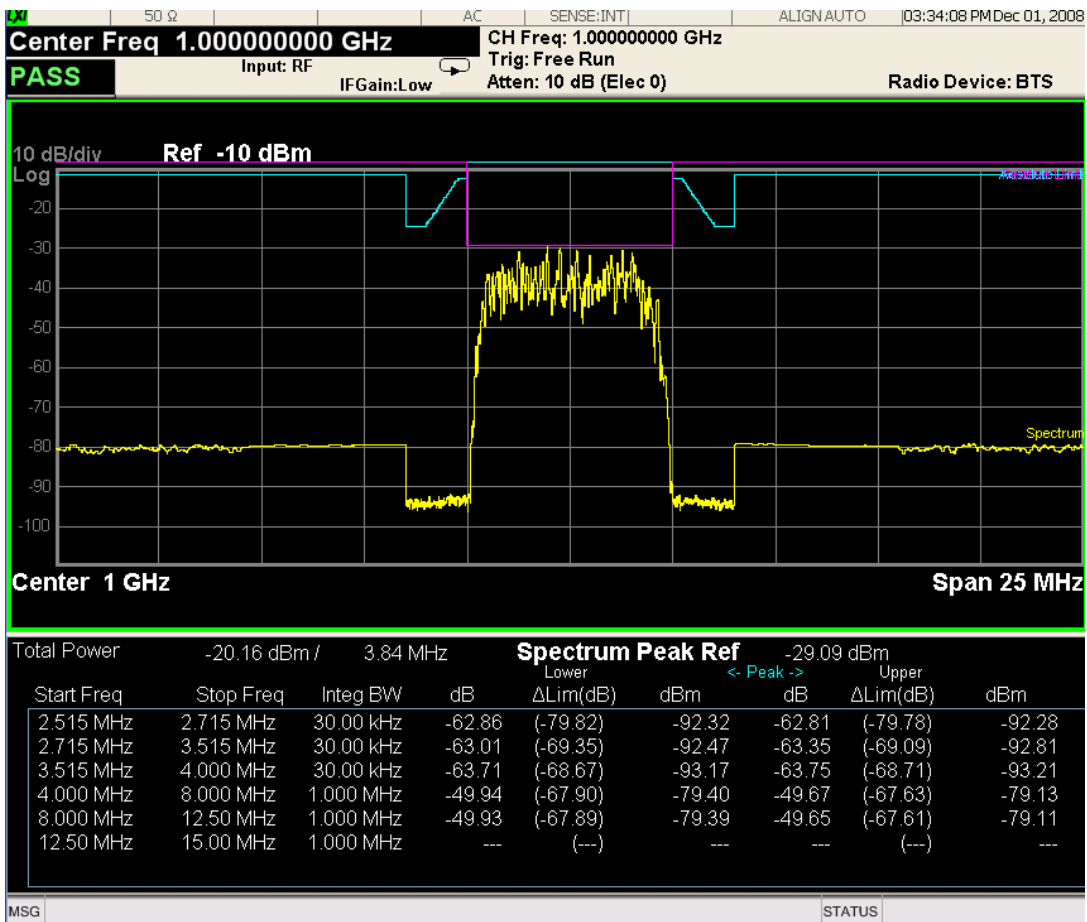

For WLAN 802.11 ac (80 + 80 MHz), power readouts of both of the carriers are displayed in the lower result window.

10 Spectrum Emission Mask Measurement
View/Display

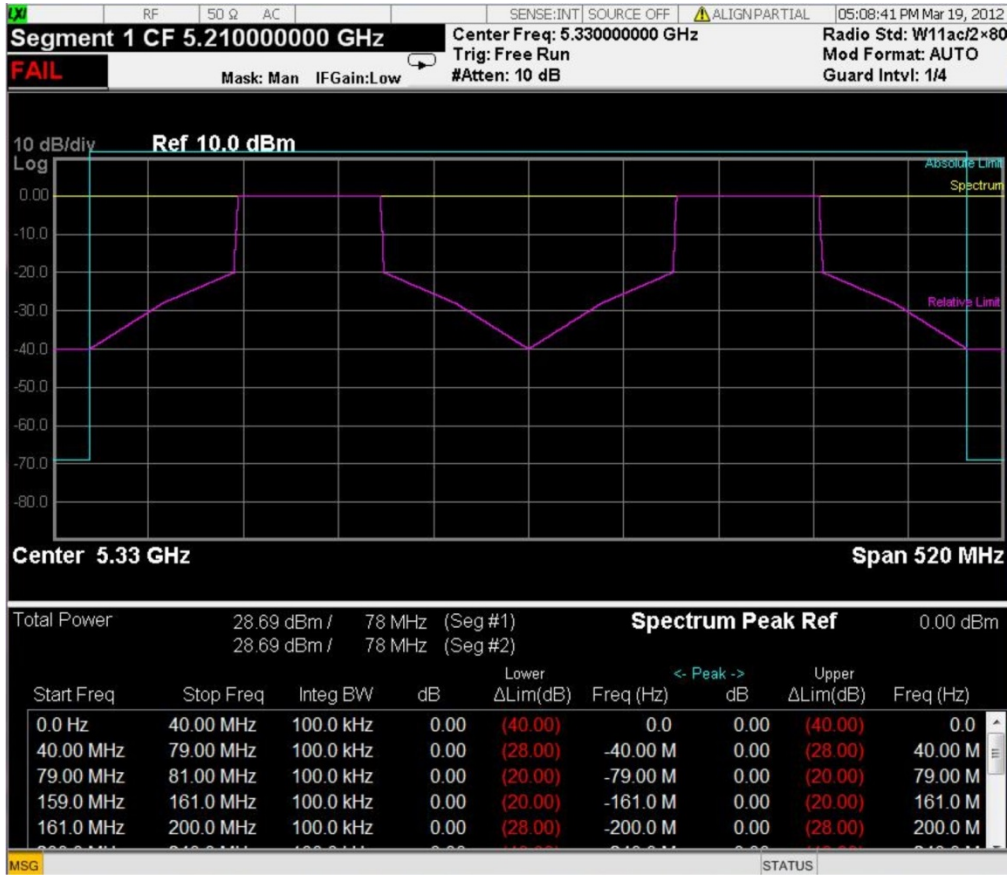

Trace Window

Corresponding Trace yellow - Combined trace from carrier and each offset

Results Window

Name	Corresponding Results
Total Pwr	Absolute power at the reference area.
	Channel Integration Bandwidth
Spectrum Peak Ref	n=5 1st element Peak power at the reference area
Start (Hz)	Start frequency for offset
Stop (Hz)	Stop frequency for offset
Meas BW (Hz)	Measurement bandwidth for offset
Lower Peak (dB)	Relative peak power on minimum margin point of the negative offset
Lower Δlim (dB)	Minimum margin from limit line which is decided by Fail Mask setting on the negative offset

Name	Corresponding Results
Lower Peak (dBm)	Absolute peak power on minimum margin point of the negative offset
Upper Peak (dB)	Relative peak power on minimum margin point of the positive offset
Upper Δlim (dB)	Minimum margin from limit line which is decided by Fail Mask setting on the positive offset
Upper Peak (dBm)	Absolute peak power on minimum margin point of the positive offset

Key Path	View/Display
Initial S/W Revision	Prior to A.02.00

Limit Lines

Toggles the limit lines display function for the spectrum emission mask measurements On and Off.

Key Path	View/Display
Mode	SA, WCDMA, C2K, WIMAX OFDMA, TD-SCDMA, 1xEVDO, DTMB (CTTB), DVB-T/H, ISDB-T, CMMB, LTE, LTE-TDD, Digital Cable TV, WLAN, MSR, LTEAFDD, LTEATDD
Remote Command	:CALCulate:SEMask:LLINE:STATE ON OFF 1 0 :CALCulate:SEMask:LLINE:STATE?
Example	CALC:SEM:LLIN:STAT OFF CALC:SEM:LLIN:STAT?
Notes	You must be in the mode that includes SEM measurement to use this command. Use :INSTrument:SElect to set the mode.
Preset	ON
State Saved	Saved in instrument state.
Range	On Off
Initial S/W Revision	Prior to A.02.00
Modified at S/W Revision	A.02.00, A.03.00

11 Spurious Emissions Measurement

The Spurious Emissions measurement identifies and determines the power level of spurious emissions in certain frequency bands. For measurement results and views, see ["View/Display" on page 1260](#).

This topic contains the following sections:

["Measurement Commands for Spurious Emissions" on page 1094](#)

["Remote Command Results for Spurious Emissions Measurement" on page 1095](#)

Measurement Commands for Spurious Emissions

The following commands can be used to retrieve the measurement results:

`:CONFigure:SPURious`

`:CONFigure:SPURious:NDEFault`

`:INITiate:SPURious`

`:FETCh:SPURious [n]?`

`:READ:SPURious [n]?`

`:MEASure:SPURious [n]?`

For more measurement related commands, see the SENSE subsystem, and the section "[Remote Measurement Functions](#)" on page 2205.

Remote Command Results for Spurious Emissions Measurement

The following table describes the results returned by the FETCh, MEASure, and READ queries listed above, according to the index value n. Note that the queries are not available when viewing the Range Table.

n	Return Value
1 (or not supplied)	Returns a variable-length (1+6*Spurs – up to 1201 entries) comma separated list containing detailed information in the following format: 1. Number of spurs in following list (Integer) 2.[Repeat the following for each spur] a.Spur # b.Range # Spur was located (Integer) c.Frequency of Spur (Hz, Float64) d.Amplitude of Spur (dBm, Float32) e.Absolute Limit (dBm, Float32) f.Pass or Fail (1 0, Boolean)
2 – 21	Returns a comma separated list of the trace data for the selected range (where range number = n – 1) using Detector 1. If selected range is not active SCPI_NAN is returned for each trace data element where SCPI_NAN = 9.91E37.
22	Returns the number of spurs found.
23 – 42	Returns a comma separated list of the trace data for the selected range (where range number = n – 22) using Detector 2. If selected range is not active or Detector 2 selection is off, SCPI_NAN is returned for each trace data element where SCPI_NAN = 9.91E37.
Key Path	Meas
Initial S/W Revision	Prior to A.02.00

AMPTD Y Scale

AMPTD Y Scale opens a menu of functions that enable you to modify the Amplitude parameters.

Key Path	Front-panel key
Initial S/W Revision	Prior to A.02.00

Ref Value

Sets the value for the absolute power reference. When Auto Scaling for the Y-axis is off, the measurement uses the current reference level settings. When Auto Scaling for the Y-axis is on, the analyzer will set the reference level such that the absolute limit will be positioned two divisions down from the top of the display.

Key Path	AMPTD Y Scale
Mode	SA, WCDMA, WIMAX OFDMA, TD-SCDMA,C2k, 1xEV-DO, DVB-T/H, LTE, LTETDD, WLAN, MSR, LTEAFDD, LTEATDD
Remote Command	:DISPlay:SPURious:VIEW[1]:WINDow[1]:TRACe:Y[:SCALE]:RLEVel < real> :DISPlay:SPURious:VIEW[1]:WINDow[1]:TRACe:Y[:SCALE]:RLEVel?
Example	DISP:SPUR:VIEW:WIND:TRAC:Y:RLEV -50 dBm DISP:SPUR:VIEW:WIND:TRAC:Y:RLEV?
Notes	You must be in the Spectrum Analysis mode, W-CDMA mode, cdma2000 mode, DVB-T/H mode, TD-SCDMA mode, LTE mode, LTETDD mode, WLAN mode, MSR, LTE-Advanced FDD/TDD mode or WiMAX mode to use this command. Use INSTRument:SElect to set the mode.
Couplings	When the Y Auto Scaling is off, the measurement uses the current reference level settings. When the Y Auto Scaling is on, the analyzer automatically sets the reference level such that the absolute limit is positioned two divisions down from the top of the display. This is the most useful setting when searching for spurs. The algorithm used for determining the ref level is Ref Level = Absolute Limit + (2 * Scale/Div). All other reference level settings are left as the current base instrument settings.
Preset	0.00 dBm
State Saved	Saved in instrument state.
Min	-250.0 dBm
Max	250.0 dBm
Initial S/W Revision	Prior to A.02.00
Modified at S/W Revision	A.03.00

Attenuation

This menu controls the attenuator functions and interactions between the attenuation system components.

There are two attenuator configurations in the X-Series. One is a dual attenuator configuration consisting of a mechanical attenuator and an optional electronic attenuator. The other configuration uses a single

attenuator with combined mechanical and electronic sections that controls all the attenuation functions. Different models in the X-Series come with different configurations.

See ["Dual Attenuator Configurations:" on page 1097](#)

See ["Single Attenuator Configuration:" on page 1098](#)

Most Attenuation settings are the same for all measurements – they do not change as you change measurements. Settings like these are called “Meas Global” and are unaffected by Meas Preset.

Key Path	AMPTD Y Scale
Scope	Meas Global
Dependencies	In measurements that support the I/Q inputs, this key is unavailable when I/Q is the selected input, and is replaced by the Range key in that case.
Readback Line	Contains a summary in [] brackets of the current total attenuation. See the descriptions of the , " (Mech) Atten " on page 2141, and " Enable Elec Atten " on page 2143 keys for more detail on the contributors to the total attenuation. Note that when "Pre-Adjust for Min Clip" is on, this value can change at the start of every measurement.
Initial S/W Revision	Prior to A.02.00
Modified at S/W Revision	A.03.00

Dual Attenuator Configurations:

Configuration 1: Mechanical attenuator + optional electronic attenuator

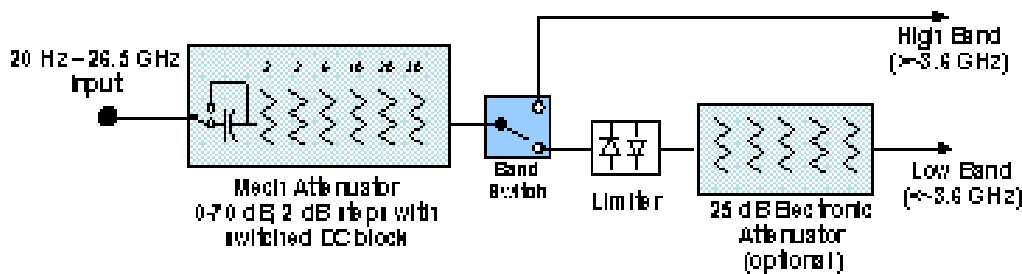

Configuration 2: Mechanical attenuator, no optional electronic attenuator

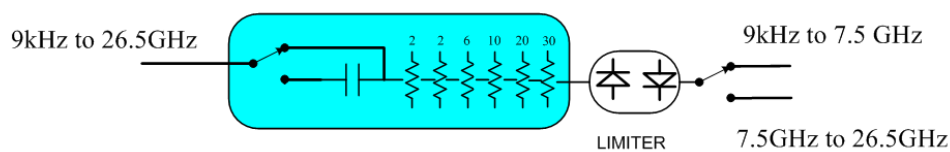

(note that Configuration 2 is not strictly speaking a dual-section attenuator, since there is no electronic section available. However, it behaves exactly like Configuration 1 without the Electronic Attenuator option EA3, therefore for the sake of this document it is grouped into the “Dual Attenuator” configuration)

Single Attenuator Configuration:

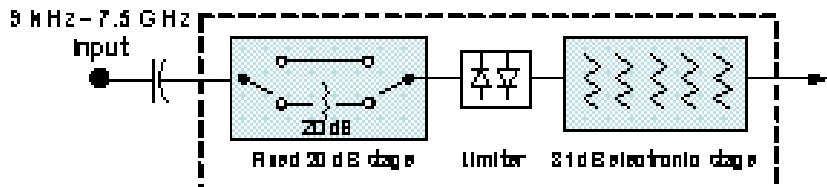

You can tell which attenuator configuration you have by pressing the Attenuation key, which (in most Modes) opens the Attenuation menu. If the first key in the Attenuation menu says Mech Atten you have the dual attenuator configuration. If the first key says Atten you have the single attenuator configuration.

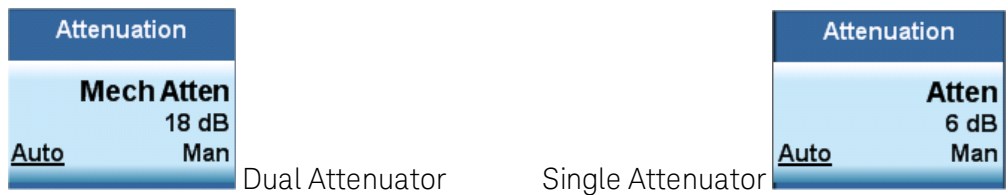

In the single attenuator configuration, you control the attenuation with a single control, as the fixed stage has only two states. In the dual attenuator configuration, both stages have significant range so you are given separate control of the mechanical and electronic attenuator stages.

When you have the dual attenuator configuration, you may still have only a single attenuator, because unless option EA3 (the Electronic Attenuator option) is available, and you purchase it, you will have only the mechanical attenuator.

(Mech) Atten

This key is labeled Mech Atten in dual attenuator models and Atten in single attenuator models. In the dual attenuator configuration, this key only affects the mechanical attenuator.

This key lets you modify the attenuation applied to the RF input signal path. This value is normally auto coupled to the Ref Level, the Internal Preamp Gain, any External Gain that is entered, and the Max Mixer Level, as described in the table below.

See ["Attenuator Configurations and Auto/Man" on page 1100](#)

Key Path	AMPTD Y Scale, Attenuation
Remote Command	<pre>[:SENSe]:POWer[:RF]:ATTenuation <rel_ampl> [:SENSe]:POWer[:RF]:ATTenuation? [:SENSe]:POWer[:RF]:ATTenuation:AUTO OFF ON 0 1 [:SENSe]:POWer[:RF]:ATTenuation:AUTO?</pre>
Example	<p>POW:ATT 20</p> <p>Dual attenuator configuration: sets the mechanical attenuator to 20 dB</p> <p>Single attenuator mode: sets the main attenuation to 20 dB (see below for definition of “main” attenuation).</p> <p>If the attenuator was in Auto, it sets it to Manual.</p>
Dependencies	Some measurements do not support the Auto setting of (Mech) Atten. In these measurements, the

Auto/Man selection is not available, and the Auto/Man line on the key disappears.

In dual attenuator configurations, when the electronic attenuator is enabled, the mechanical attenuator has no auto setting and the Auto/Man line on the key disappears. The state of Auto/Man is remembered and restored when the electronic attenuator is once again disabled. This is described in more detail in the "[Enable Elec Atten](#)" on page 2143 key description.

See "[Attenuator Configurations and Auto/Man](#)" on page 1100 for more information on the Auto/Man functionality of Attenuation.

Couplings

When (Mech) Atten is in Auto, it uses the following algorithm to determine a value:

If the USB Preamp is connected to USB, use 0 dB.

Otherwise, $Atten = ReferenceLevel + PreAmpGain + ExternalGain - RefLevelOffset - MaxMixerLevel + IF\ Gain$.

Limit this value to be between 6 dB and the Max value. No value below 6 dB can ever be chosen by Auto.

The resulting value is rounded up to the largest value possible given the attenuation step setting. That is, 50.01 dB would change to 60 dB (for a 10 dB attenuation step).

The "IF Gain" term in the equation above is either 0 dB or +10 dB, depending on the settings of FFT IF Gain, Swept IF Gain, max Ref Level and the Auto/Man setting of Mech Atten.

In External Mixing and BBIQ, where the Attenuator is not in the signal path, the Attenuator setting changes as described above when (Mech) Atten is in Auto, but no changes are made to the actual attenuator hardware setting until the input is changed back to the RF Input.

Preset The preset for Mech Attenuation is "Auto."
 The Auto value of attenuation is:
 CXA, EXA, MXA and PXA: 10 dB

State Saved Saved in instrument state

Min 0 dB

The attenuation set by this key cannot be decreased below 6 dB with the knob or step keys. To get to a value below 6 dB it has to be directly entered from the keypad or via SCPI. This protects from adjusting the attenuation to a dangerously small value which can put the instrument at risk of damage to input circuitry. However, if the current mechanical attenuation is below 6 dB it can be increased with the knob and step keys, but not decreased.

Max CXA N9000A-503/507: 50 dB
 CXA N9000A-513/526: 70dB
 EXA: 60 dB
 MXA and PXA: 70 dB

In the single attenuator configuration, the total of ATT and EATT cannot exceed 50 dB, so if the EATT is set to 24 dB first, the main attenuation cannot be greater than 26 dB and will be reduced accordingly; if the main attenuator is set to 40 dB first, EATT cannot be greater than 10 dB.

Initial S/W Revision Prior to A.02.00

Modified at S/W Revision A.03.00

Attenuator Configurations and Auto/Man

As described in the Attenuation key description, there are two distinct attenuator configurations available in the X-Series, the single attenuator and dual attenuator configurations. In dual attenuator configurations, we have the mechanical attenuation and the electronic attenuation, and the current total attenuation is the sum of the electronic + mechanical attenuation. In single attenuator configurations, we refer to the attenuation set using the (Mech) Atten key (or POW:ATT SCPI) as the “main” attenuation; and the attenuation that is set by the SCPI command POW:EATT as the “soft” attenuation (the POW:EATT command is honored even in the single attenuator configuration, for compatibility purposes). Then the current total attenuation is the sum of the main + soft attenuation. See the Elec Atten key description for more on “soft” attenuation.

In the dual attenuator configuration, when the electronic attenuator is enabled, there is no Auto/Man functionality for the mechanical attenuator, and the third line of the key label (the Auto/Man line) disappears:

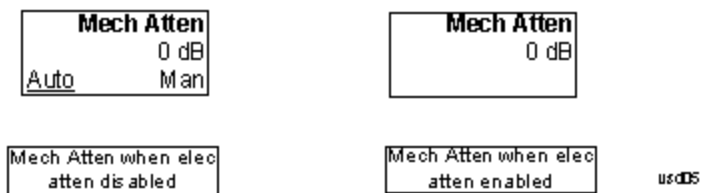

Enable Elec Atten

Enables the Electronic Attenuator.

The electronic attenuator offers finer steps than the mechanical attenuator, has no acoustical noise, is faster, and is less subject to wear. These advantages primarily aid in remote operation and are negligible for front panel use. See ["Using the Electronic Attenuator: Pros and Cons" on page 1102](#) for a detailed discussion of the pros and cons of using the electronic attenuator.

For the single attenuator configuration, for SCPI backwards compatibility, the “soft” attenuation feature replaces the dual attenuator configuration’s electronic attenuator. All the same couplings and limitations apply. See ["Attenuator Configurations and Auto/Man" on page 2143](#)

See ["More Information" on page 1101](#)

Key Path	AMPTD Y Scale, Attenuation
Remote Command	[:SENSE] :POWER [:RF] :EATTenuation :STATE OFF ON 0 1 [:SENSe] :POWER [:RF] :EATTenuation :STATe?
Example	POW:EATT:STAT ON
Dependencies	This key only appears in Dual Attenuator models with an Electronic Attenuator installed. It does not appear in models with the Single Attenuator configuration, as in the single attenuator configuration there is no “electronic attenuator” there is only a single integrated attenuator (which has both a mechanical and electronic stage). However, in the single attenuator configuration, EATT SCPI commands are accepted for compatibility with other X-series instruments and set a “soft” attenuation as described in "Attenuator Configurations and Auto/Man" on page 2143 . The electronic attenuator (and the “soft” attenuation function provided in single attenuator configurations) is unavailable above 3.6 GHz. Therefore, if the Stop Frequency of the analyzer is > 3.6 GHz then the Enable Elec Atten key will be OFF and grayed out.

	<p>If the Internal Preamp is on, meaning it is set to Low Band or Full, the electronic attenuator (and the “soft” attenuation function provided in single attenuator configurations) is unavailable. In this case the Enable Elec Atten key will be OFF and grayed out.</p> <p>If either of the above is true, if the SCPI command is sent, an error indicating that the electronic attenuator is unavailable will be sent.</p> <p>If the electronic/soft Attenuator is enabled, then the Stop Freq of the analyzer is limited to 3.6 GHz and the Internal Preamp is unavailable.</p> <p>The SCPI-only “soft” electronic attenuation for the single-attenuator configuration is not available in all measurements; in particular, it is not available in the Swept SA measurement.</p>
Couplings	Enabling and disabling the Electronic Attenuator affects the setting of the Mechanical Attenuator (in dual attenuator configurations). This is described in more detail below this table.
Preset	OFF for Swept SA measurement; ON for all other measurements that support the electronic attenuator
State Saved	Saved in instrument state
Initial S/W Revision	Prior to A.02.00
Modified at S/W Revision	A.03.00

More Information

Mechanical Attenuator Transition Rules

When the Electronic Attenuator is enabled, the Mechanical Attenuator transitions to a state that has no Auto function. Below are the rules for transitioning the Mechanical Attenuator. NOTE that the information below ONLY applies to the dual attenuator configurations, and ONLY when the Electronic Attenuator is installed:

When the Electronic Attenuation is enabled from a disabled state:

- The Mechanical Attenuator is initialized to 10 dB (this is its optimal performance setting). You can then set it as desired with SCPI, numeric keypad, step keys, or knob, and it behaves as it normally would in manual mode
- The Auto/Man state of (Mech) Atten is saved
- The Auto/Man line on the (Mech) Atten key disappears and the auto rules are disabled
- The Electronic Attenuator is set to 10 dB less than the previous value of the Mechanical Attenuator, within the limitation that it must stay within the range of 0 to 24 dB of attenuation.

Examples in the dual attenuator configuration:

- Mech Atten at 20 dB. Elec Atten enabled, Mech Atten set to 10 dB, and Elec Atten set to 10 dB. New total attenuation equals the value before Elec Atten enabled.
- Mech Atten at 0 dB. Elec Atten enabled, Mech Atten set to 10 dB, and Elec Atten set to 0 dB. New total attenuation does not equal the value before Elec Atten enabled.
- Mech Atten at 40 dB. Elec Atten enabled, Mech Atten set to 10 dB, and Elec Atten set to 24 dB. New total attenuation does not equal the value before Elec Atten enabled.

When the Electronic Attenuation is disabled from an enabled state:

- The Elec Atten key is grayed out
- The Auto/Man state of (Mech) Atten is restored
- If now in Auto, (Mech) Atten recouples
- If now in Man, (Mech) Atten is set to the value of total attenuation that existed before the Elec Atten was disabled. The resulting value is rounded up to the smallest value possible given the (Mech) Atten Step setting - (That is, 57 dB changes to 58 dB when (Mech) Atten Step is 2 dB.)

Using the Electronic Attenuator: Pros and Cons

The electronic attenuator offers finer steps than the mechanical attenuator, has no acoustical noise, is faster, and is less subject to wear.

The “finer steps” advantage of the electronic attenuator is beneficial in optimizing the alignment of the analyzer dynamic range to the signal power in the front panel as well as remote use. Thus, you can achieve improved relative signal measurement accuracy. Compared to a mechanical attenuator with 2 dB steps, the 1 dB resolution of the electronic attenuator only gives better resolution when the odd-decibel steps are used. Those odd-decibel steps are less accurately calibrated than the even-decibel steps, so one tradeoff for this superior relative accuracy is reduced absolute amplitude accuracy.

Another disadvantage of the electronic attenuator is that the spectrum analyzer loses its “Auto” setting, making operation less convenient.

Also, the relationship between the dynamic range specifications (TOI, SHI, compression and noise) and instrument performance are less well-known with the electrical attenuator. With the mechanical attenuator, TOI, SHI and compression threshold levels increase dB-for-dB with increasing attenuation, and the noise floor does as well. With the electronic attenuator, there is an excess attenuation of about 1 to 3 dB between 0 and 3.6 GHz, making the effective TOI, SHI, and so forth, less well known. Excess attenuation is the actual attenuation relative to stated attenuation. Excess attenuation is accounted for in the analyzer calibration

Elec Atten

Controls the Electronic Attenuator in dual attenuator configurations. This key does not appear in single attenuator configurations, as the control of both the mechanical and electronic stages of the single attenuator is integrated into the single Atten key.

Key Path	AMPTD Y Scale, Attenuation
Remote Command	<code>[:SENSe] :POWeR [:RF] :EATTenuation <rel_amp1></code> <code>[:SENSe] :POWeR [:RF] :EATTenuation?</code>
Notes	Electronic Attenuation’s specification is defined only when Mechanical Attenuation is 6 dB.
Dependencies	This key only appears in Dual Attenuator models with an Electronic Attenuator installed. It does not appear in models with the Single Attenuator configuration, as in the single attenuator configuration there is no “electronic attenuator” there is only a single integrated attenuator (which has both a mechanical and electronic stage). However, in the single attenuator configuration, EATT SCPI commands are accepted for compatibility with other X-series instruments and set a “soft” attenuation as described in "Attenuator Configurations and Auto/Man" on page 2143 . The “soft” attenuation is treated as an addition to the “main” attenuation value set by the Atten softkey or the

	POW:ATT SCPI command and affects the total attenuation displayed on the Attenuation key and the Meas Bar. When Enable Elec Atten is off or grayed out, the Elec Atten key is grayed out.
Preset	0 dB
State Saved	Saved in instrument state
Min	0 dB
Max	Dual attenuator configuration: 24 dB Single attenuator configuration: the total of ATT and EATT cannot exceed 50 dB, so if the EATT is set to 24 dB first, the main attenuation cannot be greater than 26 dB and will be reduced accordingly; if the main attenuator is set to 40 dB first, EATT cannot be greater than 10 dB
Initial S/W Revision	Prior to A.02.00
Modified at S/W Revision	A.03.00

Adjust Atten for Min Clip

Sets the combination of mechanical and electronic attenuation and gain based on the current measured signal level so that clipping will be at a minimum.

This is an "immediate action" function, that is, it executes once, when the key is pressed.

This key is grayed out in measurements that do not support this functionality. The spectrum analyzer measurement, Swept SA, does not support this functionality.

Key Path	AMPTD Y Scale, Attenuation
Remote Command	<code>[:SENSe] :POWer [:RF] :RANGe:OPTimize IMMEDIATE</code>
Initial S/W Revision	Prior to A.02.00
Modified at S/W Revision	A.03.00

Pre-Adjust for Min Clip

If this function is on, it does the adjustment described under "[Adjust Atten for Min Clip](#)" on page 2146 each time a measurement restarts. Therefore, in Continuous measurement mode, it only executes before the first measurement.

In dual attenuator models, you can set Elec+Mech Atten, in which case both attenuators participate in the autoranging, or Elec Atten Only, in which case the mechanical attenuator does not participate in the autoranging. This latter case results in less wear on the mechanical attenuator and is usually faster.

This key is grayed out in measurements that do not support this functionality. The spectrum analyzer measurement, Swept SA, does not support this functionality.

Key Path	AMPTD Y Scale, Attenuation
Remote Command	<code>[:SENSe] :POWer [:RF] :RANGe:OPTimize:ATTenuation OFF ELECTRical COMBined</code>

	<code>[:SENSe] :POWer [:RF] :RANGe:OPTimize:ATTenuation?</code>
Notes	The SCPI parameter ELECtrical sets this function to On in single attenuator models. The SCPI parameter COMBined is mapped to ELECtrical in single attenuator models; if you send COMBined, it sets the function to On and returns ELEC to a query.
Dependencies	This key only appears in Dual Attenuator models with an Electronic Attenuator installed. In instruments with Dual Attenuator model, when Enable Elec Atten is off or grayed out, the Pre-Adjust for Min Clip key is grayed out.
Preset	OFF for Swept SA measurement; ON for all other measurements that support Pre-Adjust for Min Clip
State Saved	Saved in instrument state
Range	Dual attenuator models: Off Elec Atten Only Mech + Elec Atten Single attenuator models: Off On
Initial S/W Revision	Prior to A.02.00
Modified at S/W Revision	A.03.00

Remote Command	<code>[:SENSe] :POWer [:RF] :RANGe:AUTO ON OFF 1 0</code> <code>[:SENSe] :POWer [:RF] :RANGe:AUTO?</code>
Notes	ON aliases to "Elec Atten Only" (:POW:RANG:OPT:ATT ELEC) OFF aliases to "Off" (:POW:RANG:OPT:ATT OFF) The query :POW:RANG:AUTO? returns true if :POW:RANG:OPT:ATT is not "Off"
Initial S/W Revision	Prior to A.02.00

Off

Turns Pre-Adjust for Min Clip off. This is the default setting.

This key is grayed out in measurements that do not support this functionality. The spectrum analyzer measurement, Swept SA, does not support this functionality.

Key Path	AMPTD Y Scale, Attenuation, Pre-Adjust for Min Clip
Example	:POW:RANGe:OPT:ATT OFF
Initial S/W Revision	Prior to A.02.00

Elec Atten Only

Selects only the electric attenuator to participate in auto ranging. This offers less wear on the mechanical attenuator and is usually faster.

This key is grayed out in measurements that do not support this functionality. The spectrum analyzer measurement, Swept SA, does not support this functionality.

Key Path	AMPTD Y Scale, Attenuation, Pre-Adjust for Min Clip
Example	:POW:RANGe:OPT:ATT ELEC
Initial S/W Revision	Prior to A.02.00

Mech + Elec Atten

In dual attenuator models, this selects both attenuators participate in the autoranging.

This key is grayed out in measurements that do not support this functionality. The spectrum analyzer measurement, Swept SA, does not support this functionality.

Key Path	AMPTD Y Scale, Attenuation, Pre-Adjust for Min Clip
Example	:POW:RANGe:OPT:ATT COMB
Initial S/W Revision	Prior to A.02.00

(Mech) Atten Step

This controls the step size used when making adjustments to the input attenuation.

This key is labeled Mech Atten Step in dual attenuator models and Atten Step in single attenuator models. In the dual attenuator configuration, this key only affects the step size of the mechanical attenuator.

Key Path	AMPTD Y Scale, Attenuation
Remote Command	[[:SENSe]:POWer[:RF]:ATTenuation:STEP[:INCRement] 10 dB 2 dB [:SENSe]:POWer[:RF]:ATTenuation:STEP[:INCRement]?
Example	POW:ATT:STEP 2
Notes	Note this feature works like a 1-N choice from the front panel, but it takes a specific value (in dB) when used remotely. The only valid values are 2 and 10.
Dependencies	Blanked in CXA and EXA if option FSA (2 dB steps) is not present. If blanked, attempts to set it via SCPI will yield an error.
Couplings	When the attenuation step size changes, the current mechanical attenuation value is adjusted (if necessary) to be quantized to the new step size. That is, if step is set to 10 dB, mech atten is increased if necessary so it is a multiple of 10 dB
Preset	PXA and MXA: 2 dB EXA and CXA: 10 dB (2 dB with option FSA)
State Saved	Saved in instrument state
Initial S/W Revision	Prior to A.02.00
Modified at S/W Revision	A.03.00

Scale/Div

Sets the units per division of the vertical scale in the logarithmic display. However, since the Auto Scaling is defaulted to On, this value is automatically determined by the measurement result. When you set a value manually, Auto Scaling automatically changes to Off.

Key Path	AMPTD Y Scale
Mode	SA, WCDMA, C2K, WIMAX OFDMA, TD-SCDMA, DVB-T/H, LTE, LTETDD, WLAN, MSR, LTEAFDD, LTEATDD
Remote Command	:DISPlay:SPURious:VIEW[1]:WINDow[1]:TRACe:Y[:SCALe]:PDIVision <rel_ ampl> :DISPlay:SPURious:VIEW[1]:WINDow[1]:TRACe:Y[:SCALe]:PDIVision?
Example	DISP:SPUR:VIEW:WIND:TRAC:Y:PDIV 10 dB DISP:SPUR:VIEW:WIND:TRAC:Y:PDIV?
Notes	You must be in the Spectrum Analysis mode, W-CDMA mode, cdma2000 mode, DVB-T/H mode, TD-SCDMA, LTE mode, LTE TDD mode, WLAN mode, MSR, LTE-Advanced FDD/TDD mode or WiMAX mode to use this command. Use INSTRument:SElect to set the mode.
Couplings	When Auto Scaling is On, this value is automatically determined by the measurement result. When you set a value manually, Auto Scaling automatically changes to Off.
Preset	10.00 dB
State Saved	Saved in instrument state.
Range	0.10 dB to 20.00 dB
Min	0.10 dB
Max	20.00 dB
Initial S/W Revision	Prior to A.02.00
Modified at S/W Revision	A.03.00

Presel Center

When this key is pressed, the centering of the preselector filter is adjusted to optimize the amplitude accuracy at the frequency of the selected marker. If the selected marker is not on when Presel Center is pressed, the analyzer will turn on the selected marker, perform a peak search, and then perform centering on the marker's center frequency. If the selected marker is already on and between the start and stop frequencies of the analyzer, the analyzer performs the preselector calibration on that marker's frequency. If the selected marker is already on, but outside the frequency range between Start Freq and Stop Freq, the analyzer will first perform a peak search, and then perform centering on the marker's center frequency.

The value displayed on the Presel Adjust key will change to reflect the new preselector tuning (see Presel Adjust).

A number of considerations should be observed to ensure proper operation. See ["Proper Preselector Operation" on page 1107](#).

Key Path	AMPTD Y Scale
-----------------	---------------

Remote Command	<code>[:SENSe] :POWer [:RF] :PCENter</code>
Example	POW:PCEN
Notes	Note that the rules outlined above under the key description apply for the remote command as well as the key. The result of the command is dependent on marker position, and so forth. Any message shown by the key press is also shown in response to the remote command.
Dependencies	<ul style="list-style-type: none"> • Grayed out if the microwave preselector is off.) • If the selected marker's frequency is below Band 1, advisory message 0.5001 is generated and no action is taken. • Grayed out if entirely in Band 0. • Blank in models that do not include a preselector, such as option 503. If the SCPI is sent in these instruments, it is accepted without error, and the query always returns 0. • Grayed out in the Spectrogram View.
Couplings	<p>The active marker position determines where the centering will be attempted.</p> <p>If the analyzer is in a measurement such as averaging when centering is initiated, the act of centering the preselector will restart averaging but the first average trace will not be taken until the centering is completed.</p>
Status Bits/OPC dependencies	<p>When centering the preselector, *OPC will not return true until the process is complete and a subsequent measurement has completed, nor will results be returned to a READ or MEASure command.</p> <p>The Measuring bit should remain set while this command is operating and should not go false until the subsequent sweep/measurement has completed.</p>
Initial S/W Revision	Prior to A.02.00
Modified at S/W Revision	A.03.00

Proper Preselector Operation

A number of considerations should be observed to ensure proper operation:

1. If the selected marker is off, the analyzer will turn on a marker, perform a peak search, and adjust the preselector using the selected marker's frequency. It uses the "highest peak" peak search method unqualified by threshold or excursion, so that there is no chance of a 'no peak found' error. It continues with that peak, even if it is the peak of just noise. Therefore, for this operation to work properly, there should be a signal on screen in a preselected range for the peak search to find.
2. If the selected marker is already on, the analyzer will attempt the centering at that marker's frequency. There is no preselector for signals below about 3.6 GHz, therefore if the marker is on a signal below 3.6 GHz, no centering will be attempted and an advisory message generated
3. In some models, the preselector can be bypassed. If it is bypassed, no centering will be attempted in that range and a message will be generated.

Preselector Adjust

Allows you to manually adjust the preselector filter frequency to optimize its response to the signal of interest. This function is only available when "Presel Center" on page 2149 is available.

For general purpose signal analysis, using Presel Center is recommended. Centering the filter minimizes the impact of long-term preselector drift. Presel Adjust can be used instead to manually optimize the preselector. One application of manual optimization would be to peak the preselector response, which both optimizes the signal-to-noise ratio and minimizes amplitude variations due to small (short-term) preselector drifting.

Key Path	AMPTD Y Scale
Scope	Meas Global
Remote Command	<code>[:SENSe] :POWer [:RF] :PADJust <freq></code> <code>[:SENSe] :POWer [:RF] :PADJust?</code>
Example	POW:PADJ 100KHz POW:PADJ?
Notes	The value on the key reads out to 0.1 MHz resolution.
Dependencies	<ul style="list-style-type: none"> • Grayed out if microwave preselector is off.) • Grayed out if entirely in Band 0. • Blank in models that do not include a preselector, such as option 503. If the SCPI is sent in these instruments, it is accepted without error, and the query always returns 0. • Grayed out in the Spectrogram View.
Preset	0 MHz
State Saved	The Presel Adjust value set by Presel Center, or by manually adjusting Presel Adjust, is not saved in instrument state, and does not survive a Preset or power cycle.
Min	-500 MHz
Max	500 MHz
Default Unit	Hz
Backwards Compatibility SCPI	<code>[:SENSe] :POWer [:RF] :MW :PADJust</code> <code>[:SENSe] :POWer [:RF] :MMW :PADJust</code> PSA had multiple preselectors, but the X-Series has only one. These commands simply alias to <code>[:SENSe] :POWer [:RF] :PADJust</code>
Initial S/W Revision	Prior to A.02.00
Modified at S/W Revision	A.03.00

Remote Command	<code>[:SENSe] :POWer [:RF] :PADJust :PRESelector MWAVE MMWave EXTERNAL</code> <code>[:SENSe] :POWer [:RF] :PADJust :PRESelector?</code>
Notes	PSA had multiple preselectors, and you could select which preselector to adjust. Since the X-Series has only one mm/uW preselector, the preselector selection softkey is no longer available. However,

to provide backward compatibility, we accept the legacy remote commands.
The command form has no effect, the query always returns MWAVE

Initial S/W Revision Prior to A.02.00

μW Path Control

The μW Path Control functions include the μW Preselector Bypass (Option MPB) and Low Noise Path (Option LNP) controls in the High Band path circuits.

When the μW Preselector is bypassed, the user has better flatness, but will be subject to spurs from out of band interfering signals. When the Low Noise Path is enabled, the analyzer automatically switches around certain circuitry in the high frequency bands which can contribute to noise, when it is appropriate based on other analyzer settings.

For most applications, the preset state is Standard Path, which gives the best remote-control throughput, minimizes acoustic noise from switching and minimizes the risk of wear out in the hardware switches. For applications that utilize the wideband IF paths, the preset state is the μW Preselector Bypass path, if option MPB is present. This is because, when using a wideband IF such as the 140 MHz IF, the μW Preselector's bandwidth can be narrower than the available IF bandwidth, causing degraded amplitude flatness and phase linearity, so it is desirable to bypass the preselector in the default case.

Users may choose Low Noise Path Enable. It gives a lower noise floor, especially in the 21–26.5 GHz region, though without improving many measures of dynamic range, and without giving the best possible noise floor. The preamp, if purchased and used, gives better noise floor than does the Low Noise Path, however its compression threshold and third-order intercept are much poorer than that of the non-preamp Low Noise Path. There are some applications, typically for signals around –30 dBm, for which the third-order dynamic range of the standard path is good enough, but the noise floor is not low enough even with 0 dB input attenuation. When the third-order dynamic range of the preamp path is too little and the noise floor of the standard path is too high, the Low Noise Path can provide the best dynamic range.

Key Path	AMPTD Y Scale
Mode	SA, BASIC, PNOISE, VSA , LTE, LTETDD
Scope	Meas Global
Remote Command	[:SENSe] :POWer [:RF] :MW:PATH STD LNPath MPBypass FULL [:SENSe] :POWer [:RF] :MW:PATH?
Example	:POW:MW:PATH LNP Enables the Low Noise path
Notes	If a Presel Center is performed, the analyzer will momentarily switch to the Standard Path, regardless of the setting of μW Path Control The DC Block will always be switched in when the low noise path is switched in, to protect succeeding circuitry from DC. Note that this does not mean “when the low noise path is enabled” but when, based on the Low Noise Path rules, the path is actually switched in. This can happen when the selection is Low Noise Path Enable . In the case where the DC Block is switched in the analyzer is now AC coupled. However, if the user has selected DC coupling, the UI will still behave as though it were DC coupled, including all annunciation, warnings, status bits, and responses to SCPI queries. This is because, based on other settings, the analyzer could switch out the low noise path at any time

	and hence go back to being DC coupled. Alignment switching ignores the settings in this menu, and restores them when finished.
Dependencies	Unavailable in BBIQ and External Mixing
Preset	All modes other than IQ Analyzer mode and VXA: STD IQ Analyzer, VXA and WLAN mode: MPB option present and licensed: MPB MPB option not present and licensed: STD
State Saved	Save in instrument state
Readback	Value selected in the submenu
Initial S/W Revision	A.04.00
Modified at S/W Revision	A.10.00

Standard Path

This path gives the best remote-control throughput, minimizes acoustic noise from switching and minimizes the risk of wear in the hardware switches, particularly in remote test scenarios where both low band and high band setups will follow in rapid succession.

In this path, the bypass of the low band/high band switch and microwave preamp is never activated, which can cause some noise degradation but preserves the life of the bypass switch.

Key Path	AMPTD Y Scale, μ W Path Control
Example	:POW:MW:PATH STD
Readback Text	Standard Path
Initial S/W Revision	A.04.00

Low Noise Path Enable

You may choose Low Noise Path Enable, which gives a lower noise floor under some circumstances, particularly when operating in the 21–26.5 GHz region. With the Low Noise Path enabled, the low band/high band switch and microwave preamp are bypassed whenever all of the following are true:

- The analyzer is not in the Low Band, meaning:
 - the start frequency is above 3.5 GHz and
 - the stop frequency is above 3.6 GHz.
- the internal preamp is not installed or (if installed) is set to Off or Low Band

Note that this means that, when any part of a sweep is done in Low Band, the Low Noise Path is not used, whether or not the Low Noise Path Enable is selected in the user interface. Also, if the preamp is turned on, the Low Noise Path is not used, whether or not the Low Noise Path Enable is selected in the user interface. The only time the Low Noise Path is used is when Low Noise Path Enable is selected, the sweep is completely in High Band (> 3.6 GHz) and no preamp is in use.

See "[More Information](#)" on page 1111

Key Path	AMPTD Y Scale, μ W Path Control
Measurement	Swept SA
Example	:POW:MW:PATH LNP
Notes	<p>For measurements that use IQ acquisition, the low noise path is used when the Center Frequency is in High Band (> 3.6 GHz) and no preamp is in use.</p> <p>In other words, the rules above are modified to use only the center frequency to qualify which path to switch in.</p> <p>This is not the case for FFT's in the Swept SA measurement; they use the same rules as swept measurements.</p>
Dependencies	<p>Key is blanked if current mode does not support it.</p> <p>Key is grayed out if mode supports it but current measurement does not support it.</p> <p>Unless Option LNP is present and licensed, key is blank and if SCPI command sent, error -241, "Hardware missing; Option not installed" is generated.</p>
Readback Text	Low Noise Path Enable
Initial S/W Revision	A.04.00

More Information

The user should understand that the Low Noise Path, while giving improved DANL, has the disadvantage of decreased TOI performance and decreased gain compression performance relative to the standard path.

The user should also understand that the bypass switch is a mechanical switch and has finite life, so if the Low Noise Path is enabled, it is possible to cause frequent cycling of this switch by frequently changing analyzer settings such that the above conditions hold true only some of the time. A user making tests of this nature should consider opting for the Standard Path, which will never throw the bypass switch, at the expense of some degraded noise performance.

The low noise path is useful for situations where the signal level is so low that the analyzer performance is dominated by noise even with 0 dB attenuation, but still high enough that the preamp option would have excessive third-order intermodulation or compression. The preamp, if purchased and used, gives better noise floor than does the "Low Noise Path." However, its compression threshold and third-order intercept are much poorer than that of the non-preamp path. There are some applications, typically for signals around -30 dBm, for which the third-order dynamic range of the standard path is good enough, but the noise floor is not low enough even with 0 dB input attenuation. When the third-order dynamic range of the preamp path is too little and the noise floor of the standard path is too high, the Low Noise Path can provide the best dynamic range

The graph below illustrates the concept. It shows, in red, the performance of an analyzer at different attenuation settings, both with the preamp on and off, in a measurement that is affected by both analyzer noise and analyzer TOI. The green shows the best available dynamic range, offset by 0.5 dB for clarity. The blue shows how the best available dynamic range improves for moderate signal levels with the low noise path switched in. In this illustration, the preamp improves the noise floor by 15 dB while degrading the third-order intercept by 30 dB, and the low noise path reduces loss by 8 dB. The attenuator step size is 2 dB.

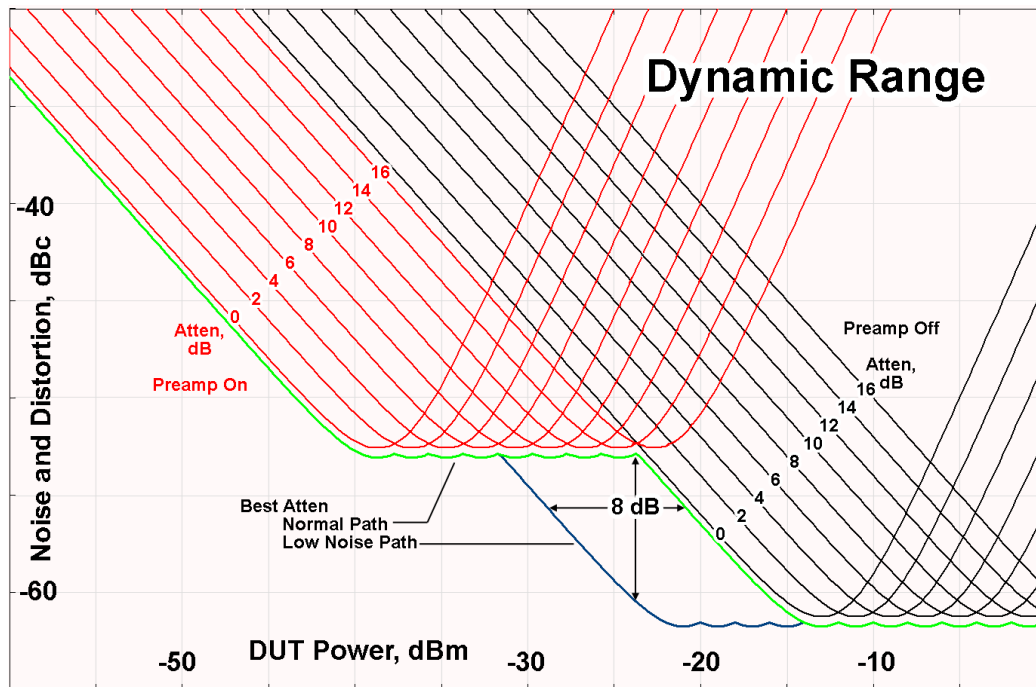

There are other times where selecting the low noise path improves performance, too. Compression-limited measurements such as finding the nulls in a pulsed-RF spectrum can profit from the low noise path in a way similar to the TOI-limited measurement illustrated. Accuracy can be improved when the low noise path allows the optimum attenuation to increase from a small amount like 0, 2 or 4 dB to a larger amount, giving better return loss at the analyzer input. Harmonic measurements, such as second and third harmonic levels, are much improved using the low noise path because of the superiority of that path for harmonic (though not intermodulation) distortion performance.

μW Preselector Bypass

This key toggles the preselector bypass switch for band 1 and higher. When the microwave preselector is on, the signal path is preselected. When the microwave preselector is off, the signal path is not preselected. The preselected path is the normal path for the analyzer.

The preselector is a tunable bandpass filter which prevents signals away from the frequency of interest from combining in the mixer to generate in-band spurious signals (images). The consequences of using a preselector filter are its limited bandwidth, the amplitude and phase ripple in its passband, and any amplitude and phase instability due to center frequency drift.

Option MPB or pre-selector bypass provides an unpreselected input mixer path for certain X-Series signal analyzers with frequency ranges above 3.6 GHz. This signal path allows a wider bandwidth and less amplitude variability, which is an advantage when doing modulation analysis and broadband signal analysis. The disadvantage is that, without the preselector, image signals will be displayed. Another disadvantage of bypassing the preselector is increased LO emission levels at the front panel input port.

Image responses are separated from the real signal by twice the 1st IF. For IF Paths of 10 MHz and 25 MHz, the 1st IF is 322.5 MHz, so the image response and the real signal will be separated by 645 MHz. The 1st IF will be different for other IF Path settings. When viewing a real signal and its corresponding image response in internal mixing, the image response will be to the left of the real signal.

Also, the image response and the real signal typically have the same amplitude and exhibit the same shape factor.

However, if Option FS1, Fast Sweep Capability, is enabled, the image response in the Swept SA measurement will appear lower in amplitude and have a much wider shape factor compared to the real signal.

Key Path	AMPTD Y Scale, μ W Path Control
Example	:POW:MW:PATH MPB
Dependencies	Key is blanked if current mode does not support it. Key is grayed out if mode supports it but current measurement does not support it. Key is blank unless Option MPB is present and licensed. If SCPI command sent when MPB not present, error -241, "Hardware missing; Option not installed" is generated.
Readback Text	μ W Preselector Bypass
Initial S/W Revision	A.04.00

Remote Command	[:SENSe] :POWer [:RF] :MW:PRESelector [:STATe] ON OFF 0 1 [:SENSe] :POWer [:RF] :MW:PRESelector [:STATe] ?
Example	:POW:MW:PRES OFF Bypasses the microwave preselector
Notes	The ON parameter sets the STD path (:POW:MW:PATH STD) The OFF parameter sets path MPB (:POW:MW:PATH MPB)
Preset	ON

Internal Preamp

Accesses a menu of keys that control the internal preamps. Turning on the preamp gives a better noise figure, but a poorer TOI to noise floor dynamic range. You can optimize this setting for your particular measurement.

The instrument takes the preamp gain into account as it sweeps. If you sweep outside of the range of the preamp the instrument will also account for that. The displayed result will always reflect the correct gain.

For some measurements, when the preamp is on and any part of the displayed frequency range is below the lowest frequency for which the preamp has specifications, a warning condition message appears in the status line. For example ,for a preamp with a 9 kHz lowest specified frequency: "Preamp: Accy unspec'd below 9 kHz".

Key Path	AMPTD Y Scale
Scope	Meas Global
Remote Command	[:SENSe] :POWer [:RF] :GAIN [:STATe] OFF ON 0 1 [:SENSe] :POWer [:RF] :GAIN [:STATe] ?
Dependencies	Preamp is not available on all hardware platforms. If the preamp is not present or is unlicensed, the

	key is not shown. The preamp is not available when the electronic/soft attenuator is enabled.
--	--

Couplings	<p>The act of connecting the U7227A USB Preamplifier to one of the analyzer's USB ports will cause the Internal Preamp to be switched on. When this happens an informational message will be generated: "Internal Preamp turned on for optimal operation with USB Preamp." Note that if the Internal Preamp was already on, there will be no change to the setting, but if it was Off it will be switched On, to Full Range.</p> <p>Note that this same action occurs when the SA mode is selected while the USB Preamp is connected to one of the analyzer's USB ports, if it is the first time that the SA mode has run since powerup, or if the last time the SA mode was running the USB Preamp was NOT connected.</p> <p>Subsequently disconnecting the USB Preamp from USB does not change the Internal Preamp setting nor restore the previous setting.</p>
Preset	OFF
State Saved	Saved in instrument state
Initial S/W Revision	Prior to A.02.00
Modified at S/W Revision	A.14.00

Key Path	AMPTD Y Scale, Internal Preamp
Scope	Meas Global
Remote Command	[:SENSe]:POWer[:RF]:GAIN:BAND LOW FULL [:SENSe]:POWer[:RF]:GAIN:BAND?
Dependencies	<p>Preamp is not available on all hardware platforms. If the preamp is not present or is unlicensed, the key is not shown.</p> <p>If a POW:GAIN:BAND FULL command is sent when a low band preamp is available, the preamp band parameter is to LOW instead of FULL, and an "Option not installed" message is generated.</p>
Preset	LOW
State Saved	Saved in instrument state
Initial S/W Revision	Prior to A.02.00

Off

Turns the internal preamp off

Key Path	AMPTD Y Scale, Internal Preamp
Example	:POW:GAIN OFF
Readback	Off
Initial S/W Revision	Prior to A.02.00

Low Band

Sets the internal preamp to use only the low band.

The frequency range of the installed (optional) low-band preamp is displayed in square brackets on the Low Band key label.

Key Path	AMPTD Y Scale, Internal Preamp
Example	:POW:GAIN ON :POW:GAIN:BAND LOW
Readback	Low Band
Initial S/W Revision	Prior to A.02.00

Full Range

Sets the internal preamp to use its full range. The low band (0–3.6 GHz or 0–3GHz, depending on the model) is supplied by the low band preamp and the frequencies above low band are supplied by the high band preamp.

The frequency range of the installed (optional) preamp is displayed in square brackets on the Full Range key label. If the high band option is not installed the Full Range key does not appear.

Key Path	AMPTD Y Scale, Internal Preamp
Example	:POW:GAIN ON :POW:GAIN:BAND FULL
Readback	Full Range
Initial S/W Revision	Prior to A.02.00

Auto Scaling

Toggles the Auto Scaling function between On and Off.

Key Path	AMPTD Y Scale
Mode	SA, WCDMA, C2K, WIMAX OFDMA, TD-SCDMA, DVB-T/H, LTE, LTETDD, WLAN, MSR, LTEAFDD, LTEATDD
Remote Command	:DISPlay:SPURious:VIEW[1]:WINDow[1]:TRACe:Y[:SCALe]:COUPle 0 1 OFF ON :DISPlay:SPURious:VIEW[1]:WINDow[1]:TRACe:Y[:SCALe]:COUPle?
Example	DISP:SPUR:VIEW:WIND:TRAC:Y:COUP OFF DISP:SPUR:VIEW:WIND:TRAC:Y:COUP?
Couplings	When Auto Scaling is On and the Restart front-panel key is pressed, this function automatically determines the scale per division and reference values based on the measurement results. When you set a value to either Scale/Div or Ref Value manually, Auto Scaling automatically changes to Off.

	When the Y Auto Scaling is off, the measurement uses the current reference level settings. When the Y Auto Scaling is on, the analyzer automatically sets the reference level such that the absolute limit is positioned two divisions down from the top of the display. This is the most useful setting when searching for spurs. The algorithm used for determining the ref level is $\text{Ref Level} = \text{Absolute Limit} + (2 * \text{Scale/Div})$. All other reference level settings are left as the current base instrument settings.
Preset	1
State Saved	Saved in instrument state.
Range	On Off
Backwards Compatibility SCPI	[:SENSe] : SPURious : POWer [:RF] : RANGe : AUTO
Initial S/W Revision	Prior to A.02.00
Modified at S/W Revision	A.03.00

Auto Couple

The Auto Couple feature provides a quick and convenient way to automatically couple multiple instrument settings. This helps ensure accurate measurements and optimum dynamic range. When the Auto Couple feature is activated, either from the front panel or remotely, all parameters of the current measurement that have an Auto/Manual mode are set to Auto mode and all measurement settings dependent on (or coupled to) the Auto/Man parameters are automatically adjusted for optimal performance.

However, the Auto Couple key actions are confined to the current measurement only. It does not affect other measurements in the mode, and it does not affect markers, marker functions, or trace or display attributes.

See "[More Information](#)" on page 1117

Key Path	Front-panel key
Remote Command	:COUPle ALL NONE
Example	:COUP ALL
Notes	:COUPle ALL puts all Auto/Man parameters in Auto mode (equivalent to pressing the Auto Couple key). :COUPLE NONE puts all Auto/Man parameters in manual mode. It decouples all the coupled instrument parameters and is not recommended for making measurements.
Initial S/W Revision	Prior to A.02.00

More Information

There are two types of functions that have Auto/Manual modes.

Auto/Man Active Function keys

An Auto/Man toggle key controls the binary state associated with an instrument parameter by toggling between Auto (where the parameter is automatically coupled to the other parameters it is dependent upon) and Man (where the parameter is controlled independent of the other parameters), as well as making the parameter the active function. The current mode is indicated on the softkey with either Auto or Man underlined as illustrated below.



Auto/Man 1-of-N keys

An Auto/Man 1-of-N key allows you to manually pick from a list of parameter values, or place the function in Auto, in which case the value is automatically selected (and indicated) as shown below. If in Auto, Auto is underlined on the calling key. If in manual operation, manual is indicated on the calling key. But the calling key does not actually toggle the function, it simply opens the menu.

11 Spurious Emissions Measurement
Auto Couple

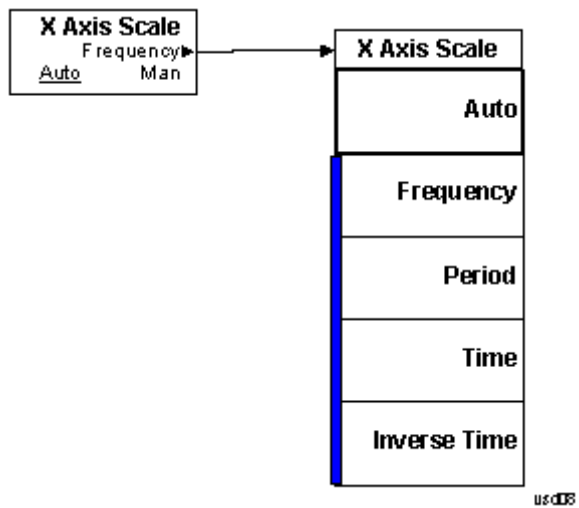

BW

BW is unavailable in the Spurious Emissions measurement. When pressed, this key displays a blank menu.

Key Path	Front-panel key
Initial S/W Revision	Prior to A.02.00

Cont (Continuous Measurement/Sweep)

Sets the analyzer for Continuous measurement operation. The single/continuous state is Meas Global so the setting will affect all measurements. If you are Paused, pressing Cont does a Resume.

Key Path	Front-panel key
Remote Command	:INITiate:CONTinuous OFF ON 0 1 :INITiate:CONTinuous?
Example	:INIT:CONT 0 puts analyzer in Single measurement operation. :INIT:CONT 1 puts analyzer in Continuous measurement operation
Preset	ON (Note that SYST:PRESet sets INIT:CONT to ON but *RST sets INIT:CONT to OFF)
State Saved	Saved in instrument state
Backwards Compatibility Notes	For Spectrum Analysis mode in ESA and PSA, there is no Cont hardkey, instead there is a Sweep Single/Cont key. In these analyzers, switching the Sweep Single/Cont key from Single to Cont restarts averages (displayed average count reset to 1), but does not restart Max Hold and Min Hold. The X-Series has Single and Cont keys in place of the SweepSingleCont key. In the X-Series, if in single measurement, the Cont key (and INIT:CONT ON) switches to continuous measurement, but never restarts a measurement and never resets a sweep.
Initial S/W Revision	Prior to A.02.00

In Swept SA Measurement (Spectrum Analysis Mode):

The analyzer takes repetitive sweeps, averages, measurements, etc., when in Continuous mode. When the average count reaches the Average/Hold Number the count stops incrementing, but the analyzer keeps sweeping. See the Trace/Detector section for the averaging formula used both before and after the Average/Hold Number is reached. The trigger condition must be met prior to each sweep. The type of trace processing for multiple sweeps, is set under the Trace/Detector key, with choices of Trace Average, Max Hold, or Min Hold.

In Other Measurements/Modes:

With Avg/Hold Num (in the Meas Setup menu) set to Off or set to On with a value of 1, a sweep is taken after the trigger condition is met; and the analyzer continues to take new sweeps after the current sweep has completed and the trigger condition is again met. However, with Avg/Hold Num set to On with a value >1, multiple sweeps (data acquisitions) are taken for the measurement. The trigger condition must be met prior to each sweep. The sweep is not stopped when the average count k equals the number N set for Avg/Hold Num is reached, but the number k stops incrementing. A measurement average usually applies to all traces, marker results, and numeric results. But sometimes it only applies to the numeric results.

If the analyzer is in Single measurement, pressing the Cont key does not change k and does not cause the sweep to be reset; the only action is to put the analyzer into Continuous measurement operation.

If it is already in continuous sweep:

the INIT:CONT 1 command has no effect

the INIT:CONT 0 command will place the analyzer in Single Sweep but will have no effect on the current sequence until $k = N$, at which point the current sequence will stop and the instrument will go to the idle state.

11 Spurious Emissions Measurement
File

File

See "File" on page 336

FREQ Channel

Accesses a menu of keys that allow you to control the Frequency and Channel parameters of the instrument.

Some features in the Frequency menu are the same for all measurements – they do not change as you change measurements. Settings like these are called “Meas Global” and are unaffected by Meas Preset. For example, the Center Freq setting is the same for all measurements – it does not change as you change measurements.

Key Path	Front-panel key
Initial S/W Revision	Prior to A.02.00

Center Freq

Sets the frequency that corresponds to the horizontal center of the graticule (when frequency Scale Type is set to linear). While adjusting the Center Frequency the Span is held constant, which means that both Start Frequency and Stop Frequency will change.

Pressing Center Freq also sets the frequency entry mode to Center/Span. In Center/Span mode, the center frequency and span values are displayed below the graticule, and the default active function in the Frequency menu is Center Freq.

The center frequency setting is the same for all measurements within a mode, that is, it is Meas Global. Some modes are also able to share a Mode Global center frequency value. If this is the case, the Mode will have a Global Settings key in its Mode Setup menu.

The Center Freq function sets (and queries) the Center Frequency for the currently selected input. If your analyzer has multiple inputs, and you select another input, the Center Freq changes to the value for that input. SCPI commands are available to directly set the Center Freq for a specific input.

Center Freq is remembered as you go from input to input. Thus you can set a Center Freq of 10 GHz with the RF Input selected, change to BBIQ and set a Center Freq of 20 MHz, then switch to External Mixing and set a Center Freq of 60 GHz, and when you go back to the RF Input the Center Freq will go back to 10 GHz; back to BBIQ and it is 20 MHz; back to External Mixing and it is 60 GHz.

See ["RF Center Freq" on page 1126](#)

See [Ext Mix Center Freq](#)

See ["I/Q Center Freq" on page 1128](#)

See ["Center Frequency Presets" on page 1124](#)

Key Path	FREQ Channel
Scope	Meas Global
Remote Command	[:SENSe] :FREQuency :CENTer <freq> [:SENSe] :FREQuency :CENTer?

Example	FREQ:CENT 50 MHz FREQ:CENT UP changes the center frequency to 150 MHz if you use FREQ:CENT:STEP 100 MHz to set the center frequency step size to 100 MHz FREQ:CENT?
Notes	This command sets either the RF or I/Q Center Frequency depending on the selected input. For RF input it is equivalent to FREQ:RF:CENT For I/Q input it is equivalent to FREQ:IQ:CENT Preset and Max values are dependent on Hardware Options (5xx) If no terminator (e.g. MHz) is sent the terminator Hz is used. If a terminator with unit other than Frequency is used, an invalid suffix error message is generated.
Dependencies	The Center Frequency can be limited by Start or Stop Freq limits, if the Span is so large that Start or Stop reach their limit.
Couplings	When operating in "swept span", any value of the Center Frequency or Span that is within the frequency range of the analyzer is allowed when the value is being set through the front panel numeric key pad or the SCPI command. The other parameter is forced to a different value if needed, to keep the Start and the Stop Frequencies within the analyzer's frequency range
Preset	Depends on instrument maximum frequency, mode, measurement, and selected input. See "Center Frequency Presets" on page 1124 and "RF Center Freq" on page 1126 and Ext Mix Center Freq and "I/Q Center Freq" on page 1128 .
State Saved	Saved in instrument state
Min	Depends on instrument maximum frequency, mode, measurement, and selected input.. See "Center Frequency Presets" on page 1124 and "RF Center Freq" on page 1126 and "I/Q Center Freq" on page 1128 .
Max	Depends on instrument maximum frequency, mode, measurement, and selected input.. See "Center Frequency Presets" on page 1124 and "RF Center Freq" on page 1126 and "I/Q Center Freq" on page 1128 .
Default Unit	Hz
Status Bits/OPC	Non-overlapped
Dependencies	
Initial S/W Revision	Prior to A.02.00

Center Frequency Presets

The following table provides the Center Frequency Presets for the Spectrum Analyzer mode, and the Max Freq, for the various frequency options:

Freq Option	CF after Mode Preset	Stop Freq after Mode Preset	Max Freq (can't tune)

			above)
503 (all but N9000A)	1.805 GHz	3.6 GHz	3.7 GHz
503 (N9000A)	1.505 GHz	3.0 GHz	3.08 GHz
507 (all but N9000A)	3.505 GHz	7.0 GHz	7.1 GHz
507 (N9000A)	3.755 GHz	7.5 GHz	7.58 GHz
508 (all but N9038A)	1.805 GHz	3.6 GHz	8.5 GHz
508 (N9038A)	4.205 GHz	8.4 GHz	8.5 GHz
513	6.805 GHz	13.6 GHz	13.8 GHz
526 (all but N9000A and N9038A)	13.255 GHz	26.5 GHz	27.0 GHz
526 (N9000A)	13.255 GHz	26.5 GHz	26.55 GHz
526 (N9038A)	1.805 GHz	3.6 GHz	27.0 GHz
532	16.005 GHz	32.0 GHz	32.5 GHz
543	21.505 GHz	43.0 GHz	TBD
544	22.005 GHz	44.0 GHz	44.5 GHz
550	25.005 GHz	50.0 GHz	51 GHz

Input 2:

Model	CF after Mode Preset	Stop Freq after Mode Preset	Max Freq (can't tune above)
N9000A opt C75	0.7505GHz	1.5 GHz	1.58 GHz
N9038A	505 MHz	1 GHz	1.000025 GHz

Tracking Generator Frequency Limits (N9000A only):

Tracking Generator Option	Min Freq (clips to this freq when turn TG on and	If above this Freq, Stop Freq clipped to this Freq when	Max Freq (can't tune above) while TG

	can't tune below while TG on)	TG turned on	on
T03	9 kHz	3.0 GHz	3.08 GHz
T06	9 kHz	6.0 GHz	6.05 GHz

The following table shows the Center Frequency Presets for modes other than Spectrum Analyzer:

Mode	CF Preset for RF
WCDMA	1 GHz
WIMAXOFDMA,	1 GHz
BASIC	1 GHz
ADEMOD	1 GHz
VSA	1 GHz
TDSCDMA	1 GHz
PNOISE	1 GHz
LTE	1 GHz
LTETDD	1 GHz
MSR	1 GHz
GSM	935.2 MHz
NFIGURE	1.505 GHz

RF Center Freq

SCPI command for specifying the RF Center Frequency. This command will set the Center Frequency to be used when the RF input is selected, even if the RF input is not the input that is selected at the time the command is sent. Note that the Center Freq function in the Frequency menu on the front panel always applies to the currently selected input.

Scope	Meas Global
Remote Command	<code>[:SENSe] :FREQuency:RF:CENTer <freq></code> <code>[:SENSe] :FREQuency:RF:CENTer?</code>
Example	FREQ:RF:CENT 30 MHz
Notes	This command is the same in all modes, but the parameter is Measurement Global. So the value is independent in each mode and common across all the measurements in the mode.
Dependencies	If the electronic/soft attenuator is enabled, any attempt to set Center Frequency such that the Stop Frequency would be >3.6 GHz fails and results in an advisory message. If the equivalent SCPI command is sent, this same message is generated as part of a “-221, Settings conflict” warning. If Source Mode is set to Tracking, and the Max or Min Center Freq is therefore limited by the limits of the source, a warning message is generated, “Data out of range;clipped to source max/min” if these limits are exceeded. Note that for an external source, these limits can be affected by the settings of

	Source Numerator, Source Denominator and Power Sweep.
Preset	See table above
State Saved	Saved in instrument state.
Min	-79.999995 MHz, unless Source Mode is set to Tracking, in which case it is limited by the minimum frequency of the Source
Max	See table above. Basically instrument maximum frequency - 5 Hz. Note that, if the Source Mode is set to Tracking, the effective instrument maximum frequency may be limited by the source maximum frequency. If the knob or step keys are being used, also depends on the value of the other three interdependent parameters Span, Start Frequency and Stop Frequency
Initial S/W Revision	Prior to A.02.00
Modified at S/W Revision	A.03.00

Ext Mix Center Freq

SCPI command for specifying the External Mixer Center Frequency. This command will set the Center Frequency to be used when the External Mixer is selected, even if the External Mixer input is not the input which is selected at the time the command is sent. Note that the Center Freq function in the Frequency menu on the front panel always applies to the currently selected input.

Scope	Meas Global
Remote Command	<code>[:SENSe] :FREQuency:EMIXer:CENTer <freq></code> <code>[:SENSe] :FREQuency:EMIXer:CENTer?</code>
Example	<code>:FREQ:EMIX:CENT 60 GHz</code> <code>:FREQ:EMIX:CENT?</code>
Notes	This command is the same in all modes, but the parameter is Measurement Global. So the value is independent in each mode and common across all the measurements in the mode.
Couplings	When returning to External Mixing after having been switched to one of the other inputs (e.g., RF), you will come back into the settings that you had when you left External Mixing. So you will come back to the band you were in with the Center Frequency that you had. However, Span is not an input-dependent parameter, therefore you will bring the span over from the other input. Therefore, the analyzer comes back with the span from the previous input, limited as necessary by the current mixer setup.
Preset	When a Mode Preset is performed while in External Mixing, the Start frequency of the current Mode is set to the nominal Min Freq of the lowest harmonic range in the Harmonic Table for the current mixer setup. Similarly, the Stop frequency of the current Mode is set to the nominal Max Freq of the highest harmonic range in the Harmonic Table. The Center Freq thus presets to the point arithmetically equidistant from these two frequencies. If the current measurement has a limited Span available to it, and cannot achieve the Span shown in the table ($\text{Span} = \text{Stop Freq} - \text{Start Freq}$), the analyzer uses the maximum Span the measurement allows, and still sets the Center Freq to the midpoint of the Start and Stop Freq values in the Harmonic Table.

	<p>When Restore Input/Output Defaults is performed, the mixer presets to the 11970A, whose Start and Stop frequencies are 26.5 and 40 GHz respectively. The center of these two frequencies is 33.25 GHz.</p> <p>Therefore, after a Restore Input/Output Defaults, if you go into External Mixing and do a Mode Preset while in the Spectrum Analyzer Mode, the resulting Center Freq is 33.25 GHz.</p>
State Saved	Saved in instrument state.
Min	The minimum frequency in the currently selected mixer band + 5 Hz
Max	<p>The maximum frequency in the currently selected mixer band – 5 Hz</p> <p>If the knob or step keys are being used, also depends on the value of the other three interdependent parameters Span, Start Frequency and Stop Frequency</p>
Initial S/W Revision	A.08.01

I/Q Center Freq

SCPI command for specifying the I/Q Center Frequency. This command will set the Center Frequency to be used when the I/Q input is selected, even if the I/Q input is not the input which is selected at the time the command is sent. Note that the Center Freq function in the Frequency menu on the front panel always applies to the currently selected input.

Scope	Meas Global
Remote Command	<pre>[:SENSe] :FREQuency:IQ:CENTer <freq></pre> <pre>[:SENSe] :FREQuency:IQ:CENTer?</pre>
Example	FREQ:IQ:CENT: 30 MHz
Notes	This command is the same in all modes, but the parameter is Measurement Global. So the value is independent in each mode and common across all the measurements in the mode.
Preset	0 Hz
State Saved	Saved in instrument state.
Min	-40.049995 MHz
Max	40.049995 MHz
Initial S/W Revision	Prior to A.02.00

Input/Output

See "Input/Output" on page 196

Marker

Displays the menu keys that enable you to select, set up and control the markers for the current measurement.

Key Path	Front-panel key
Initial S/W Revision	Prior to A.02.00

Select Marker

Displays 12 markers available for selection.

Key Path	Marker
Initial S/W Revision	Prior to A.02.00

Marker Type

Sets the marker control mode to Normal, Delta and Off. Normal enables you to activate the selected marker to read the power level and time. Delta enables you to read the differences in the power levels and time scales between the selected marker and the next marker. Off enables you to turn off the selected marker.

All interactions and dependencies detailed under the key description are enforced when the remote command is sent.

Key Path	Marker
Mode	SA, WCDMA, C2K, WIMAX OFDMA, TD-SCDMA, 1xEV-DO, DVB-T/H, LTE, LTE-TDD, WLAN, MSR, LTE-FDD, LTE-TDD
Remote Command	:CALCulate:SPURious:MARKer[1] 2 ... 12:MODE POSITION DELTA OFF :CALCulate:SPURious:MARKer[1] 2 ... 12:MODE?
Example	CALC:SPUR:MARK:MODE POS CALC:SPUR:MARK:MODE?

Notes

If the selected marker is Off, pressing Marker sets it to Normal and places it at the center of the screen on the trace determined by the Marker Trace rules. At the same time, Marker X Axis Value appears on the Active Function area.

Default Active Function: the active function for the selected marker's current control mode. If the current control mode is Off, there is no active function and the active function is turned off.

Active Function Display: the marker X axis value entered in the active function area will display the marker value to its full entered precision.

You must be in the cdma2000 mode, 1xEV-DO mode, TD-SCDMA mode, W-CDMA mode, DVB-T/H mode, GSM/EDGE mode, LTE mode, LTE TDD mode, WLAN mode, MSR, LTE-Advanced FDD/TDD mode or WiMAX mode to use this command. Use INSTRument:SElect to set the mode.

Preset	=OFF
State Saved	Saved in instrument state.
Range	Normal Delta Off
Initial S/W Revision	Prior to A.02.00
Modified at S/W Revision	A.03.00

Properties

Accesses the Properties menu to set certain properties of the selected marker.

Key Path	Marker
Initial S/W Revision	Prior to A.02.00

Select Marker

Displays 12 markers available for selection.

Key Path	Marker
Initial S/W Revision	Prior to A.02.00

Relative To

Selects the marker the selected marker will be relative to (its reference marker).

Every marker has another marker to which it is relative. This marker is referred to as the "reference marker" for that marker. This attribute is set by the Marker, Properties, Relative To key. The marker must be a Delta marker to make this attribute relevant. If it is a Delta marker, the reference marker determines how the marker is controlled and how its value is displayed. A marker cannot be relative to itself.

Key Path	Marker, Properties
Mode	SA, WCDMA, C2K, WIMAX OFDMA, TD-SCDMA, 1xEV-DO, DVB-T/H, LTE, LTE-TDD, WLAN, MSR, LTEAFDD, LTEATDD
Remote Command	:CALCulate:SPURious:MARKer[1] 2 ... 12:REFerence <integer> :CALCulate:SPURious:MARKer[1] 2 ... 12:REFerence?
Example	CALC:SPUR:MARK3:REF 5 CALC:SPUR:MARK:REF?
Notes	A marker cannot be relative to itself so that choice is grayed out, and if sent from SCPI generates error -221: "Settings conflict; marker cannot be relative to itself." When queried a single value will be returned (the specified marker numbers relative marker). You must be in the Spectrum Analysis mode, GSM mode, LTE mode, LTE TDD mode, WLAN mode, MSR, LTE-Advanced FDD/TDD mode or WiMAX mode or TD-SCDMA mode to use this command.

	Use INSTRument:SElect to set the mode.
Preset	2 3 4 5 6 7 8 9 10 11 12 1
State Saved	Saved in instrument state.
Min	1
Max	12
Initial S/W Revision	Prior to A.02.00
Modified at S/W Revision	A.03.00

Couple Markers

When this function is true, moving any marker causes an equal X Axis movement of every other marker which is not Off. By “equal X Axis movement” we mean that we preserve the difference between each marker’s X Axis value (in the fundamental x-axis units of the trace that marker is on) and the X Axis value of the marker being moved (in the same fundamental x-axis units).

Key Path	Marker
Mode	SA, WCDMA, C2K, WIMAX OFDMA, TD-SCDMA, 1xEV-DO, DVB-T/H, LTE, LTETDD, WLAN, MSR, LTEAFDD, LTEATDD
Remote Command	:CALCulate:SPURious:MARKer:COUPle[:STATe] ON OFF 1 0 :CALCulate:SPURious:MARKer:COUPle[:STATe]?
Example	CALC:SPUR:MARK:COUP ON CALC:SPUR:MARK:COUP?
Preset	OFF
State Saved	Saved in instrument state.
Range	On Off
Initial S/W Revision	Prior to A.02.00
Modified at S/W Revision	A.03.00

All Markers Off

Turns off all markers.

Key Path	Marker
Mode	SA, WCDMA, C2K, WIMAX OFDMA, TD-SCDMA, 1xEV-DO, DVB-T/H, LTE, LTETDD, WLAN, MSR, LTEAFDD, LTEATDD
Remote Command	:CALCulate:SPURious:MARKer:AOFF
Example	CALC:SPUR:MARK:AOFF
Initial S/W Revision	Prior to A.02.00
Modified at S/W Revision	A.03.00

Marker X Axis Value (Remote Command only)

Sets the Marker X Axis value in the current marker X Axis Scale unit. It has no effect if the control mode is Off, but is the SCPI equivalent of entering an X value if the control mode is Normal or Delta.

Mode	SA, WCDMA, C2K, WIMAX OFDMA, TD-SCDMA, DVB-T/H, LTE, LTETDD, WLAN, MSR, LTEAFDD, LTEATDD
Remote Command	:CALCulate:SPURious:MARKer[1] 2 ... 12:X <freq> :CALCulate:SPURious:MARKer[1] 2 ... 12:X?
Example	CALC:SPUR:MARK2:X 25 kHz CALC:SPUR:MARK3:X?
Notes	If no suffix is sent it will use the fundamental units for the current marker X Axis Scale. If a suffix is sent that does not match the current marker X Axis Scale unit, an error "Invalid suffix" will be generated. The query returns the absolute X Axis marker value if the control mode is Normal, or the offset from the reference marker if the control mode is Delta. The query is returned in the fundamental units for the current marker X Axis scale: Hz for Frequency and Inverse Time, seconds for Period and Time. If the marker is Off, the response is not a number.
Preset	1 GHz
State Saved	No
Min	-9.9E+37
Max	9.9E+37
Initial S/W Revision	Prior to A.02.00
Modified at S/W Revision	A.03.00

Marker X Axis Position (Remote Command only)

Sets the Marker X position in trace points. It has no effect if the control mode is Off, but is the SCPI equivalent of entering a value if the control mode is Normal or Delta - except in trace points rather than X Axis Scale units. The entered value is immediately translated into the current X Axis Scale units for setting the value of the marker.

Mode	SA, WCDMA, C2K, WIMAX OFDMA, TD-SCDMA, 1xEV-DO, DVB-T/H, LTE, LTETDD, WLAN, MSR, LTEAFDD, LTEATDD
Remote Command	:CALCulate:SPURious:MARKer[1] 2 ... 12:X:POSition <integer> :CALCulate:SPURious:MARKer[1] 2 ... 12:X:POSition?
Example	CALC:SPUR:MARK10:X:POS 300 CALC:SPUR:MARK10:X:POS?
Notes	The query returns the absolute X Axis marker value in trace points if the control mode is Normal, or the offset from the reference marker in trace points if the control mode is Delta. The value is returned as a real number, not an integer, corresponding to the translation from X Axis Scale units to trace points . If the marker is Off the response is not a number.
Preset	300

State Saved	No
Min	-9.9E+37
Max	9.9E+37
Initial S/W Revision	Prior to A.02.00
Modified at S/W Revision	A.03.00

Marker Y Axis Value (Remote Command only)

Returns the marker Y Axis value in the current marker Y Axis unit.

Mode	SA, WCDMA, C2K, WIMAX OFDMA, TD-SCDMA, 1xEV-DO, DVB-T/H, LTE, LTE-TDD, WLAN, MSR, LTEAFDD, LTEATDD
Remote Command	:CALCulate:SPURious:MARKer[1 2 ... 12:Y?
Example	CALC:SPUR:MARK11:Y?
Notes	If no suffix is sent, it will use the current Y Axis unit. If a suffix is sent that does not have units of absolute amplitude, an error "Invalid suffix" will be generated.
Preset	Depends on Y axis range of selected Trace.
State Saved	No
Initial S/W Revision	Prior to A.02.00
Modified at S/W Revision	A.03.00

Marker Function

There are no 'Marker Functions' supported in Spurious Emissions so this front-panel key displays a blank menu when pressed.

Key Path	Front-panel key
Initial S/W Revision	Prior to A.02.00

Marker To

There is no 'Marker To' functionality supported in Spurious Emissions, so this front-panel key displays a blank menu when pressed.

Key Path	Front-panel key
Initial S/W Revision	Prior to A.02.00

Meas

The information in this section is common to all measurements. For key and remote command information for a specific measurement, refer to the section that describes the measurement of interest.

Measurements available under the Meas key are specific to the current Mode.

When viewing Help for measurements, note the following:

NOTE

Operation for some keys differs between measurements. The information displayed in Help pertains to the current measurement. To see how a key operates in a different measurement, exit Help (press the Cancel Esc key), select the measurement, then reenter Help (press the Help key) and press that key.

Key Path	Front-panel key
Initial S/W Revision	Prior to A.02.00

Remote Measurement Functions

This section contains the following topics:

["Measurement Group of Commands" on page 2206](#)

["Current Measurement Query \(Remote Command Only\)" on page 2208](#)

["Limit Test Current Results \(Remote Command Only\)" on page 2208](#)

["Data Query \(Remote Command Only\)" on page 2208](#)

["Calculate/Compress Trace Data Query \(Remote Command Only\)" on page 2209](#)

["Calculate Peaks of Trace Data \(Remote Command Only\)" on page 2214](#)

[Hardware-Accelerated Fast Power Measurement \(Remote Command Only\)](#)

["Format Data: Numeric Data \(Remote Command Only\)" on page 2215](#)

["Format Data: Byte Order \(Remote Command Only\)" on page 2216](#)

Initial S/W Revision	Prior to A.02.00
----------------------	------------------

Measurement Group of Commands

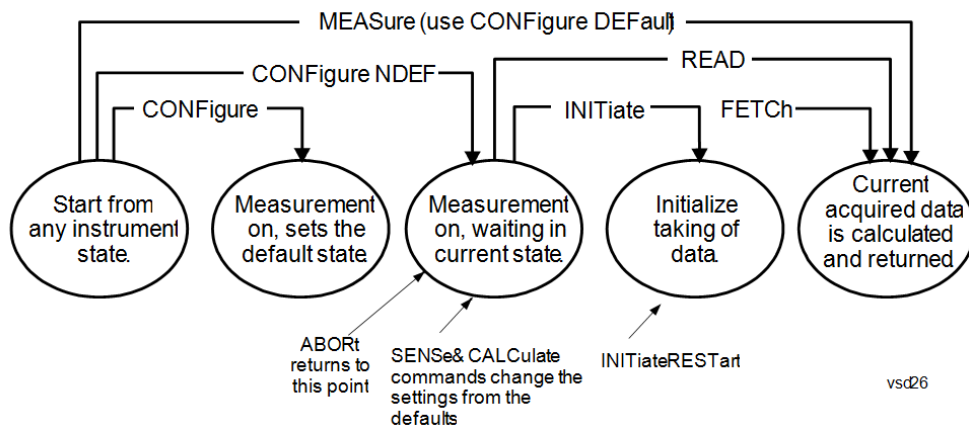

Measure Commands:

:MEASure:<measurement>[n]?

This is a fast single-command way to make a measurement using the factory default instrument settings. These are the settings and units that conform to the Mode Setup settings (e.g. radio standard) that you have currently selected.

- Stops the current measurement (if any) and sets up the instrument for the specified measurement using the factory defaults
- Initiates the data acquisition for the measurement
- Blocks other SCPI communication, waiting until the measurement is complete before returning results.
- If the function does averaging, it is turned on and the number of averages is set to 10.
- After the data is valid it returns the scalar results, or the trace data, for the specified measurement. The type of data returned may be defined by an [n] value that is sent with the command.
- The scalar measurement results will be returned if the optional [n] value is not included, or is set to 1. If the [n] value is set to a value other than 1, the selected trace data results will be returned. See each command for details of what types of scalar results or trace data results are available.
- ASCII is the default format for the data output. (Older versions of Spectrum Analysis and Phase Noise mode measurements only use ASCII.) The binary data formats should be used for handling large blocks of data since they are smaller and faster than the ASCII format. Refer to the FORMat:DATA command for more information.

If you need to change some of the measurement parameters from the factory default settings you can set up the measurement with the CONFigure command. Use the commands in the SENSE:<measurement> and CALCulate:<measurement> subsystems to change the settings. Then you can use the READ? command to initiate the measurement and query the results.

If you need to repeatedly make a given measurement with settings other than the factory defaults, you can use the commands in the SENSE:<measurement> and CALCulate:<measurement> subsystems to set up the measurement. Then use the READ? command to initiate the measurement and query results.

Measurement settings persist if you initiate a different measurement and then return to a previous one. Use READ:<measurement>? if you want to use those persistent settings. If you want to go back to the default settings, use MEASure:<measurement>?.

Configure Commands:

:CONFigure:<measurement>

This command stops the current measurement (if any) and sets up the instrument for the specified measurement using

the factory default instrument settings. It does not initiate the taking of measurement data unless INIT:CONTInuous is ON. If you change any measurement settings after using the CONFigure command, the READ command can be used to initiate a measurement without changing the settings back to their defaults.

In the Swept SA measurement in Spectrum Analyzer mode the CONFigure command also turns the averaging function on and sets the number of averages to 10 for all measurements.

:CONFigure: <measurement>: NDEFault stops the current measurement and changes to the specified measurement. It does not change the settings to the defaults. It does not initiate the taking of measurement data unless INIT:CONTInuous is ON.

The CONFigure? query returns the current measurement name.

The CONFigure:CATalog? query returns a quoted string of all licensed measurement names in the current mode. For example, "SAN, CHP, OBW, ACP, PST, TXP, SPUR, SEM, LIST".

Fetch Commands:

:FETCh:<measurement>[n]?

This command puts selected data from the most recent measurement into the output buffer. Use FETCh if you have already made a good measurement and you want to return several types of data (different [n] values, for example, both scalars and trace data) from a single measurement. FETCh saves you the time of re-making the measurement. You can only FETCh results from the measurement that is currently active, it will not change to a different measurement. An error message is reported if a measurement other than the current one is specified.

If you need to get new measurement data, use the READ command, which is equivalent to an INITiate followed by a FETCh.

The scalar measurement results will be returned if the optional [n] value is not included, or is set to 1. If the [n] value is set to a value other than 1, the selected trace data results will be returned. See each command for details of what types of scalar results or trace data results are available. The binary data formats should be used for handling large blocks of data since they are smaller and transfer faster than the ASCII format. (FORMat:DATA)

FETCh may be used to return results other than those specified with the original READ or MEASure command that you sent.

INITiate Commands:

:INITiate:<measurement>

This command is not available for measurements in all the instrument modes:

- Initiates a trigger cycle for the specified measurement, but does not output any data. You must then use the FETCh<meas> command to return data. If a measurement other than the current one is specified, the instrument will switch to that measurement and then initiate it.
- For example, suppose you have previously initiated the ACP measurement, but now you are running the channel power measurement. If you send INIT:ACP? it will change from channel power to ACP and will initiate an ACP measurement.
- Does not change any of the measurement settings. For example, if you have previously started the ACP measurement and you send INIT:ACP? it will initiate a new ACP measurement using the same instrument settings as the last time ACP was run.
- If your selected measurement is currently active (in the idle state) it triggers the measurement, assuming the trigger conditions are met. Then it completes one trigger cycle. Depending upon the measurement and the number of averages, there may be multiple data acquisitions, with multiple trigger events, for one full trigger cycle. It also holds off additional commands on GPIB until the acquisition is complete.

READ Commands:

:READ:<measurement>[n]?

- Does not preset the measurement to the factory default settings. For example, if you have previously initiated the ACP
-

measurement and you send READ:ACP? it will initiate a new measurement using the same instrument settings.

- Initiates the measurement and puts valid data into the output buffer. If a measurement other than the current one is specified, the instrument will switch to that measurement before it initiates the measurement and returns results.
 - For example, suppose you have previously initiated the ACP measurement, but now you are running the channel power measurement. Then you send READ:ACP? It will change from channel power back to ACP and, using the previous ACP settings, will initiate the measurement and return results.
 - Blocks other SCPI communication, waiting until the measurement is complete before returning the results
 - If the optional [n] value is not included, or is set to 1, the scalar measurement results will be returned. If the [n] value is set to a value other than 1, the selected trace data results will be returned. See each command for details of what types of scalar results or trace data results are available. The binary data formats should be used when handling large blocks of data since they are smaller and faster than the ASCII format. (FORMat:DATA)
-

Initial S/W Revision	Prior to A.02.00
----------------------	------------------

Current Measurement Query (Remote Command Only)

This command returns the name of the measurement that is currently running.

Remote Command	:CONFigure?
-----------------------	-------------

Example	CONF?
----------------	-------

Initial S/W Revision	Prior to A.02.00
----------------------	------------------

Limit Test Current Results (Remote Command Only)

Queries the status of the current measurement limit testing. It returns a 0 if the measured results pass when compared with the current limits. It returns a 1 if the measured results fail any limit tests.

Remote Command	:CALCulate:CLIMits:FAIL?
-----------------------	--------------------------

Example	CALC:CLIM:FAIL? queries the current measurement to see if it fails the defined limits. Returns a 0 or 1: 0 it passes, 1 it fails.
----------------	--

Initial S/W Revision	Prior to A.02.00
----------------------	------------------

Data Query (Remote Command Only)

Returns the designated measurement data for the currently selected measurement and subopcode.

n = any valid subopcode for the current measurement. See the measurement command results table for your current measurement, for information about what data is returned for the subopcodes.

This command uses the data setting specified by the FORMat:BOReDer and FORMat:DATA commands and can return real or ASCII data. (See the format command descriptions under Input/Output in the Analyzer Setup section.)

Remote Command	:CALCulate:DATA[n]?
Notes	The return trace depends on the measurement. In CALCulate:<meas>:DATA[n], n is any valid subopcode for the current measurement. It returns the same data as the FETCH:<measurement>? query where <measurement> is the current measurement.
Initial S/W Revision	Prior to A.02.00

Calculate/Compress Trace Data Query (Remote Command Only)

Returns compressed data for the currently selected measurement and sub-opcode [n].

n = any valid sub-opcode for that measurement. See the MEASure:<measurement>? command description of your specific measurement for information on the data that can be returned.

The data is returned in the current Y Axis Unit of the analyzer. The command is used with a sub-opcode <n> (default=1) to specify the trace. With trace queries, it is best if the analyzer is not sweeping during the query. Therefore, it is generally advisable to be in Single Sweep, or Update=Off.

This command is used to compress or decimate a long trace to extract and return only the desired data. A typical example would be to acquire N frames of GSM data and return the mean power of the first burst in each frame. The command can also be used to identify the best curve fit for the data.

Remote Command	:CALCulate:DATA<n>:COMPRESS? BLOCK CFIT MAXimum MINimum MEAN DMEan RMS RMSCubed SAMPLE SDEVIation PPHase [,<soffset> [,<length>[,<roffset>[,<rlimit>]]]]
Example	To query the mean power of a set of GSM bursts: Supply a signal that is a set of GSM bursts. Select the IQ Waveform measurement (in IQ Analyzer Mode). Set the sweep time to acquire at least one burst. Set the triggers such that acquisition happens at a known position relative to a burst. Then query the mean burst levels using, CALC:DATA2:COMP? MEAN, 24e-6, 526e-6 (These parameter values correspond to GSM signals, where 526e-6 is the length of the burst in the slot and you just want 1 burst.)
Notes	The command supports 5 parameters. Note that the last 4 (<soffset>, <length>, <roffset>, <rlimit>) are optional. But these optional parameters must be entered in the specified order. For example, if you want to specify <length>, then you must also specify <soffset>. See details below for a definition of each of these parameters. This command uses the data in the format specified by FORMat:DATA, returning either binary or ASCII data.
Initial S/W Revision	Prior to A.02.00

- BLOCK or block data - returns all the data points from the region of the trace data that you specify. For example, it could be used to return the data points of an input signal over several timeslots, excluding the portions of the trace data that you do not want. (This is x,y pairs for trace data and I,Q pairs for complex data.)

- CFIT or curve fit - applies curve fitting routines to the data. <soffset> and <length> are required to define the data that you want. <roffset> is an optional parameter for the desired order of the curve equation. The query will return the following values: the x-offset (in seconds) and the curve coefficients ((order + 1) values).

MIN, MAX, MEAN, DME, RMS, RMSC, SAMP, SDEV and PPH return one data value for each specified region (or <length>) of trace data, for as many regions as possible until you run out of trace data (using <roffset> to specify regions). Or they return the number of regions you specify (using <rlimit>) ignoring any data beyond that.

- MINimum - returns the minimum data point (y value) for the specified region(s) of trace data. For I/Q trace data, the minimum magnitude of the I/Q pairs is returned.
- MAXimum - returns the maximum data point (y value) for the specified region(s) of trace data. For I/Q trace data, the maximum magnitude of the I/Q pairs is returned.
- MEAN - returns a single value that is the arithmetic mean of the data point values (in dB/ dBm) for the specified region(s) of trace data. For I/Q trace data, the mean of the magnitudes of the I/Q pairs is returned. See the following equations.

•

NOTE

If the original trace data is in dB, this function returns the arithmetic mean of those log values, not log of the mean power which is a more useful value. The mean of the log is the better measurement technique when measuring CW signals in the presence of noise. The mean of the power, expressed in dB, is useful in power measurements such as Channel Power. To achieve the mean of the power, use the RMS option.

Equation 1

Mean Value of Data Points for Specified Region(s)

$$MEAN = \frac{1}{n} \sum_{X_i \in \text{region}(s)} X_i$$

where X_i is a data point value, and n is the number of data points in the specified region(s).

Equation 2

Mean Value of I/Q Data Pairs for Specified Region(s)

$$MEAN = \frac{1}{n} \sum_{X_i \in \text{region}(s)} |X_i|$$

where $|X_i|$ is the magnitude of an I/Q pair, and n is the number of I/Q pairs in the specified region(s).

- DMEan - returns a single value that is the mean power (in dB/ dBm) of the data point values for the specified region(s) of trace data. See the following equation:

Equation 3

DMEan Value of Data Points for Specified Region(s)

$$\text{DME} = 10 \times \log_{10} \left(\frac{1}{n} \sum_{X_i \in \text{region}(s)} 10^{\frac{X_i}{10}} \right)$$

- RMS - returns a single value that is the average power on a root-mean-squared voltage scale (arithmetic rms) of the data point values for the specified region(s) of trace data. See the following equation.

NOTE

For I/Q trace data, the rms of the magnitudes of the I/Q pairs is returned. See the following equation. This function is very useful for I/Q trace data. However, if the original trace data is in dB, this function returns the rms of the log values which is not usually needed.

Equation 4

RMS Value of Data Points for Specified Region(s)

$$\text{RMS} = \sqrt{\frac{1}{n} \sum_{X_i \in \text{region}(s)} X_i^2}$$

where X_i is a data point value, and n is the number of data points in the specified region(s).

Equation 5

RMS Value of I/Q Data Pairs for Specified Region(s)

$$\text{RMS} = \sqrt{\frac{1}{n} \sum_{X_i \in \text{region}(s)} X_i X_i^*}$$

where X_i is the complex value representation of an I/Q pair, X_i^* its conjugate complex number, and n is the number of I/Q pairs in the specified region(s).

Once you have the rms value for a region of trace data (linear or I/Q), you may want to calculate the mean power. You must convert this rms value (peak volts) to power in dBm:

$$10 \times \log[10 \times (\text{rms value})^2]$$

- SAMPLe - returns the first data value (x,y pair) for the specified region(s) of trace data. For I/Q trace data, the first I/Q pair is returned.
- SDEVIation - returns a single value that is the arithmetic standard deviation for the data point values for the specified region(s) of trace data. See the following equation.
- For I/Q trace data, the standard deviation of the magnitudes of the I/Q pairs is returned. See the following equation.

Equation 6

Standard Deviation of Data Point Values for Specified Region(s)

$$\text{SDEV} = \sqrt{\frac{1}{n} \sum_{X_i \in \text{region}(s)} (X_i - \bar{X})^2}$$

where X_i is a data point value, \bar{X} is the arithmetic mean of the data point values for the specified region (s), and n is the number of data points in the specified region(s).

$$\text{SDEV} = \sqrt{\frac{1}{n} \sum_{X_i \in \text{region}(s)} (|X_i| - \bar{X})^2}$$

where $|X_i|$ is the magnitude of an I/Q pair, \bar{X} is the mean of the magnitudes for the specified region(s), and n is the number of data points in the specified region(s).

- PPHase - returns the x,y pairs of both rms power (dBm) and arithmetic mean phase (radian) for every specified region and frequency offset (Hz). The number of pairs is defined by the specified number of regions. This parameter can be used for I/Q vector ($n=0$) in Waveform (time domain) measurement and all parameters are specified by data point in PPHase.

The rms power of the specified region may be expressed as:

$$\text{Power} = 10 \times \log [10 \times (\text{RMS I/Q value})] + 10.$$

The RMS I/Q value (peak volts) is:

$$\sqrt{\frac{1}{n} \sum_{X_i \in \text{region}} X_i X_i^*}$$

where X_i is the complex value representation of an I/Q pair, X_i^* its conjugate complex number, and n is the number of I/Q pairs in the specified region.

The arithmetic mean phase of the specified region may be expressed as:

$$\frac{1}{n} \sum_{Y_i \in \text{region}} Y_i$$

where Y_i is the unwrapped phase of I/Q pair with applying frequency correction and n is the number of I/Q pairs in the specified region.

The frequency correction is made by the frequency offset calculated by the arithmetic mean of every specified region's frequency offset. Each frequency offset is calculated by the least square method against the unwrapped phase of I/Q pair.

Sample Trace Data - Constant Envelope

(See below for explanation of variables.)

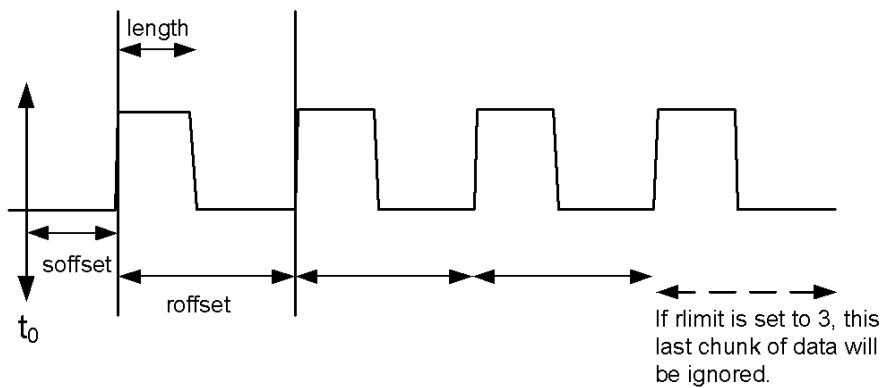

Sample Trace Data - Not Constant Envelope

(See below for explanation of variables.)

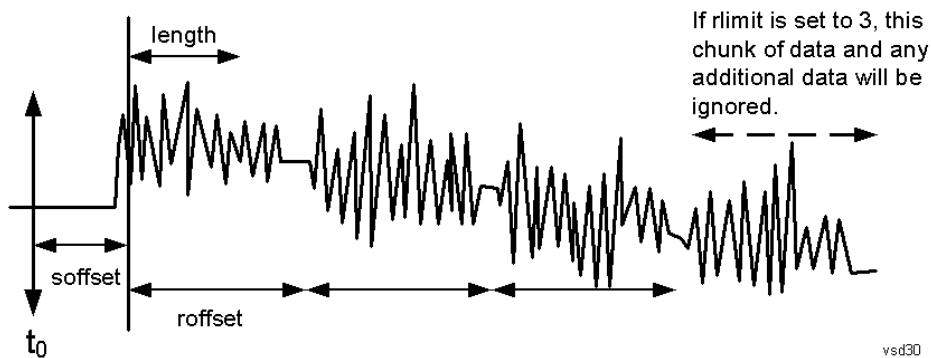

<soffset> - start offset is an optional real number. (It is in seconds for time-domain traces, and is a dimensionless index 0 to Npoints - 1, for frequency-domain traces). It specifies the amount of data at the beginning of the trace that will be ignored before the decimation process starts. It is the time or frequency change from the start of the trace to the point where you want to start using the data. The default value is zero.

<length> - is an optional real number. (It is in seconds for time-domain traces, and is a dimensionless index 0 to Npoints - 1, for frequency-domain traces). It defines how much data will be compressed into one value. This parameter has a default value equal to the current trace length.

<roffset> - repeat offset is an optional real number. (It is in seconds for time-domain traces, and is a dimensionless index 0 to Npoints - 1, for frequency-domain traces). It defines the beginning of the next field of trace elements to be compressed. This is relative to the beginning of the previous field. This parameter has a default value equal to the <length> variable. Note that this parameter is used for a completely different purpose when curve fitting (see CFIT above).

<rlimit> - repeat limit is an optional integer. It specifies the number of data items that you want returned. It will ignore any additional items beyond that number. You can use the Start offset and the Repeat limit to pick out exactly what part of the data you want to use. The default value is all the data.

Calculate Peaks of Trace Data (Remote Command Only)

Returns a list of all the peaks for the currently selected measurement and sub-opcode [n]. The peaks must meet the requirements of the peak threshold and excursion values.

n = any valid sub-opcode for the current measurement. See the MEASure:<measurement> command description of your specific measurement for information on the data that can be returned.

The command can only be used with specific sub-opcodes with measurement results that are trace data. Both real and complex traces can be searched, but complex traces are converted to magnitude in dBm. In many measurements the sub-opcode n=0, is the raw trace data which cannot be searched for peaks. And Sub-opcode n=1, is often calculated results values which also cannot be searched for peaks.

This command uses the data setting specified by the FORMat:BORDER and FORMat:DATA commands and can return real or ASCII data. If the format is set to INT,32, it returns REAL,32 data.

The command has four types of parameters:

- Threshold (in dBm)
- Excursion (in dB)
- Sorting order (amplitude, frequency, time)
- Optional in some measurements: Display line use (all, > display line, < display line)

Remote Command	For Swept SA measurement: :CALCulate:DATA[1] 2 ... 6:PEAKs? <threshold>,<excursion>[,AMPLitude FREQuency TIME[,ALL GTDLine LTDLine]] For most other measurements: :CALCulate:DATA[1] 2 ... 6:PEAKs? <threshold>,<excursion>[,AMPLitude FREQuency TIME]
-----------------------	---

Example	Example for Swept SA measurement in Spectrum Analyzer Mode: CALC:DATA4:PEAK? -40, 10, FREQ, GTDL This will identify the peaks of trace 4 that are above -40 dBm, with excursions of at least 10 dB. The peaks are returned in order of increasing frequency, starting with the lowest frequency. Only the peaks that are above the display line are returned. Query Results 1: With FORMat:DATA REAL, 32 selected, it returns a list of floating-point numbers. The first value in the list is the number of peak points that are in the following list. A peak point consists of two values: a peak amplitude followed by its corresponding frequency (or time). If no peaks are found the peak list will consist of only the number of peaks, (0).
----------------	--

Notes	<n> - is the trace that will be used <threshold> - is the level below which trace data peaks are ignored. Note that the threshold value is required and is always used as a peak criterion. To effectively disable the threshold criterion for this command, provide a substantially low threshold value such as -200 dBm. Also note that the threshold value used in this command is independent of and has no effect on the threshold value stored under the Peak Criteria menu. <excursion> - is the minimum amplitude variation (rise and fall) required for a signal to be identified as peak. Note that the excursion value is required and is always used as a peak criterion. To effectively disable the excursion criterion for this command, provide the minimum value of 0.0 dB. Also note that the excursion value used in this command is independent of and has no effect on the
--------------	--

excursion value stored under the Peak Criteria menu.

Values must be provided for threshold and excursion. The sorting and display line parameters are optional (defaults are AMPLitude and ALL).

Note that there is always a Y-axis value for the display line, regardless of whether the display line state is on or off. It is the current Y-axis value of the display line which is used by this command to determine whether a peak should be reported

Sorting order:

AMPLitude - lists the peaks in order of descending amplitude, with the highest peak first (default if optional parameter not sent)

FREQUency - lists the peaks in order of occurrence, left to right across the x-axis.

TIME - lists the peaks in order of occurrence, left to right across the x-axis.

Peaks vs. Display Line:

ALL - lists all of the peaks found (default if optional parameter not sent).

GTDLine (greater than display line) - lists all of the peaks found above the display line.

LTDLine (less than display line) - lists all of the peaks found below the display line.

Initial S/W Revision Prior to A.02.00

Format Data: Numeric Data (Remote Command Only)

This command specifies the format of the trace data input and output. It specifies the formats used for trace data during data transfer across any remote port. It affects only the data format for setting and querying trace data for the :TRACe[:DATA], TRACe[:DATA]?, :CALCulate:DATA[n]? and FETCh:SANalyzer [n]? commands and queries.

Remote Command :FORMat[:TRACe][:DATA] ASCii|INTeger,32|REAL,32 |REAL,64
:FORMat[:TRACe][:DATA]?

Notes The query response is:
ASCii: ASC,8
REAL,32: REAL,32
REAL,64: REAL,64
INTeger,32: INT,32

When the numeric data format is REAL or ASCii, data is output in the current Y Axis unit. When the data format is INTeger, data is output in units of m dBm (.001 dBm).

The INT,32 format returns binary 32-bit integer values in internal units (m dBm), in a definite length block.

Dependencies Sending a data format spec with an invalid number (for example, INT,48) generates no error. The analyzer simply uses the default (8 for ASCii, 32 for INTeger, 32 for REAL).

Sending data to the analyzer which does not conform to the current FORMat specified, results in an error. Sending ASCII data when a definite block is expected generates message -161 "Invalid Block Data" and sending a definite block when ASCII data is expected generates message -121 "Invalid Character in Number".

Preset ASCii

Backwards Compatibility Notes Note that the INT,32 format is only applicable to the command, TRACe:DATA. This preserves backwards compatibility for the Swept SA measurement. For all other commands/queries which honor FORMat:DATA, if INT,32 is sent the analyzer will behave as though it were set to REAL,32.

Initial S/W Revision Prior to A.02.00

The specs for each output type follow:

AScii - Amplitude values are in ASCII, in the current Y Axis Unit, one ASCII character per digit, values separated by commas, each value in the form:

SX.YYYYYEsZZ

Where:

S = sign (+ or -)

X = one digit to left of decimal point

Y = 5 digits to right of decimal point

E = E, exponent header

s = sign of exponent (+ or -)

ZZ = two digit exponent

REAL,32 - Binary 32-bit real values in the current Y Axis Unit, in a definite length block.

REAL,64 - Binary 64-bit real values in the current Y Axis Unit, in a definite length block.

Format Data: Byte Order (Remote Command Only)

This command selects the binary data byte order for data transfer and other queries. It controls whether binary data is transferred in normal or swapped mode. This command affects only the byte order for setting and querying trace data for the :TRACe[:DATA], TRACe[:DATA]? , :CALCulate:DATA[n]? and FETCh:SANalyzer[n]? commands and queries.

By definition any command that says it uses FORMat:DATA uses any format supported by FORMat:DATA.

The NORMal order is a byte sequence that begins with the most significant byte (MSB) first, and ends with the least significant byte (LSB) last in the sequence: 1|2|3|4. SWAPped order is when the byte sequence begins with the LSB first, and ends with the MSB last in the sequence: 4|3|2|1.

Remote Command	:FORMat:BORDER NORMal SWAPped :FORMat:BORDER?
Preset	NORMal
Initial S/W Revision	Prior to A.02.00

Meas Setup

Displays the measurement setup menu for the currently selected measurement.

Key Path	Front-panel key
Initial S/W Revision	Prior to A.02.00

Avg/Hold Num

Specifies the number of measurement averages used to calculate the measurement result. The average is displayed at the end of each sweep.

Average State allows you to turn averaging on or off.

Key Path	Meas Setup
Mode	SA, WCDMA, C2K, WiMAX OFDMA, CDMA1xEVDO, TD-SCDMA, DVB-T/H, LTE, LTE-TDD, WLAN, MSR, LTE-AFDD, LTE-TDD
Remote Command	[:SENSe]:SPURious:AVERage:COUNT <integer> [:SENSe]:SPURious:AVERage:COUNT? [:SENSe]:SPURious:AVERage[:STATe] ON OFF 1 0 [:SENSe]:SPURious:AVERage[:STATe]?
Example	SPUR:AVER:COUN 2500 SPUR:AVER:COUN? SPUR:AVER ON SPUR:AVER?
Notes	You must be in the Spectrum Analysis mode, W-CDMA mode, cdma2000 mode, DVB-T/H mode, TD-SCDMA mode, LTE mode, LTE TDD mode, WLAN mode, MSR, LTE-Advanced FDD/TDD mode or WiMAX mode to use this command. Use INSTRument:SElect to set the mode.
Preset	10 OFF
State Saved	Saved in instrument state.
Min	1
Max	10000
Initial S/W Revision	Prior to A.02.00
Modified at S/W Revision	A.03.00

Avg Mode

Enables you to set the averaging mode.

- When set to Exponential (Exp) the measurement averaging continues using the specified number of averages to compute each averaged value. The average will be displayed at the end of each sweep.

- When set to Repeat, the measurement resets the average counter each time the specified number of averages is reached.

Key Path	Meas Setup
Mode	SA, WCDMA, WIMAX OFDMA, TD-SCDMA, DVB-T/H, LTE, LTETDD, WLAN, MSR, LTEAFDD, LTEATDD
Remote Command	[:SENSe] :SPURious:AVErAge:TCONtrol EXPonential REPeat [:SENSe] :SPURious:AVErAge:TCONtrol?
Example	SPUR:AVER:TCON REP SPUR:AVER:TCON?
Notes	You must be in the cdma2000 mode, TD-SCDMA mode, W-CDMA mode, DVB-T/H mode, GSM/EDGE mode, LTE mode, LTE TDD mode, WLAN mode, MSR, LTE-Advanced FDD/TDD mode or WiMAX mode to use this command. Use INSTRUMENT:SElect to set the mode.
Preset	EXPonential
State Saved	Saved in instrument state.
Range	Exp Repeat
Initial S/W Revision	Prior to A.02.00
Modified at S/W Revision	A.03.00

Range Table

Enables you to set range parameters.

To change a parameter, select the appropriate menu softkey and enter the value using the numeric keypad or the knob. The analyzer settings will be updated with the new parameter values.

When the current view is the Range Table view, the selected range is highlighted and displayed in the Range Table automatically. With the normal window arrangement, up to five ranges are displayed. In the zoom mode, all 20 ranges can be displayed.

In the Range Table window, there are three tables corresponding to each page of the Range Table menu. When the Range Table key is pressed, the table of the first menu page is displayed.

The Displayed table is changed by changing the Range Table menu page. It can also be changed by a remote command. When the Range Table is changed by the command, the menu page changes accordingly if the Range Table menu is displayed.

Key Path	Meas Setup
Initial S/W Revision	Prior to A.02.00

Range

Changing the range updates the values on the other menu keys so that they reflect the settings for the selected range. If Range is turned on, it will be used as part of the measurement. If it is off, it will be excluded. A range is made up of the next fifteen parameters. This parameter can send up to 20 values. The

location in the list sent corresponds to the range the value is associated with. Missing values are not permitted; that is, if you want to change values 2 and 6 you must send all values up to 6. Subsequent values will remain as they were. The query for this parameter always returns 20 values.

Key Path	Meas Setup, Range Table
Mode	SA, WCDMA, C2K, 1xEV-DO, WIMAX OFDMA, TD-SCDMA, DVB-T/H, LTE, LTE-TDD, MSR, LTEAFDD, LTEATDD
Remote Command	:DISPlay:SPURious:VIEW:RANGe[:SElect] <integer> :DISPlay:SPURious:VIEW:RANGe[:SElect]? [:SENSe]:SPURious[:RANGe][:LIST]:STATe ON OFF 1 0, ON OFF 1 0, ON OFF 1 0, ON OFF 1 0, ON OFF 1 0, ON OFF 1 0, ON OFF 1 0, ON OFF 1 0, ON OFF 1 0, ON OFF 1 0, ON OFF 1 0, ON OFF 1 0, ON OFF 1 0, ON OFF 1 0, ON OFF 1 0, ON OFF 1 0, ON OFF 1 0, ON OFF 1 0 [:SENSe]:SPURious[:RANGe][:LIST]:STATe?
Example	DISP:SPUR:VIEW:RANG 2 DISP:SPUR:VIEW:RANG? SPUR:STAT ON SPUR:STAT?
Notes	You must be in cdma2000 mode, TD-SCDMA mode, W-CDMA mode, DVB-T/H mode, GSM/EDGE mode, LTE mode, LTE TDD mode, MSR, LTE-Advanced FDD/TDD mode or WiMAX mode to use this command. Use INSTRument:SElect to set the mode.
Preset	1 SA, WIMAX OFDMA: ON, ON, ON, ON, ON, OFF, OFF, OFF, OFF, OFF, OFF, OFF, OFF, OFF, OFF, OFF, OFF, OFF, OFF, OFF WCDMA: ON, ON, ON, ON, ON, ON, ON, ON, OFF, OFF, OFF, OFF, OFF, OFF, OFF, OFF, OFF, OFF, OFF, OFF C2k, 1xEV-DO: ON, ON, ON, ON, OFF, OFF, OFF, OFF, OFF, OFF, OFF, OFF, OFF, OFF, OFF, OFF, OFF, OFF, OFF, OFF TD-SCDMA: ON, ON, ON, ON, OFF, OFF, OFF, OFF, OFF, OFF, OFF, OFF, OFF, OFF, OFF, OFF, OFF, OFF, OFF, OFF, OFF DVB-T/H: ON, ON, ON, ON, ON, ON, OFF, OFF, OFF, OFF, OFF, OFF, OFF, OFF, OFF, OFF, OFF, OFF, OFF, OFF, OFF LTE, MSR, LTEAFDD: ON, ON, ON, ON, ON, ON, ON, ON, OFF, OFF, OFF, OFF, OFF, OFF, OFF, OFF, OFF, OFF, OFF, OFF LTE-TDD, LT LTEATDD: OFF, OFF, ON, ON, ON, ON, ON, OFF, OFF, OFF, OFF, OFF, OFF, OFF, OFF, OFF, OFF, OFF, OFF, OFF, OFF
State Saved	Not saved in State
Min	1
Max	20
Initial S/W Revision	Prior to A.02.00
Modified at S/W Revision	A.03.00, A.10.00

Start Freq

Sets the start frequency of the analyzer. This parameter can send up to 20 values. The location where the start frequency occurs in the list sent to the measurement corresponds to the range the value is associated with.

Missing values are not permitted. If you want to change values 2 and 6 you must send all values up to 6. Subsequent values will remain as they were. The query for this parameter always returns 20 values.

Key Path	Meas Setup, Range Table
Mode	SA, WCDMA, C2K, WIMAX OFDMA, TD-SCDMA, 1xEV-DO, DVB-T/H, LTE, LTETDD, WLAN
Remote Command	[[:SENSE]:SPURious[:RANGE][:LIST]:FREQuency:STARt <freq>, <freq>, <freq>, <freq>, <freq>, <freq>, <freq>, <freq>, <freq>, <freq>, <freq>, <freq>, <freq>, <freq>, <freq>, <freq>, <freq>, <freq>, <freq>, <freq>] [[:SENSe]:SPURious[:RANGE][:LIST]:FREQuency:STARt?
Example	SPUR:FREQ:STAR 9 kHz, 150 kHz, 30 MHz, 1GHz, 1.5 GHz, 1.5 GHz, 1.5 GHz, 1.5 GHz, 1.5 GHz, 1.5 GHz, 1.5 GHz, 1.5 GHz, 1.5 GHz, 1.5 GHz, 1.5 GHz, 1.5 GHz, 1.5 GHz, 1.5 GHz, 1.5 GHz, 1.5 GHz SPUR:FREQ:STAR?
Notes	You must be in cdma2000 mode, TD-SCDMA mode, W-CDMA mode, DVB-T/H, GSM/EDGE mode, LTE mode, LTE TDD mode, WLAN mode, MSR or WiMAX mode to use this command. Use INSTRument:SElect to set the mode.
Preset	SA, WIMAX OFDMA:+1.92000000E+009, +1.89350000E+009, +2.10000000E+009, +2.17500000E+009, +8.00000000E+008, +1.50000000E+009, +1.50000000E+009, +1.50000000E+009, +1.50000000E+009, +1.50000000E+009, +1.50000000E+009, +1.50000000E+009, +1.50000000E+009, +1.50000000E+009, +1.50000000E+009, +1.50000000E+009, +1.50000000E+009, +1.50000000E+009, +1.50000000E+009, +1.50000000E+009 WCDMA:9kHz, 150kHz, 30MHz, 1GHz, 2.1GHz, 2.1GHz, 2.1774GHz, 2.18GHz, 1.5GHz, 1.5GHz, 1.5GHz, 1.5GHz, 1.5GHz, 1.5GHz, 1.5GHz, 1.5GHz, 1.5GHz, 1.5GHz, 1.5GHz, 1.5GHz C2K, 1xEV-DO: 9kHz, 150kHz, 30 MHz, 1GHz, 2.5GHz, 2.5GHz, 2.5GHz, 2.5 GHz, 2.5 GHz, 2.5 GHz, 2.5 GHz, 2.5 GHz, 2.5 GHz, 2.5 GHz, 2.5 GHz, 2.5 GHz, 2.5 GHz, 2.5 GHz, 2.5 GHz, 2.5 GHz TD-SCDMA: 9 kHz, 150 kHz, 30 MHz, 1GHz, 1.5 GHz, 1.5 GHz, 1.5 GHz, 1.5 GHz, 1.5 GHz, 1.5 GHz, 1.5 GHz, 1.5 GHz, 1.5 GHz, 1.5 GHz, 1.5 GHz, 1.5 GHz, 1.5 GHz, 1.5 GHz, 1.5 GHz, 1.5 GHz DVB-T/H: 9kHz, 174MHz, 400MHz, 790MHz, 862MHz, 1GHz, 1.5GHz, 1.5GHz, 1.5GHz, 1.5GHz, 1.5GHz, 1.5GHz, 1.5GHz, 1.5GHz, 1.5GHz, 1.5GHz, 1.5GHz, 1.5GHz, 1.5GHz, 1.5GHz, 1.5GHz, 1.5GHz LTE, MSR: 9 kHz, 150 kHz, 30 MHz, 1 GHz, 1.92GHz, 1.98 GHz, 2.18 GHz, 1.5 GHz, 1.5 GHz, 1.5 GHz, 1.5 GHz, 1.5 GHz, 1.5 GHz, 1.5 GHz, 1.5 GHz, 1.5 GHz, 1.5 GHz, 1.5 GHz, 1.5 GHz, 1.5 GHz, 1.5 GHz, 1.5 GHz LTETDD: 9 kHz, 150 kHz, 30 MHz, 1 GHz, 1.90GHz, 2.01 GHz, 2.025 GHz, 1.5 GHz, 1.5 GHz, 1.5 GHz, 1.5 GHz, 1.5 GHz, 1.5 GHz, 1.5 GHz, 1.5 GHz, 1.5 GHz, 1.5 GHz, 1.5 GHz, 1.5 GHz, 1.5 GHz, 1.5 GHz, 1.5 GHz WLAN: 9 kHz, 150 kHz, 30 MHz, 1 GHz, 1.5 GHz, 1.5 GHz, 1.5 GHz, 1.5 GHz, 1.5 GHz, 1.5 GHz, 1.5 GHz, 1.5 GHz, 1.5 GHz, 1.5 GHz, 1.5 GHz, 1.5 GHz, 1.5 GHz, 1.5 GHz, 1.5 GHz, 1.5 GHz, 1.5 GHz
State Saved	Saved in instrument state.
Min	-80 MHz

Max	Hardware Dependent: Option 503: 3699999990 Option 508: 8499999990 Option 513: 1379999990 Option 526: 2699999990
Initial S/W Revision	Prior to A.02.00
Modified at S/W Revision	A.03.00

Stop Freq

Sets the stop frequency of the analyzer. This parameter can send up to 20 values.

The location of where the stop frequency occurs in the list sent to the measurement corresponds to the range the value is associated with.

Missing values are not permitted. If you want to change values 2 and 6 you must send all values up to 6. Subsequent values will remain as they were. The query for this parameter always returns 20 values.

Key Path	Meas Setup, Range Table
Mode	SA, WCDMA, C2K, WIMAX OFDMA, TD-SCDMA, 1xEV-DO, DVB-T/H, WLAN
Remote Command	[:SENSE] : SPURious [:RANGE] [:LIST] : FREQuency : STOP <freq>, <freq>, <freq>, <freq>, <freq>, <freq>, <freq>, <freq>, <freq>, <freq>, <freq>, <freq>, <freq>, <freq>, <freq>, <freq>, <freq>, <freq> [:SENSe] : SPURious [:RANGE] [:LIST] : FREQuency : STOP?
Example	SPUR:FREQ:STOP 150kHz, 30MHz, 1GHz, 2.1GHz, 2.1GHz, 2.1774GHz, 2.18GHz, 12.75GHz, 2.5GHz, 2.5GHz, 2.5GHz, 2.5GHz, 2.5GHz, 2.5GHz, 2.5GHz, 2.5GHz, 2.5GHz, 2.5GHz, 2.5GHz, 2.5GHz SPUR:FREQ:STOP?
Notes	You must be in cdma2000 mode, TD-SCDMA mode, W-CDMA mode, DVB-T/H, GSM/EDGE mode, LTE mode, LTE TDD mode, WLAN mode, MSR or WiMAX mode to use this command. Use INSTRument:SElect to set the mode.
Preset	SA, WIMAX OFDMA: +1.98000000E+009, +1.91960000E+009, +2.10150000E+009, +2.18000000E+009, +1.00000000E+009, +2.50000000E+009, +2.50000000E+009, +2.50000000E+009, +2.50000000E+009, +2.50000000E+009, +2.50000000E+009, +2.50000000E+009, +2.50000000E+009, +2.50000000E+009, +2.50000000E+009, +2.50000000E+009, +2.50000000E+009, +2.50000000E+009, +2.50000000E+009 WCDMA: 150kHz, 30MHz, 1GHz, 2.1GHz, 2.1GHz, 2.1774GHz, 2.18GHz, 12.75GHz, 2.5GHz, 2.5GHz, 2.5GHz, 2.5GHz, 2.5GHz, 2.5GHz, 2.5GHz, 2.5GHz, 2.5GHz, 2.5GHz, 2.5GHz, 2.5GHz C2K, 1xEV-DO: 150kHz, 30 MHz, 1GHz, 5GHz, 2.5GHz, 2.5GHz, 2.5GHz, 2.5 GHz, 2.5 GHz, 2.5 GHz, 2.5 GHz, 2.5 GHz, 2.5 GHz, 2.5 GHz, 2.5 GHz, 2.5 GHz, 2.5 GHz, 2.5 GHz, 2.5 GHz TD-SCDMA: 150kHz, 30 MHz, 1GHz, 12.75GHz, 2.5 GHz, 2.5 GHz, 2.5 GHz, 2.5 GHz, 2.5 GHz, 2.5 GHz, 2.5 GHz, 2.5 GHz, 2.5 GHz, 2.5 GHz, 2.5 GHz, 2.5 GHz, 2.5 GHz DVB-T/H: 174MHz, 400MHz, 790MHz, 862MHz, 1GHz, 4.5GHz, 2.5GHz, 2.5GHz, 2.5GHz

	2.5GHz, 2.5GHz, 2.5GHz, 2.5GHz, 2.5GHz, 2.5GHz, 2.5GHz, 2.5GHz, 2.5GHz, 2.5GHz, 2.5GHz LTE, MSR: 150kHz, 30MHz, 1GHz, 1.92GHz, 1.98GHz, 2.1GHz, 12.75GHz, 2.5GHz, 2.5GHz, 2.5GHz, 2.5GHz, 2.5GHz, 2.5GHz, 2.5GHz, 2.5GHz, 2.5GHz, 2.5GHz, 2.5GHz, 2.5GHz LTETDD: 150kHz, 30MHz, 1GHz, 1.90GHz, 2.01GHz, 2.025GHz, 12.75GHz, 2.5GHz, 2.5GHz, 2.5GHz, 2.5GHz, 2.5GHz, 2.5GHz, 2.5GHz, 2.5GHz, 2.5GHz, 2.5GHz, 2.5GHz, 2.5GHz WLAN: 150 kHz, 30 MHz, 1 GHz, 12.75 GHz, 2.5 GHz, 2.5 GHz, 2.5 GHz, 2.5 GHz, 2.5 GHz, 2.5 GHz, 2.5 GHz, 2.5 GHz, 2.5 GHz, 2.5 GHz, 2.5 GHz, 2.5 GHz, 2.5 GHz, 2.5 GHz, 2.5 GHz, 2.5 GHz, 2.5 GHz, 2.5 GHz
State Saved	Saved in instrument state.
Min	-79999990
Max	Hardware Dependent: Option 503: 3.7 GHz Option 508: 8.5 GHz Option 513: 13.8 GHz Option 526: 27.0 GHz
Initial S/W Revision	Prior to A.02.00
Modified at S/W Revision	A.03.00

Res BW

Sets the resolution bandwidth of the analyzer. This parameter can send up to 20 values.

The location of where the resolution bandwidth occurs in the list sent to the measurement corresponds to the range the value is associated with.

Missing values are not permitted. In other words, if you want to change values 2 and 6 you must send all values up to 6. Subsequent values will remain as they were. The query for this parameter always returns 20 values.

Key Path	Meas Setup, Range Table
Mode	SA, WCDMA, C2K, WIMAX OFDMA, TD-SCDMA, 1xEV-DO, DVB-T/H, LTE, LTETDD, WLAN, MSR, LTEAFDD, LTEATDD
Remote Command	[:SENSe] : SPURious [:RANGe] [:LIST] : BANDwidth [:RESolution] <freq>, <freq>, <freq>, <freq>, <freq>, <freq>, <freq>, <freq>, <freq>, <freq>, <freq>, <freq>, <freq>, <freq>, <freq>, <freq>, <freq>, <freq>, <freq>, <freq> [:SENSe] : SPURious [:RANGe] [:LIST] : BANDwidth [:RESolution] ? [:SENSe] : SPURious [:RANGe] [:LIST] : BANDwidth [:RESolution] : AUTO OFF ON 0 1, OFF ON 0 1 [:SENSe] : SPURious [:RANGe] [:LIST] : BANDwidth [:RESolution] : AUTO?
Example	SPUR:BAND 1kHz, 10kHz, 100kHz, 1MHz, 1MHz, 1MHz, 1MHz, 3MHz, 3MHz, 3MHz, 3MHz,

	<p>3MHz, 3MHz, 3MHz, 3MHz, 3MHz, 3MHz, 3MHz, 3MHz, 3MHz</p> <p>SPUR:BAND?</p> <p>SPUR:BWID:AUTO ON, ON, ON, OFF, OFF, OFF, OFF, OFF, ON, ON, ON, ON, OFF, OFF, OFF, OFF, OFF, OFF, ON, ON</p> <p>SPUR:BWID:AUTO?</p>
Notes	<p>You must be in cdma2000 mode, TD-SCDMA mode, W-CDMA mode, DVB-T/H, GSM/EDGE mode, LTE mode, LTE TDD mode, WLAN mode, MSR, LTE-Advanced FDD/TDD mode or WiMAX mode to use this command. Use INSTRument:SElect to set the mode.</p>
Preset	<p>SA, WIMAX OFDMA:1.2MHz, 0.51MHz, 0.1MHz, 0.1MHz, 4MHz, 3MHz, 3MHz, 3MHz, 3MHz, 3MHz, 3MHz, 3MHz, 3MHz, 3MHz, 3MHz, 3MHz, 3MHz, 3MHz, 3MHz, 3MHz, 3MHz</p> <p>WCDMA:1kHz, 10kHz, 100kHz, 1MHz, 1MHz, 1MHz, 1MHz, 1MHz, 3MHz, 3MHz, 3MHz, 3MHz, 3MHz, 3MHz, 3MHz, 3MHz, 3MHz, 3MHz, 3MHz, 3MHz, 3MHz</p> <p>C2k, 1xEV-DO: 1kHz, 10kHz, 100kHz, 1MHz, 1MHz, 1MHz, 1MHz, 3MHz, 3MHz, 3MHz, 3MHz, 3MHz, 3MHz, 3MHz, 3MHz, 3MHz, 3MHz, 3MHz, 3MHz, 3MHz, 3MHz</p> <p>TD-SCDMA: 1kHz, 10kHz, 100kHz, 1MHz, 3MHz, 3MHz, 3MHz, 3MHz, 3MHz, 3MHz, 3MHz, 3MHz, 3MHz, 3MHz, 3MHz, 3MHz, 3MHz, 3MHz, 3MHz, 3MHz, 3MHz</p> <p>DVB-T/H: 100kHz, 3.9kHz, 100kHz, 3.9kHz, 100kHz, 100kHz, 3MHz, 3MHz, 3MHz, 3MHz, 3MHz, 3MHz, 3MHz, 3MHz, 3MHz, 3MHz, 3MHz, 3MHz, 3MHz, 3MHz, 3MHz</p> <p>LTE, MSR, LTEAFDD: 1kHz, 10kHz, 100kHz, 1MHz, 100kHz, 1MHz, 1MHz, 3MHz, 3MHz, 3MHz, 3MHz, 3MHz, 3MHz, 3MHz, 3MHz, 3MHz, 3MHz, 3MHz, 3MHz, 3MHz, 3MHz</p> <p>LTETDD, LTEATDD: 1kHz, 10kHz, 100kHz, 1MHz, 1MHz, 1MHz, 1MHz, 3MHz, 3MHz, 3MHz, 3MHz, 3MHz, 3MHz, 3MHz, 3MHz, 3MHz, 3MHz, 3MHz, 3MHz, 3MHz, 3MHz</p> <p>WLAN:</p> <p>1kHz, 10kHz, 100kHz, 1MHz, 3MHz, 3MHz, 3MHz, 3MHz, 3MHz, 3MHz, 3MHz, 3MHz, 3MHz, 3MHz, 3MHz, 3MHz, 3MHz, 3MHz, 3MHz, 3MHz, 3MHz</p> <p>SA, WIMAX OFDMA:OFF, OFF, OFF, OFF, OFF, ON, ON, ON, ON, ON, ON, ON, ON, ON, ON, ON, ON, ON, ON, ON, ON, ON, ON, ON</p> <p>WCDMA:OFF, OFF, OFF, OFF, OFF, OFF, OFF, OFF, ON, ON, ON, ON, ON, ON, ON, ON, ON, ON, ON, ON, ON, ON, ON, ON</p> <p>C2k, 1xEV-DO:OFF, OFF, OFF, OFF, OFF, OFF, OFF, ON, ON, ON, ON, ON, ON, ON, ON, ON, ON, ON, ON, ON, ON, ON, ON, ON</p> <p>TD-SCDMA: OFF, OFF, OFF, OFF, ON</p> <p>DVB-T/H:</p> <p>OFF, OFF, OFF, OFF, OFF, OFF, ON, ON, ON, ON, ON, ON, ON, ON, ON, ON, ON, ON, ON, ON, ON, ON, ON, ON</p> <p>LTE, MSR, LTEAFDD: OFF, OFF, OFF, OFF, OFF, OFF, OFF, ON, ON, ON, ON, ON, ON, ON, ON, ON, ON, ON, ON, ON, ON, ON, ON, ON</p> <p>LTETDD, LTEATDD: OFF, OFF, OFF, OFF, OFF, OFF, OFF, ON, ON, ON, ON, ON, ON, ON, ON, ON, ON, ON, ON, ON, ON, ON, ON, ON</p> <p>WLAN:</p> <p>OFF, OFF, OFF, OFF, ON</p>
State Saved	<p>Saved in instrument state.</p>
Min	<p>1 Hz</p>

Max	8 MHz
Backwards Compatibility SCPI	[:SENSE] : SPURious [:RANGE] [:LIST] : BWIDth [:RESolution]
Initial S/W Revision	Prior to A.02.00
Modified at S/W Revision	A.03.00

Video BW

Sets the Video BW mode of the analyzer. This can be Auto, where the analyzer determines the optimum setting, or Manual, where you determine the setting. This parameter can send up to 20 values. The location in the list sent corresponds to the range the value is associated with. Missing values are not permitted; that is, if you want to change values 2 and 6 you must send all values up to 6. Subsequent values will remain as they were. The query for this parameter always returns 20 values.

Key Path	Meas Setup, Range Table
Mode	SA, WCDMA, C2K, WIMAX OFDMA, TD-SCDMA, 1xEV-DO, DVB-T/H, LTE, LTETDD, WLAN, MSR, LTEAFDD, LTEATDD
Remote Command	<pre>[:SENSE] : SPURious [:RANGE] [:LIST] : BANDwidth : VIDeo <freq>, <freq>, <freq>, <freq>, <freq>, <freq>, <freq>, <freq>, <freq>, <freq>, <freq>, <freq>, <freq>, <freq>, <freq>, <freq>, <freq>, <freq>, <freq> [:SENSE] : SPURious [:RANGE] [:LIST] : BANDwidth : VIDeo? [:SENSE] : SPURious [:RANGE] [:LIST] : BANDwidth : VIDeo : AUTO OFF ON 0 1, OFF ON 0 1 [:SENSE] : SPURious [:RANGE] [:LIST] : BANDwidth : VIDeo : AUTO?</pre>
Example	<pre>SPUR:BAND:VID 1kHz, 10kHz, 100kHz, 1MHz, 1MHz, 1MHz, 1MHz, 3MHz, 3MHz, 3MHz, 3MHz, 3MHz, 3MHz, 3MHz, 3MHz, 3MHz, 3MHz, 3MHz, 3MHz, 3MHz, 3MHz SPUR:BAND:VID? SPUR:BAND:VID:AUTO ON, ON, OFF, OFF, OFF, ON, ON, ON, OFF, OFF, OFF, OFF, OFF, OFF, ON, ON, ON, ON, ON SPUR:BAND:VID:AUTO?</pre>
Notes	You must be in the cdma2000 mode, 1xEV-DO mode, TD-SCDMA mode, W-CDMA mode, DVB-T/H mode, GSM/EDGE mode, LTE mode, LTE TDD mode, WLAN mode, MSR, LTE-Advanced FDD/TDD mode or WiMAX mode to use this command. Use INSTRUMENT:SElect to set the mode.
Preset	<p>SA, WCDMA, C2K, WIMAX OFDMA, TD-SCDMA, 1xEV-DO, DVB-T/H WLAN: Automatically calculated</p> <p>LTE, MSR, LTEATDD: 4.7kHz, 47kHz, 470kHz, 5MHz, 470kHz, 5MHz, 5MHz, 300kHz, 300kHz, 300kHz, 300kHz, 300kHz, 300kHz, 300kHz, 300kHz, 300kHz, 300kHz, 300kHz, 300kHz, 300kHz</p> <p>LTETDD, LTEATDD: 4.7kHz, 47kHz, 470kHz, 5MHz, 470kHz, 5MHz, 5MHz, 300kHz, 300kHz, 300kHz, 300kHz, 300kHz, 300kHz, 300kHz, 300kHz, 300kHz, 300kHz, 300kHz, 300kHz, 300kHz</p> <p>ON, ON, ON, ON, ON, ON, ON, ON, ON, ON, ON, ON, ON, ON, ON, ON, ON, ON, ON, ON</p>

Abs Start Limit

Determines the limit above which spurs will report a failing. If Abs Stop Limit Mode is set to Auto, this is coupled to Abs Stop Limit to make a flat limit line. If set to Man, Abs Start Limit and Abs Stop Limit can take different values to make a sloped limit line.

If the Limit Line Test parameter is off then any spurs which are found to be above the current 'Peak Excursion' will be added to the results table. From these spurs, the amplitude will be checked using the abs limit start and abs limit stop parameters and then calculate the limit. An 'F' will be appended to the amplitude value of the spur if the measured amplitude is above the limit. If the Limit Line Test is on, only the spurs whose amplitudes exceed the limit will be reported.

This parameter can send up to 20 values. The location in the list sent corresponds to the range of the associated value. Missing values are not permitted. If you want to change values 2 and 6 you must send all values up to 6. Subsequent values will remain as they were. The query for this parameter always returns 20 values.

Key Path	Meas Setup, Range Table
Mode	SA, WCDMA, C2K, WIMAX OFDMA, TD-SCDMA, 1xEV-DO, DVB-T/H, LTE, LTETDD, WLAN, MSR, LTEAFDD, LTEATDD
Remote Command	:CALCulate:SPURious[:RANGe][:LIST]:LIMit:ABSolute[:UPPer]:DATA[:START] <ampl>, <ampl>, <ampl>, <ampl>, <ampl>, <ampl>, <ampl>, <ampl>, <ampl>, <ampl>, <ampl>, <ampl>, <ampl>, <ampl>, <ampl>, <ampl>, <ampl>, <ampl>, <ampl>, <ampl> :CALCulate:SPURious[:RANGe][:LIST]:LIMit:ABSolute[:UPPer]:DATA[:START]?
Example	CALC:SPUR:LIM:ABS:DATA 0, 0, 0, 0, 0, 0, 0, 0, 0, 0, 0, 0, 0, 0, 0, 0, 0, 0, 0, 0 CALC:SPUR:LIM:ABS:DATA?
Preset	SA, WIMAX OFDMA: -5.00000000E+001, -5.00000000E+001, -5.00000000E+001, -5.00000000E+001, -5.00000000E+001, -5.00000000E+001, -5.00000000E+001, -5.00000000E+001, -5.00000000E+001, -5.00000000E+001, -5.00000000E+001, -5.00000000E+001, -5.00000000E+001, -5.00000000E+001, -5.00000000E+001, -5.00000000E+001, -5.00000000E+001, -5.00000000E+001, -5.00000000E+001, -5.00000000E+001 WCDMA: -36dBm, -36dBm, -36dBm, -30dBm, -25dBm, -15dBm, -25dBm, -30dBm, -50dBm, -50dBm, -50dBm, -50dBm, -50dBm, -50dBm, -50dBm, -50dBm, -50dBm, -50dBm, -50dBm, -50dBm, -50dBm C2K, 1xEV-DO: -13 dBm, -13dBm, -13 dBm, -13 dBm, -50 dBm, -50 dBm, -50 dBm, -50 dBm, -50 dBm, -50 dBm, -50 dBm, -50 dBm, -50 dBm, -50 dBm, -50 dBm, -50 dBm, -50 dBm, -50 dBm, -50 dBm, -50 dBm TD-SCDMA: -13 dBm, -13dBm, -13 dBm, -13 dBm, -50 dBm, -50 dBm, -50 dBm, -50 dBm, -50 dBm, -50 dBm, -50 dBm, -50 dBm, -50 dBm, -50 dBm, -50 dBm, -50 dBm, -50 dBm, -50 dBm, -50 dBm, -50 dBm DVB-T/H: -36dBm, -82dBm, -36dBm, -76dBm, -36dBm, -30dBm, -50dBm, -50dBm, -50dBm, -50dBm, -50dBm, -50dBm, -50dBm, -50dBm, -50dBm, -50dBm, -50dBm, -50dBm, -50dBm, -50dBm, -50dBm LTE, MSR, LTEAFDD: -36dBm, -36dBm, -36dBm, -30dBm, -96dBm, -30dBm, -30dBm, -50dBm, -50dBm, -50dBm, -50dBm, -50dBm, -50dBm, -50dBm, -50dBm, -50dBm, -50dBm, -50dBm, -50dBm, -50dBm, -50dBm

	-50dBm, -50dBm, -50dBm, -50dBm, -50dBm, -50dBm, -50dBm, -50dBm, -50dBm, -50dBm, -50dBm, -50dBm
	LTETDD, LTEATDD: -36dBm, -36dBm, -36dBm, -30dBm, -96dBm, -30dBm, -30dBm, -50dBm, -50dBm, -50dBm, -50dBm, -50dBm, -50dBm, -50dBm, -50dBm, -50dBm, -50dBm, -50dBm, -50dBm, -50dBm
	WLAN: -36dBm, -36dBm, -36dBm, -30dBm, -50dBm, -50dBm, -50dBm, -50dBm, -50dBm, -50dBm, -50dBm, -50dBm, -50dBm, -50dBm, -50dBm, -50dBm, -50dBm, -50dBm, -50dBm, -50dBm
State Saved	Saved in instrument state.
Min	-150.0 dBm
Max	50.0 dBm
Initial S/W Revision	Prior to A.02.00
Modified at S/W Revision	A.03.00

Abs Stop Limit

Abs Stop Limit is used to determine the limit above which spurs will report a failing. If Abs Stop Limit Mode is set to Auto, this is coupled to Abs Start Limit to make a flat limit line. If set to Man, Abs Start Limit and Abs Stop Limit can take different values to make a sloped limit line.

Abs Stop Limit Mode, when set to Couple, couples Abs Start Limit and Abs Stop Limit to make a flat limit line. If set to Man, Abs Start and Abs Stop can take different values to make a sloped limit line.

This parameter can send up to 20 values. The location in the list sent corresponds to the range of the associated value. Missing values are not permitted; that is, if you want to change values 2 and 6 you must send all values up to 6. Subsequent values will remain as they were. The query for this parameter always returns 20 values.

Key Path	Meas Setup, Range Table
Mode	SA, WCDMA, C2K, WIMAX OFDMA, TD-SCDMA, 1xEV-DO, DVB-T/H, LTE, LTETDD, WLAN, MSR, LTEAFDD, LTEATDD
Remote Command	<pre> :CALCulate:SPURious[:RANGE][:LIST]:LIMit:ABSolute[:UPPer]:DATA:STOP <ampl>, <ampl>, <ampl>, <ampl>, <ampl>, <ampl>, <ampl>, <ampl>, <ampl>, <ampl>, <ampl>, <ampl>, <ampl>, <ampl>, <ampl>, <ampl>, <ampl>, <ampl>, <ampl>, <ampl>, <ampl>, <ampl> :CALCulate:SPURious[:RANGE][:LIST]:LIMit:ABSolute[:UPPer]:DATA:STOP? :CALCulate:SPURious[:RANGE][:LIST]:LIMit:ABSolute [:UPPer]:DATA:STOP:AUTO OFF ON 0 1, OFF ON 0 1, OFF ON 0 1, OFF ON 0 1, OFF ON 0 1, OFF ON 0 1, OFF ON 0 1, OFF ON 0 1, OFF ON 0 1, OFF ON 0 1, OFF ON 0 1, OFF ON 0 1, OFF ON 0 1, OFF ON 0 1, OFF ON 0 1, OFF ON 0 1, OFF ON 0 1, OFF ON 0 1, OFF ON 0 1, OFF ON 0 1 :CALCulate:SPURious[:RANGE][:LIST]:LIMit:ABSolute [:UPPer]:DATA:STOP:AUTO? </pre>
Example	CALC:SPUR:LIM:ABS:DATA:STOP -25, -25, -25, -25, -25, -25, -25, -25, -25, -25, -25, -

	<p>25, -25, -25, -25, -25, -25, -25, -25</p> <p>CALC:SPUR:LIM:ABS:DATA:STOP?</p> <p>CALC:SPUR:LIM:ABS:DATA:STOP:AUTO ON, ON, ON, ON, ON, ON, ON, ON, ON, ON, ON, ON, ON, ON, ON, ON, ON, ON, ON, ON</p> <p>CALC:SPUR:LIM:ABS:DATA:STOP:AUTO?</p>
Preset	<p>SA, WIMAX OFDMA: -5.00000000E+001, -5.00000000E+001, -5.00000000E+001, -5.00000000E+001, -5.00000000E+001, -5.00000000E+001, -5.00000000E+001, -5.00000000E+001, -5.00000000E+001, -5.00000000E+001, -5.00000000E+001, -5.00000000E+001, -5.00000000E+001, -5.00000000E+001, -5.00000000E+001, -5.00000000E+001, -5.00000000E+001, -5.00000000E+001</p> <p>WCDMA: -36dBm, -36dBm, -36dBm, -30dBm, -25dBm, -15dBm, -25dBm, -30dBm, -50dBm, -50dBm, -50dBm, -50dBm, -50dBm, -50dBm, -50dBm, -50dBm, -50dBm, -50dBm, -50dBm, -50dBm, -50dBm</p> <p>C2K, 1xEV-DO:</p> <p>-13 dBm, -13dBm, -13 dBm, -13 dBm, -50 dBm, -50 dBm, -50 dBm, -50 dBm, -50 dBm, -50 dBm, -50 dBm, -50 dBm, -50 dBm, -50 dBm, -50 dBm, -50 dBm, -50 dBm, -50 dBm, -50 dBm</p> <p>TD-SCDMA:</p> <p>-13 dBm, -13dBm, -13 dBm, -13 dBm, -50 dBm, -50 dBm, -50 dBm, -50 dBm, -50 dBm, -50 dBm, -50 dBm, -50 dBm, -50 dBm, -50 dBm, -50 dBm, -50 dBm, -50 dBm, -50 dBm, -50 dBm</p> <p>DVB-T/H:</p> <p>-36dBm, -82dBm, -36dBm, -76dBm, -36dBm, -30dBm, -50dBm, -50dBm, -50dBm, -50dBm, -50dBm, -50dBm, -50dBm, -50dBm, -50dBm, -50dBm, -50dBm, -50dBm, -50dBm, -50dBm</p> <p>LTE, MSR, LTEAFDD: -36dBm, -36dBm, -36dBm, -30dBm, -96dBm, -30dBm, -30dBm, -50dBm, -50dBm, -50dBm, -50dBm, -50dBm, -50dBm, -50dBm, -50dBm, -50dBm, -50dBm, -50dBm, -50dBm, -50dBm, -50dBm</p> <p>LTETDD, LTEATDD: -36dBm, -36dBm, -36dBm, -52dBm, -52dBm, -30dBm, -30dBm, -50dBm, -50dBm, -50dBm, -50dBm, -50dBm, -50dBm, -50dBm, -50dBm, -50dBm, -50dBm, -50dBm, -50dBm, -50dBm, -50dBm</p> <p>WLAN:</p> <p>-36dBm, -36dBm, -36dBm, -30dBm, -50dBm, -50dBm, -50dBm, -50dBm, -50dBm, -50dBm, -50dBm, -50dBm, -50dBm, -50dBm, -50dBm, -50dBm, -50dBm, -50dBm, -50dBm, -50dBm</p> <p>ON, ON, ON, ON, ON, ON, ON, ON, ON, ON, ON, ON, ON, ON, ON, ON, ON, ON, ON, ON</p>
State Saved	Saved in instrument state.
Min	-150.0 dBm
Max	50.0 dBm
Initial S/W Revision	Prior to A.02.00
Modified at S/W Revision	A.03.00

Peak Excursion

Sets the minimum amplitude variation of signals that can be identified as peaks. If a value of 6 dB is selected, peaks that rise and fall more than 6 dB above the peak threshold value are identified.

This parameter can send up to 20 values. The location in the list sent corresponds to the range of the associated value. Missing values are not permitted. If you want to change values 2 and 6 you must send all values up to 6. Subsequent values will remain as they were. The query for this parameter always returns 20 values.

Key Path	Meas Setup, Range Table
Mode	SA, WCDMA, C2K, WIMAX OFDMA, TD-SCDMA, 1xEV-DO, DVB-T/H, LTE, LTETDD, WLAN, MSR, LTEAFDD, LTEATDD
Remote Command	[:SENSe] :SPURious [:RANGe] [:LIST] :PEAK:EXCursion <rel_ampl>, <rel_ampl>, <rel_ampl>, <rel_ampl>, <rel_ampl>, <rel_ampl>, <rel_ampl>, <rel_ampl>, <rel_ampl>, <rel_ampl>, <rel_ampl>, <rel_ampl>, <rel_ampl>, <rel_ampl>, <rel_ampl>, <rel_ampl>, <rel_ampl>, <rel_ampl>, <rel_ampl>, <rel_ampl> [:SENSe] :SPURious [:RANGe] [:LIST] :PEAK:EXCursion?
Example	SPUR:PEAK:EXC 20, 20 SPUR:PEAK:EXC?
Preset	+6.00000000E+000, +6.00000000E+000, +6.00000000E+000, +6.00000000E+000, +6.00000000E+000, +6.00000000E+000, +6.00000000E+000, +6.00000000E+000, +6.00000000E+000, +6.00000000E+000, +6.00000000E+000, +6.00000000E+000, +6.00000000E+000, +6.00000000E+000, +6.00000000E+000, +6.00000000E+000, +6.00000000E+000, +6.00000000E+000, +6.00000000E+000, +6.00000000E+000
State Saved	Saved in instrument state.
Min	0.0 dB
Max	100.0 dB
Initial S/W Revision	Prior to A.02.00
Modified at S/W Revision	A.03.00

Pk Threshold

Sets the minimum amplitude of signals that can be identified as peaks. For example, if a value of -90 dBm is selected, only peaks that rise and fall more than the peak excursion value which are above -90 dBm are identified.

This parameter can send up to 20 values. The location in the list sent corresponds to the range of the associated value. Missing values are not permitted. If you want to change values 2 and 6 you must send all values up to 6. Subsequent values will remain as they were. The query for this parameter always returns 20 values.

Key Path	Meas Setup, Range Table
Mode	SA, WCDMA, C2K, WIMAX OFDMA, TD-SCDMA, 1xEV-DO, DVB-T/H, LTE, LTETDD, WLAN, MSR, LTEAFDD, LTEATDD
Remote Command	[:SENSe] :SPURious [:RANGe] [:LIST] :PEAK:THReshold <real>, <real>, <real>, <real>, <real>, <real>, <real>, <real>, <real>, <real>, <real>, <real>, <real>, <real>, <real>, <real>, <real>, <real>, <real>, <real>

	<pre><real>, <real>, <real>, <real>, <real>, <real>, <real>, <real>, <real>, <real>, <real>, <real>, <real>, <real>, <real>, <real>, <real> [:SENSe]:SPURious[:RANGe][:LIST]:PEAK:THReshold?</pre>
Example	<pre>SPUR:PEAK:THR 0,0,0 SPUR:PEAK:THR?</pre>
Preset	<pre>-9.00000000E+001, -9.00000000E+001, -9.00000000E+001, -9.00000000E+001, - 9.00000000E+001, -9.00000000E+001, -9.00000000E+001, -9.00000000E+001, - 9.00000000E+001, -9.00000000E+001, -9.00000000E+001, -9.00000000E+001, - 9.00000000E+001, -9.00000000E+001, -9.00000000E+001, -9.00000000E+001, - 9.00000000E+001, -9.00000000E+001, -9.00000000E+001, -9.00000000E+001</pre>
State Saved	Saved in instrument state.
Min	-200
Max	0
Initial S/W Revision	Prior to A.02.00
Modified at S/W Revision	A.03.00, A.07.00

Attenuation

Defines attenuation value for each range.

- When Auto state is ON, attenuation value under AMPTD Y Scale is used.
- When Auto state is OFF, this value is used as mechanical attenuation value without electric attenuation.

Key Path	Meas Setup, Range Table
Mode	SA, WCDMA, C2K, WIMAX OFDMA, TD-SCDMA, 1xEV-DO, DVB-T/H, LTE, LTE-TDD, WLAN, MSR, LTE-AFDD, LTE-TDD
Remote Command	<pre>[:SENSe]:SPURious[:RANGe][:LIST]:ATTenuation <rel_ampl>, <rel_ampl>, <rel_ampl>, <rel_ampl>, <rel_ampl>, <rel_ampl>, <rel_ampl>, <rel_ampl>, <rel_ampl>, <rel_ampl>, <rel_ampl>, <rel_ampl>, <rel_ampl>, <rel_ampl>, <rel_ampl>, <rel_ampl>, <rel_ampl>, <rel_ampl>, <rel_ampl>, <rel_ampl> [:SENSe]:SPURious[:RANGe][:LIST]:ATTenuation? [:SENSe]:SPURious[:RANGe][:LIST]:ATTenuation:AUTO OFF ON 0 1, OFF ON 0 1, OFF ON 0 1, OFF ON 0 1, OFF ON 0 1, OFF ON 0 1, OFF ON 0 1, OFF ON 0 1, OFF ON 0 1, OFF ON 0 1, OFF ON 0 1, OFF ON 0 1, OFF ON 0 1, OFF ON 0 1, OFF ON 0 1, OFF ON 0 1, OFF ON 0 1, OFF ON 0 1, OFF ON 0 1, OFF ON 0 1 [:SENSe]:SPURious[:RANGe][:LIST]:ATTenuation:AUTO?</pre>
Example	<pre>SPUR:ATT 10dB, 10dB, 10dB, 10dB, 10dB, 10dB, 10dB, 10dB, 10dB, 10dB, 10dB, 10dB, 10dB, 10dB, 10dB, 10dB, 10dB, 10dB, 10dB, 10dB SPUR:ATT? SPUR:ATT:AUTO 0, 0, 0, 0, 0, 0, 0, 0, 0, 0, 0, 0, 0, 0, 0, 0, 0, 0, 0, 0 SPUR:ATT:AUTO?</pre>

Sweep Time

Sets the sweep time mode of the analyzer. This can be Auto, where the analyzer determines the optimum setting, or Manual, where you determine the setting.

This parameter can send up to 20 values. The location in the list sent corresponds to the range of the associated value. Missing values are not permitted. If you want to change values 2 and 6 you must send all values up to 6. Subsequent values will remain as they were. The query for this parameter always returns 20 values.

Key Path	Meas Setup, Range Table
Mode	SA, WCDMA, C2K, WIMAX OFDMA, TD-SCDMA, 1xEV-DO, DVB-T/H, LTE, LTETDD, WLAN, MSR, LTEAFDD, LTEATDD
Remote Command	<pre>[:SENSe]:SPURious[:RANGe][:LIST]:SWEep:TIME <time>, <time>, <time>, <time>, <time>, <time>, <time>, <time>, <time>, <time>, <time>, <time>, <time>, <time>, <time>, <time>, <time>, <time>, <time>, <time> [:SENSe]:SPURious[:RANGe][:LIST]:SWEep:TIME? [:SENSe]:SPURious[:RANGe][:LIST]:SWEep:TIME:AUTO OFF ON 0 1,OFF ON 0 1,OFF ON 0 1,OFF ON 0 1,OFF ON 0 1,OFF ON 0 1,OFF ON 0 1,OFF ON 0 1,OFF ON 0 1,OFF ON 0 1,OFF ON 0 1,OFF ON 0 1,OFF ON 0 1,OFF ON 0 1,OFF ON 0 1,OFF ON 0 1,OFF ON 0 1,OFF ON 0 1,OFF ON 0 1,OFF ON 0 1 [:SENSe]:SPURious[:RANGe][:LIST]:SWEep:TIME:AUTO?</pre>
Example	<pre>SPUR:SWE:TIME 10, 10 SPUR:SWE:TIME? SPUR:SWE:TIME:AUTO ON, ON, ON, ON, ON, ON, ON, ON, ON, ON, ON, ON, ON, ON, ON, ON, ON, ON, ON, ON SPUR:SWE:TIME:AUTO?</pre>
Notes	You must be in cdma2000 mode, TD-SCDMA mode, W-CDMA mode, DVB-T/H, SA mode, LTE mode, LTE TDD mode, WLAN mode, MSR, LTE-Advanced FDD/TDD mode or WiMAX mode to use this command. Use INSTRument:SElect to set the mode.
Preset	Automatically calculated
State Saved	Saved in instrument state.
Min	1.0E-3
Max	2.0E+3
Initial S/W Revision	Prior to A.02.00
Modified at S/W Revision	A.03.00

Points

Sets the number of points per sweep for the measurement. This parameter can send up to 20 values. The location in the list sent corresponds to the range of the associated value. Missing values are not permitted. If you want to change values 2 and 6 you must send all values up to 6. Subsequent values will remain as they were. The query for this parameter always returns 20 values.

The Points mode can be manual, where you determine the setting or auto, where the analyzer determines the number of trace points to ensure the sweep points resolution equals RBW/2. This is calculated using the following algorithm:

Points = (Stop Freq – Start Freq) / (ResBW / 2), with the computed values being clipped to a minimum of 601 and a maximum of 20001.

This parameter can send up to 20 values. The location in the list sent corresponds to the range the value is associated with. Missing values are not permitted; that is, if you want to change values 2 and 6 you must send all values up to 6. Subsequent values will remain as they were. The query for this parameter always returns 20 values.

Key Path	Meas Setup, Range Table
Mode	SA, WCDMA, C2K, WIMAX OFDMA, TD-SCDMA, 1xEV-DO, DVB-T/H, LTE, LTETDD, WLAN, MSR, LTEAFDD, LTEATDD
Remote Command	<pre>[:SENSe] :SPURious [:RANGe] [:LIST] :SWEep:POINts <integer> [:SENSe] :SPURious [:RANGe] [:LIST] :SWEep:POINts? [:SENSe] :SPURious [:RANGe] [:LIST] :SWEep:POINts:AUTO OFF ON 0 1, OFF ON 0 1, OFF ON 0 1, OFF ON 0 1, OFF ON 0 1, OFF ON 0 1, OFF ON 0 1, OFF ON 0 1, OFF ON 0 1, OFF ON 0 1, OFF ON 0 1, OFF ON 0 1, OFF ON 0 1, OFF ON 0 1, OFF ON 0 1, OFF ON 0 1, OFF ON 0 1, OFF ON 0 1, OFF ON 0 1, OFF ON 0 1</pre> <pre>[:SENSe] :SPURious [:RANGe] [:LIST] :SWEep:POINts:AUTO?</pre>
Example	<pre>SPUR:SWE:POIN 1001,1001,1001 SPUR:SWE:POIN? SPUR:SWE:POIN:AUTO ON,ON,ON SPUR:SWE:POIN:AUTO?</pre>
Preset	<pre>SA, WIMAX OFDMA, DVB-T/H, WLAN: +601, +601 WCDMA: 601, 2985, 9700, 1100, 601, 601, 601, 10570, 601, 601, 601, 601, 601, 601, 601, 601, 601, 601, 601, 601 C2K: 601, 601, 9970, 11750, , 601, 601, 601, 601, 601, 601, 601, 601, 601, 601, 601, 601, 601, 601, 601, 601 CDMA1xEVDO: 601, 601, 9970, 11750, 601, 601, 601, 10570, 601, 601, 601, 601, 601, 601, 601, 601, 601, 601, 601, 601 TD-SCDMA: 601, 5970, 19400, 20001, 601, 601, 601, 601, 601, 601, 601, 601, 601, 601, 601, 601, 601, 601, 601, 601, 601 LTE, LTETDD, MSR, LTEAFDD, LTEATDD : Automatically calculated. WLAN: Automatically calculated. OFF, OFF, OFF, OFF, OFF, OFF, OFF, OFF, OFF, OFF, OFF, OFF, OFF, OFF, OFF, OFF, OFF, OFF, OFF LTE, LTETDD, WLAN, MSR, LTEAFDD, LTEATDD: ON, ON, ON, ON, ON, ON, ON, ON, ON, ON, ON, ON, ON, ON, ON, ON, ON, ON, ON</pre>
State Saved	Saved in instrument state.
Min	101

Max	20001
Initial S/W Revision	Prior to A.02.00
Modified at S/W Revision	A.03.00

IF Gain

Sets the IF Gain function to Auto, On (the extra 10 dB) or Off. These settings affect sensitivity and IF overloads. A switched IF amplifier with approximately 10 dB of gain is available. This amplifier takes full advantage of the RF dynamic range of the analyzer. When it can be turned on without an overload, the dynamic range is always better with the amplifier on than off.

Key Path	Meas Setup, Range Table
Dependencies	The IF Gain keys (FFT IF Gain and Swept IF Gain) have no effect when the U7227A USB Preamplifier is connected. This is not annotated or reflected on any softkey; there are no keys grayed out nor any SCPI locked out. The analyzer simply behaves as though both FFT IF Gain and Swept IF Gain are set to Low regardless of the setting on the keys.
Initial S/W Revision	Prior to A.02.00

IF Gain Auto

Activates the rules for auto IF Gain.

Mode	SA, WCDMA, C2K, WIMAX OFDMA, TD-SCDMA, 1xEV-DO, DVB-T/H, LTE, LTE4DD, WLAN, MSR, LTEAFDD, LTEATDD
Remote Command	[:SENSe] : SPURious : IF : GAIN : AUTO [: STATE] OFF ON 0 1, OFF ON 0 1 1, OFF ON 0 1, OFF ON 0 1, OFF ON 0 1, OFF ON 0 1, OFF ON 0 1 1, OFF ON 0 1, OFF ON 0 1, OFF ON 0 1, OFF ON 0 1, OFF ON 0 1 1, OFF ON 0 1, OFF ON 0 1, OFF ON 0 1, OFF ON 0 1, OFF ON 0 1 1, OFF ON 0 1, OFF ON 0 1, OFF ON 0 1, OFF ON 0 1, OFF ON 0 1 [:SENSe] : SPURious : IF : GAIN : AUTO [: STATE] ?
Example	SPUR:IF:GAIN:AUTO ON,ON SPUR:IF:GAIN:AUTO?
Couplings	When the sweep type is Swept, 'Auto' sets IF Gain to High Gain under any of the following conditions: the input attenuator is set to 0 dB, the preamp is turned on, or the Max Mixer Level is -20 dBm or lower. For other settings using the swept sweep type, auto sets IF Gain to Low Gain.
Preset	OFF, OFF, OFF, OFF, OFF, OFF, OFF, OFF, OFF, OFF, OFF, OFF, OFF, OFF, OFF, OFF, OFF, OFF,
State Saved	Saved in instrument state.
Range	Auto Man
Initial S/W Revision	Prior to A.02.00
Modified at S/W Revision	A.03.00

IF Gain State

Selects the range of IF Gain.

Mode	SA, WCDMA, C2K, WIMAX OFDMA, TD-SCDMA, 1xEV-DO, DVB-T/H, LTE, LTE-TDD, WLAN, MSR, LTE-AFDD, LTE-TDD
Remote Command	[:SENSe] :SPURious:IF:GAIN[:STATe] OFF ON 0 1, OFF ON 0 1, OFF ON 0 1, OFF ON 0 1, OFF ON 0 1, OFF ON 0 1, OFF ON 0 1, OFF ON 0 1, OFF ON 0 1, OFF ON 0 1, OFF ON 0 1, OFF ON 0 1, OFF ON 0 1, OFF ON 0 1, OFF ON 0 1, OFF ON 0 1, OFF ON 0 1, OFF ON 0 1, OFF ON 0 1, OFF ON 0 1 [:SENSe] :SPURious:IF:GAIN[:STATe] ?
Example	SPUR:IF:GAIN ON,ON SPUR:IF:GAIN?
Preset	OFF, OFF, OFF, OFF, OFF, OFF, OFF, OFF, OFF, OFF, OFF, OFF, OFF, OFF, OFF, OFF, OFF, OFF
State Saved	Saved in instrument state.
Range	Low Gain (Best for Large Signals) High Gain (Best Noise Level)
Initial S/W Revision	Prior to A.02.00

Meas Type

Selects either Examine or Full measurement type. This parameter is coupled to the average mode. Therefore, if the examine measurement type is selected, the measurement sets the average mode to exponential. If the full measurement type is selected, the measurement sets the average mode to repeat. The behavior of each measurement type is described in the table below. When averaging is on, trace averaging is used as each active range is measured. Averaging is not used at any other time.

Type	Single	Continuous		
No Spurs Found	Spurs Found	No Spurs Found	Spurs Found	
Examine	All active ranges are measured. On completion the measurement is set to the idle state and the 'No Spurs' happening is displayed.	All active ranges are measured and the spurs found reported. On completion the measurement is set to the idle state and the trace containing the worst spur restored. The spur menu key is enabled. A marker is also added which is set to the frequency of the worst spur.	All active ranges are measured. On completion the SA remains set to last range checked with an active trace and the 'No Spurs' happening is displayed.	All active ranges are measured and the spurs found reported. On completion the SA is set to the range containing the worst spur found and continually sweeps this range. Note that the trace is continually updated but the metrics results aren't updated until restart to keep the initial results as references. Use marker readouts to refer the latest results. The spur menu key is enabled. A marker is also added which is set to the frequency of

Type	Single	Continuous		
No Spurs Found	Spurs Found	No Spurs Found	Spurs Found	Spurs Found
				the worst spur.
Full	All active ranges are measured. On completion measurement is set to idle state and the 'No Spurs' happening is displayed.	All active ranges are measured and spurs found reported. On completion the measurement is set to the idle state, displaying the trace of the last active range.	Measurement continually cycles through all active ranges.	All active ranges are measured and spurs found reported. On each cycle of the active ranges the spurs found are reset. This ensures any remote queries retrieve the trace data that matches the currently displayed results.

Key Path	Meas Setup
Mode	SA, WCDMA, C2K, WIMAX OFDMA, TD-SCDMA, 1xEV-DO, DVB-T/H, LTE, LTETDD, WLAN, MSR, LTEAFDD, LTEATDD
Remote Command	[:SENSe] :SPURious:TYPE EXAMine FULL [:SENSe] :SPURious:TYPE?
Example	SPUR:TYPE FULL SPUR:TYPE?
Preset	EXAMine
State Saved	Saved in instrument state.
Range	Examine Full
Initial S/W Revision	Prior to A.02.00
Modified at S/W Revision	A.03.00

Spur

Displays any spurs found. It is only enabled when the measurement type is set to examine and will turn on upon completion of a measurement. Once the Spur menu key has been enabled, you can view any spur. The measurement sets the analyzer to the range in which the currently selected spur was found. The range settings only changes if the spur selected is in a range which is different from the current range settings. A marker is used to identify the currently selected spur on the trace.

Key Path	Meas Setup
Mode	SA, WCDMA, C2K, WIMAX OFDMA, CDMA1xEVDO, TD-SCDMA, DVB-T/H, LTE, LTETDD, WLAN, MSR, LTEAFDD, LTEATDD
Remote Command	[:SENSe] :SPURious:SPUR <integer> [:SENSe] :SPURious:SPUR?
Example	SPUR:SPUR 55

SPUR:SPUR?	
Preset	1
State Saved	No
Min	1
Max	200
Initial S/W Revision	Prior to A.02.00
Modified at S/W Revision	A.03.00

Spurious Report Mode

Selects the spurious report mode.

- Select Limit Line Test (LIMTest) to report only spurs above the limit line. Any spurs reported will cause the measurement to fail. See Abs Start Limit for more information.
- Select All Spurs (ALL) to report all spurs detected by Peak Threshold and Peak Excursion.
- Select Minimum Margin (MMARgin) to report only the spur with the minimum margin from the limit line. For the spur above the limit, its margin is defined as the negative margin. If there are more than one spurs above the limit, only one spur with the largest negative margin is reported.

Key Path	Meas Setup
Mode	SA, WCDMA, C2K, WIMAX OFDMA, TD-SCDMA, 1xEV-DO, DVB-T/H, LTE, LTETDD, WLAN, MSR, LTEAFDD, LTEATDD
Remote Command	[:SENSe] : SPURious : REPT : MODE ALL LIMTest MMARgin [:SENSe] : SPURious : REPT : MODE ?
Example	SPUR:REPT:MODE LIMIT SPUR:REPT:MODE?
Dependencies	MMARgin is available only when option N9060A-7FP is installed.
Preset	ALL
State Saved	Saved in instrument state.
Range	All Spurs Limit Test Minimum Margin
Initial S/W Revision	Prior to A.02.00
Modified at S/W Revision	A.03.00, A.11.00

Meas Preset

Restores all measurement parameters to their default values.

Key Path	Meas Setup
Mode	SA, WCDMA, C2K, WIMAX OFDMA, TD-SCDMA, 1xEV-DO, DVB-T/H, LTE, LTETDD, WLAN, MSR, LTEAFDD, LTEATDD

Remote Command	:CONFigure:SPURious
Example	CONF:SPUR
Initial S/W Revision	Prior to A.02.00
Modified at S/W Revision	A.03.00

Fast Spurious Meas (Remote Command only)

This command is provided as the backward compatibility SCPI command of the Fast Spurious Measurement. Since this command is another representation of Spurious Report Mode, this command is coupled with the command.

When set to ON, only spurs above the limit line are reported. This is the same as Spurious Report Mode "LIMTest".

When set to OFF, all detected spurs are reported. This is the same as Spurious Report Mode "ALL."

Mode	SA, WCDMA, C2K, WIMAX OFDMA, TD-SCDMA, 1xEV-DO, DVB-T/H, WLAN, MSR, LTEAFDD, LTEATDD
Remote Command	[:SENSe] :SPURious:FSMeas ON OFF 1 0 [:SENSe] :SPURious:FSMeas?
Example	SPUR:FSM ON SPUR:FSM?
Couplings	If SPUR:REPT:MODE is ALL, this parameter is OFF. If SPUR:REPT:MODE is LIMTest, this parameter is ON.
Preset	OFF
State Saved	Saved in instrument state.
Initial S/W Revision	A.04.00

11 Spurious Emissions Measurement
Mode

Mode

See "[Mode](#)" on page 286

Mode Preset

Returns the active mode to a known state.

Mode Preset does the following for the currently active mode:

- Aborts the currently running measurement.
- Brings up the default menu for the mode, with no active function.
- Sets measurement Global settings to their preset values for the active mode only.
- Activates the default measurement.
- Brings up the default menu for the mode.
- Clears the input and output buffers.
- Sets Status Byte to 0.

Mode Preset does not:

- Cause a mode switch
- Affect mode persistent settings
- Affect system settings

See "[How-To Preset](#)" on page 1174 for more information.

Key Path	Front-panel key
Remote Command	:SYSTem:PRESet
Example	:SYST:PRES
Notes	*RST is preferred over :SYST:PRES for remote operation. *RST does a Mode Preset, as done by the :SYST:PRES command, and it sets the measurement mode to Single measurement rather than Continuous for optimal remote control throughput. Clears all pending OPC bits. The Status Byte is set to 0.
Couplings	A Mode Preset aborts the currently running measurement, activates the default measurement, and gets the mode to a consistent state with all of the default couplings set.
Backwards Compatibility Notes	In the X-Series, the legacy "Factory Preset" has been replaced with Mode Preset, which only presets the currently active mode, not the entire instrument. In the X-Series, the way to preset the entire instrument is by using System, Restore System Defaults All, which behaves essentially the same way as restore System Defaults does on ESA and PSA. There is also no "Preset Type" as there is on the PSA. There is a green Mode Preset front-panel key that does a Mode Preset and a white-with-green-letters User Preset front-panel key that does a User Preset. The old PRESet:TYPE command is ignored (without generating an error), and SYST:PRES without a parameter does a Mode Preset, which should cover most backward code compatibility issues. The settings and correction data under the Input/Output front-panel key (examples: Input Z Corr, Ext Amp Gain, etc.) are no longer part of any Mode, so they will not be preset by a Mode Preset. They are preset using Restore Input/Output Defaults, Restore System Defaults All. Note that because User Preset does a Recall State, and all of these settings are saved in State, they ARE recalled when using

	User Preset.
Initial S/W Revision	Prior to A.02.00

How-To Preset

The table below shows all possible presets, their corresponding SCPI commands and front-panel access (key paths). Instrument settings depend on the current measurement context. Some settings are local to the current measurement, some are global (common) across all the measurements in the current mode, and some are global to all the available modes. In a similar way, restoring the settings to their preset state can be done within the different contexts.

Auto Couple - is a measurement local key. It sets all Auto/Man parameter couplings in the measurement to Auto. Any Auto/Man selection that is local to other measurements in the mode will not be affected.

Meas Preset - is a measurement local key. Meas Preset resets all the variables local to the current measurement except the persistent ones.

Mode Preset - resets all the current mode's measurement local and measurement global variables except the persistent ones.

Restore Mode Defaults - resets ALL the Mode variables (and all the Meas global and Meas local variables), including the persistent ones.

Type Of Preset	SCPI Command	Front Panel Access
Auto Couple	:COUPle ALL	Auto Couple front-panel key
Meas Preset	:CONFigure:<Measurement>	Meas Setup Menu
Mode Preset	:SYSTem:PRESet	Mode Preset (green key)
Restore Mode Defaults	:INSTrument:DEFault	Mode Setup Menu
Restore All Mode Defaults	:SYSTem:DEFault MODEs	System Menu; Restore System Default Menu
*RST	*RST	not possible (Mode Preset with Single)
Restore Input/Output Defaults	:SYSTem:DEFault INPUt	System Menu; Restore System Default Menu
Restore Power On Defaults	:SYSTem:DEFault PON	System Menu; Restore System Default Menu
Restore Alignment Defaults	:SYSTem:DEFault ALIGN	System Menu; Restore System Default Menu
Restore Miscellaneous Defaults	:SYSTem:DEFault MISC	System Menu; Restore System Default Menu
Restore All System Defaults	:SYSTem:DEFault [ALL] :SYSTem:PRESet:PERsistent	System Menu; Restore System Default Menu
User Preset	:SYSTem:PRESet:USER	User Preset Menu
User Preset All Modes	:SYSTem:PRESet:USER:ALL	User Preset Menu

Power On Mode Preset	:SYSTem:PON:TYPE MODE	System Menu
Power On User Preset	:SYSTem:PON:TYPE USER	System Menu
Power On Last State	:SYSTem:PON:TYPE LAST	System Menu

Preset Type (Remote Command Only)

As stated in the Backward Compatibility section, to be compatible with ESA/PSA the PRESet:TYPE command will be implemented as a no-op.

Mode	All
Remote Command	:SYSTem:PRESet:TYPE FACTory MODE USER :SYSTem:PRESet:TYPE?
Example	:SYST:PRESet:TYPE FACT
Notes	This command is supported for backward compatibility only. It is a no-op which does not change the behavior of any preset operation.
Preset	This is unaffected by Preset but is set to Mode on a “Restore System Defaults->All”
State Saved	No
Initial S/W Revision	Prior to A.02.00

Mode Setup

See "[Mode Setup](#)" on page 316

Peak Search

Performs a peak search and opens the Peak Search menu. The Peak Search functions allow you to define specific search criteria to determine which signals can be considered peaks, excluding unwanted signals from the search.

Places the selected marker on the trace point with the maximum y-axis value for that marker's trace.

Key Path	Front-panel key
Mode	SA, WCDMA, C2K, WIMAX OFDMA, 1xEV-DO, DVB-T/H, LTE, LTETDD, WLAN, MSR, LTEAFDD, LTEATDD
Remote Command	:CALCulate:SPURious:MARKer[1] 2 ... 12:MAXimum
Example	CALC:SPUR:MARK2:MAX
Initial S/W Revision	Prior to A.02.00
Modified at S/W Revision	A.03.00

Next Peak

Moves the selected marker to the peak that has the next highest amplitude less than the current marker value.

Key Path	Peak Search
Mode	SA, WCDMA, C2K, WIMAX OFDMA, TD-SCDMA, 1xEV-DO, DVB-T/H, LTE, LTETDD, WLAN, MSR, LTEAFDD, LTEATDD
Remote Command	:CALCulate:SPURious:MARKer[1] 2 ... 12:MAXimum:NEXT
Example	CALC:SPUR:MARK2:MAX:NEXT
Initial S/W Revision	Prior to A.02.00
Modified at S/W Revision	A.03.00

Next Pk Right

Moves the selected marker to the nearest peak to the right of the current marker which meets all enabled peak criteria.

Key Path	Peak Search
Mode	SA, WCDMA, C2K, WIMAX OFDMA, TD-SCDMA, 1xEV-DO, DVB-T/H, LTE, LTETDD, WLAN
Remote Command	:CALCulate:SPURious:MARKer[1] 2 ... 12:MAXimum:RIGHT
Example	CALC:SPUR:MARK2:MAX:RIGH
Initial S/W Revision	Prior to A.02.00
Modified at S/W Revision	A.03.00

Next Pk Left

Moves the selected marker to the nearest peak to the left of the current marker which meets all enabled peak criteria.

Key Path	Peak Search
Mode	SA, WCDMA, C2K, WIMAX OFDMA, TD-SCDMA, 1xEV-DO, DVB-T/H, LTE, LTETDD, WLAN, MSR, LTEAFDD, LTEATDD
Remote Command	:CALCulate:SPURious:MARKer[1 2 ... 12:MAXimum:LEFT
Example	CALC:SPUR:MARK2:MAX:LEFT
Initial S/W Revision	Prior to A.02.00
Modified at S/W Revision	A.03.00

Marker Delta

Performs the same function as the Delta 1-of-N selection key in the Marker menu. This sets the control mode for the selected marker to Delta mode. See the Marker section for the complete description of this function. The key is duplicated here in the Peak Search Menu to allow you to conveniently perform a peak search and change the control of the Marker mode to Delta without having to access two separate menus.

Key Path	Peak Search
Initial S/W Revision	Prior to A.02.00

Pk-Pk Search

Finds and displays the amplitude and frequency (or time, if in zero span) differences between the highest and lowest y-axis value.

Key Path	Peak Search
Mode	SA, WCDMA, C2K, WIMAX OFDMA, TD-SCDMA, 1xEV-DO, DVB-T/H, LTE, LTETDD, WLAN, MSR, LTEAFDD, LTEATDD
Remote Command	:CALCulate:SPURious:MARKer[1 2 ... 12:PTPeak
Example	CALC:SPUR:MARK:PTP
Notes	Turns on the Marker Δ
Dependencies	This key is not available (key is grayed-out) when Coupled Markers is on.
Initial S/W Revision	Prior to A.02.00
Modified at S/W Revision	A.03.00

Min Search

Moves the selected marker to the minimum y-axis value on the current trace.

Key Path	Peak Search
Mode	SA, WCDMA, C2K, WIMAX OFDMA, TD-SCDMA, 1xEV-DO, DVB-T/H, LTE, LTETDD, WLAN, MSR, LTEAFDD, LTEATDD
Remote Command	:CALCulate:SPURious:MARKer[1] 2 ... 12:MINimum
Example	CALC:SPUR:MARK:MIN
Initial S/W Revision	Prior to A.02.00
Modified at S/W Revision	A.03.00

11 Spurious Emissions Measurement
Print

Print

See "[Print](#)" on page 341

Quick Save

The Quick Save front-panel key repeats the most recent save that was performed from the Save menu, with the following exceptions:

- Register saves are not remembered as Saves for the purpose of the Quick Save function
- If the current measurement does not support the last non-register save that was performed, an informational message is generated, “File type not supported for this measurement”

Quick Save repeats the last type of qualified save (that is, a save qualified by the above criteria) in the last save directory by creating a unique filename using the Auto File Naming algorithm described below.

If Quick Save is pressed after startup and before any qualified Save has been performed, the Quick Save function performs a Screen Image save using the current settings for Screen Image saves (current theme, current directory), which then becomes the “last save” for the purpose of subsequent Quick Saves.

The Auto File Naming feature automatically generates a file name for use when saving a file. The filename consists of a prefix and suffix separated by a dot, as is standard for the Windows® file system. A default prefix exists for each of the available file types:

Type	Default Prefix	Menu
State	State_	(Save/Recall)
Trace + State	State_	(Save/Recall)
Screen	Screen_	(Save/Recall)
Amplitude Corrections	Ampcor_	(Import/Export)
Traces	Trace_	(Import/Export)
Limit Lines	LLine_	(Import/Export)
Measurement Result	MeasR_	(Import/Export)
Capture Buffer	CapBuf_	(Import/Export)

A four digit number is appended to the prefix to create a unique file name. The numbering sequence starts at 0000 within each Mode for each file type and updates incrementally to 9999, then wraps to 0000 again. It remembers where it was through a Mode Preset and when leaving and returning to the Mode. It is reset by Restore Misc Defaults and Restore System Defaults and subsequent running of the instrument application. So, for example, the first auto file name generated for State files is State_0000.state. The next is State_0001, and so forth.

One of the key features of Auto File Name is that we guarantee that the Auto File Name will never conflict with an existing file. The algorithm looks for the next available number. If it gets to 9999, then it looks for holes. If it find no holes, that is no more numbers are available, it gives an error.

For example, if when we get to State_0010.state there is already a State_0010.state file in the current directory, it advances the counter to State_0011.state to ensure that no conflict will exist (and then it verifies that State_0011.state also does not exist in the current directory and advances again if it does, and so forth).

If you enter a file name for a given file type, then the prefix becomes the filename you entered instead of the default prefix, followed by an underscore. The last four letters (the suffix) are the 4-digit number.

For example, if you save a measurement results file as “fred.csv”, then the next auto file name chosen for a measurement results save will be fred_0000.csv.

NOTE

Although 0000 is used in the example above, the number that is used is actually the current number in the Meas Results sequence, that is, the number that would have been used if you had not entered your own file name.

NOTE

If the filename you entered ends with _dddd, where d=any number, making it look just like an auto file name, then the next auto file name picks up where you left off with the suffix being dddd + 1.

Key Path	Front-panel key
Notes	No remote command for this key specifically.
Initial S/W Revision	Prior to A.02.00

Recall

The Recall menu lets you choose what you want to recall, and where you want to recall it from. Among the types of files you can recall are **States and Traces**. In addition, an Import (Data) option lets you recall a number of data types stored in CSV files (as used by Excel and other spreadsheet programs).

The default paths for Recall are data type dependent and are the same as for the Save key.

Key Path	Front-panel key
Notes	<p>No remote command for this key specifically, but the :MMEM:LOAD command is available for specific file types. An example is :MMEM:LOAD:STATe <filename>.</p> <p>If you try to recall a State file for a mode that is not licensed or not available in the instrument, an error message will occur and the state will not change.</p>
Backwards Compatibility Notes	<p>In legacy analyzers, it was possible to load a state without affecting the trace data, limit lines or correction data. Similarly (since User Preset is actually loading a state), it was possible to do a User Preset without affecting the trace data, limit lines or correction data.</p> <p>In the X-Series, “state” always includes all of this data; so whenever state is loaded, all of the traces, limit lines and corrections are affected. Although this differs from previous behavior, it is desirable behavior, and should not cause adverse issues for users.</p>
Backwards Compatibility Notes	<p>Recall for the X-Series supports backward compatibility in the sense that you can recall a state file from any X-Series model number and any version of X-Series software. This is only possible if part of the recalling process goes through a limiting step after recalling the mode settings, at least for settings that may vary with version number, model number, option and license differences. If you try to recall a state file onto an instrument with less capability than what was available on the instrument during the save, the recall will ignore the state it doesn't support and it will limit the recalled setting to what it allows.</p> <p>Example: if the saved state includes preamp ON, but the recalling instrument does not have a preamp; the preamp is limited to OFF. Conversely, if you save a state without a preamp, the preamp is OFF in the state file. When this saved file is recalled on an instrument with a licensed preamp, the preamp is changed to OFF. Another example is if the saved state has center frequency set to 20 GHz, but the instrument recalling the saved state is a different model and only supports 13.5 GHz. In this case, the center frequency is limited along with any other frequency based settings. Since the center frequency can't be preserved in this case, the recall limiting tries to at least preserve span to keep the measurement setup as intact as possible.</p> <p>It may be appropriate to issue a warning if the state is limited on the recall; warnings do not go out to SCPI so this would only affect the manual user.</p> <p>Note that there is no state file compatibility outside of the X-Series. For example, you cannot recall a state file from ESA or PSA.</p>
Initial S/W Revision	Prior to A.02.00

State

The Recall State menu lets you choose a register or file from which to recall the state.

The content of a state file includes all of the settings and data required to return the analyzer as closely as possible to the Mode it was in, with the exact settings that were in place, when the save occurred. The Mode settings in each state file include the settings that are affected by Mode Preset, as well as the

additional settings affected by Restore Mode Defaults; all of the Mode’s settings. In addition, all of the settings of the Input/Output system are included, even though they are outside of the Mode’s state, because they are needed to restore the complete setup. Persistent System settings (for example, GPIB address) are not affected by either a Mode Preset or Restore Mode Defaults, nor are they included in a saved State file.

Since each state file is only for one Mode, the settings for other Modes are unaffected when it is loaded. Recall State will cause a mode switch if the state being recalled is not from the current active mode.

After the recall completes, the message "File <filename> recalled" or “Recalled State Register <register number>” is displayed.

For rapid recalls, the State menu lists 16 registers that you can choose from to recall. Pressing a Register key initiates the recall. You can also select a file from which to recall.

The default path for all State Files is:

My Documents\<mode name>\state

where <mode name> is the parameter used to select the mode with the INST:SEL command (for example, SA for the Spectrum Analyzer).

See "[More Information](#)" on page 1185.

Key Path	Recall
Mode	All
Remote Command	:MMEMory:LOAD:STATe <filename>
Example	:MMEM:LOAD:STAT "myState.state" This recalls the file myState.state on the default path
Example	MMEM:LOAD:STAT "MyStateFile.state" This loads the state file data (on the default file directory path) into the instrument state.
Notes	<p>When you pick a file to recall, the analyzer first verifies that the file is recallable in the current instrument by checking the software version and model number of the instrument. If everything matches, a full recall proceeds by aborting the currently running measurement, clearing any pending operations, and then loading the State from the saved state file. You can open state files from any mode, so recalling a State file switches to the mode that was active when the save occurred. After switching to the mode of the saved state file, mode settings and data (if any for the mode) are loaded with values from the saved file. The saved measurement of the mode becomes the newly active measurement and the data relevant to the measurement (if there is any) is recalled.</p> <p>If there is a mismatch between file version or model number or instrument version or model number, the recall function tries to recall as much as possible and returns a warning message. It may limit settings that differ based on model number, licensing or version number.</p> <p>After recalling the state, the Recall State function does the following:</p> <ul style="list-style-type: none"> • Makes the saved measurement for the mode the active measurement. • Clears the input and output buffers. • Status Byte is set to 0. • Executes a *CLS <p>If the file specified is empty an error is generated. If the specified file does not exist, another error is generated. If there is a mismatch between the file and the proper file type, an error is generated. If</p>

	there is a mismatch between file version or model number or instrument version or model number, a warning is displayed. Then it returns to the State menu and File Open dialog goes away. After the Recall, the analyzer exits the Recall menu and returns to the previous menu.
Backwards Compatibility SCPI	:MMEMory:LOAD:STATe 1,<filename> For backwards compatibility, the above syntax is supported. The "1" is simply ignored.
Initial S/W Revision	Prior to A.02.00

More Information

In measurements that support saving Traces, for example, Swept SA, the Trace data is saved along with the State in the State file. When recalling the State, the Trace data is recalled as well. Traces are recalled exactly as they were stored, including the writing mode and update and display modes. If a Trace was updating and visible when the State was saved, it will come back updating and visible, and its data will be rewritten right away. When you use State to save and recall traces, any trace whose data must be preserved should be placed in View or Blank mode before saving.

The following table describes the Trace Save and Recall possibilities:

You want to recall state and one trace's data, leaving other traces unaffected.	Save Trace+State from 1 trace. Make sure that no other traces are updating (they should all be in View or Blank mode) when the save is performed.	On Recall, specify the trace you want to load the one trace's data into. This trace will load in View. All other traces' data will be unaffected, although their trace mode will be as it was when the state save was performed.
You want to recall all traces	Save Trace+State from ALL traces.	On Recall, all traces will come back in View (or Blank if they were in Blank or Background when saved)
You want all traces to load exactly as they were when saved.	Save State	On recall, all traces' mode and data will be exactly as they were when saved. Any traces that were updating will have their data immediately overwritten.

From File...

When you press "From File", the analyzer brings up a Windows dialog and a menu entitled "File Open." This menu allows you to navigate to the various fields in the Windows dialog without using a keyboard or mouse. The Tab and Arrow keys can also be used for dialog navigation.

11 Spurious Emissions Measurement Recall

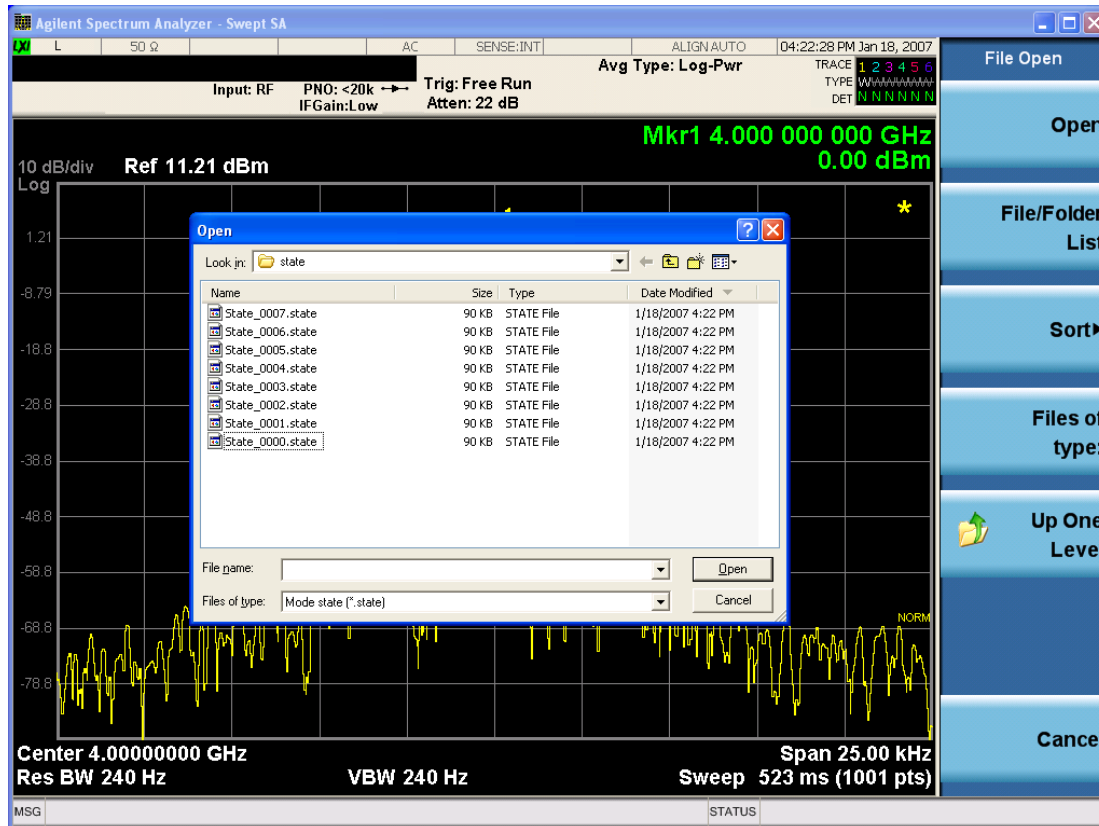

Listed below are the functions of the various fields in the dialog, and the corresponding softkeys:

Open

Performs the recall of the specified file. While the recall is being performed, the floppy icon appears briefly in the Meas bar.

File/Folder List

Enables you to navigate to the center of the dialog that contains the list of files and folders. Once here you can get information about the file and use the tab keys to navigate to the other fields in the dialog, such as Look In.

Look In

The Look In field shows the path from which the file will be recalled and allows you to change the path using the up and down arrow keys to navigate to other paths; the Enter key to open a directory; and the Backspace key to go back one directory. The **Look In field** first uses the last path from the Save As dialog **Save In:** path for that same file type. There is no softkey for directly navigating to the Look In field, but you can use the left tab to get here from the File/Folder List.

User specified paths are remembered when you leave and return to a Mode and are reset back to the default using Restore Mode Defaults.

Sort

Accesses a menu that enables you to sort the files within the File Open dialog. Only one sorting type can be selected at a time and the sorting happens immediately. The sorting types are By Date, By Name, By extension, and By Size.

Files of Type

This field shows the file suffix for the type of file you have selected to recall. For example, if you navigated here while recalling State, "Mode state (*.state)" is in the field. If you navigated here while recalling Trace, ""Mode state (*.trace)" is in the field. If you navigated here while importing a trace data file, "Trace Data (*.csv)" is in the field. For some file types, there is more than one choice in the dropdown menu, which you can select by using the up and down arrow keys and Enter.

Up One Level

This key corresponds to the icon of a folder with the up arrow that is in the tool bar of the dialog. When pressed, it causes the file and folder list to navigate up one level in the directory structure. The Backspace key does the same thing.

Cancel

This key corresponds to the Cancel selection in the dialog. It causes the current **Open** request to be cancelled. The ESC key does the same thing.

Key Path	Recall, State
Notes	Brings up the Open dialog for recalling a State Save Type
Initial S/W Revision	Prior to A.02.00

Edit Register Names

You may enter a custom name on any of the Register keys, to help you remember what you are using that state to save. To do this, press the Edit Register Names key, choose the register whose name you wish to edit, and then enter the desired label using the Alpha Editor or an external PC keyboard.

The maximum number of characters that can be added is 30. In most cases, 30 characters will fit on two lines of the key.

For more information and the SCPI command, see Edit Register Names under the Save, State function.

Key Path	Recall, State
Mode	All
Dependencies	N9060A-7FP or N9060B-2FP license required to edit the register names. When the feature is not licensed, sending the SCPI command generates an error, -221, "Settings conflict;Option not available"
Initial S/W Revision	A.11.00

Register 1 thru Register 16

Selecting any one of these register keys causes the State of the mode from the specified Register to be recalled. Each of the register keys annotates whether it is empty or at what date and time it was last

modified. In addition, you can use the Edit Register Names key under Save, State to enter custom names for each register.

Registers are shared by all modes, so recalling from any one of the registers will cause a mode switch to the mode that was active when the save to the Register occurred.

Although these 16 registers are the only registers available from the front panel, there are 128 state registers available in the instrument. Registers 17–128 are only available from the SCPI interface, using the *RCL command.

After the recall completes, the message "Register <register number> recalled" appears in the message bar. If you are in the Spectrum Analyzer Mode, and you are recalling a register that was saved in the Spectrum Analyzer Mode, then after the recall, you will still be in the Recall Register menu. If the Recall causes you to switch modes, then after the Recall, you will be in the Frequency menu.

If a requested register is empty an error is generated.

Key Path	Recall, State
Example	*RCL 1
Range	1–16 from front panel, 1–128 from SCPI
Readback	Date and time with seconds resolution are displayed on the key OR A custom name of up to 30 characters entered using the Save, State, Edit Register Names key OR “(empty)” if no prior save operation has been performed to this register.
Initial S/W Revision	Prior to A.02.00
Modified at S/W Revision	Prior to A.11.00

Register 1 thru Register 16

Selecting any one of these register keys causes the State of the mode from the specified Register to be recalled. Each of the register keys annotates whether it is empty or at what date and time it was last modified. In addition, you can use the Edit Register Names key under Save, State to enter custom names for each register.

Registers are shared by all modes, so recalling from any one of the registers will cause a mode switch to the mode that was active when the save to the Register occurred.

Although these 16 registers are the only registers available from the front panel, there are 128 state registers available in the instrument. Registers 17–128 are only available from the SCPI interface, using the *RCL command.

After the recall completes, the message "Register <register number> recalled" appears in the message bar. If you are in the Spectrum Analyzer Mode, and you are recalling a register that was saved in the Spectrum Analyzer Mode, then after the recall, you will still be in the Recall Register menu. If the Recall causes you to switch modes, then after the Recall, you will be in the Frequency menu.

If a requested register is empty an error is generated.

Key Path	Recall, State
Example	*RCL 1
Range	1-16 from front panel, 1-128 from SCPI
Readback	Date and time with seconds resolution are displayed on the key OR A custom name of up to 30 characters entered using the Save, State,Edit Register Names key OR “(empty)” if no prior save operation has been performed to this register.
Initial S/W Revision	Prior to A.02.00
Modified at S/W Revision	Prior to A.11.00

Data (Import)

Importing a data file loads data that was previously saved from the current measurement or from other measurements and/or modes that produce compatible data files. The Import Menu only contains Data Types that are supported by the current measurement.

Since the commonly exported data files are in .csv format, the data can be edited by the user prior to importing. This allows you to export a data file, manipulate the data in Excel (the most common PC Application for manipulating .csv files) and then import it.

Importing Data loads measurement data from the specified file into the specified or default destination, depending on the data type selected. Selecting an Import Data menu key will not actually cause the importing to occur, since the analyzer still needs to know from where to get the data. Pressing the Open key in this menu brings up the Open dialog and Open menu that provides you with the options from where to recall the data. Once a filename has been selected or entered in the Open menu, the recall occurs as soon as the Open button is pressed.

Key Path	Recall
Mode	All
Notes	The menu is built from whatever data types are available for the mode. Some keys will be missing completely, so the key locations in the sub-menu will vary. No SCPI command directly controls the Data Type that this key controls. The Data Type is included in the MMEM:LOAD commands.
Dependencies	If a file type is not used by a certain measurement, it is grayed out for that measurement. The key for a file type will not show at all if there are no measurements in the Mode that support it.
Preset	Is not affected by Preset or shutdown, but is reset during Restore Mode Defaults
Readback	The data type that is currently selected
Initial S/W Revision	Prior to A.02.00

Mask

Enables you to recall a preset mask file. This file type (.mask) differs from a normal “state” file because it contains the configuration for Carrier, Offset, and Limit for the specific preset profile BW. A brief description of the mask file is available in the properties view of each file. (Right-mouse-click on the file, select, "Properties" to view this information.) A detailed list of the mask parameter values is located in the .pdf file of the same name in the same directory. Blank values in the .pdf file are parameters that will not be overwritten when recalling the mask.

Key Path	Recall, Data
Mode	WIMAXOFDMA
Remote Command	:MMEMory:LOAD:MASK <string>
Example	:MMEM:LOAD:MASK "MyLimitFile.mask"
Notes	Set of parameters related to Limit, Carrier and Offset are overwritten by Preset Mask file.
Initial S/W Revision	A.02.00

This topic contains the following sections:

["File location and extension" on page 1190](#)

["Example of Preset Mask file" on page 1191](#)

File location and extension

File location: The preset mask file is located in “My Documents\WIMAXOFDMA\data\masks”.

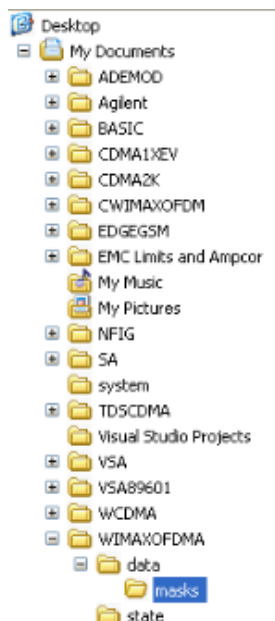

NOTE

When your X-Series analyzer starts, all mask files located in “My Documents\WIMAXOFDMA\data/masks” are overwritten, so any files you wish to save should be stored in another directory location.

File type: The file type is binary file.

File Name: The file name is decided by following naming rules. Each specific keyword is connected with underscore.

<Standard name>_<Radio device>_<Preset Profile BW>_<Measurement>.mask

<Standard name>: This term references the standard associated with each mask file.

<Radio device>: This term specifies to which radio device (BS or MS) the mask file pertains.

<Preset Profile BW>: This term specifies to which Preset Profile BW the mask file pertains.

<Measurement>: This term specifies the measurement to which the mask file is applied. Your selections are: SEM, ACP, or Mode. When selecting **Mode**, the values of some parameters in both the ACP and SEM measurement are overwritten.

File extension: The extension of preset mask file is “mask” to distinguish it from a “state” file.

When you press the open key under the Data menu, the “My Documents\WIMAXOFDMA\data\masks” folder is opened. Select one mask file.

NOTE

When you change the preset BW profile or Radio Device, all measurement parameters are reset to their original values. Thus you have to recall the appropriate preset mask file again after the change.

Example of Preset Mask file

When you import a preset mask file, it is a “Recall” function. Specific parameter values are overwritten by the contents of the preset mask file (see table below). Those values not specified by the preset mask file remain unchanged. Because the file format type is binary, you cannot view, change, or create the preset mask file. Here is an example of a preset mask file used for ACP measurements.

File Location: My Documents/WIMAXOFDMA/data/masks

File Name: ETSI-EN301-021-SysE_BS_10MHz_ACP.mask

The .pdf file that lists the parameters similarly to that shown below is named, "ETSI-EN301-021-SysE_BS_10MHz_ACP.pdf"

The set of parameters listed in the following table for the Preset Profile BW (10MHz) are imported into the ACP measurement.

Offset	Start Freq (MHz)	Stop Freq (MHz)	Sweep Time	Res BW (Hz)	Meas BW	Rel Start	Rel Stop	Fail Mask
A	5	7.14		30k	1	-8	-25	Rel
B	7.14	10.57		30k	1	-25	-27	Rel
C	10.57	20		30k	1	-27	-50	Rel
D	20	25		30k	1	-50	-50	Rel
E	25	30		30k	1	-50	-50	Rel

Zone Map

Pressing this key selects Zone Map as the data type to be imported.

The WiMAX-OFDMA application can load the Singal Studio Setup file, and the OFDMA Map file is compatible with the 89601A Mobile WiMAX omf file.

Key Path	Recall, Data
Remote Command	:MMEMory:LOAD:ZMAP <string>
Example	MMEM:LOAD:ZMAP "ZMap_0000.omf"
Notes	The SCPI parameter is a quoted string that specifies the filename. Both single and double quotes are supported for any filename parameter over SCPI.
Dependencies	You must be in the 802.16 OFDMA (WiMAX/WiBro) mode.
Status Bits/OPC dependencies	Sequential – waits for the previous measurement to complete.
Initial S/W Revision	Prior to A.02.00

Open...

When you press “Open”, the analyzer brings up a Windows dialog and a menu entitled “File Open.” This menu allows you to navigate to the various fields in the Windows dialog without using a keyboard or mouse. The Tab and Arrow keys can also be used for dialog navigation.

See "[From File...](#)" on page 2241 in Recall, State, for a full description of this dialog and menu.

Key Path	Recall, Data
Notes	The key location is mode-dependent and will vary. Brings up Open dialog for recalling a <mode specific> Save Type
Initial S/W Revision	Prior to A.02.00

Restart

The Restart function restarts the current sweep, or measurement, or set of averaged/held sweeps or measurements. If you are Paused, pressing Restart does a Resume.

The Restart function is accessed in several ways:

- Pressing the Restart key
- Sending the remote command INIT:IMMEDIATE
- Sending the remote command INIT:RESTART

See "[More Information](#)" on page 1193

Key Path	Front-panel key
Remote Command	:INITiate[:IMMEDIATE] :INITiate:RESTART
Example	:INIT:IMM :INIT:REST
Notes	:INITiate:RESTART and :INITiate:IMMEDIATE perform exactly the same function.
Couplings	Resets average/hold count k. For the first sweep overwrites all active (update=on) traces with new current data. For application modes, it resets other parameters as required by the measurement.
Status Bits/OPC dependencies	This is an Overlapped command. The STATUS:OPERation register bits 0 through 8 are cleared. The STATUS:QUESTIONable register bit 9 (INTEgrity sum) is cleared. The SWEEPING bit is set. The MEASURING bit is set.
Backwards Compatibility Notes	For Spectrum Analysis mode in ESA and PSA, the Restart hardkey and the INITiate:RESTART command restart trace averages (displayed average count reset to 1) for a trace in Clear Write, but did not restart Max Hold and Min Hold. In the X-Series, the Restart hardkey and the INITiate:RESTART command restart not only Trace Average, but MaxHold and MinHold traces as well. For wireless comms modes in ESA and PSA, the Restart hardkey and the INITiate:RESTART command restart every measurement, which includes all traces and numeric results. There is no change to this operation.
Initial S/W Revision	Prior to A.02.00

More Information

The **Restart** function first aborts the current sweep/measurement as quickly as possible. It then resets the sweep and trigger systems, sets up the measurement and initiates a new data measurement sequence with a new data acquisition (sweep) taken once the trigger condition is met.

If the analyzer is in the process of aligning when **Restart** is executed, the alignment finishes before the restart function is performed.

Even when set for Single operation, multiple sweeps may be taken when Restart is pressed (for example, when averaging/holding is on). Thus when we say that **Restart** "restarts a measurement," we may mean:

- It restarts the current sweep
- It restarts the current measurement
- It restarts the current set of sweeps if any trace is in Trace Average, Max Hold or Min Hold
- It restarts the current set of measurements if Averaging, or Max Hold, or Min Hold is on for the measurement
- depending on the current settings.

With **Average/Hold Number** (in **Meas Setup** menu) set to 1, or Averaging off, or no trace in Trace Average or Hold, a single sweep is equivalent to a single measurement. A single sweep is taken after the trigger condition is met; and the analyzer stops sweeping once that sweep has completed. However, with **Average/Hold Number** >1 and at least one trace set to **Trace Average, Max Hold, or Min Hold (SA Measurement)** or **Averaging on (most other measurements)**, multiple sweeps/data acquisitions are taken for a single measurement. The trigger condition must be met prior to each sweep. The sweep is stopped when the average count k equals the number N set for **Average/Hold Number**. A measurement average usually applies to all traces, marker results, and numeric results; but sometimes it only applies to the numeric results.

Once the full set of sweeps has been taken, the analyzer will go to idle state. To take one more sweep without resetting the average count, increment the average count by 1, by pressing the step up key while **Average/Hold Number** is the active function, or sending the remote command CALC:AVER:TCON UP.

Save

The Save menu lets you choose what you want to save and where you want to save it. Among the types of files you can save are **States**, **Traces**, and **Screen Images**. In addition, an Export (Data) option lets you save a number of data types as CSV files for easy import into Excel and other spreadsheet programs.

Key Path	Front-panel key
Mode	All
Notes	No remote command for this key specifically, but the :MMEM:STORe command is available for specific file types. An example is :MMEM:STOR:STATe <filename>.
Initial S/W Revision	Prior to A.02.00

State

The Save State menu lets you choose a register or file for saving the state.

The content of a state file includes all of the settings and data required to return the analyzer as closely as possible to the Mode it was in, with the exact settings which were in place, when the save occurred. The Mode settings in each state file include the settings that are affected by Mode Preset, as well as the additional settings affected by Restore Mode Defaults; all of the Mode's settings. In addition, all of the settings of the Input/Output system are included, even though they are outside of the Mode's state, because they are needed to restore the complete setup. Persistent System settings (for example, Verbose SCPI) are not affected by either Mode Preset or Restore Mode Defaults, nor are they included in a saved State file.

After the save completes, the message "File <filename> saved" or "State Register <register number> saved" is displayed.

For rapid saving, the State menu lists 16 registers to save to. Pressing a Register key initiates the save. You can also select a file to save to.

The default path for all State Files is:

My Documents\<>mode name>\state

where <mode name> is the parameter used to select the mode with the INST:SEL command (for example, SA for the Spectrum Analyzer).

Key Path	Save
Mode	All
Remote Command	:MMEMory:STORe:STATe <filename>
Example	MMEM:STOR:STATe "MyStateFile.state" This stores the current instrument state data in the file MyStateFile.state in the default directory.
Notes	Both single and double quotes are supported for any filename parameter over remote. After saving to a register, that register's menu key is updated with the date the time, unless a custom label has been entered for that key. After saving to a register, you remain in the Save State menu, so that you can see the Register key

update. After saving to a file, the analyzer automatically returns to the previous menu and any Save As dialog goes away.

Backwards :MMEMory:STORe:STATe 1,<filename>

Compatibility SCPI For backwards compatibility, the above syntax is supported. The "1" is simply ignored. The command is sequential.

Initial S/W Revision Prior to A.02.00

To File . . .

When you press “To File”, the analyzer brings up a Windows dialog and a menu entitled “Save As.” This menu allows you to navigate to the various fields in the Windows dialog without using a keyboard or mouse. The Tab and Arrow keys can also be used for dialog navigation.

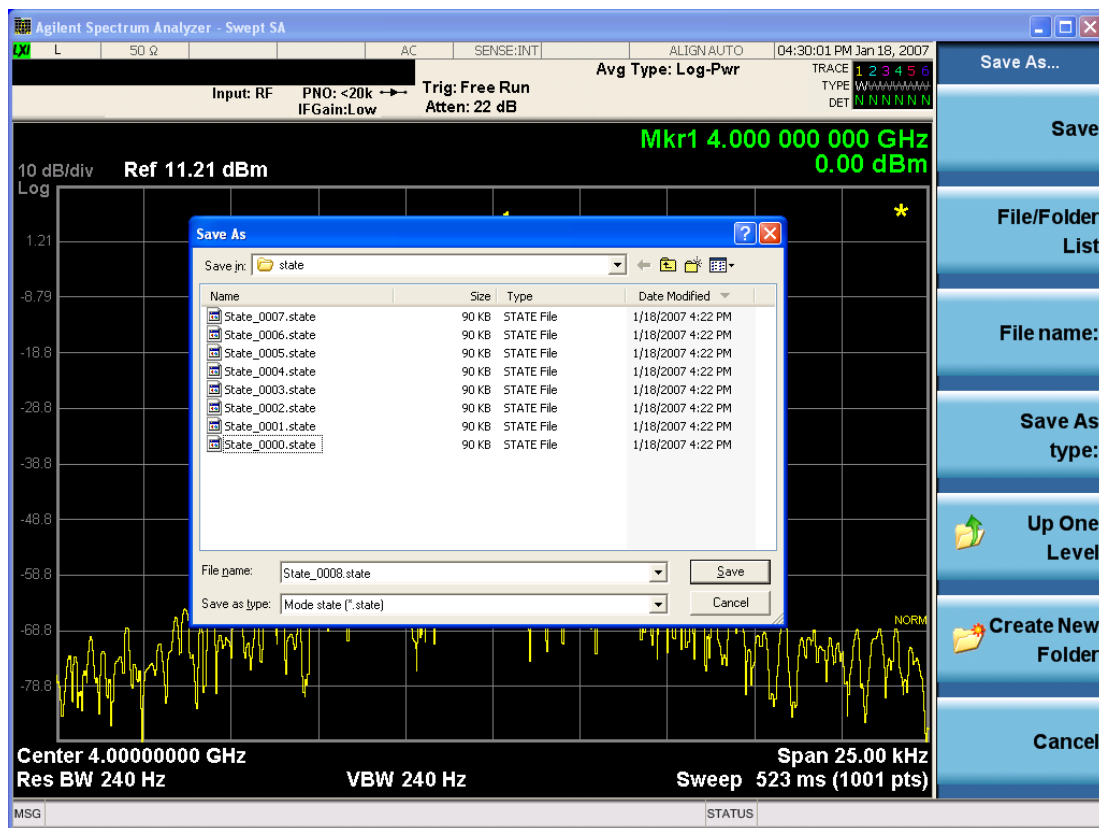

The Listed below

are the functions of the various fields in the dialog, and the corresponding softkeys:

Save

Performs the save to the specified file of the selected type. If the file already exists, a dialog will appear that allows you to replace the existing file by selecting OK, or you can Cancel the request. If you select OK, the file will be overwritten. Using the C: drive is strongly discouraged, since it runs the risk of being overwritten during an instrument software upgrade.

While the save is being performed, the floppy icon appears briefly in the Meas bar.

File/Folder List

Enables you to navigate to the center of the dialog that contains the list of files and folders. Once here you can get information about the file and use the tab keys to navigate to the other fields in the dialog, such as Save In.

Save In

The Save In field shows the path to which the file will be saved and allows you to change the path using the up and down arrow keys to navigate to other paths; the Enter key to open a directory; and the Backspace key to go back one directory. The **Save In field** defaults to the default path for this type of file and remembers the last path you used to save this type of file. There is no softkey for directly navigating to the Save In field but you can use left tab to get here from the File/Folder List.

User specified paths are remembered when you leave and return to a Mode and are reset back to the default using Restore Mode Defaults.

File Name

The File Name field is initially loaded with an automatically generated filename specific to the appropriate Save Type. The automatically generated filename is guaranteed not to conflict with any filename currently in the directory. You may replace or modify this filename using the File Name key. See the ["Quick Save " on page 2237](#) documentation for more on the automatic file naming algorithm.

When you press the File Name key the analyzer displays the Alpha Editor. Use the knob to choose the letter to add and the front-panel Enter key to add the letter to the file name. The BK character moves you back and the FW character moves you forward in the filename. The Select key on the front panel generates a space character. When you are done entering the filename press the Done softkey. This returns back to the **File Open** dialog and menu, but does not cause the save to occur.

Save As Type

This field shows the file suffix for the type of file you have selected to save. For example, if you navigated here while saving State, "Mode state (*.state)" is in the field. If you navigated here from saving Trace, ""Mode state (*.trace)" is in the field. If you navigated here while exporting a trace data file, "Trace Data (*.csv)" is in the field. For some file types, there is more than one choice in the dropdown, which you can select by using the up and down arrow keys and Enter.

Up One Level

This key corresponds to the icon of a folder with the up arrow that is in the tool bar of the dialog. When pressed, it causes the file and folder list to navigate up one level in the directory structure. The Backspace key does the same thing.

Create New Folder

This key corresponds to the icon of a folder with the "*" that is in the tool bar of the dialog. When pressed, a new folder is created in the current directory with the name **New Folder** and you can enter a new folder name using the Alpha Editor.

Cancel

This key corresponds to the Cancel selection in the dialog. It causes the current **Save As** request to be cancelled. The ESC key does the same thing.

Key Path	Save, State
Mode	All
Notes	Brings up Save As dialog for saving a State Save Type
Initial S/W Revision	Prior to A.02.00

Edit Register Names

You may enter a custom name on any of the Register keys, to help you remember what you are using that state to save. To do this, press the Edit Register Names key, choose the register whose name you wish to edit, and then enter the desired label using the Alpha Editor or an external PC keyboard.

The maximum number of characters that can be added is 30. In most cases, 30 characters will fit on two lines of the key.

See ["More Information" on page 1198](#)

Key Path	Save, State
Mode	All
Remote Command	:MMEMory:REGister:STATe:LABel <reg number>,"label" :MMEMory:REGister:STATe:LABel? <reg number>
Example	:MMEM:REG:STAT:LAB 1,"my label"
Notes	<reg number> is an integer from 1 to 16. If the SCPI specifies an invalid register number an error message is generated, -222,"Data out of range;Invalid register label number" "label" is a string from 0 to 30 characters in length. If a label exceeds 30 characters, an error message is generated, -150,"String data error;Label clipped to 30 characters" "label" of length 0 erases the custom label and restores the default (time and date) label. E.g.: :MMEM:REG:STAT:LAB 1,""
Dependencies	N9060A-7FP or N9060B-2FP license required to edit the register names. When the feature is not licensed, sending this command generates an error, -221,"Settings conflict;Option not available"
Preset	The names are unaffected by Preset or power cycle but are set to the default label (time and date) on a "Restore System Defaults->Misc"
Initial S/W Revision	A.11.00

More Information

When you edit one of the register names, the time and date field will be replaced by the custom name.

If you delete all the characters in the custom name, it restores the default (time and date).

The register names are stored within the state files, but they are not part of the instrument state; that is, once you have edited a register name, loading a new state will not change that register name. Another consequence of this is that the names will be persistent through a power cycle. Also, if a named state file is transferred to another analyzer, it will bring its custom name along with it.

If you try to edit the name of an empty register, the analyzer will first save the state to have a file to put the name in. If you load a named state file into an analyzer with older firmware it will ignore the metadata.

The *SAV and *RCL commands will not be affected by the custom register names, nor will the MMEM commands.

Register 1 thru Register 16

Selecting any one of these register menu keys causes the State of the currently active mode to be saved to the specified Register. The registers are provided for rapid saving and recalling, since you do not need to specify a filename or navigate to a file. Each of the register menu keys annotates whether it is empty or at what date and time it was last modified. In addition, you can use the Edit Register Names key to enter custom names for each register.

Although these 16 registers are the only registers available from the front panel, there are 128 state registers available in the instrument. Registers 17–128 are only available from the SCPI interface, using the *SAV command.

There is one set of 128 state registers in the instrument, not one set for each Mode. When a state is saved, the Mode it was saved from is saved with it; then when it is recalled, the instrument switches to that Mode.

After the save completes, the corresponding register menu key annotation is updated with the date and time and the message "Register <register number> saved" is displayed.

Key Path	Save, State
Mode	All
Example	*SAV 1
Range	1–16 from front panel, 1–128 from SCPI
Readback	Date and time with seconds resolution are displayed on the key OR A custom name of up to 30 characters entered using the Edit Register Names key OR “(empty)” if no prior save operation has been performed to this register.
Initial S/W Revision	Prior to A.02.00
Modified at S/W Revision	A.11.00

Register 1 thru Register 16

Selecting any one of these register menu keys causes the State of the currently active mode to be saved to the specified Register. The registers are provided for rapid saving and recalling, since you do not need to specify a filename or navigate to a file. Each of the register menu keys annotates whether it is empty or at what date and time it was last modified. In addition, you can use the Edit Register Names key to enter custom names for each register.

Although these 16 registers are the only registers available from the front panel, there are 128 state registers available in the instrument. Registers 17–128 are only available from the SCPI interface, using the *SAV command.

There is one set of 128 state registers in the instrument, not one set for each Mode. When a state is saved, the Mode it was saved from is saved with it; then when it is recalled, the instrument switches to that Mode.

After the save completes, the corresponding register menu key annotation is updated with the date and time and the message "Register <register number> saved" is displayed.

Key Path	Save, State
Mode	All
Example	*SAV 1
Range	1-16 from front panel, 1-128 from SCPI
Readback	Date and time with seconds resolution are displayed on the key OR A custom name of up to 30 characters entered using the Edit Register Names key OR “(empty)” if no prior save operation has been performed to this register.
Initial S/W Revision	Prior to A.02.00
Modified at S/W Revision	A.11.00

Data (Export)

Exporting a data file stores data from the current measurement to mass storage files. The Export Menu only contains data types that are supported by the current measurement.

Since the commonly exported data files are in .csv format, the data can be edited by you prior to importing. This allows you to export a data file, manipulate the data in Excel (the most common PC Application for manipulating .csv files) and then import it.

Selecting an Export Data menu key will not actually cause the exporting to occur, since the analyzer still needs to know where you wish to save the data. Pressing the Save As key in this menu brings up the Save As dialog and Save As menu that allows you to specify the destination file and directory. Once a filename has been selected or entered in the Open menu, the export will occur as soon as the Save key is pressed.

Key Path	Save
Mode	All
Notes	The menu is built from whatever data types are available for the mode. So the key locations in the sub menu will vary. No SCPI command directly controls the Data Type that this key controls. The Data Type is included in the MMEM:STORe commands.
Dependencies	If a file type is not used by a certain measurement, that type is grayed out for that measurement. The key for a file type will not show at all if there are no measurements in the Mode that support it.
Preset	Is not affected by a Preset or shutdown, but is reset during Restore Mode Defaults
Readback	The data type that is currently selected
Initial S/W Revision	Prior to A.02.00

Measurement Results

Pressing this key selects Meas Results as the data type to be exported.

The Meas Results file contains measurement result sets, plus information describing the current state of the analyzer, as detailed in ["Meas Results File Definition" on page 1201](#) and ["Meas Results File Example" on page 1203](#) below.

Key Path	Save, Data
Remote Command	:MMEMory:STORe:RESults <string>
Example	:MMEM:STOR:RES "MeasR_0000.csv"
Notes	<p>If the save is initiated via SCPI and the file already exists, the file will be overwritten.</p> <p>The SCPI command exports Spurious Emissions measurement results to the file specified as the parameter in the current path. The default path is My Documents\<current mode>\data\SPUR\results.</p> <p>Using the C: drive is strongly discouraged, since it runs the risk of being overwritten during an instrument software upgrade.</p> <p>The SCPI parameter is a quoted string that specifies the filename. Both single and double quotes are supported for any filename parameter over SCPI.</p>
Dependencies	The current active measurement must be the Spurious Emissions measurement to use this command.
Status Bits/OPC dependencies	Sequential – waits for the previous measurement to complete
Initial S/W Revision	Prior to A.02.00

Meas Results File Definition

The content of a Meas Results File is defined in this section.

The first lines in the file consist of identification and instrument configuration details, as follows.

- File ID string, which is "MeasResult"
- Measurement ID following Mode ID, which is "SA:SPUR" for example.
- Firmware rev and model number
- Option string
- Abs Start Limit
- Abs Stop Limit
- Abs Stop Limit Mode
- Auto Scaling
- Auto Sweep Time Rules
- Automatic Trigger Time
- Automatic Trigger Time State

- Average Mode
- Average Number
- Average State
- Detector 1
- Detector 2
- Electrical Atten
- Electrical Atten State
- External Array Trigger Delay
- External Array Trigger Delay State
- External Array Trigger Level
- External Array Trigger Slope
- Filter Type
- IF Gain Auto
- IF Gain State
- Internal Preamp
- Internal Preamp Band
- Line Trigger Delay
- Line Trigger Delay State
- Line Trigger Slope
- Meas Type
- Mechanical Atten
- MechanicalAttenStepEnum
- Peak Excursn
- Periodic Timer Period
- Periodic Timer Sync Source
- Periodic Timer Trigger Delay
- Periodic Timer Trigger Delay State
- Pk Threshold
- Points
- Points Mode
- Range State

- Ref Value
- Res BW
- Res BW Mode
- RFBurst Trigger Delay
- RFBurst Trigger Delay State
- RFBurst Trigger Level Abs
- RFBurst Trigger Level Rel
- RFBurst Trigger Level Type
- RFBurst Trigger Slope
- Scale/Div
- Spurious Report Mode
- SpurRangeStartFrequencyArray
- SpurRangeStopFrequencyArray
- Sweep Time
- Sweep Time Mode
- Trigger Holdoff
- Trigger Holdoff State
- TriggerSource
- Video BW
- Video BW Mode

The data above is followed in the file by a line containing “MeasResult1” to “MeasResult42”. This line forms a header for each set of measurement results, which appear in subsequent lines. Each line of Measurement Results consists of 42 comma-separated values, from the MeasResult1 value to the MeasResult42 value.

The MeasResult1 set in the file corresponds to the data returned by MEAS/READ/FETCH:SPURious1; the MeasResult2 set corresponds to the data returned by MEAS/READ/FETCH:SPURious2, and so on.

The exported file is in CSV format, with a .csv extension.

Meas Results File Example

When imported into Excel, a typical Meas Results file appears as shown in the example below.

NOTE: The following table omits the columns for MeasResult11 to MeasResult42, due to lack of space.

MeasResult	1	2	3	4	5	6	7	8	9	10
SA:SPUR										

A.10.53	N903 0A										
526 ALV ATP B1X B1Y B25 B40 BBA CR3 CRP DCF DDA DP2 DRD EA3 EDP EMC EP1 ERC ESC ESP EXM FSA LFE LNP MAT MPB NFE NUL P26 PFR PNC RTL RTS S40 SB1 SEC SM1 TVT YAS YAV	1										
Abs Start Limit	-50	-50	-50	-50	-50	-50	-50	-50	-50	-50	-50
Abs Stop Limit	-50	-50	-50	-50	-50	-50	-50	-50	-50	-50	-50
Abs Stop Limit Mode	TRUE	TRUE	TRUE	TRUE	TRUE	TRUE	TRUE	TRUE	TRUE	TRUE	TRUE
Auto Scaling	TRUE										
Auto Sweep Time Rules	Norm										
Automatic Trigger Time	0.1										
Automatic Trigger Time State	FALSE										
Average Mode	Exponential										
Average Number	10										
Average State	FALSE										
Detector 1	Peak	Peak	Peak	Peak	Peak	Peak	Peak	Peak	Peak	Peak	Peak
Detector 2	Off	Off	Off	Off	Off	Off	Off	Off	Off	Off	Off
Electrical Atten	0										
Electrical Atten State	FALSE										
External Array Trigger Delay	1.00 E-06	1.00 E-06									
External Array Trigger Delay State	FALSE	FALSE									
External Array Trigger Level	1.2	1.2									
External Array Trigger Slope	Positive	Positive									

Filter Type	Gaussian	Gaussian	Gaussian	Gaussian	Gaussian	Gaussian	Gaussian	Gaussian	Gaussian	Gaussian
IF Gain Auto	FALSE	FALSE	FALSE	FALSE	FALSE	FALSE	FALSE	FALSE	FALSE	FALSE
IF Gain State	FALSE	FALSE	FALSE	FALSE	FALSE	FALSE	FALSE	FALSE	FALSE	FALSE
Internal Preamp	FALSE									
Internal Preamp Band	Low									
Line Trigger Delay	1.00E-06									
Line Trigger Delay State	FALSE									
Line Trigger Slope	Positive									
Meas Type	Examine									
Mechanical Atten	10									
MechanicalAtten StepEnum	S2dB									
Peak Excursn	6	6	6	6	6	6	6	6	6	6
Periodic Timer Period	0.02									
Periodic Timer Sync Source	None									
Periodic Timer Trigger Delay	1.00E-06									
Periodic Timer Trigger Delay State	FALSE									
Pk Threshold	-90	-90	-90	-90	-90	-90	-90	-90	-90	-90
Points	601	601	601	601	601	601	601	601	601	601
Points Mode	FALSE	FALSE	FALSE	FALSE	FALSE	FALSE	FALSE	FALSE	FALSE	FALSE
Range State	TRUE	TRUE	TRUE	TRUE	TRUE	FALSE	FALSE	FALSE	FALSE	FALSE
Ref Value	0									
Res BW	1200000	510000	100000	100000	400000	300000	300000	300000	300000	300000
Res BW Mode	FALSE	FALSE	FALSE	FALSE	FALSE	TRUE	TRUE	TRUE	TRUE	TRUE
RFBurst Trigger Delay	1.00E-06									
RFBurst Trigger Delay State	FALSE									
RFBurst Trigger	-20									

Level Abs										
RFBurst Trigger Level Rel	-6									
RFBurst Trigger Level Type	Absolute									
RFBurst Trigger Slope	Positive									
Scale/Div	10									
Spurious Report Mode	All									
SpurRangeStartFrequencyArray	1.92E+09	1.89E+09	2.1E+09	2.18E+09	8E+08	1.5E+09	1.5E+09	1.5E+09	1.5E+09	1.5E+09
SpurRangeStopFrequencyArray	1.98E+09	1.92E+09	2.1E+09	2.18E+09	1E+09	2.5E+09	2.5E+09	2.5E+09	2.5E+09	2.5E+09
Sweep Time	0.001	0.001	0.0012	0.00396	0.001	0.001	0.001	0.001	0.001	0.001
Sweep Time Mode	TRUE	TRUE	TRUE	TRUE	TRUE	TRUE	TRUE	TRUE	TRUE	TRUE
Trigger Holdoff	0.1									
Trigger Holdoff State	FALSE									
TriggerSource	Free									
Video BW	120000	51000	10000	10000	39000	30000	30000	30000	30000	30000
Video BW Mode	TRUE	TRUE	TRUE	TRUE	TRUE	TRUE	TRUE	TRUE	TRUE	TRUE
MeasResult1	MeasResult2	MeasResult3	MeasResult4	MeasResult5	MeasResult6	MeasResult7	MeasResult8	MeasResult9	MeasResult10	MeasResult11
19	-80.27209	-80.87862	-90.94577	-89.27086	-76.77856	9.91E+37	9.91E+37	9.91E+37	9.91E+37	9.91E+37
1	-78.28497	-80.93996	-91.00485	-90.56063	-76.33968					

Zone Map

Pressing this key selects Zone Map as the data type to be exported.

The Zone Map file contains information about current Zone Map configuration. Its format is compatible with the 89601A OFDMA map file. It is detailed in ["Zone Map File Contents" on page 1207](#) below.

Key Path	Save, Data
Remote Command	:MMEMory:STORe:ZMAP <string>
Example	MMEM:STOR:ZMAP "ZMap_0000.omf"
Notes	<p>If the save is initiated via SCPI and the file already exists, the file will be overwritten.</p> <p>The SCPI command exports Zone Map information to the file specified as the parameter in the current path. The default path is My Documents\WIMAXOFDMA\.</p> <p>Using the C: drive is strongly discouraged, since it runs the risk of being overwritten during an instrument software upgrade.</p> <p>The SCPI parameter is a quoted string that specifies the filename. Both single and double quotes are supported for any filename parameter over SCPI.</p>
Dependencies	You must be in the 802.16 OFDMA (WiMAX/WiBro) mode.
Status Bits/OPC dependencies	Sequential - waits for the previous measurement to complete.
Initial S/W Revision	Prior to A.02.00

Zone Map File Contents

A Zone Map File contains the following information of the Zone Map configuration. See ["Zone Map Data" on page 329](#) for detailed definitions.

- DemodOfdmaMap_AutoDetect
- DemodOfdmaMap_Count
- DemodOfdmaMap_F1_DL_Count
- DemodOfdmaMap_F1_DL_Z1_Active
- DemodOfdmaMap_F1_DL_Z1_AmcType
- DemodOfdmaMap_F1_DL_Z1_B1_Active
- DemodOfdmaMap_F1_DL_Z1_B1_AllocType
- DemodOfdmaMap_F1_DL_Z1_B1_Boost
- DemodOfdmaMap_F1_DL_Z1_B1_BurstType
- DemodOfdmaMap_F1_DL_Z1_B1_ColorIndex
- DemodOfdmaMap_F1_DL_Z1_B1_ModType
- DemodOfdmaMap_F1_DL_Z1_B1_Name
- DemodOfdmaMap_F1_DL_Z1_B1_SubchannelInterval
- DemodOfdmaMap_F1_DL_Z1_B1_SubchannelOffset
- DemodOfdmaMap_F1_DL_Z1_B1_SymbolInterval
- DemodOfdmaMap_F1_DL_Z1_B1_SymbolOffset

- DemodOfdmaMap_F1_DL_Z1_Count
- DemodOfdmaMap_F1_DL_Z1_DedicPilots
- DemodOfdmaMap_F1_DL_Z1_IDCell
- DemodOfdmaMap_F1_DL_Z1_IDCellCouple
- DemodOfdmaMap_F1_DL_Z1_Len
- DemodOfdmaMap_F1_DL_Z1_Locked
- DemodOfdmaMap_F1_DL_Z1_Name
- DemodOfdmaMap_F1_DL_Z1_PrbsID
- DemodOfdmaMap_F1_DL_Z1_StcMatrix
- DemodOfdmaMap_F1_DL_Z1_StcType
- DemodOfdmaMap_F1_DL_Z1_SymOffset
- DemodOfdmaMap_F1_DL_Z1_UseAllSC
- DemodOfdmaMap_F1_DL_Z1_WrapType
- DemodOfdmaMap_F1_DL_Z1_ZoneType
- DemodOfdmaMap_F1_UL_Count
- DemodOfdmaMap_F1_UL_Z1_Active
- DemodOfdmaMap_F1_UL_Z1_AmcType
- DemodOfdmaMap_F1_UL_Z1_B1_Active
- DemodOfdmaMap_F1_UL_Z1_B1_AllocType
- DemodOfdmaMap_F1_UL_Z1_B1_Boost
- DemodOfdmaMap_F1_UL_Z1_B1_BurstType
- DemodOfdmaMap_F1_UL_Z1_B1_ColorIndex
- DemodOfdmaMap_F1_UL_Z1_B1_ModType
- DemodOfdmaMap_F1_UL_Z1_B1_Name
- DemodOfdmaMap_F1_UL_Z1_B1_PilotPattern
- DemodOfdmaMap_F1_UL_Z1_B1_StcMode
- DemodOfdmaMap_F1_UL_Z1_B1_SubchannelInterval
- DemodOfdmaMap_F1_UL_Z1_B1_SubchannelOffset
- DemodOfdmaMap_F1_UL_Z1_B1_SymbolInterval
- DemodOfdmaMap_F1_UL_Z1_B1_SymbolOffset
- DemodOfdmaMap_F1_UL_Z1_Count

- DemodOfdmaMap_F1_UL_Z1_Gap
- DemodOfdmaMap_F1_UL_Z1_IDCell
- DemodOfdmaMap_F1_UL_Z1_Len
- DemodOfdmaMap_F1_UL_Z1_Locked
- DemodOfdmaMap_F1_UL_Z1_Name
- DemodOfdmaMap_F1_UL_Z1_SymOffset
- DemodOfdmaMap_F1_UL_Z1_UseSubchRotate
- DemodOfdmaMap_F1_UL_Z1_WrapType
- DemodOfdmaMap_F1_UL_Z1_ZoneType
- DemodOfdmaMap_Name
- DemodOfdmaMap_RefreshMap

Save As . . .

When you press “Save As”, the analyzer brings up a Windows dialog and a menu entitled “**Save As.**” This menu allows you to navigate to the various fields in the Windows dialog without using a keyboard or mouse. The Tab and Arrow keys can also be used for dialog navigation.

See "[To File . . .](#)" on page 2252 in Save, State for a full description of this dialog and menu.

The default path for saving files is:

For all of the Trace Data Files:

My Documents\`<mode name>`\data\traces

For all of the Limit Data Files:

My Documents\`<mode name>`\data\limits

For all of the Measurement Results Data Files:

My Documents\`<mode name>`\data\`<measurement name>`\results

For all of the Capture Buffer Data Files:

My Documents\`<mode name>`\data\captureBuffer

Key Path	Save, Data
Mode	All
Notes	The key location is mode-dependent and will vary. Brings up the Save As dialog for saving a <code><mode specific></code> Save Type. The save is performed immediately and does not wait until the measurement is complete.
Initial S/W Revision	Prior to A.02.00

Screen Image

Pressing Screen Image accesses a menu of functions that enable you to specify a format and location for the saved screen image. It brings up a menu that allows you to specify the color scheme of the Screen Image (Themes) or navigate to the Save As dialog to perform the actual save.

Screen Image files contain an exact representation of the analyzer display. They cannot be loaded back onto the analyzer, but they can be loaded into your PC for use in many popular applications.

The image to be saved is actually captured when the Save front panel key is pressed, and kept in temporary storage to be used if you ask for a Screen Image save. When the Screen Image key is pressed, a "thumbnail" of the captured image is displayed, as shown below:

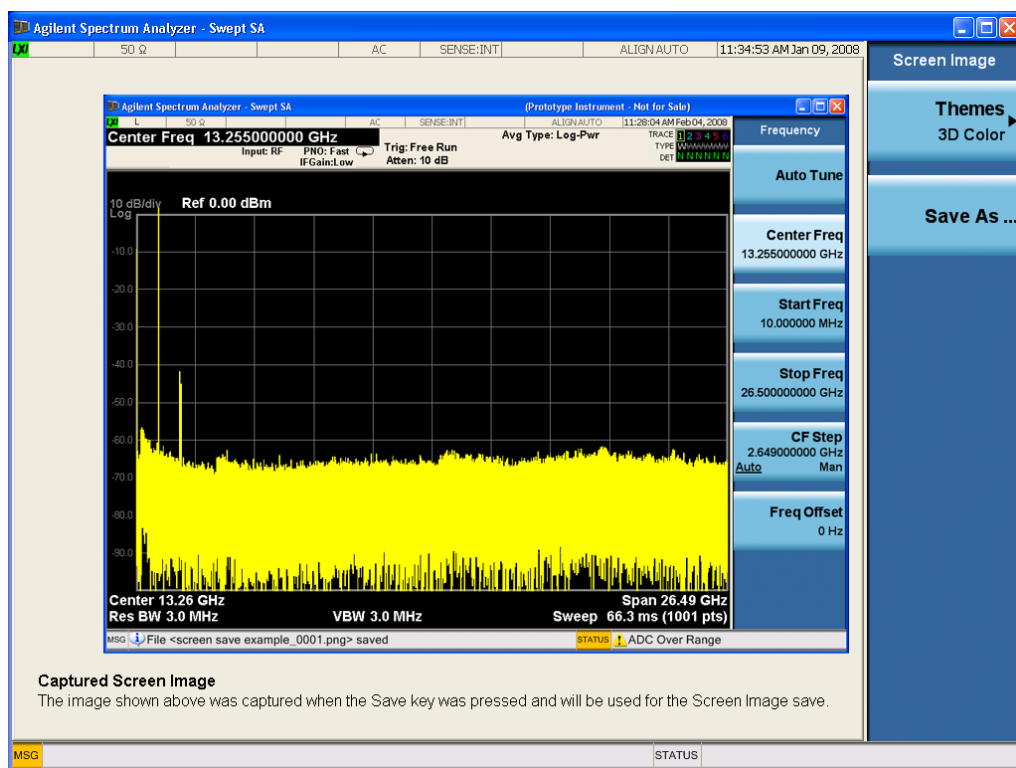

When you continue on into the Save As menu and complete the Screen Image save, the image depicted in the thumbnail is the one that gets saved, showing the menus that were on the screen before going into the Save menus. The save is performed immediately and does not wait until the measurement is complete.

After you have completed the save, the Quick Save front-panel key lets you quickly repeat the last save performed, using an auto-named file, with the current screen data.

NOTE

For versions previous to A.01.55, if you initiate a screen image save by navigating through the Save menus, the image that is saved will contain the Save menu softkeys, not the menus and the active function that were on the screen when you first pressed the Save front panel key.

Key Path	Save
Mode	All

Remote Command	:MMEMory:STORe:SCReen <filename>
Example	:MMEM:STOR:SCR "myScreen.png" This stores the current screen image in the file MyScreenFile.png in the default directory.
Initial S/W Revision	Prior to A.02.00

Themes

Accesses a menu of functions that enable you to choose the theme to be used when saving the screen image.

The **Themes** option is the same as the **Themes** option under the **Display** and **Page Setup** dialogs. It allows you to choose between themes to be used when saving the screen image.

Key Path	Save, Screen Image
Remote Command	:MMEMory:STORe:SCReen:THEMe TDColor TDMonochrome FCOLOR FMONochrome :MMEMory:STORe:SCReen:THEMe?
Example	:MMEM:STOR:SCR:THEM TDM
Preset	3D Color; Is not part of Preset, but is reset by Restore Misc Defaults or Restore System Defaults All and survives subsequent running of the modes.
Readback	3D Color 3D Mono Flat Color Flat Mono
Backwards Compatibility Notes	In ESA and PSA we offer the choice of "Reverse Bitmap" or "Reverse Metafile" when saving screen images. This is much like the "Flat Color" theme available in X-Series. Also, if you selected Reverse Bitmap AND a black & white screen image, that would be much like "Flat Monochrome". In other words, each of the X-Series themes has a similar screen image type in ESA/PSA. But they are not identical.
Initial S/W Revision	Prior to A.02.00

3D Color

Selects a standard color theme with each object filled, shaded and colored as designed.

Key Path	Save, Screen Image, Themes
Example	MMEM:STOR:SCR:THEM TDC
Readback	3D Color
Initial S/W Revision	Prior to A.02.00

3D Monochrome

Selects a format that is like 3D color but shades of gray are used instead of colors.

Key Path	Save, Screen Image, Themes
Example	MMEM:STOR:SCR:THEM TDM
Readback	3D Mono
Initial S/W Revision	Prior to A.02.00

Flat Color

Selects a format that is best when the screen is to be printed on an ink printer.

Key Path	Save, Screen Image, Themes
Example	MMEM:STOR:SCR:THEM FCOL
Readback	Flat Color
Initial S/W Revision	Prior to A.02.00

Flat Monochrome

Selects a format that is like Flat Color. But only black is used (no colors, not even gray), and no fill.

Key Path	Save, Screen Image, Themes
Example	MMEM:STOR:SCR:THEM FMON
Readback	Flat Mono
Initial S/W Revision	Prior to A.02.00

Save As...

When you press "Save As", the analyzer brings up a Windows dialog and a menu entitled "**Save As.**" This menu allows you to navigate to the various fields in the Windows dialog without using a keyboard or mouse. The Tab and Arrow keys can also be used for dialog navigation.

See "[To File . . .](#)" on page 2252 in Save, State for a full description of this dialog and menu.

The default path for Screen Images is

My Documents\`<mode name>`\screen.

where `<mode name>` is the parameter used to select the mode with the INST:SEL command (for example, SA for the Spectrum Analyzer).

Key Path	Save, Screen Image
Notes	Brings up Save As dialog for saving a Screen Image Save Type
Initial S/W Revision	Prior to A.02.00

Mass Storage Catalog (Remote Command Only)

Key path	SCPI Only
Remote Command	:MMEMory:CATalog? [<directory_name>]
Notes	<p>The string must be a valid logical path.</p> <p>Queries disk usage information (drive capacity, free space available) and obtains a list of files and directories in a specified directory in the following format: <numeric_value>,<numeric_value>,{<file_entry>}</p> <p>It returns two numeric parameters and as many strings as there are files and directories. The first parameter indicates the total amount of storage currently used in bytes. The second parameter indicates the total amount of storage available, also in bytes. The <file_entry> is a string. Each <file_entry> indicates the name, type, and size of one file in the directory list: <file_name>,<file_type>,<file_size></p> <p>As the windows file system has an extension that indicates file type, <file_type> is always empty. <file_size> provides the size of the file in bytes. For directories, <file_entry> is surrounded by square brackets and both <file_type> and <file_size> are empty</p>
Initial S/W Revision	Prior to A.02.00

Mass Storage Change Directory (Remote Command Only)

Key path	SCPI Only
Remote Command	:MMEMory:CDIRectory [<directory_name>] :MMEMory:CDIRectory?
Notes	<p>The string must be a valid logical path.</p> <p>Changes the default directory for a mass memory file system. The <directory_name> parameter is a string. If no parameter is specified, the directory is set to the *RST value.</p> <p>At *RST, this value is set to the default user data storage area, that is defined as System.Environment.SpecialFolder.Personal.</p> <p>Query returns full path of the default directory.</p>
Initial S/W Revision	Prior to A.02.00

Mass Storage Copy (Remote Command Only)

Key path	SCPI Only
Remote Command	:MMEMory:COPY <string>,<string>[,<string>,<string>]
Notes	<p>The string must be a valid logical path.</p> <p>Copies an existing file to a new file or an existing directory to a new directory.</p> <p>Two forms of parameters are allowed. The first form has two parameters. In this form, the first parameter specifies the source, and the second parameter specifies the destination.</p> <p>The second form has four parameters. In this form, the first and third parameters specify the source. The second and fourth parameters specify the directories. The first pair of parameters specifies the</p>

source. The second pair specifies the destination. An error is generated if the source doesn't exist or the destination file already exists.

This command will generate an "access denied" error if the destination is a restricted folder (e.g., C:\Windows) and the current user does not have Power User or Administrator privileges.

Mass Storage Device Copy (Remote Command Only)

This command transfers data to/from a file and a peripheral device.

Key path	SCPI Only
Remote Command	:MMEMory:COpy:DEvice <source_string>,<dest_string>
Notes	The strings must be a valid logical path or a valid device keyword. If the <code>dest_string</code> is a device keyword, the data is copied from the source file to the device. If the <code>source_string</code> is a device keyword, the data is copied to the source file from the device. Valid device keywords are: SNS (smart noise source) An error is generated if the file or device is not found.

Mass Storage Delete (Remote Command Only)

Key path	SCPI Only
Remote Command	:MMEMory:DElete <file_name>[,<directory_name>]
Notes	The string must be a valid logical path. Removes a file from the specified directory. The <code><file_name></code> parameter specifies the file name to be removed. This command will generate an "access denied" error if the file is in a restricted folder (e.g., C:\Windows) and the current user does not have Power User or Administrator privileges.
Initial S/W Revision	Prior to A.02.00

Mass Storage Data (Remote Command Only)

Creates a file containing the specified data OR queries the data from an existing file.

Key path	SCPI Only
Remote Command	:MMEMory:DATA <file_name>,<data> :MMEMory:DATA? <file_name>
Notes	The string must be a valid logical path. The command form is <code>MMEMory:DATA <file_name>,<data></code> . It loads <code><data></code> into the file <code><file_name></code> . <code><data></code> is in 488.2 block format. <code><file_name></code> is string data. The query form is <code>MMEMory:DATA? <file_name></code> with the response being the associated <code><data></code> in block format.
Initial S/W Revision	Prior to A.02.00

Mass Storage Make Directory (Remote Command Only)

Key path	SCPI Only
Remote Command	:MMEMory:MDIRectory <directory_name>
Notes	<p>The string must be a valid logical path.</p> <p>Creates a new directory. The <directory_name> parameter specifies the name to be created.</p> <p>This command will generate an “access denied” error if the new directory would be in a restricted folder (e.g., C:\Windows) and the current user does not have Power User or Administrator privileges.</p>
Initial S/W Revision	Prior to A.02.00

Mass Storage Move (Remote Command Only)

Key path	SCPI Only
Remote Command	:MMEMory:MOVE <string>,<string>[,<string>,<string>]
Notes	<p>The string must be a valid logical path.</p> <p>Moves an existing file to a new file or an existing directory to a new directory.</p> <p>Two forms of parameters are allowed. The first form has two parameters. In this form, the first parameter specifies the source, and the second parameter specifies the destination.</p> <p>The second form has four parameters. In this form, the first and third parameters specify the source. The second and fourth parameters specify the directories. The first pair of parameters specifies the source. The second pair specifies the destination. An error is generated if the source doesn't exist or the destination file already exists.</p> <p>This command will generate an “access denied” error if the destination is a restricted folder (e.g., C:\Windows) and the current user does not have Power User or Administrator privileges.</p>
Initial S/W Revision	Prior to A.02.00

Mass Storage Remove Directory (Remote Command Only)

Key path	SCPI Only
Remote Command	:MMEMory:RDIRectory <directory_name>
Notes	<p>The string must be a valid logical path.</p> <p>Removes a directory. The <directory_name> parameter specifies the directory name to be removed. All files and directories under the specified directory shall also be removed.</p> <p>This command will generate an “access denied” error if the folder is a restricted folder (e.g., C:\Windows) or is in a restricted folder and the current user does not have Power User or Administrator privileges.</p>
Initial S/W Revision	Prior to A.02.00

Single (Single Measurement/Sweep)

Sets the analyzer for Single measurement operation. The single/continuous state is Meas Global, so the setting will affect all the measurements. If you are Paused, pressing Single does a Resume.

See "[More Information](#)" on page 1216

Key Path	Front-panel key
Example	:INIT:CONT OFF
Notes	See Cont key description.
Backwards Compatibility Notes	<p>For Spectrum Analysis mode in ESA and PSA, the Single hardkey and the INITiate:IMM switched from continuous measurement to single measurement and restarted sweeps and averages (displayed average count reset to 1), but did not restart Max Hold and Min Hold. In the X-Series, the Single hardkey and the INITiate:IMM command initiate a sweep/ measurement/ average sequence/hold sequence including MaxHold and MinHold.</p> <p>For Spectrum Analysis mode in ESA and PSA, the Single hardkey restarted the sweep regardless of whether or not you were in an active sweep or sweep sequence. In the X-Series, Restart does this but Single only restarts the sweep or sweep sequence if you are in the idle state.</p> <p>INIT[:IMM] in ESA & PSA Spectrum Analysis Mode does an implied ABORT. In some other PSA Modes, INIT[:IMM] is ignored if not in the idle state. . The X-Series follows the ESA/PSA SA Mode model, which may cause some Modes to have compatibility problems.</p>
Initial S/W Revision	Prior to A.02.00

More Information

See "[Restart](#)" on page 2249 for details on the INIT:IMMEDIATE (Restart) function.

If you are already in single sweep, the INIT:CONT OFF command has no effect.

If you are already in Single Sweep, then pressing the Single key in the middle of a sweep does not restart the sweep or sequence. Similarly, pressing the Single key does not restart the sweep or sequence if the sweep is not in the idle state (for example, if you are taking a very slow sweep, or the analyzer is waiting for a trigger). Instead, it results in a message. "Already in Single, press Restart to initiate a new sweep or sequence". Even though pressing the Single key in the middle of a sweep does not restart the sweep, sending INIT:IMMEDIATE does reset it.

To take one more sweep without resetting the average count, increment the average count by 1, by pressing the step up key while **Average/Hold Number** is the active function, or sending the remote command CALC:AVER:TCON UP.

Source

There is no Source control functionality for this measurement. When this key is pressed, the screen either displays a blank menu, or the previously-selected menu remains unchanged.

Key Path	Front-panel key
----------	-----------------

Span X Scale

Span X Scale is unavailable in the Spurious Emissions measurement. When pressed, this key displays a blank menu.

Key Path	Front-panel key
Initial S/W Revision	Prior to A.02.00

Sweep/Control

Accesses the Sweep/Control menu keys used to set up and control the sweep time and source.

Key Path	Front-panel key
Initial S/W Revision	Prior to A.02.00

Sweep Setup

Sets the sweep functions that control the sweep state and time.

Key Path	Sweep/Control
Initial S/W Revision	Prior to A.02.00

Auto Sweep Time Rules

Switches the analyzer between normal and accuracy sweep states. Setting Auto Sweep Time to Accy will result in slower sweep times, usually about three times as long, but better amplitude accuracy for CW signals. The instrument amplitude accuracy specifications only apply when Auto Sweep Time is set to Accy.

Additional amplitude errors which occur when Auto Sweep Time is set to Norm are usually well under 0.1 dB, though this is not guaranteed. Because of the faster sweep times and still low errors, Norm is the preferred setting of Auto Sweep Time. Auto Sweep Time is set to Norm on a Preset or Auto Couple. This means that in the Preset or Auto Coupled state, instrument amplitude accuracy specifications do not apply.

Key Path	Sweep/Control, Sweep Setup
Mode	SA, WCDMA, C2K, WIMAX OFDMA, TD-SCDMA, 1xEV-DO, DVB-T/H, LTE, LTETDD, WLAN, MSR, LTEAFDD, LTEATDD
Remote Command	[:SENSe] :SPURious :SWEep :TIME :AUTO :RULEs NORMal ACCuracy [:SENSe] :SPURious :SWEep :TIME :AUTO :RULEs ?
Example	SPUR:SWE:TIME:AUTO:RUL ACC SPUR:SWE:TIME:AUTO:RUL?
Notes	In Zero Span, this key is irrelevant and inaccessible (because the whole Sweep Setup menu is grayed out), however, Sweep Setup settings can be changed remotely with no error indication.
Preset	NORMal
State Saved	Saved in instrument state.
Range	Norm Accy
Initial S/W Revision	Prior to A.02.00
Modified at S/W Revision	A.03.00

Sweep Type

Sets the sweep type of the spurious measurement to either Auto or Swept. When in Auto, the selections of swept type of ranges are governed by the Best Speed Sweep Type Rule, and FFT analysis might be chosen for some ranges if it speeds up the measurement.

Key Path	Sweep/Control, Sweep Setup
Mode	SA, WCDMA, C2K, WIMAX OFDMA, TD-SCDMA, 1xEV-DO, DVB-T/H, LTE, LTE-TDD, WLAN, MSR, LTEAFDD, LTEATDD
Remote Command	[:SENSe] :SPURious [:RANGe] :ALL:SWEep:TYPE:AUTO OFF ON 0 1 [:SENSe] :SPURious [:RANGe] :ALL:SWEep:TYPE:AUTO?
Example	SPUR:ALL:SWE:TYPE:AUTO 1 SPUR:ALL:SWE:TYPE:AUTO?
Dependencies	This parameter is available only when option N9060A-7FP is installed.
Preset	ON
State Saved	Saved in instrument state.
Range	Auto Swept
Initial S/W Revision	A.11.00

Pause

Pauses a measurement after the current data acquisition is complete.

When paused, the label on the key changes to Resume. Pressing Resume resumes the measurement at the point it was at when paused.

See "[Pause/Resume](#)" on page 2282 for more information.

Key Path	Sweep/Control
Initial S/W Revision	Prior to A.02.00

Gate

Accesses a menu that enables you to control the gating function. The Gate functionality is used to view signals best viewed by qualifying them with other events.

Gate setup parameters are the same for all measurements – they do not change as you change measurements. Settings like these are called “Meas Global” and are unaffected by Meas Preset.

Note that Sweep Time autocoupling rules and annotation are changed by Gate being on.

Key Path	Sweep/Control
Scope	Meas Global
Readback	

The state and method of Gate, as [Off, LO] or [On, Video]. Note that for measurements that only support gated LO, the method is nonetheless read back, but always as LO.

Initial S/W Revision Prior to A.02.00

Gate On/Off

Turns the gate function on and off.

When the Gate Function is on, the selected Gate Method is used along with the gate settings and the signal at the gate source to control the sweep and video system with the gate signal. Not all measurements allow every type of Gate Methods.

When Gate is on, the annunciation in the measurement bar reflects that it is on and what method is used, as seen in the following "Gate: LO" annunciator graphic.

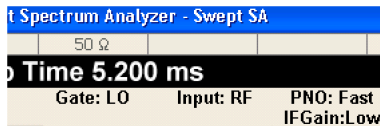

Key Path	Sweep/Control, Gate
Remote Command	[:SENSe] :SWEep:EGATe [:STATe] OFF ON 0 1 [:SENSe] :SWEep:EGATe [:STATe] ?
Example	SWE:EGAT ON SWE:EGAT?

Dependencies

The function is unavailable (grayed out) and Off when:

- Gate Method is LO or Video and FFT Sweep Type is manually selected.
- Gate Method is FFT and Swept Sweep Type is manually selected.
- Marker Count is ON.

The following are unavailable whenever Gate is on:

- FFT under Sweep Type when Method=LO or Video or Swept under Sweep Type when Method=FFT
- Marker Count

While Gate is on, the Auto Rules for Sweep Type are modified so that the choice agrees with the Gate Method: i.e., FFT for Method = FFT and Swept for Method = LO or Video.

The Gate softkey and all SCPI under the [:SENSe]:SWEep:EGATe SCPI node are grayed out when Source Mode is Tracking with an external source. This is because the Gate circuitry is used to sync the external source. If the Tracking Source is turned on, the Gate is turned off.

When in the ACP measurement:

- When Meas Method is RBW or FAST, this function is unavailable and the key is grayed out.
- Whenever Gate is on, Meas Method, RBW or FAST is unavailable and keys for those are grayed out.
- When Gate is on, Offset Res BW and Offset Video BW are ignored (if you set these values) and the

	measurement works as if all Offset Res BW and all Offset Video BW are coupled with the Res BW and the Video BW under the BW menu. When Gate is on, the Offset BW key in the Offset/Limit menu is grayed out.
Preset	Off LTETDD: On
State Saved	Saved in instrument state
Range	On Off
Backwards Compatibility SCPI	[[:SENSE]:SWEep:TIME:GATE[:STATe] ESA compatibility
Backwards Compatibility Notes	In ESA, Trig Delay (On) and Gate (On) could not be active at the same time.. This dependency does not exist in PSA or in the X-Series.
Initial S/W Revision	Prior to A.02.00

Gate View On/Off

Turning on Gate View in the Swept SA measurement provides a single-window gate view display..

Turning on Gate View in other measurements shows the split-screen Gate View. In these measurements, when the Gate View is on, the regular view of the current measurement traces and results are reduced vertically to about 70% of the regular height. The Zero Span window, showing the positions of the Gate, is shown between the Measurement Bar and the reduced measurement window. By reducing the height of the measurement window, some of the annotation on the Data Display may not fit and is not shown.

Key Path	Sweep/Control, Gate
Remote Command	[[:SENSE]:SWEep:EGATe:VIEW ON OFF 1 0 [:SENSE]:SWEep:EGATe:VIEW?
Example	SWE:EGAT:VIEW ON turns on the gate view.
Dependencies	In the Swept SA measurement: In Gate View, the regular Sweep Time key is grayed out . When pressed, the grayed out key puts up the informational message "Use Gate View Sweep Time in the Gate menu." In the other measurements: When you turn Gate View on, the lower window takes on the current state of the instrument. Upon leaving Gate View, the instrument takes on the state of the lower window. When you turn Gate View on, the upper window Sweep Time is set to the gate view sweep time.
Couplings	These couplings apply to the Swept SA measurement: <ul style="list-style-type: none"> • When Gate View is turned on, the instrument is set to Zero Span. • Gate View automatically turns off whenever a Span other than Zero is selected. • Gate View automatically turns off if you press the Last Span key while in Gate View, and the instrument returns to the Span it was in before entering Gate View (even if that is Zero Span). • When Gate View is turned on, the sweep time used is the gate view sweep time. This is set according to the rules in section "Gate View Setup" on page 2083 • When Gate View is turned off, Sweep Time is set to the normal Swept SA measurement sweep time.

- If Gate View is on and Gate is off, then turning on Gate turns off Gate View.

Preset	OFF
State Saved	Saved in instrument state
Range	On Off
Initial S/W Revision	Prior to A.02.00

A sample of the Gate View screen in the Swept SA measurement is shown in the following graphic :

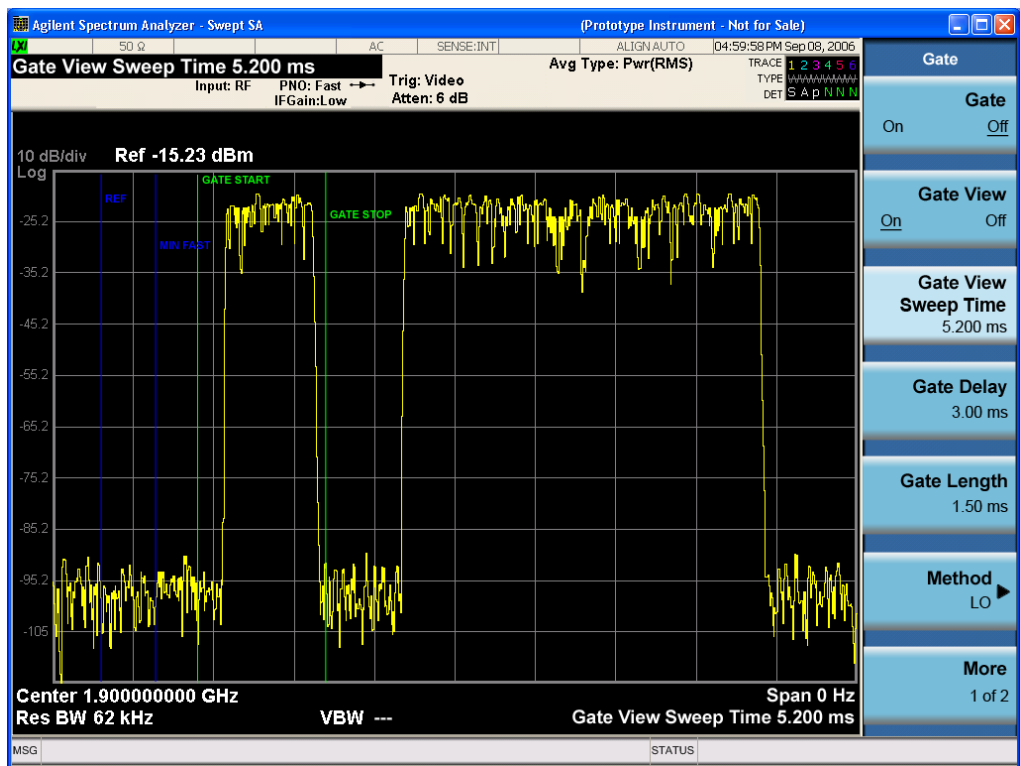

A sample of the Gate View screen in other measurements is shown in the following graphic . This example is for the ACP measurement:

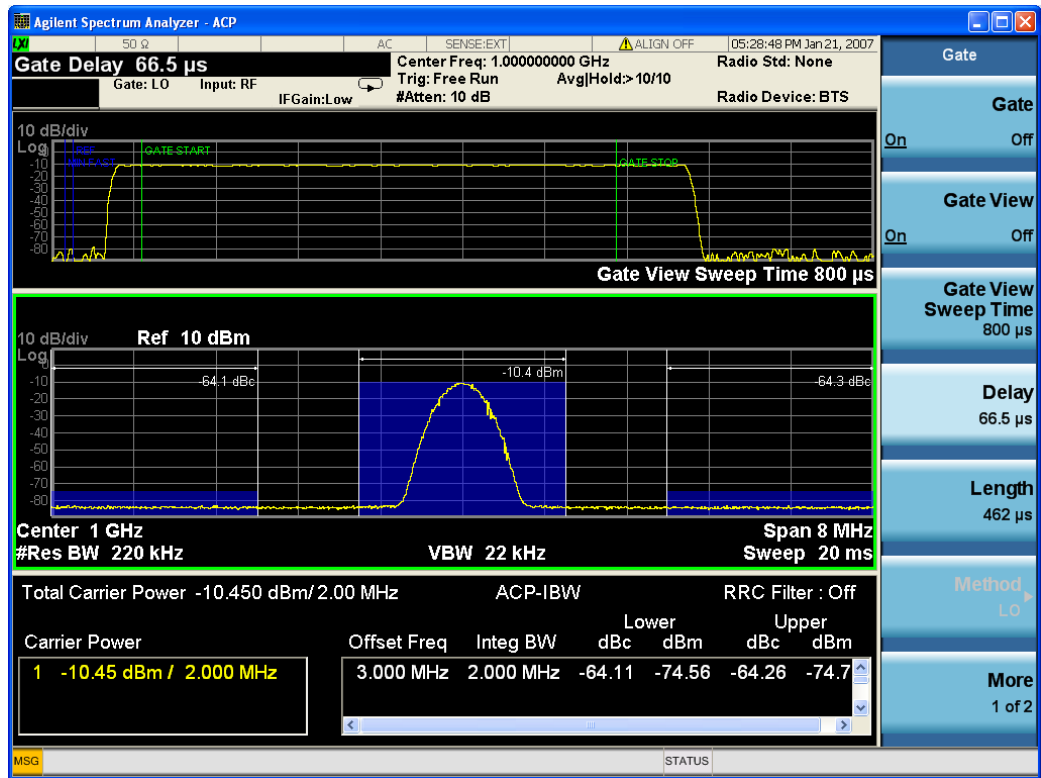

Turning Gate View off returns the analyzer to the Normal measurement view.

In the Swept SA, the normal measurement view is the single-window Swept SA view. When returning to this view, the Swept SA measurement returns to the Span it was in before entering **Gate View** (even if that is Zero Span).

The **Gate View** window is triggered from the Gate Source, with zero trigger delay. Also, when updating the **Gate View** window, the Gate itself must not operate. So it is internally shut off while the gate view window is being updated. For the Swept SA measurement, this means that the Gate is internally shut off whenever the gate view window is displayed. The measurement bar and softkeys continue to show the Trigger source for the main sweep window and give no indication that the Gate is shut off or that the Gate View window is triggered from the Gate Source.

When in **Gate View**, vertical lines are displayed in the Gate View window as follows:

- Green lines are displayed at the gate edges as follows: in Edge Gate, a line is shown for Delay and one for the end of the Gate period, defined by Length. In Level Gate a line is shown only for Delay. You can adjust the position of the green lines by adjusting the gate length and the gate delay. These lines update in the Gate View window as the active function changes, even if the window is not being updated. In Gated LO and Gated Video, these lines are positioned relative to the delay reference line (not relative to 0 time). In Gated FFT, their location is relative to the left edge of the screen.
- A blue line is displayed showing the delay reference, that is, the reference point for the Gate Delay within the Zero Span window. The blue line represents where (in time) the effective location of the gate start would be if the gate were programmed to zero delay.
-

- The second blue line is labeled "MIN FAST" as shown in the figure above because it represents the minimum Gate Delay for fast Gated LO operation. This line is only displayed in Gated LO. You cannot scroll (knob) or decrement (down key) the Gate Delay to less than that represented by the position of this line, it can only be set below this position manually, although once there it can be moved freely with the knob while below the line.
- A yellow line in the Gated Video case only, is displayed at $Blength$, where $Blength$ is the display point (bucket) length for the swept trace, which is given by the sweep time for that trace divided by number of Points - 1. So it is referenced to 0 time, not to the delay reference. This line is labeled NEXT PT (it is not shown in the figure above because the figure above is for Gated LO).
- The yellow line represents the edge of a display point (bucket). Normally in Gated Video, the bucket length must be selected so that it exceeds the off time of the burst. There is another way to use the analyzer in Gated Video measurements, and that is to set the bucket width much shorter than the off time of the burst. Then use the Max Hold trace function to fill in "missing" buckets more slowly. This allows you to see some of the patterns of the Gated Video results earlier, though seeing a completely filled-in spectrum later.

Gate View Setup

Accesses a menu that enables you to setup parameters relevant to the Gate View

Key Path	Sweep/Control, Gate
Scope	Meas Global
Initial S/W Revision	A.10.00

Gate View Sweep Time

Controls the sweep time in the Gate View window. To provide an optimal view of the gate signal, the analyzer initializes Gate View Sweep Time based on the current settings of Gate Delay and Gate Length.

Key Path	Sweep/Control, Gate, Gate View Setup
Remote Command	[:SENSe] :SWEep:EGATe:TIME <time> [:SENSe] :SWEep:EGATe:TIME?
Example	SWE:EGAT:TIME 500 ms
Dependencies	Gate View Sweep Time is initialized: <ul style="list-style-type: none"> • On Preset (after initializing delay and length). • Every time the Gate Method is set/changed. <p>Additionally, in the Swept SA measurement, whenever you do a Preset, or leave Gate View, the analyzer remembers the Gate Delay and Gate Length settings. Then, when returning to Gate View, if the current Gate Delay and/or Gate Length do not match the remembered values Gate View Sweep Time is re-initialized.</p> <ol style="list-style-type: none"> 1. Compute the location of the "gate stop" line, which you know is at time $t = t_{min} + GateDelay + GateLength$.
Preset	519.3 μ s

	WiMAX OFDMA: 5 ms GSM/EDGE: 1 ms
State Saved	Saved in instrument state
Max	6000 s
Initial S/W Revision	Prior to A.02.00

Gate View Start Time

Controls the time at the left edge of the Gate View.

Key Path	Sweep/Control, Gate, Gate View Setup
Remote Command	[:SENSe] :SWEep:EGATe:VIEW:STARt <time> [:SENSe] :SWEep:EGATe:VIEW:STARt?
Example	SWE:EGAT:VIEW:STAR 10ms
Notes	Units of time are required or no units; otherwise an invalid suffix error message will be generated. See error -131.
Preset	0 ms
State Saved	Saved in instrument state
Min	0
Max	500 ms
Initial S/W Revision	A.10.00

Gate Delay

Controls the length of time from the time the gate condition goes True until the gate is turned on.

Key Path	Sweep/Control, Gate
Remote Command	[:SENSe] :SWEep:EGATe:DELAy <time> [:SENSe] :SWEep:EGATe:DELAy?
Example	SWE:EGAT:DELAy 500ms SWE:EGAT:DELAy?
Notes	Units of time are required or no units; otherwise an invalid suffix error message will be generated.
Preset	57.7 us WiMAX OFDMA: 71 us GSM/EDGE: 600 us WLAN: 500 us
State Saved	Saved in instrument state

Min	0.0 us
Max	100 s
Backwards Compatibility SCPI	[:SENSe]:SWEep:TIME:GATE:DELay ESA compatibility
Initial S/W Revision	Prior to A.02.00

Gate Length

Controls the length of time that the gate is on after it opens.

Key Path	Sweep/Control, Gate
Remote Command	[:SENSe]:SWEep:EGATe:LENGth <time> [:SENSe]:SWEep:EGATe:LENGth?
Example	SWE:EGAT:LENG 1 SWE:EGAT:LENG?
Notes	Units of time are required or no units; otherwise an invalid suffix error message will be generated.

Dependencies

Grayed out when Gate Method is set to FFT in which case the label changes to that shown below.



The key is also grayed out if Gate Control = Level.

Preset	461.6 us WiMAX OFDMA: 50 us GSM/EDGE: 200 us WLAN: 1.54 ms
State Saved	Saved in instrument state
Min	100 ns
Max	5 s
Backwards Compatibility SCPI	[:SENSe]:SWEep:TIME:GATE:LENGth ESA compatibility
Initial S/W Revision	Prior to A.02.00

Gate Source

The menus under the Gate Source key are the same as those under the Trigger key, with the exception that neither Free Run nor Video are available as Gate Source selections. However, a different SCPI command

is used to select the Gate Source (see table below) because you may independently set the Gate Source and the Trigger Source.

Any changes to the settings in the setup menus under each Gate Source selection key (for example: Trigger Level, Trigger Delay, etc.) also affect the corresponding settings under the Trigger menu keys. The SCPI commands used for these are the same for Trigger and Gate, since there is only one setting which affects both Gate and Trigger. Example: to set the Trigger Level for External 1 you use the command :TRIG:EXT1:LEV regardless of whether you are using External 1 as a Trigger Source or a Gate Source.

Key Path	Sweep/Control, Gate
Remote Command	[:SENSe] :SWEep:EGATe:SOURce EXTernal1 EXTernal2 LINE FRAMe RFBurst [:SENSe] :SWEep:EGATe:SOURce?
Dependencies	In some models, there is no second External input. In these models, the External 2 key is blanked and the EXTernal2 parameter will generate a "Hardware missing; Not available for this model number" error.
Preset	EXTernal 1 GSM/EDGE, MSR: FRAMe LTETDD: EXTernal 1When Direction is Downlink, FRAMe when Direction is Uplink.
Backwards Compatibility Notes	In ESA, there is a single Gate input port. In PSA, the Gate Source may be taken from one of two specified input ports. In the X-Series, any Trigger Source can be a Gate Source.
Initial S/W Revision	Prior to A.02.00
Modified at S/W Revision	A.03.00, A.14.00

Line

Pressing this key, when it is not selected, selects the line signal as the trigger. A new sweep/measurement will start synchronized with the next cycle of the line voltage. Pressing this key, when it is already selected, access the line trigger setup menu.

Key Path	Trigger
Example	TRIG:SOUR LINE Swept SA measurement TRIG:<meas>:SOUR LINE Measurements other than Swept SA
Dependencies	Line trigger is not available when operating from a "dc power source", for example, when the instrument is powered from batteries.
State Saved	Saved in instrument state
Status Bits/OPC dependencies	The Status Operation Register bit 5 "Waiting for Trigger" is set at the same time as the Sweeping or Measuring bit is set. It is cleared when the trigger actually occurs (that is, after the trigger event occurs and all the applicable trigger criteria have been met). A corresponding pop-up message ("Waiting for trigger") is generated if no trigger signal appears after approximately 2 sec. This message goes away when a trigger signal appears.
Initial S/W Revision	Prior to A.02.00

Trig Slope

Controls the trigger polarity. It is set positive to trigger on a rising edge and negative to trigger on a falling edge.

Key Path	Trigger, Line
Remote Command	:TRIGger[:SEquence]:LINE:SLOPe POSitive NEGative :TRIGger[:SEquence]:LINE:SLOPe?
Example	TRIG:LINE:SLOP NEG
Preset	POSitive
State Saved	Saved in instrument state
Backwards Compatibility Notes	The legacy :TRIGger[:SEquence]:SLOPe command affects the slopes for the VID, LINE, EXT1, EXT2, and RFB triggers.
Initial S/W Revision	Prior to A.02.00

External 1

Pressing this key, when it is not selected, selects an external input signal as the trigger. A new sweep/measurement will start when the external trigger condition is met using the external 1 input connector on the rear panel.

Pressing this key, when it is already selected, accesses the external 1 trigger setup menu.

Key Path	Trigger
Example	TRIG:SOUR EXT1 Swept SA measurement TRIG:<meas>:SOUR EXT1 Measurements other than Swept SA
Dependencies	Grayed out if in use by Point Trigger in the Source Setup menu. Forced to Free Run if already selected and Point Trigger is set to External 1.
State Saved	Saved in instrument state
Status Bits/OPC dependencies	The Status Operation Register bit 5 "Waiting for Trigger" is set at the same time as the Sweeping or Measuring bit is set. It is cleared when the trigger actually occurs (that is, after the trigger event occurs and all the applicable trigger criteria have been met). A corresponding pop-up message ("Waiting for trigger") is generated if no trigger signal appears after approximately 2 sec. This message goes away when a trigger signal appears.
Initial S/W Revision	Prior to A.02.00

Trigger Level

Sets the value where the external 1 trigger input will trigger a new sweep/measurement.

Key Path	Trigger, External 1
Remote Command	:TRIGger[:SEquence]:EXTernal1:LEVel <level>

	:TRIGger[:SEquence]:EXTernal:LEVel?
Example	TRIG:EXT1:LEV 0.4 V
Couplings	This same level is used for the Ext1 trigger source in the Trigger menu, for the Ext1 selection in the Periodic Timer sync source (in the Trigger menu and in the Gate Source menu), and also for the Ext1 selection in the Gate Source menu.
Preset	1.2 V
State Saved	Saved in instrument state
Min	-5 V
Max	5 V
Default Unit	V
Backwards Compatibility SCPI	:TRIGger[:SEquence]:EXTernal:LEVel
Backwards Compatibility SCPI	For backward compatibility, the parameter EXTernal is mapped to EXTernal1
Backwards Compatibility SCPI	:TRIGger[:SEquence]:FRAMe:EXTernal1:LEVel
Initial S/W Revision	Prior to A.02.00

Trig Slope

Controls the trigger polarity. It is set positive to trigger on a rising edge and negative to trigger on a falling edge.

Key Path	Trigger, External 1
Remote Command	:TRIGger[:SEquence]:EXTernal:SLOPe POSitive NEGative :TRIGger[:SEquence]:EXTernal:SLOPe?
Example	TRIG:EXT1:SLOP NEG
Couplings	This same slope is used in the Ext1 selection for the trigger source in the Trigger menu and for the period timer sync source (in the Trigger menu and in the Gate Source menu).
Preset	POSitive
State Saved	Saved in instrument state
Backwards Compatibility SCPI	:TRIGger[:SEquence]:EXTernal:SLOPe
Backwards Compatibility SCPI	For backward compatibility, the parameter EXTernal is mapped to EXTernal1
Backwards Compatibility SCPI	:TRIGger[:SEquence]:FRAMe:EXTernal1:SLOPe
Backwards Compatibility Notes	The legacy :TRIGger[:SEquence]:SLOPe command affects the slopes for the VID, LINE, EXT1, EXT2, and RFB triggers.
Initial S/W Revision	Prior to A.02.00

External 2

Pressing this key, when it is not selected, selects an external input signal as the trigger. A new sweep/measurement will start when the external trigger condition is met using the external 2 input connector. The external trigger 2 input connector is on the rear panel.

Pressing this key, when it is already selected, accesses the external 2 trigger setup menu.

Key Path	Trigger
Example	TRIG:SOUR EXT2 Swept SA measurement TRIG:<meas>:SOUR EXT2 Measurements other than Swept SA
Dependencies	In some models, there is no second External input. In these models, the External 2 key is blanked and the EXTernal2 parameter will generate a "Hardware missing; Not available for this model number" message. Grayed out if in use by Point Trigger in the Source Setup menu. Forced to Free Run if already selected and Point Trigger is set to External 2.
State Saved	Saved in instrument state
Status Bits/OPC dependencies	The Status Operation Register bit 5 "Waiting for Trigger" is set at the same time as the Sweeping or Measuring bit is set. It is cleared when the trigger actually occurs (that is, after the trigger event occurs and all the applicable trigger criteria have been met). A corresponding pop-up message ("Waiting for trigger") is generated if no trigger signal appears after approximately 2 sec. This message goes away when a trigger signal appears.
Initial S/W Revision	Prior to A.02.00
Modified at S/W Revision	A.03.00

Trigger Level

Sets the value where the external 2 trigger input will trigger a new sweep/measurement.

Key Path	Trigger, External 2
Remote Command	:TRIGger[:SEquence]:EXTernal2:LEVel :TRIGger[:SEquence]:EXTernal2:LEVel?
Example	TRIG:EXT2:LEV 1.1 V
Couplings	This same level is used for the Ext2 trigger source in the Trigger menu, for the Ext2 selection in the Periodic Timer sync source (in the Trigger menu and in the Gate Source menu), and also for the Ext2 selection in the Gate Source menu.
Preset	1.2 V
State Saved	Saved in instrument state
Min	-5 V
Max	5 V
Default Unit	V
Backwards Compatibility SCPI	:TRIGger[:SEquence]:FRAMe:EXTernal2:LEVel
Initial S/W Revision	Prior to A.02.00

Trig Slope

Controls the trigger polarity. It is set positive to trigger on a rising edge and negative to trigger on a falling edge.

Key Path	Trigger, External 2
Remote Command	:TRIGger[:SEquence]:EXTernal2:SLOPe POSitive NEGative :TRIGger[:SEquence]:EXTernal2:SLOPe?
Example	TRIG:EXT2:SLOP NEG
Couplings	This same slope is used in the Ext2 selection for the trigger source in the Trigger menu and for the period timer sync source (in the Trigger menu and in the Gate Source menu).
Preset	POSitive
State Saved	Saved in instrument state
Backwards Compatibility SCPI	:TRIGger[:SEquence]:FRAMe:EXTernal2:SLOPe
Backwards Compatibility Notes	The legacy :TRIGger[:SEquence]:SLOPe command affects the slopes for the VID, LINE, EXT1, EXT2, and RFB triggers.
Initial S/W Revision	Prior to A.02.00

RF Burst

Pressing this key, when it is not selected, selects the RF Burst as the trigger. A new sweep/measurement will start when an RF burst envelope signal is identified from the signal at the RF Input connector. Pressing this key, when it is already selected, accesses the RF Burst trigger setup menu.

In some models, a variety of burst trigger circuitry is available, resulting in various available burst trigger bandwidths. The analyzer automatically chooses the appropriate trigger path based on the hardware configuration and other settings of the analyzer.

Key Path	Trigger
Example	TRIG:SOUR RFB Swept SA measurement TRIG:<meas>:SOUR RFB Measurements other than Swept SA
State Saved	Saved in instrument state
Status Bits/OPC dependencies	The Status Operation Register bit 5 "Waiting for Trigger" is set at the same time as the Sweeping or Measuring bit is set. It is cleared when the trigger actually occurs (that is, after the trigger event occurs and all the applicable trigger criteria have been met). A corresponding pop-up message ("Waiting for trigger") is generated if no trigger signal appears after approximately 2 sec. This message goes away when a trigger signal appears.
Backwards Compatibility Notes	The legacy command: :TRIGger[:SEquence]:RFBurst:FSElectivity[:STATe] OFF ON 0 1 is not supported in the X-Series, as the hardware to do Frequency Selective burst triggers does not exist in X-Series.

Initial S/W Revision	Prior to A.02.00
Modified at S/W Revision	A.04.00

Absolute Trigger Level

Sets the absolute trigger level for the RF burst envelope.

When using the External Mixing path, the Absolute Trigger Level is uncalibrated because the factory default was set to accommodate the expected IF levels for the RF path.

Key Path	Trigger, RF Burst
Scope	Meas Global
Remote Command	:TRIGger[:SEquence]:RFBurst:LEVel:ABSolute <ampl> :TRIGger[:SEquence]:RFBurst:LEVel:ABSolute?
Example	TRIG:RFB:LEV:ABS 10 dBm sets the trigger level of the RF burst envelope signal to the absolute level of 10 dBm
Notes	Sending this command does not switch the setting from relative to absolute; to switch it you need to send the :TRIGger[:SEquence]:RFBurst:LEVel:TYPE command, below. Amplitude Corrections are not taken into account by the Absolute Trigger Level. For example, if you have given yourself effective gain with an amplitude correction factor, the Absolute Trigger will not fire until you have set the trigger level that far below the displayed signal level, rather than simply to the displayed signal level. This is only true for Amplitude Corrections, not External Gain or Ref Level Offset functions. If mode is Bluetooth, the default value is -50 dBm.
Couplings	This same level is used for the RF Burst trigger source in the Trigger menu, for the RF Burst selection in the Periodic Timer sync source (in the Trigger menu and in the Gate Source menu), and also for the RF Burst selection in the Gate Source menu
Preset	-20 dBm
State Saved	Saved in instrument state
Min	-200 dBm
Max	100 dBm
Default Unit	depends on the current selected Y-Axis unit
Backwards Compatibility SCPI	:TRIGger[:SEquence]:FRAME:RFBurst:LEVel:ABSolute
Initial S/W Revision	Prior to A.02.00
Modified at S/W Revision	A.04.00

Key Path	Trigger, RF Burst
Remote Command	:TRIGger[:SEquence]:RFBurst:LEVel:TYPE ABSolute RELative :TRIGger[:SEquence]:RFBurst:LEVel:TYPE?

Example	TRIG:RFB:LEV:TYPE REL sets the trigger level type of the RF burst trigger to Relative.
Preset	ABSolute
State Saved	Saved in instrument state
Initial S/W Revision	Prior to A.02.00
Modified at S/W Revision	A.04.00

Relative Trigger Level

Sets the relative trigger level for the RF burst envelope.

In some models, the relative burst trigger function is implemented in hardware. In other models, without the advanced triggering hardware required, the relative burst trigger function is implemented in software in some measurements, and is unavailable in other measurements.

When implemented in software, the relative RF Burst trigger function is implemented as follows:

1. The measurement starts with the absolute RF Burst trigger setting. If it cannot get a trigger with that level, auto trigger fires and the acquisition starts anyway. After the acquisition, the measurement searches for the peak in the acquired waveform and saves it.
2. Now, in the next cycle of the measurement, the measurement determines a new absolute RF Burst level based on the peak value from the first measurement and the Relative RF Burst Trigger Level (always 0 or negative dB) set by the user. The following formula is used:
3. absolute RF Burst level = peak level of the previous acquisition + relative RF Burst level
4. If the new absolute RF Burst level differs from the previous by more than 0.5 dB, the new level is sent to the hardware; otherwise it is not updated (to avoid slowing down the acquisition)

Steps 2 and 3 repeat for subsequent measurements.

Key Path	Trigger, RF Burst
Scope	Meas Global
Remote Command	:TRIGger[:SEquence]:RFBurst:LEVel:RELative <rel_amp1> :TRIGger[:SEquence]:RFBurst:LEVel:RELative?
Example	TRIG:RFB:LEV:REL -10 dB sets the trigger level of the RF burst envelope signal to the relative level of -10 dB
Notes	Sending this command does not switch the setting from absolute to relative; to switch it you need to send the :TRIGger[:SEquence]:RFBurst:LEVel:TYPE command, above. The relative trigger level is not available in some measurements. In those measurements the RELative parameter, and the :TRIGger[:SEquence]:RFBurst:LEVel:TYPE command (above), will generate an error if sent.
Dependencies	This key is grayed out and Absolute Trigger Level selected if the required hardware is not present in your analyzer and the current measurement does not support Relative triggering.
Preset	-6 dB

	GSM: -25 dB
State Saved	Saved in instrument state
Min	-45 dB
Max	0 dB
Default Unit	dB or dBc
Backwards Compatibility SCPI	:TRIGger[:SEquence]:RFBurst:LEVel
	This legacy command is aliased to :TRIGger[:SEquence]:RFBurst:LEVel:RELative because the PSA had ONLY relative burst triggering
Initial S/W Revision	Prior to A.02.00
Modified at S/W Revision	A.04.00

Trigger Slope

It is set positive to trigger on a rising edge and negative to trigger on a falling edge.

Key Path	Trigger, RF Burst
Remote Command	:TRIGger[:SEquence]:RFBurst:SLOPe POSitive NEGative :TRIGger[:SEquence]:RFBurst:SLOPe?
Example	TRIG:RFB:SLOP NEG
Couplings	This same slope is used in the RF Burst selection for the trigger source in the Trigger menu and for the period timer sync source (in the Trigger menu and in the Gate Source menu).
Preset	POSitive
State Saved	Saved in instrument state
Backwards Compatibility SCPI	:TRIGger[:SEquence]:FRAMe:RFBurst:SLOPe
Backwards Compatibility Notes	The legacy :TRIGger[:SEquence]:SLOPe command affects the slopes for the VID, LINE, EXT1, EXT2, and RFB triggers.
Initial S/W Revision	Prior to A.02.00

Periodic Timer (Frame Trigger)

Pressing this key, when it is not selected, selects the internal periodic timer signal as the trigger. Triggering occurrences are set by the **Period** parameter, which is modified by the **Sync Source** and **Offset**. Pressing this key, when it is already selected, accesses the periodic timer trigger setup functions.

If you do not have a sync source selected (it is Off), then the internal timer will not be synchronized with any external timing events.

Key Path	Trigger
Example	TRIG:SOUR FRAM Swept SA measurement TRIG:<meas>:SOUR FRAM Measurements other than Swept SA

State Saved	Saved in instrument state
Readback	[Sync: <value of Sync Source>], for example, [Sync: External 1]
Status Bits/OPC dependencies	The Status Operation Register bit 5 "Waiting for Trigger" is set at the same time as the Sweeping or Measuring bit is set. It is cleared when the trigger actually occurs (that is, after the trigger event occurs and all the applicable trigger criteria have been met). A corresponding pop-up message ("Waiting for trigger") is generated if no trigger signal appears after approximately 2 sec. This message goes away when a trigger signal appears.
Initial S/W Revision	Prior to A.02.00

Periodic Timer Triggering:

This feature selects the internal periodic timer signal as the trigger. Trigger occurrences are set by the **Periodic Timer** parameter, which is modified by the **Sync Source** and **Offset**.

The figure below shows the action of the periodic timer trigger. Before reviewing the figure, we'll explain some uses for the periodic trigger.

A common application is measuring periodic burst RF signals for which a trigger signal is not easily available. For example, we might be measuring a TDMA radio which bursts every 20 ms. Let's assume that the 20 ms period is very consistent. Let's also assume that we do not have an external trigger source available that is synchronized with the period, and that the signal-to-noise ratio of the signal is not high enough to provide a clean RF burst trigger at all of the analysis frequencies. For example, we might want to measure spurious transmissions at an offset from the carrier that is larger than the bandwidth of the RF burst trigger. In this application, we can set the Periodic Timer to a 20.00 ms period and adjust the offset from that timer to position our trigger just where we want it. If we find that the 20.00 ms is not exactly right, we can adjust the period slightly to minimize the drift between the period timer and the signal to be measured.

A second way to use this feature would be to use **Sync Source** temporarily, instead of **Offset**. In this case, we might tune to the signal in a narrow span and use the RF Burst trigger to synchronize the periodic timer. Then we would turn the sync source off so that it would not miss-trigger. Miss-triggering can occur when we are tuned so far away from the RF burst trigger that it is no longer reliable.

A third example would be to synchronize to a signal that has a reference time element of much longer period than the period of interest. In some CDMA applications, it is useful to look at signals with a short periodicity, by synchronizing that periodicity to the "even-second clock" edge that happens every two seconds. Thus, we could connect the even-second clock trigger to Ext1 and use then Ext1 as the sync source for the periodic timer.

The figure below illustrates this third example. The top trace represents the even-second clock. It causes the periodic timer to synchronize with the leading edge shown. The analyzer trigger occurs at a time delayed by the accumulated offset from the period trigger event. The periodic timer continues to run, and triggers continue to occur, with a periodicity determined by the analyzer time base. The timer output (labeled "late event") will drift away from its ideal time due to imperfect matching between the time base of the signal being measured and the time base of the analyzer, and also because of imperfect setting of the period parameter. But the synchronization is restored on the next even-second clock event. ("Accumulated offset" is described in the in the **Offset** function section.)

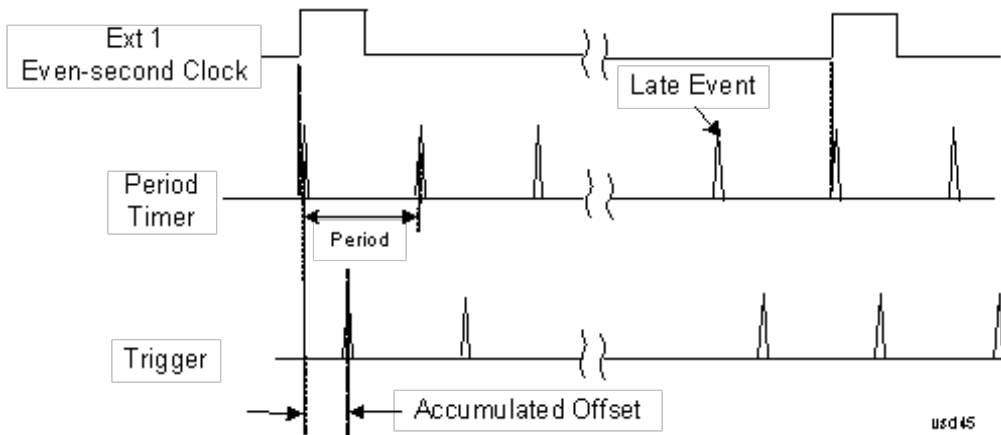

Period

Sets the period of the internal periodic timer clock. For digital communications signals, this is usually set to the frame period of your current input signal. In the case that sync source is not set to OFF, and the external sync source rate is changed for some reason, the periodic timer is synchronized at the every external synchronization pulse by resetting the internal state of the timer circuit.

Key Path	Trigger, Periodic Timer
Remote Command	:TRIGger[:SEquence]:FRAMe:PERiod <time> :TRIGger[:SEquence]:FRAMe:PERiod?
Example	TRIG:FRAM:PER 100 ms
Dependencies	The invalid data indicator turns on when the period is changed, until the next sweep/measurement completes.
Couplings	The same period is used in the Gate Source selection of the period timer.
Preset	20 ms GSM: 4.615383
State Saved	Saved in instrument state
Min	100.000 ns
Max	559.0000 ms
Default Unit	S
Initial S/W Revision	Prior to A.02.00

Offset

Adjusts the accumulated offset between the periodic timer events and the trigger event. Adjusting the accumulated offset is different than setting an offset, and requires explanation.

The periodic timer is usually not synchronized with any external events, so the timing of its output events has no absolute meaning. Since the timing relative to external events (RF signals) is important, you need to be able to adjust (offset) it. However, you have no direct way to see when the periodic timer events occur. All that you can see is the trigger timing. When you want to adjust the trigger timing, you will be changing the internal offset between the periodic timer events and the trigger event. Because the absolute value of

that internal offset is unknown, we will just call that the accumulated offset. Whenever the Offset parameter is changed, you are changing that accumulated offset. You can reset the displayed offset using Reset Offset Display. Changing the display does not change the value of the accumulated offset, and you can still make additional changes to accumulated offset.

To avoid ambiguity, we define that an increase in the "offset" parameter, either from the knob or the SCPI adjust command, serves to delay the timing of the trigger event.

Key Path	Trigger, Periodic Timer
Remote Command	:TRIGger[:SEquence]:FRAMe:OFFSet <time> :TRIGger[:SEquence]:FRAMe:OFFSet?
Example	TRIG:FRAM:OFFS 1.2 ms
Notes	<p>The front panel interface (for example, the knob), and this command, adjust the accumulated offset, which is shown on the active function display. However, the actual amount sent to the hardware each time the offset is updated is the delta value, that is, the current accumulated offset value minus the previous accumulated offset value. Note that the accumulated offset value is essentially arbitrary; it represents the accumulated offset from the last time the offset was zeroed (with the Reset Offset Display key).</p> <p>Note that this command does not change the period of the trigger waveform. Note also that Offset is used only when the sync source is set to OFF, otherwise delay is used, see section "Trig Delay" on page 443.</p> <p>An increase in the "offset" parameter, either from the knob or the SCPI adjust command, serves to delay the timing of the trigger event.</p>
Notes	<p>When the SCPI command is sent the value shown on the key (and the Active Function, if this happens to be the active function) is updated with the new value. However, the actual amount sent to the hardware is the delta value, that is, the current accumulated offset value minus the previous accumulated offset value.</p> <p>The SCPI query simply returns the value currently showing on the key.</p>
Dependencies	The invalid data indicator turns on when the offset is changed, until the next sweep/measurement completes.
Couplings	The same offset is used in the Gate Source selection of the period timer.
Preset	0 s
State Saved	Saved in instrument state
Min	-10.000 s
Max	10.000 s
Default Unit	S
Initial S/W Revision	Prior to A.02.00

Offset Adjust (Remote Command Only)

This remote command does not work at all like the related front panel keys. This command lets you advance the phase of the frame trigger by the amount you specify.

It does not change the period of the trigger waveform. If the command is sent multiple times, it advances the phase of the frame trigger an additional amount each time it is sent. Negative numbers are permitted.

Remote Command	:TRIGger[:SEquence]:FRAMe:ADJust <time>
Example	TRIG:FRAM:ADJ 1.2 ms
Notes	Note also that Offset is used only when the sync source is set to OFF, otherwise delay is used, see section "Trig Delay" on page 443 An increase in the "offset" parameter, either from the knob or the SCPI adjust command, serves to delay the timing of the trigger event.
Notes	The front panel interface (for example, the knob) and the :TRIG:FRAM:OFFS command adjust the accumulated offset, which is shown on the active function display. However, the actual amount sent to the hardware is the delta value, that is, the current offset value minus the previous offset value. When the SCPI command is sent the value shown on the key (and the Active Function, if this happens to be the active function) is updated by increasing it (or decreasing it if the value sent is negative) by the amount specified in the SCPI command. This is a "command only" SCPI command, with no query.
Dependencies	The invalid data indicator turns on when the offset is changed, until the next sweep/measurement completes.
Couplings	The same offset is used in the Gate Source selection of the period timer.
Preset	0 s
State Saved	Saved in instrument state
Min	-10.000 s
Max	10.000 s
Default Unit	S
Initial S/W Revision	Prior to A.02.00

Reset Offset Display

Resets the value of the periodic trigger offset display setting to 0.0 seconds. The current displayed trigger location may include an offset value defined with the Offset key. Pressing this key redefines the currently displayed trigger location as the new trigger point that is 0.0 s offset. The Offset key can then be used to add offset relative to this new timing.

Key Path	Trigger, Periodic Timer
Remote Command	:TRIGger[:SEquence]:FRAMe:OFFSet:DISPlay:RESet
Example	TRIG:FRAM:OFFS:DISP:RES
Initial S/W Revision	Prior to A.02.00

Sync Source

Selects a signal source for you to synchronize your periodic timer trigger to, otherwise you are triggering at some arbitrary location in the frame. Synchronization reduces the precision requirements on the setting of the period.

For convenience you may adjust the level and slope of the selected sync source in a conditional branch setup menu accessed from the Sync Source menu. Note that these settings match those in the **Trigger** and **Gate Source** menus; that is, each trigger source has only one value of level and slope, regardless of which menu it is accessed from.

Key Path	Trigger, Periodic Timer
Remote Command	:TRIGger[:SEquence]:FRAMe:SYNC EXTernal1 EXTernal2 RFBurst OFF :TRIGger[:SEquence]:FRAMe:SYNC?
Example	TRIG:FRAM:SYNC EXT2
Dependencies	In some models, there is no second External input. In these models, the External 2 key is blanked and the EXTERNAL2 parameter will generate a “Hardware missing; Not available for this model number” message.
Preset	Off GSM/EDGE, MSR,LTE,LTETDD: RFBurst
State Saved	Saved in instrument state
Readback	The current setting is read back to this key and it is also Readback to the previous Periodic Timer trigger key.
Backwards Compatibility SCPI	:TRIGger[:SEquence]:FRAMe:SYNC EXTernal For backward compatibility, the parameter EXTernal is mapped to EXTernal1
Initial S/W Revision	Prior to A.02.00
Modified at S/W Revision	A.03.00, A.14.00

Off

Turns off the sync source for your periodic trigger. With the sync source off, the timing will drift unless the signal source frequency is locked to the analyzer frequency reference.

Key Path	Trigger, Periodic Timer, Sync Source
Example	TRIG:FRAM:SYNC OFF
Readback	Off
Initial S/W Revision	Prior to A.02.00

External 1

Pressing this key, when it is not selected, selects an external input signal as the trigger. A new sweep/measurement will start when the external trigger condition is met using the external 1 input connector on the rear panel.

Pressing this key, when it is already selected, accesses the external 1 trigger setup menu.

Key Path	Trigger
Example	TRIG:SOUR EXT1 Swept SA measurement

	TRIG:<meas>:SOUR EXT1 Measurements other than Swept SA
Dependencies	Grayed out if in use by Point Trigger in the Source Setup menu. Forced to Free Run if already selected and Point Trigger is set to External 1.
State Saved	Saved in instrument state
Status Bits/OPC dependencies	The Status Operation Register bit 5 "Waiting for Trigger" is set at the same time as the Sweeping or Measuring bit is set. It is cleared when the trigger actually occurs (that is, after the trigger event occurs and all the applicable trigger criteria have been met). A corresponding pop-up message ("Waiting for trigger") is generated if no trigger signal appears after approximately 2 sec. This message goes away when a trigger signal appears.
Initial S/W Revision	Prior to A.02.00

Trigger Level

Sets the value where the external 1 trigger input will trigger a new sweep/measurement.

Key Path	Trigger, External 1
Remote Command	:TRIGger[:SEquence]:EXTernal1:LEVel <level> :TRIGger[:SEquence]:EXTernal1:LEVel?
Example	TRIG:EXT1:LEV 0.4 V
Couplings	This same level is used for the Ext1 trigger source in the Trigger menu, for the Ext1 selection in the Periodic Timer sync source (in the Trigger menu and in the Gate Source menu), and also for the Ext1 selection in the Gate Source menu.
Preset	1.2 V
State Saved	Saved in instrument state
Min	-5 V
Max	5 V
Default Unit	V
Backwards Compatibility SCPI	:TRIGger[:SEquence]:EXTernal:LEVel For backward compatibility, the parameter EXTernal is mapped to EXTernal1
Backwards Compatibility SCPI	:TRIGger[:SEquence]:FRAMe:EXTernal1:LEVel
Initial S/W Revision	Prior to A.02.00

Trig Slope

Controls the trigger polarity. It is set positive to trigger on a rising edge and negative to trigger on a falling edge.

Key Path	Trigger, External 1
Remote Command	:TRIGger[:SEquence]:EXTernal1:SLOPe POSitive NEGative

	:TRIGger[:SEquence]:EXTernal1:SLOPe?
Example	TRIG:EXT1:SLOP NEG
Couplings	This same slope is used in the Ext1 selection for the trigger source in the Trigger menu and for the period timer sync source (in the Trigger menu and in the Gate Source menu).
Preset	POSitive
State Saved	Saved in instrument state
Backwards Compatibility SCPI	:TRIGger[:SEquence]:EXTernal:SLOPe For backward compatibility, the parameter EXTernal is mapped to EXTernal1
Backwards Compatibility SCPI	:TRIGger[:SEquence]:FRAMe:EXTernal1:SLOPe
Backwards Compatibility Notes	The legacy :TRIGger[:SEquence]:SLOPe command affects the slopes for the VID, LINE, EXT1, EXT2, and RFB triggers.
Initial S/W Revision	Prior to A.02.00

External 2

Pressing this key, when it is not selected, selects an external input signal as the trigger. A new sweep/measurement will start when the external trigger condition is met using the external 2 input connector. The external trigger 2 input connector is on the rear panel.

Pressing this key, when it is already selected, accesses the external 2 trigger setup menu.

Key Path	Trigger
Example	TRIG:SOUR EXT2 Swept SA measurement TRIG:<meas>:SOUR EXT2 Measurements other than Swept SA
Dependencies	In some models, there is no second External input. In these models, the External 2 key is blanked and the EXTernal2 parameter will generate a "Hardware missing; Not available for this model number" message. Grayed out if in use by Point Trigger in the Source Setup menu. Forced to Free Run if already selected and Point Trigger is set to External 2.
State Saved	Saved in instrument state
Status Bits/OPC dependencies	The Status Operation Register bit 5 "Waiting for Trigger" is set at the same time as the Sweeping or Measuring bit is set. It is cleared when the trigger actually occurs (that is, after the trigger event occurs and all the applicable trigger criteria have been met). A corresponding pop-up message ("Waiting for trigger") is generated if no trigger signal appears after approximately 2 sec. This message goes away when a trigger signal appears.
Initial S/W Revision	Prior to A.02.00
Modified at S/W Revision	A.03.00

Trigger Level

Sets the value where the external 2 trigger input will trigger a new sweep/measurement.

Key Path	Trigger, External 2
Remote Command	:TRIGger[:SEquence]:EXTernal2:LEVel :TRIGger[:SEquence]:EXTernal2:LEVel?
Example	TRIG:EXT2:LEV 1.1 V
Couplings	This same level is used for the Ext2 trigger source in the Trigger menu, for the Ext2 selection in the Periodic Timer sync source (in the Trigger menu and in the Gate Source menu), and also for the Ext2 selection in the Gate Source menu.
Preset	1.2 V
State Saved	Saved in instrument state
Min	-5 V
Max	5 V
Default Unit	V
Backwards Compatibility SCPI	:TRIGger[:SEquence]:FRAMe:EXTernal2:LEVel
Initial S/W Revision	Prior to A.02.00

Trig Slope

Controls the trigger polarity. It is set positive to trigger on a rising edge and negative to trigger on a falling edge.

Key Path	Trigger, External 2
Remote Command	:TRIGger[:SEquence]:EXTernal2:SLOPe POSitive NEGative :TRIGger[:SEquence]:EXTernal2:SLOPe?
Example	TRIG:EXT2:SLOP NEG
Couplings	This same slope is used in the Ext2 selection for the trigger source in the Trigger menu and for the period timer sync source (in the Trigger menu and in the Gate Source menu).
Preset	POSitive
State Saved	Saved in instrument state
Backwards Compatibility SCPI	:TRIGger[:SEquence]:FRAMe:EXTernal2:SLOPe
Backwards Compatibility Notes	The legacy :TRIGger[:SEquence]:SLOPe command affects the slopes for the VID, LINE, EXT1, EXT2, and RFB triggers.
Initial S/W Revision	Prior to A.02.00

RF Burst

Pressing this key, when it is not selected, selects the RF Burst as the trigger. A new sweep/measurement will start when an RF burst envelope signal is identified from the signal at the RF Input connector. Pressing this key, when it is already selected, accesses the RF Burst trigger setup menu.

In some models, a variety of burst trigger circuitry is available, resulting in various available burst trigger bandwidths. The analyzer automatically chooses the appropriate trigger path based on the hardware configuration and other settings of the analyzer.

Key Path	Trigger
Example	TRIG:SOUR RFB Swept SA measurement TRIG:<meas>:SOUR RFB Measurements other than Swept SA
State Saved	Saved in instrument state
Status Bits/OPC dependencies	The Status Operation Register bit 5 "Waiting for Trigger" is set at the same time as the Sweeping or Measuring bit is set. It is cleared when the trigger actually occurs (that is, after the trigger event occurs and all the applicable trigger criteria have been met). A corresponding pop-up message ("Waiting for trigger") is generated if no trigger signal appears after approximately 2 sec. This message goes away when a trigger signal appears.
Backwards Compatibility Notes	The legacy command: :TRIGger[:SEquence]:RFBurst:FSElectivity[:STATe] OFF ON 0 1 is not supported in the X-Series, as the hardware to do Frequency Selective burst triggers does not exist in X-Series.
Initial S/W Revision	Prior to A.02.00
Modified at S/W Revision	A.04.00

Absolute Trigger Level

Sets the absolute trigger level for the RF burst envelope.

When using the External Mixing path, the Absolute Trigger Level is uncalibrated because the factory default was set to accommodate the expected IF levels for the RF path.

Key Path	Trigger, RF Burst
Scope	Meas Global
Remote Command	:TRIGger[:SEquence]:RFBurst:LEVel:ABSolute <ampl> :TRIGger[:SEquence]:RFBurst:LEVel:ABSolute?
Example	TRIG:RFB:LEV:ABS 10 dBm sets the trigger level of the RF burst envelope signal to the absolute level of 10 dBm
Notes	Sending this command does not switch the setting from relative to absolute; to switch it you need to send the :TRIGger[:SEquence]:RFBurst:LEVel:TYPE command, below. Amplitude Corrections are not taken into account by the Absolute Trigger Level. For example, if you have given yourself effective gain with an amplitude correction factor, the Absolute Trigger will not fire until you have set the trigger level that far below the displayed signal level, rather than simply to the displayed signal level. This is only true for Amplitude Corrections, not External Gain or Ref Level Offset functions. If mode is Bluetooth, the default value is -50 dBm.
Couplings	This same level is used for the RF Burst trigger source in the Trigger menu, for the RF Burst selection in the Periodic Timer sync source (in the Trigger menu and in the Gate Source menu), and also for the

	RF Burst selection in the Gate Source menu
Preset	-20 dBm
State Saved	Saved in instrument state
Min	-200 dBm
Max	100 dBm
Default Unit	depends on the current selected Y-Axis unit
Backwards Compatibility SCPI	:TRIGger[:SEquence]:FRAMe:RFBurst:LEVel:ABSolute
Initial S/W Revision	Prior to A.02.00
Modified at S/W Revision	A.04.00

Key Path	Trigger, RF Burst
Remote Command	:TRIGger[:SEquence]:RFBurst:LEVel:TYPE ABSolute RELative :TRIGger[:SEquence]:RFBurst:LEVel:TYPE?
Example	TRIG:RFB:LEV:TYPE REL sets the trigger level type of the RF burst trigger to Relative.
Preset	ABSolute
State Saved	Saved in instrument state
Initial S/W Revision	Prior to A.02.00
Modified at S/W Revision	A.04.00

Trigger Slope

It is set positive to trigger on a rising edge and negative to trigger on a falling edge.

Key Path	Trigger, RF Burst
Remote Command	:TRIGger[:SEquence]:RFBurst:SLOPe POSitive NEGative :TRIGger[:SEquence]:RFBurst:SLOPe?
Example	TRIG:RFB:SLOP NEG
Couplings	This same slope is used in the RF Burst selection for the trigger source in the Trigger menu and for the period timer sync source (in the Trigger menu and in the Gate Source menu).
Preset	POSitive
State Saved	Saved in instrument state
Backwards Compatibility SCPI	:TRIGger[:SEquence]:FRAMe:RFBurst:SLOPe
Backwards Compatibility Notes	The legacy :TRIGger[:SEquence]:SLOPe command affects the slopes for the VID, LINE, EXT1, EXT2, and RFB triggers.
Initial S/W Revision	Prior to A.02.00

Sync Holdoff

Sync Holdoff specifies the duration that the sync source signal must be kept false before the transition to true to be recognized as the sync timing. The periodic timer phase is aligned when the sync source signal becomes true, after the Holdoff time is satisfied.

A holdoff of 2 ms will work with most WiMAX signals, but there may be cases where the burst off duration is less than 1 ms and this value will need to be changed.

Key Path	Trigger, Periodic Timer
Remote Command	:TRIGger[:SEquence]:FRAMe:SYNC:HOLDoff <time> :TRIGger[:SEquence]:FRAMe:SYNC:HOLDoff? :TRIGger[:SEquence]:FRAMe:SYNC:HOLDoff:STATe OFF ON 0 1 :TRIGger[:SEquence]:FRAMe:SYNC:HOLDoff:STATe?
Preset	On, 1.000 ms
State Saved	Saved in instrument state
Min	0 ms
Max	+500 ms
Default Unit	s
Initial S/W Revision	Prior to A.02.00

Control Edge/Level

Sets the method of controlling the gating function from the gating signal.

Edge

In Edge triggering, the gate opens (after the Delay) on the selected edge (for example, positive) of the gate signal and closes on the alternate edge (for example, negative).

Level

In Level triggering, the gate opens (after the Delay) when the gate signal has achieved a certain level and stays open as long as that level is maintained.

Key Path	Sweep/Control, Gate
Remote Command	[:SENSe]:SWEep:EGATe:CONTRol EDGE LEVEL [:SENSe]:SWEep:EGATe:CONTRol?
Example	SWE:EGAT:CONT EDGE
Dependencies	If the Gate Method is FFT the Control key is grayed out and Edge is selected. If the Gate Source is TV, Frame or Line, the Control key is grayed out and Edge is selected.
Preset	EDGE
State Saved	Saved in instrument state
Backwards Compatibility SCPI	[:SENSe]:SWEep:TIME:GATE:TYPE ESA Compatibility
Initial S/W Revision	Prior to A.02.00

Gate Holdoff

Lets you increase or decrease the wait time after a gate event ends before the analyzer will respond to the next gate signal.

After any Gate event finishes, the analyzer must wait for the sweep system to settle before it can respond to another Gate signal. The analyzer calculates a "wait time," taking into account a number of factors, including RBW and Phase Noise Optimization settings. The goal is to achieve the same accuracy when gated as in ungated operation. The figure below illustrates this concept:

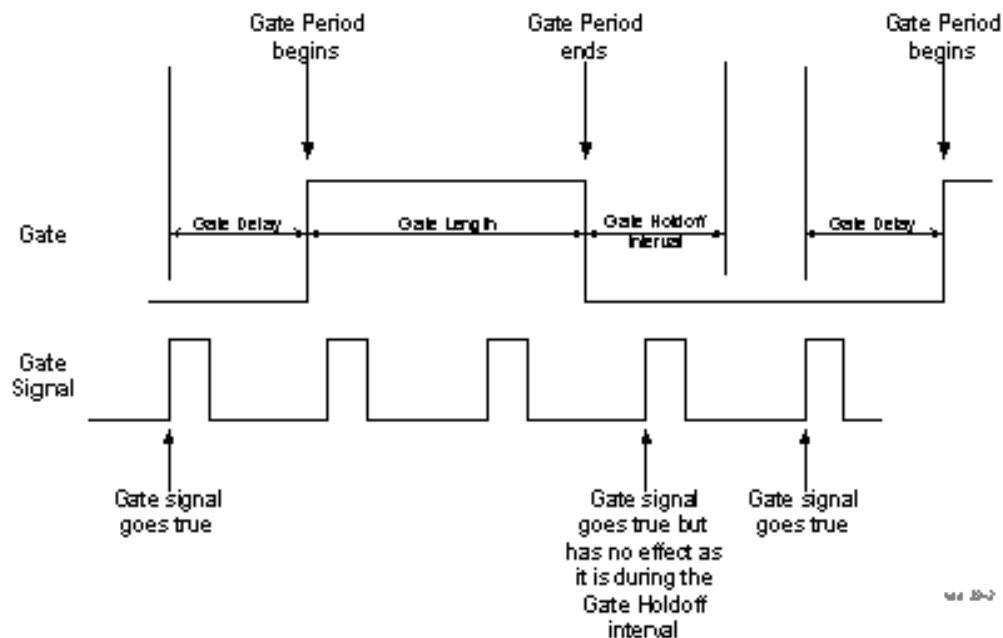

When Gate Holdoff is in Auto, the wait time calculated by the analyzer is used. When Gate Time is in Manual, the user may adjust the wait time, usually decreasing it in order to achieve greater speed, but at the risk of decreasing accuracy.

When the Method key is set to Video or FFT, the Gate Holdoff function has no effect.

In measurements that do not support Auto, the value shown when Auto is selected is "----" and the manually set holdoff is returned to a query.

Key Path	Sweep/Control, Gate
Remote Command	<pre>[:SENSe] :SWEep:EGATe:HOLDoff <time> [:SENSe] :SWEep:EGATe:HOLDoff? [:SENSe] :SWEep:EGATe:HOLDoff:AUTO OFF ON 0 1 [:SENSe] :SWEep:EGATe:HOLDoff:AUTO?</pre>
Example	<pre>SWE:EGAT:HOLD 0.0002 SWE:EGAT:HOLD? SWE:EGAT:HOLD:AUTO ON</pre>

SWE:EGAT:HOLD:AUTO?	
Couplings	<p>When Gate Holdoff is Auto, the Gate Holdoff key shows the value calculated by the analyzer for the wait time.</p> <p>Pressing the Gate Holdoff key while it is in Auto and not selected, causes the key to become selected and allows the user to adjust the value. If the value is adjusted, the setting changes to Man.</p> <p>Pressing the Gate Holdoff key, while it is in Auto and selected, does not change the value of Gate Holdoff, but causes the setting to change to Man. Now the user can adjust the value.</p> <p>Pressing the key while it is in Man and selected, cause the value to change back to Auto.</p> <p>Pressing the key while it is in Man and not selected, causes the key to become selected and allows the user to adjust the value.</p> <p>When Method is set to Video or FFT, the Gate Holdoff function has no effect.</p>
Preset	<p>Auto</p> <p>Auto/On</p>
State Saved	Saved in instrument state
Min	1 μ sec
Max	1 sec
Initial S/W Revision	Prior to A.02.00

Gate Delay Compensation

This function allows you to select an RBW-dependent value by which to adjust the gate delay, to compensate for changes in the delay caused by RBW effects.

You can select between uncompensated operation and two types of compensation, Delay Until RBW Settled and Compensate for RBW Group Delay.

See ["More Information" on page 1249](#)

Key Path	Sweep/Control, Gate
Scope	Meas Global
Remote Command	<pre>[:SENSe] :SWEep:EGATe:DELAy:COMPensation:TYPE OFF SETTled GDELAy [:SENSe] :SWEep:EGATe:DELAy:COMPensation:TYPE?</pre>
Example	<pre>SWE:EGAT:DEL:COMP:TYPE SETT SWE:EGAT:DEL:COMP:TYPE?</pre>
Notes	<p>Although this function is Meas Global, there are some measurements that do not support this function. In those measurements the operation will be Uncompensated. Going into one of those measurements will not change the Meas Global selection; it will simply display the grayed-out menu key with "Uncompensated" showing as the selection. This is a non-forceful grayout, so the SCPI command is still accepted.</p> <p>If Gate Delay Compensation is not supported at all within a particular mode, the key is not displayed, and if the SCPI command is sent while in a measurement within that mode, an "Undefined Header" message is generated.</p> <p>Measurements that do not support this function include:</p>

Swept SA	
Preset	TD-SCDMA mode: Compensate for RBW Group Delay All other modes: Delay Until RBW Settled
State Saved	Saved in instrument state
Range	Uncompensated Delay Until RBW Settled Compensate for RBW Group Delay
Readback text	Uncompensated Settled Group Delay
Initial S/W Revision	Prior to A.02.00
Modified at S/W Revision	A.11.0

More Information

Selecting Uncompensated means that the actual gate delay is as you sets it.

Selecting Delay Until RBW Settled causes the gate delay to be increased above the user setting by an amount equal to $3.06/\text{RBW}$. This compensated delay causes the GATE START and GATE STOP lines on the display to move by the compensation amount, and the actual hardware gate delay to be increased by the same amount. All the other gate lines (for example, MIN FAST) are unaffected. If the RBW subsequently changes, the compensation is readjusted for the new RBW. The value shown on the Gate Delay key does NOT change.

Delay Until RBW Settled allows excellent measurements of gated signals, by allowing the IF to settle following any transient that affects the burst. Excellent measurements also require that the analysis region not extend into the region affected by the falling edge of the burst. Thus, excellent measurements can only be made over a width that declines with narrowing RBWs, which is achieved by decreasing the gate length below the user setting by an amount equal to $2.53/\text{RBW}$. Therefore, for general purpose compensation, you will still want to change the gate length with changes in RBW even if the gate delay is compensated. The compensated Gate Length is limited by the analyzer so that it will never go below 10% of the value shown on the Gate Length key, as otherwise the sweep times could get very long. Anytime the Gate Length and RBW values combine in such a way that this limiting takes place, a warning is displayed. For measurements which contain multiple sweeps with different RBW like SEM and SPUR, the smallest RBW is used for this limiting.

Selecting Compensate for RBW Group Delay causes the gate delay to be increased above the user setting by an amount equal to $1.81/\text{RBW}$. This compensated delay causes the GATE START, GATE STOP lines on the display to move by the compensation amount, and the actual hardware gate delay to be increased by the same amount. All the other gate lines (for example, MIN FAST) are unaffected. If the RBW subsequently changes, the compensation is readjusted for the new RBW. The value shown on the Gate Delay key does NOT change. Compensate for RBW Group Delay also includes gate length compensation; the gate length itself is adjusted as necessary to attempt to compensate for delay effects imposed by the RBW.

Compensate for RBW Group Delay is similar to Delay Until RBW Settled, but compensates for the group delay of the RBW filter, rather than the filter settling time. As the RBW gets narrow, this can allow the settling tail of the RBW to affect the beginning part of the gated measurement, and allow the beginning of the RBW settling transient to affect the end of the gated measurement. These two effects are symmetric

because the RBW response is symmetric. Because the gate length is not automatically compensated, some users might find this compensation to be more intuitive than compensation for RBW settling.

Min Fast Position Query (Remote Command Only)

This command queries the position of the MIN FAST line, relative to the delay reference (REF) line. See section "Gate View On/Off" on page 2080. If this query is sent while not in gate view, the MinFast calculation is performed based on the current values of the appropriate parameters and the result is returned. Knowing this value lets you set an optimal gate delay value for the current measurement setup.

Remote Command	<code>[:SENSe] :SWEep:EGATe:MINFast?</code>
Example	<code>SWE:EGAT:MIN?</code>
Initial S/W Revision	Prior to A.02.00

Gate Preset (Remote Command Only)

Presets the time-gated spectrum analysis capability.

This command sets gate parameter values to the ESA preset values, as follows:

Gate trigger type = edge

Gate polarity = positive

Gate delay = 1 us

Gate length = 1 us

Remote Command	<code>[:SENSe] :SWEep:TIME:GATE:PRESet</code> ESA Compatibility
Initial S/W Revision	Prior to A.02.00

Gate Level (Remote Command Only)

Sets the gate input transition point level for the external TRIGGER inputs on the front and rear panel. This is a legacy command for PSA compatibility. It is simply an alias to the equivalent trigger level command.

Remote Command	<code>[:SENSe] :SWEep:EGATe:EXTernal [1] 2 :LEVel <voltage></code> <code>[:SENSe] :SWEep:EGATe:EXTernal [1] 2 :LEVel?</code>
Notes	This command is simply an alias to <code>:TRIGger[:SEQUence]:EXTernal[1]2:LEVel</code> For details refer
Initial S/W Revision	Prior to A.02.00

Gate Polarity (Remote Command Only)

Sets the polarity for the gate signal. This setup is now done using the gate trigger's slope setting.

When Positive (Pos) is selected, a positive-going edge (Edge) or a high voltage (Level) will satisfy the gate condition, after the delay set with the Gate Delay key. When Negative (Neg) is selected, a negative-going edge (Edge) or a low voltage (Level) will satisfy the gate condition after the delay.

Remote Command	[:SENSe] :SWEep:EGATe:POLarity NEGative POSitive [:SENSe] :SWEep:EGATe:POLarity?
Example	SWE:EGAT:POL NEG SWE:EGAT:POL?
Preset	POSitive
State Saved	Saved in instrument state
Backwards Compatibility SCPI	[:SENSe] :SWEep:TIME:GATE:POLarity ESA compatibility
Initial S/W Revision	Prior to A.02.00

Remote Command	[:SENSe] :SWEep:TIME:GATE:LEVel HIGH LOW [:SENSe] :SWEep:TIME:GATE:LEVel? ESA compatibility
Preset	HIGH
Initial S/W Revision	Prior to A.02.00

Gate

Accesses a menu that enables you to control the gating function.

The Gate functionality is used to view signals best viewed by qualifying them with other events. See "[Gate](#)" on page 2079 for more details.

Key Path	Sweep/Control
Initial S/W Revision	A.03.00

11 Spurious Emissions Measurement
System

System

See "[System](#)" on page 342

Trace/Detector

Trace/Detector is unavailable in the Spurious Emissions measurement. When pressed, this key displays a blank menu.

Key Path	Front-panel key
Initial S/W Revision	Prior to A.02.00

Trigger

See ["Trigger" on page 412](#)

Free Run

See ["Free Run " on page 419](#)

Video

See ["Video \(IF Envelope\) " on page 420](#)

Trigger Level

See ["Trigger Level " on page 420](#)

Trig Slope

See ["Trig Slope " on page 421](#)

Trig Delay

See ["Trig Delay " on page 422](#)

Line

See ["Line " on page 2087](#)

Trig Slope

See ["Trig Slope " on page 2087](#)

Trig Delay

See ["Trig Delay " on page 424](#)

External 1

See ["External 1 " on page 2099](#)

Trigger Level

See ["Trigger Level " on page 2099](#)

Trig Slope

See ["Trig Slope " on page 2100](#)

Trig Delay

See ["Trig Delay " on page 427](#)

External 2

See ["External 2 " on page 2101](#)

Trigger Level

See ["Trigger Level "](#) on page 2101

Trig Slope

See ["Trig Slope "](#) on page 2102

Trig Delay

See ["Trig Delay "](#) on page 429

RF Burst

See ["RF Burst "](#) on page 2102

Absolute Trigger

See ["Absolute Trigger Level"](#) on page 2103

Relative Trigger

See ["Relative Trigger Level"](#) on page 2092

Trig Slope

See ["Trigger Slope "](#) on page 2104

Trig Delay

See ["Trig Delay "](#) on page 433

Periodic Timer

See ["Periodic Timer \(Frame Trigger\) "](#) on page 2094

Period

See ["Period "](#) on page 2095

Offset

See ["Offset "](#) on page 2096

Reset Offset Display

See ["Reset Offset Display "](#) on page 2098

Sync Source

See ["Sync Source "](#) on page 2098

Off

See ["Off "](#) on page 2099

External 1

See ["External 1 "](#) on page 2099

Trigger Level

See ["Trigger Level "](#) on page 2099

Trig Slope

See ["Trig Slope "](#) on page 2100

External 2

See ["External 2 "](#) on page 2101

Trigger Level

See ["Trigger Level "](#) on page 2101

Trig Slope

See ["Trig Slope "](#) on page 2102

RF Burst

See ["RF Burst "](#) on page 2102

Absolute Trigger

See ["Absolute Trigger Level"](#) on page 2103

Trig Slope

See ["Trigger Slope "](#) on page 2104

Trig Delay

See ["Trig Delay"](#) on page 443

Auto/Holdoff

See ["Auto/Holdoff "](#) on page 444

Auto Trig

See ["Auto Trig "](#) on page 444

Trig Holdoff

See ["Trig Holdoff "](#) on page 445

User Preset

Accesses a menu that gives you the following three choices:

- User Preset – recalls a state previously saved using the Save User Preset function.
- User Preset All Modes – presets all of the modes in the analyzer
- Save User Preset– saves the current state for the current mode

Key Path	Front-panel key
Backwards Compatibility Notes	<p>User Preset is actually loading a state, and in legacy analyzers, it was possible to load a state without affecting the trace data, limit lines or correction data. Similarly it was possible to do a User Preset without affecting the trace data, limit lines or correction data.</p> <p>In the X-Series, “state” always includes all of this data; so whenever state is loaded, or User Preset is executed, all of the traces, limit lines and corrections are affected. Although this differs from previous behavior, it is desirable behavior, and should not cause adverse issues for users.</p> <p>On ESA and PSA, User Preset affected the entire instrument’s state. In the X-Series, User Preset only recalls the state for the active mode. There is a User Preset file for each mode. User Preset can never cause a mode switch as it can in legacy analyzers. If you want to recall all modes to their user preset file state, you will need to do a User Preset after mode switching into each mode.</p> <p>User Preset recalls mode state which can now include data like traces; whereas on ESA and PSA, User Preset did not affect data.</p>
Initial S/W Revision	Prior to A.02.00

User Preset

User Preset sets the state of the currently active mode back to the state that was previously saved for this mode using the Save User Preset menu key or the SCPI command, SYST:PRES:USER:SAV. It not only recalls the Mode Preset settings, but it also recalls all of the mode persistent settings, and the Input/Output system setting that existed at the time Save User Preset was executed.

If a Save User Preset has not been done at any time, User Preset recalls the default user preset file for the currently active mode. The default user preset files are created if, at power-on, a mode detects there is no user preset file. There will never be a scenario when there is no user preset file to restore. For each mode, the default user preset state is the same state that would be saved if a Save User Preset is performed in each mode right after doing a Restore Mode Default and after a Restore Input/Output Defaults.

The User Preset function does the following:

- Aborts the currently running measurement.
- Sets the mode State to the values defined by Save User Preset.
- Makes the saved measurement for the currently running mode the active measurement.
- Brings up the saved menu for the power-on mode.
- Clears the input and output buffers.
- Sets the Status Byte to 0.

Key Path	User Preset
Remote Command	:SYSTem:PRESet:USER
Example	:SYST:PRES:USER:SAVE:SYST:PRES:USER
Notes	:SYST:PRES:USER:SAVE is used to save the current state as the user preset state. Clears all pending OPC bits. The Status Byte is set to 0. Pressing the User Preset front-panel key while already in the User Preset menu will cause the User Preset to get executed
Couplings	A user preset will cause the currently running measurement to be aborted and cause the saved measurement to be active. Recalling a User Preset file has the same issues that recalling a Save State file has. Some settings may need to be limited and therefore re-coupled, since the capabilities of the mode may have changes when the User Preset file was last saved.
Initial S/W Revision	Prior to A.02.00

User Preset All Modes

Recalls all of the User Preset files for each mode, switches to the power-on mode, and activates the saved measurement from the power-on mode User Preset file.

NOTE

When the instrument is secured, all of the user preset files are converted back to their default user preset files.

The User Preset function does the following:

- Aborts the currently running measurement.
- Switches the Mode to the power-on mode.
- Restores the User Preset files for each mode.
- Makes the saved measurement for the power-on mode the active measurement.
- Brings up the saved menu for the power-on mode.
- Clears the input and output buffers.
- Sets the Status Byte to 0.

Key Path	User Preset
Remote Command	:SYSTem:PRESet:USER:ALL
Example	:SYST:PRES:USER:SAVE:SYST:PRES:USER:ALL
Notes	Clears all pending OPC bits. The Status Byte is set to 0. :SYST:PRES:USER:SAVE is used to save the current state as the user preset state.
Couplings	A user preset will cause the currently running measurement to be aborted, cause a mode switch to the power-on mode, and cause the saved measurement to be active in the power-on mode. Recalling a User Preset file has the same issues that recalling a Save State file has. Some settings may need to be limited and therefore re-coupled, since the capabilities of the mode may have changes when the User Preset file was last saved.
Initial S/W Revision	Prior to A.02.00

Save User Preset

Saves the currently active mode and its State. You can recall this User Preset file by pressing the User Preset menu key or sending the SYST:PRES:USER remote command. This same state is also saved by the Save State function.

Key Path	User Preset
Remote Command	:SYSTem:PRESet:USER:SAVE
Example	:SYST:PRES:USER:SAVE
Notes	:SYST:PRES:SAVE creates the same file as if the user requested a *SAV or a MMEM:STOR:STAT, except User Preset Save does not allow the user to specify the filename or the location of the file.
Initial S/W Revision	Prior to A.02.00

View/Display

Accesses a menu that includes keys that enables you to control the instrument display.

For details of available views, see [View Selection](#).

For details of remote commands associated with views, see [Range Table Selection \(SCPI only command\)](#).

Key Path	Front-panel key
Initial S/W Revision	Prior to A.02.00

Display

The Display menu is common to most measurements, and is used for configuring items on the display. Some Display menu settings apply to all the measurements in a mode, and some only to the current measurement. Those under the System Display Settings key apply to all measurements in all modes.

Key Path	Display
Key Path	View/Display
Initial S/W Revision	Prior to A.02.00

Annotation

Turns on and off various parts of the display annotation. The annotation is divided up into four categories:

1. Meas Bar: This is the measurement bar at the top of the screen. It does not include the settings panel or the Active Function. Turning off the Meas Bar turns off the settings panel and the Active Function. When the Meas Bar is off, the graticule area expands to fill the area formerly occupied by the Meas Bar.
2. Screen Annotation: this is the annotation and annunciation around the graticule, including any annotation on lines (such as the display line, the threshold line, etc.) This does NOT include the marker number or the N dB result. When off, the graticule expands to fill the entire graticule area.
3. Trace annotation: these are the labels on the traces, showing their detector (or their math mode).
4. Active Function annotation: this is the active function display in the meas bar, and all of the active function values displayed on softkeys.

See the figure below. Each type of annotation can be turned on and off individually.

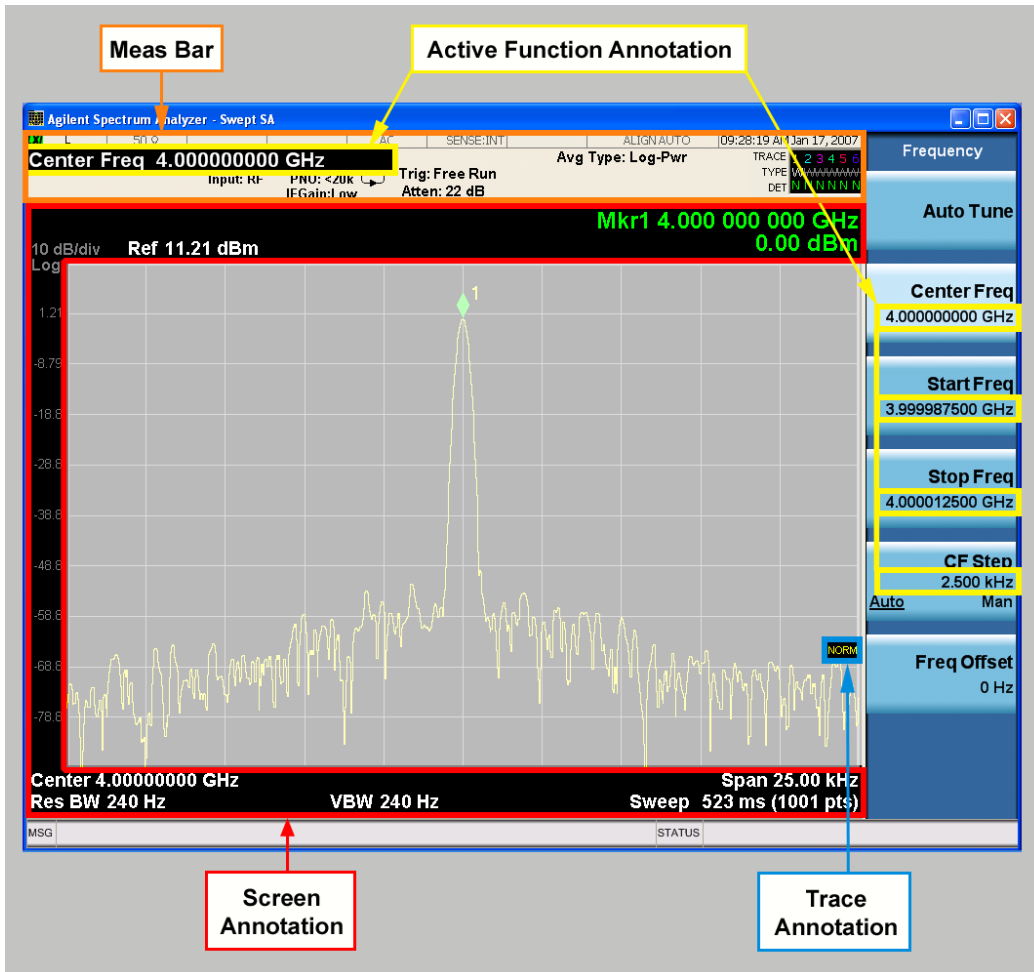

Key Path	View/Display, Display
Initial S/W Revision	Prior to A.02.00

Meas Bar On/Off

This function turns the Measurement Bar on and off, including the settings panel. When off, the graticule area expands to fill the area formerly occupied by the Measurement Bar.

Key Path	View/Display, Display, Annotation
Remote Command	:DISPlay:ANNotation:MBAR[:STATE] OFF ON 0 1 :DISPlay:ANNotation:MBAR[:STATE]?
Example	DISP:ANN:MBAR OFF
Dependencies	Grayed out and forced to OFF when System Display Settings, Annotation is set to Off.
Preset	On This should remain Off through a Preset when System DisplaySettings, Annotation is set to Off.
State Saved	Saved in instrument state.
Initial S/W Revision	Prior to A.02.00

Screen

This controls the display of the annunciation and annotation around the graticule, including any annotation on lines (such as the display line, the threshold line, etc.) and the y-axis annotation. This does NOT include marker annotation (or the N dB result). When off, the graticule expands to fill the entire graticule area, leaving only the 1.5% gap above the graticule as described in the Trace/Detector chapter.

Key Path	View/Display, Display, Annotation
Remote Command	:DISPlay:ANNotation:SCReen[:STATe] OFF ON 0 1 :DISPlay:ANNotation:SCReen[:STATe]?
Example	DISP:ANN:SCR OFF
Dependencies	Grayed-out and forced to OFF when System Display Settings, Annotation is set to Off.
Preset	On This should remain Off through a Preset when System DisplaySettings, Annotation is set to Off
State Saved	Saved in instrument state.
Initial S/W Revision	Prior to A.02.00

Active Function Values On/Off

Turns on and off the active function display in the Meas Bar, and all of the active function values displayed on the softkeys.

Note that all of the softkeys that have active functions have these numeric values blanked when this function is on. This is a security feature..

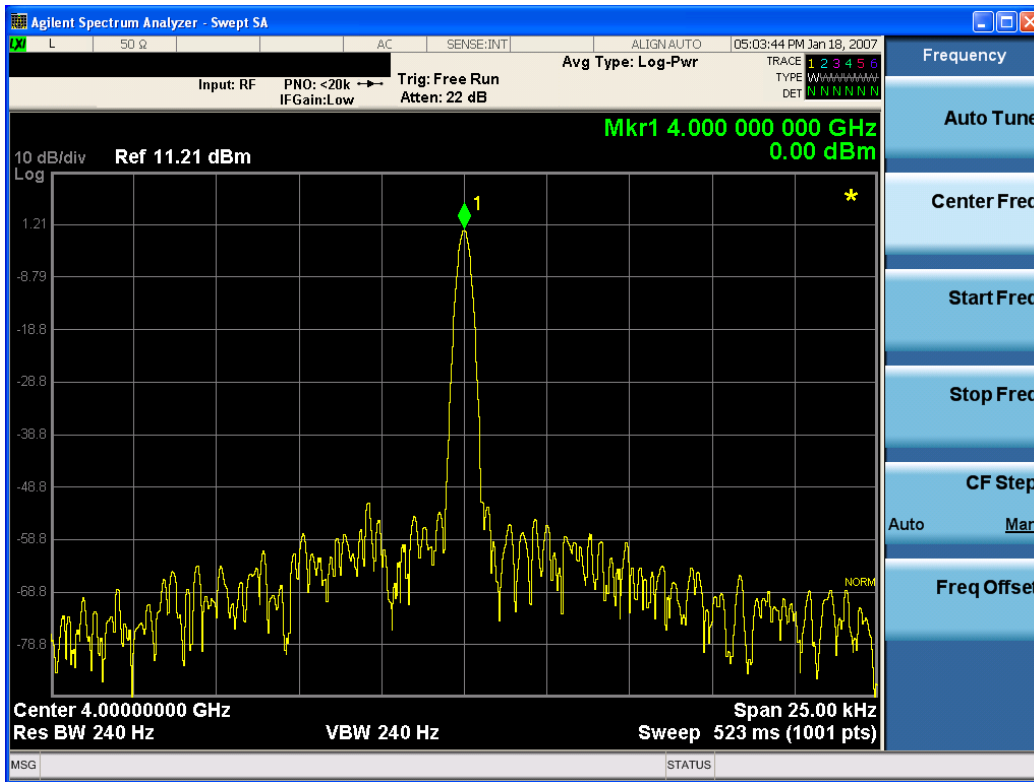

Key Path	View/Display, Display, Annotation
Remote Command	:DISPlay:ACTivefunc[:STATE] ON OFF 1 0 :DISPlay:ACTivefunc[:STATE]?
Example	DISP:ACT OFF
Dependencies	Grayed out and forced to OFF when System Display Settings, Annotation is set to Off.
Preset	On This should remain Off through a Preset when System DisplaySettings, Annotation is set to Off
State Saved	Saved in instrument state.
Initial S/W Revision	Prior to A.02.00

Title

Displays menu keys that enable you to change or clear a title on your display.

Key Path	View/Display, Display
Initial S/W Revision	Prior to A.02.00

Change Title

Writes a title into the "measurement name" field in the banner, for example, "Swept SA".

Press Change Title to enter a new title through the alpha editor. Press Enter or Return to complete the entry. Press ESC to cancel the entry and preserve your existing title.

The display title will replace the measurement name. It remains for this measurement until you press Change Title again, or you recall a state, or a Preset is performed. A title can also be cleared by pressing Title, Clear Title.

NOTE

Notice the inclusion of the <measurement> parameter in the command below. Because each measurement remembers the Display Title, the command must be qualified with the measurement name. For the Swept SA measurement this is not the case; no <measurement> parameter is used when changing the Display Title for the Swept SA measurement.

Key Path	View/Display, Display, Title
Mode	All
Remote Command	:DISPlay:<measurement>:ANNotation:TITLe:DATA <string> :DISPlay:<measurement>:ANNotation:TITLe:DATA?
Example	DISP:ANN:TITL:DATA "This Is My Title" This example is for the Swept SA measurement in the Spectrum Analyzer mode. The SANalyzer <measurement> name is not used. DISP:ACP:ANN:TITL:DATA "This Is My Title" This example is for Measurements other than Swept SA. Both set the title to: This Is My Title
Notes	Pressing this key cancels any active function. When a title is edited the previous title remains intact (it is not cleared) and the cursor goes at the end so that characters can be added or BKSP can be used to go back over previous characters.
Preset	No title (measurement name instead)
State Saved	Saved in instrument state.
Initial S/W Revision	Prior to A.02.00

Clear Title

Clears a title from the front-panel display. Once cleared, the title cannot be retrieved. After the title is cleared, the current Measurement Name replaces it in the title bar.

Key Path	View/Display, Display, Title
Example	The following commands clear the title and restore the measurement's original title: DISP:ANN:TITL:DATA "" This example is for the Swept SA measurement in the Spectrum Analyzer mode. The SANalyzer <measurement> name is not used. DISP:ACP:ANN:TITL:DATA "" This example is for ACP; in measurements other than Swept SA the measurement name is required.
Notes	Uses the :DISPlay:<measurement>:ANNotation:TITLe:DATA <string> command with an empty string (in the Swept SA, the <measurement> is omitted).
Preset	Performed on Preset.
Initial S/W Revision	Prior to A.02.00

Graticule

Pressing Graticule turns the display graticule On or Off. It also turns the graticule y-axis annotation on and off.

Key Path	View/Display, Display
Remote Command	:DISPlay:WINDow[1]:TRACe:GRATicule:GRID[:STATe] OFF ON 0 1 :DISPlay:WINDow[1]:TRACe:GRATicule:GRID[:STATe]?
Example	DISP:WIND:TRAC:GRAT:GRID OFF
Notes	The graticule is the set of horizontal and vertical lines that make up the grid/divisions for the x-axis and y-axis.
Preset	On
State Saved	Saved in instrument state
Initial S/W Revision	Prior to A.02.00

System Display Settings

These settings are "Mode Global" – they affect all modes and measurements and are reset only by Restore Misc Defaults or Restore System Defaults under System.

Key Path	View/Display, Display
Initial S/W Revision	Prior to A.02.00

Annotation Local Settings

This is a Mode Global override of the meas local annotation settings. When it is All Off, it forces ScreenAnnotation, Meas Bar, Trace, and Active Function Values settings to be OFF for all measurements in all modes. This provides the security based "annotation off" function of previous analyzers; hence it uses the legacy SCPI command.

When it is All Off, the Screen, Meas Bar, Trace, and Active Function Values keys under the Display, Annotation menu are grayed out and forced to Off. When Local Settings is selected, you are able to set the local annotation settings on a measurement by measurement basis.

Key Path	View/Display, Display, System Display Settings
Remote Command	:DISPlay:WINDow[1]:ANNOtation[:ALL] OFF ON 0 1 :DISPlay:WINDow[1]:ANNOtation[:ALL]?
Example	:DISP:WIND:ANN OFF
Preset	On (Set by Restore Misc Defaults)
State Saved	Not saved in instrument state.
Backwards Compatibility Notes	The WINDow parameter and optional subopcode is included for backwards compatibility but ignored – all windows are equally affected.
Initial S/W Revision	Prior to A.02.00

Themes

Accesses a menu of functions that enable you to choose the theme to be used when saving the screen image.

The **Themes** option is the same as the **Themes** option under the **Display** and **Page Setup** dialogs. It allows you to choose between themes to be used when saving the screen image.

Key Path	Save, Screen Image
Remote Command	:MMEMory:STORe:SCReen:THEMe TDColor TDMonochrome FCOLor FMONochrome :MMEMory:STORe:SCReen:THEMe?
Example	:MMEM:STOR:SCR:THEM TDM
Preset	3D Color; Is not part of Preset, but is reset by Restore Misc Defaults or Restore System Defaults All and survives subsequent running of the modes.
Readback	3D Color 3D Mono Flat Color Flat Mono
Backwards Compatibility Notes	In ESA and PSA we offer the choice of "Reverse Bitmap" or "Reverse Metafile" when saving screen images. This is much like the "Flat Color" theme available in X-Series. Also, if you selected Reverse Bitmap AND a black & white screen image, that would be much like "Flat Monochrome". In other words, each of the X-Series themes has a similar screen image type in ESA/PSA. But they are not identical.
Initial S/W Revision	Prior to A.02.00

3D Color

Selects a standard color theme with each object filled, shaded and colored as designed.

Key Path	Save, Screen Image, Themes
Example	MMEM:STOR:SCR:THEM TDC
Readback	3D Color
Initial S/W Revision	Prior to A.02.00

3D Monochrome

Selects a format that is like 3D color but shades of gray are used instead of colors.

Key Path	Save, Screen Image, Themes
Example	MMEM:STOR:SCR:THEM TDM
Readback	3D Mono
Initial S/W Revision	Prior to A.02.00

Flat Color

Selects a format that is best when the screen is to be printed on an ink printer.

Key Path	Save, Screen Image, Themes
Example	MMEM:STOR:SCR:THEM FCOL
Readback	Flat Color
Initial S/W Revision	Prior to A.02.00

Flat Monochrome

Selects a format that is like Flat Color. But only black is used (no colors, not even gray), and no fill.

Key Path	Save, Screen Image, Themes
Example	MMEM:STOR:SCR:THEM FMON
Readback	Flat Mono
Initial S/W Revision	Prior to A.02.00

Backlight

Accesses the display backlight on/off keys. This setting may interact with settings under the Windows "Power" menu.

When the backlight is off, pressing ESC, TAB, SPACE, ENTER, UP, DOWN, LEFT, RIGHT, DEL, BKSP, CTRL, or ALT turns the backlight on without affecting the application. Pressing any other key will turn backlight on and could potentially perform the action as well.

Key Path	View/Display, Display, System Display Settings
Remote Command	:DISPlay:BACKlight ON OFF :DISPlay:BACKlight?
Preset	ON (Set by Restore Misc Defaults)
Initial S/W Revision	Prior to A.02.00

Backlight Intensity

An active function used to set the backlight intensity. It goes from 0 to 100 where 100 is full on and 0 is off. This value is independent of the values set under the Backlight on/off key.

Key Path	View/Display, Display, System Display Settings
Remote Command	:DISPlay:BACKlight:INTensity <integer> :DISPlay:BACKlight:INTensity?
Example	DISP:BACK:INT 50

Preset	100 (Set by Restore Misc Defaults)
Min	0
Max	100
Initial S/W Revision	Prior to A.02.00

View Selection

Selects the desired view. The following views are available:

- **"Graph + Metrics" on page 1268** – The lower window displays a list of spurs detected in a measurement cycle. The upper window displays a trace of the range that contains the currently selected spur.
- **"Range Table" on page 1269** – The lower window displays settings of ranges. The upper window displays a trace of the currently selected range.
- **"All Ranges" on page 1272** – The lower window displays a list of spurs detected in a measurement cycle. The upper window displays a merged trace of all the ranges.

Key Path	View/Display
Mode	SA, WCDMA, C2K, 1xEV-DO, WIMAX OFDMA, TD-SCDMA, DVB-T/H, LTE, LTE-TDD, MSR, LTE-FDD, LTE-TDD
Remote Command	:DISPlay:SPURious:VIEW[:SElect] RESult RANGE ALL :DISPlay:SPURious:VIEW[:SElect]?
Example	DISP:SPUR:VIEW RANG DISP:SPUR:VIEW?
Notes	You must be in cdma2000 mode, TD-SCDMA mode, W-CDMA mode, DVB-T/H mode, GSM/EDGE mode, LTE mode, LTE TDD mode, LTE-Advanced FDD/TDD mode, MSR or WiMAX mode to use this command. Use INSTRument:SElect to set the mode.
Preset	RESult
State Saved	No
Range	Graph + Metrics Range Table All Ranges
Initial S/W Revision	A.10.00
Modified at S/W Revision	A.11.00

Graph + Metrics

Select Graph + Metrics to view measurement results.

- The lower window displays a list of spurs detected in a measurement cycle. The currently selected spur, which is highlighted, can be changed by the Spur softkey in the Meas Setup menu.
- The upper window displays a trace of the range that contains the currently selected spur.

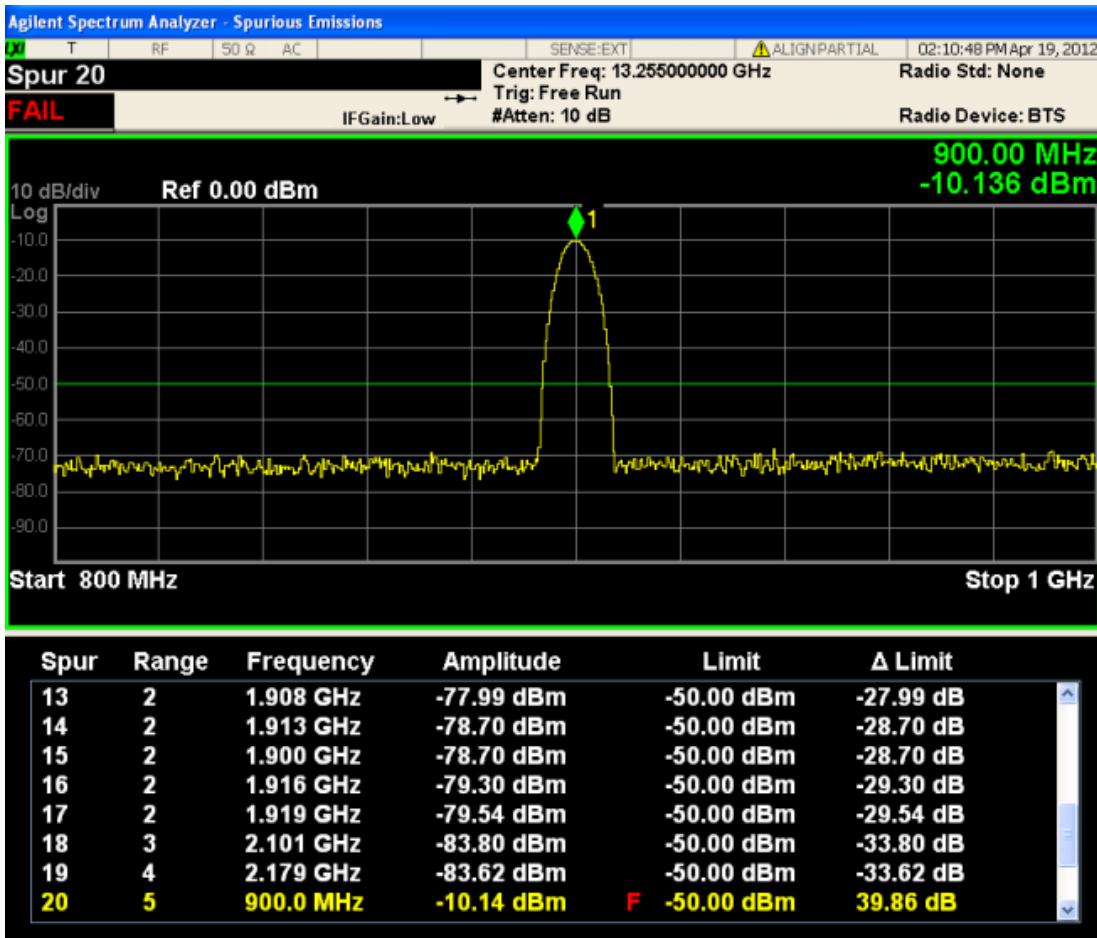

Result	Units	Min	Max
Spur	N/A	0	200
Range	N/A	1	20
Frequency	Hz	Analyzer Min	Analyzer Max
Amplitude	dBm	-150	50
Limit	dBm	-150	50

The spurs listed are within the current value of the Marker Peak Excursion setting of the absolute limit. All of the spurs listed passed. Any spur that has failed the absolute limit will have an 'F' beside it.

Range Table

Select Range Table to view range settings.

- The upper window displays a trace of the range specified by the Range key under Range Table in Meas Setup.
- The lower window displays the range setting.

11 Spurious Emissions Measurement
View/Display

All enabled range may not be displayed with the normal window arrangement. Even in that case, the instrument always displays the highlighted line in the table. When you zoom the lower window, all 20 ranges can be displayed.

When the range state is OFF, “---” appears, to indicate the range is inactive.

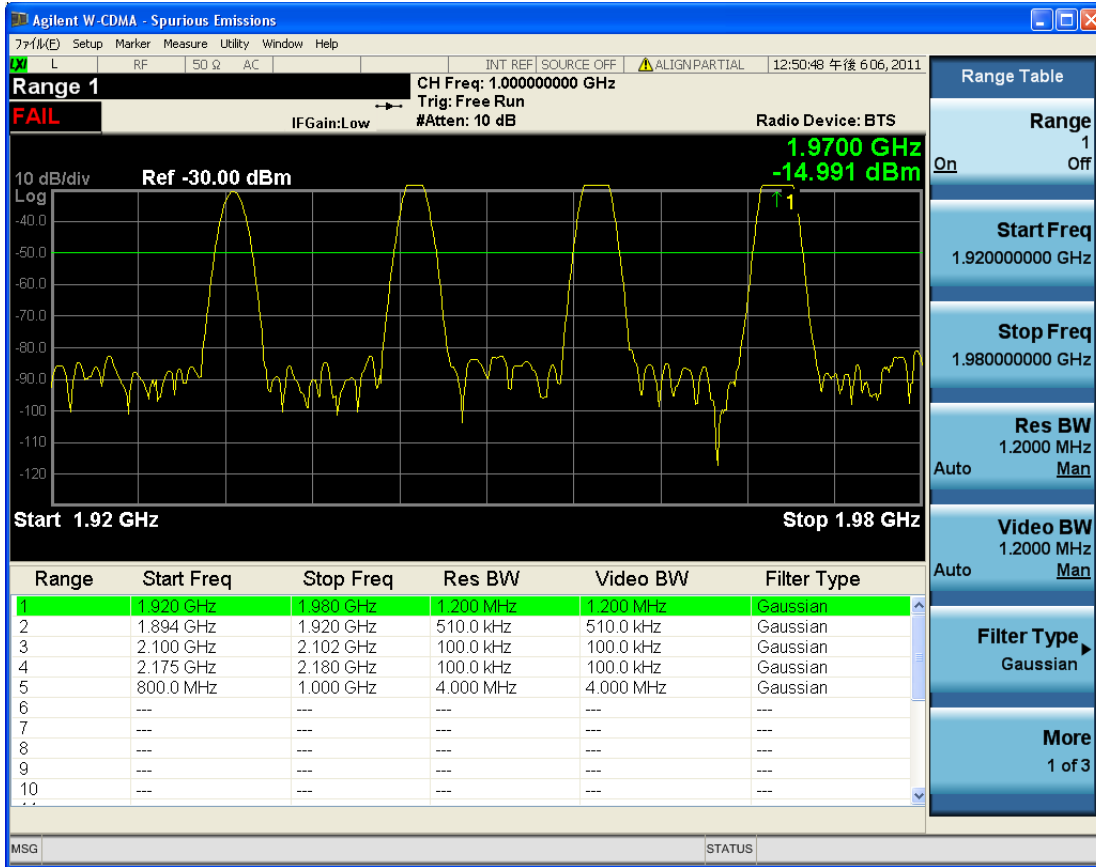

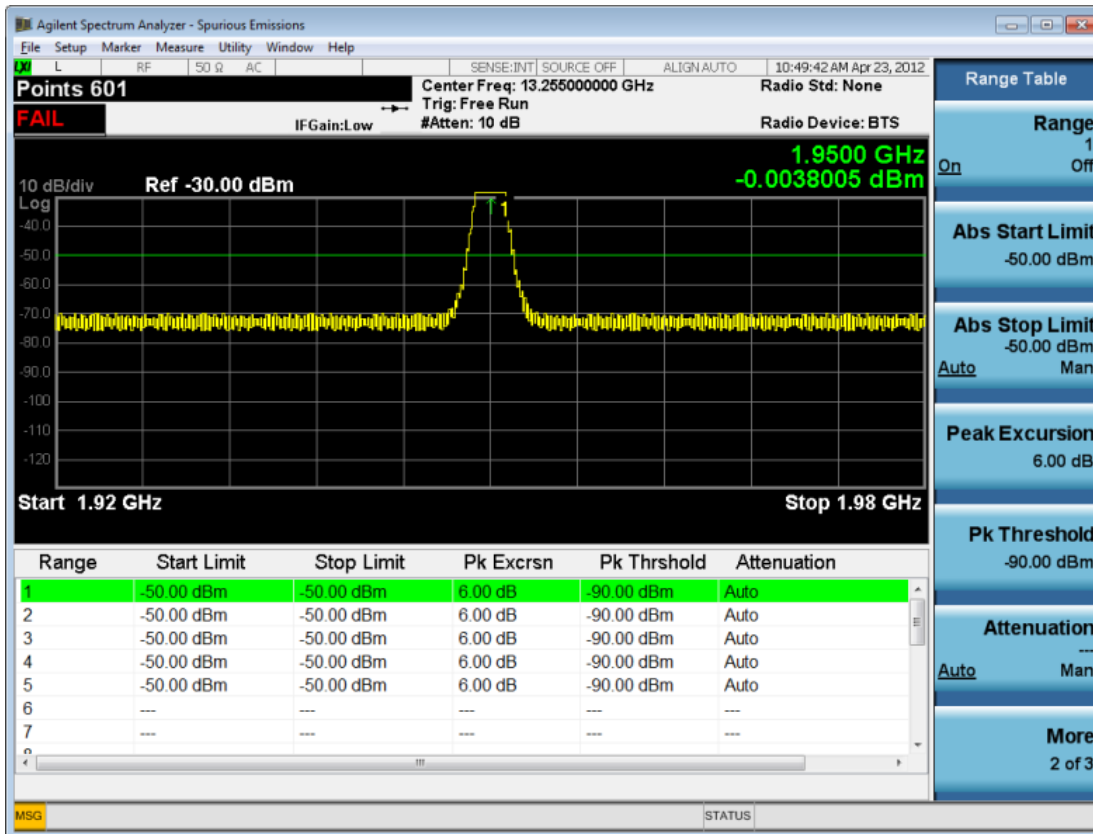

11 Spurious Emissions Measurement
View/Display

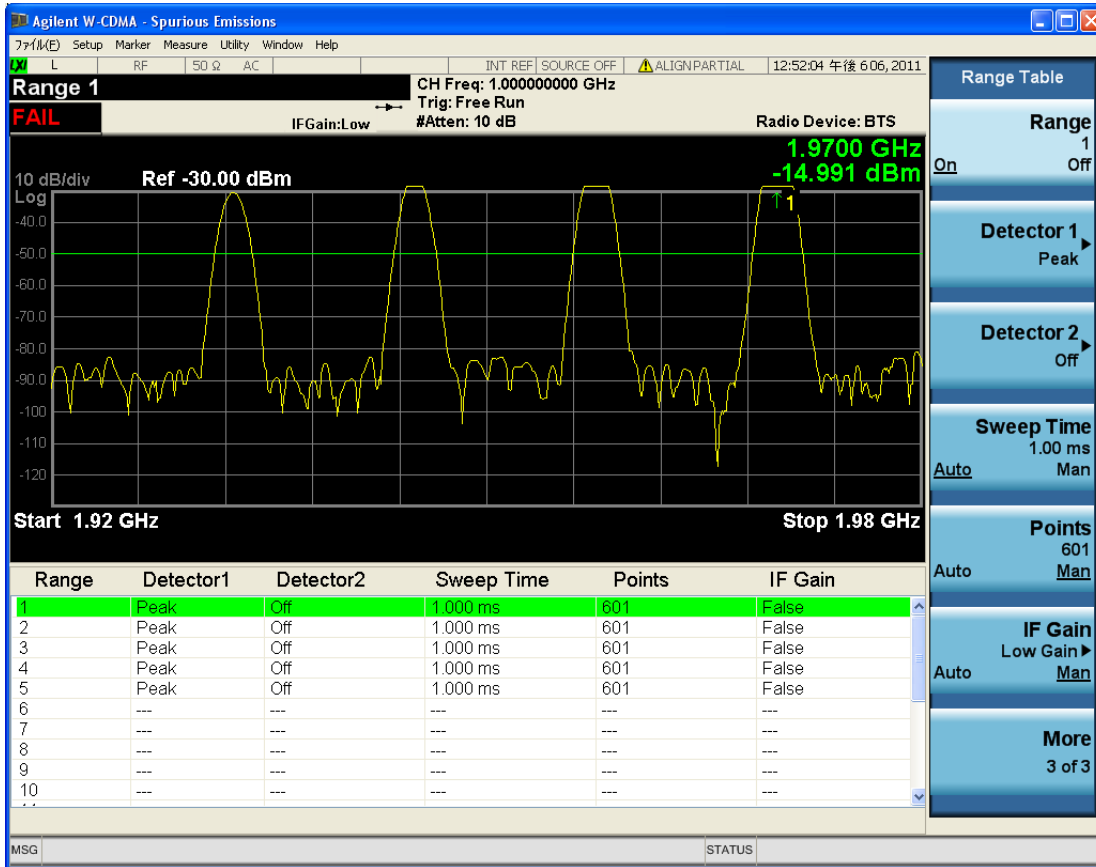

All Ranges

Select All Ranges to view measurement results for all the ranges.

- The upper window displays a merged trace of all the ranges.
- The lower window displays a list of spurs detected in a measurement cycle. The currently selected spur, which is highlighted, can be changed by the Spur softkey in the Meas Setup menu.

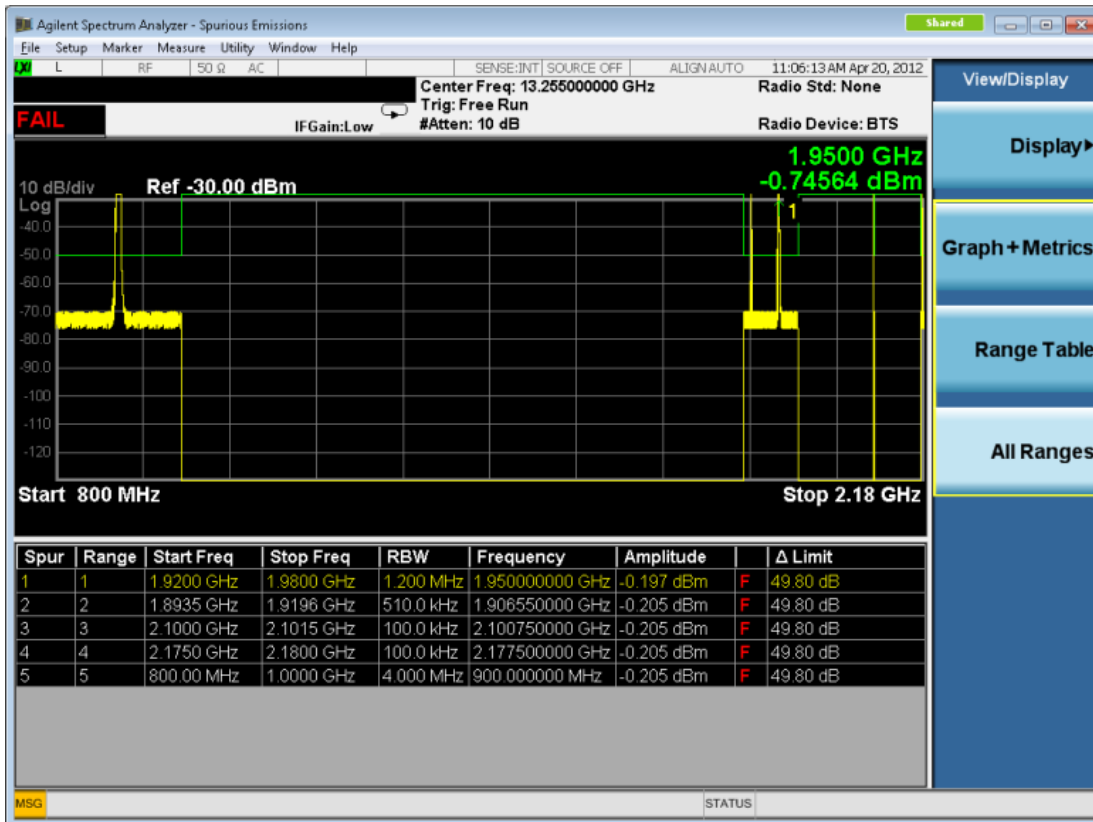

Range Table Selection (SCPI only command)

Switches contents of Range Table. There are three tables in the Range Table window, corresponding to each page of the Range Table menu. If the Range Table menu is displayed, this command changes the page of the Range Table menu too. Pressing the Range Table softkey always changes the current Range Table to 1.

Key Path	SCPI only
Mode	SA, WCDMA, C2K, 1xEV-DO, WIMAX OFDMA, TD-SCDMA, DVB-T/H, LTE, LTETDD, WLAN, MSR, LTEAFDD, LTEATDD
Remote Command	:DISPlay:SPURious:VIEW:RANGe:TABLE <integer> :DISPlay:SPURious:VIEW:RANGe:TABLE?
Example	DISP:SPUR:VIEW:RANG:TABL 2 DISP:SPUR:VIEW:RANG:TABL?
Notes	You must be in cdma2000 mode, TD-SCDMA mode, W-CDMA mode, DVB-T/H mode, GSM/EDGE mode, LTE mode, LTE TDD mode, WLAN mode, LTE-Advanced FDD/TDD mode, MSR or WiMAX mode to use this command. Use INSTRument:SElect to set the mode.
Preset	1
State Saved	No
Min	1
Max	3
Initial S/W Revision	A.10.00

12 Occupied Bandwidth Measurement

The Occupied Bandwidth measurement computes and displays the bandwidth occupied by a given percentage of the total mean power of a signal. For measurement results and views, see ["View/Display" on page 1430](#).

This topic contains the following sections:

["Remote Commands for Occupied Bandwidth" on page 1276](#)

["Remote Command Results for Occupied Bandwidth Measurement" on page 1277](#)

Remote Commands for Occupied Bandwidth

The following commands and queries can be used to retrieve the measurement results:

```
:CONFigure:OBWidth
:CONFigure:OBWidth:NDEFault
:INITiate:OBWidth
:FETCh:OBWidth[n]?
:MEASure:OBWidth[n]?
:READ:OBWidth[n]?
:FETCh:OBWidth:OBWidth?
:MEASure:OBWidth:OBWidth?
:READ:OBWidth:OBWidth?
:FETCh:OBWidth:FERRor?
:MEASure:OBWidth:FERRor?
:READ:OBWidth:FERRor?
:FETCh:OBWidth:XDB?
:MEASure:OBWidth:XDB?
:READ:OBWidth:XDB?
```

See also the section, "[Remote Measurement Functions](#)" on page 2205.

Remote Command Results for Occupied Bandwidth Measurement

The following table describes the results returned by the FETCh:OBWidth[n]?, MEASure:OBWidth[n]?, and READ:OBWidth[n]? queries listed above, according to the index value n.

n	Results Returned
n=1 (or not specified)	Returns 7 scalar results, in the following order: 1. Occupied bandwidth - Hz 2. Total Power - dBm (Total Power will be obsolete in TD-SCDMA mode, this place will be replaced by NaN) 3. Span - Hz 4. Spectrum Trace Points - points 5. Res BW - Hz 6. Transmit Frequency Error Hz 7. x DB Bandwidth - Hz
2	Returns the frequency-domain spectrum trace (data array) for the entire frequency range being measured.
n = 3 (Mode = MSR, LTEAFDD, LTEATDD)	1. Number of active carriers Returns number of active carriers within Span in Auto detected mode, otherwise the command is out of scope

Key Path	Meas
Initial S/W Revision	Prior to A.02.00

AMPTD Y Scale (Amplitude/Y Scale)

Activates the Reference Value function and displays the Amplitude menu keys. These functions control how data on the vertical (Y) axis is displayed and control instrument settings that affect the vertical axis

See AMPTD Y Scale for more information.

Key Path	Front-panel key
Initial S/W Revision	Prior to A.02.00

Ref Value

Sets the absolute power reference value. However, since the Auto Scaling is defaulted to On, this value is automatically determined by the measurement result. When you set a value manually, Auto Scaling automatically changes to Off.

Key Path	AMPTD Y Scale
Mode	SA, WCDMA, C2K, WIMAX OFDMA, TD-SCDMA, 1xEVDO, ISDB-T, CMMB, LTE, LTETDD, BLUETOOTH, WLAN, MSR, LTEAFDD, LTEATDD
Remote Command	:DISPlay:OBWidth:VIEW[1]:WINDow[1]:TRACe:Y[:SCALe]:RLEVel <real> :DISPlay:OBWidth:VIEW[1]:WINDow[1]:TRACe:Y[:SCALe]:RLEVel?
Example	DISP:OBW:VIEW:WIND:TRAC:Y:RLEV 125 DISP:OBW:VIEW:WIND:TRAC:Y:RLEV?
Notes	You must be in the Spectrum Analysis mode, W-CDMA mode, cdma2000 mode, TD-SCDMA mode, ISDB-T mode, CMMB mode, BLUETOOTH mode, LTE mode, LTE TDD mode, WLAN mode, 1xEVDO mode, MSR, LTE-Advanced FDD/TDD or WIMAX OFDMA mode to use this command. Use:INSTrument:SElect to set the mode.
Couplings	When the Auto Scaling is On, this value is automatically determined by the measurement result. When you set a value manually, Auto Scaling automatically changes to Off.
Preset	10.00 dBm
State Saved	Saved in instrument state.
Min	-250.00 dBm
Max	250.00 dBm
Initial S/W Revision	Prior to A.02.00
Modified at S/W Revision	A.03.00

Attenuation

This menu controls the attenuator functions and interactions between the attenuation system components.

There are two attenuator configurations in the X-Series. One is a dual attenuator configuration consisting of a mechanical attenuator and an optional electronic attenuator. The other configuration uses a single

attenuator with combined mechanical and electronic sections that controls all the attenuation functions. Different models in the X-Series come with different configurations.

See ["Dual Attenuator Configurations:" on page 1279](#)

See ["Single Attenuator Configuration:" on page 1280](#)

Most Attenuation settings are the same for all measurements – they do not change as you change measurements. Settings like these are called “Meas Global” and are unaffected by Meas Preset.

Key Path	AMPTD Y Scale
Scope	Meas Global
Dependencies	In measurements that support the I/Q inputs, this key is unavailable when I/Q is the selected input, and is replaced by the Range key in that case.
Readback Line	Contains a summary in [] brackets of the current total attenuation. See the descriptions of the , " (Mech) Atten " on page 2141, and " Enable Elec Atten " on page 2143 keys for more detail on the contributors to the total attenuation. Note that when "Pre-Adjust for Min Clip" is on, this value can change at the start of every measurement.
Initial S/W Revision	Prior to A.02.00
Modified at S/W Revision	A.03.00

Dual Attenuator Configurations:

Configuration 1: Mechanical attenuator + optional electronic attenuator

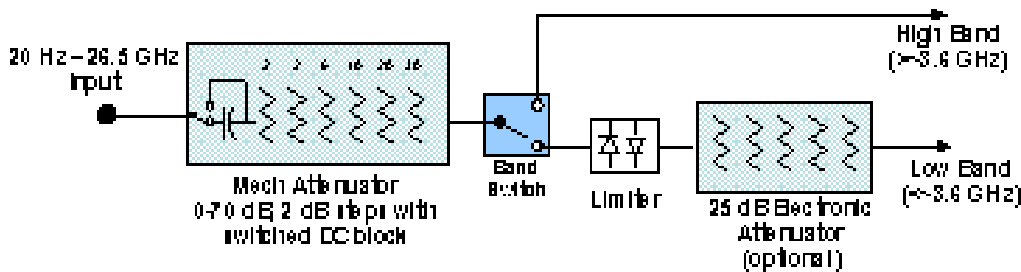

Configuration 2: Mechanical attenuator, no optional electronic attenuator

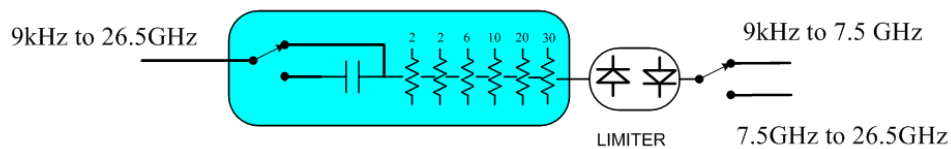

(note that Configuration 2 is not strictly speaking a dual-section attenuator, since there is no electronic section available. However, it behaves exactly like Configuration 1 without the Electronic Attenuator option EA3, therefore for the sake of this document it is grouped into the “Dual Attenuator” configuration)

Single Attenuator Configuration:

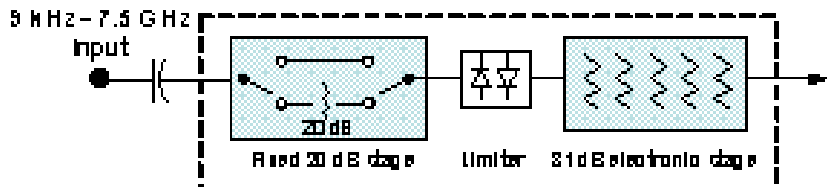

You can tell which attenuator configuration you have by pressing the Attenuation key, which (in most Modes) opens the Attenuation menu. If the first key in the Attenuation menu says Mech Atten you have the dual attenuator configuration. If the first key says Atten you have the single attenuator configuration.

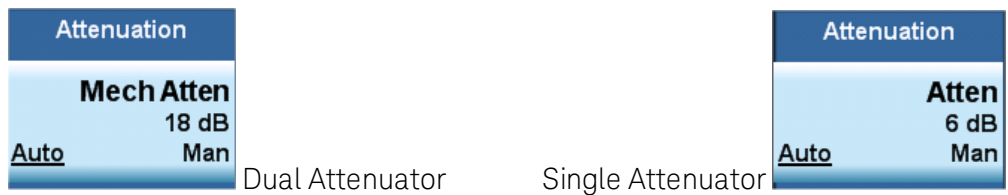

In the single attenuator configuration, you control the attenuation with a single control, as the fixed stage has only two states. In the dual attenuator configuration, both stages have significant range so you are given separate control of the mechanical and electronic attenuator stages.

When you have the dual attenuator configuration, you may still have only a single attenuator, because unless option EA3 (the Electronic Attenuator option) is available, and you purchase it, you will have only the mechanical attenuator.

(Mech) Atten

This key is labeled Mech Atten in dual attenuator models and Atten in single attenuator models. In the dual attenuator configuration, this key only affects the mechanical attenuator.

This key lets you modify the attenuation applied to the RF input signal path. This value is normally auto coupled to the Ref Level, the Internal Preamp Gain, any External Gain that is entered, and the Max Mixer Level, as described in the table below.

See ["Attenuator Configurations and Auto/Man" on page 1282](#)

Key Path	AMPTD Y Scale, Attenuation
Remote Command	<pre>[:SENSE] :POWER [:RF] :ATTenuation <rel_ampl> [:SENSE] :POWER [:RF] :ATTenuation? [:SENSE] :POWER [:RF] :ATTenuation:AUTO OFF ON 0 1 [:SENSE] :POWER [:RF] :ATTenuation:AUTO?</pre>
Example	<p>POW:ATT 20</p> <p>Dual attenuator configuration: sets the mechanical attenuator to 20 dB</p> <p>Single attenuator mode: sets the main attenuation to 20 dB (see below for definition of “main” attenuation).</p> <p>If the attenuator was in Auto, it sets it to Manual.</p>
Dependencies	Some measurements do not support the Auto setting of (Mech) Atten. In these measurements, the

Auto/Man selection is not available, and the Auto/Man line on the key disappears.

In dual attenuator configurations, when the electronic attenuator is enabled, the mechanical attenuator has no auto setting and the Auto/Man line on the key disappears. The state of Auto/Man is remembered and restored when the electronic attenuator is once again disabled. This is described in more detail in the ["Enable Elec Atten" on page 2143](#) key description.

See ["Attenuator Configurations and Auto/Man" on page 1282](#) for more information on the Auto/Man functionality of Attenuation.

Couplings

When (Mech) Atten is in Auto, it uses the following algorithm to determine a value:
If the USB Preamp is connected to USB, use 0 dB.
Otherwise, $Atten = ReferenceLevel + PreAmpGain + ExternalGain - RefLevelOffset - MaxMixerLevel + IF\ Gain$.
Limit this value to be between 6 dB and the Max value. No value below 6 dB can ever be chosen by Auto.
The resulting value is rounded up to the largest value possible given the attenuation step setting. That is, 50.01 dB would change to 60 dB (for a 10 dB attenuation step).
The "IF Gain" term in the equation above is either 0 dB or +10 dB, depending on the settings of FFT IF Gain, Swept IF Gain, max Ref Level and the Auto/Man setting of Mech Atten.
In External Mixing and BBIQ, where the Attenuator is not in the signal path, the Attenuator setting changes as described above when (Mech) Atten is in Auto, but no changes are made to the actual attenuator hardware setting until the input is changed back to the RF Input.

Preset The preset for Mech Attenuation is "Auto."
The Auto value of attenuation is:
CXA, EXA, MXA and PXA: 10 dB

State Saved Saved in instrument state

Min 0 dB
The attenuation set by this key cannot be decreased below 6 dB with the knob or step keys. To get to a value below 6 dB it has to be directly entered from the keypad or via SCPI. This protects from adjusting the attenuation to a dangerously small value which can put the instrument at risk of damage to input circuitry. However, if the current mechanical attenuation is below 6 dB it can be increased with the knob and step keys, but not decreased.

Max CXA N9000A-503/507: 50 dB
CXA N9000A-513/526: 70dB
EXA: 60 dB
MXA and PXA: 70 dB
In the single attenuator configuration, the total of ATT and EATT cannot exceed 50 dB, so if the EATT is set to 24 dB first, the main attenuation cannot be greater than 26 dB and will be reduced accordingly; if the main attenuator is set to 40 dB first, EATT cannot be greater than 10 dB.

Initial S/W Revision Prior to A.02.00

Modified at S/W Revision A.03.00

Attenuator Configurations and Auto/Man

As described in the Attenuation key description, there are two distinct attenuator configurations available in the X-Series, the single attenuator and dual attenuator configurations. In dual attenuator configurations, we have the mechanical attenuation and the electronic attenuation, and the current total attenuation is the sum of the electronic + mechanical attenuation. In single attenuator configurations, we refer to the attenuation set using the (Mech) Atten key (or POW:ATT SCPI) as the “main” attenuation; and the attenuation that is set by the SCPI command POW:EATT as the “soft” attenuation (the POW:EATT command is honored even in the single attenuator configuration, for compatibility purposes). Then the current total attenuation is the sum of the main + soft attenuation. See the Elec Atten key description for more on “soft” attenuation.

In the dual attenuator configuration, when the electronic attenuator is enabled, there is no Auto/Man functionality for the mechanical attenuator, and the third line of the key label (the Auto/Man line) disappears:

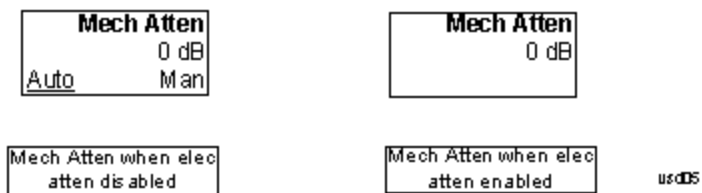

Enable Elec Atten

Enables the Electronic Attenuator.

The electronic attenuator offers finer steps than the mechanical attenuator, has no acoustical noise, is faster, and is less subject to wear. These advantages primarily aid in remote operation and are negligible for front panel use. See ["Using the Electronic Attenuator: Pros and Cons" on page 1284](#) for a detailed discussion of the pros and cons of using the electronic attenuator.

For the single attenuator configuration, for SCPI backwards compatibility, the “soft” attenuation feature replaces the dual attenuator configuration’s electronic attenuator. All the same couplings and limitations apply. See ["Attenuator Configurations and Auto/Man" on page 2143](#)

See ["More Information" on page 1283](#)

Key Path	AMPTD Y Scale, Attenuation
Remote Command	[:SENSe] :POWer [:RF] :EATTenuation :STATe OFF ON 0 1 [:SENSe] :POWer [:RF] :EATTenuation :STATe ?
Example	POW:EATT:STAT ON
Dependencies	This key only appears in Dual Attenuator models with an Electronic Attenuator installed. It does not appear in models with the Single Attenuator configuration, as in the single attenuator configuration there is no “electronic attenuator” there is only a single integrated attenuator (which has both a mechanical and electronic stage). However, in the single attenuator configuration, EATT SCPI commands are accepted for compatibility with other X-series instruments and set a “soft” attenuation as described in "Attenuator Configurations and Auto/Man" on page 2143 . The electronic attenuator (and the “soft” attenuation function provided in single attenuator configurations) is unavailable above 3.6 GHz. Therefore, if the Stop Frequency of the analyzer is > 3.6 GHz then the Enable Elec Atten key will be OFF and grayed out.

	<p>If the Internal Preamp is on, meaning it is set to Low Band or Full, the electronic attenuator (and the “soft” attenuation function provided in single attenuator configurations) is unavailable. In this case the Enable Elec Atten key will be OFF and grayed out.</p> <p>If either of the above is true, if the SCPI command is sent, an error indicating that the electronic attenuator is unavailable will be sent.</p> <p>If the electronic/soft Attenuator is enabled, then the Stop Freq of the analyzer is limited to 3.6 GHz and the Internal Preamp is unavailable.</p> <p>The SCPI-only “soft” electronic attenuation for the single-attenuator configuration is not available in all measurements; in particular, it is not available in the Swept SA measurement.</p>
Couplings	Enabling and disabling the Electronic Attenuator affects the setting of the Mechanical Attenuator (in dual attenuator configurations). This is described in more detail below this table.
Preset	OFF for Swept SA measurement; ON for all other measurements that support the electronic attenuator
State Saved	Saved in instrument state
Initial S/W Revision	Prior to A.02.00
Modified at S/W Revision	A.03.00

More Information

Mechanical Attenuator Transition Rules

When the Electronic Attenuator is enabled, the Mechanical Attenuator transitions to a state that has no Auto function. Below are the rules for transitioning the Mechanical Attenuator. NOTE that the information below ONLY applies to the dual attenuator configurations, and ONLY when the Electronic Attenuator is installed:

When the Electronic Attenuation is enabled from a disabled state:

- The Mechanical Attenuator is initialized to 10 dB (this is its optimal performance setting). You can then set it as desired with SCPI, numeric keypad, step keys, or knob, and it behaves as it normally would in manual mode
- The Auto/Man state of (Mech) Atten is saved
- The Auto/Man line on the (Mech) Atten key disappears and the auto rules are disabled
- The Electronic Attenuator is set to 10 dB less than the previous value of the Mechanical Attenuator, within the limitation that it must stay within the range of 0 to 24 dB of attenuation.

Examples in the dual attenuator configuration:

- Mech Atten at 20 dB. Elec Atten enabled, Mech Atten set to 10 dB, and Elec Atten set to 10 dB. New total attenuation equals the value before Elec Atten enabled.
- Mech Atten at 0 dB. Elec Atten enabled, Mech Atten set to 10 dB, and Elec Atten set to 0 dB. New total attenuation does not equal the value before Elec Atten enabled.
- Mech Atten at 40 dB. Elec Atten enabled, Mech Atten set to 10 dB, and Elec Atten set to 24 dB. New total attenuation does not equal the value before Elec Atten enabled.

When the Electronic Attenuation is disabled from an enabled state:

- The Elec Atten key is grayed out
- The Auto/Man state of (Mech) Atten is restored
- If now in Auto, (Mech) Atten recouples
- If now in Man, (Mech) Atten is set to the value of total attenuation that existed before the Elec Atten was disabled. The resulting value is rounded up to the smallest value possible given the (Mech) Atten Step setting - (That is, 57 dB changes to 58 dB when (Mech) Atten Step is 2 dB.)

Using the Electronic Attenuator: Pros and Cons

The electronic attenuator offers finer steps than the mechanical attenuator, has no acoustical noise, is faster, and is less subject to wear.

The “finer steps” advantage of the electronic attenuator is beneficial in optimizing the alignment of the analyzer dynamic range to the signal power in the front panel as well as remote use. Thus, you can achieve improved relative signal measurement accuracy. Compared to a mechanical attenuator with 2 dB steps, the 1 dB resolution of the electronic attenuator only gives better resolution when the odd-decibel steps are used. Those odd-decibel steps are less accurately calibrated than the even-decibel steps, so one tradeoff for this superior relative accuracy is reduced absolute amplitude accuracy.

Another disadvantage of the electronic attenuator is that the spectrum analyzer loses its “Auto” setting, making operation less convenient.

Also, the relationship between the dynamic range specifications (TOI, SHI, compression and noise) and instrument performance are less well-known with the electrical attenuator. With the mechanical attenuator, TOI, SHI and compression threshold levels increase dB-for-dB with increasing attenuation, and the noise floor does as well. With the electronic attenuator, there is an excess attenuation of about 1 to 3 dB between 0 and 3.6 GHz, making the effective TOI, SHI, and so forth, less well known. Excess attenuation is the actual attenuation relative to stated attenuation. Excess attenuation is accounted for in the analyzer calibration

Elec Atten

Controls the Electronic Attenuator in dual attenuator configurations. This key does not appear in single attenuator configurations, as the control of both the mechanical and electronic stages of the single attenuator is integrated into the single Atten key.

Key Path	AMPTD Y Scale, Attenuation
Remote Command	<code>[:SENSe] :POWer [:RF] :EATTenuation <rel_amp1></code> <code>[:SENSe] :POWer [:RF] :EATTenuation?</code>
Notes	Electronic Attenuation’s specification is defined only when Mechanical Attenuation is 6 dB.
Dependencies	This key only appears in Dual Attenuator models with an Electronic Attenuator installed. It does not appear in models with the Single Attenuator configuration, as in the single attenuator configuration there is no “electronic attenuator” there is only a single integrated attenuator (which has both a mechanical and electronic stage). However, in the single attenuator configuration, EATT SCPI commands are accepted for compatibility with other X-series instruments and set a “soft” attenuation as described in "Attenuator Configurations and Auto/Man" on page 2143 . The “soft” attenuation is treated as an addition to the “main” attenuation value set by the Atten softkey or the

	POW:ATT SCPI command and affects the total attenuation displayed on the Attenuation key and the Meas Bar. When Enable Elec Atten is off or grayed out, the Elec Atten key is grayed out.
Preset	0 dB
State Saved	Saved in instrument state
Min	0 dB
Max	Dual attenuator configuration: 24 dB Single attenuator configuration: the total of ATT and EATT cannot exceed 50 dB, so if the EATT is set to 24 dB first, the main attenuation cannot be greater than 26 dB and will be reduced accordingly; if the main attenuator is set to 40 dB first, EATT cannot be greater than 10 dB
Initial S/W Revision	Prior to A.02.00
Modified at S/W Revision	A.03.00

Adjust Atten for Min Clip

Sets the combination of mechanical and electronic attenuation and gain based on the current measured signal level so that clipping will be at a minimum.

This is an "immediate action" function, that is, it executes once, when the key is pressed.

This key is grayed out in measurements that do not support this functionality. The spectrum analyzer measurement, Swept SA, does not support this functionality.

Key Path	AMPTD Y Scale, Attenuation
Remote Command	<code>[:SENSe] :POWer [:RF] :RANGe:OPTimize IMMEDIATE</code>
Initial S/W Revision	Prior to A.02.00
Modified at S/W Revision	A.03.00

Pre-Adjust for Min Clip

If this function is on, it does the adjustment described under "[Adjust Atten for Min Clip](#)" on page 2146 each time a measurement restarts. Therefore, in Continuous measurement mode, it only executes before the first measurement.

In dual attenuator models, you can set Elec+Mech Atten, in which case both attenuators participate in the autoranging, or Elec Atten Only, in which case the mechanical attenuator does not participate in the autoranging. This latter case results in less wear on the mechanical attenuator and is usually faster.

This key is grayed out in measurements that do not support this functionality. The spectrum analyzer measurement, Swept SA, does not support this functionality.

Key Path	AMPTD Y Scale, Attenuation
Remote Command	<code>[:SENSe] :POWer [:RF] :RANGe:OPTimize:ATTenuation OFF ELECTRICAL COMBINED</code>

	<code>[:SENSe] :POWer [:RF] :RANGe:OPTimize:ATTenuation?</code>
Notes	The SCPI parameter ELECtrical sets this function to On in single attenuator models. The SCPI parameter COMBined is mapped to ELECtrical in single attenuator models; if you send COMBined, it sets the function to On and returns ELEC to a query.
Dependencies	This key only appears in Dual Attenuator models with an Electronic Attenuator installed. In instruments with Dual Attenuator model, when Enable Elec Atten is off or grayed out, the Pre-Adjust for Min Clip key is grayed out.
Preset	OFF for Swept SA measurement; ON for all other measurements that support Pre-Adjust for Min Clip
State Saved	Saved in instrument state
Range	Dual attenuator models: Off Elec Atten Only Mech + Elec Atten Single attenuator models: Off On
Initial S/W Revision	Prior to A.02.00
Modified at S/W Revision	A.03.00

Remote Command	<code>[:SENSe] :POWer [:RF] :RANGe:AUTO ON OFF 1 0</code> <code>[:SENSe] :POWer [:RF] :RANGe:AUTO?</code>
Notes	ON aliases to "Elec Atten Only" (:POW:RANG:OPT:ATT ELEC) OFF aliases to "Off" (:POW:RANG:OPT:ATT OFF) The query :POW:RANG:AUTO? returns true if :POW:RANG:OPT:ATT is not "Off"
Initial S/W Revision	Prior to A.02.00

Off

Turns Pre-Adjust for Min Clip off. This is the default setting.

This key is grayed out in measurements that do not support this functionality. The spectrum analyzer measurement, Swept SA, does not support this functionality.

Key Path	AMPTD Y Scale, Attenuation, Pre-Adjust for Min Clip
Example	:POW:RANGe:OPT:ATT OFF
Initial S/W Revision	Prior to A.02.00

Elec Atten Only

Selects only the electric attenuator to participate in auto ranging. This offers less wear on the mechanical attenuator and is usually faster.

This key is grayed out in measurements that do not support this functionality. The spectrum analyzer measurement, Swept SA, does not support this functionality.

Key Path	AMPTD Y Scale, Attenuation, Pre-Adjust for Min Clip
Example	:POW:RANGe:OPT:ATT ELEC
Initial S/W Revision	Prior to A.02.00

Mech + Elec Atten

In dual attenuator models, this selects both attenuators participate in the autoranging.

This key is grayed out in measurements that do not support this functionality. The spectrum analyzer measurement, Swept SA, does not support this functionality.

Key Path	AMPTD Y Scale, Attenuation, Pre-Adjust for Min Clip
Example	:POW:RANGe:OPT:ATT COMB
Initial S/W Revision	Prior to A.02.00

(Mech) Atten Step

This controls the step size used when making adjustments to the input attenuation.

This key is labeled Mech Atten Step in dual attenuator models and Atten Step in single attenuator models. In the dual attenuator configuration, this key only affects the step size of the mechanical attenuator.

Key Path	AMPTD Y Scale, Attenuation
Remote Command	[[:SENSe]:POWer[:RF]:ATTenuation:STEP[:INCRement] 10 dB 2 dB [:SENSe]:POWer[:RF]:ATTenuation:STEP[:INCRement]?
Example	POW:ATT:STEP 2
Notes	Note this feature works like a 1-N choice from the front panel, but it takes a specific value (in dB) when used remotely. The only valid values are 2 and 10.
Dependencies	Blanked in CXA and EXA if option FSA (2 dB steps) is not present. If blanked, attempts to set it via SCPI will yield an error.
Couplings	When the attenuation step size changes, the current mechanical attenuation value is adjusted (if necessary) to be quantized to the new step size. That is, if step is set to 10 dB, mech atten is increased if necessary so it is a multiple of 10 dB
Preset	PXA and MXA: 2 dB EXA and CXA: 10 dB (2 dB with option FSA)
State Saved	Saved in instrument state
Initial S/W Revision	Prior to A.02.00
Modified at S/W Revision	A.03.00

Scale/Div

Sets the logarithmic units per vertical graticule division on the display. When the Auto Scaling is On, the Scale/Div is automatically determined by the measurement result. When you set a value manually, Auto Scaling is automatically toggled to Off.

Key Path	AMPTD Y Scale
Mode	SA, WCDMA, C2K, WIMAX OFDMA, TD-SCDMA, 1xEVDO, ISDB-T, CMMB, LTE, LTETDD, BLUETOOTH, WLAN, MSR, LTEAFDD, LTEATDD
Remote Command	:DISPlay:OBWidth:VIEW[1]:WINDow[1]:TRACe:Y[:SCALe]:PDIVision <rel_amp1> :DISPlay:OBWidth:VIEW[1]:WINDow[1]:TRACe:Y[:SCALe]:PDIVision?
Example	DISP:OBW:VIEW:WIND:TRAC:Y:PDIV 5 DISP:OBW:VIEW:WIND:TRAC:Y:PDIV?
Notes	You must be in the Spectrum Analysis mode, W-CDMA mode, cdma2000 mode, TD-SCDMA mode, ISDB-T mode, CMMB mode, LTE mode, LTE TDD mode, BLUETOOTH mode, WLAN mode, 1xEVDO mode, MSR, LTE-Advanced FDD/TDD or WIMAX OFDMA mode to use this command. Use :INSTrument:SElect to set the mode.
Couplings	When the Auto Scaling is On, this value is automatically determined by the measurement result. When you set a value manually, Auto Scaling automatically changes to Off.
Preset	10.00 dB
State Saved	Saved in instrument state.
Min	0.10 dB
Max	20.00 dB
Initial S/W Revision	Prior to A.02.00
Modified at S/W Revision	A.03.00

Presel Center

When this key is pressed, the centering of the preselector filter is adjusted to optimize the amplitude accuracy at the frequency of the selected marker. If the selected marker is not on when Presel Center is pressed, the analyzer will turn on the selected marker, perform a peak search, and then perform centering on the marker's center frequency. If the selected marker is already on and between the start and stop frequencies of the analyzer, the analyzer performs the preselector calibration on that marker's frequency. If the selected marker is already on, but outside the frequency range between Start Freq and Stop Freq, the analyzer will first perform a peak search, and then perform centering on the marker's center frequency.

The value displayed on the Presel Adjust key will change to reflect the new preselector tuning (see Presel Adjust).

A number of considerations should be observed to ensure proper operation. See ["Proper Preselector Operation" on page 1289](#).

Key Path	AMPTD Y Scale
Remote Command	[:SENSE]:POWer[:RF]:PCENTER

Example	POW:PCEN
Notes	Note that the rules outlined above under the key description apply for the remote command as well as the key. The result of the command is dependent on marker position, and so forth. Any message shown by the key press is also shown in response to the remote command.
Dependencies	<ul style="list-style-type: none"> • Grayed out if the microwave preselector is off.) • If the selected marker's frequency is below Band 1, advisory message 0.5001 is generated and no action is taken. • Grayed out if entirely in Band 0. • Blank in models that do not include a preselector, such as option 503. If the SCPI is sent in these instruments, it is accepted without error, and the query always returns 0. • Grayed out in the Spectrogram View.
Couplings	<p>The active marker position determines where the centering will be attempted.</p> <p>If the analyzer is in a measurement such as averaging when centering is initiated, the act of centering the preselector will restart averaging but the first average trace will not be taken until the centering is completed.</p>
Status Bits/OPC dependencies	<p>When centering the preselector, *OPC will not return true until the process is complete and a subsequent measurement has completed, nor will results be returned to a READ or MEASURE command.</p> <p>The Measuring bit should remain set while this command is operating and should not go false until the subsequent sweep/measurement has completed.</p>
Initial S/W Revision	Prior to A.02.00
Modified at S/W Revision	A.03.00

Proper Preselector Operation

A number of considerations should be observed to ensure proper operation:

1. If the selected marker is off, the analyzer will turn on a marker, perform a peak search, and adjust the preselector using the selected marker's frequency. It uses the "highest peak" peak search method unqualified by threshold or excursion, so that there is no chance of a 'no peak found' error. It continues with that peak, even if it is the peak of just noise. Therefore, for this operation to work properly, there should be a signal on screen in a preselected range for the peak search to find.
2. If the selected marker is already on, the analyzer will attempt the centering at that marker's frequency. There is no preselector for signals below about 3.6 GHz, therefore if the marker is on a signal below 3.6 GHz, no centering will be attempted and an advisory message generated
3. In some models, the preselector can be bypassed. If it is bypassed, no centering will be attempted in that range and a message will be generated.

Preselector Adjust

Allows you to manually adjust the preselector filter frequency to optimize its response to the signal of interest. This function is only available when "[Presel Center](#)" on page 2149 is available.

For general purpose signal analysis, using Presel Center is recommended. Centering the filter minimizes the impact of long-term preselector drift. Presel Adjust can be used instead to manually optimize the preselector. One application of manual optimization would be to peak the preselector response, which both optimizes the signal-to-noise ratio and minimizes amplitude variations due to small (short-term) preselector drifting.

Key Path	AMPTD Y Scale
Scope	Meas Global
Remote Command	<code>[:SENSe] :POWer [:RF] :PADJust <freq></code> <code>[:SENSe] :POWer [:RF] :PADJust?</code>
Example	POW:PADJ 100KHz POW:PADJ?
Notes	The value on the key reads out to 0.1 MHz resolution.
Dependencies	<ul style="list-style-type: none"> • Grayed out if microwave preselector is off.) • Grayed out if entirely in Band 0. • Blank in models that do not include a preselector, such as option 503. If the SCPI is sent in these instruments, it is accepted without error, and the query always returns 0. • Grayed out in the Spectrogram View.
Preset	0 MHz
State Saved	The Presel Adjust value set by Presel Center, or by manually adjusting Presel Adjust, is not saved in instrument state, and does not survive a Preset or power cycle.
Min	-500 MHz
Max	500 MHz
Default Unit	Hz
Backwards Compatibility SCPI	<code>[:SENSe] :POWer [:RF] :MW :PADJust</code> <code>[:SENSe] :POWer [:RF] :MMW :PADJust</code> PSA had multiple preselectors, but the X-Series has only one. These commands simply alias to <code>[:SENSe] :POWer [:RF] :PADJust</code>
Initial S/W Revision	Prior to A.02.00
Modified at S/W Revision	A.03.00

Remote Command	<code>[:SENSe] :POWer [:RF] :PADJust :PRESelector MWAVE MMWave EXTERNAL</code> <code>[:SENSe] :POWer [:RF] :PADJust :PRESelector?</code>
Notes	PSA had multiple preselectors, and you could select which preselector to adjust. Since the X-Series has only one mm/uW preselector, the preselector selection softkey is no longer available. However, to provide backward compatibility, we accept the legacy remote commands. The command form has no effect, the query always returns MWAVE
Initial S/W Revision	Prior to A.02.00

μW Path Control

The μW Path Control functions include the μW Preselector Bypass (Option MPB) and Low Noise Path (Option LNP) controls in the High Band path circuits.

When the μW Preselector is bypassed, the user has better flatness, but will be subject to spurs from out of band interfering signals. When the Low Noise Path is enabled, the analyzer automatically switches around certain circuitry in the high frequency bands which can contribute to noise, when it is appropriate based on other analyzer settings.

For most applications, the preset state is Standard Path, which gives the best remote-control throughput, minimizes acoustic noise from switching and minimizes the risk of wear out in the hardware switches. For applications that utilize the wideband IF paths, the preset state is the μW Preselector Bypass path, if option MPB is present. This is because, when using a wideband IF such as the 140 MHz IF, the μW Preselector's bandwidth can be narrower than the available IF bandwidth, causing degraded amplitude flatness and phase linearity, so it is desirable to bypass the preselector in the default case.

Users may choose Low Noise Path Enable. It gives a lower noise floor, especially in the 21–26.5 GHz region, though without improving many measures of dynamic range, and without giving the best possible noise floor. The preamp, if purchased and used, gives better noise floor than does the Low Noise Path, however its compression threshold and third-order intercept are much poorer than that of the non-preamp Low Noise Path. There are some applications, typically for signals around –30 dBm, for which the third-order dynamic range of the standard path is good enough, but the noise floor is not low enough even with 0 dB input attenuation. When the third-order dynamic range of the preamp path is too little and the noise floor of the standard path is too high, the Low Noise Path can provide the best dynamic range.

Key Path	AMPTD Y Scale
Mode	SA, BASIC, PNOISE, VSA , LTE, LTETDD
Scope	Meas Global
Remote Command	[:SENSe] :POWer [:RF] :MW:PATH STD LNPath MPBypass FULL [:SENSe] :POWer [:RF] :MW:PATH?
Example	:POW:MW:PATH LNP Enables the Low Noise path
Notes	If a Presel Center is performed, the analyzer will momentarily switch to the Standard Path, regardless of the setting of μW Path Control The DC Block will always be switched in when the low noise path is switched in, to protect succeeding circuitry from DC. Note that this does not mean “when the low noise path is enabled” but when, based on the Low Noise Path rules, the path is actually switched in. This can happen when the selection is Low Noise Path Enable . In the case where the DC Block is switched in the analyzer is now AC coupled. However, if the user has selected DC coupling, the UI will still behave as though it were DC coupled, including all annunciation, warnings, status bits, and responses to SCPI queries. This is because, based on other settings, the analyzer could switch out the low noise path at any time and hence go back to being DC coupled. Alignment switching ignores the settings in this menu, and restores them when finished.
Dependencies	Unavailable in BBIQ and External Mixing
Preset	All modes other than IQ Analyzer mode and VXA: STD IQ Analyzer, VXA and WLAN mode:

	MPB option present and licensed: MPB MPB option not present and licensed: STD
State Saved	Save in instrument state
Readback	Value selected in the submenu
Initial S/W Revision	A.04.00
Modified at S/W Revision	A.10.00

Standard Path

This path gives the best remote-control throughput, minimizes acoustic noise from switching and minimizes the risk of wear in the hardware switches, particularly in remote test scenarios where both low band and high band setups will follow in rapid succession.

In this path, the bypass of the low band/high band switch and microwave preamp is never activated, which can cause some noise degradation but preserves the life of the bypass switch.

Key Path	AMPTD Y Scale, μ W Path Control
Example	:POW:MW:PATH STD
Readback Text	Standard Path
Initial S/W Revision	A.04.00

Low Noise Path Enable

You may choose Low Noise Path Enable, which gives a lower noise floor under some circumstances, particularly when operating in the 21–26.5 GHz region. With the Low Noise Path enabled, the low band/high band switch and microwave preamp are bypassed whenever all of the following are true:

- The analyzer is not in the Low Band, meaning:
- the start frequency is above 3.5 GHz and
- the stop frequency is above 3.6 GHz.
- the internal preamp is not installed or (if installed) is set to Off or Low Band

Note that this means that, when any part of a sweep is done in Low Band, the Low Noise Path is not used, whether or not the Low Noise Path Enable is selected in the user interface. Also, if the preamp is turned on, the Low Noise Path is not used, whether or not the Low Noise Path Enable is selected in the user interface. The only time the Low Noise Path is used is when Low Noise Path Enable is selected, the sweep is completely in High Band (> 3.6 GHz) and no preamp is in use.

See "[More Information](#)" on page 1293

Key Path	AMPTD Y Scale, μ W Path Control
Measurement	Swept SA

Example	:POW:MW:PATH LNP
Notes	<p>For measurements that use IQ acquisition, the low noise path is used when the Center Frequency is in High Band (> 3.6 GHz) and no preamp is in use.</p> <p>In other words, the rules above are modified to use only the center frequency to qualify which path to switch in.</p> <p>This is not the case for FFT's in the Swept SA measurement; they use the same rules as swept measurements.</p>
Dependencies	<p>Key is blanked if current mode does not support it.</p> <p>Key is grayed out if mode supports it but current measurement does not support it.</p> <p>Unless Option LNP is present and licensed, key is blank and if SCPI command sent, error -241, "Hardware missing; Option not installed" is generated.</p>
Readback Text	Low Noise Path Enable
Initial S/W Revision	A.04.00

More Information

The user should understand that the Low Noise Path, while giving improved DANL, has the disadvantage of decreased TOI performance and decreased gain compression performance relative to the standard path.

The user should also understand that the bypass switch is a mechanical switch and has finite life, so if the Low Noise Path is enabled, it is possible to cause frequent cycling of this switch by frequently changing analyzer settings such that the above conditions hold true only some of the time. A user making tests of this nature should consider opting for the Standard Path, which will never throw the bypass switch, at the expense of some degraded noise performance.

The low noise path is useful for situations where the signal level is so low that the analyzer performance is dominated by noise even with 0 dB attenuation, but still high enough that the preamp option would have excessive third-order intermodulation or compression. The preamp, if purchased and used, gives better noise floor than does the "Low Noise Path." However, its compression threshold and third-order intercept are much poorer than that of the non-preamp path. There are some applications, typically for signals around -30 dBm, for which the third-order dynamic range of the standard path is good enough, but the noise floor is not low enough even with 0 dB input attenuation. When the third-order dynamic range of the preamp path is too little and the noise floor of the standard path is too high, the Low Noise Path can provide the best dynamic range

The graph below illustrates the concept. It shows, in red, the performance of an analyzer at different attenuation settings, both with the preamp on and off, in a measurement that is affected by both analyzer noise and analyzer TOI. The green shows the best available dynamic range, offset by 0.5 dB for clarity. The blue shows how the best available dynamic range improves for moderate signal levels with the low noise path switched in. In this illustration, the preamp improves the noise floor by 15 dB while degrading the third-order intercept by 30 dB, and the low noise path reduces loss by 8 dB. The attenuator step size is 2 dB.

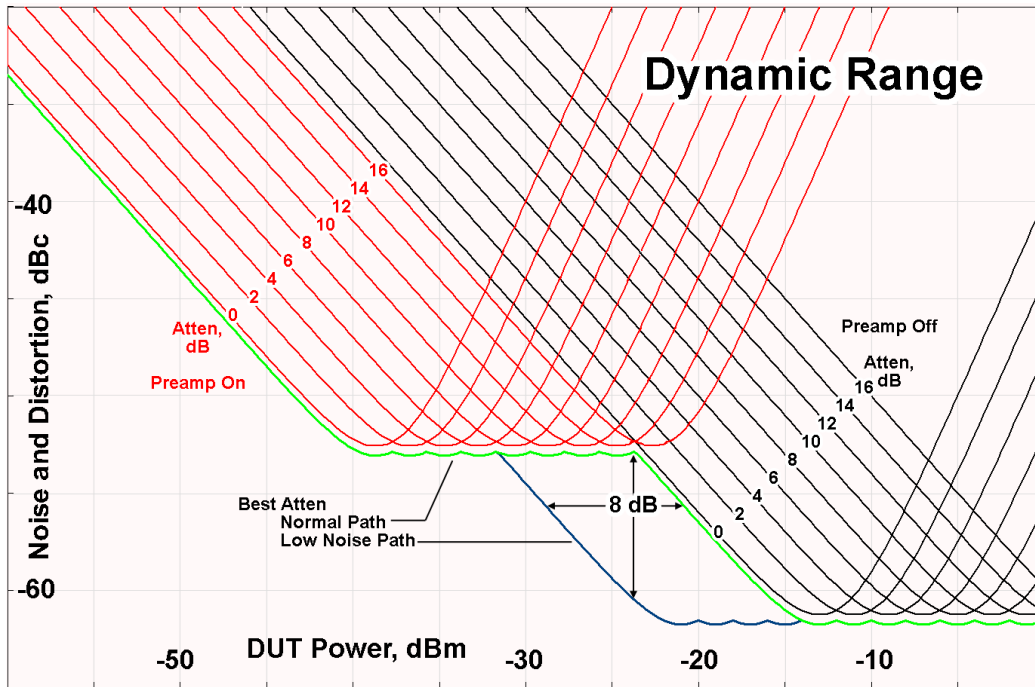

There are other times where selecting the low noise path improves performance, too. Compression-limited measurements such as finding the nulls in a pulsed-RF spectrum can profit from the low noise path in a way similar to the TOI-limited measurement illustrated. Accuracy can be improved when the low noise path allows the optimum attenuation to increase from a small amount like 0, 2 or 4 dB to a larger amount, giving better return loss at the analyzer input. Harmonic measurements, such as second and third harmonic levels, are much improved using the low noise path because of the superiority of that path for harmonic (though not intermodulation) distortion performance.

μW Preselector Bypass

This key toggles the preselector bypass switch for band 1 and higher. When the microwave preselector is on, the signal path is preselected. When the microwave preselector is off, the signal path is not preselected. The preselected path is the normal path for the analyzer.

The preselector is a tunable bandpass filter which prevents signals away from the frequency of interest from combining in the mixer to generate in-band spurious signals (images). The consequences of using a preselector filter are its limited bandwidth, the amplitude and phase ripple in its passband, and any amplitude and phase instability due to center frequency drift.

Option MPB or pre-selector bypass provides an unpreselected input mixer path for certain X-Series signal analyzers with frequency ranges above 3.6 GHz. This signal path allows a wider bandwidth and less amplitude variability, which is an advantage when doing modulation analysis and broadband signal analysis. The disadvantage is that, without the preselector, image signals will be displayed. Another disadvantage of bypassing the preselector is increased LO emission levels at the front panel input port.

Image responses are separated from the real signal by twice the 1st IF. For IF Paths of 10 MHz and 25 MHz, the 1st IF is 322.5 MHz, so the image response and the real signal will be separated by 645 MHz. The 1st IF will be different for other IF Path settings. When viewing a real signal and its corresponding image response in internal mixing, the image response will be to the left of the real signal.

Also, the image response and the real signal typically have the same amplitude and exhibit the same shape factor.

However, if Option FS1, Fast Sweep Capability, is enabled, the image response in the Swept SA measurement will appear lower in amplitude and have a much wider shape factor compared to the real signal.

Key Path	AMPTD Y Scale, μ W Path Control
Example	:POW:MW:PATH MPB
Dependencies	Key is blanked if current mode does not support it. Key is grayed out if mode supports it but current measurement does not support it. Key is blank unless Option MPB is present and licensed. If SCPI command sent when MPB not present, error -241, "Hardware missing; Option not installed" is generated.
Readback Text	μ W Preselector Bypass
Initial S/W Revision	A.04.00

Remote Command	[:SENSe] :POWer [:RF] :MW:PRESelector [:STATe] ON OFF 0 1 [:SENSe] :POWer [:RF] :MW:PRESelector [:STATe] ?
Example	:POW:MW:PRES OFF Bypasses the microwave preselector
Notes	The ON parameter sets the STD path (:POW:MW:PATH STD) The OFF parameter sets path MPB (:POW:MW:PATH MPB)
Preset	ON

Internal Preamp

Accesses a menu of keys that control the internal preamps. Turning on the preamp gives a better noise figure, but a poorer TOI to noise floor dynamic range. You can optimize this setting for your particular measurement.

The instrument takes the preamp gain into account as it sweeps. If you sweep outside of the range of the preamp the instrument will also account for that. The displayed result will always reflect the correct gain.

For some measurements, when the preamp is on and any part of the displayed frequency range is below the lowest frequency for which the preamp has specifications, a warning condition message appears in the status line. For example ,for a preamp with a 9 kHz lowest specified frequency: "Preamp: Accy unspec'd below 9 kHz".

Key Path	AMPTD Y Scale
Scope	Meas Global
Remote Command	[:SENSe] :POWer [:RF] :GAIN [:STATe] OFF ON 0 1 [:SENSe] :POWer [:RF] :GAIN [:STATe] ?
Dependencies	Preamp is not available on all hardware platforms. If the preamp is not present or is unlicensed, the

	key is not shown. The preamp is not available when the electronic/soft attenuator is enabled.
--	--

Couplings	The act of connecting the U7227A USB Preamplifier to one of the analyzer's USB ports will cause the Internal Preamp to be switched on. When this happens an informational message will be generated: "Internal Preamp turned on for optimal operation with USB Preamp." Note that if the Internal Preamp was already on, there will be no change to the setting, but if it was Off it will be switched On, to Full Range. Note that this same action occurs when the SA mode is selected while the USB Preamp is connected to one of the analyzer's USB ports, if it is the first time that the SA mode has run since powerup, or if the last time the SA mode was running the USB Preamp was NOT connected. Subsequently disconnecting the USB Preamp from USB does not change the Internal Preamp setting nor restore the previous setting.
Preset	OFF
State Saved	Saved in instrument state
Initial S/W Revision	Prior to A.02.00
Modified at S/W Revision	A.14.00

Key Path	AMPTD Y Scale, Internal Preamp
Scope	Meas Global
Remote Command	[:SENSe] : POWer [:RF] : GAIN : BAND LOW FULL [:SENSe] : POWer [:RF] : GAIN : BAND ?
Dependencies	Preamp is not available on all hardware platforms. If the preamp is not present or is unlicensed, the key is not shown. If a POW:GAIN:BAND FULL command is sent when a low band preamp is available, the preamp band parameter is to LOW instead of FULL, and an "Option not installed" message is generated.
Preset	LOW
State Saved	Saved in instrument state
Initial S/W Revision	Prior to A.02.00

Off

Turns the internal preamp off

Key Path	AMPTD Y Scale, Internal Preamp
Example	:POW:GAIN OFF
Readback	Off
Initial S/W Revision	Prior to A.02.00

Low Band

Sets the internal preamp to use only the low band.

The frequency range of the installed (optional) low-band preamp is displayed in square brackets on the Low Band key label.

Key Path	AMPTD Y Scale, Internal Preamp
Example	:POW:GAIN ON :POW:GAIN:BAND LOW
Readback	Low Band
Initial S/W Revision	Prior to A.02.00

Full Range

Sets the internal preamp to use its full range. The low band (0–3.6 GHz or 0–3GHz, depending on the model) is supplied by the low band preamp and the frequencies above low band are supplied by the high band preamp.

The frequency range of the installed (optional) preamp is displayed in square brackets on the Full Range key label. If the high band option is not installed the Full Range key does not appear.

Key Path	AMPTD Y Scale, Internal Preamp
Example	:POW:GAIN ON :POW:GAIN:BAND FULL
Readback	Full Range
Initial S/W Revision	Prior to A.02.00

Ref Position

Positions the reference level at the top, center or bottom of the Y Scale display. Changing the reference position does not change the reference level value.

Key Path	AMPTD Y Scale
Mode	SA, WCDMA, C2K, WIMAX OFDMA, TD-SCDMA, 1xEVDO, ISDB-T, CMMB, LTE, LTE-TDD, BLUETOOTH, WLAN, MSR, LTEAFDD, LTEATDD
Remote Command	:DISPlay:OBWidth:VIEW[1]:WINDow[1]:TRACe:Y[:SCALE]:RPOSition TOP CENTER BOTTom :DISPlay:OBWidth:VIEW[1]:WINDow[1]:TRACe:Y[:SCALE]:RPOSition?
Example	DISP:OBW:VIEW:WIND:TRAC:Y:RPOS BOTT DISP:OBW:VIEW:WIND:TRAC:Y:RPOS?
Notes	You must be in the Spectrum Analysis mode, W-CDMA mode, cdma2000 mode, TD-SCDMA mode, ISDB-T mode, CMMB mode, LTE mode, LTE TDD mode, BLUETOOTH mode, WLAN mode, 1xEVDO mode, MSR, LTE-Advanced FDD/TDD or WIMAX OFDMA mode to use this command.

	Use:INSTRument:SElect to set the mode.
Preset	TOP
State Saved	Saved in instrument state.
Range	Top Ctr Bot
Initial S/W Revision	Prior to A.02.00
Modified at S/W Revision	A.03.00

Auto Scaling

Allows you to toggle the Auto Scaling function between On and Off.

Key Path	AMPTD Y Scale
Mode	SA, WCDMA, C2K, WIMAX OFDMA, TD-SCDMA, 1xEVDO, ISDB-T, CMMB, LTE, LTETDD, BLUETOOTH, WLAN, MSR, LTEAFDD, LTEATDD
Remote Command	:DISPlay:OBWidth:VIEW[1]:WINDow[1]:TRACe:Y[:SCALe]:COUPle 0 1 OFF ON :DISPlay:OBWidth:VIEW[1]:WINDow[1]:TRACe:Y[:SCALe]:COUPle?
Example	DISP:OBW:VIEW:WIND:TRAC:Y:COUP ON DISP:OBW:VIEW:WIND:TRAC:Y:COUP?
Couplings	When Auto Scaling is On, upon pressing the Restart front-panel key, this function automatically sets the scale per division to 10 dB and determines reference values based on the measurement results. When you set a value to either Scale/Div or Ref Value manually, Auto Scaling automatically changes to Off.
Preset	1
State Saved	Saved in instrument state.
Range	On Off
Initial S/W Revision	Prior to A.02.00
Modified at S/W Revision	A.03.00

Auto Couple

The Auto Couple feature provides a quick and convenient way to automatically couple multiple instrument settings. This helps ensure accurate measurements and optimum dynamic range. When the Auto Couple feature is activated, either from the front panel or remotely, all parameters of the current measurement that have an Auto/Manual mode are set to Auto mode and all measurement settings dependent on (or coupled to) the Auto/Man parameters are automatically adjusted for optimal performance.

However, the Auto Couple key actions are confined to the current measurement only. It does not affect other measurements in the mode, and it does not affect markers, marker functions, or trace or display attributes.

See "[More Information](#)" on page 1299

Key Path	Front-panel key
Remote Command	:COUPle ALL NONE
Example	:COUP ALL
Notes	:COUPle ALL puts all Auto/Man parameters in Auto mode (equivalent to pressing the Auto Couple key). :COUPLE NONE puts all Auto/Man parameters in manual mode. It decouples all the coupled instrument parameters and is not recommended for making measurements.
Initial S/W Revision	Prior to A.02.00

More Information

There are two types of functions that have Auto/Manual modes.

Auto/Man Active Function keys

An Auto/Man toggle key controls the binary state associated with an instrument parameter by toggling between Auto (where the parameter is automatically coupled to the other parameters it is dependent upon) and Man (where the parameter is controlled independent of the other parameters), as well as making the parameter the active function. The current mode is indicated on the softkey with either Auto or Man underlined as illustrated below.



Auto/Man 1-of-N keys

An Auto/Man 1-of-N key allows you to manually pick from a list of parameter values, or place the function in Auto, in which case the value is automatically selected (and indicated) as shown below. If in Auto, Auto is underlined on the calling key. If in manual operation, manual is indicated on the calling key. But the calling key does not actually toggle the function, it simply opens the menu.

12 Occupied Bandwidth Measurement
Auto Couple

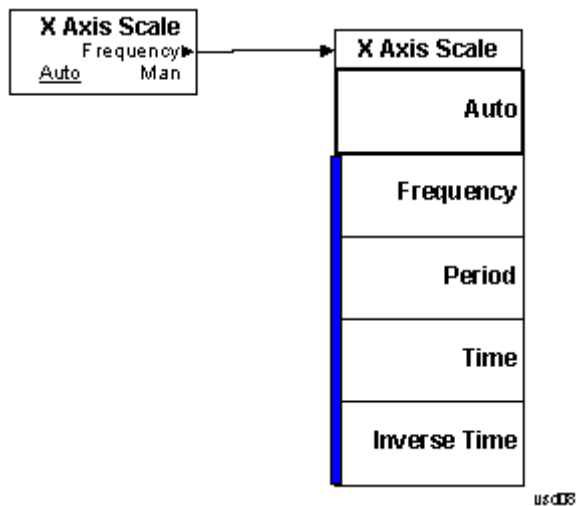

BW

Accesses a menu of functions that enable you to specify and control the video and resolution bandwidths. You can also select the type of filter for the measurement.

Key Path	Front-panel key
Initial S/W Revision	Prior to A.02.00

Res BW

Sets the resolution bandwidth for the current measurement. If an unavailable bandwidth is entered with the numeric keypad, the closest available bandwidth is selected.

Key Path	BW
Mode	SA, WCDMA, C2K, WIMAX OFDMA, TD-SCDMA, 1xEVDO, ISDB-T, CMMB, LTE, LTETDD, BLUETOOTH, WLAN, MSR, LTEAFDD, LTEATDD
Remote Command	[:SENSe]:OBWidth:BANDwidth[:RESolution] <bandwidth> [:SENSe]:OBWidth:BANDwidth[:RESolution]? [:SENSe]:OBWidth:BANDwidth[:RESolution]:AUTO ON OFF 1 0 [:SENSe]:OBWidth:BANDwidth[:RESolution]:AUTO?
Example	OBW:BAND 250000 OBW:BAND? OBW:BAND:AUTO OFF OBW:BAND:AUTO?
Notes	You must be in the Spectrum Analysis mode, W-CDMA mode, cdma2000 mode, TD-SCDMA mode, ISDB-T mode, CMMB mode, LTE mode, LTE TDD mode, BLUETOOTH mode, WLAN mode, 1xEVDO mode, MSR, LTE-Advanced FDD/TDD or WIMAX OFDMA mode to use this command. Use:INSTRument:SElect to set the mode.
Couplings	Sweep time is coupled to RBW. As the RBW changes, the sweep time (if set to Auto) is changed to maintain amplitude calibration. Video bandwidth (VBW) is coupled to RBW. As the resolution bandwidth changes, the video bandwidth (if set to Auto) changes to maintain the ratio of VBW/RBW (10:1). When Res BW is set to Auto, the resolution bandwidth is auto-coupled to span. The ratio of Span/RBW is approximately 106:1 when auto coupled. When Res BW is set to Man, bandwidths are entered manually, and these bandwidths are used regardless of other analyzer settings.
Preset	SA: Auto WCDMA: 30 kHz CDMA2K: 12 kHz WIMAX OFDMA: 100 kHz TD-SCDMA: 30 kHz 1xEVDO: 30 kHz ISDB-T: 10 kHz

	CMMB: 3 kHz LTE: 30 kHz LTETDD: 30 kHz BLUETOOTH:10 kHz WLAN: 100kHz MSR: 30 kHz, LTEAFDD, LTEATDD: 30 kHz SA: ON WCDMA, C2K, TD-SCDMA, WIMAX OFDMA, 1xEVDO , ISDB-T, CMMB, LTE, LTETDD, WLAN, MSR, LTEAFDD, LTEATDD: OFF
State Saved	Saved in instrument state.
Min	1 Hz
Max	8 MHz
Backwards Compatibility SCPI	[:SENSe] :OBWidth:BWIDth[:RESolution]
Initial S/W Revision	Prior to A.02.00
Modified at S/W Revision	A.03.00

Video BW

Changes the analyzer post-detection filter.

Key Path	BW
Mode	SA, WCDMA, C2K, WIMAX OFDMA, TD-SCDMA, 1xEVDO, ISDB-T, CMMB, LTE, LTETDD, BLUETOOTH, WLAN, MSR, LTEAFDD, LTEATDD
Remote Command	<pre>[:SENSe] :OBWidth:BA^NDwidth:VIDeo <bandwidth> [:SENSe] :OBWidth:BA^NDwidth:VIDeo? [:SENSe] :OBWidth:BA^NDwidth:VIDeo:AUTO ON OFF 1 0 [:SENSe] :OBWidth:BA^NDwidth:VIDeo:AUTO?</pre>
Example	<pre>OBW:BA^ND:VID 5 MHz OBW:BA^ND:VID? OBW:BA^ND:VID:AUTO ON OBW:BA^ND:VID:AUTO?</pre>
Notes	You must be in the Spectrum Analysis mode, W-CDMA mode, cdma2000 mode, TD-SCDMA mode, ISDB-T mode, CMMB mode, LTE mode, LTE TDD mode, BLUETOOTH mode, WLAN mode, 1xEVDO mode, MSR, LTE-Advanced FDD/TDD or WIMAX OFDMA mode to use this command. Use:INSTrument:SElect to set the mode.
Dependencies	When using the average detector with either Sweep Time set to Man, or in zero span, the VBW setting has no effect and is disabled (grayed out).
Couplings	Video bandwidth (VBW) is coupled to RBW. As the resolution bandwidth changes, the video bandwidth (if set to Auto) changes to maintain the ratio set by VBW/RBW.

Sweep Time is coupled to Video Bandwidth (VBW). As the VBW is changed, the sweep time (when set to Auto) is changed to maintain amplitude calibration. This occurs because of common hardware between the two circuits, even though the Video BW filter is not actually “in-circuit” when the detector is set to Average. Because the purpose of the average detector and the VBW filter are the same, either can be used to reduce the variance of the result.

Although the VBW filter is not “in-circuit” when using the average detector, the Video BW key can have an effect on (Auto) sweep time, and is not disabled. In this case, reducing the VBW setting increases the sweep time, which increases the averaging time, producing a lower-variance trace.

When the video bandwidth is AUTO coupled, the video bandwidth value is set to:

Resolution Bandwidth * Video Bandwidth to Resolution Bandwidth Ratio

Preset	SA, LTE, LTETDD, WLAN, MSR, LTEAFDD, LTEATDD: Auto WCDMA: 300 kHz CDMA2K:120 kHz WIMAX OFDMA: 1 MHz TD-SCDMA: 300 kHz 1xEVDO: 300 kHz ISDB-T: 300 Hz CMMB: 3 kHz BLUETOOTH: 30 kHz ON ISDB-T, CMMB: OFF
State Saved	Saved in instrument state.
Min	1 Hz
Max	50 MHz
Backwards Compatibility SCPI	[:SENSe] :OBwidth :BWIDth :VIDeo
Initial S/W Revision	Prior to A.02.00
Modified at S/W Revision	A.03.00

Filter Type

Allows you to select the type of filter to be used for the current measurement. Besides the Gaussian filter shape, there are certain special filter types, such as Flat Top, that are desirable under certain conditions.

Key Path	BW
Mode	SA, WCDMA, C2K, WIMAX OFDMA, TD-SCDMA, 1xEVDO, ISDB-T, CMMB, LTE, LTETDD, BLUETOOTH, WLAN, MSR, LTEAFDD, LTEATDD
Remote Command	[:SENSe] :OBwidth :BANDwidth :SHAPE GAUSSian FLATtop [:SENSe] :OBwidth :BANDwidth :SHAPE?
Example	OBW:BAND:SHAP GAUS

	OBW:BAND:SHAP?
Preset	GAUSSian
State Saved	Saved in instrument state.
Range	Gaussian Flattop
Backwards Compatibility SCPI	[:SENSe] :OBWidth:BWIDth:SHAPE
Initial S/W Revision	Prior to A.02.00
Modified at S/W Revision	A.03.00

Cont (Continuous Measurement/Sweep)

Sets the analyzer for Continuous measurement operation. The single/continuous state is Meas Global so the setting will affect all measurements. If you are Paused, pressing Cont does a Resume.

Key Path	Front-panel key
Remote Command	:INITiate:CONTinuous OFF ON 0 1 :INITiate:CONTinuous?
Example	:INIT:CONT 0 puts analyzer in Single measurement operation. :INIT:CONT 1 puts analyzer in Continuous measurement operation
Preset	ON (Note that SYST:PRESet sets INIT:CONT to ON but *RST sets INIT:CONT to OFF)
State Saved	Saved in instrument state
Backwards Compatibility Notes	For Spectrum Analysis mode in ESA and PSA, there is no Cont hardkey, instead there is a Sweep Single/Cont key. In these analyzers, switching the Sweep Single/Cont key from Single to Cont restarts averages (displayed average count reset to 1), but does not restart Max Hold and Min Hold. The X-Series has Single and Cont keys in place of the SweepSingleCont key. In the X-Series, if in single measurement, the Cont key (and INIT:CONT ON) switches to continuous measurement, but never restarts a measurement and never resets a sweep.
Initial S/W Revision	Prior to A.02.00

In Swept SA Measurement (Spectrum Analysis Mode):

The analyzer takes repetitive sweeps, averages, measurements, etc., when in Continuous mode. When the average count reaches the Average/Hold Number the count stops incrementing, but the analyzer keeps sweeping. See the Trace/Detector section for the averaging formula used both before and after the Average/Hold Number is reached. The trigger condition must be met prior to each sweep. The type of trace processing for multiple sweeps, is set under the Trace/Detector key, with choices of Trace Average, Max Hold, or Min Hold.

In Other Measurements/Modes:

With Avg/Hold Num (in the Meas Setup menu) set to Off or set to On with a value of 1, a sweep is taken after the trigger condition is met; and the analyzer continues to take new sweeps after the current sweep has completed and the trigger condition is again met. However, with Avg/Hold Num set to On with a value >1, multiple sweeps (data acquisitions) are taken for the measurement. The trigger condition must be met prior to each sweep. The sweep is not stopped when the average count k equals the number N set for Avg/Hold Num is reached, but the number k stops incrementing. A measurement average usually applies to all traces, marker results, and numeric results. But sometimes it only applies to the numeric results.

If the analyzer is in Single measurement, pressing the Cont key does not change k and does not cause the sweep to be reset; the only action is to put the analyzer into Continuous measurement operation.

If it is already in continuous sweep:

the INIT:CONT 1 command has no effect

12 Occupied Bandwidth Measurement
Cont (Continuous Measurement/Sweep)

the INIT:CONT 0 command will place the analyzer in Single Sweep but will have no effect on the current sequence until $k = N$, at which point the current sequence will stop and the instrument will go to the idle state.

File

See "File" on page 336

FREQ Channel

Accesses a menu of keys that allow you to control the Frequency and Channel parameters of the instrument.

Some features in the Frequency menu are the same for all measurements – they do not change as you change measurements. Settings like these are called “Meas Global” and are unaffected by Meas Preset. For example, the Center Freq setting is the same for all measurements - it does not change as you change measurements.

Key Path	Front-panel key
Initial S/W Revision	Prior to A.02.00

Center Freq

Sets the frequency that corresponds to the horizontal center of the graticule (when frequency Scale Type is set to linear). While adjusting the Center Frequency the Span is held constant, which means that both Start Frequency and Stop Frequency will change.

Pressing Center Freq also sets the frequency entry mode to Center/Span. In Center/Span mode, the center frequency and span values are displayed below the graticule, and the default active function in the Frequency menu is Center Freq.

The center frequency setting is the same for all measurements within a mode, that is, it is Meas Global. Some modes are also able to share a Mode Global center frequency value. If this is the case, the Mode will have a Global Settings key in its Mode Setup menu.

The Center Freq function sets (and queries) the Center Frequency for the currently selected input. If your analyzer has multiple inputs, and you select another input, the Center Freq changes to the value for that input. SCPI commands are available to directly set the Center Freq for a specific input.

Center Freq is remembered as you go from input to input. Thus you can set a Center Freq of 10 GHz with the RF Input selected, change to BBIQ and set a Center Freq of 20 MHz, then switch to External Mixing and set a Center Freq of 60 GHz, and when you go back to the RF Input the Center Freq will go back to 10 GHz; back to BBIQ and it is 20 MHz; back to External Mixing and it is 60 GHz.

See ["RF Center Freq" on page 1311](#)

See [Ext Mix Center Freq](#)

See ["I/Q Center Freq" on page 1313](#)

See ["Center Frequency Presets" on page 1309](#)

Key Path	FREQ Channel
Scope	Meas Global
Remote Command	<code>[:SENSe] :FREQuency:CENTer <freq></code> <code>[:SENSe] :FREQuency:CENTer?</code>

Example	FREQ:CENT 50 MHz FREQ:CENT UP changes the center frequency to 150 MHz if you use FREQ:CENT:STEP 100 MHz to set the center frequency step size to 100 MHz FREQ:CENT?
Notes	This command sets either the RF or I/Q Center Frequency depending on the selected input. For RF input it is equivalent to FREQ:RF:CENT For I/Q input it is equivalent to FREQ:IQ:CENT Preset and Max values are dependent on Hardware Options (5xx) If no terminator (e.g. MHz) is sent the terminator Hz is used. If a terminator with unit other than Frequency is used, an invalid suffix error message is generated.
Dependencies	The Center Frequency can be limited by Start or Stop Freq limits, if the Span is so large that Start or Stop reach their limit.
Couplings	When operating in “swept span”, any value of the Center Frequency or Span that is within the frequency range of the analyzer is allowed when the value is being set through the front panel numeric key pad or the SCPI command. The other parameter is forced to a different value if needed, to keep the Start and the Stop Frequencies within the analyzer’s frequency range
Preset	Depends on instrument maximum frequency, mode, measurement, and selected input. See "Center Frequency Presets" on page 1309 and "RF Center Freq" on page 1311 and Ext Mix Center Freq and "I/Q Center Freq" on page 1313 .
State Saved	Saved in instrument state
Min	Depends on instrument maximum frequency, mode, measurement, and selected input.. See "Center Frequency Presets" on page 1309 and "RF Center Freq" on page 1311 and "I/Q Center Freq" on page 1313 .
Max	Depends on instrument maximum frequency, mode, measurement, and selected input.. See "Center Frequency Presets" on page 1309 and "RF Center Freq" on page 1311 and "I/Q Center Freq" on page 1313 .
Default Unit	Hz
Status Bits/OPC	Non-overlapped
Dependencies	
Initial S/W Revision	Prior to A.02.00

Center Frequency Presets

The following table provides the Center Frequency Presets for the Spectrum Analyzer mode, and the Max Freq, for the various frequency options:

Freq Option	CF after Mode Preset	Stop Freq after Mode Preset	Max Freq (can't tune)

12 Occupied Bandwidth Measurement
FREQ Channel

			above)
503 (all but N9000A)	1.805 GHz	3.6 GHz	3.7 GHz
503 (N9000A)	1.505 GHz	3.0 GHz	3.08 GHz
507 (all but N9000A)	3.505 GHz	7.0 GHz	7.1 GHz
507 (N9000A)	3.755 GHz	7.5 GHz	7.58 GHz
508 (all but N9038A)	1.805 GHz	3.6 GHz	8.5 GHz
508 (N9038A)	4.205 GHz	8.4 GHz	8.5 GHz
513	6.805 GHz	13.6 GHz	13.8 GHz
526 (all but N9000A and N9038A)	13.255 GHz	26.5 GHz	27.0 GHz
526 (N9000A)	13.255 GHz	26.5 GHz	26.55 GHz
526 (N9038A)	1.805 GHz	3.6 GHz	27.0 GHz
532	16.005 GHz	32.0 GHz	32.5 GHz
543	21.505 GHz	43.0 GHz	TBD
544	22.005 GHz	44.0 GHz	44.5 GHz
550	25.005 GHz	50.0 GHz	51 GHz

Input 2:

Model	CF after Mode Preset	Stop Freq after Mode Preset	Max Freq (can't tune above)
N9000A opt C75	0.7505GHz	1.5 GHz	1.58 GHz
N9038A	505 MHz	1 GHz	1.000025 GHz

Tracking Generator Frequency Limits (N9000A only):

Tracking Generator Option	Min Freq (clips to this freq when turn TG on and	If above this Freq, Stop Freq clipped to this Freq when	Max Freq (can't tune above) while TG

	can't tune below while TG on)	TG turned on	on
T03	9 kHz	3.0 GHz	3.08 GHz
T06	9 kHz	6.0 GHz	6.05 GHz

The following table shows the Center Frequency Presets for modes other than Spectrum Analyzer:

Mode	CF Preset for RF
WCDMA	1 GHz
WIMAXOFDMA,	1 GHz
BASIC	1 GHz
ADEMOD	1 GHz
VSA	1 GHz
TDSCDMA	1 GHz
PNOISE	1 GHz
LTE	1 GHz
LTETDD	1 GHz
MSR	1 GHz
GSM	935.2 MHz
NFIGURE	1.505 GHz

RF Center Freq

SCPI command for specifying the RF Center Frequency. This command will set the Center Frequency to be used when the RF input is selected, even if the RF input is not the input that is selected at the time the command is sent. Note that the Center Freq function in the Frequency menu on the front panel always applies to the currently selected input.

Scope	Meas Global
Remote Command	<code>[:SENSe] :FREQuency:RF:CENTer <freq></code> <code>[:SENSe] :FREQuency:RF:CENTer?</code>
Example	FREQ:RF:CENT 30 MHz
Notes	This command is the same in all modes, but the parameter is Measurement Global. So the value is independent in each mode and common across all the measurements in the mode.
Dependencies	If the electronic/soft attenuator is enabled, any attempt to set Center Frequency such that the Stop Frequency would be >3.6 GHz fails and results in an advisory message. If the equivalent SCPI command is sent, this same message is generated as part of a “-221, Settings conflict” warning. If Source Mode is set to Tracking, and the Max or Min Center Freq is therefore limited by the limits of the source, a warning message is generated, “Data out of range;clipped to source max/min” if these limits are exceeded. Note that for an external source, these limits can be affected by the settings of

	Source Numerator, Source Denominator and Power Sweep.
Preset	See table above
State Saved	Saved in instrument state.
Min	-79.999995 MHz, unless Source Mode is set to Tracking, in which case it is limited by the minimum frequency of the Source
Max	See table above. Basically instrument maximum frequency – 5 Hz. Note that, if the Source Mode is set to Tracking, the effective instrument maximum frequency may be limited by the source maximum frequency. If the knob or step keys are being used, also depends on the value of the other three interdependent parameters Span, Start Frequency and Stop Frequency
Initial S/W Revision	Prior to A.02.00
Modified at S/W Revision	A.03.00

Ext Mix Center Freq

SCPI command for specifying the External Mixer Center Frequency. This command will set the Center Frequency to be used when the External Mixer is selected, even if the External Mixer input is not the input which is selected at the time the command is sent. Note that the Center Freq function in the Frequency menu on the front panel always applies to the currently selected input.

Scope	Meas Global
Remote Command	<code>[:SENSe] :FREQuency:EMIXer:CENTer <freq></code> <code>[:SENSe] :FREQuency:EMIXer:CENTer?</code>
Example	<code>:FREQ:EMIX:CENT 60 GHz</code> <code>:FREQ:EMIX:CENT?</code>
Notes	This command is the same in all modes, but the parameter is Measurement Global. So the value is independent in each mode and common across all the measurements in the mode.
Couplings	When returning to External Mixing after having been switched to one of the other inputs (e.g., RF), you will come back into the settings that you had when you left External Mixing. So you will come back to the band you were in with the Center Frequency that you had. However, Span is not an input-dependent parameter, therefore you will bring the span over from the other input. Therefore, the analyzer comes back with the span from the previous input, limited as necessary by the current mixer setup.
Preset	When a Mode Preset is performed while in External Mixing, the Start frequency of the current Mode is set to the nominal Min Freq of the lowest harmonic range in the Harmonic Table for the current mixer setup. Similarly, the Stop frequency of the current Mode is set to the nominal Max Freq of the highest harmonic range in the Harmonic Table. The Center Freq thus presets to the point arithmetically equidistant from these two frequencies. If the current measurement has a limited Span available to it, and cannot achieve the Span shown in the table (Span=Stop Freq – Start Freq), the analyzer uses the maximum Span the measurement allows, and still sets the Center Freq to the midpoint of the Start and Stop Freq values in the Harmonic Table.

	When Restore Input/Output Defaults is performed, the mixer presets to the 11970A, whose Start and Stop frequencies are 26.5 and 40 GHz respectively. The center of these two frequencies is 33.25 GHz. Therefore, after a Restore Input/Output Defaults, if you go into External Mixing and do a Mode Preset while in the Spectrum Analyzer Mode, the resulting Center Freq is 33.25 GHz.
State Saved	Saved in instrument state.
Min	The minimum frequency in the currently selected mixer band + 5 Hz
Max	The maximum frequency in the currently selected mixer band – 5 Hz If the knob or step keys are being used, also depends on the value of the other three interdependent parameters Span, Start Frequency and Stop Frequency
Initial S/W Revision	A.08.01

I/Q Center Freq

SCPI command for specifying the I/Q Center Frequency. This command will set the Center Frequency to be used when the I/Q input is selected, even if the I/Q input is not the input which is selected at the time the command is sent. Note that the Center Freq function in the Frequency menu on the front panel always applies to the currently selected input.

Scope	Meas Global
Remote Command	[:SENSe] :FREQuency:IQ:CENTer <freq> [:SENSe] :FREQuency:IQ:CENTer?
Example	FREQ:IQ:CENT: 30 MHz
Notes	This command is the same in all modes, but the parameter is Measurement Global. So the value is independent in each mode and common across all the measurements in the mode.
Preset	0 Hz
State Saved	Saved in instrument state.
Min	-40.049995 MHz
Max	40.049995 MHz
Initial S/W Revision	Prior to A.02.00

12 Occupied Bandwidth Measurement
Input/Output

Input/Output

See "[Input/Output](#)" on page 196

Marker

Accesses a menu that enables you to select, set up and control the markers for the current measurement.

Key Path	Front-panel key
Initial S/W Revision	Prior to A.02.00

Select Marker

Displays the menu keys that enable you to select, set up and control the markers for the current measurement

Key Path	Marker
Initial S/W Revision	Prior to A.02.00

Select Marker

Displays 12 markers available for selection.

Key Path	Marker, Properties
Initial S/W Revision	Prior to A.02.00

Marker Type

Sets the marker control mode to Normal, Delta or Off, If the selected marker is Off, pressing Marker sets it to Normal and places a single marker at the center of the display. At the same time, Marker X Axis Value appears on the Active Function area.

Key Path	Marker
Mode	SA, WCDMA, C2K, WIMAX OFDMA, TD-SCDMA, 1xEVDO, ISDB-T, CMMB, LTE, LTETDD, BLUETOOTH, WLAN, MSR, LTEAFDD, LTEATDD
Remote Command	:CALCulate:OBWidth:MARKer[1] 2 ... 12:MODE POSition DELTa OFF :CALCulate:OBWidth:MARKer[1] 2 ... 12:MODE?
Example	CALC:OBW:MARK:MODE POS CALC:OBW:MARK:MODE?
Notes	If the selected marker is Off, pressing Marker sets it to Normal and places it at the center of the screen on the trace determined by the Marker Trace rules. At the same time, Marker X Axis Value appears on the Active Function area. Default Active Function: the active function for the selected marker's current control mode. If the current control mode is Off, there is no active function and the active function is turned off. Active Function Display: the marker X axis value entered in the active function area displays the marker value to its full entered precision.

Preset	OFF
State Saved	Saved in instrument state.
Range	Normal Delta Off
Initial S/W Revision	Prior to A.02.00
Modified at S/W Revision	A.03.00

Properties

Accesses the marker properties menu.

Key Path	Marker
Initial S/W Revision	Prior to A.02.00

Select Marker

Displays the menu keys that enable you to select, set up and control the markers for the current measurement

Key Path	Marker
Initial S/W Revision	Prior to A.02.00

Select Marker

Displays 12 markers available for selection.

Key Path	Marker, Properties
Initial S/W Revision	Prior to A.02.00

Relative To

Selects the desired marker. The selected marker will be relative to its reference marker.

Key Path	Marker, Properties
Mode	SA, WCDMA, C2K, WIMAX OFDMA, TD-SCDMA, 1xEVDO, ISDB-T, CMMB, LTE, LTETDD, BLUETOOTH, WLAN, MSR, LTEAFDD, LTEATDD
Remote Command	:CALCulate:OBWidth:MARKer[1] 2 ... 12:REFerence <integer> :CALCulate:OBWidth:MARKer[1] 2 ... 12:REFerence?
Example	CALC:OBW:MARK:REF 2

	CALC:OBW:MARK:REF?
Notes	A marker cannot be relative to itself so that choice is grayed out, and if sent from SCPI generates error -221: "Settings conflict; marker cannot be relative to itself." When queried a single value is returned (the specified marker numbers relative marker). You must be in the Spectrum Analysis mode, WCDMA mode, TD-SCDMA mode, 1xEVDO mode, WIMAX OFDMA mode ISDB-T mode, WLAN mode, CMMB mode, LTE mode, LTETDD mode or BLUETOOTH mode to use this command. Use:INSTrument:SElect to set the mode.
Preset	2 3 4 5 6 7 8 9 10 11 12 1
State Saved	Saved in instrument state.
Min	1
Max	12
Readback	Current selected relative to marker number.
Initial S/W Revision	Prior to A.02.00
Modified at S/W Revision	A.03.00

All Markers Off

Turns off all markers.

Key Path	Marker
Mode	SA, WCDMA, C2K, WIMAX OFDMA, TD-SCDMA, 1xEVDO, ISDB-T, CMMB, LTE, LTETDD, BLUETOOTH, WLAN, MSR, LTEAFDD, LTEATDD
Remote Command	:CALCulate:OBWidth:MARKer:AOff
Example	CALC:OBW:MARK:AOff
Initial S/W Revision	Prior to A.02.00
Modified at S/W Revision	A.03.00

Marker X Axis Value (Remote Command Only)

Sets the marker X Axis value in the current marker X Axis Scale unit. It has no effect if the control mode is Off.

Key Path	SCPI only
Mode	SA, WCDMA, C2K, WIMAX OFDMA, TD-SCDMA, 1xEVDO, ISDB-T, CMMB, LTE, LTETDD, BLUETOOTH, WLAN, MSR, LTEAFDD, LTEATDD
Remote Command	:CALCulate:OBWidth:MARKer[1] 2 ... 12:X <freq> :CALCulate:OBWidth:MARKer[1] 2 ... 12:X?
Example	CALC:OBW:MARK3:X 0 CALC:OBW:MARK3:X?
Notes	The query returns the marker's absolute X Axis value if the control mode is Normal, or the offset from

	the marker's reference marker if the control mode is Delta. The query is returned in the fundamental units for the current marker X Axis scale: Hz for Frequency.
Preset	After a preset, all markers are turned OFF, so Marker X Axis Value query returns a not a number (NAN).
State Saved	No
Min	-9.9E+37
Max	9.9E+37
Initial S/W Revision	Prior to A.02.00
Modified at S/W Revision	A.03.00

Marker X Axis Position (Remote Command Only)

Sets the marker X position in trace points. It has no effect if the control mode is Off.

Key Path	SCPI only
Mode	SA, WCDMA, C2K, WIMAX OFDMA, TD-SCDMA, 1xEVDO, ISDB-T, CMMB, LTE, LTETDD, BLUETOOTH, WLAN, MSR, LTEAFDD, LTEATDD
Remote Command	:CALCulate:OBWidth:MARKer[1] 2 ... 12:X:POSition <real> :CALCulate:OBWidth:MARKer[1] 2 ... 12:X:POSition?
Example	CALC:OBW:MARK10:X:POS 0 CALC:OBW:MARK10:X:POS?
Notes	The query returns the marker's absolute X Axis value in trace points if the control mode is Normal, or the offset from the marker's reference marker in trace points if the control mode is Delta.
Preset	After a preset, all markers are turned OFF, so Marker X Axis Value query returns a not a number (NAN).
State Saved	No
Min	-9.9E+37
Max	9.9E+37
Initial S/W Revision	Prior to A.02.00
Modified at S/W Revision	A.03.00

Marker Y Axis Value (Remote Command Only)

Returns the marker Y Axis value in the current marker Y Axis unit.

Key Path	SCPI only
Mode	SA, WCDMA, C2K, WIMAX OFDMA, TD-SCDMA, 1xEVDO, ISDB-T, CMMB, LTE, LTETDD, BLUETOOTH, WLAN, MSR, LTEAFDD, LTEATDD
Remote Command	:CALCulate:OBWidth:MARKer[1] 2 ... 12:Y?

Example	CALC:OBW:MARK11:Y?
Preset	Result dependent on Markers setup and signal source.
State Saved	No
Min	-9.9E+37
Max	9.9E+37
Initial S/W Revision	Prior to A.02.00
Modified at S/W Revision	A.03.00

Backward Compatibility SCPI Commands

Sets or queries the state of a marker. Setting a marker which is OFF to state ON or 1 puts it in Normal mode and places it at the center of the screen.

Key Path	SCPI only
Mode	SA, WCDMA, C2K, WIMAX OFDMA, TD-SCDMA, 1xEVDO, ISDB-T, CMMB, LTE, LTETDD, BLUETOOTH, WLAN, MSR, LTEAFDD, LTEATDD
Remote Command	:CALCulate:OBWidth:MARKer[1] 2 ... 12:STATe OFF ON 0 1 :CALCulate:OBWidth:MARKer[1] 2 ... 12:STATe?
Example	CALC:OBW:MARK3:STAT ON CALC:OBW:MARK3:STAT?
Preset	OFF
State Saved	Saved in instrument state.
Initial S/W Revision	Prior to A.02.00
Modified at S/W Revision	A.03.00

Marker Function

There are no 'Marker Functions' supported in this measurement. When pressed, this key displays a blank menu.

Key Path	Front panel key
Initial S/W Revision	Prior to A.02.00

Marker To

There is no 'Marker To' functionality supported in this measurement. When pressed, this key displays a blank menu.

Key Path	Front panel key
Initial S/W Revision	Prior to A.02.00

Meas

The information in this section is common to all measurements. For key and remote command information for a specific measurement, refer to the section that describes the measurement of interest.

Measurements available under the Meas key are specific to the current Mode.

When viewing Help for measurements, note the following:

NOTE

Operation for some keys differs between measurements. The information displayed in Help pertains to the current measurement. To see how a key operates in a different measurement, exit Help (press the Cancel Esc key), select the measurement, then reenter Help (press the Help key) and press that key.

Key Path	Front-panel key
Initial S/W Revision	Prior to A.02.00

Remote Measurement Functions

This section contains the following topics:

["Measurement Group of Commands" on page 2206](#)

["Current Measurement Query \(Remote Command Only\) " on page 2208](#)

["Limit Test Current Results \(Remote Command Only\)" on page 2208](#)

["Data Query \(Remote Command Only\)" on page 2208](#)

["Calculate/Compress Trace Data Query \(Remote Command Only\)" on page 2209](#)

["Calculate Peaks of Trace Data \(Remote Command Only\)" on page 2214](#)

[Hardware-Accelerated Fast Power Measurement \(Remote Command Only\)](#)

["Format Data: Numeric Data \(Remote Command Only\)" on page 2215](#)

["Format Data: Byte Order \(Remote Command Only\)" on page 2216](#)

Initial S/W Revision	Prior to A.02.00
----------------------	------------------

Measurement Group of Commands

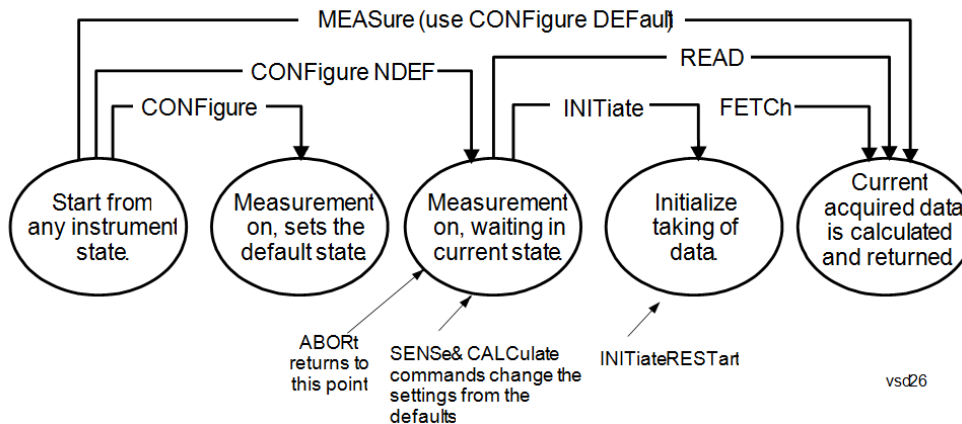

Measure Commands:

:MEASure:<measurement>[n]?

This is a fast single-command way to make a measurement using the factory default instrument settings. These are the settings and units that conform to the Mode Setup settings (e.g. radio standard) that you have currently selected.

- Stops the current measurement (if any) and sets up the instrument for the specified measurement using the factory defaults
- Initiates the data acquisition for the measurement
- Blocks other SCPI communication, waiting until the measurement is complete before returning results.
- If the function does averaging, it is turned on and the number of averages is set to 10.
- After the data is valid it returns the scalar results, or the trace data, for the specified measurement. The type of data returned may be defined by an [n] value that is sent with the command.
- The scalar measurement results will be returned if the optional [n] value is not included, or is set to 1. If the [n] value is set to a value other than 1, the selected trace data results will be returned. See each command for details of what types of scalar results or trace data results are available.
- ASCII is the default format for the data output. (Older versions of Spectrum Analysis and Phase Noise mode measurements only use ASCII.) The binary data formats should be used for handling large blocks of data since they are smaller and faster than the ASCII format. Refer to the FORMat:DATA command for more information.

If you need to change some of the measurement parameters from the factory default settings you can set up the measurement with the CONFigure command. Use the commands in the SENSe:<measurement> and CALCulate:<measurement> subsystems to change the settings. Then you can use the READ? command to initiate the measurement and query the results.

If you need to repeatedly make a given measurement with settings other than the factory defaults, you can use the commands in the SENSe:<measurement> and CALCulate:<measurement> subsystems to set up the measurement. Then use the READ? command to initiate the measurement and query results.

Measurement settings persist if you initiate a different measurement and then return to a previous one. Use READ:<measurement>? if you want to use those persistent settings. If you want to go back to the default settings, use MEASure:<measurement>?.

Configure Commands:

:CONFigure:<measurement>

This command stops the current measurement (if any) and sets up the instrument for the specified measurement using

the factory default instrument settings. It does not initiate the taking of measurement data unless INIT:CONTinuous is ON. If you change any measurement settings after using the CONFigure command, the READ command can be used to initiate a measurement without changing the settings back to their defaults.

In the Swept SA measurement in Spectrum Analyzer mode the CONFigure command also turns the averaging function on and sets the number of averages to 10 for all measurements.

:CONFigure: <measurement>: NDEFault stops the current measurement and changes to the specified measurement. It does not change the settings to the defaults. It does not initiate the taking of measurement data unless INIT:CONTinuous is ON.

The CONFigure? query returns the current measurement name.

The CONFigure:CATalog? query returns a quoted string of all licensed measurement names in the current mode. For example, "SAN, CHP, OBW, ACP, PST, TXP, SPUR, SEM, LIST".

Fetch Commands:

:FETCh:<measurement>[n]?

This command puts selected data from the most recent measurement into the output buffer. Use FETCh if you have already made a good measurement and you want to return several types of data (different [n] values, for example, both scalars and trace data) from a single measurement. FETCh saves you the time of re-making the measurement. You can only FETCh results from the measurement that is currently active, it will not change to a different measurement. An error message is reported if a measurement other than the current one is specified.

If you need to get new measurement data, use the READ command, which is equivalent to an INITiate followed by a FETCh.

The scalar measurement results will be returned if the optional [n] value is not included, or is set to 1. If the [n] value is set to a value other than 1, the selected trace data results will be returned. See each command for details of what types of scalar results or trace data results are available. The binary data formats should be used for handling large blocks of data since they are smaller and transfer faster than the ASCII format. (FORMat:DATA)

FETCh may be used to return results other than those specified with the original READ or MEASure command that you sent.

INITiate Commands:

:INITiate:<measurement>

This command is not available for measurements in all the instrument modes:

- Initiates a trigger cycle for the specified measurement, but does not output any data. You must then use the FETCh<meas> command to return data. If a measurement other than the current one is specified, the instrument will switch to that measurement and then initiate it.
 - For example, suppose you have previously initiated the ACP measurement, but now you are running the channel power measurement. If you send INIT:ACP? it will change from channel power to ACP and will initiate an ACP measurement.
 - Does not change any of the measurement settings. For example, if you have previously started the ACP measurement and you send INIT:ACP? it will initiate a new ACP measurement using the same instrument settings as the last time ACP was run.
 - If your selected measurement is currently active (in the idle state) it triggers the measurement, assuming the trigger conditions are met. Then it completes one trigger cycle. Depending upon the measurement and the number of averages, there may be multiple data acquisitions, with multiple trigger events, for one full trigger cycle. It also holds off additional commands on GPIB until the acquisition is complete.
-

READ Commands:

:READ:<measurement>[n]?

- Does not preset the measurement to the factory default settings. For example, if you have previously initiated the ACP
-

measurement and you send READ:ACP? it will initiate a new measurement using the same instrument settings.

- Initiates the measurement and puts valid data into the output buffer. If a measurement other than the current one is specified, the instrument will switch to that measurement before it initiates the measurement and returns results.
 - For example, suppose you have previously initiated the ACP measurement, but now you are running the channel power measurement. Then you send READ:ACP? It will change from channel power back to ACP and, using the previous ACP settings, will initiate the measurement and return results.
 - Blocks other SCPI communication, waiting until the measurement is complete before returning the results
 - If the optional [n] value is not included, or is set to 1, the scalar measurement results will be returned. If the [n] value is set to a value other than 1, the selected trace data results will be returned. See each command for details of what types of scalar results or trace data results are available. The binary data formats should be used when handling large blocks of data since they are smaller and faster than the ASCII format. (FORMat:DATA)
-

Initial S/W Revision	Prior to A.02.00
----------------------	------------------

Current Measurement Query (Remote Command Only)

This command returns the name of the measurement that is currently running.

Remote Command	:CONFigure?
-----------------------	-------------

Example	CONF?
----------------	-------

Initial S/W Revision	Prior to A.02.00
----------------------	------------------

Limit Test Current Results (Remote Command Only)

Queries the status of the current measurement limit testing. It returns a 0 if the measured results pass when compared with the current limits. It returns a 1 if the measured results fail any limit tests.

Remote Command	:CALCulate:CLIMits:FAIL?
-----------------------	--------------------------

Example	CALC:CLIM:FAIL? queries the current measurement to see if it fails the defined limits. Returns a 0 or 1: 0 it passes, 1 it fails.
----------------	--

Initial S/W Revision	Prior to A.02.00
----------------------	------------------

Data Query (Remote Command Only)

Returns the designated measurement data for the currently selected measurement and subopcode.

n = any valid subopcode for the current measurement. See the measurement command results table for your current measurement, for information about what data is returned for the subopcodes.

This command uses the data setting specified by the FORMat:BORDER and FORMat:DATA commands and can return real or ASCII data. (See the format command descriptions under Input/Output in the Analyzer Setup section.)

Remote Command	:CALCulate:DATA[n]?
Notes	The return trace depends on the measurement. In CALCulate:<meas>:DATA[n], n is any valid subopcode for the current measurement. It returns the same data as the FETCH:<measurement>? query where <measurement> is the current measurement.
Initial S/W Revision	Prior to A.02.00

Calculate/Compress Trace Data Query (Remote Command Only)

Returns compressed data for the currently selected measurement and sub-opcode [n].

n = any valid sub-opcode for that measurement. See the MEASure:<measurement>? command description of your specific measurement for information on the data that can be returned.

The data is returned in the current Y Axis Unit of the analyzer. The command is used with a sub-opcode <n> (default=1) to specify the trace. With trace queries, it is best if the analyzer is not sweeping during the query. Therefore, it is generally advisable to be in Single Sweep, or Update=Off.

This command is used to compress or decimate a long trace to extract and return only the desired data. A typical example would be to acquire N frames of GSM data and return the mean power of the first burst in each frame. The command can also be used to identify the best curve fit for the data.

Remote Command	:CALCulate:DATA<n>:COMPRESS? BLOCK CFIT MAXimum MINimum MEAN DMEan RMS RMSCubed SAMPLE SDEViation PPHase [,<soffset> [,<length>[,<roffset>[,<rlimit>]]]]
Example	To query the mean power of a set of GSM bursts: Supply a signal that is a set of GSM bursts. Select the IQ Waveform measurement (in IQ Analyzer Mode). Set the sweep time to acquire at least one burst. Set the triggers such that acquisition happens at a known position relative to a burst. Then query the mean burst levels using, CALC:DATA2:COMP? MEAN, 24e-6, 526e-6 (These parameter values correspond to GSM signals, where 526e-6 is the length of the burst in the slot and you just want 1 burst.)
Notes	The command supports 5 parameters. Note that the last 4 (<soffset>, <length>, <roffset>, <rlimit>) are optional. But these optional parameters must be entered in the specified order. For example, if you want to specify <length>, then you must also specify <soffset>. See details below for a definition of each of these parameters. This command uses the data in the format specified by FORMat:DATA, returning either binary or ASCII data.
Initial S/W Revision	Prior to A.02.00

- BLOCK or block data - returns all the data points from the region of the trace data that you specify. For example, it could be used to return the data points of an input signal over several timeslots, excluding the portions of the trace data that you do not want. (This is x,y pairs for trace data and I,Q pairs for complex data.)

- CFIT or curve fit - applies curve fitting routines to the data. <soffset> and <length> are required to define the data that you want. <roffset> is an optional parameter for the desired order of the curve equation. The query will return the following values: the x-offset (in seconds) and the curve coefficients ((order + 1) values).

MIN, MAX, MEAN, DME, RMS, RMSC, SAMP, SDEV and PPH return one data value for each specified region (or <length>) of trace data, for as many regions as possible until you run out of trace data (using <roffset> to specify regions). Or they return the number of regions you specify (using <rlimit>) ignoring any data beyond that.

- MINimum - returns the minimum data point (y value) for the specified region(s) of trace data. For I/Q trace data, the minimum magnitude of the I/Q pairs is returned.
- MAXimum - returns the maximum data point (y value) for the specified region(s) of trace data. For I/Q trace data, the maximum magnitude of the I/Q pairs is returned.
- MEAN - returns a single value that is the arithmetic mean of the data point values (in dB/ dBm) for the specified region(s) of trace data. For I/Q trace data, the mean of the magnitudes of the I/Q pairs is returned. See the following equations.

-

NOTE

If the original trace data is in dB, this function returns the arithmetic mean of those log values, not log of the mean power which is a more useful value. The mean of the log is the better measurement technique when measuring CW signals in the presence of noise. The mean of the power, expressed in dB, is useful in power measurements such as Channel Power. To achieve the mean of the power, use the RMS option.

Equation 1

Mean Value of Data Points for Specified Region(s)

$$\text{MEAN} = \frac{1}{n} \sum_{X_i \in \text{region}(s)} X_i$$

where X_i is a data point value, and n is the number of data points in the specified region(s).

Equation 2

Mean Value of I/Q Data Pairs for Specified Region(s)

$$\text{MEAN} = \frac{1}{n} \sum_{X_i \in \text{region}(s)} |X_i|$$

where $|X_i|$ is the magnitude of an I/Q pair, and n is the number of I/Q pairs in the specified region(s).

- DMEan - returns a single value that is the mean power (in dB/ dBm) of the data point values for the specified region(s) of trace data. See the following equation:

Equation 3

DMEan Value of Data Points for Specified Region(s)

$$\text{DME} = 10 \times \log_{10} \left(\frac{1}{n} \sum_{X_i \in \text{region}(s)} 10^{\frac{X_i}{10}} \right)$$

- RMS - returns a single value that is the average power on a root-mean-squared voltage scale (arithmetic rms) of the data point values for the specified region(s) of trace data. See the following equation.

NOTE

For I/Q trace data, the rms of the magnitudes of the I/Q pairs is returned. See the following equation. This function is very useful for I/Q trace data. However, if the original trace data is in dB, this function returns the rms of the log values which is not usually needed.

Equation 4

RMS Value of Data Points for Specified Region(s)

$$\text{RMS} = \sqrt{\frac{1}{n} \sum_{X_i \in \text{region}(s)} X_i^2}$$

where X_i is a data point value, and n is the number of data points in the specified region(s).

Equation 5

RMS Value of I/Q Data Pairs for Specified Region(s)

$$\text{RMS} = \sqrt{\frac{1}{n} \sum_{X_i \in \text{region}(s)} X_i X_i^*}$$

where X_i is the complex value representation of an I/Q pair, X_i^* its conjugate complex number, and n is the number of I/Q pairs in the specified region(s).

Once you have the rms value for a region of trace data (linear or I/Q), you may want to calculate the mean power. You must convert this rms value (peak volts) to power in dBm:

$$10 \times \log[10 \times (\text{rms value})^2]$$

- SAMPlE - returns the first data value (x,y pair) for the specified region(s) of trace data. For I/Q trace data, the first I/Q pair is returned.
- SDEViation - returns a single value that is the arithmetic standard deviation for the data point values for the specified region(s) of trace data. See the following equation.
- For I/Q trace data, the standard deviation of the magnitudes of the I/Q pairs is returned. See the following equation.

Equation 6

Standard Deviation of Data Point Values for Specified Region(s)

$$\text{SDEV} = \sqrt{\frac{1}{n} \sum_{X_i \in \text{region}(s)} (X_i - \bar{X})^2}$$

where X_i is a data point value, \bar{X} is the arithmetic mean of the data point values for the specified region (s), and n is the number of data points in the specified region(s).

$$\text{SDEV} = \sqrt{\frac{1}{n} \sum_{X_i \in \text{region}(s)} (|X_i| - \bar{X})^2}$$

where $|X_i|$ is the magnitude of an I/Q pair, \bar{X} is the mean of the magnitudes for the specified region(s), and n is the number of data points in the specified region(s).

- PPHase - returns the x,y pairs of both rms power (dBm) and arithmetic mean phase (radian) for every specified region and frequency offset (Hz). The number of pairs is defined by the specified number of regions. This parameter can be used for I/Q vector ($n=0$) in Waveform (time domain) measurement and all parameters are specified by data point in PPHase.

The rms power of the specified region may be expressed as:

$$\text{Power} = 10 \times \log [10 \times (\text{RMS I/Q value})] + 10.$$

The RMS I/Q value (peak volts) is:

$$\sqrt{\frac{1}{n} \sum_{X_i \in \text{region}} X_i X_i^*}$$

where X_i is the complex value representation of an I/Q pair, X_i^* its conjugate complex number, and n is the number of I/Q pairs in the specified region.

The arithmetic mean phase of the specified region may be expressed as:

$$\frac{1}{n} \sum_{Y_i \in \text{region}} Y_i$$

where Y_i is the unwrapped phase of I/Q pair with applying frequency correction and n is the number of I/Q pairs in the specified region.

The frequency correction is made by the frequency offset calculated by the arithmetic mean of every specified region's frequency offset. Each frequency offset is calculated by the least square method against the unwrapped phase of I/Q pair.

Sample Trace Data - Constant Envelope

(See below for explanation of variables.)

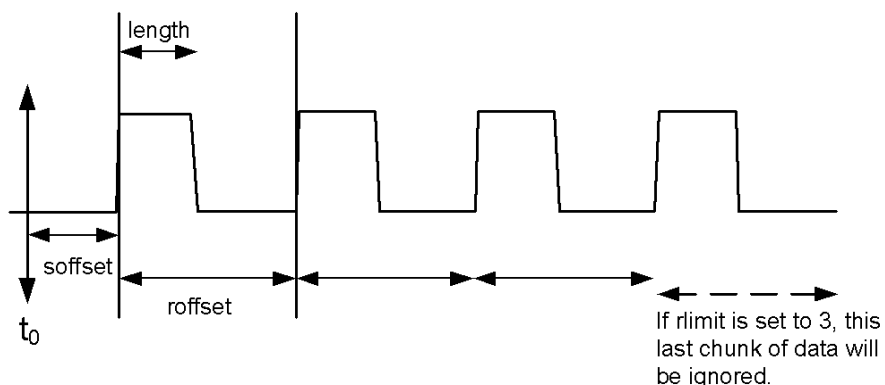

Sample Trace Data - Not Constant Envelope

(See below for explanation of variables.)

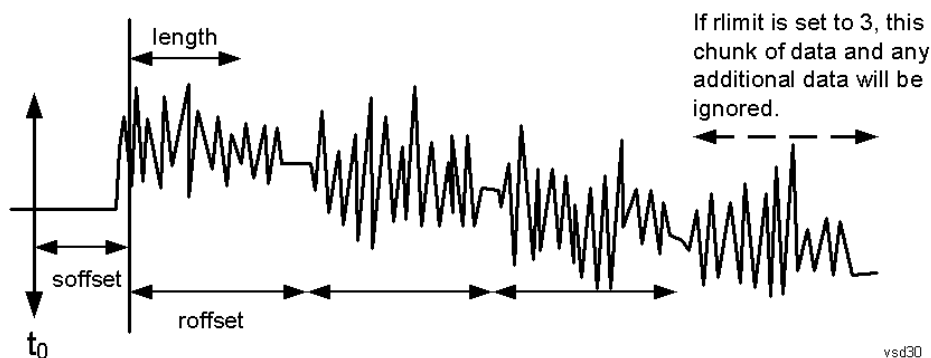

<soffset> - start offset is an optional real number. (It is in seconds for time-domain traces, and is a dimensionless index 0 to Npoints - 1, for frequency-domain traces). It specifies the amount of data at the beginning of the trace that will be ignored before the decimation process starts. It is the time or frequency change from the start of the trace to the point where you want to start using the data. The default value is zero.

<length> - is an optional real number. (It is in seconds for time-domain traces, and is a dimensionless index 0 to Npoints - 1, for frequency-domain traces). It defines how much data will be compressed into one value. This parameter has a default value equal to the current trace length.

<roffset> - repeat offset is an optional real number. (It is in seconds for time-domain traces, and is a dimensionless index 0 to Npoints - 1, for frequency-domain traces). It defines the beginning of the next field of trace elements to be compressed. This is relative to the beginning of the previous field. This parameter has a default value equal to the <length> variable. Note that this parameter is used for a completely different purpose when curve fitting (see CFIT above).

<rlimit> - repeat limit is an optional integer. It specifies the number of data items that you want returned. It will ignore any additional items beyond that number. You can use the Start offset and the Repeat limit to pick out exactly what part of the data you want to use. The default value is all the data.

Calculate Peaks of Trace Data (Remote Command Only)

Returns a list of all the peaks for the currently selected measurement and sub-opcode [n]. The peaks must meet the requirements of the peak threshold and excursion values.

n = any valid sub-opcode for the current measurement. See the MEASure:<measurement> command description of your specific measurement for information on the data that can be returned.

The command can only be used with specific sub-opcodes with measurement results that are trace data. Both real and complex traces can be searched, but complex traces are converted to magnitude in dBm. In many measurements the sub-opcode n=0, is the raw trace data which cannot be searched for peaks. And Sub-opcode n=1, is often calculated results values which also cannot be searched for peaks.

This command uses the data setting specified by the FORMat:BORDER and FORMat:DATA commands and can return real or ASCII data. If the format is set to INT,32, it returns REAL,32 data.

The command has four types of parameters:

- Threshold (in dBm)
- Excursion (in dB)
- Sorting order (amplitude, frequency, time)
- Optional in some measurements: Display line use (all, > display line, < display line)

Remote Command	<p>For Swept SA measurement:</p> <pre>:CALCulate:DATA[1] 2 ... 6:PEAKs? <threshold>,<excursion>[,AMPLitude FREQuency TIME[,ALL GTDLLine LTDLine]]</pre> <p>For most other measurements:</p> <pre>:CALCulate:DATA[1] 2 ... 6:PEAKs? <threshold>,<excursion>[,AMPLitude FREQuency TIME]</pre>
-----------------------	---

Example	<p>Example for Swept SA measurement in Spectrum Analyzer Mode:</p> <p>CALC:DATA4:PEAK? -40, 10, FREQ, GTDL This will identify the peaks of trace 4 that are above -40 dBm, with excursions of at least 10 dB. The peaks are returned in order of increasing frequency, starting with the lowest frequency. Only the peaks that are above the display line are returned.</p> <p>Query Results 1:</p> <p>With FORMat:DATA REAL, 32 selected, it returns a list of floating-point numbers. The first value in the list is the number of peak points that are in the following list. A peak point consists of two values: a peak amplitude followed by its corresponding frequency (or time).</p> <p>If no peaks are found the peak list will consist of only the number of peaks, (0).</p>
----------------	---

Notes	<p><n> - is the trace that will be used</p> <p><threshold> - is the level below which trace data peaks are ignored. Note that the threshold value is required and is always used as a peak criterion. To effectively disable the threshold criterion for this command, provide a substantially low threshold value such as -200 dBm. Also note that the threshold value used in this command is independent of and has no effect on the threshold value stored under the Peak Criteria menu.</p> <p><excursion> - is the minimum amplitude variation (rise and fall) required for a signal to be identified as peak. Note that the excursion value is required and is always used as a peak criterion. To effectively disable the excursion criterion for this command, provide the minimum value of 0.0 dB. Also note that the excursion value used in this command is independent of and has no effect on the</p>
--------------	---

excursion value stored under the Peak Criteria menu.

Values must be provided for threshold and excursion. The sorting and display line parameters are optional (defaults are AMPLitude and ALL).

Note that there is always a Y-axis value for the display line, regardless of whether the display line state is on or off. It is the current Y-axis value of the display line which is used by this command to determine whether a peak should be reported

Sorting order:

AMPLitude - lists the peaks in order of descending amplitude, with the highest peak first (default if optional parameter not sent)

FREQuency - lists the peaks in order of occurrence, left to right across the x-axis.

TIME - lists the peaks in order of occurrence, left to right across the x-axis.

Peaks vs. Display Line:

ALL - lists all of the peaks found (default if optional parameter not sent).

GTDLine (greater than display line) - lists all of the peaks found above the display line.

LTDLine (less than display line) - lists all of the peaks found below the display line.

Initial S/W Revision Prior to A.02.00

Format Data: Numeric Data (Remote Command Only)

This command specifies the format of the trace data input and output. It specifies the formats used for trace data during data transfer across any remote port. It affects only the data format for setting and querying trace data for the :TRACe[:DATA], TRACe[:DATA]?, :CALCulate:DATA[n]? and FETCh:SANalyzer [n]? commands and queries.

Remote Command :FORMat [:TRACe] [:DATA] ASCii|INTeger,32|REAL,32 |REAL,64
:FORMat [:TRACe] [:DATA] ?

Notes The query response is:
ASCii: ASC,8
REAL,32: REAL,32
REAL,64: REAL,64
INTeger,32: INT,32

When the numeric data format is REAL or ASCii, data is output in the current Y Axis unit. When the data format is INTeger, data is output in units of m dBm (.001 dBm).

The INT,32 format returns binary 32-bit integer values in internal units (m dBm), in a definite length block.

Dependencies Sending a data format spec with an invalid number (for example, INT,48) generates no error. The analyzer simply uses the default (8 for ASCii, 32 for INTeger, 32 for REAL).

Sending data to the analyzer which does not conform to the current FORMat specified, results in an error. Sending ASCII data when a definite block is expected generates message -161 "Invalid Block Data" and sending a definite block when ASCII data is expected generates message -121 "Invalid Character in Number".

Preset ASCii

Backwards Compatibility Notes Note that the INT,32 format is only applicable to the command, TRACe:DATA. This preserves backwards compatibility for the Swept SA measurement. For all other commands/queries which honor FORMat:DATA, if INT,32 is sent the analyzer will behave as though it were set to REAL,32.

Initial S/W Revision Prior to A.02.00

The specs for each output type follow:

ASCIi - Amplitude values are in ASCII, in the current Y Axis Unit, one ASCII character per digit, values separated by commas, each value in the form:

SX.YYYYYEsZZ

Where:

S = sign (+ or -)

X = one digit to left of decimal point

Y = 5 digits to right of decimal point

E = E, exponent header

s = sign of exponent (+ or -)

ZZ = two digit exponent

REAL,32 - Binary 32-bit real values in the current Y Axis Unit, in a definite length block.

REAL,64 - Binary 64-bit real values in the current Y Axis Unit, in a definite length block.

Format Data: Byte Order (Remote Command Only)

This command selects the binary data byte order for data transfer and other queries. It controls whether binary data is transferred in normal or swapped mode. This command affects only the byte order for setting and querying trace data for the :TRACe[:DATA], TRACe[:DATA]? , :CALCulate:DATA[n]? and FETCh:SANalyzer[n]? commands and queries.

By definition any command that says it uses FORMat:DATA uses any format supported by FORMat:DATA.

The NORMal order is a byte sequence that begins with the most significant byte (MSB) first, and ends with the least significant byte (LSB) last in the sequence: 1|2|3|4. SWAPPed order is when the byte sequence begins with the LSB first, and ends with the MSB last in the sequence: 4|3|2|1.

Remote Command	:FORMat:BORDER NORMal SWAPPed :FORMat:BORDER?
Preset	NORMal
Initial S/W Revision	Prior to A.02.00

Meas Setup

Displays the setup menu for the current measurement. The measurement setup parameters include the number of measurement averages used to calculate the measurement result and the averaging mode. The setup menu also includes the option to reset the measurement settings to their factory defaults.

Key Path	Front-panel key
Initial S/W Revision	Prior to A.02.00

Avg/Hold Num

Specifies the number of measurement averages used when calculating the measurement result. The average is displayed at the end of each sweep.

Initiates an averaging routine that averages the sweep points in a number of successive sweeps, resulting in trace smoothing.

After the specified number of average counts, the average mode (termination control) setting determines the average action.

Key Path	Meas Setup
Mode	SA, WCDMA, C2K, WIMAX OFDMA, TD-SCDMA, 1xEVDO, ISDB-T, CMMB, LTE, LTETDD, BLUETOOTH, WLAN, MSR, LTEAFDD, LTEATDD
Remote Command	[:SENSe]:OBWidth:AVERage:COUNT <integer> [:SENSe]:OBWidth:AVERage:COUNT? [:SENSe]:OBWidth:AVERage[:STATe] ON OFF 1 0 [:SENSe]:OBWidth:AVERage[:STATe]?
Example	OBW:AVER:COUN 1500 OBW:AVER:COUN? OBW:AVER ON OBW:AVER?
Notes	You must be in the Spectrum Analysis mode, W-CDMA mode, cdma2000 mode, TD-SCDMA mode, ISDB-T mode, CMMB mode, LTE mode, LTE TDD mode, BLUETOOTH mode, WLAN mode, 1xEVDO mode, MSR, LTE-Advanced FDD/TDD or WIMAX OFDMA mode to use this command. Use:INSTrument:SElect to set the mode.
Couplings	None Averaging state is coupled to Max Hold. If Max Hold is changed from Off to On, Averaging state is automatically set to On.
Preset	10 ON
State Saved	Saved in instrument state.
Min	1
Max	10000

Backwards Compatibility SCPI	<code>[:SENSe] :EBWidth :AVERage :COUNT</code>
Initial S/W Revision	Prior to A.02.00
Modified at S/W Revision	A.03.00

Avg Mode

Enables you to set the averaging mode.

- When set to Exponential (Exp) the measurement averaging continues using the specified number of averages to compute each averaged value. The average is displayed at the end of each sweep.
- When set to Repeat, the measurement resets the average counter each time the specified number of averages is reached.

Key Path	Meas Setup
Mode	SA, WCDMA, C2K, WIMAX OFDMA, TD-SCDMA , 1xEVDO, ISDB-T, CMMB, LTE, LTETDD, BLUETOOTH, WLAN, MSR, LTEAFDD, LTEATDD
Remote Command	<code>[:SENSe] :OBWidth :AVERage :TCONtrol EXPonential REPeat</code> <code>[:SENSe] :OBWidth :AVERage :TCONtrol ?</code>
Example	OBW:AVER:TCON REP OBW:AVER:TCON?
Notes	You must be in the Spectrum Analysis mode, W-CDMA mode, cdma2000 mode, TD-SCDMA mode, ISDB-T mode, CMMB mode, LTE mode, LTE TDD mode, BLUETOOTH mode, WLAN mode, 1xEVDO mode, MSR, LTE-Advanced FDD/TDD or WIMAX OFDMA mode to use this command. Use:INSTRument:SElect to set the mode.
Preset	EXP
State Saved	Saved in instrument state.
Range	Exp Repeat
Initial S/W Revision	Prior to A.02.00
Modified at S/W Revision	A.03.00

Occ BW % Pwr

Assigns the percentage of the total power that is measured within the Occupied Bandwidth for the current measurement. The resulting Occupied Bandwidth limits are displayed by markers placed on the frequencies of the specified percentage.

Key Path	Meas Setup
Mode	SA, WCDMA, C2K, WIMAX OFDMA, TD-SCDMA, 1xEVDO, ISDB-T, CMMB, LTE, LTETDD, BLUETOOTH, WLAN, MSR, LTEAFDD, LTEATDD
Remote Command	<code>[:SENSe] :OBWidth :PERCent <real></code>

	<code>[:SENSe] :OBWidth:PERCent?</code>
Example	OBW:PERC 75 OBW:PERC?
Notes	You must be in the Spectrum Analysis mode, W-CDMA mode, cdma2000 mode, TD-SCDMA mode, ISDB-T mode, CMMB mode, LTE mode, LTE TDD mode, BLUETOOTH mode, WLAN mode, 1xEVDO mode, MSR, LTE-Advanced FDD/TDD or WIMAX OFDMA mode to use this command. Use:INSTrument:SElect to set the mode. If Mode is BLUETOOTH, the key will be grayed out.
Preset	99.00
State Saved	Saved in instrument state.
Min	10
Max	99.99
Initial S/W Revision	Prior to A.02.00
Modified at S/W Revision	A.03.00

x dB

Sets the x dB value used for the "x dB bandwidth" result that measures the bandwidth between two points on the signal which is x dB down from the highest signal point within the OBW Span.

Key Path	Meas Setup
Mode	SA, WCDMA, C2K, WIMAX OFDMA, TD-SCDMA, 1xEVDO, ISDB-T, CMMB, LTE, LTE TDD, BLUETOOTH, WLAN, MSR, LTEAFDD, LTEATDD
Remote Command	<code>[:SENSe] :OBWidth:XDB <rel_ampl></code> <code>[:SENSe] :OBWidth:XDB?</code>
Example	OBW:XDB -20 OBW:XDB?
Notes	You must be in the Spectrum Analysis mode, W-CDMA mode, cdma2000 mode, TD-SCDMA mode, ISDB-T mode, CMMB mode, LTE mode, LTE TDD mode, BLUETOOTH mode, WLAN mode, 1xEVDO mode, MSR, LTE-Advanced FDD/TDD or WIMAX OFDMA mode to use this command. Use:INSTrument:SElect to set the mode.
Preset	-26.0 dB BLUETOOTH: -20.0 dB.
State Saved	Saved in instrument state.
Min	-100.0 dB
Max	-0.1 dB
Backwards Compatibility SCPI	<code>[:SENSe] :EBWidth:XDB</code>
Initial S/W Revision	Prior to A.02.00
Modified at S/W Revision	A.03.00

IF Gain

The IF Gain key can be used to set the IF Gain function to Auto, Low Gain or High Gain. These settings affect sensitivity and IF overloads.

This only applies to the RF input. It does not apply to baseband I/Q input.

Key Path	Meas Setup, IF Gain
Dependencies	The IF Gain keys (FFT IF Gain and Swept IF Gain) have no effect when the U7227A USB Preamplifier is connected. This is not annotated or reflected on any softkey; there are no keys grayed out nor any SCPI locked out. The analyzer simply behaves as though both FFT IF Gain and Swept IF Gain are set to Low regardless of the setting on the keys.
Initial S/W Revision	Prior to A.02.00

IF Gain Auto

Activates the Auto Rules for IF Gain. When Auto is active, the IF Gain is set to High Gain under and of the following conditions:

- the input attenuator is set to 0 dB
- the preamp is turned On and the frequency range is under 3.6 GHz

For other settings, Auto sets the IF Gain to Low Gain.

Key Path	Meas Setup, IF Gain
Mode	SA, WCDMA, C2K, WIMAX OFDMA, TD-SCDMA, 1xEVDO, ISDB-T, CMMB, LTE, LTE4DD, BLUETOOTH, WLAN, MSR, LTEAFDD, LTEATDD
Remote Command	<code>[:SENSe] :OBWidth :IF :GAIN :AUTO [:STATe] ON OFF 1 0</code> <code>[:SENSe] :OBWidth :IF :GAIN :AUTO [:STATe] ?</code>
Example	<code>OBW:IF:GAIN:AUTO OFF</code> <code>OBW:IF:GAIN:AUTO?</code>
Couplings	When the auto attenuation exists (for example, with electrical attenuator), the IF Gain setting is changed as following rule. Auto sets IF Gain to High Gain under any of the following conditions: the input attenuator is set to 0 dB, or the preamp is turned on and the frequency range is less than 3.6 GHz. For other settings, Auto sets IF Gain to Low Gain.
Preset	OFF
State Saved	Saved in instrument state.
Range	Off On
Initial S/W Revision	Prior to A.02.00
Modified at S/W Revision	A.03.00

IF Gain State

Selects the range of the IF Gain.

Key Path	Meas Setup, IF Gain
Mode	SA, WCDMA, C2K, WIMAX OFDMA, TD-SCDMA, 1xEVDO, ISDB-T, CMMB, LTE, LTETDD, BLUETOOTH, WLAN, MSR, LTEAFDD, LTEATDD
Remote Command	[:SENSe] :OBWidth:IF:GAIN [:STATe] ON OFF 1 0 [:SENSe] :OBWidth:IF:GAIN [:STATe] ?
Example	OBW:IF:GAIN ON OBW:IF:GAIN?
Notes	Where ON = high gain OFF = low gain
Couplings	When the auto attenuation exists (for example, with electrical attenuator), the IF Gain setting is changed as following rule. Auto sets IF Gain to High Gain under any of the following conditions: the input attenuator is set to 0 dB, or the preamp is turned on and the frequency range is less than 3.6 GHz. For other settings, Auto sets IF Gain to Low Gain.
Preset	OFF
State Saved	Saved in instrument state.
Range	Low Gain High Gain
Initial S/W Revision	Prior to A.02.00
Modified at S/W Revision	A.03.00

Limit (for all modes except MSR and LTE-Advanced FDD/TDD)

Enables you to turn on or off limit checking at the specified frequency. For results that fail the limit test, a red FAIL appears in the measure bar.

Key Path	Meas Setup
Mode	SA, WCDMA, C2K, WIMAX OFDMA, TD-SCDMA, 1xEVDO, ISDB-T, CMMB, LTE, LTETDD, BLUETOOTH, WLAN
Remote Command	:CALCulate:OBWidth:LIMit:FBLimit <freq> :CALCulate:OBWidth:LIMit:FBLimit? :CALCulate:OBWidth:LIMit[:TEST] ON OFF 1 0 :CALCulate:OBWidth:LIMit[:TEST] ?
Example	CALC:OBW:LIM:FBL 50 kHz CALC:OBW:LIM:FBL? CALC:OBW:LIM OFF CALC:OBW:LIM?
Notes	You must be in the Spectrum Analysis mode, W-CDMA mode, cdma2000 mode, TD-SCDMA mode, ISDB-T mode, CMMB mode, LTE mode, LTE TDD mode, BLUETOOTH mode, WLAN mode, 1xEVDO mode or WIMAX OFDMA mode to use this command. Use:INSTRument:SElect to set the mode.

Preset	SA, WCDMA: 5 MHz C2K: 1.48 MHz WIMAX OFDMA: 10 MHz TD-SCDMA: 1.6 MHz 1xEVDO: 1.48 MHz ISDB-T: 5.7 MHz CMMB: 7.512 MHz LTE, LTETDD: 5 MHz BLUETOOTH: 1 MHz WLAN: If Radio Std is 802.11a/g(OFDM/DSSS-OFDM): 20MHz If Radio Std is 802.11b: 25 MHz If Radio Std is 802.11n(20MHz): 20 MHz If Radio Std is 802.11n(40MHz): 40 MHz If Radio Std is 802.11ac(20MHz): 20 MHz If Radio Std is 802.11ac(40MHz): 40 MHz If Radio Std is 802.11ac(80MHz): 80 MHz If Radio Std is 802.11ac(160MHz): 160 MHz SA: OFF WCDMA, WIMAX OFDMA, TD-SCDMA, 1xEVDO, ISDB-T, CMMB, LTE, LTETDD: ON
State Saved	Saved in instrument state.
Min	1 kHz
Max	Depends on instrument maximum frequency.
Initial S/W Revision	Prior to A.02.00
Modified at S/W Revision	A.03.00

Meas Preset

Restores all measurement parameters to their default values.

Key Path	Meas Setup
Mode	SA, WCDMA, C2K, WIMAX OFDMA, TD-SCDMA, 1xEVDO, ISDB-T, CMMB, LTE, LTETDD, BLUETOOTH, WLAN, MSR, LTEAFDD, LTEATDD
Remote Command	:CONFigure:OBWidth
Example	CONF:OBW
Initial S/W Revision	Prior to A.02.00
Modified at S/W Revision	A.03.00

Max Hold (Remote Command Only)

When On, Max Hold displays and holds the maximum responses of the current measurement. Turn Max Hold to Off to disable the maximum hold feature.

Key Path	SCPI Only
Mode	SA, WCDMA, C2K, WIMAX OFDMA, TD-SCDMA, 1xEVDO, ISDB-T, CMMB, LTE, LTETDD, BLUETOOTH, WLAN, MSR, LTEAFDD, LTEATDD
Remote Command	[:SENSe] :OBWidth:MAXHold ON OFF 1 0 [:SENSe] :OBWidth:MAXHold?
Example	OBW:MAXH ON OBW:MAXH?
Notes	You must be in the Spectrum Analysis mode, W-CDMA mode, cdma2000 mode, TD-SCDMA mode, ISDB-T mode, CMMB mode, LTE mode, LTE TDD mode, BLUETOOTH mode, WLAN mode, 1xEVDO mode, MSR, LTE-Advanced FDD/TDD or WIMAX OFDMA mode to use this command. Use:INSTrument:SElect to set the mode.
Couplings	Max Hold is coupled to Average/Hold state. The Max Hold function is activated only if Average state is On. If Max Hold is changed to On when Average state is Off, Average state is automatically set to On.
Preset	OFF
State Saved	Saved in instrument state.
Range	On Off
Backwards Compatibility SCPI	[:SENSe] :EBWidth:MAXHold
Initial S/W Revision	Prior to A.02.00
Modified at S/W Revision	A.03.00

Mode

See ["Mode" on page 286](#)

Mode Preset

Returns the active mode to a known state.

Mode Preset does the following for the currently active mode:

- Aborts the currently running measurement.
- Brings up the default menu for the mode, with no active function.
- Sets measurement Global settings to their preset values for the active mode only.
- Activates the default measurement.
- Brings up the default menu for the mode.
- Clears the input and output buffers.
- Sets Status Byte to 0.

Mode Preset does not:

- Cause a mode switch
- Affect mode persistent settings
- Affect system settings

See "[How-To Preset](#)" on page 1343 for more information.

Key Path	Front-panel key
Remote Command	:SYSTem:PRESet
Example	:SYST:PRES
Notes	*RST is preferred over :SYST:PRES for remote operation. *RST does a Mode Preset, as done by the :SYST:PRES command, and it sets the measurement mode to Single measurement rather than Continuous for optimal remote control throughput. Clears all pending OPC bits. The Status Byte is set to 0.
Couplings	A Mode Preset aborts the currently running measurement, activates the default measurement, and gets the mode to a consistent state with all of the default couplings set.
Backwards Compatibility Notes	In the X-Series, the legacy "Factory Preset" has been replaced with Mode Preset, which only presets the currently active mode, not the entire instrument. In the X-Series, the way to preset the entire instrument is by using System, Restore System Defaults All, which behaves essentially the same way as restore System Defaults does on ESA and PSA. There is also no "Preset Type" as there is on the PSA. There is a green Mode Preset front-panel key that does a Mode Preset and a white-with-green-letters User Preset front-panel key that does a User Preset. The old PRESet:TYPE command is ignored (without generating an error), and SYST:PRES without a parameter does a Mode Preset, which should cover most backward code compatibility issues. The settings and correction data under the Input/Output front-panel key (examples: Input Z Corr, Ext Amp Gain, etc.) are no longer part of any Mode, so they will not be preset by a Mode Preset. They are preset using Restore Input/Output Defaults, Restore System Defaults All. Note that because User Preset does a Recall State, and all of these settings are saved in State, they ARE recalled when using

	User Preset.
Initial S/W Revision	Prior to A.02.00

How-To Preset

The table below shows all possible presets, their corresponding SCPI commands and front-panel access (key paths). Instrument settings depend on the current measurement context. Some settings are local to the current measurement, some are global (common) across all the measurements in the current mode, and some are global to all the available modes. In a similar way, restoring the settings to their preset state can be done within the different contexts.

Auto Couple - is a measurement local key. It sets all Auto/Man parameter couplings in the measurement to Auto. Any Auto/Man selection that is local to other measurements in the mode will not be affected.

Meas Preset - is a measurement local key. Meas Preset resets all the variables local to the current measurement except the persistent ones.

Mode Preset - resets all the current mode's measurement local and measurement global variables except the persistent ones.

Restore Mode Defaults - resets ALL the Mode variables (and all the Meas global and Meas local variables), including the persistent ones.

Type Of Preset	SCPI Command	Front Panel Access
Auto Couple	:COUPlE ALL	Auto Couple front-panel key
Meas Preset	:CONFIgure:<Measurement>	Meas Setup Menu
Mode Preset	:SYSTem:PRESet	Mode Preset (green key)
Restore Mode Defaults	:INSTrument:DEFault	Mode Setup Menu
Restore All Mode Defaults	:SYSTem:DEFault MODEs	System Menu; Restore System Default Menu
*RST	*RST	not possible (Mode Preset with Single)
Restore Input/Output Defaults	:SYSTem:DEFault INPut	System Menu; Restore System Default Menu
Restore Power On Defaults	:SYSTem:DEFault PON	System Menu; Restore System Default Menu
Restore Alignment Defaults	:SYSTem:DEFault ALIGn	System Menu; Restore System Default Menu
Restore Miscellaneous Defaults	:SYSTem:DEFault MISC	System Menu; Restore System Default Menu
Restore All System Defaults	:SYSTem:DEFault [ALL] :SYSTem:PRESet:PERSistent	System Menu; Restore System Default Menu
User Preset	:SYSTem:PRESet:USER	User Preset Menu
User Preset All Modes	:SYSTem:PRESet:USER:ALL	User Preset Menu

Power On Mode Preset	:SYSTem:PON:TYPE MODE	System Menu
Power On User Preset	:SYSTem:PON:TYPE USER	System Menu
Power On Last State	:SYSTem:PON:TYPE LAST	System Menu

Preset Type (Remote Command Only)

As stated in the Backward Compatibility section, to be compatible with ESA/PSA the PRESet:TYPE command will be implemented as a no-op.

Mode	All
Remote Command	:SYSTem:PRESet:TYPE FACTory MODE USER :SYSTem:PRESet:TYPE?
Example	:SYST:PRESet:TYPE FACT
Notes	This command is supported for backward compatibility only. It is a no-op which does not change the behavior of any preset operation.
Preset	This is unaffected by Preset but is set to Mode on a "Restore System Defaults->All"
State Saved	No
Initial S/W Revision	Prior to A.02.00

Mode Setup

See "[Mode Setup](#)" on page 316

Peak Search

Places the selected marker on the trace point with the maximum y-axis value for that marker's trace. Pressing Peak Search with the selected marker off causes the selected marker to be set to Normal, then a peak search is immediately performed.

Key Path	Front panel key
Mode	SA, WCDMA, C2K, WIMAX OFDMA, TD-SCDMA, 1xEVDO, ISDB-T, CMMB, LTE, LTETDD, BLUETOOTH, WLAN, MSR, LTEAFDD, LTEATDD
Remote Command	:CALCulate:OBWidth:MARKer[1] 2 ... 12:MAXimum
Example	CALC:OBW:MARK2:MAX
Initial S/W Revision	Prior to A.02.00
Modified at S/W Revision	A.03.00

Print

See "Print" on page 341

Quick Save

The Quick Save front-panel key repeats the most recent save that was performed from the Save menu, with the following exceptions:

- Register saves are not remembered as Saves for the purpose of the Quick Save function
- If the current measurement does not support the last non-register save that was performed, an informational message is generated, “File type not supported for this measurement”

Quick Save repeats the last type of qualified save (that is, a save qualified by the above criteria) in the last save directory by creating a unique filename using the Auto File Naming algorithm described below.

If Quick Save is pressed after startup and before any qualified Save has been performed, the Quick Save function performs a Screen Image save using the current settings for Screen Image saves (current theme, current directory), which then becomes the “last save” for the purpose of subsequent Quick Saves.

The Auto File Naming feature automatically generates a file name for use when saving a file. The filename consists of a prefix and suffix separated by a dot, as is standard for the Windows® file system. A default prefix exists for each of the available file types:

Type	Default Prefix	Menu
State	State_	(Save/Recall)
Trace + State	State_	(Save/Recall)
Screen	Screen_	(Save/Recall)
Amplitude Corrections	Ampcor_	(Import/Export)
Traces	Trace_	(Import/Export)
Limit Lines	LLine_	(Import/Export)
Measurement Result	MeasR_	(Import/Export)
Capture Buffer	CapBuf_	(Import/Export)

A four digit number is appended to the prefix to create a unique file name. The numbering sequence starts at 0000 within each Mode for each file type and updates incrementally to 9999, then wraps to 0000 again. It remembers where it was through a Mode Preset and when leaving and returning to the Mode. It is reset by Restore Misc Defaults and Restore System Defaults and subsequent running of the instrument application. So, for example, the first auto file name generated for State files is State_0000.state. The next is State_0001, and so forth.

One of the key features of Auto File Name is that we guarantee that the Auto File Name will never conflict with an existing file. The algorithm looks for the next available number. If it gets to 9999, then it looks for holes. If it find no holes, that is no more numbers are available, it gives an error.

For example, if when we get to State_0010.state there is already a State_0010.state file in the current directory, it advances the counter to State_0011.state to ensure that no conflict will exist (and then it verifies that State_0011.state also does not exist in the current directory and advances again if it does, and so forth).

If you enter a file name for a given file type, then the prefix becomes the filename you entered instead of the default prefix, followed by an underscore. The last four letters (the suffix) are the 4-digit number.

For example, if you save a measurement results file as “fred.csv”, then the next auto file name chosen for a measurement results save will be fred_0000.csv.

NOTE Although 0000 is used in the example above, the number that is used is actually the current number in the Meas Results sequence, that is, the number that would have been used if you had not entered your own file name.

NOTE If the filename you entered ends with _dddd, where d=any number, making it look just like an auto file name, then the next auto file name picks up where you left off with the suffix being dddd + 1.

Key Path	Front-panel key
Notes	No remote command for this key specifically.
Initial S/W Revision	Prior to A.02.00

Recall

The Recall menu lets you choose what you want to recall, and where you want to recall it from. Among the types of files you can recall are **States and Traces**. In addition, an Import (Data) option lets you recall a number of data types stored in CSV files (as used by Excel and other spreadsheet programs).

The default paths for Recall are data type dependent and are the same as for the Save key.

Key Path	Front-panel key
Notes	<p>No remote command for this key specifically, but the :MMEM:LOAD command is available for specific file types. An example is :MMEM:LOAD:STATE <filename>.</p> <p>If you try to recall a State file for a mode that is not licensed or not available in the instrument, an error message will occur and the state will not change.</p>
Backwards Compatibility Notes	<p>In legacy analyzers, it was possible to load a state without affecting the trace data, limit lines or correction data. Similarly (since User Preset is actually loading a state), it was possible to do a User Preset without affecting the trace data, limit lines or correction data.</p> <p>In the X-Series, “state” always includes all of this data; so whenever state is loaded, all of the traces, limit lines and corrections are affected. Although this differs from previous behavior, it is desirable behavior, and should not cause adverse issues for users.</p>
Backwards Compatibility Notes	<p>Recall for the X-Series supports backward compatibility in the sense that you can recall a state file from any X-Series model number and any version of X-Series software. This is only possible if part of the recalling process goes through a limiting step after recalling the mode settings, at least for settings that may vary with version number, model number, option and license differences. If you try to recall a state file onto an instrument with less capability than what was available on the instrument during the save, the recall will ignore the state it doesn't support and it will limit the recalled setting to what it allows.</p> <p>Example: if the saved state includes preamp ON, but the recalling instrument does not have a preamp; the preamp is limited to OFF. Conversely, if you save a state without a preamp, the preamp is OFF in the state file. When this saved file is recalled on an instrument with a licensed preamp, the preamp is changed to OFF. Another example is if the saved state has center frequency set to 20 GHz, but the instrument recalling the saved state is a different model and only supports 13.5 GHz. In this case, the center frequency is limited along with any other frequency based settings. Since the center frequency can't be preserved in this case, the recall limiting tries to at least preserve span to keep the measurement setup as intact as possible.</p> <p>It may be appropriate to issue a warning if the state is limited on the recall; warnings do not go out to SCPI so this would only affect the manual user.</p> <p>Note that there is no state file compatibility outside of the X-Series. For example, you cannot recall a state file from ESA or PSA.</p>
Initial S/W Revision	Prior to A.02.00

State

The Recall State menu lets you choose a register or file from which to recall the state.

The content of a state file includes all of the settings and data required to return the analyzer as closely as possible to the Mode it was in, with the exact settings that were in place, when the save occurred. The Mode settings in each state file include the settings that are affected by Mode Preset, as well as the

additional settings affected by Restore Mode Defaults; all of the Mode’s settings. In addition, all of the settings of the Input/Output system are included, even though they are outside of the Mode’s state, because they are needed to restore the complete setup. Persistent System settings (for example, GPIB address) are not affected by either a Mode Preset or Restore Mode Defaults, nor are they included in a saved State file.

Since each state file is only for one Mode, the settings for other Modes are unaffected when it is loaded. Recall State will cause a mode switch if the state being recalled is not from the current active mode.

After the recall completes, the message "File <filename> recalled" or “Recalled State Register <register number>” is displayed.

For rapid recalls, the State menu lists 16 registers that you can choose from to recall. Pressing a Register key initiates the recall. You can also select a file from which to recall.

The default path for all State Files is:

My Documents\<<mode name>\state

where <mode name> is the parameter used to select the mode with the INST:SEL command (for example, SA for the Spectrum Analyzer).

See "[More Information](#)" on page 1352.

Key Path	Recall
Mode	All
Remote Command	:MMEMory:LOAD:STATe <filename>
Example	:MMEM:LOAD:STAT "myState.state" This recalls the file myState.state on the default path
Example	MMEM:LOAD:STAT "MyStateFile.state" This loads the state file data (on the default file directory path) into the instrument state.
Notes	<p>When you pick a file to recall, the analyzer first verifies that the file is recallable in the current instrument by checking the software version and model number of the instrument. If everything matches, a full recall proceeds by aborting the currently running measurement, clearing any pending operations, and then loading the State from the saved state file. You can open state files from any mode, so recalling a State file switches to the mode that was active when the save occurred. After switching to the mode of the saved state file, mode settings and data (if any for the mode) are loaded with values from the saved file. The saved measurement of the mode becomes the newly active measurement and the data relevant to the measurement (if there is any) is recalled.</p> <p>If there is a mismatch between file version or model number or instrument version or model number, the recall function tries to recall as much as possible and returns a warning message. It may limit settings that differ based on model number, licensing or version number.</p> <p>After recalling the state, the Recall State function does the following:</p> <ul style="list-style-type: none"> • Makes the saved measurement for the mode the active measurement. • Clears the input and output buffers. • Status Byte is set to 0. • Executes a *CLS <p>If the file specified is empty an error is generated. If the specified file does not exist, another error is generated. If there is a mismatch between the file and the proper file type, an error is generated. If</p>

	there is a mismatch between file version or model number or instrument version or model number, a warning is displayed. Then it returns to the State menu and File Open dialog goes away. After the Recall, the analyzer exits the Recall menu and returns to the previous menu.
Backwards Compatibility SCPI	:MMEMory:LOAD:STATe 1,<filename> For backwards compatibility, the above syntax is supported. The "1" is simply ignored.
Initial S/W Revision	Prior to A.02.00

More Information

In measurements that support saving Traces, for example, Swept SA, the Trace data is saved along with the State in the State file. When recalling the State, the Trace data is recalled as well. Traces are recalled exactly as they were stored, including the writing mode and update and display modes. If a Trace was updating and visible when the State was saved, it will come back updating and visible, and its data will be rewritten right away. When you use State to save and recall traces, any trace whose data must be preserved should be placed in View or Blank mode before saving.

The following table describes the Trace Save and Recall possibilities:

You want to recall state and one trace's data, leaving other traces unaffected.	Save Trace+State from 1 trace. Make sure that no other traces are updating (they should all be in View or Blank mode) when the save is performed.	On Recall, specify the trace you want to load the one trace's data into. This trace will load in View. All other traces' data will be unaffected, although their trace mode will be as it was when the state save was performed.
You want to recall all traces	Save Trace+State from ALL traces.	On Recall, all traces will come back in View (or Blank if they were in Blank or Background when saved)
You want all traces to load exactly as they were when saved.	Save State	On recall, all traces' mode and data will be exactly as they were when saved. Any traces that were updating will have their data immediately overwritten.

From File...

When you press "From File", the analyzer brings up a Windows dialog and a menu entitled "File Open." This menu allows you to navigate to the various fields in the Windows dialog without using a keyboard or mouse. The Tab and Arrow keys can also be used for dialog navigation.

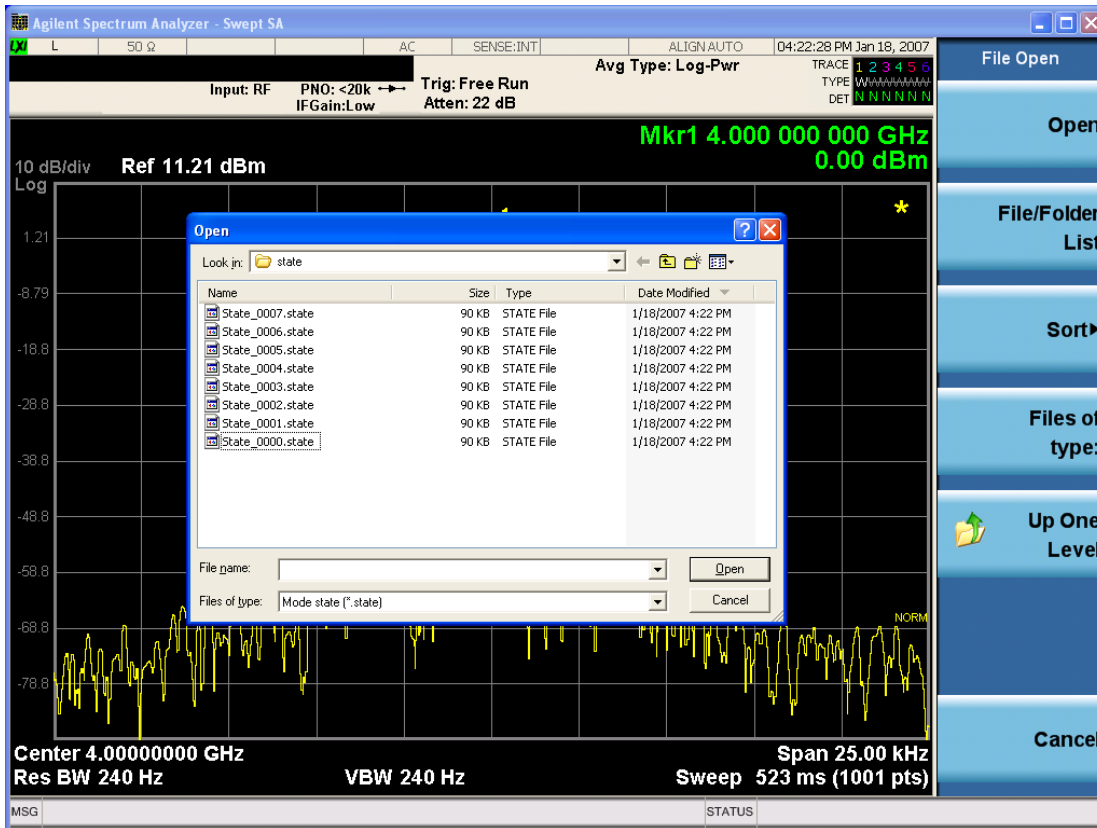

Listed below are the functions of the various fields in the dialog, and the corresponding softkeys:

Open

Performs the recall of the specified file. While the recall is being performed, the floppy icon appears briefly in the Meas bar.

File/Folder List

Enables you to navigate to the center of the dialog that contains the list of files and folders. Once here you can get information about the file and use the tab keys to navigate to the other fields in the dialog, such as Look In.

Look In

The Look In field shows the path from which the file will be recalled and allows you to change the path using the up and down arrow keys to navigate to other paths; the Enter key to open a directory; and the Backspace key to go back one directory. The **Look In field** first uses the last path from the Save As dialog **Save In:** path for that same file type. There is no softkey for directly navigating to the Look In field, but you can use the left tab to get here from the File/Folder List.

User specified paths are remembered when you leave and return to a Mode and are reset back to the default using Restore Mode Defaults.

Sort

Accesses a menu that enables you to sort the files within the File Open dialog. Only one sorting type can be selected at a time and the sorting happens immediately. The sorting types are By Date, By Name, By extension, and By Size.

Files of Type

This field shows the file suffix for the type of file you have selected to recall. For example, if you navigated here while recalling State, "Mode state (*.state)" is in the field. If you navigated here while recalling Trace, ""Mode state (*.trace)" is in the field. If you navigated here while importing a trace data file, "Trace Data (*.csv)" is in the field. For some file types, there is more than one choice in the dropdown menu, which you can select by using the up and down arrow keys and Enter.

Up One Level

This key corresponds to the icon of a folder with the up arrow that is in the tool bar of the dialog. When pressed, it causes the file and folder list to navigate up one level in the directory structure. The Backspace key does the same thing.

Cancel

This key corresponds to the Cancel selection in the dialog. It causes the current **Open** request to be cancelled. The ESC key does the same thing.

Key Path	Recall, State
Notes	Brings up the Open dialog for recalling a State Save Type
Initial S/W Revision	Prior to A.02.00

Edit Register Names

You may enter a custom name on any of the Register keys, to help you remember what you are using that state to save. To do this, press the Edit Register Names key, choose the register whose name you wish to edit, and then enter the desired label using the Alpha Editor or an external PC keyboard.

The maximum number of characters that can be added is 30. In most cases, 30 characters will fit on two lines of the key.

For more information and the SCPI command, see Edit Register Names under the Save, State function.

Key Path	Recall, State
Mode	All
Dependencies	N9060A-7FP or N9060B-2FP license required to edit the register names. When the feature is not licensed, sending the SCPI command generates an error, -221, "Settings conflict;Option not available"
Initial S/W Revision	A.11.00

Register 1 thru Register 16

Selecting any one of these register keys causes the State of the mode from the specified Register to be recalled. Each of the register keys annotates whether it is empty or at what date and time it was last

modified. In addition, you can use the Edit Register Names key under Save, State to enter custom names for each register.

Registers are shared by all modes, so recalling from any one of the registers will cause a mode switch to the mode that was active when the save to the Register occurred.

Although these 16 registers are the only registers available from the front panel, there are 128 state registers available in the instrument. Registers 17–128 are only available from the SCPI interface, using the *RCL command.

After the recall completes, the message "Register <register number> recalled" appears in the message bar. If you are in the Spectrum Analyzer Mode, and you are recalling a register that was saved in the Spectrum Analyzer Mode, then after the recall, you will still be in the Recall Register menu. If the Recall causes you to switch modes, then after the Recall, you will be in the Frequency menu.

If a requested register is empty an error is generated.

Key Path	Recall, State
Example	*RCL 1
Range	1–16 from front panel, 1–128 from SCPI
Readback	Date and time with seconds resolution are displayed on the key OR A custom name of up to 30 characters entered using the Save, State, Edit Register Names key OR “(empty)” if no prior save operation has been performed to this register.
Initial S/W Revision	Prior to A.02.00
Modified at S/W Revision	Prior to A.11.00

Register 1 thru Register 16

Selecting any one of these register keys causes the State of the mode from the specified Register to be recalled. Each of the register keys annotates whether it is empty or at what date and time it was last modified. In addition, you can use the Edit Register Names key under Save, State to enter custom names for each register.

Registers are shared by all modes, so recalling from any one of the registers will cause a mode switch to the mode that was active when the save to the Register occurred.

Although these 16 registers are the only registers available from the front panel, there are 128 state registers available in the instrument. Registers 17–128 are only available from the SCPI interface, using the *RCL command.

After the recall completes, the message "Register <register number> recalled" appears in the message bar. If you are in the Spectrum Analyzer Mode, and you are recalling a register that was saved in the Spectrum Analyzer Mode, then after the recall, you will still be in the Recall Register menu. If the Recall causes you to switch modes, then after the Recall, you will be in the Frequency menu.

If a requested register is empty an error is generated.

Key Path	Recall, State
Example	*RCL 1
Range	1-16 from front panel, 1-128 from SCPI
Readback	Date and time with seconds resolution are displayed on the key OR A custom name of up to 30 characters entered using the Save, State, Edit Register Names key OR “(empty)” if no prior save operation has been performed to this register.
Initial S/W Revision	Prior to A.02.00
Modified at S/W Revision	Prior to A.11.00

Data (Import)

Importing a data file loads data that was previously saved from the current measurement or from other measurements and/or modes that produce compatible data files. The Import Menu only contains Data Types that are supported by the current measurement.

Since the commonly exported data files are in .csv format, the data can be edited by the user prior to importing. This allows you to export a data file, manipulate the data in Excel (the most common PC Application for manipulating .csv files) and then import it.

Importing Data loads measurement data from the specified file into the specified or default destination, depending on the data type selected. Selecting an Import Data menu key will not actually cause the importing to occur, since the analyzer still needs to know from where to get the data. Pressing the Open key in this menu brings up the Open dialog and Open menu that provides you with the options from where to recall the data. Once a filename has been selected or entered in the Open menu, the recall occurs as soon as the Open button is pressed.

Key Path	Recall
Mode	All
Notes	The menu is built from whatever data types are available for the mode. Some keys will be missing completely, so the key locations in the sub-menu will vary. No SCPI command directly controls the Data Type that this key controls. The Data Type is included in the MMEM:LOAD commands.
Dependencies	If a file type is not used by a certain measurement, it is grayed out for that measurement. The key for a file type will not show at all if there are no measurements in the Mode that support it.
Preset	Is not affected by Preset or shutdown, but is reset during Restore Mode Defaults
Readback	The data type that is currently selected
Initial S/W Revision	Prior to A.02.00

Mask

Enables you to recall a preset mask file. This file type (.mask) differs from a normal “state” file because it contains the configuration for Carrier, Offset, and Limit for the specific preset profile BW. A brief description of the mask file is available in the properties view of each file. (Right-mouse-click on the file, select, "Properties" to view this information.) A detailed list of the mask parameter values is located in the .pdf file of the same name in the same directory. Blank values in the .pdf file are parameters that will not be overwritten when recalling the mask.

Key Path	Recall, Data
Mode	WIMAXOFDMA
Remote Command	:MMEMory:LOAD:MASK <string>
Example	:MMEM:LOAD:MASK "MyLimitFile.mask"
Notes	Set of parameters related to Limit, Carrier and Offset are overwritten by Preset Mask file.
Initial S/W Revision	A.02.00

This topic contains the following sections:

["File location and extension" on page 1357](#)

["Example of Preset Mask file" on page 1358](#)

File location and extension

File location: The preset mask file is located in “My Documents\WIMAXOFDMA\data\masks”.

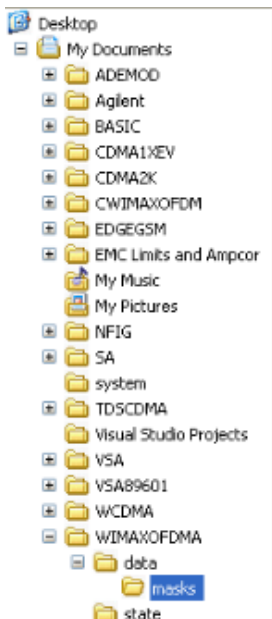

NOTE

When your X-Series analyzer starts, all mask files located in “My Documents\WIMAXOFDMA\data/masks” are overwritten, so any files you wish to save should be stored in another directory location.

File type: The file type is binary file.

File Name: The file name is decided by following naming rules. Each specific keyword is connected with underscore.

<Standard name>_<Radio device>_<Preset Profile BW>_<Measurement>.mask

<Standard name>: This term references the standard associated with each mask file.

<Radio device>: This term specifies to which radio device (BS or MS) the mask file pertains.

<Preset Profile BW>: This term specifies to which Preset Profile BW the mask file pertains.

<Measurement>: This term specifies the measurement to which the mask file is applied. Your selections are: SEM, ACP, or Mode. When selecting **Mode**, the values of some parameters in both the ACP and SEM measurement are overwritten.

File extension: The extension of preset mask file is “mask” to distinguish it from a “state” file.

When you press the open key under the Data menu, the “My Documents\WIMAXOFDMA\data.masks” folder is opened. Select one mask file.

NOTE

When you change the preset BW profile or Radio Device, all measurement parameters are reset to their original values. Thus you have to recall the appropriate preset mask file again after the change.

Example of Preset Mask file

When you import a preset mask file, it is a “Recall” function. Specific parameter values are overwritten by the contents of the preset mask file (see table below). Those values not specified by the preset mask file remain unchanged. Because the file format type is binary, you cannot view, change, or create the preset mask file. Here is an example of a preset mask file used for ACP measurements.

File Location: My Documents/WIMAXOFDMA/data/masks

File Name: ETSI-EN301-021-SysE_BS_10MHz_ACP.mask

The .pdf file that lists the parameters similarly to that shown below is named, "ETSI-EN301-021-SysE_BS_10MHz_ACP.pdf"

The set of parameters listed in the following table for the Preset Profile BW (10MHz) are imported into the ACP measurement.

Offset	Start Freq (MHz)	Stop Freq (MHz)	Sweep Time	Res BW (Hz)	Meas BW	Rel Start	Rel Stop	Fail Mask
A	5	7.14		30k	1	-8	-25	Rel
B	7.14	10.57		30k	1	-25	-27	Rel
C	10.57	20		30k	1	-27	-50	Rel
D	20	25		30k	1	-50	-50	Rel
E	25	30		30k	1	-50	-50	Rel

Zone Map

Pressing this key selects Zone Map as the data type to be imported.

The WiMAX-OFDMA application can load the Singal Studio Setup file, and the OFDMA Map file is compatible with the 89601A Mobile WiMAX omf file.

Key Path	Recall, Data
Remote Command	:MMEMory:LOAD:ZMAP <string>
Example	MMEM:LOAD:ZMAP "ZMap_0000.omf"
Notes	The SCPI parameter is a quoted string that specifies the filename. Both single and double quotes are supported for any filename parameter over SCPI.
Dependencies	You must be in the 802.16 OFDMA (WiMAX/WiBro) mode.
Status Bits/OPC dependencies	Sequential - waits for the previous measurement to complete.
Initial S/W Revision	Prior to A.02.00

Open...

When you press "Open", the analyzer brings up a Windows dialog and a menu entitled "**File Open.**" This menu allows you to navigate to the various fields in the Windows dialog without using a keyboard or mouse. The Tab and Arrow keys can also be used for dialog navigation.

See "[From File...](#)" on page 2241 in Recall, State, for a full description of this dialog and menu.

Key Path	Recall, Data
Notes	The key location is mode-dependent and will vary. Brings up Open dialog for recalling a <mode specific> Save Type
Initial S/W Revision	Prior to A.02.00

Restart

The Restart function restarts the current sweep, or measurement, or set of averaged/held sweeps or measurements. If you are Paused, pressing Restart does a Resume.

The Restart function is accessed in several ways:

- Pressing the Restart key
- Sending the remote command INIT:IMMediate
- Sending the remote command INIT:REStArt

See "[More Information](#)" on page 1360

Key Path	Front-panel key
Remote Command	:INITiate[:IMMediate] :INITiate:REStArt
Example	:INIT:IMM :INIT:REST
Notes	:INITiate:REStArt and :INITiate:IMMediate perform exactly the same function.
Couplings	Resets average/hold count k. For the first sweep overwrites all active (update=on) traces with new current data. For application modes, it resets other parameters as required by the measurement.
Status Bits/OPC dependencies	This is an Overlapped command. The STATus:OPERation register bits 0 through 8 are cleared. The STATus:QUESTionable register bit 9 (INTegrity sum) is cleared. The SWEEPING bit is set. The MEASURING bit is set.
Backwards Compatibility Notes	For Spectrum Analysis mode in ESA and PSA, the Restart hardkey and the INITiate:REStArt command restart trace averages (displayed average count reset to 1) for a trace in Clear Write, but did not restart Max Hold and Min Hold. In the X-Series, the Restart hardkey and the INITiate:REStArt command restart not only Trace Average, but MaxHold and MinHold traces as well. For wireless comms modes in ESA and PSA, the Restart hardkey and the INITiate:REStArt command restart every measurement, which includes all traces and numeric results. There is no change to this operation.
Initial S/W Revision	Prior to A.02.00

More Information

The **Restart** function first aborts the current sweep/measurement as quickly as possible. It then resets the sweep and trigger systems, sets up the measurement and initiates a new data measurement sequence with a new data acquisition (sweep) taken once the trigger condition is met.

If the analyzer is in the process of aligning when **Restart** is executed, the alignment finishes before the restart function is performed.

Even when set for Single operation, multiple sweeps may be taken when Restart is pressed (for example, when averaging/holding is on). Thus when we say that **Restart** "restarts a measurement," we may mean:

- It restarts the current sweep
- It restarts the current measurement
- It restarts the current set of sweeps if any trace is in Trace Average, Max Hold or Min Hold
- It restarts the current set of measurements if Averaging, or Max Hold, or Min Hold is on for the measurement
- depending on the current settings.

With **Average/Hold Number** (in **Meas Setup** menu) set to 1, or Averaging off, or no trace in Trace Average or Hold, a single sweep is equivalent to a single measurement. A single sweep is taken after the trigger condition is met; and the analyzer stops sweeping once that sweep has completed. However, with **Average/Hold Number** >1 and at least one trace set to **Trace Average, Max Hold, or Min Hold (SA Measurement)** or **Averaging on (most other measurements)**, multiple sweeps/data acquisitions are taken for a single measurement. The trigger condition must be met prior to each sweep. The sweep is stopped when the average count k equals the number N set for **Average/Hold Number**. A measurement average usually applies to all traces, marker results, and numeric results; but sometimes it only applies to the numeric results.

Once the full set of sweeps has been taken, the analyzer will go to idle state. To take one more sweep without resetting the average count, increment the average count by 1, by pressing the step up key while **Average/Hold Number** is the active function, or sending the remote command `CALC:AVER:TCON UP`.

Save

The Save menu lets you choose what you want to save and where you want to save it. Among the types of files you can save are **States**, **Traces**, and **Screen Images**. In addition, an Export (Data) option lets you save a number of data types as CSV files for easy import into Excel and other spreadsheet programs.

Key Path	Front-panel key
Mode	All
Notes	No remote command for this key specifically, but the :MMEM:STORe command is available for specific file types. An example is :MMEM:STOR:STATe <filename>.
Initial S/W Revision	Prior to A.02.00

State

The Save State menu lets you choose a register or file for saving the state.

The content of a state file includes all of the settings and data required to return the analyzer as closely as possible to the Mode it was in, with the exact settings which were in place, when the save occurred. The Mode settings in each state file include the settings that are affected by Mode Preset, as well as the additional settings affected by Restore Mode Defaults; all of the Mode's settings. In addition, all of the settings of the Input/Output system are included, even though they are outside of the Mode's state, because they are needed to restore the complete setup. Persistent System settings (for example, Verbose SCPI) are not affected by either Mode Preset or Restore Mode Defaults, nor are they included in a saved State file.

After the save completes, the message "File <filename> saved" or "State Register <register number> saved" is displayed.

For rapid saving, the State menu lists 16 registers to save to. Pressing a Register key initiates the save. You can also select a file to save to.

The default path for all State Files is:

My Documents\<<mode name>\state

where <mode name> is the parameter used to select the mode with the INST:SEL command (for example, SA for the Spectrum Analyzer).

Key Path	Save
Mode	All
Remote Command	:MMEMory:STORe:STATe <filename>
Example	MMEM:STOR:STATe "MyStateFile.state" This stores the current instrument state data in the file MyStateFile.state in the default directory.
Notes	Both single and double quotes are supported for any filename parameter over remote. After saving to a register, that register's menu key is updated with the date the time, unless a custom label has been entered for that key. After saving to a register, you remain in the Save State menu, so that you can see the Register key

update. After saving to a file, the analyzer automatically returns to the previous menu and any Save As dialog goes away.

Backwards Compatibility SCPI	:MMEMory:STORe:STATe 1,<filename>
Initial S/W Revision	Prior to A.02.00

To File . . .

When you press “To File”, the analyzer brings up a Windows dialog and a menu entitled “**Save As.**” This menu allows you to navigate to the various fields in the Windows dialog without using a keyboard or mouse. The Tab and Arrow keys can also be used for dialog navigation.

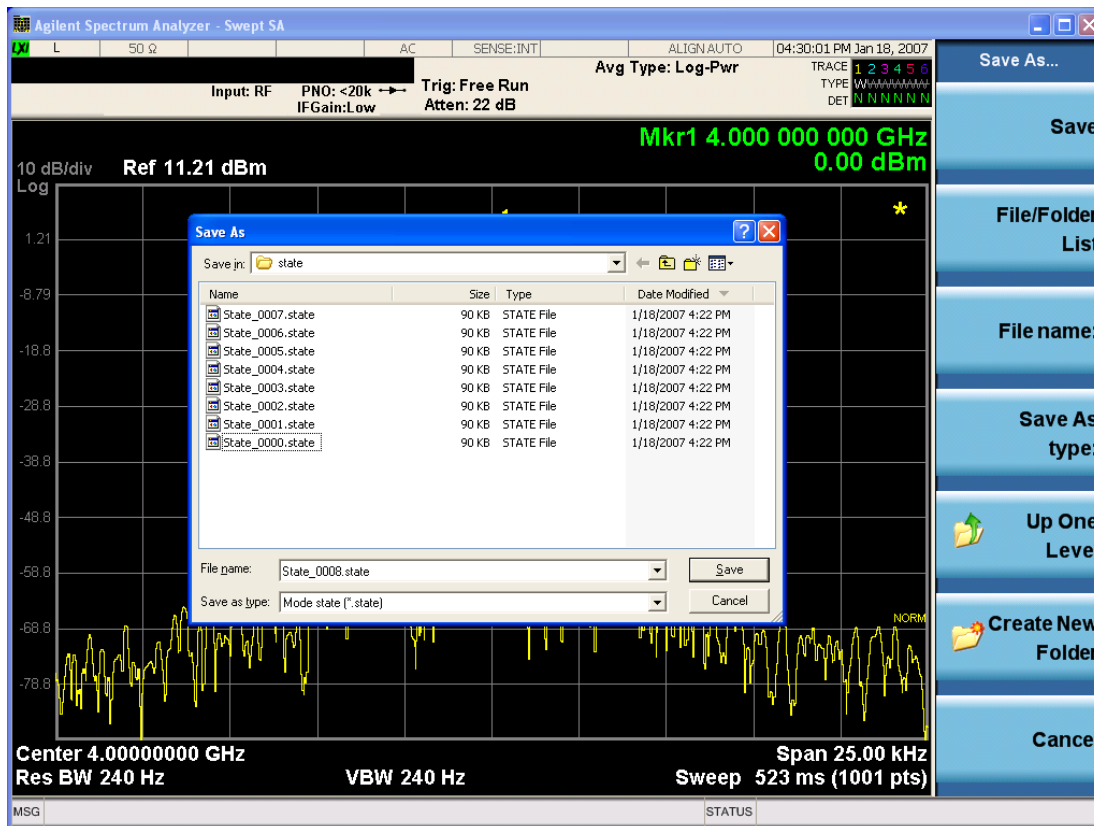

The Listed below

are the functions of the various fields in the dialog, and the corresponding softkeys:

Save

Performs the save to the specified file of the selected type. If the file already exists, a dialog will appear that allows you to replace the existing file by selecting OK, or you can Cancel the request. If you select OK, the file will be overwritten. Using the C: drive is strongly discouraged, since it runs the risk of being overwritten during an instrument software upgrade.

While the save is being performed, the floppy icon appears briefly in the Meas bar.

File/Folder List

Enables you to navigate to the center of the dialog that contains the list of files and folders. Once here you can get information about the file and use the tab keys to navigate to the other fields in the dialog, such as Save In.

Save In

The Save In field shows the path to which the file will be saved and allows you to change the path using the up and down arrow keys to navigate to other paths; the Enter key to open a directory; and the Backspace key to go back one directory. The **Save In field** defaults to the default path for this type of file and remembers the last path you used to save this type of file. There is no softkey for directly navigating to the Save In field but you can use left tab to get here from the File/Folder List.

User specified paths are remembered when you leave and return to a Mode and are reset back to the default using Restore Mode Defaults.

File Name

The File Name field is initially loaded with an automatically generated filename specific to the appropriate Save Type. The automatically generated filename is guaranteed not to conflict with any filename currently in the directory. You may replace or modify this filename using the File Name key. See the ["Quick Save " on page 2237](#) documentation for more on the automatic file naming algorithm.

When you press the File Name key the analyzer displays the Alpha Editor. Use the knob to choose the letter to add and the front-panel Enter key to add the letter to the file name. The BK character moves you back and the FW character moves you forward in the filename. The Select key on the front panel generates a space character. When you are done entering the filename press the Done softkey. This returns back to the **File Open** dialog and menu, but does not cause the save to occur.

Save As Type

This field shows the file suffix for the type of file you have selected to save. For example, if you navigated here while saving State, "Mode state (*.state)" is in the field. If you navigated here from saving Trace, ""Mode state (*.trace)" is in the field. If you navigated here while exporting a trace data file, "Trace Data (*.csv)" is in the field. For some file types, there is more than one choice in the dropdown, which you can select by using the up and down arrow keys and Enter.

Up One Level

This key corresponds to the icon of a folder with the up arrow that is in the tool bar of the dialog. When pressed, it causes the file and folder list to navigate up one level in the directory structure. The Backspace key does the same thing.

Create New Folder

This key corresponds to the icon of a folder with the "*" that is in the tool bar of the dialog. When pressed, a new folder is created in the current directory with the name **New Folder** and you can enter a new folder name using the Alpha Editor.

Cancel

This key corresponds to the Cancel selection in the dialog. It causes the current **Save As** request to be cancelled. The ESC key does the same thing.

Key Path	Save, State
Mode	All
Notes	Brings up Save As dialog for saving a State Save Type
Initial S/W Revision	Prior to A.02.00

Edit Register Names

You may enter a custom name on any of the Register keys, to help you remember what you are using that state to save. To do this, press the Edit Register Names key, choose the register whose name you wish to edit, and then enter the desired label using the Alpha Editor or an external PC keyboard.

The maximum number of characters that can be added is 30. In most cases, 30 characters will fit on two lines of the key.

See ["More Information" on page 1365](#)

Key Path	Save, State
Mode	All
Remote Command	:MMEMory:REGister:STATe:LABel <reg number>,"label" :MMEMory:REGister:STATe:LABel? <reg number>
Example	:MMEM:REG:STAT:LAB 1,"my label"
Notes	<reg number> is an integer from 1 to 16. If the SCPI specifies an invalid register number an error message is generated, -222,"Data out of range;Invalid register label number" "label" is a string from 0 to 30 characters in length. If a label exceeds 30 characters, an error message is generated, -150,"String data error;Label clipped to 30 characters" "label" of length 0 erases the custom label and restores the default (time and date) label. E.g.: :MMEM:REG:STAT:LAB 1,""
Dependencies	N9060A-7FP or N9060B-2FP license required to edit the register names. When the feature is not licensed, sending this command generates an error, -221,"Settings conflict;Option not available"
Preset	The names are unaffected by Preset or power cycle but are set to the default label (time and date) on a "Restore System Defaults->Misc"
Initial S/W Revision	A.11.00

More Information

When you edit one of the register names, the time and date field will be replaced by the custom name.

If you delete all the characters in the custom name, it restores the default (time and date).

The register names are stored within the state files, but they are not part of the instrument state; that is, once you have edited a register name, loading a new state will not change that register name. Another consequence of this is that the names will be persistent through a power cycle. Also, if a named state file is transferred to another analyzer, it will bring its custom name along with it.

If you try to edit the name of an empty register, the analyzer will first save the state to have a file to put the name in. If you load a named state file into an analyzer with older firmware it will ignore the metadata.

The *SAV and *RCL commands will not be affected by the custom register names, nor will the MMEM commands.

Register 1 thru Register 16

Selecting any one of these register menu keys causes the State of the currently active mode to be saved to the specified Register. The registers are provided for rapid saving and recalling, since you do not need to specify a filename or navigate to a file. Each of the register menu keys annotates whether it is empty or at what date and time it was last modified. In addition, you can use the Edit Register Names key to enter custom names for each register.

Although these 16 registers are the only registers available from the front panel, there are 128 state registers available in the instrument. Registers 17–128 are only available from the SCPI interface, using the *SAV command.

There is one set of 128 state registers in the instrument, not one set for each Mode. When a state is saved, the Mode it was saved from is saved with it; then when it is recalled, the instrument switches to that Mode.

After the save completes, the corresponding register menu key annotation is updated with the date and time and the message "Register <register number> saved" is displayed.

Key Path	Save, State
Mode	All
Example	*SAV 1
Range	1–16 from front panel, 1–128 from SCPI
Readback	Date and time with seconds resolution are displayed on the key OR A custom name of up to 30 characters entered using the Edit Register Names key OR “(empty)” if no prior save operation has been performed to this register.
Initial S/W Revision	Prior to A.02.00
Modified at S/W Revision	A.11.00

Register 1 thru Register 16

Selecting any one of these register menu keys causes the State of the currently active mode to be saved to the specified Register. The registers are provided for rapid saving and recalling, since you do not need to specify a filename or navigate to a file. Each of the register menu keys annotates whether it is empty or at what date and time it was last modified. In addition, you can use the Edit Register Names key to enter custom names for each register.

Although these 16 registers are the only registers available from the front panel, there are 128 state registers available in the instrument. Registers 17–128 are only available from the SCPI interface, using the *SAV command.

There is one set of 128 state registers in the instrument, not one set for each Mode. When a state is saved, the Mode it was saved from is saved with it; then when it is recalled, the instrument switches to that Mode.

After the save completes, the corresponding register menu key annotation is updated with the date and time and the message "Register <register number> saved" is displayed.

Key Path	Save, State
Mode	All
Example	*SAV 1
Range	1–16 from front panel, 1–128 from SCPI
Readback	Date and time with seconds resolution are displayed on the key OR A custom name of up to 30 characters entered using the Edit Register Names key OR “(empty)” if no prior save operation has been performed to this register.
Initial S/W Revision	Prior to A.02.00
Modified at S/W Revision	A.11.00

Data (Export)

Exporting a data file stores data from the current measurement to mass storage files. The Export Menu only contains data types that are supported by the current measurement.

Since the commonly exported data files are in .csv format, the data can be edited by you prior to importing. This allows you to export a data file, manipulate the data in Excel (the most common PC Application for manipulating .csv files) and then import it.

Selecting an Export Data menu key will not actually cause the exporting to occur, since the analyzer still needs to know where you wish to save the data. Pressing the Save As key in this menu brings up the Save As dialog and Save As menu that allows you to specify the destination file and directory. Once a filename has been selected or entered in the Open menu, the export will occur as soon as the Save key is pressed.

Key Path	Save
Mode	All
Notes	The menu is built from whatever data types are available for the mode. So the key locations in the sub menu will vary. No SCPI command directly controls the Data Type that this key controls. The Data Type is included in the MMEM:STORe commands.
Dependencies	If a file type is not used by a certain measurement, that type is grayed out for that measurement. The key for a file type will not show at all if there are no measurements in the Mode that support it.
Preset	Is not affected by a Preset or shutdown, but is reset during Restore Mode Defaults
Readback	The data type that is currently selected
Initial S/W Revision	Prior to A.02.00

Measurement Results

Pressing this key selects Meas Results as the data type to be exported.

The Meas Results file contains measurement result sets, plus information describing the current state of the analyzer, as detailed in ["Meas Results File Definition" on page 1368](#) and ["Meas Results File Example" on page 1369](#) below.

Key Path	Save, Data
Remote Command	:MMEMory:STORe:RESults <string>
Example	:MMEM:STOR:RES "MeasR_0000.csv"
Notes	<p>If the save is initiated via SCPI and the file already exists, the file will be overwritten.</p> <p>The SCPI command exports Occupied Bandwidth measurement results to the file specified as the parameter in the current path. The default path is My Documents\<current mode>\data\obw\results.<="" p=""><p>Using the C: drive is strongly discouraged, since it runs the risk of being overwritten during an instrument software upgrade.</p><p>The SCPI parameter is a quoted string that specifies the filename. Both single and double quotes are supported for any filename parameter over SCPI.</p></current></p>
Dependencies	The current active measurement must be the Occupied Bandwidth measurement to use this command.
Status Bits/OPC dependencies	Sequential – waits for the previous measurement to complete
Initial S/W Revision	Prior to A.02.00

Meas Results File Definition

The content of a Meas Results File is defined in this section.

The first lines in the file consist of identification and instrument configuration details, as follows.

- File ID string, which is "MeasResult"
- Measurement ID following Mode ID, which is "SA:OBW" for example.
- Firmware rev and model number
- Option string
- Auto Sweep Time Rules
- Average Mode
- Average Number
- Average State
- Center Frequency
- Detector
- Electrical Atten

- Electrical Atten State
- IFGain
- IFGainAuto
- Internal Preamp
- Internal Preamp Band
- Limit
- Limit State
- Max Hold
- Mechanical Atten
- MechanicalAttenStepEnum
- OBW Percent Pwr
- Resolution Band Width
- Resolution Bandwidth Shape
- Span
- Sweep Points
- Sweep Time
- Sweep Time Auto
- TriggerSource
- Video Bandwidth
- x DB

The data above is followed in the file by a line containing “MeasResult1” and “MeasResult2”. This line forms a header for each set of measurement results, which appear in subsequent lines. Each line of Measurement Results consists of two comma-separated values, for MeasResult1 and MeasResult2 respectively.

The MeasResult1 set in the file corresponds to the data returned by MEAS|READ|FETCh:OBWidth1, and the MeasResult2 set corresponds to the data returned by MEAS|READ|FETCh:OBWidth2.

The exported file is in CSV format, with a .csv extension.

Meas Results File Example

When imported into Microsoft Excel, a typical Meas Results CSV file appears as shown in the example below.

MeasResult

SA:OBW

A.10.53	N9030A
526 ALV ATP B1X B1Y B25 B40 BBA CR3 CRP DCF DDA DP2 DRD EA3 EDP EMC EP1 ERC ESC ESP EXM FSA LFE LNP MAT MPB NFE NUL P26 PFR PNC RTL RTS S40 SB1 SEC SM1 TVT YAS YAV	1
Auto Sweep Time Rules	Normal
Average Mode	Exponential
Average Number	10
Average State	TRUE
Center Frequency	1.33E+10
Detector	Average
IFGain	FALSE
IFGainAuto	FALSE
Internal Preamp	FALSE
Internal Preamp Band	Low
Limit	5000000
Limit State	FALSE
Max Hold	FALSE
OBW Percent Pwr	99
Resolution Band Width	27000
Resolution Bandwidth Shape	Gaussian
Span	3000000
Sweep Points	1001
Sweep Time	0.004933
Sweep Time Auto	TRUE
TriggerSource	Free
Video Bandwidth	270000
x DB	-26
MeasResult1	MeasResult2
2971020.10835045	-94.3702543927405
-74.9741251886604	-94.1447790390963

Zone Map

Pressing this key selects Zone Map as the data type to be exported.

The Zone Map file contains information about current Zone Map configuration. Its format is compatible with the 89601A OFDMA map file. It is detailed in ["Zone Map File Contents" on page 1371](#) below.

Key Path	Save, Data
Remote Command	:MMEMory:STORe:ZMAP <string>
Example	MMEM:STOR:ZMAP "ZMap_0000.omf"
Notes	<p>If the save is initiated via SCPI and the file already exists, the file will be overwritten.</p> <p>The SCPI command exports Zone Map information to the file specified as the parameter in the current path. The default path is My Documents\WIMAXOFDMA\.</p> <p>Using the C: drive is strongly discouraged, since it runs the risk of being overwritten during an instrument software upgrade.</p> <p>The SCPI parameter is a quoted string that specifies the filename. Both single and double quotes are supported for any filename parameter over SCPI.</p>
Dependencies	You must be in the 802.16 OFDMA (WiMAX/WiBro) mode.
Status Bits/OPC dependencies	Sequential - waits for the previous measurement to complete.
Initial S/W Revision	Prior to A.02.00

Zone Map File Contents

A Zone Map File contains the following information of the Zone Map configuration. See ["Zone Map Data" on page 329](#) for detailed definitions.

- DemodOfdmaMap_AutoDetect
- DemodOfdmaMap_Count
- DemodOfdmaMap_F1_DL_Count
- DemodOfdmaMap_F1_DL_Z1_Active
- DemodOfdmaMap_F1_DL_Z1_AmcType
- DemodOfdmaMap_F1_DL_Z1_B1_Active
- DemodOfdmaMap_F1_DL_Z1_B1_AllocType
- DemodOfdmaMap_F1_DL_Z1_B1_Boost
- DemodOfdmaMap_F1_DL_Z1_B1_BurstType
- DemodOfdmaMap_F1_DL_Z1_B1_ColorIndex
- DemodOfdmaMap_F1_DL_Z1_B1_ModType
- DemodOfdmaMap_F1_DL_Z1_B1_Name
- DemodOfdmaMap_F1_DL_Z1_B1_SubchannelInterval
- DemodOfdmaMap_F1_DL_Z1_B1_SubchannelOffset
- DemodOfdmaMap_F1_DL_Z1_B1_SymbolInterval
- DemodOfdmaMap_F1_DL_Z1_B1_SymbolOffset

- DemodOfdmaMap_F1_DL_Z1_Count
- DemodOfdmaMap_F1_DL_Z1_DedicPilots
- DemodOfdmaMap_F1_DL_Z1_IDCell
- DemodOfdmaMap_F1_DL_Z1_IDCellCouple
- DemodOfdmaMap_F1_DL_Z1_Len
- DemodOfdmaMap_F1_DL_Z1_Locked
- DemodOfdmaMap_F1_DL_Z1_Name
- DemodOfdmaMap_F1_DL_Z1_PrbsID
- DemodOfdmaMap_F1_DL_Z1_StcMatrix
- DemodOfdmaMap_F1_DL_Z1_StcType
- DemodOfdmaMap_F1_DL_Z1_SymOffset
- DemodOfdmaMap_F1_DL_Z1_UseAllSC
- DemodOfdmaMap_F1_DL_Z1_WrapType
- DemodOfdmaMap_F1_DL_Z1_ZoneType
- DemodOfdmaMap_F1_UL_Count
- DemodOfdmaMap_F1_UL_Z1_Active
- DemodOfdmaMap_F1_UL_Z1_AmcType
- DemodOfdmaMap_F1_UL_Z1_B1_Active
- DemodOfdmaMap_F1_UL_Z1_B1_AllocType
- DemodOfdmaMap_F1_UL_Z1_B1_Boost
- DemodOfdmaMap_F1_UL_Z1_B1_BurstType
- DemodOfdmaMap_F1_UL_Z1_B1_ColorIndex
- DemodOfdmaMap_F1_UL_Z1_B1_ModType
- DemodOfdmaMap_F1_UL_Z1_B1_Name
- DemodOfdmaMap_F1_UL_Z1_B1_PilotPattern
- DemodOfdmaMap_F1_UL_Z1_B1_StcMode
- DemodOfdmaMap_F1_UL_Z1_B1_SubchannelInterval
- DemodOfdmaMap_F1_UL_Z1_B1_SubchannelOffset
- DemodOfdmaMap_F1_UL_Z1_B1_SymbolInterval
- DemodOfdmaMap_F1_UL_Z1_B1_SymbolOffset
- DemodOfdmaMap_F1_UL_Z1_Count

- DemodOfdmaMap_F1_UL_Z1_Gap
- DemodOfdmaMap_F1_UL_Z1_IDCell
- DemodOfdmaMap_F1_UL_Z1_Len
- DemodOfdmaMap_F1_UL_Z1_Locked
- DemodOfdmaMap_F1_UL_Z1_Name
- DemodOfdmaMap_F1_UL_Z1_SymOffset
- DemodOfdmaMap_F1_UL_Z1_UseSubchRotate
- DemodOfdmaMap_F1_UL_Z1_WrapType
- DemodOfdmaMap_F1_UL_Z1_ZoneType
- DemodOfdmaMap_Name
- DemodOfdmaMap_RefreshMap

Save As . . .

When you press “Save As”, the analyzer brings up a Windows dialog and a menu entitled “**Save As.**” This menu allows you to navigate to the various fields in the Windows dialog without using a keyboard or mouse. The Tab and Arrow keys can also be used for dialog navigation.

See "[To File . . .](#)" on page 2252 in Save, State for a full description of this dialog and menu.

The default path for saving files is:

For all of the Trace Data Files:

My Documents\`<mode name>`\data\traces

For all of the Limit Data Files:

My Documents\`<mode name>`\data\limits

For all of the Measurement Results Data Files:

My Documents\`<mode name>`\data\`<measurement name>`\results

For all of the Capture Buffer Data Files:

My Documents\`<mode name>`\data\captureBuffer

Key Path	Save, Data
Mode	All
Notes	The key location is mode-dependent and will vary. Brings up the Save As dialog for saving a <code><mode specific></code> Save Type. The save is performed immediately and does not wait until the measurement is complete.
Initial S/W Revision	Prior to A.02.00

Screen Image

Pressing Screen Image accesses a menu of functions that enable you to specify a format and location for the saved screen image. It brings up a menu that allows you to specify the color scheme of the Screen Image (Themes) or navigate to the Save As dialog to perform the actual save.

Screen Image files contain an exact representation of the analyzer display. They cannot be loaded back onto the analyzer, but they can be loaded into your PC for use in many popular applications.

The image to be saved is actually captured when the Save front panel key is pressed, and kept in temporary storage to be used if you ask for a Screen Image save. When the Screen Image key is pressed, a "thumbnail" of the captured image is displayed, as shown below:

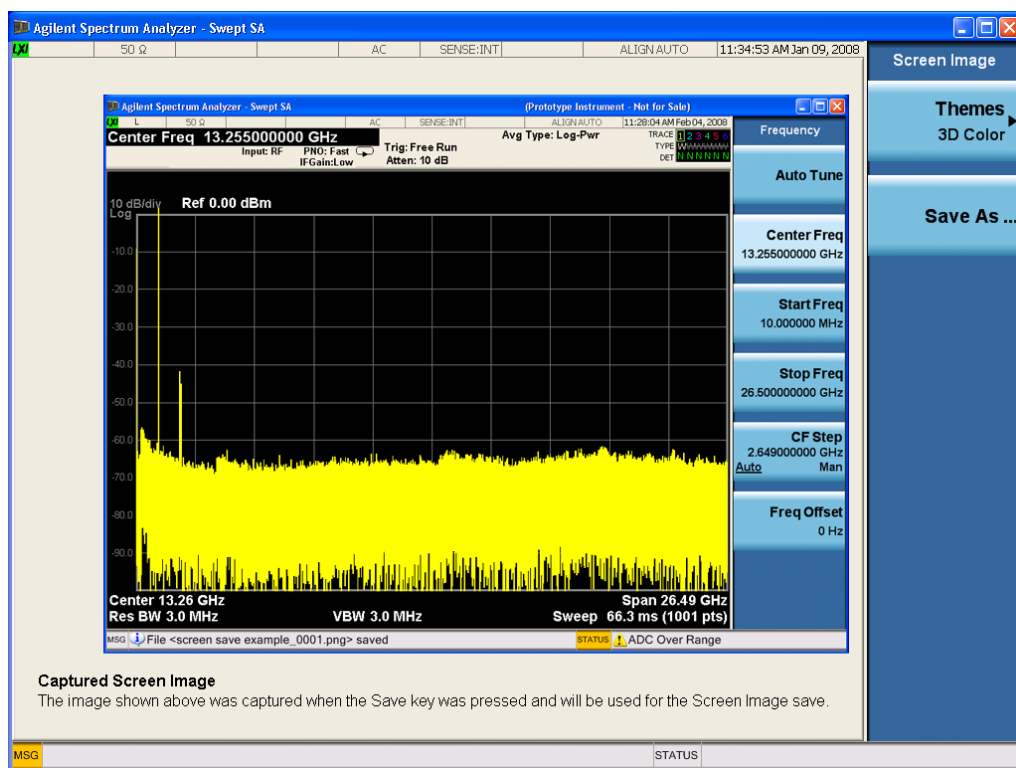

When you continue on into the Save As menu and complete the Screen Image save, the image depicted in the thumbnail is the one that gets saved, showing the menus that were on the screen before going into the Save menus. The save is performed immediately and does not wait until the measurement is complete.

After you have completed the save, the Quick Save front-panel key lets you quickly repeat the last save performed, using an auto-named file, with the current screen data.

NOTE

For versions previous to A.01.55, if you initiate a screen image save by navigating through the Save menus, the image that is saved will contain the Save menu softkeys, not the menus and the active function that were on the screen when you first pressed the Save front panel key.

Key Path	Save
Mode	All

Remote Command	:MMEMory:STORe:SCReen <filename>
Example	:MMEM:STOR:SCR "myScreen.png" This stores the current screen image in the file MyScreenFile.png in the default directory.
Initial S/W Revision	Prior to A.02.00

Themes

Accesses a menu of functions that enable you to choose the theme to be used when saving the screen image.

The **Themes** option is the same as the **Themes** option under the **Display** and **Page Setup** dialogs. It allows you to choose between themes to be used when saving the screen image.

Key Path	Save, Screen Image
Remote Command	:MMEMory:STORe:SCReen:THEME TDColor TDMonochrome FCOLOR FMONochrome :MMEMory:STORe:SCReen:THEMe?
Example	:MMEM:STOR:SCR:THEM TDM
Preset	3D Color; Is not part of Preset, but is reset by Restore Misc Defaults or Restore System Defaults All and survives subsequent running of the modes.
Readback	3D Color 3D Mono Flat Color Flat Mono
Backwards Compatibility Notes	In ESA and PSA we offer the choice of "Reverse Bitmap" or "Reverse Metafile" when saving screen images. This is much like the "Flat Color" theme available in X-Series. Also, if you selected Reverse Bitmap AND a black & white screen image, that would be much like "Flat Monochrome". In other words, each of the X-Series themes has a similar screen image type in ESA/PSA. But they are not identical.
Initial S/W Revision	Prior to A.02.00

3D Color

Selects a standard color theme with each object filled, shaded and colored as designed.

Key Path	Save, Screen Image, Themes
Example	MMEM:STOR:SCR:THEM TDC
Readback	3D Color
Initial S/W Revision	Prior to A.02.00

3D Monochrome

Selects a format that is like 3D color but shades of gray are used instead of colors.

Key Path	Save, Screen Image, Themes
Example	MMEM:STOR:SCR:THEM TDM
Readback	3D Mono
Initial S/W Revision	Prior to A.02.00

Flat Color

Selects a format that is best when the screen is to be printed on an ink printer.

Key Path	Save, Screen Image, Themes
Example	MMEM:STOR:SCR:THEM FCOL
Readback	Flat Color
Initial S/W Revision	Prior to A.02.00

Flat Monochrome

Selects a format that is like Flat Color. But only black is used (no colors, not even gray), and no fill.

Key Path	Save, Screen Image, Themes
Example	MMEM:STOR:SCR:THEM FMON
Readback	Flat Mono
Initial S/W Revision	Prior to A.02.00

Save As...

When you press "Save As", the analyzer brings up a Windows dialog and a menu entitled "**Save As.**" This menu allows you to navigate to the various fields in the Windows dialog without using a keyboard or mouse. The Tab and Arrow keys can also be used for dialog navigation.

See "[To File . . .](#)" on page 2252 in Save, State for a full description of this dialog and menu.

The default path for Screen Images is

My Documents\`<mode name>`\screen.

where `<mode name>` is the parameter used to select the mode with the INST:SEL command (for example, SA for the Spectrum Analyzer).

Key Path	Save, Screen Image
Notes	Brings up Save As dialog for saving a Screen Image Save Type
Initial S/W Revision	Prior to A.02.00

Mass Storage Catalog (Remote Command Only)

Key path	SCPI Only
Remote Command	:MMEMory:CATalog? [<directory_name>]
Notes	<p>The string must be a valid logical path.</p> <p>Queries disk usage information (drive capacity, free space available) and obtains a list of files and directories in a specified directory in the following format: <numeric_value>,<numeric_value>,{<file_entry>}</p> <p>It returns two numeric parameters and as many strings as there are files and directories. The first parameter indicates the total amount of storage currently used in bytes. The second parameter indicates the total amount of storage available, also in bytes. The <file_entry> is a string. Each <file_entry> indicates the name, type, and size of one file in the directory list: <file_name>,<file_type>,<file_size></p> <p>As the windows file system has an extension that indicates file type, <file_type> is always empty. <file_size> provides the size of the file in bytes. For directories, <file_entry> is surrounded by square brackets and both <file_type> and <file_size> are empty</p>
Initial S/W Revision	Prior to A.02.00

Mass Storage Change Directory (Remote Command Only)

Key path	SCPI Only
Remote Command	:MMEMory:CDIRectory [<directory_name>] :MMEMory:CDIRectory?
Notes	<p>The string must be a valid logical path.</p> <p>Changes the default directory for a mass memory file system. The <directory_name> parameter is a string. If no parameter is specified, the directory is set to the *RST value.</p> <p>At *RST, this value is set to the default user data storage area, that is defined as System.Environment.SpecialFolder.Personal.</p> <p>Query returns full path of the default directory.</p>
Initial S/W Revision	Prior to A.02.00

Mass Storage Copy (Remote Command Only)

Key path	SCPI Only
Remote Command	:MMEMory:COPY <string>,<string>[,<string>,<string>]
Notes	<p>The string must be a valid logical path.</p> <p>Copies an existing file to a new file or an existing directory to a new directory.</p> <p>Two forms of parameters are allowed. The first form has two parameters. In this form, the first parameter specifies the source, and the second parameter specifies the destination.</p> <p>The second form has four parameters. In this form, the first and third parameters specify the source. The second and fourth parameters specify the directories. The first pair of parameters specifies the</p>

source. The second pair specifies the destination. An error is generated if the source doesn't exist or the destination file already exists.

This command will generate an "access denied" error if the destination is a restricted folder (e.g., C:\Windows) and the current user does not have Power User or Administrator privileges.

Mass Storage Device Copy (Remote Command Only)

This command transfers data to/from a file and a peripheral device.

Key path	SCPI Only
Remote Command	:MMEMory:COpy:DEvice <source_string>,<dest_string>
Notes	<p>The strings must be a valid logical path or a valid device keyword. If the dest_string is a device keyword, the data is copied from the source file to the device. If the source_string is a device keyword, the data is copied to the source file from the device.</p> <p>Valid device keywords are:</p> <p>SNS (smart noise source)</p> <p>An error is generated if the file or device is not found.</p>

Mass Storage Delete (Remote Command Only)

Key path	SCPI Only
Remote Command	:MMEMory:DElete <file_name>[,<directory_name>]
Notes	<p>The string must be a valid logical path.</p> <p>Removes a file from the specified directory. The <file_name> parameter specifies the file name to be removed. This command will generate an "access denied" error if the file is in a restricted folder (e.g., C:\Windows) and the current user does not have Power User or Administrator privileges.</p>
Initial S/W Revision	Prior to A.02.00

Mass Storage Data (Remote Command Only)

Creates a file containing the specified data OR queries the data from an existing file.

Key path	SCPI Only
Remote Command	<p>:MMEMory:DATA <file_name>,<data></p> <p>:MMEMory:DATA? <file_name></p>
Notes	<p>The string must be a valid logical path.</p> <p>The command form is MMEMory:DATA <file_name>,<data>. It loads <data> into the file <file_name>. <data> is in 488.2 block format. <file_name> is string data.</p> <p>The query form is MMEMory:DATA? <file_name> with the response being the associated <data> in block format.</p>
Initial S/W Revision	Prior to A.02.00

Mass Storage Make Directory (Remote Command Only)

Key path	SCPI Only
Remote Command	:MMEMory:MDIRectory <directory_name>
Notes	<p>The string must be a valid logical path.</p> <p>Creates a new directory. The <directory_name> parameter specifies the name to be created.</p> <p>This command will generate an “access denied” error if the new directory would be in a restricted folder (e.g., C:\Windows) and the current user does not have Power User or Administrator privileges.</p>
Initial S/W Revision	Prior to A.02.00

Mass Storage Move (Remote Command Only)

Key path	SCPI Only
Remote Command	:MMEMory:MOVE <string>,<string>[,<string>,<string>]
Notes	<p>The string must be a valid logical path.</p> <p>Moves an existing file to a new file or an existing directory to a new directory.</p> <p>Two forms of parameters are allowed. The first form has two parameters. In this form, the first parameter specifies the source, and the second parameter specifies the destination.</p> <p>The second form has four parameters. In this form, the first and third parameters specify the source. The second and fourth parameters specify the directories. The first pair of parameters specifies the source. The second pair specifies the destination. An error is generated if the source doesn't exist or the destination file already exists.</p> <p>This command will generate an “access denied” error if the destination is a restricted folder (e.g., C:\Windows) and the current user does not have Power User or Administrator privileges.</p>
Initial S/W Revision	Prior to A.02.00

Mass Storage Remove Directory (Remote Command Only)

Key path	SCPI Only
Remote Command	:MMEMory:RDIRectory <directory_name>
Notes	<p>The string must be a valid logical path.</p> <p>Removes a directory. The <directory_name> parameter specifies the directory name to be removed. All files and directories under the specified directory shall also be removed.</p> <p>This command will generate an “access denied” error if the folder is a restricted folder (e.g., C:\Windows) or is in a restricted folder and the current user does not have Power User or Administrator privileges.</p>
Initial S/W Revision	Prior to A.02.00

Single (Single Measurement/Sweep)

Sets the analyzer for Single measurement operation. The single/continuous state is Meas Global, so the setting will affect all the measurements. If you are Paused, pressing Single does a Resume.

See ["More Information" on page 1380](#)

Key Path	Front-panel key
Example	:INIT:CONT OFF
Notes	See Cont key description.
Backwards Compatibility Notes	<p>For Spectrum Analysis mode in ESA and PSA, the Single hardkey and the INITiate:IMM switched from continuous measurement to single measurement and restarted sweeps and averages (displayed average count reset to 1), but did not restart Max Hold and Min Hold. In the X-Series, the Single hardkey and the INITiate:IMM command initiate a sweep/ measurement/ average sequence/hold sequence including MaxHold and MinHold.</p> <p>For Spectrum Analysis mode in ESA and PSA, the Single hardkey restarted the sweep regardless of whether or not you were in an active sweep or sweep sequence. In the X-Series, Restart does this but Single only restarts the sweep or sweep sequence if you are in the idle state.</p> <p>INIT[:IMM] in ESA & PSA Spectrum Analysis Mode does an implied ABORT. In some other PSA Modes, INIT[:IMM] is ignored if not in the idle state. . The X-Series follows the ESA/PSA SA Mode model, which may cause some Modes to have compatibility problems.</p>
Initial S/W Revision	Prior to A.02.00

More Information

See ["Restart" on page 2249](#) for details on the INIT:IMMEDIATE (Restart) function.

If you are already in single sweep, the INIT:CONT OFF command has no effect.

If you are already in Single Sweep, then pressing the Single key in the middle of a sweep does not restart the sweep or sequence. Similarly, pressing the Single key does not restart the sweep or sequence if the sweep is not in the idle state (for example, if you are taking a very slow sweep, or the analyzer is waiting for a trigger). Instead, it results in a message. "Already in Single, press Restart to initiate a new sweep or sequence". Even though pressing the Single key in the middle of a sweep does not restart the sweep, sending INIT:IMMEDIATE does reset it.

To take one more sweep without resetting the average count, increment the average count by 1, by pressing the step up key while **Average/Hold Number** is the active function, or sending the remote command CALC:AVER:TCON UP.

Source

There is no Source control functionality for this measurement. When this key is pressed, the screen either displays a blank menu, or the previously-selected menu remains unchanged.

Key Path	Front-panel key
----------	-----------------

Span X Scale

Activates the Span function and displays the menu of span functions. The parameter values are measurement independent.

Key Path	Front-panel key
Initial S/W Revision	Prior to A.02.00

Span

Set the frequency of the occupied bandwidth span for the current measurement.

Key Path	Span X Scale
Mode	SA, WCDMA, C2K, WIMAX OFDMA, TD-SCDMA, 1xEVDO, ISDB-T, CMMB, LTE, LTETDD, BLUETOOTH, WLAN, MSR, LTEAFDD, LTEATDD
Remote Command	[:SENSe] :OBWidth:FREQuency:SPAN <freq> [:SENSe] :OBWidth:FREQuency:SPAN? [:SENSe] :OBWidth:FREQuency:SPAN:AUTO ON OFF 0 1 [:SENSe] :OBWidth:FREQuency:SPAN:AUTO?
Example	OBW:FREQ:SPAN 2.4 MHz OBW:FREQ:SPAN? OBW:FREQ:SPAN:AUTO 0 OBW:FREQ:SPAN:AUTO?
Notes	Span Auto Detector ([:SENSe] :OBWidth:FREQuency:SPAN:AUTO) is only available in MSR and LTE-Advanced FDD/TDD mode. The BAF SCPI is MSR and LTE-Advanced FDD/TDD only.
Couplings	When changing the Occupied Bandwidth Span, the Resolution Bandwidth and Video Bandwidth are set to AUTO to prevent the span from clipping. This is only available in MSR and LTE-Advanced FDD/TDD mode.
Preset	SA: 3 MHz WCDMA: 10 MHz WIMAX OFDMA: 20 MHz CDMA2K: 2 MHz TD-SCDMA: 4.8 MHz 1xEVDO: 3.75 MHz ISDB-T: 20 MHz CMMB: 8 MHz LTE, LTETDD, LTEAFDD, LTEATDD: 10 MHz BLUETOOTH:2 MHz WLAN: If Radio Std is 802.11a/g 802.11n(20MHz) 802.11ac(20MHz): 25 MHz If Radio Std is 802.11b: 30MHz

	If Radio Std is 802.11n(40MHz), 802.11ac (40MHz): 50 MHz If Radio Std is 802.11ac(80MHz): 100MHz If Radio Std is 802.11ac(160MHz): 200MHz MSR: 20MHz ON
State Saved	Saved in instrument state.
Min	100 Hz
Max	Hardware Maximum Span
Backwards Compatibility SCPI	[:SENSe] :EBWidth :FREQuency :SPAN
Initial S/W Revision	Prior to A.02.00
Modified at S/W Revision	A.03.00, A.10.00, A.14.00

Full Span

Changes the Occupied Bandwidth Span to show the full frequency range of the analyzer. When using external mixing, it changes the displayed frequency span to the frequency range specified for the selected external mixing band.

Key Path	Span X Scale
Mode	SA, WCDMA, C2K, WIMAX OFDMA, ISDB-T, CMMB, LTE, LTETDD, BLUETOOTH, WLAN
Remote Command	[:SENSe] :OBWidth :FREQuency :SPAN :FULL
Example	OBW:FREQ:SPAN:FULL
Notes	You must be in the Spectrum Analysis mode, W-CDMA mode, ISDB-T mode, CMMB mode, LTE mode, LTE TDD mode, BLUETOOTH mode, WLAN mode, cdma2000 mode, MSR or WIMAX OFDMA mode to use this command. Use:INSTrument:SElect to set the mode.
Dependencies	For MSR and LTE-Advanced FDD/TDD mode, this key is blank.
Couplings	Selecting full span changes the measurement span value.
Initial S/W Revision	Prior to A.02.00
Modified at S/W Revision	A.03.00

Last Span

Changes the measurement frequency span to previous measurement span setting. If there is no existing previous span value then the span remains unchanged.

Key Path	Span X Scale
Mode	SA, WCDMA, C2K, WIMAX OFDMA, ISDB-T, CMMB, LTE, LTETDD, BLUETOOTH, WLAN, MSR, LTEAFDD, LTEATDD
Remote Command	[:SENSe] :OBWidth :FREQuency :SPAN :PREVIOUS

Example	OBW:FREQ:SPAN:PREV
Notes	You must be in the Spectrum Analysis mode, W-CDMA mode, ISDB-T mode, CMMB mode, LTE mode, LTE TDD mode, BLUETOOTH mode, WLAN mode, cdma2000 mode, MSR, LTE-Advanced FDD/TDD or WIMAX OFDMA mode to use this command. Use:INSTrument:SElect to set the mode.
Couplings	Selecting last span changes the measurement span value.
Initial S/W Revision	Prior to A.02.00
Modified at S/W Revision	A.03.00

Sweep/Control

Displays a menu of functions that enable you to set up and control the sweep time and source for the current measurement.

For details about this key, see ["Sweep/Control" on page 2282](#).

Key Path	Front-panel key
Initial S/W Revision	Prior to A.02.00

Sweep Time

Selects the length of time in which the spectrum analyzer sweeps the displayed frequency span. Additional overhead time, which impacts the sweep rate, is not calculated as part of the sweep time. In fact:

- sweep rate = span/sweep time
- update rate = 1/(sweep time + overhead)
- sweep cycle time = sweep time + overhead

Sweep time is coupled to RBW and VBW, and is impacted by the number of sweep points, so changing those parameters may change the sweep time.

This function is not available when the selected input is I/Q.

Key Path	Sweep/Control
Mode	SA, WCDMA, C2K, WIMAX OFDMA, TD-SCDMA, 1xEVDO, ISDB-T, CMMB, LTE, LTETDD, BLUETOOTH, WLAN, MSR, LTEAFDD, LTEATDD
Remote Command	[:SENSe]:OBWidth:SWEep:TIME <time> [:SENSe]:OBWidth:SWEep:TIME? [:SENSe]:OBWidth:SWEep:TIME:AUTO OFF ON 0 1 [:SENSe]:OBWidth:SWEep:TIME:AUTO?
Example	OBW:SWE:TIME 50 ms OBW:SWE:TIME? OBW:SWE:TIME:AUTO ON OBW:SWE:TIME:AUTO?
Couplings	When you manually change the Time, this state automatically goes to 'Man'.
Preset	SA, WIMAX OFDMA, C2K, TD-SCDMA, 1xEVDO, ISDB-T, CMMB, LTE, LTETDD, BLUETOOTH, WLAN, MSR, LTEAFDD, LTEATDD: Automatically Calculated WCDMA: 32.6 ms SA, WIMAX OFDMA, C2K, TD-SCDMA, 1xEVDO, ISDB-T, CMMB, LTE, LTETDD, WLAN, MSR, LTEAFDD, LTEATDD: ON WCDMA: OFF
State Saved	Saved in instrument state.

Min	1 ms
Max	4000 s
Initial S/W Revision	Prior to A.02.00
Modified at S/W Revision	A.03.00

Sweep Setup

Accesses the sweep setup settings for the current measurement.

Key Path	Sweep/Control
Initial S/W Revision	Prior to A.02.00

Auto Sweep Time Rules

Switches the analyzer between normal and accuracy sweep states.

Setting Auto Sweep Time to Accy results in slower sweep times, usually about three times as long, but better amplitude accuracy for CW signals. The instrument amplitude accuracy specifications only apply when Auto Sweep Time is set to Accy.

Additional amplitude errors which occur when Auto Sweep Time is set to Norm are usually well under 0.1 dB, though this is not guaranteed. Because of the faster sweep times and still low errors, Norm is the preferred setting of Auto Sweep Time. Auto Sweep Time is set to Norm on a Preset or Auto Couple. This means that in the Preset or Auto Coupled state, instrument amplitude accuracy specifications do not apply.

Key Path	Sweep/Control, Sweep Setup
Mode	SA, WCDMA, C2K, WIMAX OFDMA, TD-SCDMA, 1xEVDO, ISDB-T, CMMB, LTE, LTETDD, BLUETOOTH, WLAN, MSR, LTEAFDD, LTEATDD
Remote Command	[:SENSe] :OBWidth :SWEep :TIME :AUTO :RULes NORMal ACCuracy [:SENSe] :OBWidth :SWEep :TIME :AUTO :RULes ?
Example	OBW:SWE:TIME:AUTO:RUL NORM OBW:SWE:TIME:AUTO:RUL ?
Notes	Set to Norm when Auto Couple is pressed or sent remotely.
Preset	NORMal
State Saved	Saved in instrument state.
Range	Norm Accy
Initial S/W Revision	Prior to A.02.00
Modified at S/W Revision	A.03.00

Pause

Pauses the measurement after the current data acquisition is complete.

When Paused, the label on the key changes to Resume. Pressing Resume resumes the measurement at the point where it had been paused.

See "[Pause/Resume](#)" on page 2282 for more information.

Key Path	Sweep/Control
Initial S/W Revision	Prior to A.02.00

Gate

Accesses a menu that enables you to control the gating function. The Gate functionality is used to view signals best viewed by qualifying them with other events.

Gate setup parameters are the same for all measurements – they do not change as you change measurements. Settings like these are called “Meas Global” and are unaffected by Meas Preset.

Note that Sweep Time autocoupling rules and annotation are changed by Gate being on.

Key Path	Sweep/Control
Scope	Meas Global
Readback	The state and method of Gate, as [Off, LO] or [On, Video]. Note that for measurements that only support gated LO, the method is nonetheless read back, but always as LO.
Initial S/W Revision	Prior to A.02.00

Gate On/Off

Turns the gate function on and off.

When the Gate Function is on, the selected Gate Method is used along with the gate settings and the signal at the gate source to control the sweep and video system with the gate signal. Not all measurements allow every type of Gate Methods.

When Gate is on, the annunciation in the measurement bar reflects that it is on and what method is used, as seen in the following "Gate: LO" annunciator graphic.

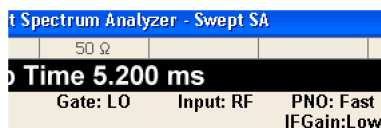

Key Path	Sweep/Control, Gate
Remote Command	[:SENSe] :SWEep:EGATE [:STATe] OFF ON 0 1

	[:SENSe] :SWEep:EGATe [:STATe] ?
Example	SWE:EGAT ON SWE:EGAT?
Dependencies	<p>The function is unavailable (grayed out) and Off when:</p> <ul style="list-style-type: none"> • Gate Method is LO or Video and FFT Sweep Type is manually selected. • Gate Method is FFT and Swept Sweep Type is manually selected. • Marker Count is ON. <p>The following are unavailable whenever Gate is on:</p> <ul style="list-style-type: none"> • FFT under Sweep Type when Method=LO or Video or Swept under Sweep Type when Method=FFT • Marker Count <p>While Gate is on, the Auto Rules for Sweep Type are modified so that the choice agrees with the Gate Method: i.e., FFT for Method = FFT and Swept for Method = LO or Video.</p> <p>The Gate softkey and all SCPI under the [:SENSe]:SWEep:EGATe SCPI node are grayed out when Source Mode is Tracking with an external source. This is because the Gate circuitry is used to sync the external source. If the Tracking Source is turned on, the Gate is turned off.</p> <p>When in the ACP measurement:</p> <ul style="list-style-type: none"> • When Meas Method is RBW or FAST, this function is unavailable and the key is grayed out. • Whenever Gate is on, Meas Method, RBW or FAST is unavailable and keys for those are grayed out. • When Gate is on, Offset Res BW and Offset Video BW are ignored (if you set these values) and the measurement works as if all Offset Res BW and all Offset Video BW are coupled with the Res BW and the Video BW under the BW menu. When Gate is on, the Offset BW key in the Offset/Limit menu is grayed out.
Preset	Off LTETDD: On
State Saved	Saved in instrument state
Range	On Off
Backwards Compatibility SCPI	[:SENSe]:SWEep:TIME:GATE[:STATe] ESA compatibility
Backwards Compatibility Notes	In ESA, Trig Delay (On) and Gate (On) could not be active at the same time.. This dependency does not exist in PSA or in the X-Series.
Initial S/W Revision	Prior to A.02.00

Gate View On/Off

Turning on Gate View in the Swept SA measurement provides a single-window gate view display..

Turning on Gate View in other measurements shows the split-screen Gate View. In these measurements, when the Gate View is on, the regular view of the current measurement traces and results are reduced vertically to about 70% of the regular height. The Zero Span window, showing the positions of the Gate, is shown between the Measurement Bar and the reduced measurement window. By reducing the height of the measurement window, some of the annotation on the Data Display may not fit and is not shown.

Key Path	Sweep/Control, Gate
Remote Command	[:SENSe] :SWEep:EGATe:VIEW ON OFF 1 0 [:SENSe] :SWEep:EGATe:VIEW?
Example	SWE:EGAT:VIEW ON turns on the gate view.
Dependencies	In the Swept SA measurement: In Gate View, the regular Sweep Time key is grayed out . When pressed, the grayed out key puts up the informational message "Use Gate View Sweep Time in the Gate menu." In the other measurements: When you turn Gate View on, the lower window takes on the current state of the instrument. Upon leaving Gate View, the instrument takes on the state of the lower window. When you turn Gate View on, the upper window Sweep Time is set to the gate view sweep time.
Couplings	These couplings apply to the Swept SA measurement: <ul style="list-style-type: none"> • When Gate View is turned on, the instrument is set to Zero Span. • Gate View automatically turns off whenever a Span other than Zero is selected. • Gate View automatically turns off if you press the Last Span key while in Gate View, and the instrument returns to the Span it was in before entering Gate View (even if that is Zero Span). • When Gate View is turned on, the sweep time used is the gate view sweep time. This is set according to the rules in section "Gate View Setup" on page 2083 • When Gate View is turned off, Sweep Time is set to the normal Swept SA measurement sweep time. • If Gate View is on and Gate is off, then turning on Gate turns off Gate View.
Preset	OFF
State Saved	Saved in instrument state
Range	On Off
Initial S/W Revision	Prior to A.02.00

A sample of the Gate View screen in the Swept SA measurement is shown in the following graphic :

12 Occupied Bandwidth Measurement
Sweep/Control

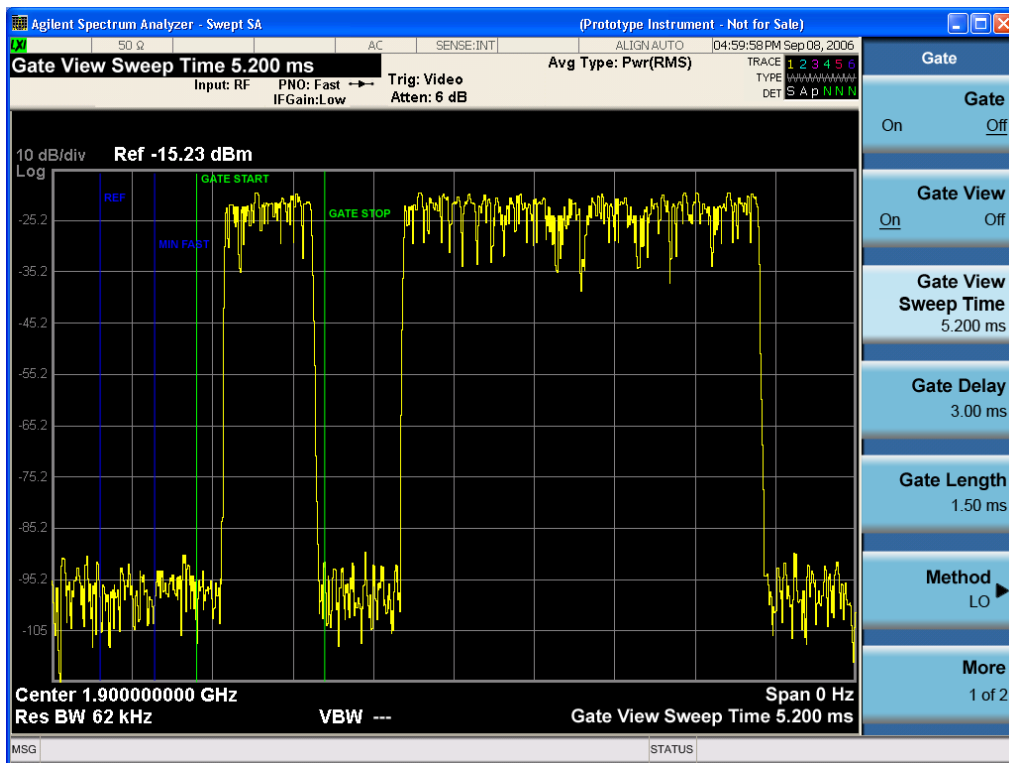

A sample of the Gate View screen in other measurements is shown in the following graphic. This example is for the ACP measurement:

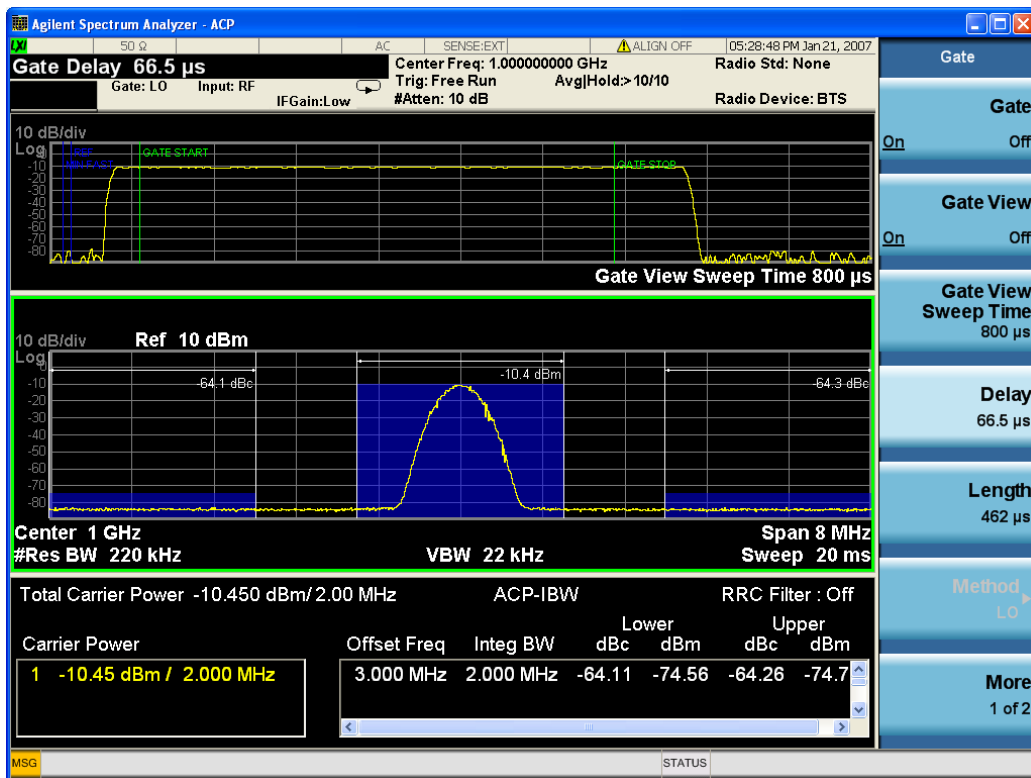

Turning Gate View off returns the analyzer to the Normal measurement view.

In the Swept SA, the normal measurement view is the single-window Swept SA view. When returning to this view, the Swept SA measurement returns to the Span it was in before entering **Gate View** (even if that is Zero Span).

The **Gate View** window is triggered from the Gate Source, with zero trigger delay. Also, when updating the **Gate View** window, the Gate itself must not operate. So it is internally shut off while the gate view window is being updated. For the Swept SA measurement, this means that the Gate is internally shut off whenever the gate view window is displayed. The measurement bar and softkeys continue to show the Trigger source for the main sweep window and give no indication that the Gate is shut off or that the Gate View window is triggered from the Gate Source.

When in **Gate View**, vertical lines are displayed in the Gate View window as follows:

- Green lines are displayed at the gate edges as follows: in Edge Gate, a line is shown for Delay and one for the end of the Gate period, defined by Length. In Level Gate a line is shown only for Delay. You can adjust the position of the green lines by adjusting the gate length and the gate delay. These lines update in the Gate View window as the active function changes, even if the window is not being updated. In Gated LO and Gated Video, these lines are positioned relative to the delay reference line (not relative to 0 time). In Gated FFT, their location is relative to the left edge of the screen.
- A blue line is displayed showing the delay reference, that is, the reference point for the Gate Delay within the Zero Span window. The blue line represents where (in time) the effective location of the gate start would be if the gate were programmed to zero delay.
-
- The second blue line is labeled "MIN FAST" as shown in the figure above because it represents the minimum Gate Delay for fast Gated LO operation. This line is only displayed in Gated LO. You cannot scroll (knob) or decrement (down key) the Gate Delay to less than that represented by the position of this line, it can only be set below this position manually, although once there it can be moved freely with the knob while below the line.
- A yellow line in the Gated Video case only, is displayed at Blength, where Blength is the display point (bucket) length for the swept trace, which is given by the sweep time for that trace divided by number of Points – 1. So it is referenced to 0 time, not to the delay reference. This line is labeled NEXT PT (it is not shown in the figure above because the figure above is for Gated LO).
- The yellow line represents the edge of a display point (bucket). Normally in Gated Video, the bucket length must be selected so that it exceeds the off time of the burst. There is another way to use the analyzer in Gated Video measurements, and that is to set the bucket width much shorter than the off time of the burst. Then use the Max Hold trace function to fill in "missing" buckets more slowly. This allows you to see some of the patterns of the Gated Video results earlier, though seeing a completely filled-in spectrum later.

Gate View Setup

Accesses a menu that enables you to setup parameters relevant to the Gate View

Key Path	Sweep/Control, Gate
Scope	Meas Global
Initial S/W Revision	A.10.00

Gate View Sweep Time

Controls the sweep time in the Gate View window. To provide an optimal view of the gate signal, the analyzer initializes Gate View Sweep Time based on the current settings of Gate Delay and Gate Length.

Key Path	Sweep/Control, Gate, Gate View Setup
Remote Command	[:SENSe] :SWEep:EGATe:TIME <time> [:SENSe] :SWEep:EGATe:TIME?
Example	SWE:EGAT:TIME 500 ms
Dependencies	Gate View Sweep Time is initialized: <ul style="list-style-type: none"> • On Preset (after initializing delay and length). • Every time the Gate Method is set/changed. <p>Additionally, in the Swept SA measurement, whenever you do a Preset, or leave Gate View, the analyzer remembers the Gate Delay and Gate Length settings. Then, when returning to Gate View, if the current Gate Delay and/or Gate Length do not match the remembered values Gate View Sweep Time is re-initialized.</p> <ol style="list-style-type: none"> 1. Compute the location of the "gate stop" line, which you know is at time $t = t_{min} + \text{GateDelay} + \text{GateLength}$.
Preset	519.3 μ s WiMAX OFDMA: 5 ms GSM/EDGE: 1 ms
State Saved	Saved in instrument state
Max	6000 s
Initial S/W Revision	Prior to A.02.00

Gate View Start Time

Controls the time at the left edge of the Gate View.

Key Path	Sweep/Control, Gate, Gate View Setup
Remote Command	[:SENSe] :SWEep:EGATe:VIEW:START <time> [:SENSe] :SWEep:EGATe:VIEW:START?
Example	SWE:EGAT:VIEW:STAR 10ms
Notes	Units of time are required or no units; otherwise an invalid suffix error message will be generated. See error -131.
Preset	0 ms
State Saved	Saved in instrument state
Min	0
Max	500 ms
Initial S/W Revision	A.10.00

Gate Delay

Controls the length of time from the time the gate condition goes True until the gate is turned on.

Key Path	Sweep/Control, Gate
Remote Command	[:SENSe] :SWEep:EGATe:DELay <time> [:SENSe] :SWEep:EGATe:DELay?
Example	SWE:EGAT:DELay 500ms SWE:EGAT:DELay?
Notes	Units of time are required or no units; otherwise an invalid suffix error message will be generated.
Preset	57.7 us WiMAX OFDMA: 71 us GSM/EDGE: 600 us WLAN: 500 us
State Saved	Saved in instrument state
Min	0.0 us
Max	100 s
Backwards Compatibility SCPI	[:SENSe] :SWEep:TIME:GATE:DELay ESA compatibility
Initial S/W Revision	Prior to A.02.00

Gate Length

Controls the length of time that the gate is on after it opens.

Key Path	Sweep/Control, Gate
Remote Command	[:SENSe] :SWEep:EGATe:LENGth <time> [:SENSe] :SWEep:EGATe:LENGth?
Example	SWE:EGAT:LENG 1 SWE:EGAT:LENG?
Notes	Units of time are required or no units; otherwise an invalid suffix error message will be generated.
Dependencies	<p>Grayed out when Gate Method is set to FFT in which case the label changes to that shown below.</p> <div style="border: 1px solid black; padding: 5px; display: inline-block;"> <p>Gate Length (=1.83/RBW) 2.8 ms</p> </div> <p style="margin-left: 20px;">vsd 39-1</p> <p>The key is also grayed out if Gate Control = Level.</p>
Preset	461.6 us

	WiMAX OFDMA: 50 us GSM/EDGE: 200 us WLAN: 1.54 ms
State Saved	Saved in instrument state
Min	100 ns
Max	5 s
Backwards Compatibility SCPI	[:SENSe] :SWEep:TIME:GATE:LENGth ESA compatibility
Initial S/W Revision	Prior to A.02.00

Gate Source

The menus under the Gate Source key are the same as those under the Trigger key, with the exception that neither Free Run nor Video are available as Gate Source selections. However, a different SCPI command is used to select the Gate Source (see table below) because you may independently set the Gate Source and the Trigger Source.

Any changes to the settings in the setup menus under each Gate Source selection key (for example: Trigger Level, Trigger Delay, etc.) also affect the corresponding settings under the Trigger menu keys. The SCPI commands used for these are the same for Trigger and Gate, since there is only one setting which affects both Gate and Trigger. Example: to set the Trigger Level for External 1 you use the command :TRIG:EXT1:LEV regardless of whether you are using External 1 as a Trigger Source or a Gate Source.

Key Path	Sweep/Control, Gate
Remote Command	[:SENSe] :SWEep:EGATE:SOURce EXTernal1 EXTernal2 LINE FRAME RFBurst [:SENSe] :SWEep:EGATE:SOURce?
Dependencies	In some models, there is no second External input. In these models, the External 2 key is blanked and the EXTernal2 parameter will generate a "Hardware missing; Not available for this model number" error.
Preset	EXTernal 1 GSM/EDGE, MSR: FRAME LTETDD: EXTernal 1When Direction is Downlink, FRAME when Direction is Uplink.
Backwards Compatibility Notes	In ESA, there is a single Gate input port. In PSA, the Gate Source may be taken from one of two specified input ports. In the X-Series, any Trigger Source can be a Gate Source.
Initial S/W Revision	Prior to A.02.00
Modified at S/W Revision	A.03.00, A.14.00

Line

Pressing this key, when it is not selected, selects the line signal as the trigger. A new sweep/measurement will start synchronized with the next cycle of the line voltage. Pressing this key, when it is already selected, access the line trigger setup menu.

Key Path	Trigger
Example	TRIG:SOUR LINE Swept SA measurement TRIG:<meas>:SOUR LINE Measurements other than Swept SA
Dependencies	Line trigger is not available when operating from a "dc power source", for example, when the instrument is powered from batteries.
State Saved	Saved in instrument state
Status Bits/OPC dependencies	The Status Operation Register bit 5 "Waiting for Trigger" is set at the same time as the Sweeping or Measuring bit is set. It is cleared when the trigger actually occurs (that is, after the trigger event occurs and all the applicable trigger criteria have been met). A corresponding pop-up message ("Waiting for trigger") is generated if no trigger signal appears after approximately 2 sec. This message goes away when a trigger signal appears.
Initial S/W Revision	Prior to A.02.00

Trig Slope

Controls the trigger polarity. It is set positive to trigger on a rising edge and negative to trigger on a falling edge.

Key Path	Trigger, Line
Remote Command	:TRIGger[:SEQuence]:LINE:SLOPe POSitive NEGative :TRIGger[:SEQuence]:LINE:SLOPe?
Example	TRIG:LINE:SLOP NEG
Preset	POSitive
State Saved	Saved in instrument state
Backwards Compatibility Notes	The legacy :TRIGger[:SEQuence]:SLOPe command affects the slopes for the VID, LINE, EXT1, EXT2, and RFB triggers.
Initial S/W Revision	Prior to A.02.00

External 1

Pressing this key, when it is not selected, selects an external input signal as the trigger. A new sweep/measurement will start when the external trigger condition is met using the external 1 input connector on the rear panel.

Pressing this key, when it is already selected, accesses the external 1 trigger setup menu.

Key Path	Trigger
Example	TRIG:SOUR EXT1 Swept SA measurement TRIG:<meas>:SOUR EXT1 Measurements other than Swept SA
Dependencies	Grayed out if in use by Point Trigger in the Source Setup menu. Forced to Free Run if already selected and Point Trigger is set to External 1.
State Saved	Saved in instrument state
Status Bits/OPC dependencies	The Status Operation Register bit 5 "Waiting for Trigger" is set at the same time as the Sweeping or Measuring bit is set. It is cleared when the trigger actually occurs (that is, after the trigger event occurs and all the applicable trigger criteria have been met). A corresponding pop-up message ("Waiting for trigger") is generated if no trigger signal appears after approximately 2 sec. This message goes away when a trigger signal appears.
Initial S/W Revision	Prior to A.02.00

Trigger Level

Sets the value where the external 1 trigger input will trigger a new sweep/measurement.

Key Path	Trigger, External 1
Remote Command	:TRIGger[:SEquence]:EXTernal1:LEVel <level> :TRIGger[:SEquence]:EXTernal1:LEVel?
Example	TRIG:EXT1:LEV 0.4 V
Couplings	This same level is used for the Ext1 trigger source in the Trigger menu, for the Ext1 selection in the Periodic Timer sync source (in the Trigger menu and in the Gate Source menu), and also for the Ext1 selection in the Gate Source menu.
Preset	1.2 V
State Saved	Saved in instrument state
Min	-5 V
Max	5 V
Default Unit	V
Backwards Compatibility SCPI	:TRIGger[:SEquence]:EXTernal:LEVel For backward compatibility, the parameter EXTernal is mapped to EXTernal1
Backwards Compatibility SCPI	:TRIGger[:SEquence]:FRAME:EXTernal1:LEVel
Initial S/W Revision	Prior to A.02.00

Trig Slope

Controls the trigger polarity. It is set positive to trigger on a rising edge and negative to trigger on a falling edge.

Key Path	Trigger, External 1
Remote Command	:TRIGger[:SEquence]:EXTernal1:SLOPe POSitive NEGative :TRIGger[:SEquence]:EXTernal1:SLOPe?
Example	TRIG:EXT1:SLOP NEG
Couplings	This same slope is used in the Ext1 selection for the trigger source in the Trigger menu and for the period timer sync source (in the Trigger menu and in the Gate Source menu).
Preset	POSitive
State Saved	Saved in instrument state
Backwards Compatibility SCPI	:TRIGger[:SEquence]:EXTernal:SLOPe For backward compatibility, the parameter EXTernal is mapped to EXTernal1
Backwards Compatibility SCPI	:TRIGger[:SEquence]:FRAMe:EXTernal1:SLOPe
Backwards Compatibility Notes	The legacy :TRIGger[:SEquence]:SLOPe command affects the slopes for the VID, LINE, EXT1, EXT2, and RFB triggers.
Initial S/W Revision	Prior to A.02.00

External 2

Pressing this key, when it is not selected, selects an external input signal as the trigger. A new sweep/measurement will start when the external trigger condition is met using the external 2 input connector. The external trigger 2 input connector is on the rear panel.

Pressing this key, when it is already selected, accesses the external 2 trigger setup menu.

Key Path	Trigger
Example	TRIG:SOUR EXT2 Swept SA measurement TRIG:<meas>:SOUR EXT2 Measurements other than Swept SA
Dependencies	In some models, there is no second External input. In these models, the External 2 key is blanked and the EXTernal2 parameter will generate a "Hardware missing; Not available for this model number" message. Grayed out if in use by Point Trigger in the Source Setup menu. Forced to Free Run if already selected and Point Trigger is set to External 2.
State Saved	Saved in instrument state
Status Bits/OPC dependencies	The Status Operation Register bit 5 "Waiting for Trigger" is set at the same time as the Sweeping or Measuring bit is set. It is cleared when the trigger actually occurs (that is, after the trigger event occurs and all the applicable trigger criteria have been met). A corresponding pop-up message ("Waiting for trigger") is generated if no trigger signal appears after approximately 2 sec. This message goes away when a trigger signal appears.
Initial S/W Revision	Prior to A.02.00
Modified at S/W Revision	A.03.00

Trigger Level

Sets the value where the external 2 trigger input will trigger a new sweep/measurement.

Key Path	Trigger, External 2
Remote Command	:TRIGger[:SEquence]:EXTernal2:LEVel :TRIGger[:SEquence]:EXTernal2:LEVel?
Example	TRIG:EXT2:LEV 1.1 V
Couplings	This same level is used for the Ext2 trigger source in the Trigger menu, for the Ext2 selection in the Periodic Timer sync source (in the Trigger menu and in the Gate Source menu), and also for the Ext2 selection in the Gate Source menu.
Preset	1.2 V
State Saved	Saved in instrument state
Min	-5 V
Max	5 V
Default Unit	V
Backwards Compatibility SCPI	:TRIGger[:SEquence]:FRAMe:EXTernal2:LEVel
Initial S/W Revision	Prior to A.02.00

Trig Slope

Controls the trigger polarity. It is set positive to trigger on a rising edge and negative to trigger on a falling edge.

Key Path	Trigger, External 2
Remote Command	:TRIGger[:SEquence]:EXTernal2:SLOPe POSitive NEGative :TRIGger[:SEquence]:EXTernal2:SLOPe?
Example	TRIG:EXT2:SLOP NEG
Couplings	This same slope is used in the Ext2 selection for the trigger source in the Trigger menu and for the period timer sync source (in the Trigger menu and in the Gate Source menu).
Preset	POSitive
State Saved	Saved in instrument state
Backwards Compatibility SCPI	:TRIGger[:SEquence]:FRAMe:EXTernal2:SLOPe
Backwards Compatibility Notes	The legacy :TRIGger[:SEquence]:SLOPe command affects the slopes for the VID, LINE, EXT1, EXT2, and RFB triggers.
Initial S/W Revision	Prior to A.02.00

RF Burst

Pressing this key, when it is not selected, selects the RF Burst as the trigger. A new sweep/measurement will start when an RF burst envelope signal is identified from the signal at the RF Input connector. Pressing this key, when it is already selected, accesses the RF Burst trigger setup menu.

In some models, a variety of burst trigger circuitry is available, resulting in various available burst trigger bandwidths. The analyzer automatically chooses the appropriate trigger path based on the hardware configuration and other settings of the analyzer.

Key Path	Trigger
Example	TRIG:SOUR RFB Swept SA measurement TRIG:<meas>:SOUR RFB Measurements other than Swept SA
State Saved	Saved in instrument state
Status Bits/OPC dependencies	The Status Operation Register bit 5 "Waiting for Trigger" is set at the same time as the Sweeping or Measuring bit is set. It is cleared when the trigger actually occurs (that is, after the trigger event occurs and all the applicable trigger criteria have been met). A corresponding pop-up message ("Waiting for trigger") is generated if no trigger signal appears after approximately 2 sec. This message goes away when a trigger signal appears.
Backwards Compatibility Notes	The legacy command: :TRIGger[:SEQuence]:RFBurst:FSElectivity[:STATe] OFF ON 0 1 is not supported in the X-Series, as the hardware to do Frequency Selective burst triggers does not exist in X-Series.
Initial S/W Revision	Prior to A.02.00
Modified at S/W Revision	A.04.00

Absolute Trigger Level

Sets the absolute trigger level for the RF burst envelope.

When using the External Mixing path, the Absolute Trigger Level is uncalibrated because the factory default was set to accommodate the expected IF levels for the RF path.

Key Path	Trigger, RF Burst
Scope	Meas Global
Remote Command	:TRIGger[:SEQuence]:RFBurst:LEVel:ABSolute <amp1> :TRIGger[:SEQuence]:RFBurst:LEVel:ABSolute?
Example	TRIG:RFB:LEV:ABS 10 dBm sets the trigger level of the RF burst envelope signal to the absolute level of 10 dBm
Notes	Sending this command does not switch the setting from relative to absolute; to switch it you need to send the :TRIGger[:SEQuence]:RFBurst:LEVel:TYPE command, below. Amplitude Corrections are not taken into account by the Absolute Trigger Level. For example, if you have given yourself effective gain with an amplitude correction factor, the Absolute Trigger will not fire until you have set the trigger level that far below the displayed signal level, rather than simply to

	the displayed signal level. This is only true for Amplitude Corrections, not External Gain or Ref Level Offset functions. If mode is Bluetooth, the default value is -50 dBm.
Couplings	This same level is used for the RF Burst trigger source in the Trigger menu, for the RF Burst selection in the Periodic Timer sync source (in the Trigger menu and in the Gate Source menu), and also for the RF Burst selection in the Gate Source menu
Preset	-20 dBm
State Saved	Saved in instrument state
Min	-200 dBm
Max	100 dBm
Default Unit	depends on the current selected Y-Axis unit
Backwards Compatibility SCPI	:TRIGger[:SEquence]:FRAME:RFBurst:LEVel:ABSolute
Initial S/W Revision	Prior to A.02.00
Modified at S/W Revision	A.04.00

Key Path	Trigger, RF Burst
Remote Command	:TRIGger[:SEquence]:RFBurst:LEVel:TYPE ABSolute RELative :TRIGger[:SEquence]:RFBurst:LEVel:TYPE?
Example	TRIG:RFB:LEV:TYPE REL sets the trigger level type of the RF burst trigger to Relative.
Preset	ABSolute
State Saved	Saved in instrument state
Initial S/W Revision	Prior to A.02.00
Modified at S/W Revision	A.04.00

Relative Trigger Level

Sets the relative trigger level for the RF burst envelope.

In some models, the relative burst trigger function is implemented in hardware. In other models, without the advanced triggering hardware required, the relative burst trigger function is implemented in software in some measurements, and is unavailable in other measurements.

When implemented in software, the relative RF Burst trigger function is implemented as follows:

1. The measurement starts with the absolute RF Burst trigger setting. If it cannot get a trigger with that level, auto trigger fires and the acquisition starts anyway. After the acquisition, the measurement searches for the peak in the acquired waveform and saves it.

2. Now, in the next cycle of the measurement, the measurement determines a new absolute RF Burst level based on the peak value from the first measurement and the Relative RF Burst Trigger Level (always 0 or negative dB) set by the user. The following formula is used:
 3. absolute RF Burst level = peak level of the previous acquisition + relative RF Burst level
 4. If the new absolute RF Burst level differs from the previous by more than 0.5 dB, the new level is sent to the hardware; otherwise it is not updated (to avoid slowing down the acquisition)
- Steps 2 and 3 repeat for subsequent measurements.

Key Path	Trigger, RF Burst
Scope	Meas Global
Remote Command	:TRIGger[:SEquence]:RFBurst:LEVel:RELative <rel_ampl> :TRIGger[:SEquence]:RFBurst:LEVel:RELative?
Example	TRIG:RFB:LEV:REL -10 dB sets the trigger level of the RF burst envelope signal to the relative level of -10 dB
Notes	Sending this command does not switch the setting from absolute to relative; to switch it you need to send the :TRIGger[:SEquence]:RFBurst:LEVel:TYPE command, above. The relative trigger level is not available in some measurements. In those measurements the RELative parameter, and the :TRIGger[:SEquence]:RFBurst:LEVel:TYPE command (above), will generate an error if sent.
Dependencies	This key is grayed out and Absolute Trigger Level selected if the required hardware is not present in your analyzer and the current measurement does not support Relative triggering.
Preset	-6 dB GSM: -25 dB
State Saved	Saved in instrument state
Min	-45 dB
Max	0 dB
Default Unit	dB or dBc
Backwards Compatibility SCPI	:TRIGger[:SEquence]:RFBurst:LEVel This legacy command is aliased to :TRIGger[:SEquence]:RFBurst:LEVel:RELative because the PSA had ONLY relative burst triggering
Initial S/W Revision	Prior to A.02.00
Modified at S/W Revision	A.04.00

Trigger Slope

It is set positive to trigger on a rising edge and negative to trigger on a falling edge.

Key Path	Trigger, RF Burst
Remote Command	:TRIGger[:SEquence]:RFBurst:SLOPe Positive NEGative :TRIGger[:SEquence]:RFBurst:SLOPe?

Example	TRIG:RFB:SLOP NEG
Couplings	This same slope is used in the RF Burst selection for the trigger source in the Trigger menu and for the period timer sync source (in the Trigger menu and in the Gate Source menu).
Preset	POSitive
State Saved	Saved in instrument state
Backwards Compatibility SCPI	:TRIGger[:SEQuence]:FRAMe:RFBurst:SLOPe
Backwards Compatibility Notes	The legacy :TRIGger[:SEQuence]:SLOPe command affects the slopes for the VID, LINE, EXT1, EXT2, and RFB triggers.
Initial S/W Revision	Prior to A.02.00

Periodic Timer (Frame Trigger)

Pressing this key, when it is not selected, selects the internal periodic timer signal as the trigger. Triggering occurrences are set by the **Period** parameter, which is modified by the **Sync Source** and **Offset**. Pressing this key, when it is already selected, accesses the periodic timer trigger setup functions.

If you do not have a sync source selected (it is Off), then the internal timer will not be synchronized with any external timing events.

Key Path	Trigger
Example	TRIG:SOUR FRAM Swept SA measurement TRIG:<meas>:SOUR FRAM Measurements other than Swept SA
State Saved	Saved in instrument state
Readback	[Sync: <value of Sync Source>], for example, [Sync: External 1]
Status Bits/OPC dependencies	The Status Operation Register bit 5 "Waiting for Trigger" is set at the same time as the Sweeping or Measuring bit is set. It is cleared when the trigger actually occurs (that is, after the trigger event occurs and all the applicable trigger criteria have been met). A corresponding pop-up message ("Waiting for trigger") is generated if no trigger signal appears after approximately 2 sec. This message goes away when a trigger signal appears.
Initial S/W Revision	Prior to A.02.00

Periodic Timer Triggering:

This feature selects the internal periodic timer signal as the trigger. Trigger occurrences are set by the **Periodic Timer** parameter, which is modified by the **Sync Source** and **Offset**.

The figure below shows the action of the periodic timer trigger. Before reviewing the figure, we'll explain some uses for the periodic trigger.

A common application is measuring periodic burst RF signals for which a trigger signal is not easily available. For example, we might be measuring a TDMA radio which bursts every 20 ms. Let's assume that the 20 ms period is very consistent. Let's also assume that we do not have an external trigger source

available that is synchronized with the period, and that the signal-to-noise ratio of the signal is not high enough to provide a clean RF burst trigger at all of the analysis frequencies. For example, we might want to measure spurious transmissions at an offset from the carrier that is larger than the bandwidth of the RF burst trigger. In this application, we can set the Periodic Timer to a 20.00 ms period and adjust the offset from that timer to position our trigger just where we want it. If we find that the 20.00 ms is not exactly right, we can adjust the period slightly to minimize the drift between the period timer and the signal to be measured.

A second way to use this feature would be to use **Sync Source** temporarily, instead of **Offset**. In this case, we might tune to the signal in a narrow span and use the RF Burst trigger to synchronize the periodic timer. Then we would turn the sync source off so that it would not miss-trigger. Miss-triggering can occur when we are tuned so far away from the RF burst trigger that it is no longer reliable.

A third example would be to synchronize to a signal that has a reference time element of much longer period than the period of interest. In some CDMA applications, it is useful to look at signals with a short periodicity, by synchronizing that periodicity to the "even-second clock" edge that happens every two seconds. Thus, we could connect the even-second clock trigger to Ext1 and use then Ext1 as the sync source for the periodic timer.

The figure below illustrates this third example. The top trace represents the even-second clock. It causes the periodic timer to synchronize with the leading edge shown. The analyzer trigger occurs at a time delayed by the accumulated offset from the period trigger event. The periodic timer continues to run, and triggers continue to occur, with a periodicity determined by the analyzer time base. The timer output (labeled "late event") will drift away from its ideal time due to imperfect matching between the time base of the signal being measured and the time base of the analyzer, and also because of imperfect setting of the period parameter. But the synchronization is restored on the next even-second clock event. ("Accumulated offset" is described in the in the **Offset** function section.)

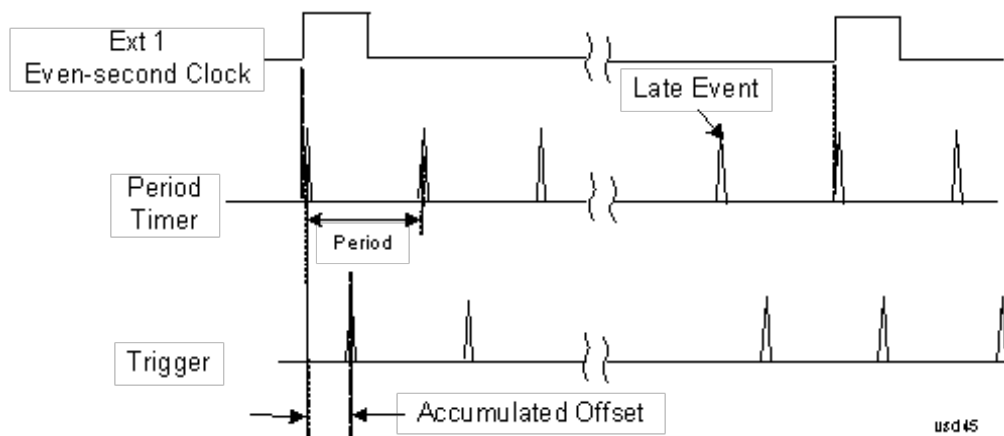

Period

Sets the period of the internal periodic timer clock. For digital communications signals, this is usually set to the frame period of your current input signal. In the case that sync source is not set to OFF, and the external sync source rate is changed for some reason, the periodic timer is synchronized at the every external synchronization pulse by resetting the internal state of the timer circuit.

Key Path	Trigger, Periodic Timer
Remote Command	:TRIGger[:SEquence]:FRAMe:PERIOD <time>

	:TRIGger[:SEquence]:FRAMe:PERiod?
Example	TRIG:FRAM:PER 100 ms
Dependencies	The invalid data indicator turns on when the period is changed, until the next sweep/measurement completes.
Couplings	The same period is used in the Gate Source selection of the period timer.
Preset	20 ms GSM: 4.615383
State Saved	Saved in instrument state
Min	100.000 ns
Max	559.0000 ms
Default Unit	S
Initial S/W Revision	Prior to A.02.00

Offset

Adjusts the accumulated offset between the periodic timer events and the trigger event. Adjusting the accumulated offset is different than setting an offset, and requires explanation.

The periodic timer is usually not synchronized with any external events, so the timing of its output events has no absolute meaning. Since the timing relative to external events (RF signals) is important, you need to be able to adjust (offset) it. However, you have no direct way to see when the periodic timer events occur. All that you can see is the trigger timing. When you want to adjust the trigger timing, you will be changing the internal offset between the periodic timer events and the trigger event. Because the absolute value of that internal offset is unknown, we will just call that the accumulated offset. Whenever the Offset parameter is changed, you are changing that accumulated offset. You can reset the displayed offset using Reset Offset Display. Changing the display does not change the value of the accumulated offset, and you can still make additional changes to accumulated offset.

To avoid ambiguity, we define that an increase in the "offset" parameter, either from the knob or the SCPI adjust command, serves to delay the timing of the trigger event.

Key Path	Trigger, Periodic Timer
Remote Command	:TRIGger[:SEquence]:FRAMe:OFFSet <time> :TRIGger[:SEquence]:FRAMe:OFFSet?
Example	TRIG:FRAM:OFFS 1.2 ms
Notes	The front panel interface (for example, the knob), and this command, adjust the accumulated offset, which is shown on the active function display. However, the actual amount sent to the hardware each time the offset is updated is the delta value, that is, the current accumulated offset value minus the previous accumulated offset value. Note that the accumulated offset value is essentially arbitrary; it represents the accumulated offset from the last time the offset was zeroed (with the Reset Offset Display key). Note that this command does not change the period of the trigger waveform. Note also that Offset is used only when the sync source is set to OFF, otherwise delay is used, see section " Trig Delay " on page 443 .

	An increase in the "offset" parameter, either from the knob or the SCPI adjust command, serves to delay the timing of the trigger event.
Notes	When the SCPI command is sent the value shown on the key (and the Active Function, if this happens to be the active function) is updated with the new value. However, the actual amount sent to the hardware is the delta value, that is, the current accumulated offset value minus the previous accumulated offset value. The SCPI query simply returns the value currently showing on the key.
Dependencies	The invalid data indicator turns on when the offset is changed, until the next sweep/measurement completes.
Couplings	The same offset is used in the Gate Source selection of the period timer.
Preset	0 s
State Saved	Saved in instrument state
Min	-10.000 s
Max	10.000 s
Default Unit	S
Initial S/W Revision	Prior to A.02.00

Offset Adjust (Remote Command Only)

This remote command does not work at all like the related front panel keys. This command lets you advance the phase of the frame trigger by the amount you specify.

It does not change the period of the trigger waveform. If the command is sent multiple times, it advances the phase of the frame trigger an additional amount each time it is sent. Negative numbers are permitted.

Remote Command	:TRIGger[:SEquence]:FRAMe:ADJust <time>
Example	TRIG:FRAM:ADJ 1.2 ms
Notes	Note also that Offset is used only when the sync source is set to OFF, otherwise delay is used, see section " Trig Delay " on page 443 An increase in the "offset" parameter, either from the knob or the SCPI adjust command, serves to delay the timing of the trigger event.
Notes	The front panel interface (for example, the knob) and the :TRIG:FRAM:OFFS command adjust the accumulated offset, which is shown on the active function display. However, the actual amount sent to the hardware is the delta value, that is, the current offset value minus the previous offset value. When the SCPI command is sent the value shown on the key (and the Active Function, if this happens to be the active function) is updated by increasing it (or decreasing it if the value sent is negative) by the amount specified in the SCPI command. This is a "command only" SCPI command, with no query.
Dependencies	The invalid data indicator turns on when the offset is changed, until the next sweep/measurement completes.
Couplings	The same offset is used in the Gate Source selection of the period timer.
Preset	0 s

State Saved	Saved in instrument state
Min	-10.000 s
Max	10.000 s
Default Unit	S
Initial S/W Revision	Prior to A.02.00

Reset Offset Display

Resets the value of the periodic trigger offset display setting to 0.0 seconds. The current displayed trigger location may include an offset value defined with the Offset key. Pressing this key redefines the currently displayed trigger location as the new trigger point that is 0.0 s offset. The Offset key can then be used to add offset relative to this new timing.

Key Path	Trigger, Periodic Timer
Remote Command	:TRIGger[:SEquence]:FRAMe:OFFSet:DISPlay:RESet
Example	TRIG:FRAM:OFFS:DISP:RES
Initial S/W Revision	Prior to A.02.00

Sync Source

Selects a signal source for you to synchronize your periodic timer trigger to, otherwise you are triggering at some arbitrary location in the frame. Synchronization reduces the precision requirements on the setting of the period.

For convenience you may adjust the level and slope of the selected sync source in a conditional branch setup menu accessed from the Sync Source menu. Note that these settings match those in the **Trigger** and **Gate Source** menus; that is, each trigger source has only one value of level and slope, regardless of which menu it is accessed from.

Key Path	Trigger, Periodic Timer
Remote Command	:TRIGger[:SEquence]:FRAMe:SYNC EXTernal1 EXTernal2 RFBurst OFF :TRIGger[:SEquence]:FRAMe:SYNC?
Example	TRIG:FRAM:SYNC EXT2
Dependencies	In some models, there is no second External input. In these models, the External 2 key is blanked and the EXTernal2 parameter will generate a "Hardware missing; Not available for this model number" message.
Preset	Off GSM/EDGE, MSR,LTE,LTETDD: RFBurst
State Saved	Saved in instrument state
Readback	The current setting is read back to this key and it is also Readback to the previous Periodic Timer trigger key.

Backwards Compatibility SCPI	:TRIGger[:SEquence]:FRAMe:SYNC EXTernal
Initial S/W Revision	Prior to A.02.00
Modified at S/W Revision	A.03.00, A.14.00

Off

Turns off the sync source for your periodic trigger. With the sync source off, the timing will drift unless the signal source frequency is locked to the analyzer frequency reference.

Key Path	Trigger, Periodic Timer, Sync Source
Example	TRIG:FRAM:SYNC OFF
Readback	Off
Initial S/W Revision	Prior to A.02.00

External 1

Pressing this key, when it is not selected, selects an external input signal as the trigger. A new sweep/measurement will start when the external trigger condition is met using the external 1 input connector on the rear panel.

Pressing this key, when it is already selected, accesses the external 1 trigger setup menu.

Key Path	Trigger
Example	TRIG:SOUR EXT1 Swept SA measurement TRIG:<meas>:SOUR EXT1 Measurements other than Swept SA
Dependencies	Grayed out if in use by Point Trigger in the Source Setup menu. Forced to Free Run if already selected and Point Trigger is set to External 1.
State Saved	Saved in instrument state
Status Bits/OPC dependencies	The Status Operation Register bit 5 "Waiting for Trigger" is set at the same time as the Sweeping or Measuring bit is set. It is cleared when the trigger actually occurs (that is, after the trigger event occurs and all the applicable trigger criteria have been met). A corresponding pop-up message ("Waiting for trigger") is generated if no trigger signal appears after approximately 2 sec. This message goes away when a trigger signal appears.
Initial S/W Revision	Prior to A.02.00

Trigger Level

Sets the value where the external 1 trigger input will trigger a new sweep/measurement.

Key Path	Trigger, External 1
Remote Command	:TRIGger[:SEquence]:EXTErnal1:LEVel <level> :TRIGger[:SEquence]:EXTErnal1:LEVel?
Example	TRIG:EXT1:LEV 0.4 V
Couplings	This same level is used for the Ext1 trigger source in the Trigger menu, for the Ext1 selection in the Periodic Timer sync source (in the Trigger menu and in the Gate Source menu), and also for the Ext1 selection in the Gate Source menu.
Preset	1.2 V
State Saved	Saved in instrument state
Min	-5 V
Max	5 V
Default Unit	V
Backwards Compatibility SCPI	:TRIGger[:SEquence]:EXTErnal:LEVel For backward compatibility, the parameter EXTErnal is mapped to EXTErnal1
Backwards Compatibility SCPI	:TRIGger[:SEquence]:FRAME:EXTErnal1:LEVel
Initial S/W Revision	Prior to A.02.00

Trig Slope

Controls the trigger polarity. It is set positive to trigger on a rising edge and negative to trigger on a falling edge.

Key Path	Trigger, External 1
Remote Command	:TRIGger[:SEquence]:EXTErnal1:SLOPe POSitive NEGative :TRIGger[:SEquence]:EXTErnal1:SLOPe?
Example	TRIG:EXT1:SLOP NEG
Couplings	This same slope is used in the Ext1 selection for the trigger source in the Trigger menu and for the period timer sync source (in the Trigger menu and in the Gate Source menu).
Preset	POSitive
State Saved	Saved in instrument state
Backwards Compatibility SCPI	:TRIGger[:SEquence]:EXTErnal:SLOPe For backward compatibility, the parameter EXTErnal is mapped to EXTErnal1
Backwards Compatibility SCPI	:TRIGger[:SEquence]:FRAME:EXTErnal1:SLOPe
Backwards Compatibility Notes	The legacy :TRIGger[:SEquence]:SLOPe command affects the slopes for the VID, LINE, EXT1, EXT2, and RFB triggers.
Initial S/W Revision	Prior to A.02.00

External 2

Pressing this key, when it is not selected, selects an external input signal as the trigger. A new sweep/measurement will start when the external trigger condition is met using the external 2 input connector. The external trigger 2 input connector is on the rear panel.

Pressing this key, when it is already selected, accesses the external 2 trigger setup menu.

Key Path	Trigger
Example	TRIG:SOUR EXT2 Swept SA measurement TRIG:<meas>:SOUR EXT2 Measurements other than Swept SA
Dependencies	In some models, there is no second External input. In these models, the External 2 key is blanked and the EXTernal2 parameter will generate a "Hardware missing; Not available for this model number" message. Grayed out if in use by Point Trigger in the Source Setup menu. Forced to Free Run if already selected and Point Trigger is set to External 2.
State Saved	Saved in instrument state
Status Bits/OPC dependencies	The Status Operation Register bit 5 "Waiting for Trigger" is set at the same time as the Sweeping or Measuring bit is set. It is cleared when the trigger actually occurs (that is, after the trigger event occurs and all the applicable trigger criteria have been met). A corresponding pop-up message ("Waiting for trigger") is generated if no trigger signal appears after approximately 2 sec. This message goes away when a trigger signal appears.
Initial S/W Revision	Prior to A.02.00
Modified at S/W Revision	A.03.00

Trigger Level

Sets the value where the external 2 trigger input will trigger a new sweep/measurement.

Key Path	Trigger, External 2
Remote Command	:TRIGger[:SEquence]:EXTernal2:LEVel :TRIGger[:SEquence]:EXTernal2:LEVel?
Example	TRIG:EXT2:LEV 1.1 V
Couplings	This same level is used for the Ext2 trigger source in the Trigger menu, for the Ext2 selection in the Periodic Timer sync source (in the Trigger menu and in the Gate Source menu), and also for the Ext2 selection in the Gate Source menu.
Preset	1.2 V
State Saved	Saved in instrument state
Min	-5 V
Max	5 V
Default Unit	V
Backwards Compatibility SCPI	:TRIGger[:SEquence]:FRAMe:EXTernal2:LEVel
Initial S/W Revision	Prior to A.02.00

Trig Slope

Controls the trigger polarity. It is set positive to trigger on a rising edge and negative to trigger on a falling edge.

Key Path	Trigger, External 2
Remote Command	:TRIGger[:SEQuence]:EXTernal2:SLOPe POSitive NEGative :TRIGger[:SEQuence]:EXTernal2:SLOPe?
Example	TRIG:EXT2:SLOP NEG
Couplings	This same slope is used in the Ext2 selection for the trigger source in the Trigger menu and for the period timer sync source (in the Trigger menu and in the Gate Source menu).
Preset	POSitive
State Saved	Saved in instrument state
Backwards Compatibility SCPI	:TRIGger[:SEQuence]:FRAMe:EXTernal2:SLOPe
Backwards Compatibility Notes	The legacy :TRIGger[:SEQuence]:SLOPe command affects the slopes for the VID, LINE, EXT1, EXT2, and RFB triggers.
Initial S/W Revision	Prior to A.02.00

RF Burst

Pressing this key, when it is not selected, selects the RF Burst as the trigger. A new sweep/measurement will start when an RF burst envelope signal is identified from the signal at the RF Input connector. Pressing this key, when it is already selected, accesses the RF Burst trigger setup menu.

In some models, a variety of burst trigger circuitry is available, resulting in various available burst trigger bandwidths. The analyzer automatically chooses the appropriate trigger path based on the hardware configuration and other settings of the analyzer.

Key Path	Trigger
Example	TRIG:SOUR RFB Swept SA measurement TRIG:< meas>:SOUR RFB Measurements other than Swept SA
State Saved	Saved in instrument state
Status Bits/OPC dependencies	The Status Operation Register bit 5 "Waiting for Trigger" is set at the same time as the Sweeping or Measuring bit is set. It is cleared when the trigger actually occurs (that is, after the trigger event occurs and all the applicable trigger criteria have been met). A corresponding pop-up message ("Waiting for trigger") is generated if no trigger signal appears after approximately 2 sec. This message goes away when a trigger signal appears.
Backwards Compatibility Notes	The legacy command: :TRIGger[:SEQuence]:RFBurst:FSElectivity[:STATe] OFF ON 0 1 is not supported in the X-Series, as the hardware to do Frequency Selective burst triggers does not exist in X-Series.

Initial S/W Revision	Prior to A.02.00
Modified at S/W Revision	A.04.00

Absolute Trigger Level

Sets the absolute trigger level for the RF burst envelope.

When using the External Mixing path, the Absolute Trigger Level is uncalibrated because the factory default was set to accommodate the expected IF levels for the RF path.

Key Path	Trigger, RF Burst
Scope	Meas Global
Remote Command	:TRIGger[:SEquence]:RFBurst:LEVel:ABSolute <ampl> :TRIGger[:SEquence]:RFBurst:LEVel:ABSolute?
Example	TRIG:RFB:LEV:ABS 10 dBm sets the trigger level of the RF burst envelope signal to the absolute level of 10 dBm
Notes	Sending this command does not switch the setting from relative to absolute; to switch it you need to send the :TRIGger[:SEquence]:RFBurst:LEVel:TYPE command, below. Amplitude Corrections are not taken into account by the Absolute Trigger Level. For example, if you have given yourself effective gain with an amplitude correction factor, the Absolute Trigger will not fire until you have set the trigger level that far below the displayed signal level, rather than simply to the displayed signal level. This is only true for Amplitude Corrections, not External Gain or Ref Level Offset functions. If mode is Bluetooth, the default value is -50 dBm.
Couplings	This same level is used for the RF Burst trigger source in the Trigger menu, for the RF Burst selection in the Periodic Timer sync source (in the Trigger menu and in the Gate Source menu), and also for the RF Burst selection in the Gate Source menu
Preset	-20 dBm
State Saved	Saved in instrument state
Min	-200 dBm
Max	100 dBm
Default Unit	depends on the current selected Y-Axis unit
Backwards Compatibility SCPI	:TRIGger[:SEquence]:FRAME:RFBurst:LEVel:ABSolute
Initial S/W Revision	Prior to A.02.00
Modified at S/W Revision	A.04.00

Key Path	Trigger, RF Burst
Remote Command	:TRIGger[:SEquence]:RFBurst:LEVel:TYPE ABSolute RELative :TRIGger[:SEquence]:RFBurst:LEVel:TYPE?

Example	TRIG:RFB:LEV:TYPE REL sets the trigger level type of the RF burst trigger to Relative.
Preset	ABSolute
State Saved	Saved in instrument state
Initial S/W Revision	Prior to A.02.00
Modified at S/W Revision	A.04.00

Trigger Slope

It is set positive to trigger on a rising edge and negative to trigger on a falling edge.

Key Path	Trigger, RF Burst
Remote Command	:TRIGger[:SEquence]:RFBurst:SLOPe POSitive NEGative :TRIGger[:SEquence]:RFBurst:SLOPe?
Example	TRIG:RFB:SLOP NEG
Couplings	This same slope is used in the RF Burst selection for the trigger source in the Trigger menu and for the period timer sync source (in the Trigger menu and in the Gate Source menu).
Preset	POSitive
State Saved	Saved in instrument state
Backwards Compatibility SCPI	:TRIGger[:SEquence]:FRAME:RFBurst:SLOPe
Backwards Compatibility Notes	The legacy :TRIGger[:SEquence]:SLOPe command affects the slopes for the VID, LINE, EXT1, EXT2, and RFB triggers.
Initial S/W Revision	Prior to A.02.00

Sync Holdoff

Sync Holdoff specifies the duration that the sync source signal must be kept false before the transition to true to be recognized as the sync timing. The periodic timer phase is aligned when the sync source signal becomes true, after the Holdoff time is satisfied.

A holdoff of 2 ms will work with most WiMAX signals, but there may be cases where the burst off duration is less than 1 ms and this value will need to be changed.

Key Path	Trigger, Periodic Timer
Remote Command	:TRIGger[:SEquence]:FRAME:SYNC:HOLDoff <time> :TRIGger[:SEquence]:FRAME:SYNC:HOLDoff? :TRIGger[:SEquence]:FRAME:SYNC:HOLDoff:STATe OFF ON 0 1 :TRIGger[:SEquence]:FRAME:SYNC:HOLDoff:STATe?
Preset	On, 1.000 ms

State Saved	Saved in instrument state
Min	0 ms
Max	+500 ms
Default Unit	s
Initial S/W Revision	Prior to A.02.00

Control Edge/Level

Sets the method of controlling the gating function from the gating signal.

Edge

In Edge triggering, the gate opens (after the Delay) on the selected edge (for example, positive) of the gate signal and closes on the alternate edge (for example, negative).

Level

In Level triggering, the gate opens (after the Delay) when the gate signal has achieved a certain level and stays open as long as that level is maintained.

Key Path	Sweep/Control, Gate
Remote Command	[:SENSe] :SWEep:EGATe:CONTRol EDGE LEVel [:SENSe] :SWEep:EGATe:CONTRol?
Example	SWE:EGAT:CONT EDGE
Dependencies	If the Gate Method is FFT the Control key is grayed out and Edge is selected. If the Gate Source is TV, Frame or Line, the Control key is grayed out and Edge is selected.
Preset	EDGE
State Saved	Saved in instrument state
Backwards Compatibility SCPI	[:SENSe]:SWEep:TIME:GATE:TYPE ESA Compatibility
Initial S/W Revision	Prior to A.02.00

Gate Holdoff

Lets you increase or decrease the wait time after a gate event ends before the analyzer will respond to the next gate signal.

After any Gate event finishes, the analyzer must wait for the sweep system to settle before it can respond to another Gate signal. The analyzer calculates a "wait time," taking into account a number of factors, including RBW and Phase Noise Optimization settings. The goal is to achieve the same accuracy when gated as in ungated operation. The figure below illustrates this concept:

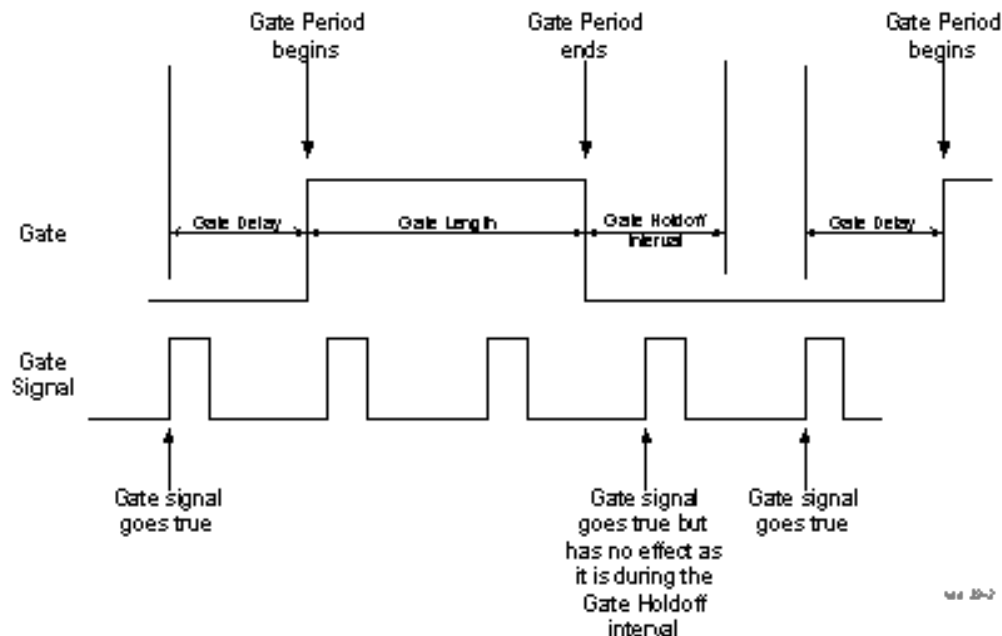

When Gate Holdoff is in Auto, the wait time calculated by the analyzer is used. When Gate Time is in Manual, the user may adjust the wait time, usually decreasing it in order to achieve greater speed, but at the risk of decreasing accuracy.

When the Method key is set to Video or FFT, the Gate Holdoff function has no effect.

In measurements that do not support Auto, the value shown when Auto is selected is “---” and the manually set holdoff is returned to a query.

Key Path	Sweep/Control, Gate
Remote Command	<pre>[:SENSe] :SWEep:EGATe:HOLDoff <time> [:SENSe] :SWEep:EGATe:HOLDoff? [:SENSe] :SWEep:EGATe:HOLDoff:AUTO OFF ON 0 1 [:SENSe] :SWEep:EGATe:HOLDoff:AUTO?</pre>
Example	<pre>SWE:EGAT:HOLD 0.0002 SWE:EGAT:HOLD? SWE:EGAT:HOLD:AUTO ON SWE:EGAT:HOLD:AUTO?</pre>
Couplings	<p>When Gate Holdoff is Auto, the Gate Holdoff key shows the value calculated by the analyzer for the wait time.</p> <p>Pressing the Gate Holdoff key while it is in Auto and not selected, causes the key to become selected and allows the user to adjust the value. If the value is adjusted, the setting changes to Man.</p> <p>Pressing the Gate Holdoff key, while it is in Auto and selected, does not change the value of Gate Holdoff, but causes the setting to change to Man. Now the user can adjust the value.</p> <p>Pressing the key while it is in Man and selected, cause the value to change back to Auto.</p> <p>Pressing the key while it is in Man and not selected, causes the key to become selected and allows the user to adjust the value.</p>

	When Method is set to Video or FFT, the Gate Holdoff function has no effect.
Preset	Auto Auto/On
State Saved	Saved in instrument state
Min	1 μ sec
Max	1 sec
Initial S/W Revision	Prior to A.02.00

Gate Delay Compensation

This function allows you to select an RBW-dependent value by which to adjust the gate delay, to compensate for changes in the delay caused by RBW effects.

You can select between uncompensated operation and two types of compensation, Delay Until RBW Settled and Compensate for RBW Group Delay.

See ["More Information" on page 1416](#)

Key Path	Sweep/Control, Gate
Scope	Meas Global
Remote Command	[:SENSe] :SWEep:EGATe:DELaY:COMPensation:TYPE OFF SETTled GDELaY [:SENSe] :SWEep:EGATe:DELaY:COMPensation:TYPE?
Example	SWE:EGAT:DEL:COMP:TYPE SETT SWE:EGAT:DEL:COMP:TYPE?
Notes	Although this function is Meas Global, there are some measurements that do not support this function. In those measurements the operation will be Uncompensated. Going into one of those measurements will not change the Meas Global selection; it will simply display the grayed-out menu key with “Uncompensated” showing as the selection. This is a non-forceful grayout, so the SCPI command is still accepted. If Gate Delay Compensation is not supported at all within a particular mode, the key is not displayed, and if the SCPI command is sent while in a measurement within that mode, an “Undefined Header” message is generated. Measurements that do not support this function include: Swept SA
Preset	TD-SCDMA mode: Compensate for RBW Group Delay All other modes: Delay Until RBW Settled
State Saved	Saved in instrument state
Range	Uncompensated Delay Until RBW Settled Compensate for RBW Group Delay
Readback text	Uncompensated Settled Group Delay
Initial S/W Revision	Prior to A.02.00
Modified at S/W Revision	A.11.0

More Information

Selecting Uncompensated means that the actual gate delay is as you sets it.

Selecting Delay Until RBW Settled causes the gate delay to be increased above the user setting by an amount equal to $3.06/\text{RBW}$. This compensated delay causes the GATE START and GATE STOP lines on the display to move by the compensation amount, and the actual hardware gate delay to be increased by the same amount. All the other gate lines (for example, MIN FAST) are unaffected. If the RBW subsequently changes, the compensation is readjusted for the new RBW. The value shown on the Gate Delay key does NOT change.

Delay Until RBW Settled allows excellent measurements of gated signals, by allowing the IF to settle following any transient that affects the burst. Excellent measurements also require that the analysis region not extend into the region affected by the falling edge of the burst. Thus, excellent measurements can only be made over a width that declines with narrowing RBWs, which is achieved by decreasing the gate length below the user setting by an amount equal to $2.53/\text{RBW}$. Therefore, for general purpose compensation, you will still want to change the gate length with changes in RBW even if the gate delay is compensated. The compensated Gate Length is limited by the analyzer so that it will never go below 10% of the value shown on the Gate Length key, as otherwise the sweep times could get very long. Anytime the Gate Length and RBW values combine in such a way that this limiting takes place, a warning is displayed. For measurements which contain multiple sweeps with different RBW like SEM and SPUR, the smallest RBW is used for this limiting.

Selecting Compensate for RBW Group Delay causes the gate delay to be increased above the user setting by an amount equal to $1.81/\text{RBW}$. This compensated delay causes the GATE START, GATE STOP lines on the display to move by the compensation amount, and the actual hardware gate delay to be increased by the same amount. All the other gate lines (for example, MIN FAST) are unaffected. If the RBW subsequently changes, the compensation is readjusted for the new RBW. The value shown on the Gate Delay key does NOT change. Compensate for RBW Group Delay also includes gate length compensation; the gate length itself is adjusted as necessary to attempt to compensate for delay effects imposed by the RBW.

Compensate for RBW Group Delay is similar to Delay Until RBW Settled, but compensates for the group delay of the RBW filter, rather than the filter settling time. As the RBW gets narrow, this can allow the settling tail of the RBW to affect the beginning part of the gated measurement, and allow the beginning of the RBW settling transient to affect the end of the gated measurement. These two effects are symmetric because the RBW response is symmetric. Because the gate length is not automatically compensated, some users might find this compensation to be more intuitive than compensation for RBW settling.

Min Fast Position Query (Remote Command Only)

This command queries the position of the MIN FAST line, relative to the delay reference (REF) line. See section ["Gate View On/Off" on page 2080](#). If this query is sent while not in gate view, the MinFast calculation is performed based on the current values of the appropriate parameters and the result is returned. Knowing this value lets you set an optimal gate delay value for the current measurement setup.

Remote Command	<code>[:SENSe] :SWEep:EGATe:MINFast?</code>
Example	<code>SWE:EGAT:MIN?</code>
Initial S/W Revision	Prior to A.02.00

Gate Preset (Remote Command Only)

Presets the time-gated spectrum analysis capability.

This command sets gate parameter values to the ESA preset values, as follows:

Gate trigger type = edge

Gate polarity = positive

Gate delay = 1 us

Gate length = 1 us

Remote Command	<code>[[:SENSe]:SWEep:TIME:GATE:PRESet</code> ESA Compatibility
Initial S/W Revision	Prior to A.02.00

Gate Level (Remote Command Only)

Sets the gate input transition point level for the external TRIGGER inputs on the front and rear panel. This is a legacy command for PSA compatibility. It is simply an alias to the equivalent trigger level command.

Remote Command	<code>[[:SENSe]:SWEep:EGATE:EXTernal[1] 2:LEVel <voltage></code> <code>[[:SENSe]:SWEep:EGATE:EXTernal[1] 2:LEVel?</code>
Notes	This command is simply an alias to <code>:TRIGger[:SEQUence]:EXTernal[1] 2:LEVel</code> For details refer
Initial S/W Revision	Prior to A.02.00

Gate Polarity (Remote Command Only)

Sets the polarity for the gate signal. This setup is now done using the gate trigger's slope setting.

When Positive (Pos) is selected, a positive-going edge (Edge) or a high voltage (Level) will satisfy the gate condition, after the delay set with the Gate Delay key. When Negative (Neg) is selected, a negative-going edge (Edge) or a low voltage (Level) will satisfy the gate condition after the delay.

Remote Command	<code>[[:SENSe]:SWEep:EGATE:POLarity NEGative POSitive</code> <code>[[:SENSe]:SWEep:EGATE:POLarity?</code>
Example	<code>SWE:EGAT:POL NEG</code> <code>SWE:EGAT:POL?</code>
Preset	POSitive
State Saved	Saved in instrument state
Backwards Compatibility SCPI	<code>[[:SENSe]:SWEep:TIME:GATE:POLarity</code> ESA compatibility
Initial S/W Revision	Prior to A.02.00

Remote Command	[:SENSe] :SWEep:TIME:GATE:LEVel HIGH LOW [:SENSe] :SWEep:TIME:GATE:LEVel? ESA compatibility
Preset	HIGH
Initial S/W Revision	Prior to A.02.00

Points

Sets the number of points per sweep. The resolution of setting the sweep time depends on the number of points selected. The current value of points is displayed parenthetically, next to the sweep time in the lower-right corner of the display.

Key Path	Sweep/Control
Mode	SA, WCDMA, C2K, WIMAX OFDMA, TD-SCDMA, 1xEVDO, ISDB-T, CMMB, LTE, LTETDD, BLUETOOTH, WLAN, MSR, LTEAFDD, LTEATDD
Remote Command	[:SENSe] :OBWidth:SWEep:POINts <integer> [:SENSe] :OBWidth:SWEep:POINts?
Example	OBW:SWE:POIN 1500 OBW:SWE:POIN?
Notes	This function is not available when signal identification is set to On (external mixing). Affected by: log sweep Grayed out in measurements that don't support swept Blanked in modes that do not support swept. Whenever the number of sweep points change: - All trace data is erased - Any traces with Update Off also go to Display Off (like going from View to Blank in the older analyzers) - Sweep time is re-quantized - Any limit lines that are on are updated - If averaging/hold is on, averaging/hold starts over
Couplings	Whenever the number of sweep points change, the sweep time is re-quantized.
Preset	LTE, LTETDD, MSR, LTEAFDD, LTEATDD: 2001 Other: 1001
State Saved	Saved in instrument state.
Min	101
Max	20001
Initial S/W Revision	Prior to A.02.00
Modified at S/W Revision	A.03.00

System

See ["System" on page 342](#)

Trace/Detector

Accesses a menu of functions that enable you to control the detectors for the current measurement.

Key Path	Front-panel key
Initial S/W Revision	Prior to A.02.00

Trace Type

Allows you to select the type of trace you want to use for the current measurement.

The first page of this menu contains a 1–of–N selection of the trace type (Clear Write, Average, Max Hold, Min Hold) for the selected trace.

Key Path	Trace/Detector
Mode	SA, WCDMA, C2K, WIMAX OFDMA, TD-SCDMA, 1xEVDO, ISDB-T, CMMB, LTE, LTETDD, BLUETOOTH, WLAN, MSR, LTEAFDD, LTEATDD
Remote Command	:TRACe:OBWidth:TYPE WRITe AVERAge MAXHold MINHold :TRACe:OBWidth:TYPE?
Example	TRAC:OBW:TYPE MINH TRAC:OBW:TYPE?
Notes	WRITe = Clear Write AVERAge = Average MAXHold = Maximum Hold MINHold = Minimum Hold
Couplings	When Detector setting is “Auto” ([[:SENSe]:OBWidth:DETEctor:AUTO?]), Detector ([[:SENSe]:OBWidth:DETEctor[:FUNction]?]) switches aligning with the switch of this parameter: “NORMal” with WRITe (Clear Write), “AVERAge” with AVERAge, “POSitive (peak)” with MAXHold, and “NEGative (peak)” with MINHold.
Preset	AVERAge BLUETOOTH: MAX HOLD.
State Saved	Saved in instrument state.
Range	WRITe AVERAge MAXHold MINHold
Initial S/W Revision	Prior to A.02.00
Modified at S/W Revision	A.03.00

Detector

Accesses a menu of functions that enables you to control the detectors for the current measurement. The following choices are available:

- **Auto**– the detector selected depends on marker functions, trace functions, average type, and the trace averaging function.

- **Normal**—the detector determines the peak of the CW-like signals, and it yields alternating maximums and minimums of noise-like signals. This is also referred to as Rosenfell detection.
- **Average**—the detector determines the average of the signal within the sweep points. The averaging method depends upon the Average Type selection (voltage, power or log scales).
- **Peak (Positive)**—the detector determines the maximum of the signal within the sweep points.
- **Sample**—the detector indicates the instantaneous level of the signal at the center of the sweep points represented by each display point.
- **Negative Peak**—the detector determines the minimum of the signal within the sweep points.

Key Path	Detector
Initial S/W Revision	Prior to A.02.00

Auto

When the detector choice is Auto, the analyzer selects the detector. The selected detector depends on marker functions, trace functions, and trace averaging functions for the current measurement.

Key Path	Trace/Detector
Remote Command	[[:SENSe]:OBWidth:DETECTOR:AUTO ON OFF 1 0 [:SENSe]:OBWidth:DETECTOR:AUTO?
Example	OBW:DET:AUTO ON OBW:DET:AUTO?
Couplings	When Detector setting is “Auto” ([[:SENSe]:OBWidth:DETECTOR:AUTO?]), Detector ([[:SENSe]:OBWidth:DETECTOR:FUNCTION?]) switches aligning with the switch of this parameter: “NORMal” with Clear Write, “AVERage” with AVERage, “POSitive (peak)” with MAXHold, and “NEGative (peak)” with MINHold.
Preset	ON ISDB-T: OFF
State Saved	Saved in instrument state.
Initial S/W Revision	Prior to A.02.00
Modified at S/W Revision	A.03.00

Detector Selection

Allows you to select a specific detector for the current measurement. When the detector choice is Auto, the analyzer selects the detector. The selected detector depends on marker functions, trace functions, and trace averaging functions for the current measurement.

Key Path	Trace/Detector
Mode	SA, WCDMA, C2K, WIMAX OFDMA, TD-SCDMA, 1xEVDO, ISDB-T, CMMB, LTE, LTETDD, BLUETOOTH, WLAN, MSR, LTEAFDD, LTEATDD

Remote Command	[:SENSe]:OBWidth:DETEctor[:FUNction] NORMal AVERage POSitive SAMPle NEGative [:SENSe]:OBWidth:DETEctor[:FUNction]?
Example	OBW:DET NORM OBW:DET?
Notes	When you manually select a detector (instead of selecting Auto), that detector is used regardless of other analyzer settings. The detector choices are: The Normal detector determines the peak of CW-like signals, and it yields alternating maximums and minimums of noise-like signals. This is also referred to as Rosenfell detection. The Average detector determines the average of the signal within the sweep points. The averaging method is Power Average (RMS). The Peak detector determines the maximum of the signal within the sweep points. The Sample detector indicates the instantaneous level of the signal at the center of the sweep points represented by each display point. The Negative Peak detector determines the minimum of the signal within the sweep points.
Couplings	When Detector setting is "Auto" ([:SENSe]:OBWidth:DETEctor:AUTO?), Detector ([:SENSe]:OBWidth:DETEctor[:FUNction]?) switches aligning with the switch of this parameter: "NORMal" with Clear Write, "AVERage" with AVERage, "POSitive (peak)" with MAXHold, and "NEGative (peak)" with MINHold.
Preset	AVERage ISDB-T: Peak BLUETOOTH: Peak
State Saved	Saved in instrument state.
Range	Normal Average Peak Sample Negative Peak
Initial S/W Revision	Prior to A.02.00
Modified at S/W Revision	A.03.00

Trigger

See ["Trigger" on page 412](#)

Free Run

See ["Free Run " on page 419](#)

Video

See ["Video \(IF Envelope\) " on page 420](#)

Trigger Level

See ["Trigger Level " on page 420](#)

Trig Slope

See ["Trig Slope " on page 421](#)

Trig Delay

See ["Trig Delay " on page 422](#)

Line

See ["Line " on page 2087](#)

Trig Slope

See ["Trig Slope " on page 2087](#)

Trig Delay

See ["Trig Delay " on page 424](#)

External 1

See ["External 1 " on page 2099](#)

Trigger Level

See ["Trigger Level " on page 2099](#)

Trig Slope

See ["Trig Slope " on page 2100](#)

Trig Delay

See ["Trig Delay " on page 427](#)

External 2

See ["External 2 " on page 2101](#)

Trigger Level

See ["Trigger Level "](#) on page 2101

Trig Slope

See ["Trig Slope "](#) on page 2102

Trig Delay

See ["Trig Delay "](#) on page 429

RF Burst

See ["RF Burst "](#) on page 2102

Absolute Trigger

See ["Absolute Trigger Level"](#) on page 2103

Relative Trigger

See ["Relative Trigger Level"](#) on page 2092

Trig Slope

See ["Trigger Slope "](#) on page 2104

Trig Delay

See ["Trig Delay "](#) on page 433

Periodic Timer

See ["Periodic Timer \(Frame Trigger\) "](#) on page 2094

Period

See ["Period "](#) on page 2095

Offset

See ["Offset "](#) on page 2096

Reset Offset Display

See ["Reset Offset Display "](#) on page 2098

Sync Source

See ["Sync Source "](#) on page 2098

Off

See ["Off "](#) on page 2099

External 1

See "[External 1](#) " on page 2099

Trigger Level

See "[Trigger Level](#) " on page 2099

Trig Slope

See "[Trig Slope](#) " on page 2100

External 2

See "[External 2](#) " on page 2101

Trigger Level

See "[Trigger Level](#) " on page 2101

Trig Slope

See "[Trig Slope](#) " on page 2102

RF Burst

See "[RF Burst](#) " on page 2102

Absolute Trigger

See "[Absolute Trigger Level](#)" on page 2103

Trig Slope

See "[Trigger Slope](#) " on page 2104

Trig Delay

See "[Trig Delay](#)" on page 443

Auto/Holdoff

See "[Auto/Holdoff](#) " on page 444

Auto Trig

See "[Auto Trig](#) " on page 444

Trig Holdoff

See "[Trig Holdoff](#) " on page 445

User Preset

Accesses a menu that gives you the following three choices:

- User Preset – recalls a state previously saved using the Save User Preset function.
- User Preset All Modes – presets all of the modes in the analyzer
- Save User Preset– saves the current state for the current mode

Key Path	Front-panel key
Backwards Compatibility Notes	<p>User Preset is actually loading a state, and in legacy analyzers, it was possible to load a state without affecting the trace data, limit lines or correction data. Similarly it was possible to do a User Preset without affecting the trace data, limit lines or correction data.</p> <p>In the X-Series, “state” always includes all of this data; so whenever state is loaded, or User Preset is executed, all of the traces, limit lines and corrections are affected. Although this differs from previous behavior, it is desirable behavior, and should not cause adverse issues for users.</p> <p>On ESA and PSA, User Preset affected the entire instrument’s state. In the X-Series, User Preset only recalls the state for the active mode. There is a User Preset file for each mode. User Preset can never cause a mode switch as it can in legacy analyzers. If you want to recall all modes to their user preset file state, you will need to do a User Preset after mode switching into each mode.</p> <p>User Preset recalls mode state which can now include data like traces; whereas on ESA and PSA, User Preset did not affect data.</p>
Initial S/W Revision	Prior to A.02.00

User Preset

User Preset sets the state of the currently active mode back to the state that was previously saved for this mode using the Save User Preset menu key or the SCPI command, SYST:PRES:USER:SAV. It not only recalls the Mode Preset settings, but it also recalls all of the mode persistent settings, and the Input/Output system setting that existed at the time Save User Preset was executed.

If a Save User Preset has not been done at any time, User Preset recalls the default user preset file for the currently active mode. The default user preset files are created if, at power-on, a mode detects there is no user preset file. There will never be a scenario when there is no user preset file to restore. For each mode, the default user preset state is the same state that would be saved if a Save User Preset is performed in each mode right after doing a Restore Mode Default and after a Restore Input/Output Defaults.

The User Preset function does the following:

- Aborts the currently running measurement.
- Sets the mode State to the values defined by Save User Preset.
- Makes the saved measurement for the currently running mode the active measurement.
- Brings up the saved menu for the power-on mode.
- Clears the input and output buffers.
- Sets the Status Byte to 0.

Key Path	User Preset
Remote Command	:SYSTem:PRESet:USER
Example	:SYST:PRES:USER:SAVE:SYST:PRES:USER
Notes	:SYST:PRES:USER:SAVE is used to save the current state as the user preset state. Clears all pending OPC bits. The Status Byte is set to 0. Pressing the User Preset front-panel key while already in the User Preset menu will cause the User Preset to get executed
Couplings	A user preset will cause the currently running measurement to be aborted and cause the saved measurement to be active. Recalling a User Preset file has the same issues that recalling a Save State file has. Some settings may need to be limited and therefore re-coupled, since the capabilities of the mode may have changes when the User Preset file was last saved.
Initial S/W Revision	Prior to A.02.00

User Preset All Modes

Recalls all of the User Preset files for each mode, switches to the power-on mode, and activates the saved measurement from the power-on mode User Preset file.

NOTE

When the instrument is secured, all of the user preset files are converted back to their default user preset files.

The User Preset function does the following:

- Aborts the currently running measurement.
- Switches the Mode to the power-on mode.
- Restores the User Preset files for each mode.
- Makes the saved measurement for the power-on mode the active measurement.
- Brings up the saved menu for the power-on mode.
- Clears the input and output buffers.
- Sets the Status Byte to 0.

Key Path	User Preset
Remote Command	:SYSTem:PRESet:USER:ALL
Example	:SYST:PRES:USER:SAVE:SYST:PRES:USER:ALL
Notes	Clears all pending OPC bits. The Status Byte is set to 0. :SYST:PRES:USER:SAVE is used to save the current state as the user preset state.
Couplings	A user preset will cause the currently running measurement to be aborted, cause a mode switch to the power-on mode, and cause the saved measurement to be active in the power-on mode. Recalling a User Preset file has the same issues that recalling a Save State file has. Some settings may need to be limited and therefore re-coupled, since the capabilities of the mode may have changes when the User Preset file was last saved.
Initial S/W Revision	Prior to A.02.00

Save User Preset

Saves the currently active mode and its State. You can recall this User Preset file by pressing the User Preset menu key or sending the SYST:PRES:USER remote command. This same state is also saved by the Save State function.

Key Path	User Preset
Remote Command	:SYSTem:PRESet:USER:SAVE
Example	:SYST:PRES:USER:SAVE
Notes	:SYST:PRES:SAVE creates the same file as if the user requested a *SAV or a MMEM:STOR:STAT, except User Preset Save does not allow the user to specify the filename or the location of the file.
Initial S/W Revision	Prior to A.02.00

View/Display

Accesses a menu of functions that enable you to set the view and display parameters for the current measurement.

There is a single results view available for this measurement. For more details, and samples of screen content for each supported mode, see "[Spectrum View](#)" on page 1430 below.

The following result descriptions are available:

Occupied Bandwidth

The occupied bandwidth result is $f_2 - f_1$, where f_1 and f_2 are calculated.

Total Power

The total power is the power integrated in the specified span setting.

Transmit Freq Error

The transmit freq error (transmit frequency error) result is calculated as the difference between $(f_2+f_1)/2$ and the tuned center frequency of the signal, where f_1 and f_2 are calculated.

x dB Bandwidth

The x dB result is a bandwidth measured between two points on the signal which are a certain number of dBs down from the highest signal point within the OBW Span. For example, If the 'x dB' parameter is set to -26 dB, and the 'Occupied BW Span' is set to 10 MHz, then the maximum signal power level is first determined from the 10 MHz wide trace sweep. Next, the two furthest frequencies below (x_{db_f1}) and above (x_{db_f2}) the frequency of the maximum level occurrence are found where the signal level is 26 dB below the peak level. This calculation also uses linear interpolation to find the lower and upper carrier boundary point within the width of a sweep point (the span divided by the number of sweep points).

The x dB bandwidth is calculated to be $x_{db_f2} - x_{db_f1}$.

Spectrum View

For SA, WCDMA, C2K, 1xEVDO, WIMAX OFDMA, WLAN modes:

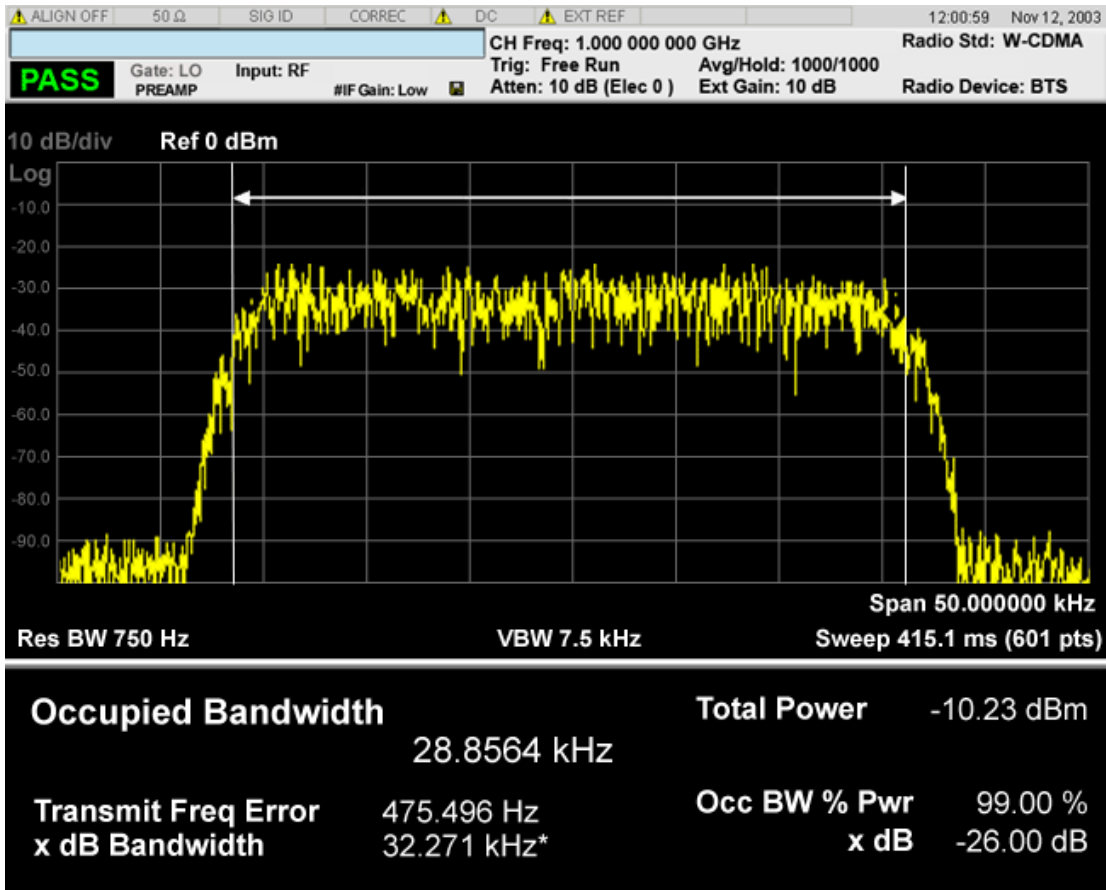

For TD-SCDMA mode only:

12 Occupied Bandwidth Measurement
View/Display

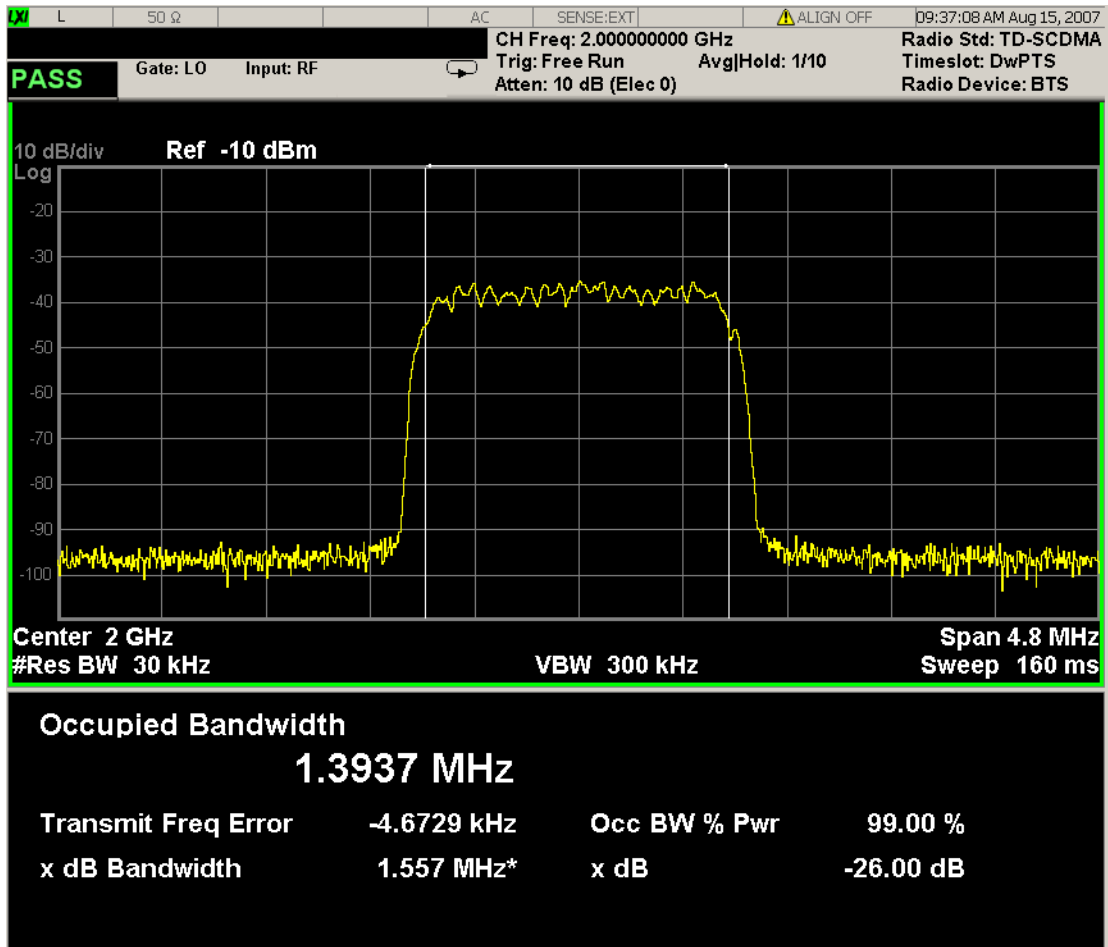

For Bluetooth mode only:

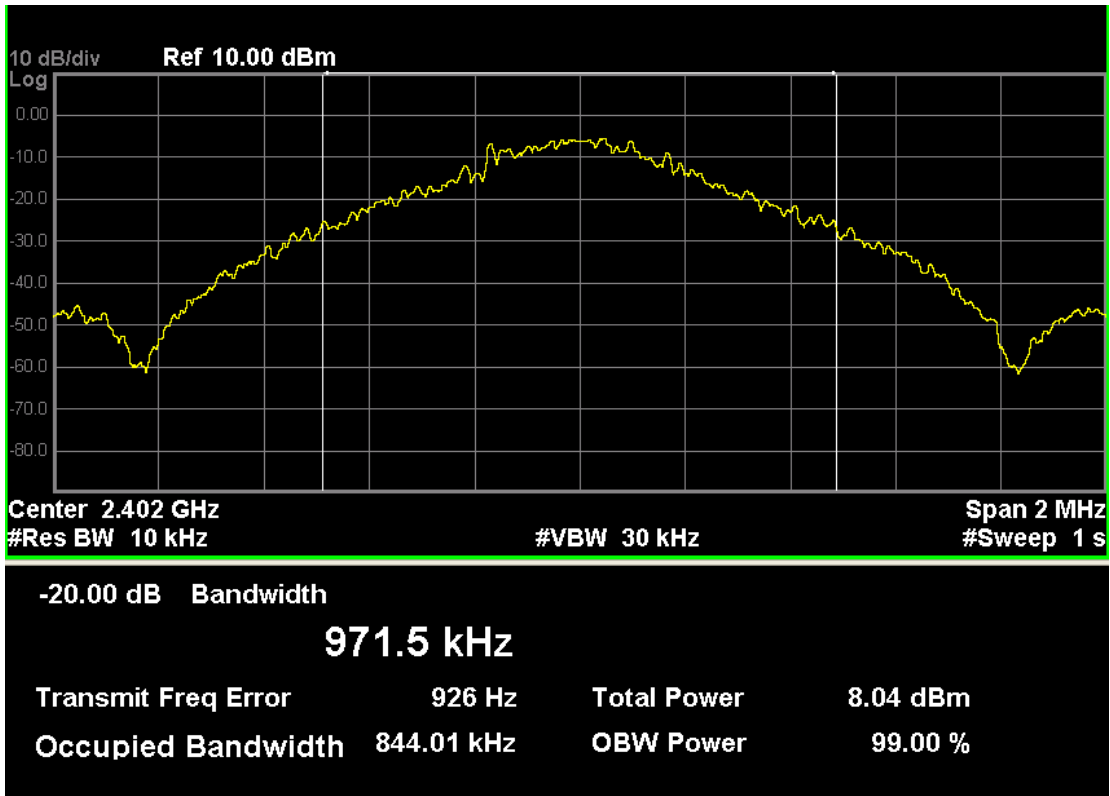

For MSR mode only:

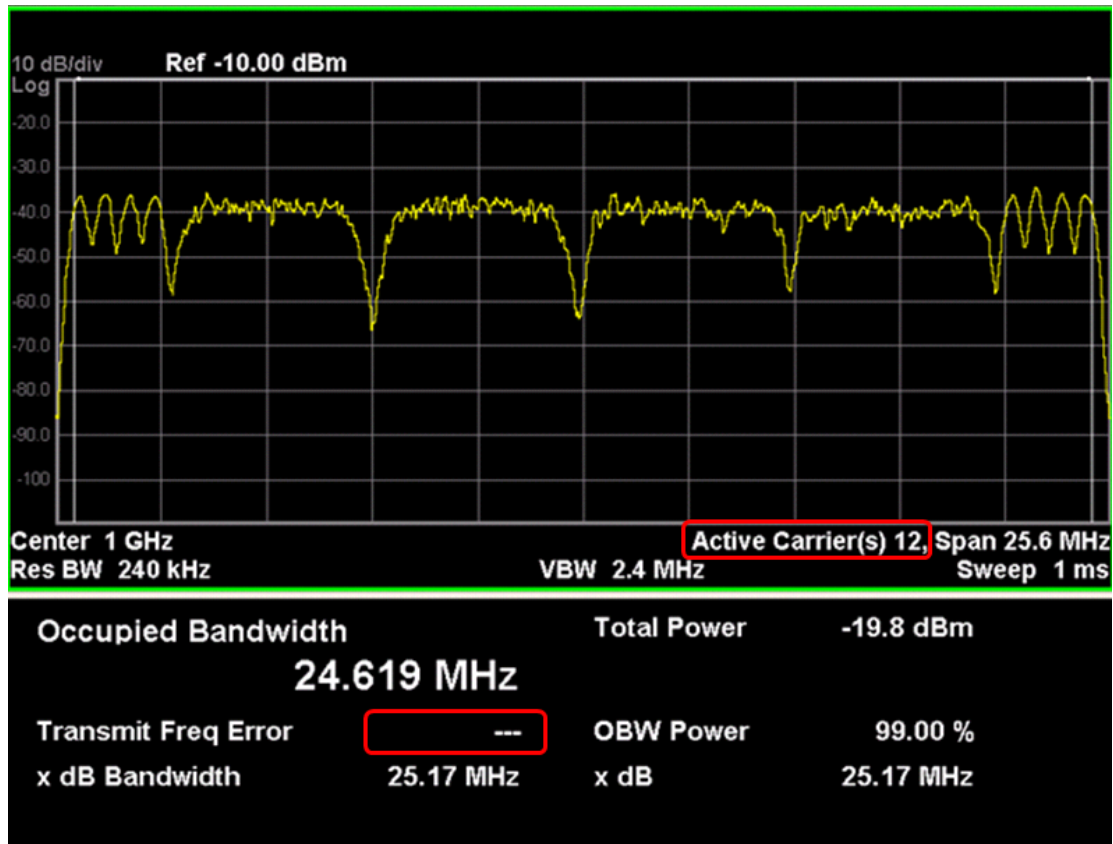

The number of active carriers is displayed. Since span is determined from detected carriers in auto mode, it is necessary to show how many carriers are identified as active., as highlighted above.

When there is one active carrier, Transmit Freq Error is displayed. Otherwise, “---“ is displayed, as shown above.

For LTE-Advanced FDD/TDD mode only:

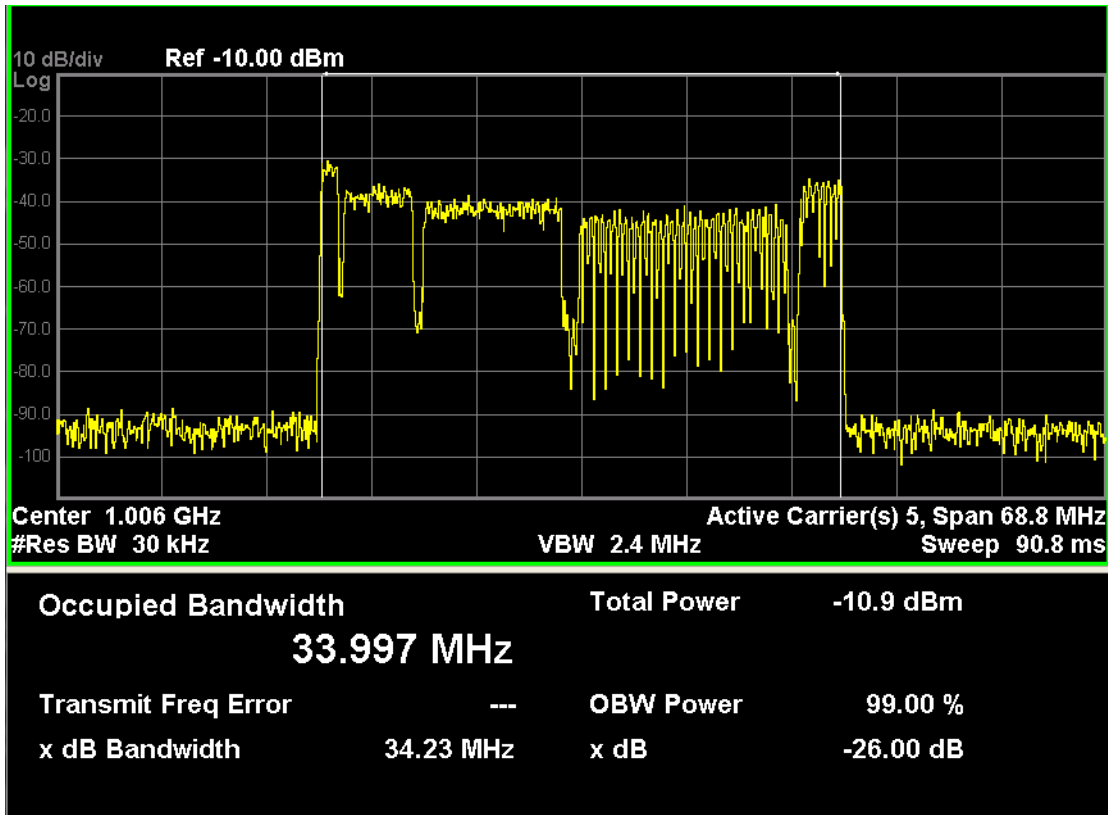

The number of active carriers is displayed to show how many carriers are identified as active in auto detected mode of span, otherwise “-” is displayed to indicate that it is out of scope.

When there is one active carrier, Transmit Freq Error is displayed. Otherwise, “---” is displayed.

Key Path	Front-panel key
Initial S/W Revision	Prior to A.02.00

Display

The Display menu is common to most measurements, and is used for configuring items on the display. Some Display menu settings apply to all the measurements in a mode, and some only to the current measurement. Those under the System Display Settings key apply to all measurements in all modes.

Key Path	Display
Key Path	View/Display
Initial S/W Revision	Prior to A.02.00

Annotation

Turns on and off various parts of the display annotation. The annotation is divided up into four categories:

1. Meas Bar: This is the measurement bar at the top of the screen. It does not include the settings panel or the Active Function. Turning off the Meas Bar turns off the settings panel and the Active Function. When the Meas Bar is off, the graticule area expands to fill the area formerly occupied by the Meas Bar.
2. Screen Annotation: this is the annotation and annunciation around the graticule, including any annotation on lines (such as the display line, the threshold line, etc.) This does NOT include the marker number or the N dB result. When off, the graticule expands to fill the entire graticule area.
3. Trace annotation: these are the labels on the traces, showing their detector (or their math mode).
4. Active Function annotation: this is the active function display in the meas bar, and all of the active function values displayed on softkeys.

See the figure below. Each type of annotation can be turned on and off individually.

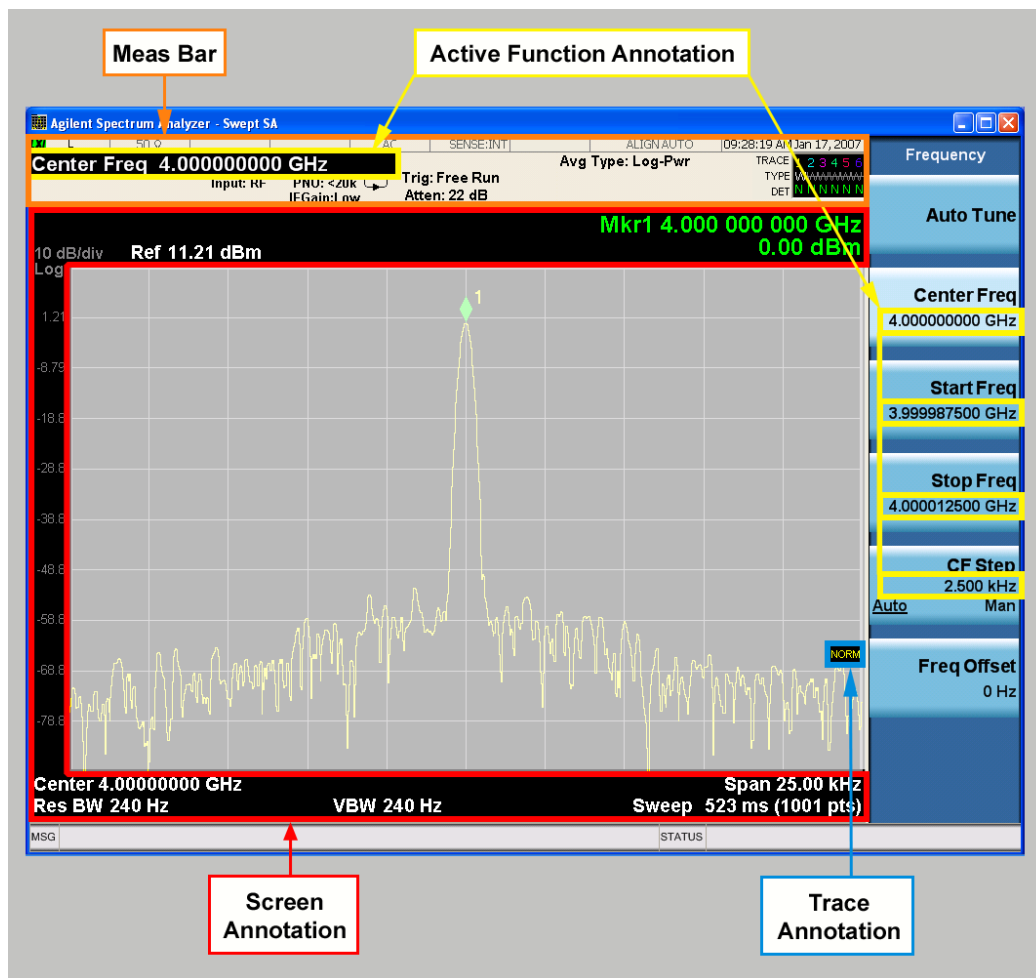

Key Path	View/Display, Display
Initial S/W Revision	Prior to A.02.00

Meas Bar On/Off

This function turns the Measurement Bar on and off, including the settings panel. When off, the graticule area expands to fill the area formerly occupied by the Measurement Bar.

Key Path	View/Display, Display, Annotation
Remote Command	:DISPlay:ANNotation:MBAR[:STATe] OFF ON 0 1 :DISPlay:ANNotation:MBAR[:STATe]?
Example	DISP:ANN:MBAR OFF
Dependencies	Grayed out and forced to OFF when System Display Settings, Annotation is set to Off.
Preset	On This should remain Off through a Preset when System DisplaySettings, Annotation is set to Off.
State Saved	Saved in instrument state.
Initial S/W Revision	Prior to A.02.00

Screen

This controls the display of the annunciation and annotation around the graticule, including any annotation on lines (such as the display line, the threshold line, etc.) and the y-axis annotation. This does NOT include marker annotation (or the N dB result). When off, the graticule expands to fill the entire graticule area, leaving only the 1.5% gap above the graticule as described in the Trace/Detector chapter.

Key Path	View/Display, Display, Annotation
Remote Command	:DISPlay:ANNotation:SCREen[:STATe] OFF ON 0 1 :DISPlay:ANNotation:SCREen[:STATe]?
Example	DISP:ANN:SCR OFF
Dependencies	Grayed-out and forced to OFF when System Display Settings, Annotation is set to Off.
Preset	On This should remain Off through a Preset when System DisplaySettings, Annotation is set to Off
State Saved	Saved in instrument state.
Initial S/W Revision	Prior to A.02.00

Active Function Values On/Off

Turns on and off the active function display in the Meas Bar, and all of the active function values displayed on the softkeys.

Note that all of the softkeys that have active functions have these numeric values blanked when this function is on. This is a security feature..

12 Occupied Bandwidth Measurement
View/Display

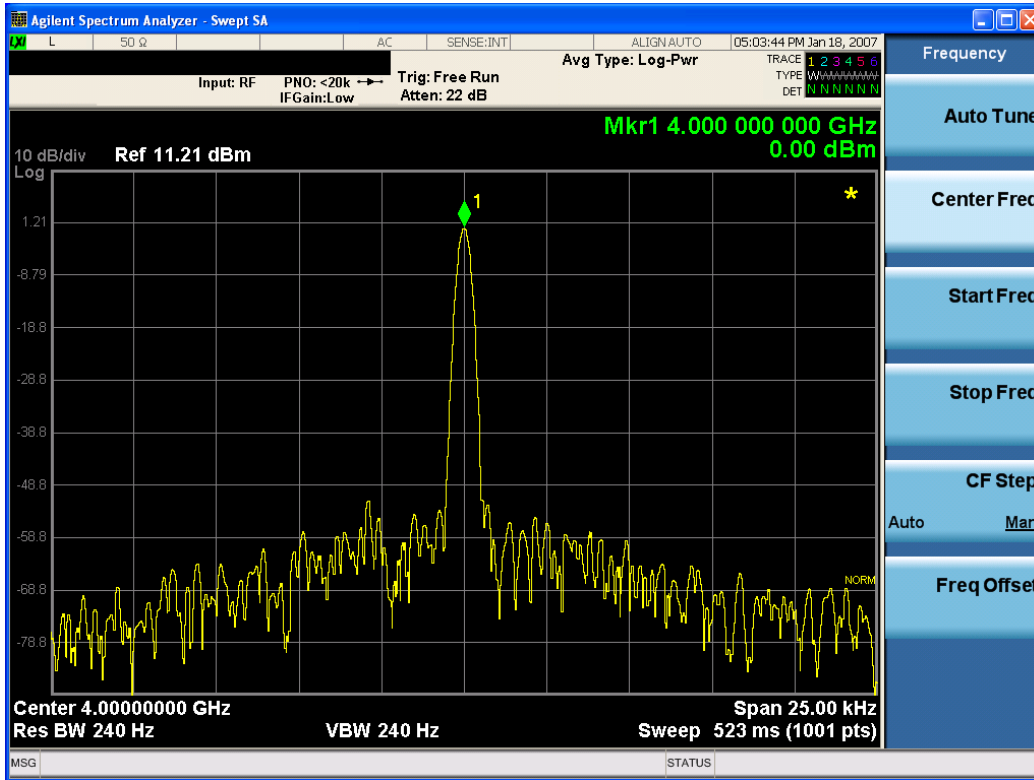

Key Path	View/Display, Display, Annotation
Remote Command	:DISPlay:ACTivefunc[:STATE] ON OFF 1 0 :DISPlay:ACTivefunc[:STATE] ?
Example	DISP:ACT OFF
Dependencies	Grayed out and forced to OFF when System Display Settings, Annotation is set to Off.
Preset	On This should remain Off through a Preset when System DisplaySettings, Annotation is set to Off
State Saved	Saved in instrument state.
Initial S/W Revision	Prior to A.02.00

Title

Displays menu keys that enable you to change or clear a title on your display.

Key Path	View/Display, Display
Initial S/W Revision	Prior to A.02.00

Change Title

Writes a title into the "measurement name" field in the banner, for example, "Swept SA".

Press Change Title to enter a new title through the alpha editor. Press Enter or Return to complete the entry. Press ESC to cancel the entry and preserve your existing title.

The display title will replace the measurement name. It remains for this measurement until you press Change Title again, or you recall a state, or a Preset is performed. A title can also be cleared by pressing Title, Clear Title.

NOTE

Notice the inclusion of the <measurement> parameter in the command below. Because each measurement remembers the Display Title, the command must be qualified with the measurement name. For the Swept SA measurement this is not the case; no <measurement> parameter is used when changing the Display Title for the Swept SA measurement.

Key Path	View/Display, Display, Title
Mode	All
Remote Command	:DISPlay:<measurement>:ANNotation:TITLe:DATA <string> :DISPlay:<measurement>:ANNotation:TITLe:DATA?
Example	DISP:ANN:TITL:DATA "This Is My Title" This example is for the Swept SA measurement in the Spectrum Analyzer mode. The SANalyzer <measurement> name is not used. DISP:ACP:ANN:TITL:DATA "This Is My Title" This example is for Measurements other than Swept SA. Both set the title to: This Is My Title
Notes	Pressing this key cancels any active function. When a title is edited the previous title remains intact (it is not cleared) and the cursor goes at the end so that characters can be added or BKSP can be used to go back over previous characters.
Preset	No title (measurement name instead)
State Saved	Saved in instrument state.
Initial S/W Revision	Prior to A.02.00

Clear Title

Clears a title from the front-panel display. Once cleared, the title cannot be retrieved. After the title is cleared, the current Measurement Name replaces it in the title bar.

Key Path	View/Display, Display, Title
Example	The following commands clear the title and restore the measurement's original title: DISP:ANN:TITL:DATA "" This example is for the Swept SA measurement in the Spectrum Analyzer mode. The SANalyzer <measurement> name is not used. DISP:ACP:ANN:TITL:DATA "" This example is for ACP; in measurements other than Swept SA the measurement name is required.
Notes	Uses the :DISPlay:<measurement>:ANNotation:TITLe:DATA <string> command with an empty string (in the Swept SA, the <measurement> is omitted).
Preset	Performed on Preset.
Initial S/W Revision	Prior to A.02.00

Graticule

Pressing Graticule turns the display graticule On or Off. It also turns the graticule y-axis annotation on and off.

Key Path	View/Display, Display
Remote Command	:DISPlay:WINDow[1]:TRACe:GRATicule:GRID[:STATe] OFF ON 0 1 :DISPlay:WINDow[1]:TRACe:GRATicule:GRID[:STATe]?
Example	DISP:WIND:TRAC:GRAT:GRID OFF
Notes	The graticule is the set of horizontal and vertical lines that make up the grid/divisions for the x-axis and y-axis.
Preset	On
State Saved	Saved in instrument state
Initial S/W Revision	Prior to A.02.00

System Display Settings

These settings are "Mode Global" – they affect all modes and measurements and are reset only by Restore Misc Defaults or Restore System Defaults under System.

Key Path	View/Display, Display
Initial S/W Revision	Prior to A.02.00

Annotation Local Settings

This is a Mode Global override of the meas local annotation settings. When it is All Off, it forces ScreenAnnotation, Meas Bar, Trace, and Active Function Values settings to be OFF for all measurements in all modes. This provides the security based "annotation off" function of previous analyzers; hence it uses the legacy SCPI command.

When it is All Off, the Screen, Meas Bar, Trace, and Active Function Values keys under the Display, Annotation menu are grayed out and forced to Off. When Local Settings is selected, you are able to set the local annotation settings on a measurement by measurement basis.

Key Path	View/Display, Display, System Display Settings
Remote Command	:DISPlay:WINDow[1]:ANNotation[:ALL] OFF ON 0 1 :DISPlay:WINDow[1]:ANNotation[:ALL]?
Example	:DISP:WIND:ANN OFF
Preset	On (Set by Restore Misc Defaults)
State Saved	Not saved in instrument state.
Backwards Compatibility Notes	The WINDow parameter and optional subopcode is included for backwards compatibility but ignored – all windows are equally affected.
Initial S/W Revision	Prior to A.02.00

Themes

Accesses a menu of functions that enable you to choose the theme to be used when saving the screen image.

The **Themes** option is the same as the **Themes** option under the **Display** and **Page Setup** dialogs. It allows you to choose between themes to be used when saving the screen image.

Key Path	Save, Screen Image
Remote Command	:MMEMory:STORe:SCReen:THEMe TDColor TDMonochrome FCOLor FMONochrome :MMEMory:STORe:SCReen:THEMe?
Example	:MMEM:STOR:SCR:THEM TDM
Preset	3D Color; Is not part of Preset, but is reset by Restore Misc Defaults or Restore System Defaults All and survives subsequent running of the modes.
Readback	3D Color 3D Mono Flat Color Flat Mono
Backwards Compatibility Notes	In ESA and PSA we offer the choice of "Reverse Bitmap" or "Reverse Metafile" when saving screen images. This is much like the "Flat Color" theme available in X-Series. Also, if you selected Reverse Bitmap AND a black & white screen image, that would be much like "Flat Monochrome". In other words, each of the X-Series themes has a similar screen image type in ESA/PSA. But they are not identical.
Initial S/W Revision	Prior to A.02.00

3D Color

Selects a standard color theme with each object filled, shaded and colored as designed.

Key Path	Save, Screen Image, Themes
Example	MMEM:STOR:SCR:THEM TDC
Readback	3D Color
Initial S/W Revision	Prior to A.02.00

3D Monochrome

Selects a format that is like 3D color but shades of gray are used instead of colors.

Key Path	Save, Screen Image, Themes
Example	MMEM:STOR:SCR:THEM TDM
Readback	3D Mono
Initial S/W Revision	Prior to A.02.00

Flat Color

Selects a format that is best when the screen is to be printed on an ink printer.

Key Path	Save, Screen Image, Themes
Example	MMEM:STOR:SCR:THEM FCOL
Readback	Flat Color
Initial S/W Revision	Prior to A.02.00

Flat Monochrome

Selects a format that is like Flat Color. But only black is used (no colors, not even gray), and no fill.

Key Path	Save, Screen Image, Themes
Example	MMEM:STOR:SCR:THEM FMON
Readback	Flat Mono
Initial S/W Revision	Prior to A.02.00

Backlight

Accesses the display backlight on/off keys. This setting may interact with settings under the Windows "Power" menu.

When the backlight is off, pressing ESC, TAB, SPACE, ENTER, UP, DOWN, LEFT, RIGHT, DEL, BKSP, CTRL, or ALT turns the backlight on without affecting the application. Pressing any other key will turn backlight on and could potentially perform the action as well.

Key Path	View/Display, Display, System Display Settings
Remote Command	:DISPlay:BACKlight ON OFF :DISPlay:BACKlight?
Preset	ON (Set by Restore Misc Defaults)
Initial S/W Revision	Prior to A.02.00

Backlight Intensity

An active function used to set the backlight intensity. It goes from 0 to 100 where 100 is full on and 0 is off. This value is independent of the values set under the Backlight on/off key.

Key Path	View/Display, Display, System Display Settings
Remote Command	:DISPlay:BACKlight:INTensity <integer> :DISPlay:BACKlight:INTensity?
Example	DISP:BACK:INT 50

Preset	100 (Set by Restore Misc Defaults)
Min	0
Max	100
Initial S/W Revision	Prior to A.02.00

13 Power vs Time Measurement

This measures power vs. time in the time domain. It compares the average power of the RF signal burst to a specified limit mask for pass/fail judgment. You must be in the WIMAXOFDMA mode to use these commands. Use INSTRUMENT:SElect to set the mode. For measurement results and views, see

This topic contains the following sections:

["Measurement Commands for Power vs Time" on page 1446](#)

["Remote Command Results for Power vs Time Measurement" on page 1447](#)

Measurement Commands for Power vs Time

The following commands are used to retrieve the measurement results:

`:CONFigure:PVTime`

`:CONFigure:PVTime:NDEFault`

`:INITiate:PVTime`

`:FETCh:PVTime[n]?`

`:READ:PVTime[n]?`

`:MEASure:PVTime[n]?`

For more measurement related commands, see the SENSE subsystem, and the section "[Remote Measurement Functions](#)" on page 2205.

Remote Command Results for Power vs Time Measurement

n	Results Returned
0	Returns unprocessed I/Q trace data as a series of comma-separated trace point values, in volts. The I values are listed first in each pair, using 0 through the even-indexed values. The Q values are odd-indexed values.
n=1 (or not specified)	<p>Returns the following comma-separated scalar results:</p> <ol style="list-style-type: none"> 1. Sample time is a floating point number representing the time between samples when using the trace queries (n=0, 2, etc.). 2. Power of single burst is the mean power (in dBm) of the power reference region in the most recently acquired data, or in the last data acquired at the end of a set of averages. 3. Power averaged is the power (in dBm) for N averages of the power reference region, if averaging is on. 4. The power is averaged across the power reference region of the burst. 5. If there are multiple bursts in the acquired trace, only the first burst that satisfies the burst detection setting is picked up for the averaging process. 6. If averaging is off, the value of Power averaged is the same as the Power value. 7. Number of samples is the number of data points in the captured signal. This number is useful when performing a query on the signal (i.e. when n=0, 2, etc.). 8. Start point of the useful part of the burst is the index of the data point at the start of the useful part of the burst. 9. If there are multiple bursts in the acquired trace, only the first burst that satisfies burst detection setting is picked up for the calculation process. 10. Stop point of the useful part of the burst is the index of the data point at the end of the useful part of the burst. 11. If there are multiple bursts in the acquired trace, only the first burst that satisfies burst detection setting is picked up for the calculation process. 12. Index of the data point where T0 occurred. 13. If there are multiple bursts in the acquired trace, only the first burst that satisfies burst detection setting is picked up for the calculation process. 14. Burst length of the useful part of the burst is the length of the burst measured at -3dB below the mean power in the useful part of the burst. 15. If there are multiple bursts in the acquired trace, only the first burst that satisfies burst detection setting is picked up for the calculation process. 16. Maximum value is the maximum peak level of the most recently acquired trace data (in dBm). 17. Minimum value is the minimum peak level of the most recently acquired trace data (in dBm). 18. Burst search threshold is the value (in dBm) of the threshold where a valid burst is identified, after the data has been acquired. 19. If there are multiple bursts in the acquired trace, only the first burst that satisfies burst detection setting is picked up for the calculation process. 20. IQ point delta is the number of data points in a data points offset that are internally applied to the useful data in traces n=2,3,4. You must apply this correction value to find the actual location of the Start, Stop, or T0 values. 21. (e.g. for n=2, Start (for the IQ trace data) = Start + IQ_point_delta) 22. 1st Error point is the time (in second) which indicates the point on the X Scale where the first failure of a signal was detected. Use a marker to locate this point in order to examine the nature of the failure. If the limit passes, the returned data has no meaning. 23. Time Offset is a floating-point number of the time interval in second between the trigger point and T0. The definition of the T0 depends on "Time Reference" parameter setting.

	24. If there are multiple bursts in the acquired trace, only the first burst that satisfies burst detection setting is picked up for the calculation process.
2	<p>Measured Trace data</p> <p>This returns comma-separated floating point numbers representing the Measured Trace data (in dBm).</p>
3	<p>Measured Max Hold Trace data</p> <p>This returns comma-separated floating point numbers representing the Measured Max Hold Trace data (in dBm).</p>
4	<p>Measured Min Hold Trace data</p> <p>This returns comma-separated floating point numbers representing the Measured Min Hold Trace data (in dBm).</p>
5	<p>Upper Mask Trace data</p> <p>This returns comma-separated floating point numbers representing the Upper Mask Trace data (in dBm).</p>
6	<p>Lower Mask Trace data</p> <p>This returns comma-separated floating point numbers representing the Lower Mask Trace data (in dBm).</p>
7	<p>Averaged absolute power of the regions</p> <p>This returns comma-separated float values representing the averaged absolute power of each region (in dBm) for each burst in capture length. The total number of returned values is 12 * number of bursts found.</p> <ol style="list-style-type: none"> 1. Averaged absolute power of region A 2. Averaged absolute power of region B 3. Averaged absolute power of region C 4. Averaged absolute power of region D 5. Averaged absolute power of region E 6. Averaged absolute power of region F 7. Averaged absolute power of region G 8. Averaged absolute power of region H 9. Averaged absolute power of region I 10. Averaged absolute power of region J 11. Averaged absolute power of region K 12. Averaged absolute power of region L
8	<p>Averaged relative power of the regions</p> <p>This returns comma-separated float values representing the averaged relative power to the region specified as the power reference (in dB) for each burst in capture length. The total number of returned values is 12 * number of bursts found.</p> <ol style="list-style-type: none"> 1. Averaged relative power of region A 2. Averaged relative power of region B 3. Averaged relative power of region C 4. Averaged relative power of region D 5. Averaged relative power of region E 6. Averaged relative power of region F 7. Averaged relative power of region G 8. Averaged relative power of region H 9. Averaged relative power of region I 10. Averaged relative power of region J

	11. Averaged relative power of region K 12. Averaged relative power of region L
9	<p>Max hold absolute power of the regions</p> <p>This returns comma-separated float values representing the maximum hold absolute power of each region (in dBm) for each burst in capture length. The total number of returned values is 12 * number of bursts found.</p> <ol style="list-style-type: none"> 1. Max hold absolute power of region A 2. Max hold absolute power of region B 3. Max hold absolute power of region C 4. Max hold absolute power of region D 5. Max hold absolute power of region E 6. Max hold absolute power of region F 7. Max hold absolute power of region G 8. Max hold absolute power of region H 9. Max hold absolute power of region I 10. Max hold absolute power of region J 11. Max hold absolute power of region K 12. Max hold absolute power of region L
10	<p>Max hold relative power of the regions</p> <p>This returns comma-separated float values representing the maximum hold relative power to the region specified as the power reference (in dB) for each burst in capture length. The total number of returned values is 12 * number of bursts found.</p> <ol style="list-style-type: none"> 1. Max hold relative power of region A 2. Max hold relative power of region B 3. Max hold relative power of region C 4. Max hold relative power of region D 5. Max hold relative power of region E 6. Max hold relative power of region F 7. Max hold relative power of region G 8. Max hold relative power of region H 9. Max hold relative power of region I 10. Max hold relative power of region J 11. Max hold relative power of region K 12. Max hold relative power of region L
11	<p>Min hold absolute power of the regions</p> <p>This returns comma-separated float values representing the minimum hold absolute power of each region (in dBm) for each burst in capture length. The total number of returned values is 12 * number of bursts found.</p> <ol style="list-style-type: none"> 1. Min hold absolute power of region A 2. Min hold absolute power of region B 3. Min hold absolute power of region C 4. Min hold absolute power of region D 5. Min hold absolute power of region E

	<ol style="list-style-type: none">6. Min hold absolute power of region F7. Min hold absolute power of region G8. Min hold absolute power of region H9. Min hold absolute power of region I10. Min hold absolute power of region J11. Min hold absolute power of region K12. Min hold absolute power of region L
12	<p>Min hold relative power of the regions</p> <p>This returns comma-separated float values representing the minimum hold relative power to the region specified as the power reference (in dB) for each burst in capture length. The total number of returned values is 12 * number of bursts found.</p> <ol style="list-style-type: none">1. Min hold relative power of region A2. Min hold relative power of region B3. Min hold relative power of region C4. Min hold relative power of region D5. Min hold relative power of region E6. Min hold relative power of region F7. Min hold relative power of region G8. Min hold relative power of region H9. Min hold relative power of region I10. Min hold relative power of region J11. Min hold relative power of region K12. Min hold relative power of region L
13	<p>Minimum relative level to the upper limit mask</p> <p>This returns comma-separated float values representing the minimum relative level to the upper limit mask of each region (in dB) for each burst in capture length. The total number of returned values is 12 * number of bursts found.</p> <p>If this value is negative or zero for a region, judgment passes with the upper mask of the region.</p> <p>If this value is positive for a region, judgment fails with the upper mask of the region.</p> <ol style="list-style-type: none">1. Minimum relative level to the upper limit mask of region A2. Minimum relative level to the upper limit mask of region B3. Minimum relative level to the upper limit mask of region C4. Minimum relative level to the upper limit mask of region D5. Minimum relative level to the upper limit mask of region E6. Minimum relative level to the upper limit mask of region F7. Minimum relative level to the upper limit mask of region G8. Minimum relative level to the upper limit mask of region H9. Minimum relative level to the upper limit mask of region I10. Minimum relative level to the upper limit mask of region J11. Minimum relative level to the upper limit mask of region K12. Minimum relative level to the upper limit mask of region L

14	<p>Minimum relative level to the lower limit mask</p> <p>This returns comma-separated float values representing the minimum relative level to the lower limit mask of each region (in dB) for each burst in capture length. The total number of returned values is 12 * number of bursts found.</p> <p>If this value is positive or zero for a region, judgment passes with the lower mask of the region.</p> <p>If this value is negative for a region, judgment fails with the lower mask of the region.</p> <ol style="list-style-type: none"> 1. Minimum relative level to the lower limit mask of region A 2. Minimum relative level to the lower limit mask of region B 3. Minimum relative level to the lower limit mask of region C 4. Minimum relative level to the lower limit mask of region D 5. Minimum relative level to the lower limit mask of region E 6. Minimum relative level to the lower limit mask of region F 7. Minimum relative level to the lower limit mask of region G 8. Minimum relative level to the lower limit mask of region H 9. Minimum relative level to the lower limit mask of region I 10. Minimum relative level to the lower limit mask of region J 11. Minimum relative level to the lower limit mask of region K 12. Minimum relative level to the lower limit mask of region L
----	--

Key Path	Meas
Initial S/W Revision	Prior to A.02.00

AMPTD Y Scale

Accesses the AMPTD Y Scale menu that allows you to set desired vertical scale settings.

See the “AMPTD Y Scale” section for more information.

Key Path	Front Panel
Initial S/W Revision	Prior to A.02.00

Ref Value

Sets the absolute power reference.

Key Path	AMPTD Y Scale
Mode	WIMAXOFDMA
Remote Command	:DISPlay:PVTime:VIEW[1]:WINDow[1]:TRACe:Y[:SCALe]:RLEVel <real> :DISPlay:PVTime:VIEW[1]:WINDow[1]:TRACe:Y[:SCALe]:RLEVel?
Example	DISP:PVT:VIEW:WIND:TRAC:Y:RLEV 5dbm DISP:PVT:VIEW:WIND:TRAC:Y:RLEV?
Couplings	When Auto Scaling is set to On, this value is automatically determined by the measurement result. When you set this value manually, Auto Scaling is automatically set to Off.
Preset	10.00
State Saved	Saved in instrument state.
Min	-250.0
Max	250.0
Initial S/W Revision	Prior to A.02.00

Attenuation

This menu controls the attenuator functions and interactions between the attenuation system components.

There are two attenuator configurations in the X-Series. One is a dual attenuator configuration consisting of a mechanical attenuator and an optional electronic attenuator. The other configuration uses a single attenuator with combined mechanical and electronic sections that controls all the attenuation functions. Different models in the X-Series come with different configurations.

See "[Dual Attenuator Configurations:](#)" on page 1453

See "[Single Attenuator Configuration:](#)" on page 1453

Most Attenuation settings are the same for all measurements – they do not change as you change measurements. Settings like these are called “Meas Global” and are unaffected by Meas Preset.

Key Path	AMPTD Y Scale
----------	---------------

Scope	Meas Global
Dependencies	In measurements that support the I/Q inputs, this key is unavailable when I/Q is the selected input, and is replaced by the Range key in that case.
Readback Line	Contains a summary in [] brackets of the current total attenuation. See the descriptions of the , " (Mech) Atten " on page 2141, and " Enable Elec Atten " on page 2143 keys for more detail on the contributors to the total attenuation. Note that when "Pre-Adjust for Min Clip" is on, this value can change at the start of every measurement.
Initial S/W Revision	Prior to A.02.00
Modified at S/W Revision	A.03.00

Dual Attenuator Configurations:

Configuration 1: Mechanical attenuator + optional electronic attenuator

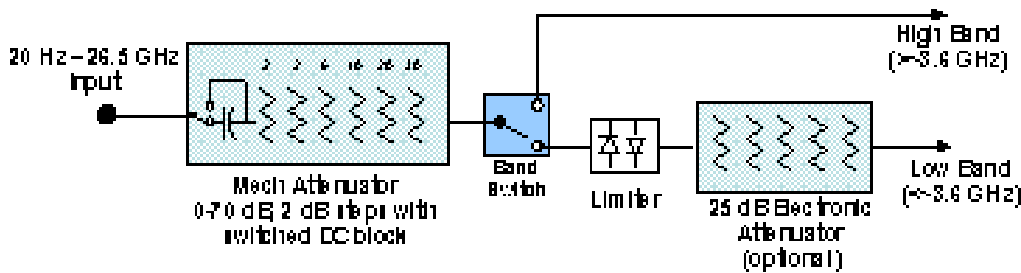

Configuration 2: Mechanical attenuator, no optional electronic attenuator

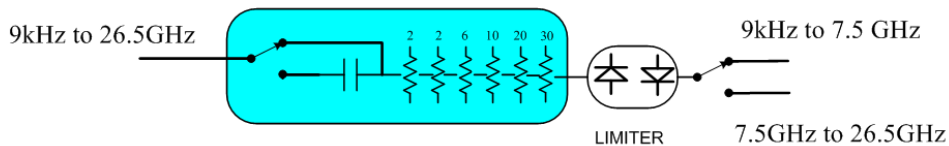

(note that Configuration 2 is not strictly speaking a dual-section attenuator, since there is no electronic section available. However, it behaves exactly like Configuration 1 without the Electronic Attenuator option EA3, therefore for the sake of this document it is grouped into the "Dual Attenuator" configuration)

Single Attenuator Configuration:

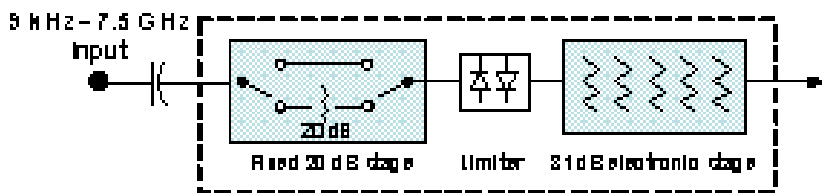

You can tell which attenuator configuration you have by pressing the Attenuation key, which (in most Modes) opens the Attenuation menu. If the first key in the Attenuation menu says Mech Atten you have the dual attenuator configuration. If the first key says Atten you have the single attenuator configuration.

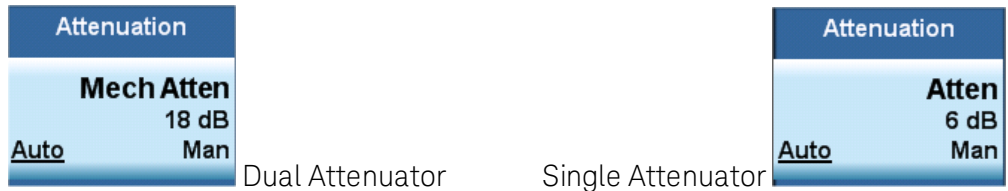

In the single attenuator configuration, you control the attenuation with a single control, as the fixed stage has only two states. In the dual attenuator configuration, both stages have significant range so you are given separate control of the mechanical and electronic attenuator stages.

When you have the dual attenuator configuration, you may still have only a single attenuator, because unless option EA3 (the Electronic Attenuator option) is available, and you purchase it, you will have only the mechanical attenuator.

(Mech) Atten

This key is labeled Mech Atten in dual attenuator models and Atten in single attenuator models. In the dual attenuator configuration, this key only affects the mechanical attenuator.

This key lets you modify the attenuation applied to the RF input signal path. This value is normally auto coupled to the Ref Level, the Internal Preamp Gain, any External Gain that is entered, and the Max Mixer Level, as described in the table below.

See "[Attenuator Configurations and Auto/Man](#)" on page 1455

Key Path	AMPTD Y Scale, Attenuation
Remote Command	<pre>[:SENSe] :POWer [:RF] :ATTenuation <rel_ampl> [:SENSe] :POWer [:RF] :ATTenuation? [:SENSe] :POWer [:RF] :ATTenuation:AUTO OFF ON 0 1 [:SENSe] :POWer [:RF] :ATTenuation:AUTO?</pre>
Example	<p>POW:ATT 20</p> <p>Dual attenuator configuration: sets the mechanical attenuator to 20 dB</p> <p>Single attenuator mode: sets the main attenuation to 20 dB (see below for definition of "main" attenuation).</p> <p>If the attenuator was in Auto, it sets it to Manual.</p>
Dependencies	<p>Some measurements do not support the Auto setting of (Mech) Atten. In these measurements, the Auto/Man selection is not available, and the Auto/Man line on the key disappears.</p> <p>In dual attenuator configurations, when the electronic attenuator is enabled, the mechanical attenuator has no auto setting and the Auto/Man line on the key disappears. The state of Auto/Man is remembered and restored when the electronic attenuator is once again disabled. This is described in more detail in the "Enable Elec Atten" on page 2143 key description.</p> <p>See "Attenuator Configurations and Auto/Man" on page 1455 for more information on the Auto/Man functionality of Attenuation.</p>

Couplings

	<p>When (Mech) Atten is in Auto, it uses the following algorithm to determine a value: If the USB Preamp is connected to USB, use 0 dB. Otherwise, Atten = ReferenceLevel + PreAmpGain + ExternalGain – RefLevelOffset - MaxMixerLevel + IF Gain. Limit this value to be between 6 dB and the Max value. No value below 6 dB can ever be chosen by Auto. The resulting value is rounded up to the largest value possible given the attenuation step setting. That is, 50.01 dB would change to 60 dB (for a 10 dB attenuation step). The “IF Gain” term in the equation above is either 0 dB or +10 dB, depending on the settings of FFT IF Gain, Swept IF Gain, max Ref Level and the Auto/Man setting of Mech Atten. In External Mixing and BBIQ, where the Attenuator is not in the signal path, the Attenuator setting changes as described above when (Mech) Atten is in Auto, but no changes are made to the actual attenuator hardware setting until the input is changed back to the RF Input.</p>
Preset	<p>The preset for Mech Attenuation is “Auto.” The Auto value of attenuation is: CXA, EXA, MXA and PXA: 10 dB</p>
State Saved	Saved in instrument state
Min	<p>0 dB The attenuation set by this key cannot be decreased below 6 dB with the knob or step keys. To get to a value below 6 dB it has to be directly entered from the keypad or via SCPI. This protects from adjusting the attenuation to a dangerously small value which can put the instrument at risk of damage to input circuitry. However, if the current mechanical attenuation is below 6 dB it can be increased with the knob and step keys, but not decreased.</p>
Max	<p>CXA N9000A–503/507: 50 dB CXA N9000A–513/526: 70dB EXA: 60 dB MXA and PXA: 70 dB In the single attenuator configuration, the total of ATT and EATT cannot exceed 50 dB, so if the EATT is set to 24 dB first, the main attenuation cannot be greater than 26 dB and will be reduced accordingly; if the main attenuator is set to 40 dB first, EATT cannot be greater than 10 dB.</p>
Initial S/W Revision	Prior to A.02.00
Modified at S/W Revision	A.03.00

Attenuator Configurations and Auto/Man

As described in the Attenuation key description, there are two distinct attenuator configurations available in the X-Series, the single attenuator and dual attenuator configurations. In dual attenuator configurations, we have the mechanical attenuation and the electronic attenuation, and the current total attenuation is the sum of the electronic + mechanical attenuation. In single attenuator configurations, we refer to the attenuation set using the (Mech) Atten key (or POW:ATT SCPI) as the “main” attenuation; and the attenuation that is set by the SCPI command POW:EATT as the “soft” attenuation (the POW:EATT command is honored even in the single attenuator configuration, for compatibility purposes). Then the

current total attenuation is the sum of the main + soft attenuation. See the Elec Atten key description for more on “soft” attenuation.

In the dual attenuator configuration, when the electronic attenuator is enabled, there is no Auto/Man functionality for the mechanical attenuator, and the third line of the key label (the Auto/Man line) disappears:



Enable Elec Atten

Enables the Electronic Attenuator.

The electronic attenuator offers finer steps than the mechanical attenuator, has no acoustical noise, is faster, and is less subject to wear. These advantages primarily aid in remote operation and are negligible for front panel use. See ["Using the Electronic Attenuator: Pros and Cons" on page 1458](#) for a detailed discussion of the pros and cons of using the electronic attenuator.

For the single attenuator configuration, for SCPI backwards compatibility, the “soft” attenuation feature replaces the dual attenuator configuration’s electronic attenuator. All the same couplings and limitations apply. See ["Attenuator Configurations and Auto/Man" on page 2143](#)

See ["More Information" on page 1457](#)

Key Path	AMPTD Y Scale, Attenuation
Remote Command	[:SENSe] :POWeR [:RF] :EATTenuation :STATe OFF ON 0 1 [:SENSe] :POWeR [:RF] :EATTenuation :STATe ?
Example	POW:EATT:STAT ON
Dependencies	<p>This key only appears in Dual Attenuator models with an Electronic Attenuator installed. It does not appear in models with the Single Attenuator configuration, as in the single attenuator configuration there is no “electronic attenuator” there is only a single integrated attenuator (which has both a mechanical and electronic stage). However, in the single attenuator configuration, EATT SCPI commands are accepted for compatibility with other X-series instruments and set a “soft” attenuation as described in "Attenuator Configurations and Auto/Man" on page 2143.</p> <p>The electronic attenuator (and the “soft” attenuation function provided in single attenuator configurations) is unavailable above 3.6 GHz. Therefore, if the Stop Frequency of the analyzer is > 3.6 GHz then the Enable Elec Atten key will be OFF and grayed out.</p> <p>If the Internal Preamp is on, meaning it is set to Low Band or Full, the electronic attenuator (and the “soft” attenuation function provided in single attenuator configurations) is unavailable. In this case the Enable Elec Atten key will be OFF and grayed out.</p> <p>If either of the above is true, if the SCPI command is sent, an error indicating that the electronic attenuator is unavailable will be sent.</p> <p>If the electronic/soft Attenuator is enabled, then the Stop Freq of the analyzer is limited to 3.6 GHz and the Internal Preamp is unavailable.</p> <p>The SCPI-only “soft” electronic attenuation for the single-attenuator configuration is not available in</p>

	all measurements; in particular, it is not available in the Swept SA measurement.
Couplings	Enabling and disabling the Electronic Attenuator affects the setting of the Mechanical Attenuator (in dual attenuator configurations). This is described in more detail below this table.
Preset	OFF for Swept SA measurement; ON for all other measurements that support the electronic attenuator
State Saved	Saved in instrument state
Initial S/W Revision	Prior to A.02.00
Modified at S/W Revision	A.03.00

More Information

Mechanical Attenuator Transition Rules

When the Electronic Attenuator is enabled, the Mechanical Attenuator transitions to a state that has no Auto function. Below are the rules for transitioning the Mechanical Attenuator. NOTE that the information below ONLY applies to the dual attenuator configurations, and ONLY when the Electronic Attenuator is installed:

When the Electronic Attenuation is enabled from a disabled state:

- The Mechanical Attenuator is initialized to 10 dB (this is its optimal performance setting). You can then set it as desired with SCPI, numeric keypad, step keys, or knob, and it behaves as it normally would in manual mode
- The Auto/Man state of (Mech) Atten is saved
- The Auto/Man line on the (Mech) Atten key disappears and the auto rules are disabled
- The Electronic Attenuator is set to 10 dB less than the previous value of the Mechanical Attenuator, within the limitation that it must stay within the range of 0 to 24 dB of attenuation.

Examples in the dual attenuator configuration:

- Mech Atten at 20 dB. Elec Atten enabled, Mech Atten set to 10 dB, and Elec Atten set to 10 dB. New total attenuation equals the value before Elec Atten enabled.
- Mech Atten at 0 dB. Elec Atten enabled, Mech Atten set to 10 dB, and Elec Atten set to 0 dB. New total attenuation does not equal the value before Elec Atten enabled.
- Mech Atten at 40 dB. Elec Atten enabled, Mech Atten set to 10 dB, and Elec Atten set to 24 dB. New total attenuation does not equal the value before Elec Atten enabled.

When the Electronic Attenuation is disabled from an enabled state:

- The Elec Atten key is grayed out
- The Auto/Man state of (Mech) Atten is restored
- If now in Auto, (Mech) Atten recouples

- If now in Man, (Mech) Atten is set to the value of total attenuation that existed before the Elec Atten was disabled. The resulting value is rounded up to the smallest value possible given the (Mech) Atten Step setting - (That is, 57 dB changes to 58 dB when (Mech) Atten Step is 2 dB.)

Using the Electronic Attenuator: Pros and Cons

The electronic attenuator offers finer steps than the mechanical attenuator, has no acoustical noise, is faster, and is less subject to wear.

The “finer steps” advantage of the electronic attenuator is beneficial in optimizing the alignment of the analyzer dynamic range to the signal power in the front panel as well as remote use. Thus, you can achieve improved relative signal measurement accuracy. Compared to a mechanical attenuator with 2 dB steps, the 1 dB resolution of the electronic attenuator only gives better resolution when the odd-decibel steps are used. Those odd-decibel steps are less accurately calibrated than the even-decibel steps, so one tradeoff for this superior relative accuracy is reduced absolute amplitude accuracy.

Another disadvantage of the electronic attenuator is that the spectrum analyzer loses its “Auto” setting, making operation less convenient.

Also, the relationship between the dynamic range specifications (TOI, SHI, compression and noise) and instrument performance are less well-known with the electrical attenuator. With the mechanical attenuator, TOI, SHI and compression threshold levels increase dB-for-dB with increasing attenuation, and the noise floor does as well. With the electronic attenuator, there is an excess attenuation of about 1 to 3 dB between 0 and 3.6 GHz, making the effective TOI, SHI, and so forth, less well known. Excess attenuation is the actual attenuation relative to stated attenuation. Excess attenuation is accounted for in the analyzer calibration

Elec Atten

Controls the Electronic Attenuator in dual attenuator configurations. This key does not appear in single attenuator configurations, as the control of both the mechanical and electronic stages of the single attenuator is integrated into the single Atten key.

Key Path	AMPTD Y Scale, Attenuation
Remote Command	<code>[:SENSe] :POWer [:RF] :EATTenuation <rel_amp></code> <code>[:SENSe] :POWer [:RF] :EATTenuation?</code>
Notes	Electronic Attenuation's specification is defined only when Mechanical Attenuation is 6 dB.
Dependencies	This key only appears in Dual Attenuator models with an Electronic Attenuator installed. It does not appear in models with the Single Attenuator configuration, as in the single attenuator configuration there is no “electronic attenuator” there is only a single integrated attenuator (which has both a mechanical and electronic stage). However, in the single attenuator configuration, EATT SCPI commands are accepted for compatibility with other X-series instruments and set a “soft” attenuation as described in "Attenuator Configurations and Auto/Man" on page 2143 . The “soft” attenuation is treated as an addition to the “main” attenuation value set by the Atten softkey or the POW:ATT SCPI command and affects the total attenuation displayed on the Attenuation key and the Meas Bar. When Enable Elec Atten is off or grayed out, the Elec Atten key is grayed out.
Preset	0 dB
State Saved	Saved in instrument state

Min	0 dB
Max	Dual attenuator configuration: 24 dB Single attenuator configuration: the total of ATT and EATT cannot exceed 50 dB, so if the EATT is set to 24 dB first, the main attenuation cannot be greater than 26 dB and will be reduced accordingly; if the main attenuator is set to 40 dB first, EATT cannot be greater than 10 dB
Initial S/W Revision	Prior to A.02.00
Modified at S/W Revision	A.03.00

Adjust Atten for Min Clip

Sets the combination of mechanical and electronic attenuation and gain based on the current measured signal level so that clipping will be at a minimum.

This is an "immediate action" function, that is, it executes once, when the key is pressed.

This key is grayed out in measurements that do not support this functionality. The spectrum analyzer measurement, Swept SA, does not support this functionality.

Key Path	AMPTD Y Scale, Attenuation
Remote Command	<code>[:SENSe] :POWer [:RF] :RANGe:OPTimize IMMEDIATE</code>
Initial S/W Revision	Prior to A.02.00
Modified at S/W Revision	A.03.00

Pre-Adjust for Min Clip

If this function is on, it does the adjustment described under ["Adjust Atten for Min Clip" on page 2146](#) each time a measurement restarts. Therefore, in Continuous measurement mode, it only executes before the first measurement.

In dual attenuator models, you can set Elec+Mech Atten, in which case both attenuators participate in the autoranging, or Elec Atten Only, in which case the mechanical attenuator does not participate in the autoranging. This latter case results in less wear on the mechanical attenuator and is usually faster.

This key is grayed out in measurements that do not support this functionality. The spectrum analyzer measurement, Swept SA, does not support this functionality.

Key Path	AMPTD Y Scale, Attenuation
Remote Command	<code>[:SENSe] :POWer [:RF] :RANGe:OPTimize:ATTenuation OFF ELECTrical COMBined</code> <code>[:SENSe] :POWer [:RF] :RANGe:OPTimize:ATTenuation?</code>
Notes	The SCPI parameter ELECTrical sets this function to On in single attenuator models. The SCPI parameter COMBined is mapped to ELECTrical in single attenuator models; if you send COMBined, it sets the function to On and returns ELEC to a query.
Dependencies	This key only appears in Dual Attenuator models with an Electronic Attenuator installed.

	In instruments with Dual Attenuator model, when Enable Elec Atten is off or grayed out, the Pre-Adjust for Min Clip key is grayed out.
Preset	OFF for Swept SA measurement; ON for all other measurements that support Pre-Adjust for Min Clip
State Saved	Saved in instrument state
Range	Dual attenuator models: Off Elec Atten Only Mech + Elec Atten Single attenuator models: Off On
Initial S/W Revision	Prior to A.02.00
Modified at S/W Revision	A.03.00

Remote Command	<code>[:SENSe] :POWer [:RF] :RANGe :AUTO ON OFF 1 0</code> <code>[:SENSe] :POWer [:RF] :RANGe :AUTO ?</code>
Notes	ON aliases to "Elec Atten Only" (:POW:RANG:OPT:ATT ELEC) OFF aliases to "Off" (:POW:RANG:OPT:ATT OFF) The query :POW:RANG:AUTO? returns true if :POW:RANG:OPT:ATT is not "Off"
Initial S/W Revision	Prior to A.02.00

Off

Turns Pre-Adjust for Min Clip off. This is the default setting.

This key is grayed out in measurements that do not support this functionality. The spectrum analyzer measurement, Swept SA, does not support this functionality.

Key Path	AMPTD Y Scale, Attenuation, Pre-Adjust for Min Clip
Example	:POW:RANG:OPT:ATT OFF
Initial S/W Revision	Prior to A.02.00

Elec Atten Only

Selects only the electric attenuator to participate in auto ranging. This offers less wear on the mechanical attenuator and is usually faster.

This key is grayed out in measurements that do not support this functionality. The spectrum analyzer measurement, Swept SA, does not support this functionality.

Key Path	AMPTD Y Scale, Attenuation, Pre-Adjust for Min Clip
Example	:POW:RANG:OPT:ATT ELEC
Initial S/W Revision	Prior to A.02.00

Mech + Elec Atten

In dual attenuator models, this selects both attenuators participate in the autoranging.

This key is grayed out in measurements that do not support this functionality. The spectrum analyzer measurement, Swept SA, does not support this functionality.

Key Path	AMPTD Y Scale, Attenuation, Pre-Adjust for Min Clip
Example	:POW:RANGe:OPT:ATT COMB
Initial S/W Revision	Prior to A.02.00

(Mech) Atten Step

This controls the step size used when making adjustments to the input attenuation.

This key is labeled Mech Atten Step in dual attenuator models and Atten Step in single attenuator models. In the dual attenuator configuration, this key only affects the step size of the mechanical attenuator.

Key Path	AMPTD Y Scale, Attenuation
Remote Command	<code>[:SENSe] :POWer [:RF] :ATTenuation :STEP [:INCRement] 10 dB 2 dB</code> <code>[:SENSe] :POWer [:RF] :ATTenuation :STEP [:INCRement] ?</code>
Example	POW:ATT:STEP 2
Notes	Note this feature works like a 1-N choice from the front panel, but it takes a specific value (in dB) when used remotely. The only valid values are 2 and 10.
Dependencies	Blanked in CXA and EXA if option FSA (2 dB steps) is not present. If blanked, attempts to set it via SCPI will yield an error.
Couplings	When the attenuation step size changes, the current mechanical attenuation value is adjusted (if necessary) to be quantized to the new step size. That is, if step is set to 10 dB, mech atten is increased if necessary so it is a multiple of 10 dB
Preset	PXA and MXA: 2 dB EXA and CXA: 10 dB (2 dB with option FSA)
State Saved	Saved in instrument state
Initial S/W Revision	Prior to A.02.00
Modified at S/W Revision	A.03.00

Scale/Div

Allows you to enter a numeric value to change vertical display sensitivity.

Key Path	AMPTD Y Scale
----------	---------------

Mode	WIMAXOFDMA
Remote Command	:DISPlay:PVTime:VIEW[1]:WINDow[1]:TRACe:Y[:SCALe]:PDIVision <rel_amp1> :DISPlay:PVTime:VIEW[1]:WINDow[1]:TRACe:Y[:SCALe]:PDIVision?
Example	DISP:PVT:VIEW:WIND:TRAC:Y:PDIV 10dB DISP:PVT:VIEW:WIND:TRAC:Y:PDIV?
Couplings	When the Auto Scaling is set to On, this value is automatically determined by the measurement result. When you set a value manually, Auto Scaling is automatically set to Off.
Preset	10.00 dB
State Saved	Saved in instrument state.
Min	0.1 dB
Max	20.00 dB
Initial S/W Revision	Prior to A.02.00

Presel Center

When this key is pressed, the centering of the preselector filter is adjusted to optimize the amplitude accuracy at the frequency of the selected marker. If the selected marker is not on when Presel Center is pressed, the analyzer will turn on the selected marker, perform a peak search, and then perform centering on the marker's center frequency. If the selected marker is already on and between the start and stop frequencies of the analyzer, the analyzer performs the preselector calibration on that marker's frequency. If the selected marker is already on, but outside the frequency range between Start Freq and Stop Freq, the analyzer will first perform a peak search, and then perform centering on the marker's center frequency.

The value displayed on the Presel Adjust key will change to reflect the new preselector tuning (see Presel Adjust).

A number of considerations should be observed to ensure proper operation. See "[Proper Preselector Operation](#)" on page 1463.

Key Path	AMPTD Y Scale
Remote Command	[:SENSe]:POWer[:RF]:PCENter
Example	POW:PCEN
Notes	Note that the rules outlined above under the key description apply for the remote command as well as the key. The result of the command is dependent on marker position, and so forth. Any message shown by the key press is also shown in response to the remote command.
Dependencies	<ul style="list-style-type: none"> • Grayed out if the microwave preselector is off.) • If the selected marker's frequency is below Band 1, advisory message 0.5001 is generated and no action is taken. • Grayed out if entirely in Band 0. • Blank in models that do not include a preselector, such as option 503. If the SCPI is sent in these instruments, it is accepted without error, and the query always returns 0. • Grayed out in the Spectrogram View.

Couplings	The active marker position determines where the centering will be attempted. If the analyzer is in a measurement such as averaging when centering is initiated, the act of centering the preselector will restart averaging but the first average trace will not be taken until the centering is completed.
Status Bits/OPC dependencies	When centering the preselector, *OPC will not return true until the process is complete and a subsequent measurement has completed, nor will results be returned to a READ or MEASure command. The Measuring bit should remain set while this command is operating and should not go false until the subsequent sweep/measurement has completed.
Initial S/W Revision	Prior to A.02.00
Modified at S/W Revision	A.03.00

Proper Preselector Operation

A number of considerations should be observed to ensure proper operation:

1. If the selected marker is off, the analyzer will turn on a marker, perform a peak search, and adjust the preselector using the selected marker's frequency. It uses the "highest peak" peak search method unqualified by threshold or excursion, so that there is no chance of a 'no peak found' error. It continues with that peak, even if it is the peak of just noise. Therefore, for this operation to work properly, there should be a signal on screen in a preselected range for the peak search to find.
2. If the selected marker is already on, the analyzer will attempt the centering at that marker's frequency. There is no preselector for signals below about 3.6 GHz, therefore if the marker is on a signal below 3.6 GHz, no centering will be attempted and an advisory message generated
3. In some models, the preselector can be bypassed. If it is bypassed, no centering will be attempted in that range and a message will be generated.

Preselector Adjust

Allows you to manually adjust the preselector filter frequency to optimize its response to the signal of interest. This function is only available when "[Presel Center](#)" on page 2149 is available.

For general purpose signal analysis, using Presel Center is recommended. Centering the filter minimizes the impact of long-term preselector drift. Presel Adjust can be used instead to manually optimize the preselector. One application of manual optimization would be to peak the preselector response, which both optimizes the signal-to-noise ratio and minimizes amplitude variations due to small (short-term) preselector drifting.

Key Path	AMPTD Y Scale
Scope	Meas Global
Remote Command	[:SENSe] :POWer [:RF] :PADJust <freq> [:SENSe] :POWer [:RF] :PADJust?
Example	POW:PADJ 100KHz

	POW:PADJ?
Notes	The value on the key reads out to 0.1 MHz resolution.
Dependencies	<ul style="list-style-type: none"> • Grayed out if microwave preselector is off.) • Grayed out if entirely in Band 0. • Blank in models that do not include a preselector, such as option 503. If the SCPI is sent in these instruments, it is accepted without error, and the query always returns 0. • Grayed out in the Spectrogram View.
Preset	0 MHz
State Saved	The Presel Adjust value set by Presel Center, or by manually adjusting Presel Adjust, is not saved in instrument state, and does not survive a Preset or power cycle.
Min	-500 MHz
Max	500 MHz
Default Unit	Hz
Backwards Compatibility SCPI	<pre>[:SENSe] :POWer [:RF] :MW :PADJust</pre> <pre>[:SENSe] :POWer [:RF] :MMW :PADJust</pre> <p>PSA had multiple preselectors, but the X-Series has only one. These commands simply alias to [:SENSe]:POWER[:RF]:PADJust</p>
Initial S/W Revision	Prior to A.02.00
Modified at S/W Revision	A.03.00

Remote Command	<pre>[:SENSe] :POWer [:RF] :PADJust :PRESelector MWAVE MMWave EXTERNAL</pre> <pre>[:SENSe] :POWer [:RF] :PADJust :PRESelector?</pre>
Notes	<p>PSA had multiple preselectors, and you could select which preselector to adjust. Since the X-Series has only one mm/uW preselector, the preselector selection softkey is no longer available. However, to provide backward compatibility, we accept the legacy remote commands.</p> <p>The command form has no effect, the query always returns MWAVE</p>
Initial S/W Revision	Prior to A.02.00

μW Path Control

The μW Path Control functions include the μW Preselector Bypass (Option MPB) and Low Noise Path (Option LNP) controls in the High Band path circuits.

When the μW Preselector is bypassed, the user has better flatness, but will be subject to spurs from out of band interfering signals. When the Low Noise Path is enabled, the analyzer automatically switches around certain circuitry in the high frequency bands which can contribute to noise, when it is appropriate based on other analyzer settings.

For most applications, the preset state is Standard Path, which gives the best remote-control throughput, minimizes acoustic noise from switching and minimizes the risk of wear out in the hardware switches. For applications that utilize the wideband IF paths, the preset state is the μ W Preselector Bypass path, if option MPB is present. This is because, when using a wideband IF such as the 140 MHz IF, the μ W Preselector's bandwidth can be narrower than the available IF bandwidth, causing degraded amplitude flatness and phase linearity, so it is desirable to bypass the preselector in the default case.

Users may choose Low Noise Path Enable. It gives a lower noise floor, especially in the 21–26.5 GHz region, though without improving many measures of dynamic range, and without giving the best possible noise floor. The preamp, if purchased and used, gives better noise floor than does the Low Noise Path, however its compression threshold and third-order intercept are much poorer than that of the non-preamp Low Noise Path. There are some applications, typically for signals around –30 dBm, for which the third-order dynamic range of the standard path is good enough, but the noise floor is not low enough even with 0 dB input attenuation. When the third-order dynamic range of the preamp path is too little and the noise floor of the standard path is too high, the Low Noise Path can provide the best dynamic range.

Key Path	AMPTD Y Scale
Mode	SA, BASIC, PNOISE, VSA , LTE, LTETDD
Scope	Meas Global
Remote Command	[:SENSe] :POWer [:RF] :MW:PATH STD LNPath MPBypass FULL [:SENSe] :POWer [:RF] :MW:PATH?
Example	:POW:MW:PATH LNP Enables the Low Noise path
Notes	If a Presel Center is performed, the analyzer will momentarily switch to the Standard Path, regardless of the setting of μ W Path Control The DC Block will always be switched in when the low noise path is switched in, to protect succeeding circuitry from DC. Note that this does not mean “when the low noise path is enabled” but when, based on the Low Noise Path rules, the path is actually switched in. This can happen when the selection is Low Noise Path Enable . In the case where the DC Block is switched in the analyzer is now AC coupled. However, if the user has selected DC coupling, the UI will still behave as though it were DC coupled, including all annunciation, warnings, status bits, and responses to SCPI queries. This is because, based on other settings, the analyzer could switch out the low noise path at any time and hence go back to being DC coupled. Alignment switching ignores the settings in this menu, and restores them when finished.
Dependencies	Unavailable in BBIQ and External Mixing
Preset	All modes other than IQ Analyzer mode and VXA: STD IQ Analyzer, VXA and WLAN mode: MPB option present and licensed: MPB MPB option not present and licensed: STD
State Saved	Save in instrument state
Readback	Value selected in the submenu
Initial S/W Revision	A.04.00
Modified at S/W Revision	A.10.00

Standard Path

This path gives the best remote-control throughput, minimizes acoustic noise from switching and minimizes the risk of wear in the hardware switches, particularly in remote test scenarios where both low band and high band setups will follow in rapid succession.

In this path, the bypass of the low band/high band switch and microwave preamp is never activated, which can cause some noise degradation but preserves the life of the bypass switch.

Key Path	AMPTD Y Scale, μ W Path Control
Example	:POW:MW:PATH STD
Readback Text	Standard Path
Initial S/W Revision	A.04.00

Low Noise Path Enable

You may choose Low Noise Path Enable, which gives a lower noise floor under some circumstances, particularly when operating in the 21–26.5 GHz region. With the Low Noise Path enabled, the low band/high band switch and microwave preamp are bypassed whenever all of the following are true:

- The analyzer is not in the Low Band, meaning:
- the start frequency is above 3.5 GHz and
- the stop frequency is above 3.6 GHz.
- the internal preamp is not installed or (if installed) is set to Off or Low Band

Note that this means that, when any part of a sweep is done in Low Band, the Low Noise Path is not used, whether or not the Low Noise Path Enable is selected in the user interface. Also, if the preamp is turned on, the Low Noise Path is not used, whether or not the Low Noise Path Enable is selected in the user interface. The only time the Low Noise Path is used is when Low Noise Path Enable is selected, the sweep is completely in High Band (> 3.6 GHz) and no preamp is in use.

See "[More Information](#)" on page 1467

Key Path	AMPTD Y Scale, μ W Path Control
Measurement	Swept SA
Example	:POW:MW:PATH LNP
Notes	<p>For measurements that use IQ acquisition, the low noise path is used when the Center Frequency is in High Band (> 3.6 GHz) and no preamp is in use.</p> <p>In other words, the rules above are modified to use only the center frequency to qualify which path to switch in.</p> <p>This is not the case for FFT's in the Swept SA measurement; they use the same rules as swept measurements.</p>
Dependencies	<p>Key is blanked if current mode does not support it.</p> <p>Key is grayed out if mode supports it but current measurement does not support it.</p> <p>Unless Option LNP is present and licensed, key is blank and if SCPI command sent, error -241,</p>

	"Hardware missing; Option not installed" is generated.
Readback Text	Low Noise Path Enable
Initial S/W Revision	A.04.00

More Information

The user should understand that the Low Noise Path, while giving improved DANL, has the disadvantage of decreased TOI performance and decreased gain compression performance relative to the standard path.

The user should also understand that the bypass switch is a mechanical switch and has finite life, so if the Low Noise Path is enabled, it is possible to cause frequent cycling of this switch by frequently changing analyzer settings such that the above conditions hold true only some of the time. A user making tests of this nature should consider opting for the Standard Path, which will never throw the bypass switch, at the expense of some degraded noise performance.

The low noise path is useful for situations where the signal level is so low that the analyzer performance is dominated by noise even with 0 dB attenuation, but still high enough that the preamp option would have excessive third-order intermodulation or compression. The preamp, if purchased and used, gives better noise floor than does the "Low Noise Path." However, its compression threshold and third-order intercept are much poorer than that of the non-preamp path. There are some applications, typically for signals around -30 dBm, for which the third-order dynamic range of the standard path is good enough, but the noise floor is not low enough even with 0 dB input attenuation. When the third-order dynamic range of the preamp path is too little and the noise floor of the standard path is too high, the Low Noise Path can provide the best dynamic range

The graph below illustrates the concept. It shows, in red, the performance of an analyzer at different attenuation settings, both with the preamp on and off, in a measurement that is affected by both analyzer noise and analyzer TOI. The green shows the best available dynamic range, offset by 0.5 dB for clarity. The blue shows how the best available dynamic range improves for moderate signal levels with the low noise path switched in. In this illustration, the preamp improves the noise floor by 15 dB while degrading the third-order intercept by 30 dB, and the low noise path reduces loss by 8 dB. The attenuator step size is 2 dB.

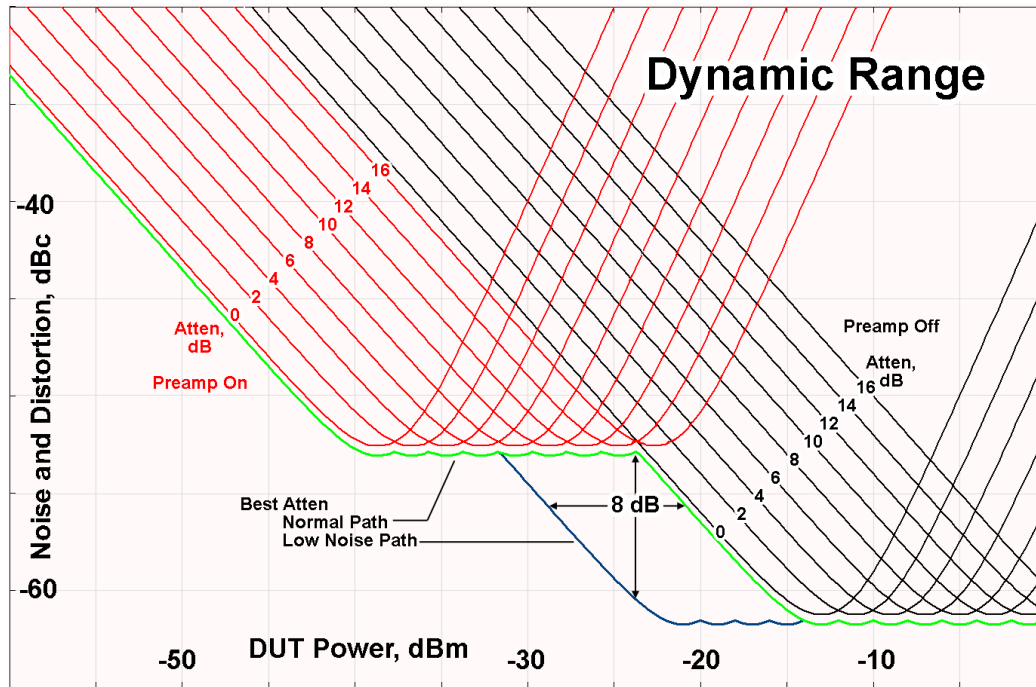

There are other times where selecting the low noise path improves performance, too. Compression-limited measurements such as finding the nulls in a pulsed-RF spectrum can profit from the low noise path in a way similar to the TOI-limited measurement illustrated. Accuracy can be improved when the low noise path allows the optimum attenuation to increase from a small amount like 0, 2 or 4 dB to a larger amount, giving better return loss at the analyzer input. Harmonic measurements, such as second and third harmonic levels, are much improved using the low noise path because of the superiority of that path for harmonic (though not intermodulation) distortion performance.

μW Preselector Bypass

This key toggles the preselector bypass switch for band 1 and higher. When the microwave preselector is on, the signal path is preselected. When the microwave preselector is off, the signal path is not preselected. The preselected path is the normal path for the analyzer.

The preselector is a tunable bandpass filter which prevents signals away from the frequency of interest from combining in the mixer to generate in-band spurious signals (images). The consequences of using a preselector filter are its limited bandwidth, the amplitude and phase ripple in its passband, and any amplitude and phase instability due to center frequency drift.

Option MPB or pre-selector bypass provides an unpreselected input mixer path for certain X-Series signal analyzers with frequency ranges above 3.6 GHz. This signal path allows a wider bandwidth and less amplitude variability, which is an advantage when doing modulation analysis and broadband signal analysis. The disadvantage is that, without the preselector, image signals will be displayed. Another disadvantage of bypassing the preselector is increased LO emission levels at the front panel input port.

Image responses are separated from the real signal by twice the 1st IF. For IF Paths of 10 MHz and 25 MHz, the 1st IF is 322.5 MHz, so the image response and the real signal will be separated by 645 MHz. The 1st IF will be different for other IF Path settings. When viewing a real signal and its corresponding image response in internal mixing, the image response will be to the left of the real signal.

Also, the image response and the real signal typically have the same amplitude and exhibit the same shape factor.

However, if Option FS1, Fast Sweep Capability, is enabled, the image response in the Swept SA measurement will appear lower in amplitude and have a much wider shape factor compared to the real signal.

Key Path	AMPTD Y Scale, μ W Path Control
Example	:POW:MW:PATH MPB
Dependencies	Key is blanked if current mode does not support it. Key is grayed out if mode supports it but current measurement does not support it. Key is blank unless Option MPB is present and licensed. If SCPI command sent when MPB not present, error -241, "Hardware missing; Option not installed" is generated.
Readback Text	μ W Preselector Bypass
Initial S/W Revision	A.04.00

Remote Command	[:SENSe] :POWer [:RF] :MW :PRESelector [:STATe] ON OFF 0 1 [:SENSe] :POWer [:RF] :MW :PRESelector [:STATe] ?
Example	:POW:MW:PRES OFF Bypasses the microwave preselector
Notes	The ON parameter sets the STD path (:POW:MW:PATH STD) The OFF parameter sets path MPB (:POW:MW:PATH MPB)
Preset	ON

Internal Preamp

Accesses a menu of keys that control the internal preamps. Turning on the preamp gives a better noise figure, but a poorer TOI to noise floor dynamic range. You can optimize this setting for your particular measurement.

The instrument takes the preamp gain into account as it sweeps. If you sweep outside of the range of the preamp the instrument will also account for that. The displayed result will always reflect the correct gain.

For some measurements, when the preamp is on and any part of the displayed frequency range is below the lowest frequency for which the preamp has specifications, a warning condition message appears in the status line. For example, for a preamp with a 9 kHz lowest specified frequency: "Preamp: Accy unspec'd below 9 kHz".

Key Path	AMPTD Y Scale
Scope	Meas Global
Remote Command	[:SENSe] :POWer [:RF] :GAIN [:STATe] OFF ON 0 1 [:SENSe] :POWer [:RF] :GAIN [:STATe] ?
Dependencies	Preamp is not available on all hardware platforms. If the preamp is not present or is unlicensed, the

	key is not shown. The preamp is not available when the electronic/soft attenuator is enabled.
--	--

Couplings	The act of connecting the U7227A USB Preamplifier to one of the analyzer's USB ports will cause the Internal Preamp to be switched on. When this happens an informational message will be generated: "Internal Preamp turned on for optimal operation with USB Preamp." Note that if the Internal Preamp was already on, there will be no change to the setting, but if it was Off it will be switched On, to Full Range. Note that this same action occurs when the SA mode is selected while the USB Preamp is connected to one of the analyzer's USB ports, if it is the first time that the SA mode has run since powerup, or if the last time the SA mode was running the USB Preamp was NOT connected. Subsequently disconnecting the USB Preamp from USB does not change the Internal Preamp setting nor restore the previous setting.
Preset	OFF
State Saved	Saved in instrument state
Initial S/W Revision	Prior to A.02.00
Modified at S/W Revision	A.14.00

Key Path	AMPTD Y Scale, Internal Preamp
Scope	Meas Global
Remote Command	[:SENSe] :POWer [:RF] :GAIN:BAND LOW FULL [:SENSe] :POWer [:RF] :GAIN:BAND?
Dependencies	Preamp is not available on all hardware platforms. If the preamp is not present or is unlicensed, the key is not shown. If a POW:GAIN:BAND FULL command is sent when a low band preamp is available, the preamp band parameter is to LOW instead of FULL, and an "Option not installed" message is generated.
Preset	LOW
State Saved	Saved in instrument state
Initial S/W Revision	Prior to A.02.00

Off

Turns the internal preamp off

Key Path	AMPTD Y Scale, Internal Preamp
Example	:POW:GAIN OFF
Readback	Off
Initial S/W Revision	Prior to A.02.00

Low Band

Sets the internal preamp to use only the low band.

The frequency range of the installed (optional) low-band preamp is displayed in square brackets on the Low Band key label.

Key Path	AMPTD Y Scale, Internal Preamp
Example	:POW:GAIN ON :POW:GAIN:BAND LOW
Readback	Low Band
Initial S/W Revision	Prior to A.02.00

Full Range

Sets the internal preamp to use its full range. The low band (0–3.6 GHz or 0–3GHz, depending on the model) is supplied by the low band preamp and the frequencies above low band are supplied by the high band preamp.

The frequency range of the installed (optional) preamp is displayed in square brackets on the Full Range key label. If the high band option is not installed the Full Range key does not appear.

Key Path	AMPTD Y Scale, Internal Preamp
Example	:POW:GAIN ON :POW:GAIN:BAND FULL
Readback	Full Range
Initial S/W Revision	Prior to A.02.00

Ref Position

Allows you to set the display reference position to the top, center, or bottom of the display.

Key Path	AMPTD Y Scale, More
Mode	WIMAXOFDMA
Remote Command	:DISPlay:PVTime:VIEW[1]:WINDow[1]:TRACe:Y[:SCALe]:RPOSition TOP CENTer BOTTom :DISPlay:PVTime:VIEW[1]:WINDow[1]:TRACe:Y[:SCALe]:RPOSition?
Example	DISP:PVT:VIEW:WIND:TRAC:Y:RPOS CENT DISP:PVT:VIEW:WIND:TRAC:Y:RPOS?
Preset	TOP
State Saved	Saved in instrument state.
Range	Top Ctr Bot
Initial S/W Revision	Prior to A.02.00

Auto Scaling

Allows you to toggle the Y axis Auto Scaling function between On and Off.

Key Path	AMPTD Y Scale, More
Mode	WIMAXOFDMA
Remote Command	:DISPlay:PVTime:VIEW[1]:WINDow[1]:TRACe:Y[:SCALe]:COUPle 0 1 OFF ON :DISPlay:PVTime:VIEW[1]:WINDow[1]:TRACe:Y[:SCALe]:COUPle?
Example	DISP:PVT:VIEW:WIND:TRAC:Y:COUP 0 DISP:PVT:VIEW:WIND:TRAC:Y:COUP?
Couplings	When Auto Scaling is On and you press the Restart front-panel key, this function automatically determines the scale per division and reference values based on the measurement results. When you manually set a value for the Rel Value or Scale/Div , this parameter is automatically set to Off.
Preset	ON
State Saved	Saved in instrument state.
Range	On Off
Initial S/W Revision	Prior to A.02.00

Auto Couple

The Auto Couple feature provides a quick and convenient way to automatically couple multiple instrument settings. This helps ensure accurate measurements and optimum dynamic range. When the Auto Couple feature is activated, either from the front panel or remotely, all parameters of the current measurement that have an Auto/Manual mode are set to Auto mode and all measurement settings dependent on (or coupled to) the Auto/Man parameters are automatically adjusted for optimal performance.

However, the Auto Couple key actions are confined to the current measurement only. It does not affect other measurements in the mode, and it does not affect markers, marker functions, or trace or display attributes.

See "[More Information](#)" on page 1473

Key Path	Front-panel key
Remote Command	:COUPle ALL NONE
Example	:COUP ALL
Notes	:COUPle ALL puts all Auto/Man parameters in Auto mode (equivalent to pressing the Auto Couple key). :COUPLE NONE puts all Auto/Man parameters in manual mode. It decouples all the coupled instrument parameters and is not recommended for making measurements.
Initial S/W Revision	Prior to A.02.00

More Information

There are two types of functions that have Auto/Manual modes.

Auto/Man Active Function keys

An Auto/Man toggle key controls the binary state associated with an instrument parameter by toggling between Auto (where the parameter is automatically coupled to the other parameters it is dependent upon) and Man (where the parameter is controlled independent of the other parameters), as well as making the parameter the active function. The current mode is indicated on the softkey with either Auto or Man underlined as illustrated below.



Auto/Man 1-of-N keys

An Auto/Man 1-of-N key allows you to manually pick from a list of parameter values, or place the function in Auto, in which case the value is automatically selected (and indicated) as shown below. If in Auto, Auto is underlined on the calling key. If in manual operation, manual is indicated on the calling key. But the calling key does not actually toggle the function, it simply opens the menu.

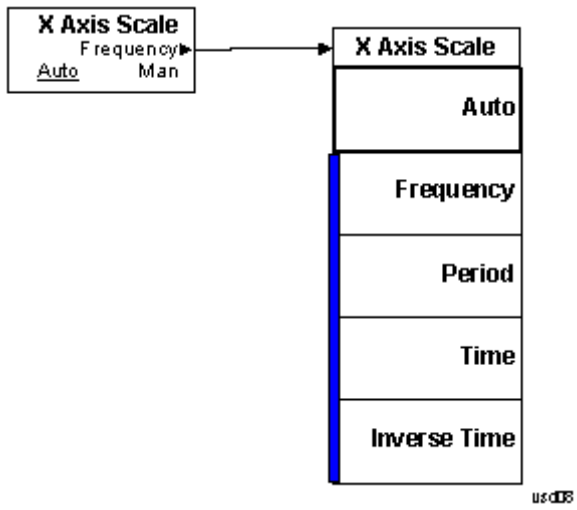

BW

Accesses a menu that allows you to control bandwidth settings.

Key Path	BW
Initial S/W Revision	Prior to A.02.00

Info BW

Sets the information bandwidth. This is the bandwidth used for the power measurement. The optimal setting occurs when the bandwidth is wide enough to pass all the power of the bursted signal, while not being so wide that it passes noise, which reduces dynamic range and diminishes the accuracy of low level measurements.

Key Path	BW
Mode	WIMAXOFDMA
Remote Command	<code>[:SENSe] :PVTime :BANDwidth [:RESolution] <bandwidth></code> <code>[:SENSe] :PVTime :BANDwidth [:RESolution] ?</code>
Example	PVT:BAND 1 kHz PVT:BAND?
Preset	Hardware Dependent: No Option = 10 MHz WB (25 MHz or wider) = 25 MHz
State Saved	Saved in instrument state.
Min	1 kHz
Max	Hardware Dependent: No Option = 10 MHz B25 = 25MHz Wider Options = 40MHz
Backwards Compatibility SCPI	<code>[:SENSe] :PVTime :BWIDth [:RESolution]</code>
Initial S/W Revision	Prior to A.02.00
Modified at S/W Revision	A.06.00

Filter Type

Allows you to select a Gaussian or a Flattop filter. A Gaussian is typically preferred but a Flattop is desirable under certain conditions.

Key Path	BW
----------	----

Mode	WIMAXOFDMA
Remote Command	[:SENSe] :PVTime :BANDwidth :TYPE GAUSSian FLATtop [:SENSe] :PVTime :BANDwidth :TYPE?
Example	PVT:BAND:TYPE GAUS PVT:BAND:TYPE?
Notes	<p>This selects either a Gaussian or Flat (Flattop) filter. Gaussian is the better choice when looking at the overall burst, or rising and falling edges, because it has excellent pulse response. For most Time vs. Power measurements, the user is not mainly interested in trading off time domain accuracy vs. noise, but is more interested in total power accuracy vs. noise.</p> <p>If you want to want to examine just the useful part of the burst, choose Flat. This is an advanced control that normally does not need to be changed. Setting this to a value other than the factory default, may cause invalid measurement results.</p> <p>–FLATtop – a filter with a flat amplitude response, that provides the best amplitude accuracy. –GAUSSian – a filter with Gaussian characteristics, that provides the best pulse response.</p>
Preset	FLATtop
State Saved	Saved in instrument state.
Range	Gaussian Flattop
Backwards Compatibility SCPI	[:SENSe] :PVTime :BANDwidth BWIDth [:RESolution] :TYPE
Initial S/W Revision	Prior to A.02.00

Cont (Continuous Measurement/Sweep)

Sets the analyzer for Continuous measurement operation. The single/continuous state is Meas Global so the setting will affect all measurements. If you are Paused, pressing Cont does a Resume.

Key Path	Front-panel key
Remote Command	:INITiate:CONTinuous OFF ON 0 1 :INITiate:CONTinuous?
Example	:INIT:CONT 0 puts analyzer in Single measurement operation. :INIT:CONT 1 puts analyzer in Continuous measurement operation
Preset	ON (Note that SYST:PRESet sets INIT:CONT to ON but *RST sets INIT:CONT to OFF)
State Saved	Saved in instrument state
Backwards Compatibility Notes	For Spectrum Analysis mode in ESA and PSA, there is no Cont hardkey, instead there is a Sweep Single/Cont key. In these analyzers, switching the Sweep Single/Cont key from Single to Cont restarts averages (displayed average count reset to 1), but does not restart Max Hold and Min Hold. The X-Series has Single and Cont keys in place of the SweepSingleCont key. In the X-Series, if in single measurement, the Cont key (and INIT:CONT ON) switches to continuous measurement, but never restarts a measurement and never resets a sweep.
Initial S/W Revision	Prior to A.02.00

In Swept SA Measurement (Spectrum Analysis Mode):

The analyzer takes repetitive sweeps, averages, measurements, etc., when in Continuous mode. When the average count reaches the Average/Hold Number the count stops incrementing, but the analyzer keeps sweeping. See the Trace/Detector section for the averaging formula used both before and after the Average/Hold Number is reached. The trigger condition must be met prior to each sweep. The type of trace processing for multiple sweeps, is set under the Trace/Detector key, with choices of Trace Average, Max Hold, or Min Hold.

In Other Measurements/Modes:

With Avg/Hold Num (in the Meas Setup menu) set to Off or set to On with a value of 1, a sweep is taken after the trigger condition is met; and the analyzer continues to take new sweeps after the current sweep has completed and the trigger condition is again met. However, with Avg/Hold Num set to On with a value >1, multiple sweeps (data acquisitions) are taken for the measurement. The trigger condition must be met prior to each sweep. The sweep is not stopped when the average count k equals the number N set for Avg/Hold Num is reached, but the number k stops incrementing. A measurement average usually applies to all traces, marker results, and numeric results. But sometimes it only applies to the numeric results.

If the analyzer is in Single measurement, pressing the Cont key does not change k and does not cause the sweep to be reset; the only action is to put the analyzer into Continuous measurement operation.

If it is already in continuous sweep:

the INIT:CONT 1 command has no effect

13 Power vs Time Measurement
Cont (Continuous Measurement/Sweep)

the INIT:CONT 0 command will place the analyzer in Single Sweep but will have no effect on the current sequence until $k = N$, at which point the current sequence will stop and the instrument will go to the idle state.

File

See "File" on page 336

FREQ Channel

Accesses a menu of keys that allow you to control the Frequency and Channel parameters of the instrument.

Some features in the Frequency menu are the same for all measurements – they do not change as you change measurements. Settings like these are called “Meas Global” and are unaffected by Meas Preset. For example, the Center Freq setting is the same for all measurements - it does not change as you change measurements.

Key Path	Front-panel key
Initial S/W Revision	Prior to A.02.00

Center Freq

Sets the frequency that corresponds to the horizontal center of the graticule (when frequency Scale Type is set to linear). While adjusting the Center Frequency the Span is held constant, which means that both Start Frequency and Stop Frequency will change.

Pressing Center Freq also sets the frequency entry mode to Center/Span. In Center/Span mode, the center frequency and span values are displayed below the graticule, and the default active function in the Frequency menu is Center Freq.

The center frequency setting is the same for all measurements within a mode, that is, it is Meas Global. Some modes are also able to share a Mode Global center frequency value. If this is the case, the Mode will have a Global Settings key in its Mode Setup menu.

The Center Freq function sets (and queries) the Center Frequency for the currently selected input. If your analyzer has multiple inputs, and you select another input, the Center Freq changes to the value for that input. SCPI commands are available to directly set the Center Freq for a specific input.

Center Freq is remembered as you go from input to input. Thus you can set a Center Freq of 10 GHz with the RF Input selected, change to BBIQ and set a Center Freq of 20 MHz, then switch to External Mixing and set a Center Freq of 60 GHz, and when you go back to the RF Input the Center Freq will go back to 10 GHz; back to BBIQ and it is 20 MHz; back to External Mixing and it is 60 GHz.

See ["RF Center Freq" on page 1483](#)

See [Ext Mix Center Freq](#)

See ["I/Q Center Freq" on page 1485](#)

See ["Center Frequency Presets" on page 1481](#)

Key Path	FREQ Channel
Scope	Meas Global
Remote Command	<code>[:SENSe] :FREQuency:CENTer <freq></code> <code>[:SENSe] :FREQuency:CENTer?</code>

Example	FREQ:CENT 50 MHz FREQ:CENT UP changes the center frequency to 150 MHz if you use FREQ:CENT:STEP 100 MHz to set the center frequency step size to 100 MHz FREQ:CENT?
Notes	This command sets either the RF or I/Q Center Frequency depending on the selected input. For RF input it is equivalent to FREQ:RF:CENT For I/Q input it is equivalent to FREQ:IQ:CENT Preset and Max values are dependent on Hardware Options (5xx) If no terminator (e.g. MHz) is sent the terminator Hz is used. If a terminator with unit other than Frequency is used, an invalid suffix error message is generated.
Dependencies	The Center Frequency can be limited by Start or Stop Freq limits, if the Span is so large that Start or Stop reach their limit.
Couplings	When operating in “swept span”, any value of the Center Frequency or Span that is within the frequency range of the analyzer is allowed when the value is being set through the front panel numeric key pad or the SCPI command. The other parameter is forced to a different value if needed, to keep the Start and the Stop Frequencies within the analyzer’s frequency range
Preset	Depends on instrument maximum frequency, mode, measurement, and selected input. See "Center Frequency Presets" on page 1481 and "RF Center Freq" on page 1483 and Ext Mix Center Freq and "I/Q Center Freq" on page 1485 .
State Saved	Saved in instrument state
Min	Depends on instrument maximum frequency, mode, measurement, and selected input.. See "Center Frequency Presets" on page 1481 and "RF Center Freq" on page 1483 and "I/Q Center Freq" on page 1485 .
Max	Depends on instrument maximum frequency, mode, measurement, and selected input.. See "Center Frequency Presets" on page 1481 and "RF Center Freq" on page 1483 and "I/Q Center Freq" on page 1485 .
Default Unit	Hz
Status Bits/OPC	Non-overlapped
Dependencies	
Initial S/W Revision	Prior to A.02.00

Center Frequency Presets

The following table provides the Center Frequency Presets for the Spectrum Analyzer mode, and the Max Freq, for the various frequency options:

Freq Option	CF after Mode Preset	Stop Freq after Mode Preset	Max Freq (can't tune)

13 Power vs Time Measurement
FREQ Channel

			above)
503 (all but N9000A)	1.805 GHz	3.6 GHz	3.7 GHz
503 (N9000A)	1.505 GHz	3.0 GHz	3.08 GHz
507 (all but N9000A)	3.505 GHz	7.0 GHz	7.1 GHz
507 (N9000A)	3.755 GHz	7.5 GHz	7.58 GHz
508 (all but N9038A)	1.805 GHz	3.6 GHz	8.5 GHz
508 (N9038A)	4.205 GHz	8.4 GHz	8.5 GHz
513	6.805 GHz	13.6 GHz	13.8 GHz
526 (all but N9000A and N9038A)	13.255 GHz	26.5 GHz	27.0 GHz
526 (N9000A)	13.255 GHz	26.5 GHz	26.55 GHz
526 (N9038A)	1.805 GHz	3.6 GHz	27.0 GHz
532	16.005 GHz	32.0 GHz	32.5 GHz
543	21.505 GHz	43.0 GHz	TBD
544	22.005 GHz	44.0 GHz	44.5 GHz
550	25.005 GHz	50.0 GHz	51 GHz

Input 2:

Model	CF after Mode Preset	Stop Freq after Mode Preset	Max Freq (can't tune above)
N9000A opt C75	0.7505GHz	1.5 GHz	1.58 GHz
N9038A	505 MHz	1 GHz	1.000025 GHz

Tracking Generator Frequency Limits (N9000A only):

Tracking Generator Option	Min Freq (clips to this freq when turn TG on and	If above this Freq, Stop Freq clipped to this Freq when	Max Freq (can't tune above) while TG

	can't tune below while TG on)	TG turned on	on
T03	9 kHz	3.0 GHz	3.08 GHz
T06	9 kHz	6.0 GHz	6.05 GHz

The following table shows the Center Frequency Presets for modes other than Spectrum Analyzer:

Mode	CF Preset for RF
WCDMA	1 GHz
WIMAXOFDMA,	1 GHz
BASIC	1 GHz
ADEMOD	1 GHz
VSA	1 GHz
TDSCDMA	1 GHz
PNOISE	1 GHz
LTE	1 GHz
LTETDD	1 GHz
MSR	1 GHz
GSM	935.2 MHz
NFIGURE	1.505 GHz

RF Center Freq

SCPI command for specifying the RF Center Frequency. This command will set the Center Frequency to be used when the RF input is selected, even if the RF input is not the input that is selected at the time the command is sent. Note that the Center Freq function in the Frequency menu on the front panel always applies to the currently selected input.

Scope	Meas Global
Remote Command	<code>[:SENSe] :FREQuency:RF:CENTer <freq></code> <code>[:SENSe] :FREQuency:RF:CENTer?</code>
Example	FREQ:RF:CENT 30 MHz
Notes	This command is the same in all modes, but the parameter is Measurement Global. So the value is independent in each mode and common across all the measurements in the mode.
Dependencies	If the electronic/soft attenuator is enabled, any attempt to set Center Frequency such that the Stop Frequency would be >3.6 GHz fails and results in an advisory message. If the equivalent SCPI command is sent, this same message is generated as part of a “-221, Settings conflict” warning. If Source Mode is set to Tracking, and the Max or Min Center Freq is therefore limited by the limits of the source, a warning message is generated, “Data out of range;clipped to source max/min” if these limits are exceeded. Note that for an external source, these limits can be affected by the settings of

	Source Numerator, Source Denominator and Power Sweep.
Preset	See table above
State Saved	Saved in instrument state.
Min	-79.999995 MHz, unless Source Mode is set to Tracking, in which case it is limited by the minimum frequency of the Source
Max	See table above. Basically instrument maximum frequency - 5 Hz. Note that, if the Source Mode is set to Tracking, the effective instrument maximum frequency may be limited by the source maximum frequency. If the knob or step keys are being used, also depends on the value of the other three interdependent parameters Span, Start Frequency and Stop Frequency
Initial S/W Revision	Prior to A.02.00
Modified at S/W Revision	A.03.00

Ext Mix Center Freq

SCPI command for specifying the External Mixer Center Frequency. This command will set the Center Frequency to be used when the External Mixer is selected, even if the External Mixer input is not the input which is selected at the time the command is sent. Note that the Center Freq function in the Frequency menu on the front panel always applies to the currently selected input.

Scope	Meas Global
Remote Command	<code>[:SENSe] :FREQuency:EMIXer:CENTer <freq></code> <code>[:SENSe] :FREQuency:EMIXer:CENTer?</code>
Example	<code>:FREQ:EMIX:CENT 60 GHz</code> <code>:FREQ:EMIX:CENT?</code>
Notes	This command is the same in all modes, but the parameter is Measurement Global. So the value is independent in each mode and common across all the measurements in the mode.
Couplings	When returning to External Mixing after having been switched to one of the other inputs (e.g., RF), you will come back into the settings that you had when you left External Mixing. So you will come back to the band you were in with the Center Frequency that you had. However, Span is not an input-dependent parameter, therefore you will bring the span over from the other input. Therefore, the analyzer comes back with the span from the previous input, limited as necessary by the current mixer setup.
Preset	When a Mode Preset is performed while in External Mixing, the Start frequency of the current Mode is set to the nominal Min Freq of the lowest harmonic range in the Harmonic Table for the current mixer setup. Similarly, the Stop frequency of the current Mode is set to the nominal Max Freq of the highest harmonic range in the Harmonic Table. The Center Freq thus presets to the point arithmetically equidistant from these two frequencies. If the current measurement has a limited Span available to it, and cannot achieve the Span shown in the table (Span=Stop Freq - Start Freq), the analyzer uses the maximum Span the measurement allows, and still sets the Center Freq to the midpoint of the Start and Stop Freq values in the Harmonic Table.

	When Restore Input/Output Defaults is performed, the mixer presets to the 11970A, whose Start and Stop frequencies are 26.5 and 40 GHz respectively. The center of these two frequencies is 33.25 GHz. Therefore, after a Restore Input/Output Defaults, if you go into External Mixing and do a Mode Preset while in the Spectrum Analyzer Mode, the resulting Center Freq is 33.25 GHz.
State Saved	Saved in instrument state.
Min	The minimum frequency in the currently selected mixer band + 5 Hz
Max	The maximum frequency in the currently selected mixer band – 5 Hz If the knob or step keys are being used, also depends on the value of the other three interdependent parameters Span, Start Frequency and Stop Frequency
Initial S/W Revision	A.08.01

I/Q Center Freq

SCPI command for specifying the I/Q Center Frequency. This command will set the Center Frequency to be used when the I/Q input is selected, even if the I/Q input is not the input which is selected at the time the command is sent. Note that the Center Freq function in the Frequency menu on the front panel always applies to the currently selected input.

Scope	Meas Global
Remote Command	[:SENSe] :FREQuency:IQ:CENTer <freq> [:SENSe] :FREQuency:IQ:CENTer?
Example	FREQ:IQ:CENT: 30 MHz
Notes	This command is the same in all modes, but the parameter is Measurement Global. So the value is independent in each mode and common across all the measurements in the mode.
Preset	0 Hz
State Saved	Saved in instrument state.
Min	-40.049995 MHz
Max	40.049995 MHz
Initial S/W Revision	Prior to A.02.00

13 Power vs Time Measurement
Input/Output

Input/Output

See "[Input/Output](#)" on page 196

Marker

Accesses the menu that allow you to select, set up, and control the markers for the current measurement. Sets the marker control mode as described under Normal, Delta, Fixed and Off, below. All interactions and dependencies detailed under the softkey description are enforced when the remote command is sent.

Key Path	Marker
Initial S/W Revision	Prior to A.02.00

Select Marker

Accesses menus that allow you to activate one or more markers

See the “Marker” section for more information.

Key Path	Marker
Initial S/W Revision	Prior to A.02.00

Marker Type

The Marker front panel key accesses the Marker menu. Contained within this menu is a 1-of-N selection of the control mode (Normal, Delta, Off) for the selected marker.

See the “Marker” section for more information.

Key Path	Marker
Mode	WIMAXOFDMA
Remote Command	:CALCulate:PVTime:MARKer[1] 2 ...12:MODE Position DELTA OFF :CALCulate:PVTime:MARKer[1] 2 ...12:MODE?
Example	CALC:PVT:MARK:MODE OFF CALC:PVT:MARK:MODE?
Notes	If the selected marker is Off, pressing Marker sets it to Normal and places it at the center of the screen on the trace determined by the Marker Trace rules. At the same time, Marker X Axis Value appears in the Active Function area. Default Active Function: the active function for the selected marker's current control mode. If the current control mode is Off, there is no active function and the active function is turned off. Active Function Display: the marker X axis value entered in the active function area displays the marker value to its fully entered precision.
Preset	OFF
State Saved	Saved in instrument state.
Range	Normal Delta Off
Initial S/W Revision	Prior to A.02.00

Properties

Accesses a menu that allow you to set marker properties and to access the marker trace menu.

Key Path	Marker
Initial S/W Revision	Prior to A.02.00

Select Marker

Accesses menus that allow you to activate one or more markers

See the “Marker” section for more information.

Key Path	Marker
Initial S/W Revision	Prior to A.02.00

Relative To

Selects the marker that the selected marker is relative to, which is referred to as its “reference marker”.

Key Path	Marker, Properties
Mode	WIMAXOFDMA
Remote Command	:CALCulate:PVTime:MARKer[1] 2 ...12:REFeRence <integer> :CALCulate:PVTime:MARKer[1] 2 ...12:REFeRence?
Example	CALC:PVT:MARK:REF 5 CALC:PVT:MARK:REF?
Notes	A marker cannot be relative to itself so that choice is grayed out, and if sent from SCPI, generates error -221: “Settings conflict; marker cannot be relative to itself.” When queried, a single value is returned - the specified marker number’s relative marker.
Preset	2 3 4 5 6 7 8 9 10 11 12 1
State Saved	Saved in instrument state.
Min	1
Max	12
Initial S/W Revision	Prior to A.02.00

Marker Trace

Assigns the specified marker to the designated trace.

Key Path	Marker
Mode	WIMAXOFDMA

Remote Command	:CALCulate:PVTime:MARKer[1] 2 ...12:TRACe RFENvelope UMASK LMASk MAXHold MINHold :CALCulate:PVTime:MARKer[1] 2 ...12:TRACe?
Example	CALC:PVT:MARK:TRAC MINH CALC:PVT:MARK:TRAC?
Dependencies	Max Hold RF Envelop is only available when Max Trace is set to On. Min Hold RF Envelop is only available when Min Hold Trace is set to On. Otherwise, the menu keys are grayed out and the commands are unavailable.
Preset	RFENvelope
State Saved	Saved in instrument state.
Range	RF Envelope Upper Mask Lower Mask Max Hold RF Envelope Min Hold RF Envelope
Initial S/W Revision	Prior to A.02.00

Couple Marker

When this function is invoked, moving any marker causes an “equal X Axis movement” of every other marker which is active. By “equal X Axis movement” we mean that the difference between each marker’s X Axis value (in the fundamental x-axis units of the trace that marker is on) is preserved, as is the X Axis value of the marker being moved (in the same fundamental X-axis units).

NOTE This may result in markers going off screen.

Key Path	Marker
Mode	WIMAXOFDMA
Remote Command	:CALCulate:PVTime:MARKer:COUple[:STATE] ON OFF 1 0 :CALCulate:PVTime:MARKer:COUple[:STATE]?
Example	CALC:PVT:MARK:COUP ON CALC:PVT:MARK:COUP?
Preset	OFF
State Saved	Saved in instrument state.
Range	On Off
Initial S/W Revision	Prior to A.02.00

All Markers Off

Turns all markers Off.

Key Path	Marker, More
Mode	WIMAXOFDMA
Remote Command	:CALCulate:PVTime:MARKer:AOFF

Example	CALC:PVT:MARK:AOFF
Initial S/W Revision	Prior to A.02.00

Marker Function

There are no 'Marker Functions' supported in Power vs. Time so this front-panel key displays a blank softkey when pressed.

Key Path	Marker
Initial S/W Revision	Prior to A.02.00

Marker To

There is no 'Marker To' functionality supported in Power vs. Time so this front-panel key displays a blank softkey menu when pressed.

Key Path	Marker
Initial S/W Revision	Prior to A.02.00

Meas

The information in this section is common to all measurements. For key and remote command information for a specific measurement, refer to the section that describes the measurement of interest.

Measurements available under the Meas key are specific to the current Mode.

When viewing Help for measurements, note the following:

NOTE

Operation for some keys differs between measurements. The information displayed in Help pertains to the current measurement. To see how a key operates in a different measurement, exit Help (press the Cancel Esc key), select the measurement, then reenter Help (press the Help key) and press that key.

Key Path	Front-panel key
Initial S/W Revision	Prior to A.02.00

Remote Measurement Functions

This section contains the following topics:

"Measurement Group of Commands" on page 2206

"Current Measurement Query (Remote Command Only)" on page 2208

"Limit Test Current Results (Remote Command Only)" on page 2208

"Data Query (Remote Command Only)" on page 2208

"Calculate/Compress Trace Data Query (Remote Command Only)" on page 2209

"Calculate Peaks of Trace Data (Remote Command Only)" on page 2214

Hardware-Accelerated Fast Power Measurement (Remote Command Only)

"Format Data: Numeric Data (Remote Command Only)" on page 2215

"Format Data: Byte Order (Remote Command Only)" on page 2216

Initial S/W Revision	Prior to A.02.00
----------------------	------------------

Measurement Group of Commands

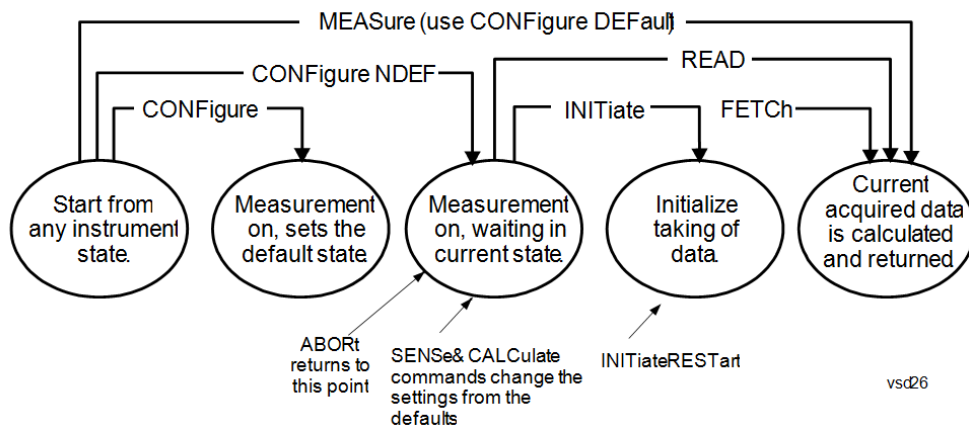

Measure Commands:

:MEASure:<measurement>[n]?

This is a fast single-command way to make a measurement using the factory default instrument settings. These are the settings and units that conform to the Mode Setup settings (e.g. radio standard) that you have currently selected.

- Stops the current measurement (if any) and sets up the instrument for the specified measurement using the factory defaults
- Initiates the data acquisition for the measurement
- Blocks other SCPI communication, waiting until the measurement is complete before returning results.
- If the function does averaging, it is turned on and the number of averages is set to 10.
- After the data is valid it returns the scalar results, or the trace data, for the specified measurement. The type of data returned may be defined by an [n] value that is sent with the command.
- The scalar measurement results will be returned if the optional [n] value is not included, or is set to 1. If the [n] value is set to a value other than 1, the selected trace data results will be returned. See each command for details of what types of scalar results or trace data results are available.
- ASCII is the default format for the data output. (Older versions of Spectrum Analysis and Phase Noise mode measurements only use ASCII.) The binary data formats should be used for handling large blocks of data since they are smaller and faster than the ASCII format. Refer to the FORMat:DATA command for more information.

If you need to change some of the measurement parameters from the factory default settings you can set up the measurement with the CONFigure command. Use the commands in the SENSE:<measurement> and CALCulate:<measurement> subsystems to change the settings. Then you can use the READ? command to initiate the measurement and query the results.

If you need to repeatedly make a given measurement with settings other than the factory defaults, you can use the commands in the SENSE:<measurement> and CALCulate:<measurement> subsystems to set up the measurement. Then use the READ? command to initiate the measurement and query results.

Measurement settings persist if you initiate a different measurement and then return to a previous one. Use READ:<measurement>? if you want to use those persistent settings. If you want to go back to the default settings, use MEASure:<measurement>?.

Configure Commands:

:CONFigure:<measurement>

This command stops the current measurement (if any) and sets up the instrument for the specified measurement using

the factory default instrument settings. It does not initiate the taking of measurement data unless INIT:CONTInuous is ON. If you change any measurement settings after using the CONFigure command, the READ command can be used to initiate a measurement without changing the settings back to their defaults.

In the Swept SA measurement in Spectrum Analyzer mode the CONFigure command also turns the averaging function on and sets the number of averages to 10 for all measurements.

:CONFigure: <measurement>: NDEFault stops the current measurement and changes to the specified measurement. It does not change the settings to the defaults. It does not initiate the taking of measurement data unless INIT:CONTInuous is ON.

The CONFigure? query returns the current measurement name.

The CONFigure:CATalog? query returns a quoted string of all licensed measurement names in the current mode. For example, "SAN, CHP, OBW, ACP, PST, TXP, SPUR, SEM, LIST".

Fetch Commands:

:FETCh:<measurement>[n]?

This command puts selected data from the most recent measurement into the output buffer. Use FETCh if you have already made a good measurement and you want to return several types of data (different [n] values, for example, both scalars and trace data) from a single measurement. FETCh saves you the time of re-making the measurement. You can only FETCh results from the measurement that is currently active, it will not change to a different measurement. An error message is reported if a measurement other than the current one is specified.

If you need to get new measurement data, use the READ command, which is equivalent to an INITiate followed by a FETCh.

The scalar measurement results will be returned if the optional [n] value is not included, or is set to 1. If the [n] value is set to a value other than 1, the selected trace data results will be returned. See each command for details of what types of scalar results or trace data results are available. The binary data formats should be used for handling large blocks of data since they are smaller and transfer faster than the ASCII format. (FORMat:DATA)

FETCh may be used to return results other than those specified with the original READ or MEASure command that you sent.

INITiate Commands:

:INITiate:<measurement>

This command is not available for measurements in all the instrument modes:

- Initiates a trigger cycle for the specified measurement, but does not output any data. You must then use the FETCh<meas> command to return data. If a measurement other than the current one is specified, the instrument will switch to that measurement and then initiate it.
- For example, suppose you have previously initiated the ACP measurement, but now you are running the channel power measurement. If you send INIT:ACP? it will change from channel power to ACP and will initiate an ACP measurement.
- Does not change any of the measurement settings. For example, if you have previously started the ACP measurement and you send INIT:ACP? it will initiate a new ACP measurement using the same instrument settings as the last time ACP was run.
- If your selected measurement is currently active (in the idle state) it triggers the measurement, assuming the trigger conditions are met. Then it completes one trigger cycle. Depending upon the measurement and the number of averages, there may be multiple data acquisitions, with multiple trigger events, for one full trigger cycle. It also holds off additional commands on GPIB until the acquisition is complete.

READ Commands:

:READ:<measurement>[n]?

- Does not preset the measurement to the factory default settings. For example, if you have previously initiated the ACP
-

measurement and you send READ:ACP? it will initiate a new measurement using the same instrument settings.

- Initiates the measurement and puts valid data into the output buffer. If a measurement other than the current one is specified, the instrument will switch to that measurement before it initiates the measurement and returns results.
 - For example, suppose you have previously initiated the ACP measurement, but now you are running the channel power measurement. Then you send READ:ACP? It will change from channel power back to ACP and, using the previous ACP settings, will initiate the measurement and return results.
 - Blocks other SCPI communication, waiting until the measurement is complete before returning the results
 - If the optional [n] value is not included, or is set to 1, the scalar measurement results will be returned. If the [n] value is set to a value other than 1, the selected trace data results will be returned. See each command for details of what types of scalar results or trace data results are available. The binary data formats should be used when handling large blocks of data since they are smaller and faster than the ASCII format. (FORMat:DATA)
-

Initial S/W Revision	Prior to A.02.00
----------------------	------------------

Current Measurement Query (Remote Command Only)

This command returns the name of the measurement that is currently running.

Remote Command	:CONFigure?
-----------------------	-------------

Example	CONF?
----------------	-------

Initial S/W Revision	Prior to A.02.00
----------------------	------------------

Limit Test Current Results (Remote Command Only)

Queries the status of the current measurement limit testing. It returns a 0 if the measured results pass when compared with the current limits. It returns a 1 if the measured results fail any limit tests.

Remote Command	:CALCulate:CLIMits:FAIL?
-----------------------	--------------------------

Example	CALC:CLIM:FAIL? queries the current measurement to see if it fails the defined limits. Returns a 0 or 1: 0 it passes, 1 it fails.
----------------	--

Initial S/W Revision	Prior to A.02.00
----------------------	------------------

Data Query (Remote Command Only)

Returns the designated measurement data for the currently selected measurement and subopcode.

n = any valid subopcode for the current measurement. See the measurement command results table for your current measurement, for information about what data is returned for the subopcodes.

This command uses the data setting specified by the FORMat:BORDER and FORMat:DATA commands and can return real or ASCII data. (See the format command descriptions under Input/Output in the Analyzer Setup section.)

Remote Command	:CALCulate:DATA[n]?
Notes	The return trace depends on the measurement. In CALCulate:<meas>:DATA[n], n is any valid subopcode for the current measurement. It returns the same data as the FETCH:<measurement>? query where <measurement> is the current measurement.
Initial S/W Revision	Prior to A.02.00

Calculate/Compress Trace Data Query (Remote Command Only)

Returns compressed data for the currently selected measurement and sub-opcode [n].

n = any valid sub-opcode for that measurement. See the MEASure:<measurement>? command description of your specific measurement for information on the data that can be returned.

The data is returned in the current Y Axis Unit of the analyzer. The command is used with a sub-opcode <n> (default=1) to specify the trace. With trace queries, it is best if the analyzer is not sweeping during the query. Therefore, it is generally advisable to be in Single Sweep, or Update=Off.

This command is used to compress or decimate a long trace to extract and return only the desired data. A typical example would be to acquire N frames of GSM data and return the mean power of the first burst in each frame. The command can also be used to identify the best curve fit for the data.

Remote Command	:CALCulate:DATA<n>:COMPRESS? BLOCK CFIT MAXimum MINimum MEAN DMEan RMS RMSCubed SAMPLE SDEVIation PPHase [,<soffset> [,<length>[,<roffset>[,<rlimit>]]]]
Example	To query the mean power of a set of GSM bursts: Supply a signal that is a set of GSM bursts. Select the IQ Waveform measurement (in IQ Analyzer Mode). Set the sweep time to acquire at least one burst. Set the triggers such that acquisition happens at a known position relative to a burst. Then query the mean burst levels using, CALC:DATA2:COMP? MEAN, 24e-6, 526e-6 (These parameter values correspond to GSM signals, where 526e-6 is the length of the burst in the slot and you just want 1 burst.)
Notes	The command supports 5 parameters. Note that the last 4 (<soffset>, <length>, <roffset>, <rlimit>) are optional. But these optional parameters must be entered in the specified order. For example, if you want to specify <length>, then you must also specify <soffset>. See details below for a definition of each of these parameters. This command uses the data in the format specified by FORMat:DATA, returning either binary or ASCII data.
Initial S/W Revision	Prior to A.02.00

- BLOCK or block data - returns all the data points from the region of the trace data that you specify. For example, it could be used to return the data points of an input signal over several timeslots, excluding the portions of the trace data that you do not want. (This is x,y pairs for trace data and I,Q pairs for complex data.)

- CFIT or curve fit - applies curve fitting routines to the data. <soffset> and <length> are required to define the data that you want. <roffset> is an optional parameter for the desired order of the curve equation. The query will return the following values: the x-offset (in seconds) and the curve coefficients ((order + 1) values).

MIN, MAX, MEAN, DME, RMS, RMSC, SAMP, SDEV and PPH return one data value for each specified region (or <length>) of trace data, for as many regions as possible until you run out of trace data (using <roffset> to specify regions). Or they return the number of regions you specify (using <rlimit>) ignoring any data beyond that.

- MINimum - returns the minimum data point (y value) for the specified region(s) of trace data. For I/Q trace data, the minimum magnitude of the I/Q pairs is returned.
- MAXimum - returns the maximum data point (y value) for the specified region(s) of trace data. For I/Q trace data, the maximum magnitude of the I/Q pairs is returned.
- MEAN - returns a single value that is the arithmetic mean of the data point values (in dB/ dBm) for the specified region(s) of trace data. For I/Q trace data, the mean of the magnitudes of the I/Q pairs is returned. See the following equations.

•

NOTE

If the original trace data is in dB, this function returns the arithmetic mean of those log values, not log of the mean power which is a more useful value. The mean of the log is the better measurement technique when measuring CW signals in the presence of noise. The mean of the power, expressed in dB, is useful in power measurements such as Channel Power. To achieve the mean of the power, use the RMS option.

Equation 1

Mean Value of Data Points for Specified Region(s)

$$MEAN = \frac{1}{n} \sum_{X_i \in \text{region}(s)} X_i$$

where X_i is a data point value, and n is the number of data points in the specified region(s).

Equation 2

Mean Value of I/Q Data Pairs for Specified Region(s)

$$MEAN = \frac{1}{n} \sum_{X_i \in \text{region}(s)} |X_i|$$

where $|X_i|$ is the magnitude of an I/Q pair, and n is the number of I/Q pairs in the specified region(s).

- DMEan - returns a single value that is the mean power (in dB/ dBm) of the data point values for the specified region(s) of trace data. See the following equation:

Equation 3

DMEan Value of Data Points for Specified Region(s)

$$\text{DME} = 10 \times \log_{10} \left(\frac{1}{n} \sum_{X_i \in \text{region}(s)} 10^{\frac{X_i}{10}} \right)$$

- RMS - returns a single value that is the average power on a root-mean-squared voltage scale (arithmetic rms) of the data point values for the specified region(s) of trace data. See the following equation.

NOTE

For I/Q trace data, the rms of the magnitudes of the I/Q pairs is returned. See the following equation. This function is very useful for I/Q trace data. However, if the original trace data is in dB, this function returns the rms of the log values which is not usually needed.

Equation 4

RMS Value of Data Points for Specified Region(s)

$$\text{RMS} = \sqrt{\frac{1}{n} \sum_{X_i \in \text{region}(s)} X_i^2}$$

where X_i is a data point value, and n is the number of data points in the specified region(s).

Equation 5

RMS Value of I/Q Data Pairs for Specified Region(s)

$$\text{RMS} = \sqrt{\frac{1}{n} \sum_{X_i \in \text{region}(s)} X_i X_i^*}$$

where X_i is the complex value representation of an I/Q pair, X_i^* its conjugate complex number, and n is the number of I/Q pairs in the specified region(s).

Once you have the rms value for a region of trace data (linear or I/Q), you may want to calculate the mean power. You must convert this rms value (peak volts) to power in dBm:

$$10 \times \log[10 \times (\text{rms value})^2]$$

- SAMPLe - returns the first data value (x,y pair) for the specified region(s) of trace data. For I/Q trace data, the first I/Q pair is returned.
- SDEViation - returns a single value that is the arithmetic standard deviation for the data point values for the specified region(s) of trace data. See the following equation.
- For I/Q trace data, the standard deviation of the magnitudes of the I/Q pairs is returned. See the following equation.

Equation 6

Standard Deviation of Data Point Values for Specified Region(s)

$$\text{SDEV} = \sqrt{\frac{1}{n} \sum_{X_i \in \text{region}(s)} (X_i - \bar{X})^2}$$

where X_i is a data point value, \bar{X} is the arithmetic mean of the data point values for the specified region (s), and n is the number of data points in the specified region(s).

$$\text{SDEV} = \sqrt{\frac{1}{n} \sum_{X_i \in \text{region}(s)} (|X_i| - \bar{X})^2}$$

where $|X_i|$ is the magnitude of an I/Q pair, \bar{X} is the mean of the magnitudes for the specified region(s), and n is the number of data points in the specified region(s).

- PPHase - returns the x,y pairs of both rms power (dBm) and arithmetic mean phase (radian) for every specified region and frequency offset (Hz). The number of pairs is defined by the specified number of regions. This parameter can be used for I/Q vector ($n=0$) in Waveform (time domain) measurement and all parameters are specified by data point in PPHase.

The rms power of the specified region may be expressed as:

$$\text{Power} = 10 \times \log [10 \times (\text{RMS I/Q value})] + 10.$$

The RMS I/Q value (peak volts) is:

$$\sqrt{\frac{1}{n} \sum_{X_i \in \text{region}} X_i X_i^*}$$

where X_i is the complex value representation of an I/Q pair, X_i^* its conjugate complex number, and n is the number of I/Q pairs in the specified region.

The arithmetic mean phase of the specified region may be expressed as:

$$\frac{1}{n} \sum_{Y_i \in \text{region}} Y_i$$

where Y_i is the unwrapped phase of I/Q pair with applying frequency correction and n is the number of I/Q pairs in the specified region.

The frequency correction is made by the frequency offset calculated by the arithmetic mean of every specified region's frequency offset. Each frequency offset is calculated by the least square method against the unwrapped phase of I/Q pair.

Sample Trace Data - Constant Envelope

(See below for explanation of variables.)

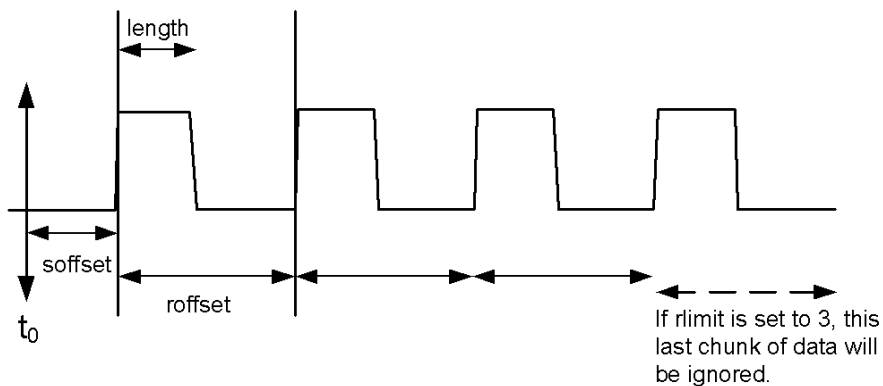

Sample Trace Data - Not Constant Envelope

(See below for explanation of variables.)



<soffset> - start offset is an optional real number. (It is in seconds for time-domain traces, and is a dimensionless index 0 to Npoints - 1, for frequency-domain traces). It specifies the amount of data at the beginning of the trace that will be ignored before the decimation process starts. It is the time or frequency change from the start of the trace to the point where you want to start using the data. The default value is zero.

<length> - is an optional real number. (It is in seconds for time-domain traces, and is a dimensionless index 0 to Npoints - 1, for frequency-domain traces). It defines how much data will be compressed into one value. This parameter has a default value equal to the current trace length.

<roffset> - repeat offset is an optional real number. (It is in seconds for time-domain traces, and is a dimensionless index 0 to Npoints - 1, for frequency-domain traces). It defines the beginning of the next field of trace elements to be compressed. This is relative to the beginning of the previous field. This parameter has a default value equal to the <length> variable. Note that this parameter is used for a completely different purpose when curve fitting (see CFIT above).

<rlimit> - repeat limit is an optional integer. It specifies the number of data items that you want returned. It will ignore any additional items beyond that number. You can use the Start offset and the Repeat limit to pick out exactly what part of the data you want to use. The default value is all the data.

Calculate Peaks of Trace Data (Remote Command Only)

Returns a list of all the peaks for the currently selected measurement and sub-opcode [n]. The peaks must meet the requirements of the peak threshold and excursion values.

n = any valid sub-opcode for the current measurement. See the MEASure:<measurement> command description of your specific measurement for information on the data that can be returned.

The command can only be used with specific sub-opcodes with measurement results that are trace data. Both real and complex traces can be searched, but complex traces are converted to magnitude in dBm. In many measurements the sub-opcode n=0, is the raw trace data which cannot be searched for peaks. And Sub-opcode n=1, is often calculated results values which also cannot be searched for peaks.

This command uses the data setting specified by the FORMat:BORDER and FORMat:DATA commands and can return real or ASCII data. If the format is set to INT,32, it returns REAL,32 data.

The command has four types of parameters:

- Threshold (in dBm)
- Excursion (in dB)
- Sorting order (amplitude, frequency, time)
- Optional in some measurements: Display line use (all, > display line, < display line)

Remote Command	<p>For Swept SA measurement:</p> <pre>:CALCulate:DATA[1] 2 ... 6:PEAKs? <threshold>,<excursion>[,AMPLitude FREQuency TIME[,ALL GTDLine LTDLine]]</pre> <p>For most other measurements:</p> <pre>:CALCulate:DATA[1] 2 ... 6:PEAKs? <threshold>,<excursion>[,AMPLitude FREQuency TIME]</pre>
-----------------------	--

Example	<p>Example for Swept SA measurement in Spectrum Analyzer Mode:</p> <p>CALC:DATA4:PEAK? -40, 10, FREQ, GTDL This will identify the peaks of trace 4 that are above -40 dBm, with excursions of at least 10 dB. The peaks are returned in order of increasing frequency, starting with the lowest frequency. Only the peaks that are above the display line are returned.</p> <p>Query Results 1:</p> <p>With FORMat:DATA REAL, 32 selected, it returns a list of floating-point numbers. The first value in the list is the number of peak points that are in the following list. A peak point consists of two values: a peak amplitude followed by its corresponding frequency (or time).</p> <p>If no peaks are found the peak list will consist of only the number of peaks, (0).</p>
----------------	---

Notes	<p><n> - is the trace that will be used</p> <p><threshold> - is the level below which trace data peaks are ignored. Note that the threshold value is required and is always used as a peak criterion. To effectively disable the threshold criterion for this command, provide a substantially low threshold value such as -200 dBm. Also note that the threshold value used in this command is independent of and has no effect on the threshold value stored under the Peak Criteria menu.</p> <p><excursion> - is the minimum amplitude variation (rise and fall) required for a signal to be identified as peak. Note that the excursion value is required and is always used as a peak criterion. To effectively disable the excursion criterion for this command, provide the minimum value of 0.0 dB. Also note that the excursion value used in this command is independent of and has no effect on the</p>
--------------	---

excursion value stored under the Peak Criteria menu.

Values must be provided for threshold and excursion. The sorting and display line parameters are optional (defaults are AMPLitude and ALL).

Note that there is always a Y-axis value for the display line, regardless of whether the display line state is on or off. It is the current Y-axis value of the display line which is used by this command to determine whether a peak should be reported

Sorting order:

AMPLitude - lists the peaks in order of descending amplitude, with the highest peak first (default if optional parameter not sent)

FREQUency - lists the peaks in order of occurrence, left to right across the x-axis.

TIME - lists the peaks in order of occurrence, left to right across the x-axis.

Peaks vs. Display Line:

ALL - lists all of the peaks found (default if optional parameter not sent).

GTDLine (greater than display line) - lists all of the peaks found above the display line.

LTDLine (less than display line) - lists all of the peaks found below the display line.

Initial S/W Revision Prior to A.02.00

Format Data: Numeric Data (Remote Command Only)

This command specifies the format of the trace data input and output. It specifies the formats used for trace data during data transfer across any remote port. It affects only the data format for setting and querying trace data for the :TRACe[:DATA], TRACe[:DATA]?, :CALCulate:DATA[n]? and FETCh:SANalyzer [n]? commands and queries.

Remote Command :FORMat[:TRACe][:DATA] ASCii|INTeger,32|REAL,32 |REAL,64
:FORMat[:TRACe][:DATA]?

Notes The query response is:
ASCii: ASC,8
REAL,32: REAL,32
REAL,64: REAL,64
INTeger,32: INT,32

When the numeric data format is REAL or ASCii, data is output in the current Y Axis unit. When the data format is INTeger, data is output in units of m dBm (.001 dBm).

The INT,32 format returns binary 32-bit integer values in internal units (m dBm), in a definite length block.

Dependencies Sending a data format spec with an invalid number (for example, INT,48) generates no error. The analyzer simply uses the default (8 for ASCii, 32 for INTeger, 32 for REAL).

Sending data to the analyzer which does not conform to the current FORMat specified, results in an error. Sending ASCII data when a definite block is expected generates message -161 "Invalid Block Data" and sending a definite block when ASCII data is expected generates message -121 "Invalid Character in Number".

Preset ASCii

Backwards Compatibility Notes Note that the INT,32 format is only applicable to the command, TRACe:DATA. This preserves backwards compatibility for the Swept SA measurement. For all other commands/queries which honor FORMat:DATA, if INT,32 is sent the analyzer will behave as though it were set to REAL,32.

Initial S/W Revision Prior to A.02.00

The specs for each output type follow:

AScii - Amplitude values are in ASCII, in the current Y Axis Unit, one ASCII character per digit, values separated by commas, each value in the form:

SX.YYYYYEsZZ

Where:

S = sign (+ or -)

X = one digit to left of decimal point

Y = 5 digits to right of decimal point

E = E, exponent header

s = sign of exponent (+ or -)

ZZ = two digit exponent

REAL,32 - Binary 32-bit real values in the current Y Axis Unit, in a definite length block.

REAL,64 - Binary 64-bit real values in the current Y Axis Unit, in a definite length block.

Format Data: Byte Order (Remote Command Only)

This command selects the binary data byte order for data transfer and other queries. It controls whether binary data is transferred in normal or swapped mode. This command affects only the byte order for setting and querying trace data for the :TRACe[:DATA], TRACe[:DATA]? , :CALCulate:DATA[n]? and FETCh:SANalyzer[n]? commands and queries.

By definition any command that says it uses FORMat:DATA uses any format supported by FORMat:DATA.

The NORMal order is a byte sequence that begins with the most significant byte (MSB) first, and ends with the least significant byte (LSB) last in the sequence: 1|2|3|4. SWAPped order is when the byte sequence begins with the LSB first, and ends with the MSB last in the sequence: 4|3|2|1.

Remote Command	:FORMat:BORDER NORMal SWAPped :FORMat:BORDER?
Preset	NORMal
Initial S/W Revision	Prior to A.02.00

Meas Setup

Accesses the measurement setup menu for the current measurement.

Key Path	Meas Setup
Initial S/W Revision	Prior to A.02.00

Avg/Hold Num

Used to specify the number of data acquisitions that are averaged. After the specified number of average counts, the averaging mode (termination control) setting determines the averaging action.

- On - Sets measurement averaging on.
- Off - Sets measurement averaging off.

Key Path	Meas Setup
Mode	WIMAXOFDMA
Remote Command	[:SENSe]:PVTime:AVERage:COUNT <integer> [:SENSe]:PVTime:AVERage:COUNT? [:SENSe]:PVTime:AVERage[:STATe] OFF ON 0 1 [:SENSe]:PVTime:AVERage[:STATe]?
Example	PVT:AVER:COUN 1 PVT:AVER:COUN? PVT:AVER OFF PVT:AVER?
Preset	50 OFF
State Saved	Saved in instrument state.
Min	1
Max	10000
Initial S/W Revision	Prior to A.02.00

Avg Mode

Selects the type of termination control used for the averaging function. This determines the averaging action after the specified number of data acquisitions (average count) is reached.

KEY:Exponential SCPI:EXPonential	After the average count is reached, each successive data acquisition is exponentially weighted and combined with the existing average.
KEY:Repeat SCPI:REPeat	After reaching the average count, the averaging is reset and a new average is started. The default value is Exp.

Key Path	Meas Setup
Mode	WIMAXOFDMA
Remote Command	[:SENSe] :PVTime :AVERage :TCONtrol EXPonential REPEAT [:SENSe] :PVTime :AVERage :TCONtrol ?
Example	PVT:AVER:TCON REP PVT:AVER:TCON?
Preset	EXPonential
State Saved	Saved in instrument state.
Range	Exp Repeat
Initial S/W Revision	Prior to A.02.00

Avg Type

Specifies the type of trace and result averaging to use.

This parameter is valid only for Measure Trace.

KEY:Pwr Avg (RMS) SCPI:RMS POWER	True power averaging that is equivalent to taking the RMS value of the voltage. It is the most accurate type of averaging.
KEY:Log-Pwr Avg (Video) SCPI:LOG LPOWER	Simulates the traditional spectrum analyzer type of averaging by averaging the log of the power.

Key Path	Meas Setup
Mode	WIMAXOFDMA
Remote Command	[:SENSe] :PVTime :AVERage :TYPE LOG LPOWER RMS POWER [:SENSe] :PVTime :AVERage :TYPE ?
Example	PVT:AVER:TYPE LOG PVT:AVER:TYPE?
Preset	RMS
State Saved	Saved in instrument state.
Range	Pwr Avg (RMS) Log-Pwr Avg(Video)
Initial S/W Revision	Prior to A.02.00

Capture Length

Enables you to specify the capture length.

Key Path	Meas Setup
----------	------------

Mode	WIMAXOFDMA
Remote Command	[:SENSe] :PVTime:SWEep:TIME <integer> [:SENSe] :PVTime:SWEep:TIME?
Example	PVT:SWE:TIME 1 PVT:SWE:TIME?
Preset	1
State Saved	Saved in instrument state.
Min	1
Max	4
Initial S/W Revision	Prior to A.02.00

Burst Sync

Specifies the method used to detect a burst.

KEY:RF Amptd SCPI:RFBurst	The measurement algorithm searches for a burst that satisfies the burst detection parameters such as Threshold Lvl and Burst Slope Threshold. The search is performed from the beginning of the capture data.
KEY:None SCPI:NONE	The measurement algorithm does not search a burst at all. Instead, the algorithm assumes that the burst begins from the trigger timing setting (e.g. RF Burst Trigger or External Trigger) and lasts for a predefined period as determined by the region limit setting. This means you need to set the external trigger to exactly the same setting as the burst rising setting.

Key Path	Meas Setup
Mode	WIMAXOFDMA
Remote Command	[:SENSe] :PVTime:BSYNc:SOURce RFBurst NONE [:SENSe] :PVTime:BSYNc:SOURce?
Example	PVT:BSYN:SOUR NONE PVT:BSYN:SOUR?
Preset	RFBurst
State Saved	Saved in instrument state.
Range	RF Amptd None
Initial S/W Revision	Prior to A.02.00

Region/Limits

Accesses the Region/Limits menu allows you to set up the test limit mask for the specified time period. A time period is called a region. You can define multiple regions. The start and stop time of the regions, and the absolute or relative power of the upper and lower limit masks for the regions, are configurable.

Key Path	Meas Setup
Initial S/W Revision	Prior to A.02.00

Region

Time slices along the burst are called regions. You can define up to 12 regions, which are designated by the characters A to L. You can configure the following parameters for each region: Start Time, Stop Time, Upper Abs Start, Upper Abs Stop, Upper Rel Start, Upper Rel Stop, Upper Fail Mask, Lower Abs Start, Lower Abs Stop, Lower Rel Start, Lower Rel Stop and Lower Fail Mask.

Key Path	Meas Setup, More, Region/Limits
Mode	WIMAXOFDMA
Preset	A
Range	A B C D E F G H I J K L
Initial S/W Revision	Prior to A.02.00

Start Time

Specifies the start time for each region.

Key Path	Meas Setup, More, Region/Limits
Mode	WIMAXOFDMA
Remote Command	<pre>:CALCulate:PVTime:MASK[1] 2:LIST:TIME:STARt <real>, <real>, <real>, <real>, <real>, <real>, <real>, <real>, <real>, <real> :CALCulate:PVTime:MASK[1] 2:LIST:TIME:STARt? :CALCulate:PVTime:MASK[1] 2:LIST:STATe ON OFF 1 0, ON OFF 1 0, ON OFF 1 0, ON OFF 1 0, ON OFF 1 0, ON OFF 1 0, ON OFF 1 0, ON OFF 1 0, ON OFF 1 0, ON OFF 1 0, ON OFF 1 0, ON OFF 1 0 :CALCulate:PVTime:MASK[1] 2:LIST:STATe?</pre>
Example	<pre>CALC:PVT:MASK2:LIST:TIME:STAR -1.0, -50.0e-6, 0.0 CALC:PVT:MASK2:LIST:TIME:STAR? CALC:PVT:MASK1:LIST:STAT 1,1,1 CALC:PVT:MASK1:LIST:STAT?</pre>
Notes	<p>The time is relative to the T0 point.</p> <p>A value must be entered for all regions. A value of 0 must be entered for those regions to which this parameter is not being applied.</p>

	Comma separated list of 12 values. MASK1 is for BTS, 2 for MS. Default is BTS.
Couplings	Coupled to Stop Time. When Start Time is set to a larger value than the Stop Time, the Stop Time is forced to increase to the same value as the new Start Time. When Stop Time is set to a smaller value than the Start Time, the Start Time is forced to decrease to the same value as the new Stop Time.
Preset	-1.0, -50.0e-6, 0.0, 50.0e-6, 500.0e-6, 2.5e-3, 4.8e-3, 0.0, 0.0, 0.0, 0.0, 0.0
State Saved	Saved in instrument state.
Min	-1.0
Max	1.0
Initial S/W Revision	Prior to A.02.00

Stop Time

Specifies the stop time of each region.

Key Path	Meas Setup, More, Region/Limits
Mode	WIMAXOFDMA
Remote Command	:CALCulate:PVTime:MASK[1] 2:LIST:TIME:STOP <real>, <real>, <real>, <real>, <real>, <real>, <real>, <real>, <real>, <real> :CALCulate:PVTime:MASK[1] 2:LIST:TIME:STOP?
Example	CALC:PVT:MASK2:LIST:TIME:STOP -50.0e-6, 0.0 CALC:PVT:MASK2:LIST:TIME:STOP?
Notes	The time is relative to the T0 point. A value must be entered for all regions. A value of 0 must be entered for those regions to which this parameter is not being applied. Comma separated list of 12 values. MASK1 is for BTS, 2 for MS. Default is BTS.
Couplings	Coupled to Start Time. When Start Time is set to a larger value than the Stop Time, the Stop Time is forced to increase to the same value as the new Start Time. When Stop Time is set to a smaller value than the Start Time, the Start Time is forced to decrease to the same value as the new Stop Time.
Preset	-50.0e-6, 0.0, 50.0e-6, 500.0e-6, 2.5e-3, 4.8e-3, 1.0, 0.0, 0.0, 0.0, 0.0, 0.0
State Saved	Saved in instrument state.
Min	-1.0
Max	1.0
Initial S/W Revision	Prior to A.02.00

Upper Abs Start

Specifies the absolute power level limit at the start time of the selected region.

Key Path	Meas Setup, More, Region/Limits, More
Mode	WIMAXOFDMA
Remote Command	:CALCulate:PVTime:MASK[1] 2:LIST:UPPer:STARt:ABSolute <real>, <real>, <real>, <real>, <real>, <real>, <real>, <real>, <real>, <real>, <real>, <real> :CALCulate:PVTime:MASK[1] 2:LIST:UPPer:STARt:ABSolute?
Example	CALC:PVT:MASK2:LIST:UPPer:STAR:ABS 0,0,0 CALC:PVT:MASK2:LIST:UPPer:STAR:ABS?
Notes	A value must be entered for all regions. A value of 0 may be entered for those regions to which this parameter is not being applied. Comma separated list of 12 values. MASK1 is for BTS, 2 for MS. Default is BTS.
Preset	0.0, 0.0, 0.0, 0.0, 0.0, 0.0, 200.0, 0.0, 0.0, 0.0, 0.0, 0.0.
State Saved	Saved in instrument state.
Min	-200 dBm
Max	200 dBm
Initial S/W Revision	Prior to A.02.00

Upper Abs Stop

Specifies the absolute power level limit at the stop time of the selected region. The parameter can be toggled between Auto and Man. If set to Auto, this parameter is coupled to Upper Abs Start to make a flat limit line. If set to Man, Upper Abs Start and Upper Abs Stop can be assigned different values to make a sloped limit line.

Key Path	Meas Setup, More, Region/Limits, More
Mode	WIMAXOFDMA
Remote Command	:CALCulate:PVTime:MASK[1] 2:LIST:UPPer:STOP:ABSolute <real>, <real>, <real>, <real>, <real>, <real>, <real>, <real>, <real>, <real>, <real>, <real> :CALCulate:PVTime:MASK[1] 2:LIST:UPPer:STOP:ABSolute? :CALCulate:PVTime:MASK[1] 2:LIST:UPPer:STOP:ABSolute:AUTO ON OFF 1 0, ON OFF 1 0, ON OFF 1 0, ON OFF 1 0, ON OFF 1 0, ON OFF 1 0, ON OFF 1 0, ON OFF 1 0, ON OFF 1 0, ON OFF 1 0, ON OFF 1 0, ON OFF 1 0 :CALCulate:PVTime:MASK[1] 2:LIST:UPPer:STOP:ABSolute:AUTO?
Example	CALC:PVT:MASK1:LIST:UPPer:STOP:ABS 1,1,1 CALC:PVT:MASK1:LIST:UPPer:STOP:ABS? CALC:PVT:MASK1:LIST:UPPer:STOP:ABS:AUTO 1, 1, 1 CALC:PVT:MASK1:LIST:UPPer:STOP:ABS:AUTO?
Notes	A value must be entered for all regions. A value of 0 may be entered for those regions to which this parameter is not being applied. Comma separated list of 12 values. MASK1 is for BTS, 2 for MS. Default is BTS.

Couplings	Coupled to Upper Abs Start, if coupling is set to "Auto". In this case, Upper Abs Stop keeps the same value as Upper Abs Start.
Preset	0.0, 0.0, 0.0, 0.0, 0.0, 0.0, 0.0, 0.0, 0.0, 0.0, 0.0, 0.0 1, 1, 1, 1, 1, 1, 1, 1, 1, 1, 1, 1
State Saved	Saved in instrument state.
Min	-200 dBm
Max	200 dBm
Initial S/W Revision	Prior to A.02.00

Upper Rel Start

Specifies the relative power level limit at the start time of the selected region. The reference power level is specified by the Power Reference parameter ["Power Reference" on page 1516](#)

Key Path	Meas Setup, More, Region/Limits, More
Mode	WIMAXOFDMA
Remote Command	:CALCulate:PVTime:MASK[1] 2:LIST:UPPer:STARt:RELative <rel_ampl>, <rel_ampl>, <rel_ampl>, <rel_ampl>, <rel_ampl>, <rel_ampl>, <rel_ampl>, <rel_ampl>, <rel_ampl>, <rel_ampl>, <rel_ampl>, <rel_ampl> :CALCulate:PVTime:MASK[1] 2:LIST:UPPer:STARt:RELative?
Example	CALC:PVT:MASK:LIST:UPPer:STAR:REL 1,1,1 CALC:PVT:MASK:LIST:UPPer:STAR:REL?
Notes	A value must be entered for all regions. A value of 0 may be entered for those regions to which this parameter is not being applied. Comma separated list of 12 values. MASK1 is for BTS, 2 for MS. Default is BTS.
Preset	-25.0, 16.0, 16.0, 16.0, 7.0, -25.0, 200.0, 0.0, 0.0, 0.0, 0.0, 0.0
State Saved	Saved in instrument state.
Min	-200 dB
Max	200 dB
Initial S/W Revision	Prior to A.02.00

Upper Rel Stop

Specifies the relative power level limit at the stop time of the selected region. The parameter can be toggled between Auto and Man. If set to Auto, this parameter is coupled to Upper Rel Start to make a flat limit line. If set to Man, Upper Rel Start and Upper Rel Stop can be assigned different values to make a sloped limit line.

Key Path	Meas Setup, More, Region/Limits, More
Mode	WIMAXOFDMA

Remote Command	<pre> :CALCulate:PVTime:MASK[1] 2:LIST:UPPer:STOP:RELative <rel_ampl>, <rel_ ampl>, <rel_ampl>, <rel_ampl>, <rel_ampl>, <rel_ampl>, <rel_ampl>, <rel_ampl>, <rel_ampl>, <rel_ampl>, <rel_ampl> :CALCulate:PVTime:MASK[1] 2:LIST:UPPer:STOP:RELative? :CALCulate:PVTime:MASK[1] 2:LIST:UPPer:STOP:RELative:AUTO ON OFF 1 0, ON OFF 1 0, ON OFF 1 0, ON OFF 1 0, ON OFF 1 0, ON OFF 1 0, ON OFF 1 0, ON OFF 1 0, ON OFF 1 0, ON OFF 1 0, ON OFF 1 0, ON OFF 1 0 :CALCulate:PVTime:MASK[1] 2:LIST:UPPer:STOP:RELative:AUTO? </pre>
Example	<pre> CALC:PVT:MASK:LIST:UPP:STOP:REL 0,0,0 CALC:PVT:MASK:LIST:UPP:STOP:REL? CALC:PVT:MASK1:LIST:UPP:STOP:REL:AUTO 0, 0, 0 CALC:PVT:MASK1:LIST:UPP:STOP:REL:AUTO? </pre>
Notes	<p>A value must be entered for all regions. A value of 0 may be entered for those regions for which this parameter is not being applied.</p> <p>Comma separated list of 12 values. MASK1 is for BTS, 2 for MS. Default is BTS.</p>
Couplings	Coupled to Upper Abs Start, if coupling is set to "Auto". In this case, Upper Rel Stop keeps the same value as Upper Rel Start.
Preset	0.0, 0.0, 0.0, 0.0, 0.0, 0.0, 0.0, 0.0, 0.0, 0.0, 0.0, 0.0 1, 1, 1, 1, 1, 1, 1, 1, 1, 1, 1, 1
State Saved	Saved in instrument state.
Min	-200 dB
Max	200 dB
Initial S/W Revision	Prior to A.02.00

Upper Fail Mask

Specifies the fail condition of the upper limit for the selected region.

KEY:Absolute SCPI:ABSolute	The measurement reports "FAIL" if the result exceeds the upper absolute limit.
KEY:Relative SCPI:Relative	The measurement reports "FAIL" if the result exceeds the upper relative limit.
KEY:Abs AND Rel SCPI:AND	The measurement reports "FAIL" if the result exceeds both the upper absolute limit and the upper relative limit.
KEY:Abs OR Rel SCPI:AND	The measurement reports "FAIL" if the result exceeds either the upper absolute limit or the upper relative limit.

Key Path	Meas Setup, More, Region/Limits, More
-----------------	---------------------------------------

Mode	WIMAXOFDMA
Remote Command	:CALCulate:PVTime:MASK[1] 2:LIST:UPPer:TEST ABSolute RELative AND OR, ABSolute RELative AND OR, ABSolute RELative AND OR, ABSolute RELative AND OR, ABSolute RELative AND OR, ABSolute RELative AND OR, ABSolute RELative AND OR, ABSolute RELative AND OR, ABSolute RELative AND OR, ABSolute RELative AND OR, ABSolute RELative AND OR, :CALCulate:PVTime:MASK[1] 2:LIST:UPPer:TEST?
Example	CALC:PVT:MASK2:LIST:UPPer:TEST AND, AND, AND CALC:PVT:MASK2:LIST:UPPer:TEST?
Notes	Comma separated list of 12 values. MASK1 is for BTS, 2 for MS. Default is BTS.
Preset	REL, REL, REL, REL, REL, REL, ABS, REL, REL, REL, REL, REL
State Saved	Saved in instrument state.
Range	Absolute Relative Abs AND Rel Abs OR Rel
Initial S/W Revision	Prior to A.02.00

Lower Abs Start

Specifies the absolute power level limit at the start time of the selected region.

Key Path	Meas Setup, More, Region/Limits, More
Mode	WIMAXOFDMA
Remote Command	:CALCulate:PVTime:MASK[1] 2:LIST:LOWer:STARt:ABSolute <real>, <real>, <real>, <real>, <real>, <real>, <real>, <real>, <real>, <real>, <real>, <real> :CALCulate:PVTime:MASK[1] 2:LIST:LOWer:STARt:ABSolute?
Example	CALC:PVT:MASK2:LIST:LOW:STAR:ABS 200,200 CALC:PVT:MASK2:LIST:LOW:STAR:ABS?
Notes	A value must be entered for all regions. A value of 0 may be entered for those regions for which this parameter is not being applied. Comma separated list of 12 values. MASK1 is for BTS, 2 for MS. Default is BTS.
Preset	-200.0, -200.0, -200.0, -200.0, -200.0, -200.0, -200.0, 0.0, 0.0, 0.0, 0.0, 0.0
State Saved	Saved in instrument state.
Min	-200 dBm
Max	200 dBm
Initial S/W Revision	Prior to A.02.00

Lower Abs Stop

Specifies the absolute power level limit at the stop time of the selected region. The parameter can be toggled between Auto and Man. If set to Auto, this parameter is coupled to Lower Abs Start to make a flat limit line. If set to Man, Lower Abs Start and Lower Abs Stop can be assigned different values to make a sloped limit line.

Key Path	Meas Setup, More, Region/Limits, More
Mode	WIMAXOFDMA
Remote Command	:CALCulate:PVTime:MASK[1] 2:LIST:LOWer:STOP:ABSolute <real>, <real>, <real>, <real>, <real>, <real>, <real>, <real>, <real>, <real>, <real> :CALCulate:PVTime:MASK[1] 2:LIST:LOWer:STOP:ABSolute? :CALCulate:PVTime:MASK[1] 2:LIST:LOWer:STOP:ABSolute:AUTO ON OFF 1 0, ON OFF 1 0, ON OFF 1 0, ON OFF 1 0, ON OFF 1 0, ON OFF 1 0, ON OFF 1 0, ON OFF 1 0, ON OFF 1 0, ON OFF 1 0, ON OFF 1 0, ON OFF 1 0, ON OFF 1 0 :CALCulate:PVTime:MASK[1] 2:LIST:LOWer:STOP:ABSolute:AUTO?
Example	CALC:PVT:MASK1:LIST:LOWer:STOP:ABS 200, 200 CALC:PVT:MASK1:LIST:LOWer:STOP:ABS? CALC:PVT:MASK1:LIST:LOWer:STOP:ABS:AUTO 1, 1, 1, 1 CALC:PVT:MASK1:LIST:LOWer:STOP:ABS:AUTO?
Notes	A value must be entered for all regions. A value of 0 may be entered for those regions for which this parameter is not being applied. Comma separated list of 12 values. MASK1 is for BTS, 2 for MS. Default is BTS.
Couplings	Coupled to Lower Abs Start, if coupling is set to "Auto". In this case, Lower Abs Stop keeps the same value as Lower Abs Start.
Preset	0.0, 0.0, 0.0, 0.0, 0.0, 0.0, 0.0, 0.0, 0.0, 0.0, 0.0, 0.0 1, 1, 1, 1, 1, 1, 1, 1, 1, 1, 1, 1
State Saved	Saved in instrument state.
Min	-200 dBm
Max	200 dBm
Initial S/W Revision	Prior to A.02.00

Lower Rel Start

Specifies the relative power level limit at the start time of the selected region. The reference power level is specified by the Power Reference parameter. ["Power Reference" on page 1516](#)

Key Path	Meas Setup, More, Region/Limits, More
Mode	WIMAXOFDMA
Remote Command	:CALCulate:PVTime:MASK[1] 2:LIST:LOWer:START:RELative <rel_ampl>, <rel_ampl>, <rel_ampl>, <rel_ampl>, <rel_ampl>, <rel_ampl>, <rel_ampl>, <rel_ampl>, <rel_ampl>, <rel_ampl>, <rel_ampl>, <rel_ampl>

	:CALCulate:PVTime:MASK[1] 2:LIST:LOWer:STARt:RELative?
Example	CALC:PVT:MASK:LIST:LOWer:STAR:REL 1, 1, 1, 1, 1, 1 CALC:PVT:MASK:LIST:LOWer:STAR:REL?
Notes	A value must be entered for all regions. A value of 0 may be entered for those regions for which this parameter is not being applied. Comma separated list of 12 values. MASK1 is for BTS, 2 for MS. Default is BTS.
Preset	0.0, 0.0, 0.0, 0.0, 0.0, 0.0, 0.0, 0.0, 0.0, 0.0, 0.0, 0.0
State Saved	Saved in instrument state.
Min	-200 dB
Max	200 dB
Initial S/W Revision	Prior to A.02.00

Lower Rel Stop

Specifies the relative power level limit at the stop time of the selected region. The parameter can be toggled between Auto and Man. If set to Auto, this parameter is coupled to Lower Rel Start to make a flat limit line. If set to Man, Lower Rel Start and Lower Rel Stop can be assigned different values to make a sloped limit line.

Key Path	Meas Setup, More, Region/Limits, More
Mode	WIMAXOFDMA
Remote Command	:CALCulate:PVTime:MASK[1] 2:LIST:LOWer:STOP:RELative <rel_ampl>, <rel_ampl>, <rel_ampl>, <rel_ampl>, <rel_ampl>, <rel_ampl>, <rel_ampl>, <rel_ampl>, <rel_ampl>, <rel_ampl>, <rel_ampl>, <rel_ampl> :CALCulate:PVTime:MASK[1] 2:LIST:LOWer:STOP:RELative? :CALCulate:PVTime:MASK[1] 2:LIST:LOWer:STOP:RELative:AUTO ON OFF 1 0, ON OFF 1 0, ON OFF 1 0, ON OFF 1 0, ON OFF 1 0, ON OFF 1 0, ON OFF 1 0, ON OFF 1 0, ON OFF 1 0, ON OFF 1 0, ON OFF 1 0, ON OFF 1 0, ON OFF 1 0 :CALCulate:PVTime:MASK[1] 2:LIST:LOWer:STOP:RELative:AUTO?
Example	CALC:PVT:MASK:LIST:LOWer:STOP:REL 10, 10, 10 CALC:PVT:MASK:LIST:LOWer:STOP:REL? CALC:PVT:MASK1:LIST:LOW:STOP:REL:AUTO 0, 0, 0, 0, 0, 0 CALC:PVT:MASK1:LIST:LOW:STOP:REL:AUTO?
Notes	A value must be entered for all regions. A value of 0 may be entered for those regions for which this parameter is not being applied. Comma separated list of 12 values. MASK1 is for BTS, 2 for MS. Default is BTS.
Couplings	Coupled to Lower Abs Start, if coupling is set to "Auto". In this case, Lower Rel Stop keeps the same value as Lower Rel Start.
Preset	0.0, 0.0, 0.0, 0.0, 0.0, 0.0, 0.0, 0.0, 0.0, 0.0, 0.0, 0.0 1, 1, 1, 1, 1, 1, 1, 1, 1, 1, 1, 1

State Saved	Saved in instrument state.
Min	-200 dB
Max	200 dB
Initial S/W Revision	Prior to A.02.00

Lower Fail Mask

Specifies the fail condition of the lower limit for the selected region.

KEY:Absolute SCPI:ABSolute	The measurement reports "FAIL" if the result exceeds the lower absolute limit.
KEY:Relative SCPI:Relative	The measurement reports "FAIL" if the result exceeds the lower relative limit.
KEY:Abs AND Rel SCPI:AND	The measurement reports "FAIL" if the result exceeds both the lower absolute limit and the lower relative limit.
KEY:Abs OR Rel SCPI:AND	The measurement reports "FAIL" if the result exceeds either the lower absolute limit or the lower relative limit.

Key Path	Meas Setup, More, Region/Limits, More
Mode	WIMAXOFDMA
Remote Command	:CALCulate:PVTime:MASK[1] 2:LIST:LOWer:TEST ABSolute RELative AND OR, ABSolute RELative AND OR, ABSolute RELative AND OR, ABSolute RELative AND OR, ABSolute RELative AND OR, ABSolute RELative AND OR, ABSolute RELative AND OR, ABSolute RELative AND OR, ABSolute RELative AND OR, :CALCulate:PVTime:MASK[1] 2:LIST:LOWer:TEST?
Example	CALC:PVT:MASK2:LIST:LOW:TEST OR,OR,OR,OR CALC:PVT:MASK2:LIST:LOW:TEST?
Notes	Comma separated list of 12 values. MASK1 is for BTS, 2 for MS. Default is BTS.
Preset	ABS, ABS, ABS, ABS, ABS, ABS, ABS, REL, REL, REL, REL, REL
State Saved	Saved in instrument state.
Range	Absolute Relative Abs AND Rel Abs OR Rel
Initial S/W Revision	Prior to A.02.00

Power Reference

Specifies a region, the power level of which is used to set the reference power level for the relative limit mask of all regions.

Key Path	Meas Setup, More
Mode	WIMAXOFDMA
Remote Command	:CALCulate:PVTime:MASK[1] 2:PREference A B C D E F G H I J K L :CALCulate:PVTime:MASK[1] 2:PREference?
Example	CALC:PVT:MASK:PREF A CALC:PVT:MASK:PREF?
Notes	MASK1 is for BTS, 2 for MS. Default is BTS.
Preset	D
State Saved	Saved in instrument state.
Range	Region A Region B Region C Region D Region E Region F Region G Region H Region I Region J Region K Region L
Initial S/W Revision	Prior to A.02.00

Time Reference

Specifies a reference position along the burst for start time and stop time settings for all regions. If you want to fine tune the reference position, set the Time Ref Offset parameter in the Advanced menu (See ["Time Ref Offset" on page 1520](#)"Time Ref Offset" on page 1520.)

KEY:Burst Rising SCPI:RISE	Uses the burst rising timing as the time reference in applying the limit mask.
KEY:Burst Center SCPI:CENTer	Uses the burst center timing as the time reference in applying the limit mask.
KEY:Trigger SCPI:TRIGger	Uses the trigger timing as the time reference in applying the limit mask.

Key Path	Meas Setup, More
Mode	WIMAXOFDMA
Remote Command	:CALCulate:PVTime:MASK[1] 2:TREference RISE CENTer TRIGger :CALCulate:PVTime:MASK[1] 2:TREference?
Example	CALC:PVT:MASK:TREF CENT CALC:PVT:MASK:TREF?
Notes	MASK1 is for BTS, 2 for MS. Default is BTS.
Preset	RISE
State Saved	Saved in instrument state.
Range	Burst Rising Burst Center Trigger
Backwards Compatibility SCPI	:CALCulate:PVTime:MASK[1] 2:REference
Initial S/W Revision	Prior to A.02.00

Meas Preset

Returns parameters for the current measurement to those set by the factory.

Key Path	Meas Setup, More
Mode	WIMAXOFDMA
Remote Command	:CONFigure:PVTime
Example	CONF:PVT
Initial S/W Revision	Prior to A.02.00

Advanced

Accesses advanced measurement setup features. These features are intended for the advanced user.

Key Path	Meas Setup
Initial S/W Revision	Prior to A.02.00

Threshold Lvl

If Burst Sync is set to RF Amptd, the measurement algorithm looks for a burst in the captured data. This parameter determines the power level above which the algorithm considers any burst as a candidate for a valid burst.

"Burst Slope Threshold" on page 1519 and "Burst Slope Detect Intvl" on page 1519 are also used in the burst detection algorithm.

Key Path	Meas Setup, More, Advanced
Mode	WIMAXOFDMA
Remote Command	[:SENSe] :PVTime:BURSt:THReshold <real> [:SENSe] :PVTime:BURSt:THReshold? [:SENSe] :PVTime:BURSt:THReshold:TYPE ABSolute RELative [:SENSe] :PVTime:BURSt:THReshold:TYPE?
Example	PVT:BURS:THR -100 PVT:BURS:THR? PVT:BURS:THR:TYPE REL PVT:BURS:THR:TYPE?
Notes	This command does not accept units such as dBm or dB. The BAF SCPI Command determines whether this command is set to an absolute or a relative power level. If the BAF choice is "Absolute", this parameter is expressed in units of dBm. Both positive and negative values are allowed.

	If the BAF choice is "Relative", this parameter is expressed in units of dB relative to the peak value for the capture length. Only negative values and zero are allowed. Positive values are clipped to zero.
Preset	-20.0 RELative
State Saved	Saved in instrument state.
Min	-100
Max	100
Backwards Compatibility SCPI	[:SENSe] :PVTime:BURSt:STHreshold
Initial S/W Revision	Prior to A.02.00

Burst Slope Threshold

If Burst Sync is set to RF Amptd, the measurement algorithm looks for a burst in the captured data. This parameter specifies the minimum slope in the relative power level change per 1 μ s. The slope of the captured signal power level must be greater than this parameter value in order to be considered as a valid burst.

"Threshold Lvl " on page 1518 and "Burst Slope Detect Intvl" on page 1519 are also used in the burst detection algorithm.

Key Path	Meas Setup, More, Advanced
Mode	WIMAXOFDMA
Remote Command	[:SENSe] :PVTime:BURSt:SLOPe <real> [:SENSe] :PVTime:BURSt:SLOPe?
Example	PVT:BURS:SLOP 0.1 PVT:BURS:SLOP?
Notes	This SCPI command does not accept units such as dB/ms.
Preset	2.0
State Saved	Saved in instrument state.
Min	0.1
Max	10.0
Initial S/W Revision	Prior to A.02.00

Burst Slope Detect Intvl

If Burst Sync is set to RF Amptd, the measurement algorithm looks for a burst in the captured data. This parameter specifies the time period for which the burst rising should keep the slope greater than Burst Search Slope Threshold in order to be considered as a valid burst.

"Burst Slope Threshold" on page 1519 and "Threshold Lvl " on page 1518 are also used in the burst detection algorithm.

Key Path	Meas Setup, More, Advanced
Mode	WIMAXOFDMA
Remote Command	<code>[:SENSe] :PVTime:BURSt:SLOPe:DETection:TIME <time></code> <code>[:SENSe] :PVTime:BURSt:SLOPe:DETection:TIME?</code>
Example	<code>PVT:BURS:SLOP:DET:TIME 10us</code> <code>PVT:BURS:SLOP:DET:TIME?</code>
Preset	10.0 us
State Saved	Saved in instrument state.
Min	0.1 us
Max	100.0 us
Backwards Compatibility SCPI	<code>[:SENSe] :PVTime:BURSt:SLOPe:INTEgration:TIME</code>
Initial S/W Revision	Prior to A.02.00

Time Ref Offset

This parameter is used to fine tune the reference position of the limit masks that has been specified by start time and stop time pairs. ["Time Reference" on page 1517](#)

Key Path	Meas Setup, More, Advanced
Mode	WIMAXOFDMA
Remote Command	<code>:CALCulate:PVTime:TREFeRence[:OFFSet]:TIME <time></code> <code>:CALCulate:PVTime:TREFeRence[:OFFSet]:TIME?</code>
Example	<code>CALC:PVT:TREF:TIME 0</code> <code>CALC:PVT:TREF:TIME?</code>
Preset	0.0
State Saved	Saved in instrument state.
Min	-10.0 ms
Max	10.0 ms
Backwards Compatibility SCPI	<code>:CALCulate:PVTime:REFerence[:OFFSet]:TIME</code>
Initial S/W Revision	Prior to A.02.00

IF Gain

Accesses the menu that sets ranging in the digital IF when acquiring an I/Q time record.

This only applies to the RF input. It does not apply to baseband I/Q input.

NOTE This function is not affected by RF Input Range attenuation.

Key Path	Meas Setup, More, Advanced,
Initial S/W Revision	Prior to A.02.00

IF Gain Auto

Allows the instrument to pick the IF Gain method that is appropriate. This “Auto” state is set by the Auto Couple key, and it always selects “Low Gain” for the IF Gain State.

Key Path	Meas Setup, More, Advanced, IF Gain
Mode	WIMAXOFDMA
Remote Command	[:SENSe] :PVTime:IF:GAIN:AUTO OFF ON 0 1 [:SENSe] :PVTime:IF:GAIN:AUTO?
Example	PVT:IF:GAIN:AUTO ON PVT:IF:GAIN:AUTO?
Dependencies	IF Gain only applies to the RF input. It does not apply to baseband I/Q input..
Couplings	When this parameter is set to “ON”, the IF Gain State parameter is set to “LOW”. When this parameter is set to “OFF”, the IF Gain State parameter does not change, and keeps its previous value.
Preset	ON
State Saved	Saved in instrument state.
Initial S/W Revision	Prior to A.02.00

IF Gain State

Sets the digital IF gain.

KEY:Low Gain SCPI:LOW	Low gain. This setting is optimal for Large Signals.
KEY:High Gain SCPI:HIGH	High gain. This setting is optimal for Noise Level.

Key Path	Meas Setup, More, Advanced, IF Gain
Mode	WIMAXOFDMA
Remote Command	[:SENSe] :PVTime:IF:GAIN[:STATe] LOW HIGH [:SENSe] :PVTime:IF:GAIN[:STATe]?
Example	PVT:IF:GAINHIGH PVT:IF:GAIN?
Dependencies	IF Gain only applies to the RF input. It does not apply to baseband I/Q input.

13 Power vs Time Measurement
Meas Setup

Couplings	Couple to IF Gain Auto.
Preset	LOW
State Saved	Saved in instrument state.
Range	Low Gain (Best for Large Signals) High Gain (Best Noise Level)
Initial S/W Revision	Prior to A.02.00

Mode

See "Mode" on page 286

Mode Preset

Returns the active mode to a known state.

Mode Preset does the following for the currently active mode:

- Aborts the currently running measurement.
- Brings up the default menu for the mode, with no active function.
- Sets measurement Global settings to their preset values for the active mode only.
- Activates the default measurement.
- Brings up the default menu for the mode.
- Clears the input and output buffers.
- Sets Status Byte to 0.

Mode Preset does not:

- Cause a mode switch
- Affect mode persistent settings
- Affect system settings

See "[How-To Preset](#)" on page 1525 for more information.

Key Path	Front-panel key
Remote Command	:SYSTem:PRESet
Example	:SYST:PRES
Notes	*RST is preferred over :SYST:PRES for remote operation. *RST does a Mode Preset, as done by the :SYST:PRES command, and it sets the measurement mode to Single measurement rather than Continuous for optimal remote control throughput. Clears all pending OPC bits. The Status Byte is set to 0.
Couplings	A Mode Preset aborts the currently running measurement, activates the default measurement, and gets the mode to a consistent state with all of the default couplings set.
Backwards Compatibility Notes	In the X-Series, the legacy "Factory Preset" has been replaced with Mode Preset, which only presets the currently active mode, not the entire instrument. In the X-Series, the way to preset the entire instrument is by using System, Restore System Defaults All, which behaves essentially the same way as restore System Defaults does on ESA and PSA. There is also no "Preset Type" as there is on the PSA. There is a green Mode Preset front-panel key that does a Mode Preset and a white-with-green-letters User Preset front-panel key that does a User Preset. The old PRESet:TYPE command is ignored (without generating an error), and SYST:PRES without a parameter does a Mode Preset, which should cover most backward code compatibility issues. The settings and correction data under the Input/Output front-panel key (examples: Input Z Corr, Ext Amp Gain, etc.) are no longer part of any Mode, so they will not be preset by a Mode Preset. They are preset using Restore Input/Output Defaults, Restore System Defaults All. Note that because User Preset does a Recall State, and all of these settings are saved in State, they ARE recalled when using

	User Preset.
Initial S/W Revision	Prior to A.02.00

How-To Preset

The table below shows all possible presets, their corresponding SCPI commands and front-panel access (key paths). Instrument settings depend on the current measurement context. Some settings are local to the current measurement, some are global (common) across all the measurements in the current mode, and some are global to all the available modes. In a similar way, restoring the settings to their preset state can be done within the different contexts.

Auto Couple - is a measurement local key. It sets all Auto/Man parameter couplings in the measurement to Auto. Any Auto/Man selection that is local to other measurements in the mode will not be affected.

Meas Preset - is a measurement local key. Meas Preset resets all the variables local to the current measurement except the persistent ones.

Mode Preset - resets all the current mode's measurement local and measurement global variables except the persistent ones.

Restore Mode Defaults - resets ALL the Mode variables (and all the Meas global and Meas local variables), including the persistent ones.

Type Of Preset	SCPI Command	Front Panel Access
Auto Couple	:COUPlE ALL	Auto Couple front-panel key
Meas Preset	:CONFIgure:<Measurement>	Meas Setup Menu
Mode Preset	:SYSTem:PRESet	Mode Preset (green key)
Restore Mode Defaults	:INSTrument:DEFault	Mode Setup Menu
Restore All Mode Defaults	:SYSTem:DEFault MODEs	System Menu; Restore System Default Menu
*RST	*RST	not possible (Mode Preset with Single)
Restore Input/Output Defaults	:SYSTem:DEFault INPut	System Menu; Restore System Default Menu
Restore Power On Defaults	:SYSTem:DEFault PON	System Menu; Restore System Default Menu
Restore Alignment Defaults	:SYSTem:DEFault ALIGn	System Menu; Restore System Default Menu
Restore Miscellaneous Defaults	:SYSTem:DEFault MISC	System Menu; Restore System Default Menu
Restore All System Defaults	:SYSTem:DEFault [ALL] :SYSTem:PRESet:PERSistent	System Menu; Restore System Default Menu
User Preset	:SYSTem:PRESet:USER	User Preset Menu
User Preset All Modes	:SYSTem:PRESet:USER:ALL	User Preset Menu

Power On Mode Preset	:SYSTem:PON:TYPE MODE	System Menu
Power On User Preset	:SYSTem:PON:TYPE USER	System Menu
Power On Last State	:SYSTem:PON:TYPE LAST	System Menu

Preset Type (Remote Command Only)

As stated in the Backward Compatibility section, to be compatible with ESA/PSA the PRESet:TYPE command will be implemented as a no-op.

Mode	All
Remote Command	:SYSTem:PRESet:TYPE FACTory MODE USER :SYSTem:PRESet:TYPE?
Example	:SYST:PRESet:TYPE FACT
Notes	This command is supported for backward compatibility only. It is a no-op which does not change the behavior of any preset operation.
Preset	This is unaffected by Preset but is set to Mode on a "Restore System Defaults->All"
State Saved	No
Initial S/W Revision	Prior to A.02.00

Mode Setup

See ["Mode Setup" on page 316](#)

Peak Search

Places the selected marker on the trace point that has the maximum y-axis value for that marker's trace. Pressing Peak Search with the selected marker Off causes the selected marker to be set to Normal; then a peak search is immediately performed.

Key Path	Peak Search
Mode	WIMAXOFDMA
Remote Command	:CALCulate:PVTTime:MARKer[1] 2 ...12:MAXimum
Example	CALC:PVT:MARK2:MAX
Initial S/W Revision	Prior to A.02.00

Print

See "Print" on page 341

Quick Save

The Quick Save front-panel key repeats the most recent save that was performed from the Save menu, with the following exceptions:

- Register saves are not remembered as Saves for the purpose of the Quick Save function
- If the current measurement does not support the last non-register save that was performed, an informational message is generated, “File type not supported for this measurement”

Quick Save repeats the last type of qualified save (that is, a save qualified by the above criteria) in the last save directory by creating a unique filename using the Auto File Naming algorithm described below.

If Quick Save is pressed after startup and before any qualified Save has been performed, the Quick Save function performs a Screen Image save using the current settings for Screen Image saves (current theme, current directory), which then becomes the “last save” for the purpose of subsequent Quick Saves.

The Auto File Naming feature automatically generates a file name for use when saving a file. The filename consists of a prefix and suffix separated by a dot, as is standard for the Windows® file system. A default prefix exists for each of the available file types:

Type	Default Prefix	Menu
State	State_	(Save/Recall)
Trace + State	State_	(Save/Recall)
Screen	Screen_	(Save/Recall)
Amplitude Corrections	Ampcor_	(Import/Export)
Traces	Trace_	(Import/Export)
Limit Lines	LLine_	(Import/Export)
Measurement Result	MeasR_	(Import/Export)
Capture Buffer	CapBuf_	(Import/Export)

A four digit number is appended to the prefix to create a unique file name. The numbering sequence starts at 0000 within each Mode for each file type and updates incrementally to 9999, then wraps to 0000 again. It remembers where it was through a Mode Preset and when leaving and returning to the Mode. It is reset by Restore Misc Defaults and Restore System Defaults and subsequent running of the instrument application. So, for example, the first auto file name generated for State files is State_0000.state. The next is State_0001, and so forth.

One of the key features of Auto File Name is that we guarantee that the Auto File Name will never conflict with an existing file. The algorithm looks for the next available number. If it gets to 9999, then it looks for holes. If it find no holes, that is no more numbers are available, it gives an error.

For example, if when we get to State_0010.state there is already a State_0010.state file in the current directory, it advances the counter to State_0011.state to ensure that no conflict will exist (and then it verifies that State_0011.state also does not exist in the current directory and advances again if it does, and so forth).

If you enter a file name for a given file type, then the prefix becomes the filename you entered instead of the default prefix, followed by an underscore. The last four letters (the suffix) are the 4-digit number.

For example, if you save a measurement results file as “fred.csv”, then the next auto file name chosen for a measurement results save will be fred_0000.csv.

NOTE Although 0000 is used in the example above, the number that is used is actually the current number in the Meas Results sequence, that is, the number that would have been used if you had not entered your own file name.

NOTE If the filename you entered ends with _dddd, where d=any number, making it look just like an auto file name, then the next auto file name picks up where you left off with the suffix being dddd + 1.

Key Path	Front-panel key
Notes	No remote command for this key specifically.
Initial S/W Revision	Prior to A.02.00

Recall

The Recall menu lets you choose what you want to recall, and where you want to recall it from. Among the types of files you can recall are **States and Traces**. In addition, an Import (Data) option lets you recall a number of data types stored in CSV files (as used by Excel and other spreadsheet programs).

The default paths for Recall are data type dependent and are the same as for the Save key.

Key Path	Front-panel key
Notes	<p>No remote command for this key specifically, but the :MMEM:LOAD command is available for specific file types. An example is :MMEM:LOAD:STATe <filename>.</p> <p>If you try to recall a State file for a mode that is not licensed or not available in the instrument, an error message will occur and the state will not change.</p>
Backwards Compatibility Notes	<p>In legacy analyzers, it was possible to load a state without affecting the trace data, limit lines or correction data. Similarly (since User Preset is actually loading a state), it was possible to do a User Preset without affecting the trace data, limit lines or correction data.</p> <p>In the X-Series, “state” always includes all of this data; so whenever state is loaded, all of the traces, limit lines and corrections are affected. Although this differs from previous behavior, it is desirable behavior, and should not cause adverse issues for users.</p>
Backwards Compatibility Notes	<p>Recall for the X-Series supports backward compatibility in the sense that you can recall a state file from any X-Series model number and any version of X-Series software. This is only possible if part of the recalling process goes through a limiting step after recalling the mode settings, at least for settings that may vary with version number, model number, option and license differences. If you try to recall a state file onto an instrument with less capability than what was available on the instrument during the save, the recall will ignore the state it doesn't support and it will limit the recalled setting to what it allows.</p> <p>Example: if the saved state includes preamp ON, but the recalling instrument does not have a preamp; the preamp is limited to OFF. Conversely, if you save a state without a preamp, the preamp is OFF in the state file. When this saved file is recalled on an instrument with a licensed preamp, the preamp is changed to OFF. Another example is if the saved state has center frequency set to 20 GHz, but the instrument recalling the saved state is a different model and only supports 13.5 GHz. In this case, the center frequency is limited along with any other frequency based settings. Since the center frequency can't be preserved in this case, the recall limiting tries to at least preserve span to keep the measurement setup as intact as possible.</p> <p>It may be appropriate to issue a warning if the state is limited on the recall; warnings do not go out to SCPI so this would only affect the manual user.</p> <p>Note that there is no state file compatibility outside of the X-Series. For example, you cannot recall a state file from ESA or PSA.</p>
Initial S/W Revision	Prior to A.02.00

State

The Recall State menu lets you choose a register or file from which to recall the state.

The content of a state file includes all of the settings and data required to return the analyzer as closely as possible to the Mode it was in, with the exact settings that were in place, when the save occurred. The Mode settings in each state file include the settings that are affected by Mode Preset, as well as the

additional settings affected by Restore Mode Defaults; all of the Mode’s settings. In addition, all of the settings of the Input/Output system are included, even though they are outside of the Mode’s state, because they are needed to restore the complete setup. Persistent System settings (for example, GPIB address) are not affected by either a Mode Preset or Restore Mode Defaults, nor are they included in a saved State file.

Since each state file is only for one Mode, the settings for other Modes are unaffected when it is loaded. Recall State will cause a mode switch if the state being recalled is not from the current active mode.

After the recall completes, the message "File <filename> recalled" or “Recalled State Register <register number>” is displayed.

For rapid recalls, the State menu lists 16 registers that you can choose from to recall. Pressing a Register key initiates the recall. You can also select a file from which to recall.

The default path for all State Files is:

My Documents\<<mode name>\state

where <mode name> is the parameter used to select the mode with the INST:SEL command (for example, SA for the Spectrum Analyzer).

See "[More Information](#)" on page 1534.

Key Path	Recall
Mode	All
Remote Command	:MMEMory:LOAD:STATe <filename>
Example	:MMEM:LOAD:STAT "myState.state" This recalls the file myState.state on the default path
Example	MMEM:LOAD:STAT "MyStateFile.state" This loads the state file data (on the default file directory path) into the instrument state.
Notes	<p>When you pick a file to recall, the analyzer first verifies that the file is recallable in the current instrument by checking the software version and model number of the instrument. If everything matches, a full recall proceeds by aborting the currently running measurement, clearing any pending operations, and then loading the State from the saved state file. You can open state files from any mode, so recalling a State file switches to the mode that was active when the save occurred. After switching to the mode of the saved state file, mode settings and data (if any for the mode) are loaded with values from the saved file. The saved measurement of the mode becomes the newly active measurement and the data relevant to the measurement (if there is any) is recalled.</p> <p>If there is a mismatch between file version or model number or instrument version or model number, the recall function tries to recall as much as possible and returns a warning message. It may limit settings that differ based on model number, licensing or version number.</p> <p>After recalling the state, the Recall State function does the following:</p> <ul style="list-style-type: none"> • Makes the saved measurement for the mode the active measurement. • Clears the input and output buffers. • Status Byte is set to 0. • Executes a *CLS <p>If the file specified is empty an error is generated. If the specified file does not exist, another error is generated. If there is a mismatch between the file and the proper file type, an error is generated. If</p>

	there is a mismatch between file version or model number or instrument version or model number, a warning is displayed. Then it returns to the State menu and File Open dialog goes away. After the Recall, the analyzer exits the Recall menu and returns to the previous menu.
Backwards Compatibility SCPI	:MMEMory:LOAD:STATe 1,<filename> For backwards compatibility, the above syntax is supported. The "1" is simply ignored.
Initial S/W Revision	Prior to A.02.00

More Information

In measurements that support saving Traces, for example, Swept SA, the Trace data is saved along with the State in the State file. When recalling the State, the Trace data is recalled as well. Traces are recalled exactly as they were stored, including the writing mode and update and display modes. If a Trace was updating and visible when the State was saved, it will come back updating and visible, and its data will be rewritten right away. When you use State to save and recall traces, any trace whose data must be preserved should be placed in View or Blank mode before saving.

The following table describes the Trace Save and Recall possibilities:

You want to recall state and one trace's data, leaving other traces unaffected.	Save Trace+State from 1 trace. Make sure that no other traces are updating (they should all be in View or Blank mode) when the save is performed.	On Recall, specify the trace you want to load the one trace's data into. This trace will load in View. All other traces' data will be unaffected, although their trace mode will be as it was when the state save was performed.
You want to recall all traces	Save Trace+State from ALL traces.	On Recall, all traces will come back in View (or Blank if they were in Blank or Background when saved)
You want all traces to load exactly as they were when saved.	Save State	On recall, all traces' mode and data will be exactly as they were when saved. Any traces that were updating will have their data immediately overwritten.

From File...

When you press "From File", the analyzer brings up a Windows dialog and a menu entitled "File Open." This menu allows you to navigate to the various fields in the Windows dialog without using a keyboard or mouse. The Tab and Arrow keys can also be used for dialog navigation.

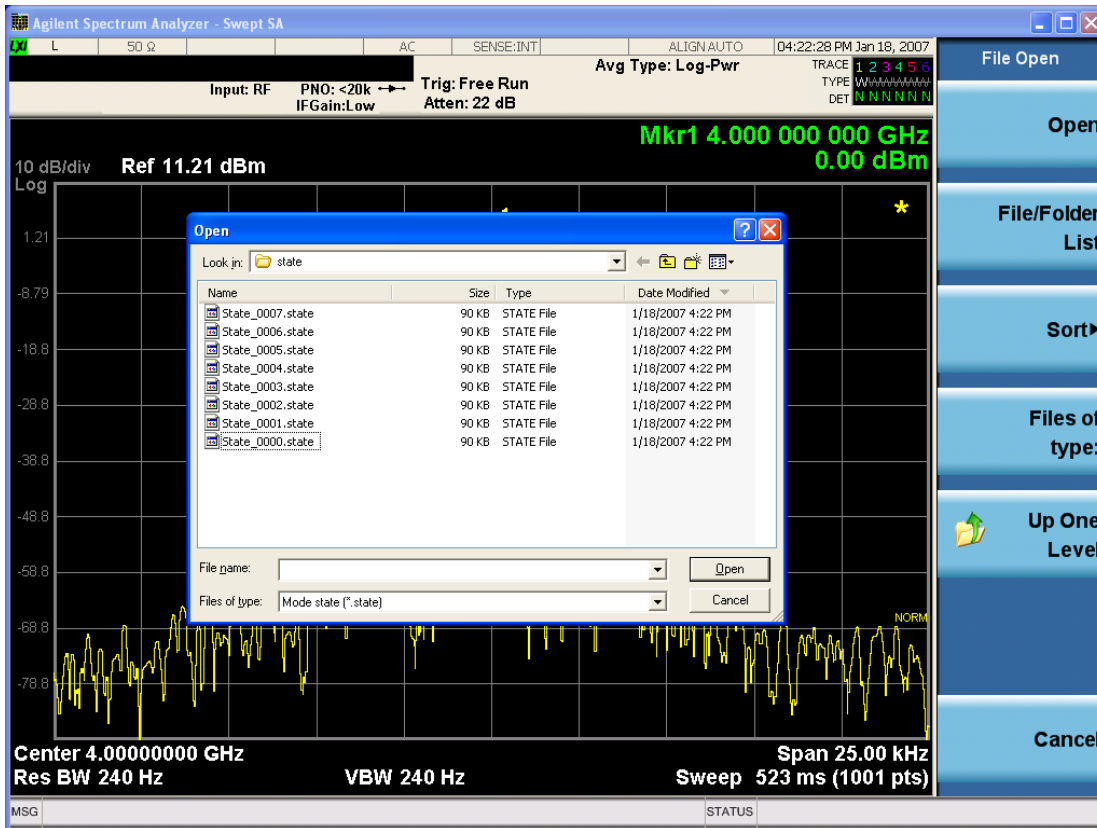

Listed below are the functions of the various fields in the dialog, and the corresponding softkeys:

Open

Performs the recall of the specified file. While the recall is being performed, the floppy icon appears briefly in the Meas bar.

File/Folder List

Enables you to navigate to the center of the dialog that contains the list of files and folders. Once here you can get information about the file and use the tab keys to navigate to the other fields in the dialog, such as Look In.

Look In

The Look In field shows the path from which the file will be recalled and allows you to change the path using the up and down arrow keys to navigate to other paths; the Enter key to open a directory; and the Backspace key to go back one directory. The **Look In field** first uses the last path from the Save As dialog **Save In:** path for that same file type. There is no softkey for directly navigating to the Look In field, but you can use the left tab to get here from the File/Folder List.

User specified paths are remembered when you leave and return to a Mode and are reset back to the default using Restore Mode Defaults.

Sort

Accesses a menu that enables you to sort the files within the File Open dialog. Only one sorting type can be selected at a time and the sorting happens immediately. The sorting types are By Date, By Name, By extension, and By Size.

Files of Type

This field shows the file suffix for the type of file you have selected to recall. For example, if you navigated here while recalling State, "Mode state (*.state)" is in the field. If you navigated here while recalling Trace, ""Mode state (*.trace)" is in the field. If you navigated here while importing a trace data file, "Trace Data (*.csv)" is in the field. For some file types, there is more than one choice in the dropdown menu, which you can select by using the up and down arrow keys and Enter.

Up One Level

This key corresponds to the icon of a folder with the up arrow that is in the tool bar of the dialog. When pressed, it causes the file and folder list to navigate up one level in the directory structure. The Backspace key does the same thing.

Cancel

This key corresponds to the Cancel selection in the dialog. It causes the current **Open** request to be cancelled. The ESC key does the same thing.

Key Path	Recall, State
Notes	Brings up the Open dialog for recalling a State Save Type
Initial S/W Revision	Prior to A.02.00

Edit Register Names

You may enter a custom name on any of the Register keys, to help you remember what you are using that state to save. To do this, press the Edit Register Names key, choose the register whose name you wish to edit, and then enter the desired label using the Alpha Editor or an external PC keyboard.

The maximum number of characters that can be added is 30. In most cases, 30 characters will fit on two lines of the key.

For more information and the SCPI command, see Edit Register Names under the Save, State function.

Key Path	Recall, State
Mode	All
Dependencies	N9060A-7FP or N9060B-2FP license required to edit the register names. When the feature is not licensed, sending the SCPI command generates an error, -221, "Settings conflict;Option not available"
Initial S/W Revision	A.11.00

Register 1 thru Register 16

Selecting any one of these register keys causes the State of the mode from the specified Register to be recalled. Each of the register keys annotates whether it is empty or at what date and time it was last

modified. In addition, you can use the Edit Register Names key under Save, State to enter custom names for each register.

Registers are shared by all modes, so recalling from any one of the registers will cause a mode switch to the mode that was active when the save to the Register occurred.

Although these 16 registers are the only registers available from the front panel, there are 128 state registers available in the instrument. Registers 17–128 are only available from the SCPI interface, using the *RCL command.

After the recall completes, the message "Register <register number> recalled" appears in the message bar. If you are in the Spectrum Analyzer Mode, and you are recalling a register that was saved in the Spectrum Analyzer Mode, then after the recall, you will still be in the Recall Register menu. If the Recall causes you to switch modes, then after the Recall, you will be in the Frequency menu.

If a requested register is empty an error is generated.

Key Path	Recall, State
Example	*RCL 1
Range	1–16 from front panel, 1–128 from SCPI
Readback	Date and time with seconds resolution are displayed on the key OR A custom name of up to 30 characters entered using the Save, State, Edit Register Names key OR “(empty)” if no prior save operation has been performed to this register.
Initial S/W Revision	Prior to A.02.00
Modified at S/W Revision	Prior to A.11.00

Register 1 thru Register 16

Selecting any one of these register keys causes the State of the mode from the specified Register to be recalled. Each of the register keys annotates whether it is empty or at what date and time it was last modified. In addition, you can use the Edit Register Names key under Save, State to enter custom names for each register.

Registers are shared by all modes, so recalling from any one of the registers will cause a mode switch to the mode that was active when the save to the Register occurred.

Although these 16 registers are the only registers available from the front panel, there are 128 state registers available in the instrument. Registers 17–128 are only available from the SCPI interface, using the *RCL command.

After the recall completes, the message "Register <register number> recalled" appears in the message bar. If you are in the Spectrum Analyzer Mode, and you are recalling a register that was saved in the Spectrum Analyzer Mode, then after the recall, you will still be in the Recall Register menu. If the Recall causes you to switch modes, then after the Recall, you will be in the Frequency menu.

If a requested register is empty an error is generated.

Key Path	Recall, State
Example	*RCL 1
Range	1-16 from front panel, 1-128 from SCPI
Readback	Date and time with seconds resolution are displayed on the key OR A custom name of up to 30 characters entered using the Save, State, Edit Register Names key OR "(empty)" if no prior save operation has been performed to this register.
Initial S/W Revision	Prior to A.02.00
Modified at S/W Revision	Prior to A.11.00

Data (Import)

Importing a data file loads data that was previously saved from the current measurement or from other measurements and/or modes that produce compatible data files. The Import Menu only contains Data Types that are supported by the current measurement.

Since the commonly exported data files are in .csv format, the data can be edited by the user prior to importing. This allows you to export a data file, manipulate the data in Excel (the most common PC Application for manipulating .csv files) and then import it.

Importing Data loads measurement data from the specified file into the specified or default destination, depending on the data type selected. Selecting an Import Data menu key will not actually cause the importing to occur, since the analyzer still needs to know from where to get the data. Pressing the Open key in this menu brings up the Open dialog and Open menu that provides you with the options from where to recall the data. Once a filename has been selected or entered in the Open menu, the recall occurs as soon as the Open button is pressed.

Key Path	Recall
Mode	All
Notes	The menu is built from whatever data types are available for the mode. Some keys will be missing completely, so the key locations in the sub-menu will vary. No SCPI command directly controls the Data Type that this key controls. The Data Type is included in the MMEM:LOAD commands.
Dependencies	If a file type is not used by a certain measurement, it is grayed out for that measurement. The key for a file type will not show at all if there are no measurements in the Mode that support it.
Preset	Is not affected by Preset or shutdown, but is reset during Restore Mode Defaults
Readback	The data type that is currently selected
Initial S/W Revision	Prior to A.02.00

Mask

Enables you to recall a preset mask file. This file type (.mask) differs from a normal “state” file because it contains the configuration for Carrier, Offset, and Limit for the specific preset profile BW. A brief description of the mask file is available in the properties view of each file. (Right-mouse-click on the file, select, "Properties" to view this information.) A detailed list of the mask parameter values is located in the .pdf file of the same name in the same directory. Blank values in the .pdf file are parameters that will not be overwritten when recalling the mask.

Key Path	Recall, Data
Mode	WIMAXOFDMA
Remote Command	:MMEMory:LOAD:MASK <string>
Example	:MMEM:LOAD:MASK "MyLimitFile.mask"
Notes	Set of parameters related to Limit, Carrier and Offset are overwritten by Preset Mask file.
Initial S/W Revision	A.02.00

This topic contains the following sections:

["File location and extension" on page 1539](#)

["Example of Preset Mask file" on page 1540](#)

File location and extension

File location: The preset mask file is located in “My Documents\WIMAXOFDMA\data\masks”.

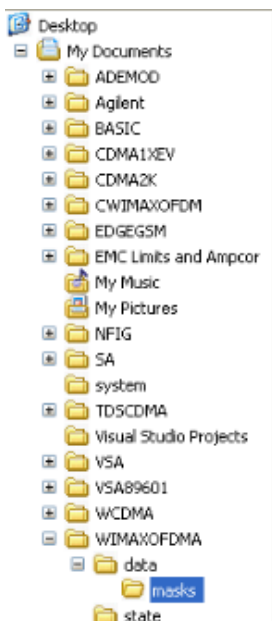

NOTE

When your X-Series analyzer starts, all mask files located in “My Documents\WIMAXOFDMA\data/masks” are overwritten, so any files you wish to save should be stored in another directory location.

File type: The file type is binary file.

File Name: The file name is decided by following naming rules. Each specific keyword is connected with underscore.

<Standard name>_<Radio device>_<Preset Profile BW>_<Measurement>.mask

<Standard name>: This term references the standard associated with each mask file.

<Radio device>: This term specifies to which radio device (BS or MS) the mask file pertains.

<Preset Profile BW>: This term specifies to which Preset Profile BW the mask file pertains.

<Measurement>: This term specifies the measurement to which the mask file is applied. Your selections are: SEM, ACP, or Mode. When selecting **Mode**, the values of some parameters in both the ACP and SEM measurement are overwritten.

File extension: The extension of preset mask file is “mask” to distinguish it from a “state” file.

When you press the open key under the Data menu, the “My Documents\WIMAXOFDMA\data\masks” folder is opened. Select one mask file.

NOTE

When you change the preset BW profile or Radio Device, all measurement parameters are reset to their original values. Thus you have to recall the appropriate preset mask file again after the change.

Example of Preset Mask file

When you import a preset mask file, it is a “Recall” function. Specific parameter values are overwritten by the contents of the preset mask file (see table below). Those values not specified by the preset mask file remain unchanged. Because the file format type is binary, you cannot view, change, or create the preset mask file. Here is an example of a preset mask file used for ACP measurements.

File Location: My Documents/WIMAXOFDMA/data/masks

File Name: ETSI-EN301-021-SysE_BS_10MHz_ACP.mask

The .pdf file that lists the parameters similarly to that shown below is named, "ETSI-EN301-021-SysE_BS_10MHz_ACP.pdf"

The set of parameters listed in the following table for the Preset Profile BW (10MHz) are imported into the ACP measurement.

Offset	Start Freq (MHz)	Stop Freq (MHz)	Sweep Time	Res BW (Hz)	Meas BW	Rel Start	Rel Stop	Fail Mask
A	5	7.14		30k	1	-8	-25	Rel
B	7.14	10.57		30k	1	-25	-27	Rel
C	10.57	20		30k	1	-27	-50	Rel
D	20	25		30k	1	-50	-50	Rel
E	25	30		30k	1	-50	-50	Rel

Zone Map

Pressing this key selects Zone Map as the data type to be imported.

The WiMAX-OFDMA application can load the Singal Studio Setup file, and the OFDMA Map file is compatible with the 89601A Mobile WiMAX omf file.

Key Path	Recall, Data
Remote Command	:MMEMoRY:LOAD:ZMAP <string>
Example	MMEM:LOAD:ZMAP "ZMap_0000.omf"
Notes	The SCPI parameter is a quoted string that specifies the filename. Both single and double quotes are supported for any filename parameter over SCPI.
Dependencies	You must be in the 802.16 OFDMA (WiMAX/WiBro) mode.
Status Bits/OPC dependencies	Sequential - waits for the previous measurement to complete.
Initial S/W Revision	Prior to A.02.00

Open...

When you press "Open", the analyzer brings up a Windows dialog and a menu entitled "**File Open.**" This menu allows you to navigate to the various fields in the Windows dialog without using a keyboard or mouse. The Tab and Arrow keys can also be used for dialog navigation.

See "[From File...](#)" on page 2241 in Recall, State, for a full description of this dialog and menu.

Key Path	Recall, Data
Notes	The key location is mode-dependent and will vary. Brings up Open dialog for recalling a <mode specific> Save Type
Initial S/W Revision	Prior to A.02.00

Restart

The Restart function restarts the current sweep, or measurement, or set of averaged/held sweeps or measurements. If you are Paused, pressing Restart does a Resume.

The Restart function is accessed in several ways:

- Pressing the Restart key
- Sending the remote command INIT:IMMEDIATE
- Sending the remote command INIT:RESTART

See "[More Information](#)" on page 1542

Key Path	Front-panel key
Remote Command	:INITiate[:IMMEDIATE] :INITiate:RESTART
Example	:INIT:IMM :INIT:REST
Notes	:INITiate:RESTART and :INITiate:IMMEDIATE perform exactly the same function.
Couplings	Resets average/hold count k. For the first sweep overwrites all active (update=on) traces with new current data. For application modes, it resets other parameters as required by the measurement.
Status Bits/OPC dependencies	This is an Overlapped command. The STATus:OPERation register bits 0 through 8 are cleared. The STATus:QUESTionable register bit 9 (INTegrity sum) is cleared. The SWEEPING bit is set. The MEASURING bit is set.
Backwards Compatibility Notes	For Spectrum Analysis mode in ESA and PSA, the Restart hardkey and the INITiate:RESTART command restart trace averages (displayed average count reset to 1) for a trace in Clear Write, but did not restart Max Hold and Min Hold. In the X-Series, the Restart hardkey and the INITiate:RESTART command restart not only Trace Average, but MaxHold and MinHold traces as well. For wireless comms modes in ESA and PSA, the Restart hardkey and the INITiate:RESTART command restart every measurement, which includes all traces and numeric results. There is no change to this operation.
Initial S/W Revision	Prior to A.02.00

More Information

The **Restart** function first aborts the current sweep/measurement as quickly as possible. It then resets the sweep and trigger systems, sets up the measurement and initiates a new data measurement sequence with a new data acquisition (sweep) taken once the trigger condition is met.

If the analyzer is in the process of aligning when **Restart** is executed, the alignment finishes before the restart function is performed.

Even when set for Single operation, multiple sweeps may be taken when Restart is pressed (for example, when averaging/holding is on). Thus when we say that **Restart** "restarts a measurement," we may mean:

- It restarts the current sweep
- It restarts the current measurement
- It restarts the current set of sweeps if any trace is in Trace Average, Max Hold or Min Hold
- It restarts the current set of measurements if Averaging, or Max Hold, or Min Hold is on for the measurement
- depending on the current settings.

With **Average/Hold Number** (in **Meas Setup** menu) set to 1, or Averaging off, or no trace in Trace Average or Hold, a single sweep is equivalent to a single measurement. A single sweep is taken after the trigger condition is met; and the analyzer stops sweeping once that sweep has completed. However, with **Average/Hold Number** >1 and at least one trace set to **Trace Average, Max Hold, or Min Hold (SA Measurement)** or **Averaging on (most other measurements)**, multiple sweeps/data acquisitions are taken for a single measurement. The trigger condition must be met prior to each sweep. The sweep is stopped when the average count k equals the number N set for **Average/Hold Number**. A measurement average usually applies to all traces, marker results, and numeric results; but sometimes it only applies to the numeric results.

Once the full set of sweeps has been taken, the analyzer will go to idle state. To take one more sweep without resetting the average count, increment the average count by 1, by pressing the step up key while **Average/Hold Number** is the active function, or sending the remote command `CALC:AVER:TCON UP`.

Save

The Save menu lets you choose what you want to save and where you want to save it. Among the types of files you can save are **States**, **Traces**, and **Screen Images**. In addition, an Export (Data) option lets you save a number of data types as CSV files for easy import into Excel and other spreadsheet programs.

Key Path	Front-panel key
Mode	All
Notes	No remote command for this key specifically, but the :MMEM:STORe command is available for specific file types. An example is :MMEM:STOR:STATe <filename>.
Initial S/W Revision	Prior to A.02.00

State

The Save State menu lets you choose a register or file for saving the state.

The content of a state file includes all of the settings and data required to return the analyzer as closely as possible to the Mode it was in, with the exact settings which were in place, when the save occurred. The Mode settings in each state file include the settings that are affected by Mode Preset, as well as the additional settings affected by Restore Mode Defaults; all of the Mode's settings. In addition, all of the settings of the Input/Output system are included, even though they are outside of the Mode's state, because they are needed to restore the complete setup. Persistent System settings (for example, Verbose SCPI) are not affected by either Mode Preset or Restore Mode Defaults, nor are they included in a saved State file.

After the save completes, the message "File <filename> saved" or "State Register <register number> saved" is displayed.

For rapid saving, the State menu lists 16 registers to save to. Pressing a Register key initiates the save. You can also select a file to save to.

The default path for all State Files is:

My Documents\<<mode name>\state

where <mode name> is the parameter used to select the mode with the INST:SEL command (for example, SA for the Spectrum Analyzer).

Key Path	Save
Mode	All
Remote Command	:MMEMory:STORe:STATe <filename>
Example	MMEM:STOR:STATe "MyStateFile.state" This stores the current instrument state data in the file MyStateFile.state in the default directory.
Notes	Both single and double quotes are supported for any filename parameter over remote. After saving to a register, that register's menu key is updated with the date the time, unless a custom label has been entered for that key. After saving to a register, you remain in the Save State menu, so that you can see the Register key

update. After saving to a file, the analyzer automatically returns to the previous menu and any Save As dialog goes away.

Backwards Compatibility SCPI	:MMEMory:STORe:STATe 1,<filename>
Initial S/W Revision	Prior to A.02.00

To File . . .

When you press “To File”, the analyzer brings up a Windows dialog and a menu entitled “**Save As.**” This menu allows you to navigate to the various fields in the Windows dialog without using a keyboard or mouse. The Tab and Arrow keys can also be used for dialog navigation.

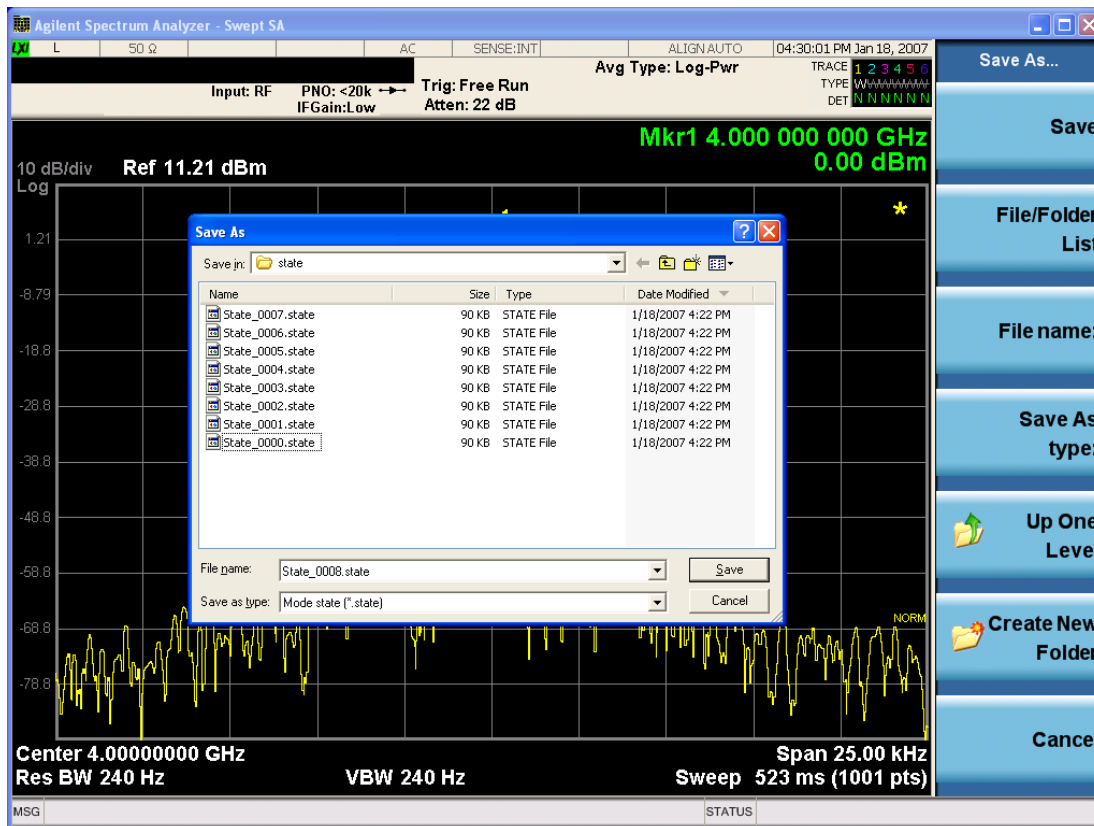

The Listed below

are the functions of the various fields in the dialog, and the corresponding softkeys:

Save

Performs the save to the specified file of the selected type. If the file already exists, a dialog will appear that allows you to replace the existing file by selecting OK, or you can Cancel the request. If you select OK, the file will be overwritten. Using the C: drive is strongly discouraged, since it runs the risk of being overwritten during an instrument software upgrade.

While the save is being performed, the floppy icon appears briefly in the Meas bar.

File/Folder List

Enables you to navigate to the center of the dialog that contains the list of files and folders. Once here you can get information about the file and use the tab keys to navigate to the other fields in the dialog, such as Save In.

Save In

The Save In field shows the path to which the file will be saved and allows you to change the path using the up and down arrow keys to navigate to other paths; the Enter key to open a directory; and the Backspace key to go back one directory. The **Save In field** defaults to the default path for this type of file and remembers the last path you used to save this type of file. There is no softkey for directly navigating to the Save In field but you can use left tab to get here from the File/Folder List.

User specified paths are remembered when you leave and return to a Mode and are reset back to the default using Restore Mode Defaults.

File Name

The File Name field is initially loaded with an automatically generated filename specific to the appropriate Save Type. The automatically generated filename is guaranteed not to conflict with any filename currently in the directory. You may replace or modify this filename using the File Name key. See the ["Quick Save " on page 2237](#) documentation for more on the automatic file naming algorithm.

When you press the File Name key the analyzer displays the Alpha Editor. Use the knob to choose the letter to add and the front-panel Enter key to add the letter to the file name. The BK character moves you back and the FW character moves you forward in the filename. The Select key on the front panel generates a space character. When you are done entering the filename press the Done softkey. This returns back to the **File Open** dialog and menu, but does not cause the save to occur.

Save As Type

This field shows the file suffix for the type of file you have selected to save. For example, if you navigated here while saving State, "Mode state (*.state)" is in the field. If you navigated here from saving Trace, ""Mode state (*.trace)" is in the field. If you navigated here while exporting a trace data file, "Trace Data (*.csv)" is in the field. For some file types, there is more than one choice in the dropdown, which you can select by using the up and down arrow keys and Enter.

Up One Level

This key corresponds to the icon of a folder with the up arrow that is in the tool bar of the dialog. When pressed, it causes the file and folder list to navigate up one level in the directory structure. The Backspace key does the same thing.

Create New Folder

This key corresponds to the icon of a folder with the "*" that is in the tool bar of the dialog. When pressed, a new folder is created in the current directory with the name **New Folder** and you can enter a new folder name using the Alpha Editor.

Cancel

This key corresponds to the Cancel selection in the dialog. It causes the current **Save As** request to be cancelled. The ESC key does the same thing.

Key Path	Save, State
Mode	All
Notes	Brings up Save As dialog for saving a State Save Type
Initial S/W Revision	Prior to A.02.00

Edit Register Names

You may enter a custom name on any of the Register keys, to help you remember what you are using that state to save. To do this, press the Edit Register Names key, choose the register whose name you wish to edit, and then enter the desired label using the Alpha Editor or an external PC keyboard.

The maximum number of characters that can be added is 30. In most cases, 30 characters will fit on two lines of the key.

See "[More Information](#)" on page 1547

Key Path	Save, State
Mode	All
Remote Command	:MMEMory:REGister:STATe:LABel <reg number>,"label" :MMEMory:REGister:STATe:LABel? <reg number>
Example	:MMEM:REG:STAT:LAB 1,"my label"
Notes	<reg number> is an integer from 1 to 16. If the SCPI specifies an invalid register number an error message is generated, -222,"Data out of range;Invalid register label number" "label" is a string from 0 to 30 characters in length. If a label exceeds 30 characters, an error message is generated, -150,"String data error;Label clipped to 30 characters" "label" of length 0 erases the custom label and restores the default (time and date) label. E.g.: :MMEM:REG:STAT:LAB 1,""
Dependencies	N9060A-7FP or N9060B-2FP license required to edit the register names. When the feature is not licensed, sending this command generates an error, -221,"Settings conflict;Option not available"
Preset	The names are unaffected by Preset or power cycle but are set to the default label (time and date) on a "Restore System Defaults->Misc"
Initial S/W Revision	A.11.00

More Information

When you edit one of the register names, the time and date field will be replaced by the custom name.

If you delete all the characters in the custom name, it restores the default (time and date).

The register names are stored within the state files, but they are not part of the instrument state; that is, once you have edited a register name, loading a new state will not change that register name. Another consequence of this is that the names will be persistent through a power cycle. Also, if a named state file is transferred to another analyzer, it will bring its custom name along with it.

If you try to edit the name of an empty register, the analyzer will first save the state to have a file to put the name in. If you load a named state file into an analyzer with older firmware it will ignore the metadata.

The *SAV and *RCL commands will not be affected by the custom register names, nor will the MMEM commands.

Register 1 thru Register 16

Selecting any one of these register menu keys causes the State of the currently active mode to be saved to the specified Register. The registers are provided for rapid saving and recalling, since you do not need to specify a filename or navigate to a file. Each of the register menu keys annotates whether it is empty or at what date and time it was last modified. In addition, you can use the Edit Register Names key to enter custom names for each register.

Although these 16 registers are the only registers available from the front panel, there are 128 state registers available in the instrument. Registers 17–128 are only available from the SCPI interface, using the *SAV command.

There is one set of 128 state registers in the instrument, not one set for each Mode. When a state is saved, the Mode it was saved from is saved with it; then when it is recalled, the instrument switches to that Mode.

After the save completes, the corresponding register menu key annotation is updated with the date and time and the message "Register <register number> saved" is displayed.

Key Path	Save, State
Mode	All
Example	*SAV 1
Range	1–16 from front panel, 1–128 from SCPI
Readback	Date and time with seconds resolution are displayed on the key OR A custom name of up to 30 characters entered using the Edit Register Names key OR “(empty)” if no prior save operation has been performed to this register.
Initial S/W Revision	Prior to A.02.00
Modified at S/W Revision	A.11.00

Register 1 thru Register 16

Selecting any one of these register menu keys causes the State of the currently active mode to be saved to the specified Register. The registers are provided for rapid saving and recalling, since you do not need to specify a filename or navigate to a file. Each of the register menu keys annotates whether it is empty or at what date and time it was last modified. In addition, you can use the Edit Register Names key to enter custom names for each register.

Although these 16 registers are the only registers available from the front panel, there are 128 state registers available in the instrument. Registers 17–128 are only available from the SCPI interface, using the *SAV command.

There is one set of 128 state registers in the instrument, not one set for each Mode. When a state is saved, the Mode it was saved from is saved with it; then when it is recalled, the instrument switches to that Mode.

After the save completes, the corresponding register menu key annotation is updated with the date and time and the message "Register <register number> saved" is displayed.

Key Path	Save, State
Mode	All
Example	*SAV 1
Range	1–16 from front panel, 1–128 from SCPI
Readback	Date and time with seconds resolution are displayed on the key OR A custom name of up to 30 characters entered using the Edit Register Names key OR “(empty)” if no prior save operation has been performed to this register.
Initial S/W Revision	Prior to A.02.00
Modified at S/W Revision	A.11.00

Data (Export)

Exporting a data file stores data from the current measurement to mass storage files. The Export Menu only contains data types that are supported by the current measurement.

Since the commonly exported data files are in .csv format, the data can be edited by you prior to importing. This allows you to export a data file, manipulate the data in Excel (the most common PC Application for manipulating .csv files) and then import it.

Selecting an Export Data menu key will not actually cause the exporting to occur, since the analyzer still needs to know where you wish to save the data. Pressing the Save As key in this menu brings up the Save As dialog and Save As menu that allows you to specify the destination file and directory. Once a filename has been selected or entered in the Open menu, the export will occur as soon as the Save key is pressed.

Key Path	Save
Mode	All
Notes	The menu is built from whatever data types are available for the mode. So the key locations in the sub menu will vary. No SCPI command directly controls the Data Type that this key controls. The Data Type is included in the MMEM:STORe commands.
Dependencies	If a file type is not used by a certain measurement, that type is grayed out for that measurement. The key for a file type will not show at all if there are no measurements in the Mode that support it.
Preset	Is not affected by a Preset or shutdown, but is reset during Restore Mode Defaults
Readback	The data type that is currently selected
Initial S/W Revision	Prior to A.02.00

Measurement Results

Pressing this key selects Meas Results as the data type to be exported. Pressing the key a second time brings up the Meas Results menu, which allows you to select which **Meas Result** to save. In the Swept SA measurement, there are three types of Measurement Results files: Peak Table, Marker Table and Spectrogram.

See "[Meas Results File Contents](#)" on page 1550.

See "[Marker Table](#)" on page 1550.

See "[Peak Table](#)" on page 1553.

See "[Spectrogram](#)" on page 1556

Remote Command	:MMEMory:STORe:RESults:MTABle PTABle SPEctrogram <filename>
Example	:MMEM:STOR:RES:MTAB "myResults.csv" Saves the results from the current marker table to the file myResults.csv in the current path. :MMEM:STOR:RES:PTAB "myResults.csv" Saves the results from the current peak table to the file myResults.csv in the current path. :MMEM:STOR:RES:SPEC "myResults.csv" Saves the results from the current Spectrogram display to the file myResults.csv in the current path. The default path is My Documents\SA\data\SAN\results
Notes	If the save is initiated via SCPI, and the file already exists, the file will be overwritten. Using the C: drive is strongly discouraged, since it runs the risk of being overwritten during an instrument software upgrade. Both single and double quotes are supported for any filename parameter over SCPI.
Dependencies	If a save of Marker Table results is requested and the Marker Table is not on, no file is saved and a message is generated If a save of Peak Table results is requested and the Peak Table is not on, no file is saved and a message is generated If a save of Spectrogram results is requested and the Spectrogram is not on, no file is saved and a message is generated. The Spectrogram choice only appears if option EDP is licensed.
Preset	Not part of Preset, but is reset to Peak Table by Restore Mode Defaults. Survives a shutdown.
Initial S/W Revision	Prior to A.02.00

Meas Results File Contents

All files are .csv files. The following section details the data in each file type.

Marker Table

This section discusses the Marker Table Meas Results file format.

Imagine that, at the point where a Marker Table Meas Result is requested, the following screen is showing:

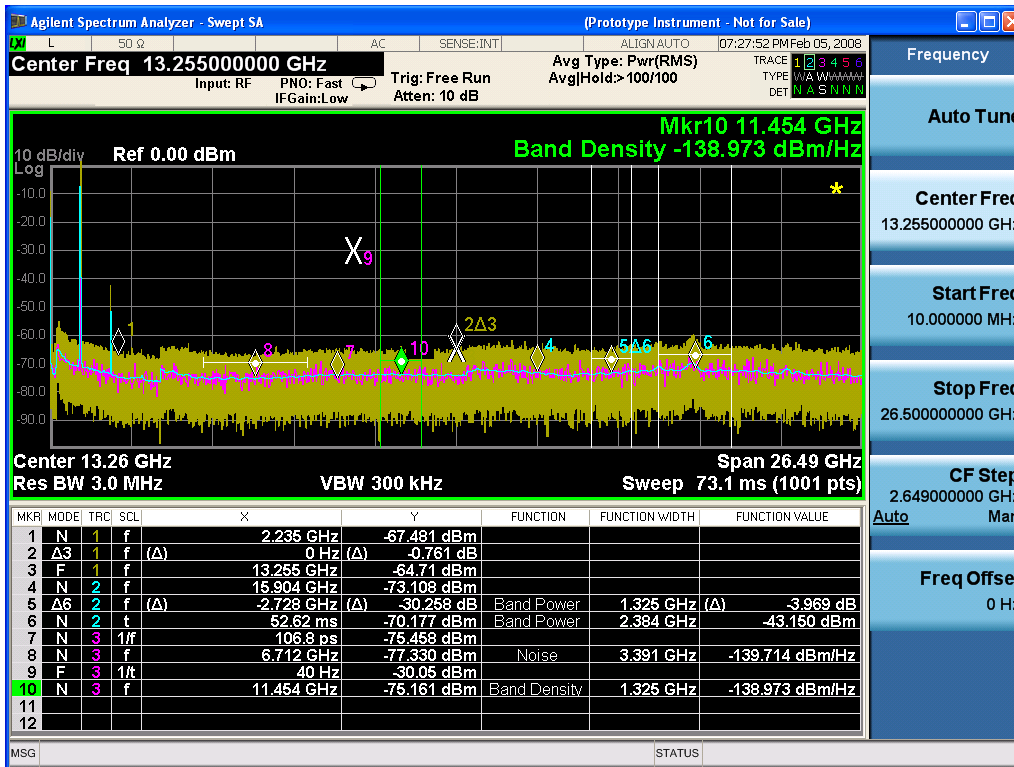

Then the Meas Results file, when opened, would show the following data:

MeasurementR	
result	
Swept SA	
A.01.40_R0017	N9020A
526 B25 PFR	1
P26 EA3	
Result Type	Marker Table
Ref Level	0
Number of Points	1001
Sweep Time	0.0662666 67
Start Frequency	10000000
Stop Frequency	26500000 000
Average Count	0
Average Type	LogPower (Video)
RBW	3000000

RBW Filter	Gaussian
RBW Filter BW	3dB
VBW	3000000
Sweep Type	Swept
X Axis Scale	Lin
PreAmp State	Off
PreAmp Band	Low
Trigger Source	Free
Trigger Level	1.2
Trigger Slope	Positive
Trigger Delay	1.00E-06
Phase Noise Optimization	Fast
Swept If Gain	Low
FFT If Gain	Autorange
RF Coupling	AC
FFT Width	411900
Ext Ref	10000000
Input	RF
RF Calibrator	Off
Attenuation	10
Ref Level Offset	0
External Gain	0
X Axis Units	Hz
Y Axis Units	dBm

DATA									
MKR	MODE	TR C	SCL	X	Y	FUNCTI ON	FUNCTIO N WIDTH	FUNCTI ON VALUE	FUNCTI ON UNIT
1	Normal	1	Freque ncy	2.2350E+09	- 67.481	Off	0.0000E+00	0	None
2	Delta3	1	Freque ncy	0.0000E+00	- 0.761	Off	0.0000E+00	0	None
3	Fixed	1	Freque ncy	1.3255E+10	- 64.71	Off	0.0000E+00	0	None
4	Normal	2	Freque ncy	1.5904E+10	- 73.1	Off	0.0000E+00	0	None

08									
5	Delta7	2	Frequency	- 2.7280E+ 09	- 30.2 58	Band Power	1.3250E+ 06	-3.969	dB
6	Normal	2	Time	5.2620E- 02	- 70.1 77	Band Power	2.3840E+ 06	-43.15	dBm
7	Normal	3	Period	1.0680E- 10	- 75.4 58	Off	0.0000E+ 00	0	None
8	Normal	3	Frequency	6.7120E+ 09	- 77.3 3	Noise	3.3910E+ 06	- 139.71 4	dBm/Hz
9	Fixed	3	Inverse Time	4.0000E+ 01	- 30.0 5	Off	0.0000E+ 00	0	None
10	Normal	3	Frequency	1.1454E+ 10	- 75.1 61	Band Density	1.3250E+ 06	- 138.97 3	dBm/Hz
11	Off	1	Frequency	0.0000E+ 00	0	Off	0.0000E+ 00	0	None
12	Off	1	Frequency	0.0000E+ 00	0	Off	0.0000E+ 00	0	None

The numbers appear in the file exactly as they appear onscreen. If it says 11.454 GHz onscreen, then in the file it is 11.454E+09.

The metadata header is very similar to the metadata used in the trace data .csv files. See Trace File Contents. The only new information concerns the 1-of-N fields in the marker table itself.

Peak Table

This section discusses the Peak Table Meas Results file format.

Imagine that, at the point where a Marker Table Meas Result is requested, the following screen is showing:

13 Power vs Time Measurement
Save

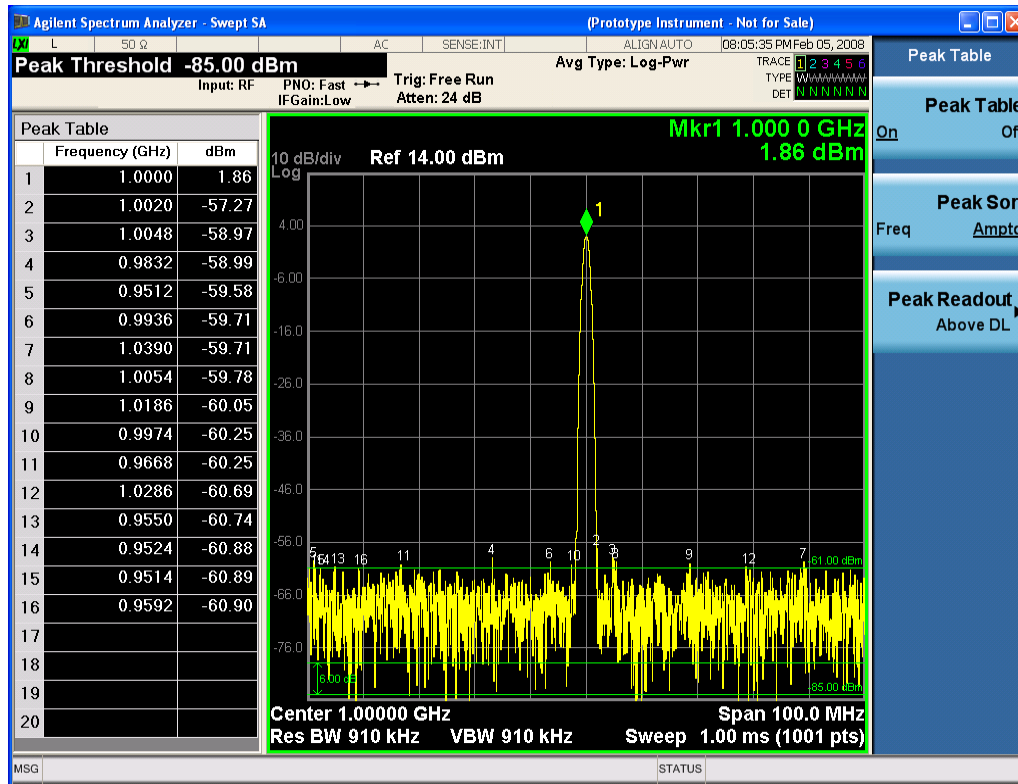

Then the Meas Results file, when opened, would show the header data (the same as for the Marker Table except that the Result Type is Peak Table) ending with a few fields of specific interest to Peak Table users:

- Peak Threshold
- Peak Threshold State (On|Off)
- Peak Excursion
- Peak Excursion State (On|Off)
- Display Line
- Peak Readout (All|AboveDL|BelowDL)
- Peak Sort (Freq|Amptd)

These fields are then followed by the data for the Peak Table itself.

Note that the label for the Frequency column changes to Time in 0 span.

Here is what the table for the above display looks like:

MeasurementResult	
Swept SA	
A.01.40_R0017	N9020A
526 B25 PFR P26 EA3	1

Result Type	Peak Table
Ref Level	0
Number of Points	1001
Sweep Time	0.066266667
Start Frequency	10000000
Stop Frequency	26500000000
Average Count	0
Average Type	LogPower(Video)
RBW	3000000
RBW Filter	Gaussian
RBW Filter BW	3dB
VBW	3000000
Sweep Type	Swept
X Axis Scale	Lin
PreAmp State	Off
PreAmp Band	Low
Trigger Source	Free
Trigger Level	1.2
Trigger Slope	Positive
Trigger Delay	1.00E-06
Phase Noise Optimization	Fast
Swept If Gain	Low
FFT If Gain	Autorange
RF Coupling	AC
FFT Width	411900
Ext Ref	10000000
Input	RF
RF Calibrator	Off
Attenuation	10
Ref Level Offset	0
External Gain	0
X Axis Units	Hz
Y Axis Units	dBm
Peak Threshold	-85
Peak Threshold State	On
Peak Excursion	6
Peak Excursion State	On

Display Line	-61	
Peak Readout	AboveDL	
Peak Sort	Amptd	
DATA		
Peak	Frequency	Amplitude
1	1.0000E+06	1.86
2	1.0020E+06	-57.27
3	1.0048E+06	-58.97
4	9.8320E+05	-58.99
5	9.5120E+05	-59.58
6	9.9360E+05	-59.71
7	1.0390E+06	-59.71
8	1.0054E+06	-59.78
9	1.1086E+06	-60.05
10	9.9740E+05	-60.25
11	9.6680E+05	-60.25
12	1.0286E+06	-60.69
13	9.5500E+05	-60.74
14	9.5240E+05	-60.88
15	9.5140E+05	-60.89
16	9.5920E+05	-60.90
17		
18		
19		
20		

Spectrogram

This section discusses the Spectrogram Results file format. The Spectrogram choice only appears if option EDP is licensed.

The Spectrogram results are the same as a Trace data export, except that instead of having just one trace's data, all 300 traces appear one after the other.

Each trace has its own data mark; the data for Spectrogram Trace 0 follows the row marked DATA, the data for Spectrogram Trace 1 follows the row marked DATA1, for Spectrogram Trace 2 follows the row marked DATA2, and so on.

Each DATA row has a timestamp in the second column (as of firmware revision A.11.01). So, for example, if Trace 0 had a relative start time of 1729.523 sec, then the first DATA row would look like this:

DATA,1729.523

And if Trace 13 had a relative start time of 100.45 sec, then the fourteenth data row would look like:

DATA13,100.453

To find the absolute time for the relative timestamps of each trace, the last row before the first DATA row gives the absolute start time of the Spectrogram, in the form YYYYMMDDHHMMSS

So, for example, if the absolute start time is 13:23:45:678 on January 30, 2012, this row would look like:

Start Time,20120130132345678

NOTE The resolution of the absolute time stored is 1 ms, which matches up with the fact that the fastest sweep time is also 1 ms. However, there is no specification for the absolute accuracy of the clock in the analyzer, nor is there any facility provided to allow the user to set this time to any particular degree of accuracy.

Traces that have not yet been filled in the Spectrogram display are empty; there is no DATA header for them. The file ends after the last non-empty trace.

Imagine that, at the point where a Spectrogram Meas Result is requested, the following screen is showing:

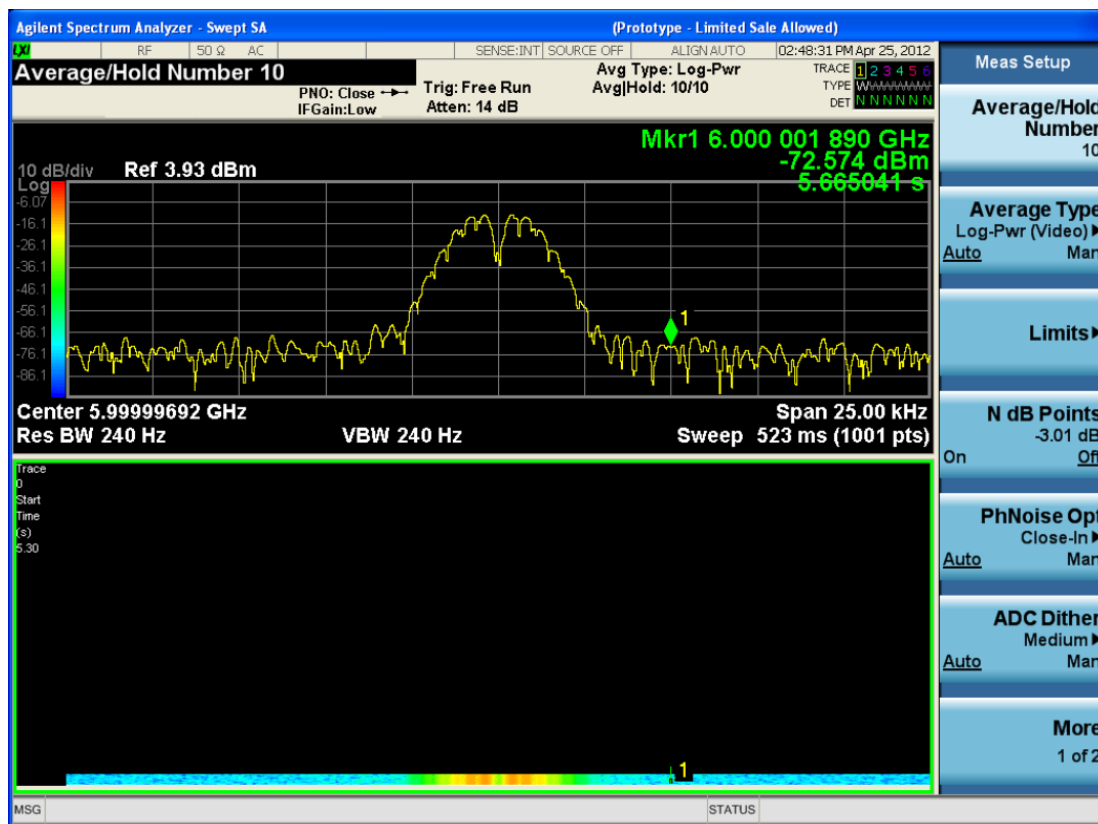

For the purpose of this example, we have set the Average/Hold Number to 10, thus we have only traces 0 thru 10. The Spectrogram was started at 02:28:08:700 pm on April 25, 2012 (that is, 700 ms after 2:28:08 pm), although the screen dump itself shows a different time, as it was taken ten minutes after the

Spectrogram data. Trace 0 is showing a start time of 5.30 seconds, meaning 5.3 seconds after the Spectrogram started (trace 10 has a start time of 0, as it was the first trace taken but has now rolled up into the tenth trace slot).

The Meas Results file, when opened, shows the header data and ten traces of trace data. Below is an extract from the result file for the above display. Note the start time of 20120425142808700 showing in the last row before the first DATA row, and the relative time of 5.299231048 showing in the first DATA row:

Result Type	Spectrogram
MeasResult	
Swept SA	
A.11.00.01	N9020A
503 508 513 526 ALL ALV B1C B1X B25 B2X B40 BAB BBA CR3 CRP DP2 DRD EA3 EDP EMC EP1 ERC ESC ESP EXM FSA HBA K03 LFE MPB P03 P08 P13 P26 PFR RTL RTS S40 SB1 SEC SM1 UK6 YAS YAV	1
Segment	0
Number of Points	1001
Sweep Time	0.523333333
Start Frequency	5999984415
Stop Frequency	6000009415
Average Count	0
Average Type	LogPower(Video)
RBW	240
RBW Filter	Gaussian
RBW Filter BW	3dB
VBW	240
Sweep Type	Swept
X Axis Scale	Lin
PreAmp State	Off
PreAmp Band	Low
Trigger Source	Free
Trigger Level	1.2
Trigger Slope	Positive
Trigger Delay	0
Phase Noise Optimization	Wide
Swept If Gain	Low
FFT If Gain	Autorange
RF Coupling	AC

Result Type	Spectrogram
FFT Width	411900
Ext Ref	10000000
Input	RF
RF Calibrator	Off
Attenuation	14
Ref Level Offset	0
External Gain	0
Trace Type	Clearwrite
Detector	Normal
Trace Math	Off
Trace Math Oper1	Trace5
Trace Math Oper2	Trace6
Trace Math Offset	0
Trace Name	Trace1
X Axis Units	Hz
Y Axis Units	dBm
Start Time	20120425142808700
DATA	5.299231048
5999984415	-76.34749519
5999984440	-77.28097006
5999984465	-75.32317869
5999984490	-73.64417681
5999984515	-72.67154604

- o
- o
- o

6000009315	-77.94423277
6000009340	-79.51829697
6000009365	-78.46108961
6000009390	-78.46108957
6000009415	-76.59570596
DATA2	4.708697055
5999984415	-80.98197882
5999984440	-80.98197879

Save

5999984465	-75.83142132
5999984490	-74.02712079
5999984515	-73.57213005

O

O

O

6000009315	-75.9183103
6000009340	-79.53787488
6000009365	-78.82602191
6000009390	-78.82602188
6000009415	-76.37486709
DATA10	0
5999984415	-75.56751112
5999984440	-75.76485645
5999984465	-76.67718717
5999984490	-78.79238489
5999984515	-83.72680212

O

O

O

6000009315	-71.3942461
6000009340	-72.28308332
6000009365	-73.92684489
6000009390	-75.45548832
6000009415	-75.17904815

Zone Map

Pressing this key selects Zone Map as the data type to be exported.

The Zone Map file contains information about current Zone Map configuration. Its format is compatible with the 89601A OFDMA map file. It is detailed in ["Zone Map File Contents" on page 1561](#) below.

Key Path	Save, Data
Remote Command	:MMEMory:STORe:ZMAP <string>
Example	MMEM:STOR:ZMAP "ZMap_0000.omf"
Notes	<p>If the save is initiated via SCPI and the file already exists, the file will be overwritten.</p> <p>The SCPI command exports Zone Map information to the file specified as the parameter in the current path. The default path is My Documents\WIMAXOFDMA\.</p> <p>Using the C: drive is strongly discouraged, since it runs the risk of being overwritten during an instrument software upgrade.</p> <p>The SCPI parameter is a quoted string that specifies the filename. Both single and double quotes are supported for any filename parameter over SCPI.</p>
Dependencies	You must be in the 802.16 OFDMA (WiMAX/WiBro) mode.
Status Bits/OPC dependencies	Sequential - waits for the previous measurement to complete.
Initial S/W Revision	Prior to A.02.00

Zone Map File Contents

A Zone Map File contains the following information of the Zone Map configuration. See ["Zone Map Data" on page 329](#) for detailed definitions.

- DemodOfdmaMap_AutoDetect
- DemodOfdmaMap_Count
- DemodOfdmaMap_F1_DL_Count
- DemodOfdmaMap_F1_DL_Z1_Active
- DemodOfdmaMap_F1_DL_Z1_AmcType
- DemodOfdmaMap_F1_DL_Z1_B1_Active
- DemodOfdmaMap_F1_DL_Z1_B1_AllocType
- DemodOfdmaMap_F1_DL_Z1_B1_Boost
- DemodOfdmaMap_F1_DL_Z1_B1_BurstType
- DemodOfdmaMap_F1_DL_Z1_B1_ColorIndex
- DemodOfdmaMap_F1_DL_Z1_B1_ModType
- DemodOfdmaMap_F1_DL_Z1_B1_Name
- DemodOfdmaMap_F1_DL_Z1_B1_SubchannelInterval
- DemodOfdmaMap_F1_DL_Z1_B1_SubchannelOffset
- DemodOfdmaMap_F1_DL_Z1_B1_SymbolInterval
- DemodOfdmaMap_F1_DL_Z1_B1_SymbolOffset

- DemodOfdmaMap_F1_DL_Z1_Count
- DemodOfdmaMap_F1_DL_Z1_DedicPilots
- DemodOfdmaMap_F1_DL_Z1_IDCell
- DemodOfdmaMap_F1_DL_Z1_IDCellCouple
- DemodOfdmaMap_F1_DL_Z1_Len
- DemodOfdmaMap_F1_DL_Z1_Locked
- DemodOfdmaMap_F1_DL_Z1_Name
- DemodOfdmaMap_F1_DL_Z1_PrbsID
- DemodOfdmaMap_F1_DL_Z1_StcMatrix
- DemodOfdmaMap_F1_DL_Z1_StcType
- DemodOfdmaMap_F1_DL_Z1_SymOffset
- DemodOfdmaMap_F1_DL_Z1_UseAllSC
- DemodOfdmaMap_F1_DL_Z1_WrapType
- DemodOfdmaMap_F1_DL_Z1_ZoneType
- DemodOfdmaMap_F1_UL_Count
- DemodOfdmaMap_F1_UL_Z1_Active
- DemodOfdmaMap_F1_UL_Z1_AmcType
- DemodOfdmaMap_F1_UL_Z1_B1_Active
- DemodOfdmaMap_F1_UL_Z1_B1_AllocType
- DemodOfdmaMap_F1_UL_Z1_B1_Boost
- DemodOfdmaMap_F1_UL_Z1_B1_BurstType
- DemodOfdmaMap_F1_UL_Z1_B1_ColorIndex
- DemodOfdmaMap_F1_UL_Z1_B1_ModType
- DemodOfdmaMap_F1_UL_Z1_B1_Name
- DemodOfdmaMap_F1_UL_Z1_B1_PilotPattern
- DemodOfdmaMap_F1_UL_Z1_B1_StcMode
- DemodOfdmaMap_F1_UL_Z1_B1_SubchannelInterval
- DemodOfdmaMap_F1_UL_Z1_B1_SubchannelOffset
- DemodOfdmaMap_F1_UL_Z1_B1_SymbolInterval
- DemodOfdmaMap_F1_UL_Z1_B1_SymbolOffset
- DemodOfdmaMap_F1_UL_Z1_Count

- DemodOfdmaMap_F1_UL_Z1_Gap
- DemodOfdmaMap_F1_UL_Z1_IDCell
- DemodOfdmaMap_F1_UL_Z1_Len
- DemodOfdmaMap_F1_UL_Z1_Locked
- DemodOfdmaMap_F1_UL_Z1_Name
- DemodOfdmaMap_F1_UL_Z1_SymOffset
- DemodOfdmaMap_F1_UL_Z1_UseSubchRotate
- DemodOfdmaMap_F1_UL_Z1_WrapType
- DemodOfdmaMap_F1_UL_Z1_ZoneType
- DemodOfdmaMap_Name
- DemodOfdmaMap_RefreshMap

Save As . . .

When you press “Save As”, the analyzer brings up a Windows dialog and a menu entitled “**Save As.**” This menu allows you to navigate to the various fields in the Windows dialog without using a keyboard or mouse. The Tab and Arrow keys can also be used for dialog navigation.

See "[To File . . .](#)" on page 2252 in Save, State for a full description of this dialog and menu.

The default path for saving files is:

For all of the Trace Data Files:

My Documents\<<mode name>\data\traces

For all of the Limit Data Files:

My Documents\<<mode name>\data\limits

For all of the Measurement Results Data Files:

My Documents\<<mode name>\data\<<measurement name>\results

For all of the Capture Buffer Data Files:

My Documents\<<mode name>\data\captureBuffer

Key Path	Save, Data
Mode	All
Notes	The key location is mode-dependent and will vary. Brings up the Save As dialog for saving a <mode specific> Save Type. The save is performed immediately and does not wait until the measurement is complete.
Initial S/W Revision	Prior to A.02.00

Screen Image

Pressing Screen Image accesses a menu of functions that enable you to specify a format and location for the saved screen image. It brings up a menu that allows you to specify the color scheme of the Screen Image (Themes) or navigate to the Save As dialog to perform the actual save.

Screen Image files contain an exact representation of the analyzer display. They cannot be loaded back onto the analyzer, but they can be loaded into your PC for use in many popular applications.

The image to be saved is actually captured when the Save front panel key is pressed, and kept in temporary storage to be used if you ask for a Screen Image save. When the Screen Image key is pressed, a "thumbnail" of the captured image is displayed, as shown below:

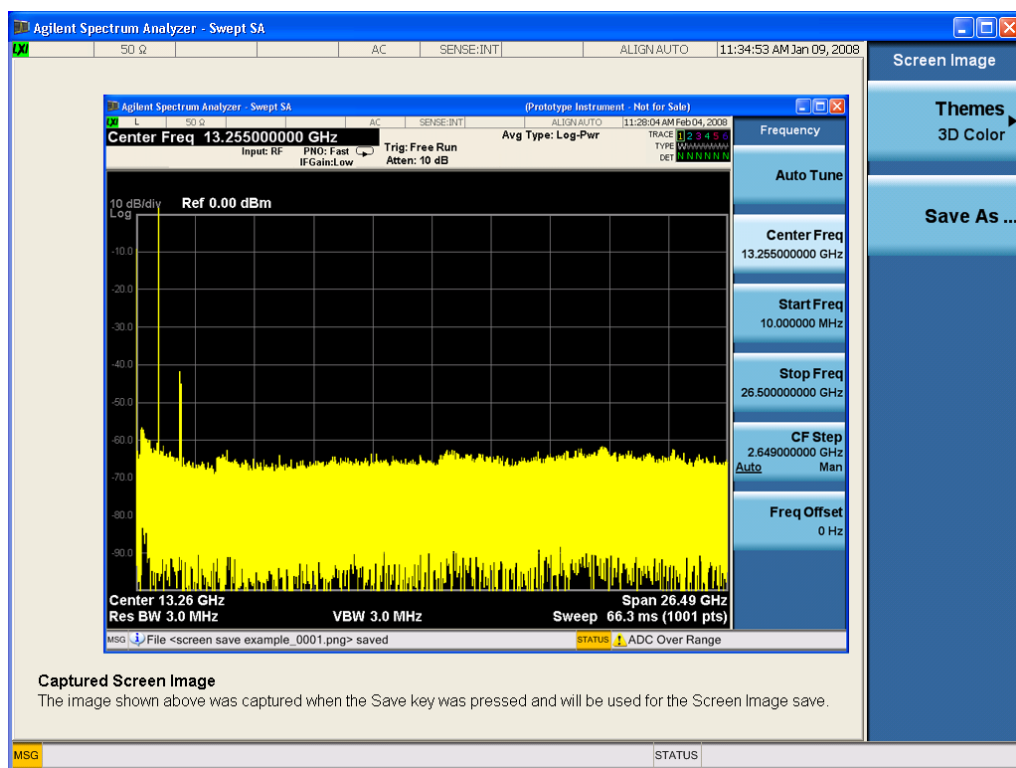

When you continue on into the Save As menu and complete the Screen Image save, the image depicted in the thumbnail is the one that gets saved, showing the menus that were on the screen before going into the Save menus. The save is performed immediately and does not wait until the measurement is complete.

After you have completed the save, the Quick Save front-panel key lets you quickly repeat the last save performed, using an auto-named file, with the current screen data.

NOTE

For versions previous to A.01.55, if you initiate a screen image save by navigating through the Save menus, the image that is saved will contain the Save menu softkeys, not the menus and the active function that were on the screen when you first pressed the Save front panel key.

Key Path	Save
Mode	All

Remote Command	:MMEMory:STORe:SCReen <filename>
Example	:MMEM:STOR:SCR "myScreen.png" This stores the current screen image in the file MyScreenFile.png in the default directory.
Initial S/W Revision	Prior to A.02.00

Themes

Accesses a menu of functions that enable you to choose the theme to be used when saving the screen image.

The **Themes** option is the same as the **Themes** option under the **Display** and **Page Setup** dialogs. It allows you to choose between themes to be used when saving the screen image.

Key Path	Save, Screen Image
Remote Command	:MMEMory:STORe:SCReen:THEME TDColor TDMonochrome FCOLOR FMONochrome :MMEMory:STORe:SCReen:THEMe?
Example	:MMEM:STOR:SCR:THEM TDM
Preset	3D Color; Is not part of Preset, but is reset by Restore Misc Defaults or Restore System Defaults All and survives subsequent running of the modes.
Readback	3D Color 3D Mono Flat Color Flat Mono
Backwards Compatibility Notes	In ESA and PSA we offer the choice of "Reverse Bitmap" or "Reverse Metafile" when saving screen images. This is much like the "Flat Color" theme available in X-Series. Also, if you selected Reverse Bitmap AND a black & white screen image, that would be much like "Flat Monochrome". In other words, each of the X-Series themes has a similar screen image type in ESA/PSA. But they are not identical.
Initial S/W Revision	Prior to A.02.00

3D Color

Selects a standard color theme with each object filled, shaded and colored as designed.

Key Path	Save, Screen Image, Themes
Example	MMEM:STOR:SCR:THEM TDC
Readback	3D Color
Initial S/W Revision	Prior to A.02.00

3D Monochrome

Selects a format that is like 3D color but shades of gray are used instead of colors.

Key Path	Save, Screen Image, Themes
Example	MMEM:STOR:SCR:THEM TDM
Readback	3D Mono
Initial S/W Revision	Prior to A.02.00

Flat Color

Selects a format that is best when the screen is to be printed on an ink printer.

Key Path	Save, Screen Image, Themes
Example	MMEM:STOR:SCR:THEM FCOL
Readback	Flat Color
Initial S/W Revision	Prior to A.02.00

Flat Monochrome

Selects a format that is like Flat Color. But only black is used (no colors, not even gray), and no fill.

Key Path	Save, Screen Image, Themes
Example	MMEM:STOR:SCR:THEM FMON
Readback	Flat Mono
Initial S/W Revision	Prior to A.02.00

Save As...

When you press "Save As", the analyzer brings up a Windows dialog and a menu entitled "**Save As.**" This menu allows you to navigate to the various fields in the Windows dialog without using a keyboard or mouse. The Tab and Arrow keys can also be used for dialog navigation.

See "[To File . . .](#)" on page 2252 in Save, State for a full description of this dialog and menu.

The default path for Screen Images is

My Documents\`<mode name>`\screen.

where `<mode name>` is the parameter used to select the mode with the INST:SEL command (for example, SA for the Spectrum Analyzer).

Key Path	Save, Screen Image
Notes	Brings up Save As dialog for saving a Screen Image Save Type
Initial S/W Revision	Prior to A.02.00

Mass Storage Catalog (Remote Command Only)

Key path	SCPI Only
Remote Command	:MMEMory:CATalog? [<directory_name>]
Notes	<p>The string must be a valid logical path.</p> <p>Queries disk usage information (drive capacity, free space available) and obtains a list of files and directories in a specified directory in the following format: <numeric_value>,<numeric_value>,{<file_entry>}</p> <p>It returns two numeric parameters and as many strings as there are files and directories. The first parameter indicates the total amount of storage currently used in bytes. The second parameter indicates the total amount of storage available, also in bytes. The <file_entry> is a string. Each <file_entry> indicates the name, type, and size of one file in the directory list: <file_name>,<file_type>,<file_size></p> <p>As the windows file system has an extension that indicates file type, <file_type> is always empty. <file_size> provides the size of the file in bytes. For directories, <file_entry> is surrounded by square brackets and both <file_type> and <file_size> are empty</p>
Initial S/W Revision	Prior to A.02.00

Mass Storage Change Directory (Remote Command Only)

Key path	SCPI Only
Remote Command	:MMEMory:CDIRectory [<directory_name>] :MMEMory:CDIRectory?
Notes	<p>The string must be a valid logical path.</p> <p>Changes the default directory for a mass memory file system. The <directory_name> parameter is a string. If no parameter is specified, the directory is set to the *RST value.</p> <p>At *RST, this value is set to the default user data storage area, that is defined as System.Environment.SpecialFolder.Personal.</p> <p>Query returns full path of the default directory.</p>
Initial S/W Revision	Prior to A.02.00

Mass Storage Copy (Remote Command Only)

Key path	SCPI Only
Remote Command	:MMEMory:COPY <string>,<string>[,<string>,<string>]
Notes	<p>The string must be a valid logical path.</p> <p>Copies an existing file to a new file or an existing directory to a new directory.</p> <p>Two forms of parameters are allowed. The first form has two parameters. In this form, the first parameter specifies the source, and the second parameter specifies the destination.</p> <p>The second form has four parameters. In this form, the first and third parameters specify the source. The second and fourth parameters specify the directories. The first pair of parameters specifies the</p>

source. The second pair specifies the destination. An error is generated if the source doesn't exist or the destination file already exists.

This command will generate an "access denied" error if the destination is a restricted folder (e.g., C:\Windows) and the current user does not have Power User or Administrator privileges.

Mass Storage Device Copy (Remote Command Only)

This command transfers data to/from a file and a peripheral device.

Key path	SCPI Only
Remote Command	:MMEMory:COpy:DEvice <source_string>,<dest_string>
Notes	The strings must be a valid logical path or a valid device keyword. If the dest_string is a device keyword, the data is copied from the source file to the device. If the source_string is a device keyword, the data is copied to the source file from the device. Valid device keywords are: SNS (smart noise source) An error is generated if the file or device is not found.

Mass Storage Delete (Remote Command Only)

Key path	SCPI Only
Remote Command	:MMEMory:DElete <file_name>[,<directory_name>]
Notes	The string must be a valid logical path. Removes a file from the specified directory. The <file_name> parameter specifies the file name to be removed. This command will generate an "access denied" error if the file is in a restricted folder (e.g., C:\Windows) and the current user does not have Power User or Administrator privileges.
Initial S/W Revision	Prior to A.02.00

Mass Storage Data (Remote Command Only)

Creates a file containing the specified data OR queries the data from an existing file.

Key path	SCPI Only
Remote Command	:MMEMory:DATA <file_name>,<data> :MMEMory:DATA? <file_name>
Notes	The string must be a valid logical path. The command form is MMEMory:DATA <file_name>,<data>. It loads <data> into the file <file_name>. <data> is in 488.2 block format. <file_name> is string data. The query form is MMEMory:DATA? <file_name> with the response being the associated <data> in block format.
Initial S/W Revision	Prior to A.02.00

Mass Storage Make Directory (Remote Command Only)

Key path	SCPI Only
Remote Command	:MMEMory:MDIRectory <directory_name>
Notes	<p>The string must be a valid logical path.</p> <p>Creates a new directory. The <directory_name> parameter specifies the name to be created.</p> <p>This command will generate an “access denied” error if the new directory would be in a restricted folder (e.g., C:\Windows) and the current user does not have Power User or Administrator privileges.</p>
Initial S/W Revision	Prior to A.02.00

Mass Storage Move (Remote Command Only)

Key path	SCPI Only
Remote Command	:MMEMory:MOVE <string>,<string>[,<string>,<string>]
Notes	<p>The string must be a valid logical path.</p> <p>Moves an existing file to a new file or an existing directory to a new directory.</p> <p>Two forms of parameters are allowed. The first form has two parameters. In this form, the first parameter specifies the source, and the second parameter specifies the destination.</p> <p>The second form has four parameters. In this form, the first and third parameters specify the source. The second and fourth parameters specify the directories. The first pair of parameters specifies the source. The second pair specifies the destination. An error is generated if the source doesn't exist or the destination file already exists.</p> <p>This command will generate an “access denied” error if the destination is a restricted folder (e.g., C:\Windows) and the current user does not have Power User or Administrator privileges.</p>
Initial S/W Revision	Prior to A.02.00

Mass Storage Remove Directory (Remote Command Only)

Key path	SCPI Only
Remote Command	:MMEMory:RDIRectory <directory_name>
Notes	<p>The string must be a valid logical path.</p> <p>Removes a directory. The <directory_name> parameter specifies the directory name to be removed. All files and directories under the specified directory shall also be removed.</p> <p>This command will generate an “access denied” error if the folder is a restricted folder (e.g., C:\Windows) or is in a restricted folder and the current user does not have Power User or Administrator privileges.</p>
Initial S/W Revision	Prior to A.02.00

Single (Single Measurement/Sweep)

Sets the analyzer for Single measurement operation. The single/continuous state is Meas Global, so the setting will affect all the measurements. If you are Paused, pressing Single does a Resume.

See ["More Information" on page 1570](#)

Key Path	Front-panel key
Example	:INIT:CONT OFF
Notes	See Cont key description.
Backwards Compatibility Notes	<p>For Spectrum Analysis mode in ESA and PSA, the Single hardkey and the INITiate:IMM switched from continuous measurement to single measurement and restarted sweeps and averages (displayed average count reset to 1), but did not restart Max Hold and Min Hold. In the X-Series, the Single hardkey and the INITiate:IMM command initiate a sweep/ measurement/ average sequence/hold sequence including MaxHold and MinHold.</p> <p>For Spectrum Analysis mode in ESA and PSA, the Single hardkey restarted the sweep regardless of whether or not you were in an active sweep or sweep sequence. In the X-Series, Restart does this but Single only restarts the sweep or sweep sequence if you are in the idle state.</p> <p>INIT[:IMM] in ESA & PSA Spectrum Analysis Mode does an implied ABORT. In some other PSA Modes, INIT[:IMM] is ignored if not in the idle state. . The X-Series follows the ESA/PSA SA Mode model, which may cause some Modes to have compatibility problems.</p>
Initial S/W Revision	Prior to A.02.00

More Information

See ["Restart" on page 2249](#) for details on the INIT:IMMEDIATE (Restart) function.

If you are already in single sweep, the INIT:CONT OFF command has no effect.

If you are already in Single Sweep, then pressing the Single key in the middle of a sweep does not restart the sweep or sequence. Similarly, pressing the Single key does not restart the sweep or sequence if the sweep is not in the idle state (for example, if you are taking a very slow sweep, or the analyzer is waiting for a trigger). Instead, it results in a message. "Already in Single, press Restart to initiate a new sweep or sequence". Even though pressing the Single key in the middle of a sweep does not restart the sweep, sending INIT:IMMEDIATE does reset it.

To take one more sweep without resetting the average count, increment the average count by 1, by pressing the step up key while **Average/Hold Number** is the active function, or sending the remote command CALC:AVER:TCON UP.

Source

There is no Source control functionality for this measurement. When this key is pressed, the screen either displays a blank menu, or the previously-selected menu remains unchanged.

Key Path	Front-panel key
----------	-----------------

SPAN X Scale

Accesses the SPAN/X Scale menu that allows you to set the desired horizontal scale settings.
See “SPAN X Scale” in the “Analyzer Setup Functions” section for more information.

Key Path	Front Panel
Initial S/W Revision	Prior to A.02.00

Ref Value

Allows you to set the display X reference value.

Key Path	SPAN X Scale
Mode	WIMAXOFDMA
Remote Command	:DISPlay:PVTime:VIEW[1]:WINDow[1]:TRACe:X[:SCALe]:RLEVel <time> :DISPlay:PVTime:VIEW[1]:WINDow[1]:TRACe:X[:SCALe]:RLEVel?
Example	DISP:PVT:VIEW:WIND:TRAC:X:RLEV 1s DISP:PVT:VIEW:WIND:TRAC:X:RLEV?
Couplings	If Auto Scaling is On, this value is automatically determined by the measurement result. When a value is set manually, Auto Scaling is automatically set to Off.
Preset	0 s
State Saved	Saved in instrument state.
Min	-10.0 s
Max	10.00 s
Initial S/W Revision	Prior to A.02.00

Scale/Div

Allows you to set the display X scale/division value.

Key Path	SPAN X Scale
Mode	WIMAXOFDMA
Remote Command	:DISPlay:PVTime:VIEW[1]:WINDow[1]:TRACe:X[:SCALe]:PDIVision <time> :DISPlay:PVTime:VIEW[1]:WINDow[1]:TRACe:X[:SCALe]:PDIVision?
Example	DISP:PVT:VIEW:WIND:TRAC:X:PDIV 1ms DISP:PVT:VIEW:WIND:TRAC:X:PDIV?
Couplings	If Auto Scaling is set to On, this value is automatically determined by the measurement result. When a value is set manually, Auto Scaling is automatically set to Off.
Preset	1.0 ms

State Saved	Saved in instrument state.
Min	1.00 ns
Max	1.00 s
Initial S/W Revision	Prior to A.02.00

Ref Position

Allows you to set the X reference position to the left, center, or right of the display.

Key Path	SPAN X Scale
Mode	WIMAXOFDMA
Remote Command	:DISPlay:PVTime:VIEW[1]:WINDow[1]:TRACe:X[:SCALe]:RPOSition LEFT CENTER RIGHT :DISPlay:PVTime:VIEW[1]:WINDow[1]:TRACe:X[:SCALe]:RPOSition?
Example	DISP:PVT:VIEW:WIND:TRAC:X:RPOS LEFT DISP:PVT:VIEW:WIND:TRAC:X:RPOS?
Preset	LEFT
State Saved	Saved in instrument state.
Range	Left Ctr Right
Initial S/W Revision	Prior to A.02.00

Auto Scaling

Allows you to toggle the X Auto Scaling function between On and Off.

Key Path	SPAN X Scale
Mode	WIMAXOFDMA
Remote Command	:DISPlay:PVTime:VIEW[1]:WINDow[1]:TRACe:X[:SCALe]:COUPle 0 1 OFF ON :DISPlay:PVTime:VIEW[1]:WINDow[1]:TRACe:X[:SCALe]:COUPle?
Example	DISP:PVT:VIEW:WIND:TRAC:X:COUP OFF DISP:PVT:VIEW:WIND:TRAC:X:COUP?
Couplings	Upon pressing the Restart front-panel key, the scale coupling function automatically determines the scale per division and reference values, based on the measurement results, if this parameter is set to On. When you manually set a value to either Rel Value or Scale/Div , X Auto Scaling is automatically set to Off.
Preset	ON
State Saved	Saved in instrument state.
Range	On Off
Initial S/W Revision	Prior to A.02.00

Sweep/Control

Accesses a menu that allows you to select parameters that affect the sweep of the displayed measurement signal.

Only the Pause/Resume key is available.

See "[Sweep/Control](#)" on page 2282 in the "Common Measurement Functions" for more information.

Key Path	Sweep/Control
Initial S/W Revision	Prior to A.02.00

Pause/Resume

This key allows you to pause or resume the measurement of the displayed signal.

See "Trigger" section for more information on trigger settings.

Key Path	Sweep/Control
Initial S/W Revision	Prior to A.02.00

13 Power vs Time Measurement
System

System

See "[System](#)" on page 342

Trace/Detector

Accesses a menu that allows you to control trace settings.

Key Path	Trace/Detector
Initial S/W Revision	Prior to A.02.00

Max Hold Trace

This key allows you to make the Max Hold Trace visible or invisible in the display.

Key Path	Trace/Detector
Mode	WIMAXOFDMA
Remote Command	:DISPlay:PVTime:VIEW[1]:WINDow[1]:TRACe:MAXHold[:STATe] ON OFF 1 0 :DISPlay:PVTime:VIEW[1]:WINDow[1]:TRACe:MAXHold[:STATe] ?
Example	DISP:PVT:VIEW:WIND:TRAC:MAXH ON DISP:PVT:VIEW:WIND:TRAC:MAXH?
Preset	OFF
State Saved	Saved in instrument state.
Range	On Off
Initial S/W Revision	Prior to A.02.00

Min Hold Trace

This key allows you to make the Min Hold Trace visible or invisible in the display.

Key Path	Trace/Detector
Mode	WIMAXOFDMA
Remote Command	:DISPlay:PVTime:VIEW[1]:WINDow[1]:TRACe:MINHold[:STATe] ON OFF 1 0 :DISPlay:PVTime:VIEW[1]:WINDow[1]:TRACe:MINHold[:STATe] ?
Example	DISP:PVT:VIEW:WIND:TRAC:MINH ON DISP:PVT:VIEW:WIND:TRAC:MINH?
Preset	OFF
State Saved	Saved in instrument state.
Range	On Off
Initial S/W Revision	Prior to A.02.00

Trigger

See ["Trigger" on page 412](#)

Free Run

See ["Free Run " on page 419](#)

Video

See ["Video \(IF Envelope\) " on page 420](#)

Trigger Level

See ["Trigger Level " on page 420](#)

Trig Slope

See ["Trig Slope " on page 421](#)

Trig Delay

See ["Trig Delay " on page 422](#)

Line

See ["Line " on page 2087](#)

Trig Slope

See ["Trig Slope " on page 2087](#)

Trig Delay

See ["Trig Delay " on page 424](#)

External 1

See ["External 1 " on page 2099](#)

Trigger Level

See ["Trigger Level " on page 2099](#)

Trig Slope

See ["Trig Slope " on page 2100](#)

Trig Delay

See ["Trig Delay " on page 427](#)

External 2

See ["External 2 " on page 2101](#)

Trigger Level

See ["Trigger Level "](#) on page 2101

Trig Slope

See ["Trig Slope "](#) on page 2102

Trig Delay

See ["Trig Delay "](#) on page 429

RF Burst

See ["RF Burst "](#) on page 2102

Absolute Trigger

See ["Absolute Trigger Level"](#) on page 2103

Relative Trigger

See ["Relative Trigger Level"](#) on page 2092

Trig Slope

See ["Trigger Slope "](#) on page 2104

Trig Delay

See ["Trig Delay "](#) on page 433

Periodic Timer

See ["Periodic Timer \(Frame Trigger\) "](#) on page 2094

Period

See ["Period "](#) on page 2095

Offset

See ["Offset "](#) on page 2096

Offset Adjust (Remote Command Only)

See ["Offset Adjust \(Remote Command Only\)"](#) on page 2097

Reset Offset Display

See ["Reset Offset Display "](#) on page 2098

Sync Source

See ["Sync Source "](#) on page 2098

Off

See ["Off "](#) on page 2099

External 1

See ["External 1 "](#) on page 2099

Trigger Level

See ["Trigger Level "](#) on page 2099

Trig Slope

See ["Trig Slope "](#) on page 2100

External 2

See ["External 2 "](#) on page 2101

Trigger Level

See ["Trigger Level "](#) on page 2101

Trig Slope

See ["Trig Slope "](#) on page 2102

RF Burst

See ["RF Burst "](#) on page 2102

Absolute Trigger

See ["Absolute Trigger Level"](#) on page 2103

Trig Slope

See ["Trigger Slope "](#) on page 2104

Trig Delay

See ["Trig Delay"](#) on page 443

Auto/Holdoff

See ["Auto/Holdoff "](#) on page 444

Auto Trig

See ["Auto Trig "](#) on page 444

Trig Holdoff

See ["Trig Holdoff "](#) on page 445

User Preset

Accesses a menu that gives you the following three choices:

- User Preset – recalls a state previously saved using the Save User Preset function.
- User Preset All Modes – presets all of the modes in the analyzer
- Save User Preset– saves the current state for the current mode

Key Path	Front-panel key
Backwards Compatibility Notes	<p>User Preset is actually loading a state, and in legacy analyzers, it was possible to load a state without affecting the trace data, limit lines or correction data. Similarly it was possible to do a User Preset without affecting the trace data, limit lines or correction data.</p> <p>In the X-Series, “state” always includes all of this data; so whenever state is loaded, or User Preset is executed, all of the traces, limit lines and corrections are affected. Although this differs from previous behavior, it is desirable behavior, and should not cause adverse issues for users.</p> <p>On ESA and PSA, User Preset affected the entire instrument’s state. In the X-Series, User Preset only recalls the state for the active mode. There is a User Preset file for each mode. User Preset can never cause a mode switch as it can in legacy analyzers. If you want to recall all modes to their user preset file state, you will need to do a User Preset after mode switching into each mode.</p> <p>User Preset recalls mode state which can now include data like traces; whereas on ESA and PSA, User Preset did not affect data.</p>
Initial S/W Revision	Prior to A.02.00

User Preset

User Preset sets the state of the currently active mode back to the state that was previously saved for this mode using the Save User Preset menu key or the SCPI command, SYST:PRES:USER:SAV. It not only recalls the Mode Preset settings, but it also recalls all of the mode persistent settings, and the Input/Output system setting that existed at the time Save User Preset was executed.

If a Save User Preset has not been done at any time, User Preset recalls the default user preset file for the currently active mode. The default user preset files are created if, at power-on, a mode detects there is no user preset file. There will never be a scenario when there is no user preset file to restore. For each mode, the default user preset state is the same state that would be saved if a Save User Preset is performed in each mode right after doing a Restore Mode Default and after a Restore Input/Output Defaults.

The User Preset function does the following:

- Aborts the currently running measurement.
- Sets the mode State to the values defined by Save User Preset.
- Makes the saved measurement for the currently running mode the active measurement.
- Brings up the saved menu for the power-on mode.
- Clears the input and output buffers.
- Sets the Status Byte to 0.

Key Path	User Preset
Remote Command	:SYSTem:PRESet:USER
Example	:SYST:PRES:USER:SAVE:SYST:PRES:USER
Notes	:SYST:PRES:USER:SAVE is used to save the current state as the user preset state. Clears all pending OPC bits. The Status Byte is set to 0. Pressing the User Preset front-panel key while already in the User Preset menu will cause the User Preset to get executed
Couplings	A user preset will cause the currently running measurement to be aborted and cause the saved measurement to be active. Recalling a User Preset file has the same issues that recalling a Save State file has. Some settings may need to be limited and therefore re-coupled, since the capabilities of the mode may have changes when the User Preset file was last saved.
Initial S/W Revision	Prior to A.02.00

User Preset All Modes

Recalls all of the User Preset files for each mode, switches to the power-on mode, and activates the saved measurement from the power-on mode User Preset file.

NOTE

When the instrument is secured, all of the user preset files are converted back to their default user preset files.

The User Preset function does the following:

- Aborts the currently running measurement.
- Switches the Mode to the power-on mode.
- Restores the User Preset files for each mode.
- Makes the saved measurement for the power-on mode the active measurement.
- Brings up the saved menu for the power-on mode.
- Clears the input and output buffers.
- Sets the Status Byte to 0.

Key Path	User Preset
Remote Command	:SYSTem:PRESet:USER:ALL
Example	:SYST:PRES:USER:SAVE:SYST:PRES:USER:ALL
Notes	Clears all pending OPC bits. The Status Byte is set to 0. :SYST:PRES:USER:SAVE is used to save the current state as the user preset state.
Couplings	A user preset will cause the currently running measurement to be aborted, cause a mode switch to the power-on mode, and cause the saved measurement to be active in the power-on mode. Recalling a User Preset file has the same issues that recalling a Save State file has. Some settings may need to be limited and therefore re-coupled, since the capabilities of the mode may have changes when the User Preset file was last saved.
Initial S/W Revision	Prior to A.02.00

Save User Preset

Saves the currently active mode and its State. You can recall this User Preset file by pressing the User Preset menu key or sending the SYST:PRES:USER remote command. This same state is also saved by the Save State function.

Key Path	User Preset
Remote Command	:SYSTem:PRESet:USER:SAVE
Example	:SYST:PRES:USER:SAVE
Notes	:SYST:PRES:SAVE creates the same file as if the user requested a *SAV or a MMEM:STOR:STAT, except User Preset Save does not allow the user to specify the filename or the location of the file.
Initial S/W Revision	Prior to A.02.00

View/Display

Accesses the View/Display menu for the current measurement. This menu includes the Display key which allows you to access parameters that control the display. All softkeys in the “View/Display” menu work regardless of which result window currently has the focus.

For example, the scroll function works on the lower numeric result window even if the upper RF Envelope window currently has the focus.

This measurement consists of one view, which consists of two windows.

["RF Envelop window" on page 1584](#)

["Numeric Results window" on page 1585](#)

NOTE

There is no view dedicated to each region. You can use X Scale function to flexibly zoom in to a particular time period in RF Envelope window.

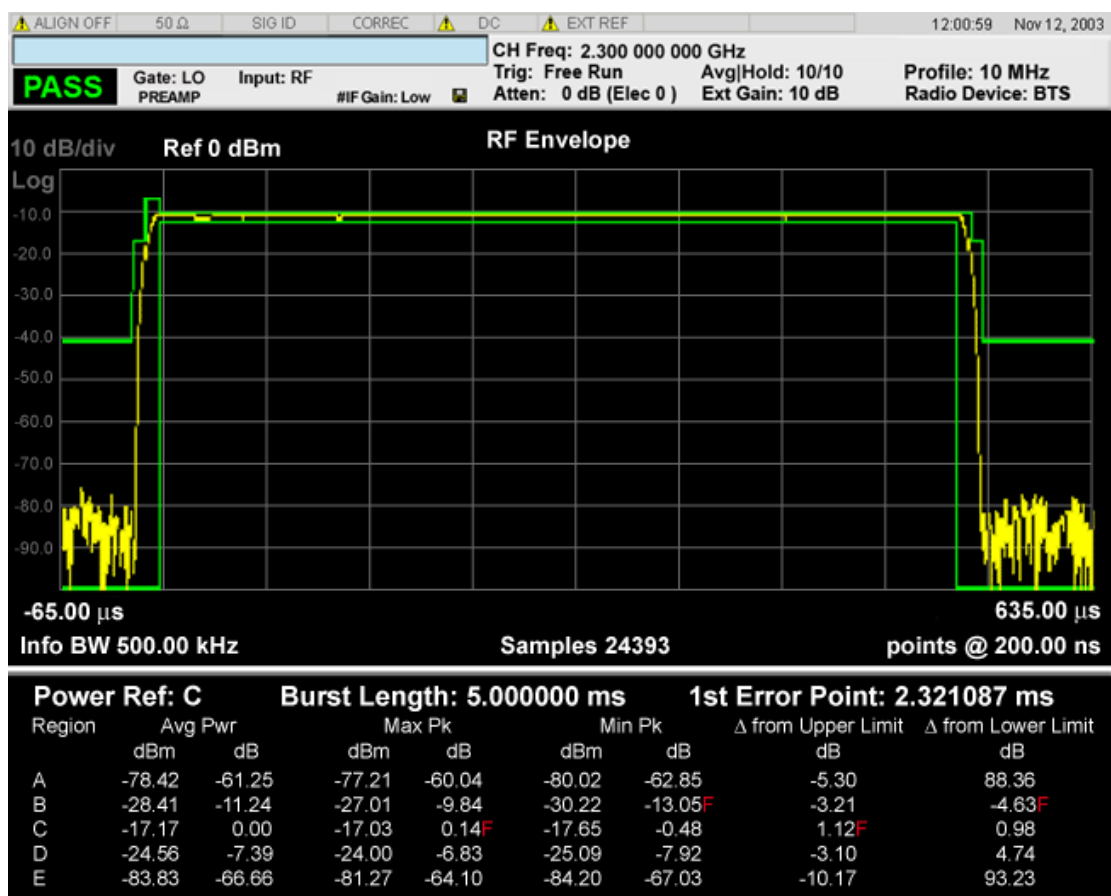

RF Envelop window

Marker Operation	Yes
Corresponding Trace	Corrected measured trace (n=2,3,4,5,6)

Numeric Results window

Name	Corresponding Results	Display Format
Burst Length	n=1 8th	99.999999 ms
1st Error Point	n=1 13th	99.999999 ms
Avg Pwr dBm	n=7 Averaged absolute power of the regions (in dBm)	99.99 dBm
Avg Pwr dB	n=8 Averaged relative power of the regions (in dB)	99.99 dB
Max Pk dBm	n=9 Max hold absolute power of the regions (in dBm)	99.99 dBm
Max Pk dB	n=10 Max hold relative power of the regions (in dB)	99.99 dB
Min Pk dBm	n=11 Min hold absolute power of the regions (in dBm)	99.99 dBm
Min Pk dB	n=12 Min hold relative power of the regions (in dB)	99.99 dB
Δ from Upper Limit dB	n=13 Minimum relative level to the upper limit mask (in dB)	99.99 dB
Δ from Lower Limit dB	n=14 Minimum relative level to the lower limit mask (in dB)	99.99 dB

Key Path	View/Display
Initial S/W Revision	Prior to A.02.00

Display

The Display menu is common to most measurements, and is used for configuring items on the display. Some Display menu settings apply to all the measurements in a mode, and some only to the current measurement. Those under the System Display Settings key apply to all measurements in all modes.

Key Path	Display
Key Path	View/Display
Initial S/W Revision	Prior to A.02.00

Annotation

Turns on and off various parts of the display annotation. The annotation is divided up into four categories:

1. Meas Bar: This is the measurement bar at the top of the screen. It does not include the settings panel or the Active Function. Turning off the Meas Bar turns off the settings panel and the Active Function. When the Meas Bar is off, the graticule area expands to fill the area formerly occupied by the Meas Bar.
2. Screen Annotation: this is the annotation and annunciation around the graticule, including any annotation on lines (such as the display line, the threshold line, etc.) This does NOT include the marker number or the N dB result. When off, the graticule expands to fill the entire graticule area.
3. Trace annotation: these are the labels on the traces, showing their detector (or their math mode).
4. Active Function annotation: this is the active function display in the meas bar, and all of the active function values displayed on softkeys.

See the figure below. Each type of annotation can be turned on and off individually.

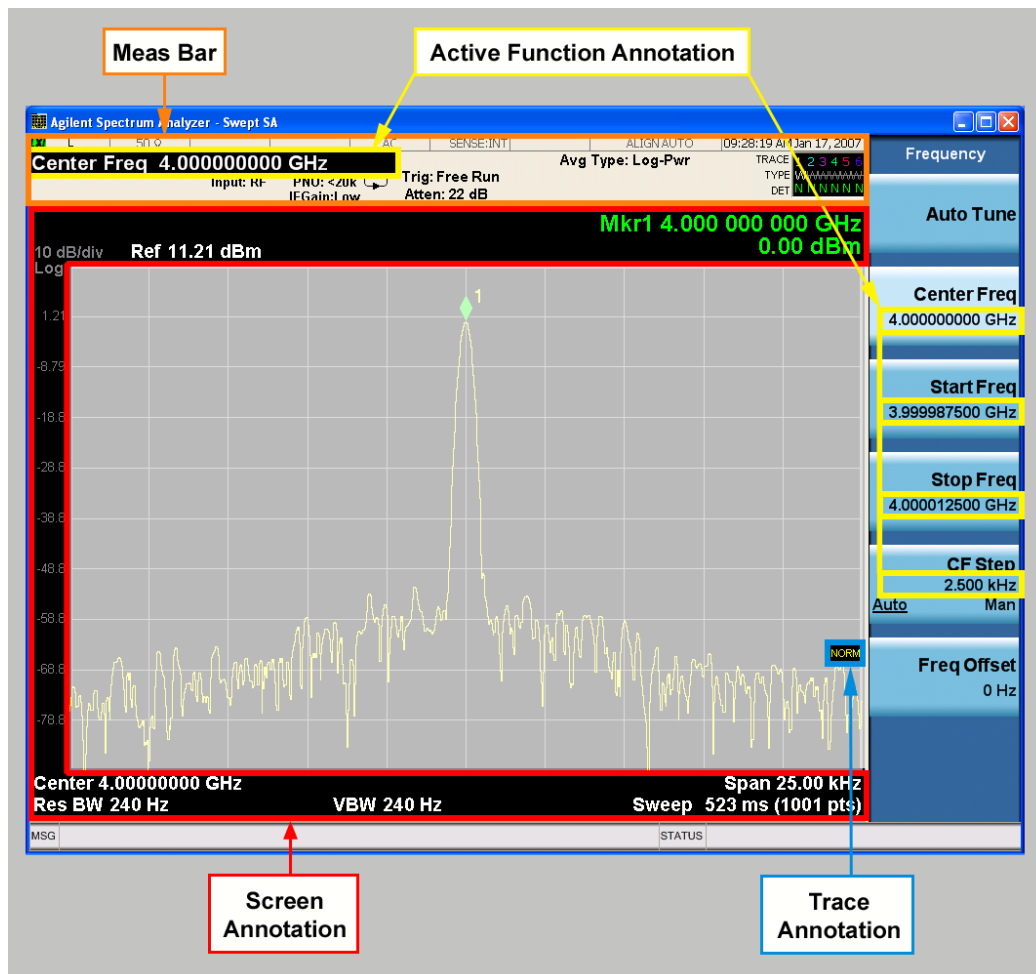

Key Path	View/Display, Display
Initial S/W Revision	Prior to A.02.00

Meas Bar On/Off

This function turns the Measurement Bar on and off, including the settings panel. When off, the graticule area expands to fill the area formerly occupied by the Measurement Bar.

Key Path	View/Display, Display, Annotation
Remote Command	:DISPlay:ANNotation:MBAR[:STATe] OFF ON 0 1 :DISPlay:ANNotation:MBAR[:STATe]?
Example	DISP:ANN:MBAR OFF
Dependencies	Grayed out and forced to OFF when System Display Settings, Annotation is set to Off.
Preset	On This should remain Off through a Preset when System DisplaySettings, Annotation is set to Off.
State Saved	Saved in instrument state.
Initial S/W Revision	Prior to A.02.00

Screen

This controls the display of the annunciation and annotation around the graticule, including any annotation on lines (such as the display line, the threshold line, etc.) and the y-axis annotation. This does NOT include marker annotation (or the N dB result). When off, the graticule expands to fill the entire graticule area, leaving only the 1.5% gap above the graticule as described in the Trace/Detector chapter.

Key Path	View/Display, Display, Annotation
Remote Command	:DISPlay:ANNotation:SCReen[:STATe] OFF ON 0 1 :DISPlay:ANNotation:SCReen[:STATe]?
Example	DISP:ANN:SCR OFF
Dependencies	Grayed-out and forced to OFF when System Display Settings, Annotation is set to Off.
Preset	On This should remain Off through a Preset when System DisplaySettings, Annotation is set to Off
State Saved	Saved in instrument state.
Initial S/W Revision	Prior to A.02.00

Active Function Values On/Off

Turns on and off the active function display in the Meas Bar, and all of the active function values displayed on the softkeys.

Note that all of the softkeys that have active functions have these numeric values blanked when this function is on. This is a security feature..

13 Power vs Time Measurement
View/Display

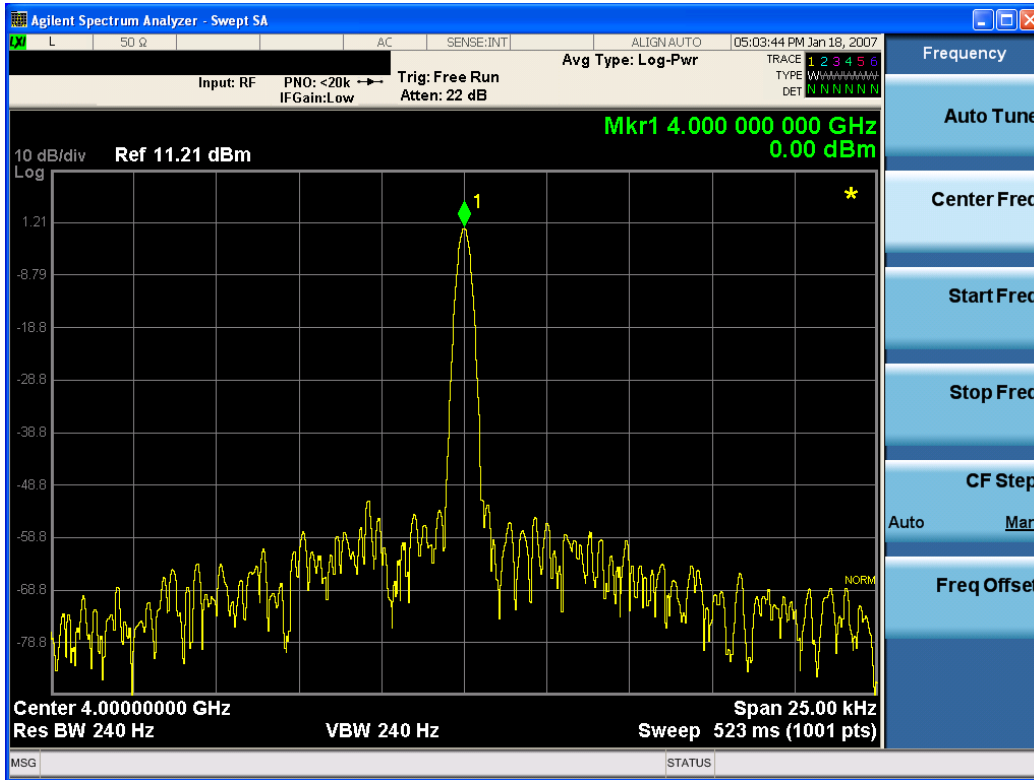

Key Path	View/Display, Display, Annotation
Remote Command	:DISPlay:ACTivefunc[:STATE] ON OFF 1 0 :DISPlay:ACTivefunc[:STATE] ?
Example	DISP:ACT OFF
Dependencies	Grayed out and forced to OFF when System Display Settings, Annotation is set to Off.
Preset	On This should remain Off through a Preset when System DisplaySettings, Annotation is set to Off
State Saved	Saved in instrument state.
Initial S/W Revision	Prior to A.02.00

Title

Displays menu keys that enable you to change or clear a title on your display.

Key Path	View/Display, Display
Initial S/W Revision	Prior to A.02.00

Change Title

Writes a title into the "measurement name" field in the banner, for example, "Swept SA".

Press Change Title to enter a new title through the alpha editor. Press Enter or Return to complete the entry. Press ESC to cancel the entry and preserve your existing title.

The display title will replace the measurement name. It remains for this measurement until you press Change Title again, or you recall a state, or a Preset is performed. A title can also be cleared by pressing Title, Clear Title.

NOTE

Notice the inclusion of the <measurement> parameter in the command below. Because each measurement remembers the Display Title, the command must be qualified with the measurement name. For the Swept SA measurement this is not the case; no <measurement> parameter is used when changing the Display Title for the Swept SA measurement.

Key Path	View/Display, Display, Title
Mode	All
Remote Command	:DISPlay:<measurement>:ANNotation:TITLe:DATA <string> :DISPlay:<measurement>:ANNotation:TITLe:DATA?
Example	DISP:ANN:TITL:DATA "This Is My Title" This example is for the Swept SA measurement in the Spectrum Analyzer mode. The SANalyzer <measurement> name is not used. DISP:ACP:ANN:TITL:DATA "This Is My Title" This example is for Measurements other than Swept SA. Both set the title to: This Is My Title
Notes	Pressing this key cancels any active function. When a title is edited the previous title remains intact (it is not cleared) and the cursor goes at the end so that characters can be added or BKSP can be used to go back over previous characters.
Preset	No title (measurement name instead)
State Saved	Saved in instrument state.
Initial S/W Revision	Prior to A.02.00

Clear Title

Clears a title from the front-panel display. Once cleared, the title cannot be retrieved. After the title is cleared, the current Measurement Name replaces it in the title bar.

Key Path	View/Display, Display, Title
Example	The following commands clear the title and restore the measurement's original title: DISP:ANN:TITL:DATA "" This example is for the Swept SA measurement in the Spectrum Analyzer mode. The SANalyzer <measurement> name is not used. DISP:ACP:ANN:TITL:DATA "" This example is for ACP; in measurements other than Swept SA the measurement name is required.
Notes	Uses the :DISPlay:<measurement>:ANNotation:TITLe:DATA <string> command with an empty string (in the Swept SA, the <measurement> is omitted).
Preset	Performed on Preset.
Initial S/W Revision	Prior to A.02.00

Graticule

Pressing Graticule turns the display graticule On or Off. It also turns the graticule y-axis annotation on and off.

Key Path	View/Display, Display
Remote Command	:DISPlay:WINDow[1]:TRACe:GRATicule:GRID[:STATe] OFF ON 0 1 :DISPlay:WINDow[1]:TRACe:GRATicule:GRID[:STATe]?
Example	DISP:WIND:TRAC:GRAT:GRID OFF
Notes	The graticule is the set of horizontal and vertical lines that make up the grid/divisions for the x-axis and y-axis.
Preset	On
State Saved	Saved in instrument state
Initial S/W Revision	Prior to A.02.00

System Display Settings

These settings are "Mode Global" – they affect all modes and measurements and are reset only by Restore Misc Defaults or Restore System Defaults under System.

Key Path	View/Display, Display
Initial S/W Revision	Prior to A.02.00

Annotation Local Settings

This is a Mode Global override of the meas local annotation settings. When it is All Off, it forces ScreenAnnotation, Meas Bar, Trace, and Active Function Values settings to be OFF for all measurements in all modes. This provides the security based "annotation off" function of previous analyzers; hence it uses the legacy SCPI command.

When it is All Off, the Screen, Meas Bar, Trace, and Active Function Values keys under the Display, Annotation menu are grayed out and forced to Off. When Local Settings is selected, you are able to set the local annotation settings on a measurement by measurement basis.

Key Path	View/Display, Display, System Display Settings
Remote Command	:DISPlay:WINDow[1]:ANNotation[:ALL] OFF ON 0 1 :DISPlay:WINDow[1]:ANNotation[:ALL]?
Example	:DISP:WIND:ANN OFF
Preset	On (Set by Restore Misc Defaults)
State Saved	Not saved in instrument state.
Backwards Compatibility Notes	The WINDow parameter and optional subopcode is included for backwards compatibility but ignored – all windows are equally affected.
Initial S/W Revision	Prior to A.02.00

Themes

Accesses a menu of functions that enable you to choose the theme to be used when saving the screen image.

The **Themes** option is the same as the **Themes** option under the **Display** and **Page Setup** dialogs. It allows you to choose between themes to be used when saving the screen image.

Key Path	Save, Screen Image
Remote Command	:MMEMory:STORe:SCReen:THEMe TDColor TDMonochrome FCOLOR FMONochrome :MMEMory:STORe:SCReen:THEMe?
Example	:MMEM:STOR:SCR:THEM TDM
Preset	3D Color; Is not part of Preset, but is reset by Restore Misc Defaults or Restore System Defaults All and survives subsequent running of the modes.
Readback	3D Color 3D Mono Flat Color Flat Mono
Backwards Compatibility Notes	In ESA and PSA we offer the choice of "Reverse Bitmap" or "Reverse Metafile" when saving screen images. This is much like the "Flat Color" theme available in X-Series. Also, if you selected Reverse Bitmap AND a black & white screen image, that would be much like "Flat Monochrome". In other words, each of the X-Series themes has a similar screen image type in ESA/PSA. But they are not identical.
Initial S/W Revision	Prior to A.02.00

3D Color

Selects a standard color theme with each object filled, shaded and colored as designed.

Key Path	Save, Screen Image, Themes
Example	MMEM:STOR:SCR:THEM TDC
Readback	3D Color
Initial S/W Revision	Prior to A.02.00

3D Monochrome

Selects a format that is like 3D color but shades of gray are used instead of colors.

Key Path	Save, Screen Image, Themes
Example	MMEM:STOR:SCR:THEM TDM
Readback	3D Mono
Initial S/W Revision	Prior to A.02.00

Flat Color

Selects a format that is best when the screen is to be printed on an ink printer.

Key Path	Save, Screen Image, Themes
Example	MMEM:STOR:SCR:THEM FCOL
Readback	Flat Color
Initial S/W Revision	Prior to A.02.00

Flat Monochrome

Selects a format that is like Flat Color. But only black is used (no colors, not even gray), and no fill.

Key Path	Save, Screen Image, Themes
Example	MMEM:STOR:SCR:THEM FMON
Readback	Flat Mono
Initial S/W Revision	Prior to A.02.00

Backlight

Accesses the display backlight on/off keys. This setting may interact with settings under the Windows "Power" menu.

When the backlight is off, pressing ESC, TAB, SPACE, ENTER, UP, DOWN, LEFT, RIGHT, DEL, BKSP, CTRL, or ALT turns the backlight on without affecting the application. Pressing any other key will turn backlight on and could potentially perform the action as well.

Key Path	View/Display, Display, System Display Settings
Remote Command	:DISPlay:BACKlight ON OFF :DISPlay:BACKlight?
Preset	ON (Set by Restore Misc Defaults)
Initial S/W Revision	Prior to A.02.00

Backlight Intensity

An active function used to set the backlight intensity. It goes from 0 to 100 where 100 is full on and 0 is off. This value is independent of the values set under the Backlight on/off key.

Key Path	View/Display, Display, System Display Settings
Remote Command	:DISPlay:BACKlight:INTensity <integer> :DISPlay:BACKlight:INTensity?
Example	DISP:BACK:INT 50

Preset	100 (Set by Restore Misc Defaults)
Min	0
Max	100
Initial S/W Revision	Prior to A.02.00

Limit Mask

Turns the limit mask On or Off.

Key Path	View/Display
Mode	WIMAXOFDMA
Remote Command	:DISPlay:PVTime:VIEW[1]:WINDow[1]:LMASk ON OFF 1 0 :DISPlay:PVTime:VIEW[1]:WINDow[1]:LMASk?
Example	DISP:PVT:VIEW:WIND:LMAS ON DISP:PVT:VIEW:WIND:LMAS?
Preset	ON
State Saved	Saved in instrument state.
Range	On Off
Initial S/W Revision	Prior to A.02.00

Scroll

Accesses the Scroll menu, which contains features that enable you to navigate the display.

Key Path	View/Display
Initial S/W Revision	Prior to A.02.00

Prev Page

Moves the display one page back to the previous page of the result metrics window.

Key Path	View/Display, Scroll
Mode	WIMAXOFDMA
Initial S/W Revision	Prior to A.02.00

Next Page

Moves the display one page forward to the next page of the result metrics window.

Key Path	View/Display, Scroll
----------	----------------------

Mode	WIMAXOFDMA
Initial S/W Revision	Prior to A.02.00

Scroll Up

Moves one line upward from the current line of the result metrics window.

Pressing the up arrow hard key has the same effect as this function, if no active function is shown. If an active function is shown, the up arrow hard key controls the active function, but has no effect on line movement.

Key Path	View/Display, Scroll
Mode	WIMAXOFDMA
Initial S/W Revision	Prior to A.02.00

Scroll Down

Moves one line downward from the current line of the result metrics window.

Pressing the down arrow hard key has the same effect as this function, if no active function is shown. If an active function is shown, the up arrow hard key controls the active function, but has no effect on line movement, as the Scroll Down function does.

Key Path	View/Display, Scroll
Mode	WIMAXOFDMA
Initial S/W Revision	Prior to A.02.00

First Page

Moves the display to the first page of the result metrics window.

Key Path	View/Display, Scroll
Mode	WIMAXOFDMA
Initial S/W Revision	Prior to A.02.00

Last Page

Moves the display to the last page of the result metrics window.

Key Path	View/Display, Scroll
Mode	WIMAXOFDMA
Initial S/W Revision	Prior to A.02.00

14 Modulation Analysis Measurement

The Modulation Analysis measurement provides an overall indication of the performance of the transmitter of the UUT. For more details, see "[Modulation Analysis Measurement Description](#)" on [page 1614](#). For measurement results and views, see "[View/Display](#)" on [page 1791](#).

This topic contains the following sections:

["Measurement Commands for Modulation Analysis"](#) on [page 1598](#)

["Remote Command Results for Modulation Analysis Measurements"](#) on [page 1599](#)

Measurement Commands for Modulation Analysis

:CONFigure:EVM

:CONFigure:EVM:NDEFault

:INITiate:EVM

:FETCh:EVM[n]?

:READ:EVM[n]?

:MEASure:EVM[n]

For more measurement related commands, see the SENSE subsystem, and the section "[Remote Measurement Functions](#)" on page 2205.

Remote Command Results for Modulation Analysis Measurements

Index: n	Results Returned
0	Returns unprocessed I/Q trace data of Capture Interval, as a series of trace point values. The I values are listed first in each pair, using the 0 through even-indexed values. The Q values are the odd-indexed values.
1 (or not specified)	<p>Returns the following comma-separated scalar results:</p> <ol style="list-style-type: none"> 1. Averaged Total RMS RCE (EVM) in dB – a floating point number in dB 2. Averaged Total RMS RCE (EVM) in % – a floating point number in percentage 3. Max Total RMS RCE (EVM) in dB – a floating point number in dB 4. Max Total RMS RCE (EVM) in % – a floating point number in percentage 5. Standard Deviation of Total RMS RCE (EVM) in dB – a floating point number in dB 6. Standard Deviation of Total RMS RCE (EVM) in % – a floating point number in percentage 7. Averaged Peak RMS RCE (EVM) in dB – a floating point number in dB. This is a result of composite subcarriers in each symbol. 8. Averaged Peak RMS RCE (EVM) in % – a floating point number in percentage. This is a result of composite subcarriers in each symbol. 9. Max Peak RMS RCE (EVM) in dB – a floating point number in dB. This is a result of composite subcarriers in each symbol. 10. Max Peak RMS RCE (EVM) in % – a floating point number in percentage. This is a result of composite subcarriers in each symbol. 11. Max Peak RMS RCE Symbol Number – an integer number at which the peak RCE is detected. 12. Max Peak RMS RCE Subcarrier Number – an integer number at which the peak RCE is detected 13. Standard Deviation of Peak RMS RCE (EVM) in dB – a floating point number in dB. This is a result of composite subcarriers in each symbol. 14. Standard Deviation of Peak RMS RCE (EVM) in % – a floating point number in percentage. This is a result of composite subcarriers in each symbol. 15. Averaged Pilot RCE in dB – a floating point number in dB. 16. Averaged Pilot RCE in % – a floating point number in percentage. 17. Max Pilot RCE in dB – a floating point number in dB. 18. Max Pilot RCE in % – a floating point number in percentage. 19. Standard Deviation of Pilot RCE in dB – a floating point number in dB. 20. Standard Deviation of Pilot RCE in % – a floating point number in percentage. 21. Averaged RMS RCE of Unmodulated subcarriers in dB – a floating point number in dB. This measurement is based on the requirement of IEEE Std 802.16 2004-Cor1, section 8.4.12.3.4. 22. Averaged RMS RCE of Unmodulated subcarriers in % – a floating point number in %. This measurement is based on the requirement of IEEE Std 802.16 2004-Cor1, section 8.4.12.3.4. 23. Max RMS RCE of Unmodulated subcarriers in dB – a floating point number in dB. 24. Max RMS RCE of Unmodulated subcarriers in % – a floating point number in %. 25. Standard Deviation of RMS RCE of Unmodulated subcarriers in dB – a floating point

Index: n	Results Returned
	number in dB.
	26. Standard Deviation of RMS RCE of Unmodulated subcarriers in % - a floating point number in %.
	27. Averaged RMS Frequency Error - a floating point number in Hz.
	28. Max RMS Frequency Error - a floating point number in Hz.
	29. Standard Deviation of Frequency Error - a floating point number in Hz.
	30. Averaged IQ Origin Offset - a floating point number in dB.
	31. Max IQ Origin Offset - a floating point number in dB.
	32. Standard Deviation of IQ Origin Offset - a floating point number in dB.
	33. Averaged Symbol Clock Error - a floating point number in ppm.
	34. Max Symbol Clock Error - a floating point number in ppm.
	35. Standard Deviation of Symbol Clock Error - a floating point number in ppm.
	36. Averaged Sync Correlation - a floating point number with no units which denotes an indicator of the synchronization.
	37. Max Sync Correlation - a floating point number with no units which denotes an indicator of the synchronization.
	38. Standard Deviation of Sync Correlation - a floating point number with no units which denotes an indicator of the synchronization.
	39. Averaged Time Offset - a floating point number in seconds.
	40. Max Time Offset - a floating point number in seconds.
	41. Standard Deviation of Time Offset - a floating point number in seconds.
	42. Averaged RSSI - a floating point number in dBm.
	43. Max RSSI - a floating point number in dBm
	44. Standard Deviation of RSSI - a floating point number in dBm.
	45. Averaged FFT Total Power - a floating point number in dBm.
	46. Max FFT Total Power - a floating point number in dBm.
	47. Standard Deviation of FFT Total Power - a floating point number in dBm.
	48. Channel power - a floating number in dBm.
	49. OBW - a floating number in Hz
	50. PRBS - an integer number
	51. IDCell - an integer number
	52. Segment - an integer number
	53. Mean Transmit Power - a floating point number in dBm.
	54. Nominal BW - a floating point number in Hz.
	55. Abs Max Subcarrier Power (dBm) - a floating point number in dBm.
	56. Abs Max Subcarrier Power (dBc) - a floating point number in dBc.
	57. Abs Max Subcarrier Power to Upper Limit - a floating point number in dB.
	58. Abs Max Subcarrier Power Index - an integer number.
	59. Abs Min Subcarrier Power (dBm) - a floating point number in dBm.
	60. Abs Min Subcarrier Power (dBc) - a floating point number in dBc.

Index: n	Results Returned
	61. Abs Min Subcarrier Power to Lower Limit – a floating point number in dB.
	62. Abs Min Subcarrier Power Index – an integer number.
	63. Diff Max Subcarrier Power – a floating point number in dB.
	64. Diff Max Subcarrier Power to Upper Limit – a floating point number in dB.
	65. Diff Max Subcarrier Power Index – an integer number.
	66. Diff Min Subcarrier Power – a floating point number in dB.
	67. Diff Min Subcarrier Power to Lower Limit – a floating point number in dB.
	68. Diff Min Subcarrier Power Index – an integer number.
	69. Sampling Frequency – a floating point number in Hz.
	70. Averaged Preamble RCE (EVM) in dB – a floating point number in dB. If Radio Device is MS, returns 999.0.
	71. Averaged Preamble RCE (EVM) in % – a floating point number in percentage. If Radio Device is MS, returns 999.0.
	72. Max Preamble RCE (EVM) in dB – a floating point number in dB. If Radio Device is MS, returns 999.0.
	73. Max Preamble RCE (EVM) in % – a floating point number in percentage. If Radio Device is MS, returns 999.0.
	74. Standard Deviation of Preamble RCE (EVM) in dB – a floating point number in dB. If Radio Device is MS, Average State is OFF, or Average Number is 1, returns 0.
	75. Standard Deviation of Preamble RCE (EVM) in % – a floating point number in percentage. If Radio Device is MS, Average State is OFF, or Average Number is 1, returns -999.0.
	76. Averaged Preamble Physical CINR for Reuse type 1 – a floating point number in dB. If Radio Device is MS, returns -999.0.
	77. Max Preamble PCINR for R1 – a floating point number in dB. If Radio Device is MS, returns -999.0.
	78. Standard Deviation of Preamble PCINR for R1 – a floating point number in dB. If Radio Device is MS, Average State is OFF, or Average Number is 1, returns -999.0.
	79. Averaged Preamble PCINR for Reuse type 3 – a floating point number in dB. When the signal does not have a preamble, returns -999.0.
	80. Max Preamble PCINR for R3 – a floating point number in dB. When the signal does not have a preamble, returns -999.0.
	81. Standard Deviation of Preamble PCINR for Reuse type 3 – a floating point number in dB. If Radio Device is MS, Average State is OFF, or Average Number is 1, returns -999.0.
	82. Reserved in future use.
	83. Reserved in future use.
	84. Reserved in future use.
	85. Reserved in future use.
	86. Reserved in future use.
	87. Reserved in future use.
	88. Reserved in future use.
	89. Reserved in future use.
	90. Reserved in future use.

Index: n	Results Returned
	<p>91. Averaged I/Q Timing Skew – a floating point number in sec.</p> <p>92. Max I/Q Timing Skew – a floating point number in sec.</p> <p>93. Standard Deviation of I/Q Timing Skew – a floating point number in sec. If Average State is OFF or Average Number is 1, returns -999.0.</p> <p>94. Averaged Quadrature Error – a floating point number in degrees.</p> <p>95. Max Quad Error – a floating point number in degrees.</p> <p>96. Standard Deviation of Quad Error – a floating point number in degrees. If Average State is OFF or Average Number is 1, returns -999.0.</p> <p>97. Averaged Gain Imbalance – a floating point number in dB.</p> <p>98. Max Gain Imbalance – a floating point number in dB.</p> <p>99. Standard Deviation of Gain Imbalance – a floating point number in dB. If Average State is OFF or Average Number is 1, returns -999.0.</p> <p>100. Averaged Preamble Power Boost – a floating point number in dB. When the signal does not have a preamble, returns -999.0.</p> <p>101. Max Preamble Power Boost – a floating point number in dB. When the signal does not have a preamble, returns -999.0.</p> <p>102. Reserved for future use.</p> <p>103. Averaged Number of Preamble Errors – a floating point number which denotes number of symbols whose phase error exceeds 45 degrees. When the signal does not have a preamble, returns 999.</p> <p>104. Max Preamble Peak Phase Error – an interger number Which denotes number of symbols whose phase error exceeds 45 degrees. When the signal does not have a preamble, returns 999.</p> <p>105. Reserved for future use.</p>
2	<p>Symbol Error trace  returns series of floating point numbers (in dB) that represent each sample in the EVM trace of used subcarriers and symbols in measured zone. The order of the trace is as follows:</p> <p>1st number: a value of 1st subcarrier/1st symbol</p> <p>2nd number: a value of 2nd subcarrier/1st symbol</p> <p>...</p> <p>Nsub-th number:a value of Nsub-th subcarrier/1st symbol</p> <p>(Nsub+1)th number:a value of 1st subcarrier/2nd symbol</p> <p>...</p> <p>(Nsym*Nsub)th number:a value of Nsub-th subcarrier/Nsym-th sym</p> <p>Where Nsub denotes number of used subcarriers and Nsym denotes number of symbols of the measured zone.</p>
3	<p>RMS Symbol Error vs Subcarrier returns series of floating point numbers (in dB) that represent error vector RMS'ed across symbols vs subcarrier. The order of the trace is as follows:</p> <p>1st number: a value of 1st subcarrier</p> <p>2nd number: a value of 2nd subcarrier</p> <p>...</p> <p>Nsub-th number:a value of Nsub-th subcarrier</p>

Index: n	Results Returned
4	<p>RMS Symbol Error vs Symbol returns series of floating point numbers (in dB) that represent error vector RMS'ed across subcarriers vs symbol. The order of the trace is as follows:</p> <p>1st number: a value of 1st symbol</p> <p>2nd number: a value of 2nd symbol</p> <p>...</p> <p>Nsym-th number: a value of Nsym-th symbol</p>
5	<p>Symbol Power trace  returns series of floating point numbers (in dBm) that represent each sample in the symbol power trace of used subcarriers and symbols in measured zone. The order of the trace is as follows:</p> <p>1st number: a value of 1st subcarrier/1st symbol</p> <p>2nd number: a value of 2nd subcarrier/1st symbol</p> <p>...</p> <p>Nsub-th number: a value of Nsub-th subcarrier/1st symbol</p> <p>(Nsub+1)th number: a value of 1st subcarrier/2nd symbol</p> <p>...</p> <p>(Nsym*Nsub)th number: a value of Nsub-th subcarrier/Nsym-th sym</p> <p>Where Nsub denotes number of used subcarriers and Nsym denotes number of symbols of the measured zone.</p>
6	<p>RMS Symbol Power vs Subcarrier returns series of floating point numbers (in dBm) that represent symbol power RMS'ed across symbols vs subcarrier. The order of the trace is as follows:</p> <p>1st number: a value of 1st subcarrier</p> <p>2nd number: a value of 2nd subcarrier</p> <p>...</p> <p>Nsub-th number: a value of Nsub-th subcarrier</p>
7	<p>RMS Symbol Power vs Symbol returns series of floating point numbers (in dBm) that represent symbol power RMS'ed across subcarriers vs symbol. The order of the trace is as follows:</p> <p>1st number: a value of 1st symbol</p> <p>2nd number: a value of 2nd symbol</p> <p>...</p> <p>Nsym-th number: a value of Nsym-th symbol</p>
8	<p>IQ measured trace returns series of floating point numbers that alternately represent I and Q pairs of the corrected measured trace. The magnitude of each I and Q pair are normalized to 1.0 if "Normalized" is set to ON. The first number is the I sample of symbol 0 decision point and the second number is the Q sample of symbol 0 decision point. The order of the trace is as follows:</p> <p>1st number: a value of I-ch of 1st subcarrier/1st symbol</p> <p>2nd number: a value of Q-ch of 1st subcarrier/1st symbol</p> <p>3rd number: a value of I-ch of 2nd subcarrier/1st symbol</p> <p>4th number: a value of Q-ch of 2nd subcarrier/1st symbol</p> <p>...</p>

Index: n	Results Returned
	<p>($N_{sub} * 2 - 1$)-th number: a value of I-ch of N_{sub}-th subcar/1st symbol ($N_{sub} * 2$)-th number: a value of Q-ch of N_{sub}-th subcar/1st symbol ($N_{sub} * 2 + 1$)-th number: a value of I-ch of N_{sub}-th subcar/2nd symbol ($N_{sub} * 2 + 2$)-th number: a value of Q-ch of N_{sub}-th subcar/2nd symbol ... ($N_{sym} * N_{sub} * 2 - 1$)-th number: a value of I-ch of N_{sub}-th subcarr/N_{sym}-th sym ($N_{sym} * N_{sub} * 2$)-th number: a value of Q-ch of N_{sub}-th subcarr/N_{sym}-th sym Where N_{sub} denotes number of used subcarriers and N_{sym} denotes number of symbols of the measured zone.</p>
9	Channel Frequency Response (Spectral Flatness) – floating point numbers which denote the equalizer channel frequency response, which is the reciprocal of the equalizer frequency response. This has one point per subcarrier. The equalizer frequency response is normally estimated from the channel estimation sequence portion of the OFDMA preamble.
10	Spectral Flatness Upper Limit Mask – floating point numbers which denote the upper limit mask trace of spectral flatness.
11	Spectral Flatness Lower Limit Mask – floating point numbers which denote the lower limit mask trace of spectral flatness.
12	Adjacent subcarrier power difference in dB (Spectral Flatness Diff) – computed by scanning through the Channel Frequency Response trace and taking the ratio of each bin to the previous bin. If the signal does not use all subcarriers, the trace assumes a smooth interpolation between the subcarriers that are used.
13	Spectral Flatness Diff Upper Limit Mask – floating point numbers which denote the upper limit mask trace of spectral flatness diff.
14	Spectral Flatness Diff Lower Limit Mask – floating point numbers which denote the lower limit mask trace of spectral flatness diff.
15	Preamble Frequency Error – shows the total frequency error during the preamble portion of the OFDMA burst. Preamble Frequency Error is sampled at 256 times the subcarrier spacing.
16	Common Pilot Error – shows the complex difference between the measured and ideal pilot subcarrier symbols. Residual phase and frequency settling that occurs following the preamble is measured via the Common Pilot Error.
17	<p>Data Burst Info – shows summary data for the active Data Burst. The shown Data Burst Number is designated by the parameter :CALCulate:EVM:INFormation:BURSt?. The array consists of following elements:</p> <ol style="list-style-type: none"> 1. Burst Type(int) 2. 0 = Normal, 1 = FCH, 2 = DL-MAP 3. Data Modulation Format 4. 0 = QPSK-1/2 5. 1 = QPSK-3/4 6. 9 = QPSK-Unknown 7. 10 = 16QAM-1/2 8. 11 = 16QAM-3/4 9. 19 = 16QAM-Unknown

Index: n	Results Returned
	10. 20 = 64QAM-1/2
	11. 21 = 64QAM-2/3
	12. 22 = 64QAM-3/4
	13. 29 = 64QAM-Unknown
	14. Boosting Level in dB
	15. Subchannel Offset
	16. Subchannel Interval
	17. Symbol Offset
	18. Symbol Interval
	19. Burst power in dBm
	20. RCE of whole burst in dB
	21. RCE of data portion in dB
	22. Burst Pilot Power in dBm. When Radio Device is BTS, returns -999.0.
18	Demod Bit trace – shows Demod Bit Trace of the measured zone or burst.
19	FFT Spectrum trace – shows FFT Spectrum Trace
20	Time Domain trace – shows the time domain power trace of the burst.
21	<p>Spectral Flatness results of each offset – summary data for spectral flatness results of each offset</p> <ol style="list-style-type: none"> 1. Abs Max Subcarrier Power (dBm) for Offset A Negative Side – a floating point number in dBm. If Offset A is off, this returns -999.0. 2. Abs Max Subcarrier Power (dBc) for Offset A Negative Side – a floating point number in dBc. If Offset A is off, this returns -999.0. 3. Abs Max Subcarrier Power to Upper Limit for Offset A Negative Side – a floating point number in dB. If Offset A is off or Offset Side is POS, this returns -999.0. 4. Abs Max Subcarrier Power Index for Offset A Negative Side – an integer number. If Offset A is off, this returns -999.0. 5. Abs Min Subcarrier Power (dBm) for Offset A Negative Side – a floating point number in dBm. If Offset A is off, this returns 999.0. 6. Abs Min Subcarrier Power (dBc) for Offset A Negative Side – a floating point number in dBc. If Offset A is off, this returns 999.0. 7. Abs Min Subcarrier Power to Lower Limit for Offset A Negative Side – a floating point number in dB. If Offset A is off or Offset Side is POS, this returns 999.0. 8. Abs Min Subcarrier Power Index for Offset A Negative Side – an integer number. If Offset A is off, this returns -999.0. 9. Abs Max Subcarrier Power (dBm) for Offset A Positive Side – a floating point number in dBm. If Offset A is off, this returns -999.0. 10. Abs Max Subcarrier Power (dBc) for Offset A Positive Side – a floating point number in dBc. If Offset A is off, this returns -999.0. 11. Abs Max Subcarrier Power to Upper Limit for Offset A Positive Side – a floating point number in dB. If Offset A is off or Offset Side is NEG, this returns -999.0. 12. Abs Max Subcarrier Power Index for Offset A Positive Side – an integer number. If Offset A is off, this returns -999.0.

Index: n	Results Returned
	13. Abs Min Subcarrier Power (dBm) for Offset A Positive Side - a floating point number in dBm. If Offset A is off, this returns 999.0.
	14. Abs Min Subcarrier Power (dBc) for Offset A Positive Side - a floating point number in dBc. If Offset A is off, this returns 999.0.
	15. Abs Min Subcarrier Power to Lower Limit for Offset A Positive Side - a floating point number in dB. If Offset A is off or Offset Side is NEG, this returns 999.0.
	16. Abs Min Subcarrier Power Index for Offset A Positive Side - an integer number. If Offset A is off, this returns -999.0.
	17. Abs Max Subcarrier Power (dBm) for Offset B Negative Side - a floating point number in dBm. If Offset B is off, this returns -999.0.
	18. Abs Max Subcarrier Power (dBc) for Offset B Negative Side - a floating point number in dBc. If Offset B is off, this returns -999.0.
	19. Abs Max Subcarrier Power to Upper Limit for Offset B Negative Side - a floating point number in dB. If Offset B is off or Offset Side is POS, this returns -999.0.
	20. Abs Max Subcarrier Power Index for Offset B Negative Side - an integer number. If Offset B is off, this returns -999.0.
	21. Abs Min Subcarrier Power (dBm) for Offset B Negative Side - a floating point number in dBm. If Offset B is off, this returns 999.0.
	22. Abs Min Subcarrier Power (dBc) for Offset B Negative Side - a floating point number in dBc. If Offset B is off, this returns 999.0.
	23. Abs Min Subcarrier Power to Lower Limit for Offset B Negative Side - a floating point number in dB. If Offset B is off or Offset Side is POS, this returns 999.0.
	24. Abs Min Subcarrier Power Index for Offset B Negative Side - an integer number. If Offset B is off, this returns -999.0.
	25. Abs Max Subcarrier Power (dBm) for Offset B Positive Side - a floating point number in dBm. If Offset B is off, this returns -999.0.
	26. Abs Max Subcarrier Power (dBc) for Offset B Positive Side - a floating point number in dBc. If Offset B is off, this returns -999.0.
	27. Abs Max Subcarrier Power to Upper Limit for Offset B Positive Side - a floating point number in dB. If Offset B is off or Offset Side is NEG, this returns -999.0.
	28. Abs Max Subcarrier Power Index for Offset B Positive Side - an integer number. If Offset B is off, this returns -999.0.
	29. Abs Min Subcarrier Power (dBm) for Offset B Positive Side - a floating point number in dBm. If Offset B is off, this returns 999.0.
	30. Abs Min Subcarrier Power (dBc) for Offset B Positive Side - a floating point number in dBc. If Offset B is off, this returns 999.0.
	31. Abs Min Subcarrier Power to Lower Limit for Offset B Positive Side - a floating point number in dB. If Offset B is off or Offset Side is NEG, this returns 999.0.
	32. Abs Min Subcarrier Power Index for Offset B Positive Side - an integer number. If Offset B is off, this returns -999.0.
	33. Abs Max Subcarrier Power (dBm) for Offset C Negative Side - a floating point number in dBm. If Offset C is off, this returns -999.0.
	34. Abs Max Subcarrier Power (dBc) for Offset C Negative Side - a floating point number in dBc. If Offset C is off, this returns -999.0.

Index: n	Results Returned
	35. Abs Max Subcarrier Power to Upper Limit for Offset C Negative Side – a floating point number in dB. If Offset C is off or Offset Side is POS, this returns –999.0.
	36. Abs Max Subcarrier Power Index for Offset C Negative Side – an integer number. If Offset C is off, this returns –999.0.
	37. Abs Min Subcarrier Power (dBm) for Offset C Negative Side - a floating point number in dBm. If Offset C is off, this returns 999.0.
	38. Abs Min Subcarrier Power (dBc) for Offset C Negative Side - a floating point number in dBc. If Offset C is off, this returns 999.0.
	39. Abs Min Subcarrier Power to Lower Limit for Offset C Negative Side – a floating point number in dB. If Offset C is off or Offset Side is POS, this returns 999.0.
	40. Abs Min Subcarrier Power Index for Offset C Negative Side – an integer number. If Offset C is off, this returns –999.0.
	41. Abs Max Subcarrier Power (dBm) for Offset C Positive Side – a floating point number in dBm. If Offset C is off, this returns –999.0.
	42. Abs Max Subcarrier Power (dBc) for Offset C Positive Side – a floating point number in dBc. If Offset C is off, this returns –999.0.
	43. Abs Max Subcarrier Power to Upper Limit for Offset C Positive Side – a floating point number in dB. If Offset C is off or Offset Side is NEG, this returns –999.0.
	44. Abs Max Subcarrier Power Index for Offset C Positive Side – an integer number. If Offset C is off, this returns –999.0.
	45. Abs Min Subcarrier Power (dBm) for Offset C Positive Side - a floating point number in dBm. If Offset C is off, this returns 999.0.
	46. Abs Min Subcarrier Power (dBc) for Offset C Positive Side - a floating point number in dBc. If Offset C is off, this returns 999.0.
	47. Abs Min Subcarrier Power to Lower Limit for Offset C Positive Side – a floating point number in dB. If Offset C is off or Offset Side is NEG, this returns 999.0.
	48. Abs Min Subcarrier Power Index for Offset C Positive Side – an integer number. If Offset C is off, this returns –999.0.
	49. Abs Max Subcarrier Power (dBm) for Offset D Negative Side – a floating point number in dBm. If Offset D is off, this returns –999.0.
	50. Abs Max Subcarrier Power (dBc) for Offset D Negative Side – a floating point number in dBc. If Offset D is off, this returns –999.0.
	51. Abs Max Subcarrier Power to Upper Limit for Offset D Negative Side – a floating point number in dB. If Offset D is off or Offset Side is POS, this returns –999.0.
	52. Abs Max Subcarrier Power Index for Offset D Negative Side – an integer number. If Offset D is off, this returns –999.0.
	53. Abs Min Subcarrier Power (dBm) for Offset D Negative Side - a floating point number in dBm. If Offset D is off, this returns 999.0.
	54. Abs Min Subcarrier Power (dBc) for Offset D Negative Side - a floating point number in dBc. If Offset D is off, this returns 999.0.
	55. Abs Min Subcarrier Power to Lower Limit for Offset D Negative Side – a floating point number in dB. If Offset D is off or Offset Side is POS, this returns 999.0.
	56. Abs Min Subcarrier Power Index for Offset D Negative Side – an integer number. If Offset D is off, this returns –999.0.

Index: n	Results Returned
	57. Abs Max Subcarrier Power (dBm) for Offset D Positive Side – a floating point number in dBm. If Offset D is off, this returns –999.0.
	58. Abs Max Subcarrier Power (dBc) for Offset D Positive Side – a floating point number in dBc. If Offset D is off, this returns –999.0.
	59. Abs Max Subcarrier Power to Upper Limit for Offset D Positive Side – a floating point number in dB. If Offset D is off or Offset Side is NEG, this returns –999.0.
	60. Abs Max Subcarrier Power Index for Offset D Positive Side – an integer number. If Offset D is off, this returns –999.0.
	61. Abs Min Subcarrier Power (dBm) for Offset D Positive Side – a floating point number in dBm. If Offset D is off, this returns 999.0.
	62. Abs Min Subcarrier Power (dBc) for Offset D Positive Side – a floating point number in dBc. If Offset D is off, this returns 999.0.
	63. Abs Min Subcarrier Power to Lower Limit for Offset D Positive Side – a floating point number in dB. If Offset D is off or Offset Side is NEG, this returns 999.0.
	64. Abs Min Subcarrier Power Index for Offset D Positive Side – an integer number. If Offset D is off, this returns –999.0.
	65. Abs Max Subcarrier Power (dBm) for Offset E Negative Side – a floating point number in dBm. If Offset E is off, this returns –999.0.
	66. Abs Max Subcarrier Power (dBc) for Offset E Negative Side – a floating point number in dBc. If Offset E is off, this returns –999.0.
	67. Abs Max Subcarrier Power to Upper Limit for Offset E Negative Side – a floating point number in dB. If Offset E is off or Offset Side is POS, this returns –999.0.
	68. Abs Max Subcarrier Power Index for Offset E Negative Side – an integer number. If Offset E is off, this returns –999.0.
	69. Abs Min Subcarrier Power (dBm) for Offset E Negative Side – a floating point number in dBm. If Offset E is off, this returns 999.0.
	70. Abs Min Subcarrier Power (dBc) for Offset E Negative Side – a floating point number in dBc. If Offset E is off, this returns 999.0.
	71. Abs Min Subcarrier Power to Lower Limit for Offset E Negative Side – a floating point number in dB. If Offset E is off or Offset Side is POS, this returns 999.0.
	72. Abs Min Subcarrier Power Index for Offset E Negative Side – an integer number. If Offset E is off, this returns –999.0.
	73. Abs Max Subcarrier Power (dBm) for Offset E Positive Side – a floating point number in dBm. If Offset E is off, this returns –999.0.
	74. Abs Max Subcarrier Power (dBc) for Offset E Positive Side – a floating point number in dBc. If Offset E is off, this returns –999.0.
	75. Abs Max Subcarrier Power to Upper Limit for Offset E Positive Side – a floating point number in dB. If Offset E is off or Offset Side is NEG, this returns –999.0.
	76. Abs Max Subcarrier Power Index for Offset E Positive Side – an integer number. If Offset E is off, this returns –999.0.
	77. Abs Min Subcarrier Power (dBm) for Offset E Positive Side – a floating point number in dBm. If Offset E is off, this returns 999.0.
	78. Abs Min Subcarrier Power (dBc) for Offset E Positive Side – a floating point number in dBc. If Offset E is off, this returns 999.0.

Index: n	Results Returned
	79. Abs Min Subcarrier Power to Lower Limit for Offset E Positive Side – a floating point number in dB. If Offset E is off or Offset Side is NEG, this returns 999.0.
	80. Abs Min Subcarrier Power Index for Offset E Positive Side – an integer number. If Offset E is off, this returns –999.0.
	81. Abs Max Subcarrier Power (dBm) for Offset F Negative Side – a floating point number in dBm. If Offset F is off, this returns –999.0.
	82. Abs Max Subcarrier Power (dBc) for Offset F Negative Side – a floating point number in dBc. If Offset F is off, this returns –999.0.
	83. Abs Max Subcarrier Power to Upper Limit for Offset F Negative Side – a floating point number in dB. If Offset F is off or Offset Side is POS, this returns –999.0.
	84. Abs Max Subcarrier Power Index for Offset F Negative Side – an integer number. If Offset F is off, this returns –999.0.
	85. Abs Min Subcarrier Power (dBm) for Offset F Negative Side – a floating point number in dBm. If Offset F is off, this returns 999.0.
	86. Abs Min Subcarrier Power (dBc) for Offset F Negative Side – a floating point number in dBc. If Offset F is off, this returns 999.0.
	87. Abs Min Subcarrier Power to Lower Limit for Offset F Negative Side – a floating point number in dB. If Offset F is off or Offset Side is POS, this returns 999.0.
	88. Abs Min Subcarrier Power Index for Offset F Negative Side – an integer number. If Offset F is off, this returns –999.0.
	89. Abs Max Subcarrier Power (dBm) for Offset F Positive Side – a floating point number in dBm. If Offset F is off, this returns –999.0.
	90. Abs Max Subcarrier Power (dBc) for Offset F Positive Side – a floating point number in dBc. If Offset F is off, this returns –999.0.
	91. Abs Max Subcarrier Power to Upper Limit for Offset F Positive Side – a floating point number in dB. If Offset F is off or Offset Side is NEG, this returns –999.0.
	92. Abs Max Subcarrier Power Index for Offset F Positive Side – an integer number. If Offset F is off, this returns –999.0.
	93. Abs Min Subcarrier Power (dBm) for Offset F Positive Side – a floating point number in dBm. If Offset F is off, this returns 999.0.
	94. Abs Min Subcarrier Power (dBc) for Offset F Positive Side – a floating point number in dBc. If Offset F is off, this returns 999.0.
	95. Abs Min Subcarrier Power to Lower Limit for Offset F Positive Side – a floating point number in dB. If Offset F is off or Offset Side is NEG, this returns 999.0.
	96. Abs Min Subcarrier Power Index for Offset F Positive Side – an integer number. If Offset F is off, this returns –999.0.
	97. Diff Max Subcarrier Power for Offset A Negative Side – a floating point number in dB. If Offset A is off, this returns –999.0.
	98. Diff Max Subcarrier Power to Upper Limit for Offset A Negative Side – a floating point number in dB. If Offset A is off and Offset Side is POS, this returns –999.0.
	99. Diff Max Subcarrier Power Index for Offset A Negative Side – an integer number. If Offset A is off, this returns –999.
	100. Diff Min Subcarrier Power for Offset A Negative Side – a floating point number in dB. If Offset A is off, this returns 999.0.

Index: n	Results Returned
	101. Diff Min Subcarrier Power to Lower Limit for Offset A Negative Side – a floating point number in dB. If Offset A is off and Offset Side is POS, this returns –999.0.
	102. Diff Min Subcarrier Power Index for Offset A Negative Side – an integer number. If Offset A is off, this returns –999.0.
	103. Diff Max Subcarrier Power for Offset A Positive Side – a floating point number in dB. If Offset A is off, this returns –999.0.
	104. Diff Max Subcarrier Power to Upper Limit for Offset A Positive Side – a floating point number in dB. If Offset A is off and Offset Side is POS, this returns –999.0.
	105. Diff Max Subcarrier Power Index for Offset A Positive Side – an integer number. If Offset A is off, this returns –999.
	106. Diff Min Subcarrier Power for Offset A Positive Side – a floating point number in dB. If Offset A is off, this returns 999.0.
	107. Diff Min Subcarrier Power to Lower Limit for Offset A Positive Side – a floating point number in dB. If Offset A is off and Offset Side is POS, this returns –999.0.
	108. Diff Min Subcarrier Power Index for Offset A Positive Side – an integer number. If Offset A is off, this returns –999.0.
	109. Diff Max Subcarrier Power for Offset B Negative Side – a floating point number in dB. If Offset B is off, this returns –999.0.
	110. Diff Max Subcarrier Power to Upper Limit for Offset B Negative Side – a floating point number in dB. If Offset B is off and Offset Side is POS, this returns –999.0.
	111. Diff Max Subcarrier Power Index for Offset B Negative Side – an integer number. If Offset B is off, this returns –999.
	112. Diff Min Subcarrier Power for Offset B Negative Side – a floating point number in dB. If Offset B is off, this returns 999.0.
	113. Diff Min Subcarrier Power to Lower Limit for Offset B Negative Side – a floating point number in dB. If Offset B is off and Offset Side is POS, this returns –999.0.
	114. Diff Min Subcarrier Power Index for Offset B Negative Side – an integer number. If Offset B is off, this returns –999.0.
	115. Diff Max Subcarrier Power for Offset B Positive Side – a floating point number in dB. If Offset B is off, this returns –999.0.
	116. Diff Max Subcarrier Power to Upper Limit for Offset B Positive Side – a floating point number in dB. If Offset B is off and Offset Side is POS, this returns –999.0.
	117. Diff Max Subcarrier Power Index for Offset B Positive Side – an integer number. If Offset B is off, this returns –999.
	118. Diff Min Subcarrier Power for Offset B Positive Side – a floating point number in dB. If Offset B is off, this returns 999.0.
	119. Diff Min Subcarrier Power to Lower Limit for Offset B Positive Side – a floating point number in dB. If Offset B is off and Offset Side is POS, this returns –999.0.
	120. Diff Min Subcarrier Power Index for Offset B Positive Side – an integer number. If Offset B is off, this returns –999.0.
	121. Diff Max Subcarrier Power for Offset C Negative Side – a floating point number in dB. If Offset C is off, this returns –999.0.
	122. Diff Max Subcarrier Power to Upper Limit for Offset C Negative Side – a floating point number in dB. If Offset C is off and Offset Side is POS, this returns –999.0.

Index: n	Results Returned
	123. Diff Max Subcarrier Power Index for Offset C Negative Side – an integer number. If Offset C is off, this returns –999.
	124. Diff Min Subcarrier Power for Offset C Negative Side – a floating point number in dB. If Offset C is off, this returns 999.0.
	125. Diff Min Subcarrier Power to Lower Limit for Offset C Negative Side – a floating point number in dB. If Offset C is off and Offset Side is POS, this returns –999.0.
	126. Diff Min Subcarrier Power Index for Offset C Negative Side – an integer number. If Offset C is off, this returns –999.0.
	127. Diff Max Subcarrier Power for Offset C Positive Side – a floating point number in dB. If Offset C is off, this returns –999.0.
	128. Diff Max Subcarrier Power to Upper Limit for Offset C Positive Side – a floating point number in dB. If Offset C is off and Offset Side is POS, this returns –999.0.
	129. Diff Max Subcarrier Power Index for Offset C Positive Side – an integer number. If Offset C is off, this returns –999.
	130. Diff Min Subcarrier Power for Offset C Positive Side – a floating point number in dB. If Offset C is off, this returns 999.0.
	131. Diff Min Subcarrier Power to Lower Limit for Offset C Positive Side – a floating point number in dB. If Offset C is off and Offset Side is POS, this returns –999.0.
	132. Diff Min Subcarrier Power Index for Offset C Positive Side – an integer number. If Offset C is off, this returns –999.0.
	133. Diff Max Subcarrier Power for Offset D Negative Side – a floating point number in dB. If Offset D is off, this returns –999.0.
	134. Diff Max Subcarrier Power to Upper Limit for Offset D Negative Side – a floating point number in dB. If Offset D is off and Offset Side is POS, this returns –999.0.
	135. Diff Max Subcarrier Power Index for Offset D Negative Side – an integer number. If Offset D is off, this returns –999.
	136. Diff Min Subcarrier Power for Offset D Negative Side – a floating point number in dB. If Offset D is off, this returns 999.0.
	137. Diff Min Subcarrier Power to Lower Limit for Offset D Negative Side – a floating point number in dB. If Offset D is off and Offset Side is POS, this returns –999.0.
	138. Diff Min Subcarrier Power Index for Offset D Negative Side – an integer number. If Offset D is off, this returns –999.0.
	139. Diff Max Subcarrier Power for Offset D Positive Side – a floating point number in dB. If Offset D is off, this returns –999.0.
	140. Diff Max Subcarrier Power to Upper Limit for Offset D Positive Side – a floating point number in dB. If Offset D is off and Offset Side is POS, this returns –999.0.
	141. Diff Max Subcarrier Power Index for Offset D Positive Side – an integer number. If Offset D is off, this returns –999.
	142. Diff Min Subcarrier Power for Offset D Positive Side – a floating point number in dB. If Offset D is off, this returns 999.0.
	143. Diff Min Subcarrier Power to Lower Limit for Offset D Positive Side – a floating point number in dB. If Offset D is off and Offset Side is POS, this returns –999.0.
	144. Diff Min Subcarrier Power Index for Offset D Positive Side – an integer number. If Offset D is off, this returns –999.0.

Index: n	Results Returned
	145. Diff Max Subcarrier Power for Offset E Negative Side - a floating point number in dB. If Offset E is off, this returns -999.0.
	146. Diff Max Subcarrier Power to Upper Limit for Offset E Negative Side - a floating point number in dB. If Offset E is off and Offset Side is POS, this returns -999.0.
	147. Diff Max Subcarrier Power Index for Offset E Negative Side - an integer number. If Offset E is off, this returns -999.
	148. Diff Min Subcarrier Power for Offset E Negative Side - a floating point number in dB. If Offset E is off, this returns 999.0.
	149. Diff Min Subcarrier Power to Lower Limit for Offset E Negative Side - a floating point number in dB. If Offset E is off and Offset Side is POS, this returns -999.0.
	150. Diff Min Subcarrier Power Index for Offset E Negative Side - an integer number. If Offset E is off, this returns -999.0.
	151. Diff Max Subcarrier Power for Offset E Positive Side - a floating point number in dB. If Offset E is off, this returns -999.0.
	152. Diff Max Subcarrier Power to Upper Limit for Offset E Positive Side - a floating point number in dB. If Offset E is off and Offset Side is POS, this returns -999.0.
	153. Diff Max Subcarrier Power Index for Offset E Positive Side - an integer number. If Offset E is off, this returns -999.
	154. Diff Min Subcarrier Power for Offset E Positive Side - a floating point number in dB. If Offset E is off, this returns 999.0.
	155. Diff Min Subcarrier Power to Lower Limit for Offset E Positive Side - a floating point number in dB. If Offset E is off and Offset Side is POS, this returns -999.0.
	156. Diff Min Subcarrier Power Index for Offset E Positive Side - an integer number. If Offset E is off, this returns -999.0.
	157. Diff Max Subcarrier Power for Offset F Negative Side - a floating point number in dB. If Offset F is off, this returns -999.0.
	158. Diff Max Subcarrier Power to Upper Limit for Offset F Negative Side - a floating point number in dB. If Offset F is off and Offset Side is POS, this returns -999.0.
	159. Diff Max Subcarrier Power Index for Offset F Negative Side - an integer number. If Offset F is off, this returns -999.
	160. Diff Min Subcarrier Power for Offset F Negative Side - a floating point number in dB. If Offset F is off, this returns 999.0.
	161. Diff Min Subcarrier Power to Lower Limit for Offset F Negative Side - a floating point number in dB. If Offset F is off and Offset Side is POS, this returns -999.0.
	162. Diff Min Subcarrier Power Index for Offset F Negative Side - an integer number. If Offset F is off, this returns -999.0.
	163. Diff Max Subcarrier Power for Offset F Positive Side - a floating point number in dB. If Offset F is off, this returns -999.0.
	164. Diff Max Subcarrier Power to Upper Limit for Offset F Positive Side - a floating point number in dB. If Offset F is off and Offset Side is POS, this returns -999.0.
	165. Diff Max Subcarrier Power Index for Offset F Positive Side - an integer number. If Offset F is off, this returns -999.
	166. Diff Min Subcarrier Power for Offset F Positive Side - a floating point number in dB. If Offset F is off, this returns 999.0.

Index: n	Results Returned
	167. Diff Min Subcarrier Power to Lower Limit for Offset F Positive Side – a floating point number in dB. If Offset F is off and Offset Side is POS, this returns -999.0.
	168. Diff Min Subcarrier Power Index for Offset F Positive Side – an integer number. If Offset F is off, this returns -999.0.

Modulation Analysis Measurement Description

The measurement provides a full set of demodulation properties that support OFDMA scalable parameters including data tone modulation, frame length, nominal bandwidth, BW ratio, guard interval, and FFT size. This measurement covers the following metrics:

- IQ Meas constellation measurement data (includes multiple formats when present)
- Auto detected format: BPSK, QPSK, 16QAM, 64QAM (color coded for display)
- Subchannelization supported
- RCE vs. Time and Frequency
- Preamble Frequency err (used to show frequency settling)
- Data burst information (modulation format, size and burst power)

This measurement takes into account all possible error mechanisms in the entire transmission chain including: baseband filtering, I/Q modulation anomalies, filter amplitude and phase non-linearities, and power amplifier distortions.

Key Path	Meas
Initial S/W Revision	Prior to A.02.00
Modified at S/W Revision	A.02.00

AMPTD Y Scale

The AMPTD Y Scale key accesses the menus that enable you to set the desired vertical scale and associated settings. The settings available vary depending on the active window focus.

Key Path	Front-Panel
Initial S/W Revision	Prior to A.02.00

Ref Value

Y Ref Value sets the reference value for the y-axis of the windows listed below, which are explained in greater detail in the following sections.

NOTE

The settings available vary depending on the active window displayed. Scroll down for more information.

Key Path	AMPTD Y Scale
Initial S/W Revision	Prior to A.02.00

Ref Value (Symbol Error vs. Subcarrier/Symbol Error vs. Symbol Window - Log)

Y Ref Value sets the reference value for the y-axis in the Symbol Error vs. Subcarrier and Symbol Error vs. Symbol windows. The unit of value for the Y reference is set to dB when Scale Type (Log) is selected.

Key Path	AMPTD Y Scale
Mode	WIMAXOFDMA
Remote Command	:DISPlay:EVM:VIEW3:WINDow[1] 2:TRACe:Y[1][:SCALe]:RLEVel <rel_ampl> :DISPlay:EVM:VIEW3:WINDow[1] 2:TRACe:Y[1][:SCALe]:RLEVel?
Example	DISP:EVM:VIEW3:WIND:TRAC:Y:RLEV 20 DISP:EVM:VIEW3:WIND:TRAC:Y:RLEV?
Notes	When Auto Scaling is set to On, this value is automatically determined by the measurement result. The value is switched depending on Scale Type.
Couplings	When this value is set manually, Auto Scaling is set to Off. Attenuation is not coupled to Ref Value.
Preset	0
State Saved	Saved in instrument state.
Min	-500
Max	500
Initial S/W Revision	Prior to A.02.00

Ref Value (Symbol Error vs. Subcarrier/Symbol Error vs. Symbol Window - Lin)

Y Ref Value sets the reference value for the y-axis in the Symbol Error vs. Subcarrier and Symbol Error vs. Symbol windows. The unit of value for the Y reference is set to % when Scale Type (Lin) is selected.

Key Path	AMPTD Y Scale
Mode	WIMAXOFDMA
Remote Command	:DISPlay:EVM:VIEW3:WINDow[1] 2:TRACe:Y2[:SCALe]:RLEVel <real> :DISPlay:EVM:VIEW3:WINDow[1] 2:TRACe:Y2[:SCALe]:RLEVel?
Example	DISP:EVM:VIEW3:WIND:TRAC:Y2:RLEV 20 DISP:EVM:VIEW3:WIND:TRAC:Y2:RLEV?
Notes	When Auto Scaling is set to On, this value is automatically determined by the measurement result. The value is switched depending on Scale Type.
Couplings	When this value is set manually, Auto Scaling is set to Off. Attenuation is not coupled to Ref Value.
Preset	0
State Saved	Saved in instrument state.
Min	0
Max	500
Initial S/W Revision	Prior to A.02.00

Ref Value (Absolute Flatness Window)

Y Ref Value sets the reference value for the y-axis in the Absolute Flatness window of the Spectral Flatness view.

Key Path	AMPTD Y Scale
Mode	WIMAXOFDMA
Remote Command	:DISPlay:EVM:VIEW6:WINDow[1]:TRACe:Y[:SCALe]:RLEVel <rel_amp1> :DISPlay:EVM:VIEW6:WINDow[1]:TRACe:Y[:SCALe]:RLEVel?
Example	DISP:EVM:VIEW6:WIND:TRAC:Y:RLEV 100 DISP:EVM:VIEW6:WIND:TRAC:Y:RLEV?
Notes	When Auto Scaling is set to On, this value is automatically determined by the measurement result. The value is switched depending on Scale Type.
Couplings	When this value is set manually, Auto Scaling is set to Off. Attenuation is not coupled to Ref Value.
Preset	0.00 dB
State Saved	Saved in instrument state.
Min	-250 dB
Max	250 dB
Initial S/W Revision	Prior to A.02.00

Ref Value (Differential Flatness Window)

Y Ref Value sets the reference value for the y-axis in the Differential Flatness window of the Spectral Flatness view.

Key Path	AMPTD Y Scale
Mode	WIMAXOFDMA
Remote Command	:DISPlay:EVM:VIEW6:WINDow2:TRACe:Y[:SCALe]:RLEVel <rel_amp1> :DISPlay:EVM:VIEW6:WINDow2:TRACe:Y[:SCALe]:RLEVel?
Example	DISP:EVM:VIEW6:WIND2:TRAC:Y:RLEV 1.0 DISP:EVM:VIEW6:WIND2:TRAC:Y:RLEV?
Notes	When Auto Scaling is set to On, this value is automatically determined by the measurement result. The value is switched depending on Scale Type.
Couplings	When this value is set manually, Auto Scaling is set to Off. Attenuation is not coupled to Ref Value.
Preset	0.00 dB
State Saved	Saved in instrument state.
Min	-20 dB
Max	20 dB
Initial S/W Revision	Prior to A.02.00

Ref Value (Power vs. Time/Power vs. Spectrum Window)

Y Ref Value sets the reference value for the y-axis in the Power vs. Time and Power vs. Spectrum windows of the Power vs. Time and Spectrum view.

Key Path	AMPTD Y Scale
Mode	WIMAXOFDMA
Remote Command	:DISPlay:EVM:VIEW7:WINDow[1] 2:TRACe:Y[:SCALe]:RLEVel <real> :DISPlay:EVM:VIEW7:WINDow[1] 2:TRACe:Y[:SCALe]:RLEVel?
Example	DISP:EVM:VIEW7:WIND:TRAC:Y:RLEV 100 DISP:EVM:VIEW7:WIND:TRAC:Y:RLEV?
Notes	When Auto Scaling is On, this value is automatically determined by the measurement result. The value is switched depending on Scale Type.
Couplings	When this value is set manually, Auto Scaling is set to Off. Attenuation is not coupled to Ref Value.
Preset	0.00 dBm
State Saved	Saved in instrument state.
Min	-250 dBm

Max	250 dBm
Initial S/W Revision	Prior to A.02.00

Ref Value (Symbol Power vs. Subcarrier/Symbol Power vs. Symbol Window)

Y Ref Value sets the reference value for the y-axis in the Symbol Power vs. subcarrier and Symbol Power vs. Symbol window of the Symbol Power view.

Key Path	AMPTD Y Scale
Mode	WIMAXOFDMA
Remote Command	:DISPlay:EVM:VIEW4:WINDow[1] 2:TRACe:Y[:SCALe]:RLEVel <real> :DISPlay:EVM:VIEW4:WINDow[1] 2:TRACe:Y[:SCALe]:RLEVel?
Example	DISP:EVM:VIEW4:WIND:TRAC:Y:RLEV 100 DISP:EVM:VIEW4:WIND:TRAC:Y:RLEV?
Notes	When Auto Scaling is On, this value is automatically determined by the measurement result. The value is switched depending on Scale Type.
Couplings	When this value is set manually, Auto Scaling is set to Off. Attenuation is not coupled to Ref Value.
Preset	0.00 dBm
State Saved	Saved in instrument state.
Min	-250 dBm
Max	250 dBm
Initial S/W Revision	Prior to A.02.00

Attenuation

This menu controls the attenuator functions and interactions between the attenuation system components.

There are two attenuator configurations in the X-Series. One is a dual attenuator configuration consisting of a mechanical attenuator and an optional electronic attenuator. The other configuration uses a single attenuator with combined mechanical and electronic sections that controls all the attenuation functions. Different models in the X-Series come with different configurations.

See ["Dual Attenuator Configurations:" on page 1619](#)

See ["Single Attenuator Configuration:" on page 1619](#)

Most Attenuation settings are the same for all measurements – they do not change as you change measurements. Settings like these are called “Meas Global” and are unaffected by Meas Preset.

Key Path	AMPTD Y Scale
----------	---------------

Scope	Meas Global
Dependencies	In measurements that support the I/Q inputs, this key is unavailable when I/Q is the selected input, and is replaced by the Range key in that case.
Readback Line	Contains a summary in [] brackets of the current total attenuation. See the descriptions of the , " (Mech) Atten " on page 2141, and " Enable Elec Atten " on page 2143 keys for more detail on the contributors to the total attenuation. Note that when "Pre-Adjust for Min Clip" is on, this value can change at the start of every measurement.
Initial S/W Revision	Prior to A.02.00
Modified at S/W Revision	A.03.00

Dual Attenuator Configurations:

Configuration 1: Mechanical attenuator + optional electronic attenuator

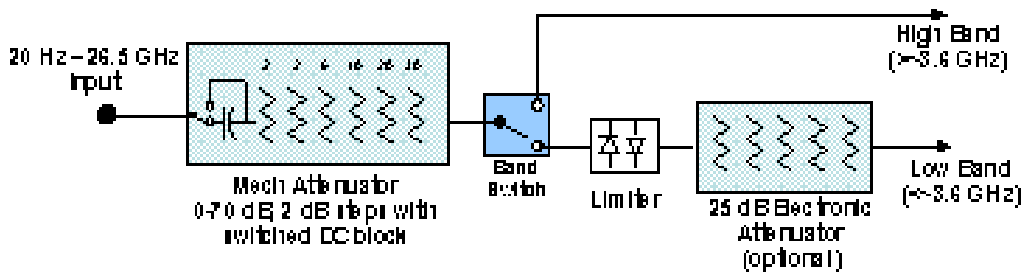

Configuration 2: Mechanical attenuator, no optional electronic attenuator

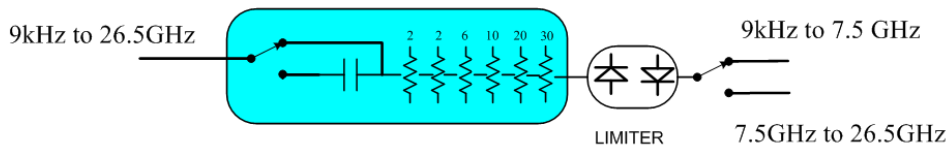

(note that Configuration 2 is not strictly speaking a dual-section attenuator, since there is no electronic section available. However, it behaves exactly like Configuration 1 without the Electronic Attenuator option EA3, therefore for the sake of this document it is grouped into the "Dual Attenuator" configuration)

Single Attenuator Configuration:

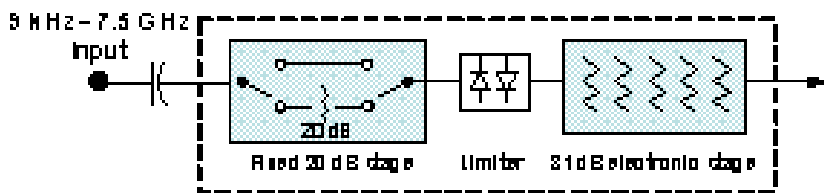

You can tell which attenuator configuration you have by pressing the Attenuation key, which (in most Modes) opens the Attenuation menu. If the first key in the Attenuation menu says Mech Atten you have the dual attenuator configuration. If the first key says Atten you have the single attenuator configuration.

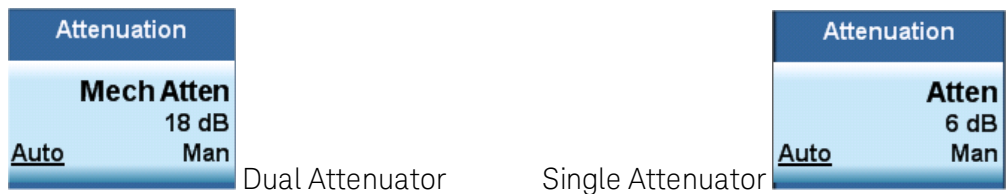

In the single attenuator configuration, you control the attenuation with a single control, as the fixed stage has only two states. In the dual attenuator configuration, both stages have significant range so you are given separate control of the mechanical and electronic attenuator stages.

When you have the dual attenuator configuration, you may still have only a single attenuator, because unless option EA3 (the Electronic Attenuator option) is available, and you purchase it, you will have only the mechanical attenuator.

(Mech) Atten

This key is labeled Mech Atten in dual attenuator models and Atten in single attenuator models. In the dual attenuator configuration, this key only affects the mechanical attenuator.

This key lets you modify the attenuation applied to the RF input signal path. This value is normally auto coupled to the Ref Level, the Internal Preamp Gain, any External Gain that is entered, and the Max Mixer Level, as described in the table below.

See "[Attenuator Configurations and Auto/Man](#)" on page 1621

Key Path	AMPTD Y Scale, Attenuation
Remote Command	<pre>[:SENSe] : POWer [:RF] : ATTenuation <rel_ampl> [:SENSe] : POWer [:RF] : ATTenuation? [:SENSe] : POWer [:RF] : ATTenuation : AUTO OFF ON 0 1 [:SENSe] : POWer [:RF] : ATTenuation : AUTO ?</pre>
Example	<p>POW:ATT 20</p> <p>Dual attenuator configuration: sets the mechanical attenuator to 20 dB</p> <p>Single attenuator mode: sets the main attenuation to 20 dB (see below for definition of "main" attenuation).</p> <p>If the attenuator was in Auto, it sets it to Manual.</p>
Dependencies	<p>Some measurements do not support the Auto setting of (Mech) Atten. In these measurements, the Auto/Man selection is not available, and the Auto/Man line on the key disappears.</p> <p>In dual attenuator configurations, when the electronic attenuator is enabled, the mechanical attenuator has no auto setting and the Auto/Man line on the key disappears. The state of Auto/Man is remembered and restored when the electronic attenuator is once again disabled. This is described in more detail in the "Enable Elec Atten" on page 2143 key description.</p> <p>See "Attenuator Configurations and Auto/Man" on page 1621 for more information on the Auto/Man functionality of Attenuation.</p>
Couplings	

	<p>When (Mech) Atten is in Auto, it uses the following algorithm to determine a value: If the USB Preamp is connected to USB, use 0 dB. Otherwise, $Atten = ReferenceLevel + PreAmpGain + ExternalGain - RefLevelOffset - MaxMixerLevel + IF\ Gain$. Limit this value to be between 6 dB and the Max value. No value below 6 dB can ever be chosen by Auto. The resulting value is rounded up to the largest value possible given the attenuation step setting. That is, 50.01 dB would change to 60 dB (for a 10 dB attenuation step). The "IF Gain" term in the equation above is either 0 dB or +10 dB, depending on the settings of FFT IF Gain, Swept IF Gain, max Ref Level and the Auto/Man setting of Mech Atten. In External Mixing and BBIQ, where the Attenuator is not in the signal path, the Attenuator setting changes as described above when (Mech) Atten is in Auto, but no changes are made to the actual attenuator hardware setting until the input is changed back to the RF Input.</p>
Preset	<p>The preset for Mech Attenuation is "Auto." The Auto value of attenuation is: CXA, EXA, MXA and PXA: 10 dB</p>
State Saved	Saved in instrument state
Min	<p>0 dB The attenuation set by this key cannot be decreased below 6 dB with the knob or step keys. To get to a value below 6 dB it has to be directly entered from the keypad or via SCPI. This protects from adjusting the attenuation to a dangerously small value which can put the instrument at risk of damage to input circuitry. However, if the current mechanical attenuation is below 6 dB it can be increased with the knob and step keys, but not decreased.</p>
Max	<p>CXA N9000A-503/507: 50 dB CXA N9000A-513/526: 70dB EXA: 60 dB MXA and PXA: 70 dB In the single attenuator configuration, the total of ATT and EATT cannot exceed 50 dB, so if the EATT is set to 24 dB first, the main attenuation cannot be greater than 26 dB and will be reduced accordingly; if the main attenuator is set to 40 dB first, EATT cannot be greater than 10 dB.</p>
Initial S/W Revision	Prior to A.02.00
Modified at S/W Revision	A.03.00

Attenuator Configurations and Auto/Man

As described in the Attenuation key description, there are two distinct attenuator configurations available in the X-Series, the single attenuator and dual attenuator configurations. In dual attenuator configurations, we have the mechanical attenuation and the electronic attenuation, and the current total attenuation is the sum of the electronic + mechanical attenuation. In single attenuator configurations, we refer to the attenuation set using the (Mech) Atten key (or POW:ATT SCPI) as the "main" attenuation; and the attenuation that is set by the SCPI command POW:EATT as the "soft" attenuation (the POW:EATT command is honored even in the single attenuator configuration, for compatibility purposes). Then the

current total attenuation is the sum of the main + soft attenuation. See the Elec Atten key description for more on “soft” attenuation.

In the dual attenuator configuration, when the electronic attenuator is enabled, there is no Auto/Man functionality for the mechanical attenuator, and the third line of the key label (the Auto/Man line) disappears:

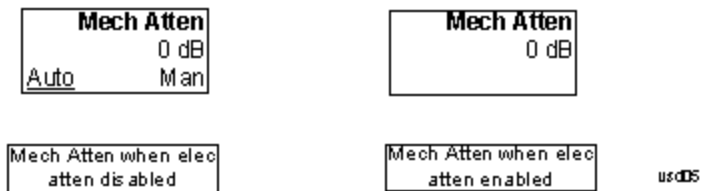

Enable Elec Atten

Enables the Electronic Attenuator.

The electronic attenuator offers finer steps than the mechanical attenuator, has no acoustical noise, is faster, and is less subject to wear. These advantages primarily aid in remote operation and are negligible for front panel use. See ["Using the Electronic Attenuator: Pros and Cons" on page 1624](#) for a detailed discussion of the pros and cons of using the electronic attenuator.

For the single attenuator configuration, for SCPI backwards compatibility, the “soft” attenuation feature replaces the dual attenuator configuration’s electronic attenuator. All the same couplings and limitations apply. See ["Attenuator Configurations and Auto/Man" on page 2143](#)

See ["More Information" on page 1623](#)

Key Path	AMPTD Y Scale, Attenuation
Remote Command	[:SENSe] :POWer [:RF] :EATTenuation :STATe OFF ON 0 1 [:SENSe] :POWer [:RF] :EATTenuation :STATe ?
Example	POW:EATT:STAT ON
Dependencies	<p>This key only appears in Dual Attenuator models with an Electronic Attenuator installed. It does not appear in models with the Single Attenuator configuration, as in the single attenuator configuration there is no “electronic attenuator” there is only a single integrated attenuator (which has both a mechanical and electronic stage). However, in the single attenuator configuration, EATT SCPI commands are accepted for compatibility with other X-series instruments and set a “soft” attenuation as described in "Attenuator Configurations and Auto/Man" on page 2143.</p> <p>The electronic attenuator (and the “soft” attenuation function provided in single attenuator configurations) is unavailable above 3.6 GHz. Therefore, if the Stop Frequency of the analyzer is > 3.6 GHz then the Enable Elec Atten key will be OFF and grayed out.</p> <p>If the Internal Preamp is on, meaning it is set to Low Band or Full, the electronic attenuator (and the “soft” attenuation function provided in single attenuator configurations) is unavailable. In this case the Enable Elec Atten key will be OFF and grayed out.</p> <p>If either of the above is true, if the SCPI command is sent, an error indicating that the electronic attenuator is unavailable will be sent.</p> <p>If the electronic/soft Attenuator is enabled, then the Stop Freq of the analyzer is limited to 3.6 GHz and the Internal Preamp is unavailable.</p> <p>The SCPI-only “soft” electronic attenuation for the single-attenuator configuration is not available in</p>

	all measurements; in particular, it is not available in the Swept SA measurement.
Couplings	Enabling and disabling the Electronic Attenuator affects the setting of the Mechanical Attenuator (in dual attenuator configurations). This is described in more detail below this table.
Preset	OFF for Swept SA measurement; ON for all other measurements that support the electronic attenuator
State Saved	Saved in instrument state
Initial S/W Revision	Prior to A.02.00
Modified at S/W Revision	A.03.00

More Information

Mechanical Attenuator Transition Rules

When the Electronic Attenuator is enabled, the Mechanical Attenuator transitions to a state that has no Auto function. Below are the rules for transitioning the Mechanical Attenuator. NOTE that the information below ONLY applies to the dual attenuator configurations, and ONLY when the Electronic Attenuator is installed:

When the Electronic Attenuation is enabled from a disabled state:

- The Mechanical Attenuator is initialized to 10 dB (this is its optimal performance setting). You can then set it as desired with SCPI, numeric keypad, step keys, or knob, and it behaves as it normally would in manual mode
- The Auto/Man state of (Mech) Atten is saved
- The Auto/Man line on the (Mech) Atten key disappears and the auto rules are disabled
- The Electronic Attenuator is set to 10 dB less than the previous value of the Mechanical Attenuator, within the limitation that it must stay within the range of 0 to 24 dB of attenuation.

Examples in the dual attenuator configuration:

- Mech Atten at 20 dB. Elec Atten enabled, Mech Atten set to 10 dB, and Elec Atten set to 10 dB. New total attenuation equals the value before Elec Atten enabled.
- Mech Atten at 0 dB. Elec Atten enabled, Mech Atten set to 10 dB, and Elec Atten set to 0 dB. New total attenuation does not equal the value before Elec Atten enabled.
- Mech Atten at 40 dB. Elec Atten enabled, Mech Atten set to 10 dB, and Elec Atten set to 24 dB. New total attenuation does not equal the value before Elec Atten enabled.

When the Electronic Attenuation is disabled from an enabled state:

- The Elec Atten key is grayed out
- The Auto/Man state of (Mech) Atten is restored
- If now in Auto, (Mech) Atten recouples

- If now in Man, (Mech) Atten is set to the value of total attenuation that existed before the Elec Atten was disabled. The resulting value is rounded up to the smallest value possible given the (Mech) Atten Step setting - (That is, 57 dB changes to 58 dB when (Mech) Atten Step is 2 dB.)

Using the Electronic Attenuator: Pros and Cons

The electronic attenuator offers finer steps than the mechanical attenuator, has no acoustical noise, is faster, and is less subject to wear.

The “finer steps” advantage of the electronic attenuator is beneficial in optimizing the alignment of the analyzer dynamic range to the signal power in the front panel as well as remote use. Thus, you can achieve improved relative signal measurement accuracy. Compared to a mechanical attenuator with 2 dB steps, the 1 dB resolution of the electronic attenuator only gives better resolution when the odd-decibel steps are used. Those odd-decibel steps are less accurately calibrated than the even-decibel steps, so one tradeoff for this superior relative accuracy is reduced absolute amplitude accuracy.

Another disadvantage of the electronic attenuator is that the spectrum analyzer loses its “Auto” setting, making operation less convenient.

Also, the relationship between the dynamic range specifications (TOI, SHI, compression and noise) and instrument performance are less well-known with the electrical attenuator. With the mechanical attenuator, TOI, SHI and compression threshold levels increase dB-for-dB with increasing attenuation, and the noise floor does as well. With the electronic attenuator, there is an excess attenuation of about 1 to 3 dB between 0 and 3.6 GHz, making the effective TOI, SHI, and so forth, less well known. Excess attenuation is the actual attenuation relative to stated attenuation. Excess attenuation is accounted for in the analyzer calibration

Elec Atten

Controls the Electronic Attenuator in dual attenuator configurations. This key does not appear in single attenuator configurations, as the control of both the mechanical and electronic stages of the single attenuator is integrated into the single Atten key.

Key Path	AMPTD Y Scale, Attenuation
Remote Command	<code>[:SENSe] :POWer [:RF] :EATTenuation <rel_amp></code> <code>[:SENSe] :POWer [:RF] :EATTenuation?</code>
Notes	Electronic Attenuation's specification is defined only when Mechanical Attenuation is 6 dB.
Dependencies	This key only appears in Dual Attenuator models with an Electronic Attenuator installed. It does not appear in models with the Single Attenuator configuration, as in the single attenuator configuration there is no “electronic attenuator” there is only a single integrated attenuator (which has both a mechanical and electronic stage). However, in the single attenuator configuration, EATT SCPI commands are accepted for compatibility with other X-series instruments and set a “soft” attenuation as described in "Attenuator Configurations and Auto/Man" on page 2143 . The “soft” attenuation is treated as an addition to the “main” attenuation value set by the Atten softkey or the POW:ATT SCPI command and affects the total attenuation displayed on the Attenuation key and the Meas Bar. When Enable Elec Atten is off or grayed out, the Elec Atten key is grayed out.
Preset	0 dB
State Saved	Saved in instrument state

Min	0 dB
Max	Dual attenuator configuration: 24 dB Single attenuator configuration: the total of ATT and EATT cannot exceed 50 dB, so if the EATT is set to 24 dB first, the main attenuation cannot be greater than 26 dB and will be reduced accordingly; if the main attenuator is set to 40 dB first, EATT cannot be greater than 10 dB
Initial S/W Revision	Prior to A.02.00
Modified at S/W Revision	A.03.00

Adjust Atten for Min Clip

Sets the combination of mechanical and electronic attenuation and gain based on the current measured signal level so that clipping will be at a minimum.

This is an "immediate action" function, that is, it executes once, when the key is pressed.

This key is grayed out in measurements that do not support this functionality. The spectrum analyzer measurement, Swept SA, does not support this functionality.

Key Path	AMPTD Y Scale, Attenuation
Remote Command	<code>[:SENSe] :POWer [:RF] :RANGe :OPTimize IMMEDIATE</code>
Initial S/W Revision	Prior to A.02.00
Modified at S/W Revision	A.03.00

Pre-Adjust for Min Clip

If this function is on, it does the adjustment described under "[Adjust Atten for Min Clip](#)" on page 2146 each time a measurement restarts. Therefore, in Continuous measurement mode, it only executes before the first measurement.

In dual attenuator models, you can set Elec+Mech Atten, in which case both attenuators participate in the autoranging, or Elec Atten Only, in which case the mechanical attenuator does not participate in the autoranging. This latter case results in less wear on the mechanical attenuator and is usually faster.

This key is grayed out in measurements that do not support this functionality. The spectrum analyzer measurement, Swept SA, does not support this functionality.

Key Path	AMPTD Y Scale, Attenuation
Remote Command	<code>[:SENSe] :POWer [:RF] :RANGe :OPTimize :ATTenuation OFF ELECTrical COMBined</code> <code>[:SENSe] :POWer [:RF] :RANGe :OPTimize :ATTenuation?</code>
Notes	The SCPI parameter ELECTrical sets this function to On in single attenuator models. The SCPI parameter COMBined is mapped to ELECTrical in single attenuator models; if you send COMBined, it sets the function to On and returns ELEC to a query.
Dependencies	This key only appears in Dual Attenuator models with an Electronic Attenuator installed.

	In instruments with Dual Attenuator model, when Enable Elec Atten is off or grayed out, the Pre-Adjust for Min Clip key is grayed out.
Preset	OFF for Swept SA measurement; ON for all other measurements that support Pre-Adjust for Min Clip
State Saved	Saved in instrument state
Range	Dual attenuator models: Off Elec Atten Only Mech + Elec Atten Single attenuator models: Off On
Initial S/W Revision	Prior to A.02.00
Modified at S/W Revision	A.03.00

Remote Command	<code>[:SENSe] :POWer [:RF] :RANGe :AUTO ON OFF 1 0</code> <code>[:SENSe] :POWer [:RF] :RANGe :AUTO?</code>
Notes	ON aliases to "Elec Atten Only" (:POW:RANG:OPT:ATT ELEC) OFF aliases to "Off" (:POW:RANG:OPT:ATT OFF) The query :POW:RANG:AUTO? returns true if :POW:RANG:OPT:ATT is not "Off"
Initial S/W Revision	Prior to A.02.00

Off

Turns Pre-Adjust for Min Clip off. This is the default setting.

This key is grayed out in measurements that do not support this functionality. The spectrum analyzer measurement, Swept SA, does not support this functionality.

Key Path	AMPTD Y Scale, Attenuation, Pre-Adjust for Min Clip
Example	:POW:RANG:OPT:ATT OFF
Initial S/W Revision	Prior to A.02.00

Elec Atten Only

Selects only the electric attenuator to participate in auto ranging. This offers less wear on the mechanical attenuator and is usually faster.

This key is grayed out in measurements that do not support this functionality. The spectrum analyzer measurement, Swept SA, does not support this functionality.

Key Path	AMPTD Y Scale, Attenuation, Pre-Adjust for Min Clip
Example	:POW:RANG:OPT:ATT ELEC
Initial S/W Revision	Prior to A.02.00

Mech + Elec Atten

In dual attenuator models, this selects both attenuators participate in the autoranging.

This key is grayed out in measurements that do not support this functionality. The spectrum analyzer measurement, Swept SA, does not support this functionality.

Key Path	AMPTD Y Scale, Attenuation, Pre-Adjust for Min Clip
Example	:POW:RANGe:OPT:ATT COMB
Initial S/W Revision	Prior to A.02.00

(Mech) Atten Step

This controls the step size used when making adjustments to the input attenuation.

This key is labeled Mech Atten Step in dual attenuator models and Atten Step in single attenuator models. In the dual attenuator configuration, this key only affects the step size of the mechanical attenuator.

Key Path	AMPTD Y Scale, Attenuation
Remote Command	[:SENSe] :POWer [:RF] :ATTenuation:STEP [:INCRement] 10 dB 2 dB [:SENSe] :POWer [:RF] :ATTenuation:STEP [:INCRement] ?
Example	POW:ATT:STEP 2
Notes	Note this feature works like a 1-N choice from the front panel, but it takes a specific value (in dB) when used remotely. The only valid values are 2 and 10.
Dependencies	Blanked in CXA and EXA if option FSA (2 dB steps) is not present. If blanked, attempts to set it via SCPI will yield an error.
Couplings	When the attenuation step size changes, the current mechanical attenuation value is adjusted (if necessary) to be quantized to the new step size. That is, if step is set to 10 dB, mech atten is increased if necessary so it is a multiple of 10 dB
Preset	PXA and MXA: 2 dB EXA and CXA: 10 dB (2 dB with option FSA)
State Saved	Saved in instrument state
Initial S/W Revision	Prior to A.02.00
Modified at S/W Revision	A.03.00

Scale/Div

Sets the logarithmic units per vertical graticule division in the display for the windows listed below, which are explained in greater detail in the following sections. When Auto Scaling is On, the Scale/Div is automatically determined by the measurement result. When you set a value manually, Auto Scaling is automatically toggled to Off.

Key Path	AMPTD Y Scale
Initial S/W Revision	Prior to A.02.00

Scale/Div (Symbol Error vs. Subcarrier/Symbol Error vs. Symbol Window - Log)

Sets the logarithmic units per vertical graticule division in the display for the Symbol Error vs. Subcarrier and Symbol Error vs. Symbol windows. The unit of value for the Y reference is set to dB when Scale Type (Log) is selected.

Key Path	AMPTD Y Scale
Mode	WIMAXOFDMA
Remote Command	:DISPlay:EVM:VIEW3:WINDow[1] 2:TRACe:Y[1][:SCALe]:PDIVision <rel_ampl> :DISPlay:EVM:VIEW3:WINDow[1] 2:TRACe:Y[1][:SCALe]:PDIVision?
Example	DISP:EVM:VIEW3:WIND:TRAC:Y:PDIV 10 DISP:EVM:VIEW3:WIND:TRAC:Y:PDIV?
Notes	When Auto Scaling is set to On, this value is automatically determined by the measurement result. The value is switched depending on Scale Type.
Couplings	When you set a value manually, Auto Scaling automatically changes to Off.
Preset	10 dB
State Saved	Saved in instrument state.
Min	0.01 dB
Max	40 dB
Initial S/W Revision	Prior to A.02.00

Scale/Div (Symbol Error vs. Subcarrier/Symbol Error vs. Symbol Window- Lin)

Sets the logarithmic units per vertical graticule division in the display for the Symbol Error vs. Subcarrier and Symbol Error vs. Symbol windows. The unit of value for the Y reference is set to % when Scale Type (Lin) is selected.

Key Path	AMPTD Y Scale
Mode	WIMAXOFDMA
Remote Command	:DISPlay:EVM:VIEW3:WINDow[1] 2:TRACe:Y2[:SCALe]:PDIVision <real> :DISPlay:EVM:VIEW3:WINDow[1] 2:TRACe:Y2[:SCALe]:PDIVision?
Example	DISP:EVM:VIEW3:WIND:TRAC:Y2:PDIV 10 DISP:EVM:VIEW3:WIND:TRAC:Y2:PDIV?
Notes	When Auto Scaling is set to On, this value is automatically determined by the measurement result. The value is switched depending on Scale Type.
Couplings	When you set a value manually, Auto Scaling automatically changes to Off.

Preset	1
State Saved	Saved in instrument state.
Min	0.01
Max	50
Initial S/W Revision	Prior to A.02.00

Scale/Div (Absolute Flatness Window)

Sets the logarithmic units per vertical graticule division in the display for the Absolute Flatness window of the Spectral Flatness view.

Key Path	AMPTD Y Scale
Mode	WIMAXOFDMA
Remote Command	:DISPlay:EVM:VIEW6:WINDow[1]:TRACe:Y[:SCALe]:PDIVision <rel_amp1> :DISPlay:EVM:VIEW6:WINDow[1]:TRACe:Y[:SCALe]:PDIVision?
Example	DISP:EVM:VIEW6:WIND:TRAC:Y:PDIV 10 DISP:EVM:VIEW6:WIND:TRAC:Y:PDIV?
Notes	When Auto Scaling is On, this value is automatically determined by the measurement result. The value is switched depending on Scale Type.
Couplings	When you set a value manually, Auto Scaling automatically changes to Off.
Preset	1.0 dB
State Saved	Saved in instrument state.
Min	0.10 dB
Max	40 dB
Initial S/W Revision	Prior to A.02.00

Scale/Div (Differential Flatness Window)

Sets the logarithmic units per vertical graticule division in the display for the Differential Flatness window of the Spectral Flatness view.

Key Path	AMPTD Y Scale
Mode	WIMAXOFDMA
Remote Command	:DISPlay:EVM:VIEW6:WINDow2:TRACe:Y[:SCALe]:PDIVision <rel_amp1> :DISPlay:EVM:VIEW6:WINDow2:TRACe:Y[:SCALe]:PDIVision?
Example	DISP:EVM:VIEW6:WIND2:TRAC:Y:PDIV 10 DISP:EVM:VIEW6:WIND2:TRAC:Y:PDIV?
Notes	When Auto Scaling is set to On, this value is automatically determined by the measurement result. The value is switched depending on Scale Type.

Couplings	When this value is set manually, Auto Scaling is set to Off.
Preset	0.2 dB
State Saved	Saved in instrument state.
Min	0.01 dB
Max	40 dB
Initial S/W Revision	Prior to A.02.00

Scale/Div (Power vs. Time/Power vs. Spectrum Window)

Sets the logarithmic units per vertical graticule division in the display for the Power vs. Time and Power vs. Spectrum windows of the Power vs. Time and Spectrum view.

Key Path	AMPTD Y Scale
Mode	WIMAXOFDMA
Remote Command	:DISPlay:EVM:VIEW7:WINDow[1] 2:TRACe:Y[:SCALe]:PDIVision <rel_ampl> :DISPlay:EVM:VIEW7:WINDow[1] 2:TRACe:Y[:SCALe]:PDIVision?
Example	DISP:EVM:VIEW7:WIND:TRAC:Y:PDIV 10 DISP:EVM:VIEW7:WIND:TRAC:Y:PDIV?
Notes	When Auto Scaling is set to On, this value is automatically determined by the measurement result. The value is switched depending on Scale Type.
Couplings	When this value is set manually, Auto Scaling is set to Off.
Preset	10 dB
State Saved	Saved in instrument state.
Min	0.10 dB
Max	40 dB
Initial S/W Revision	Prior to A.02.00

Scale/Div (Symbol Power vs. Subcarrier/Symbol Power vs. Symbol Window)

Sets the logarithmic units per vertical graticule division in the display for the Symbol Power vs. subcarrier and Symbol Power vs. Symbol window of the Symbol Power view.

Key Path	AMPTD Y Scale
Mode	WIMAXOFDMA
Remote Command	:DISPlay:EVM:VIEW4:WINDow[1] 2:TRACe:Y[:SCALe]:PDIVision <rel_ampl> :DISPlay:EVM:VIEW4:WINDow[1] 2:TRACe:Y[:SCALe]:PDIVision?
Example	DISP:EVM:VIEW4:WIND:TRAC:Y:PDIV 10 DISP:EVM:VIEW4:WIND:TRAC:Y:PDIV?
Notes	When Auto Scaling is On, this value is automatically determined by the measurement result.

	The value is switched depending on Scale Type.
Couplings	When this value is set manually, Auto Scaling is set to Off.
Preset	10 dB
State Saved	Saved in instrument state.
Min	0.10 dB
Max	20 dB
Initial S/W Revision	Prior to A.02.00

Presel Center

When this key is pressed, the centering of the preselector filter is adjusted to optimize the amplitude accuracy at the frequency of the selected marker. If the selected marker is not on when Presel Center is pressed, the analyzer will turn on the selected marker, perform a peak search, and then perform centering on the marker's center frequency. If the selected marker is already on and between the start and stop frequencies of the analyzer, the analyzer performs the preselector calibration on that marker's frequency. If the selected marker is already on, but outside the frequency range between Start Freq and Stop Freq, the analyzer will first perform a peak search, and then perform centering on the marker's center frequency.

The value displayed on the Presel Adjust key will change to reflect the new preselector tuning (see Presel Adjust).

A number of considerations should be observed to ensure proper operation. See ["Proper Preselector Operation" on page 1632](#).

Key Path	AMPTD Y Scale
Remote Command	<code>[:SENSe] :POWer [:RF] :PCENter</code>
Example	POW:PCEN
Notes	Note that the rules outlined above under the key description apply for the remote command as well as the key. The result of the command is dependent on marker position, and so forth. Any message shown by the key press is also shown in response to the remote command.
Dependencies	<ul style="list-style-type: none"> • Grayed out if the microwave preselector is off.) • If the selected marker's frequency is below Band 1, advisory message 0.5001 is generated and no action is taken. • Grayed out if entirely in Band 0. • Blank in models that do not include a preselector, such as option 503. If the SCPI is sent in these instruments, it is accepted without error, and the query always returns 0. • Grayed out in the Spectrogram View.
Couplings	The active marker position determines where the centering will be attempted. If the analyzer is in a measurement such as averaging when centering is initiated, the act of centering the preselector will restart averaging but the first average trace will not be taken until the centering is completed.
Status Bits/OPC	When centering the preselector, *OPC will not return true until the process is complete and a

dependencies	subsequent measurement has completed, nor will results be returned to a READ or MEASure command. The Measuring bit should remain set while this command is operating and should not go false until the subsequent sweep/measurement has completed.
Initial S/W Revision	Prior to A.02.00
Modified at S/W Revision	A.03.00

Proper Preselector Operation

A number of considerations should be observed to ensure proper operation:

1. If the selected marker is off, the analyzer will turn on a marker, perform a peak search, and adjust the preselector using the selected marker's frequency. It uses the "highest peak" peak search method unqualified by threshold or excursion, so that there is no chance of a 'no peak found' error. It continues with that peak, even if it is the peak of just noise. Therefore, for this operation to work properly, there should be a signal on screen in a preselected range for the peak search to find.
2. If the selected marker is already on, the analyzer will attempt the centering at that marker's frequency. There is no preselector for signals below about 3.6 GHz, therefore if the marker is on a signal below 3.6 GHz, no centering will be attempted and an advisory message generated
3. In some models, the preselector can be bypassed. If it is bypassed, no centering will be attempted in that range and a message will be generated.

Preselector Adjust

Allows you to manually adjust the preselector filter frequency to optimize its response to the signal of interest. This function is only available when "Presel Center" on page 2149 is available.

For general purpose signal analysis, using Presel Center is recommended. Centering the filter minimizes the impact of long-term preselector drift. Presel Adjust can be used instead to manually optimize the preselector. One application of manual optimization would be to peak the preselector response, which both optimizes the signal-to-noise ratio and minimizes amplitude variations due to small (short-term) preselector drifting.

Key Path	AMPTD Y Scale
Scope	Meas Global
Remote Command	[:SENSe] :POWeR [:RF] :PADJust <freq> [:SENSe] :POWeR [:RF] :PADJust?
Example	POW:PADJ 100KHz POW:PADJ?
Notes	The value on the key reads out to 0.1 MHz resolution.
Dependencies	<ul style="list-style-type: none"> • Grayed out if microwave preselector is off.) • Grayed out if entirely in Band 0.

- Blank in models that do not include a preselector, such as option 503. If the SCPI is sent in these instruments, it is accepted without error, and the query always returns 0.
- Grayed out in the Spectrogram View.

Preset	0 MHz
State Saved	The Presel Adjust value set by Presel Center, or by manually adjusting Presel Adjust, is not saved in instrument state, and does not survive a Preset or power cycle.
Min	-500 MHz
Max	500 MHz
Default Unit	Hz
Backwards Compatibility SCPI	[:SENSe]:POWer[:RF]:MW:PADJust [:SENSe]:POWer[:RF]:MMW:PADJust PSA had multiple preselectors, but the X-Series has only one. These commands simply alias to [:SENSe]:POWer[:RF]:PADJust
Initial S/W Revision	Prior to A.02.00
Modified at S/W Revision	A.03.00

Remote Command	[:SENSe]:POWer[:RF]:PADJust:PRESelector MWAVE MMWave EXternal [:SENSe]:POWer[:RF]:PADJust:PRESelector?
Notes	PSA had multiple preselectors, and you could select which preselector to adjust. Since the X-Series has only one mm/uW preselector, the preselector selection softkey is no longer available. However, to provide backward compatibility, we accept the legacy remote commands. The command form has no effect, the query always returns MWAVE
Initial S/W Revision	Prior to A.02.00

μW Path Control

The μW Path Control functions include the μW Preselector Bypass (Option MPB) and Low Noise Path (Option LNP) controls in the High Band path circuits.

When the μW Preselector is bypassed, the user has better flatness, but will be subject to spurs from out of band interfering signals. When the Low Noise Path is enabled, the analyzer automatically switches around certain circuitry in the high frequency bands which can contribute to noise, when it is appropriate based on other analyzer settings.

For most applications, the preset state is Standard Path, which gives the best remote-control throughput, minimizes acoustic noise from switching and minimizes the risk of wear out in the hardware switches. For applications that utilize the wideband IF paths, the preset state is the μW Preselector Bypass path, if option MPB is present. This is because, when using a wideband IF such as the 140 MHz IF, the μW Preselector's bandwidth can be narrower than the available IF bandwidth, causing degraded amplitude flatness and phase linearity, so it is desirable to bypass the preselector in the default case.

Users may choose Low Noise Path Enable. It gives a lower noise floor, especially in the 21–26.5 GHz region, though without improving many measures of dynamic range, and without giving the best possible noise floor. The preamp, if purchased and used, gives better noise floor than does the Low Noise Path, however its compression threshold and third-order intercept are much poorer than that of the non-preamp Low Noise Path. There are some applications, typically for signals around –30 dBm, for which the third-order dynamic range of the standard path is good enough, but the noise floor is not low enough even with 0 dB input attenuation. When the third-order dynamic range of the preamp path is too little and the noise floor of the standard path is too high, the Low Noise Path can provide the best dynamic range.

Key Path	AMPTD Y Scale
Mode	SA, BASIC, PNOISE, VSA , LTE, LTETDD
Scope	Meas Global
Remote Command	[:SENSe] : POWer [:RF] : MW : PATH STD LNPath MPBypass FULL [:SENSe] : POWer [:RF] : MW : PATH ?
Example	:POW:MW:PATH LNP Enables the Low Noise path
Notes	If a Presel Center is performed, the analyzer will momentarily switch to the Standard Path, regardless of the setting of μ W Path Control The DC Block will always be switched in when the low noise path is switched in, to protect succeeding circuitry from DC. Note that this does not mean “when the low noise path is enabled” but when, based on the Low Noise Path rules, the path is actually switched in. This can happen when the selection is Low Noise Path Enable . In the case where the DC Block is switched in the analyzer is now AC coupled. However, if the user has selected DC coupling, the UI will still behave as though it were DC coupled, including all annunciation, warnings, status bits, and responses to SCPI queries. This is because, based on other settings, the analyzer could switch out the low noise path at any time and hence go back to being DC coupled. Alignment switching ignores the settings in this menu, and restores them when finished.
Dependencies	Unavailable in BBIQ and External Mixing
Preset	All modes other than IQ Analyzer mode and VXA: STD IQ Analyzer, VXA and WLAN mode: MPB option present and licensed: MPB MPB option not present and licensed: STD
State Saved	Save in instrument state
Readback	Value selected in the submenu
Initial S/W Revision	A.04.00
Modified at S/W Revision	A.10.00

Standard Path

This path gives the best remote-control throughput, minimizes acoustic noise from switching and minimizes the risk of wear in the hardware switches, particularly in remote test scenarios where both low band and high band setups will follow in rapid succession.

In this path, the bypass of the low band/high band switch and microwave preamp is never activated, which can cause some noise degradation but preserves the life of the bypass switch.

Key Path	AMPTD Y Scale, μ W Path Control
Example	:POW:MW:PATH STD
Readback Text	Standard Path
Initial S/W Revision	A.04.00

Low Noise Path Enable

You may choose Low Noise Path Enable, which gives a lower noise floor under some circumstances, particularly when operating in the 21–26.5 GHz region. With the Low Noise Path enabled, the low band/high band switch and microwave preamp are bypassed whenever all of the following are true:

- The analyzer is not in the Low Band, meaning:
- the start frequency is above 3.5 GHz and
- the stop frequency is above 3.6 GHz.
- the internal preamp is not installed or (if installed) is set to Off or Low Band

Note that this means that, when any part of a sweep is done in Low Band, the Low Noise Path is not used, whether or not the Low Noise Path Enable is selected in the user interface. Also, if the preamp is turned on, the Low Noise Path is not used, whether or not the Low Noise Path Enable is selected in the user interface. The only time the Low Noise Path is used is when Low Noise Path Enable is selected, the sweep is completely in High Band (> 3.6 GHz) and no preamp is in use.

See "[More Information](#)" on page 1636

Key Path	AMPTD Y Scale, μ W Path Control
Measurement	Swept SA
Example	:POW:MW:PATH LNP
Notes	<p>For measurements that use IQ acquisition, the low noise path is used when the Center Frequency is in High Band (> 3.6 GHz) and no preamp is in use.</p> <p>In other words, the rules above are modified to use only the center frequency to qualify which path to switch in.</p> <p>This is not the case for FFT's in the Swept SA measurement; they use the same rules as swept measurements.</p>
Dependencies	<p>Key is blanked if current mode does not support it.</p> <p>Key is grayed out if mode supports it but current measurement does not support it.</p> <p>Unless Option LNP is present and licensed, key is blank and if SCPI command sent, error -241, "Hardware missing; Option not installed" is generated.</p>
Readback Text	Low Noise Path Enable
Initial S/W Revision	A.04.00

More Information

The user should understand that the Low Noise Path, while giving improved DANL, has the disadvantage of decreased TOI performance and decreased gain compression performance relative to the standard path.

The user should also understand that the bypass switch is a mechanical switch and has finite life, so if the Low Noise Path is enabled, it is possible to cause frequent cycling of this switch by frequently changing analyzer settings such that the above conditions hold true only some of the time. A user making tests of this nature should consider opting for the Standard Path, which will never throw the bypass switch, at the expense of some degraded noise performance.

The low noise path is useful for situations where the signal level is so low that the analyzer performance is dominated by noise even with 0 dB attenuation, but still high enough that the preamp option would have excessive third-order intermodulation or compression. The preamp, if purchased and used, gives better noise floor than does the “Low Noise Path.” However, its compression threshold and third-order intercept are much poorer than that of the non-preamp path. There are some applications, typically for signals around -30 dBm, for which the third-order dynamic range of the standard path is good enough, but the noise floor is not low enough even with 0 dB input attenuation. When the third-order dynamic range of the preamp path is too little and the noise floor of the standard path is too high, the Low Noise Path can provide the best dynamic range

The graph below illustrates the concept. It shows, in red, the performance of an analyzer at different attenuation settings, both with the preamp on and off, in a measurement that is affected by both analyzer noise and analyzer TOI. The green shows the best available dynamic range, offset by 0.5 dB for clarity. The blue shows how the best available dynamic range improves for moderate signal levels with the low noise path switched in. In this illustration, the preamp improves the noise floor by 15 dB while degrading the third-order intercept by 30 dB, and the low noise path reduces loss by 8 dB. The attenuator step size is 2 dB.

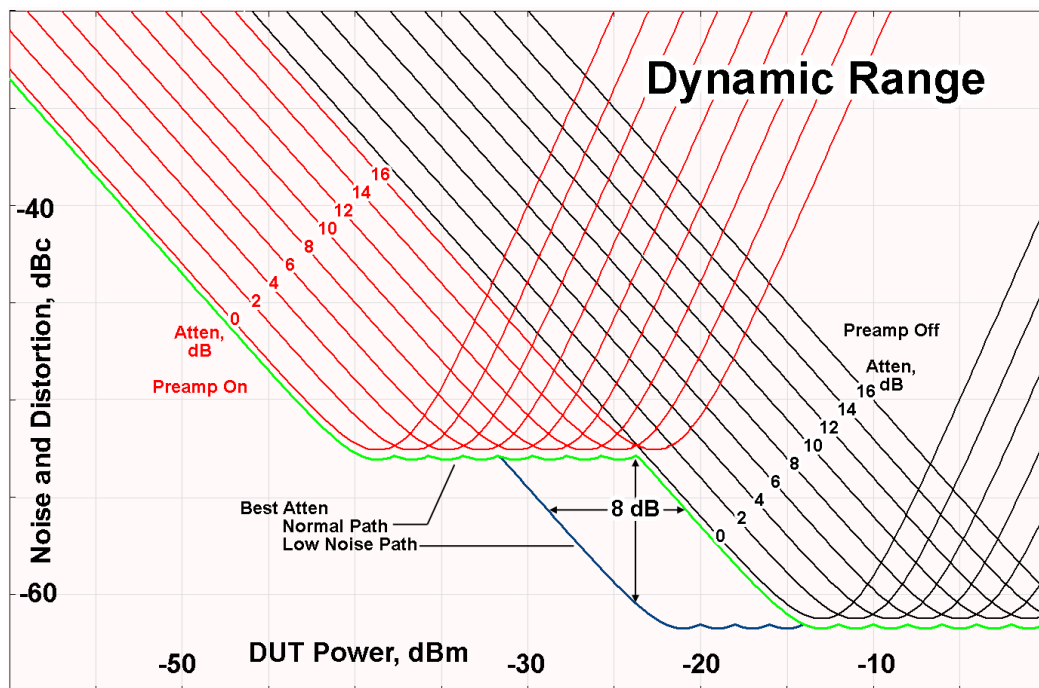

There are other times where selecting the low noise path improves performance, too. Compression-limited measurements such as finding the nulls in a pulsed-RF spectrum can profit from the low noise path in a way similar to the TOI-limited measurement illustrated. Accuracy can be improved when the low noise path allows the optimum attenuation to increase from a small amount like 0, 2 or 4 dB to a larger amount, giving better return loss at the analyzer input. Harmonic measurements, such as second and third harmonic levels, are much improved using the low noise path because of the superiority of that path for harmonic (though not intermodulation) distortion performance.

μW Preselector Bypass

This key toggles the preselector bypass switch for band 1 and higher. When the microwave preselect is on, the signal path is preselected. When the microwave preselector is off, the signal path is not preselected. The preselected path is the normal path for the analyzer.

The preselector is a tunable bandpass filter which prevents signals away from the frequency of interest from combining in the mixer to generate in-band spurious signals (images). The consequences of using a preselector filter are its limited bandwidth, the amplitude and phase ripple in its passband, and any amplitude and phase instability due to center frequency drift.

Option MPB or pre-selector bypass provides an unpreselected input mixer path for certain X-Series signal analyzers with frequency ranges above 3.6 GHz. This signal path allows a wider bandwidth and less amplitude variability, which is an advantage when doing modulation analysis and broadband signal analysis. The disadvantage is that, without the preselector, image signals will be displayed. Another disadvantage of bypassing the preselector is increased LO emission levels at the front panel input port.

Image responses are separated from the real signal by twice the 1st IF. For IF Paths of 10 MHz and 25 MHz, the 1st IF is 322.5 MHz, so the image response and the real signal will be separated by 645 MHz. The 1st IF will be different for other IF Path settings. When viewing a real signal and its corresponding image response in internal mixing, the image response will be to the left of the real signal.

Also, the image response and the real signal typically have the same amplitude and exhibit the same shape factor.

However, if Option FS1, Fast Sweep Capability, is enabled, the image response in the Swept SA measurement will appear lower in amplitude and have a much wider shape factor compared to the real signal.

Key Path	AMPTD Y Scale, μW Path Control
Example	:POW:MW:PATH MPB
Dependencies	Key is blanked if current mode does not support it. Key is grayed out if mode supports it but current measurement does not support it. Key is blank unless Option MPB is present and licensed. If SCPI command sent when MPB not present, error -241, "Hardware missing; Option not installed" is generated.
Readback Text	μW Preselector Bypass
Initial S/W Revision	A.04.00
Remote Command	[:SENSe] :POWer [:RF] :MW:PRESelector [:STATe] ON OFF 0 1 [:SENSe] :POWer [:RF] :MW:PRESelector [:STATe] ?

Example	:POW:MW:PRES OFF Bypasses the microwave preselector
Notes	The ON parameter sets the STD path (:POW:MW:PATH STD) The OFF parameter sets path MPB (:POW:MW:PATH MPB)
Preset	ON

Internal Preamp

Accesses a menu of keys that control the internal preamps. Turning on the preamp gives a better noise figure, but a poorer TOI to noise floor dynamic range. You can optimize this setting for your particular measurement.

The instrument takes the preamp gain into account as it sweeps. If you sweep outside of the range of the preamp the instrument will also account for that. The displayed result will always reflect the correct gain.

For some measurements, when the preamp is on and any part of the displayed frequency range is below the lowest frequency for which the preamp has specifications, a warning condition message appears in the status line. For example, for a preamp with a 9 kHz lowest specified frequency: "Preamp: Accy unspec'd below 9 kHz".

Key Path	AMPTD Y Scale
Scope	Meas Global
Remote Command	[:SENSe] :POWer [:RF] :GAIN [:STATe] OFF ON 0 1 [:SENSe] :POWer [:RF] :GAIN [:STATe] ?
Dependencies	Preamp is not available on all hardware platforms. If the preamp is not present or is unlicensed, the key is not shown. The preamp is not available when the electronic/soft attenuator is enabled.
Couplings	The act of connecting the U7227A USB Preamplifier to one of the analyzer's USB ports will cause the Internal Preamp to be switched on. When this happens an informational message will be generated: "Internal Preamp turned on for optimal operation with USB Preamp." Note that if the Internal Preamp was already on, there will be no change to the setting, but if it was Off it will be switched On, to Full Range. Note that this same action occurs when the SA mode is selected while the USB Preamp is connected to one of the analyzer's USB ports, if it is the first time that the SA mode has run since powerup, or if the last time the SA mode was running the USB Preamp was NOT connected. Subsequently disconnecting the USB Preamp from USB does not change the Internal Preamp setting nor restore the previous setting.
Preset	OFF
State Saved	Saved in instrument state
Initial S/W Revision	Prior to A.02.00
Modified at S/W Revision	A.14.00

Key Path	AMPTD Y Scale, Internal Preamp
Scope	Meas Global
Remote Command	[:SENSe] :POWer [:RF] :GAIN:BAND LOW FULL [:SENSe] :POWer [:RF] :GAIN:BAND?
Dependencies	Preamp is not available on all hardware platforms. If the preamp is not present or is unlicensed, the key is not shown. If a POW:GAIN:BAND FULL command is sent when a low band preamp is available, the preamp band parameter is to LOW instead of FULL, and an "Option not installed" message is generated.
Preset	LOW
State Saved	Saved in instrument state
Initial S/W Revision	Prior to A.02.00

Off

Turns the internal preamp off

Key Path	AMPTD Y Scale, Internal Preamp
Example	:POW:GAIN OFF
Readback	Off
Initial S/W Revision	Prior to A.02.00

Low Band

Sets the internal preamp to use only the low band.

The frequency range of the installed (optional) low-band preamp is displayed in square brackets on the Low Band key label.

Key Path	AMPTD Y Scale, Internal Preamp
Example	:POW:GAIN ON :POW:GAIN:BAND LOW
Readback	Low Band
Initial S/W Revision	Prior to A.02.00

Full Range

Sets the internal preamp to use its full range. The low band (0–3.6 GHz or 0–3GHz, depending on the model) is supplied by the low band preamp and the frequencies above low band are supplied by the high band preamp.

The frequency range of the installed (optional) preamp is displayed in square brackets on the Full Range key label. If the high band option is not installed the Full Range key does not appear.

Key Path	AMPTD Y Scale, Internal Preamp
Example	:POW:GAIN ON :POW:GAIN:BAND FULL
Readback	Full Range
Initial S/W Revision	Prior to A.02.00

Range

This key is only available when I/Q is the selected input. It replaces the Attenuation key in that case.

Each input channel (I and Q) has four internal gain ranges. The maximum allowed voltage in each gain range is slightly more than the nominal value, so the break point between ranges is a couple of millivolts higher than the nominal (setting a peak voltage of 0.502 mV will still map to the 0.5 V Peak range).

Gain Setting	Volts RMS	Volts Peak	Volts Peak - Peak	dBm (50Ω)	Break Point
0 dB	0.7071	1.0	2.0	10	n/a
6 dB	0.3536	0.5	1.0	4	0.502 V Peak
12 dB	0.1768	0.25	0.5	-2	0.252 V Peak
18 dB	0.0884	0.125	0.25	-8	0.127 V Peak

Key Path	AMPTD Y Scale
Notes	Visible only when the selected input is I/Q.
State Saved	No
Readback Text	When Range is Auto, "[Auto]" When Range is Man and I & Q are the same, "[<range value>]" When Range is Man and I & Q are different: "[: <I range value> Q: <Q range value>]" See I Range and Q Range for the <range value> enumeration definition.
Initial S/W Revision	Prior to A.02.00

Range Auto/Man

The Auto setting for Range causes the range to be set based on the Y Scale settings. When Range is "Auto", the I & Q Range are set based on the top of the Y Scale when the Y scale is in dB units (for example, power), or to the max(abs(top), abs(bottom)) when the Y scale reference is not at the top of the screen.

Not all measurements support Range Auto/Man. If Auto is not supported in the current measurement, this key is grayed out and shows “Man” and MAN is returned to a SCPI query, but this does NOT change the Auto/Man setting for Range. When you go to a measurement that supports Auto, it goes back to Auto if it was previously in Auto mode.

Key Path	AMPTD Y Scale, Range
Scope	Meas Global
Remote Command	[:SENSe] :VOLTagE:IQ:RANGe:AUTO OFF ON 0 1 [:SENSe] :VOLTagE:IQ:RANGe:AUTO?
Example	Put the I Range and Q Range in manual. VOLT:IQ:RANG:AUTO OFF
Dependencies	If Auto is not supported, sending the SCPI command will generate an error.
Couplings	When in Auto, both I Range and Q Range are set to the same value, computed as follows: Maximum absolute value is computed for the Y Scale. The top and bottom of the graph are computed based on Ref Value, Scale/Div, and Ref Position. Formula: YMax = max(abs(top), abs(bottom)). The I Range and Q Range are then set to YMax.
Preset	ON
State Saved	Saved in instrument state
Range	Auto Man
Initial S/W Revision	Prior to A.02.00

Remote Command	[:SENSe] :POWer:IQ:RANGe:AUTO OFF ON 0 1 [:SENSe] :POWer:IQ:RANGe:AUTO?
Example	Put the I Range and Q Range in manual. POW:IQ:RANG:AUTO OFF
Notes	The POW:IQ:RANG:AUTO is an alternate form of the VOLT:IQ:RANG:AUTO command. This is to maintain consistency with I Range and Q Range, which support both the POWER and VOLTage forms of the command.
Preset	ON
Range	Auto Man
Initial S/W Revision	Prior to A.02.00

I Range

This is the internal gain range for the I channel when Input Path is I Only or I and I/Q, and it is used for both the I and Q channels when the Input Path is I+jQ. See "[I/Q Gain Ranges](#)" on page 2165.

Key Path	AMPTD Y Scale, Range
Remote Command	[:SENSe] :VOLTagE:IQ[:I]:RANGe[:UPPer] <voltage> [:SENSe] :VOLTagE:IQ[:I]:RANGe[:UPPer] ?

Example	Set the I Range to 0.5 V Peak VOLT:IQ:RANG 0.5 V
Notes	The numeric entries are mapped to the smallest gain range whose break point is greater than or equal to the value, or 1 V Peak if the value is greater than 1 V.
Couplings	When Q Same as I is On, the I Range value will be copied to the Q Range. Changing the value will also set Range = Man.
Preset	1 V Peak
State Saved	Saved in instrument state
Range	1 V Peak 0.5 V Peak 0.25 V Peak 0.125 V Peak
Min	0.125 V
Max	1 V
Initial S/W Revision	Prior to A.02.00

Remote Command	<code>[:SENSe] :POWer :IQ [:I] :RANGe [:UPPer] <ampl></code> <code>[:SENSe] :POWer :IQ [:I] :RANGe [:UPPer] ?</code>
-----------------------	---

Example	Set the I Range to 0.5 V Peak when Reference Z is 50Ω, and to 1.0 V Peak when Reference Z is 75Ω. POW:IQ:RANG 4 dBm
Notes	The POWER form of the command is provided for convenience. It maps to the same underlying gain range parameter as the VOLTage form of the command. The Reference Z (not the I channel Input Z) is used to convert the power to peak voltage, which is then used to set the I Range as with the VOLTage form of the command. The power values of the 4 range states (1V Peak, 0.5V Peak, 0.25V Peak, and 0.125V Peak) will vary with Reference Z. Here are some examples: 50Ω: 10, 4, -2, -8 75Ω: 8.2, 2.2, -3.8, -9.8 600Ω: -0.8, -6.8, -12.8, -18.9
Preset	10.0 dBm
Range	-20 dBm to 10 dBm
Min	-20 dBm
Max	10 dBm
Initial S/W Revision	Prior to A.02.00

1 V Peak

Set the channel gain state to 1 Volt Peak.

Key Path	AMPTD Y Scale, I Range Q Range
Initial S/W Revision	Prior to A.02.00

0.5 V Peak

Set the channel gain state to 0.5 Volt Peak.

Key Path	AMPTD Y Scale, I Range Q Range
Initial S/W Revision	Prior to A.02.00

0.25 V Peak

Set the channel gain state to 0.25 Volt Peak.

Key Path	AMPTD Y Scale, I Range Q Range
Initial S/W Revision	Prior to A.02.00

0.125 V Peak

Set the channel gain state to 0.125 Volt Peak.

Key Path	AMPTD Y Scale, I Range Q Range
Initial S/W Revision	Prior to A.02.00

Q Range Value

This is the internal gain range for the Q channel. See "[I/Q Gain Ranges](#)" on page 2165. The Q Range only applies to Input Path Q Only and Ind I/Q. For input I+jQ the I Range determines both I and Q channel range settings.

Key Path	AMPTD Y Scale, Range
Remote Command	[:SENSe] :VOLTage:IQ:Q:RANGe[:UPPer] <voltage> [:SENSe] :VOLTage:IQ:Q:RANGe[:UPPer] ?
Example	Set the Q Range to 0.5 V Peak VOLT:IQ:Q:RANG 0.5 V
Notes	The numeric entries are mapped to the smallest gain range whose break point is greater than or equal to the value, or 1 V Peak if the value is greater than 1 V. The Q Range is only used for Input Path Q Only and Ind I/Q. For input I+jQ the I Range determines both I and Q channel range settings.
Couplings	When Q Same as I is On, the I Range value will be copied to the Q Range and the range value keys are disabled. Changing the value will also set Range = Man.
Preset	1 V Peak

State Saved	Saved in instrument state
Range	1 V Peak 0.5 V Peak 0.25 V Peak 0.125 V Peak
Min	0.125 V
Max	1 V
Initial S/W Revision	Prior to A.02.00

Remote Command	<code>[:SENSe] :POWer:IQ:Q:RANGe[:UPPer] <ampl></code> <code>[:SENSe] :POWer:IQ:Q:RANGe[:UPPer]?</code>
-----------------------	--

Example	Will set the Q Range to 0.5 V Peak when Reference Z is 50Ω, and to 1.0 V Peak when Reference Z is 75Ω. POW:IQ:Q:RANG 4 dBm
----------------	---

Notes	The POWER form of the command is provided for convenience. It maps to the same underlying gain range parameter as the VOLTage form of the command. The Reference Z (not the Q channel Input Z) is used to convert the power to peak voltage, which is then used to set the Q Range as with the VOLTage form of the command. The power values of the 4 range states (1V Peak, 0.5V Peak, 0.25V Peak, and 0.125V Peak) will vary with Reference Z. Here are some examples: 50Ω: 10, 4, -2, -8 75Ω: 8.2, 2.2, -3.8, -9.8 600Ω: -0.8, -6.8, -12.8, -18.9
-------	--

Preset	10.0 dBm
Range	-20 dBm to 10 dBm
Min	-20 dBm
Max	10 dBm
Initial S/W Revision	Prior to A.02.00

Q Same as I

Many, but not all, usages require the I and Q channels to have an identical setup. To simplify channel setup, the Q Same as I will cause the Q channel range to be mirrored from the I channel. That way you only need to set up one channel (the I channel). The I channel values are copied to the Q channel, so at the time Q Same as I is Off, the I and Q channel setups will be identical.

Key Path	AMPTD Y Scale, Range, Q Range
----------	-------------------------------

Remote Command	<code>[:SENSe] :VOLTage POWer:IQ:MIRRored OFF ON 0 1</code> <code>[:SENSe] :VOLTage POWer:IQ:MIRRored?</code>
-----------------------	--

Example	Turn off the mirroring of I Range to Q Range. VOLT:IQ:MIRR OFF POW:IQ:MIRR OFF
----------------	--

Couplings	When On, the I Range value is mirrored (copied) to the Q Range.
Preset	On
State Saved	Saved in instrument state.
Range	On Off
Readback Text	"Q Same as I" when On, otherwise none.
Initial S/W Revision	Prior to A.02.00

1 V Peak

Set the channel gain state to 1 Volt Peak.

Key Path	AMPTD Y Scale, I Range Q Range
Initial S/W Revision	Prior to A.02.00

0.5 V Peak

Set the channel gain state to 0.5 Volt Peak.

Key Path	AMPTD Y Scale, I Range Q Range
Initial S/W Revision	Prior to A.02.00

0.25 V Peak

Set the channel gain state to 0.25 Volt Peak.

Key Path	AMPTD Y Scale, I Range Q Range
Initial S/W Revision	Prior to A.02.00

0.125 V Peak

Set the channel gain state to 0.125 Volt Peak.

Key Path	AMPTD Y Scale, I Range Q Range
Initial S/W Revision	Prior to A.02.00

I/Q Gain Ranges

See the following sections:

["1 V Peak" on page 2165](#)

["0.5 V Peak" on page 2165](#)

["0.25 V Peak" on page 2165](#)

["0.125 V Peak" on page 2166](#)

1 V Peak

Set the channel gain state to 1 Volt Peak.

Key Path	AMPTD Y Scale, I Range Q Range
Initial S/W Revision	Prior to A.02.00

0.5 V Peak

Set the channel gain state to 0.5 Volt Peak.

Key Path	AMPTD Y Scale, I Range Q Range
Initial S/W Revision	Prior to A.02.00

0.25 V Peak

Set the channel gain state to 0.25 Volt Peak.

Key Path	AMPTD Y Scale, I Range Q Range
Initial S/W Revision	Prior to A.02.00

0.125 V Peak

Set the channel gain state to 0.125 Volt Peak.

Key Path	AMPTD Y Scale, I Range Q Range
Initial S/W Revision	Prior to A.02.00

Ref Position

Sets the reference position of the y-axis to the top, center, or bottom in the display of the following view windows, which are explained in greater detail in the following sections. Changing the reference position does not affect the reference level value.

Key Path	AMPTD Y Scale
Initial S/W Revision	Prior to A.02.00

Ref Position (Symbol Error vs. Subcarrier/Symbol Error vs. Symbol Window)

Ref Position sets the reference position of the y-axis to the top, center, or bottom in the display of the Symbol Error vs. Subcarrier and Symbol Error vs. Symbol windows.

Key Path	AMPTD Y Scale, More
Mode	WIMAXOFDMA
Remote Command	:DISPlay:EVM:VIEW3:WINDow[1] 2:TRACe:Y[1] 2[:SCALe]:RPOSition TOP CENTER BOTTom :DISPlay:EVM:VIEW3:WINDow[1] 2:TRACe:Y[1] 2[:SCALe]:RPOSition?
Example	DISP:EVM:VIEW3:WIND2:TRAC:Y:RPOS CENT DISP:EVM:VIEW3:WIND2:TRAC:Y:RPOS?
Preset	Y[1]: TOP Y2 : BOTTom
State Saved	Saved in instrument state.
Range	Top Ctr Bot
Initial S/W Revision	Prior to A.02.00

Ref Position (Absolute Flatness Window)

Ref Position sets the reference position of the y-axis to the top, center, or bottom in the display of the Absolute Flatness window of the Spectral Flatness view.

Key Path	AMPTD Y Scale, More
Mode	WIMAXOFDMA
Remote Command	:DISPlay:EVM:VIEW6:WINDow[1]:TRACe:Y[:SCALe]:RPOSition TOP CENTer BOTTom :DISPlay:EVM:VIEW6:WINDow[1]:TRACe:Y[:SCALe]:RPOSition?
Example	DISP:EVM:VIEW6:WIND:TRAC:Y:RPOS CENT DISP:EVM:VIEW6:WIND:TRAC:Y:RPOS?
Preset	CENT
State Saved	Saved in instrument state.
Range	Top Ctr Bot
Initial S/W Revision	Prior to A.02.00

Ref Position (Differential Flatness Window)

Ref Position sets the reference position of the y-axis to the top, center, or bottom in the display of the Differential Flatness window of the Spectral Flatness view.

Key Path	AMPTD Y Scale, More
----------	---------------------

Mode	WIMAXOFDMA
Remote Command	:DISPlay:EVM:VIEW6:WINDow2:TRACe:Y[:SCALe]:RPOSition TOP CENTer BOTTom :DISPlay:EVM:VIEW6:WINDow2:TRACe:Y[:SCALe]:RPOSition?
Example	DISP:EVM:VIEW6:WIND2:TRAC:Y:RPOS CENT DISP:EVM:VIEW6:WIND2:TRAC:Y:RPOS?
Preset	CENTER
State Saved	Saved in instrument state.
Range	Top Ctr Bot
Initial S/W Revision	Prior to A.02.00

Ref Position (Power vs. Time/Power vs. Spectrum Window)

Ref Position sets the reference position of the y-axis to the top, center, or bottom in the display of the Power vs. Time and Power vs. Spectrum windows of the Power vs. Time and Spectrum view.

Key Path	AMPTD Y Scale, More
Mode	WIMAXOFDMA
Remote Command	:DISPlay:EVM:VIEW7:WINDow[1] 2:TRACe:Y[:SCALe]:RPOSition TOP CENTer BOTTom :DISPlay:EVM:VIEW7:WINDow[1] 2:TRACe:Y[:SCALe]:RPOSition?
Example	DISP:EVM:VIEW7:WIND2:TRAC:Y:RPOS CENT DISP:EVM:VIEW7:WIND2:TRAC:Y:RPOS?
Preset	TOP
State Saved	Saved in instrument state.
Range	Top Ctr Bot
Initial S/W Revision	Prior to A.02.00

Ref Position (Symbol Power vs. Subcarrier/Symbol Power vs. Symbol Window)

Ref Position sets the reference position of the y-axis to the top, center, or bottom in the display of the Symbol Power vs. subcarrier and Symbol Power vs. Symbol windows of the Symbol Power view.

Key Path	AMPTD Y Scale, More
Mode	WIMAXOFDMA
Remote Command	:DISPlay:EVM:VIEW4:WINDow[1] 2:TRACe:Y[:SCALe]:RPOSition TOP CENTer BOTTom :DISPlay:EVM:VIEW4:WINDow[1] 2:TRACe:Y[:SCALe]:RPOSition?
Example	DISP:EVM:VIEW4:WIND2:TRAC:Y:RPOS CENT DISP:EVM:VIEW4:WIND2:TRAC:Y:RPOS?

Preset	TOP
State Saved	Saved in instrument state.
Range	Top Ctr Bot
Initial S/W Revision	Prior to A.02.00

Auto Scaling

Toggles the Auto Scaling function between On and Off in the windows listed below, which are explained in greater detail in the following sections. Upon pressing the Restart front-panel key or Restart softkey in the Meas Control menu, the Auto Scaling function automatically determines the scale per division and reference values based on the measurement results.

Key Path	AMPTD Y Scale
Initial S/W Revision	Prior to A.02.00

AutoScaling (Symbol Error vs. Subcarrier/Symbol Error vs. Symbol Window)

Auto Scaling toggles the Auto Scaling function between On and Off in the Symbol Error vs. Subcarrier and Symbol Error vs. Symbol windows.

Key Path	AMPTD Y Scale, More
Mode	WIMAXOFDMA
Remote Command	:DISPlay:EVM:VIEW3:WINDow[1] 2:TRACe:Y[1] 2[:SCALe]:COUPLe ON OFF 1 0 :DISPlay:EVM:VIEW3:WINDow[1] 2:TRACe:Y[1] 2[:SCALe]:COUPLe?
Example	DISP:EVM:VIEW3:WIND2:TRAC:Y:COUP 0 DISP:EVM:VIEW3:WIND2:TRAC:Y:COUP?
Couplings	When you set a value to either Scale/Div or Ref Value manually, Auto Scaling automatically changes to Off. When this value is set to On, Ref Value and Scale/Div are automatically determined by the measurement result.
Preset	OFF
State Saved	Saved in instrument state.
Range	On Off
Initial S/W Revision	Prior to A.02.00

AutoScaling (Absolute Flatness/Differential Flatness Window)

Auto Scaling toggles the Auto Scaling function between On and Off in the Absolute Flatness and Differential Flatness windows.

Key Path	AMPTD Y Scale, More
Mode	WIMAXOFDMA
Remote Command	:DISPlay:EVM:VIEW6:WINDow[1] 2:TRACe:Y[:SCALe]:COUPle ON OFF 1 0 :DISPlay:EVM:VIEW6:WINDow[1] 2:TRACe:Y[:SCALe]:COUPle?
Example	DISP:EVM:VIEW6:WIND2:TRAC:Y:COUP 0 DISP:EVM:VIEW6:WIND2:TRAC:Y:COUP?
Couplings	When you set a value to either Scale/Div or Ref Value manually, Auto Scaling automatically changes to Off. When this value is set to On, Ref Value and Scale/Div are automatically determined by the measurement result.
Preset	OFF
State Saved	Saved in instrument state.
Range	On Off
Initial S/W Revision	Prior to A.02.00

AutoScaling (Power vs. Time/Power vs. Spectrum Window)

Auto Scaling toggles the Auto Scaling function between On and Off in the Power vs. Time and Power vs. Spectrum windows.

Key Path	AMPTD Y Scale, More
Mode	WIMAXOFDMA
Remote Command	:DISPlay:EVM:VIEW7:WINDow[1] 2:TRACe:Y[:SCALe]:COUPle ON OFF 1 0 :DISPlay:EVM:VIEW7:WINDow[1] 2:TRACe:Y[:SCALe]:COUPle?
Example	DISP:EVM:VIEW7:WIND2:TRAC:Y:COUP 0 DISP:EVM:VIEW7:WIND2:TRAC:Y:COUP?
Couplings	When you set a value to either Scale/Div or Ref Value manually, Auto Scaling automatically changes to Off. When this value is set to On, Ref Value and Scale/Div are automatically determined by the measurement result.
Preset	OFF
State Saved	Saved in instrument state.
Range	On Off
Initial S/W Revision	Prior to A.02.00

AutoScaling (Symbol Power vs. Subcarrier/Symbol Power vs. Symbol Window)

Auto Scaling toggles the Auto Scaling function between On and Off in the Symbol Power vs. Subcarrier and Symbol Power vs. Symbol windows.

Key Path	AMPTD Y Scale, More
Mode	WIMAXOFDMA
Remote Command	:DISPlay:EVM:VIEW4:WINDow[1] 2:TRACe:Y[:SCALe]:COUPle ON OFF 1 0 :DISPlay:EVM:VIEW4:WINDow[1] 2:TRACe:Y[:SCALe]:COUPle?
Example	DISP:EVM:VIEW4:WIND2:TRAC:Y:COUP 0 DISP:EVM:VIEW4:WIND2:TRAC:Y:COUP?
Couplings	When you set a value to either Scale/Div or Ref Value manually, Auto Scaling automatically changes to Off. When this value is set to On, Ref Value and Scale/Div are automatically determined by the measurement result.
Preset	OFF
State Saved	Saved in instrument state.
Range	On Off
Initial S/W Revision	Prior to A.02.00

Auto Couple

The Auto Couple feature provides a quick and convenient way to automatically couple multiple instrument settings. This helps ensure accurate measurements and optimum dynamic range. When the Auto Couple feature is activated, either from the front panel or remotely, all parameters of the current measurement that have an Auto/Manual mode are set to Auto mode and all measurement settings dependent on (or coupled to) the Auto/Man parameters are automatically adjusted for optimal performance.

However, the Auto Couple key actions are confined to the current measurement only. It does not affect other measurements in the mode, and it does not affect markers, marker functions, or trace or display attributes.

See "[More Information](#)" on page 1652

Key Path	Front-panel key
Remote Command	:COUPLe ALL NONE
Example	:COUP ALL
Notes	:COUPLe ALL puts all Auto/Man parameters in Auto mode (equivalent to pressing the Auto Couple key). :COUPLE NONE puts all Auto/Man parameters in manual mode. It decouples all the coupled instrument parameters and is not recommended for making measurements.
Initial S/W Revision	Prior to A.02.00

More Information

There are two types of functions that have Auto/Manual modes.

Auto/Man Active Function keys

An Auto/Man toggle key controls the binary state associated with an instrument parameter by toggling between Auto (where the parameter is automatically coupled to the other parameters it is dependent upon) and Man (where the parameter is controlled independent of the other parameters), as well as making the parameter the active function. The current mode is indicated on the softkey with either Auto or Man underlined as illustrated below.

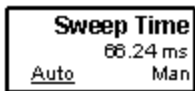

usd07

Auto/Man 1-of-N keys

An Auto/Man 1-of-N key allows you to manually pick from a list of parameter values, or place the function in Auto, in which case the value is automatically selected (and indicated) as shown below. If in Auto, Auto is underlined on the calling key. If in manual operation, manual is indicated on the calling key. But the calling key does not actually toggle the function, it simply opens the menu.

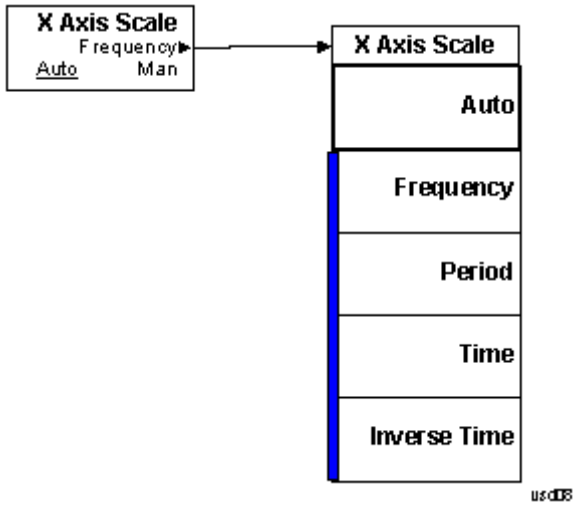

BW

Accesses parameters that affect bandwidth.

Key Path	BW
Initial S/W Revision	Prior to A.02.00

Info BW

Activates the Info BW active function, which enables you to manually set the information bandwidth (Info BW) of the analyzer.

Key Path	BW
Mode	WIMAXOFDMA
Remote Command	<code>[:SENSe] :EVM :BANDwidth [:RESolution] <bandwidth></code> <code>[:SENSe] :EVM :BANDwidth [:RESolution] ?</code>
Example	EVM:BAND 10e6 EVM:BAND?
Preset	10 MHz
State Saved	Saved in instrument state.
Min	1 MHz
Max	Hardware Dependent: RF Input: No Option = 10 MHz Option B25 = 25 MHz WB (40 MHz or wider) = 40 MHz I/Q Input (for I+jQ): No Option = 20 MHz Option B25 or S40 = 40 MHz
Backwards Compatibility SCPI	<code>[:SENSe] :EVM :BWIDth [:RESolution]</code>
Initial S/W Revision	Prior to A.02.00
Modified at S/W Revision	A.02.00, A.06.00

Cont (Continuous Measurement/Sweep)

Sets the analyzer for Continuous measurement operation. The single/continuous state is Meas Global so the setting will affect all measurements. If you are Paused, pressing Cont does a Resume.

Key Path	Front-panel key
Remote Command	:INITiate:CONTinuous OFF ON 0 1 :INITiate:CONTinuous?
Example	:INIT:CONT 0 puts analyzer in Single measurement operation. :INIT:CONT 1 puts analyzer in Continuous measurement operation
Preset	ON (Note that SYST:PRESet sets INIT:CONT to ON but *RST sets INIT:CONT to OFF)
State Saved	Saved in instrument state
Backwards Compatibility Notes	For Spectrum Analysis mode in ESA and PSA, there is no Cont hardkey, instead there is a Sweep Single/Cont key. In these analyzers, switching the Sweep Single/Cont key from Single to Cont restarts averages (displayed average count reset to 1), but does not restart Max Hold and Min Hold. The X-Series has Single and Cont keys in place of the SweepSingleCont key. In the X-Series, if in single measurement, the Cont key (and INIT:CONT ON) switches to continuous measurement, but never restarts a measurement and never resets a sweep.
Initial S/W Revision	Prior to A.02.00

In Swept SA Measurement (Spectrum Analysis Mode):

The analyzer takes repetitive sweeps, averages, measurements, etc., when in Continuous mode. When the average count reaches the Average/Hold Number the count stops incrementing, but the analyzer keeps sweeping. See the Trace/Detector section for the averaging formula used both before and after the Average/Hold Number is reached. The trigger condition must be met prior to each sweep. The type of trace processing for multiple sweeps, is set under the Trace/Detector key, with choices of Trace Average, Max Hold, or Min Hold.

In Other Measurements/Modes:

With Avg/Hold Num (in the Meas Setup menu) set to Off or set to On with a value of 1, a sweep is taken after the trigger condition is met; and the analyzer continues to take new sweeps after the current sweep has completed and the trigger condition is again met. However, with Avg/Hold Num set to On with a value >1, multiple sweeps (data acquisitions) are taken for the measurement. The trigger condition must be met prior to each sweep. The sweep is not stopped when the average count k equals the number N set for Avg/Hold Num is reached, but the number k stops incrementing. A measurement average usually applies to all traces, marker results, and numeric results. But sometimes it only applies to the numeric results.

If the analyzer is in Single measurement, pressing the Cont key does not change k and does not cause the sweep to be reset; the only action is to put the analyzer into Continuous measurement operation.

If it is already in continuous sweep:

the INIT:CONT 1 command has no effect

14 Modulation Analysis Measurement
Cont (Continuous Measurement/Sweep)

the INIT:CONT 0 command will place the analyzer in Single Sweep but will have no effect on the current sequence until $k = N$, at which point the current sequence will stop and the instrument will go to the idle state.

File

See "File" on page 336

FREQ Channel

Accesses a menu of keys that allow you to control the Frequency and Channel parameters of the instrument.

Some features in the Frequency menu are the same for all measurements – they do not change as you change measurements. Settings like these are called “Meas Global” and are unaffected by Meas Preset. For example, the Center Freq setting is the same for all measurements - it does not change as you change measurements.

Key Path	Front-panel key
Initial S/W Revision	Prior to A.02.00

Center Freq

Sets the frequency that corresponds to the horizontal center of the graticule (when frequency Scale Type is set to linear). While adjusting the Center Frequency the Span is held constant, which means that both Start Frequency and Stop Frequency will change.

Pressing Center Freq also sets the frequency entry mode to Center/Span. In Center/Span mode, the center frequency and span values are displayed below the graticule, and the default active function in the Frequency menu is Center Freq.

The center frequency setting is the same for all measurements within a mode, that is, it is Meas Global. Some modes are also able to share a Mode Global center frequency value. If this is the case, the Mode will have a Global Settings key in its Mode Setup menu.

The Center Freq function sets (and queries) the Center Frequency for the currently selected input. If your analyzer has multiple inputs, and you select another input, the Center Freq changes to the value for that input. SCPI commands are available to directly set the Center Freq for a specific input.

Center Freq is remembered as you go from input to input. Thus you can set a Center Freq of 10 GHz with the RF Input selected, change to BBIQ and set a Center Freq of 20 MHz, then switch to External Mixing and set a Center Freq of 60 GHz, and when you go back to the RF Input the Center Freq will go back to 10 GHz; back to BBIQ and it is 20 MHz; back to External Mixing and it is 60 GHz.

See ["RF Center Freq" on page 1661](#)

See [Ext Mix Center Freq](#)

See ["I/Q Center Freq" on page 1663](#)

See ["Center Frequency Presets" on page 1659](#)

Key Path	FREQ Channel
Scope	Meas Global
Remote Command	<code>[:SENSe] :FREQuency:CENTer <freq></code> <code>[:SENSe] :FREQuency:CENTer?</code>

Example	FREQ:CENT 50 MHz FREQ:CENT UP changes the center frequency to 150 MHz if you use FREQ:CENT:STEP 100 MHz to set the center frequency step size to 100 MHz FREQ:CENT?
Notes	This command sets either the RF or I/Q Center Frequency depending on the selected input. For RF input it is equivalent to FREQ:RF:CENT For I/Q input it is equivalent to FREQ:IQ:CENT Preset and Max values are dependent on Hardware Options (5xx) If no terminator (e.g. MHz) is sent the terminator Hz is used. If a terminator with unit other than Frequency is used, an invalid suffix error message is generated.
Dependencies	The Center Frequency can be limited by Start or Stop Freq limits, if the Span is so large that Start or Stop reach their limit.
Couplings	When operating in “swept span”, any value of the Center Frequency or Span that is within the frequency range of the analyzer is allowed when the value is being set through the front panel numeric key pad or the SCPI command. The other parameter is forced to a different value if needed, to keep the Start and the Stop Frequencies within the analyzer’s frequency range
Preset	Depends on instrument maximum frequency, mode, measurement, and selected input. See "Center Frequency Presets" on page 1659 and "RF Center Freq" on page 1661 and Ext Mix Center Freq and "I/Q Center Freq" on page 1663 .
State Saved	Saved in instrument state
Min	Depends on instrument maximum frequency, mode, measurement, and selected input.. See "Center Frequency Presets" on page 1659 and "RF Center Freq" on page 1661 and "I/Q Center Freq" on page 1663 .
Max	Depends on instrument maximum frequency, mode, measurement, and selected input.. See "Center Frequency Presets" on page 1659 and "RF Center Freq" on page 1661 and "I/Q Center Freq" on page 1663 .
Default Unit	Hz
Status Bits/OPC	Non-overlapped
Dependencies	
Initial S/W Revision	Prior to A.02.00

Center Frequency Presets

The following table provides the Center Frequency Presets for the Spectrum Analyzer mode, and the Max Freq, for the various frequency options:

Freq Option	CF after Mode Preset	Stop Freq after Mode Preset	Max Freq (can't tune)

14 Modulation Analysis Measurement
FREQ Channel

			above)
503 (all but N9000A)	1.805 GHz	3.6 GHz	3.7 GHz
503 (N9000A)	1.505 GHz	3.0 GHz	3.08 GHz
507 (all but N9000A)	3.505 GHz	7.0 GHz	7.1 GHz
507 (N9000A)	3.755 GHz	7.5 GHz	7.58 GHz
508 (all but N9038A)	1.805 GHz	3.6 GHz	8.5 GHz
508 (N9038A)	4.205 GHz	8.4 GHz	8.5 GHz
513	6.805 GHz	13.6 GHz	13.8 GHz
526 (all but N9000A and N9038A)	13.255 GHz	26.5 GHz	27.0 GHz
526 (N9000A)	13.255 GHz	26.5 GHz	26.55 GHz
526 (N9038A)	1.805 GHz	3.6 GHz	27.0 GHz
532	16.005 GHz	32.0 GHz	32.5 GHz
543	21.505 GHz	43.0 GHz	TBD
544	22.005 GHz	44.0 GHz	44.5 GHz
550	25.005 GHz	50.0 GHz	51 GHz

Input 2:

Model	CF after Mode Preset	Stop Freq after Mode Preset	Max Freq (can't tune above)
N9000A opt C75	0.7505GHz	1.5 GHz	1.58 GHz
N9038A	505 MHz	1 GHz	1.000025 GHz

Tracking Generator Frequency Limits (N9000A only):

Tracking Generator Option	Min Freq (clips to this freq when turn TG on and	If above this Freq, Stop Freq clipped to this Freq when	Max Freq (can't tune above) while TG

	can't tune below while TG on)	TG turned on	on
T03	9 kHz	3.0 GHz	3.08 GHz
T06	9 kHz	6.0 GHz	6.05 GHz

The following table shows the Center Frequency Presets for modes other than Spectrum Analyzer:

Mode	CF Preset for RF
WCDMA	1 GHz
WIMAXOFDMA,	1 GHz
BASIC	1 GHz
ADEMOD	1 GHz
VSA	1 GHz
TDSCDMA	1 GHz
PNOISE	1 GHz
LTE	1 GHz
LTETDD	1 GHz
MSR	1 GHz
GSM	935.2 MHz
NFIGURE	1.505 GHz

RF Center Freq

SCPI command for specifying the RF Center Frequency. This command will set the Center Frequency to be used when the RF input is selected, even if the RF input is not the input that is selected at the time the command is sent. Note that the Center Freq function in the Frequency menu on the front panel always applies to the currently selected input.

Scope	Meas Global
Remote Command	<code>[:SENSe] :FREQuency:RF:CENTer <freq></code> <code>[:SENSe] :FREQuency:RF:CENTer?</code>
Example	FREQ:RF:CENT 30 MHz
Notes	This command is the same in all modes, but the parameter is Measurement Global. So the value is independent in each mode and common across all the measurements in the mode.
Dependencies	If the electronic/soft attenuator is enabled, any attempt to set Center Frequency such that the Stop Frequency would be >3.6 GHz fails and results in an advisory message. If the equivalent SCPI command is sent, this same message is generated as part of a “-221, Settings conflict” warning. If Source Mode is set to Tracking, and the Max or Min Center Freq is therefore limited by the limits of the source, a warning message is generated, “Data out of range;clipped to source max/min” if these limits are exceeded. Note that for an external source, these limits can be affected by the settings of

	Source Numerator, Source Denominator and Power Sweep.
Preset	See table above
State Saved	Saved in instrument state.
Min	-79.999995 MHz, unless Source Mode is set to Tracking, in which case it is limited by the minimum frequency of the Source
Max	See table above. Basically instrument maximum frequency - 5 Hz. Note that, if the Source Mode is set to Tracking, the effective instrument maximum frequency may be limited by the source maximum frequency. If the knob or step keys are being used, also depends on the value of the other three interdependent parameters Span, Start Frequency and Stop Frequency
Initial S/W Revision	Prior to A.02.00
Modified at S/W Revision	A.03.00

Ext Mix Center Freq

SCPI command for specifying the External Mixer Center Frequency. This command will set the Center Frequency to be used when the External Mixer is selected, even if the External Mixer input is not the input which is selected at the time the command is sent. Note that the Center Freq function in the Frequency menu on the front panel always applies to the currently selected input.

Scope	Meas Global
Remote Command	<code>[:SENSe] :FREQuency:EMIXer:CENTer <freq></code> <code>[:SENSe] :FREQuency:EMIXer:CENTer?</code>
Example	<code>:FREQ:EMIX:CENT 60 GHz</code> <code>:FREQ:EMIX:CENT?</code>
Notes	This command is the same in all modes, but the parameter is Measurement Global. So the value is independent in each mode and common across all the measurements in the mode.
Couplings	When returning to External Mixing after having been switched to one of the other inputs (e.g., RF), you will come back into the settings that you had when you left External Mixing. So you will come back to the band you were in with the Center Frequency that you had. However, Span is not an input-dependent parameter, therefore you will bring the span over from the other input. Therefore, the analyzer comes back with the span from the previous input, limited as necessary by the current mixer setup.
Preset	When a Mode Preset is performed while in External Mixing, the Start frequency of the current Mode is set to the nominal Min Freq of the lowest harmonic range in the Harmonic Table for the current mixer setup. Similarly, the Stop frequency of the current Mode is set to the nominal Max Freq of the highest harmonic range in the Harmonic Table. The Center Freq thus presets to the point arithmetically equidistant from these two frequencies. If the current measurement has a limited Span available to it, and cannot achieve the Span shown in the table (Span=Stop Freq - Start Freq), the analyzer uses the maximum Span the measurement allows, and still sets the Center Freq to the midpoint of the Start and Stop Freq values in the Harmonic Table.

	When Restore Input/Output Defaults is performed, the mixer presets to the 11970A, whose Start and Stop frequencies are 26.5 and 40 GHz respectively. The center of these two frequencies is 33.25 GHz. Therefore, after a Restore Input/Output Defaults, if you go into External Mixing and do a Mode Preset while in the Spectrum Analyzer Mode, the resulting Center Freq is 33.25 GHz.
State Saved	Saved in instrument state.
Min	The minimum frequency in the currently selected mixer band + 5 Hz
Max	The maximum frequency in the currently selected mixer band – 5 Hz If the knob or step keys are being used, also depends on the value of the other three interdependent parameters Span, Start Frequency and Stop Frequency
Initial S/W Revision	A.08.01

I/Q Center Freq

SCPI command for specifying the I/Q Center Frequency. This command will set the Center Frequency to be used when the I/Q input is selected, even if the I/Q input is not the input which is selected at the time the command is sent. Note that the Center Freq function in the Frequency menu on the front panel always applies to the currently selected input.

Scope	Meas Global
Remote Command	[:SENSe] :FREQuency:IQ:CENTer <freq> [:SENSe] :FREQuency:IQ:CENTer?
Example	FREQ:IQ:CENT: 30 MHz
Notes	This command is the same in all modes, but the parameter is Measurement Global. So the value is independent in each mode and common across all the measurements in the mode.
Preset	0 Hz
State Saved	Saved in instrument state.
Min	-40.049995 MHz
Max	40.049995 MHz
Initial S/W Revision	Prior to A.02.00

Input/Output

See "[Input/Output](#)" on page 196

Marker

Accesses the menu that enables you to select, set up, and control the markers.

Key Path	Marker
Initial S/W Revision	Prior to A.02.00

Select Marker

Displays 12 markers available for selection.

Key Path	Marker
Initial S/W Revision	Prior to A.02.00

Marker Type

Sets the marker control mode as described under Normal, Delta and Off, below. All interactions and dependencies detailed under the key description are enforced when the remote command is sent.

Key Path	Marker
Mode	WIMAXOFDMA
Remote Command	:CALCulate:EVM:MARKer[1] 2 ...12:MODE POSition DELTA OFF :CALCulate:EVM:MARKer[1] 2 ...12:MODE?
Example	CALC:EVM:MARK:MODE POS CALC:EVM:MARK:MODE?
Notes	If the selected marker is Off, pressing Marker sets it to Normal and places it at the center of the screen on the trace determined by the Marker Trace rules. At the same time, Marker X Axis Value appears on the Active Function area. Default Active Function: The active function for the selected marker's current control mode. If the current control mode is Off, there is no active function, and the active function is set to Off. Active Function Display: - the marker Chip value in the IQ Measured Polar graph - the marker X axis value in any other graph The value entered in the active function area will display the marker value to its full entered precision.
Preset	OFF
State Saved	Saved in instrument state.
Range	Normal Delta Off
Initial S/W Revision	Prior to A.02.00

Properties

Accesses a menu that enables you to set marker properties and to access the marker trace menu.

Key Path	Marker
Initial S/W Revision	Prior to A.02.00

Select Marker

Displays 12 markers available for selection.

Key Path	Marker
Initial S/W Revision	Prior to A.02.00

Relative To

Selects the marker that the selected marker will be relative to - its reference marker.

Key Path	Marker, Properties
Mode	WIMAXOFDMA
Remote Command	:CALCulate:EVM:MARKer[1] 2 ...12:REFerence <integer> :CALCulate:EVM:MARKer[1] 2 ...12:REFerence?
Example	CALC:EVM:MARK:REF 2 CALC:EVM:MARK:REF?
Notes	A marker cannot be relative to itself so that choice is grayed out, and if sent from SCPI generates error -221: "Settings conflict; marker cannot be relative to itself." When queried a single value will be returned (the specified marker numbers relative marker).
Preset	2 3 4 5 6 7 8 9 10 11 12 1
State Saved	Saved in instrument state.
Min	1
Max	12
Initial S/W Revision	Prior to A.02.00

Marker Trace

Accesses a menu that enables you to assign a specified marker to the designated trace.

Symbol Traces means that three traces for I/Q polar, Symbol Error Carrier, Symbol Error Symbol, Symbol Power Carrier, and Symbol Power Symbol can be assigned. If used, a marker pointer is placed on each trace. In this case, the three pointers will move at the same time, as coupled markers, whenever the X position of the Symbol Traces changes.

Key Path	Marker
Mode	WIMAXOFDMA
Remote Command	:CALCulate:EVM:MARKer[1] 2 ...12:TRACe SYMBol POLar EVCarrier RECarrier EVSymbol RESymbol PCARrier RPCarrier PSYMBOL RPSymbol FLATness DFLatness PVT SPECTrum :CALCulate:EVM:MARKer[1] 2 ...12:TRACe?
Example	CALC:EVM:MARK:TRAC SYMB CALC:EVM:MARK:TRAC?
Preset	SYMB
State Saved	Saved in instrument state.
Range	Symbol Traces IQ Measured Polar ConstIn Error Vector Carrier RMS Error Vector Carrier Error Vector Symbol RMS Error Vector Symbol Symbol Power Carrier RMS Symbol Power Carrier Symbol Power Symbol RMS Symbol Power Symbol PvT Spectrum
Initial S/W Revision	Prior to A.02.00

All Markers Off

Turns all markers off.

Key Path	Marker, More
Mode	WIMAXOFDMA
Remote Command	:CALCulate:EVM:MARKer:AOFF
Example	CALC:EVM:MARK:AOFF
Initial S/W Revision	Prior to A.02.00

Marker X Axis Value (Remote Command only)

Sets the marker X Axis value in the current marker X Axis Scale unit. It has no effect if the control mode is Off, but is the SCPI equivalent of entering an X value if the control mode is Normal or Delta.

Mode	WIMAXOFDMA
Remote Command	:CALCulate:EVM:MARKer[1] 2 ...12:X <real> :CALCulate:EVM:MARKer[1] 2 ...12:X?
Example	CALC:EVM:MARK3:X 0 CALC:EVM:MARK3:X?
Notes	If no suffix is sent, it will use the fundamental units for the current marker X Axis Scale. If a suffix is sent that does not match the current marker X Axis Scale unit, an "Invalid suffix" error will be generated. The query returns the marker's absolute X Axis value if the control mode is Normal, or the offset from the marker's reference marker if the control mode is Delta. The query is returned in the fundamental units for the current marker X Axis scale: Hz for Frequency and Inverse Time, seconds for Period and

	Time. If the marker is Off the response is not a number (NAN).
Preset	After a preset, all markers are set to Off, so a Marker X Axis Value query will return a not a number (NAN).
State Saved	No
Min	-9.9E+37
Max	9.9E+37.
Initial S/W Revision	Prior to A.02.00

Marker X Axis Position (Remote Command only)

Sets the marker X position in trace points. It has no effect if the control mode is Off, but is the SCPI equivalent of entering a value if the control mode is Normal or Delta - except in trace points rather than X Axis Scale units. The entered value is immediately translated into the current X Axis Scale units for setting the value of the marker.

Mode	WIMAXOFDMA
Remote Command	:CALCulate:EVM:MARKer[1] 2 ...12:X:POSition <real> :CALCulate:EVM:MARKer[1] 2 ...12:X:POSition?
Example	CALC:EVM:MARK10:X:POS 10 CALC:EVM:MARK10:X:POS?
Notes	The query returns the marker's absolute X Axis value in trace points if the control mode is Normal, or the offset from the marker's reference marker in trace points, if the control mode is Delta. The value is returned as a real number, not an integer, corresponding to the translation from X Axis Scale units to trace points (see "Fractional Trace Points", above). If the marker is Off the response is not a number(NAN).
Preset	After a preset, all markers are set to Off, so Marker X Axis Value query will return a not a number (NAN).
State Saved	No
Min	-9.9E+37
Max	9.9E+37
Initial S/W Revision	Prior to A.02.00

Marker X Axis Subcarrier (Remote Command only)

Sets the marker X subcarrier in trace points. It has no effect if the control mode is Off, but is the SCPI equivalent of entering a value if the control mode is Normal or Delta - except in trace points rather than X Axis Scale units. The entered value is immediately translated into the current X Axis Scale units for setting the value of the marker.

Mode	WIMAXOFDMA
Remote Command	:CALCulate:EVM:MARKer[1] 2 ...12:X:SUBCarrier <integer>

	:CALCulate:EVM:MARKer[1] 2 ...12:X:SUBCarrier?
Example	CALC:EVM:MARK10:X:SUBC 20 CALC:EVM:MARK10:X:SUBC?
Notes	The query returns the marker's absolute X Axis subcarrier value in trace points if the control mode is Normal, or the offset from the marker's reference marker in trace points, if the control mode is Delta. If the marker is Off the response is not a number(NAN). This command is not available when Marker Trace of the selected marker (:CALCulate:EVM:MARKer[1]]2 3 4 5 6 7 8 9 10 11 12:TRACe?) is set to PVT or SPECTrum. In this case, this command is ignored.
Preset	After a preset, all markers are set to Off, so Marker X Axis Subcarrier Value query will return a not a number (NAN).
State Saved	No
Min	-2147483648
Max	2147483647
Initial S/W Revision	Prior to A.02.00

Marker X Axis Symbol (Remote Command only)

Sets the marker X symbol in trace points. It has no effect if the control mode is Off, but is the SCPI equivalent of entering a value if the control mode is Normal or Delta - except in trace points rather than X Axis Scale units. The entered value is immediately translated into the current X Axis Scale units for setting the value of the marker.

Mode	WIMAXOFDMA
Remote Command	:CALCulate:EVM:MARKer[1] 2 ...12:X:SYMBOL <integer> :CALCulate:EVM:MARKer[1] 2 ...12:X:SYMBOL?
Example	CALC:EVM:MARK10:X:SYMB 1 CALC:EVM:MARK10:X:SYMB?
Notes	The query returns the marker's absolute X Axis subcarrier value in trace points if the control mode is Normal, or the offset from the marker's reference marker in trace points, if the control mode is Delta. If the marker is Off the response is not a number(NAN). This command is not available when Marker Trace of the selected marker (:CALCulate:EVM:MARKer[1]]2 3 4 5 6 7 8 9 10 11 12:TRACe?) is set to RECarrier, RPCarrier, FLATness, DFLatness, PVT or SPECTrum. In this case, this command is ignored.
Preset	After a preset, all markers are set to Off, so Marker X Axis Symbol Value query will return a not a number (NAN).
State Saved	No
Min	-2147483648
Max	2147483647
Initial S/W Revision	Prior to A.02.00

Marker Y Axis Value (Remote Command only)

Sets the marker Y Axis value in the current marker Y Axis unit.

Mode	WIMAXOFDMA
Remote Command	:CALCulate:EVM:MARKer [1] 2 ...12:Y?
Example	CALC:EVM:MARK11:Y?
Notes	<p>If no suffix is sent it will use the current Y Axis unit. If a suffix is sent that does not have units of absolute amplitude, an "Invalid suffix" error will be generated.</p> <p>The query returns the marker Y-axis result if the control mode is Normal or Delta. If the marker is Off the response is not a number (NAN)</p> <p>Query results depend on the selected Marker Trace as follows:</p> <p>Symbol Traces:I, Q, EVM(%), RCE(dB), Power(dBm)</p> <p>*I/Q Measured Polar:I, Q (In normalized voltage)</p> <p>*Error Vector Carrier:EVM(%), RCE(dB)</p> <p>RMS Error Vector Carrier:EVM(%), RCE(dB)</p> <p>*Error Vector Symbol:EVM(%), RCE(dB)</p> <p>RMS Error Vector Symbol:EVM(%), RCE(dB)</p> <p>*Symbol Power Carrier:dBm</p> <p>RMS Symbol Power Carrier:dBm</p> <p>*Symbol Power Symbol:dBm</p> <p>RMS Symbol Power Symbol:dBm</p> <p>Abs Spectral Flatness:dB</p> <p>Diff Spectral Flatness:dB</p> <p>PvT:dBm</p> <p>Spectrum:dBm</p> <p>Each asterisk(*) indicates Marker Traces that are coupled to Symbol Trace when Symbol Traces is selected.</p>
Preset	Result dependant on Markers setup and signal source
State Saved	No
Backwards Compatibility SCPI	:CALCulate:EVM:MARKer [1] 2 ...12:FUNCTion:RESult?
Initial S/W Revision	Prior to A.02.00

Backward Compatibility SCPI Commands

Sets or queries the state of a marker. Setting a marker which is Off to On, or 1, puts it in Normal mode and places it at the center of the screen.

Mode	WIMAXOFDMA
Remote Command	:CALCulate:EVM:MARKer [1] 2 ...12:STATe OFF ON 0 1 :CALCulate:EVM:MARKer [1] 2 ...12:STATe?

Example	CALC:EVM:MARK3:STAT ON CALC:EVM:MARK3:STAT?
Preset	OFF
State Saved	Saved in instrument state.
Range	On Off
Initial S/W Revision	Prior to A.02.00

Marker Function

There are no 'Marker Functions' supported in Mod Analysis so this front-panel key will display a blank softkey when pressed.

Key Path	Marker
Initial S/W Revision	Prior to A.02.00

Marker To

There is no 'Marker To' functionality supported in Mod Analysis so this front-panel key will display a blank softkey when pressed.

Key Path	Marker
Initial S/W Revision	Prior to A.02.00

Meas

The information in this section is common to all measurements. For key and remote command information for a specific measurement, refer to the section that describes the measurement of interest.

Measurements available under the Meas key are specific to the current Mode.

When viewing Help for measurements, note the following:

NOTE

Operation for some keys differs between measurements. The information displayed in Help pertains to the current measurement. To see how a key operates in a different measurement, exit Help (press the Cancel Esc key), select the measurement, then reenter Help (press the Help key) and press that key.

Key Path	Front-panel key
Initial S/W Revision	Prior to A.02.00

Remote Measurement Functions

This section contains the following topics:

["Measurement Group of Commands" on page 2206](#)

["Current Measurement Query \(Remote Command Only\)" on page 2208](#)

["Limit Test Current Results \(Remote Command Only\)" on page 2208](#)

["Data Query \(Remote Command Only\)" on page 2208](#)

["Calculate/Compress Trace Data Query \(Remote Command Only\)" on page 2209](#)

["Calculate Peaks of Trace Data \(Remote Command Only\)" on page 2214](#)

[Hardware-Accelerated Fast Power Measurement \(Remote Command Only\)](#)

["Format Data: Numeric Data \(Remote Command Only\)" on page 2215](#)

["Format Data: Byte Order \(Remote Command Only\)" on page 2216](#)

Initial S/W Revision	Prior to A.02.00
----------------------	------------------

Measurement Group of Commands

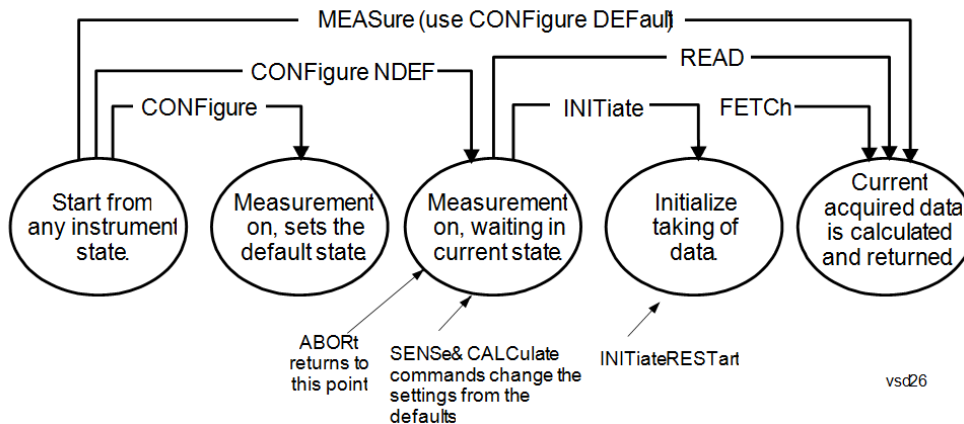

Measure Commands:

:MEASure:<measurement>[n]?

This is a fast single-command way to make a measurement using the factory default instrument settings. These are the settings and units that conform to the Mode Setup settings (e.g. radio standard) that you have currently selected.

- Stops the current measurement (if any) and sets up the instrument for the specified measurement using the factory defaults
- Initiates the data acquisition for the measurement
- Blocks other SCPI communication, waiting until the measurement is complete before returning results.
- If the function does averaging, it is turned on and the number of averages is set to 10.
- After the data is valid it returns the scalar results, or the trace data, for the specified measurement. The type of data returned may be defined by an [n] value that is sent with the command.
- The scalar measurement results will be returned if the optional [n] value is not included, or is set to 1. If the [n] value is set to a value other than 1, the selected trace data results will be returned. See each command for details of what types of scalar results or trace data results are available.
- ASCII is the default format for the data output. (Older versions of Spectrum Analysis and Phase Noise mode measurements only use ASCII.) The binary data formats should be used for handling large blocks of data since they are smaller and faster than the ASCII format. Refer to the FORMat:DATA command for more information.

If you need to change some of the measurement parameters from the factory default settings you can set up the measurement with the CONFigure command. Use the commands in the SENSe:<measurement> and CALCulate:<measurement> subsystems to change the settings. Then you can use the READ? command to initiate the measurement and query the results.

If you need to repeatedly make a given measurement with settings other than the factory defaults, you can use the commands in the SENSe:<measurement> and CALCulate:<measurement> subsystems to set up the measurement. Then use the READ? command to initiate the measurement and query results.

Measurement settings persist if you initiate a different measurement and then return to a previous one. Use READ:<measurement>? if you want to use those persistent settings. If you want to go back to the default settings, use MEASure:<measurement>?.

Configure Commands:

:CONFigure:<measurement>

This command stops the current measurement (if any) and sets up the instrument for the specified measurement using

the factory default instrument settings. It does not initiate the taking of measurement data unless INIT:CONTinuous is ON. If you change any measurement settings after using the CONFigure command, the READ command can be used to initiate a measurement without changing the settings back to their defaults.

In the Swept SA measurement in Spectrum Analyzer mode the CONFigure command also turns the averaging function on and sets the number of averages to 10 for all measurements.

:CONFigure: <measurement>: NDEFault stops the current measurement and changes to the specified measurement. It does not change the settings to the defaults. It does not initiate the taking of measurement data unless INIT:CONTinuous is ON.

The CONFigure? query returns the current measurement name.

The CONFigure:CATalog? query returns a quoted string of all licensed measurement names in the current mode. For example, "SAN, CHP, OBW, ACP, PST, TXP, SPUR, SEM, LIST".

Fetch Commands:

:FETCh:<measurement>[n]?

This command puts selected data from the most recent measurement into the output buffer. Use FETCh if you have already made a good measurement and you want to return several types of data (different [n] values, for example, both scalars and trace data) from a single measurement. FETCh saves you the time of re-making the measurement. You can only FETCh results from the measurement that is currently active, it will not change to a different measurement. An error message is reported if a measurement other than the current one is specified.

If you need to get new measurement data, use the READ command, which is equivalent to an INITiate followed by a FETCh.

The scalar measurement results will be returned if the optional [n] value is not included, or is set to 1. If the [n] value is set to a value other than 1, the selected trace data results will be returned. See each command for details of what types of scalar results or trace data results are available. The binary data formats should be used for handling large blocks of data since they are smaller and transfer faster than the ASCII format. (FORMat:DATA)

FETCh may be used to return results other than those specified with the original READ or MEASure command that you sent.

INITiate Commands:

:INITiate:<measurement>

This command is not available for measurements in all the instrument modes:

- Initiates a trigger cycle for the specified measurement, but does not output any data. You must then use the FETCh<meas> command to return data. If a measurement other than the current one is specified, the instrument will switch to that measurement and then initiate it.
 - For example, suppose you have previously initiated the ACP measurement, but now you are running the channel power measurement. If you send INIT:ACP? it will change from channel power to ACP and will initiate an ACP measurement.
 - Does not change any of the measurement settings. For example, if you have previously started the ACP measurement and you send INIT:ACP? it will initiate a new ACP measurement using the same instrument settings as the last time ACP was run.
 - If your selected measurement is currently active (in the idle state) it triggers the measurement, assuming the trigger conditions are met. Then it completes one trigger cycle. Depending upon the measurement and the number of averages, there may be multiple data acquisitions, with multiple trigger events, for one full trigger cycle. It also holds off additional commands on GPIB until the acquisition is complete.
-

READ Commands:

:READ:<measurement>[n]?

- Does not preset the measurement to the factory default settings. For example, if you have previously initiated the ACP
-

measurement and you send READ:ACP? it will initiate a new measurement using the same instrument settings.

- Initiates the measurement and puts valid data into the output buffer. If a measurement other than the current one is specified, the instrument will switch to that measurement before it initiates the measurement and returns results.
 - For example, suppose you have previously initiated the ACP measurement, but now you are running the channel power measurement. Then you send READ:ACP? It will change from channel power back to ACP and, using the previous ACP settings, will initiate the measurement and return results.
 - Blocks other SCPI communication, waiting until the measurement is complete before returning the results
 - If the optional [n] value is not included, or is set to 1, the scalar measurement results will be returned. If the [n] value is set to a value other than 1, the selected trace data results will be returned. See each command for details of what types of scalar results or trace data results are available. The binary data formats should be used when handling large blocks of data since they are smaller and faster than the ASCII format. (FORMat:DATA)
-

Initial S/W Revision	Prior to A.02.00
----------------------	------------------

Current Measurement Query (Remote Command Only)

This command returns the name of the measurement that is currently running.

Remote Command	:CONFigure?
-----------------------	-------------

Example	CONF?
----------------	-------

Initial S/W Revision	Prior to A.02.00
----------------------	------------------

Limit Test Current Results (Remote Command Only)

Queries the status of the current measurement limit testing. It returns a 0 if the measured results pass when compared with the current limits. It returns a 1 if the measured results fail any limit tests.

Remote Command	:CALCulate:CLIMits:FAIL?
-----------------------	--------------------------

Example	CALC:CLIM:FAIL? queries the current measurement to see if it fails the defined limits. Returns a 0 or 1: 0 it passes, 1 it fails.
----------------	--

Initial S/W Revision	Prior to A.02.00
----------------------	------------------

Data Query (Remote Command Only)

Returns the designated measurement data for the currently selected measurement and subopcode.

n = any valid subopcode for the current measurement. See the measurement command results table for your current measurement, for information about what data is returned for the subopcodes.

This command uses the data setting specified by the FORMat:BORDER and FORMat:DATA commands and can return real or ASCII data. (See the format command descriptions under Input/Output in the Analyzer Setup section.)

Remote Command	:CALCulate:DATA[n]?
Notes	The return trace depends on the measurement. In CALCulate:<meas>:DATA[n], n is any valid subopcode for the current measurement. It returns the same data as the FETCH:<measurement>? query where <measurement> is the current measurement.
Initial S/W Revision	Prior to A.02.00

Calculate/Compress Trace Data Query (Remote Command Only)

Returns compressed data for the currently selected measurement and sub-opcode [n].

n = any valid sub-opcode for that measurement. See the MEASure:<measurement>? command description of your specific measurement for information on the data that can be returned.

The data is returned in the current Y Axis Unit of the analyzer. The command is used with a sub-opcode <n> (default=1) to specify the trace. With trace queries, it is best if the analyzer is not sweeping during the query. Therefore, it is generally advisable to be in Single Sweep, or Update=Off.

This command is used to compress or decimate a long trace to extract and return only the desired data. A typical example would be to acquire N frames of GSM data and return the mean power of the first burst in each frame. The command can also be used to identify the best curve fit for the data.

Remote Command	:CALCulate:DATA<n>:COMPRESS? BLOCK CFIT MAXimum MINimum MEAN DMEan RMS RMSCubed SAMPLE SDEViation PPHase [,<soffset> [,<length>[,<roffset>[,<rlimit>]]]]
Example	To query the mean power of a set of GSM bursts: Supply a signal that is a set of GSM bursts. Select the IQ Waveform measurement (in IQ Analyzer Mode). Set the sweep time to acquire at least one burst. Set the triggers such that acquisition happens at a known position relative to a burst. Then query the mean burst levels using, CALC:DATA2:COMP? MEAN, 24e-6, 526e-6 (These parameter values correspond to GSM signals, where 526e-6 is the length of the burst in the slot and you just want 1 burst.)
Notes	The command supports 5 parameters. Note that the last 4 (<soffset>, <length>, <roffset>, <rlimit>) are optional. But these optional parameters must be entered in the specified order. For example, if you want to specify <length>, then you must also specify <soffset>. See details below for a definition of each of these parameters. This command uses the data in the format specified by FORMat:DATA, returning either binary or ASCII data.
Initial S/W Revision	Prior to A.02.00

- BLOCK or block data - returns all the data points from the region of the trace data that you specify. For example, it could be used to return the data points of an input signal over several timeslots, excluding the portions of the trace data that you do not want. (This is x,y pairs for trace data and I,Q pairs for complex data.)

- CFIT or curve fit - applies curve fitting routines to the data. <soffset> and <length> are required to define the data that you want. <roffset> is an optional parameter for the desired order of the curve equation. The query will return the following values: the x-offset (in seconds) and the curve coefficients ((order + 1) values).

MIN, MAX, MEAN, DME, RMS, RMSC, SAMP, SDEV and PPH return one data value for each specified region (or <length>) of trace data, for as many regions as possible until you run out of trace data (using <roffset> to specify regions). Or they return the number of regions you specify (using <rlimit>) ignoring any data beyond that.

- MINimum - returns the minimum data point (y value) for the specified region(s) of trace data. For I/Q trace data, the minimum magnitude of the I/Q pairs is returned.
- MAXimum - returns the maximum data point (y value) for the specified region(s) of trace data. For I/Q trace data, the maximum magnitude of the I/Q pairs is returned.
- MEAN - returns a single value that is the arithmetic mean of the data point values (in dB/ dBm) for the specified region(s) of trace data. For I/Q trace data, the mean of the magnitudes of the I/Q pairs is returned. See the following equations.

•

NOTE

If the original trace data is in dB, this function returns the arithmetic mean of those log values, not log of the mean power which is a more useful value. The mean of the log is the better measurement technique when measuring CW signals in the presence of noise. The mean of the power, expressed in dB, is useful in power measurements such as Channel Power. To achieve the mean of the power, use the RMS option.

Equation 1

Mean Value of Data Points for Specified Region(s)

$$\text{MEAN} = \frac{1}{n} \sum_{X_i \in \text{region}(s)} X_i$$

where X_i is a data point value, and n is the number of data points in the specified region(s).

Equation 2

Mean Value of I/Q Data Pairs for Specified Region(s)

$$\text{MEAN} = \frac{1}{n} \sum_{X_i \in \text{region}(s)} |X_i|$$

where $|X_i|$ is the magnitude of an I/Q pair, and n is the number of I/Q pairs in the specified region(s).

- DMEan - returns a single value that is the mean power (in dB/ dBm) of the data point values for the specified region(s) of trace data. See the following equation:

Equation 3

DMEan Value of Data Points for Specified Region(s)

$$\text{DME} = 10 \times \log_{10} \left(\frac{1}{n} \sum_{X_i \in \text{region}(s)} 10^{\frac{X_i}{10}} \right)$$

- RMS - returns a single value that is the average power on a root-mean-squared voltage scale (arithmetic rms) of the data point values for the specified region(s) of trace data. See the following equation.

NOTE

For I/Q trace data, the rms of the magnitudes of the I/Q pairs is returned. See the following equation. This function is very useful for I/Q trace data. However, if the original trace data is in dB, this function returns the rms of the log values which is not usually needed.

Equation 4

RMS Value of Data Points for Specified Region(s)

$$\text{RMS} = \sqrt{\frac{1}{n} \sum_{X_i \in \text{region}(s)} X_i^2}$$

where X_i is a data point value, and n is the number of data points in the specified region(s).

Equation 5

RMS Value of I/Q Data Pairs for Specified Region(s)

$$\text{RMS} = \sqrt{\frac{1}{n} \sum_{X_i \in \text{region}(s)} X_i X_i^*}$$

where X_i is the complex value representation of an I/Q pair, X_i^* its conjugate complex number, and n is the number of I/Q pairs in the specified region(s).

Once you have the rms value for a region of trace data (linear or I/Q), you may want to calculate the mean power. You must convert this rms value (peak volts) to power in dBm:

$$10 \times \log[10 \times (\text{rms value})^2]$$

- SAMPlE - returns the first data value (x,y pair) for the specified region(s) of trace data. For I/Q trace data, the first I/Q pair is returned.
- SDEVIation - returns a single value that is the arithmetic standard deviation for the data point values for the specified region(s) of trace data. See the following equation.
- For I/Q trace data, the standard deviation of the magnitudes of the I/Q pairs is returned. See the following equation.

Equation 6

Standard Deviation of Data Point Values for Specified Region(s)

$$\text{SDEV} = \sqrt{\frac{1}{n} \sum_{X_i \in \text{region}(s)} (X_i - \bar{X})^2}$$

where X_i is a data point value, \bar{X} is the arithmetic mean of the data point values for the specified region (s), and n is the number of data points in the specified region(s).

$$\text{SDEV} = \sqrt{\frac{1}{n} \sum_{X_i \in \text{region}(s)} (|X_i| - \bar{X})^2}$$

where $|X_i|$ is the magnitude of an I/Q pair, \bar{X} is the mean of the magnitudes for the specified region(s), and n is the number of data points in the specified region(s).

- PPHase - returns the x,y pairs of both rms power (dBm) and arithmetic mean phase (radian) for every specified region and frequency offset (Hz). The number of pairs is defined by the specified number of regions. This parameter can be used for I/Q vector ($n=0$) in Waveform (time domain) measurement and all parameters are specified by data point in PPHase.

The rms power of the specified region may be expressed as:

$$\text{Power} = 10 \times \log [10 \times (\text{RMS I/Q value})] + 10.$$

The RMS I/Q value (peak volts) is:

$$\sqrt{\frac{1}{n} \sum_{X_i \in \text{region}} X_i X_i^*}$$

where X_i is the complex value representation of an I/Q pair, X_i^* its conjugate complex number, and n is the number of I/Q pairs in the specified region.

The arithmetic mean phase of the specified region may be expressed as:

$$\frac{1}{n} \sum_{Y_i \in \text{region}} Y_i$$

where Y_i is the unwrapped phase of I/Q pair with applying frequency correction and n is the number of I/Q pairs in the specified region.

The frequency correction is made by the frequency offset calculated by the arithmetic mean of every specified region's frequency offset. Each frequency offset is calculated by the least square method against the unwrapped phase of I/Q pair.

Sample Trace Data - Constant Envelope

(See below for explanation of variables.)

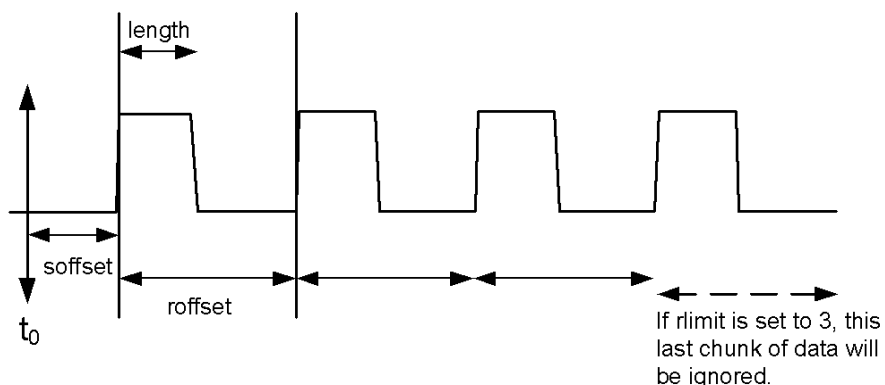

Sample Trace Data - Not Constant Envelope

(See below for explanation of variables.)

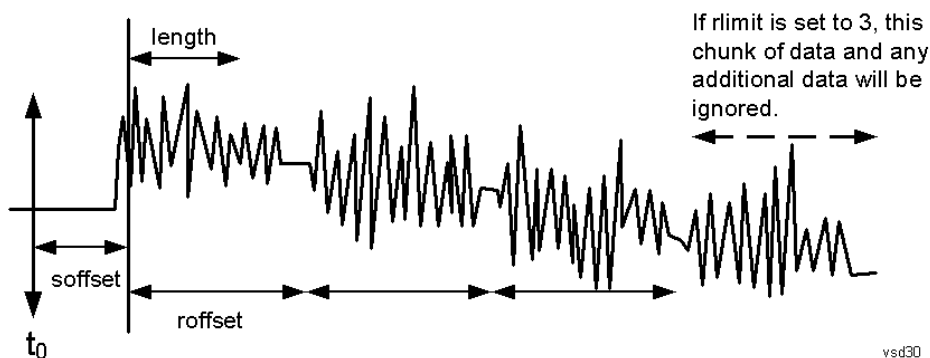

<soffset> - start offset is an optional real number. (It is in seconds for time-domain traces, and is a dimensionless index 0 to Npoints - 1, for frequency-domain traces). It specifies the amount of data at the beginning of the trace that will be ignored before the decimation process starts. It is the time or frequency change from the start of the trace to the point where you want to start using the data. The default value is zero.

<length> - is an optional real number. (It is in seconds for time-domain traces, and is a dimensionless index 0 to Npoints - 1, for frequency-domain traces). It defines how much data will be compressed into one value. This parameter has a default value equal to the current trace length.

<roffset> - repeat offset is an optional real number. (It is in seconds for time-domain traces, and is a dimensionless index 0 to Npoints - 1, for frequency-domain traces). It defines the beginning of the next field of trace elements to be compressed. This is relative to the beginning of the previous field. This parameter has a default value equal to the <length> variable. Note that this parameter is used for a completely different purpose when curve fitting (see CFIT above).

<rlimit> - repeat limit is an optional integer. It specifies the number of data items that you want returned. It will ignore any additional items beyond that number. You can use the Start offset and the Repeat limit to pick out exactly what part of the data you want to use. The default value is all the data.

Calculate Peaks of Trace Data (Remote Command Only)

Returns a list of all the peaks for the currently selected measurement and sub-opcode [n]. The peaks must meet the requirements of the peak threshold and excursion values.

n = any valid sub-opcode for the current measurement. See the MEASure:<measurement> command description of your specific measurement for information on the data that can be returned.

The command can only be used with specific sub-opcodes with measurement results that are trace data. Both real and complex traces can be searched, but complex traces are converted to magnitude in dBm. In many measurements the sub-opcode n=0, is the raw trace data which cannot be searched for peaks. And Sub-opcode n=1, is often calculated results values which also cannot be searched for peaks.

This command uses the data setting specified by the FORMat:BORDER and FORMat:DATA commands and can return real or ASCII data. If the format is set to INT,32, it returns REAL,32 data.

The command has four types of parameters:

- Threshold (in dBm)
- Excursion (in dB)
- Sorting order (amplitude, frequency, time)
- Optional in some measurements: Display line use (all, > display line, < display line)

Remote Command	<p>For Swept SA measurement:</p> <pre>:CALCulate:DATA[1] 2 ... 6:PEAKs? <threshold>,<excursion>[,AMPLitude FREQuency TIME[,ALL GTDLline LTDLine]]</pre> <p>For most other measurements:</p> <pre>:CALCulate:DATA[1] 2 ... 6:PEAKs? <threshold>,<excursion>[,AMPLitude FREQuency TIME]</pre>
Example	<p>Example for Swept SA measurement in Spectrum Analyzer Mode:</p> <p>CALC:DATA4:PEAK? -40, 10, FREQ, GTDL This will identify the peaks of trace 4 that are above -40 dBm, with excursions of at least 10 dB. The peaks are returned in order of increasing frequency, starting with the lowest frequency. Only the peaks that are above the display line are returned.</p> <p>Query Results 1:</p> <p>With FORMat:DATA REAL, 32 selected, it returns a list of floating-point numbers. The first value in the list is the number of peak points that are in the following list. A peak point consists of two values: a peak amplitude followed by its corresponding frequency (or time).</p> <p>If no peaks are found the peak list will consist of only the number of peaks, (0).</p>
Notes	<p><n> - is the trace that will be used</p> <p><threshold> - is the level below which trace data peaks are ignored. Note that the threshold value is required and is always used as a peak criterion. To effectively disable the threshold criterion for this command, provide a substantially low threshold value such as -200 dBm. Also note that the threshold value used in this command is independent of and has no effect on the threshold value stored under the Peak Criteria menu.</p> <p><excursion> - is the minimum amplitude variation (rise and fall) required for a signal to be identified as peak. Note that the excursion value is required and is always used as a peak criterion. To effectively disable the excursion criterion for this command, provide the minimum value of 0.0 dB. Also note that the excursion value used in this command is independent of and has no effect on the</p>

excursion value stored under the Peak Criteria menu.

Values must be provided for threshold and excursion. The sorting and display line parameters are optional (defaults are AMPLitude and ALL).

Note that there is always a Y-axis value for the display line, regardless of whether the display line state is on or off. It is the current Y-axis value of the display line which is used by this command to determine whether a peak should be reported

Sorting order:

AMPLitude - lists the peaks in order of descending amplitude, with the highest peak first (default if optional parameter not sent)

FREQuency - lists the peaks in order of occurrence, left to right across the x-axis.

TIME - lists the peaks in order of occurrence, left to right across the x-axis.

Peaks vs. Display Line:

ALL - lists all of the peaks found (default if optional parameter not sent).

GTDLine (greater than display line) - lists all of the peaks found above the display line.

LTDLine (less than display line) - lists all of the peaks found below the display line.

Initial S/W Revision Prior to A.02.00

Format Data: Numeric Data (Remote Command Only)

This command specifies the format of the trace data input and output. It specifies the formats used for trace data during data transfer across any remote port. It affects only the data format for setting and querying trace data for the :TRACe[:DATA], TRACe[:DATA]?, :CALCulate:DATA[n]? and FETCh:SANalyzer [n]? commands and queries.

Remote Command :FORMat [:TRACe] [:DATA] ASCii | INTeger, 32 | REAL, 32 | REAL, 64
:FORMat [:TRACe] [:DATA] ?

Notes The query response is:
ASCii: ASC,8
REAL,32: REAL,32
REAL,64: REAL,64
INTeger,32: INT,32

When the numeric data format is REAL or ASCii, data is output in the current Y Axis unit. When the data format is INTeger, data is output in units of m dBm (.001 dBm).

The INT,32 format returns binary 32-bit integer values in internal units (m dBm), in a definite length block.

Dependencies Sending a data format spec with an invalid number (for example, INT,48) generates no error. The analyzer simply uses the default (8 for ASCii, 32 for INTeger, 32 for REAL).

Sending data to the analyzer which does not conform to the current FORMat specified, results in an error. Sending ASCII data when a definite block is expected generates message -161 "Invalid Block Data" and sending a definite block when ASCII data is expected generates message -121 "Invalid Character in Number".

Preset ASCii

Backwards Compatibility Notes Note that the INT,32 format is only applicable to the command, TRACe:DATA. This preserves backwards compatibility for the Swept SA measurement. For all other commands/queries which honor FORMat:DATA, if INT,32 is sent the analyzer will behave as though it were set to REAL,32.

Initial S/W Revision Prior to A.02.00

The specs for each output type follow:

ASCIi - Amplitude values are in ASCII, in the current Y Axis Unit, one ASCII character per digit, values separated by commas, each value in the form:

SX.YYYYYEsZZ

Where:

S = sign (+ or -)

X = one digit to left of decimal point

Y = 5 digits to right of decimal point

E = E, exponent header

s = sign of exponent (+ or -)

ZZ = two digit exponent

REAL,32 - Binary 32-bit real values in the current Y Axis Unit, in a definite length block.

REAL,64 - Binary 64-bit real values in the current Y Axis Unit, in a definite length block.

Format Data: Byte Order (Remote Command Only)

This command selects the binary data byte order for data transfer and other queries. It controls whether binary data is transferred in normal or swapped mode. This command affects only the byte order for setting and querying trace data for the :TRACe[:DATA], TRACe[:DATA]? , :CALCulate:DATA[n]? and FETCh:SANalyzer[n]? commands and queries.

By definition any command that says it uses FORMat:DATA uses any format supported by FORMat:DATA.

The NORMal order is a byte sequence that begins with the most significant byte (MSB) first, and ends with the least significant byte (LSB) last in the sequence: 1|2|3|4. SWAPped order is when the byte sequence begins with the LSB first, and ends with the MSB last in the sequence: 4|3|2|1.

Remote Command	:FORMat:BORDER NORMal SWAPped :FORMat:BORDER?
Preset	NORMal
Initial S/W Revision	Prior to A.02.00

Meas Setup

Accesses a menu that enables you to set measurement setup parameters.

Key Path	Meas Setup
Initial S/W Revision	Prior to A.02.00

Avg/Hold Num

Sets the number of data acquisitions that will be averaged. After the specified number of average counts, the averaging mode setting determines the averaging action.

Key Path	Meas Setup
Mode	WIMAXOFDMA
Remote Command	[:SENSe] :EVM:AVERage:COUNT <integer> [:SENSe] :EVM:AVERage:COUNT? [:SENSe] :EVM:AVERage [:STATe] OFF ON 0 1 [:SENSe] :EVM:AVERage [:STATe] ?
Example	EVM:AVER:COUN 100 EVM:AVER:COUN? EVM:AVER OFF EVM:AVER?
Preset	10 OFF
State Saved	Saved in instrument state.
Min	1
Max	10000
Initial S/W Revision	Prior to A.02.00

Avg Mode

Selects the type of termination control used for the averaging function. This determines the averaging action after the specified number of data acquisitions (average count) is reached.

KEYExponential averaging SCPIEXPponential	When Measure is set at Cont, data acquisitions will continue indefinitely. After N averages, exponential averaging is used with a weighting factor of N (the displayed average count stops at N). Exponential averaging weights new data more than old data, which enables tracking of slow-changing signals.
KEYRepeat averaging SCPIREPeat	When Measure is set at Cont, data acquisitions will continue indefinitely. After N averages is reached, all previous result data is cleared and the average count is set back to 1. This is equivalent to

being in Measure Single and pressing the Restart key when the Single measurement finishes.

Key Path	Meas Setup
Mode	WIMAXOFDMA
Remote Command	[:SENSe] :EVM:AVERage:TCONtrol EXPonential REPeat [:SENSe] :EVM:AVERage:TCONtrol?
Example	EVM:AVER:TCON EXP EVM:AVER:TCON?
Preset	REPeat
State Saved	Saved in instrument state.
Range	Exp Repeat
Initial S/W Revision	Prior to A.02.00

Limits

Accesses measurement setup limit parameters.

Key Path	Meas Setup
Initial S/W Revision	Prior to A.02.00

RMS RCE

Accesses RMS RCE measurement setup limit parameters.

Key Path	Meas Setup, Limits
Initial S/W Revision	Prior to A.02.00

Limits

Sets the limit state for the RMS EVM measurement pass/fail test.

Key Path	Meas Setup, Limits, RMS RCE
Mode	WIMAXOFDMA
Remote Command	:CALCulate:EVM:LIMit [1] 2:RRCE:STATe OFF ON 0 1 :CALCulate:EVM:LIMit [1] 2:RRCE:STATe?
Example	CALC:EVM:LIM:RRCE:STAT ON CALC:EVM:LIM:RRCE:STAT?

Notes	LIMit1 is for BS, 2 for MS. Default is BS.
Preset	ON
State Saved	Saved in instrument state.
Range	On Off
Initial S/W Revision	Prior to A.02.00

Composite

Sets the limit for RMS RCE measurement pass/fail test.

Key Path	Meas Setup, Limits, RMS RCE
Mode	WIMAXOFDMA
Remote Command	:CALCulate:EVM:LIMit[1] 2:RRCE <rel_ampl> :CALCulate:EVM:LIMit[1] 2:RRCE? :CALCulate:EVM:LIMit[1] 2:RRCE:AUTO 0 1 OFF ON :CALCulate:EVM:LIMit[1] 2:RRCE:AUTO?
Example	CALC:EVM:LIM:RRCE -50 CALC:EVM:LIM:RRCE? CALC:EVM:LIM:RRCE:AUTO 0 CALC:EVM:LIM:RRCE:AUTO?
Notes	LIMit1 is for BS, 2 for MS. Default is BS.
Couplings	Mode: Auto The actual limit value depends on the modulation type when single burst was focused. The limit value is selected by the detected modulation type automatically. If composite burst was focused, the manual limit value is used. Mode: Manual The Limit value is used for single or composite burst types.
Preset	0.00 1
State Saved	Saved in instrument state.
Min	-100
Max	0.00
Initial S/W Revision	Prior to A.02.00

QPSK-1/2

Sets the limit of the QPSK coding rate 1/2 burst for the RMS RCE measurement pass/fail test.

Key Path	Meas Setup, Limits, RMS RCE
----------	-----------------------------

Mode	WIMAXOFDMA
Remote Command	:CALCulate:EVM:LIMit[1] 2:RRCE:QPSK:R1B2 <rel_ampl> :CALCulate:EVM:LIMit[1] 2:RRCE:QPSK:R1B2?
Example	CALC:EVM:LIM:RRCE:QPSK:R1B2 -10.0 CALC:EVM:LIM:RRCE:QPSK:R1B2?
Notes	LIMit1 is for BS, 2 for MS. Default is BS.
Preset	-15
State Saved	Saved in instrument state.
Min	-100.0
Max	0.0
Initial S/W Revision	Prior to A.02.00

QPSK-3/4

Sets the limit of the QPSK coding rate 3/4 burst for the RMS RCE measurement pass/fail test.

Key Path	Meas Setup, Limits, RMS RCE
Mode	WIMAXOFDMA
Remote Command	:CALCulate:EVM:LIMit[1] 2:RRCE:QPSK:R3B4 <rel_ampl> :CALCulate:EVM:LIMit[1] 2:RRCE:QPSK:R3B4?
Example	CALC:EVM:LIM:RRCE:QPSK:R3B4 -10.0 CALC:EVM:LIM:RRCE:QPSK:R3B4?
Notes	LIMit1 is for BS, 2 for MS. Default is BS.
Preset	-18
State Saved	Saved in instrument state.
Min	-100.0
Max	0.0
Initial S/W Revision	Prior to A.02.00

16QAM-1/2

Sets the limit of the 16QAM coding rate 1/2 burst for the RMS RCE measurement pass/fail test.

Key Path	Meas Setup, Limits, RMS RCE
Mode	WIMAXOFDMA
Remote Command	:CALCulate:EVM:LIMit[1] 2:RRCE:QA16:R1B2 <rel_ampl> :CALCulate:EVM:LIMit[1] 2:RRCE:QA16:R1B2?
Example	CALC:EVM:LIM:RRCE:QA16:R1B2 -10.0 CALC:EVM:LIM:RRCE:QA16:R1B2?

Notes	LIMit1 is for BS, 2 for MS. Default is BS.
Preset	-20.5
State Saved	Saved in instrument state.
Min	-100.00
Max	0
Initial S/W Revision	Prior to A.02.00

16QAM-3/4

Sets the limit of the 16QAM coding rate 3/4 burst for the RMS RCE measurement pass/fail test.

Key Path	Meas Setup, Limits, RMS RCE
Mode	WIMAXOFDMA
Remote Command	:CALCulate:EVM:LIMit[1] 2:RRCE:QA16:R3B4 <rel_ampl> :CALCulate:EVM:LIMit[1] 2:RRCE:QA16:R3B4?
Example	CALC:EVM:LIM:RRCE:QA16:R3B4 -10.0 CALC:EVM:LIM:RRCE:QA16:R3B4?
Notes	LIMit1 is for BS, 2 for MS. Default is BS.
Preset	-24.0
State Saved	Saved in instrument state.
Min	-100.0
Max	0.0
Initial S/W Revision	Prior to A.02.00

64QAM-1/2

Sets the limit of the 64QAM coding rate 1/2 burst for the RMS RCE measurement pass/fail test.

Key Path	Meas Setup, Limits, RMS RCE, More
Mode	WIMAXOFDMA
Remote Command	:CALCulate:EVM:LIMit[1]:RRCE:QA64:R1B2 <rel_ampl> :CALCulate:EVM:LIMit[1]:RRCE:QA64:R1B2?
Example	CALC:EVM:LIM:RRCE:QA64:R1B2 -10.0 CALC:EVM:LIM:RRCE:QA64:R1B2?
Preset	-15
State Saved	Saved in instrument state.
Min	-100.00
Max	0.00
Initial S/W Revision	Prior to A.02.00

64QAM-2/3

Sets the limit of the 64QAM coding rate 2/3 burst for the RMS RCE measurement pass/fail test.

Key Path	Meas Setup, Limits, RMS RCE, More
Mode	WIMAXOFDMA
Remote Command	:CALCulate:EVM:LIMit[1]:RRCE:QA64:R2B3 <rel_amp1> :CALCulate:EVM:LIMit[1]:RRCE:QA64:R2B3?
Example	CALC:EVM:LIM:RRCE:QA64:R2B3 -10.0 CALC:EVM:LIM:RRCE:QA64:R2B3?
Preset	-18
State Saved	Saved in instrument state.
Min	-100.00
Max	0.00
Initial S/W Revision	Prior to A.02.00

64QAM-3/4

Sets the limit of the 64QAM coding rate 3/4 burst for the RMS RCE measurement pass/fail test.

Key Path	Meas Setup, Limits, RMS RCE, More
Mode	WIMAXOFDMA
Remote Command	:CALCulate:EVM:LIMit[1]:RRCE:QA64:R3B4 <rel_amp1> :CALCulate:EVM:LIMit[1]:RRCE:QA64:R3B4?
Example	CALC:EVM:LIM:RRCE:QA64:R3B4 -10.0 CALC:EVM:LIM:RRCE:QA64:R3B4?
Preset	-18
State Saved	Saved in instrument state.
Min	-100.00
Max	0.00
Initial S/W Revision	Prior to A.02.00

Peak RCE

Sets the limit for the Peak RCE measurement pass/fail test.

Key Path	Meas Setup, Limits
Mode	WIMAXOFDMA
Remote Command	:CALCulate:EVM:LIMit[1] 2:PRCE <rel_amp1>

	:CALCulate:EVM:LIMit[1] 2:PRCE?
	:CALCulate:EVM:LIMit[1] 2:PRCE:STATe OFF ON 0 1
	:CALCulate:EVM:LIMit[1] 2:PRCE:STATe?
Example	CALC:EVM:LIM:PRCE -50 CALC:EVM:LIM:PRCE? CALC:EVM:LIM:PRCE:STAT ON CALC:EVM:LIM:PRCE:STAT?
Notes	LIMit1 is for BS, 2 for MS. Default is BS.
Preset	0.00 OFF
State Saved	Saved in instrument state.
Min	-100
Max	0.00
Initial S/W Revision	Prior to A.02.00

Pilot RCE

Sets the limit for the Pilot RCE measurement pass/fail test.

Key Path	Meas Setup, Limits
Mode	WIMAXOFDMA
Remote Command	:CALCulate:EVM:LIMit[1] 2:RCEPilot <rel_ampl> :CALCulate:EVM:LIMit[1] 2:RCEPilot? :CALCulate:EVM:LIMit[1] 2:RCEPilot:STATe OFF ON 0 1 :CALCulate:EVM:LIMit[1] 2:RCEPilot:STATe?
Example	CALC:EVM:LIM:RCEP -50 CALC:EVM:LIM:RCEP? CALC:EVM:LIM:RCEP:STAT ON CALC:EVM:LIM:RCEP:STAT?
Notes	LIMit1 is for BS, 2 for MS. Default is BS.
Preset	0.00 OFF
State Saved	Saved in instrument state.
Min	-100
Max	0.00
Initial S/W Revision	Prior to A.02.00

Frequency Error

Sets the limit in ppm for the absolute Frequency Error measurement pass/fail test.

Key Path	Meas Setup, Limits
Mode	WIMAXOFDMA
Remote Command	:CALCulate:EVM:LIMit[1] 2:FERRor <real> :CALCulate:EVM:LIMit[1] 2:FERRor? :CALCulate:EVM:LIMit[1] 2:FERRor:STATe OFF ON 0 1 :CALCulate:EVM:LIMit[1] 2:FERRor:STATe?
Example	CALC:EVM:LIM:FERR 50 CALC:EVM:LIM:FERR? CALC:EVM:LIM:FERR:STAT ON CALC:EVM:LIM:FERR:STAT?
Notes	LIMit1 is for BS, 2 for MS. Default is BS.
Preset	2.00 ON
State Saved	Saved in instrument state.
Min	0
Max	100
Initial S/W Revision	Prior to A.02.00

Time Offset

Sets the limit for the Time Offset measurement pass/fail test.

Key Path	Meas Setup, Limits
Mode	WIMAXOFDMA
Remote Command	:CALCulate:EVM:LIMit[1] 2:TOFFset <time> :CALCulate:EVM:LIMit[1] 2:TOFFset? :CALCulate:EVM:LIMit[1] 2:TOFF:STATe OFF ON 0 1 :CALCulate:EVM:LIMit[1] 2:TOFF:STATe?
Example	CALC:EVM:LIM:TOFF 100e-3 CALC:EVM:LIM:TOFF? CALC:EVM:LIM:TOFF:STAT ON CALC:EVM:LIM:TOFF:STAT?
Notes	LIMit1 is for BS, 2 for MS. Default is BS.
Preset	1e-6 ON
State Saved	Saved in instrument state.

Min	0
Max	100e-3
Initial S/W Revision	Prior to A.02.00

I/Q Offset

Sets the limit state for the I/Q Offset measurement pass/fail test.

Key Path	Meas Setup, Limits
Mode	WIMAXOFDMA
Remote Command	:CALCulate:EVM:LIMit[1] 2:IQOffset <rel_amp1> :CALCulate:EVM:LIMit[1] 2:IQOffset? :CALCulate:EVM:LIMit[1] 2:IQOffset:STATe OFF ON 0 1 :CALCulate:EVM:LIMit[1] 2:IQOffset:STATe?
Example	CALC:EVM:LIM1:IQOF 0 CALC:EVM:LIM1:IQOF? CALC:EVM:LIM:IQOF:STAT OFF CALC:EVM:LIM:IQOF:STAT?
Notes	LIMit1 is for BS, 2 for MS. Default is BS.
Preset	-15 dB ON
State Saved	Saved in instrument state.
Min	-100
Max	0
Initial S/W Revision	Prior to A.02.00

Abs Spectral Flatness

Accesses a menu that enables you to set absolute spectral flatness measurement setup parameters .

Key Path	Meas Setup, Limits, More
Initial S/W Revision	Prior to A.02.00

Offset

Selects the offset pairs (upper and lower) that the softkeys affect, and displays the memory selection menu from A to F. The memory selection menu enables you to store up to 5 sets of limit values for the offset pairs, such as Start Subcarrier/ Stop Subcarrier, Upper Mask Start/Upper Mask Stop, and Lower Mask

Start/Lower. Press Offset until the letter of the desired offset (A, B, C, D, E, or F) is underlined. Only one selection at a time is shown on this softkey label.

Key Path	Meas Setup, Limits, More, Abs Spectral Flatness
Mode	WIMAXOFDMA
Preset	A
Range	A B C D E F
Initial S/W Revision	Prior to A.02.00

Start Subcarrier

Specifies the start subcarrier for the currently selected offset.

Key Path	Meas Setup, Limits, More, Abs Spectral Flatness
Mode	WIMAXOFDMA
Remote Command	<pre>:CALCulate:EVM:LIMit[1] 2:SPECTrum:AMPFlatness:ABS:OFFSet:LIST:SUBCarrier:START <integer>, <integer>, <integer>, <integer>, <integer>, <integer> :CALCulate:EVM:LIMit[1] 2:SPECTrum:AMPFlatness:ABS:OFFSet:LIST:SUBCarrier:START? :CALCulate:EVM:LIMit[1] 2:SPECTrum:AMPFlatness:ABS:OFFSet:LIST:SUBCarrier:STATE ON OFF 1 0, ON OFF 1 0, ON OFF 1 0, ON OFF 1 0, ON OFF 1 0, ON OFF 1 0 :CALCulate:EVM:LIMit[1] 2:SPECTrum:AMPFlatness:ABS:OFFSet:LIST:SUBCarrier:STATE?</pre>
Example	<pre>CALC:EVM:LIM:SPEC:AMPF:ABS:OFFS:LIST:SUBC:STAR 1, 210, 0, 0, 0, 0 CALC:EVM:LIM:SPEC:AMPF:ABS:OFFS:LIST:SUBC:STAR? CALC:EVM:LIM:SPEC:AMPF:ABS:OFFS:LIST:SUBC:STAT ON, ON, ON, OFF, OFF, OFF CALC:EVM:LIM:SPEC:AMPF:ABS:OFFS:LIST:SUBC:STAT?</pre>
Notes	<p>On/Off (:CALCulate:EVM:LIMit[1] 2:SPECTrum:AMPFlatness:ABS:OFFSet:LIST:SUBCarrier:STATE) determines whether or not the designated offsets are available for the limit test. For example, :CALCulate:EVM:LIMit[1] 2:SPECTrum:AMPFlatness:ABS:OFFSet:LIST:SUBCarrier:STATE 1,0,0,0,0,0 means that only the first offset's limit test is available.</p> <p>See the following table for the default values for each Radio Standard.</p> <p>Comma separated list of 6 values. LIMit1 is for BS, 2 for MS. Default is BS.</p>
Couplings	<p>(1)Coupled to Stop Subcarrier. Start Subcarrier should be less than or equal to Stop Subcarrier.</p> <p>(2)Affected by Radio Device, FFT Size (See the Mode Setup section), and the permutation type of the selected zone as follows:</p> <pre>Downlink FFT 2048, PUSC :0, 1, 420, 0, 0, 0 Downlink FFT 1024, PUSC (default): 0, 1, 210, 0, 0, 0 Downlink FFT 512, PUSC :0, 1, 105, 0, 0, 0 Downlink FFT 128, PUSC : 0, 1, 21, 0, 0, 0 Downlink FFT 2048, FUSC :0, 1, 426, 0, 0, 0</pre>

Downlink FFT 1024, FUSC : 0, 1, 213, 0, 0, 0
 Downlink FFT 512, FUSC : 0, 1, 107, 0, 0, 0
 Downlink FFT 128, FUSC : 0, 1, 26, 0, 0, 0
 Downlink FFT 2048, OFUSC : 0, 1, 432, 0, 0, 0
 Downlink FFT 1024, OFUSC : 0, 1, 216, 0, 0, 0
 Downlink FFT 512, OFUSC : 0, 1, 108, 0, 0, 0
 Downlink FFT 128, OFUSC : 0, 1, 27, 0, 0, 0
 Downlink FFT 2048, AMC : 0, 1, 432, 0, 0, 0
 Downlink FFT 1024, AMC : 0, 1, 216, 0, 0, 0
 Downlink FFT 512, AMC : 0, 1, 108, 0, 0, 0
 Downlink FFT 128, AMC : 0, 1, 27, 0, 0, 0
 Uplink FFT 2048, PUSC : 0, 1, 420, 0, 0, 0
 Uplink FFT 1024, PUSC (default): 0, 1, 210, 0, 0, 0
 Uplink FFT 512, PUSC : 0, 1, 102, 0, 0, 0
 Uplink FFT 128, PUSC : 0, 1, 24, 0, 0, 0
 Uplink FFT 2048, OPUSC : 0, 1, 432, 0, 0, 0
 Uplink FFT 1024, OPUSC : 0, 1, 216, 0, 0, 0
 Uplink FFT 512, OPUSC : 0, 1, 108, 0, 0, 0
 Uplink FFT 128, OPUSC : 0, 1, 27, 0, 0, 0

Preset	1, 210, 0, 0, 0, 0 1,1,0,0,0,0
State Saved	Saved in instrument state.
Min	-1024
Max	1024
Initial S/W Revision	Prior to A.02.00

Stop Subcarrier

Specifies the stop subcarrier for the currently selected offset.

Key Path	Meas Setup, Limits, More, Abs Spectral Flatness
Mode	WIMAXOFDMA
Remote Command	:CALCulate:EVM:LIMit[1] 2:SPECTrum:AMPFlatness:ABS:OFFSet:LIST:SUBCarrier:STOP <integer>, <integer>, <integer>, <integer>, <integer>, <integer>, :CALCulate:EVM:LIMit[1] 2:SPECTrum:AMPFlatness:ABS:OFFSet:LIST:SUBCarrier:STOP?
Example	CALC:EVM:LIM:SPEC:AMPF:ABS:OFFS:LIST:SUBC:STOP 210, 420, 0, 0, 0, 0 CALC:EVM:LIM:SPEC:AMPF:ABS:OFFS:LIST:SUBC:STOP?
Notes	See the following table for the default values for each Radio Standard.

	Comma separated list of 6 values. LIMit1 is for BS, 2 for MS. Default is BS.
Couplings	<p>(1)Coupled to Start Subcarrier. Stop Subcarrier should be greater than or equal to Start Subcarrier.</p> <p>(2)Affected by Radio Device, FFT Size (See the Mode Setup section), and the permutation type of the selected zone as follows:</p> <p>Downlink FFT 2048, PUSC :0, 420, 840, 0, 0, 0</p> <p>Downlink FFT 1024, PUSC (default): 0, 210, 420, 0, 0, 0</p> <p>Downlink FFT 512, PUSC :0, 105, 210, 0, 0, 0</p> <p>Downlink FFT 128, PUSC : 0, 21, 42, 0, 0, 0</p> <p>Downlink FFT 2048, FUSC :0, 426, 851, 0, 0, 0</p> <p>Downlink FFT 1024, FUSC : 0, 213, 425, 0, 0, 0</p> <p>Downlink FFT 512, FUSC : 0, 107, 213, 0, 0, 0</p> <p>Downlink FFT 128, FUSC : 0, 26, 53, 0, 0, 0</p> <p>Downlink FFT 2048, OFUSC : 0, 432, 864, 0, 0, 0</p> <p>Downlink FFT 1024, OFUSC : 0, 216, 432, 0, 0, 0</p> <p>Downlink FFT 512, OFUSC : 0, 108, 216, 0, 0, 0</p> <p>Downlink FFT 128, OFUSC : 0, 27, 54, 0, 0, 0</p> <p>Downlink FFT 2048, AMC :0, 432, 864, 0, 0, 0</p> <p>Downlink FFT 1024, AMC : 0, 216, 432, 0, 0, 0</p> <p>Downlink FFT 512, AMC : 0, 108, 216, 0, 0, 0</p> <p>Downlink FFT 128, AMC : 0, 27, 54, 0, 0, 0</p> <p>Uplink FFT 2048, PUSC :0, 420, 840, 0, 0, 0</p> <p>Uplink FFT 1024, PUSC (default): 0, 210, 420, 0, 0, 0</p> <p>Uplink FFT 512, PUSC :0, 102, 205, 0, 0, 0</p> <p>Uplink FFT 128, PUSC : 0, 24, 48, 0, 0, 0</p> <p>Uplink FFT 2048, OPUSC :0, 432, 864, 0, 0, 0</p> <p>Uplink FFT 1024, OPUSC : 0, 216, 432, 0, 0, 0</p> <p>Uplink FFT 512, OPUSC :0, 108, 216, 0, 0, 0</p> <p>Uplink FFT 128, OPUSC : 0, 27, 54, 0, 0, 0</p>
Preset	210,420,0,0,0,0
State Saved	Saved in instrument state.
Min	-1024
Max	1024
Initial S/W Revision	Prior to A.02.00

Offset Side

Specifies which offset side will be measured.

Key Path	Meas Setup, Limits, More, Abs Spectral Flatness
----------	---

Mode	WIMAXOFDMA
Remote Command	:CALCulate:EVM:LIMit[1] 2:SPECTrum:AMPFlatness:ABS:OFFSet:LIST:SIDE BOTH NEGative POSitive, BOTH NEGative POSitive, BOTH NEGative POSitive, BOTH NEGative POSitive, BOTH NEGative POSitive :CALCulate:EVM:LIMit[1] 2:SPECTrum:AMPFlatness:ABS:OFFSet:LIST:SIDE?
Example	CALC:EVM:LIM:SPEC:AMPF:ABS:OFFS:LIST:SIDE BOTH, BOTH, BOTH, BOTH, BOTH CALC:EVM:LIM:SPEC:AMPF:ABS:OFFS:LIST:SIDE?
Notes	LIMit1 is for BS, 2 for MS. Default is BS.
Preset	BOTH, BOTH, BOTH, BOTH, BOTH, BOTH BOTH, BOTH, BOTH, BOTH, BOTH, BOTH
State Saved	Saved in instrument state.
Range	Neg Both Pos
Initial S/W Revision	Prior to A.02.00

Upper Mask Start

Sets the upper limit level at the start subcarrier for the selected offset.

Key Path	Meas Setup, Limits, More, Abs Spectral Flatness, More
Mode	WIMAXOFDMA
Remote Command	:CALCulate:EVM:LIMit[1] 2:SPECTrum:AMPFlatness:ABS:OFFSet:LIST:UPPer:START <real>, <real>, <real>, <real><real><real> :CALCulate:EVM:LIMit[1] 2:SPECTrum:AMPFlatness:ABS:OFFSet:LIST:UPPer:START? :CALCulate:EVM:LIMit[1] 2:SPECTrum:AMPFlatness:ABS:OFFSet:LIST:UPPer:STATe ON OFF 1 0, ON OFF 1 0, ON OFF 1 0, ON OFF 1 0, ON OFF 1 0, ON OFF 1 0 :CALCulate:EVM:LIMit[1] 2:SPECTrum:AMPFlatness:ABS:OFFSet:LIST:UPPer:STATe?
Example	CALC:EVM:LIM:SPEC:AMPF:ABS:OFFS:LIST:UPP:STAR 2, 2, 0, 0, 0, 0 CALC:EVM:LIM:SPEC:AMPF:ABS:OFFS:LIST:UPP:STAR? CALC:EVM:LIM:SPEC:AMPF:ABS:OFFS:LIST:UPP:STATe 0, 0, 0, 0, 0, 0 CALC:EVM:LIM:SPEC:AMPF:ABS:OFFS:LIST:UPP:STATe?
Notes	On/Off (:CALCulate:EVM:LIMit[1] 2:SPECTrum:AMPFlatness:ABS:OFFSet:LIST:UPPer:STATe) determines whether or not the designated offsets are available for the upper mask limit test. For example, :CALCulate:EVM:LIMit[1] 2:SPECTrum:AMPFlatness:ABS:OFFSet:LIST:UPPer:STATe 1,0,0,0,0,0 means that only the first offset's upper mask test is available. See the following table for the default values for each Radio Standard. Comma separated list of 6 values. LIMit1 is for BS, 2 for MS. Default is BS.
Preset	2,2,0,0,0,0 1,1,0,0,0,0

State Saved	Saved in instrument state.
Min	-100 dB
Max	100 dB
Initial S/W Revision	Prior to A.02.00

Upper Mask Stop

Sets the upper mask limit at the stop subcarrier for the selected offset. The upper mask limit ranges from -100 to +100 dB. You can also toggle this function between Auto and Man settings. If set to Auto, the Upper Mask Stop power level limit is coupled to Upper Mask Start, and results in a flat limit line. If set to Man, Upper Mask Start and Upper Mask Stop take different values and result in a sloped limit line.

Key Path	Meas Setup, Limits, More, Abs Spectral Flatness, More
Mode	WIMAXOFDMA
Remote Command	<pre>:CALCulate:EVM:LIMit[1] 2:SPECTrum:AMPFlatness:ABS:OFFSet:LIST:UPPer:STOP <real>, <real>, <real>, <real>, <real>, <real> :CALCulate:EVM:LIMit[1] 2:SPECTrum:AMPFlatness:ABS:OFFSet:LIST:UPPer:STOP? :CALCulate:EVM:LIMit[1] 2:SPECTrum:AMPFlatness:ABS:OFFSet:LIST:UPPer:STOP:AUTO MANual AUTO, MANual AUTO, MANual AUTO, MANual AUTO, MANual AUTO, MANual AUTO :CALCulate:EVM:LIMit[1] 2:SPECTrum:AMPFlatness:ABS:OFFSet:LIST:UPPer:STOP:AUTO?</pre>
Example	<pre>CALC:EVM:LIM:SPEC:AMPF:ABS:OFFS:LIST:UPP:STOP -15, 2, 2, 0, 0, 0 CALC:EVM:LIM:SPEC:AMPF:ABS:OFFS:LIST:UPP:STOP? CALC:EVM:LIM:SPEC:AMPF:ABS:OFFS:LIST:UPP:STOP:AUTO AUTO, AUTO, AUTO, AUTO, AUTO, AUTO CALC:EVM:LIM:SPEC:AMPF:ABS:OFFS:LIST:UPP:STOP:AUTO?</pre>
Notes	See the following table for the default values for each Radio Standard. Comma separated list of 6 values. LIMit1 is for BS, 2 for MS. Default is BS.
Couplings	When coupling is set to Auto, the value will be the same as Upper Mask Start.
Preset	2,2,0,0,0,0 AUTO,AUTO,AUTO,AUTO,AUTO,AUTO
State Saved	Saved in instrument state.
Min	-100 dB
Max	100 dB
Initial S/W Revision	Prior to A.02.00

Lower Mask Start

Sets the upper limit level at the start subcarrier for the selected offset.

Key Path	Meas Setup, Limits, More, Abs Spectral Flatness, More
Mode	WIMAXOFDMA
Remote Command	<pre>:CALCulate:EVM:LIMit[1] 2:SPECTrum:AMPFlatness:ABS:OFFSet:LIST:LOWer:STARt <real>, <real>, <real>, <real>, <real>, <real> :CALCulate:EVM:LIMit[1] 2:SPECTrum:AMPFlatness:ABS:OFFSet:LIST:LOWer:STARt? :CALCulate:EVM:LIMit[1] 2:SPECTrum:AMPFlatness:ABS:OFFSet:LIST:LOWer:STATe ON OFF 1 0, ON OFF 1 0, ON OFF 1 0, ON OFF 1 0, ON OFF 1 0, ON OFF 1 0 :CALCulate:EVM:LIMit[1] 2:SPECTrum:AMPFlatness:ABS:OFFSet:LIST:LOWer:STATe?</pre>
Example	<pre>CALC:EVM:LIM:SPEC:AMPF:ABS:OFFS:LIST:LOW:STAR -2, -4, 0, 0, 0, 0 CALC:EVM:LIM:SPEC:AMPF:ABS:OFFS:LIST:LOW:STAR? CALC:EVM:LIM:SPEC:AMPF:ABS:OFFS:LIST:LOW:STATe 1, 1, 0, 0, 0, 0 CALC:EVM:LIM:SPEC:AMPF:ABS:OFFS:LIST:LOW:STATe?</pre>
Notes	<p>On/Off (:CALCulate:EVM:LIMit[1] 2:SPECTrum:AMPFlatness:ABS:OFFSet:LIST:LOWer:STATe) determines whether or not the designated offsets are available for the lower mask limit test. For example, :CALCulate:EVM:LIMit[1] 2:SPECTrum:AMPFlatness:ABS:OFFSet:LIST:LOWer:STATe 1,0,0,0,0,0 means that only the first offset's lower mask test is available.</p> <p>See the following table for the default values for each Radio Standard.</p> <p>Comma separated list of 6 values. LIMit1 is for BS, 2 for MS. Default is BS.</p>
Preset	<pre>-2,-4,0,0,0,0 1,1,0,0,0,0</pre>
State Saved	Saved in instrument state.
Min	-100 dB
Max	100 dB
Initial S/W Revision	Prior to A.02.00

Lower Mask Stop

Sets the lower mask limit at the stop subcarrier for the selected offset. The upper mask limit ranges from – 100 to +100 dB. You can also toggle this function between Auto and Man settings. If set to Auto, the Upper Mask Stop power level limit is coupled to Upper Mask Start, which results in a flat limit line. If set to Man, Upper Mask Start and Upper Mask Stop take different values and result in a sloped limit line.

Key Path	Meas Setup, Limits, More, Abs Spectral Flatness, More
Mode	WIMAXOFDMA
Remote Command	:CALCulate:EVM:LIMit[1]

```
|2:SPECTrum:AMPFlatness:ABS:OFFSet:LIST:LOWer:STOP <real>, <real>,
<real>, <real>, <real>, <real>

:CALCulate:EVM:LIMit[1]
|2:SPECTrum:AMPFlatness:ABS:OFFSet:LIST:LOWer:STOP?

:CALCulate:EVM:LIMit[1]
|2:SPECTrum:AMPFlatness:ABS:OFFSet:LIST:LOWer:STOP:AUTO MANual | AUTO,
MANual | AUTO, MANual | AUTO, MANual | AUTO, MANual | AUTO, MANual |
AUTO

:CALCulate:EVM:LIMit[1]
|2:SPECTrum:AMPFlatness:ABS:OFFSet:LIST:LOWer:STOP:AUTO?
```

Example	CALC:EVM:LIM:SPEC:AMPF:ABS:OFFS:LIST:LOW:STOP -2, -4, 0, 0, 0, 0 CALC:EVM:LIM:SPEC:AMPF:ABS:OFFS:LIST:LOW:STOP? CALC:EVM:LIM:SPEC:AMPF:ABS:OFFS:LIST:LOW:STOP:AUTO AUTO, AUTO, AUTO, AUTO, AUTO, AUTO CALC:EVM:LIM:SPEC:AMPF:ABS:OFFS:LIST:LOW:STOP:AUTO?
Notes	See the following table for the default values for each Radio Standard. Comma separated list of 6 values. LIMit1 is for BS, 2 for MS. Default is BS.
Couplings	When coupling is set to Auto, the value will be the same as Lower Mask Start.
Preset	-2,-4,0,0,0,0 AUTO,AUTO,AUTO,AUTO,AUTO,AUTO
State Saved	Saved in instrument state.
Min	-100 dB
Max	100 dB
Initial S/W Revision	Prior to A.02.00

Zone/Data Burst Map

Selects the Zone Definition which defines the zone information.

Key Path	Meas Setup, More
Remote Command	:CALCulate:EVM:MAP:SElect:TYPE AUTO CUSTom FCH :CALCulate:EVM:MAP:SElect:TYPE?
Example	CALC:EVM:MAP:SEL:TYPE AUTO CALC:EVM:MAP:SEL:TYPE?
Preset	CUSTom
State Saved	Saved in instrument state.
Range	Auto Detected Map Custom Map FCH Only
Readback Text	Auto Det Map Custom Map FchOnly
Initial S/W Revision	Prior to A.02.00

Auto Detect Now

Detects Map information automatically using DL-MAP/UL-MAP and DCD/UCD.

Key Path	Meas Setup, More, Zone Data Burst Map
Mode	WIMAXOFDMA
Remote Command	:CALCulate:EVM:MAP:DETECT
Example	CALC:EVM:MAP:DET
Initial S/W Revision	Prior to A.02.00

Zone Num

Selects the zone definition to be used.

Key Path	Meas Setup, More
Mode	WIMAXOFDMA
Remote Command	:CALCulate:EVM:ZONE <integer> :CALCulate:EVM:ZONE?
Example	CALC:EVM:ZONE 1 CALC:EVM:ZONE?
Preset	1
State Saved	Saved in instrument state.
Min	1
Max	determined by current map
Initial S/W Revision	Prior to A.02.00

Data Burst Analysis

Selects a method of burst analysis. You can choose between the burst map method or the single burst method.

Key Path	Meas Setup, More
Remote Command	:CALCulate:EVM:BURSt:TYPE[:SElect] MAP SINGLE UZONE :CALCulate:EVM:BURSt:TYPE[:SElect]?
Example	CALC:EVM:BURS:TYPE MAP CALC:EVM:BURS:TYPE?
Preset	MAP
State Saved	Saved in instrument state.
Range	Burst Map Single Burst (Manual) Uniform Zone (Manual)
Readback Text	Burst Map Single Burst Uniform Zone
Initial S/W Revision	Prior to A.02.00

Burst Map

Analyzes a frame according to the defined map information.

Key Path	Meas Setup, Data Burst Analysis
Initial S/W Revision	Prior to A.02.00

Use Defined Boosting Level

Selects whether to automatically set boosting levels, or to use the values that are specified for the bursts.

Key Path	Meas Setup, More, Burst Analysis, Burst Map
Mode	WIMAXOFDMA
Remote Command	:CALCulate:EVM:BURSt:POWer:MAP ON OFF 1 0 :CALCulate:EVM:BURSt:POWer:MAP?
Example	CALC:EVM:BURS:POW:MAP 0 CALC:EVM:BURS:POW:MAP?
Preset	ON
State Saved	Saved in instrument state.
Initial S/W Revision	Prior to A.02.00

Single Burst

Accesses single burst parameters.

Key Path	Meas Setup, Data Burst Analysis
Initial S/W Revision	Prior to A.02.00

Subchan Offset

Sets the number of the Subchannel logical offset for the burst region.

Key Path	Meas Setup, More, Burst Analysis, Signal Burst
Mode	WIMAXOFDMA
Remote Command	:CALCulate:EVM:BURSt[1] 2:SUBChannel:OFFSet <integer> :CALCulate:EVM:BURSt[1] 2:SUBChannel:OFFSet?
Example	CALC:EVM:BURS:SUBC:OFFS 1 CALC:EVM:BURS:SUBC:OFFS?
Notes	BURSt1 is for BS, 2 for MS. Default is BS.

Preset	0
State Saved	Saved in instrument state.
Min	0
Max	Number of subchannels on current zone - 1
Initial S/W Revision	Prior to A.02.00

Burst Region Subchannel Interval

Sets the number of the subchannel logical interval for the burst region.

Key Path	Meas Setup, More, Burst Analysis, Signal Burst
Mode	WIMAXOFDMA
Remote Command	:CALCulate:EVM:BURSt[1] 2:SUBChannel:INTerval <integer> :CALCulate:EVM:BURSt[1] 2:SUBChannel:INTerval?
Example	CALC:EVM:BURS:SUBC:INT 1 CALC:EVM:BURS:SUBC:INT?
Notes	BURSt1 is for BS, 2 for MS. Default is BS.
Preset	1
State Saved	Saved in instrument state.
Min	1
Max	Number of subchannels on current zone - Burst Region Subchannel Offset
Initial S/W Revision	Prior to A.02.00

Symbol Offset

Sets the number of the OFDMA symbol offset for the burst region.

Key Path	Meas Setup, More, Burst Analysis, Signal Burst
Mode	WIMAXOFDMA
Remote Command	:CALCulate:EVM:BURSt[1] 2:SYMBol:OFFSet <integer> :CALCulate:EVM:BURSt[1] 2:SYMBol:OFFSet?
Example	CALC:EVM:BURS:SYMB:OFFS 1 CALC:EVM:BURS:SYMB:OFFS?
Notes	BURSt1 is for BS, 2 for MS. Default is BS.
Preset	0
State Saved	Saved in instrument state.
Min	0
Max	500
Initial S/W Revision	Prior to A.02.00

Symbol Interval

Sets the number of the OFDMA symbol interval for the burst position.

Key Path	Meas Setup, More, Burst Analysis, Signal Burst
Mode	WIMAXOFDMA
Remote Command	:CALCulate:EVM:BURSt[1] 2:SYMBOL:INTERval <integer> :CALCulate:EVM:BURSt[1] 2:SYMBOL:INTERval?
Example	CALC:EVM:BURS:SYMB:INT 1 CALC:EVM:BURS:SYMB:INT?
Notes	BURSt1 is for BS, 2 for MS. Default is BS.
Preset	1
State Saved	Saved in instrument state.
Min	1
Max	15 – Burst Region Symbol Offset
Initial S/W Revision	Prior to A.02.00

Burst Shape

Selects between wrapped or rectangle burst shapes.

Key Path	Meas Setup, More, Burst Analysis, Signal Burst
Remote Command	:CALCulate:EVM:BURSt[1] 2:SHAPE WRAPped RECTangle :CALCulate:EVM:BURSt[1] 2:SHAPE?
Example	CALC:EVM:BURS:SHAP WRAP CALC:EVM:BURS:SHAP?
Notes	BURSt1 is for BS, 2 for MS. Default is BS.
Preset	RECTangle
State Saved	Saved in instrument state.
Range	Wrapped Rectangle
Readback Text	WRAP RECT
Initial S/W Revision	Prior to A.02.00

Data Mod Type

Selects the Data Modulation Type to be used.

Key Path	Meas Setup, More, Burst Analysis, Signal Burst
Remote Command	:CALCulate:EVM:BURSt[1] 2:MODulation:TYPE QPSKR1BY2 QPSKR3BY4

	QAM16R1BY2 QAM16R3BY4 QAM64R1BY2 QAM64R2BY3 QAM64R3BY4 :CALCulate:EVM:BURSt[1] 2:MODulation:TYPE?
Example	CALC:EVM:BURS:MOD:TYPE QPSKR1BY2 CALC:EVM:BURS:MOD:TYPE?
Notes	BURSt1 is for BS, 2 for MS. Default is BS.
Preset	QPSKR1BY2
State Saved	Saved in instrument state.
Range	QPSK-1/2 QPSK-3/4 16QAM-1/2 16QAM-3/4 64QAM-1/2 64QAM-2/3 64QAM-3/4
Readback Text	QPSK-1/2 QPSK-3/4 16QAM-1/2 16QAM-3/4 64QAM-1/2 64QAM-2/3 64QAM-3/4
Initial S/W Revision	Prior to A.02.00

Uniform Zone

Defines a single burst as a Uniform Zone.

Key Path	Meas Setup, Data Burst Analysis
Initial S/W Revision	Prior to A.02.00

Data Mod Type

Selects the Data Modulation Type to be used.

Key Path	Meas Setup, More, Burst Analysis, Uniform Zone
Remote Command	:CALCulate:EVM:UZONe[1] 2:MODulation:TYPE QPSKR1BY2 QPSKR3BY4 QAM16R1BY2 QAM16R3BY4 QAM64R1BY2 QAM64R2BY3 QAM64R3BY4 :CALCulate:EVM:UZONe[1] 2:MODulation:TYPE?
Example	CALC:EVM:UZON:MOD:TYPE QAM64R3BY4 CALC:EVM:UZON:MOD:TYPE?
Notes	UZONe1 is for BS, 2 for MS. Default is BS.
Preset	QPSKR1BY2
State Saved	Saved in instrument state.
Range	QPSK-1/2 QPSK-3/4 16QAM-1/2 16QAM-3/4 64QAM-1/2 64QAM-2/3 64QAM-3/4
Readback Text	QPSK-1/2 QPSK-3/4 16QAM-1/2 16QAM-3/4 64QAM-1/2 64QAM-2/3 64QAM-3/4
Initial S/W Revision	Prior to A.02.00

Zone Offset

Sets the Zone Offset in symbols.

Key Path	Meas Setup, More
Mode	WIMAXOFDMA
Remote Command	:CALCulate:EVM:ZONE:OFFSet <integer> :CALCulate:EVM:ZONE:OFFSet?
Example	CALC:EVM:ZONE:OFFS 2 CALC:EVM:ZONE:OFFS?
Dependencies	Grayed out when Burst Map is selected in Burst Analysis.
Preset	1
State Saved	Saved in instrument state.
Min	0
Max	determined by current map
Initial S/W Revision	Prior to A.02.00

Zone Interval

Sets Zone Interval in symbols.

Key Path	Meas Setup, More
Mode	WIMAXOFDMA
Remote Command	:CALCulate:EVM:ZONE:INTerval <integer> :CALCulate:EVM:ZONE:INTerval?
Example	CALC:EVM:ZONE:INT 12 CALC:EVM:ZONE:INT?
Dependencies	Grayed out when Burst Map is selected in Burst Analysis.
Preset	2
State Saved	Saved in instrument state.
Min	1
Max	determined by current map
Initial S/W Revision	Prior to A.02.00

Data Burst Select

The analyzer enables single or multiple burst analysis. To select all data burst for analysis, press 'All On' key. To select a single data burst for analysis, press 'Single' key on a selected Data Burst Num. To select multiple data bursts for analysis, turn on a selected Data Burst Num.

Key Path	Meas Setup, Data Burst Select
Initial S/W Revision	Prior to A.02.00

Data Burst Num

Selects multiple data bursts for analysis when it is set to On.

Key Path	Meas Setup, More, Data Burst Select
Mode	WIMAXOFDMA
Remote Command	:CALCulate:EVM:BURSt:STATe ON OFF 1 0, ... :CALCulate:EVM:BURSt:STATe?
Example	CALC:EVM:BURS:STAT 0,0 CALC:EVM:BURS:STAT?
Notes	Number of elements is determined by Number of Bursts provided by :CALC:EVM:BURS:NUMB?. See "Number of Bursts (Query Only)" on page 1958 .
Preset	1
State Saved	Saved in instrument state.
Range	On Off
Initial S/W Revision	Prior to A.02.00

All On

Selects all data burst for analysis.

Key Path	Meas Setup, More, Data Burst Select
Mode	WIMAXOFDMA
Notes	Number of elements is determined by Number of Bursts provided by :CALC:EVM:BURS:NUMB?. See "Number of Bursts (Query Only)" on page 1958 .
Initial S/W Revision	Prior to A.02.00

Single

Selects a single data burst for analysis.

Key Path	Meas Setup, More, Data Burst Select
Mode	WIMAXOFDMA
Notes	Number of elements is determined by Number of Bursts provided by :CALC:EVM:BURS:NUMB?. See "Number of Bursts (Query Only)" on page 1958 .
Initial S/W Revision	Prior to A.02.00

Preamble Index

Sets the number that the Preamble Index specifies for the preamble sequence of the downlink subframe.

Key Path	Meas Setup, More, More
Mode	WIMAXOFDMA
Remote Command	:CALCulate:EVM:PINdex <integer> :CALCulate:EVM:PINdex?
Example	CALC:EVM:PIND 1 CALC:EVM:PIND?
Notes	This parameter is available only in BS mode.
Preset	0
State Saved	Saved in instrument state.
Min	0
Max	113
Initial S/W Revision	Prior to A.02.00

Subchannel Group Bitmask

Specifies which subchannel groups are allocated to the segment. The DL PUSC zone definition provides 6 subchannel groups which specify the number of used subchannels and how they are mapped to subcarriers for analysis of DL-PUSC data bursts.

Key Path	Meas Setup, More, More
Remote Command	:CALCulate:EVM:SUBChannel:MASK OFF ON 0 1, ... :CALCulate:EVM:SUBChannel:MASK?
Example	CALC:EVM:SUBC:MASK 1,1,1,1,1,1 CALC:EVM:SUBC:MASK?
Notes	This parameter is available only in BS mode. This parameter depends on Preamble Index parameter (1.6.6.13) When On PreambleIndex = 0, 1, ..., 31, 96, 99, 102, 105, 108 and 111 (Segment #0), Group #0 should be ALWAYS ON. When On PreambleIndex = 32, 33, ..., 63, 97, 100, 103, 106, 109 and 112 (Segment #1), Group #2 should be ALWAYS ON. When On PreambleIndex = 64, 65, ..., 95, 98, 101, 104, 107, 110 and 113 (Segment #2), Group #4 should be ALWAYS ON.
Preset	1, 1, 1, 1, 1, 1
State Saved	Saved in instrument state.
Initial S/W Revision	Prior to A.02.00

Meas Preset

Restores all the measurement parameters to their default values.

Key Path	Meas Setup, More, More
Mode	WIMAXOFDMA
Remote Command	:CONFigure:EVM
Example	CONF:EVM
Initial S/W Revision	Prior to A.02.00

Advanced

Accesses advanced features. These features are recommended for use only by advanced users.

Key Path	Meas Setup, More
Initial S/W Revision	Prior to A.02.00

Pilot in RMS/Pk RCE

Includes or excludes the Pilot in RCE calculations.

Key Path	Meas Setup, More, More, Advanced
Mode	WIMAXOFDMA
Remote Command	:CALCulate:EVM:PILot INCLude EXCLude :CALCulate:EVM:PILot?
Example	CALC:EVM:PIL INCL CALC:EVM:PIL?
Preset	EXCLude
State Saved	Saved in instrument state.
Range	INCLude EXCLude
Initial S/W Revision	Prior to A.02.00

Spectrum

Sets a spectrum to either normal or to inverted for demodulation related measurements. If set to INVert, the upper and lower spectrums are swapped.

The invert function conjugates the spectrum, which is equivalent to taking the negative of the quadrature component in demodulation. The correct setting (Normal or Invert) depends on whether the signal at the input of the instrument has a high or a low side mix.

Key Path	Meas Setup, More, More, Advanced
Mode	WIMAXOFDMA
Remote Command	:CALCulate:EVM:SPECTrum INVert NORMal

	:CALCulate:EVM:SPECTrum?
Example	CALC:EVM:SPEC INV CALC:EVM:SPEC?
Preset	NORMal
State Saved	Saved in instrument state.
Range	Normal Invert
Initial S/W Revision	Prior to A.02.00

Symbol Timing Adjust

Symbol Timing Adjust enables you to adjust the "useful symbol time period" (TFFT) within the "OFDMA extended symbol time period" (TS). Symbol Timing Adjust shifts the start of the TFFT period to earlier in the TS time period. You specify the amount of TFFT shift as a percentage of the TFFT length.

The extended OFDMA symbol time period (TS) consists of a guard interval (TGI) plus a "useful symbol time period" (T

FFT). Within the TS, the analyzer performs the demodulation and data analysis on only one TFFT time period. The Symbol Time Adjust parameter enables you to move the TFFT within the TS.

Typically, the TGI time period is ignored and only the TFFT time period is used. The Symbol Time Adjust parameter causes the demodulation start time to begin earlier within each extended symbol time. The minimum Symbol Time Adjust value is equal to $-(\text{guard interval})/100$, the maximum value is "0" (full guard interval).

The Symbol Time Adjust parameter is reset to the default value whenever the Guard Interval is changed. The default value is -3.125% , if the guard interval is $1/16$ or greater. The default value is equal to $\text{TGI} \cdot 100/2$ (half the guard interval) when the guard interval is less than $1/16$.

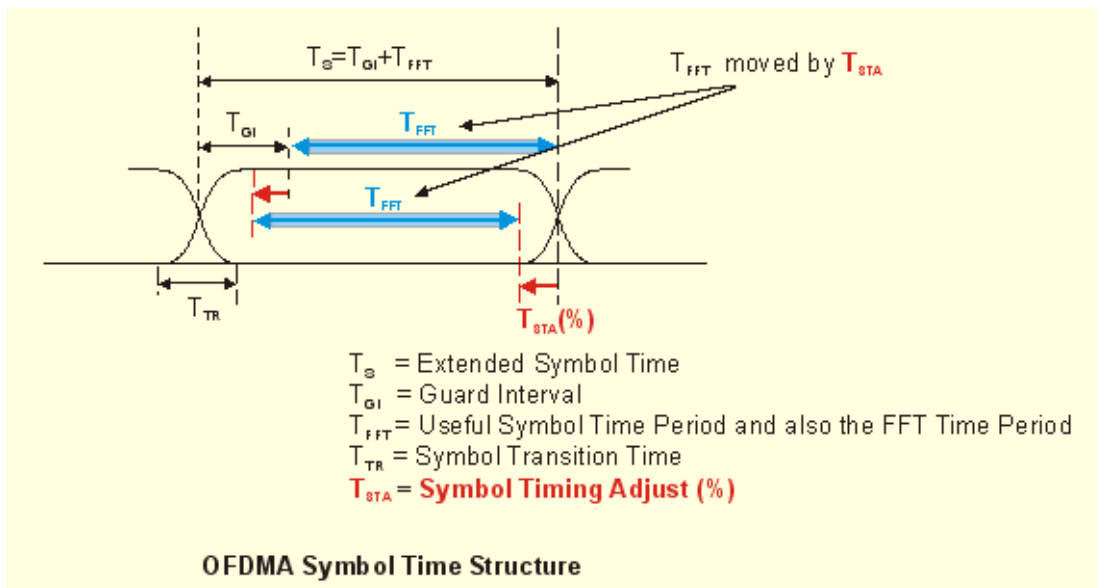

Key Path	Meas Setup, More, More, Advanced
Remote Command	:CALCulate:EVM:SYMBOL:ADJust <real> :CALCulate:EVM:SYMBOL:ADJust?
Example	CALC:EVM:SYMB:ADJ -3.125 CALC:EVM:SYMB:ADJ?
Preset	-3.125%
State Saved	Saved in instrument state.
Range	-12.5 % to - 0 %
Min	-12.5 %
Max	0 %
Initial S/W Revision	Prior to A.02.00

Pilot Tracking

802.16 OFDMA performs demodulation relative to the data in pilot carriers embedded in the signal. These pilot carriers replace data-carrying elements of the signal and allow some kinds of impairments to be removed or "tracked out".

Many impairments will be common to all pilot carriers and can be measured and displayed as "common pilot error".

In addition, several specific tracking functions can be individually switched on and off in the demodulation performed by this measurement. This is a very useful troubleshooting approach, since modulation errors can be examined with and without the benefit of particular types of pilot tracking.

Key Path	Meas Setup, Advanced
Initial S/W Revision	Prior to A.02.00

Track Amplitude

Track Amplitude specifies whether the analyzer tracks amplitude changes in the pilot subcarriers. When Track Amplitude is selected, the analyzer applies pilot subcarrier amplitude error correction to the pilot and data subcarriers. This is in addition to Track Phase and Track Timing error correction, if selected.

Key Path	Meas Setup, More, More, Advanced, Pilot Tracking
Mode	WIMAXOFDMA
Remote Command	:CALCulate:EVM:PILot:TRACk:AMPLitude OFF ON 0 1 :CALCulate:EVM:PILot:TRACk:AMPLitude?
Example	CALC:EVM:PIL:TRAC:AMPL 1 CALC:EVM:PIL:TRAC:AMPL?
Preset	OFF

State Saved	Saved in instrument state.
Range	On Off
Initial S/W Revision	Prior to A.02.00

Track Phase

The Track Phase parameter specifies whether the analyzer tracks phase changes in the pilot subcarriers. When Track Phase is selected, the analyzer applies pilot subcarrier phase error correction to the pilot and data subcarriers. This is in addition to Track Amplitude and Track Timing error correction if selected.

Key Path	Meas Setup, More, More, Advanced, Pilot Tracking
Mode	WIMAXOFDMA
Remote Command	:CALCulate:EVM:PIlot:TRACk:PHASe OFF ON 0 1 :CALCulate:EVM:PIlot:TRACk:PHASe?
Example	CALC:EVM:PIL:TRAC:PHAS 0 CALC:EVM:PIL:TRAC:PHAS?
Preset	ON
State Saved	Saved in instrument state.
Range	On Off
Initial S/W Revision	Prior to A.02.00

Track Timing

The Track Timing parameter specifies whether the analyzer tracks timing changes in the pilot subcarriers. When Track Timing is selected the analyzer applies pilot subcarrier timing error correction (frequency offset correction) to the pilot and data subcarriers. This is in addition to Track Amplitude and Track Phase error correction if selected.

Key Path	Meas Setup, More, More, Advanced, Pilot Tracking
Mode	WIMAXOFDMA
Remote Command	:CALCulate:EVM:PIlot:TRACk:TIMing OFF ON 0 1 :CALCulate:EVM:PIlot:TRACk:TIMing?
Example	CALC:EVM:PIL:TRAC:TIM 1 CALC:EVM:PIL:TRAC:TIM?
Preset	ON
State Saved	Saved in instrument state.
Range	On Off
Initial S/W Revision	Prior to A.02.00

Equalizer Training

When demodulating the 802.16 OFDMA signal, the analyzer uses an equalizer to correct for linear impairments in the signal path, such as multi-path. The analyzer supports three different methods to initialize, or "train", the equalizer: Preamble Only, Preamble, Data & Pilots and Preamble & Pilots Only. Selecting an appropriate method can help isolate problems that contribute to increased RCE (EVM).

Key Path	Meas Setup, More, More, Advanced
Remote Command	:CALCulate:EVM:EQUalizer:TMODe SEQuence SDATa SPILot :CALCulate:EVM:EQUalizer:TMODe?
Example	CALC:EVM:EQU:TMOD SDAT CALC:EVM:EQU:TMOD?
Preset	SDATa
State Saved	Saved in instrument state.
Range	BS: Preamble Only Preamble, Data & Pilots Preamble & Pilots MS: No Equalization Data & Pilots Pilots Only
Readback Text	BS: Preamble Pr, Data & Pilots Pr & Pilots MS: No Equalization Data & Pilots Pilots Only
Initial S/W Revision	Prior to A.02.00

Equalizer Smoothing

This parameter determines whether a spectral flatness result trace is smoothed.

Key Path	Meas Setup, More, More, Advanced
Mode	WIMAXOFDMA
Remote Command	:CALCulate:EVM:EQUalizer:SMOothing:STATe OFF ON 0 1 :CALCulate:EVM:EQUalizer:SMOothing:STATe?
Example	CALC:EVM:EQU:SMO:STAT 1 CALC:EVM:EQU:SMO:STAT?
Preset	OFF
State Saved	Saved in instrument state.
Range	On Off
Initial S/W Revision	Prior to A.02.00

PhNoise Opt

The Phase Noise Optimization setting affects the phase noise distribution on the analyzer's LO.

Key Path	Meas Setup, Advanced
----------	----------------------

Mode	WiMAXOFDMA
Remote Command	[:SENSe] :EVM:FREQuency:SYNTHeSis [:STATe] 1 2 3 [:SENSe] :EVM:FREQuency:SYNTHeSis [:STATe] ?
Example	EVM:FREQ:SYNT 1 EVM:FREQ:SYNT?
Notes	Parameter key: 1 - Best Close-in 2 - Best Wide-offset 3 - Fast Tuning
Preset	Models with option EP2: 3 Other: 1
State Saved	Saved in instrument state.
Range	Best Close-in Φ Noise [offset < 20 kHz] Best Wide-offset Φ Noise [offset > 30 kHz] Fast Tuning [Same as Close-in]
Readback Text	Close-in Wide-offset Fast Tuning
Initial S/W Revision	Prior to A.02.00
Modified at S/W Revision	A.13.00

I/Q Mismatch Compensation

I/Q Mismatch Compensation enables you to remove IQ impairments, including IQ Gain Imbalance, IQ Quadrature Error, and IQ Timing Skew errors, from the EVM and RCE metrics and demodulation measurement results. The I/Q Compensation algorithm uses the measured Gain Imb, Quad Err, and Timing Skew error estimates shown in the Syms/Errs Summary Table. This feature is useful for determining what the EVM/RCE metric results would be for a DUT in which the IQ mismatch impairments are the dominant factor in EVM/RCE degradation, but could be removed by a later calibration process or redesign.

Key Path	Meas Setup, Advanced
Mode	WiMAXOFDMA
Remote Command	:CALCulate:EVM:IQMismatch:COMPensation OFF ON 0 1 :CALCulate:EVM:IQMismatch:COMPensation?
Example	CALC:EVM:IQM:COMP 1 CALC:EVM:IQM:COMP?
Couplings	When Compensate IQ mismatch is set to ON, Data-and-Pilot method will be used, regardless of the selected Equalizer Training method (See "Equalizer Training" on page 1714 "Equalizer Training" on page 1714).
Preset	OFF
State Saved	Saved in instrument state.
Range	On Off
Initial S/W Revision	A.02.00

Multi Carrier Filter

This parameter is used to isolate the measurement channel when measuring a multi-carrier signal. The multi-carrier filter suppresses adjacent channel interference from the measurement. Using the multi-carrier filter produces better channel measurement results, such as EVM, but measurement may be slower. Unless the user measures a multi-channel signal, it is recommended to set this parameter OFF.

ON: Include the multi-carrier filter in the measurement.

OFF: Remove the multi-carrier filter from the measurement.

Key Path	Meas Setup, Advanced
Mode	WIMAXOFDMA
Remote Command	:CALCulate:EVM:MCFilter:STATe OFF ON 0 1 :CALCulate:EVM:MCFilter:STATe?
Example	CALC:EVM:MCF:STAT ON CALC:EVM:MCF:STAT?
Preset	OFF
State Saved	Saved in instrument state.
Range	On Off
Initial S/W Revision	A.02.00

UL Permbase

Sets the Uplink Permbase number for MS measurement. This parameter is needed to determine subcarrier allocation .

Key Path	Meas Setup, More, More
Mode	WIMAXOFDMA
Remote Command	:CALCulate:EVM:MS:PBASe <integer> :CALCulate:EVM:MS:PBASe?
Example	CALC:EVM:MS:PBAS 1 CALC:EVM:MS:PBAS?
Notes	This parameter is available only in MS mode.
Preset	0
State Saved	Saved in instrument state.
Min	0
Max	69
Initial S/W Revision	Prior to A.02.00

Mode

See "Mode" on page 286

Mode Preset

Returns the active mode to a known state.

Mode Preset does the following for the currently active mode:

- Aborts the currently running measurement.
- Brings up the default menu for the mode, with no active function.
- Sets measurement Global settings to their preset values for the active mode only.
- Activates the default measurement.
- Brings up the default menu for the mode.
- Clears the input and output buffers.
- Sets Status Byte to 0.

Mode Preset does not:

- Cause a mode switch
- Affect mode persistent settings
- Affect system settings

See "[How-To Preset](#)" on page 1719 for more information.

Key Path	Front-panel key
Remote Command	:SYSTem:PRESet
Example	:SYST:PRES
Notes	*RST is preferred over :SYST:PRES for remote operation. *RST does a Mode Preset, as done by the :SYST:PRES command, and it sets the measurement mode to Single measurement rather than Continuous for optimal remote control throughput. Clears all pending OPC bits. The Status Byte is set to 0.
Couplings	A Mode Preset aborts the currently running measurement, activates the default measurement, and gets the mode to a consistent state with all of the default couplings set.
Backwards Compatibility Notes	In the X-Series, the legacy "Factory Preset" has been replaced with Mode Preset, which only presets the currently active mode, not the entire instrument. In the X-Series, the way to preset the entire instrument is by using System, Restore System Defaults All, which behaves essentially the same way as restore System Defaults does on ESA and PSA. There is also no "Preset Type" as there is on the PSA. There is a green Mode Preset front-panel key that does a Mode Preset and a white-with-green-letters User Preset front-panel key that does a User Preset. The old PRESet:TYPE command is ignored (without generating an error), and SYST:PRES without a parameter does a Mode Preset, which should cover most backward code compatibility issues. The settings and correction data under the Input/Output front-panel key (examples: Input Z Corr, Ext Amp Gain, etc.) are no longer part of any Mode, so they will not be preset by a Mode Preset. They are preset using Restore Input/Output Defaults, Restore System Defaults All. Note that because User Preset does a Recall State, and all of these settings are saved in State, they ARE recalled when using

	User Preset.
Initial S/W Revision	Prior to A.02.00

How-To Preset

The table below shows all possible presets, their corresponding SCPI commands and front-panel access (key paths). Instrument settings depend on the current measurement context. Some settings are local to the current measurement, some are global (common) across all the measurements in the current mode, and some are global to all the available modes. In a similar way, restoring the settings to their preset state can be done within the different contexts.

Auto Couple - is a measurement local key. It sets all Auto/Man parameter couplings in the measurement to Auto. Any Auto/Man selection that is local to other measurements in the mode will not be affected.

Meas Preset - is a measurement local key. Meas Preset resets all the variables local to the current measurement except the persistent ones.

Mode Preset - resets all the current mode's measurement local and measurement global variables except the persistent ones.

Restore Mode Defaults - resets ALL the Mode variables (and all the Meas global and Meas local variables), including the persistent ones.

Type Of Preset	SCPI Command	Front Panel Access
Auto Couple	:COUPlE ALL	Auto Couple front-panel key
Meas Preset	:CONFIgure:<Measurement>	Meas Setup Menu
Mode Preset	:SYSTem:PRESet	Mode Preset (green key)
Restore Mode Defaults	:INSTRument:DEFault	Mode Setup Menu
Restore All Mode Defaults	:SYSTem:DEFault MODEs	System Menu; Restore System Default Menu
*RST	*RST	not possible (Mode Preset with Single)
Restore Input/Output Defaults	:SYSTem:DEFault INPut	System Menu; Restore System Default Menu
Restore Power On Defaults	:SYSTem:DEFault PON	System Menu; Restore System Default Menu
Restore Alignment Defaults	:SYSTem:DEFault ALIGn	System Menu; Restore System Default Menu
Restore Miscellaneous Defaults	:SYSTem:DEFault MISC	System Menu; Restore System Default Menu
Restore All System Defaults	:SYSTem:DEFault [ALL] :SYSTem:PRESet:PERSistent	System Menu; Restore System Default Menu
User Preset	:SYSTem:PRESet:USER	User Preset Menu
User Preset All Modes	:SYSTem:PRESet:USER:ALL	User Preset Menu

Power On Mode Preset	:SYSTem:PON:TYPE MODE	System Menu
Power On User Preset	:SYSTem:PON:TYPE USER	System Menu
Power On Last State	:SYSTem:PON:TYPE LAST	System Menu

Preset Type (Remote Command Only)

As stated in the Backward Compatibility section, to be compatible with ESA/PSA the PRESet:TYPE command will be implemented as a no-op.

Mode	All
Remote Command	:SYSTem:PRESet:TYPE FACTory MODE USER :SYSTem:PRESet:TYPE?
Example	:SYST:PRESet:TYPE FACT
Notes	This command is supported for backward compatibility only. It is a no-op which does not change the behavior of any preset operation.
Preset	This is unaffected by Preset but is set to Mode on a "Restore System Defaults->All"
State Saved	No
Initial S/W Revision	Prior to A.02.00

Mode Setup

See "[Mode Setup](#)" on page 316

Peak Search

Displays the Peak Search menu and places the selected marker on the trace point with the maximum y-axis value for that marker's trace.

Key Path	Peak Search
Mode	WIMAXOFDMA
Remote Command	:CALCulate:EVM:MARKer[1] 2 ...12:MAXimum
Example	CALC:EVM:MARK2:MAX
Initial S/W Revision	Prior to A.02.00

Next Peak

Moves the selected marker to the peak that has the next highest amplitude that is less than the marker's current value.

Key Path	Peak Search
Mode	WIMAXOFDMA
Remote Command	:CALCulate:EVM:MARKer[1] 2 ...12:MAXimum:NEXT
Example	CALC:EVM:MARK2:MAX:NEXT
Initial S/W Revision	Prior to A.02.00

Next Pk Right

Moves the selected marker to the next peak to the right of the current marker.

Key Path	Peak Search
Mode	WIMAXOFDMA
Remote Command	:CALCulate:EVM:MARKer[1] 2 ...12:MAXimum:RIGHT
Example	CALC:EVM:MARK2:MAX:RIGH
Initial S/W Revision	Prior to A.02.00

Next Pk Left

Moves the selected marker to the next peak to the left of the current marker.

Key Path	Peak Search
Mode	WIMAXOFDMA
Remote Command	:CALCulate:EVM:MARKer[1] 2 ...12:MAXimum:LEFT
Example	CALC:EVM:MARK2:MAX:LEFT
Initial S/W Revision	Prior to A.02.00

Marker Delta

Performs the same function as the Delta 1-of-N selection key in the Marker menu. This sets the control mode for the selected marker to Delta mode. The softkey enables you to conveniently perform a peak search and change the marker's control mode to Delta without having to access two separate menus.

Key Path	Peak Search
Initial S/W Revision	Prior to A.02.00

Pk-Pk Search

Finds and displays the amplitude and frequency (or time, if in zero span) differences between the highest and lowest y-axis value.

Key Path	Peak Search, More
Mode	WIMAXOFDMA
Remote Command	:CALCulate:EVM:MARKer [1] 2 ... 12:PTPeak
Example	CALC:EVM:MARK:PTP
Notes	Turns on the Marker Δ active function.
Dependencies	This key is not available when Coupled Markers is on.
Initial S/W Revision	Prior to A.02.00

Min Search

Moves the selected marker to the minimum y-axis value of the current trace.

Key Path	Peak Search, More
Mode	WIMAXOFDMA
Remote Command	:CALCulate:EVM:MARKer [1] 2 ... 12:MINimum
Example	CALC:EVM:MARK:MIN
Initial S/W Revision	Prior to A.02.00

14 Modulation Analysis Measurement
Print

Print

See ["Print" on page 341](#)

Quick Save

The Quick Save front-panel key repeats the most recent save that was performed from the Save menu, with the following exceptions:

- Register saves are not remembered as Saves for the purpose of the Quick Save function
- If the current measurement does not support the last non-register save that was performed, an informational message is generated, “File type not supported for this measurement”

Quick Save repeats the last type of qualified save (that is, a save qualified by the above criteria) in the last save directory by creating a unique filename using the Auto File Naming algorithm described below.

If Quick Save is pressed after startup and before any qualified Save has been performed, the Quick Save function performs a Screen Image save using the current settings for Screen Image saves (current theme, current directory), which then becomes the “last save” for the purpose of subsequent Quick Saves.

The Auto File Naming feature automatically generates a file name for use when saving a file. The filename consists of a prefix and suffix separated by a dot, as is standard for the Windows® file system. A default prefix exists for each of the available file types:

Type	Default Prefix	Menu
State	State_	(Save/Recall)
Trace + State	State_	(Save/Recall)
Screen	Screen_	(Save/Recall)
Amplitude Corrections	Ampcor_	(Import/Export)
Traces	Trace_	(Import/Export)
Limit Lines	LLine_	(Import/Export)
Measurement Result	MeasR_	(Import/Export)
Capture Buffer	CapBuf_	(Import/Export)

A four digit number is appended to the prefix to create a unique file name. The numbering sequence starts at 0000 within each Mode for each file type and updates incrementally to 9999, then wraps to 0000 again. It remembers where it was through a Mode Preset and when leaving and returning to the Mode. It is reset by Restore Misc Defaults and Restore System Defaults and subsequent running of the instrument application. So, for example, the first auto file name generated for State files is State_0000.state. The next is State_0001, and so forth.

One of the key features of Auto File Name is that we guarantee that the Auto File Name will never conflict with an existing file. The algorithm looks for the next available number. If it gets to 9999, then it looks for holes. If it find no holes, that is no more numbers are available, it gives an error.

For example, if when we get to State_0010.state there is already a State_0010.state file in the current directory, it advances the counter to State_0011.state to ensure that no conflict will exist (and then it verifies that State_0011.state also does not exist in the current directory and advances again if it does, and so forth).

If you enter a file name for a given file type, then the prefix becomes the filename you entered instead of the default prefix, followed by an underscore. The last four letters (the suffix) are the 4-digit number.

For example, if you save a measurement results file as “fred.csv”, then the next auto file name chosen for a measurement results save will be fred_0000.csv.

NOTE

Although 0000 is used in the example above, the number that is used is actually the current number in the Meas Results sequence, that is, the number that would have been used if you had not entered your own file name.

NOTE

If the filename you entered ends with _dddd, where d=any number, making it look just like an auto file name, then the next auto file name picks up where you left off with the suffix being dddd + 1.

Key Path	Front-panel key
Notes	No remote command for this key specifically.
Initial S/W Revision	Prior to A.02.00

Recall

The Recall menu lets you choose what you want to recall, and where you want to recall it from. Among the types of files you can recall are **States and Traces**. In addition, an Import (Data) option lets you recall a number of data types stored in CSV files (as used by Excel and other spreadsheet programs).

The default paths for Recall are data type dependent and are the same as for the Save key.

Key Path	Front-panel key
Notes	<p>No remote command for this key specifically, but the :MMEM:LOAD command is available for specific file types. An example is :MMEM:LOAD:STATe <filename>.</p> <p>If you try to recall a State file for a mode that is not licensed or not available in the instrument, an error message will occur and the state will not change.</p>
Backwards Compatibility Notes	<p>In legacy analyzers, it was possible to load a state without affecting the trace data, limit lines or correction data. Similarly (since User Preset is actually loading a state), it was possible to do a User Preset without affecting the trace data, limit lines or correction data.</p> <p>In the X-Series, “state” always includes all of this data; so whenever state is loaded, all of the traces, limit lines and corrections are affected. Although this differs from previous behavior, it is desirable behavior, and should not cause adverse issues for users.</p>
Backwards Compatibility Notes	<p>Recall for the X-Series supports backward compatibility in the sense that you can recall a state file from any X-Series model number and any version of X-Series software. This is only possible if part of the recalling process goes through a limiting step after recalling the mode settings, at least for settings that may vary with version number, model number, option and license differences. If you try to recall a state file onto an instrument with less capability than what was available on the instrument during the save, the recall will ignore the state it doesn't support and it will limit the recalled setting to what it allows.</p> <p>Example: if the saved state includes preamp ON, but the recalling instrument does not have a preamp; the preamp is limited to OFF. Conversely, if you save a state without a preamp, the preamp is OFF in the state file. When this saved file is recalled on an instrument with a licensed preamp, the preamp is changed to OFF. Another example is if the saved state has center frequency set to 20 GHz, but the instrument recalling the saved state is a different model and only supports 13.5 GHz. In this case, the center frequency is limited along with any other frequency based settings. Since the center frequency can't be preserved in this case, the recall limiting tries to at least preserve span to keep the measurement setup as intact as possible.</p> <p>It may be appropriate to issue a warning if the state is limited on the recall; warnings do not go out to SCPI so this would only affect the manual user.</p> <p>Note that there is no state file compatibility outside of the X-Series. For example, you cannot recall a state file from ESA or PSA.</p>
Initial S/W Revision	Prior to A.02.00

State

The Recall State menu lets you choose a register or file from which to recall the state.

The content of a state file includes all of the settings and data required to return the analyzer as closely as possible to the Mode it was in, with the exact settings that were in place, when the save occurred. The Mode settings in each state file include the settings that are affected by Mode Preset, as well as the

additional settings affected by Restore Mode Defaults; all of the Mode's settings. In addition, all of the settings of the Input/Output system are included, even though they are outside of the Mode's state, because they are needed to restore the complete setup. Persistent System settings (for example, GPIB address) are not affected by either a Mode Preset or Restore Mode Defaults, nor are they included in a saved State file.

Since each state file is only for one Mode, the settings for other Modes are unaffected when it is loaded. Recall State will cause a mode switch if the state being recalled is not from the current active mode.

After the recall completes, the message "File <filename> recalled" or "Recalled State Register <register number>" is displayed.

For rapid recalls, the State menu lists 16 registers that you can choose from to recall. Pressing a Register key initiates the recall. You can also select a file from which to recall.

The default path for all State Files is:

My Documents\<<mode name>\state

where <mode name> is the parameter used to select the mode with the INST:SEL command (for example, SA for the Spectrum Analyzer).

See ["More Information" on page 1729](#).

Key Path	Recall
Mode	All
Remote Command	:MMEMory:LOAD:STATe <filename>
Example	:MMEM:LOAD:STAT "myState.state" This recalls the file myState.state on the default path
Example	MMEM:LOAD:STAT "MyStateFile.state" This loads the state file data (on the default file directory path) into the instrument state.
Notes	<p>When you pick a file to recall, the analyzer first verifies that the file is recallable in the current instrument by checking the software version and model number of the instrument. If everything matches, a full recall proceeds by aborting the currently running measurement, clearing any pending operations, and then loading the State from the saved state file. You can open state files from any mode, so recalling a State file switches to the mode that was active when the save occurred. After switching to the mode of the saved state file, mode settings and data (if any for the mode) are loaded with values from the saved file. The saved measurement of the mode becomes the newly active measurement and the data relevant to the measurement (if there is any) is recalled.</p> <p>If there is a mismatch between file version or model number or instrument version or model number, the recall function tries to recall as much as possible and returns a warning message. It may limit settings that differ based on model number, licensing or version number.</p> <p>After recalling the state, the Recall State function does the following:</p> <ul style="list-style-type: none"> • Makes the saved measurement for the mode the active measurement. • Clears the input and output buffers. • Status Byte is set to 0. • Executes a *CLS <p>If the file specified is empty an error is generated. If the specified file does not exist, another error is generated. If there is a mismatch between the file and the proper file type, an error is generated. If</p>

	there is a mismatch between file version or model number or instrument version or model number, a warning is displayed. Then it returns to the State menu and File Open dialog goes away. After the Recall, the analyzer exits the Recall menu and returns to the previous menu.
Backwards Compatibility SCPI	:MMEMory:LOAD:STATe 1,<filename> For backwards compatibility, the above syntax is supported. The "1" is simply ignored.
Initial S/W Revision	Prior to A.02.00

More Information

In measurements that support saving Traces, for example, Swept SA, the Trace data is saved along with the State in the State file. When recalling the State, the Trace data is recalled as well. Traces are recalled exactly as they were stored, including the writing mode and update and display modes. If a Trace was updating and visible when the State was saved, it will come back updating and visible, and its data will be rewritten right away. When you use State to save and recall traces, any trace whose data must be preserved should be placed in View or Blank mode before saving.

The following table describes the Trace Save and Recall possibilities:

You want to recall state and one trace's data, leaving other traces unaffected.	Save Trace+State from 1 trace. Make sure that no other traces are updating (they should all be in View or Blank mode) when the save is performed.	On Recall, specify the trace you want to load the one trace's data into. This trace will load in View. All other traces' data will be unaffected, although their trace mode will be as it was when the state save was performed.
You want to recall all traces	Save Trace+State from ALL traces.	On Recall, all traces will come back in View (or Blank if they were in Blank or Background when saved)
You want all traces to load exactly as they were when saved.	Save State	On recall, all traces' mode and data will be exactly as they were when saved. Any traces that were updating will have their data immediately overwritten.

From File...

When you press "From File", the analyzer brings up a Windows dialog and a menu entitled "File Open." This menu allows you to navigate to the various fields in the Windows dialog without using a keyboard or mouse. The Tab and Arrow keys can also be used for dialog navigation.

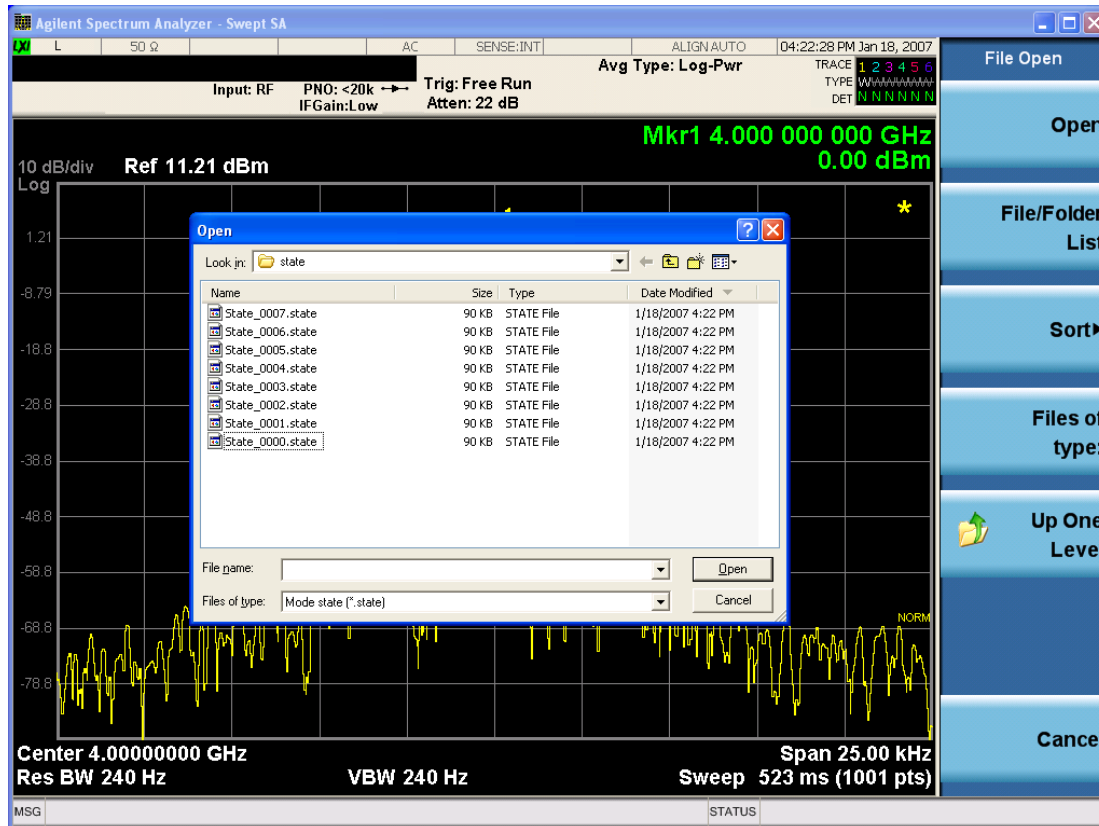

Listed below are the functions of the various fields in the dialog, and the corresponding softkeys:

Open

Performs the recall of the specified file. While the recall is being performed, the floppy icon appears briefly in the Meas bar.

File/Folder List

Enables you to navigate to the center of the dialog that contains the list of files and folders. Once here you can get information about the file and use the tab keys to navigate to the other fields in the dialog, such as Look In.

Look In

The Look In field shows the path from which the file will be recalled and allows you to change the path using the up and down arrow keys to navigate to other paths; the Enter key to open a directory; and the Backspace key to go back one directory. The **Look In field** first uses the last path from the Save As dialog **Save In:** path for that same file type. There is no softkey for directly navigating to the Look In field, but you can use the left tab to get here from the File/Folder List.

User specified paths are remembered when you leave and return to a Mode and are reset back to the default using Restore Mode Defaults.

Sort

Accesses a menu that enables you to sort the files within the File Open dialog. Only one sorting type can be selected at a time and the sorting happens immediately. The sorting types are By Date, By Name, By extension, and By Size.

Files of Type

This field shows the file suffix for the type of file you have selected to recall. For example, if you navigated here while recalling State, "Mode state (*.state)" is in the field. If you navigated here while recalling Trace, ""Mode state (*.trace)" is in the field. If you navigated here while importing a trace data file, "Trace Data (*.csv)" is in the field. For some file types, there is more than one choice in the dropdown menu, which you can select by using the up and down arrow keys and Enter.

Up One Level

This key corresponds to the icon of a folder with the up arrow that is in the tool bar of the dialog. When pressed, it causes the file and folder list to navigate up one level in the directory structure. The Backspace key does the same thing.

Cancel

This key corresponds to the Cancel selection in the dialog. It causes the current **Open** request to be cancelled. The ESC key does the same thing.

Key Path	Recall, State
Notes	Brings up the Open dialog for recalling a State Save Type
Initial S/W Revision	Prior to A.02.00

Edit Register Names

You may enter a custom name on any of the Register keys, to help you remember what you are using that state to save. To do this, press the Edit Register Names key, choose the register whose name you wish to edit, and then enter the desired label using the Alpha Editor or an external PC keyboard.

The maximum number of characters that can be added is 30. In most cases, 30 characters will fit on two lines of the key.

For more information and the SCPI command, see Edit Register Names under the Save, State function.

Key Path	Recall, State
Mode	All
Dependencies	N9060A-7FP or N9060B-2FP license required to edit the register names. When the feature is not licensed, sending the SCPI command generates an error, -221, "Settings conflict;Option not available"
Initial S/W Revision	A.11.00

Register 1 thru Register 16

Selecting any one of these register keys causes the State of the mode from the specified Register to be recalled. Each of the register keys annotates whether it is empty or at what date and time it was last

modified. In addition, you can use the Edit Register Names key under Save, State to enter custom names for each register.

Registers are shared by all modes, so recalling from any one of the registers will cause a mode switch to the mode that was active when the save to the Register occurred.

Although these 16 registers are the only registers available from the front panel, there are 128 state registers available in the instrument. Registers 17–128 are only available from the SCPI interface, using the *RCL command.

After the recall completes, the message "Register <register number> recalled" appears in the message bar. If you are in the Spectrum Analyzer Mode, and you are recalling a register that was saved in the Spectrum Analyzer Mode, then after the recall, you will still be in the Recall Register menu. If the Recall causes you to switch modes, then after the Recall, you will be in the Frequency menu.

If a requested register is empty an error is generated.

Key Path	Recall, State
Example	*RCL 1
Range	1–16 from front panel, 1–128 from SCPI
Readback	Date and time with seconds resolution are displayed on the key OR A custom name of up to 30 characters entered using the Save, State, Edit Register Names key OR “(empty)” if no prior save operation has been performed to this register.
Initial S/W Revision	Prior to A.02.00
Modified at S/W Revision	Prior to A.11.00

Register 1 thru Register 16

Selecting any one of these register keys causes the State of the mode from the specified Register to be recalled. Each of the register keys annotates whether it is empty or at what date and time it was last modified. In addition, you can use the Edit Register Names key under Save, State to enter custom names for each register.

Registers are shared by all modes, so recalling from any one of the registers will cause a mode switch to the mode that was active when the save to the Register occurred.

Although these 16 registers are the only registers available from the front panel, there are 128 state registers available in the instrument. Registers 17–128 are only available from the SCPI interface, using the *RCL command.

After the recall completes, the message "Register <register number> recalled" appears in the message bar. If you are in the Spectrum Analyzer Mode, and you are recalling a register that was saved in the Spectrum Analyzer Mode, then after the recall, you will still be in the Recall Register menu. If the Recall causes you to switch modes, then after the Recall, you will be in the Frequency menu.

If a requested register is empty an error is generated.

Key Path	Recall, State
Example	*RCL 1
Range	1-16 from front panel, 1-128 from SCPI
Readback	Date and time with seconds resolution are displayed on the key OR A custom name of up to 30 characters entered using the Save, State,Edit Register Names key OR “(empty)” if no prior save operation has been performed to this register.
Initial S/W Revision	Prior to A.02.00
Modified at S/W Revision	Prior to A.11.00

Data (Import)

Importing a data file loads data that was previously saved from the current measurement or from other measurements and/or modes that produce compatible data files. The Import Menu only contains Data Types that are supported by the current measurement.

Since the commonly exported data files are in .csv format, the data can be edited by the user prior to importing. This allows you to export a data file, manipulate the data in Excel (the most common PC Application for manipulating .csv files) and then import it.

Importing Data loads measurement data from the specified file into the specified or default destination, depending on the data type selected. Selecting an Import Data menu key will not actually cause the importing to occur, since the analyzer still needs to know from where to get the data. Pressing the Open key in this menu brings up the Open dialog and Open menu that provides you with the options from where to recall the data. Once a filename has been selected or entered in the Open menu, the recall occurs as soon as the Open button is pressed.

Key Path	Recall
Mode	All
Notes	The menu is built from whatever data types are available for the mode. Some keys will be missing completely, so the key locations in the sub-menu will vary. No SCPI command directly controls the Data Type that this key controls. The Data Type is included in the MMEM:LOAD commands.
Dependencies	If a file type is not used by a certain measurement, it is grayed out for that measurement. The key for a file type will not show at all if there are no measurements in the Mode that support it.
Preset	Is not affected by Preset or shutdown, but is reset during Restore Mode Defaults
Readback	The data type that is currently selected
Initial S/W Revision	Prior to A.02.00

Mask

Enables you to recall a preset mask file. This file type (.mask) differs from a normal “state” file because it contains the configuration for Carrier, Offset, and Limit for the specific preset profile BW. A brief description of the mask file is available in the properties view of each file. (Right-mouse-click on the file, select, "Properties" to view this information.) A detailed list of the mask parameter values is located in the .pdf file of the same name in the same directory. Blank values in the .pdf file are parameters that will not be overwritten when recalling the mask.

Key Path	Recall, Data
Mode	WIMAXOFDMA
Remote Command	:MMEMory:LOAD:MASK <string>
Example	:MMEM:LOAD:MASK "MyLimitFile.mask"
Notes	Set of parameters related to Limit, Carrier and Offset are overwritten by Preset Mask file.
Initial S/W Revision	A.02.00

This topic contains the following sections:

["File location and extension" on page 1734](#)

["Example of Preset Mask file" on page 1735](#)

File location and extension

File location: The preset mask file is located in “My Documents\WIMAXOFDMA\data\masks”.

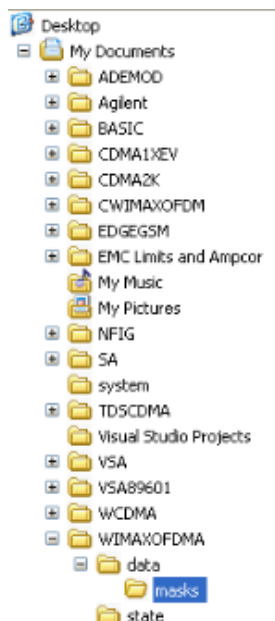

NOTE

When your X-Series analyzer starts, all mask files located in “My Documents\WIMAXOFDMA\data/masks” are overwritten, so any files you wish to save should be stored in another directory location.

File type: The file type is binary file.

File Name: The file name is decided by following naming rules. Each specific keyword is connected with underscore.

<Standard name>_<Radio device>_<Preset Profile BW>_<Measurement>.mask

<Standard name>: This term references the standard associated with each mask file.

<Radio device>: This term specifies to which radio device (BS or MS) the mask file pertains.

<Preset Profile BW>: This term specifies to which Preset Profile BW the mask file pertains.

<Measurement>: This term specifies the measurement to which the mask file is applied. Your selections are: SEM, ACP, or Mode. When selecting **Mode**, the values of some parameters in both the ACP and SEM measurement are overwritten.

File extension: The extension of preset mask file is “mask” to distinguish it from a “state” file.

When you press the open key under the Data menu, the “My Documents\WIMAXOFDMA\data\masks” folder is opened. Select one mask file.

NOTE When you change the preset BW profile or Radio Device, all measurement parameters are reset to their original values. Thus you have to recall the appropriate preset mask file again after the change.

Example of Preset Mask file

When you import a preset mask file, it is a “Recall” function. Specific parameter values are overwritten by the contents of the preset mask file (see table below). Those values not specified by the preset mask file remain unchanged. Because the file format type is binary, you cannot view, change, or create the preset mask file. Here is an example of a preset mask file used for ACP measurements.

File Location: My Documents/WIMAXOFDMA/data/masks

File Name: ETSI-EN301-021-SysE_BS_10MHz_ACP.mask

The .pdf file that lists the parameters similarly to that shown below is named, "ETSI-EN301-021-SysE_BS_10MHz_ACP.pdf"

The set of parameters listed in the following table for the Preset Profile BW (10MHz) are imported into the ACP measurement.

Offset	Start Freq (MHz)	Stop Freq (MHz)	Sweep Time	Res BW (Hz)	Meas BW	Rel Start	Rel Stop	Fail Mask
A	5	7.14		30k	1	-8	-25	Rel
B	7.14	10.57		30k	1	-25	-27	Rel
C	10.57	20		30k	1	-27	-50	Rel
D	20	25		30k	1	-50	-50	Rel
E	25	30		30k	1	-50	-50	Rel

Zone Map

Pressing this key selects Zone Map as the data type to be imported.

The WiMAX-OFDMA application can load the Singal Studio Setup file, and the OFDMA Map file is compatible with the 89601A Mobile WiMAX omf file.

Key Path	Recall, Data
Remote Command	:MMEMory:LOAD:ZMAP <string>
Example	MMEM:LOAD:ZMAP "ZMap_0000.omf"
Notes	The SCPI parameter is a quoted string that specifies the filename. Both single and double quotes are supported for any filename parameter over SCPI.
Dependencies	You must be in the 802.16 OFDMA (WiMAX/WiBro) mode.
Status Bits/OPC dependencies	Sequential – waits for the previous measurement to complete.
Initial S/W Revision	Prior to A.02.00

Open...

When you press "Open", the analyzer brings up a Windows dialog and a menu entitled "File Open." This menu allows you to navigate to the various fields in the Windows dialog without using a keyboard or mouse. The Tab and Arrow keys can also be used for dialog navigation.

See "[From File...](#)" on page 2241 in Recall, State, for a full description of this dialog and menu.

Key Path	Recall, Data
Notes	The key location is mode-dependent and will vary. Brings up Open dialog for recalling a <mode specific> Save Type
Initial S/W Revision	Prior to A.02.00

Restart

The Restart function restarts the current sweep, or measurement, or set of averaged/held sweeps or measurements. If you are Paused, pressing Restart does a Resume.

The Restart function is accessed in several ways:

- Pressing the Restart key
- Sending the remote command INIT:IMMEDIATE
- Sending the remote command INIT:RESTART

See "[More Information](#)" on page 1737

Key Path	Front-panel key
Remote Command	:INITiate[:IMMEDIATE] :INITiate:RESTART
Example	:INIT:IMM :INIT:REST
Notes	:INITiate:RESTART and :INITiate:IMMEDIATE perform exactly the same function.
Couplings	Resets average/hold count k. For the first sweep overwrites all active (update=on) traces with new current data. For application modes, it resets other parameters as required by the measurement.
Status Bits/OPC dependencies	This is an Overlapped command. The STATUS:OPERation register bits 0 through 8 are cleared. The STATUS:QUESTIONable register bit 9 (INTEgrity sum) is cleared. The SWEEPING bit is set. The MEASURING bit is set.
Backwards Compatibility Notes	For Spectrum Analysis mode in ESA and PSA, the Restart hardkey and the INITiate:RESTART command restart trace averages (displayed average count reset to 1) for a trace in Clear Write, but did not restart Max Hold and Min Hold. In the X-Series, the Restart hardkey and the INITiate:RESTART command restart not only Trace Average, but MaxHold and MinHold traces as well. For wireless comms modes in ESA and PSA, the Restart hardkey and the INITiate:RESTART command restart every measurement, which includes all traces and numeric results. There is no change to this operation.
Initial S/W Revision	Prior to A.02.00

More Information

The **Restart** function first aborts the current sweep/measurement as quickly as possible. It then resets the sweep and trigger systems, sets up the measurement and initiates a new data measurement sequence with a new data acquisition (sweep) taken once the trigger condition is met.

If the analyzer is in the process of aligning when **Restart** is executed, the alignment finishes before the restart function is performed.

Even when set for Single operation, multiple sweeps may be taken when Restart is pressed (for example, when averaging/holding is on). Thus when we say that **Restart** "restarts a measurement," we may mean:

- It restarts the current sweep
- It restarts the current measurement
- It restarts the current set of sweeps if any trace is in Trace Average, Max Hold or Min Hold
- It restarts the current set of measurements if Averaging, or Max Hold, or Min Hold is on for the measurement
- depending on the current settings.

With **Average/Hold Number** (in **Meas Setup** menu) set to 1, or Averaging off, or no trace in Trace Average or Hold, a single sweep is equivalent to a single measurement. A single sweep is taken after the trigger condition is met; and the analyzer stops sweeping once that sweep has completed. However, with **Average/Hold Number** >1 and at least one trace set to **Trace Average**, **Max Hold**, or **Min Hold (SA Measurement)** or **Averaging on (most other measurements)**, multiple sweeps/data acquisitions are taken for a single measurement. The trigger condition must be met prior to each sweep. The sweep is stopped when the average count k equals the number N set for **Average/Hold Number**. A measurement average usually applies to all traces, marker results, and numeric results; but sometimes it only applies to the numeric results.

Once the full set of sweeps has been taken, the analyzer will go to idle state. To take one more sweep without resetting the average count, increment the average count by 1, by pressing the step up key while **Average/Hold Number** is the active function, or sending the remote command `CALC:AVER:TCON UP`.

Save

The Save menu lets you choose what you want to save and where you want to save it. Among the types of files you can save are **States**, **Traces**, and **Screen Images**. In addition, an Export (Data) option lets you save a number of data types as CSV files for easy import into Excel and other spreadsheet programs.

Key Path	Front-panel key
Mode	All
Notes	No remote command for this key specifically, but the :MMEM:STORe command is available for specific file types. An example is :MMEM:STOR:STATe <filename>.
Initial S/W Revision	Prior to A.02.00

State

The Save State menu lets you choose a register or file for saving the state.

The content of a state file includes all of the settings and data required to return the analyzer as closely as possible to the Mode it was in, with the exact settings which were in place, when the save occurred. The Mode settings in each state file include the settings that are affected by Mode Preset, as well as the additional settings affected by Restore Mode Defaults; all of the Mode's settings. In addition, all of the settings of the Input/Output system are included, even though they are outside of the Mode's state, because they are needed to restore the complete setup. Persistent System settings (for example, Verbose SCPI) are not affected by either Mode Preset or Restore Mode Defaults, nor are they included in a saved State file.

After the save completes, the message "File <filename> saved" or "State Register <register number> saved" is displayed.

For rapid saving, the State menu lists 16 registers to save to. Pressing a Register key initiates the save. You can also select a file to save to.

The default path for all State Files is:

My Documents\<>mode name>\state

where <mode name> is the parameter used to select the mode with the INST:SEL command (for example, SA for the Spectrum Analyzer).

Key Path	Save
Mode	All
Remote Command	:MMEMory:STORe:STATe <filename>
Example	MMEM:STOR:STATe "MyStateFile.state" This stores the current instrument state data in the file MyStateFile.state in the default directory.
Notes	Both single and double quotes are supported for any filename parameter over remote. After saving to a register, that register's menu key is updated with the date the time, unless a custom label has been entered for that key. After saving to a register, you remain in the Save State menu, so that you can see the Register key

update. After saving to a file, the analyzer automatically returns to the previous menu and any Save As dialog goes away.

Backwards Compatibility SCPI	:MMEMory:STORe:STATe 1,<filename>
Initial S/W Revision	Prior to A.02.00

To File . . .

When you press “To File”, the analyzer brings up a Windows dialog and a menu entitled “Save As.” This menu allows you to navigate to the various fields in the Windows dialog without using a keyboard or mouse. The Tab and Arrow keys can also be used for dialog navigation.

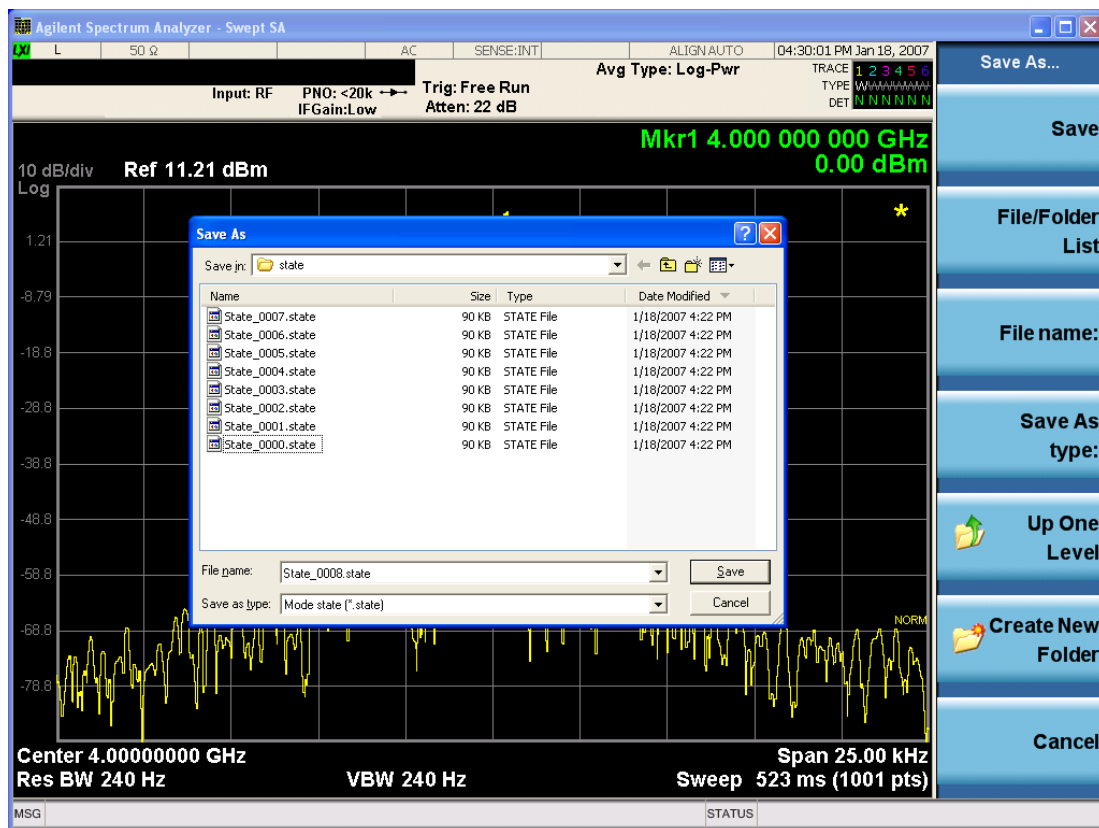

The Listed below

are the functions of the various fields in the dialog, and the corresponding softkeys:

Save

Performs the save to the specified file of the selected type. If the file already exists, a dialog will appear that allows you to replace the existing file by selecting OK, or you can Cancel the request. If you select OK, the file will be overwritten. Using the C: drive is strongly discouraged, since it runs the risk of being overwritten during an instrument software upgrade.

While the save is being performed, the floppy icon appears briefly in the Meas bar.

File/Folder List

Enables you to navigate to the center of the dialog that contains the list of files and folders. Once here you can get information about the file and use the tab keys to navigate to the other fields in the dialog, such as Save In.

Save In

The Save In field shows the path to which the file will be saved and allows you to change the path using the up and down arrow keys to navigate to other paths; the Enter key to open a directory; and the Backspace key to go back one directory. The **Save In field** defaults to the default path for this type of file and remembers the last path you used to save this type of file. There is no softkey for directly navigating to the Save In field but you can use left tab to get here from the File/Folder List.

User specified paths are remembered when you leave and return to a Mode and are reset back to the default using Restore Mode Defaults.

File Name

The File Name field is initially loaded with an automatically generated filename specific to the appropriate Save Type. The automatically generated filename is guaranteed not to conflict with any filename currently in the directory. You may replace or modify this filename using the File Name key. See the ["Quick Save " on page 2237](#) documentation for more on the automatic file naming algorithm.

When you press the File Name key the analyzer displays the Alpha Editor. Use the knob to choose the letter to add and the front-panel Enter key to add the letter to the file name. The BK character moves you back and the FW character moves you forward in the filename. The Select key on the front panel generates a space character. When you are done entering the filename press the Done softkey. This returns back to the **File Open** dialog and menu, but does not cause the save to occur.

Save As Type

This field shows the file suffix for the type of file you have selected to save. For example, if you navigated here while saving State, "Mode state (*.state)" is in the field. If you navigated here from saving Trace, ""Mode state (*.trace)" is in the field. If you navigated here while exporting a trace data file, "Trace Data (*.csv)" is in the field. For some file types, there is more than one choice in the dropdown, which you can select by using the up and down arrow keys and Enter.

Up One Level

This key corresponds to the icon of a folder with the up arrow that is in the tool bar of the dialog. When pressed, it causes the file and folder list to navigate up one level in the directory structure. The Backspace key does the same thing.

Create New Folder

This key corresponds to the icon of a folder with the "*" that is in the tool bar of the dialog. When pressed, a new folder is created in the current directory with the name **New Folder** and you can enter a new folder name using the Alpha Editor.

Cancel

This key corresponds to the Cancel selection in the dialog. It causes the current **Save As** request to be cancelled. The ESC key does the same thing.

Key Path	Save, State
Mode	All
Notes	Brings up Save As dialog for saving a State Save Type
Initial S/W Revision	Prior to A.02.00

Edit Register Names

You may enter a custom name on any of the Register keys, to help you remember what you are using that state to save. To do this, press the Edit Register Names key, choose the register whose name you wish to edit, and then enter the desired label using the Alpha Editor or an external PC keyboard.

The maximum number of characters that can be added is 30. In most cases, 30 characters will fit on two lines of the key.

See ["More Information" on page 1742](#)

Key Path	Save, State
Mode	All
Remote Command	:MMEMory:REGister:STATe:LABel <reg number>,"label" :MMEMory:REGister:STATe:LABel? <reg number>
Example	:MMEM:REG:STAT:LAB 1,"my label"
Notes	<reg number> is an integer from 1 to 16. If the SCPI specifies an invalid register number an error message is generated, -222,"Data out of range;Invalid register label number" "label" is a string from 0 to 30 characters in length. If a label exceeds 30 characters, an error message is generated, -150,"String data error;Label clipped to 30 characters" "label" of length 0 erases the custom label and restores the default (time and date) label. E.g.: :MMEM:REG:STAT:LAB 1,""
Dependencies	N9060A-7FP or N9060B-2FP license required to edit the register names. When the feature is not licensed, sending this command generates an error, -221,"Settings conflict;Option not available"
Preset	The names are unaffected by Preset or power cycle but are set to the default label (time and date) on a "Restore System Defaults->Misc"
Initial S/W Revision	A.11.00

More Information

When you edit one of the register names, the time and date field will be replaced by the custom name.

If you delete all the characters in the custom name, it restores the default (time and date).

The register names are stored within the state files, but they are not part of the instrument state; that is, once you have edited a register name, loading a new state will not change that register name. Another consequence of this is that the names will be persistent through a power cycle. Also, if a named state file is transferred to another analyzer, it will bring its custom name along with it.

If you try to edit the name of an empty register, the analyzer will first save the state to have a file to put the name in. If you load a named state file into an analyzer with older firmware it will ignore the metadata.

The *SAV and *RCL commands will not be affected by the custom register names, nor will the MMEM commands.

Register 1 thru Register 16

Selecting any one of these register menu keys causes the State of the currently active mode to be saved to the specified Register. The registers are provided for rapid saving and recalling, since you do not need to specify a filename or navigate to a file. Each of the register menu keys annotates whether it is empty or at what date and time it was last modified. In addition, you can use the Edit Register Names key to enter custom names for each register.

Although these 16 registers are the only registers available from the front panel, there are 128 state registers available in the instrument. Registers 17–128 are only available from the SCPI interface, using the *SAV command.

There is one set of 128 state registers in the instrument, not one set for each Mode. When a state is saved, the Mode it was saved from is saved with it; then when it is recalled, the instrument switches to that Mode.

After the save completes, the corresponding register menu key annotation is updated with the date and time and the message "Register <register number> saved" is displayed.

Key Path	Save, State
Mode	All
Example	*SAV 1
Range	1–16 from front panel, 1–128 from SCPI
Readback	Date and time with seconds resolution are displayed on the key OR A custom name of up to 30 characters entered using the Edit Register Names key OR “(empty)” if no prior save operation has been performed to this register.
Initial S/W Revision	Prior to A.02.00
Modified at S/W Revision	A.11.00

Register 1 thru Register 16

Selecting any one of these register menu keys causes the State of the currently active mode to be saved to the specified Register. The registers are provided for rapid saving and recalling, since you do not need to specify a filename or navigate to a file. Each of the register menu keys annotates whether it is empty or at what date and time it was last modified. In addition, you can use the Edit Register Names key to enter custom names for each register.

Although these 16 registers are the only registers available from the front panel, there are 128 state registers available in the instrument. Registers 17–128 are only available from the SCPI interface, using the *SAV command.

There is one set of 128 state registers in the instrument, not one set for each Mode. When a state is saved, the Mode it was saved from is saved with it; then when it is recalled, the instrument switches to that Mode.

After the save completes, the corresponding register menu key annotation is updated with the date and time and the message "Register <register number> saved" is displayed.

Key Path	Save, State
Mode	All
Example	*SAV 1
Range	1-16 from front panel, 1-128 from SCPI
Readback	Date and time with seconds resolution are displayed on the key OR A custom name of up to 30 characters entered using the Edit Register Names key OR “(empty)” if no prior save operation has been performed to this register.
Initial S/W Revision	Prior to A.02.00
Modified at S/W Revision	A.11.00

Data (Export)

Exporting a data file stores data from the current measurement to mass storage files. The Export Menu only contains data types that are supported by the current measurement.

Since the commonly exported data files are in .csv format, the data can be edited by you prior to importing. This allows you to export a data file, manipulate the data in Excel (the most common PC Application for manipulating .csv files) and then import it.

Selecting an Export Data menu key will not actually cause the exporting to occur, since the analyzer still needs to know where you wish to save the data. Pressing the Save As key in this menu brings up the Save As dialog and Save As menu that allows you to specify the destination file and directory. Once a filename has been selected or entered in the Open menu, the export will occur as soon as the Save key is pressed.

Key Path	Save
Mode	All
Notes	The menu is built from whatever data types are available for the mode. So the key locations in the sub menu will vary. No SCPI command directly controls the Data Type that this key controls. The Data Type is included in the MMEM:STORe commands.
Dependencies	If a file type is not used by a certain measurement, that type is grayed out for that measurement. The key for a file type will not show at all if there are no measurements in the Mode that support it.
Preset	Is not affected by a Preset or shutdown, but is reset during Restore Mode Defaults
Readback	The data type that is currently selected
Initial S/W Revision	Prior to A.02.00

Measurement Results

Pressing this key selects Meas Results as the data type to be exported. Pressing the key a second time brings up the Meas Results menu, which allows you to select which **Meas Result** to save. In the Swept SA measurement, there are three types of Measurement Results files: Peak Table, Marker Table and Spectrogram.

See "Meas Results File Contents" on page 1745.

See "Marker Table" on page 1745.

See "Peak Table" on page 1748.

See "Spectrogram" on page 1751

Remote Command	:MMEMory:STORe:RESults:MTABle PTABle SPEctrogram <filename>
Example	:MMEM:STOR:RES:MTAB "myResults.csv" Saves the results from the current marker table to the file myResults.csv in the current path. :MMEM:STOR:RES:PTAB "myResults.csv" Saves the results from the current peak table to the file myResults.csv in the current path. :MMEM:STOR:RES:SPEC "myResults.csv" Saves the results from the current Spectrogram display to the file myResults.csv in the current path. The default path is My Documents\SA\data\SAN\results
Notes	If the save is initiated via SCPI, and the file already exists, the file will be overwritten. Using the C: drive is strongly discouraged, since it runs the risk of being overwritten during an instrument software upgrade. Both single and double quotes are supported for any filename parameter over SCPI.
Dependencies	If a save of Marker Table results is requested and the Marker Table is not on, no file is saved and a message is generated If a save of Peak Table results is requested and the Peak Table is not on, no file is saved and a message is generated If a save of Spectrogram results is requested and the Spectrogram is not on, no file is saved and a message is generated. The Spectrogram choice only appears if option EDP is licensed.
Preset	Not part of Preset, but is reset to Peak Table by Restore Mode Defaults. Survives a shutdown.
Initial S/W Revision	Prior to A.02.00

Meas Results File Contents

All files are .csv files. The following section details the data in each file type.

Marker Table

This section discusses the Marker Table Meas Results file format.

Imagine that, at the point where a Marker Table Meas Result is requested, the following screen is showing:

14 Modulation Analysis Measurement
Save

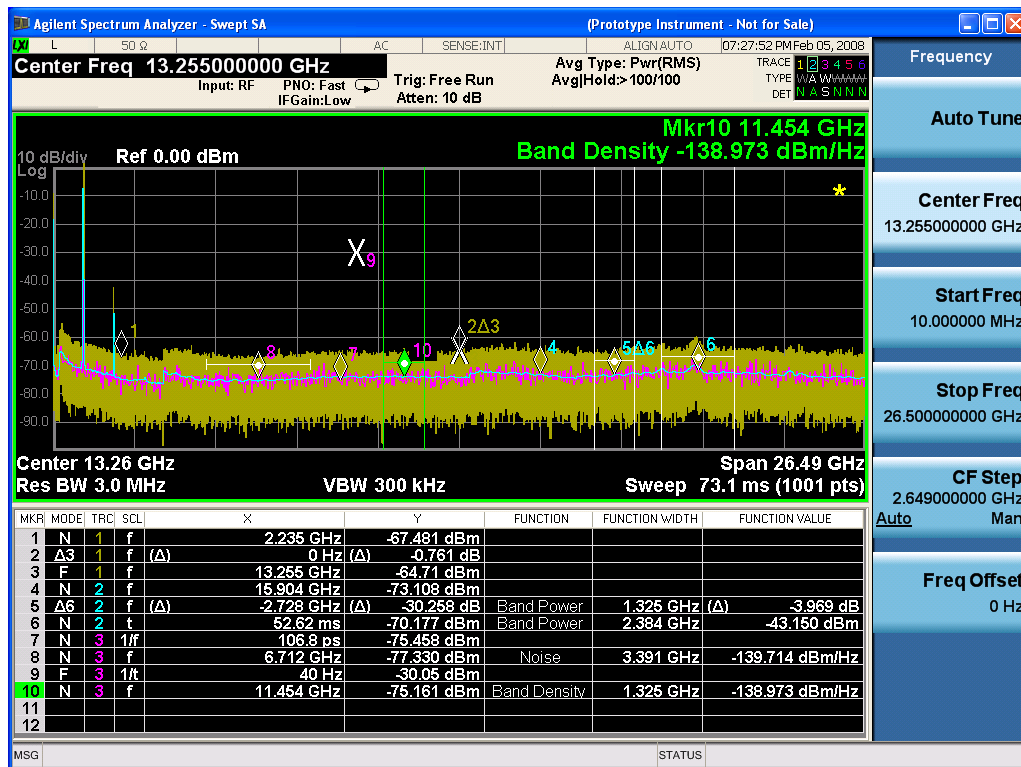

Then the Meas Results file, when opened, would show the following data:

MeasurementResult	
Swept SA	
A.01.40_R0017	N9020A
526 B25 PFR	1
P26 EA3	
Result Type	Marker Table
Ref Level	0
Number of Points	1001
Sweep Time	0.0662666 67
Start Frequency	10000000
Stop Frequency	26500000 000
Average Count	0
Average Type	LogPower (Video)
RBW	3000000

RBW Filter	Gaussian
RBW Filter BW	3dB
VBW	3000000
Sweep Type	Swept
X Axis Scale	Lin
PreAmp State	Off
PreAmp Band	Low
Trigger Source	Free
Trigger Level	1.2
Trigger Slope	Positive
Trigger Delay	1.00E-06
Phase Noise Optimization	Fast
Swept If Gain	Low
FFT If Gain	Autorange
RF Coupling	AC
FFT Width	411900
Ext Ref	10000000
Input	RF
RF Calibrator	Off
Attenuation	10
Ref Level Offset	0
External Gain	0
X Axis Units	Hz
Y Axis Units	dBm

DATA									
MKR	MODE	TR C	SCL	X	Y	FUNCTI ON	FUNCTIO N WIDTH	FUNCTI ON VALUE	FUNCTI ON UNIT
1	Normal	1	Freque ncy	2.2350E+09	- 67.481	Off	0.0000E+00	0	None
2	Delta3	1	Freque ncy	0.0000E+00	- 0.761	Off	0.0000E+00	0	None
3	Fixed	1	Freque ncy	1.3255E+10	- 64.71	Off	0.0000E+00	0	None
4	Normal	2	Freque ncy	1.5904E+10	- 73.1	Off	0.0000E+00	0	None

08									
5	Delta7	2	Frequency	-2.7280E+09	-30.258	Band Power	1.3250E+06	-3.969	dB
6	Normal	2	Time	5.2620E-02	-70.177	Band Power	2.3840E+06	-43.15	dBm
7	Normal	3	Period	1.0680E-10	-75.458	Off	0.0000E+00	0	None
8	Normal	3	Frequency	6.7120E+09	-77.33	Noise	3.3910E+06	-139.714	dBm/Hz
9	Fixed	3	Inverse Time	4.0000E+01	-30.05	Off	0.0000E+00	0	None
10	Normal	3	Frequency	1.1454E+10	-75.161	Band Density	1.3250E+06	-138.973	dBm/Hz
11	Off	1	Frequency	0.0000E+00	0	Off	0.0000E+00	0	None
12	Off	1	Frequency	0.0000E+00	0	Off	0.0000E+00	0	None

The numbers appear in the file exactly as they appear onscreen. If it says 11.454 GHz onscreen, then in the file it is 11.454E+09.

The metadata header is very similar to the metadata used in the trace data .csv files. See Trace File Contents. The only new information concerns the 1-of-N fields in the marker table itself.

Peak Table

This section discusses the Peak Table Meas Results file format.

Imagine that, at the point where a Marker Table Meas Result is requested, the following screen is showing:

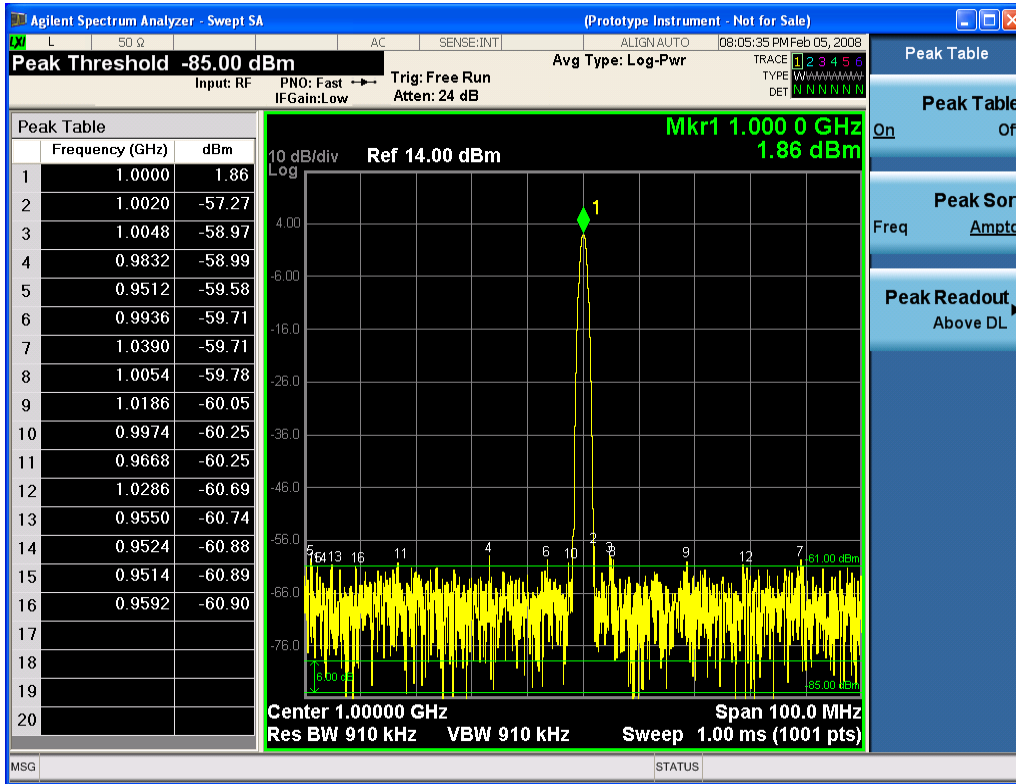

Then the Meas Results file, when opened, would show the header data (the same as for the Marker Table except that the Result Type is Peak Table) ending with a few fields of specific interest to Peak Table users:

- Peak Threshold
- Peak Threshold State (On|Off)
- Peak Excursion
- Peak Excursion State (On|Off)
- Display Line
- Peak Readout (All|AboveDL|BelowDL)
- Peak Sort (Freq|Amptd)

These fields are then followed by the data for the Peak Table itself.

Note that the label for the Frequency column changes to Time in 0 span.

Here is what the table for the above display looks like:

MeasurementResult	
Swept SA	
A.01.40_R0017	N9020A
526 B25 PFR P26 EA3	1

Result Type	Peak Table
Ref Level	0
Number of Points	1001
Sweep Time	0.066266667
Start Frequency	10000000
Stop Frequency	26500000000
Average Count	0
Average Type	LogPower(Video)
RBW	3000000
RBW Filter	Gaussian
RBW Filter BW	3dB
VBW	3000000
Sweep Type	Swept
X Axis Scale	Lin
PreAmp State	Off
PreAmp Band	Low
Trigger Source	Free
Trigger Level	1.2
Trigger Slope	Positive
Trigger Delay	1.00E-06
Phase Noise Optimization	Fast
Swept If Gain	Low
FFT If Gain	Autorange
RF Coupling	AC
FFT Width	411900
Ext Ref	10000000
Input	RF
RF Calibrator	Off
Attenuation	10
Ref Level Offset	0
External Gain	0
X Axis Units	Hz
Y Axis Units	dBm
Peak Threshold	-85
Peak Threshold State	On
Peak Excursion	6
Peak Excursion State	On

Display Line	-61	
Peak Readout	AboveDL	
Peak Sort	Amptd	
DATA		
Peak	Frequency	Amplitude
1	1.0000E+06	1.86
2	1.0020E+06	-57.27
3	1.0048E+06	-58.97
4	9.8320E+05	-58.99
5	9.5120E+05	-59.58
6	9.9360E+05	-59.71
7	1.0390E+06	-59.71
8	1.0054E+06	-59.78
9	1.1086E+06	-60.05
10	9.9740E+05	-60.25
11	9.6680E+05	-60.25
12	1.0286E+06	-60.69
13	9.5500E+05	-60.74
14	9.5240E+05	-60.88
15	9.5140E+05	-60.89
16	9.5920E+05	-60.90
17		
18		
19		
20		

Spectrogram

This section discusses the Spectrogram Results file format. The Spectrogram choice only appears if option EDP is licensed.

The Spectrogram results are the same as a Trace data export, except that instead of having just one trace's data, all 300 traces appear one after the other.

Each trace has its own data mark; the data for Spectrogram Trace 0 follows the row marked DATA, the data for Spectrogram Trace 1 follows the row marked DATA1, for Spectrogram Trace 2 follows the row marked DATA2, and so on.

Each DATA row has a timestamp in the second column (as of firmware revision A.11.01). So, for example, if Trace 0 had a relative start time of 1729.523 sec, then the first DATA row would look like this:

DATA,1729.523

And if Trace 13 had a relative start time of 100.45 sec, then the fourteenth data row would look like:

DATA13,100.453

To find the absolute time for the relative timestamps of each trace, the last row before the first DATA row gives the absolute start time of the Spectrogram, in the form YYYYMMDDHHMMSS

So, for example, if the absolute start time is 13:23:45:678 on January 30, 2012, this row would look like:

Start Time,20120130132345678

NOTE

The resolution of the absolute time stored is 1 ms, which matches up with the fact that the fastest sweep time is also 1 ms. However, there is no specification for the absolute accuracy of the clock in the analyzer, nor is there any facility provided to allow the user to set this time to any particular degree of accuracy.

Traces that have not yet been filled in the Spectrogram display are empty; there is no DATA header for them. The file ends after the last non-empty trace.

Imagine that, at the point where a Spectrogram Meas Result is requested, the following screen is showing:

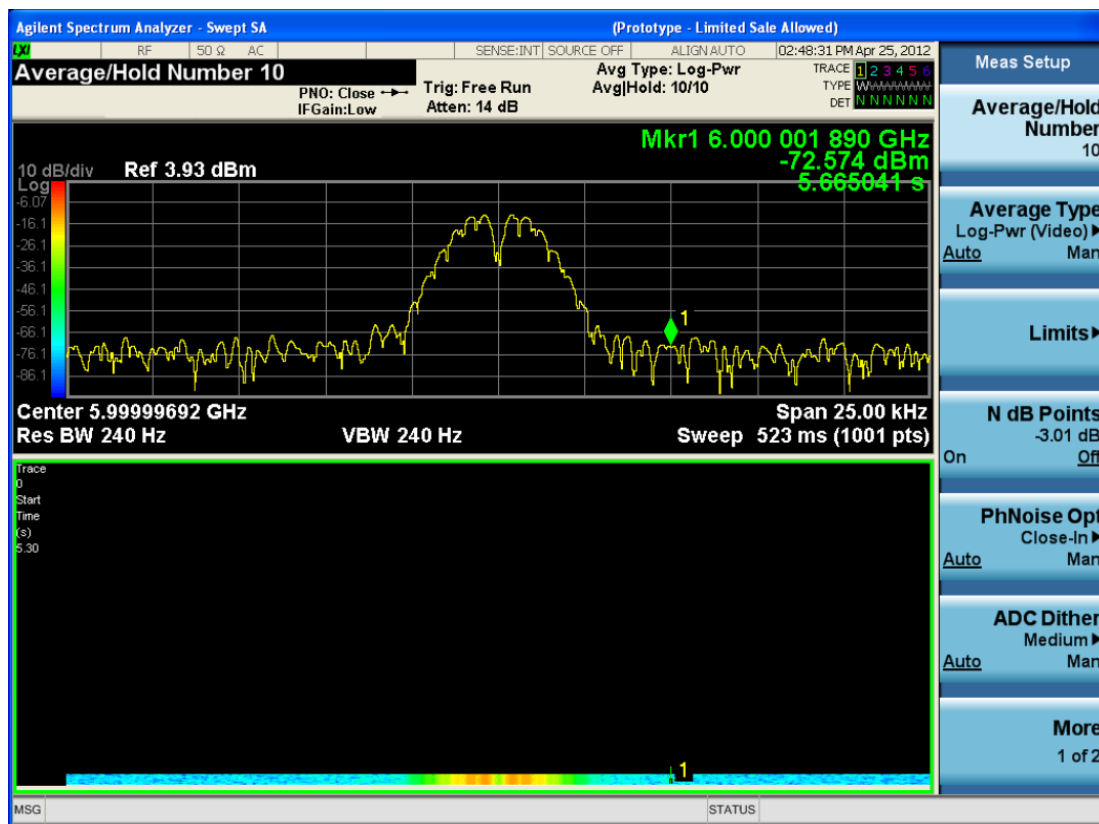

For the purpose of this example, we have set the Average/Hold Number to 10, thus we have only traces 0 thru 10. The Spectrogram was started at 02:28:08:700 pm on April 25, 2012 (that is, 700 ms after 2:28:08 pm), although the screen dump itself shows a different time, as it was taken ten minutes after the

Spectrogram data. Trace 0 is showing a start time of 5.30 seconds, meaning 5.3 seconds after the Spectrogram started (trace 10 has a start time of 0, as it was the first trace taken but has now rolled up into the tenth trace slot).

The Meas Results file, when opened, shows the header data and ten traces of trace data. Below is an extract from the result file for the above display. Note the start time of 20120425142808700 showing in the last row before the first DATA row, and the relative time of 5.299231048 showing in the first DATA row:

Result Type	Spectrogram
MeasResult	
Swept SA	
A.11.00.01	N9020A
503 508 513 526 ALL ALV B1C B1X B25 B2X B40 BAB BBA CR3 CRP DP2 DRD EA3 EDP EMC EP1 ERC ESC ESP EXM FSA HBA K03 LFE MPB P03 P08 P13 P26 PFR RTL RTS S40 SB1 SEC SM1 UK6 YAS YAV	1
Segment	0
Number of Points	1001
Sweep Time	0.523333333
Start Frequency	5999984415
Stop Frequency	6000009415
Average Count	0
Average Type	LogPower(Video)
RBW	240
RBW Filter	Gaussian
RBW Filter BW	3dB
VBW	240
Sweep Type	Swept
X Axis Scale	Lin
PreAmp State	Off
PreAmp Band	Low
Trigger Source	Free
Trigger Level	1.2
Trigger Slope	Positive
Trigger Delay	0
Phase Noise Optimization	Wide
Swept If Gain	Low
FFT If Gain	Autorange
RF Coupling	AC

Save

Result Type	Spectrogram
FFT Width	411900
Ext Ref	10000000
Input	RF
RF Calibrator	Off
Attenuation	14
Ref Level Offset	0
External Gain	0
Trace Type	Clearwrite
Detector	Normal
Trace Math	Off
Trace Math Oper1	Trace5
Trace Math Oper2	Trace6
Trace Math Offset	0
Trace Name	Trace1
X Axis Units	Hz
Y Axis Units	dBm
Start Time	20120425142808700
DATA	5.299231048
5999984415	-76.34749519
5999984440	-77.28097006
5999984465	-75.32317869
5999984490	-73.64417681
5999984515	-72.67154604

o

o

o

6000009315	-77.94423277
6000009340	-79.51829697
6000009365	-78.46108961
6000009390	-78.46108957
6000009415	-76.59570596
DATA2	4.708697055
5999984415	-80.98197882
5999984440	-80.98197879

5999984465	-75.83142132
5999984490	-74.02712079
5999984515	-73.57213005

- o
- o
- o

6000009315	-75.9183103
6000009340	-79.53787488
6000009365	-78.82602191
6000009390	-78.82602188
6000009415	-76.37486709
DATA10	0
5999984415	-75.56751112
5999984440	-75.76485645
5999984465	-76.67718717
5999984490	-78.79238489
5999984515	-83.72680212

- o
- o
- o

6000009315	-71.3942461
6000009340	-72.28308332
6000009365	-73.92684489
6000009390	-75.45548832
6000009415	-75.17904815

Zone Map

Pressing this key selects Zone Map as the data type to be exported.

The Zone Map file contains information about current Zone Map configuration. Its format is compatible with the 89601A OFDMA map file. It is detailed in ["Zone Map File Contents" on page 1756](#) below.

Key Path	Save, Data
Remote Command	:MMEMory:STORe:ZMAP <string>
Example	MMEM:STOR:ZMAP "ZMap_0000.omf"
Notes	<p>If the save is initiated via SCPI and the file already exists, the file will be overwritten.</p> <p>The SCPI command exports Zone Map information to the file specified as the parameter in the current path. The default path is My Documents\WIMAXOFDMA\.</p> <p>Using the C: drive is strongly discouraged, since it runs the risk of being overwritten during an instrument software upgrade.</p> <p>The SCPI parameter is a quoted string that specifies the filename. Both single and double quotes are supported for any filename parameter over SCPI.</p>
Dependencies	You must be in the 802.16 OFDMA (WiMAX/WiBro) mode.
Status Bits/OPC dependencies	Sequential – waits for the previous measurement to complete.
Initial S/W Revision	Prior to A.02.00

Zone Map File Contents

A Zone Map File contains the following information of the Zone Map configuration. See ["Zone Map Data" on page 329](#) for detailed definitions.

- DemodOfdmaMap_AutoDetect
- DemodOfdmaMap_Count
- DemodOfdmaMap_F1_DL_Count
- DemodOfdmaMap_F1_DL_Z1_Active
- DemodOfdmaMap_F1_DL_Z1_AmcType
- DemodOfdmaMap_F1_DL_Z1_B1_Active
- DemodOfdmaMap_F1_DL_Z1_B1_AllocType
- DemodOfdmaMap_F1_DL_Z1_B1_Boost
- DemodOfdmaMap_F1_DL_Z1_B1_BurstType
- DemodOfdmaMap_F1_DL_Z1_B1_ColorIndex
- DemodOfdmaMap_F1_DL_Z1_B1_ModType
- DemodOfdmaMap_F1_DL_Z1_B1_Name
- DemodOfdmaMap_F1_DL_Z1_B1_SubchannelInterval
- DemodOfdmaMap_F1_DL_Z1_B1_SubchannelOffset
- DemodOfdmaMap_F1_DL_Z1_B1_SymbolInterval
- DemodOfdmaMap_F1_DL_Z1_B1_SymbolOffset

- DemodOfdmaMap_F1_DL_Z1_Count
- DemodOfdmaMap_F1_DL_Z1_DedicPilots
- DemodOfdmaMap_F1_DL_Z1_IDCell
- DemodOfdmaMap_F1_DL_Z1_IDCellCouple
- DemodOfdmaMap_F1_DL_Z1_Len
- DemodOfdmaMap_F1_DL_Z1_Locked
- DemodOfdmaMap_F1_DL_Z1_Name
- DemodOfdmaMap_F1_DL_Z1_PrbsID
- DemodOfdmaMap_F1_DL_Z1_StcMatrix
- DemodOfdmaMap_F1_DL_Z1_StcType
- DemodOfdmaMap_F1_DL_Z1_SymOffset
- DemodOfdmaMap_F1_DL_Z1_UseAllSC
- DemodOfdmaMap_F1_DL_Z1_WrapType
- DemodOfdmaMap_F1_DL_Z1_ZoneType
- DemodOfdmaMap_F1_UL_Count
- DemodOfdmaMap_F1_UL_Z1_Active
- DemodOfdmaMap_F1_UL_Z1_AmcType
- DemodOfdmaMap_F1_UL_Z1_B1_Active
- DemodOfdmaMap_F1_UL_Z1_B1_AllocType
- DemodOfdmaMap_F1_UL_Z1_B1_Boost
- DemodOfdmaMap_F1_UL_Z1_B1_BurstType
- DemodOfdmaMap_F1_UL_Z1_B1_ColorIndex
- DemodOfdmaMap_F1_UL_Z1_B1_ModType
- DemodOfdmaMap_F1_UL_Z1_B1_Name
- DemodOfdmaMap_F1_UL_Z1_B1_PilotPattern
- DemodOfdmaMap_F1_UL_Z1_B1_StcMode
- DemodOfdmaMap_F1_UL_Z1_B1_SubchannelInterval
- DemodOfdmaMap_F1_UL_Z1_B1_SubchannelOffset
- DemodOfdmaMap_F1_UL_Z1_B1_SymbolInterval
- DemodOfdmaMap_F1_UL_Z1_B1_SymbolOffset
- DemodOfdmaMap_F1_UL_Z1_Count

- DemodOfdmaMap_F1_UL_Z1_Gap
- DemodOfdmaMap_F1_UL_Z1_IDCell
- DemodOfdmaMap_F1_UL_Z1_Len
- DemodOfdmaMap_F1_UL_Z1_Locked
- DemodOfdmaMap_F1_UL_Z1_Name
- DemodOfdmaMap_F1_UL_Z1_SymOffset
- DemodOfdmaMap_F1_UL_Z1_UseSubchRotate
- DemodOfdmaMap_F1_UL_Z1_WrapType
- DemodOfdmaMap_F1_UL_Z1_ZoneType
- DemodOfdmaMap_Name
- DemodOfdmaMap_RefreshMap

Save As . . .

When you press “Save As”, the analyzer brings up a Windows dialog and a menu entitled “**Save As.**” This menu allows you to navigate to the various fields in the Windows dialog without using a keyboard or mouse. The Tab and Arrow keys can also be used for dialog navigation.

See "[To File . . .](#)" on page 2252 in Save, State for a full description of this dialog and menu.

The default path for saving files is:

For all of the Trace Data Files:

My Documents\`<mode name>`\data\traces

For all of the Limit Data Files:

My Documents\`<mode name>`\data\limits

For all of the Measurement Results Data Files:

My Documents\`<mode name>`\data\`<measurement name>`\results

For all of the Capture Buffer Data Files:

My Documents\`<mode name>`\data\captureBuffer

Key Path	Save, Data
Mode	All
Notes	The key location is mode-dependent and will vary. Brings up the Save As dialog for saving a <code><mode specific></code> Save Type. The save is performed immediately and does not wait until the measurement is complete.
Initial S/W Revision	Prior to A.02.00

Screen Image

Pressing Screen Image accesses a menu of functions that enable you to specify a format and location for the saved screen image. It brings up a menu that allows you to specify the color scheme of the Screen Image (Themes) or navigate to the Save As dialog to perform the actual save.

Screen Image files contain an exact representation of the analyzer display. They cannot be loaded back onto the analyzer, but they can be loaded into your PC for use in many popular applications.

The image to be saved is actually captured when the Save front panel key is pressed, and kept in temporary storage to be used if you ask for a Screen Image save. When the Screen Image key is pressed, a "thumbnail" of the captured image is displayed, as shown below:

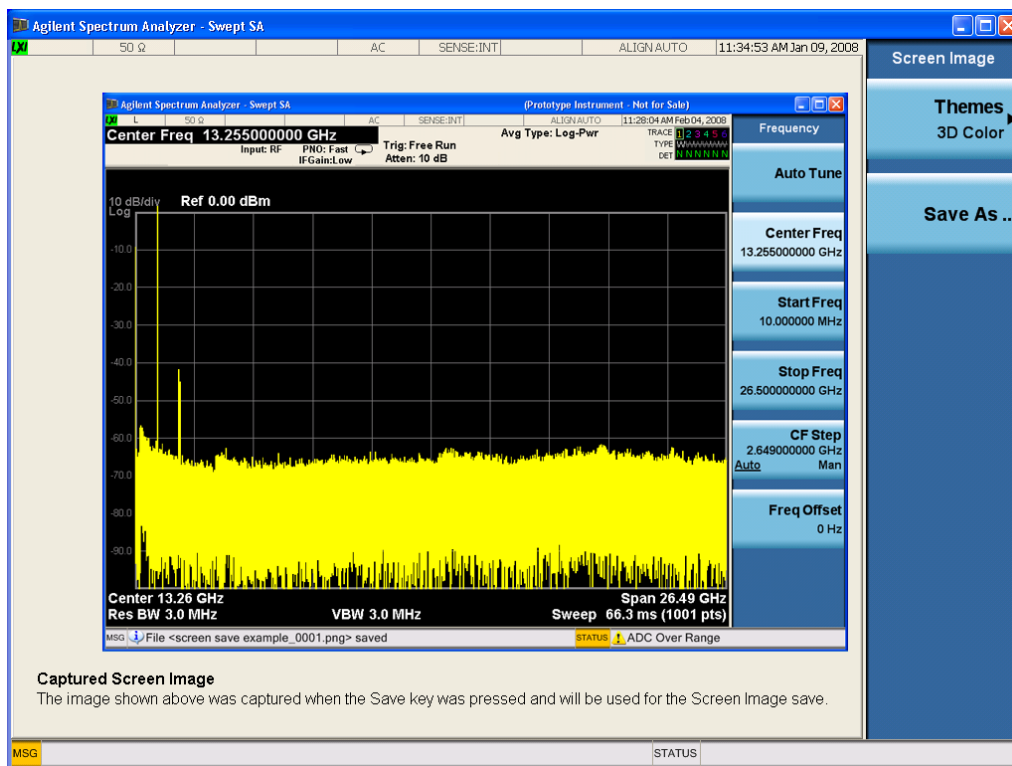

When you continue on into the Save As menu and complete the Screen Image save, the image depicted in the thumbnail is the one that gets saved, showing the menus that were on the screen before going into the Save menus. The save is performed immediately and does not wait until the measurement is complete.

After you have completed the save, the Quick Save front-panel key lets you quickly repeat the last save performed, using an auto-named file, with the current screen data.

NOTE

For versions previous to A.01.55, if you initiate a screen image save by navigating through the Save menus, the image that is saved will contain the Save menu softkeys, not the menus and the active function that were on the screen when you first pressed the Save front panel key.

Key Path	Save
Mode	All

Remote Command	:MMEMory:STORe:SCReen <filename>
Example	:MMEM:STOR:SCR "myScreen.png" This stores the current screen image in the file MyScreenFile.png in the default directory.
Initial S/W Revision	Prior to A.02.00

Themes

Accesses a menu of functions that enable you to choose the theme to be used when saving the screen image.

The **Themes** option is the same as the **Themes** option under the **Display** and **Page Setup** dialogs. It allows you to choose between themes to be used when saving the screen image.

Key Path	Save, Screen Image
Remote Command	:MMEMory:STORe:SCReen:THEMe TDColor TDMonochrome FCOLor FMONochrome :MMEMory:STORe:SCReen:THEMe?
Example	:MMEM:STOR:SCR:THEM TDM
Preset	3D Color; Is not part of Preset, but is reset by Restore Misc Defaults or Restore System Defaults All and survives subsequent running of the modes.
Readback	3D Color 3D Mono Flat Color Flat Mono
Backwards Compatibility Notes	In ESA and PSA we offer the choice of "Reverse Bitmap" or "Reverse Metafile" when saving screen images. This is much like the "Flat Color" theme available in X-Series. Also, if you selected Reverse Bitmap AND a black & white screen image, that would be much like "Flat Monochrome". In other words, each of the X-Series themes has a similar screen image type in ESA/PSA. But they are not identical.
Initial S/W Revision	Prior to A.02.00

3D Color

Selects a standard color theme with each object filled, shaded and colored as designed.

Key Path	Save, Screen Image, Themes
Example	MMEM:STOR:SCR:THEM TDC
Readback	3D Color
Initial S/W Revision	Prior to A.02.00

3D Monochrome

Selects a format that is like 3D color but shades of gray are used instead of colors.

Key Path	Save, Screen Image, Themes
Example	MMEM:STOR:SCR:THEM TDM
Readback	3D Mono
Initial S/W Revision	Prior to A.02.00

Flat Color

Selects a format that is best when the screen is to be printed on an ink printer.

Key Path	Save, Screen Image, Themes
Example	MMEM:STOR:SCR:THEM FCOL
Readback	Flat Color
Initial S/W Revision	Prior to A.02.00

Flat Monochrome

Selects a format that is like Flat Color. But only black is used (no colors, not even gray), and no fill.

Key Path	Save, Screen Image, Themes
Example	MMEM:STOR:SCR:THEM FMON
Readback	Flat Mono
Initial S/W Revision	Prior to A.02.00

Save As...

When you press "Save As", the analyzer brings up a Windows dialog and a menu entitled "**Save As.**" This menu allows you to navigate to the various fields in the Windows dialog without using a keyboard or mouse. The Tab and Arrow keys can also be used for dialog navigation.

See "[To File . . .](#)" on page 2252 in Save, State for a full description of this dialog and menu.

The default path for Screen Images is

My Documents\`<mode name>`\screen.

where `<mode name>` is the parameter used to select the mode with the INST:SEL command (for example, SA for the Spectrum Analyzer).

Key Path	Save, Screen Image
Notes	Brings up Save As dialog for saving a Screen Image Save Type
Initial S/W Revision	Prior to A.02.00

Mass Storage Catalog (Remote Command Only)

Key path	SCPI Only
Remote Command	:MMEMory:CATalog? [<directory_name>]
Notes	<p>The string must be a valid logical path.</p> <p>Queries disk usage information (drive capacity, free space available) and obtains a list of files and directories in a specified directory in the following format: <numeric_value>,<numeric_value>,{<file_entry>}</p> <p>It returns two numeric parameters and as many strings as there are files and directories. The first parameter indicates the total amount of storage currently used in bytes. The second parameter indicates the total amount of storage available, also in bytes. The <file_entry> is a string. Each <file_entry> indicates the name, type, and size of one file in the directory list: <file_name>,<file_type>,<file_size></p> <p>As the windows file system has an extension that indicates file type, <file_type> is always empty. <file_size> provides the size of the file in bytes. For directories, <file_entry> is surrounded by square brackets and both <file_type> and <file_size> are empty</p>
Initial S/W Revision	Prior to A.02.00

Mass Storage Change Directory (Remote Command Only)

Key path	SCPI Only
Remote Command	:MMEMory:CDIRectory [<directory_name>] :MMEMory:CDIRectory?
Notes	<p>The string must be a valid logical path.</p> <p>Changes the default directory for a mass memory file system. The <directory_name> parameter is a string. If no parameter is specified, the directory is set to the *RST value.</p> <p>At *RST, this value is set to the default user data storage area, that is defined as System.Environment.SpecialFolder.Personal.</p> <p>Query returns full path of the default directory.</p>
Initial S/W Revision	Prior to A.02.00

Mass Storage Copy (Remote Command Only)

Key path	SCPI Only
Remote Command	:MMEMory:COpy <string>,<string>[,<string>,<string>]
Notes	<p>The string must be a valid logical path.</p> <p>Copies an existing file to a new file or an existing directory to a new directory.</p> <p>Two forms of parameters are allowed. The first form has two parameters. In this form, the first parameter specifies the source, and the second parameter specifies the destination.</p> <p>The second form has four parameters. In this form, the first and third parameters specify the source. The second and fourth parameters specify the directories. The first pair of parameters specifies the</p>

source. The second pair specifies the destination. An error is generated if the source doesn't exist or the destination file already exists.

This command will generate an "access denied" error if the destination is a restricted folder (e.g., C:\Windows) and the current user does not have Power User or Administrator privileges.

Mass Storage Device Copy (Remote Command Only)

This command transfers data to/from a file and a peripheral device.

Key path	SCPI Only
Remote Command	:MMEMory:COpy:DEvice <source_string>,<dest_string>
Notes	<p>The strings must be a valid logical path or a valid device keyword. If the dest_string is a device keyword, the data is copied from the source file to the device. If the source_string is a device keyword, the data is copied to the source file from the device.</p> <p>Valid device keywords are:</p> <p>SNS (smart noise source)</p> <p>An error is generated if the file or device is not found.</p>

Mass Storage Delete (Remote Command Only)

Key path	SCPI Only
Remote Command	:MMEMory:DElete <file_name>[,<directory_name>]
Notes	<p>The string must be a valid logical path.</p> <p>Removes a file from the specified directory. The <file_name> parameter specifies the file name to be removed. This command will generate an "access denied" error if the file is in a restricted folder (e.g., C:\Windows) and the current user does not have Power User or Administrator privileges.</p>
Initial S/W Revision	Prior to A.02.00

Mass Storage Data (Remote Command Only)

Creates a file containing the specified data OR queries the data from an existing file.

Key path	SCPI Only
Remote Command	<p>:MMEMory:DATA <file_name>,<data></p> <p>:MMEMory:DATA? <file_name></p>
Notes	<p>The string must be a valid logical path.</p> <p>The command form is MMEMory:DATA <file_name>,<data>. It loads <data> into the file <file_name>. <data> is in 488.2 block format. <file_name> is string data.</p> <p>The query form is MMEMory:DATA? <file_name> with the response being the associated <data> in block format.</p>
Initial S/W Revision	Prior to A.02.00

Mass Storage Make Directory (Remote Command Only)

Key path	SCPI Only
Remote Command	:MMEMory:MDIRectory <directory_name>
Notes	<p>The string must be a valid logical path.</p> <p>Creates a new directory. The <directory_name> parameter specifies the name to be created.</p> <p>This command will generate an “access denied” error if the new directory would be in a restricted folder (e.g., C:\Windows) and the current user does not have Power User or Administrator privileges.</p>
Initial S/W Revision	Prior to A.02.00

Mass Storage Move (Remote Command Only)

Key path	SCPI Only
Remote Command	:MMEMory:MOVE <string>,<string>[,<string>,<string>]
Notes	<p>The string must be a valid logical path.</p> <p>Moves an existing file to a new file or an existing directory to a new directory.</p> <p>Two forms of parameters are allowed. The first form has two parameters. In this form, the first parameter specifies the source, and the second parameter specifies the destination.</p> <p>The second form has four parameters. In this form, the first and third parameters specify the source. The second and fourth parameters specify the directories. The first pair of parameters specifies the source. The second pair specifies the destination. An error is generated if the source doesn't exist or the destination file already exists.</p> <p>This command will generate an “access denied” error if the destination is a restricted folder (e.g., C:\Windows) and the current user does not have Power User or Administrator privileges.</p>
Initial S/W Revision	Prior to A.02.00

Mass Storage Remove Directory (Remote Command Only)

Key path	SCPI Only
Remote Command	:MMEMory:RDIRectory <directory_name>
Notes	<p>The string must be a valid logical path.</p> <p>Removes a directory. The <directory_name> parameter specifies the directory name to be removed. All files and directories under the specified directory shall also be removed.</p> <p>This command will generate an “access denied” error if the folder is a restricted folder (e.g., C:\Windows) or is in a restricted folder and the current user does not have Power User or Administrator privileges.</p>
Initial S/W Revision	Prior to A.02.00

Single (Single Measurement/Sweep)

Sets the analyzer for Single measurement operation. The single/continuous state is Meas Global, so the setting will affect all the measurements. If you are Paused, pressing Single does a Resume.

See ["More Information" on page 1765](#)

Key Path	Front-panel key
Example	:INIT:CONT OFF
Notes	See Cont key description.
Backwards Compatibility Notes	<p>For Spectrum Analysis mode in ESA and PSA, the Single hardkey and the INITiate:IMM switched from continuous measurement to single measurement and restarted sweeps and averages (displayed average count reset to 1), but did not restart Max Hold and Min Hold. In the X-Series, the Single hardkey and the INITiate:IMM command initiate a sweep/ measurement/ average sequence/hold sequence including MaxHold and MinHold.</p> <p>For Spectrum Analysis mode in ESA and PSA, the Single hardkey restarted the sweep regardless of whether or not you were in an active sweep or sweep sequence. In the X-Series, Restart does this but Single only restarts the sweep or sweep sequence if you are in the idle state.</p> <p>INIT[:IMM] in ESA & PSA Spectrum Analysis Mode does an implied ABORT. In some other PSA Modes, INIT[:IMM] is ignored if not in the idle state. . The X-Series follows the ESA/PSA SA Mode model, which may cause some Modes to have compatibility problems.</p>
Initial S/W Revision	Prior to A.02.00

More Information

See ["Restart" on page 2249](#) for details on the INIT:IMMEDIATE (Restart) function.

If you are already in single sweep, the INIT:CONT OFF command has no effect.

If you are already in Single Sweep, then pressing the Single key in the middle of a sweep does not restart the sweep or sequence. Similarly, pressing the Single key does not restart the sweep or sequence if the sweep is not in the idle state (for example, if you are taking a very slow sweep, or the analyzer is waiting for a trigger). Instead, it results in a message. "Already in Single, press Restart to initiate a new sweep or sequence". Even though pressing the Single key in the middle of a sweep does not restart the sweep, sending INIT:IMMEDIATE does reset it.

To take one more sweep without resetting the average count, increment the average count by 1, by pressing the step up key while **Average/Hold Number** is the active function, or sending the remote command CALC:AVER:TCON UP.

Source

There is no Source control functionality for this measurement. When this key is pressed, the screen either displays a blank menu, or the previously-selected menu remains unchanged.

Key Path	Front-panel key
----------	-----------------

SPAN X Scale

The SPAN/X Scale key accesses the menu that enables you to set the desired horizontal scale and associated settings. The settings available vary depending on the active window focus. For certain active window types, the menu is blank.

Key Path	Front-Panel
Initial S/W Revision	Prior to A.02.00

Ref Value

Sets the reference value for the x-axis of the windows listed below, which are explained in greater detail in the following sections.

NOTE The settings available vary depending on the active window displayed.

Key Path	SPAN X Scale
Initial S/W Revision	Prior to A.02.00

Ref Value (Error vs. Subcarrier Window)

Ref Value sets the reference value for the x-axis in the Symbol Error vs. Subcarrier window of the Symbol Error view.

Key Path	SPAN/X Scale
Mode	WiMAXOFDMA
Remote Command	:DISPlay:EVM:VIEW3:WINDow[1]:TRACe:X[:SCALe]:RLEVel <real> :DISPlay:EVM:VIEW3:WINDow[1]:TRACe:X[:SCALe]:RLEVel?
Example	DISP:EVM:VIEW3:WIND:TRAC:X:RLEV 0 DISP:EVM:VIEW3:WIND:TRAC:X:RLEV?
Notes	When Auto Scaling is On, this value is automatically determined by the measurement result. The value is switched depending on Scale Type.
Couplings	When this value is set manually, Auto Scaling is set to Off.
Preset	0.0
State Saved	Saved in instrument state.
Min	-5000.0
Max	5000.0
Initial S/W Revision	Prior to A.02.00

Ref Value (Symbol Power vs. Subcarrier Window)

Ref Value sets the reference value for the x-axis in the Symbol Power vs. Subcarrier window of the Symbol Power view.

Key Path	SPAN/X Scale
Mode	WiMAXOFDMA
Remote Command	:DISPlay:EVM:VIEW4:WINDow[1]:TRACe:X[:SCALE]:RLEVel <real> :DISPlay:EVM:VIEW4:WINDow[1]:TRACe:X[:SCALE]:RLEVel?
Example	DISP:EVM:VIEW4:WIND:TRAC:X:RLEV 0 DISP:EVM:VIEW4:WIND:TRAC:X:RLEV?
Notes	When Auto Scaling is On, this value is automatically determined by the measurement result. The value is switched depending on Scale Type.
Couplings	When this value is set manually, Auto Scaling is set to Off.
Preset	0.0
State Saved	Saved in instrument state.
Min	-5000.0
Max	5000.0
Initial S/W Revision	Prior to A.02.00

Ref Value (Absolute Flatness Window/Differential Flatness Window)

Ref Value sets the reference value for the x-axis in the Absolute Flatness and Differential Flatness windows of the Spectral Flatness view.

Key Path	SPAN/X Scale
Mode	WiMAXOFDMA
Remote Command	:DISPlay:EVM:VIEW6:WINDow[1] 2:TRACe:X[:SCALE]:RLEVel <real> :DISPlay:EVM:VIEW6:WINDow[1] 2:TRACe:X[:SCALE]:RLEVel?
Example	DISP:EVM:VIEW6:WIND:TRAC:X:RLEV 0 DISP:EVM:VIEW6:WIND:TRAC:X:RLEV?
Notes	When Auto Scaling is On, this value is automatically determined by the measurement result. The value is switched depending on Scale Type.
Couplings	When this value is set manually, Auto Scaling is set to Off. Values of WIND[1] and WIND2 are ALWAYS coupled with each other.
Preset	0.0
State Saved	Saved in instrument state.
Min	-5000.0
Max	5000.0
Initial S/W Revision	Prior to A.02.00

Ref Value (Power vs Time Window)

Ref Value sets the reference value for the x-axis in the Power vs. Time window of the Power vs. Time & Spectrum view.

Key Path	SPAN X Scale
Mode	WIMAXOFDMA
Remote Command	:DISPlay:EVM:VIEW7:WINDow[1]:TRACe:X[:SCALe]:RLEVel <time> :DISPlay:EVM:VIEW7:WINDow[1]:TRACe:X[:SCALe]:RLEVel?
Example	DISP:EVM:VIEW7:WIND:TRAC:X:RLEV 1 DISP:EVM:VIEW7:WIND:TRAC:X:RLEV?
Notes	When Auto Scaling is On, this value is automatically determined by the measurement result. The value is switched depending on Scale Type. You must be in the WIMAXOFDMA mode to use this command. Use INSTRument:SElect to set the mode.
Couplings	When this value is set manually, Auto Scaling is set to Off.
Preset	0 s
State Saved	Saved in instrument state.
Min	-20 s
Max	20 s
Initial S/W Revision	Prior to A.02.00

Ref Value (Symbol Error vs. Symbol Window)

Ref Value sets the reference value for the x-axis in the Symbol Error vs. Symbol window of the Symbol Error view.

Key Path	SPAN/X Scale
Mode	WiMAXOFDMA
Remote Command	:DISPlay:EVM:VIEW3:WINDow2:TRACe:X[:SCALe]:RLEVel <real> :DISPlay:EVM:VIEW3:WINDow2:TRACe:X[:SCALe]:RLEVel?
Example	DISP:EVM:VIEW3:WIND2:TRAC:X:RLEV 0 DISP:EVM:VIEW3:WIND2:TRAC:X:RLEV?
Notes	When Auto Scaling is On, this value is automatically determined by the measurement result. The value is switched depending on Scale Type.
Couplings	When this value is set manually, Auto Scaling is set to Off.
Preset	0.0
State Saved	Saved in instrument state.
Min	-5000
Max	5000
Initial S/W Revision	Prior to A.02.00

Ref Value (Symbol Power vs. Symbol Window)

Ref Value sets the reference value for the x-axis in the Symbol Power vs. Symbol window of the Symbol Power view.

Key Path	SPAN/X Scale
Mode	WiMAXOFDMA
Remote Command	:DISPlay:EVM:VIEW4:WINDow2:TRACe:X[:SCALe]:RLEVel <real> :DISPlay:EVM:VIEW4:WINDow2:TRACe:X[:SCALe]:RLEVel?
Example	DISP:EVM:VIEW4:WIND2:TRAC:X:RLEV 0 DISP:EVM:VIEW4:WIND2:TRAC:X:RLEV?
Notes	When Auto Scaling is On, this value is automatically determined by the measurement result. The value is switched depending on Scale Type.
Couplings	When this value is set manually, Auto Scaling is set to Off.
Preset	0.0
State Saved	Saved in instrument state.
Min	-5000
Max	5000
Initial S/W Revision	Prior to A.02.00

Scale/Div

Sets the horizontal scale by changing a value per division of the windows listed below, which are explained in greater detail in the following sections. NOTE: The settings available vary depending on the active window displayed.

Key Path	SPAN X Scale
Initial S/W Revision	Prior to A.02.00

Scale/Div (Symbol Error vs. Subcarrier Window)

Scale/Div sets the horizontal scale by changing a value per division in the Symbol Error vs. Subcarrier window of the Symbol Error view.

Key Path	SPAN/X Scale
Mode	WiMAXOFDMA
Remote Command	:DISPlay:EVM:VIEW3:WINDow[1]:TRACe:X[:SCALe]:PDIVision <real> :DISPlay:EVM:VIEW3:WINDow[1]:TRACe:X[:SCALe]:PDIVision?
Example	DISP:EVM:VIEW3:WIND:TRAC:X:PDIV 84 DISP:EVM:VIEW3:WIND:TRAC:X:PDIV?

Notes	When Auto Scaling is On, this value is automatically determined by the measurement result. The value is switched depending on Scale Type.
Couplings	When this value is set manually, Auto Scaling is set to Off.
Preset	84
State Saved	Saved in instrument state.
Min	1.0
Max	500.0
Initial S/W Revision	Prior to A.02.00

Scale/Div (Symbol Power vs. Subcarrier Window)

Scale/Div sets the horizontal scale by changing a value per division in the Symbol Power vs. Subcarrier window of the Symbol Power view.

Key Path	SPAN/X Scale
Mode	WiMAXOFDMA
Remote Command	:DISPlay:EVM:VIEW4:WINDow[1]:TRACe:X[:SCALe]:PDIVision <real> :DISPlay:EVM:VIEW4:WINDow[1]:TRACe:X[:SCALe]:PDIVision?
Example	DISP:EVM:VIEW4:WIND:TRAC:X:PDIV 84 DISP:EVM:VIEW4:WIND:TRAC:X:PDIV?
Notes	When Auto Scaling is On, this value is automatically determined by the measurement result. The value is switched depending on Scale Type.
Couplings	When this value is set manually, Auto Scaling is set to Off.
Preset	84
State Saved	Saved in instrument state.
Min	1.0
Max	500.0
Initial S/W Revision	Prior to A.02.00

Scale/Div (Absolute Flatness/Differential Flatness Window)

Scale/Div sets the horizontal scale by changing a value per division in the Absolute Flatness and Differential Flatness windows of the Spectral Flatness view.

Key Path	SPAN/X Scale
Mode	WiMAXOFDMA
Remote Command	:DISPlay:EVM:VIEW6:WINDow[1] 2:TRACe:X[:SCALe]:PDIVision <real> :DISPlay:EVM:VIEW6:WINDow[1] 2:TRACe:X[:SCALe]:PDIVision?
Example	DISP:EVM:VIEW6:WIND:TRAC:X:PDIV 10

	DISP:EVM:VIEW6:WIND:TRAC:X:PDIV?
Notes	When Auto Scaling is On, this value is automatically determined by the measurement result. The value is switched depending on Scale Type.
Couplings	When this value is set manually, Auto Scaling is set to Off. Values of WIND[1] and WIND2 are ALWAYS coupled with each other.
Preset	84
State Saved	Saved in instrument state.
Min	1
Max	500
Initial S/W Revision	Prior to A.02.00

Scale/Div (Power vs Time Window)

Scale/Div sets the horizontal scale by changing a value per division in the Power vs. Time window of the Power vs. Time & Spectrum view.

Key Path	SPAN X Scale
Mode	WIMAXOFDMA
Remote Command	:DISPlay:EVM:VIEW7:WINDow[1]:TRACe:X[:SCALe]:PDIVision <time> :DISPlay:EVM:VIEW7:WINDow[1]:TRACe:X[:SCALe]:PDIVision?
Example	DISP:EVM:VIEW7:WIND:TRAC:X:PDIV 1e-3 DISP:EVM:VIEW7:WIND:TRAC:X:PDIV?
Notes	If the Error! Hyperlink reference not valid. is On, this value is automatically determined by the measurement result.
Couplings	When you set a value manually, Error! Hyperlink reference not valid. automatically changes to Off.
Preset	84.0 us
State Saved	Saved in instrument state.
Min	1.00 ns
Max	1.00 s
Initial S/W Revision	Prior to A.02.00

Scale/Div (Symbol Error vs. Symbol Window)

Scale/Div sets the horizontal scale by changing a value per division in the Symbol Error vs. Symbol window of the Symbol Error view.

Key Path	SPAN/X Scale
Mode	WiMAXOFDMA
Remote Command	:DISPlay:EVM:VIEW3:WINDow2:TRACe:X[:SCALe]:PDIVision <real>

	:DISPlay:EVM:VIEW3:WINDow2:TRACe:X[:SCALe]:PDIVision?
Example	DISP:EVM:VIEW3:WIND2:TRAC:X:PDIV 1 DISP:EVM:VIEW3:WIND2:TRAC:X:PDIV?
Notes	When Auto Scaling is On, this value is automatically determined by the measurement result. The value is switched depending on Scale Type.
Couplings	When this value is set manually, Auto Scaling is set to Off.
Preset	2
State Saved	Saved in instrument state.
Min	1
Max	10
Initial S/W Revision	Prior to A.02.00

Scale/Div (Symbol Power vs. Symbol Window)

Scale/Div sets the horizontal scale by changing a value per division in the Symbol Power vs. Symbol window of the Symbol Power view.

Key Path	SPAN/X Scale
Mode	WiMAXOFDMA
Remote Command	:DISPlay:EVM:VIEW4:WINDow2:TRACe:X[:SCALe]:PDIVision <real> :DISPlay:EVM:VIEW4:WINDow2:TRACe:X[:SCALe]:PDIVision?
Example	DISP:EVM:VIEW4:WIND2:TRAC:X:PDIV 1 DISP:EVM:VIEW4:WIND2:TRAC:X:PDIV?
Notes	When Auto Scaling is On, this value is automatically determined by the measurement result. The value is switched depending on Scale Type.
Couplings	When this value is set manually, Auto Scaling is set to Off.
Preset	2
State Saved	Saved in instrument state.
Min	1
Max	10
Initial S/W Revision	Prior to A.02.00

Ref Position

Sets the reference position for the x-axis to the left, center, or right in the display of the windows listed below, which are explained in greater detail in the following sections:

Key Path	SPAN X Scale
Initial S/W Revision	Prior to A.02.00

Ref Position (Symbol Error vs. Subcarrier Window)

Ref Position sets the reference position for the x-axis to the left, center, or right in the display of the Symbol Error vs. Subcarrier window of the Symbol Error view.

Key Path	SPAN X Scale
Mode	WIMAXOFDMA
Remote Command	:DISPlay:EVM:VIEW3:WINDow[1]:TRACe:X[:SCALE]:RPOSition LEFT CENTER RIGHT :DISPlay:EVM:VIEW3:WINDow[1]:TRACe:X[:SCALE]:RPOSition?
Example	DISP:EVM:VIEW3:WIND:TRAC:X:RPOS LEFT DISP:EVM:VIEW3:WIND:TRAC:X:RPOS?
Preset	CENTER
State Saved	Saved in instrument state.
Range	Left Ctr Right
Initial S/W Revision	Prior to A.02.00

Ref Position (Symbol Power vs. Subcarrier Window)

Ref Position sets the reference position for the x-axis to the left, center, or right in the display of the Symbol Power vs. Subcarrier window of the Symbol Power view.

Key Path	SPAN X Scale
Mode	WIMAXOFDMA
Remote Command	:DISPlay:EVM:VIEW4:WINDow[1]:TRACe:X[:SCALE]:RPOSition LEFT CENTER RIGHT :DISPlay:EVM:VIEW4:WINDow[1]:TRACe:X[:SCALE]:RPOSition?
Example	DISP:EVM:VIEW4:WIND:TRAC:X:RPOS LEFT DISP:EVM:VIEW4:WIND:TRAC:X:RPOS?
Preset	CENTER
State Saved	Saved in instrument state.
Range	Left Ctr Right
Initial S/W Revision	Prior to A.02.00

Ref Position (Absolute Flatness/Differential Flatness Window)

Ref Position sets the reference position for the x-axis to the left, center, or right in the display of the Absolute Flatness and Differential Flatness windows of the Spectral Flatness view.

Key Path	SPAN X Scale
----------	--------------

Mode	WIMAXOFDMA
Remote Command	:DISPlay:EVM:VIEW6:WINDow[1] 2:TRACe:X[:SCALe]:RPOSition LEFT CENTER RIGHT :DISPlay:EVM:VIEW6:WINDow[1] 2:TRACe:X[:SCALe]:RPOSition?
Example	DISP:EVM:VIEW6:WIND2:TRAC:X:RPOS LEFT DISP:EVM:VIEW6:WIND2:TRAC:X:RPOS?
Couplings	Values of WIND[1] and WIND2 are ALWAYS coupled with each other.
Preset	CENTER
State Saved	Saved in instrument state.
Range	Left Ctr Right
Initial S/W Revision	Prior to A.02.00

Ref Position (Power vs Time Window)

Ref Position sets the reference position for the x-axis to the left, center, or right in the display of the Symbol Error vs. Subcarrier window of the Symbol Error view.

Key Path	SPAN X Scale
Mode	WIMAXOFDMA
Remote Command	:DISPlay:EVM:VIEW7:WINDow[1]:TRACe:X[:SCALe]:RPOSition LEFT CENTER RIGHT :DISPlay:EVM:VIEW7:WINDow[1]:TRACe:X[:SCALe]:RPOSition?
Example	DISP:EVM:VIEW7:WIND:TRAC:X:RPOS LEFT DISP:EVM:VIEW7:WIND:TRAC:X:RPOS?
Preset	LEFT
State Saved	Saved in instrument state.
Range	Left Ctr Right
Initial S/W Revision	Prior to A.02.00

Ref Position (Symbol Error vs Symbol Window)

Ref Position sets the reference position for the x-axis to the left, center, or right in the display of the Symbol Error vs. Symbol window of the Symbol Error view.

Key Path	SPAN X Scale
Mode	WIMAXOFDMA
Remote Command	:DISPlay:EVM:VIEW3:WINDow2:TRACe:X[:SCALe]:RPOSition LEFT CENTER RIGHT :DISPlay:EVM:VIEW3:WINDow2:TRACe:X[:SCALe]:RPOSition?
Example	DISP:EVM:VIEW3:WIND2:TRAC:X:RPOS LEFT

	DISP:EVM:VIEW3:WIND2:TRAC:X:RPOS?
Preset	LEFT
State Saved	Saved in instrument state.
Range	Left Ctr Right
Initial S/W Revision	Prior to A.02.00

Ref Position (Symbol Power vs Symbol Window)

Ref Position sets the reference position for the x-axis to the left, center, or right in the display of the Symbol Power vs. Symbol window of the Symbol Power view.

Key Path	SPAN X Scale
Mode	WIMAXOFDMA
Remote Command	:DISPlay:EVM:VIEW4:WINDow2:TRACe:X[:SCALE]:RPOSition LEFT CENTER RIGHT :DISPlay:EVM:VIEW4:WINDow2:TRACe:X[:SCALE]:RPOSition?
Example	DISP:EVM:VIEW4:WIND2:TRAC:X:RPOS LEFT DISP:EVM:VIEW4:WIND2:TRAC:X:RPOS?
Preset	LEFT
State Saved	Saved in instrument state.
Range	Left Ctr Right
Initial S/W Revision	Prior to A.02.00

Auto Scaling

Toggles the Auto Scaling function between On and Off in the windows listed below, which are explained in greater detail in the following sections:

Key Path	SPAN X Scale
Initial S/W Revision	Prior to A.02.00

AutoScaling (Symbol Error vs. Subcarrier Window)

Toggles the Auto Scaling function between On and Off in the Symbol Error vs. Subcarrier window of the Symbol Error view.

Key Path	SPAN X Scale
Mode	WIMAXOFDMA
Remote Command	:DISPlay:EVM:VIEW3:WINDow[1]:TRACe:X[:SCALE]:COUPle 0 1 OFF ON :DISPlay:EVM:VIEW3:WINDow[1]:TRACe:X[:SCALE]:COUPle?

Example	DISP:EVM:VIEW3:WIND:TRAC:X:COUP OFF DISP:EVM:VIEW3:WIND:TRAC:X:COUP?
Couplings	When this parameter is set to On, pressing the front-panel Restart key activates the scale coupling function, that automatically determines scale per division and reference values based on the measurement results. When you set a value to either Error! Hyperlink reference not valid. or Error! Hyperlink reference not valid. manually, X Auto Scaling automatically changes to Off.
Preset	ON
State Saved	Saved in instrument state.
Range	On Off
Initial S/W Revision	Prior to A.02.00

AutoScaling (Symbol Power vs. Subcarrier Window)

Toggles the Auto Scaling function between On and Off in the Symbol Power vs. Subcarrier window of the Symbol Power view.

Key Path	SPAN X Scale
Mode	WIMAXOFDMA
Remote Command	:DISPlay:EVM:VIEW4:WINDow[1]:TRACe:X[:SCALe]:COUPle 0 1 OFF ON :DISPlay:EVM:VIEW4:WINDow[1]:TRACe:X[:SCALe]:COUPle?
Example	DISP:EVM:VIEW4:WIND:TRAC:X:COUP OFF DISP:EVM:VIEW4:WIND:TRAC:X:COUP?
Couplings	When this parameter is set to On, pressing the front-panel Restart key activates the scale coupling function, that automatically determines scale per division and reference values based on the measurement results. When you set a value to either Error! Hyperlink reference not valid. or Error! Hyperlink reference not valid. manually, X Auto Scaling automatically changes to Off.
Preset	ON
State Saved	Saved in instrument state.
Range	On Off
Initial S/W Revision	Prior to A.02.00

AutoScaling (Absolute Flatness/Differential Flatness Window)

Toggles the Auto Scaling function between On and Off in the Absolute Flatness and Differential Flatness windows of the Spectral Flatness view.

Key Path	SPAN X Scale
Mode	WIMAXOFDMA
Remote Command	:DISPlay:EVM:VIEW6:WINDow[1] 2:TRACe:X[:SCALe]:COUPle 0 1 OFF ON :DISPlay:EVM:VIEW6:WINDow[1] 2:TRACe:X[:SCALe]:COUPle?

Example	DISP:EVM:VIEW6:WIND:TRAC:X:COUP OFF DISP:EVM:VIEW6:WIND:TRAC:X:COUP?
Couplings	When this parameter is set to On, pressing the front-panel Restart key activates the scale coupling function, that automatically determines scale per division and reference values based on the measurement results. When you set a value to either Error! Hyperlink reference not valid. or Error! Hyperlink reference not valid. manually, X Auto Scaling automatically changes to Off. Values of WIND[1] and WIND2 are ALWAYS coupled with each other.
Preset	ON
State Saved	Saved in instrument state.
Range	On Off
Initial S/W Revision	Prior to A.02.00

AutoScaling (Power vs Time Window)

Toggles the Auto Scaling function between On and Off in the Power vs. Time window of the Power vs. Time & Spectrum view.

Key Path	SPAN X Scale
Mode	WIMAXOFDMA
Remote Command	:DISPlay:EVM:VIEW7:WINDow[1]:TRACe:X[:SCALE]:COUPle 0 1 OFF ON :DISPlay:EVM:VIEW7:WINDow[1]:TRACe:X[:SCALE]:COUPle?
Example	DISP:EVM:VIEW7:WIND:TRAC:X:COUP OFF DISP:EVM:VIEW7:WIND:TRAC:X:COUP?
Couplings	When this parameter is set to On, pressing the front-panel Restart key activates the scale coupling function, that automatically determines scale per division and reference values based on the measurement results. When you set a value to either Error! Hyperlink reference not valid. or Error! Hyperlink reference not valid. manually, X Auto Scaling automatically changes to Off.
Preset	ON
State Saved	Saved in instrument state.
Range	On Off
Initial S/W Revision	Prior to A.02.00

AutoScaling (Symbol Error vs Symbol Window)

Toggles the Auto Scaling function between On and Off in the Symbol Error vs. Symbol window of the Symbol Error view.

Key Path	SPAN X Scale
Mode	WIMAXOFDMA
Remote Command	:DISPlay:EVM:VIEW3:WINDow2:TRACe:X[:SCALE]:COUPle 0 1 OFF ON

	:DISPlay:EVM:VIEW3:WINDow2:TRACe:X[:SCALe]:COUPle?
Example	DISP:EVM:VIEW3:WIND2:TRAC:X:COUP OFF DISP:EVM:VIEW3:WIND2:TRAC:X:COUP?
Couplings	When this parameter is set to On, pressing the front-panel Restart key activates the scale coupling function, that automatically determines scale per division and reference values based on the measurement results. When you set a value to either Error! Hyperlink reference not valid. or Error! Hyperlink reference not valid. manually, X Auto Scaling automatically changes to Off.
Preset	ON
State Saved	Saved in instrument state.
Range	On Off
Initial S/W Revision	Prior to A.02.00

AutoScaling (Symbol Power vs Symbol Window)

Toggles the Auto Scaling function between On and Off in the Symbol Power vs. Symbol window of the Symbol Power view.

Key Path	SPAN X Scale
Mode	WIMAXOFDMA
Remote Command	:DISPlay:EVM:VIEW4:WINDow2:TRACe:X[:SCALe]:COUPle 0 1 OFF ON :DISPlay:EVM:VIEW4:WINDow2:TRACe:X[:SCALe]:COUPle?
Example	DISP:EVM:VIEW4:WIND2:TRAC:X:COUP OFF DISP:EVM:VIEW4:WIND2:TRAC:X:COUP?
Couplings	When this parameter is set to On, pressing the front-panel Restart key activates the scale coupling function, that automatically determines scale per division and reference values based on the measurement results. When you set a value to either Error! Hyperlink reference not valid. or Error! Hyperlink reference not valid. manually, X Auto Scaling automatically changes to Off.
Preset	ON
State Saved	Saved in instrument state.
Range	On Off
Initial S/W Revision	Prior to A.02.00

Sweep/Control

Accesses settings that affect the sweep viewed in the display.

Key Path	Sweep/Control
Initial S/W Revision	Prior to A.02.00

Pause/Resume

Pauses a measurement after the current data acquisition is complete.

When Paused, the label on the key changes to Resume. Pressing Resume un-pauses the measurement.

See "[Pause/Resume](#)" on page 2282 for more information.

Key Path	Sweep/Control
Initial S/W Revision	Prior to A.02.00

System

See "System" on page 342

Trace/Detector

There is no 'Trace/Detector' functionality supported in Modulation Analysis so this front-panel key will display a blank softkey when pressed.

Key Path	Trace Detector
Initial S/W Revision	Prior to A.02.00

Trigger

See ["Trigger" on page 412](#)

Free Run

See ["Free Run " on page 419](#)

Video

See ["Video \(IF Envelope\) " on page 420](#)

Trigger Level

See ["Trigger Level " on page 420](#)

Trig Slope

See ["Trig Slope " on page 421](#)

Trig Delay

See ["Trig Delay " on page 422](#)

Line

See ["Line " on page 2087](#)

Trig Slope

See ["Trig Slope " on page 2087](#)

Trig Delay

See ["Trig Delay " on page 424](#)

External 1

See ["External 1 " on page 2099](#)

Trigger Level

See ["Trigger Level " on page 2099](#)

Trig Slope

See ["Trig Slope " on page 2100](#)

Trig Delay

See ["Trig Delay " on page 427](#)

External 2

See ["External 2 " on page 2101](#)

Trigger Level

See ["Trigger Level "](#) on page 2101

Trig Slope

See ["Trig Slope "](#) on page 2102

Trig Delay

See ["Trig Delay "](#) on page 429

RF Burst

See ["RF Burst "](#) on page 2102

Absolute Trigger

See ["Absolute Trigger Level"](#) on page 2103

Relative Trigger

See ["Relative Trigger Level"](#) on page 2092

Trig Slope

See ["Trigger Slope "](#) on page 2104

Trig Delay

See ["Trig Delay "](#) on page 433

Periodic Timer

See ["Periodic Timer \(Frame Trigger\) "](#) on page 2094

Period

See ["Period "](#) on page 2095

Offset

See ["Offset "](#) on page 2096

Offset Adjust (Remote Command Only)

See ["Offset Adjust \(Remote Command Only\)"](#) on page 2097

Reset Offset Display

See ["Reset Offset Display "](#) on page 2098

Sync Source

See ["Sync Source "](#) on page 2098

Off

See ["Off "](#) on page 2099

External 1

See ["External 1 "](#) on page 2099

Trigger Level

See ["Trigger Level "](#) on page 2099

Trig Slope

See ["Trig Slope "](#) on page 2100

External 2

See ["External 2 "](#) on page 2101

Trigger Level

See ["Trigger Level "](#) on page 2101

Trig Slope

See ["Trig Slope "](#) on page 2102

RF Burst

See ["RF Burst "](#) on page 2102

Absolute Trigger

See ["Absolute Trigger Level"](#) on page 2103

Trig Slope

See ["Trigger Slope "](#) on page 2104

Trig Delay

See ["Trig Delay"](#) on page 443

Auto/Holdoff

See ["Auto/Holdoff "](#) on page 444

Auto Trig

See ["Auto Trig "](#) on page 444

Trig Holdoff

See ["Trig Holdoff "](#) on page 445

Baseband I/Q

See [__](#) on page X

I/Q Mag

See ___ on page X

Trigger Level

See ___ on page X

Trig Slope

See ___ on page X

Trig Delay

See ___ on page X

I

See ___ on page X

Trigger Level

See ___ on page X

Trig Slope

See ___ on page X

Trig Delay

See ___ on page X

Q

See ___ on page X

Trigger Level

See ___ on page X

Trig Slope

See ___ on page X

Trig Delay

See ___ on page X

Input I

See ___ on page X

Trigger Level

See ___ on page X

Trig Slope

See ___ on page X

Trig Delay

See ___ on page X

Input Q

See ___ on page X

Trigger Level

See ___ on page X

Trig Slope

See ___ on page X

Trig Delay

See ___ on page X

Aux Channel Center Freq

See ___ on page X

Trigger Level

See ___ on page X

Trig Slope

See ___ on page X

Trig Delay

See ___ on page X

Trigger Center Freq

See ___ on page X

Trigger BW

See ___ on page X

User Preset

Accesses a menu that gives you the following three choices:

- User Preset – recalls a state previously saved using the Save User Preset function.
- User Preset All Modes – presets all of the modes in the analyzer
- Save User Preset– saves the current state for the current mode

Key Path	Front-panel key
Backwards Compatibility Notes	<p>User Preset is actually loading a state, and in legacy analyzers, it was possible to load a state without affecting the trace data, limit lines or correction data. Similarly it was possible to do a User Preset without affecting the trace data, limit lines or correction data.</p> <p>In the X-Series, “state” always includes all of this data; so whenever state is loaded, or User Preset is executed, all of the traces, limit lines and corrections are affected. Although this differs from previous behavior, it is desirable behavior, and should not cause adverse issues for users.</p> <p>On ESA and PSA, User Preset affected the entire instrument’s state. In the X-Series, User Preset only recalls the state for the active mode. There is a User Preset file for each mode. User Preset can never cause a mode switch as it can in legacy analyzers. If you want to recall all modes to their user preset file state, you will need to do a User Preset after mode switching into each mode.</p> <p>User Preset recalls mode state which can now include data like traces; whereas on ESA and PSA, User Preset did not affect data.</p>
Initial S/W Revision	Prior to A.02.00

User Preset

User Preset sets the state of the currently active mode back to the state that was previously saved for this mode using the Save User Preset menu key or the SCPI command, SYST:PRES:USER:SAV. It not only recalls the Mode Preset settings, but it also recalls all of the mode persistent settings, and the Input/Output system setting that existed at the time Save User Preset was executed.

If a Save User Preset has not been done at any time, User Preset recalls the default user preset file for the currently active mode. The default user preset files are created if, at power-on, a mode detects there is no user preset file. There will never be a scenario when there is no user preset file to restore. For each mode, the default user preset state is the same state that would be saved if a Save User Preset is performed in each mode right after doing a Restore Mode Default and after a Restore Input/Output Defaults.

The User Preset function does the following:

- Aborts the currently running measurement.
- Sets the mode State to the values defined by Save User Preset.
- Makes the saved measurement for the currently running mode the active measurement.
- Brings up the saved menu for the power-on mode.
- Clears the input and output buffers.
- Sets the Status Byte to 0.

Key Path	User Preset
Remote Command	:SYSTem:PRESet:USER
Example	:SYST:PRES:USER:SAVE:SYST:PRES:USER
Notes	:SYST:PRES:USER:SAVE is used to save the current state as the user preset state. Clears all pending OPC bits. The Status Byte is set to 0. Pressing the User Preset front-panel key while already in the User Preset menu will cause the User Preset to get executed
Couplings	A user preset will cause the currently running measurement to be aborted and cause the saved measurement to be active. Recalling a User Preset file has the same issues that recalling a Save State file has. Some settings may need to be limited and therefore re-coupled, since the capabilities of the mode may have changes when the User Preset file was last saved.
Initial S/W Revision	Prior to A.02.00

User Preset All Modes

Recalls all of the User Preset files for each mode, switches to the power-on mode, and activates the saved measurement from the power-on mode User Preset file.

NOTE

When the instrument is secured, all of the user preset files are converted back to their default user preset files.

The User Preset function does the following:

- Aborts the currently running measurement.
- Switches the Mode to the power-on mode.
- Restores the User Preset files for each mode.
- Makes the saved measurement for the power-on mode the active measurement.
- Brings up the saved menu for the power-on mode.
- Clears the input and output buffers.
- Sets the Status Byte to 0.

Key Path	User Preset
Remote Command	:SYSTem:PRESet:USER:ALL
Example	:SYST:PRES:USER:SAVE:SYST:PRES:USER:ALL
Notes	Clears all pending OPC bits. The Status Byte is set to 0. :SYST:PRES:USER:SAVE is used to save the current state as the user preset state.
Couplings	A user preset will cause the currently running measurement to be aborted, cause a mode switch to the power-on mode, and cause the saved measurement to be active in the power-on mode. Recalling a User Preset file has the same issues that recalling a Save State file has. Some settings may need to be limited and therefore re-coupled, since the capabilities of the mode may have changes when the User Preset file was last saved.
Initial S/W Revision	Prior to A.02.00

Save User Preset

Saves the currently active mode and its State. You can recall this User Preset file by pressing the User Preset menu key or sending the SYST:PRES:USER remote command. This same state is also saved by the Save State function.

Key Path	User Preset
Remote Command	:SYSTem:PRESet:USER:SAVE
Example	:SYST:PRES:USER:SAVE
Notes	:SYST:PRES:SAVE creates the same file as if the user requested a *SAV or a MMEM:STOR:STAT, except User Preset Save does not allow the user to specify the filename or the location of the file.
Initial S/W Revision	Prior to A.02.00

View/Display

Accesses a menu that enables you to select from the following measurement view and display settings, shown below.

This topic contains the following sections:

["Understanding Front Panel Results to Use Remote Commands" on page 1791](#)

["Front Panel Results" on page 1791](#)

["View Selection by name \(SCPI Only\)" on page 1792](#)

["View Selection by number \(SCPI Only\)" on page 1792](#)

NOTE: the view setting options depend on the measurement view that is active.

Understanding Front Panel Results to Use Remote Commands

WiMAX Modulation Analysis measurement has 7 views. They can be selected both by the front-panel and remotely (SCPI commands). View # and Window # in the table below are also used as subops of :DISPlay subsets, for example:

:DISPlay:EVM:VIEW4:WINDow2:TRACe:X:SCALe:PDIVision?

Denotes X Scale/Div value query of Symbol Power vs Symbol trace (View # = 4, Window # = 2).

Front Panel Results

View #	View	Number of Windows	Window #	Window
[1]	I/Q Symbol Constellation	2	[1]	Results Summary
			2	I/Q Symbol Constellation
2	Zone & Data Burst Info	3	[1]	Zone List
			2	Zone Definition
			3	Data Burst List
3	Symbol Error (Quad View)	4	[1]	Symbol Error vs Subcarriers
			2	Symbol Error vs Symbol
			3	I/Q Symbol Constellation
			4	Zone Definition
4	Symbol Power (Quad View)	4	[1]	Symbol Power vs Subcarriers
			2	Symbol Power vs Symbol
			3	I/Q Symbol Constellation
			4	Zone Definition
5	Peak/Average Metrics	1	[1]	Result Summary

6	Spectral Flatness	3	[1]	Absolute Flatness
			2	Differential Flatness
			3	Result Summary
7	Power vs Time & Spectrum	2	[1]	Power vs Time

View Selection by name (SCPI Only)

The following remote command enables you to select the desired measurement view by Enum .

Key Path	View/Display
Mode	WIMAXOFDMA
Remote Command	:DISPlay:EVM:VIEW[:SElect] POLar ZMAP SERRor SPOWer SUMMary FLATness PVT :DISPlay:EVM:VIEW[:SElect]?
Example	DISP:EVM:VIEW:SEL PVT DISP:EVM:VIEW:SEL?
Couplings	:DISP:EVM:VIEW[:SEL] and :DISP:EVM:VIEW:NSEL shall be synchronized with each other.
Preset	POLar
State Saved	Saved in instrument state.
Range	I/Q Measured Polar ConstIn Zone/Data Burst Info Symbol Error (Quad View) Symbol Power(Quad View) Peak/Average Metrics Spectrum Flatness Power vs Time & Spectrum
Initial S/W Revision	Prior to A.02.00

View Selection by number (SCPI Only)

The following remote command enables you to select the desired measurement view by number.

Mode	WIMAXOFDMA
Remote Command	:DISPlay:EVM:VIEW:NSElect <integer> :DISPlay:EVM:VIEW:NSElect?
Example	DISP:EVM:VIEW:NSEL 1 DISP:EVM:VIEW:NSEL?
Couplings	:DISP:EVM:VIEW[:SEL] and :DISP:EVM:VIEW:NSEL shall be synchronized with each other.
Preset	1
State Saved	Saved in instrument state.
Min	1
Max	7
Initial S/W Revision	Prior to A.02.00

Key Path	Front-Panel
Initial S/W Revision	Prior to A.02.00

Display

The Display menu is common to most measurements, and is used for configuring items on the display. Some Display menu settings apply to all the measurements in a mode, and some only to the current measurement. Those under the System Display Settings key apply to all measurements in all modes.

Key Path	Display
Key Path	View/Display
Initial S/W Revision	Prior to A.02.00

Annotation

Turns on and off various parts of the display annotation. The annotation is divided up into four categories:

1. Meas Bar: This is the measurement bar at the top of the screen. It does not include the settings panel or the Active Function. Turning off the Meas Bar turns off the settings panel and the Active Function. When the Meas Bar is off, the graticule area expands to fill the area formerly occupied by the Meas Bar.
2. Screen Annotation: this is the annotation and annunciation around the graticule, including any annotation on lines (such as the display line, the threshold line, etc.) This does NOT include the marker number or the N dB result. When off, the graticule expands to fill the entire graticule area.
3. Trace annotation: these are the labels on the traces, showing their detector (or their math mode).
4. Active Function annotation: this is the active function display in the meas bar, and all of the active function values displayed on softkeys.

See the figure below. Each type of annotation can be turned on and off individually.

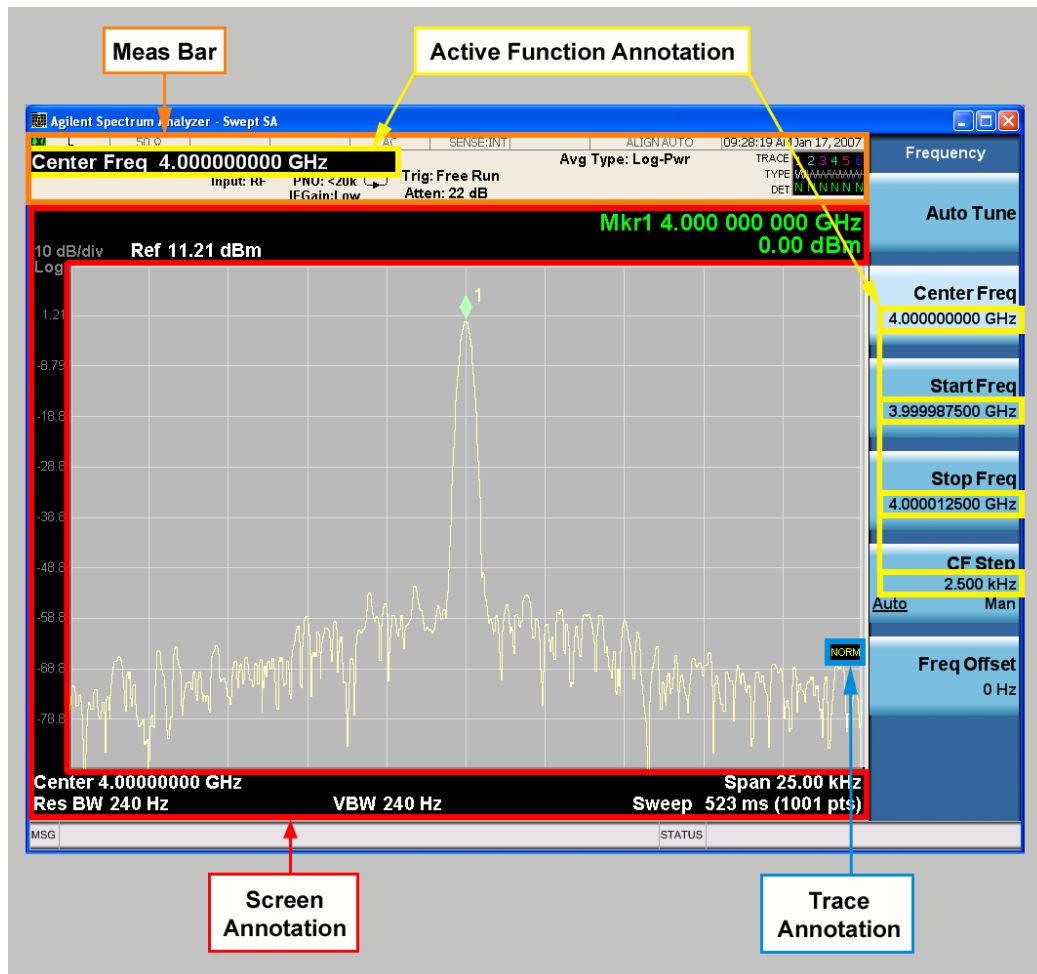

Key Path	View/Display, Display
Initial S/W Revision	Prior to A.02.00

Meas Bar On/Off

This function turns the Measurement Bar on and off, including the settings panel. When off, the graticule area expands to fill the area formerly occupied by the Measurement Bar.

Key Path	View/Display, Display, Annotation
Remote Command	:DISPlay:ANNOtation:MBAR[:STATe] OFF ON 0 1 :DISPlay:ANNOtation:MBAR[:STATe]?
Example	DISP:ANN:MBAR OFF
Dependencies	Grayed out and forced to OFF when System Display Settings, Annotation is set to Off.
Preset	On This should remain Off through a Preset when System DisplaySettings, Annotation is set to Off.
State Saved	Saved in instrument state.
Initial S/W Revision	Prior to A.02.00

Screen

This controls the display of the annunciation and annotation around the graticule, including any annotation on lines (such as the display line, the threshold line, etc.) and the y-axis annotation. This does NOT include marker annotation (or the N dB result). When off, the graticule expands to fill the entire graticule area, leaving only the 1.5% gap above the graticule as described in the Trace/Detector chapter.

Key Path	View/Display, Display, Annotation
Remote Command	:DISPlay:ANNotation:SCReen[:STATe] OFF ON 0 1 :DISPlay:ANNotation:SCReen[:STATe]?
Example	DISP:ANN:SCR OFF
Dependencies	Grayed-out and forced to OFF when System Display Settings, Annotation is set to Off.
Preset	On This should remain Off through a Preset when System DisplaySettings, Annotation is set to Off
State Saved	Saved in instrument state.
Initial S/W Revision	Prior to A.02.00

Active Function Values On/Off

Turns on and off the active function display in the Meas Bar, and all of the active function values displayed on the softkeys.

Note that all of the softkeys that have active functions have these numeric values blanked when this function is on. This is a security feature..

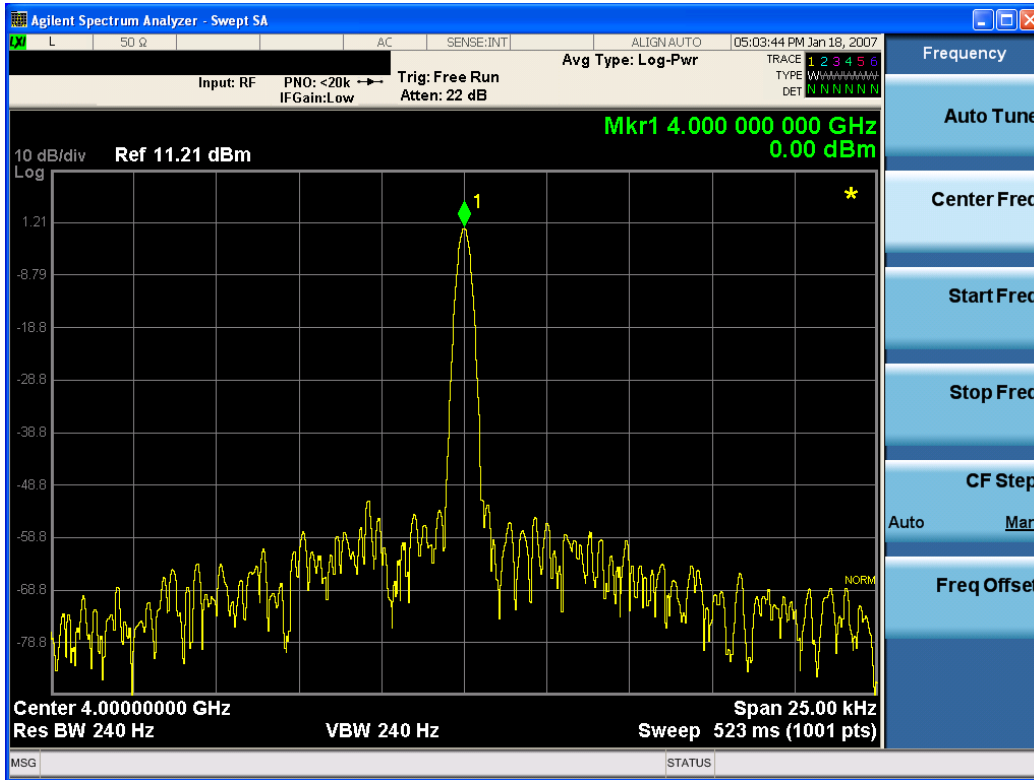

Key Path	View/Display, Display, Annotation
Remote Command	:DISPlay:ACTivefunc[:STATE] ON OFF 1 0 :DISPlay:ACTivefunc[:STATE]?
Example	DISP:ACT OFF
Dependencies	Grayed out and forced to OFF when System Display Settings, Annotation is set to Off.
Preset	On This should remain Off through a Preset when System DisplaySettings, Annotation is set to Off
State Saved	Saved in instrument state.
Initial S/W Revision	Prior to A.02.00

Title

Displays menu keys that enable you to change or clear a title on your display.

Key Path	View/Display, Display
Initial S/W Revision	Prior to A.02.00

Change Title

Writes a title into the "measurement name" field in the banner, for example, "Swept SA".

Press Change Title to enter a new title through the alpha editor. Press Enter or Return to complete the entry. Press ESC to cancel the entry and preserve your existing title.

The display title will replace the measurement name. It remains for this measurement until you press Change Title again, or you recall a state, or a Preset is performed. A title can also be cleared by pressing Title, Clear Title.

NOTE

Notice the inclusion of the <measurement> parameter in the command below. Because each measurement remembers the Display Title, the command must be qualified with the measurement name. For the Swept SA measurement this is not the case; no <measurement> parameter is used when changing the Display Title for the Swept SA measurement.

Key Path	View/Display, Display, Title
Mode	All
Remote Command	:DISPlay:<measurement>:ANNotation:TITLe:DATA <string> :DISPlay:<measurement>:ANNotation:TITLe:DATA?
Example	DISP:ANN:TITL:DATA "This Is My Title" This example is for the Swept SA measurement in the Spectrum Analyzer mode. The SANalyzer <measurement> name is not used. DISP:ACP:ANN:TITL:DATA "This Is My Title" This example is for Measurements other than Swept SA. Both set the title to: This Is My Title
Notes	Pressing this key cancels any active function. When a title is edited the previous title remains intact (it is not cleared) and the cursor goes at the end so that characters can be added or BKSP can be used to go back over previous characters.
Preset	No title (measurement name instead)
State Saved	Saved in instrument state.
Initial S/W Revision	Prior to A.02.00

Clear Title

Clears a title from the front-panel display. Once cleared, the title cannot be retrieved. After the title is cleared, the current Measurement Name replaces it in the title bar.

Key Path	View/Display, Display, Title
Example	The following commands clear the title and restore the measurement's original title: DISP:ANN:TITL:DATA "" This example is for the Swept SA measurement in the Spectrum Analyzer mode. The SANalyzer <measurement> name is not used. DISP:ACP:ANN:TITL:DATA "" This example is for ACP; in measurements other than Swept SA the measurement name is required.
Notes	Uses the :DISPlay:<measurement>:ANNotation:TITLe:DATA <string> command with an empty string (in the Swept SA, the <measurement> is omitted).
Preset	Performed on Preset.
Initial S/W Revision	Prior to A.02.00

Graticule

Pressing Graticule turns the display graticule On or Off. It also turns the graticule y-axis annotation on and off.

Key Path	View/Display, Display
Remote Command	:DISPlay:WINDow[1]:TRACe:GRATicule:GRID[:STATe] OFF ON 0 1 :DISPlay:WINDow[1]:TRACe:GRATicule:GRID[:STATe]?
Example	DISP:WIND:TRAC:GRAT:GRID OFF
Notes	The graticule is the set of horizontal and vertical lines that make up the grid/divisions for the x-axis and y-axis.
Preset	On
State Saved	Saved in instrument state
Initial S/W Revision	Prior to A.02.00

System Display Settings

These settings are "Mode Global" – they affect all modes and measurements and are reset only by Restore Misc Defaults or Restore System Defaults under System.

Key Path	View/Display, Display
Initial S/W Revision	Prior to A.02.00

Annotation Local Settings

This is a Mode Global override of the meas local annotation settings. When it is All Off, it forces ScreenAnnotation, Meas Bar, Trace, and Active Function Values settings to be OFF for all measurements in all modes. This provides the security based "annotation off" function of previous analyzers; hence it uses the legacy SCPI command.

When it is All Off, the Screen, Meas Bar, Trace, and Active Function Values keys under the Display, Annotation menu are grayed out and forced to Off. When Local Settings is selected, you are able to set the local annotation settings on a measurement by measurement basis.

Key Path	View/Display, Display, System Display Settings
Remote Command	:DISPlay:WINDow[1]:ANNotation[:ALL] OFF ON 0 1 :DISPlay:WINDow[1]:ANNotation[:ALL]?
Example	:DISP:WIND:ANN OFF
Preset	On (Set by Restore Misc Defaults)
State Saved	Not saved in instrument state.
Backwards Compatibility Notes	The WINDow parameter and optional subopcode is included for backwards compatibility but ignored – all windows are equally affected.
Initial S/W Revision	Prior to A.02.00

Themes

Accesses a menu of functions that enable you to choose the theme to be used when saving the screen image.

The **Themes** option is the same as the **Themes** option under the **Display** and **Page Setup** dialogs. It allows you to choose between themes to be used when saving the screen image.

Key Path	Save, Screen Image
Remote Command	:MMEMory:STORe:SCReen:THEMe TDColor TDMonochrome FCOLor FMONochrome :MMEMory:STORe:SCReen:THEMe?
Example	:MMEM:STOR:SCR:THEM TDM
Preset	3D Color; Is not part of Preset, but is reset by Restore Misc Defaults or Restore System Defaults All and survives subsequent running of the modes.
Readback	3D Color 3D Mono Flat Color Flat Mono
Backwards Compatibility Notes	In ESA and PSA we offer the choice of "Reverse Bitmap" or "Reverse Metafile" when saving screen images. This is much like the "Flat Color" theme available in X-Series. Also, if you selected Reverse Bitmap AND a black & white screen image, that would be much like "Flat Monochrome". In other words, each of the X-Series themes has a similar screen image type in ESA/PSA. But they are not identical.
Initial S/W Revision	Prior to A.02.00

3D Color

Selects a standard color theme with each object filled, shaded and colored as designed.

Key Path	Save, Screen Image, Themes
Example	MMEM:STOR:SCR:THEM TDC
Readback	3D Color
Initial S/W Revision	Prior to A.02.00

3D Monochrome

Selects a format that is like 3D color but shades of gray are used instead of colors.

Key Path	Save, Screen Image, Themes
Example	MMEM:STOR:SCR:THEM TDM
Readback	3D Mono
Initial S/W Revision	Prior to A.02.00

Flat Color

Selects a format that is best when the screen is to be printed on an ink printer.

Key Path	Save, Screen Image, Themes
Example	MMEM:STOR:SCR:THEM FCOL
Readback	Flat Color
Initial S/W Revision	Prior to A.02.00

Flat Monochrome

Selects a format that is like Flat Color. But only black is used (no colors, not even gray), and no fill.

Key Path	Save, Screen Image, Themes
Example	MMEM:STOR:SCR:THEM FMON
Readback	Flat Mono
Initial S/W Revision	Prior to A.02.00

Backlight

Accesses the display backlight on/off keys. This setting may interact with settings under the Windows "Power" menu.

When the backlight is off, pressing ESC, TAB, SPACE, ENTER, UP, DOWN, LEFT, RIGHT, DEL, BKSP, CTRL, or ALT turns the backlight on without affecting the application. Pressing any other key will turn backlight on and could potentially perform the action as well.

Key Path	View/Display, Display, System Display Settings
Remote Command	:DISPlay:BACKlight ON OFF :DISPlay:BACKlight?
Preset	ON (Set by Restore Misc Defaults)
Initial S/W Revision	Prior to A.02.00

Backlight Intensity

An active function used to set the backlight intensity. It goes from 0 to 100 where 100 is full on and 0 is off. This value is independent of the values set under the Backlight on/off key.

Key Path	View/Display, Display, System Display Settings
Remote Command	:DISPlay:BACKlight:INTensity <integer> :DISPlay:BACKlight:INTensity?
Example	DISP:BACK:INT 50

Preset	100 (Set by Restore Misc Defaults)
Min	0
Max	100
Initial S/W Revision	Prior to A.02.00

I/Q Symbol Measured Constin

The following figure shows I/Q Symbol Constellation view image. The window 1 (left window) shows metrics summary and the window 2 (right) shows I/Q Symbol constellation. The I/Q Symbol constellation is updated by each zone.

The view consists of the following windows:

"I/Q Symbol Constellation Window" on page 1801

"Numeric Results Window" on page 1802

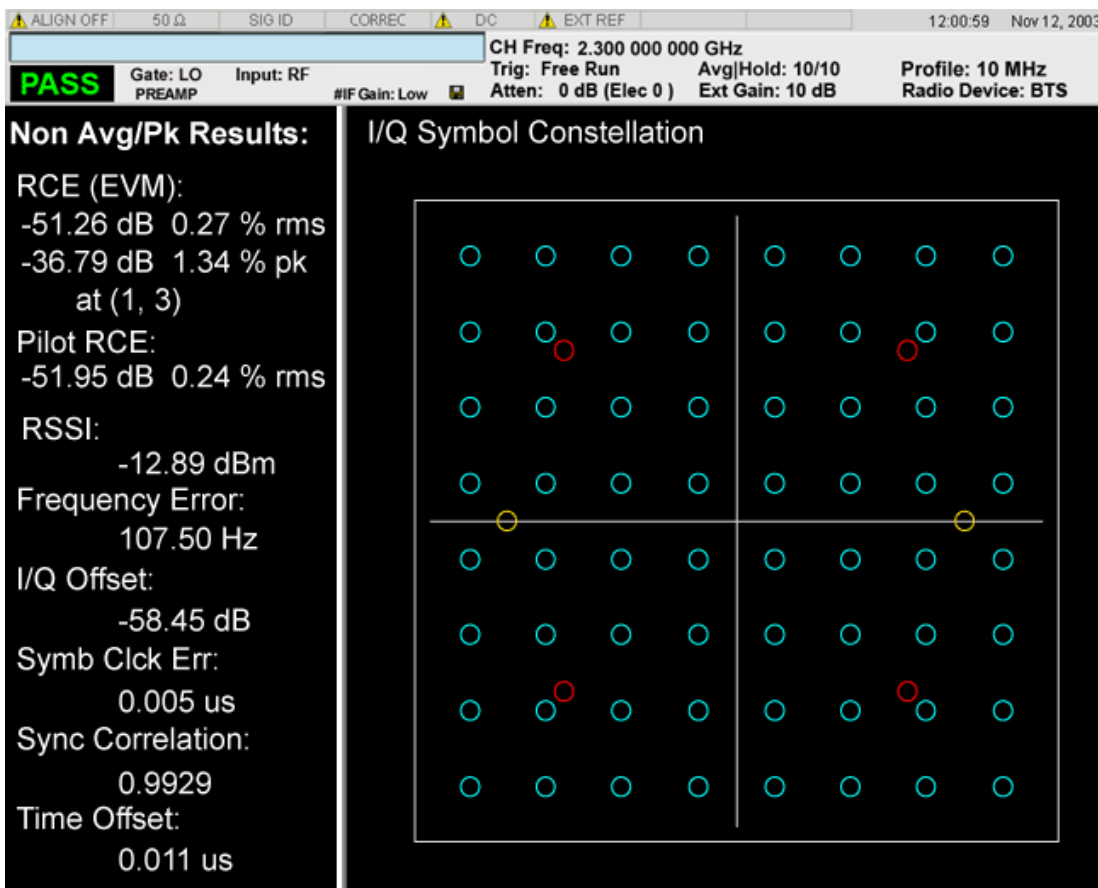

I/Q Symbol Constellation Window

Marker Operation	Yes {{Symbol, Subcarrier} - {X,Y}}
------------------	------------------------------------

Corresponding Trace	Corrected measured trace (n=8) The color of symbols is aligned to data burst definition of Zone Definition. White is reserved for pilot subcarrier. This trace is affected by I/Q Meas Polar view setting parameters.
---------------------	---

Numeric Results Window

Name	Corresponding Results	Display Format
RMS RCE (EVM)	n=1-1, Total RMS RCE (EVM) in dB n=1-0, Total RMS RCE (EVM) in %	XX.XX dB XX.XX % rms
Peak RCE (EVM)	n=1-0, Total Peak RMS RCE (EVM) in dB n=1-0, Total Peak RMS RCE (EVM) in %	XX.XX dB XX.XX % pk
Peak RCE Location	n=1-0, Peak RCE (EVM) Symbol Number n=1-0, Peak RCE (EVM) Subcarrier Number	at (XX, XX)
RMS Pilot RCE	n=1-17, Pilot RCE in dB n=1-17, Pilot RCE in %	XX.XX dB XX.XX %
RSSI	n=1-0, RSSI	XX.XX dBm
Freq Err	n=1-0, Frequency Error	XX.XX Hz
I/Q Offset	n=1-0, I/Q Offset	XX.XX dB
Symbol Clk Error	n=1-17, Symb Clk Err	XX.XX s
Sync Correlation	n=1-0, Sync Correlation	
Time Offset	n=1-0, Time Offset	XX.XX s

Key Path	View/Display
Initial S/W Revision	Prior to A.02.00

Inactive Subchannels

Include or excludes the inactive subchannels in the EVM traces (this only applies to Data Burst Analysis mode). This parameter does not affect the EVM calculation. If this parameter is set to “Include”, the EVM results will include the EVM value of the Unmodulated subchannels, and I/Q Meas will include the Unmodulated subcarriers’ constellation.

Key Path	View/Display, I/Q Measured Polar Constln
Mode	WIMAXOFDMA
Remote Command	:DISPlay:EVM:SUBChannel:INActive INCLude EXCLude :DISPlay:EVM:SUBChannel:INActive?

Example	DISP:EVM:SUBC:INAC INCL DISP:EVM:SUBC:INAC?
Preset	EXCLude
State Saved	Saved in instrument state.
Range	INCLude EXCLude
Initial S/W Revision	Prior to A.02.00

Zone Data Burst Info

Provides a combination view of a Zone list table, the selected map graph, and the Data Burst list table.

Zone & Burst Data Info view consists of 3 windows.

"Zone List Window" on page 1804

"Zone Definition Window" on page 1804

"Data Burst List Window" on page 1804

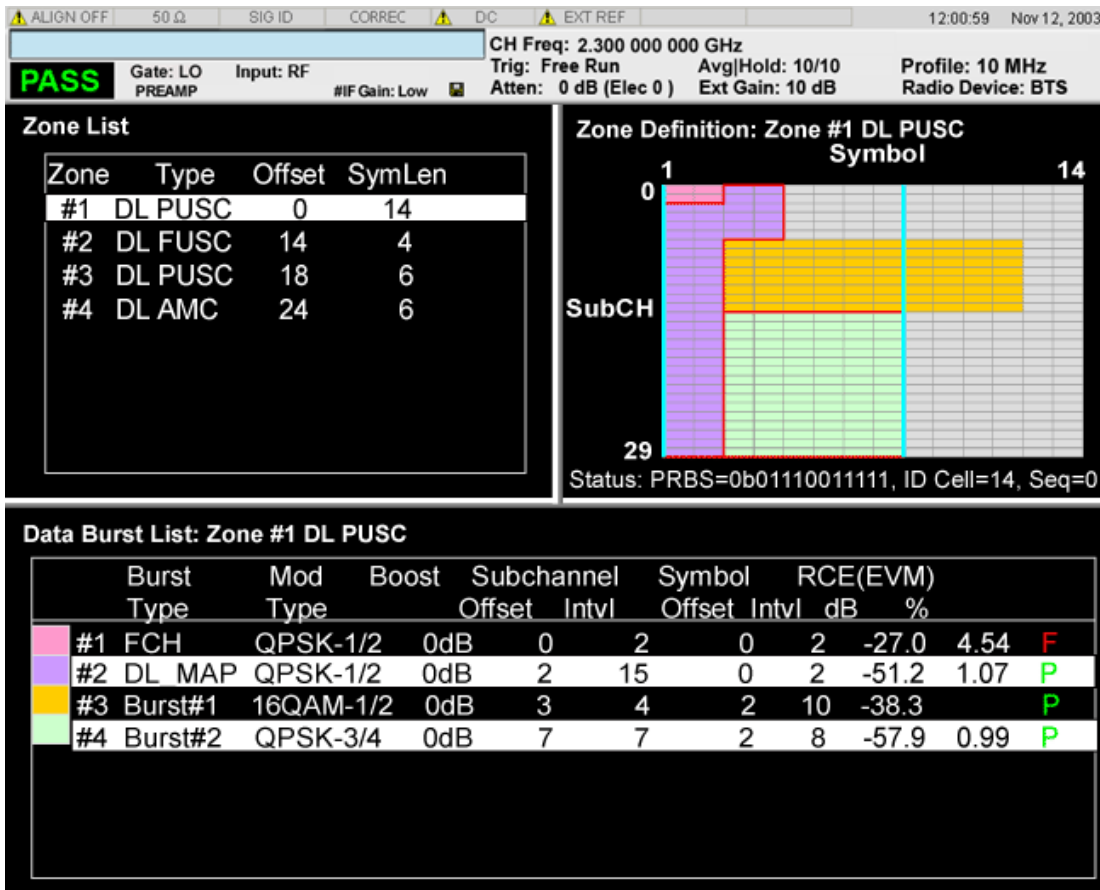

Zone List Window

Name	Corresponding Results	Display Format
Zone Name	None, exported into *.omf file.	String
Zone Type	None, exported into *.omf file.	String
Symbol Offset	None, exported into *.omf file.	XX
Symbol Length	None, exported into *.omf file.	XX

Zone Definition Window

Marker Operation	No
Corresponding Trace	None. Data Burst Info is returned by n=13 with a Data Burst Number (:CALCulate:EVM:INformation:BURSt

Name	Corresponding Results	Display Format
Status	n=1-43, PRBS n=1-44, IDCell n=1-45, Segment	0bXXXXXXXXXX XX X

Data Burst List Window

Name	Corresponding Results	Display Format
Burst Name	None	String
Burst Type	None, but the value of specified burst is returned in n=13-1.	String
Mod Type	None, but the value of specified burst is returned in n=13-2.	String (Enum)
Boost Level	None, but the value of specified burst is returned in n=13-3.	XX.XX dB
Subchannel Offset	None, but the value of specified burst is returned in n=13-4.	XX
Subchannel Interval	None, but the value of specified burst is returned in n=13-5.	XX
Symbol Offset	None, but the value of specified burst is returned in n=13-6.	XX
Symbol Interval	None, but the value of specified burst is returned in n=13-7.	XX
RCE (EVM) in dB	None, but the value of specified burst is returned in n=13-9.	XX.XX dB
RCE (EVM) in %	None, but the value of specified burst is returned in n=13-10.	XX.XX dB

Key Path	View/Display
Initial S/W Revision	Prior to A.02.00

Symbol Error (Quad View)

The Symbol Error (Quad View) view consists of 4 windows. Both the Symbol Error vs Subcarrier and the Symbol Error vs Symbol use the same trace by 2-D shuffling. I/Q Symbol Constellation window shows the same trace as one in the Symbol Power view. Zone Definition window shows graphic which depicts the current zone definition.

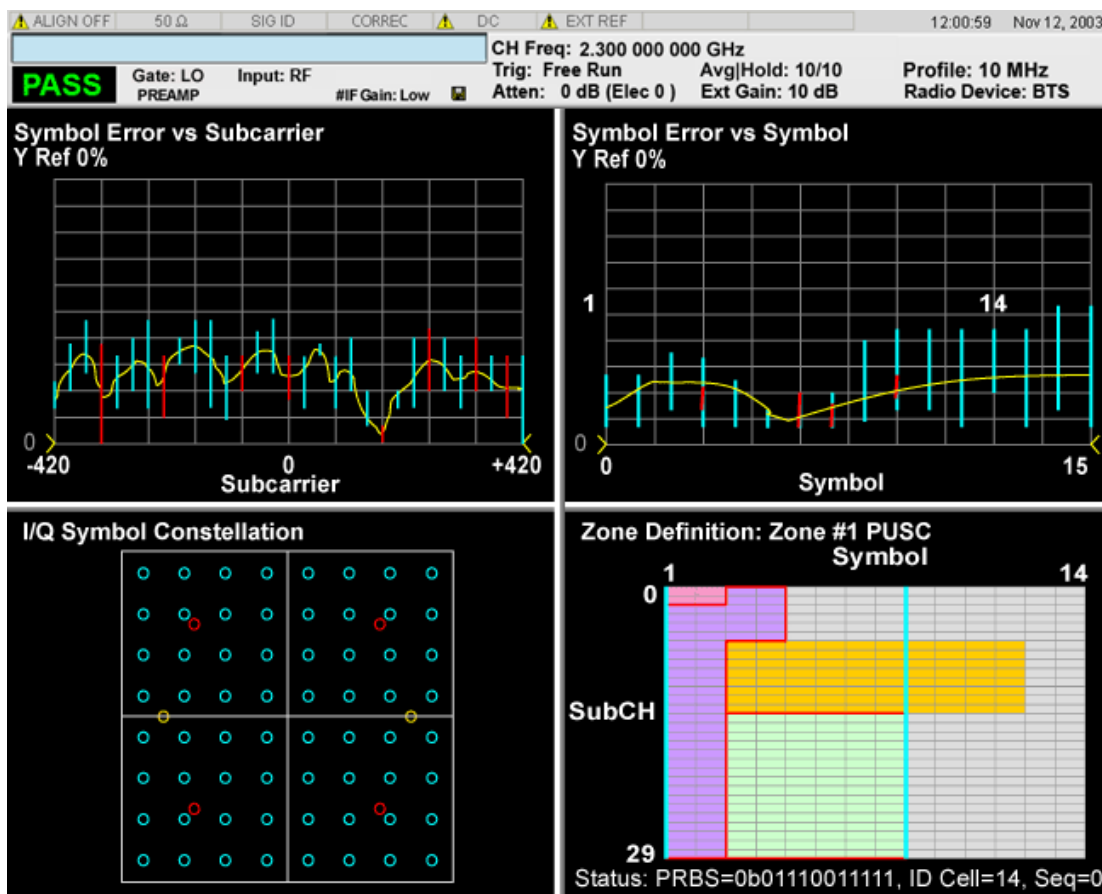

"Symbol Error vs Subcarrier Window" on page 1806

"Symbol Error vs Symbol Window" on page 1806

"I/Q Symbol Constellation Window" on page 1806

"Zone Definition Window" on page 1806

Symbol Error vs Subcarrier Window

Corresponding Trace	n=2 Symbol Error Trace	Light blue bar, colored dot
	n=3 RMS Symbol Error vs Subcarrier	Yellow

Symbol Error vs Symbol Window

Corresponding Trace	n=2 Symbol Error Trace	Light blue bar, colored dot
	n=4 RMS Symbol Error vs Symbol	Yellow

I/Q Symbol Constellation Window

The same as I/Q Symbol Constellation Window in "IQ Symbol Measured Constin" on page 1801.

Marker Operation	Yes ({Symbol, Subcarrier} - {X,Y})
Corresponding Trace	Corrected measured trace (n=8) The color of symbols is aligned to data burst definition of Zone Definition. White is reserved for pilot subcarrier.

Zone Definition Window

Marker Operation	No
Corresponding Trace	None. Data Burst Info is returned by n=17 with a Data Burst Number :(:CALCulate:EVM:INformation:BURSt)

Name	Corresponding Results	Display Format
Status	n=1-43, PRBS n=1-44, IDCell n=1-45, Segment	0bXXXXXXXXXX XX X

Key Path	View/Display
Initial S/W Revision	Prior to A.02.00

Inactive Subchannels

Include or excludes the inactive subchannels in the EVM traces (this only applies to Data Burst Analysis mode). This parameter does not affect the EVM calculation. If this parameter is set to "Include", the EVM

results will include the EVM value of the Unmodulated subchannels, and I/Q Meas will include the Unmodulated subcarriers' constellation.

Key Path	View/Display, I/Q Measured Polar Constln
Mode	WIMAXOFDMA
Remote Command	:DISPlay:EVM:SUBChannel:INActive INCLude EXCLude :DISPlay:EVM:SUBChannel:INActive?
Example	DISP:EVM:SUBC:INAC INCL DISP:EVM:SUBC:INAC?
Preset	EXCLude
State Saved	Saved in instrument state.
Range	INCLude EXCLude
Initial S/W Revision	Prior to A.02.00

Symbol Power (Quad View)

The Symbol Power (Quad View) view consists of 4 windows. Both the Symbol Power vs Subcarrier and the Symbol Power vs Symbol use the same trace by 2-D shuffling. I/Q Symbol Constellation window shows the same trace as one in the Symbol Error view. Zone Definition window shows graphic which depicts the current zone definition.

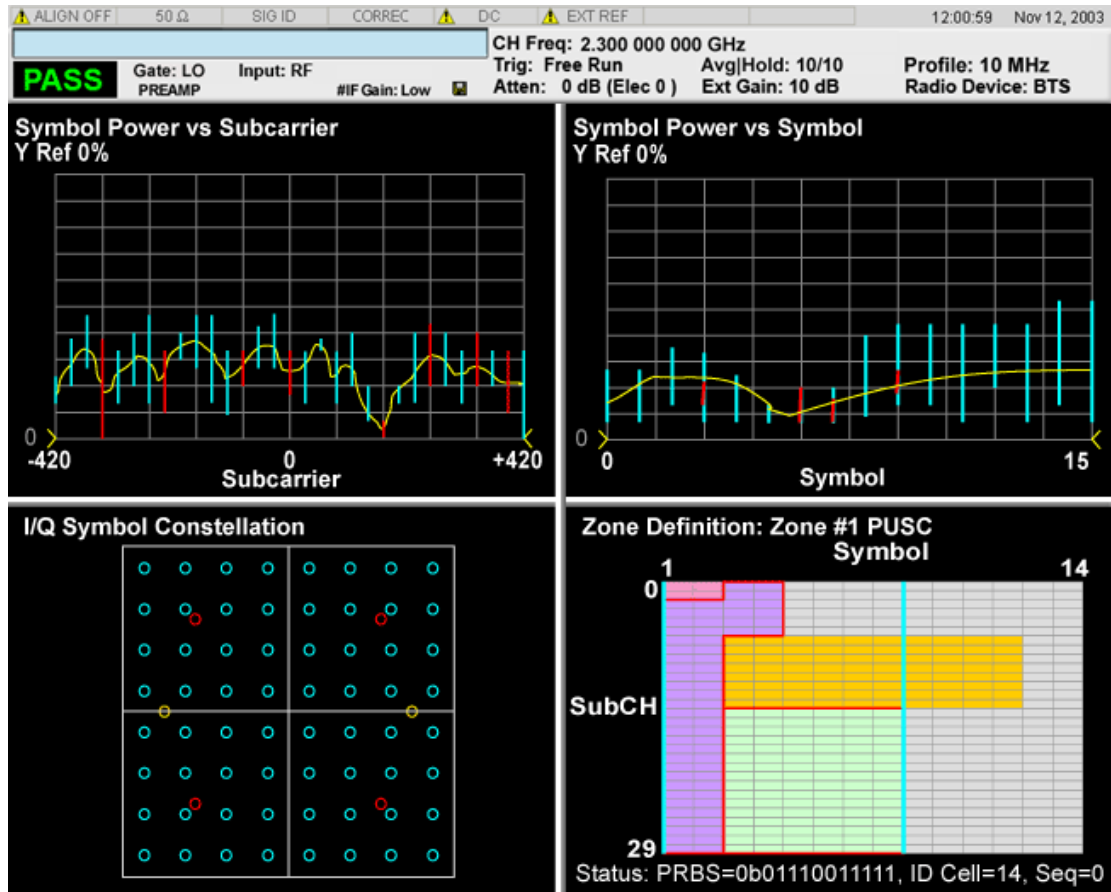

"Symbol Power Vector vs Subcarrier Window" on page 1808

"Symbol Power Vector vs Symbol" on page 1808

"I/Q Symbol Constellation" on page 1808

"Zone Definition" on page 1809

Symbol Power Vector vs Subcarrier Window

Corresponding Trace	n=5 Symbol Power Trace	Light blue bar, colored dot
	n=6 RMS Symbol Power vs Subcarrier	Yellow

Symbol Power Vector vs Symbol

Corresponding Trace	n=5 Symbol Power Trace	Light blue bar, colored dot
	n=7 RMS Symbol Power vs Symbol	Yellow

I/Q Symbol Constellation

The same as I/Q Symbol Constellation Window in "I/Q Symbol Measured Constin" on page 1801.

Marker Operation	Yes {{Symbol, Subcarrier} - {X,Y}}
Corresponding Trace	Corrected measured trace (n=8) The color of symbols is aligned to data burst definition of Zone Definition. White is reserved for pilot subcarrier.

Zone Definition

Marker Operation	No
Corresponding Trace	None. Data Burst Info is returned by n=17 with a Data Burst Number (:CALCulate:EVM:INformation:BURSt)

Name	Corresponding Results	Display Format
Status	n=1-43, PRBS n=1-44, IDCell n=1-45, Segment	0bXXXXXXXXXX XX X

Key Path	View/Display
Initial S/W Revision	Prior to A.02.00

Inactive Subchannels

Include or excludes the inactive subchannels in the EVM traces (this only applies to Data Burst Analysis mode). This parameter does not affect the EVM calculation. If this parameter is set to "Include", the EVM results will include the EVM value of the Unmodulated subchannels, and I/Q Meas will include the Unmodulated subcarriers' constellation.

Key Path	View/Display, I/Q Measured Polar Constln
Mode	WIMAXOFDMA
Remote Command	:DISPlay:EVM:SUBChannel:INActive INCLude EXCLude :DISPlay:EVM:SUBChannel:INActive?
Example	DISP:EVM:SUBC:INAC INCL DISP:EVM:SUBC:INAC?
Preset	EXCLude
State Saved	Saved in instrument state.
Range	INCLude EXCLude
Initial S/W Revision	Prior to A.02.00

Peak/Avg Metrics

Provides a table of the summary for the measurement result and information at the selected burst.

	Average	Peak Hold	Std Dev
RMS RCE (EVM):	-51.26 dB 0.27 % P	-49.33 dB 0.31 %	
Peak RCE (EVM):	-36.79 dB 1.34 % P	-34.77 dB 1.56 %	
(Pilot Included)		at SubCarr: -201, Symbol 6	
RCE - Pilot:	-51.95 dB 0.24 % P	-51.95 dB 0.25 %	
RCE - Unmod:	-65.33 dB 0.08 %	-64.11 dB 0.09 %	
RCE - Preamble:	-48.22 dB 0.39 %	-48.22 dB 0.39 %	
Freq Error:	103.34 Hz	105.68 Hz P	
Preamble Pwr (RSSI):	12.80 dBm	12.80 dBm	-52.55 dBm
Preamble PCINR R1:	41.397 dB	41.397 dB	16.741 dB
R3:	41.251 dB	41.251 dB	20.879 dB
FFT Total Power:	-20.11 dBm	-20.11 dBm	
Symbol Clock Err:	-0.112 ppm	-0.112 ppm	
Sync Correlation:	0.9948	0.9948	
Time Offset:	100.39 usec P	100.39 usec	
I/Q (DC) Offset:	-50.99 dB P	-50.99 dB	
Abs Flatness (Max):	-3.14 dBm 0.97 dBc	@Subcarrier : 15 P	
(Min):	-5.25 dBm -1.14 dBc	@Subcarrier : -209 F	
Diff Flatness (Max):	0.04 dB	@Subcarrier : -122 F	
(Min):	-0.40 dB	@Subcarrier : -404 F	

Name	Corresponding Results	Display Format
Averaged Total RMS RCE (EVM)	n=1-0, Total RMS RCE (EVM) in dB n=1-0, Total RMS RCE (EVM) in %	XX.XX dB XX.XX %
Max Total RMS RCE (EVM)	n=1-0, Total RMS RCE (EVM) in dB n=1-0, Total RMS RCE (EVM) in %	XX.XX dB XX.XX %
SD of Total RMS RCE (EVM)	n=1-0, Total RMS RCE (EVM) in dB n=1-0, Total RMS RCE (EVM) in %	XX.XX dB XX.XX %
Averaged Peak RCE (EVM)	n=1-0, Peak RMS RCE (EVM) in dB n=1-0, Peak RMS RCE (EVM) in %	XX.XX dB XX.XX %
Max Peak RCE (EVM)	n=1-0, Peak RMS RCE (EVM) in dB n=1-0, Peak RMS RCE (EVM) in %	XX.XX dB XX.XX %
Max Peak RCE symbol & subcarrier	n=1-0, Peak RCE (EVM) Subcarrier index n=1-0, Peak RCE (EVM) Symbol Number	at Subcarrier XXX Symbol XX
SD of Peak RCE (EVM)	n=1-0, Peak RMS RCE (EVM) in dB n=1-0, Peak RMS RCE (EVM) in %	XX.XX dB XX.XX %

Averaged Pilot RMS RCE (EVM)	n=1-0, Pilot RMS RCE (EVM) in dB n=1-0, Pilot RMS RCE (EVM) in %	XX.XX dB XX.XX %
Max Pilot RMS RCE (EVM)	n=1-0, Pilot RMS RCE (EVM) in dB n=1-0, Pilot RMS RCE (EVM) in %	XX.XX dB XX.XX %
SD of Pilot RMS RCE (EVM)	n=1-0, Pilot RMS RCE (EVM) in dB n=1-0, Pilot RMS RCE (EVM) in %	XX.XX dB XX.XX %
Averaged Unmod RMS RCE (EVM)	n=1-0, Unmod RMS RCE (EVM) in dB n=1-0, Unmod RMS RCE (EVM) in %	XX.XX dB XX.XX %
Max Unmod RMS RCE (EVM)	n=1-0, Unmod RMS RCE (EVM) in dB n=1-0, Unmod RMS RCE (EVM) in %	XX.XX dB XX.XX %
SD of Unmod RMS RCE (EVM)	n=1-0, Unmod RMS RCE (EVM) in dB n=1-0, Unmod RMS RCE (EVM) in %	XX.XX dB XX.XX %
Freq Err	n=1-0, Averaged Frequency Error in Hz n=1-0, Max Frequency Error in Hz n=1-0, SD of Frequency Error in Hz	XX.XX Hz XX.XX Hz
I/Q Offset	n=1-0, Averaged I/Q Origin Offset in dB n=1-0, Max I/Q Origin Offset in dB n=1-0, SD of I/Q Origin Offset in dB	XX.XX dB XX.XX dB
Symbol Clk Err	n=1-0, Averaged Symbol Clock Error in ppm n=1-0, Max Symbol Clock Error in ppm n=1-0, Averaged Symbol Clock Error in ppm	XX.XXX ppm XX.XXX ppm
Sync Corr (UL Only)	n=1-0, Averaged Sync Correlation n=1-0, Max Sync Correlation n=1-0, SD of Sync Correlation	X.XXXX X.XXXX
Time Offset	n=1-0, Averaged Time Offset in sec n=1-0, Max Time Offset in sec n=1-0, SD of Time Offset in sec	XX.XXX sec XX.XXX sec
RSSI	n=1-0, Averaged RSSI in dBm n=1-0, Max RSSI in dBm n=1-0, Averaged RSSI in dBm	XX.XX dBm XX.XX dBm
Total Power (FFT)	n=1-0, Averaged Total Power n=1-0, Max Total Power n=1-0, SD of Total Power	XX.XX dBm XX.XX dBm
Abs Max Subcarrier Power	n=1-48, Max Power in dBm n=1-49, Max Power in dBc n=1-51, Max Subcarrier Index	XX.XX dBm XX.XX dBc XXX
Abs Min Subcarrier Power	n=1-52, Min Power in dBm n=1-53, Min Power in dBc n=1-55, Min Subcarrier Index	XX.XX dBm XX.XX dBc XXX

Differential Max Subcarrier Power	n=1-56, Max Power in dB n=1-58, Max Subcarrier Index	XX.XX dB XXX
Differential Min Subcarrier Power	n=1-59, Min Power in dB n=1-61, Min Subcarrier Index	XX.XX dB XXX

Key Path	View/Display
Initial S/W Revision	Prior to A.02.00

Zoomed Result Metrics

When Result Metrics Window is focused and the user zooms the window, spectral flatness result for each offset is shown. These results are identical to n=21 of SCPI results.

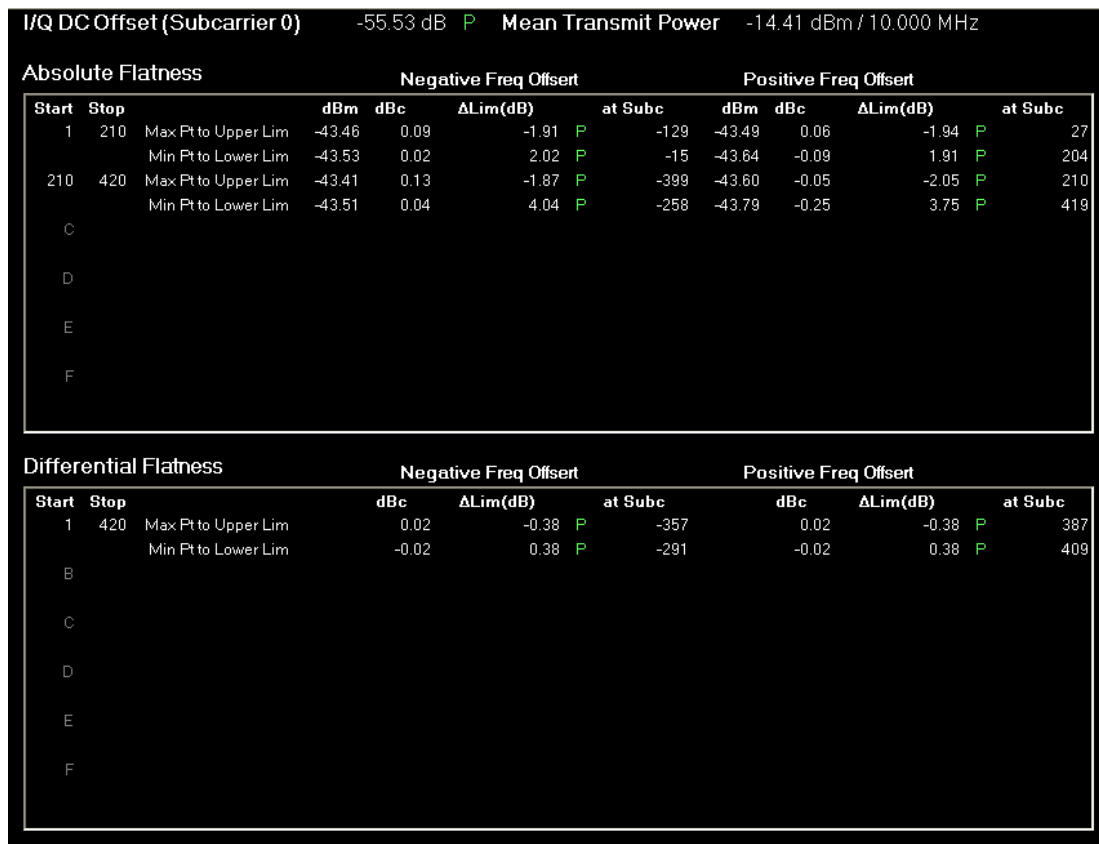

Figure 1 Zoomed Spectral Flatness Result Metrics Window

Name	Corresponding Results	Display Format
Transmit Power	n=1-46, Mean Transit Power in dBm n=1-47, Nominal BW in Hz	XX.XX dBm XX.XX Hz

Absolute Flatness		
Abs Max Subcarrier Power of Offset A, Lower Frequency Offset	n=21-1, Max Power in dBm n=21-2, Max Power in dBc n=21-3, Max Power to Upper Limit in dB n=21-4, Max Subcarrier Index	XX.XX XX.XX XX.XX XXX
Abs Min Subcarrier Power of Offset A, Lower Frequency Offset	n=21-5, Min Power in dBm n=21-6, Min Power in dBc n=21-7, Min Power to Lower Limit in dB n=21-8, Min Subcarrier Index	XX.XX XX.XX XX.XX XXX
Abs Max Subcarrier Power of Offset A, Upper Frequency Offset	n=21-9, Max Power in dBm n=21-10, Max Power in dBc n=21-11, Max Power to Upper Limit in dB n=21-12, Max Subcarrier Index	XX.XX XX.XX XX.XX XXX
Abs Min Subcarrier Power of Offset A, Upper Frequency Offset	n=21-13, Min Power in dBm n=21-14, Min Power in dBc n=21-15, Min Power to Lower Limit in dB n=21-16, Min Subcarrier Index	XX.XX XX.XX XX.XX XXX
Abs Max Subcarrier Power of Offset B, Lower Frequency Offset	n=21-17, Max Power in dBm n=21-18, Max Power in dBc n=21-19, Max Power to Upper Limit in dB n=21-20, Max Subcarrier Index	XX.XX XX.XX XX.XX XXX
Abs Min Subcarrier Power of Offset B, Lower Frequency Offset	n=21-21, Min Power in dBm n=21-22, Min Power in dBc n=21-23, Min Power to Lower Limit in dB n=21-24, Min Subcarrier Index	XX.XX XX.XX XX.XX XXX
Abs Max Subcarrier Power of Offset B, Upper Frequency Offset	n=21-25, Max Power in dBm n=21-26, Max Power in dBc n=21-27, Max Power to Upper Limit in dB n=21-28, Max Subcarrier Index	XX.XX XX.XX XX.XX XXX
Abs Min Subcarrier Power of Offset B, Upper Frequency Offset	n=21-29, Min Power in dBm n=21-30, Min Power in dBc n=21-31, Min Power to Lower Limit in dB n=21-32, Min Subcarrier Index	XX.XX XX.XX XX.XX XXX
Abs Max Subcarrier	n=21-33, Max Power in dBm	XX.XX XX.XX XX.XX XXX

Power of Offset C, Lower Frequency Offset	n=21-34, Max Power in dBc n=21-35, Max Power to Upper Limit in dB n=21-36, Max Subcarrier Index	
Abs Min Subcarrier Power of Offset C, Lower Frequency Offset	n=21-37, Min Power in dBm n=21-38, Min Power in dBc n=21-39, Min Power to Lower Limit in dB n=21-40, Min Subcarrier Index	XX.XX XX.XX XX.XX XXX
Abs Max Subcarrier Power of Offset C, Upper Frequency Offset	n=21-41, Max Power in dBm n=21-42, Max Power in dBc n=21-43, Max Power to Upper Limit in dB n=21-44, Max Subcarrier Index	XX.XX XX.XX XX.XX XXX
Abs Min Subcarrier Power of Offset C, Upper Frequency Offset	n=21-45, Min Power in dBm n=21-46, Min Power in dBc n=21-47, Min Power to Lower Limit in dB n=21-48, Min Subcarrier Index	XX.XX XX.XX XX.XX XXX
Abs Max Subcarrier Power of Offset D, Lower Frequency Offset	n=21-49, Max Power in dBm n=21-50, Max Power in dBc n=21-51, Max Power to Upper Limit in dB n=21-52, Max Subcarrier Index	XX.XX XX.XX XX.XX XXX
Abs Min Subcarrier Power of Offset D, Lower Frequency Offset	n=21-53, Min Power in dBm n=21-54, Min Power in dBc n=21-55, Min Power to Lower Limit in dB n=21-56, Min Subcarrier Index	XX.XX XX.XX XX.XX XXX
Abs Max Subcarrier Power of Offset D, Upper Frequency Offset	n=21-57, Max Power in dBm n=21-58, Max Power in dBc n=21-59, Max Power to Upper Limit in dB n=21-60, Max Subcarrier Index	XX.XX XX.XX XX.XX XXX
Abs Min Subcarrier Power of Offset D, Upper Frequency Offset	n=21-61, Min Power in dBm n=21-62, Min Power in dBc n=21-63, Min Power to Lower Limit in dB n=21-64, Min Subcarrier Index	XX.XX XX.XX XX.XX XXX
Abs Max Subcarrier Power of Offset E, Lower Frequency	n=21-65, Max Power in dBm n=21-66, Max Power in dBc	XX.XX XX.XX XX.XX XXX

Offset	n=21–67, Max Power to Upper Limit in dB n=21–68, Max Subcarrier Index	
Abs Min Subcarrier Power of Offset E, Lower Frequency Offset	n=21–69, Min Power in dBm n=21–70, Min Power in dBc n=21–71, Min Power to Lower Limit in dB n=21–72, Min Subcarrier Index	XX.XX XX.XX XX.XX XXX
Abs Max Subcarrier Power of Offset E, Upper Frequency Offset	n=21–73, Max Power in dBm n=21–74, Max Power in dBc n=21–75, Max Power to Upper Limit in dB n=21–76, Max Subcarrier Index	XX.XX XX.XX XX.XX XXX
Abs Min Subcarrier Power of Offset E, Upper Frequency Offset	n=21–77, Min Power in dBm n=21–78, Min Power in dBc n=21–79, Min Power to Lower Limit in dB n=21–80, Min Subcarrier Index	XX.XX XX.XX XX.XX XXX
Abs Max Subcarrier Power of Offset F, Lower Frequency Offset	n=21–81, Max Power in dBm n=21–82, Max Power in dBc n=21–83, Max Power to Upper Limit in dB n=21–84, Max Subcarrier Index	XX.XX XX.XX XX.XX XXX
Abs Min Subcarrier Power of Offset F, Lower Frequency Offset	n=21–85, Min Power in dBm n=21–86, Min Power in dBc n=21–87, Min Power to Lower Limit in dB n=21–88, Min Subcarrier Index	XX.XX XX.XX XX.XX XXX
Abs Max Subcarrier Power of Offset F, Upper Frequency Offset	n=21–89, Max Power in dBm n=21–90, Max Power in dBc n=21–91, Max Power to Upper Limit in dB n=21–92, Max Subcarrier Index	XX.XX XX.XX XX.XX XXX
Abs Min Subcarrier Power of Offset F, Upper Frequency Offset	n=21–93, Min Power in dBm n=21–94, Min Power in dBc n=21–95, Min Power to Lower Limit in dB n=21–96, Min Subcarrier Index	XX.XX XX.XX XX.XX XXX
Differential Flatness		
Differential Max Subcarrier Power of Offset A, Lower	n=21–97, Max Power in dB n=21–98, Max Power to Upper Limit in dB	XX.XX XX.XX XXX

Frequency Offset	n=21-99, Max Subcarrier Index	
Differential Min Subcarrier Power of Offset A, Lower Frequency Offset	n=21-100, Min Power in dB n=21-101, Min Power to Lower Limit in dB n=21-102, Min Subcarrier Index	XX.XX XX.XX XXX
Differential Max Subcarrier Power of Offset A, Upper Frequency Offset	n=21-103, Max Power in dB n=21-104, Max Power to Upper Limit in dB n=21-105, Max Subcarrier Index	XX.XX XX.XX XXX
Differential Min Subcarrier Power of Offset A, Upper Frequency Offset	n=21-106, Min Power in dB n=21-107, Min Power to Lower Limit in dB n=21-108, Min Subcarrier Index	XX.XX XX.XX XXX
Differential Max Subcarrier Power of Offset B, Lower Frequency Offset	n=21-109, Max Power in dB n=21-110, Max Power to Upper Limit in dB n=21-111, Max Subcarrier Index	XX.XX XX.XX XXX
Differential Min Subcarrier Power of Offset B, Lower Frequency Offset	n=21-112, Min Power in dB n=21-113, Min Power to Lower Limit in dB n=21-114, Min Subcarrier Index	XX.XX XX.XX XXX
Differential Max Subcarrier Power of Offset B, Upper Frequency Offset	n=21-115, Max Power in dB n=21-116, Max Power to Upper Limit in dB n=21-117, Max Subcarrier Index	XX.XX XX.XX XXX
Differential Min Subcarrier Power of Offset B, Upper Frequency Offset	n=21-118, Min Power in dB n=21-119, Min Power to Lower Limit in dB n=21-120, Min Subcarrier Index	XX.XX XX.XX XXX
Differential Max Subcarrier Power of Offset C, Lower Frequency Offset	n=21-121, Max Power in dB n=21-122, Max Power to Upper Limit in dB n=21-123, Max Subcarrier Index	XX.XX XX.XX XXX
Differential Min Subcarrier Power of Offset C, Lower Frequency Offset	n=21-124, Min Power in dB n=21-125, Min Power to Lower Limit in dB n=21-126, Min Subcarrier Index	XX.XX XX.XX XXX
Differential Max Subcarrier Power of Offset C, Upper Frequency Offset	n=21-127, Max Power in dB n=21-128, Max Power to Upper Limit in dB n=21-129, Max Subcarrier Index	XX.XX XX.XX XXX

Differential Min Subcarrier Power of Offset C, Upper Frequency Offset	n=21–130, Min Power in dB n=21–131, Min Power to Lower Limit in dB n=21–132, Min Subcarrier Index	XX.XX XX.XX XXX
Differential Max Subcarrier Power of Offset D, Lower Frequency Offset	n=21–133, Max Power in dB n=21–134, Max Power to Upper Limit in dB n=21–135, Max Subcarrier Index	XX.XX XX.XX XXX
Differential Min Subcarrier Power of Offset D, Lower Frequency Offset	n=21–136, Min Power in dB n=21–137, Min Power to Lower Limit in dB n=21–138, Min Subcarrier Index	XX.XX XX.XX XXX
Differential Max Subcarrier Power of Offset D, Upper Frequency Offset	n=21–139, Max Power in dB n=21–140, Max Power to Upper Limit in dB n=21–141, Max Subcarrier Index	XX.XX XX.XX XXX
Differential Min Subcarrier Power of Offset D, Upper Frequency Offset	n=21–142, Min Power in dB n=21–143, Min Power to Lower Limit in dB n=21–144, Min Subcarrier Index	XX.XX XX.XX XXX
Differential Max Subcarrier Power of Offset E, Lower Frequency Offset	n=21–145, Max Power in dB n=21–146, Max Power to Upper Limit in dB n=21–147, Max Subcarrier Index	XX.XX XX.XX XXX
Differential Min Subcarrier Power of Offset E, Lower Frequency Offset	n=21–148, Min Power in dB n=21–149, Min Power to Lower Limit in dB n=21–150, Min Subcarrier Index	XX.XX XX.XX XXX
Differential Max Subcarrier Power of Offset E, Upper Frequency Offset	n=21–151, Max Power in dB n=21–152, Max Power to Upper Limit in dB n=21–153, Max Subcarrier Index	XX.XX XX.XX XXX
Differential Min Subcarrier Power of Offset E, Upper Frequency Offset	n=21–154, Min Power in dB n=21–155, Min Power to Lower Limit in dB n=21–156, Min Subcarrier Index	XX.XX XX.XX XXX
Differential Max Subcarrier Power of Offset F, Lower Frequency Offset	n=21–157, Max Power in dB n=21–158, Max Power to Upper Limit in dB n=21–159, Max Subcarrier Index	XX.XX XX.XX XXX
Differential Min Subcarrier Power of	n=21–160, Min Power in dB n=21–161, Min Power to Lower Limit in	XX.XX XX.XX XXX

Offset F, Lower Frequency Offset	dB n=21-162, Min Subcarrier Index	
Differential Max Subcarrier Power of Offset F, Upper Frequency Offset	n=21-163, Max Power in dB n=21-164, Max Power to Upper Limit in dB n=21-165, Max Subcarrier Index	XX.XX XX.XX XXX
Differential Min Subcarrier Power of Offset F, Upper Frequency Offset	n=21-166, Min Power in dB n=21-167, Min Power to Lower Limit in dB n=21-168, Min Subcarrier Index	XX.XX XX.XX XXX

Key Path	View/Display, More
Initial S/W Revision	Prior to A.02.00

Power vs. Time and Spectrum

Provides a combination view of a Power vs Time graph and a Power vs. Spectrum graph.

This view consists of 2 windows.

["Power vs Time Window" on page 1819](#)

["Power vs Spectrum Window" on page 1819](#)

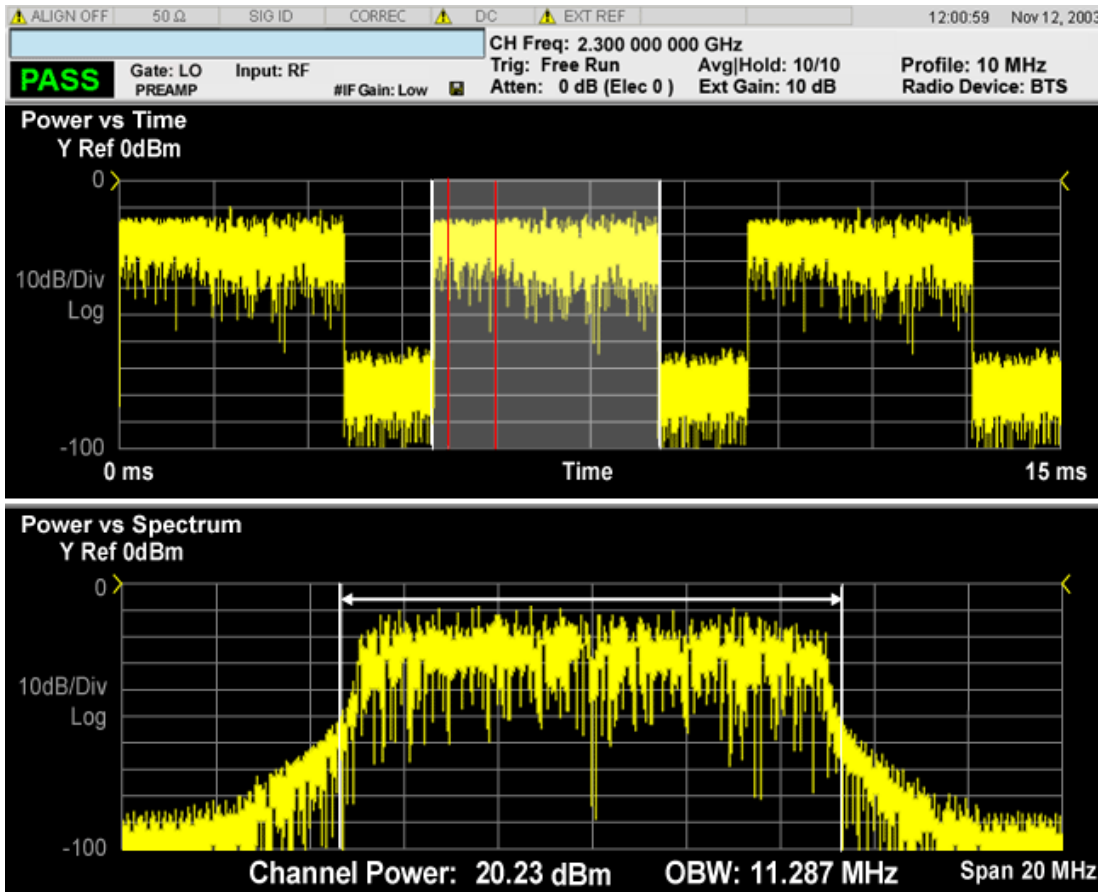

Power vs Time Window

Marker Operation	Yes (Time – Power, support marker functions)
Corresponding Trace	n=20, Power vs Time

Power vs Spectrum Window

Marker Operation	Yes (Time – Power, support marker functions)
Corresponding Trace	n=19, Power vs Spectrum
Annotations	When “OBW Line” is on, OBW

Name	Corresponding Results	Display Format
Channel Power, OBW	n=1 –41, Channel Power in dBm n=1 –42, OBW in Hz	XX.XX dBm XX.XXX Hz

Key Path	View/Display, More
Initial S/W Revision	Prior to A.02.00

OBW Line

Displays OBW values and range. .

Key Path	View/Display, Power vs Spectrum
Mode	WIMAXOFDMA
Remote Command	:DISPlay:EVM:VIEW4:WINDow2:TRACe:OBW ON OFF 0 1 :DISPlay:EVM:VIEW4:WINDow2:TRACe:OBW?
Example	DISP:EVM:VIEW4:WIND2:TRAC:OBW ON DISP:EVM:VIEW4:WIND2:TRAC:OBW?
Preset	OFF
State Saved	Saved in instrument state.
Initial S/W Revision	Prior to A.02.00

15 Power Stat CCDF Measurement

Many of the digitally modulated signals now look noise-like in the time and frequency domain. This means that statistical measurements of the signals can be a useful characterization. The Power Complementary Cumulative Distribution Function (CCDF) curves characterize the higher level power statistics of a digitally modulated signal. The curves can be useful in determining design parameters for digital communications systems.

For more details, see ["Power Stat CCDF Measurement Description" on page 1825](#).

For measurement results and views, see ["View/Display" on page 1945](#).

This topic contains the following sections:

["Measurement Commands for Power Stat CCDF" on page 1822](#)

["Remote Command Results for Power Stat CCDF" on page 1823](#)

["Power Stat CCDF Measurement Description" on page 1825](#)

Measurement Commands for Power Stat CCDF

The following commands and queries can be used to retrieve the measurement results:

`:CONFigure:PStatistic`

`:CONFigure:PStatistic:NDEFault`

`:INITiate:PStatistic`

`:FETCh:PStatistic[n]?`

`:READ:PStatistic[n]?`

`:MEASure:PStatistic[n]?`

For more measurement related commands, see the SENSE subsystem, and the section "[Remote Measurement Functions](#)" on page 2205.

Remote Command Results for Power Stat CCDF

The following table describes the results returned by the FETCh, MEASure, and READ queries listed above, according to the index value n.

n	Results Returned
0	Returns unprocessed I/Q trace data, as a series of trace point values, in volts. The I values are listed first in each pair, using the 0 through even-indexed values. The Q values are the odd-indexed values,
not specified or 1	Returns 10 scalar results: <ol style="list-style-type: none"> 1. Average input power (in dBm) 2. Probability at the average input power level (in %) 3. Power level that has 10% of the power 4. Power level that has 1% of the power 5. Power level that has 0.1% of the power 6. Power level that has 0.01% of the power 7. Power level that has 0.001% of the power 8. Power level that has 0.0001% of the power 9. Peak power (in dB) 10.Count
2	Returns a series of 5001 floating point numbers (in percent) that represent the current measured power stat trace. This is the probability at particular power levels (average power), in the following order: <ol style="list-style-type: none"> 1. Probability at 0.0 dB power 2. Probability at 0.01 dB power 3. Probability at 0.02 dB power ... 5000. Probability at 49.9 dB power 5001. Probability at 50.0 dB power
3	Returns a series of 5001 floating point numbers (in percent) that represent the Gaussian trace. This is the probability at particular power levels (average power), in the following order: <ol style="list-style-type: none"> 1. Probability at 0.0 dB power 2. Probability at 0.01 dB power 3. Probability at 0.02 dB power ... 5000. Probability at 49.9 dB power 5001. Probability at 50.0 dB power
4	Returns a series of 5001 floating point numbers (in percent) that represent the user-definable reference trace. This is the probability at particular power levels (average power), in the following order: <ol style="list-style-type: none"> 1. Probability at 0.0 dB power 2. Probability at 0.01 dB power 3. Probability at 0.02 dB power ... 5000. Probability at 49.9 dB power 5001. Probability at 50.0 dB power

Power Stat CCDF Measurement Description

The power statistics CCDF measurement can be affected by many factors. For example, modulation filtering, modulation format, combining the multiple signals at different frequencies, number of active codes, and correlation between symbols on different codes with spread spectrum systems will all affect measurement results. These factors are all related to modulation and signal parameters. External factors such as signal compression and expansion by nonlinear components, group delay distortion from filtering, and power control within the observation interval also affect the measurement.

The power measured in power statistics CCDF curves is actually instantaneous envelope power defined by the equation:

$$P = (I^2 + Q^2) / Z_0$$

where I & Q are the quadrature voltage components of the waveform, and Z_0 is the characteristic impedance.

A CCDF curve is defined by how much time the waveform spends at or above a given power level. The percent of time the signal spends at or above the level defines the probability for that particular power level. For capturing a lower probability down to 0.0001%, this measurement is made in the single mode by pressing Single. To make the power statistics CCDF measurement, the instrument uses digital signal processing (DSP) to sample the input signal in the channel bandwidth. The Gaussian distribution line as the band-limited Gaussian noise CCDF reference line, the user-definable reference trace, and the currently measured trace can be displayed on a semi-log graph. If the currently measured trace is above the user reference trace, it means that the higher peak power levels against the average power are included in the input signal.

Key Path	Meas
Initial S/W Revision	Prior to A.02.00

AMPTD Y Scale

Accesses a menu of functions that enable you to set the vertical scale parameters. The parameter values are measurement independent except all Attenuation values, and the Internal Preamp selection, which are the same across all measurements.

Key Path	Front-panel key
Initial S/W Revision	Prior to A.02.00

Attenuation

This menu controls the attenuator functions and interactions between the attenuation system components.

There are two attenuator configurations in the X-Series. One is a dual attenuator configuration consisting of a mechanical attenuator and an optional electronic attenuator. The other configuration uses a single attenuator with combined mechanical and electronic sections that controls all the attenuation functions. Different models in the X-Series come with different configurations.

See "[Dual Attenuator Configurations:](#)" on page 1826

See "[Single Attenuator Configuration:](#)" on page 1827

Most Attenuation settings are the same for all measurements – they do not change as you change measurements. Settings like these are called “Meas Global” and are unaffected by Meas Preset.

Key Path	AMPTD Y Scale
Scope	Meas Global
Dependencies	In measurements that support the I/Q inputs, this key is unavailable when I/Q is the selected input, and is replaced by the Range key in that case.
Readback Line	Contains a summary in [] brackets of the current total attenuation. See the descriptions of the , " (Mech) Atten " on page 2141, and " Enable Elec Atten " on page 2143 keys for more detail on the contributors to the total attenuation. Note that when "Pre-Adjust for Min Clip" is on, this value can change at the start of every measurement.
Initial S/W Revision	Prior to A.02.00
Modified at S/W Revision	A.03.00

Dual Attenuator Configurations:

Configuration 1: Mechanical attenuator + optional electronic attenuator

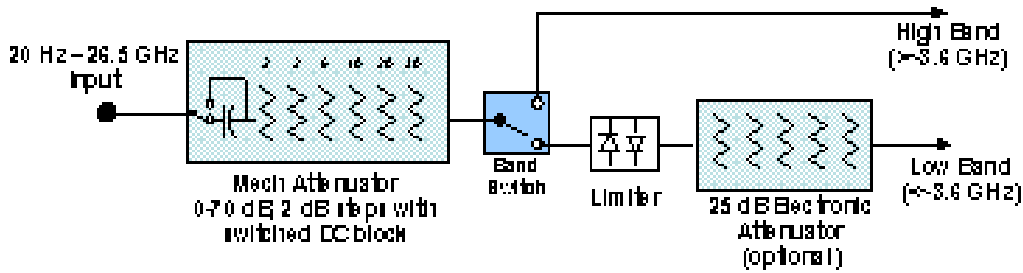

Configuration 2: Mechanical attenuator, no optional electronic attenuator

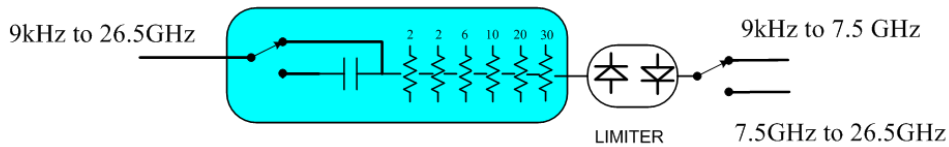

(note that Configuration 2 is not strictly speaking a dual-section attenuator, since there is no electronic section available. However, it behaves exactly like Configuration 1 without the Electronic Attenuator option EA3, therefore for the sake of this document it is grouped into the “Dual Attenuator” configuration)

Single Attenuator Configuration:

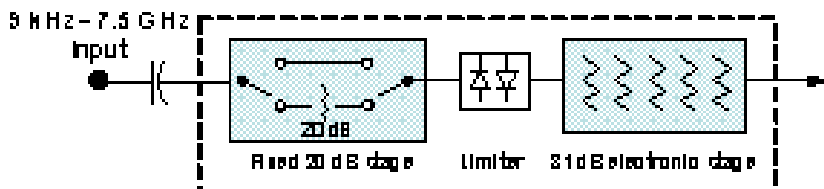

You can tell which attenuator configuration you have by pressing the Attenuation key, which (in most Modes) opens the Attenuation menu. If the first key in the Attenuation menu says Mech Atten you have the dual attenuator configuration. If the first key says Atten you have the single attenuator configuration.

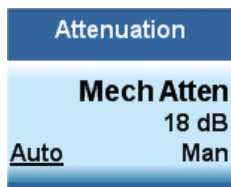

Dual Attenuator

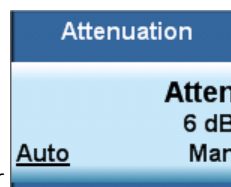

Single Attenuator

In the single attenuator configuration, you control the attenuation with a single control, as the fixed stage has only two states. In the dual attenuator configuration, both stages have significant range so you are given separate control of the mechanical and electronic attenuator stages.

When you have the dual attenuator configuration, you may still have only a single attenuator, because unless option EA3 (the Electronic Attenuator option) is available, and you purchase it, you will have only the mechanical attenuator.

(Mech) Atten

This key is labeled Mech Atten in dual attenuator models and Atten in single attenuator models. In the dual attenuator configuration, this key only affects the mechanical attenuator.

This key lets you modify the attenuation applied to the RF input signal path. This value is normally auto coupled to the Ref Level, the Internal Preamp Gain, any External Gain that is entered, and the Max Mixer Level, as described in the table below.

See "[Attenuator Configurations and Auto/Man](#)" on page 1829

Key Path	AMPTD Y Scale, Attenuation
Remote Command	<pre>[:SENSe] :POWer [:RF] :ATTenuation <rel_ampl> [:SENSe] :POWer [:RF] :ATTenuation? [:SENSe] :POWer [:RF] :ATTenuation:AUTO OFF ON 0 1 [:SENSe] :POWer [:RF] :ATTenuation:AUTO?</pre>
Example	<p>POW:ATT 20</p> <p>Dual attenuator configuration: sets the mechanical attenuator to 20 dB</p> <p>Single attenuator mode: sets the main attenuation to 20 dB (see below for definition of “main” attenuation).</p> <p>If the attenuator was in Auto, it sets it to Manual.</p>
Dependencies	<p>Some measurements do not support the Auto setting of (Mech) Atten. In these measurements, the Auto/Man selection is not available, and the Auto/Man line on the key disappears.</p> <p>In dual attenuator configurations, when the electronic attenuator is enabled, the mechanical attenuator has no auto setting and the Auto/Man line on the key disappears. The state of Auto/Man is remembered and restored when the electronic attenuator is once again disabled. This is described in more detail in the "Enable Elec Atten" on page 2143 key description.</p> <p>See "Attenuator Configurations and Auto/Man" on page 1829 for more information on the Auto/Man functionality of Attenuation.</p>
Couplings	<p>When (Mech) Atten is in Auto, it uses the following algorithm to determine a value:</p> <p>If the USB Preamp is connected to USB, use 0 dB.</p> <p>Otherwise, $Atten = ReferenceLevel + PreAmpGain + ExternalGain - RefLevelOffset - MaxMixerLevel + IF\ Gain$.</p> <p>Limit this value to be between 6 dB and the Max value. No value below 6 dB can ever be chosen by Auto.</p> <p>The resulting value is rounded up to the largest value possible given the attenuation step setting. That is, 50.01 dB would change to 60 dB (for a 10 dB attenuation step).</p> <p>The “IF Gain” term in the equation above is either 0 dB or +10 dB, depending on the settings of FFT IF Gain, Swept IF Gain, max Ref Level and the Auto/Man setting of Mech Atten.</p> <p>In External Mixing and BBIQ, where the Attenuator is not in the signal path, the Attenuator setting changes as described above when (Mech) Atten is in Auto, but no changes are made to the actual attenuator hardware setting until the input is changed back to the RF Input.</p>
Preset	<p>The preset for Mech Attenuation is “Auto.”</p> <p>The Auto value of attenuation is:</p> <p>CXA, EXA, MXA and PXA: 10 dB</p>

State Saved	Saved in instrument state
Min	0 dB The attenuation set by this key cannot be decreased below 6 dB with the knob or step keys. To get to a value below 6 dB it has to be directly entered from the keypad or via SCPI. This protects from adjusting the attenuation to a dangerously small value which can put the instrument at risk of damage to input circuitry. However, if the current mechanical attenuation is below 6 dB it can be increased with the knob and step keys, but not decreased.
Max	CXA N9000A-503/507: 50 dB CXA N9000A-513/526: 70dB EXA: 60 dB MXA and PXA: 70 dB In the single attenuator configuration, the total of ATT and EATT cannot exceed 50 dB, so if the EATT is set to 24 dB first, the main attenuation cannot be greater than 26 dB and will be reduced accordingly; if the main attenuator is set to 40 dB first, EATT cannot be greater than 10 dB.
Initial S/W Revision	Prior to A.02.00
Modified at S/W Revision	A.03.00

Attenuator Configurations and Auto/Man

As described in the Attenuation key description, there are two distinct attenuator configurations available in the X-Series, the single attenuator and dual attenuator configurations. In dual attenuator configurations, we have the mechanical attenuation and the electronic attenuation, and the current total attenuation is the sum of the electronic + mechanical attenuation. In single attenuator configurations, we refer to the attenuation set using the (Mech) Atten key (or POW:ATT SCPI) as the “main” attenuation; and the attenuation that is set by the SCPI command POW:EATT as the “soft” attenuation (the POW:EATT command is honored even in the single attenuator configuration, for compatibility purposes). Then the current total attenuation is the sum of the main + soft attenuation. See the Elec Atten key description for more on “soft” attenuation.

In the dual attenuator configuration, when the electronic attenuator is enabled, there is no Auto/Man functionality for the mechanical attenuator, and the third line of the key label (the Auto/Man line) disappears:

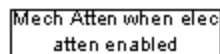
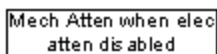
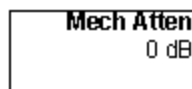
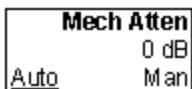

usdB

Enable Elec Atten

Enables the Electronic Attenuator.

The electronic attenuator offers finer steps than the mechanical attenuator, has no acoustical noise, is faster, and is less subject to wear. These advantages primarily aid in remote operation and are negligible

for front panel use. See ["Using the Electronic Attenuator: Pros and Cons" on page 1831](#) for a detailed discussion of the pros and cons of using the electronic attenuator.

For the single attenuator configuration, for SCPI backwards compatibility, the “soft” attenuation feature replaces the dual attenuator configuration’s electronic attenuator. All the same couplings and limitations apply. See ["Attenuator Configurations and Auto/Man" on page 2143](#)

See ["More Information" on page 1830](#)

Key Path	AMPTD Y Scale, Attenuation
Remote Command	[:SENSe] :POWer [:RF] :EATTenuation :STATe OFF ON 0 1 [:SENSe] :POWer [:RF] :EATTenuation :STATe ?
Example	POW:EATT:STAT ON
Dependencies	<p>This key only appears in Dual Attenuator models with an Electronic Attenuator installed. It does not appear in models with the Single Attenuator configuration, as in the single attenuator configuration there is no “electronic attenuator” there is only a single integrated attenuator (which has both a mechanical and electronic stage). However, in the single attenuator configuration, EATT SCPI commands are accepted for compatibility with other X-series instruments and set a “soft” attenuation as described in "Attenuator Configurations and Auto/Man" on page 2143.</p> <p>The electronic attenuator (and the “soft” attenuation function provided in single attenuator configurations) is unavailable above 3.6 GHz. Therefore, if the Stop Frequency of the analyzer is > 3.6 GHz then the Enable Elec Atten key will be OFF and grayed out.</p> <p>If the Internal Preamp is on, meaning it is set to Low Band or Full, the electronic attenuator (and the “soft” attenuation function provided in single attenuator configurations) is unavailable. In this case the Enable Elec Atten key will be OFF and grayed out.</p> <p>If either of the above is true, if the SCPI command is sent, an error indicating that the electronic attenuator is unavailable will be sent.</p> <p>If the electronic/soft Attenuator is enabled, then the Stop Freq of the analyzer is limited to 3.6 GHz and the Internal Preamp is unavailable.</p> <p>The SCPI-only “soft” electronic attenuation for the single-attenuator configuration is not available in all measurements; in particular, it is not available in the Swept SA measurement.</p>
Couplings	Enabling and disabling the Electronic Attenuator affects the setting of the Mechanical Attenuator (in dual attenuator configurations). This is described in more detail below this table.
Preset	OFF for Swept SA measurement; ON for all other measurements that support the electronic attenuator
State Saved	Saved in instrument state
Initial S/W Revision	Prior to A.02.00
Modified at S/W Revision	A.03.00

More Information

Mechanical Attenuator Transition Rules

When the Electronic Attenuator is enabled, the Mechanical Attenuator transitions to a state that has no Auto function. Below are the rules for transitioning the Mechanical Attenuator. NOTE that the information

below ONLY applies to the dual attenuator configurations, and ONLY when the Electronic Attenuator is installed:

When the Electronic Attenuation is enabled from a disabled state:

- The Mechanical Attenuator is initialized to 10 dB (this is its optimal performance setting). You can then set it as desired with SCPI, numeric keypad, step keys, or knob, and it behaves as it normally would in manual mode
- The Auto/Man state of (Mech) Atten is saved
- The Auto/Man line on the (Mech) Atten key disappears and the auto rules are disabled
- The Electronic Attenuator is set to 10 dB less than the previous value of the Mechanical Attenuator, within the limitation that it must stay within the range of 0 to 24 dB of attenuation.

Examples in the dual attenuator configuration:

- Mech Atten at 20 dB. Elec Atten enabled, Mech Atten set to 10 dB, and Elec Atten set to 10 dB. New total attenuation equals the value before Elec Atten enabled.
- Mech Atten at 0 dB. Elec Atten enabled, Mech Atten set to 10 dB, and Elec Atten set to 0 dB. New total attenuation does not equal the value before Elec Atten enabled.
- Mech Atten at 40 dB. Elec Atten enabled, Mech Atten set to 10 dB, and Elec Atten set to 24 dB. New total attenuation does not equal the value before Elec Atten enabled.

When the Electronic Attenuation is disabled from an enabled state:

- The Elec Atten key is grayed out
- The Auto/Man state of (Mech) Atten is restored
- If now in Auto, (Mech) Atten recouples
- If now in Man, (Mech) Atten is set to the value of total attenuation that existed before the Elec Atten was disabled. The resulting value is rounded up to the smallest value possible given the (Mech) Atten Step setting - (That is, 57 dB changes to 58 dB when (Mech) Atten Step is 2 dB.)

Using the Electronic Attenuator: Pros and Cons

The electronic attenuator offers finer steps than the mechanical attenuator, has no acoustical noise, is faster, and is less subject to wear.

The “finer steps” advantage of the electronic attenuator is beneficial in optimizing the alignment of the analyzer dynamic range to the signal power in the front panel as well as remote use. Thus, you can achieve improved relative signal measurement accuracy. Compared to a mechanical attenuator with 2 dB steps, the 1 dB resolution of the electronic attenuator only gives better resolution when the odd-decibel steps are used. Those odd-decibel steps are less accurately calibrated than the even-decibel steps, so one tradeoff for this superior relative accuracy is reduced absolute amplitude accuracy.

Another disadvantage of the electronic attenuator is that the spectrum analyzer loses its “Auto” setting, making operation less convenient.

Also, the relationship between the dynamic range specifications (TOI, SHI, compression and noise) and instrument performance are less well-known with the electrical attenuator. With the mechanical

attenuator, TOI, SHI and compression threshold levels increase dB-for-dB with increasing attenuation, and the noise floor does as well. With the electronic attenuator, there is an excess attenuation of about 1 to 3 dB between 0 and 3.6 GHz, making the effective TOI, SHI, and so forth, less well known. Excess attenuation is the actual attenuation relative to stated attenuation. Excess attenuation is accounted for in the analyzer calibration

Elec Atten

Controls the Electronic Attenuator in dual attenuator configurations. This key does not appear in single attenuator configurations, as the control of both the mechanical and electronic stages of the single attenuator is integrated into the single Atten key.

Key Path	AMPTD Y Scale, Attenuation
Remote Command	[:SENSe] :POWer [:RF] :EATTenuation <rel_ampl> [:SENSe] :POWer [:RF] :EATTenuation?
Notes	Electronic Attenuation's specification is defined only when Mechanical Attenuation is 6 dB.
Dependencies	This key only appears in Dual Attenuator models with an Electronic Attenuator installed. It does not appear in models with the Single Attenuator configuration, as in the single attenuator configuration there is no "electronic attenuator" there is only a single integrated attenuator (which has both a mechanical and electronic stage). However, in the single attenuator configuration, EATT SCPI commands are accepted for compatibility with other X-series instruments and set a "soft" attenuation as described in "Attenuator Configurations and Auto/Man" on page 2143 . The "soft" attenuation is treated as an addition to the "main" attenuation value set by the Atten softkey or the POW:ATT SCPI command and affects the total attenuation displayed on the Attenuation key and the Meas Bar. When Enable Elec Atten is off or grayed out, the Elec Atten key is grayed out.
Preset	0 dB
State Saved	Saved in instrument state
Min	0 dB
Max	Dual attenuator configuration: 24 dB Single attenuator configuration: the total of ATT and EATT cannot exceed 50 dB, so if the EATT is set to 24 dB first, the main attenuation cannot be greater than 26 dB and will be reduced accordingly; if the main attenuator is set to 40 dB first, EATT cannot be greater than 10 dB
Initial S/W Revision	Prior to A.02.00
Modified at S/W Revision	A.03.00

Adjust Atten for Min Clip

Sets the combination of mechanical and electronic attenuation and gain based on the current measured signal level so that clipping will be at a minimum.

This is an "immediate action" function, that is, it executes once, when the key is pressed.

This key is grayed out in measurements that do not support this functionality. The spectrum analyzer measurement, Swept SA, does not support this functionality.

Key Path	AMPTD Y Scale, Attenuation
Remote Command	[:SENSe] :POWer [:RF] :RANGe:OPTimize IMMEDIATE
Initial S/W Revision	Prior to A.02.00
Modified at S/W Revision	A.03.00

Pre-Adjust for Min Clip

If this function is on, it does the adjustment described under "[Adjust Atten for Min Clip](#)" on page 2146 each time a measurement restarts. Therefore, in Continuous measurement mode, it only executes before the first measurement.

In dual attenuator models, you can set Elec+Mech Atten, in which case both attenuators participate in the autoranging, or Elec Atten Only, in which case the mechanical attenuator does not participate in the autoranging. This latter case results in less wear on the mechanical attenuator and is usually faster.

This key is grayed out in measurements that do not support this functionality. The spectrum analyzer measurement, Swept SA, does not support this functionality.

Key Path	AMPTD Y Scale, Attenuation
Remote Command	[:SENSe] :POWer [:RF] :RANGe:OPTimize:ATTenuation OFF ELECTrical COMBined [:SENSe] :POWer [:RF] :RANGe:OPTimize:ATTenuation?
Notes	The SCPI parameter ELECTrical sets this function to On in single attenuator models. The SCPI parameter COMBined is mapped to ELECTrical in single attenuator models; if you send COMBined, it sets the function to On and returns ELEC to a query.
Dependencies	This key only appears in Dual Attenuator models with an Electronic Attenuator installed. In instruments with Dual Attenuator model, when Enable Elec Atten is off or grayed out, the Pre-Adjust for Min Clip key is grayed out.
Preset	OFF for Swept SA measurement; ON for all other measurements that support Pre-Adjust for Min Clip
State Saved	Saved in instrument state
Range	Dual attenuator models: Off Elec Atten Only Mech + Elec Atten Single attenuator models: Off On
Initial S/W Revision	Prior to A.02.00
Modified at S/W Revision	A.03.00

Remote Command	[:SENSe] :POWer [:RF] :RANGe:AUTO ON OFF 1 0 [:SENSe] :POWer [:RF] :RANGe:AUTO?
Notes	ON aliases to "Elec Atten Only" (:POW:RANG:OPT:ATT ELEC)

	OFF aliases to "Off" (:POW:RANG:OPT:ATT OFF) The query :POW:RANG:AUTO? returns true if :POW:RANG:OPT:ATT is not "Off"
Initial S/W Revision	Prior to A.02.00

Off

Turns Pre-Adjust for Min Clip off. This is the default setting.

This key is grayed out in measurements that do not support this functionality. The spectrum analyzer measurement, Swept SA, does not support this functionality.

Key Path	AMPTD Y Scale, Attenuation, Pre-Adjust for Min Clip
Example	:POW:RANGe:OPT:ATT OFF
Initial S/W Revision	Prior to A.02.00

Elec Atten Only

Selects only the electric attenuator to participate in auto ranging. This offers less wear on the mechanical attenuator and is usually faster.

This key is grayed out in measurements that do not support this functionality. The spectrum analyzer measurement, Swept SA, does not support this functionality.

Key Path	AMPTD Y Scale, Attenuation, Pre-Adjust for Min Clip
Example	:POW:RANGe:OPT:ATT ELEC
Initial S/W Revision	Prior to A.02.00

Mech + Elec Atten

In dual attenuator models, this selects both attenuators participate in the autoranging.

This key is grayed out in measurements that do not support this functionality. The spectrum analyzer measurement, Swept SA, does not support this functionality.

Key Path	AMPTD Y Scale, Attenuation, Pre-Adjust for Min Clip
Example	:POW:RANGe:OPT:ATT COMB
Initial S/W Revision	Prior to A.02.00

(Mech) Atten Step

This controls the step size used when making adjustments to the input attenuation.

This key is labeled Mech Atten Step in dual attenuator models and Atten Step in single attenuator models. In the dual attenuator configuration, this key only affects the step size of the mechanical attenuator.

Key Path	AMPTD Y Scale, Attenuation
Remote Command	[:SENSe] :POWer [:RF] :ATTenuation:STEP [:INCRement] 10 dB 2 dB [:SENSe] :POWer [:RF] :ATTenuation:STEP [:INCRement] ?
Example	POW:ATT:STEP 2
Notes	Note this feature works like a 1-N choice from the front panel, but it takes a specific value (in dB) when used remotely. The only valid values are 2 and 10.
Dependencies	Blanked in CXA and EXA if option FSA (2 dB steps) is not present. If blanked, attempts to set it via SCPI will yield an error.
Couplings	When the attenuation step size changes, the current mechanical attenuation value is adjusted (if necessary) to be quantized to the new step size. That is, if step is set to 10 dB, mech atten is increased if necessary so it is a multiple of 10 dB
Preset	PXA and MXA: 2 dB EXA and CXA: 10 dB (2 dB with option FSA)
State Saved	Saved in instrument state
Initial S/W Revision	Prior to A.02.00
Modified at S/W Revision	A.03.00

Presel Center

When this key is pressed, the centering of the preselector filter is adjusted to optimize the amplitude accuracy at the frequency of the selected marker. If the selected marker is not on when Presel Center is pressed, the analyzer will turn on the selected marker, perform a peak search, and then perform centering on the marker's center frequency. If the selected marker is already on and between the start and stop frequencies of the analyzer, the analyzer performs the preselector calibration on that marker's frequency. If the selected marker is already on, but outside the frequency range between Start Freq and Stop Freq, the analyzer will first perform a peak search, and then perform centering on the marker's center frequency.

The value displayed on the Presel Adjust key will change to reflect the new preselector tuning (see Presel Adjust).

A number of considerations should be observed to ensure proper operation. See ["Proper Preselector Operation" on page 1836](#).

Key Path	AMPTD Y Scale
Remote Command	[:SENSe] :POWer [:RF] :PCENter
Example	POW:PCEN
Notes	Note that the rules outlined above under the key description apply for the remote command as well as the key. The result of the command is dependent on marker position, and so forth. Any message shown by the key press is also shown in response to the remote command.
Dependencies	• Grayed out if the microwave preselector is off.)

-
- If the selected marker's frequency is below Band 1, advisory message 0.5001 is generated and no action is taken.
 - Grayed out if entirely in Band 0.
 - Blank in models that do not include a preselector, such as option 503. If the SCPI is sent in these instruments, it is accepted without error, and the query always returns 0.
 - Grayed out in the Spectrogram View.

Couplings	The active marker position determines where the centering will be attempted. If the analyzer is in a measurement such as averaging when centering is initiated, the act of centering the preselector will restart averaging but the first average trace will not be taken until the centering is completed.
-----------	--

Status Bits/OPC dependencies	When centering the preselector, *OPC will not return true until the process is complete and a subsequent measurement has completed, nor will results be returned to a READ or MEASure command. The Measuring bit should remain set while this command is operating and should not go false until the subsequent sweep/measurement has completed.
------------------------------	---

Initial S/W Revision	Prior to A.02.00
----------------------	------------------

Modified at S/W Revision	A.03.00
--------------------------	---------

Proper Preselector Operation

A number of considerations should be observed to ensure proper operation:

1. If the selected marker is off, the analyzer will turn on a marker, perform a peak search, and adjust the preselector using the selected marker's frequency. It uses the "highest peak" peak search method unqualified by threshold or excursion, so that there is no chance of a 'no peak found' error. It continues with that peak, even if it is the peak of just noise. Therefore, for this operation to work properly, there should be a signal on screen in a preselected range for the peak search to find.
2. If the selected marker is already on, the analyzer will attempt the centering at that marker's frequency. There is no preselector for signals below about 3.6 GHz, therefore if the marker is on a signal below 3.6 GHz, no centering will be attempted and an advisory message generated
3. In some models, the preselector can be bypassed. If it is bypassed, no centering will be attempted in that range and a message will be generated.

Preselector Adjust

Allows you to manually adjust the preselector filter frequency to optimize its response to the signal of interest. This function is only available when "**Presel Center**" on page 2149 is available.

For general purpose signal analysis, using Presel Center is recommended. Centering the filter minimizes the impact of long-term preselector drift. Presel Adjust can be used instead to manually optimize the preselector. One application of manual optimization would be to peak the preselector response, which both optimizes the signal-to-noise ratio and minimizes amplitude variations due to small (short-term) preselector drifting.

Key Path	AMPTD Y Scale
Scope	Meas Global
Remote Command	<code>[:SENSe] :POWer [:RF] :PADJust <freq></code> <code>[:SENSe] :POWer [:RF] :PADJust?</code>
Example	POW:PADJ 100KHz POW:PADJ?
Notes	The value on the key reads out to 0.1 MHz resolution.
Dependencies	<ul style="list-style-type: none"> • Grayed out if microwave preselector is off.) • Grayed out if entirely in Band 0. • Blank in models that do not include a preselector, such as option 503. If the SCPI is sent in these instruments, it is accepted without error, and the query always returns 0. • Grayed out in the Spectrogram View.
Preset	0 MHz
State Saved	The Presel Adjust value set by Presel Center, or by manually adjusting Presel Adjust, is not saved in instrument state, and does not survive a Preset or power cycle.
Min	-500 MHz
Max	500 MHz
Default Unit	Hz
Backwards Compatibility SCPI	<code>[:SENSe] :POWer [:RF] :MW :PADJust</code> <code>[:SENSe] :POWer [:RF] :MMW :PADJust</code> PSA had multiple preselectors, but the X-Series has only one. These commands simply alias to <code>[:SENSe] :POWer [:RF] :PADJust</code>
Initial S/W Revision	Prior to A.02.00
Modified at S/W Revision	A.03.00
Remote Command	<code>[:SENSe] :POWer [:RF] :PADJust :PRESelector MWAVE MMWave EXTernal</code> <code>[:SENSe] :POWer [:RF] :PADJust :PRESelector?</code>
Notes	PSA had multiple preselectors, and you could select which preselector to adjust. Since the X-Series has only one mm/uW preselector, the preselector selection softkey is no longer available. However, to provide backward compatibility, we accept the legacy remote commands. The command form has no effect, the query always returns MWAVE
Initial S/W Revision	Prior to A.02.00

μW Path Control

The μW Path Control functions include the μW Preselector Bypass (Option MPB) and Low Noise Path (Option LNP) controls in the High Band path circuits.

When the μW Preselector is bypassed, the user has better flatness, but will be subject to spurs from out of band interfering signals. When the Low Noise Path is enabled, the analyzer automatically switches around certain circuitry in the high frequency bands which can contribute to noise, when it is appropriate based on other analyzer settings.

For most applications, the preset state is Standard Path, which gives the best remote-control throughput, minimizes acoustic noise from switching and minimizes the risk of wear out in the hardware switches. For applications that utilize the wideband IF paths, the preset state is the μW Preselector Bypass path, if option MPB is present. This is because, when using a wideband IF such as the 140 MHz IF, the μW Preselector's bandwidth can be narrower than the available IF bandwidth, causing degraded amplitude flatness and phase linearity, so it is desirable to bypass the preselector in the default case.

Users may choose Low Noise Path Enable. It gives a lower noise floor, especially in the 21–26.5 GHz region, though without improving many measures of dynamic range, and without giving the best possible noise floor. The preamp, if purchased and used, gives better noise floor than does the Low Noise Path, however its compression threshold and third-order intercept are much poorer than that of the non-preamp Low Noise Path. There are some applications, typically for signals around –30 dBm, for which the third-order dynamic range of the standard path is good enough, but the noise floor is not low enough even with 0 dB input attenuation. When the third-order dynamic range of the preamp path is too little and the noise floor of the standard path is too high, the Low Noise Path can provide the best dynamic range.

Key Path	AMPTD Y Scale
Mode	SA, BASIC, PNOISE, VSA , LTE, LTETDD
Scope	Meas Global
Remote Command	[:SENSe] :POWer [:RF] :MW:PATH STD LNPath MPBypass FULL [:SENSe] :POWer [:RF] :MW:PATH?
Example	:POW:MW:PATH LNP Enables the Low Noise path
Notes	If a Presel Center is performed, the analyzer will momentarily switch to the Standard Path, regardless of the setting of μW Path Control The DC Block will always be switched in when the low noise path is switched in, to protect succeeding circuitry from DC. Note that this does not mean “when the low noise path is enabled” but when, based on the Low Noise Path rules, the path is actually switched in. This can happen when the selection is Low Noise Path Enable . In the case where the DC Block is switched in the analyzer is now AC coupled. However, if the user has selected DC coupling, the UI will still behave as though it were DC coupled, including all annunciation, warnings, status bits, and responses to SCPI queries. This is because, based on other settings, the analyzer could switch out the low noise path at any time and hence go back to being DC coupled. Alignment switching ignores the settings in this menu, and restores them when finished.
Dependencies	Unavailable in BBIQ and External Mixing
Preset	All modes other than IQ Analyzer mode and VXA: STD IQ Analyzer, VXA and WLAN mode: MPB option present and licensed: MPB

	MPB option not present and licensed: STD
State Saved	Save in instrument state
Readback	Value selected in the submenu
Initial S/W Revision	A.04.00
Modified at S/W Revision	A.10.00

Standard Path

This path gives the best remote-control throughput, minimizes acoustic noise from switching and minimizes the risk of wear in the hardware switches, particularly in remote test scenarios where both low band and high band setups will follow in rapid succession.

In this path, the bypass of the low band/high band switch and microwave preamp is never activated, which can cause some noise degradation but preserves the life of the bypass switch.

Key Path	AMPTD Y Scale, μ W Path Control
Example	:POW:MW:PATH STD
Readback Text	Standard Path
Initial S/W Revision	A.04.00

Low Noise Path Enable

You may choose Low Noise Path Enable, which gives a lower noise floor under some circumstances, particularly when operating in the 21–26.5 GHz region. With the Low Noise Path enabled, the low band/high band switch and microwave preamp are bypassed whenever all of the following are true:

- The analyzer is not in the Low Band, meaning:
- the start frequency is above 3.5 GHz and
- the stop frequency is above 3.6 GHz.
- the internal preamp is not installed or (if installed) is set to Off or Low Band

Note that this means that, when any part of a sweep is done in Low Band, the Low Noise Path is not used, whether or not the Low Noise Path Enable is selected in the user interface. Also, if the preamp is turned on, the Low Noise Path is not used, whether or not the Low Noise Path Enable is selected in the user interface. The only time the Low Noise Path is used is when Low Noise Path Enable is selected, the sweep is completely in High Band (> 3.6 GHz) and no preamp is in use.

See "[More Information](#)" on page 1840

Key Path	AMPTD Y Scale, μ W Path Control
Measurement	Swept SA
Example	:POW:MW:PATH LNP

Notes	<p>For measurements that use IQ acquisition, the low noise path is used when the Center Frequency is in High Band (> 3.6 GHz) and no preamp is in use.</p> <p>In other words, the rules above are modified to use only the center frequency to qualify which path to switch in.</p> <p>This is not the case for FFT's in the Swept SA measurement; they use the same rules as swept measurements.</p>
Dependencies	<p>Key is blanked if current mode does not support it.</p> <p>Key is grayed out if mode supports it but current measurement does not support it.</p> <p>Unless Option LNP is present and licensed, key is blank and if SCPI command sent, error -241, "Hardware missing; Option not installed" is generated.</p>
Readback Text	Low Noise Path Enable
Initial S/W Revision	A.04.00

More Information

The user should understand that the Low Noise Path, while giving improved DANL, has the disadvantage of decreased TOI performance and decreased gain compression performance relative to the standard path.

The user should also understand that the bypass switch is a mechanical switch and has finite life, so if the Low Noise Path is enabled, it is possible to cause frequent cycling of this switch by frequently changing analyzer settings such that the above conditions hold true only some of the time. A user making tests of this nature should consider opting for the Standard Path, which will never throw the bypass switch, at the expense of some degraded noise performance.

The low noise path is useful for situations where the signal level is so low that the analyzer performance is dominated by noise even with 0 dB attenuation, but still high enough that the preamp option would have excessive third-order intermodulation or compression. The preamp, if purchased and used, gives better noise floor than does the "Low Noise Path." However, its compression threshold and third-order intercept are much poorer than that of the non-preamp path. There are some applications, typically for signals around -30 dBm, for which the third-order dynamic range of the standard path is good enough, but the noise floor is not low enough even with 0 dB input attenuation. When the third-order dynamic range of the preamp path is too little and the noise floor of the standard path is too high, the Low Noise Path can provide the best dynamic range

The graph below illustrates the concept. It shows, in red, the performance of an analyzer at different attenuation settings, both with the preamp on and off, in a measurement that is affected by both analyzer noise and analyzer TOI. The green shows the best available dynamic range, offset by 0.5 dB for clarity. The blue shows how the best available dynamic range improves for moderate signal levels with the low noise path switched in. In this illustration, the preamp improves the noise floor by 15 dB while degrading the third-order intercept by 30 dB, and the low noise path reduces loss by 8 dB. The attenuator step size is 2 dB.

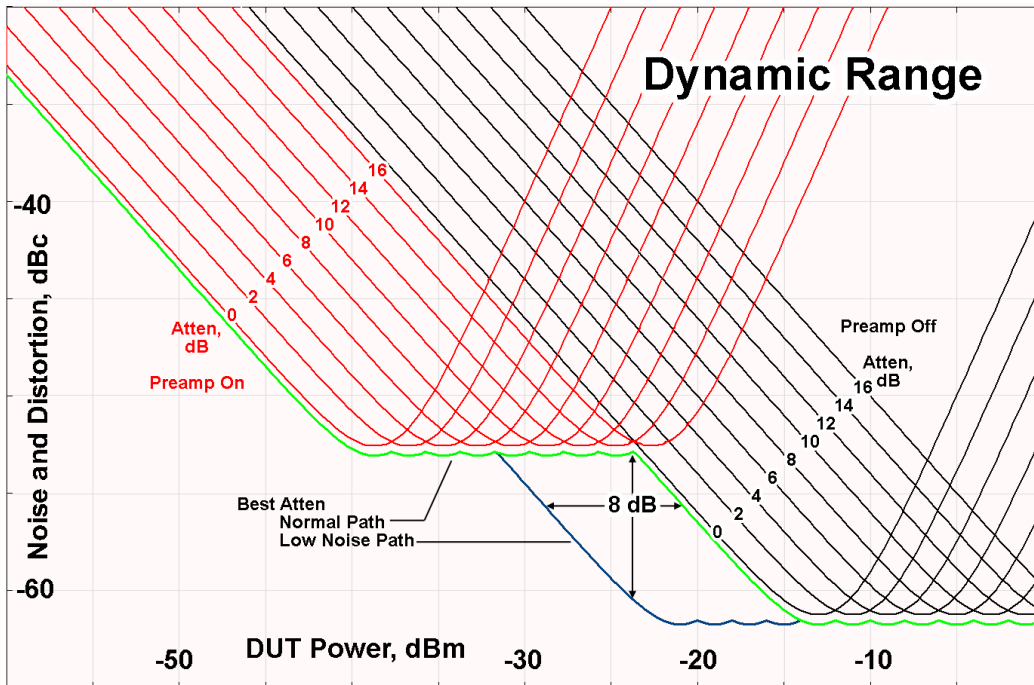

There are other times where selecting the low noise path improves performance, too. Compression-limited measurements such as finding the nulls in a pulsed-RF spectrum can profit from the low noise path in a way similar to the TOI-limited measurement illustrated. Accuracy can be improved when the low noise path allows the optimum attenuation to increase from a small amount like 0, 2 or 4 dB to a larger amount, giving better return loss at the analyzer input. Harmonic measurements, such as second and third harmonic levels, are much improved using the low noise path because of the superiority of that path for harmonic (though not intermodulation) distortion performance.

μW Preselector Bypass

This key toggles the preselector bypass switch for band 1 and higher. When the microwave preselector is on, the signal path is preselected. When the microwave preselector is off, the signal path is not preselected. The preselected path is the normal path for the analyzer.

The preselector is a tunable bandpass filter which prevents signals away from the frequency of interest from combining in the mixer to generate in-band spurious signals (images). The consequences of using a preselector filter are its limited bandwidth, the amplitude and phase ripple in its passband, and any amplitude and phase instability due to center frequency drift.

Option MPB or pre-selector bypass provides an unpreselected input mixer path for certain X-Series signal analyzers with frequency ranges above 3.6 GHz. This signal path allows a wider bandwidth and less amplitude variability, which is an advantage when doing modulation analysis and broadband signal analysis. The disadvantage is that, without the preselector, image signals will be displayed. Another disadvantage of bypassing the preselector is increased LO emission levels at the front panel input port.

Image responses are separated from the real signal by twice the 1st IF. For IF Paths of 10 MHz and 25 MHz, the 1st IF is 322.5 MHz, so the image response and the real signal will be separated by 645 MHz. The 1st IF will be different for other IF Path settings. When viewing a real signal and its corresponding image response in internal mixing, the image response will be to the left of the real signal.

Also, the image response and the real signal typically have the same amplitude and exhibit the same shape factor.

However, if Option FS1, Fast Sweep Capability, is enabled, the image response in the Swept SA measurement will appear lower in amplitude and have a much wider shape factor compared to the real signal.

Key Path	AMPTD Y Scale, μ W Path Control
Example	:POW:MW:PATH MPB
Dependencies	Key is blanked if current mode does not support it. Key is grayed out if mode supports it but current measurement does not support it. Key is blank unless Option MPB is present and licensed. If SCPI command sent when MPB not present, error -241, "Hardware missing; Option not installed" is generated.
Readback Text	μ W Preselector Bypass
Initial S/W Revision	A.04.00

Remote Command	[:SENSe] :POWeR [:RF] :MW :PRESelector [:STATe] ON OFF 0 1 [:SENSe] :POWeR [:RF] :MW :PRESelector [:STATe] ?
Example	:POW:MW:PRES OFF Bypasses the microwave preselector
Notes	The ON parameter sets the STD path (:POW:MW:PATH STD) The OFF parameter sets path MPB (:POW:MW:PATH MPB)
Preset	ON

Internal Preamp

Accesses a menu of keys that control the internal preamps. Turning on the preamp gives a better noise figure, but a poorer TOI to noise floor dynamic range. You can optimize this setting for your particular measurement.

The instrument takes the preamp gain into account as it sweeps. If you sweep outside of the range of the preamp the instrument will also account for that. The displayed result will always reflect the correct gain.

For some measurements, when the preamp is on and any part of the displayed frequency range is below the lowest frequency for which the preamp has specifications, a warning condition message appears in the status line. For example, for a preamp with a 9 kHz lowest specified frequency: "Preamp: Accy unspec'd below 9 kHz".

Key Path	AMPTD Y Scale
Scope	Meas Global
Remote Command	[:SENSe] :POWeR [:RF] :GAIN [:STATe] OFF ON 0 1 [:SENSe] :POWeR [:RF] :GAIN [:STATe] ?
Dependencies	Preamp is not available on all hardware platforms. If the preamp is not present or is unlicensed, the

	key is not shown. The preamp is not available when the electronic/soft attenuator is enabled.
--	--

Couplings	The act of connecting the U7227A USB Preamplifier to one of the analyzer's USB ports will cause the Internal Preamp to be switched on. When this happens an informational message will be generated: "Internal Preamp turned on for optimal operation with USB Preamp." Note that if the Internal Preamp was already on, there will be no change to the setting, but if it was Off it will be switched On, to Full Range. Note that this same action occurs when the SA mode is selected while the USB Preamp is connected to one of the analyzer's USB ports, if it is the first time that the SA mode has run since powerup, or if the last time the SA mode was running the USB Preamp was NOT connected. Subsequently disconnecting the USB Preamp from USB does not change the Internal Preamp setting nor restore the previous setting.
-----------	---

Preset	OFF
State Saved	Saved in instrument state
Initial S/W Revision	Prior to A.02.00
Modified at S/W Revision	A.14.00

Key Path	AMPTD Y Scale, Internal Preamp
Scope	Meas Global
Remote Command	[:SENSe] :POWer [:RF] :GAIN :BAND LOW FULL [:SENSe] :POWer [:RF] :GAIN :BAND ?
Dependencies	Preamp is not available on all hardware platforms. If the preamp is not present or is unlicensed, the key is not shown. If a POW:GAIN:BAND FULL command is sent when a low band preamp is available, the preamp band parameter is to LOW instead of FULL, and an "Option not installed" message is generated.
Preset	LOW
State Saved	Saved in instrument state
Initial S/W Revision	Prior to A.02.00

Off

Turns the internal preamp off

Key Path	AMPTD Y Scale, Internal Preamp
Example	:POW:GAIN OFF
Readback	Off
Initial S/W Revision	Prior to A.02.00

Low Band

Sets the internal preamp to use only the low band.

The frequency range of the installed (optional) low-band preamp is displayed in square brackets on the Low Band key label.

Key Path	AMPTD Y Scale, Internal Preamp
Example	:POW:GAIN ON :POW:GAIN:BAND LOW
Readback	Low Band
Initial S/W Revision	Prior to A.02.00

Full Range

Sets the internal preamp to use its full range. The low band (0–3.6 GHz or 0–3GHz, depending on the model) is supplied by the low band preamp and the frequencies above low band are supplied by the high band preamp.

The frequency range of the installed (optional) preamp is displayed in square brackets on the Full Range key label. If the high band option is not installed the Full Range key does not appear.

Key Path	AMPTD Y Scale, Internal Preamp
Example	:POW:GAIN ON :POW:GAIN:BAND FULL
Readback	Full Range
Initial S/W Revision	Prior to A.02.00

Range

This key is only available when I/Q is the selected input. It replaces the Attenuation key in that case.

Each input channel (I and Q) has four internal gain ranges. The maximum allowed voltage in each gain range is slightly more than the nominal value, so the break point between ranges is a couple of millivolts higher than the nominal (setting a peak voltage of 0.502 mV will still map to the 0.5 V Peak range).

Gain Setting	Volts RMS	Volts Peak	Volts Peak - Peak	dBm (50Ω)	Break Point
0 dB	0.7071	1.0	2.0	10	n/a
6 dB	0.3536	0.5	1.0	4	0.502 V Peak
12 dB	0.1768	0.25	0.5	-2	0.252 V Peak
18 dB	0.0884	0.125	0.25	-8	0.127 V Peak

Key Path	AMPTD Y Scale
Notes	Visible only when the selected input is I/Q.
State Saved	No
Readback Text	When Range is Auto, "[Auto]" When Range is Man and I & Q are the same, "[<range value>]" When Range is Man and I & Q are different: "I: <I range value> Q: <Q range value>]" See I Range and Q Range for the <range value> enumeration definition.
Initial S/W Revision	Prior to A.02.00

Range Auto/Man

The Auto setting for Range causes the range to be set based on the Y Scale settings. When Range is "Auto", the I & Q Range are set based on the top of the Y Scale when the Y scale is in dB units (for example, power), or to the max(abs(top), abs(bottom)) when the Y scale reference is not at the top of the screen.

Not all measurements support Range Auto/Man. If Auto is not supported in the current measurement, this key is grayed out and shows "Man" and MAN is returned to a SCPI query, but this does NOT change the Auto/Man setting for Range. When you go to a measurement that supports Auto, it goes back to Auto if it was previously in Auto mode.

Key Path	AMPTD Y Scale, Range
Scope	Meas Global
Remote Command	[:SENSe] :VOLTage:IQ:RANGe:AUTO OFF ON 0 1 [:SENSe] :VOLTage:IQ:RANGe:AUTO?
Example	Put the I Range and Q Range in manual. VOLT:IQ:RANG:AUTO OFF
Dependencies	If Auto is not supported, sending the SCPI command will generate an error.
Couplings	When in Auto, both I Range and Q Range are set to the same value, computed as follows: Maximum absolute value is computed for the Y Scale. The top and bottom of the graph are computed based on Ref Value, Scale/Div, and Ref Position. Formula: YMax = max(abs(top), abs(bottom)). The I Range and Q Range are then set to YMax.
Preset	ON
State Saved	Saved in instrument state
Range	Auto Man
Initial S/W Revision	Prior to A.02.00

Remote Command	[:SENSe] :POWer:IQ:RANGe:AUTO OFF ON 0 1 [:SENSe] :POWer:IQ:RANGe:AUTO?
----------------	--

Example	Put the I Range and Q Range in manual. POW:IQ:RANG:AUTO OFF
Notes	The POW:IQ:RANG:AUTO is an alternate form of the VOLT:IQ:RANG:AUTO command. This is to maintain consistency with I Range and Q Range, which support both the POWer and VOLTage forms of the command.
Preset	ON
Range	Auto Man
Initial S/W Revision	Prior to A.02.00

I Range

This is the internal gain range for the I channel when Input Path is I Only or I and I/Q, and it is used for both the I and Q channels when the Input Path is I+jQ. See "[I/Q Gain Ranges](#)" on page 2165.

Key Path	AMPTD Y Scale, Range
Remote Command	[:SENSe] :VOLTage :IQ [:I] :RANGe [:UPPer] <voltage> [:SENSe] :VOLTage :IQ [:I] :RANGe [:UPPer] ?
Example	Set the I Range to 0.5 V Peak VOLT:IQ:RANG 0.5 V
Notes	The numeric entries are mapped to the smallest gain range whose break point is greater than or equal to the value, or 1 V Peak if the value is greater than 1 V.
Couplings	When Q Same as I is On, the I Range value will be copied to the Q Range. Changing the value will also set Range = Man.
Preset	1 V Peak
State Saved	Saved in instrument state
Range	1 V Peak 0.5 V Peak 0.25 V Peak 0.125 V Peak
Min	0.125 V
Max	1 V
Initial S/W Revision	Prior to A.02.00

Remote Command	[:SENSe] :POWer :IQ [:I] :RANGe [:UPPer] <ampl> [:SENSe] :POWer :IQ [:I] :RANGe [:UPPer] ?
Example	Set the I Range to 0.5 V Peak when Reference Z is 50Ω, and to 1.0 V Peak when Reference Z is 75Ω. POW:IQ:RANG 4 dBm
Notes	The POWer form of the command is provided for convenience. It maps to the same underlying gain range parameter as the VOLTage form of the command. The Reference Z (not the I channel Input Z) is used to convert the power to peak voltage, which is then used to set the I Range as with the VOLTage form of the command. The power values of the 4

range states (1V Peak, 0.5V Peak, 0.25V Peak, and 0.125V Peak) will vary with Reference Z. Here are some examples:

50Ω: 10, 4, -2, -8
75Ω: 8.2, 2.2, -3.8, -9.8
600Ω: -0.8, -6.8, -12.8, -18.9

Preset	10.0 dBm
Range	-20 dBm to 10 dBm
Min	-20 dBm
Max	10 dBm
Initial S/W Revision	Prior to A.02.00

1 V Peak

Set the channel gain state to 1 Volt Peak.

Key Path	AMPTD Y Scale, I Range Q Range
Initial S/W Revision	Prior to A.02.00

0.5 V Peak

Set the channel gain state to 0.5 Volt Peak.

Key Path	AMPTD Y Scale, I Range Q Range
Initial S/W Revision	Prior to A.02.00

0.25 V Peak

Set the channel gain state to 0.25 Volt Peak.

Key Path	AMPTD Y Scale, I Range Q Range
Initial S/W Revision	Prior to A.02.00

0.125 V Peak

Set the channel gain state to 0.125 Volt Peak.

Key Path	AMPTD Y Scale, I Range Q Range
Initial S/W Revision	Prior to A.02.00

Q Range Value

This is the internal gain range for the Q channel. See "[I/Q Gain Ranges](#)" on page 2165. The Q Range only applies to Input Path Q Only and Ind I/Q. For input I+jQ the I Range determines both I and Q channel range settings.

Key Path	AMPTD Y Scale, Range
Remote Command	<code>[:SENSe] :VOLTage:IQ:Q:RANGe[:UPPer] <voltage></code> <code>[:SENSe] :VOLTage:IQ:Q:RANGe[:UPPer] ?</code>
Example	Set the Q Range to 0.5 V Peak <code>VOLT:IQ:Q:RANG 0.5 V</code>
Notes	The numeric entries are mapped to the smallest gain range whose break point is greater than or equal to the value, or 1 V Peak if the value is greater than 1 V. The Q Range is only used for Input Path Q Only and Ind I/Q. For input I+jQ the I Range determines both I and Q channel range settings.
Couplings	When Q Same as I is On, the I Range value will be copied to the Q Range and the range value keys are disabled. Changing the value will also set Range = Man.
Preset	1 V Peak
State Saved	Saved in instrument state
Range	1 V Peak 0.5 V Peak 0.25 V Peak 0.125 V Peak
Min	0.125 V
Max	1 V
Initial S/W Revision	Prior to A.02.00

Remote Command	<code>[:SENSe] :POWer:IQ:Q:RANGe[:UPPer] <ampl></code> <code>[:SENSe] :POWer:IQ:Q:RANGe[:UPPer] ?</code>
Example	Will set the Q Range to 0.5 V Peak when Reference Z is 50Ω, and to 1.0 V Peak when Reference Z is 75Ω. <code>POW:IQ:Q:RANG 4 dBm</code>
Notes	The POWER form of the command is provided for convenience. It maps to the same underlying gain range parameter as the VOLTage form of the command. The Reference Z (not the Q channel Input Z) is used to convert the power to peak voltage, which is then used to set the Q Range as with the VOLTage form of the command. The power values of the 4 range states (1V Peak, 0.5V Peak, 0.25V Peak, and 0.125V Peak) will vary with Reference Z. Here are some examples: 50Ω: 10, 4, -2, -8 75Ω: 8.2, 2.2, -3.8, -9.8 600Ω: -0.8, -6.8, -12.8, -18.9
Preset	10.0 dBm
Range	-20 dBm to 10 dBm

Min	-20 dBm
Max	10 dBm
Initial S/W Revision	Prior to A.02.00

Q Same as I

Many, but not all, usages require the I and Q channels to have an identical setup. To simplify channel setup, the Q Same as I will cause the Q channel range to be mirrored from the I channel. That way you only need to set up one channel (the I channel). The I channel values are copied to the Q channel, so at the time Q Same as I is Off, the I and Q channel setups will be identical.

Key Path	AMPTD Y Scale, Range, Q Range
Remote Command	[:SENSe] :VOLTage POWer : IQ :MIRRed OFF ON 0 1 [:SENSe] :VOLTage POWer : IQ :MIRRed ?
Example	Turn off the mirroring of I Range to Q Range. VOLT:IQ:MIRR OFF POW:IQ:MIRR OFF
Couplings	When On, the I Range value is mirrored (copied) to the Q Range.
Preset	On
State Saved	Saved in instrument state.
Range	On Off
Readback Text	"Q Same as I" when On, otherwise none.
Initial S/W Revision	Prior to A.02.00

1 V Peak

Set the channel gain state to 1 Volt Peak.

Key Path	AMPTD Y Scale, I Range Q Range
Initial S/W Revision	Prior to A.02.00

0.5 V Peak

Set the channel gain state to 0.5 Volt Peak.

Key Path	AMPTD Y Scale, I Range Q Range
Initial S/W Revision	Prior to A.02.00

0.25 V Peak

Set the channel gain state to 0.25 Volt Peak.

Key Path	AMPTD Y Scale, I Range Q Range
Initial S/W Revision	Prior to A.02.00

0.125 V Peak

Set the channel gain state to 0.125 Volt Peak.

Key Path	AMPTD Y Scale, I Range Q Range
Initial S/W Revision	Prior to A.02.00

I/Q Gain Ranges

See the following sections:

["1 V Peak" on page 2165](#)

["0.5 V Peak" on page 2165](#)

["0.25 V Peak" on page 2165](#)

["0.125 V Peak" on page 2166](#)

1 V Peak

Set the channel gain state to 1 Volt Peak.

Key Path	AMPTD Y Scale, I Range Q Range
Initial S/W Revision	Prior to A.02.00

0.5 V Peak

Set the channel gain state to 0.5 Volt Peak.

Key Path	AMPTD Y Scale, I Range Q Range
Initial S/W Revision	Prior to A.02.00

0.25 V Peak

Set the channel gain state to 0.25 Volt Peak.

Key Path	AMPTD Y Scale, I Range Q Range
Initial S/W Revision	Prior to A.02.00

0.125 V Peak

Set the channel gain state to 0.125 Volt Peak.

Key Path	AMPTD Y Scale, I Range Q Range
Initial S/W Revision	Prior to A.02.00

Presel Center

When this key is pressed, the centering of the preselector filter is adjusted to optimize the amplitude accuracy at the frequency of the selected marker.

See AMPTD Y Scale, "[Presel Center](#)" on page 2149 for more information.

This is only available when the selected input is RF.

Key Path	AMPTD Y Scale
Initial S/W Revision	Prior to A.02.00

Auto Couple

The Auto Couple feature provides a quick and convenient way to automatically couple multiple instrument settings. This helps ensure accurate measurements and optimum dynamic range. When the Auto Couple feature is activated, either from the front panel or remotely, all parameters of the current measurement that have an Auto/Manual mode are set to Auto mode and all measurement settings dependent on (or coupled to) the Auto/Man parameters are automatically adjusted for optimal performance.

However, the Auto Couple key actions are confined to the current measurement only. It does not affect other measurements in the mode, and it does not affect markers, marker functions, or trace or display attributes.

See "[More Information](#)" on page 1852

Key Path	Front-panel key
Remote Command	:COUPle ALL NONE
Example	:COUP ALL
Notes	:COUPle ALL puts all Auto/Man parameters in Auto mode (equivalent to pressing the Auto Couple key). :COUPLE NONE puts all Auto/Man parameters in manual mode. It decouples all the coupled instrument parameters and is not recommended for making measurements.
Initial S/W Revision	Prior to A.02.00

More Information

There are two types of functions that have Auto/Manual modes.

Auto/Man Active Function keys

An Auto/Man toggle key controls the binary state associated with an instrument parameter by toggling between Auto (where the parameter is automatically coupled to the other parameters it is dependent upon) and Man (where the parameter is controlled independent of the other parameters), as well as making the parameter the active function. The current mode is indicated on the softkey with either Auto or Man underlined as illustrated below.

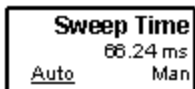

usdB

Auto/Man 1-of-N keys

An Auto/Man 1-of-N key allows you to manually pick from a list of parameter values, or place the function in Auto, in which case the value is automatically selected (and indicated) as shown below. If in Auto, Auto is underlined on the calling key. If in manual operation, manual is indicated on the calling key. But the calling key does not actually toggle the function, it simply opens the menu.

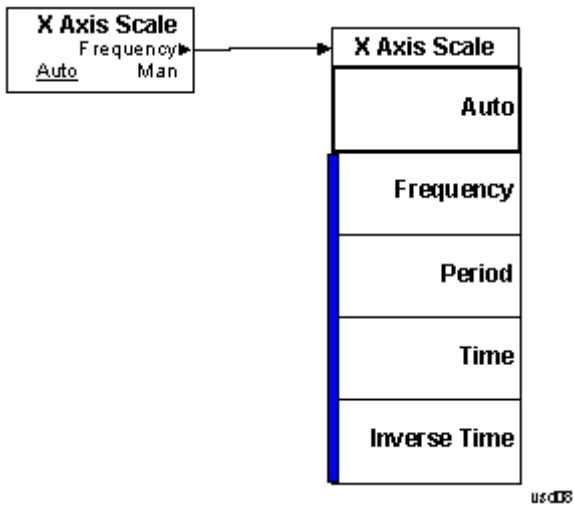

BW

Opens the BW menu, which contains keys to control the information bandwidth functions of the instrument.

Key Path	Front-panel key
Initial S/W Revision	Prior to A.02.00

Info BW

Allows you to enter a frequency value to set the channel bandwidth that will be used for data acquisition.

Key Path	BW
Mode	SA, WCDMA, C2K, WIMAXOFDMA, TD-SCDMA, 1xEV-DO, DVB-T/H, DTMB (CTTB), ISDB-T, CMMB, LTE, LTETDD, Digital Cable TV, WLAN, MSR, LTEATDD, LTEAFDD
Remote Command	[:SENSe] :PStatistic :BANDwidth <freq> [:SENSe] :PStatistic :BANDwidth?
Example	PST:BAND 8 MHz PST:BAND?
Couplings	WiMAX OFDMA: The default value depends on the Radio Standard selection..
Preset	SA, WCDM: 5 MHz C2K:1.5 MHz 1xEV-DO:1.3 MHz WiMAX OFDMA: Hardware Dependent No Option = 10 MHz WB (25 MHz or wider) = 25 MHz TD-SCDMA: 1.3 MHz DVB-T/H, DTMB (CTTB): 8 MHz ISDB-T: 6 MHz CMMB: 8 MHz LTE, LTETDD, LTEATDD, LTEAFDD: 6 MHz Digital Cable TV: 8MHz WLAN: Hardware Dependent No option = 10 MHz Option B25 = 25 MHz Option B40: if Radio Std is 802.11a/b/g/n(20MHz) = 25 MHz if Radio Std is 802.11n(40MHz) = 40 MHz if Radio Std is 802.11ac(20MHz) = 25 MHz if Radio Std is 802.11ac(40MHz) = 40 MHz Option B1X: if Radio Std is 802.11ac(80MHz) = 80 MHz

	Option B1Y: if Radio Std is 802.11ac(160MHz) = 160 MHz MSR: same as max value
State Saved	Saved in instrument state.
Min	10.0 kHz
Max	Hardware Dependent: RF Input: No Option = 10 MHz WB (25MHz or wider) = Hardware Option Limit I/Q Input (for I+jQ): No Option = 20 MHz Option B25 = 50 MHz
Backwards Compatibility SCPI	[:SENSe] :PStatistic:BWIDth
Initial S/W Revision	Prior to A.02.00
Modified at S/W Revision	A.02.00, A.03.00, A.06.00

Cont (Continuous Measurement/Sweep)

Sets the analyzer for Continuous measurement operation. The single/continuous state is Meas Global so the setting will affect all measurements. If you are Paused, pressing Cont does a Resume.

Key Path	Front-panel key
Remote Command	:INITiate:CONTinuous OFF ON 0 1 :INITiate:CONTinuous?
Example	:INIT:CONT 0 puts analyzer in Single measurement operation. :INIT:CONT 1 puts analyzer in Continuous measurement operation
Preset	ON (Note that SYST:PRESet sets INIT:CONT to ON but *RST sets INIT:CONT to OFF)
State Saved	Saved in instrument state
Backwards Compatibility Notes	For Spectrum Analysis mode in ESA and PSA, there is no Cont hardkey, instead there is a Sweep Single/Cont key. In these analyzers, switching the Sweep Single/Cont key from Single to Cont restarts averages (displayed average count reset to 1), but does not restart Max Hold and Min Hold. The X-Series has Single and Cont keys in place of the SweepSingleCont key. In the X-Series, if in single measurement, the Cont key (and INIT:CONT ON) switches to continuous measurement, but never restarts a measurement and never resets a sweep.
Initial S/W Revision	Prior to A.02.00

In Swept SA Measurement (Spectrum Analysis Mode):

The analyzer takes repetitive sweeps, averages, measurements, etc., when in Continuous mode. When the average count reaches the Average/Hold Number the count stops incrementing, but the analyzer keeps sweeping. See the Trace/Detector section for the averaging formula used both before and after the Average/Hold Number is reached. The trigger condition must be met prior to each sweep. The type of trace processing for multiple sweeps, is set under the Trace/Detector key, with choices of Trace Average, Max Hold, or Min Hold.

In Other Measurements/Modes:

With Avg/Hold Num (in the Meas Setup menu) set to Off or set to On with a value of 1, a sweep is taken after the trigger condition is met; and the analyzer continues to take new sweeps after the current sweep has completed and the trigger condition is again met. However, with Avg/Hold Num set to On with a value >1, multiple sweeps (data acquisitions) are taken for the measurement. The trigger condition must be met prior to each sweep. The sweep is not stopped when the average count k equals the number N set for Avg/Hold Num is reached, but the number k stops incrementing. A measurement average usually applies to all traces, marker results, and numeric results. But sometimes it only applies to the numeric results.

If the analyzer is in Single measurement, pressing the Cont key does not change k and does not cause the sweep to be reset; the only action is to put the analyzer into Continuous measurement operation.

If it is already in continuous sweep:

the INIT:CONT 1 command has no effect

the INIT:CONT 0 command will place the analyzer in Single Sweep but will have no effect on the current sequence until $k = N$, at which point the current sequence will stop and the instrument will go to the idle state.

15 Power Stat CCDF Measurement
File

File

See "File" on page 336

FREQ Channel

Accesses a menu of keys that allow you to control the Frequency and Channel parameters of the instrument.

Some features in the Frequency menu are the same for all measurements – they do not change as you change measurements. Settings like these are called “Meas Global” and are unaffected by Meas Preset. For example, the Center Freq setting is the same for all measurements – it does not change as you change measurements.

Key Path	Front-panel key
Initial S/W Revision	Prior to A.02.00

Center Freq

Sets the frequency that corresponds to the horizontal center of the graticule (when frequency Scale Type is set to linear). While adjusting the Center Frequency the Span is held constant, which means that both Start Frequency and Stop Frequency will change.

Pressing Center Freq also sets the frequency entry mode to Center/Span. In Center/Span mode, the center frequency and span values are displayed below the graticule, and the default active function in the Frequency menu is Center Freq.

The center frequency setting is the same for all measurements within a mode, that is, it is Meas Global. Some modes are also able to share a Mode Global center frequency value. If this is the case, the Mode will have a Global Settings key in its Mode Setup menu.

The Center Freq function sets (and queries) the Center Frequency for the currently selected input. If your analyzer has multiple inputs, and you select another input, the Center Freq changes to the value for that input. SCPI commands are available to directly set the Center Freq for a specific input.

Center Freq is remembered as you go from input to input. Thus you can set a Center Freq of 10 GHz with the RF Input selected, change to BBIQ and set a Center Freq of 20 MHz, then switch to External Mixing and set a Center Freq of 60 GHz, and when you go back to the RF Input the Center Freq will go back to 10 GHz; back to BBIQ and it is 20 MHz; back to External Mixing and it is 60 GHz.

See ["RF Center Freq" on page 1862](#)

See [Ext Mix Center Freq](#)

See ["I/Q Center Freq" on page 1864](#)

See ["Center Frequency Presets" on page 1860](#)

Key Path	FREQ Channel
Scope	Meas Global
Remote Command	[:SENSe] :FREQuency :CENTer <freq> [:SENSe] :FREQuency :CENTer?

Example	FREQ:CENT 50 MHz FREQ:CENT UP changes the center frequency to 150 MHz if you use FREQ:CENT:STEP 100 MHz to set the center frequency step size to 100 MHz FREQ:CENT?
Notes	This command sets either the RF or I/Q Center Frequency depending on the selected input. For RF input it is equivalent to FREQ:RF:CENT For I/Q input it is equivalent to FREQ:IQ:CENT Preset and Max values are dependent on Hardware Options (5xx) If no terminator (e.g. MHz) is sent the terminator Hz is used. If a terminator with unit other than Frequency is used, an invalid suffix error message is generated.
Dependencies	The Center Frequency can be limited by Start or Stop Freq limits, if the Span is so large that Start or Stop reach their limit.
Couplings	When operating in "swept span", any value of the Center Frequency or Span that is within the frequency range of the analyzer is allowed when the value is being set through the front panel numeric key pad or the SCPI command. The other parameter is forced to a different value if needed, to keep the Start and the Stop Frequencies within the analyzer's frequency range
Preset	Depends on instrument maximum frequency, mode, measurement, and selected input. See "Center Frequency Presets" on page 1860 and "RF Center Freq" on page 1862 and Ext Mix Center Freq and "I/Q Center Freq" on page 1864 .
State Saved	Saved in instrument state
Min	Depends on instrument maximum frequency, mode, measurement, and selected input.. See "Center Frequency Presets" on page 1860 and "RF Center Freq" on page 1862 and "I/Q Center Freq" on page 1864 .
Max	Depends on instrument maximum frequency, mode, measurement, and selected input.. See "Center Frequency Presets" on page 1860 and "RF Center Freq" on page 1862 and "I/Q Center Freq" on page 1864 .
Default Unit	Hz
Status Bits/OPC	Non-overlapped
Dependencies	
Initial S/W Revision	Prior to A.02.00

Center Frequency Presets

The following table provides the Center Frequency Presets for the Spectrum Analyzer mode, and the Max Freq, for the various frequency options:

Freq Option	CF after Mode Preset	Stop Freq after Mode Preset	Max Freq (can't tune)

			above)
503 (all but N9000A)	1.805 GHz	3.6 GHz	3.7 GHz
503 (N9000A)	1.505 GHz	3.0 GHz	3.08 GHz
507 (all but N9000A)	3.505 GHz	7.0 GHz	7.1 GHz
507 (N9000A)	3.755 GHz	7.5 GHz	7.58 GHz
508 (all but N9038A)	1.805 GHz	3.6 GHz	8.5 GHz
508 (N9038A)	4.205 GHz	8.4 GHz	8.5 GHz
513	6.805 GHz	13.6 GHz	13.8 GHz
526 (all but N9000A and N9038A)	13.255 GHz	26.5 GHz	27.0 GHz
526 (N9000A)	13.255 GHz	26.5 GHz	26.55 GHz
526 (N9038A)	1.805 GHz	3.6 GHz	27.0 GHz
532	16.005 GHz	32.0 GHz	32.5 GHz
543	21.505 GHz	43.0 GHz	TBD
544	22.005 GHz	44.0 GHz	44.5 GHz
550	25.005 GHz	50.0 GHz	51 GHz

Input 2:

Model	CF after Mode Preset	Stop Freq after Mode Preset	Max Freq (can't tune above)
N9000A opt C75	0.7505GHz	1.5 GHz	1.58 GHz
N9038A	505 MHz	1 GHz	1.000025 GHz

Tracking Generator Frequency Limits (N9000A only):

Tracking Generator Option	Min Freq (clips to this freq when turn TG on and	If above this Freq, Stop Freq clipped to this Freq when	Max Freq (can't tune above) while TG

	can't tune below while TG on)	TG turned on	on
T03	9 kHz	3.0 GHz	3.08 GHz
T06	9 kHz	6.0 GHz	6.05 GHz

The following table shows the Center Frequency Presets for modes other than Spectrum Analyzer:

Mode	CF Preset for RF
WCDMA	1 GHz
WIMAXOFDMA,	1 GHz
BASIC	1 GHz
ADEMOD	1 GHz
VSA	1 GHz
TDSCDMA	1 GHz
PNOISE	1 GHz
LTE	1 GHz
LTETDD	1 GHz
MSR	1 GHz
GSM	935.2 MHz
NFIGURE	1.505 GHz

RF Center Freq

SCPI command for specifying the RF Center Frequency. This command will set the Center Frequency to be used when the RF input is selected, even if the RF input is not the input that is selected at the time the command is sent. Note that the Center Freq function in the Frequency menu on the front panel always applies to the currently selected input.

Scope	Meas Global
Remote Command	[:SENSe] :FREQuency:RF:CENTer <freq> [:SENSe] :FREQuency:RF:CENTer?
Example	FREQ:RF:CENT 30 MHz
Notes	This command is the same in all modes, but the parameter is Measurement Global. So the value is independent in each mode and common across all the measurements in the mode.
Dependencies	If the electronic/soft attenuator is enabled, any attempt to set Center Frequency such that the Stop Frequency would be >3.6 GHz fails and results in an advisory message. If the equivalent SCPI command is sent, this same message is generated as part of a “-221, Settings conflict” warning. If Source Mode is set to Tracking, and the Max or Min Center Freq is therefore limited by the limits of the source, a warning message is generated, “Data out of range;clipped to source max/min” if these limits are exceeded. Note that for an external source, these limits can be affected by the settings of

	Source Numerator, Source Denominator and Power Sweep.
Preset	See table above
State Saved	Saved in instrument state.
Min	-79.999995 MHz, unless Source Mode is set to Tracking, in which case it is limited by the minimum frequency of the Source
Max	See table above. Basically instrument maximum frequency - 5 Hz. Note that, if the Source Mode is set to Tracking, the effective instrument maximum frequency may be limited by the source maximum frequency. If the knob or step keys are being used, also depends on the value of the other three interdependent parameters Span, Start Frequency and Stop Frequency
Initial S/W Revision	Prior to A.02.00
Modified at S/W Revision	A.03.00

Ext Mix Center Freq

SCPI command for specifying the External Mixer Center Frequency. This command will set the Center Frequency to be used when the External Mixer is selected, even if the External Mixer input is not the input which is selected at the time the command is sent. Note that the Center Freq function in the Frequency menu on the front panel always applies to the currently selected input.

Scope	Meas Global
Remote Command	<code>[:SENSe] :FREQuency:EMIXer:CENTer <freq></code> <code>[:SENSe] :FREQuency:EMIXer:CENTer?</code>
Example	<code>:FREQ:EMIX:CENT 60 GHz</code> <code>:FREQ:EMIX:CENT?</code>
Notes	This command is the same in all modes, but the parameter is Measurement Global. So the value is independent in each mode and common across all the measurements in the mode.
Couplings	When returning to External Mixing after having been switched to one of the other inputs (e.g., RF), you will come back into the settings that you had when you left External Mixing. So you will come back to the band you were in with the Center Frequency that you had. However, Span is not an input-dependent parameter, therefore you will bring the span over from the other input. Therefore, the analyzer comes back with the span from the previous input, limited as necessary by the current mixer setup.
Preset	When a Mode Preset is performed while in External Mixing, the Start frequency of the current Mode is set to the nominal Min Freq of the lowest harmonic range in the Harmonic Table for the current mixer setup. Similarly, the Stop frequency of the current Mode is set to the nominal Max Freq of the highest harmonic range in the Harmonic Table. The Center Freq thus presets to the point arithmetically equidistant from these two frequencies. If the current measurement has a limited Span available to it, and cannot achieve the Span shown in the table ($\text{Span} = \text{Stop Freq} - \text{Start Freq}$), the analyzer uses the maximum Span the measurement allows, and still sets the Center Freq to the midpoint of the Start and Stop Freq values in the Harmonic Table.

	<p>When Restore Input/Output Defaults is performed, the mixer presets to the 11970A, whose Start and Stop frequencies are 26.5 and 40 GHz respectively. The center of these two frequencies is 33.25 GHz.</p> <p>Therefore, after a Restore Input/Output Defaults, if you go into External Mixing and do a Mode Preset while in the Spectrum Analyzer Mode, the resulting Center Freq is 33.25 GHz.</p>
State Saved	Saved in instrument state.
Min	The minimum frequency in the currently selected mixer band + 5 Hz
Max	<p>The maximum frequency in the currently selected mixer band – 5 Hz</p> <p>If the knob or step keys are being used, also depends on the value of the other three interdependent parameters Span, Start Frequency and Stop Frequency</p>
Initial S/W Revision	A.08.01

I/Q Center Freq

SCPI command for specifying the I/Q Center Frequency. This command will set the Center Frequency to be used when the I/Q input is selected, even if the I/Q input is not the input which is selected at the time the command is sent. Note that the Center Freq function in the Frequency menu on the front panel always applies to the currently selected input.

Scope	Meas Global
Remote Command	<pre>[:SENSe] :FREQuency:IQ:CENTer <freq></pre> <pre>[:SENSe] :FREQuency:IQ:CENTer?</pre>
Example	FREQ:IQ:CENT: 30 MHz
Notes	This command is the same in all modes, but the parameter is Measurement Global. So the value is independent in each mode and common across all the measurements in the mode.
Preset	0 Hz
State Saved	Saved in instrument state.
Min	-40.049995 MHz
Max	40.049995 MHz
Initial S/W Revision	Prior to A.02.00

Input/Output

See "Input/Output" on page 196

Marker

Accesses a menu that enables you to select, set up and control the markers for the current measurement.

Key Path	Front-panel key
Initial S/W Revision	Prior to A.02.00

Select Marker

Accesses a menu that allows you to select one of 12 markers for control and function

Key Path	Marker
Initial S/W Revision	Prior to A.02.00

Marker Type

Sets the marker control mode to Normal, Delta, Fixed or Off.

If the selected marker is Off, pressing Marker sets it to Normal and places it at the center of the screen on the trace determined by the Marker Trace rules. At the same time, Marker X Axis Value appears on the Active Function area.

The Active function for the selected marker's current control mode is the default active function. If the current control mode is Off, there is no active function and the active function is turned off. The active function display is the marker X axis value entered in the active function area, which displays the marker value to its full entered precision.

All interactions and dependencies detailed under the key description are enforced when the remote command is sent.

Key Path	Marker
Mode	SA, WCDMA, C2K, WiMAX OFDMA, TD-SCDMA, 1xEV-DO, DVB-T/H, DTMB (CTTB), ISDB-T, CMMB, LTE, LTE-TDD, Digital Cable TV, WLAN, MSR, LTE-TDD, LTE-FDD
Remote Command	:CALCulate:PStatistic:MARKer[1] 2 ... 12:MODE POSition DELTa OFF :CALCulate:PStatistic:MARKer[1] 2 ... 12:MODE?
Example	CALC:PST:MARK:MODE POS CALC:PST:MARK:MODE?
Notes	If the selected marker is Off, pressing Marker sets it to Normal and places it at the center of the screen on the trace determined by the Marker Trace rules. At the same time, Marker X Axis Value appears on the Active Function area. Default Active Function: the active function for the selected marker's current control mode. If the current control mode is Off, there is no active function and the active function is turned off. Active Function Display: the marker X axis value entered in the active function area displays the marker value to its full entered precision.

Preset	OFF
State Saved	Saved in instrument state.
Range	Normal Delta Off
Initial S/W Revision	Prior to A.02.00
Modified at S/W Revision	A.02.00, A.03.00

Properties

Accesses the marker properties menu.

Key Path	Marker
Initial S/W Revision	Prior to A.02.00

Select Marker

Accesses a menu that allows you to select one of 12 markers for control and function

Key Path	Marker
Initial S/W Revision	Prior to A.02.00

Relative To

Sets the reference marker that the selected marker will be relative to.

Key Path	Marker, Properties
Mode	SA, WCDMA, C2K, WIMAXOFDMA, TD-SCDMA, 1xEV-DO, DVB-T/H, DTMB (CTTB), ISDB-T, CMMB, LTE, LTE-TDD, Digital Cable TV, WLAN, MSR, LTE-TDD, LTE-FDD
Remote Command	:CALCulate:PStatistic:MARKer[1] 2 ... 12:REference <integer> :CALCulate:PStatistic:MARKer[1] 2 ... 12:REference?
Example	CALC:PST:MARK:REF 3 CALC:PST:MARK:REF?
Notes	A marker cannot be relative to itself so that choice is grayed out, and if sent from SCPI generates error -221: "Settings conflict; marker cannot be relative to itself." When queried a single value will be returned (the specified marker numbers relative marker).
Preset	2 3 4 5 6 7 8 9 10 11 12 1
State Saved	Saved in instrument state.
Min	1
Max	12
Initial S/W Revision	Prior to A.02.00
Modified at S/W Revision	A.02.00, A.03.00

Marker Trace

Assigns the specified marker to the designated trace. The trace choices are:

- Measured
- Gaussian
- Reference

Key Path	Marker
Mode	SA, WCDMA, C2K, WIMAXOFDMA, TD-SCDMA, 1xEV-DO, DVB-T/H, DTMB (CTTB), ISDB-T, CMMB, LTE, LTE-TDD, Digital Cable TV, WLAN, MSR, LTE-TDD, LTE-FDD
Remote Command	:CALCulate:PStatistic:MARKer[1] 2 ... 12:TRACe MEASured GAUSSian REFerence :CALCulate:PStatistic:MARKer[1] 2 ... 12:TRACe?
Example	CALC:PST:MARK3:TRAC MEAS CALC:PST:MARK:TRACE?
Preset	MEASured
State Saved	Saved in instrument state.
Range	Measured Gaussian Reference
Initial S/W Revision	Prior to A.02.00
Modified at S/W Revision	A.02.00, A.03.00

Couple Markers

When this function is on, moving any marker causes an equal X axis movement of every other marker that is not off. By “equal X axis movement” we mean that we preserve the difference between each marker’s X axis value (in the fundamental x-axis units of the trace that marker is on) and the X axis value of the marker being moved (in the same fundamental x-axis units).

Key Path	Marker
Initial S/W Revision	Prior to A.02.00

All Markers Off

Turns off all markers.

Key Path	Marker, More
Mode	SA, WCDMA, C2K, WIMAXOFDMA, TD-SCDMA, 1xEV-DO, DVB-T/H, DTMB (CTTB), ISDB-T, CMMB, LTE, LTE-TDD, Digital Cable TV, WLAN, MSR, LTE-TDD, LTE-FDD
Remote Command	:CALCulate:PStatistic:MARKer:AOFF

Example	CALC:PST:MARK:AOFF
Initial S/W Revision	Prior to A.02.00
Modified at S/W Revision	A.02.00, A.03.00

Marker X Axis Value (Remote Command Only)

Sets the marker X Axis value in the current marker X Axis Scale unit. This function has no effect if the control mode is Off, but is the remote command equivalent of entering an X value if the control mode is Normal or Delta.

Mode	SA, WCDMA, C2K, WIMAXOFDMA, TD-SCDMA, 1xEV-DO, DVB-T/H, DTMB (CTTB), ISDB-T, CMMB, LTE, LTE-TDD, Digital Cable TV, WLAN, MSR, LTE-TDD, LTE-FDD
Remote Command	:CALCulate:PStatistic:MARKer[1] 2 ... 12:X <rel_amp1> :CALCulate:PStatistic:MARKer[1] 2 ... 12:X?
Example	CALC:PST:MARK3:X 0 CALC:PST:MARK3:X?
Notes	If no suffix is sent, it will use the fundamental units for the current marker X Axis Scale. If a suffix is sent that does not match the current marker X Axis Scale unit, an error "Invalid suffix" will be generated. If the specified marker is Fixed and a Marker Function is on, error -221 "Settings conflict; cannot adjust Fixed marker while Marker Function is on" is generated. The query returns the marker's absolute X Axis value if the control mode is Normal, or the offset from the marker's reference marker if the control mode is Delta. The query is returned in the fundamental units for the current marker X Axis scale: Hz for Frequency and Inverse Time, seconds for Period and Time. If the marker is Off the response is not a number.
Preset	After a preset, all Markers are turned OFF, so Marker X Axis Value query will return a not a number (NAN).
State Saved	No
Min	-9.9E+37
Max	9.9E+37
Initial S/W Revision	Prior to A.02.00
Modified at S/W Revision	A.02.00, A.03.00

Marker Y Axis Value (Remote Command Only)

Queries the marker Y Axis value in the current marker Y Axis unit.

Mode	SA, WCDMA, C2K, WIMAXOFDMA, TD-SCDMA, 1xEV-DO, DVB-T/H, DTMB (CTTB), ISDB-T, CMMB, LTE, LTE-TDD, Digital Cable TV, WLAN, MSR, LTE-TDD, LTE-FDD
Remote Command	:CALCulate:PStatistic:MARKer[1] 2 ... 12:Y?
Example	CALC:PST:MARK11:Y?
Notes	The query returns the marker Y-axis result, if the control mode is Normal, or Delta. If the marker is

	Off the response is not a number.
Preset	0
State Saved	No
Backwards Compatibility SCPI	:CALCulate:PStAtistic:MARKer[1] 2 ... 12:FUNction:RESult?
Initial S/W Revision	Prior to A.02.00
Modified at S/W Revision	A.02.00, A.03.00

Marker Function

There are no 'Marker Functions' supported in Power Stat CCDF measurement. The front-panel key displays a blank menu when pressed.

Key Path	Front-panel key
Initial S/W Revision	Prior to A.02.00

Marker To

There is no 'Marker To' functionality supported in Power Stat CCDF measurement. The front-panel key displays a blank menu when pressed.

Key Path	Front-panel key
Initial S/W Revision	Prior to A.02.00

Meas

The information in this section is common to all measurements. For key and remote command information for a specific measurement, refer to the section that describes the measurement of interest.

Measurements available under the Meas key are specific to the current Mode.

When viewing Help for measurements, note the following:

NOTE

Operation for some keys differs between measurements. The information displayed in Help pertains to the current measurement. To see how a key operates in a different measurement, exit Help (press the Cancel Esc key), select the measurement, then reenter Help (press the Help key) and press that key.

Key Path	Front-panel key
Initial S/W Revision	Prior to A.02.00

Remote Measurement Functions

This section contains the following topics:

["Measurement Group of Commands" on page 2206](#)

["Current Measurement Query \(Remote Command Only\)" on page 2208](#)

["Limit Test Current Results \(Remote Command Only\)" on page 2208](#)

["Data Query \(Remote Command Only\)" on page 2208](#)

["Calculate/Compress Trace Data Query \(Remote Command Only\)" on page 2209](#)

["Calculate Peaks of Trace Data \(Remote Command Only\)" on page 2214](#)

[Hardware-Accelerated Fast Power Measurement \(Remote Command Only\)](#)

["Format Data: Numeric Data \(Remote Command Only\)" on page 2215](#)

["Format Data: Byte Order \(Remote Command Only\)" on page 2216](#)

Initial S/W Revision	Prior to A.02.00
----------------------	------------------

Measurement Group of Commands

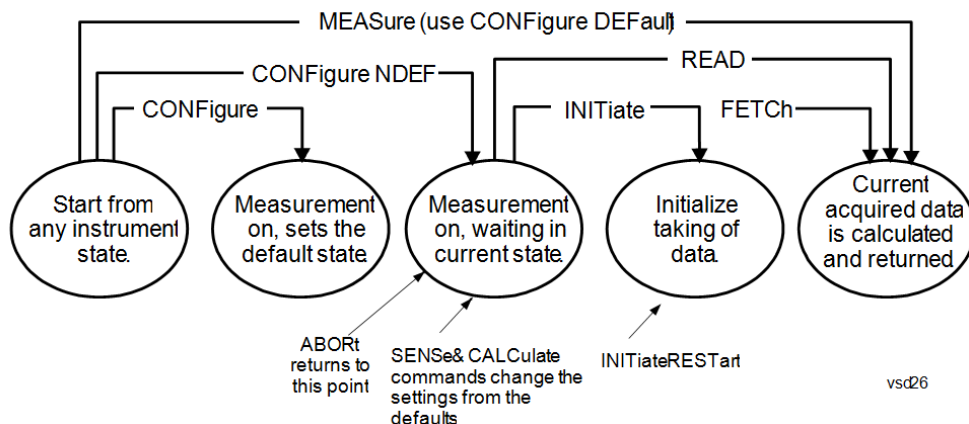

Measure Commands:

:MEASure:<measurement>[n]?

This is a fast single-command way to make a measurement using the factory default instrument settings. These are the settings and units that conform to the Mode Setup settings (e.g. radio standard) that you have currently selected.

- Stops the current measurement (if any) and sets up the instrument for the specified measurement using the factory defaults
- Initiates the data acquisition for the measurement
- Blocks other SCPI communication, waiting until the measurement is complete before returning results.
- If the function does averaging, it is turned on and the number of averages is set to 10.
- After the data is valid it returns the scalar results, or the trace data, for the specified measurement. The type of data returned may be defined by an [n] value that is sent with the command.
- The scalar measurement results will be returned if the optional [n] value is not included, or is set to 1. If the [n] value is set to a value other than 1, the selected trace data results will be returned. See each command for details of what types of scalar results or trace data results are available.
- ASCII is the default format for the data output. (Older versions of Spectrum Analysis and Phase Noise mode measurements only use ASCII.) The binary data formats should be used for handling large blocks of data since they are smaller and faster than the ASCII format. Refer to the FORMat:DATA command for more information.

If you need to change some of the measurement parameters from the factory default settings you can set up the measurement with the CONFIgure command. Use the commands in the SENSe:<measurement> and CALCulate:<measurement> subsystems to change the settings. Then you can use the READ? command to initiate the measurement and query the results.

If you need to repeatedly make a given measurement with settings other than the factory defaults, you can use the commands in the SENSe:<measurement> and CALCulate:<measurement> subsystems to set up the measurement. Then use the READ? command to initiate the measurement and query results.

Measurement settings persist if you initiate a different measurement and then return to a previous one. Use READ:<measurement>? if you want to use those persistent settings. If you want to go back to the default settings, use MEASure:<measurement>?.

Configure Commands:

:CONFIgure:<measurement>

This command stops the current measurement (if any) and sets up the instrument for the specified measurement using

the factory default instrument settings. It does not initiate the taking of measurement data unless INIT:CONTinuous is ON. If you change any measurement settings after using the CONFigure command, the READ command can be used to initiate a measurement without changing the settings back to their defaults.

In the Swept SA measurement in Spectrum Analyzer mode the CONFigure command also turns the averaging function on and sets the number of averages to 10 for all measurements.

:CONFigure: <measurement>: NDEFault stops the current measurement and changes to the specified measurement. It does not change the settings to the defaults. It does not initiate the taking of measurement data unless INIT:CONTinuous is ON.

The CONFigure? query returns the current measurement name.

The CONFigure:CATalog? query returns a quoted string of all licensed measurement names in the current mode. For example, "SAN, CHP, OBW, ACP, PST, TXP, SPUR, SEM, LIST".

Fetch Commands:

:FETCh:<measurement>[n]?

This command puts selected data from the most recent measurement into the output buffer. Use FETCh if you have already made a good measurement and you want to return several types of data (different [n] values, for example, both scalars and trace data) from a single measurement. FETCh saves you the time of re-making the measurement. You can only FETCh results from the measurement that is currently active, it will not change to a different measurement. An error message is reported if a measurement other than the current one is specified.

If you need to get new measurement data, use the READ command, which is equivalent to an INITiate followed by a FETCh.

The scalar measurement results will be returned if the optional [n] value is not included, or is set to 1. If the [n] value is set to a value other than 1, the selected trace data results will be returned. See each command for details of what types of scalar results or trace data results are available. The binary data formats should be used for handling large blocks of data since they are smaller and transfer faster than the ASCII format. (FORMat:DATA)

FETCh may be used to return results other than those specified with the original READ or MEASure command that you sent.

INITiate Commands:

:INITiate:<measurement>

This command is not available for measurements in all the instrument modes:

- Initiates a trigger cycle for the specified measurement, but does not output any data. You must then use the FETCh<meas> command to return data. If a measurement other than the current one is specified, the instrument will switch to that measurement and then initiate it.
- For example, suppose you have previously initiated the ACP measurement, but now you are running the channel power measurement. If you send INIT:ACP? it will change from channel power to ACP and will initiate an ACP measurement.
- Does not change any of the measurement settings. For example, if you have previously started the ACP measurement and you send INIT:ACP? it will initiate a new ACP measurement using the same instrument settings as the last time ACP was run.
- If your selected measurement is currently active (in the idle state) it triggers the measurement, assuming the trigger conditions are met. Then it completes one trigger cycle. Depending upon the measurement and the number of averages, there may be multiple data acquisitions, with multiple trigger events, for one full trigger cycle. It also holds off additional commands on GPIB until the acquisition is complete.

READ Commands:

:READ:<measurement>[n]?

- Does not preset the measurement to the factory default settings. For example, if you have previously initiated the ACP
-

measurement and you send READ:ACP? it will initiate a new measurement using the same instrument settings.

- Initiates the measurement and puts valid data into the output buffer. If a measurement other than the current one is specified, the instrument will switch to that measurement before it initiates the measurement and returns results.
 - For example, suppose you have previously initiated the ACP measurement, but now you are running the channel power measurement. Then you send READ:ACP? It will change from channel power back to ACP and, using the previous ACP settings, will initiate the measurement and return results.
 - Blocks other SCPI communication, waiting until the measurement is complete before returning the results
 - If the optional [n] value is not included, or is set to 1, the scalar measurement results will be returned. If the [n] value is set to a value other than 1, the selected trace data results will be returned. See each command for details of what types of scalar results or trace data results are available. The binary data formats should be used when handling large blocks of data since they are smaller and faster than the ASCII format. (FORMat:DATA)
-

Initial S/W Revision	Prior to A.02.00
----------------------	------------------

Current Measurement Query (Remote Command Only)

This command returns the name of the measurement that is currently running.

Remote Command	:CONFigure?
-----------------------	-------------

Example	CONF?
----------------	-------

Initial S/W Revision	Prior to A.02.00
----------------------	------------------

Limit Test Current Results (Remote Command Only)

Queries the status of the current measurement limit testing. It returns a 0 if the measured results pass when compared with the current limits. It returns a 1 if the measured results fail any limit tests.

Remote Command	:CALCulate:CLIMits:FAIL?
-----------------------	--------------------------

Example	CALC:CLIM:FAIL? queries the current measurement to see if it fails the defined limits. Returns a 0 or 1: 0 it passes, 1 it fails.
----------------	--

Initial S/W Revision	Prior to A.02.00
----------------------	------------------

Data Query (Remote Command Only)

Returns the designated measurement data for the currently selected measurement and subopcode.

n = any valid subopcode for the current measurement. See the measurement command results table for your current measurement, for information about what data is returned for the subopcodes.

This command uses the data setting specified by the FORMat:BORDER and FORMat:DATA commands and can return real or ASCII data. (See the format command descriptions under Input/Output in the Analyzer Setup section.)

Remote Command	:CALCulate:DATA[n]?
Notes	The return trace depends on the measurement. In CALCulate:<meas>:DATA[n], n is any valid subopcode for the current measurement. It returns the same data as the FETCH:<measurement>? query where <measurement> is the current measurement.
Initial S/W Revision	Prior to A.02.00

Calculate/Compress Trace Data Query (Remote Command Only)

Returns compressed data for the currently selected measurement and sub-opcode [n].

n = any valid sub-opcode for that measurement. See the MEASure:<measurement>? command description of your specific measurement for information on the data that can be returned.

The data is returned in the current Y Axis Unit of the analyzer. The command is used with a sub-opcode <n> (default=1) to specify the trace. With trace queries, it is best if the analyzer is not sweeping during the query. Therefore, it is generally advisable to be in Single Sweep, or Update=Off.

This command is used to compress or decimate a long trace to extract and return only the desired data. A typical example would be to acquire N frames of GSM data and return the mean power of the first burst in each frame. The command can also be used to identify the best curve fit for the data.

Remote Command	:CALCulate:DATA<n>:COMPRESS? BLOCK CFIT MAXimum MINimum MEAN DMEan RMS RMSCubed SAMPLE SDEVIation PPHase [,<soffset> [,<length>[,<roffset>[,<rlimit>]]]]
Example	To query the mean power of a set of GSM bursts: Supply a signal that is a set of GSM bursts. Select the IQ Waveform measurement (in IQ Analyzer Mode). Set the sweep time to acquire at least one burst. Set the triggers such that acquisition happens at a known position relative to a burst. Then query the mean burst levels using, CALC:DATA2:COMP? MEAN, 24e-6, 526e-6 (These parameter values correspond to GSM signals, where 526e-6 is the length of the burst in the slot and you just want 1 burst.)
Notes	The command supports 5 parameters. Note that the last 4 (<soffset>, <length>, <roffset>, <rlimit>) are optional. But these optional parameters must be entered in the specified order. For example, if you want to specify <length>, then you must also specify <soffset>. See details below for a definition of each of these parameters. This command uses the data in the format specified by FORMat:DATA, returning either binary or ASCII data.
Initial S/W Revision	Prior to A.02.00

- BLOCK or block data - returns all the data points from the region of the trace data that you specify. For example, it could be used to return the data points of an input signal over several timeslots, excluding the portions of the trace data that you do not want. (This is x,y pairs for trace data and I,Q pairs for complex data.)

- CFIT or curve fit - applies curve fitting routines to the data. <soffset> and <length> are required to define the data that you want. <roffset> is an optional parameter for the desired order of the curve equation. The query will return the following values: the x-offset (in seconds) and the curve coefficients ((order + 1) values).

MIN, MAX, MEAN, DME, RMS, RMSC, SAMP, SDEV and PPH return one data value for each specified region (or <length>) of trace data, for as many regions as possible until you run out of trace data (using <roffset> to specify regions). Or they return the number of regions you specify (using <rlimit>) ignoring any data beyond that.

- MINimum - returns the minimum data point (y value) for the specified region(s) of trace data. For I/Q trace data, the minimum magnitude of the I/Q pairs is returned.
- MAXimum - returns the maximum data point (y value) for the specified region(s) of trace data. For I/Q trace data, the maximum magnitude of the I/Q pairs is returned.
- MEAN - returns a single value that is the arithmetic mean of the data point values (in dB/ dBm) for the specified region(s) of trace data. For I/Q trace data, the mean of the magnitudes of the I/Q pairs is returned. See the following equations.

•

NOTE If the original trace data is in dB, this function returns the arithmetic mean of those log values, not log of the mean power which is a more useful value. The mean of the log is the better measurement technique when measuring CW signals in the presence of noise. The mean of the power, expressed in dB, is useful in power measurements such as Channel Power. To achieve the mean of the power, use the RMS option.

Equation 1

Mean Value of Data Points for Specified Region(s)

$$\text{MEAN} = \frac{1}{n} \sum_{X_i \in \text{region}(s)} X_i$$

where X_i is a data point value, and n is the number of data points in the specified region(s).

Equation 2

Mean Value of I/Q Data Pairs for Specified Region(s)

$$\text{MEAN} = \frac{1}{n} \sum_{X_i \in \text{region}(s)} |X_i|$$

where $|X_i|$ is the magnitude of an I/Q pair, and n is the number of I/Q pairs in the specified region(s).

- DMEan - returns a single value that is the mean power (in dB/ dBm) of the data point values for the specified region(s) of trace data. See the following equation:

Equation 3

DMEan Value of Data Points for Specified Region(s)

$$\text{DME} = 10 \times \log_{10} \left(\frac{1}{n} \sum_{X_i \in \text{region}(s)} 10^{\frac{X_i}{10}} \right)$$

- RMS - returns a single value that is the average power on a root-mean-squared voltage scale (arithmetic rms) of the data point values for the specified region(s) of trace data. See the following equation.

NOTE For I/Q trace data, the rms of the magnitudes of the I/Q pairs is returned. See the following equation. This function is very useful for I/Q trace data. However, if the original trace data is in dB, this function returns the rms of the log values which is not usually needed.

Equation 4

RMS Value of Data Points for Specified Region(s)

$$\text{RMS} = \sqrt{\frac{1}{n} \sum_{X_i \in \text{region}(s)} X_i^2}$$

where X_i is a data point value, and n is the number of data points in the specified region(s).

Equation 5

RMS Value of I/Q Data Pairs for Specified Region(s)

$$\text{RMS} = \sqrt{\frac{1}{n} \sum_{X_i \in \text{region}(s)} X_i X_i^*}$$

where X_i is the complex value representation of an I/Q pair, X_i^* its conjugate complex number, and n is the number of I/Q pairs in the specified region(s).

Once you have the rms value for a region of trace data (linear or I/Q), you may want to calculate the mean power. You must convert this rms value (peak volts) to power in dBm:

$$10 \times \log[10 \times (\text{rms value})^2]$$

- SAMPLe - returns the first data value (x,y pair) for the specified region(s) of trace data. For I/Q trace data, the first I/Q pair is returned.
- SDEViation - returns a single value that is the arithmetic standard deviation for the data point values for the specified region(s) of trace data. See the following equation.
- For I/Q trace data, the standard deviation of the magnitudes of the I/Q pairs is returned. See the following equation.

Equation 6

Standard Deviation of Data Point Values for Specified Region(s)

$$\text{SDEV} = \sqrt{\frac{1}{n} \sum_{X_i \in \text{region}(s)} (X_i - \bar{X})^2}$$

where X_i is a data point value, \bar{X} is the arithmetic mean of the data point values for the specified region (s), and n is the number of data points in the specified region(s).

$$\text{SDEV} = \sqrt{\frac{1}{n} \sum_{X_i \in \text{region}(s)} (|X_i| - \bar{X})^2}$$

where $|X_i|$ is the magnitude of an I/Q pair, \bar{X} is the mean of the magnitudes for the specified region(s), and n is the number of data points in the specified region(s).

- PPHase - returns the x,y pairs of both rms power (dBm) and arithmetic mean phase (radian) for every specified region and frequency offset (Hz). The number of pairs is defined by the specified number of regions. This parameter can be used for I/Q vector ($n=0$) in Waveform (time domain) measurement and all parameters are specified by data point in PPHase.

The rms power of the specified region may be expressed as:

$$\text{Power} = 10 \times \log [10 \times (\text{RMS I/Q value})] + 10.$$

The RMS I/Q value (peak volts) is:

$$\sqrt{\frac{1}{n} \sum_{X_i \in \text{region}} X_i X_i^*}$$

where X_i is the complex value representation of an I/Q pair, X_i^* its conjugate complex number, and n is the number of I/Q pairs in the specified region.

The arithmetic mean phase of the specified region may be expressed as:

$$\frac{1}{n} \sum_{Y_i \in \text{region}} Y_i$$

where Y_i is the unwrapped phase of I/Q pair with applying frequency correction and n is the number of I/Q pairs in the specified region.

The frequency correction is made by the frequency offset calculated by the arithmetic mean of every specified region's frequency offset. Each frequency offset is calculated by the least square method against the unwrapped phase of I/Q pair.

Sample Trace Data - Constant Envelope

(See below for explanation of variables.)

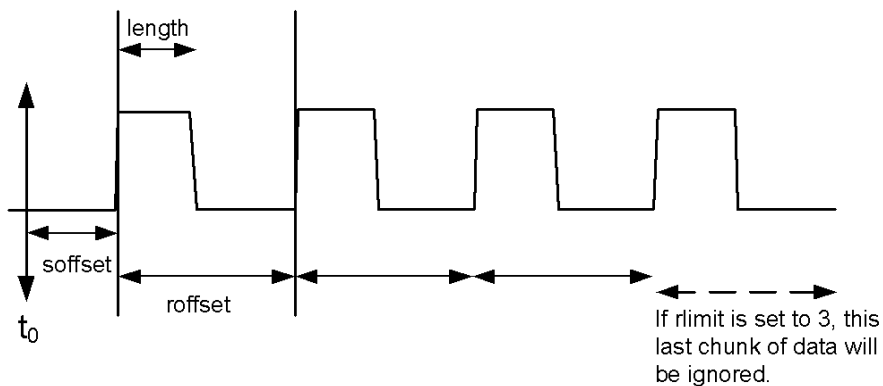

Sample Trace Data - Not Constant Envelope

(See below for explanation of variables.)

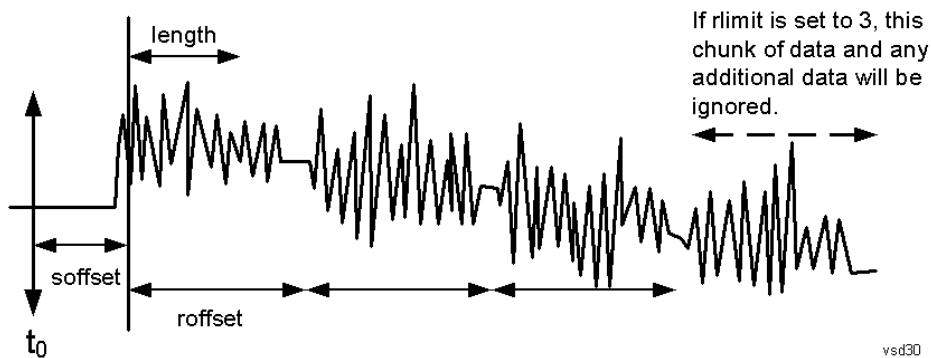

<soffset> - start offset is an optional real number. (It is in seconds for time-domain traces, and is a dimensionless index 0 to Npoints - 1, for frequency-domain traces). It specifies the amount of data at the beginning of the trace that will be ignored before the decimation process starts. It is the time or frequency change from the start of the trace to the point where you want to start using the data. The default value is zero.

<length> - is an optional real number. (It is in seconds for time-domain traces, and is a dimensionless index 0 to Npoints - 1, for frequency-domain traces). It defines how much data will be compressed into one value. This parameter has a default value equal to the current trace length.

<roffset> - repeat offset is an optional real number. (It is in seconds for time-domain traces, and is a dimensionless index 0 to Npoints - 1, for frequency-domain traces). It defines the beginning of the next field of trace elements to be compressed. This is relative to the beginning of the previous field. This parameter has a default value equal to the <length> variable. Note that this parameter is used for a completely different purpose when curve fitting (see CFIT above).

<rlimit> - repeat limit is an optional integer. It specifies the number of data items that you want returned. It will ignore any additional items beyond that number. You can use the Start offset and the Repeat limit to pick out exactly what part of the data you want to use. The default value is all the data.

Calculate Peaks of Trace Data (Remote Command Only)

Returns a list of all the peaks for the currently selected measurement and sub-opcode [n]. The peaks must meet the requirements of the peak threshold and excursion values.

n = any valid sub-opcode for the current measurement. See the MEASure:<measurement> command description of your specific measurement for information on the data that can be returned.

The command can only be used with specific sub-opcodes with measurement results that are trace data. Both real and complex traces can be searched, but complex traces are converted to magnitude in dBm. In many measurements the sub-opcode n=0, is the raw trace data which cannot be searched for peaks. And Sub-opcode n=1, is often calculated results values which also cannot be searched for peaks.

This command uses the data setting specified by the FORMat:BORDER and FORMat:DATA commands and can return real or ASCII data. If the format is set to INT,32, it returns REAL,32 data.

The command has four types of parameters:

- Threshold (in dBm)
- Excursion (in dB)
- Sorting order (amplitude, frequency, time)
- Optional in some measurements: Display line use (all, > display line, < display line)

Remote Command	<p>For Swept SA measurement:</p> <pre>:CALCulate:DATA[1] 2 ... 6:PEAKs? <threshold>,<excursion>[,AMPLitude FREQuency TIME[,ALL GTDLine LTDLine]]</pre> <p>For most other measurements:</p> <pre>:CALCulate:DATA[1] 2 ... 6:PEAKs? <threshold>,<excursion>[,AMPLitude FREQuency TIME]</pre>
-----------------------	--

Example	<p>Example for Swept SA measurement in Spectrum Analyzer Mode:</p> <p>CALC:DATA4:PEAK? -40, 10, FREQ, GTDL This will identify the peaks of trace 4 that are above -40 dBm, with excursions of at least 10 dB. The peaks are returned in order of increasing frequency, starting with the lowest frequency. Only the peaks that are above the display line are returned.</p> <p>Query Results 1:</p> <p>With FORMat:DATA REAL, 32 selected, it returns a list of floating-point numbers. The first value in the list is the number of peak points that are in the following list. A peak point consists of two values: a peak amplitude followed by its corresponding frequency (or time).</p> <p>If no peaks are found the peak list will consist of only the number of peaks, (0).</p>
----------------	---

Notes	<p><n> - is the trace that will be used</p> <p><threshold> - is the level below which trace data peaks are ignored. Note that the threshold value is required and is always used as a peak criterion. To effectively disable the threshold criterion for this command, provide a substantially low threshold value such as -200 dBm. Also note that the threshold value used in this command is independent of and has no effect on the threshold value stored under the Peak Criteria menu.</p> <p><excursion> - is the minimum amplitude variation (rise and fall) required for a signal to be identified as peak. Note that the excursion value is required and is always used as a peak criterion. To effectively disable the excursion criterion for this command, provide the minimum value of 0.0 dB. Also note that the excursion value used in this command is independent of and has no effect on the</p>
--------------	---

excursion value stored under the Peak Criteria menu.

Values must be provided for threshold and excursion. The sorting and display line parameters are optional (defaults are AMPLitude and ALL).

Note that there is always a Y-axis value for the display line, regardless of whether the display line state is on or off. It is the current Y-axis value of the display line which is used by this command to determine whether a peak should be reported

Sorting order:

AMPLitude - lists the peaks in order of descending amplitude, with the highest peak first (default if optional parameter not sent)

FREQUency - lists the peaks in order of occurrence, left to right across the x-axis.

TIME - lists the peaks in order of occurrence, left to right across the x-axis.

Peaks vs. Display Line:

ALL - lists all of the peaks found (default if optional parameter not sent).

GTDLine (greater than display line) - lists all of the peaks found above the display line.

LTDLine (less than display line) - lists all of the peaks found below the display line.

Initial S/W Revision Prior to A.02.00

Format Data: Numeric Data (Remote Command Only)

This command specifies the format of the trace data input and output. It specifies the formats used for trace data during data transfer across any remote port. It affects only the data format for setting and querying trace data for the :TRACe[:DATA], TRACe[:DATA]?, :CALCulate:DATA[n]? and FETCh:SANalyzer [n]? commands and queries.

Remote Command :FORMat[:TRACe][:DATA] ASCii|INTeger,32|REAL,32 |REAL,64
:FORMat[:TRACe][:DATA]?

Notes The query response is:
ASCii: ASC,8
REAL,32: REAL,32
REAL,64: REAL,64
INTeger,32: INT,32

When the numeric data format is REAL or ASCii, data is output in the current Y Axis unit. When the data format is INTeger, data is output in units of m dBm (.001 dBm).

The INT,32 format returns binary 32-bit integer values in internal units (m dBm), in a definite length block.

Dependencies Sending a data format spec with an invalid number (for example, INT,48) generates no error. The analyzer simply uses the default (8 for ASCii, 32 for INTeger, 32 for REAL).

Sending data to the analyzer which does not conform to the current FORMat specified, results in an error. Sending ASCII data when a definite block is expected generates message -161 "Invalid Block Data" and sending a definite block when ASCII data is expected generates message -121 "Invalid Character in Number".

Preset ASCii

Backwards Compatibility Notes Note that the INT,32 format is only applicable to the command, TRACe:DATA. This preserves backwards compatibility for the Swept SA measurement. For all other commands/queries which honor FORMat:DATA, if INT,32 is sent the analyzer will behave as though it were set to REAL,32.

Initial S/W Revision Prior to A.02.00

The specs for each output type follow:

AScii - Amplitude values are in ASCII, in the current Y Axis Unit, one ASCII character per digit, values separated by commas, each value in the form:

SX.YYYYYEsZZ

Where:

S = sign (+ or -)

X = one digit to left of decimal point

Y = 5 digits to right of decimal point

E = E, exponent header

s = sign of exponent (+ or -)

ZZ = two digit exponent

REAL,32 - Binary 32-bit real values in the current Y Axis Unit, in a definite length block.

REAL,64 - Binary 64-bit real values in the current Y Axis Unit, in a definite length block.

Format Data: Byte Order (Remote Command Only)

This command selects the binary data byte order for data transfer and other queries. It controls whether binary data is transferred in normal or swapped mode. This command affects only the byte order for setting and querying trace data for the :TRACe[:DATA], TRACe[:DATA]? , :CALCulate:DATA[n]? and FETCh:SANalyzer[n]? commands and queries.

By definition any command that says it uses FORMat:DATA uses any format supported by FORMat:DATA.

The NORMal order is a byte sequence that begins with the most significant byte (MSB) first, and ends with the least significant byte (LSB) last in the sequence: 1|2|3|4. SWAPped order is when the byte sequence begins with the LSB first, and ends with the MSB last in the sequence: 4|3|2|1.

Remote Command	:FORMat:BORDER NORMal SWAPped :FORMat:BORDER?
Preset	NORMal
Initial S/W Revision	Prior to A.02.00

Meas Setup

Accesses the functions that allow you to change the settings for your measurement requirements.

Key Path	Front-panel key
Initial S/W Revision	Prior to A.02.00

Counts

Sets the accumulated number of sampling points for data acquisition. The range is 1.000 kpt (k point) to 2.00000 Gpt (G point) with 1 kpt resolution. Counts couples to Meas Cycles. When the value for counts is changed, the Meas Cycles value will be $(\text{Counts} / \text{SamplingFrequency} * \text{MeasInterval})$.

Key Path	Meas Setup
Mode	SA, WCDMA, C2K, WIMAXOFDMA, TD-SCDMA, 1xEV-DO, DVB-T/H, DTMB (CTTB), ISDB-T, CMMB, LTE, LTE-TDD, Digital Cable TV, WLAN, MSR, LTE-TDD, LTEAFDD
Remote Command	<code>[[:SENSe]:PStatistic:COUNTs <integer></code> <code>[[:SENSe]:PStatistic:COUNTs?</code>
Example	PST:COUN 5001 PST:COUN?
Couplings	This value is coupled to Meas Cycles. When Counts is changed, the MeasCycles value will be $(\text{Counts} / \text{SamplingFrequency} * \text{MeasInterval})$. TD-SCDMA: When Counts is changed, the MeasCycles value will be $(\text{Counts} / (\text{Sampling Frequency} * \text{Time duration of measured time slots} / 5 \text{ msec}))$, Time duration of measured time slots is determined by Analysis Time Slot and Measure Interval.
Preset	10000000
State Saved	Saved in instrument state.
Min	1000
Max	2000000000
Default Unit	Kpt
Initial S/W Revision	Prior to A.02.00
Modified at S/W Revision	A.02.00, A.03.00

Meas Cycles

Set the number of measurement cycles to calculate power statistic data. This number couples to Counts. The Counts value is $(\text{MeasCycles} * \text{Sampling Frequency} * \text{MeasInterval})$.

When the counts value cannot be divided by $(\text{Sampling Frequency} * \text{MeasInterval})$, this value is displayed as a decimal fraction.

Key Path	Meas Setup
----------	------------

Mode	SA, WCDMA, C2K, WiMAX OFDMA, TD-SCDMA, 1xEV-DO, DVB-T/H, DTMB (CTTB), ISDB-T, CMMB, LTE, LTE-TDD, Digital Cable TV, WLAN, MSR, LTE-TDD, LTE-FDD
Remote Command	[:SENSe] :PStatistic:SWEep:CYCLes <integer> [:SENSe] :PStatistic:SWEep:CYCLes?
Example	PST:SWE:CYCL 1001 PST:SWE:CYCL?
Notes	.
Couplings	The Counts value will be (MeasCycles * Sampling Frequency * MeasInterval). TD-SCDMA: The Counts value will be (MeasCycles * Sampling Frequency * Time duration of measured time slots / 5 msec), Time duration of measured time slots is determined by Analysis Time Slot and Measure Interval.
Preset	Depends on the sampling frequency.
Min	1
Max	Depends on the sampling frequency.
Initial S/W Revision	Prior to A.02.00
Modified at S/W Revision	A.02.00, A.03.00

Meas Interval (Not 1xEVDO)

Sets the number of data points to be used as the measurement interval. This value couples to Counts. The Counts value is (MeasCycles * Sampling Frequency * MeasInterval).

Key Path	Meas Setup
Mode	SA, WCDMA, C2K, WiMAX OFDMA, TD-SCDMA, DVB-T/H, DTMB (CTTB), ISDB-T, CMMB, LTE, LTE-TDD, Digital Cable TV, WLAN, MSR, LTE-TDD, LTE-FDD
Remote Command	[:SENSe] :PStatistic:SWEep:TIME <time> [:SENSe] :PStatistic:SWEep:TIME?
Example	PST:SWE:TIME 2 ms PST:SWE:TIME?
Couplings	The Counts value will be (MeasCycles * Sampling Frequency * MeasInterval). WiMAX OFDMA: The default value depends on Radio Device status. TD-SCDMA: The Counts value will be (MeasCycles * Sampling Frequency * Time duration of measured time slots / 5 msec), Time duration of measured time slots is determined by Analysis Time Slot and Measure Interval. When TriggerSource is RFBurst, this button is grayed.
Preset	Others: 1.0 ms TD-SCDMA: 1 slot LTE-TDD, LTE-TDD: 500 us
Min	Others: 50.0 us TD-SCDMA: 1 slot

Max	Others: 10.0 ms TD-SCDMA: 9 slot
Initial S/W Revision	Prior to A.02.00
Modified at S/W Revision	A.02.00, A.03.00

IF Gain

Sets the IF Gain function to Auto, Low Gain or High Gain. These settings affect sensitivity and IF overloads. This only applies to the RF input. It does not apply to baseband I/Q input.

Key Path	Meas Setup
Dependencies	The IF Gain keys (FFT IF Gain and Swept IF Gain) have no effect when the U7227A USB Preamplifier is connected. This is not annotated or reflected on any softkey; there are no keys grayed out nor any SCPI locked out. The analyzer simply behaves as though both FFT IF Gain and Swept IF Gain are set to Low regardless of the setting on the keys.
Initial S/W Revision	Prior to A.02.00

IF Gain Auto

Activates the Auto Rules for IF Gain When Auto is active, the IF Gain is set to High Gain under any of the following conditions:

- the input attenuator is set to 0 dB
- the preamp is turned On
- the Max Mixer Level is -20 dBm or lower

For other settings, Auto sets IF Gain to Off.

Key Path	Meas Setup, IF Gain
Mode	SA, WCDMA, C2K, WiMAX OFDMA, TD-SCDMA, 1xEV-DO, DVB-T/H, DTMB (CTTB), ISDB-T, CMMB, LTE, LTE-TDD, Digital Cable TV, WLAN, MSR, LTE-TDD, LTE-FDD
Remote Command	<code>[:SENSe] :PStatistic:IF:GAIN:AUTO[:STATe] ON OFF 1 0</code> <code>[:SENSe] :PStatistic:IF:GAIN:AUTO[:STATe] ?</code>
Example	<code>PST:IF:GAIN:AUTO ON</code> <code>PST:IF:GAIN:AUTO?</code>
Notes	IF Gain only applies to the RF input. It does not apply to baseband I/Q input.
Couplings	When either the auto attenuation is active (for example, with electrical attenuator), or the optimize mechanical attenuator range is requested, the IF Gain setting is changed using the following rule. The Auto selection sets IF Gain On under any of the following conditions: <ul style="list-style-type: none"> • the input attenuator is set to 0 dB • the preamp is turned on,

	<ul style="list-style-type: none"> the Max Mixer Level is -20 dBm or lower. For other settings, Auto sets IF Gain to Off.
Preset	OFF
State Saved	Saved in instrument state.
Range	Auto Man
Initial S/W Revision	Prior to A.02.00
Modified at S/W Revision	A.02.00, A.03.00

IF Gain State

Selects the range of IF gain. On sets the high gain option, which allows for better noise level measurements and Off sets low gain when measuring large signals.

Key Path	Meas Setup, IF Gain
Mode	SA, WCDMA, C2K, WIMAXOFDMA, TD-SCDMA, 1xEV-DO, DVB-T/H, DTMB (CTTB), ISDB-T, CMMB, LTE, LTE-TDD, Digital Cable TV, WLAN, MSR, LTE-TDD, LTEAFDD
Remote Command	[:SENSe]:PStatistic:IF:GAIN[:STATe] ON OFF 1 0 [:SENSe]:PStatistic:IF:GAIN[:STATe]?
Example	PST:IF:GAIN ON PST:IF:GAIN?
Notes	IF Gain only applies to the RF input. It does not apply to baseband I/Q input. where ON = high gain OFF = low gain
Preset	OFF
State Saved	Saved in instrument state.
Range	Low Gain (Best for Large Signals) High Gain (Best Noise Level)
Readback Text	Low Gain High Gain
Initial S/W Revision	Prior to A.02.00
Modified at S/W Revision	A.02.00, A.03.00

Meas Preset

Restores all measurement settings to their default values.

Key Path	Meas Setup
Mode	SA, WCDMA, C2K, WIMAXOFDMA, TD-SCDMA, 1xEV-DO, DVB-T/H, DTMB (CTTB), ISDB-T, CMMB, LTE, LTE-TDD, Digital Cable TV, WLAN, MSR, LTE-TDD, LTEAFDD
Remote Command	:CONFigure:PStatistic
Example	CONF:PST

Notes	You must be in the Spectrum Analysis mode, W-CDMA mode, cdma2000 mode, TD-SCDMA mode, DVB-T/H mode, DTMB (CTTB) mode, SDB-T mode, CMMB mode, Digital Cable TV mode or WIMAXOFDMA mode to use this command. Use :INSTRument:SElect to set the mode.
Couplings	Selecting Meas Preset will restore all measurement parameters to their default values.
Initial S/W Revision	Prior to A.02.00
Modified at S/W Revision	A.02.00, A.03.00

15 Power Stat CCDF Measurement
Mode

Mode

See "[Mode](#)" on page 286

Mode Preset

Returns the active mode to a known state.

Mode Preset does the following for the currently active mode:

- Aborts the currently running measurement.
- Brings up the default menu for the mode, with no active function.
- Sets measurement Global settings to their preset values for the active mode only.
- Activates the default measurement.
- Brings up the default menu for the mode.
- Clears the input and output buffers.
- Sets Status Byte to 0.

Mode Preset does not:

- Cause a mode switch
- Affect mode persistent settings
- Affect system settings

See "[How-To Preset](#)" on page 1892 for more information.

Key Path	Front-panel key
Remote Command	:SYSTem:PRESet
Example	:SYST:PRES
Notes	*RST is preferred over :SYST:PRES for remote operation. *RST does a Mode Preset, as done by the :SYST:PRES command, and it sets the measurement mode to Single measurement rather than Continuous for optimal remote control throughput. Clears all pending OPC bits. The Status Byte is set to 0.
Couplings	A Mode Preset aborts the currently running measurement, activates the default measurement, and gets the mode to a consistent state with all of the default couplings set.
Backwards Compatibility Notes	In the X-Series, the legacy "Factory Preset" has been replaced with Mode Preset, which only presets the currently active mode, not the entire instrument. In the X-Series, the way to preset the entire instrument is by using System, Restore System Defaults All, which behaves essentially the same way as restore System Defaults does on ESA and PSA. There is also no "Preset Type" as there is on the PSA. There is a green Mode Preset front-panel key that does a Mode Preset and a white-with-green-letters User Preset front-panel key that does a User Preset. The old PRESet:TYPE command is ignored (without generating an error), and SYST:PRES without a parameter does a Mode Preset, which should cover most backward code compatibility issues. The settings and correction data under the Input/Output front-panel key (examples: Input Z Corr, Ext Amp Gain, etc.) are no longer part of any Mode, so they will not be preset by a Mode Preset. They are preset using Restore Input/Output Defaults, Restore System Defaults All. Note that because User Preset does a Recall State, and all of these settings are saved in State, they ARE recalled when using

	User Preset.
Initial S/W Revision	Prior to A.02.00

How-To Preset

The table below shows all possible presets, their corresponding SCPI commands and front-panel access (key paths). Instrument settings depend on the current measurement context. Some settings are local to the current measurement, some are global (common) across all the measurements in the current mode, and some are global to all the available modes. In a similar way, restoring the settings to their preset state can be done within the different contexts.

Auto Couple - is a measurement local key. It sets all Auto/Man parameter couplings in the measurement to Auto. Any Auto/Man selection that is local to other measurements in the mode will not be affected.

Meas Preset - is a measurement local key. Meas Preset resets all the variables local to the current measurement except the persistent ones.

Mode Preset - resets all the current mode's measurement local and measurement global variables except the persistent ones.

Restore Mode Defaults - resets ALL the Mode variables (and all the Meas global and Meas local variables), including the persistent ones.

Type Of Preset	SCPI Command	Front Panel Access
Auto Couple	:COUPle ALL	Auto Couple front-panel key
Meas Preset	:CONFigure:<Measurement>	Meas Setup Menu
Mode Preset	:SYSTem:PRESet	Mode Preset (green key)
Restore Mode Defaults	:INSTrument:DEFault	Mode Setup Menu
Restore All Mode Defaults	:SYSTem:DEFault MODes	System Menu; Restore System Default Menu
*RST	*RST	not possible (Mode Preset with Single)
Restore Input/Output Defaults	:SYSTem:DEFault INPUt	System Menu; Restore System Default Menu
Restore Power On Defaults	:SYSTem:DEFault PON	System Menu; Restore System Default Menu
Restore Alignment Defaults	:SYSTem:DEFault ALIGN	System Menu; Restore System Default Menu
Restore Miscellaneous Defaults	:SYSTem:DEFault MISC	System Menu; Restore System Default Menu
Restore All System Defaults	:SYSTem:DEFault [ALL] :SYSTem:PRESet:PERsistent	System Menu; Restore System Default Menu
User Preset	:SYSTem:PRESet:USER	User Preset Menu
User Preset All Modes	:SYSTem:PRESet:USER:ALL	User Preset Menu

Power On Mode Preset	:SYSTem:PON:TYPE MODE	System Menu
Power On User Preset	:SYSTem:PON:TYPE USER	System Menu
Power On Last State	:SYSTem:PON:TYPE LAST	System Menu

Preset Type (Remote Command Only)

As stated in the Backward Compatibility section, to be compatible with ESA/PSA the PRESet:TYPE command will be implemented as a no-op.

Mode	All
Remote Command	:SYSTem:PRESet:TYPE FACTory MODE USER :SYSTem:PRESet:TYPE?
Example	:SYST:PRESet:TYPE FACT
Notes	This command is supported for backward compatibility only. It is a no-op which does not change the behavior of any preset operation.
Preset	This is unaffected by Preset but is set to Mode on a “Restore System Defaults->All”
State Saved	No
Initial S/W Revision	Prior to A.02.00

Mode Setup

See "[Mode Setup](#)" on page 316

Peak Search

There is no 'Peak Search' functionality supported in Power Stat CCDF measurement. The front-panel key displays a blank menu when pressed.

Key Path	Front-panel key
Initial S/W Revision	Prior to A.02.00

15 Power Stat CCDF Measurement
Print

Print

See "Print" on page 341

Quick Save

The Quick Save front-panel key repeats the most recent save that was performed from the Save menu, with the following exceptions:

- Register saves are not remembered as Saves for the purpose of the Quick Save function
- If the current measurement does not support the last non-register save that was performed, an informational message is generated, “File type not supported for this measurement”

Quick Save repeats the last type of qualified save (that is, a save qualified by the above criteria) in the last save directory by creating a unique filename using the Auto File Naming algorithm described below.

If Quick Save is pressed after startup and before any qualified Save has been performed, the Quick Save function performs a Screen Image save using the current settings for Screen Image saves (current theme, current directory), which then becomes the “last save” for the purpose of subsequent Quick Saves.

The Auto File Naming feature automatically generates a file name for use when saving a file. The filename consists of a prefix and suffix separated by a dot, as is standard for the Windows® file system. A default prefix exists for each of the available file types:

Type	Default Prefix	Menu
State	State_	(Save/Recall)
Trace + State	State_	(Save/Recall)
Screen	Screen_	(Save/Recall)
Amplitude Corrections	Ampcor_	(Import/Export)
Traces	Trace_	(Import/Export)
Limit Lines	LLine_	(Import/Export)
Measurement Result	MeasR_	(Import/Export)
Capture Buffer	CapBuf_	(Import/Export)

A four digit number is appended to the prefix to create a unique file name. The numbering sequence starts at 0000 within each Mode for each file type and updates incrementally to 9999, then wraps to 0000 again. It remembers where it was through a Mode Preset and when leaving and returning to the Mode. It is reset by Restore Misc Defaults and Restore System Defaults and subsequent running of the instrument application. So, for example, the first auto file name generated for State files is State_0000.state. The next is State_0001, and so forth.

One of the key features of Auto File Name is that we guarantee that the Auto File Name will never conflict with an existing file. The algorithm looks for the next available number. If it gets to 9999, then it looks for holes. If it find no holes, that is no more numbers are available, it gives an error.

For example, if when we get to State_0010.state there is already a State_0010.state file in the current directory, it advances the counter to State_0011.state to ensure that no conflict will exist (and then it verifies that State_0011.state also does not exist in the current directory and advances again if it does, and so forth).

If you enter a file name for a given file type, then the prefix becomes the filename you entered instead of the default prefix, followed by an underscore. The last four letters (the suffix) are the 4-digit number.

For example, if you save a measurement results file as “fred.csv”, then the next auto file name chosen for a measurement results save will be fred_0000.csv.

NOTE

Although 0000 is used in the example above, the number that is used is actually the current number in the Meas Results sequence, that is, the number that would have been used if you had not entered your own file name.

NOTE

If the filename you entered ends with _dddd, where d=any number, making it look just like an auto file name, then the next auto file name picks up where you left off with the suffix being dddd + 1.

Key Path	Front-panel key
Notes	No remote command for this key specifically.
Initial S/W Revision	Prior to A.02.00

Recall

The Recall menu lets you choose what you want to recall, and where you want to recall it from. Among the types of files you can recall are **States and Traces**. In addition, an Import (Data) option lets you recall a number of data types stored in CSV files (as used by Excel and other spreadsheet programs).

The default paths for Recall are data type dependent and are the same as for the Save key.

Key Path	Front-panel key
Notes	<p>No remote command for this key specifically, but the :MMEM:LOAD command is available for specific file types. An example is :MMEM:LOAD:STATe <filename>.</p> <p>If you try to recall a State file for a mode that is not licensed or not available in the instrument, an error message will occur and the state will not change.</p>
Backwards Compatibility Notes	<p>In legacy analyzers, it was possible to load a state without affecting the trace data, limit lines or correction data. Similarly (since User Preset is actually loading a state), it was possible to do a User Preset without affecting the trace data, limit lines or correction data.</p> <p>In the X-Series, “state” always includes all of this data; so whenever state is loaded, all of the traces, limit lines and corrections are affected. Although this differs from previous behavior, it is desirable behavior, and should not cause adverse issues for users.</p>
Backwards Compatibility Notes	<p>Recall for the X-Series supports backward compatibility in the sense that you can recall a state file from any X-Series model number and any version of X-Series software. This is only possible if part of the recalling process goes through a limiting step after recalling the mode settings, at least for settings that may vary with version number, model number, option and license differences. If you try to recall a state file onto an instrument with less capability than what was available on the instrument during the save, the recall will ignore the state it doesn't support and it will limit the recalled setting to what it allows.</p> <p>Example: if the saved state includes preamp ON, but the recalling instrument does not have a preamp; the preamp is limited to OFF. Conversely, if you save a state without a preamp, the preamp is OFF in the state file. When this saved file is recalled on an instrument with a licensed preamp, the preamp is changed to OFF. Another example is if the saved state has center frequency set to 20 GHz, but the instrument recalling the saved state is a different model and only supports 13.5 GHz. In this case, the center frequency is limited along with any other frequency based settings. Since the center frequency can't be preserved in this case, the recall limiting tries to at least preserve span to keep the measurement setup as intact as possible.</p> <p>It may be appropriate to issue a warning if the state is limited on the recall; warnings do not go out to SCPI so this would only affect the manual user.</p> <p>Note that there is no state file compatibility outside of the X-Series. For example, you cannot recall a state file from ESA or PSA.</p>
Initial S/W Revision	Prior to A.02.00

State

The Recall State menu lets you choose a register or file from which to recall the state.

The content of a state file includes all of the settings and data required to return the analyzer as closely as possible to the Mode it was in, with the exact settings that were in place, when the save occurred. The Mode settings in each state file include the settings that are affected by Mode Preset, as well as the

additional settings affected by Restore Mode Defaults; all of the Mode's settings. In addition, all of the settings of the Input/Output system are included, even though they are outside of the Mode's state, because they are needed to restore the complete setup. Persistent System settings (for example, GPIB address) are not affected by either a Mode Preset or Restore Mode Defaults, nor are they included in a saved State file.

Since each state file is only for one Mode, the settings for other Modes are unaffected when it is loaded. Recall State will cause a mode switch if the state being recalled is not from the current active mode.

After the recall completes, the message "File <filename> recalled" or "Recalled State Register <register number>" is displayed.

For rapid recalls, the State menu lists 16 registers that you can choose from to recall. Pressing a Register key initiates the recall. You can also select a file from which to recall.

The default path for all State Files is:

My Documents\<mode name>\state

where <mode name> is the parameter used to select the mode with the INST:SEL command (for example, SA for the Spectrum Analyzer).

See ["More Information" on page 1901](#).

Key Path	Recall
Mode	All
Remote Command	:MMEMory:LOAD:STATe <filename>
Example	:MMEM:LOAD:STAT "myState.state" This recalls the file myState.state on the default path
Example	MMEM:LOAD:STAT "MyStateFile.state" This loads the state file data (on the default file directory path) into the instrument state.
Notes	<p>When you pick a file to recall, the analyzer first verifies that the file is recallable in the current instrument by checking the software version and model number of the instrument. If everything matches, a full recall proceeds by aborting the currently running measurement, clearing any pending operations, and then loading the State from the saved state file. You can open state files from any mode, so recalling a State file switches to the mode that was active when the save occurred. After switching to the mode of the saved state file, mode settings and data (if any for the mode) are loaded with values from the saved file. The saved measurement of the mode becomes the newly active measurement and the data relevant to the measurement (if there is any) is recalled.</p> <p>If there is a mismatch between file version or model number or instrument version or model number, the recall function tries to recall as much as possible and returns a warning message. It may limit settings that differ based on model number, licensing or version number.</p> <p>After recalling the state, the Recall State function does the following:</p> <ul style="list-style-type: none"> • Makes the saved measurement for the mode the active measurement. • Clears the input and output buffers. • Status Byte is set to 0. • Executes a *CLS <p>If the file specified is empty an error is generated. If the specified file does not exist, another error is generated. If there is a mismatch between the file and the proper file type, an error is generated. If</p>

	there is a mismatch between file version or model number or instrument version or model number, a warning is displayed. Then it returns to the State menu and File Open dialog goes away. After the Recall, the analyzer exits the Recall menu and returns to the previous menu.
Backwards Compatibility SCPI	:MMEMory:LOAD:STATe 1,<filename> For backwards compatibility, the above syntax is supported. The "1" is simply ignored.
Initial S/W Revision	Prior to A.02.00

More Information

In measurements that support saving Traces, for example, Swept SA, the Trace data is saved along with the State in the State file. When recalling the State, the Trace data is recalled as well. Traces are recalled exactly as they were stored, including the writing mode and update and display modes. If a Trace was updating and visible when the State was saved, it will come back updating and visible, and its data will be rewritten right away. When you use State to save and recall traces, any trace whose data must be preserved should be placed in View or Blank mode before saving.

The following table describes the Trace Save and Recall possibilities:

You want to recall state and one trace's data, leaving other traces unaffected.	Save Trace+State from 1 trace. Make sure that no other traces are updating (they should all be in View or Blank mode) when the save is performed.	On Recall, specify the trace you want to load the one trace's data into. This trace will load in View. All other traces' data will be unaffected, although their trace mode will be as it was when the state save was performed.
You want to recall all traces	Save Trace+State from ALL traces.	On Recall, all traces will come back in View (or Blank if they were in Blank or Background when saved)
You want all traces to load exactly as they were when saved.	Save State	On recall, all traces' mode and data will be exactly as they were when saved. Any traces that were updating will have their data immediately overwritten.

From File...

When you press "From File", the analyzer brings up a Windows dialog and a menu entitled "File Open." This menu allows you to navigate to the various fields in the Windows dialog without using a keyboard or mouse. The Tab and Arrow keys can also be used for dialog navigation.

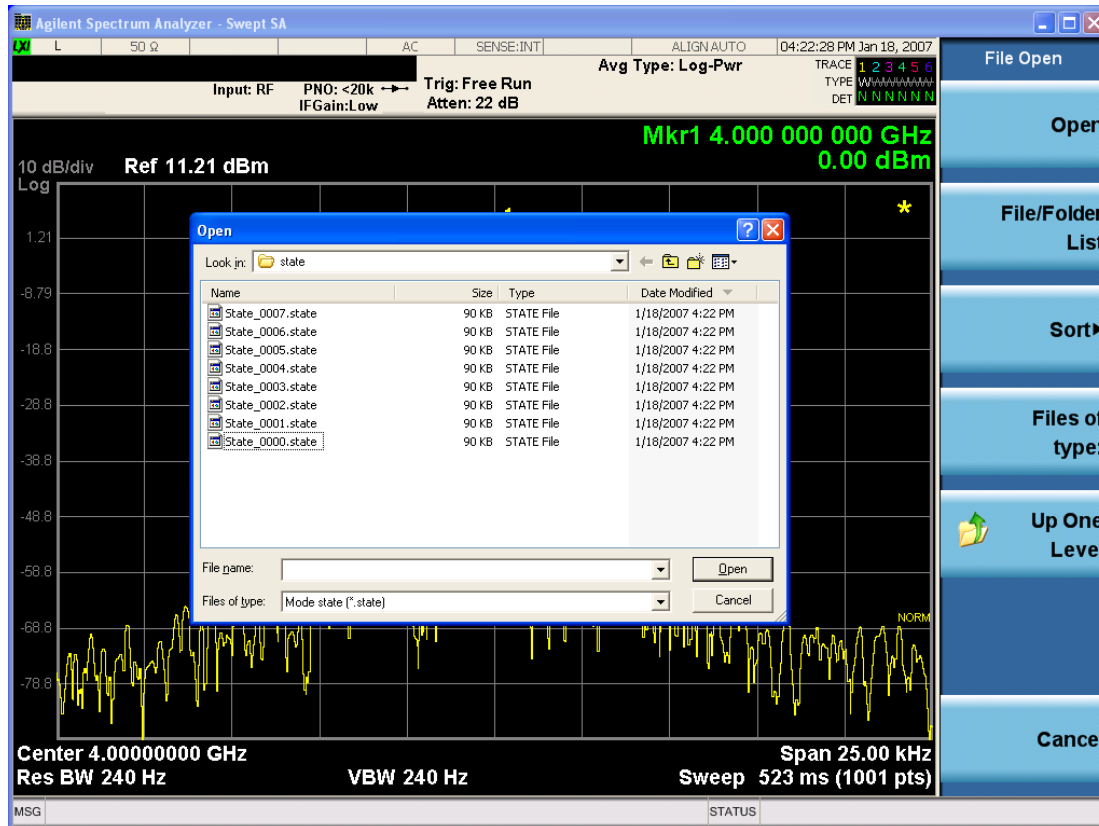

Listed below are the functions of the various fields in the dialog, and the corresponding softkeys:

Open

Performs the recall of the specified file. While the recall is being performed, the floppy icon appears briefly in the Meas bar.

File/Folder List

Enables you to navigate to the center of the dialog that contains the list of files and folders. Once here you can get information about the file and use the tab keys to navigate to the other fields in the dialog, such as Look In.

Look In

The Look In field shows the path from which the file will be recalled and allows you to change the path using the up and down arrow keys to navigate to other paths; the Enter key to open a directory; and the Backspace key to go back one directory. The **Look In field** first uses the last path from the Save As dialog **Save In:** path for that same file type. There is no softkey for directly navigating to the Look In field, but you can use the left tab to get here from the File/Folder List.

User specified paths are remembered when you leave and return to a Mode and are reset back to the default using Restore Mode Defaults.

Sort

Accesses a menu that enables you to sort the files within the File Open dialog. Only one sorting type can be selected at a time and the sorting happens immediately. The sorting types are By Date, By Name, By extension, and By Size.

Files of Type

This field shows the file suffix for the type of file you have selected to recall. For example, if you navigated here while recalling State, "Mode state (*.state)" is in the field. If you navigated here while recalling Trace, ""Mode state (*.trace)" is in the field. If you navigated here while importing a trace data file, "Trace Data (*.csv)" is in the field. For some file types, there is more than one choice in the dropdown menu, which you can select by using the up and down arrow keys and Enter.

Up One Level

This key corresponds to the icon of a folder with the up arrow that is in the tool bar of the dialog. When pressed, it causes the file and folder list to navigate up one level in the directory structure. The Backspace key does the same thing.

Cancel

This key corresponds to the Cancel selection in the dialog. It causes the current **Open** request to be cancelled. The ESC key does the same thing.

Key Path	Recall, State
Notes	Brings up the Open dialog for recalling a State Save Type
Initial S/W Revision	Prior to A.02.00

Edit Register Names

You may enter a custom name on any of the Register keys, to help you remember what you are using that state to save. To do this, press the Edit Register Names key, choose the register whose name you wish to edit, and then enter the desired label using the Alpha Editor or an external PC keyboard.

The maximum number of characters that can be added is 30. In most cases, 30 characters will fit on two lines of the key.

For more information and the SCPI command, see Edit Register Names under the Save, State function.

Key Path	Recall, State
Mode	All
Dependencies	N9060A-7FP or N9060B-2FP license required to edit the register names. When the feature is not licensed, sending the SCPI command generates an error, -221, "Settings conflict;Option not available"
Initial S/W Revision	A.11.00

Register 1 thru Register 16

Selecting any one of these register keys causes the State of the mode from the specified Register to be recalled. Each of the register keys annotates whether it is empty or at what date and time it was last

modified. In addition, you can use the Edit Register Names key under Save, State to enter custom names for each register.

Registers are shared by all modes, so recalling from any one of the registers will cause a mode switch to the mode that was active when the save to the Register occurred.

Although these 16 registers are the only registers available from the front panel, there are 128 state registers available in the instrument. Registers 17–128 are only available from the SCPI interface, using the *RCL command.

After the recall completes, the message "Register <register number> recalled" appears in the message bar. If you are in the Spectrum Analyzer Mode, and you are recalling a register that was saved in the Spectrum Analyzer Mode, then after the recall, you will still be in the Recall Register menu. If the Recall causes you to switch modes, then after the Recall, you will be in the Frequency menu.

If a requested register is empty an error is generated.

Key Path	Recall, State
Example	*RCL 1
Range	1–16 from front panel, 1–128 from SCPI
Readback	Date and time with seconds resolution are displayed on the key OR A custom name of up to 30 characters entered using the Save, State, Edit Register Names key OR “(empty)” if no prior save operation has been performed to this register.
Initial S/W Revision	Prior to A.02.00
Modified at S/W Revision	Prior to A.11.00

Register 1 thru Register 16

Selecting any one of these register keys causes the State of the mode from the specified Register to be recalled. Each of the register keys annotates whether it is empty or at what date and time it was last modified. In addition, you can use the Edit Register Names key under Save, State to enter custom names for each register.

Registers are shared by all modes, so recalling from any one of the registers will cause a mode switch to the mode that was active when the save to the Register occurred.

Although these 16 registers are the only registers available from the front panel, there are 128 state registers available in the instrument. Registers 17–128 are only available from the SCPI interface, using the *RCL command.

After the recall completes, the message "Register <register number> recalled" appears in the message bar. If you are in the Spectrum Analyzer Mode, and you are recalling a register that was saved in the Spectrum Analyzer Mode, then after the recall, you will still be in the Recall Register menu. If the Recall causes you to switch modes, then after the Recall, you will be in the Frequency menu.

If a requested register is empty an error is generated.

Key Path	Recall, State
Example	*RCL 1
Range	1-16 from front panel, 1-128 from SCPI
Readback	Date and time with seconds resolution are displayed on the key OR A custom name of up to 30 characters entered using the Save, State,Edit Register Names key OR “(empty)” if no prior save operation has been performed to this register.
Initial S/W Revision	Prior to A.02.00
Modified at S/W Revision	Prior to A.11.00

Data (Import)

Importing a data file loads data that was previously saved from the current measurement or from other measurements and/or modes that produce compatible data files. The Import Menu only contains Data Types that are supported by the current measurement.

Since the commonly exported data files are in .csv format, the data can be edited by the user prior to importing. This allows you to export a data file, manipulate the data in Excel (the most common PC Application for manipulating .csv files) and then import it.

Importing Data loads measurement data from the specified file into the specified or default destination, depending on the data type selected. Selecting an Import Data menu key will not actually cause the importing to occur, since the analyzer still needs to know from where to get the data. Pressing the Open key in this menu brings up the Open dialog and Open menu that provides you with the options from where to recall the data. Once a filename has been selected or entered in the Open menu, the recall occurs as soon as the Open button is pressed.

Key Path	Recall
Mode	All
Notes	The menu is built from whatever data types are available for the mode. Some keys will be missing completely, so the key locations in the sub-menu will vary. No SCPI command directly controls the Data Type that this key controls. The Data Type is included in the MMEM:LOAD commands.
Dependencies	If a file type is not used by a certain measurement, it is grayed out for that measurement. The key for a file type will not show at all if there are no measurements in the Mode that support it.
Preset	Is not affected by Preset or shutdown, but is reset during Restore Mode Defaults
Readback	The data type that is currently selected
Initial S/W Revision	Prior to A.02.00

Mask

Enables you to recall a preset mask file. This file type (.mask) differs from a normal “state” file because it contains the configuration for Carrier, Offset, and Limit for the specific preset profile BW. A brief description of the mask file is available in the properties view of each file. (Right-mouse-click on the file, select, "Properties" to view this information.) A detailed list of the mask parameter values is located in the .pdf file of the same name in the same directory. Blank values in the .pdf file are parameters that will not be overwritten when recalling the mask.

Key Path	Recall, Data
Mode	WIMAXOFDMA
Remote Command	:MMEMory:LOAD:MASK <string>
Example	:MMEM:LOAD:MASK "MyLimitFile.mask"
Notes	Set of parameters related to Limit, Carrier and Offset are overwritten by Preset Mask file.
Initial S/W Revision	A.02.00

This topic contains the following sections:

["File location and extension" on page 1906](#)

["Example of Preset Mask file" on page 1907](#)

File location and extension

File location: The preset mask file is located in “My Documents\WIMAXOFDMA\data\masks”.

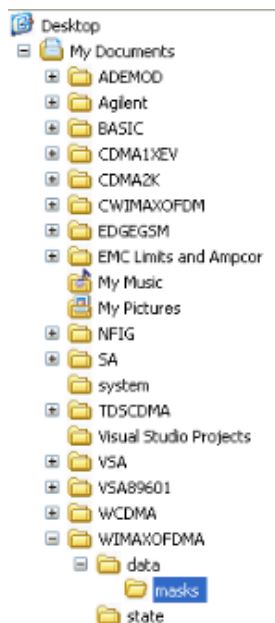

NOTE

When your X-Series analyzer starts, all mask files located in “My Documents\WIMAXOFDMA\data/masks” are overwritten, so any files you wish to save should be stored in another directory location.

File type: The file type is binary file.

File Name: The file name is decided by following naming rules. Each specific keyword is connected with underscore.

<Standard name>_<Radio device>_<Preset Profile BW>_<Measurement>.mask

<Standard name>: This term references the standard associated with each mask file.

<Radio device>: This term specifies to which radio device (BS or MS) the mask file pertains.

<Preset Profile BW>: This term specifies to which Preset Profile BW the mask file pertains.

<Measurement>: This term specifies the measurement to which the mask file is applied. Your selections are: SEM, ACP, or Mode. When selecting **Mode**, the values of some parameters in both the ACP and SEM measurement are overwritten.

File extension: The extension of preset mask file is “mask” to distinguish it from a “state” file.

When you press the open key under the Data menu, the “My Documents\WIMAXOFDMA\data\masks” folder is opened. Select one mask file.

NOTE

When you change the preset BW profile or Radio Device, all measurement parameters are reset to their original values. Thus you have to recall the appropriate preset mask file again after the change.

Example of Preset Mask file

When you import a preset mask file, it is a “Recall” function. Specific parameter values are overwritten by the contents of the preset mask file (see table below). Those values not specified by the preset mask file remain unchanged. Because the file format type is binary, you cannot view, change, or create the preset mask file. Here is an example of a preset mask file used for ACP measurements.

File Location: My Documents/WIMAXOFDMA/data/masks

File Name: ETSI-EN301-021-SysE_BS_10MHz_ACP.mask

The .pdf file that lists the parameters similarly to that shown below is named, "ETSI-EN301-021-SysE_BS_10MHz_ACP.pdf"

The set of parameters listed in the following table for the Preset Profile BW (10MHz) are imported into the ACP measurement.

Offset	Start Freq (MHz)	Stop Freq (MHz)	Sweep Time	Res BW (Hz)	Meas BW	Rel Start	Rel Stop	Fail Mask
A	5	7.14		30k	1	-8	-25	Rel
B	7.14	10.57		30k	1	-25	-27	Rel
C	10.57	20		30k	1	-27	-50	Rel
D	20	25		30k	1	-50	-50	Rel
E	25	30		30k	1	-50	-50	Rel

Zone Map

Pressing this key selects Zone Map as the data type to be imported.

The WiMAX-OFDMA application can load the Singal Studio Setup file, and the OFDMA Map file is compatible with the 89601A Mobile WiMAX omf file.

Key Path	Recall, Data
Remote Command	:MMEMory:LOAD:ZMAP <string>
Example	MMEM:LOAD:ZMAP "ZMap_0000.omf"
Notes	The SCPI parameter is a quoted string that specifies the filename. Both single and double quotes are supported for any filename parameter over SCPI.
Dependencies	You must be in the 802.16 OFDMA (WiMAX/WiBro) mode.
Status Bits/OPC dependencies	Sequential – waits for the previous measurement to complete.
Initial S/W Revision	Prior to A.02.00

Open...

When you press “Open”, the analyzer brings up a Windows dialog and a menu entitled “File Open.” This menu allows you to navigate to the various fields in the Windows dialog without using a keyboard or mouse. The Tab and Arrow keys can also be used for dialog navigation.

See "[From File...](#)" on page 2241 in Recall, State, for a full description of this dialog and menu.

Key Path	Recall, Data
Notes	The key location is mode-dependent and will vary. Brings up Open dialog for recalling a <mode specific> Save Type
Initial S/W Revision	Prior to A.02.00

Restart

The Restart function restarts the current sweep, or measurement, or set of averaged/held sweeps or measurements. If you are Paused, pressing Restart does a Resume.

The Restart function is accessed in several ways:

- Pressing the Restart key
- Sending the remote command INIT:IMMEDIATE
- Sending the remote command INIT:RESTART

See "[More Information](#)" on page 1909

Key Path	Front-panel key
Remote Command	:INITiate[:IMMEDIATE] :INITiate:RESTART
Example	:INIT:IMM :INIT:REST
Notes	:INITiate:RESTART and :INITiate:IMMEDIATE perform exactly the same function.
Couplings	Resets average/hold count k. For the first sweep overwrites all active (update=on) traces with new current data. For application modes, it resets other parameters as required by the measurement.
Status Bits/OPC dependencies	This is an Overlapped command. The STATUS:OPERation register bits 0 through 8 are cleared. The STATUS:QUESTIONable register bit 9 (INTEgrity sum) is cleared. The SWEEPING bit is set. The MEASURING bit is set.
Backwards Compatibility Notes	For Spectrum Analysis mode in ESA and PSA, the Restart hardkey and the INITiate:RESTART command restart trace averages (displayed average count reset to 1) for a trace in Clear Write, but did not restart Max Hold and Min Hold. In the X-Series, the Restart hardkey and the INITiate:RESTART command restart not only Trace Average, but MaxHold and MinHold traces as well. For wireless comms modes in ESA and PSA, the Restart hardkey and the INITiate:RESTART command restart every measurement, which includes all traces and numeric results. There is no change to this operation.
Initial S/W Revision	Prior to A.02.00

More Information

The **Restart** function first aborts the current sweep/measurement as quickly as possible. It then resets the sweep and trigger systems, sets up the measurement and initiates a new data measurement sequence with a new data acquisition (sweep) taken once the trigger condition is met.

If the analyzer is in the process of aligning when **Restart** is executed, the alignment finishes before the restart function is performed.

Even when set for Single operation, multiple sweeps may be taken when Restart is pressed (for example, when averaging/holding is on). Thus when we say that **Restart** "restarts a measurement," we may mean:

- It restarts the current sweep
- It restarts the current measurement
- It restarts the current set of sweeps if any trace is in Trace Average, Max Hold or Min Hold
- It restarts the current set of measurements if Averaging, or Max Hold, or Min Hold is on for the measurement
- depending on the current settings.

With **Average/Hold Number** (in **Meas Setup** menu) set to 1, or Averaging off, or no trace in Trace Average or Hold, a single sweep is equivalent to a single measurement. A single sweep is taken after the trigger condition is met; and the analyzer stops sweeping once that sweep has completed. However, with **Average/Hold Number** >1 and at least one trace set to **Trace Average, Max Hold, or Min Hold (SA Measurement)** or **Averaging on (most other measurements)**, multiple sweeps/data acquisitions are taken for a single measurement. The trigger condition must be met prior to each sweep. The sweep is stopped when the average count k equals the number N set for **Average/Hold Number**. A measurement average usually applies to all traces, marker results, and numeric results; but sometimes it only applies to the numeric results.

Once the full set of sweeps has been taken, the analyzer will go to idle state. To take one more sweep without resetting the average count, increment the average count by 1, by pressing the step up key while **Average/Hold Number** is the active function, or sending the remote command CALC:AVER:TCON UP.

Save

The Save menu lets you choose what you want to save and where you want to save it. Among the types of files you can save are **States**, **Traces**, and **Screen Images**. In addition, an Export (Data) option lets you save a number of data types as CSV files for easy import into Excel and other spreadsheet programs.

Key Path	Front-panel key
Mode	All
Notes	No remote command for this key specifically, but the :MMEM:STORe command is available for specific file types. An example is :MMEM:STOR:STATe <filename>.
Initial S/W Revision	Prior to A.02.00

State

The Save State menu lets you choose a register or file for saving the state.

The content of a state file includes all of the settings and data required to return the analyzer as closely as possible to the Mode it was in, with the exact settings which were in place, when the save occurred. The Mode settings in each state file include the settings that are affected by Mode Preset, as well as the additional settings affected by Restore Mode Defaults; all of the Mode's settings. In addition, all of the settings of the Input/Output system are included, even though they are outside of the Mode's state, because they are needed to restore the complete setup. Persistent System settings (for example, Verbose SCPI) are not affected by either Mode Preset or Restore Mode Defaults, nor are they included in a saved State file.

After the save completes, the message "File <filename> saved" or "State Register <register number> saved" is displayed.

For rapid saving, the State menu lists 16 registers to save to. Pressing a Register key initiates the save. You can also select a file to save to.

The default path for all State Files is:

My Documents\<>mode name>\state

where <mode name> is the parameter used to select the mode with the INST:SEL command (for example, SA for the Spectrum Analyzer).

Key Path	Save
Mode	All
Remote Command	:MMEMory:STORe:STATe <filename>
Example	MMEM:STOR:STATe "MyStateFile.state" This stores the current instrument state data in the file MyStateFile.state in the default directory.
Notes	Both single and double quotes are supported for any filename parameter over remote. After saving to a register, that register's menu key is updated with the date the time, unless a custom label has been entered for that key. After saving to a register, you remain in the Save State menu, so that you can see the Register key

update. After saving to a file, the analyzer automatically returns to the previous menu and any Save As dialog goes away.

Backwards Compatibility SCPI :MMEMory:STORe:STATe 1,<filename>

For backwards compatibility, the above syntax is supported. The "1" is simply ignored. The command is sequential.

Initial S/W Revision Prior to A.02.00

To File . . .

When you press “To File”, the analyzer brings up a Windows dialog and a menu entitled “Save As.” This menu allows you to navigate to the various fields in the Windows dialog without using a keyboard or mouse. The Tab and Arrow keys can also be used for dialog navigation.

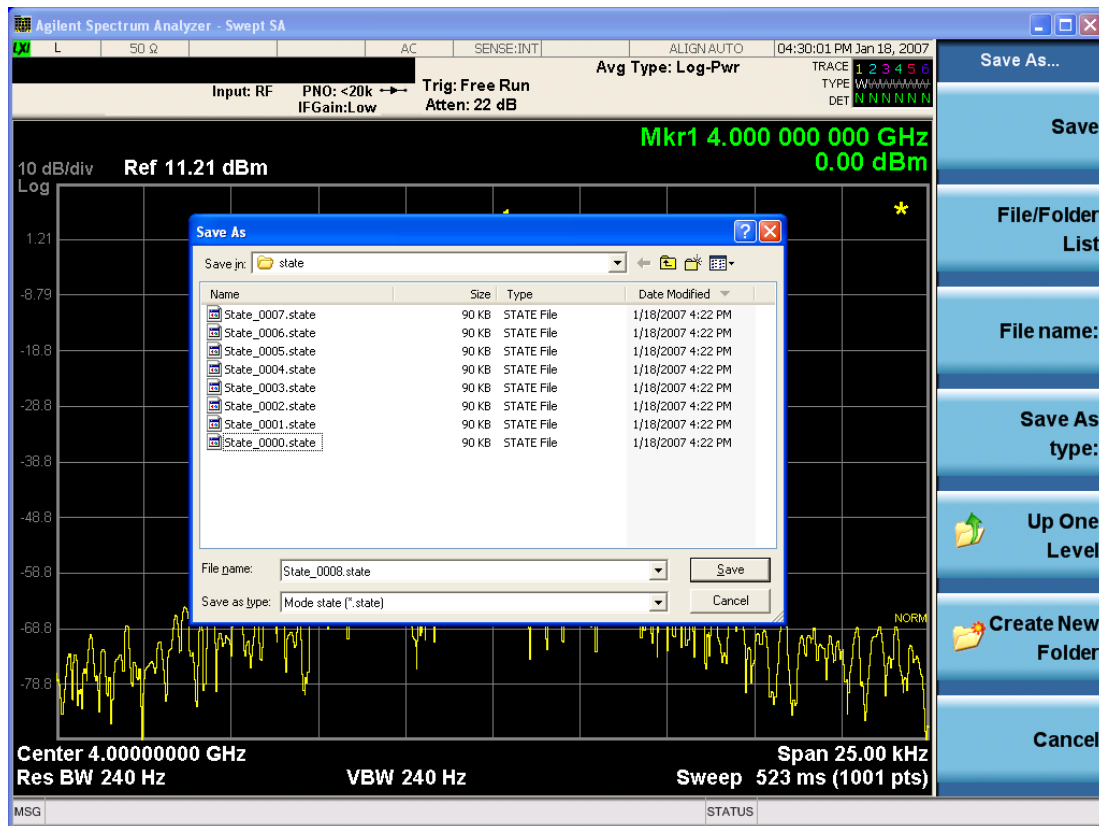

The Listed below

are the functions of the various fields in the dialog, and the corresponding softkeys:

Save

Performs the save to the specified file of the selected type. If the file already exists, a dialog will appear that allows you to replace the existing file by selecting OK, or you can Cancel the request. If you select OK, the file will be overwritten. Using the C: drive is strongly discouraged, since it runs the risk of being overwritten during an instrument software upgrade.

While the save is being performed, the floppy icon appears briefly in the Meas bar.

File/Folder List

Enables you to navigate to the center of the dialog that contains the list of files and folders. Once here you can get information about the file and use the tab keys to navigate to the other fields in the dialog, such as Save In.

Save In

The Save In field shows the path to which the file will be saved and allows you to change the path using the up and down arrow keys to navigate to other paths; the Enter key to open a directory; and the Backspace key to go back one directory. The **Save In field** defaults to the default path for this type of file and remembers the last path you used to save this type of file. There is no softkey for directly navigating to the Save In field but you can use left tab to get here from the File/Folder List.

User specified paths are remembered when you leave and return to a Mode and are reset back to the default using Restore Mode Defaults.

File Name

The File Name field is initially loaded with an automatically generated filename specific to the appropriate Save Type. The automatically generated filename is guaranteed not to conflict with any filename currently in the directory. You may replace or modify this filename using the File Name key. See the ["Quick Save " on page 2237](#) documentation for more on the automatic file naming algorithm.

When you press the File Name key the analyzer displays the Alpha Editor. Use the knob to choose the letter to add and the front-panel Enter key to add the letter to the file name. The BK character moves you back and the FW character moves you forward in the filename. The Select key on the front panel generates a space character. When you are done entering the filename press the Done softkey. This returns back to the **File Open** dialog and menu, but does not cause the save to occur.

Save As Type

This field shows the file suffix for the type of file you have selected to save. For example, if you navigated here while saving State, "Mode state (*.state)" is in the field. If you navigated here from saving Trace, ""Mode state (*.trace)" is in the field. If you navigated here while exporting a trace data file, "Trace Data (*.csv)" is in the field. For some file types, there is more than one choice in the dropdown, which you can select by using the up and down arrow keys and Enter.

Up One Level

This key corresponds to the icon of a folder with the up arrow that is in the tool bar of the dialog. When pressed, it causes the file and folder list to navigate up one level in the directory structure. The Backspace key does the same thing.

Create New Folder

This key corresponds to the icon of a folder with the "*" that is in the tool bar of the dialog. When pressed, a new folder is created in the current directory with the name **New Folder** and you can enter a new folder name using the Alpha Editor.

Cancel

This key corresponds to the Cancel selection in the dialog. It causes the current **Save As** request to be cancelled. The ESC key does the same thing.

Key Path	Save, State
Mode	All
Notes	Brings up Save As dialog for saving a State Save Type
Initial S/W Revision	Prior to A.02.00

Edit Register Names

You may enter a custom name on any of the Register keys, to help you remember what you are using that state to save. To do this, press the Edit Register Names key, choose the register whose name you wish to edit, and then enter the desired label using the Alpha Editor or an external PC keyboard.

The maximum number of characters that can be added is 30. In most cases, 30 characters will fit on two lines of the key.

See ["More Information" on page 1914](#)

Key Path	Save, State
Mode	All
Remote Command	:MMEMory:REGister:STATe:LABel <reg number>,"label" :MMEMory:REGister:STATe:LABel? <reg number>
Example	:MMEM:REG:STAT:LAB 1,"my label"
Notes	<reg number> is an integer from 1 to 16. If the SCPI specifies an invalid register number an error message is generated, -222,"Data out of range;Invalid register label number" "label" is a string from 0 to 30 characters in length. If a label exceeds 30 characters, an error message is generated, -150,"String data error;Label clipped to 30 characters" "label" of length 0 erases the custom label and restores the default (time and date) label. E.g.: :MMEM:REG:STAT:LAB 1,""
Dependencies	N9060A-7FP or N9060B-2FP license required to edit the register names. When the feature is not licensed, sending this command generates an error, -221,"Settings conflict;Option not available"
Preset	The names are unaffected by Preset or power cycle but are set to the default label (time and date) on a "Restore System Defaults->Misc"
Initial S/W Revision	A.11.00

More Information

When you edit one of the register names, the time and date field will be replaced by the custom name.

If you delete all the characters in the custom name, it restores the default (time and date).

The register names are stored within the state files, but they are not part of the instrument state; that is, once you have edited a register name, loading a new state will not change that register name. Another consequence of this is that the names will be persistent through a power cycle. Also, if a named state file is transferred to another analyzer, it will bring its custom name along with it.

If you try to edit the name of an empty register, the analyzer will first save the state to have a file to put the name in. If you load a named state file into an analyzer with older firmware it will ignore the metadata.

The *SAV and *RCL commands will not be affected by the custom register names, nor will the MMEM commands.

Register 1 thru Register 16

Selecting any one of these register menu keys causes the State of the currently active mode to be saved to the specified Register. The registers are provided for rapid saving and recalling, since you do not need to specify a filename or navigate to a file. Each of the register menu keys annotates whether it is empty or at what date and time it was last modified. In addition, you can use the Edit Register Names key to enter custom names for each register.

Although these 16 registers are the only registers available from the front panel, there are 128 state registers available in the instrument. Registers 17–128 are only available from the SCPI interface, using the *SAV command.

There is one set of 128 state registers in the instrument, not one set for each Mode. When a state is saved, the Mode it was saved from is saved with it; then when it is recalled, the instrument switches to that Mode.

After the save completes, the corresponding register menu key annotation is updated with the date and time and the message "Register <register number> saved" is displayed.

Key Path	Save, State
Mode	All
Example	*SAV 1
Range	1–16 from front panel, 1–128 from SCPI
Readback	Date and time with seconds resolution are displayed on the key OR A custom name of up to 30 characters entered using the Edit Register Names key OR “(empty)” if no prior save operation has been performed to this register.
Initial S/W Revision	Prior to A.02.00
Modified at S/W Revision	A.11.00

Register 1 thru Register 16

Selecting any one of these register menu keys causes the State of the currently active mode to be saved to the specified Register. The registers are provided for rapid saving and recalling, since you do not need to specify a filename or navigate to a file. Each of the register menu keys annotates whether it is empty or at what date and time it was last modified. In addition, you can use the Edit Register Names key to enter custom names for each register.

Although these 16 registers are the only registers available from the front panel, there are 128 state registers available in the instrument. Registers 17–128 are only available from the SCPI interface, using the *SAV command.

There is one set of 128 state registers in the instrument, not one set for each Mode. When a state is saved, the Mode it was saved from is saved with it; then when it is recalled, the instrument switches to that Mode.

After the save completes, the corresponding register menu key annotation is updated with the date and time and the message "Register <register number> saved" is displayed.

Key Path	Save, State
Mode	All
Example	*SAV 1
Range	1-16 from front panel, 1-128 from SCPI
Readback	Date and time with seconds resolution are displayed on the key OR A custom name of up to 30 characters entered using the Edit Register Names key OR “(empty)” if no prior save operation has been performed to this register.
Initial S/W Revision	Prior to A.02.00
Modified at S/W Revision	A.11.00

Data (Export)

Exporting a data file stores data from the current measurement to mass storage files. The Export Menu only contains data types that are supported by the current measurement.

Since the commonly exported data files are in .csv format, the data can be edited by you prior to importing. This allows you to export a data file, manipulate the data in Excel (the most common PC Application for manipulating .csv files) and then import it.

Selecting an Export Data menu key will not actually cause the exporting to occur, since the analyzer still needs to know where you wish to save the data. Pressing the Save As key in this menu brings up the Save As dialog and Save As menu that allows you to specify the destination file and directory. Once a filename has been selected or entered in the Open menu, the export will occur as soon as the Save key is pressed.

Key Path	Save
Mode	All
Notes	The menu is built from whatever data types are available for the mode. So the key locations in the sub menu will vary. No SCPI command directly controls the Data Type that this key controls. The Data Type is included in the MMEM:STORe commands.
Dependencies	If a file type is not used by a certain measurement, that type is grayed out for that measurement. The key for a file type will not show at all if there are no measurements in the Mode that support it.
Preset	Is not affected by a Preset or shutdown, but is reset during Restore Mode Defaults
Readback	The data type that is currently selected
Initial S/W Revision	Prior to A.02.00

Measurement Results

Pressing this key selects Meas Results as the data type to be exported.

The Meas Results file contains measurement result sets, plus information describing the current state of the analyzer, as detailed in ["Meas Results File Definition" on page 1917](#) and ["Meas Results File Example" on page 1919](#) below.

Key Path	Save, Data
Remote Command	:MMEMory:STORe:RESults <string>
Example	:MMEM:STOR:RES "MeasR_0000.csv"
Notes	<p>If the save is initiated via SCPI and the file already exists, the file will be overwritten.</p> <p>The SCPI command exports Power Stat CCDF measurement results to the file specified as the parameter in the current path. The default path is My Documents\<current an="" being="" c:="" discouraged,="" drive="" during="" instrument="" is="" it="" mode>\data\pst\results.="" of="" overwritten="" p="" risk="" runs="" since="" software="" strongly="" the="" upgrade.<="" using=""> <p>The SCPI parameter is a quoted string that specifies the filename. Both single and double quotes are supported for any filename parameter over SCPI.</p> </current></p>
Dependencies	The current active measurement must be the Power Stat CCDF measurement to use this command.
Status Bits/OPC dependencies	Sequential – waits for the previous measurement to complete
Initial S/W Revision	Prior to A.02.00

Meas Results File Definition

The content of a Meas Results File is defined in this section.

The first lines in the file consist of identification and instrument configuration details, as follows.

- File ID string, which is "MeasResult"
- Measurement ID following Mode ID, which is "SA:PST" for example.
- Firmware rev and model number
- Option string
- Automatic Trigger Time
- Automatic Trigger Time State
- CcdfCurrentCounts
- Center Frequency
- Center Frequency Step
- Center Frequency Step State
- Counts
- Electrical Atten

- Electrical Atten State
- External Array Trigger Delay
- External Array Trigger Delay State
- External Array Trigger Level
- External Array Trigger Slope
- Gaussian Line
- IF Gain Auto
- IF Gain State
- Info BW
- Internal Preamp
- Internal Preamp Band
- Line Trigger Delay
- Line Trigger Delay State
- Line Trigger Slope
- Meas Cycles
- MeasInterval
- Mechanical Atten
- MechanicalAttenStepEnum
- Periodic Timer Period
- Periodic Timer Sync Source
- Periodic Timer Trigger Delay
- Periodic Timer Trigger Delay State
- Preselector Adjust
- Ref Trace
- RFBurst Trigger Delay
- RFBurst Trigger Delay State
- RFBurst Trigger Level Abs
- RFBurst Trigger Level Rel
- RFBurst Trigger Level Type
- RFBurst Trigger Slope
- Scale/Div

- Trigger Holdoff
- Trigger Holdoff State
- TriggerSource

The data above is followed in the file by a line containing “MeasResult1” to “MeasResult4”. This line forms a header for each set of measurement results, which appear in subsequent lines. Each line of Measurement Results consists of 4 comma-separated values, from the MeasResult1 value to the MeasResult4 value.

The MeasResult1 set in the file corresponds to the data returned by MEAS|READ|FETCh:PStatistic1; the MeasResult2 set corresponds to the data returned by MEAS|READ|FETCh:PStatistic2, and so on.

The exported file is in CSV format, with a .csv extension.

Meas Results File Example

When imported into Microsoft Excel, a typical Meas Results CSV file appears as shown in the example below.

MeasResult			
SA:PST			
A.10.53	N9030A		
526 ALV ATP B1X B1Y B25 B40 BBA CR3 CRP DCF DDA DP2 DRD EA3 EDP EMC EP1 ERC ESC ESP EXM FSA LFE LNP MAT MPB NFE NUL P26 PFR PNC RTL RTS S40 SB1 SEC SM1 TVT YAS YAV	1		
Automatic Trigger Time	0.1		
Automatic Trigger Time State	FALSE		
CcdfCurrentCounts	6087500		
Center Frequency	1.33E+10		
Center Frequency Step	5000000		
Center Frequency Step State	TRUE		
Counts	10000000		
Electrical Atten	0		
Electrical Atten State	FALSE		
External Array Trigger Delay	1.00E-06	1.00E-06	
External Array Trigger Delay State	FALSE	FALSE	
External Array Trigger Level	1.2	1.2	
External Array Trigger Slope	Positive	Positive	

Gaussian Line	TRUE		
IF Gain AUto	FALSE		
IF Gain State	FALSE		
Info BW	5000000		
Internal Preamp	FALSE		
Internal Preamp Band	Low		
Line Trigger Delay	1.00E-06		
Line Trigger Delay State	FALSE		
Line Trigger Slope	Positive		
Meas Cycles	1600		
MeasInterval	0.001		
Mechanical Atten	10		
MechanicalAttenStepEnum	S2dB		
Periodic Timer Period	0.02		
Periodic Timer Sync Source	None		
Periodic Timer Trigger Delay	1.00E-06		
Periodic Timer Trigger Delay State	FALSE		
Preselector Adjust	0		
Ref Trace	FALSE		
RFBurst Trigger Delay	1.00E-06		
RFBurst Trigger Delay State	FALSE		
RFBurst Trigger Level Abs	-20		
RFBurst Trigger Level Rel	-6		
RFBurst Trigger Level Type	Absolute		
RFBurst Trigger Slope	Positive		
Scale/Div	2		
Trigger Holdoff	0.1		
Trigger Holdoff State	FALSE		
TriggerSource	Free		
MeasResult1	MeasResult2	MeasResult3	MeasResult4
-73.0651058869747	36.9712197125257	36.7879441171442	
36.9712197125257	36.8850431211499	36.7032368203129	

Zone Map

Pressing this key selects Zone Map as the data type to be exported.

The Zone Map file contains information about current Zone Map configuration. Its format is compatible with the 89601A OFDMA map file. It is detailed in ["Zone Map File Contents" on page 1921](#) below.

Key Path	Save, Data
Remote Command	:MMEMory:STORe:ZMAP <string>
Example	MMEM:STOR:ZMAP "ZMap_0000.omf"
Notes	<p>If the save is initiated via SCPI and the file already exists, the file will be overwritten.</p> <p>The SCPI command exports Zone Map information to the file specified as the parameter in the current path. The default path is My Documents\WIMAXOFDMA\.</p> <p>Using the C: drive is strongly discouraged, since it runs the risk of being overwritten during an instrument software upgrade.</p> <p>The SCPI parameter is a quoted string that specifies the filename. Both single and double quotes are supported for any filename parameter over SCPI.</p>
Dependencies	You must be in the 802.16 OFDMA (WiMAX/WiBro) mode.
Status Bits/OPC dependencies	Sequential – waits for the previous measurement to complete.
Initial S/W Revision	Prior to A.02.00

Zone Map File Contents

A Zone Map File contains the following information of the Zone Map configuration. See ["Zone Map Data" on page 329](#) for detailed definitions.

- DemodOfdmaMap_AutoDetect
- DemodOfdmaMap_Count
- DemodOfdmaMap_F1_DL_Count
- DemodOfdmaMap_F1_DL_Z1_Active
- DemodOfdmaMap_F1_DL_Z1_AmcType
- DemodOfdmaMap_F1_DL_Z1_B1_Active
- DemodOfdmaMap_F1_DL_Z1_B1_AllocType
- DemodOfdmaMap_F1_DL_Z1_B1_Boost
- DemodOfdmaMap_F1_DL_Z1_B1_BurstType
- DemodOfdmaMap_F1_DL_Z1_B1_ColorIndex
- DemodOfdmaMap_F1_DL_Z1_B1_ModType
- DemodOfdmaMap_F1_DL_Z1_B1_Name
- DemodOfdmaMap_F1_DL_Z1_B1_SubchannelInterval
- DemodOfdmaMap_F1_DL_Z1_B1_SubchannelOffset
- DemodOfdmaMap_F1_DL_Z1_B1_SymbolInterval

- DemodOfdmaMap_F1_DL_Z1_B1_SymbolOffset
- DemodOfdmaMap_F1_DL_Z1_Count
- DemodOfdmaMap_F1_DL_Z1_DedicPilots
- DemodOfdmaMap_F1_DL_Z1_IDCell
- DemodOfdmaMap_F1_DL_Z1_IDCellCouple
- DemodOfdmaMap_F1_DL_Z1_Len
- DemodOfdmaMap_F1_DL_Z1_Locked
- DemodOfdmaMap_F1_DL_Z1_Name
- DemodOfdmaMap_F1_DL_Z1_PrbsID
- DemodOfdmaMap_F1_DL_Z1_StcMatrix
- DemodOfdmaMap_F1_DL_Z1_StcType
- DemodOfdmaMap_F1_DL_Z1_SymOffset
- DemodOfdmaMap_F1_DL_Z1_UseAllSC
- DemodOfdmaMap_F1_DL_Z1_WrapType
- DemodOfdmaMap_F1_DL_Z1_ZoneType
- DemodOfdmaMap_F1_UL_Count
- DemodOfdmaMap_F1_UL_Z1_Active
- DemodOfdmaMap_F1_UL_Z1_AmcType
- DemodOfdmaMap_F1_UL_Z1_B1_Active
- DemodOfdmaMap_F1_UL_Z1_B1_AllocType
- DemodOfdmaMap_F1_UL_Z1_B1_Boost
- DemodOfdmaMap_F1_UL_Z1_B1_BurstType
- DemodOfdmaMap_F1_UL_Z1_B1_ColorIndex
- DemodOfdmaMap_F1_UL_Z1_B1_ModType
- DemodOfdmaMap_F1_UL_Z1_B1_Name
- DemodOfdmaMap_F1_UL_Z1_B1_PilotPattern
- DemodOfdmaMap_F1_UL_Z1_B1_StcMode
- DemodOfdmaMap_F1_UL_Z1_B1_SubchannelInterval
- DemodOfdmaMap_F1_UL_Z1_B1_SubchannelOffset
- DemodOfdmaMap_F1_UL_Z1_B1_SymbolInterval
- DemodOfdmaMap_F1_UL_Z1_B1_SymbolOffset

- DemodOfdmaMap_F1_UL_Z1_Count
- DemodOfdmaMap_F1_UL_Z1_Gap
- DemodOfdmaMap_F1_UL_Z1_IDCell
- DemodOfdmaMap_F1_UL_Z1_Len
- DemodOfdmaMap_F1_UL_Z1_Locked
- DemodOfdmaMap_F1_UL_Z1_Name
- DemodOfdmaMap_F1_UL_Z1_SymOffset
- DemodOfdmaMap_F1_UL_Z1_UseSubchRotate
- DemodOfdmaMap_F1_UL_Z1_WrapType
- DemodOfdmaMap_F1_UL_Z1_ZoneType
- DemodOfdmaMap_Name
- DemodOfdmaMap_RefreshMap

Save As . . .

When you press “Save As”, the analyzer brings up a Windows dialog and a menu entitled “**Save As.**” This menu allows you to navigate to the various fields in the Windows dialog without using a keyboard or mouse. The Tab and Arrow keys can also be used for dialog navigation.

See "[To File . . .](#)" on page 2252 in Save, State for a full description of this dialog and menu.

The default path for saving files is:

For all of the Trace Data Files:

My Documents\`<mode name>`\data\traces

For all of the Limit Data Files:

My Documents\`<mode name>`\data\limits

For all of the Measurement Results Data Files:

My Documents\`<mode name>`\data\`<measurement name>`\results

For all of the Capture Buffer Data Files:

My Documents\`<mode name>`\data\captureBuffer

Key Path	Save, Data
Mode	All
Notes	The key location is mode-dependent and will vary. Brings up the Save As dialog for saving a <code><mode specific></code> Save Type. The save is performed immediately and does not wait until the measurement is complete.
Initial S/W Revision	Prior to A.02.00

Screen Image

Pressing Screen Image accesses a menu of functions that enable you to specify a format and location for the saved screen image. It brings up a menu that allows you to specify the color scheme of the Screen Image (Themes) or navigate to the Save As dialog to perform the actual save.

Screen Image files contain an exact representation of the analyzer display. They cannot be loaded back onto the analyzer, but they can be loaded into your PC for use in many popular applications.

The image to be saved is actually captured when the Save front panel key is pressed, and kept in temporary storage to be used if you ask for a Screen Image save. When the Screen Image key is pressed, a "thumbnail" of the captured image is displayed, as shown below:

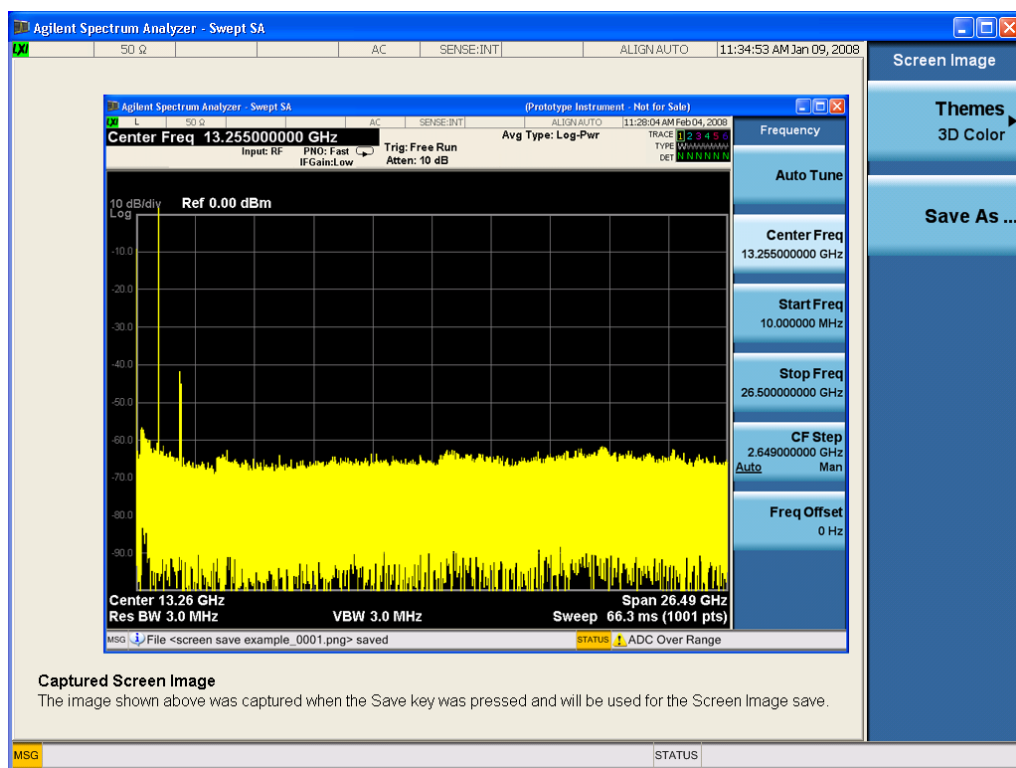

When you continue on into the Save As menu and complete the Screen Image save, the image depicted in the thumbnail is the one that gets saved, showing the menus that were on the screen before going into the Save menus. The save is performed immediately and does not wait until the measurement is complete.

After you have completed the save, the Quick Save front-panel key lets you quickly repeat the last save performed, using an auto-named file, with the current screen data.

NOTE

For versions previous to A.01.55, if you initiate a screen image save by navigating through the Save menus, the image that is saved will contain the Save menu softkeys, not the menus and the active function that were on the screen when you first pressed the Save front panel key.

Key Path	Save
Mode	All

Remote Command	:MMEMory:STORe:SCReen <filename>
Example	:MMEM:STOR:SCR "myScreen.png" This stores the current screen image in the file MyScreenFile.png in the default directory.
Initial S/W Revision	Prior to A.02.00

Themes

Accesses a menu of functions that enable you to choose the theme to be used when saving the screen image.

The **Themes** option is the same as the **Themes** option under the **Display** and **Page Setup** dialogs. It allows you to choose between themes to be used when saving the screen image.

Key Path	Save, Screen Image
Remote Command	:MMEMory:STORe:SCReen:THEMe TDColor TDMonochrome FCOLOR FMONochrome :MMEMory:STORe:SCReen:THEMe?
Example	:MMEM:STOR:SCR:THEM TDM
Preset	3D Color; Is not part of Preset, but is reset by Restore Misc Defaults or Restore System Defaults All and survives subsequent running of the modes.
Readback	3D Color 3D Mono Flat Color Flat Mono
Backwards Compatibility Notes	In ESA and PSA we offer the choice of "Reverse Bitmap" or "Reverse Metafile" when saving screen images. This is much like the "Flat Color" theme available in X-Series. Also, if you selected Reverse Bitmap AND a black & white screen image, that would be much like "Flat Monochrome". In other words, each of the X-Series themes has a similar screen image type in ESA/PSA. But they are not identical.
Initial S/W Revision	Prior to A.02.00

3D Color

Selects a standard color theme with each object filled, shaded and colored as designed.

Key Path	Save, Screen Image, Themes
Example	MMEM:STOR:SCR:THEM TDC
Readback	3D Color
Initial S/W Revision	Prior to A.02.00

3D Monochrome

Selects a format that is like 3D color but shades of gray are used instead of colors.

Key Path	Save, Screen Image, Themes
Example	MMEM:STOR:SCR:THEM TDM
Readback	3D Mono
Initial S/W Revision	Prior to A.02.00

Flat Color

Selects a format that is best when the screen is to be printed on an ink printer.

Key Path	Save, Screen Image, Themes
Example	MMEM:STOR:SCR:THEM FCOL
Readback	Flat Color
Initial S/W Revision	Prior to A.02.00

Flat Monochrome

Selects a format that is like Flat Color. But only black is used (no colors, not even gray), and no fill.

Key Path	Save, Screen Image, Themes
Example	MMEM:STOR:SCR:THEM FMON
Readback	Flat Mono
Initial S/W Revision	Prior to A.02.00

Save As...

When you press "Save As", the analyzer brings up a Windows dialog and a menu entitled "**Save As.**" This menu allows you to navigate to the various fields in the Windows dialog without using a keyboard or mouse. The Tab and Arrow keys can also be used for dialog navigation.

See "[To File . . .](#)" on page 2252 in Save, State for a full description of this dialog and menu.

The default path for Screen Images is

My Documents\`<mode name>`\screen.

where `<mode name>` is the parameter used to select the mode with the INST:SEL command (for example, SA for the Spectrum Analyzer).

Key Path	Save, Screen Image
Notes	Brings up Save As dialog for saving a Screen Image Save Type
Initial S/W Revision	Prior to A.02.00

Mass Storage Catalog (Remote Command Only)

Key path	SCPI Only
Remote Command	:MMEMory:CATalog? [<directory_name>]
Notes	<p>The string must be a valid logical path.</p> <p>Queries disk usage information (drive capacity, free space available) and obtains a list of files and directories in a specified directory in the following format: <numeric_value>,<numeric_value>,{<file_entry>}</p> <p>It returns two numeric parameters and as many strings as there are files and directories. The first parameter indicates the total amount of storage currently used in bytes. The second parameter indicates the total amount of storage available, also in bytes. The <file_entry> is a string. Each <file_entry> indicates the name, type, and size of one file in the directory list: <file_name>,<file_type>,<file_size></p> <p>As the windows file system has an extension that indicates file type, <file_type> is always empty. <file_size> provides the size of the file in bytes. For directories, <file_entry> is surrounded by square brackets and both <file_type> and <file_size> are empty</p>
Initial S/W Revision	Prior to A.02.00

Mass Storage Change Directory (Remote Command Only)

Key path	SCPI Only
Remote Command	:MMEMory:CDIRectory [<directory_name>] :MMEMory:CDIRectory?
Notes	<p>The string must be a valid logical path.</p> <p>Changes the default directory for a mass memory file system. The <directory_name> parameter is a string. If no parameter is specified, the directory is set to the *RST value.</p> <p>At *RST, this value is set to the default user data storage area, that is defined as System.Environment.SpecialFolder.Personal.</p> <p>Query returns full path of the default directory.</p>
Initial S/W Revision	Prior to A.02.00

Mass Storage Copy (Remote Command Only)

Key path	SCPI Only
Remote Command	:MMEMory:COPY <string>,<string>[,<string>,<string>]
Notes	<p>The string must be a valid logical path.</p> <p>Copies an existing file to a new file or an existing directory to a new directory.</p> <p>Two forms of parameters are allowed. The first form has two parameters. In this form, the first parameter specifies the source, and the second parameter specifies the destination.</p> <p>The second form has four parameters. In this form, the first and third parameters specify the source. The second and fourth parameters specify the directories. The first pair of parameters specifies the</p>

source. The second pair specifies the destination. An error is generated if the source doesn't exist or the destination file already exists.

This command will generate an "access denied" error if the destination is a restricted folder (e.g., C:\Windows) and the current user does not have Power User or Administrator privileges.

Mass Storage Device Copy (Remote Command Only)

This command transfers data to/from a file and a peripheral device.

Key path	SCPI Only
Remote Command	:MMEMory:COpy:DEvice <source_string>,<dest_string>
Notes	The strings must be a valid logical path or a valid device keyword. If the dest_string is a device keyword, the data is copied from the source file to the device. If the source_string is a device keyword, the data is copied to the source file from the device. Valid device keywords are: SNS (smart noise source) An error is generated if the file or device is not found.

Mass Storage Delete (Remote Command Only)

Key path	SCPI Only
Remote Command	:MMEMory:DElete <file_name>[,<directory_name>]
Notes	The string must be a valid logical path. Removes a file from the specified directory. The <file_name> parameter specifies the file name to be removed. This command will generate an "access denied" error if the file is in a restricted folder (e.g., C:\Windows) and the current user does not have Power User or Administrator privileges.
Initial S/W Revision	Prior to A.02.00

Mass Storage Data (Remote Command Only)

Creates a file containing the specified data OR queries the data from an existing file.

Key path	SCPI Only
Remote Command	:MMEMory:DATA <file_name>,<data> :MMEMory:DATA? <file_name>
Notes	The string must be a valid logical path. The command form is MMEMory:DATA <file_name>,<data>. It loads <data> into the file <file_name>. <data> is in 488.2 block format. <file_name> is string data. The query form is MMEMory:DATA? <file_name> with the response being the associated <data> in block format.
Initial S/W Revision	Prior to A.02.00

Mass Storage Make Directory (Remote Command Only)

Key path	SCPI Only
Remote Command	:MMEMory:MDIRectory <directory_name>
Notes	<p>The string must be a valid logical path.</p> <p>Creates a new directory. The <directory_name> parameter specifies the name to be created.</p> <p>This command will generate an “access denied” error if the new directory would be in a restricted folder (e.g., C:\Windows) and the current user does not have Power User or Administrator privileges.</p>
Initial S/W Revision	Prior to A.02.00

Mass Storage Move (Remote Command Only)

Key path	SCPI Only
Remote Command	:MMEMory:MOVE <string>,<string>[,<string>,<string>]
Notes	<p>The string must be a valid logical path.</p> <p>Moves an existing file to a new file or an existing directory to a new directory.</p> <p>Two forms of parameters are allowed. The first form has two parameters. In this form, the first parameter specifies the source, and the second parameter specifies the destination.</p> <p>The second form has four parameters. In this form, the first and third parameters specify the source. The second and fourth parameters specify the directories. The first pair of parameters specifies the source. The second pair specifies the destination. An error is generated if the source doesn't exist or the destination file already exists.</p> <p>This command will generate an “access denied” error if the destination is a restricted folder (e.g., C:\Windows) and the current user does not have Power User or Administrator privileges.</p>
Initial S/W Revision	Prior to A.02.00

Mass Storage Remove Directory (Remote Command Only)

Key path	SCPI Only
Remote Command	:MMEMory:RDIRectory <directory_name>
Notes	<p>The string must be a valid logical path.</p> <p>Removes a directory. The <directory_name> parameter specifies the directory name to be removed. All files and directories under the specified directory shall also be removed.</p> <p>This command will generate an “access denied” error if the folder is a restricted folder (e.g., C:\Windows) or is in a restricted folder and the current user does not have Power User or Administrator privileges.</p>
Initial S/W Revision	Prior to A.02.00

Single (Single Measurement/Sweep)

Sets the analyzer for Single measurement operation. The single/continuous state is Meas Global, so the setting will affect all the measurements. If you are Paused, pressing Single does a Resume.

See ["More Information" on page 1930](#)

Key Path	Front-panel key
Example	:INIT:CONT OFF
Notes	See Cont key description.
Backwards Compatibility Notes	<p>For Spectrum Analysis mode in ESA and PSA, the Single hardkey and the INITiate:IMM switched from continuous measurement to single measurement and restarted sweeps and averages (displayed average count reset to 1), but did not restart Max Hold and Min Hold. In the X-Series, the Single hardkey and the INITiate:IMM command initiate a sweep/ measurement/ average sequence/hold sequence including MaxHold and MinHold.</p> <p>For Spectrum Analysis mode in ESA and PSA, the Single hardkey restarted the sweep regardless of whether or not you were in an active sweep or sweep sequence. In the X-Series, Restart does this but Single only restarts the sweep or sweep sequence if you are in the idle state.</p> <p>INIT[:IMM] in ESA & PSA Spectrum Analysis Mode does an implied ABORT. In some other PSA Modes, INIT[:IMM] is ignored if not in the idle state. . The X-Series follows the ESA/PSA SA Mode model, which may cause some Modes to have compatibility problems.</p>
Initial S/W Revision	Prior to A.02.00

More Information

See ["Restart" on page 2249](#) for details on the INIT:IMMEDIATE (Restart) function.

If you are already in single sweep, the INIT:CONT OFF command has no effect.

If you are already in Single Sweep, then pressing the Single key in the middle of a sweep does not restart the sweep or sequence. Similarly, pressing the Single key does not restart the sweep or sequence if the sweep is not in the idle state (for example, if you are taking a very slow sweep, or the analyzer is waiting for a trigger). Instead, it results in a message. "Already in Single, press Restart to initiate a new sweep or sequence". Even though pressing the Single key in the middle of a sweep does not restart the sweep, sending INIT:IMMEDIATE does reset it.

To take one more sweep without resetting the average count, increment the average count by 1, by pressing the step up key while **Average/Hold Number** is the active function, or sending the remote command CALC:AVER:TCON UP.

Source

There is no Source control functionality for this measurement. When this key is pressed, the screen either displays a blank menu, or the previously-selected menu remains unchanged.

Key Path	Front-panel key
----------	-----------------

Span X Scale

The SPAN X Scale key accesses the menu to set the desired horizontal scale.

Key Path	Front-panel key
Initial S/W Revision	Prior to A.02.00

Scale/Div

Enables you to enter a time value to change the horizontal scale.

Key Path	Span X Scale
Mode	SA, WCDMA, C2K, WIMAXOFDMA, TD-SCDMA, 1xEV-DO, DVB-T/H, DTMB (CTTB), ISDB-T, CMMB, LTE, LTE-TDD, Digital Cable TV, WLAN, MSR,, LTE-TDD, LTE-AFDD
Remote Command	:DISPlay:PSTatistic:VIEW[1]:WINDow2:TRACe:X[:SCALE]:PDIVision <rel_ ampl> :DISPlay:PSTatistic:VIEW[1]:WINDow2:TRACe:X[:SCALE]:PDIVision?
Example	DISP:PST:VIEW:WIND2:TRAC:X:PDIV 10 DISP:PST:VIEW:WIND2:TRAC:X:PDIV?
Notes	CCDF measurement has the trace display only at Window 2.
Couplings	See Notes
Preset	2.00
State Saved	Saved in instrument state.
Min	0.1
Max	20
Backwards Compatibility SCPI	:DISPlay:PSTatistic:XScale
Initial S/W Revision	Prior to A.02.00
Modified at S/W Revision	A.02.00, A.03.00

Sweep/Control

Enables you to pause the power statistics CCDF measurement after the current data acquisition is complete. When Paused, the label on the menu key changes to Resume. Press Resume to resume the measurement where it was when it was paused.

Key Path	Front-panel key
Initial S/W Revision	Prior to A.02.00

Pause/Resume

Pauses a measurement after the current data acquisition is complete. When Paused, the label on the key changes to Resume. Press Resume to resume the measurement where it was when it was paused. See ["Pause/Resume" on page 2282](#) for details.

Key Path	Sweep/Control
Initial S/W Revision	Prior to A.02.00

System

See ["System" on page 342](#)

Trace/Detector

Accesses a menu of functions that enable you to control the storage and manipulation of the reference trace, as well as controls the display of the trace data.

Key Path	Front-panel key
Initial S/W Revision	Prior to A.02.00

Store Ref Trace

Copies the currently measured curve as the user-definable reference trace. The captured data remains until the other mode is chosen. Pressing this key also refreshes the reference trace.

No query command is available.

Key Path	Trace/Detector
Mode	SA, WCDMA, C2K, WIMAXOFDMA, TD-SCDMA, 1xEV-DO, DVB-T/H, DTMB (CTTB), ISDB-T, CMMB, LTE, LTE-TDD, Digital Cable TV, WLAN, MSR, LTE-TDD, LTEAFDD
Remote Command	:CALCulate:PSTatistic:STORe:REFerence
Example	CALC:PST:STOR:REF
Backwards Compatibility SCPI	[:SENSe] :PSTatistic:SRTRace
Initial S/W Revision	Prior to A.02.00
Modified at S/W Revision	A.02.00, A.03.00

Ref Trace

Toggles the reference trace display between On and Off.

Key Path	Trace/Detector
Mode	SA, WCDMA, C2K, WIMAXOFDMA, TD-SCDMA, 1xEV-DO, DVB-T/H, DTMB (CTTB), ISDB-T, CMMB, LTE, LTE-TDD, Digital Cable TV, WLAN, MSR, LTE-TDD, LTEAFDD
Remote Command	:DISPlay:PSTatistic:RTRace[:STATe] OFF ON 0 1 :DISPlay:PSTatistic:RTRace[:STATe]?
Example	DISP:PST:RTR OFF DISP:PST:RTR?
Preset	OFF
State Saved	Saved in instrument state.
Range	On Off
Backwards Compatibility SCPI	[:SENSe] :PSTatistic:RTRace[:STATe]
Initial S/W Revision	Prior to A.02.00
Modified at S/W Revision	A.02.00, A.03.00, A.04.00

Gaussian Line

Toggles the Gaussian trace display between On and Off.

Key Path	Trace/Detector
Mode	SA, WCDMA, C2K, WIMAXOFDMA, TD-SCDMA, 1xEV-DO, DVB-T/H, DTMB (CTTB), ISDB-T, CMMB, LTE, LTE-TDD, Digital Cable TV, WLAN, MSR, LTE-TDD, LTE-FDD
Remote Command	:DISPlay:PStatistic:GAUSSian[:STATe] OFF ON 0 1 :DISPlay:PStatistic:GAUSSian[:STATe]?
Example	DISP:PST:GAUS OFF DISP:PST:GAUS?
Preset	ON
State Saved	Saved in instrument state.
Range	On Off
Backwards Compatibility SCPI	[:SENSe]:PStatistic:GAUSSian[:STATe]
Initial S/W Revision	Prior to A.02.00
Modified at S/W Revision	A.02.00, A.03.00, A.04.00

Trigger

See ["Trigger" on page 412](#)

Free Run

See ["Free Run " on page 419](#)

Video

See ["Video \(IF Envelope\) " on page 420](#)

Trigger Level

See ["Trigger Level " on page 420](#)

Trig Slope

See ["Trig Slope " on page 421](#)

Trig Delay

See ["Trig Delay " on page 422](#)

Line

See ["Line " on page 2087](#)

Trig Slope

See ["Trig Slope " on page 2087](#)

Trig Delay

See ["Trig Delay " on page 424](#)

External 1

See ["External 1 " on page 2099](#)

Trigger Level

See ["Trigger Level " on page 2099](#)

Trig Slope

See ["Trig Slope " on page 2100](#)

Trig Delay

See ["Trig Delay " on page 427](#)

External 2

See ["External 2 " on page 2101](#)

Trigger Level

See ["Trigger Level "](#) on page 2101

Trig Slope

See ["Trig Slope "](#) on page 2102

Trig Delay

See ["Trig Delay "](#) on page 429

RF Burst

See ["RF Burst "](#) on page 2102

Absolute Trigger

See ["Absolute Trigger Level"](#) on page 2103

Relative Trigger

See ["Relative Trigger Level"](#) on page 2092

Trig Slope

See ["Trigger Slope "](#) on page 2104

Trig Delay

See ["Trig Delay "](#) on page 433

Periodic Timer

See ["Periodic Timer \(Frame Trigger\) "](#) on page 2094

Period

See ["Period "](#) on page 2095

Offset

See ["Offset "](#) on page 2096

Offset Adjust (Remote Command Only)

See ["Offset Adjust \(Remote Command Only\)"](#) on page 2097

Reset Offset Display

See ["Reset Offset Display "](#) on page 2098

Sync Source

See ["Sync Source "](#) on page 2098

Off

See ["Off "](#) on page 2099

External 1

See ["External 1 "](#) on page 2099

Trigger Level

See ["Trigger Level "](#) on page 2099

Trig Slope

See ["Trig Slope "](#) on page 2100

External 2

See ["External 2 "](#) on page 2101

Trigger Level

See ["Trigger Level "](#) on page 2101

Trig Slope

See ["Trig Slope "](#) on page 2102

RF Burst

See ["RF Burst "](#) on page 2102

Absolute Trigger

See ["Absolute Trigger Level"](#) on page 2103

Trig Slope

See ["Trigger Slope "](#) on page 2104

Trig Delay

See ["Trig Delay"](#) on page 443

Auto/Holdoff

See ["Auto/Holdoff "](#) on page 444

Auto Trig

See ["Auto Trig "](#) on page 444

Trig Holdoff

See ["Trig Holdoff "](#) on page 445

Baseband I/Q

See [__](#) on page X

I/Q Mag

See ___ on page X

Trigger Level

See ___ on page X

Trig Slope

See ___ on page X

Trig Delay

See ___ on page X

I

See ___ on page X

Trigger Level

See ___ on page X

Trig Slope

See ___ on page X

Trig Delay

See ___ on page X

Q

See ___ on page X

Trigger Level

See ___ on page X

Trig Slope

See ___ on page X

Trig Delay

See ___ on page X

Input I

See ___ on page X

Trigger Level

See ___ on page X

Trig Slope

See ___ on page X

Trig Delay

See ___ on page X

Input Q

See ___ on page X

Trigger Level

See ___ on page X

Trig Slope

See ___ on page X

Trig Delay

See ___ on page X

Aux Channel Center Freq

See ___ on page X

Trigger Level

See ___ on page X

Trig Slope

See ___ on page X

Trig Delay

See ___ on page X

Trigger Center Freq

See ___ on page X

Trigger BW

See ___ on page X

User Preset

Accesses a menu that gives you the following three choices:

- User Preset – recalls a state previously saved using the Save User Preset function.
- User Preset All Modes – presets all of the modes in the analyzer
- Save User Preset– saves the current state for the current mode

Key Path	Front-panel key
Backwards Compatibility Notes	<p>User Preset is actually loading a state, and in legacy analyzers, it was possible to load a state without affecting the trace data, limit lines or correction data. Similarly it was possible to do a User Preset without affecting the trace data, limit lines or correction data.</p> <p>In the X-Series, “state” always includes all of this data; so whenever state is loaded, or User Preset is executed, all of the traces, limit lines and corrections are affected. Although this differs from previous behavior, it is desirable behavior, and should not cause adverse issues for users.</p> <p>On ESA and PSA, User Preset affected the entire instrument’s state. In the X-Series, User Preset only recalls the state for the active mode. There is a User Preset file for each mode. User Preset can never cause a mode switch as it can in legacy analyzers. If you want to recall all modes to their user preset file state, you will need to do a User Preset after mode switching into each mode.</p> <p>User Preset recalls mode state which can now include data like traces; whereas on ESA and PSA, User Preset did not affect data.</p>
Initial S/W Revision	Prior to A.02.00

User Preset

User Preset sets the state of the currently active mode back to the state that was previously saved for this mode using the Save User Preset menu key or the SCPI command, SYST:PRES:USER:SAV. It not only recalls the Mode Preset settings, but it also recalls all of the mode persistent settings, and the Input/Output system setting that existed at the time Save User Preset was executed.

If a Save User Preset has not been done at any time, User Preset recalls the default user preset file for the currently active mode. The default user preset files are created if, at power-on, a mode detects there is no user preset file. There will never be a scenario when there is no user preset file to restore. For each mode, the default user preset state is the same state that would be saved if a Save User Preset is performed in each mode right after doing a Restore Mode Default and after a Restore Input/Output Defaults.

The User Preset function does the following:

- Aborts the currently running measurement.
- Sets the mode State to the values defined by Save User Preset.
- Makes the saved measurement for the currently running mode the active measurement.
- Brings up the saved menu for the power-on mode.
- Clears the input and output buffers.
- Sets the Status Byte to 0.

Key Path	User Preset
Remote Command	:SYSTem:PRESet:USER
Example	:SYST:PRES:USER:SAVE:SYST:PRES:USER
Notes	:SYST:PRES:USER:SAVE is used to save the current state as the user preset state. Clears all pending OPC bits. The Status Byte is set to 0. Pressing the User Preset front-panel key while already in the User Preset menu will cause the User Preset to get executed
Couplings	A user preset will cause the currently running measurement to be aborted and cause the saved measurement to be active. Recalling a User Preset file has the same issues that recalling a Save State file has. Some settings may need to be limited and therefore re-coupled, since the capabilities of the mode may have changes when the User Preset file was last saved.
Initial S/W Revision	Prior to A.02.00

User Preset All Modes

Recalls all of the User Preset files for each mode, switches to the power-on mode, and activates the saved measurement from the power-on mode User Preset file.

NOTE

When the instrument is secured, all of the user preset files are converted back to their default user preset files.

The User Preset function does the following:

- Aborts the currently running measurement.
- Switches the Mode to the power-on mode.
- Restores the User Preset files for each mode.
- Makes the saved measurement for the power-on mode the active measurement.
- Brings up the saved menu for the power-on mode.
- Clears the input and output buffers.
- Sets the Status Byte to 0.

Key Path	User Preset
Remote Command	:SYSTem:PRESet:USER:ALL
Example	:SYST:PRES:USER:SAVE:SYST:PRES:USER:ALL
Notes	Clears all pending OPC bits. The Status Byte is set to 0. :SYST:PRES:USER:SAVE is used to save the current state as the user preset state.
Couplings	A user preset will cause the currently running measurement to be aborted, cause a mode switch to the power-on mode, and cause the saved measurement to be active in the power-on mode. Recalling a User Preset file has the same issues that recalling a Save State file has. Some settings may need to be limited and therefore re-coupled, since the capabilities of the mode may have changes when the User Preset file was last saved.
Initial S/W Revision	Prior to A.02.00

Save User Preset

Saves the currently active mode and its State. You can recall this User Preset file by pressing the User Preset menu key or sending the SYST:PRES:USER remote command. This same state is also saved by the Save State function.

Key Path	User Preset
Remote Command	:SYSTem:PRESet:USER:SAVE
Example	:SYST:PRES:USER:SAVE
Notes	:SYST:PRES:SAVE creates the same file as if the user requested a *SAV or a MMEM:STOR:STAT, except User Preset Save does not allow the user to specify the filename or the location of the file.
Initial S/W Revision	Prior to A.02.00

View/Display

Accesses a menu of functions that enable you to control the instrument display as well as turn the bar graph On and Off.

The Power Stat CCDF measurement provides a single view. This is common for both Uplink (MS) and Downlink (BTS). The view consists of the following windows:

"Metrics window" on page 1947

"Graph window" on page 1948

"Wave window (TD-SCDMA and LTE TDD only)" on page 1948

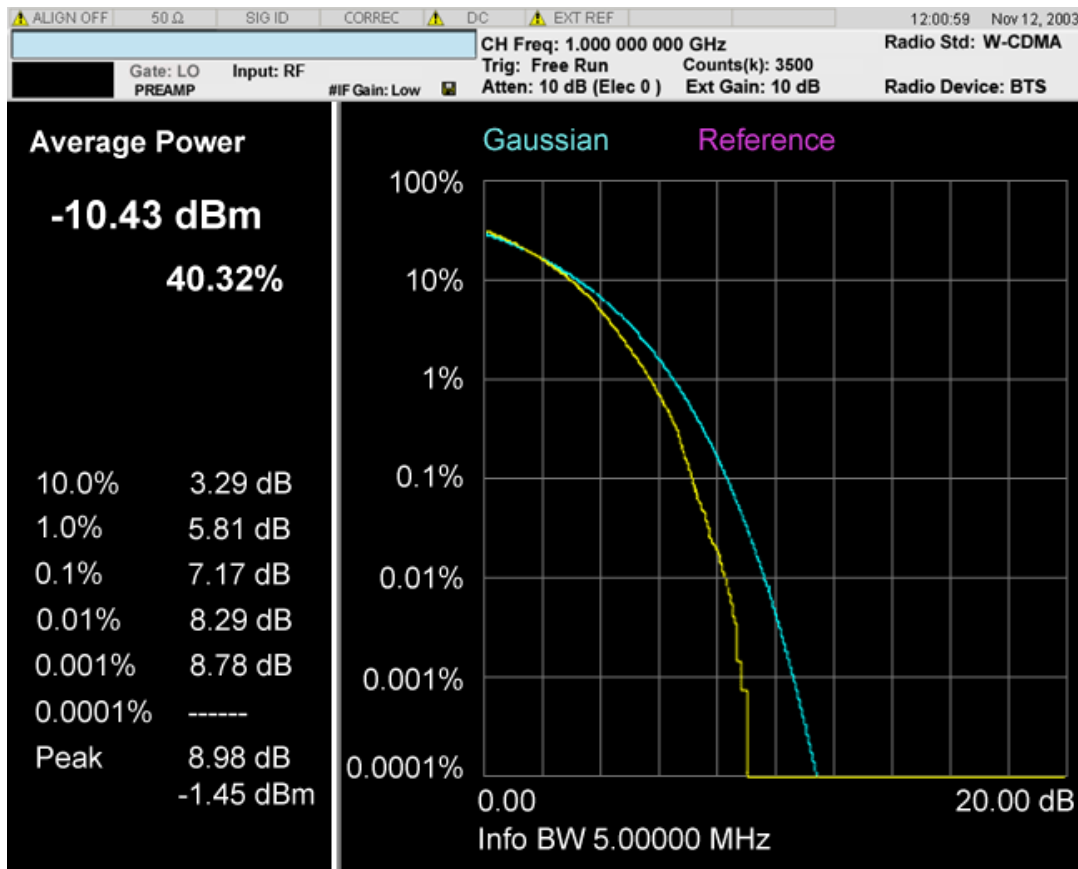

Above: View for Power Stat CCDF Measurement.

15 Power Stat CCDF Measurement
View/Display

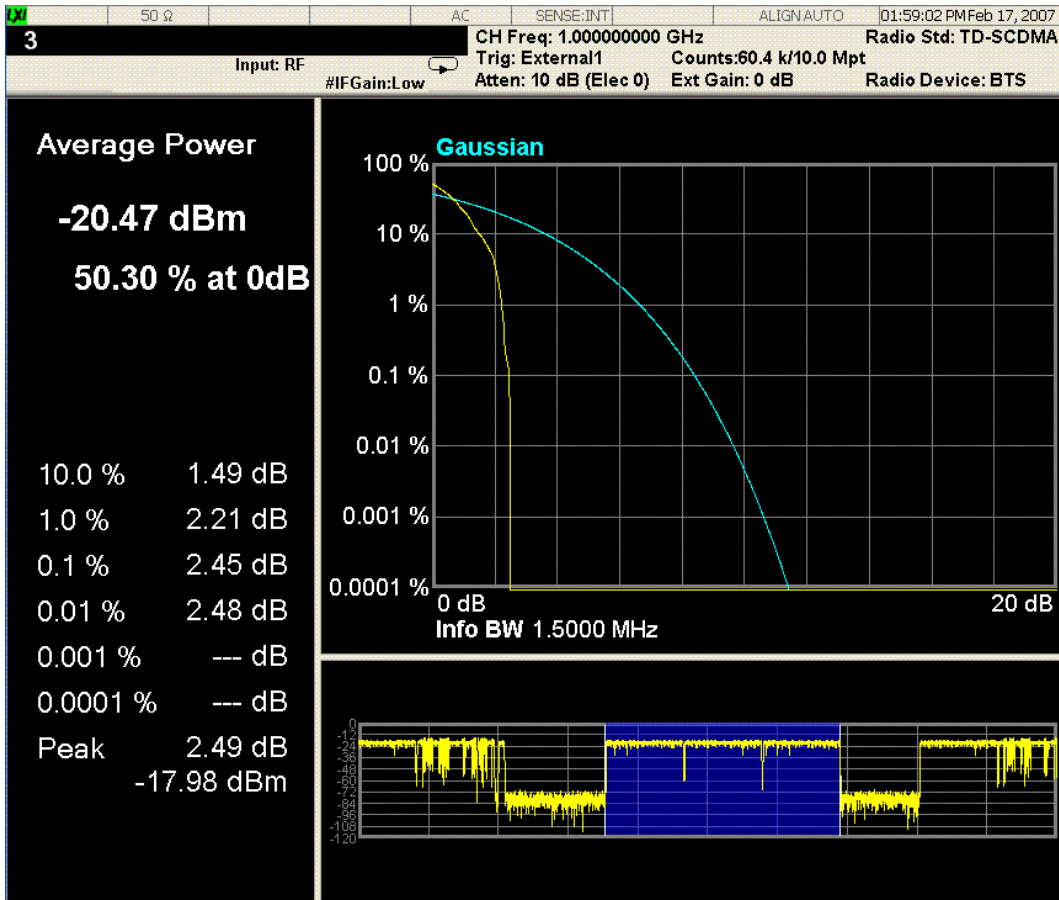

Above: Slot View for Power Stat CCDF Measurement in TD-SCDMA mode.

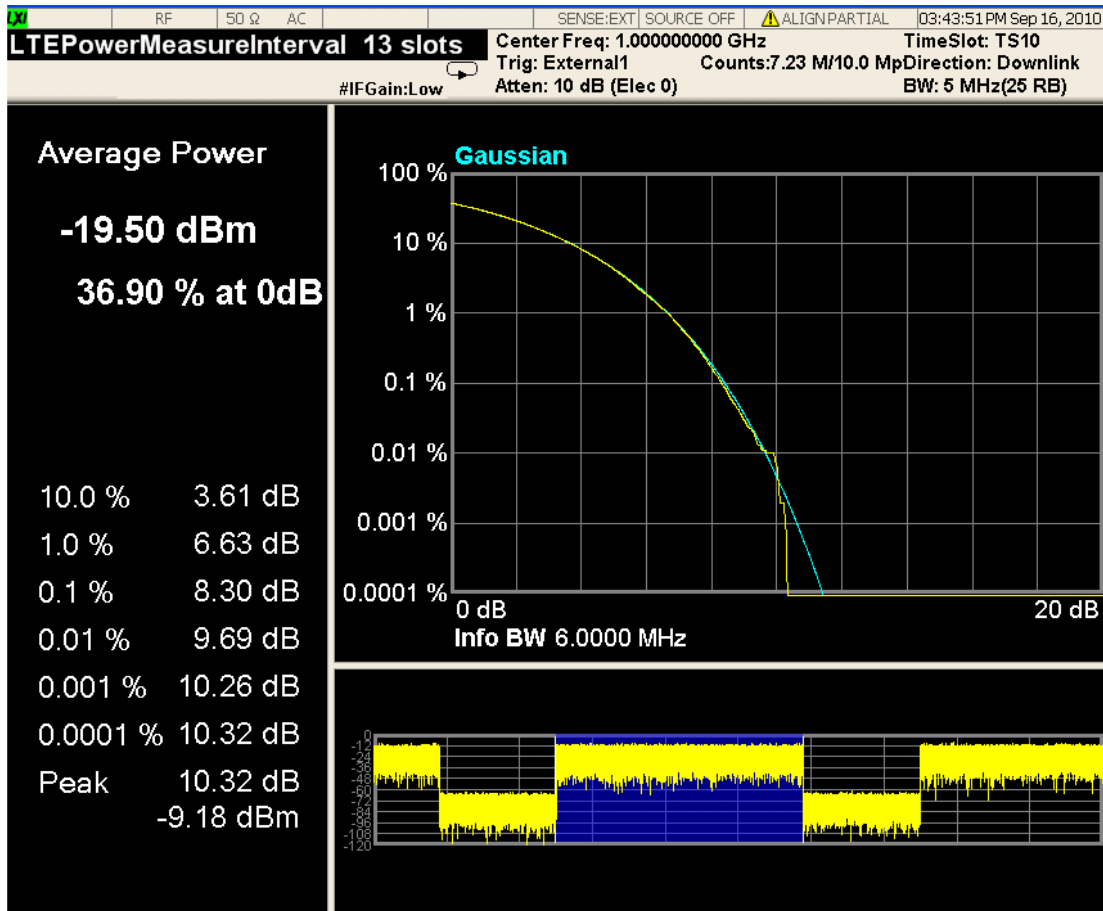

Above: View for Power Stat CCDF Measurement in LTE TDD mode.

Metrics window

Name	Corresponding Results	Explanation
Average Power [dBm]	n=1 1st Average input power	99.99 dBm
Average Power [%]	n=1 2nd Probability at the average input power level	99.99 %
10.0% [dB]	n=1 3rd Power level that has 10% of the power	99.99 dB
1.0% [dB]	n=1 4th Power level that has 1% of the power	99.99 dB
0.1% [dB]	n=1 5th Power level that has 0.1% of the power	99.99 dB
0.01% [dB]	n=1 6th Power level that has 0.01% of the power	99.99 dB
0.001% [dB]	n=1 7th	99.99 dB

Name	Corresponding Results	Explanation
	Power level that has 0.001% of the power	
0.0001% [dB]	n=1 8th	99.99 dB
	Power level that has 0.0001% of the power	
Peak [dB]	n=1 9th Peak power	99.99 dB
Peak[dBm]	This is not available from SCPI using remote commands.	99.99 dBm

Graph window

Marker Operation	Yes
Corresponding Trace	<p>Yellow: Series of 5001 floating the current measured power stat trace. (n=2) Initially all markers refer this trace.</p> <p>Light Blue: Series of 5001 floating point numbers (in percent) that represent the Gaussian trace. (n=3)</p> <p>Violet: series of 5001 floating point numbers (in percent) that represent the user-definable reference trace. (n=4)</p> <p>The Gaussian and Reference trace/line can be removed using the functions under the Trace/Detector key</p>

Wave window (TD-SCDMA and LTE TDD only)

This window is only available under TD-SCDMA mode and LTE TDD mode, and by default this window is closed, it can be turned on or off by using the softkey "Slot View". For more details, refer to the section [Slot View](#).

Marker Operation	No
Corresponding Trace	<p>Yellow: For TD-SCDMA, Waveform of entire TD-SCDMA frame. If measurement range specified by Analysis Time Slot and Measured Time Slot is out of the first frame, the display range extends to two TD-SCDMA frames. For LTETDD, Waveform of 2 continuous LTE type2 frames.</p> <p>Blue: Indicates current measurement range</p>

Key Path	Front-panel key
Initial S/W Revision	Prior to A.02.00

Display

The Display menu is common to most measurements, and is used for configuring items on the display. Some Display menu settings apply to all the measurements in a mode, and some only to the current measurement. Those under the System Display Settings key apply to all measurements in all modes.

Key Path	Display
Key Path	View/Display
Initial S/W Revision	Prior to A.02.00

Annotation

Turns on and off various parts of the display annotation. The annotation is divided up into four categories:

1. Meas Bar: This is the measurement bar at the top of the screen. It does not include the settings panel or the Active Function. Turning off the Meas Bar turns off the settings panel and the Active Function. When the Meas Bar is off, the graticule area expands to fill the area formerly occupied by the Meas Bar.
2. Screen Annotation: this is the annotation and annunciation around the graticule, including any annotation on lines (such as the display line, the threshold line, etc.) This does NOT include the marker number or the N dB result. When off, the graticule expands to fill the entire graticule area.
3. Trace annotation: these are the labels on the traces, showing their detector (or their math mode).
4. Active Function annotation: this is the active function display in the meas bar, and all of the active function values displayed on softkeys.

See the figure below. Each type of annotation can be turned on and off individually.

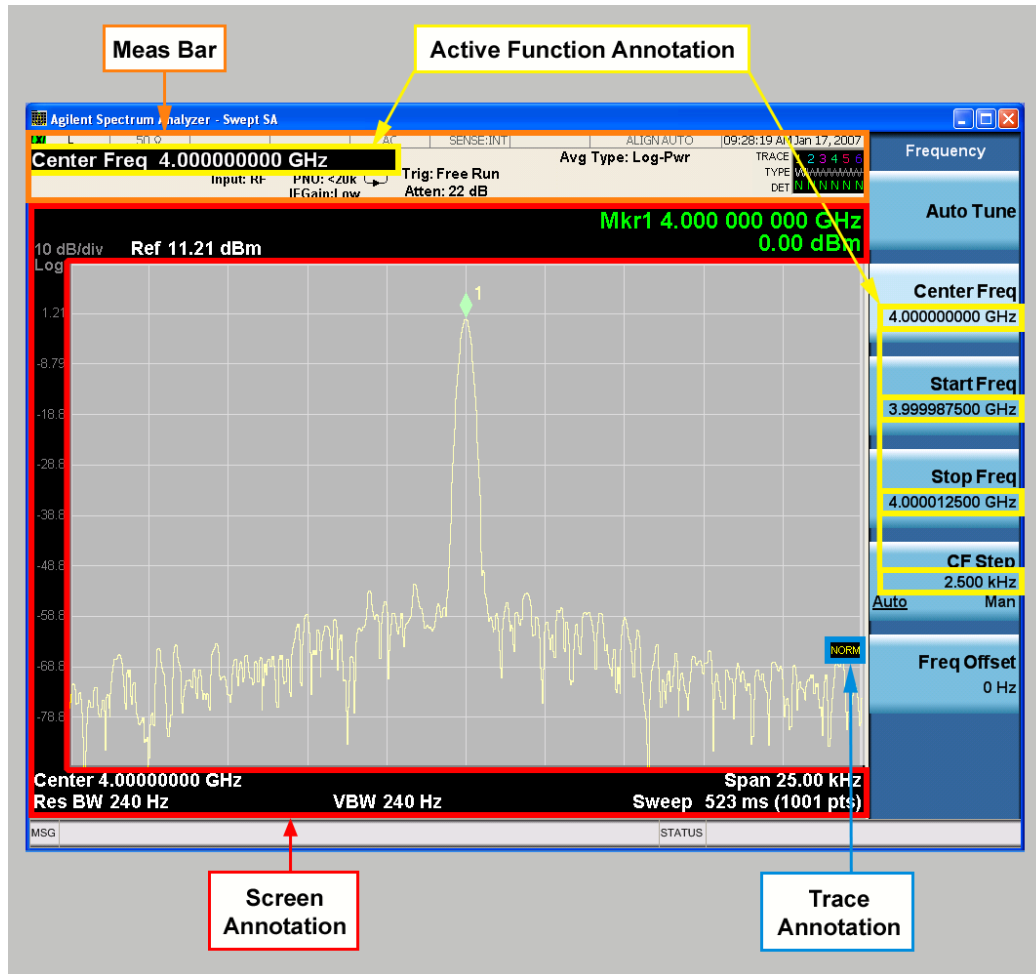

Key Path	View/Display, Display
Initial S/W Revision	Prior to A.02.00

Meas Bar On/Off

This function turns the Measurement Bar on and off, including the settings panel. When off, the graticule area expands to fill the area formerly occupied by the Measurement Bar.

Key Path	View/Display, Display, Annotation
Remote Command	:DISPlay:ANNOtation:MBAR[:STATe] OFF ON 0 1 :DISPlay:ANNOtation:MBAR[:STATe]?
Example	DISP:ANN:MBAR OFF
Dependencies	Grayed out and forced to OFF when System Display Settings, Annotation is set to Off.
Preset	On This should remain Off through a Preset when System DisplaySettings, Annotation is set to Off.
State Saved	Saved in instrument state.
Initial S/W Revision	Prior to A.02.00

Screen

This controls the display of the annunciation and annotation around the graticule, including any annotation on lines (such as the display line, the threshold line, etc.) and the y-axis annotation. This does NOT include marker annotation (or the N dB result). When off, the graticule expands to fill the entire graticule area, leaving only the 1.5% gap above the graticule as described in the Trace/Detector chapter.

Key Path	View/Display, Display, Annotation
Remote Command	:DISPlay:ANNotation:SCReen[:STATe] OFF ON 0 1 :DISPlay:ANNotation:SCReen[:STATe]?
Example	DISP:ANN:SCR OFF
Dependencies	Grayed-out and forced to OFF when System Display Settings, Annotation is set to Off.
Preset	On This should remain Off through a Preset when System DisplaySettings, Annotation is set to Off
State Saved	Saved in instrument state.
Initial S/W Revision	Prior to A.02.00

Active Function Values On/Off

Turns on and off the active function display in the Meas Bar, and all of the active function values displayed on the softkeys.

Note that all of the softkeys that have active functions have these numeric values blanked when this function is on. This is a security feature..

15 Power Stat CCDF Measurement
View/Display

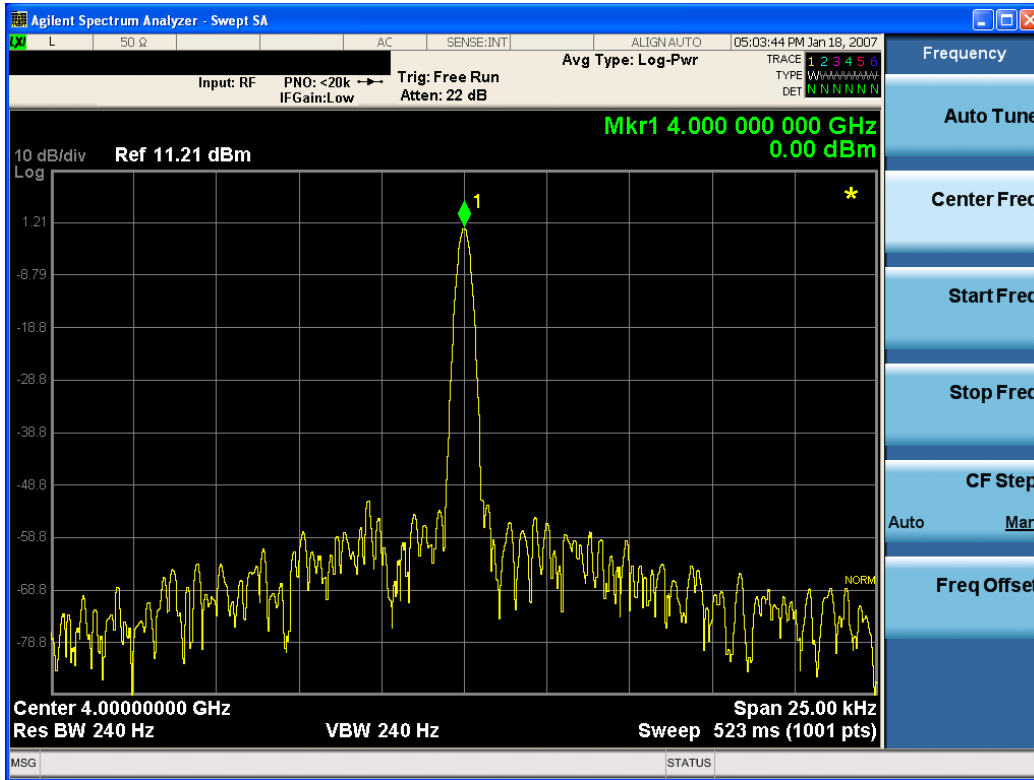

Key Path	View/Display, Display, Annotation
Remote Command	:DISPlay:ACTivefunc[:STATE] ON OFF 1 0 :DISPlay:ACTivefunc[:STATE] ?
Example	DISP:ACT OFF
Dependencies	Grayed out and forced to OFF when System Display Settings, Annotation is set to Off.
Preset	On This should remain Off through a Preset when System DisplaySettings, Annotation is set to Off
State Saved	Saved in instrument state.
Initial S/W Revision	Prior to A.02.00

Title

Displays menu keys that enable you to change or clear a title on your display.

Key Path	View/Display, Display
Initial S/W Revision	Prior to A.02.00

Change Title

Writes a title into the "measurement name" field in the banner, for example, "Swept SA".

Press Change Title to enter a new title through the alpha editor. Press Enter or Return to complete the entry. Press ESC to cancel the entry and preserve your existing title.

The display title will replace the measurement name. It remains for this measurement until you press Change Title again, or you recall a state, or a Preset is performed. A title can also be cleared by pressing Title, Clear Title.

NOTE

Notice the inclusion of the <measurement> parameter in the command below. Because each measurement remembers the Display Title, the command must be qualified with the measurement name. For the Swept SA measurement this is not the case; no <measurement> parameter is used when changing the Display Title for the Swept SA measurement.

Key Path	View/Display, Display, Title
Mode	All
Remote Command	:DISPlay:<measurement>:ANNotation:TITLe:DATA <string> :DISPlay:<measurement>:ANNotation:TITLe:DATA?
Example	DISP:ANN:TITL:DATA "This Is My Title" This example is for the Swept SA measurement in the Spectrum Analyzer mode. The SANalyzer <measurement> name is not used. DISP:ACP:ANN:TITL:DATA "This Is My Title" This example is for Measurements other than Swept SA. Both set the title to: This Is My Title
Notes	Pressing this key cancels any active function. When a title is edited the previous title remains intact (it is not cleared) and the cursor goes at the end so that characters can be added or BKSP can be used to go back over previous characters.
Preset	No title (measurement name instead)
State Saved	Saved in instrument state.
Initial S/W Revision	Prior to A.02.00

Clear Title

Clears a title from the front-panel display. Once cleared, the title cannot be retrieved. After the title is cleared, the current Measurement Name replaces it in the title bar.

Key Path	View/Display, Display, Title
Example	The following commands clear the title and restore the measurement's original title: DISP:ANN:TITL:DATA "" This example is for the Swept SA measurement in the Spectrum Analyzer mode. The SANalyzer <measurement> name is not used. DISP:ACP:ANN:TITL:DATA "" This example is for ACP; in measurements other than Swept SA the measurement name is required.
Notes	Uses the :DISPlay:<measurement>:ANNotation:TITLe:DATA <string> command with an empty string (in the Swept SA, the <measurement> is omitted).
Preset	Performed on Preset.
Initial S/W Revision	Prior to A.02.00

Graticule

Pressing Graticule turns the display graticule On or Off. It also turns the graticule y-axis annotation on and off.

Key Path	View/Display, Display
Remote Command	:DISPlay:WINDow[1]:TRACe:GRATicule:GRID[:STATe] OFF ON 0 1 :DISPlay:WINDow[1]:TRACe:GRATicule:GRID[:STATe]?
Example	DISP:WIND:TRAC:GRAT:GRID OFF
Notes	The graticule is the set of horizontal and vertical lines that make up the grid/divisions for the x-axis and y-axis.
Preset	On
State Saved	Saved in instrument state
Initial S/W Revision	Prior to A.02.00

System Display Settings

These settings are "Mode Global" – they affect all modes and measurements and are reset only by Restore Misc Defaults or Restore System Defaults under System.

Key Path	View/Display, Display
Initial S/W Revision	Prior to A.02.00

Annotation Local Settings

This is a Mode Global override of the meas local annotation settings. When it is All Off, it forces ScreenAnnotation, Meas Bar, Trace, and Active Function Values settings to be OFF for all measurements in all modes. This provides the security based "annotation off" function of previous analyzers; hence it uses the legacy SCPI command.

When it is All Off, the Screen, Meas Bar, Trace, and Active Function Values keys under the Display, Annotation menu are grayed out and forced to Off. When Local Settings is selected, you are able to set the local annotation settings on a measurement by measurement basis.

Key Path	View/Display, Display, System Display Settings
Remote Command	:DISPlay:WINDow[1]:ANNotation[:ALL] OFF ON 0 1 :DISPlay:WINDow[1]:ANNotation[:ALL]?
Example	:DISP:WIND:ANN OFF
Preset	On (Set by Restore Misc Defaults)
State Saved	Not saved in instrument state.
Backwards Compatibility Notes	The WINDow parameter and optional subopcode is included for backwards compatibility but ignored – all windows are equally affected.
Initial S/W Revision	Prior to A.02.00

Themes

Accesses a menu of functions that enable you to choose the theme to be used when saving the screen image.

The **Themes** option is the same as the **Themes** option under the **Display** and **Page Setup** dialogs. It allows you to choose between themes to be used when saving the screen image.

Key Path	Save, Screen Image
Remote Command	:MMEMory:STORe:SCReen:THEMe TDColor TDMonochrome FCOLOR FMONochrome :MMEMory:STORe:SCReen:THEMe?
Example	:MMEM:STOR:SCR:THEM TDM
Preset	3D Color; Is not part of Preset, but is reset by Restore Misc Defaults or Restore System Defaults All and survives subsequent running of the modes.
Readback	3D Color 3D Mono Flat Color Flat Mono
Backwards Compatibility Notes	In ESA and PSA we offer the choice of "Reverse Bitmap" or "Reverse Metafile" when saving screen images. This is much like the "Flat Color" theme available in X-Series. Also, if you selected Reverse Bitmap AND a black & white screen image, that would be much like "Flat Monochrome". In other words, each of the X-Series themes has a similar screen image type in ESA/PSA. But they are not identical.
Initial S/W Revision	Prior to A.02.00

3D Color

Selects a standard color theme with each object filled, shaded and colored as designed.

Key Path	Save, Screen Image, Themes
Example	MMEM:STOR:SCR:THEM TDC
Readback	3D Color
Initial S/W Revision	Prior to A.02.00

3D Monochrome

Selects a format that is like 3D color but shades of gray are used instead of colors.

Key Path	Save, Screen Image, Themes
Example	MMEM:STOR:SCR:THEM TDM
Readback	3D Mono
Initial S/W Revision	Prior to A.02.00

Flat Color

Selects a format that is best when the screen is to be printed on an ink printer.

Key Path	Save, Screen Image, Themes
Example	MMEM:STOR:SCR:THEM FCOL
Readback	Flat Color
Initial S/W Revision	Prior to A.02.00

Flat Monochrome

Selects a format that is like Flat Color. But only black is used (no colors, not even gray), and no fill.

Key Path	Save, Screen Image, Themes
Example	MMEM:STOR:SCR:THEM FMON
Readback	Flat Mono
Initial S/W Revision	Prior to A.02.00

Backlight

Accesses the display backlight on/off keys. This setting may interact with settings under the Windows "Power" menu.

When the backlight is off, pressing ESC, TAB, SPACE, ENTER, UP, DOWN, LEFT, RIGHT, DEL, BKSP, CTRL, or ALT turns the backlight on without affecting the application. Pressing any other key will turn backlight on and could potentially perform the action as well.

Key Path	View/Display, Display, System Display Settings
Remote Command	:DISPlay:BACKlight ON OFF :DISPlay:BACKlight?
Preset	ON (Set by Restore Misc Defaults)
Initial S/W Revision	Prior to A.02.00

Backlight Intensity

An active function used to set the backlight intensity. It goes from 0 to 100 where 100 is full on and 0 is off. This value is independent of the values set under the Backlight on/off key.

Key Path	View/Display, Display, System Display Settings
Remote Command	:DISPlay:BACKlight:INTensity <integer> :DISPlay:BACKlight:INTensity?
Example	DISP:BACK:INT 50

Preset	100 (Set by Restore Misc Defaults)
Min	0
Max	100
Initial S/W Revision	Prior to A.02.00

SCPI Only Parameters

Number of Bursts (Query Only)

This query returns the number of bursts to be measured. In the auto-detect mode, this parameter changes when detection is performed correctly. In the predefined-mode, this parameter is calculated from the map file.

Mode	WIMAXOFDMA
Remote Command	:CALCulate:EVM:BURSt:NUMBer?
Example	CALC:EVM:BURS:NUMB?
State Saved	No
Initial S/W Revision	Prior to A.02.00

Selected Burst Number

Selects which burst's info is returned by MEASure|READ|FETCh:EVM10?

Mode	WIMAXOFDMA
Remote Command	:CALCulate:EVM:INFormation:BURSt <integer> :CALCulate:EVM:INFormation:BURSt?
Example	CALC:EVM:INF:BURS 1 CALC:EVM:INF:BURS?
Couplings	Max value of this parameter depends on Number of Bursts (See " Number of Bursts (Query Only) " on page 1958)
Preset	1
State Saved	Saved in instrument state.
Min	1
Max	CALC:EVM:BURS:COUN?
Initial S/W Revision	Prior to A.02.00

DIUC Burst Profiles

Specifies the DCD burst profiles mapping, focusing to code type and code rate, when Auto Detection Now (see 1.7.11.7.2) works. This parameter array emulates DCD burst profiles and provides a set of values for DIUC Index = 1 thru 12 specifying values for the burst profile used, i.e. modulation type, coding type and coding rate.

The burst profile information is not saved in the Map File (.omf), though it is saved in the state file (.state).

The options are as follows:

- QPSK Convolutional Code (CC) 1/2
- QPSK CC 3/4

- QPSK Convolutional Turbo Code 1/2
- QPSK CTC 3/4
- 16QAM CC 1/2
- 16QAM CC 3/4
- 16QAM CTC 1/2
- 16QAM CTC 3/4
- 64QAM CC 1/2
- 64QAM CC 2/3
- 64QAM CC 3/4
- 64QAM CTC 1/2
- 64QAM CTC 2/3
- 64QAM CTC 3/4
- 64QAM CTC 5/6

Mode	WIMAXOFDMA
Remote Command	:CALCulate:EVM:DIUC[1] 2 ...12:CODE:TYPE[:SElect] QPSKCC1BY2 QPSKCC3BY4 QPSKCTC1BY2 QPSKCC3BY4 QAM16CC1BY2 QAM16CC3BY4 QAM16CTC1BY2 QAM16CTC3BY4 QAM64CC1BY2 QAM64CC2BY3 QAM64CC3BY4 QAM64CTC1BY2 QAM64CTC2BY3 QAM64CTC3BY4 QAM64CTC5BY6 :CALCulate:EVM:DIUC[1] 2 ...12:CODE:TYPE[:SElect]?
Example	CALC:EVM:DIUC1:CODE:TYPE QPSKCTC1BY2 CALC:EVM:DIUC10:CODE:TYPE?
Notes	Since DIUC=0 is always mapped to DL MAP, its profile is always identical to DL MAP's one and automatically determined by information in FCH. Thus, this parameter array provides setups for DIUC=1 to 12. Note that auto-detection algorithm may not be able to determine the correct data burst modulation type when measuring noisy signals. For a normal UL-MAP to be decoded successfully, the DIUC index burst profile corresponding to the first burst IE in the DL-MAP must be correctly specified. In Revision A.03.00, burst profiles can be selected only options related to CC and CTC.
Pre set	QPSKCC1BY2
State Saved	Saved in instrument state.
Range	QPSKCC1BY2 QPSKCC3BY4 QPSKCTC1BY2 QPSKCC3BY4 QAM16CC1BY2 QAM16CC3BY4 QAM16CTC1BY2 QAM16CTC3BY4 QAM64CC1BY2 QAM64CC2BY3 QAM64CC3BY4 QAM64CTC1BY2 QAM64CTC2BY3 QAM64CTC3BY4 QAM64CTC5BY6

	BY6
Initial S/ W Revision	A.03.00

16 Monitor Spectrum Measurement

The monitor spectrum measurement is used as a quick, convenient means of looking at the entire spectrum. While the look and feel are similar to the Spectrum Analyzer mode, the functionality is greatly reduced for easy operation. The main purpose of the measurement is to show the spectrum. The default span should cover an appropriate frequency range of the application.

For measurement results and views, see ["View/Display" on page 2123](#).

This topic contains the following sections:

["Measurement Commands for Monitor Spectrum" on page 1962](#)

["Remote Command Results for Monitor Spectrum Measurement" on page 1963](#)

Measurement Commands for Monitor Spectrum

The following commands can be used to retrieve the measurement results:

`:CONFigure:MONitor`

`:CONFigure:MONitor:NDEFault`

`:INITiate:MONitor`

`:FETCh:MONitor[n]?`

`:READ:MONitor[n]?`

`:MEASure:MONitor[n]?`

For more measurement related commands, see the SENSE subsystem, and the section "[Remote Measurement Functions](#)" on page 2205.

Remote Command Results for Monitor Spectrum Measurement

The following table describes the results returned by the queries listed above, according to the index value n .

n	Results Returned
1 (or not specified)	Returns trace1 data with comma separated floating numbers
2	Returns trace2 data with comma separated floating numbers
3	Returns trace3 data with comma separated floating numbers

Key Path	Meas
Initial S/W Revision	Prior to A.02.00

AMPTD Y Scale

Accesses a menu of functions that enable you to set the vertical scale parameters. These functions control how data on the vertical (Y) axis is displayed and control instrument settings that affect the vertical axis.

Key Path	Front-panel key
Initial S/W Revision	Prior to A.02.00

Ref Value

Sets the absolute power reference value. However, since Auto Scaling defaults to On, this value is automatically determined by the measurement result. When you set a value manually, Auto Scaling automatically changes to Off.

Key Path	AMPTD Y Scale
Mode	All except SA and BASIC
Remote Command	:DISPlay:MONitor:VIEW[1]:WINDow[1]:TRACe:Y[:SCALe]:RLEVel <real> :DISPlay:MONitor:VIEW[1]:WINDow[1]:TRACe:Y[:SCALe]:RLEVel?
Example	DISP:MON:VIEW:WIND:TRAC:Y:RLEV 2.0 DISP:MON:VIEW:WIND:TRAC:Y:RLEV?
Couplings	When the Auto Scaling is On, this value is automatically determined by the measurement result. When you set a value manually, Auto Scaling automatically changes to Off.
Preset	10.00 dBm
State Saved	Saved in instrument state.
Min	-250.00 dBm
Max	250.00 dBm
Initial S/W Revision	Prior to A.02.00

Attenuation

This menu controls the attenuator functions and interactions between the attenuation system components.

There are two attenuator configurations in the X-Series. One is a dual attenuator configuration consisting of a mechanical attenuator and an optional electronic attenuator. The other configuration uses a single attenuator with combined mechanical and electronic sections that controls all the attenuation functions. Different models in the X-Series come with different configurations.

See ["Dual Attenuator Configurations:" on page 1965](#)

See ["Single Attenuator Configuration:" on page 1965](#)

Most Attenuation settings are the same for all measurements – they do not change as you change measurements. Settings like these are called “Meas Global” and are unaffected by Meas Preset.

Key Path	AMPTD Y Scale
Scope	Meas Global
Dependencies	In measurements that support the I/Q inputs, this key is unavailable when I/Q is the selected input, and is replaced by the Range key in that case.
Readback Line	Contains a summary in [] brackets of the current total attenuation. See the descriptions of the , " (Mech) Atten " on page 2141, and " Enable Elec Atten " on page 2143 keys for more detail on the contributors to the total attenuation. Note that when "Pre-Adjust for Min Clip" is on, this value can change at the start of every measurement.
Initial S/W Revision	Prior to A.02.00
Modified at S/W Revision	A.03.00

Dual Attenuator Configurations:

Configuration 1: Mechanical attenuator + optional electronic attenuator

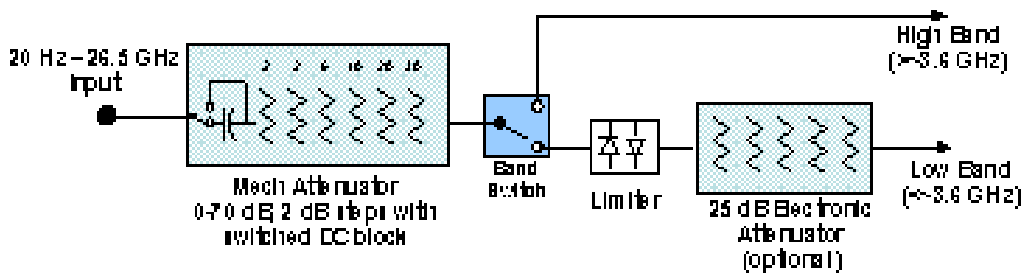

Configuration 2: Mechanical attenuator, no optional electronic attenuator

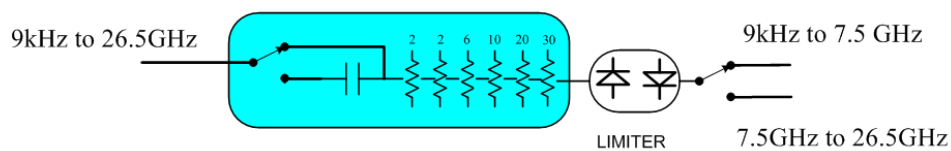

(note that Configuration 2 is not strictly speaking a dual-section attenuator, since there is no electronic section available. However, it behaves exactly like Configuration 1 without the Electronic Attenuator option EA3, therefore for the sake of this document it is grouped into the "Dual Attenuator" configuration)

Single Attenuator Configuration:

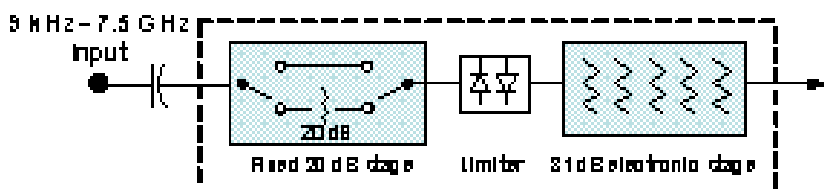

You can tell which attenuator configuration you have by pressing the Attenuation key, which (in most Modes) opens the Attenuation menu. If the first key in the Attenuation menu says Mech Atten you have the dual attenuator configuration. If the first key says Atten you have the single attenuator configuration.

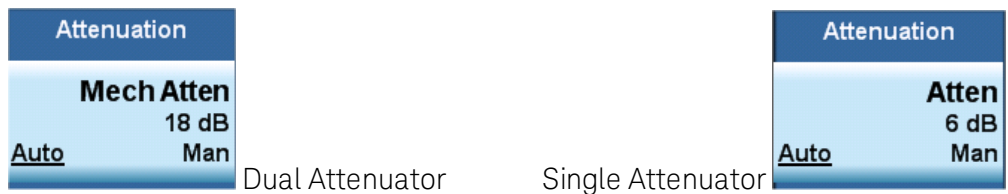

In the single attenuator configuration, you control the attenuation with a single control, as the fixed stage has only two states. In the dual attenuator configuration, both stages have significant range so you are given separate control of the mechanical and electronic attenuator stages.

When you have the dual attenuator configuration, you may still have only a single attenuator, because unless option EA3 (the Electronic Attenuator option) is available, and you purchase it, you will have only the mechanical attenuator.

(Mech) Atten

This key is labeled Mech Atten in dual attenuator models and Atten in single attenuator models. In the dual attenuator configuration, this key only affects the mechanical attenuator.

This key lets you modify the attenuation applied to the RF input signal path. This value is normally auto coupled to the Ref Level, the Internal Preamp Gain, any External Gain that is entered, and the Max Mixer Level, as described in the table below.

See "[Attenuator Configurations and Auto/Man](#)" on page 1967

Key Path	AMPTD Y Scale, Attenuation
Remote Command	<pre>[:SENSe] :POWer [:RF] :ATTenuation <rel_ampl> [:SENSe] :POWer [:RF] :ATTenuation? [:SENSe] :POWer [:RF] :ATTenuation:AUTO OFF ON 0 1 [:SENSe] :POWer [:RF] :ATTenuation:AUTO?</pre>
Example	<p>POW:ATT 20</p> <p>Dual attenuator configuration: sets the mechanical attenuator to 20 dB</p> <p>Single attenuator mode: sets the main attenuation to 20 dB (see below for definition of "main" attenuation).</p> <p>If the attenuator was in Auto, it sets it to Manual.</p>
Dependencies	<p>Some measurements do not support the Auto setting of (Mech) Atten. In these measurements, the Auto/Man selection is not available, and the Auto/Man line on the key disappears.</p> <p>In dual attenuator configurations, when the electronic attenuator is enabled, the mechanical attenuator has no auto setting and the Auto/Man line on the key disappears. The state of Auto/Man is remembered and restored when the electronic attenuator is once again disabled. This is described in more detail in the "Enable Elec Atten" on page 2143 key description.</p> <p>See "Attenuator Configurations and Auto/Man" on page 1967 for more information on the Auto/Man functionality of Attenuation.</p>
Couplings	

	<p>When (Mech) Atten is in Auto, it uses the following algorithm to determine a value: If the USB Preamp is connected to USB, use 0 dB. Otherwise, Atten = ReferenceLevel + PreAmpGain + ExternalGain – RefLevelOffset - MaxMixerLevel + IF Gain. Limit this value to be between 6 dB and the Max value. No value below 6 dB can ever be chosen by Auto. The resulting value is rounded up to the largest value possible given the attenuation step setting. That is, 50.01 dB would change to 60 dB (for a 10 dB attenuation step). The “IF Gain” term in the equation above is either 0 dB or +10 dB, depending on the settings of FFT IF Gain, Swept IF Gain, max Ref Level and the Auto/Man setting of Mech Atten. In External Mixing and BBIQ, where the Attenuator is not in the signal path, the Attenuator setting changes as described above when (Mech) Atten is in Auto, but no changes are made to the actual attenuator hardware setting until the input is changed back to the RF Input.</p>
Preset	<p>The preset for Mech Attenuation is “Auto.” The Auto value of attenuation is: CXA, EXA, MXA and PXA: 10 dB</p>
State Saved	Saved in instrument state
Min	<p>0 dB The attenuation set by this key cannot be decreased below 6 dB with the knob or step keys. To get to a value below 6 dB it has to be directly entered from the keypad or via SCPI. This protects from adjusting the attenuation to a dangerously small value which can put the instrument at risk of damage to input circuitry. However, if the current mechanical attenuation is below 6 dB it can be increased with the knob and step keys, but not decreased.</p>
Max	<p>CXA N9000A–503/507: 50 dB CXA N9000A–513/526: 70dB EXA: 60 dB MXA and PXA: 70 dB In the single attenuator configuration, the total of ATT and EATT cannot exceed 50 dB, so if the EATT is set to 24 dB first, the main attenuation cannot be greater than 26 dB and will be reduced accordingly; if the main attenuator is set to 40 dB first, EATT cannot be greater than 10 dB.</p>
Initial S/W Revision	Prior to A.02.00
Modified at S/W Revision	A.03.00

Attenuator Configurations and Auto/Man

As described in the Attenuation key description, there are two distinct attenuator configurations available in the X-Series, the single attenuator and dual attenuator configurations. In dual attenuator configurations, we have the mechanical attenuation and the electronic attenuation, and the current total attenuation is the sum of the electronic + mechanical attenuation. In single attenuator configurations, we refer to the attenuation set using the (Mech) Atten key (or POW:ATT SCPI) as the “main” attenuation; and the attenuation that is set by the SCPI command POW:EATT as the “soft” attenuation (the POW:EATT command is honored even in the single attenuator configuration, for compatibility purposes). Then the

current total attenuation is the sum of the main + soft attenuation. See the Elec Atten key description for more on “soft” attenuation.

In the dual attenuator configuration, when the electronic attenuator is enabled, there is no Auto/Man functionality for the mechanical attenuator, and the third line of the key label (the Auto/Man line) disappears:

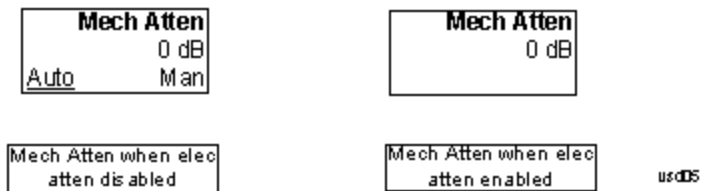

Enable Elec Atten

Enables the Electronic Attenuator.

The electronic attenuator offers finer steps than the mechanical attenuator, has no acoustical noise, is faster, and is less subject to wear. These advantages primarily aid in remote operation and are negligible for front panel use. See ["Using the Electronic Attenuator: Pros and Cons" on page 1970](#) for a detailed discussion of the pros and cons of using the electronic attenuator.

For the single attenuator configuration, for SCPI backwards compatibility, the “soft” attenuation feature replaces the dual attenuator configuration’s electronic attenuator. All the same couplings and limitations apply. See ["Attenuator Configurations and Auto/Man" on page 2143](#)

See ["More Information" on page 1969](#)

Key Path	AMPTD Y Scale, Attenuation
Remote Command	[:SENSe] :POWer [:RF] :EATTenuation :STATe OFF ON 0 1 [:SENSe] :POWer [:RF] :EATTenuation :STATe ?
Example	POW:EATT:STAT ON
Dependencies	<p>This key only appears in Dual Attenuator models with an Electronic Attenuator installed. It does not appear in models with the Single Attenuator configuration, as in the single attenuator configuration there is no “electronic attenuator” there is only a single integrated attenuator (which has both a mechanical and electronic stage). However, in the single attenuator configuration, EATT SCPI commands are accepted for compatibility with other X-series instruments and set a “soft” attenuation as described in "Attenuator Configurations and Auto/Man" on page 2143.</p> <p>The electronic attenuator (and the “soft” attenuation function provided in single attenuator configurations) is unavailable above 3.6 GHz. Therefore, if the Stop Frequency of the analyzer is > 3.6 GHz then the Enable Elec Atten key will be OFF and grayed out.</p> <p>If the Internal Preamp is on, meaning it is set to Low Band or Full, the electronic attenuator (and the “soft” attenuation function provided in single attenuator configurations) is unavailable. In this case the Enable Elec Atten key will be OFF and grayed out.</p> <p>If either of the above is true, if the SCPI command is sent, an error indicating that the electronic attenuator is unavailable will be sent.</p> <p>If the electronic/soft Attenuator is enabled, then the Stop Freq of the analyzer is limited to 3.6 GHz and the Internal Preamp is unavailable.</p> <p>The SCPI-only “soft” electronic attenuation for the single-attenuator configuration is not available in</p>

	all measurements; in particular, it is not available in the Swept SA measurement.
Couplings	Enabling and disabling the Electronic Attenuator affects the setting of the Mechanical Attenuator (in dual attenuator configurations). This is described in more detail below this table.
Preset	OFF for Swept SA measurement; ON for all other measurements that support the electronic attenuator
State Saved	Saved in instrument state
Initial S/W Revision	Prior to A.02.00
Modified at S/W Revision	A.03.00

More Information

Mechanical Attenuator Transition Rules

When the Electronic Attenuator is enabled, the Mechanical Attenuator transitions to a state that has no Auto function. Below are the rules for transitioning the Mechanical Attenuator. NOTE that the information below ONLY applies to the dual attenuator configurations, and ONLY when the Electronic Attenuator is installed:

When the Electronic Attenuation is enabled from a disabled state:

- The Mechanical Attenuator is initialized to 10 dB (this is its optimal performance setting). You can then set it as desired with SCPI, numeric keypad, step keys, or knob, and it behaves as it normally would in manual mode
- The Auto/Man state of (Mech) Atten is saved
- The Auto/Man line on the (Mech) Atten key disappears and the auto rules are disabled
- The Electronic Attenuator is set to 10 dB less than the previous value of the Mechanical Attenuator, within the limitation that it must stay within the range of 0 to 24 dB of attenuation.

Examples in the dual attenuator configuration:

- Mech Atten at 20 dB. Elec Atten enabled, Mech Atten set to 10 dB, and Elec Atten set to 10 dB. New total attenuation equals the value before Elec Atten enabled.
- Mech Atten at 0 dB. Elec Atten enabled, Mech Atten set to 10 dB, and Elec Atten set to 0 dB. New total attenuation does not equal the value before Elec Atten enabled.
- Mech Atten at 40 dB. Elec Atten enabled, Mech Atten set to 10 dB, and Elec Atten set to 24 dB. New total attenuation does not equal the value before Elec Atten enabled.

When the Electronic Attenuation is disabled from an enabled state:

- The Elec Atten key is grayed out
- The Auto/Man state of (Mech) Atten is restored
- If now in Auto, (Mech) Atten recouples

- If now in Man, (Mech) Atten is set to the value of total attenuation that existed before the Elec Atten was disabled. The resulting value is rounded up to the smallest value possible given the (Mech) Atten Step setting - (That is, 57 dB changes to 58 dB when (Mech) Atten Step is 2 dB.)

Using the Electronic Attenuator: Pros and Cons

The electronic attenuator offers finer steps than the mechanical attenuator, has no acoustical noise, is faster, and is less subject to wear.

The “finer steps” advantage of the electronic attenuator is beneficial in optimizing the alignment of the analyzer dynamic range to the signal power in the front panel as well as remote use. Thus, you can achieve improved relative signal measurement accuracy. Compared to a mechanical attenuator with 2 dB steps, the 1 dB resolution of the electronic attenuator only gives better resolution when the odd-decibel steps are used. Those odd-decibel steps are less accurately calibrated than the even-decibel steps, so one tradeoff for this superior relative accuracy is reduced absolute amplitude accuracy.

Another disadvantage of the electronic attenuator is that the spectrum analyzer loses its “Auto” setting, making operation less convenient.

Also, the relationship between the dynamic range specifications (TOI, SHI, compression and noise) and instrument performance are less well-known with the electrical attenuator. With the mechanical attenuator, TOI, SHI and compression threshold levels increase dB-for-dB with increasing attenuation, and the noise floor does as well. With the electronic attenuator, there is an excess attenuation of about 1 to 3 dB between 0 and 3.6 GHz, making the effective TOI, SHI, and so forth, less well known. Excess attenuation is the actual attenuation relative to stated attenuation. Excess attenuation is accounted for in the analyzer calibration

Elec Atten

Controls the Electronic Attenuator in dual attenuator configurations. This key does not appear in single attenuator configurations, as the control of both the mechanical and electronic stages of the single attenuator is integrated into the single Atten key.

Key Path	AMPTD Y Scale, Attenuation
Remote Command	<code>[:SENSe] :POWer [:RF] :EATTenuation <rel_amp1></code> <code>[:SENSe] :POWer [:RF] :EATTenuation?</code>
Notes	Electronic Attenuation's specification is defined only when Mechanical Attenuation is 6 dB.
Dependencies	This key only appears in Dual Attenuator models with an Electronic Attenuator installed. It does not appear in models with the Single Attenuator configuration, as in the single attenuator configuration there is no “electronic attenuator” there is only a single integrated attenuator (which has both a mechanical and electronic stage). However, in the single attenuator configuration, EATT SCPI commands are accepted for compatibility with other X-series instruments and set a “soft” attenuation as described in "Attenuator Configurations and Auto/Man" on page 2143 . The “soft” attenuation is treated as an addition to the “main” attenuation value set by the Atten softkey or the POW:ATT SCPI command and affects the total attenuation displayed on the Attenuation key and the Meas Bar. When Enable Elec Atten is off or grayed out, the Elec Atten key is grayed out.
Preset	0 dB
State Saved	Saved in instrument state

Min	0 dB
Max	Dual attenuator configuration: 24 dB Single attenuator configuration: the total of ATT and EATT cannot exceed 50 dB, so if the EATT is set to 24 dB first, the main attenuation cannot be greater than 26 dB and will be reduced accordingly; if the main attenuator is set to 40 dB first, EATT cannot be greater than 10 dB
Initial S/W Revision	Prior to A.02.00
Modified at S/W Revision	A.03.00

Adjust Atten for Min Clip

Sets the combination of mechanical and electronic attenuation and gain based on the current measured signal level so that clipping will be at a minimum.

This is an "immediate action" function, that is, it executes once, when the key is pressed.

This key is grayed out in measurements that do not support this functionality. The spectrum analyzer measurement, Swept SA, does not support this functionality.

Key Path	AMPTD Y Scale, Attenuation
Remote Command	<code>[:SENSe] :POWer [:RF] :RANGe:OPTimize IMMEDIATE</code>
Initial S/W Revision	Prior to A.02.00
Modified at S/W Revision	A.03.00

Pre-Adjust for Min Clip

If this function is on, it does the adjustment described under "[Adjust Atten for Min Clip](#)" on page 2146 each time a measurement restarts. Therefore, in Continuous measurement mode, it only executes before the first measurement.

In dual attenuator models, you can set Elec+Mech Atten, in which case both attenuators participate in the autoranging, or Elec Atten Only, in which case the mechanical attenuator does not participate in the autoranging. This latter case results in less wear on the mechanical attenuator and is usually faster.

This key is grayed out in measurements that do not support this functionality. The spectrum analyzer measurement, Swept SA, does not support this functionality.

Key Path	AMPTD Y Scale, Attenuation
Remote Command	<code>[:SENSe] :POWer [:RF] :RANGe:OPTimize:ATTenuation OFF ELECTrical COMBined</code> <code>[:SENSe] :POWer [:RF] :RANGe:OPTimize:ATTenuation?</code>
Notes	The SCPI parameter ELECTrical sets this function to On in single attenuator models. The SCPI parameter COMBined is mapped to ELECTrical in single attenuator models; if you send COMBined, it sets the function to On and returns ELEC to a query.
Dependencies	This key only appears in Dual Attenuator models with an Electronic Attenuator installed.

	In instruments with Dual Attenuator model, when Enable Elec Atten is off or grayed out, the Pre-Adjust for Min Clip key is grayed out.
Preset	OFF for Swept SA measurement; ON for all other measurements that support Pre-Adjust for Min Clip
State Saved	Saved in instrument state
Range	Dual attenuator models: Off Elec Atten Only Mech + Elec Atten Single attenuator models: Off On
Initial S/W Revision	Prior to A.02.00
Modified at S/W Revision	A.03.00

Remote Command	<code>[:SENSe] :POWer [:RF] :RANGe :AUTO ON OFF 1 0</code> <code>[:SENSe] :POWer [:RF] :RANGe :AUTO?</code>
Notes	ON aliases to "Elec Atten Only" (:POW:RANG:OPT:ATT ELEC) OFF aliases to "Off" (:POW:RANG:OPT:ATT OFF) The query :POW:RANG:AUTO? returns true if :POW:RANG:OPT:ATT is not "Off"
Initial S/W Revision	Prior to A.02.00

Off

Turns Pre-Adjust for Min Clip off. This is the default setting.

This key is grayed out in measurements that do not support this functionality. The spectrum analyzer measurement, Swept SA, does not support this functionality.

Key Path	AMPTD Y Scale, Attenuation, Pre-Adjust for Min Clip
Example	:POW:RANG:OPT:ATT OFF
Initial S/W Revision	Prior to A.02.00

Elec Atten Only

Selects only the electric attenuator to participate in auto ranging. This offers less wear on the mechanical attenuator and is usually faster.

This key is grayed out in measurements that do not support this functionality. The spectrum analyzer measurement, Swept SA, does not support this functionality.

Key Path	AMPTD Y Scale, Attenuation, Pre-Adjust for Min Clip
Example	:POW:RANG:OPT:ATT ELEC
Initial S/W Revision	Prior to A.02.00

Mech + Elec Atten

In dual attenuator models, this selects both attenuators participate in the autoranging.

This key is grayed out in measurements that do not support this functionality. The spectrum analyzer measurement, Swept SA, does not support this functionality.

Key Path	AMPTD Y Scale, Attenuation, Pre-Adjust for Min Clip
Example	:POW:RANGe:OPT:ATT COMB
Initial S/W Revision	Prior to A.02.00

(Mech) Atten Step

This controls the step size used when making adjustments to the input attenuation.

This key is labeled Mech Atten Step in dual attenuator models and Atten Step in single attenuator models. In the dual attenuator configuration, this key only affects the step size of the mechanical attenuator.

Key Path	AMPTD Y Scale, Attenuation
Remote Command	<code>[:SENSe] :POWer [:RF] :ATTenuation :STEP [:INCRement] 10 dB 2 dB</code> <code>[:SENSe] :POWer [:RF] :ATTenuation :STEP [:INCRement] ?</code>
Example	POW:ATT:STEP 2
Notes	Note this feature works like a 1-N choice from the front panel, but it takes a specific value (in dB) when used remotely. The only valid values are 2 and 10.
Dependencies	Blanked in CXA and EXA if option FSA (2 dB steps) is not present. If blanked, attempts to set it via SCPI will yield an error.
Couplings	When the attenuation step size changes, the current mechanical attenuation value is adjusted (if necessary) to be quantized to the new step size. That is, if step is set to 10 dB, mech atten is increased if necessary so it is a multiple of 10 dB
Preset	PXA and MXA: 2 dB EXA and CXA: 10 dB (2 dB with option FSA)
State Saved	Saved in instrument state
Initial S/W Revision	Prior to A.02.00
Modified at S/W Revision	A.03.00

Scale/Div

Sets the logarithmic units per vertical graticule division on the display. However, since the Auto Scaling defaults to On, this value is automatically determined by the measurement result. When you set a value manually, Auto Scaling automatically changes to Off.

Key Path	AMPTD Y Scale
Mode	All except SA and BASIC
Remote Command	:DISPlay:MONitor:VIEW[1]:WINDow[1]:TRACe:Y[:SCALe]:PDIVision <rel_ampl> :DISPlay:MONitor:VIEW[1]:WINDow[1]:TRACe:Y[:SCALe]:PDIVision?
Example	DISP:MON:VIEW:WIND:TRAC:Y:PDIV 5.0 dB DISP:MON:VIEW:WIND:TRAC:Y:PDIV?
Couplings	When the Auto Scaling is On, this value is automatically determined by the measurement result. When you set a value manually, Auto Scaling automatically changes to Off.
Preset	10.00 dB
State Saved	Saved in instrument state.
Min	0.10 dB
Max	20.00 dB
Initial S/W Revision	Prior to A.02.00

Presel Center

When this key is pressed, the centering of the preselector filter is adjusted to optimize the amplitude accuracy at the frequency of the selected marker. If the selected marker is not on when Presel Center is pressed, the analyzer will turn on the selected marker, perform a peak search, and then perform centering on the marker's center frequency. If the selected marker is already on and between the start and stop frequencies of the analyzer, the analyzer performs the preselector calibration on that marker's frequency. If the selected marker is already on, but outside the frequency range between Start Freq and Stop Freq, the analyzer will first perform a peak search, and then perform centering on the marker's center frequency.

The value displayed on the Presel Adjust key will change to reflect the new preselector tuning (see Presel Adjust).

A number of considerations should be observed to ensure proper operation. See ["Proper Preselector Operation" on page 1975](#).

Key Path	AMPTD Y Scale
Remote Command	[:SENSe]:POWer[:RF]:PCENter
Example	POW:PCEN
Notes	Note that the rules outlined above under the key description apply for the remote command as well as the key. The result of the command is dependent on marker position, and so forth. Any message shown by the key press is also shown in response to the remote command.
Dependencies	<ul style="list-style-type: none"> • Grayed out if the microwave preselector is off.) • If the selected marker's frequency is below Band 1, advisory message 0.5001 is generated and no action is taken. • Grayed out if entirely in Band 0. • Blank in models that do not include a preselector, such as option 503. If the SCPI is sent in these instruments, it is accepted without error, and the query always returns 0.

- Grayed out in the Spectrogram View.

Couplings	The active marker position determines where the centering will be attempted. If the analyzer is in a measurement such as averaging when centering is initiated, the act of centering the preselector will restart averaging but the first average trace will not be taken until the centering is completed.
Status Bits/OPC dependencies	When centering the preselector, *OPC will not return true until the process is complete and a subsequent measurement has completed, nor will results be returned to a READ or MEASURE command. The Measuring bit should remain set while this command is operating and should not go false until the subsequent sweep/measurement has completed.
Initial S/W Revision	Prior to A.02.00
Modified at S/W Revision	A.03.00

Proper Preselector Operation

A number of considerations should be observed to ensure proper operation:

1. If the selected marker is off, the analyzer will turn on a marker, perform a peak search, and adjust the preselector using the selected marker's frequency. It uses the "highest peak" peak search method unqualified by threshold or excursion, so that there is no chance of a 'no peak found' error. It continues with that peak, even if it is the peak of just noise. Therefore, for this operation to work properly, there should be a signal on screen in a preselected range for the peak search to find.
2. If the selected marker is already on, the analyzer will attempt the centering at that marker's frequency. There is no preselector for signals below about 3.6 GHz, therefore if the marker is on a signal below 3.6 GHz, no centering will be attempted and an advisory message generated
3. In some models, the preselector can be bypassed. If it is bypassed, no centering will be attempted in that range and a message will be generated.

Preselector Adjust

Allows you to manually adjust the preselector filter frequency to optimize its response to the signal of interest. This function is only available when "Presel Center" on page 2149 is available.

For general purpose signal analysis, using Presel Center is recommended. Centering the filter minimizes the impact of long-term preselector drift. Presel Adjust can be used instead to manually optimize the preselector. One application of manual optimization would be to peak the preselector response, which both optimizes the signal-to-noise ratio and minimizes amplitude variations due to small (short-term) preselector drifting.

Key Path	AMPTD Y Scale
Scope	Meas Global
Remote Command	<code>[:SENSe] :POWer [:RF] :PADJust <freq></code>

	<code>[:SENSe] :POWer [:RF] :PADJust?</code>
Example	POW:PADJ 100KHz POW:PADJ?
Notes	The value on the key reads out to 0.1 MHz resolution.
Dependencies	<ul style="list-style-type: none"> • Grayed out if microwave preselector is off.) • Grayed out if entirely in Band 0. • Blank in models that do not include a preselector, such as option 503. If the SCPI is sent in these instruments, it is accepted without error, and the query always returns 0. • Grayed out in the Spectrogram View.
Preset	0 MHz
State Saved	The Presel Adjust value set by Presel Center, or by manually adjusting Presel Adjust, is not saved in instrument state, and does not survive a Preset or power cycle.
Min	-500 MHz
Max	500 MHz
Default Unit	Hz
Backwards Compatibility SCPI	<code>[:SENSe] :POWer [:RF] :MW :PADJust</code> <code>[:SENSe] :POWer [:RF] :MMW :PADJust</code> PSA had multiple preselectors, but the X-Series has only one. These commands simply alias to <code>[:SENSe] :POWer [:RF] :PADJust</code>
Initial S/W Revision	Prior to A.02.00
Modified at S/W Revision	A.03.00

Remote Command	<code>[:SENSe] :POWer [:RF] :PADJust :PRESelector MWAVE MMWave EXTernal</code> <code>[:SENSe] :POWer [:RF] :PADJust :PRESelector?</code>
Notes	PSA had multiple preselectors, and you could select which preselector to adjust. Since the X-Series has only one mm/uW preselector, the preselector selection softkey is no longer available. However, to provide backward compatibility, we accept the legacy remote commands. The command form has no effect, the query always returns MWAVE
Initial S/W Revision	Prior to A.02.00

μW Path Control

The μW Path Control functions include the μW Preselector Bypass (Option MPB) and Low Noise Path (Option LNP) controls in the High Band path circuits.

When the μW Preselector is bypassed, the user has better flatness, but will be subject to spurs from out of band interfering signals. When the Low Noise Path is enabled, the analyzer automatically switches around

certain circuitry in the high frequency bands which can contribute to noise, when it is appropriate based on other analyzer settings.

For most applications, the preset state is Standard Path, which gives the best remote-control throughput, minimizes acoustic noise from switching and minimizes the risk of wear out in the hardware switches. For applications that utilize the wideband IF paths, the preset state is the μ W Preselector Bypass path, if option MPB is present. This is because, when using a wideband IF such as the 140 MHz IF, the μ W Preselector's bandwidth can be narrower than the available IF bandwidth, causing degraded amplitude flatness and phase linearity, so it is desirable to bypass the preselector in the default case.

Users may choose Low Noise Path Enable. It gives a lower noise floor, especially in the 21–26.5 GHz region, though without improving many measures of dynamic range, and without giving the best possible noise floor. The preamp, if purchased and used, gives better noise floor than does the Low Noise Path, however its compression threshold and third-order intercept are much poorer than that of the non-preamp Low Noise Path. There are some applications, typically for signals around –30 dBm, for which the third-order dynamic range of the standard path is good enough, but the noise floor is not low enough even with 0 dB input attenuation. When the third-order dynamic range of the preamp path is too little and the noise floor of the standard path is too high, the Low Noise Path can provide the best dynamic range.

Key Path	AMPTD Y Scale
Mode	SA, BASIC, PNOISE, VSA , LTE, LTETDD
Scope	Meas Global
Remote Command	[:SENSe] :POWer [:RF] :MW:PATH STD LNPath MPBypass FULL [:SENSe] :POWer [:RF] :MW:PATH?
Example	:POW:MW:PATH LNP Enables the Low Noise path
Notes	If a Presel Center is performed, the analyzer will momentarily switch to the Standard Path, regardless of the setting of μ W Path Control The DC Block will always be switched in when the low noise path is switched in, to protect succeeding circuitry from DC. Note that this does not mean “when the low noise path is enabled” but when, based on the Low Noise Path rules, the path is actually switched in. This can happen when the selection is Low Noise Path Enable . In the case where the DC Block is switched in the analyzer is now AC coupled. However, if the user has selected DC coupling, the UI will still behave as though it were DC coupled, including all annunciation, warnings, status bits, and responses to SCPI queries. This is because, based on other settings, the analyzer could switch out the low noise path at any time and hence go back to being DC coupled. Alignment switching ignores the settings in this menu, and restores them when finished.
Dependencies	Unavailable in BBIQ and External Mixing
Preset	All modes other than IQ Analyzer mode and VXA: STD IQ Analyzer, VXA and WLAN mode: MPB option present and licensed: MPB MPB option not present and licensed: STD
State Saved	Save in instrument state
Readback	Value selected in the submenu
Initial S/W Revision	A.04.00
Modified at S/W Revision	A.10.00

Standard Path

This path gives the best remote-control throughput, minimizes acoustic noise from switching and minimizes the risk of wear in the hardware switches, particularly in remote test scenarios where both low band and high band setups will follow in rapid succession.

In this path, the bypass of the low band/high band switch and microwave preamp is never activated, which can cause some noise degradation but preserves the life of the bypass switch.

Key Path	AMPTD Y Scale, μ W Path Control
Example	:POW:MW:PATH STD
Readback Text	Standard Path
Initial S/W Revision	A.04.00

Low Noise Path Enable

You may choose Low Noise Path Enable, which gives a lower noise floor under some circumstances, particularly when operating in the 21–26.5 GHz region. With the Low Noise Path enabled, the low band/high band switch and microwave preamp are bypassed whenever all of the following are true:

- The analyzer is not in the Low Band, meaning:
- the start frequency is above 3.5 GHz and
- the stop frequency is above 3.6 GHz.
- the internal preamp is not installed or (if installed) is set to Off or Low Band

Note that this means that, when any part of a sweep is done in Low Band, the Low Noise Path is not used, whether or not the Low Noise Path Enable is selected in the user interface. Also, if the preamp is turned on, the Low Noise Path is not used, whether or not the Low Noise Path Enable is selected in the user interface. The only time the Low Noise Path is used is when Low Noise Path Enable is selected, the sweep is completely in High Band (> 3.6 GHz) and no preamp is in use.

See "[More Information](#)" on page 1979

Key Path	AMPTD Y Scale, μ W Path Control
Measurement	Swept SA
Example	:POW:MW:PATH LNP
Notes	For measurements that use IQ acquisition, the low noise path is used when the Center Frequency is in High Band (> 3.6 GHz) and no preamp is in use. In other words, the rules above are modified to use only the center frequency to qualify which path to switch in. This is not the case for FFT's in the Swept SA measurement; they use the same rules as swept measurements.
Dependencies	Key is blanked if current mode does not support it. Key is grayed out if mode supports it but current measurement does not support it. Unless Option LNP is present and licensed, key is blank and if SCPI command sent, error -241,

	"Hardware missing; Option not installed" is generated.
Readback Text	Low Noise Path Enable
Initial S/W Revision	A.04.00

More Information

The user should understand that the Low Noise Path, while giving improved DANL, has the disadvantage of decreased TOI performance and decreased gain compression performance relative to the standard path.

The user should also understand that the bypass switch is a mechanical switch and has finite life, so if the Low Noise Path is enabled, it is possible to cause frequent cycling of this switch by frequently changing analyzer settings such that the above conditions hold true only some of the time. A user making tests of this nature should consider opting for the Standard Path, which will never throw the bypass switch, at the expense of some degraded noise performance.

The low noise path is useful for situations where the signal level is so low that the analyzer performance is dominated by noise even with 0 dB attenuation, but still high enough that the preamp option would have excessive third-order intermodulation or compression. The preamp, if purchased and used, gives better noise floor than does the "Low Noise Path." However, its compression threshold and third-order intercept are much poorer than that of the non-preamp path. There are some applications, typically for signals around -30 dBm, for which the third-order dynamic range of the standard path is good enough, but the noise floor is not low enough even with 0 dB input attenuation. When the third-order dynamic range of the preamp path is too little and the noise floor of the standard path is too high, the Low Noise Path can provide the best dynamic range

The graph below illustrates the concept. It shows, in red, the performance of an analyzer at different attenuation settings, both with the preamp on and off, in a measurement that is affected by both analyzer noise and analyzer TOI. The green shows the best available dynamic range, offset by 0.5 dB for clarity. The blue shows how the best available dynamic range improves for moderate signal levels with the low noise path switched in. In this illustration, the preamp improves the noise floor by 15 dB while degrading the third-order intercept by 30 dB, and the low noise path reduces loss by 8 dB. The attenuator step size is 2 dB.

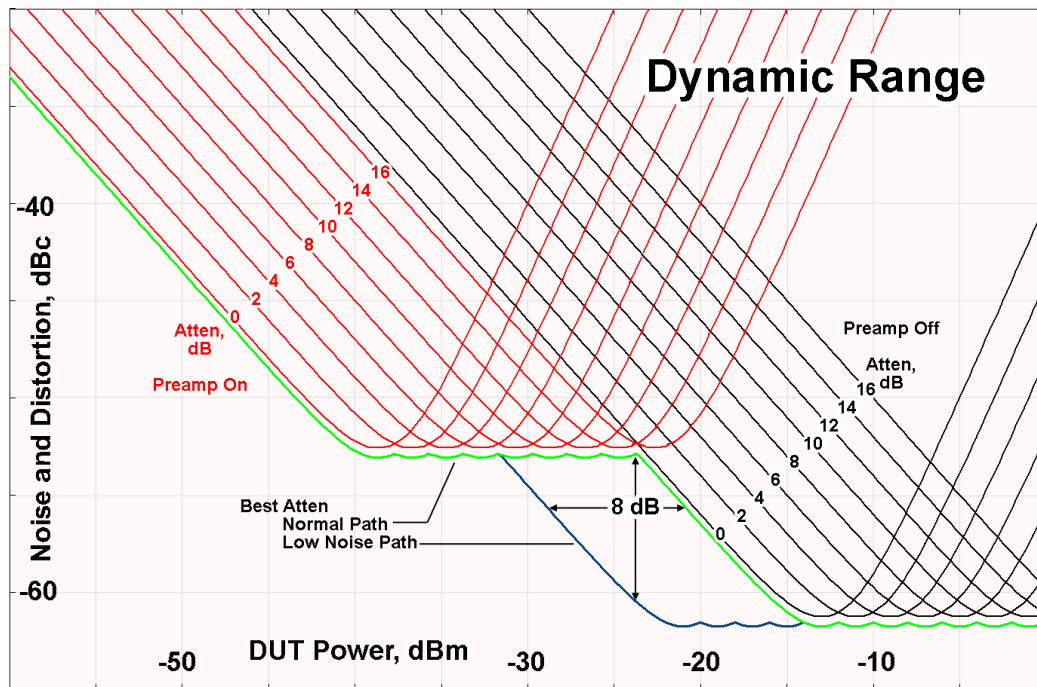

There are other times where selecting the low noise path improves performance, too. Compression-limited measurements such as finding the nulls in a pulsed-RF spectrum can profit from the low noise path in a way similar to the TOI-limited measurement illustrated. Accuracy can be improved when the low noise path allows the optimum attenuation to increase from a small amount like 0, 2 or 4 dB to a larger amount, giving better return loss at the analyzer input. Harmonic measurements, such as second and third harmonic levels, are much improved using the low noise path because of the superiority of that path for harmonic (though not intermodulation) distortion performance.

μW Preselector Bypass

This key toggles the preselector bypass switch for band 1 and higher. When the microwave preselector is on, the signal path is preselected. When the microwave preselector is off, the signal path is not preselected. The preselected path is the normal path for the analyzer.

The preselector is a tunable bandpass filter which prevents signals away from the frequency of interest from combining in the mixer to generate in-band spurious signals (images). The consequences of using a preselector filter are its limited bandwidth, the amplitude and phase ripple in its passband, and any amplitude and phase instability due to center frequency drift.

Option MPB or pre-selector bypass provides an unpreselected input mixer path for certain X-Series signal analyzers with frequency ranges above 3.6 GHz. This signal path allows a wider bandwidth and less amplitude variability, which is an advantage when doing modulation analysis and broadband signal analysis. The disadvantage is that, without the preselector, image signals will be displayed. Another disadvantage of bypassing the preselector is increased LO emission levels at the front panel input port.

Image responses are separated from the real signal by twice the 1st IF. For IF Paths of 10 MHz and 25 MHz, the 1st IF is 322.5 MHz, so the image response and the real signal will be separated by 645 MHz. The 1st IF will be different for other IF Path settings. When viewing a real signal and its corresponding image response in internal mixing, the image response will be to the left of the real signal.

Also, the image response and the real signal typically have the same amplitude and exhibit the same shape factor.

However, if Option FS1, Fast Sweep Capability, is enabled, the image response in the Swept SA measurement will appear lower in amplitude and have a much wider shape factor compared to the real signal.

Key Path	AMPTD Y Scale, μ W Path Control
Example	:POW:MW:PATH MPB
Dependencies	Key is blanked if current mode does not support it. Key is grayed out if mode supports it but current measurement does not support it. Key is blank unless Option MPB is present and licensed. If SCPI command sent when MPB not present, error -241, "Hardware missing; Option not installed" is generated.
Readback Text	μ W Preselector Bypass
Initial S/W Revision	A.04.00

Remote Command	[:SENSe] :POWer [:RF] :MW:PRESelector [:STATe] ON OFF 0 1 [:SENSe] :POWer [:RF] :MW:PRESelector [:STATe] ?
Example	:POW:MW:PRES OFF Bypasses the microwave preselector
Notes	The ON parameter sets the STD path (:POW:MW:PATH STD) The OFF parameter sets path MPB (:POW:MW:PATH MPB)
Preset	ON

Internal Preamp

Accesses a menu of keys that control the internal preamps. Turning on the preamp gives a better noise figure, but a poorer TOI to noise floor dynamic range. You can optimize this setting for your particular measurement.

The instrument takes the preamp gain into account as it sweeps. If you sweep outside of the range of the preamp the instrument will also account for that. The displayed result will always reflect the correct gain.

For some measurements, when the preamp is on and any part of the displayed frequency range is below the lowest frequency for which the preamp has specifications, a warning condition message appears in the status line. For example, for a preamp with a 9 kHz lowest specified frequency: "Preamp: Accy unspec'd below 9 kHz".

Key Path	AMPTD Y Scale
Scope	Meas Global
Remote Command	[:SENSe] :POWer [:RF] :GAIN [:STATe] OFF ON 0 1 [:SENSe] :POWer [:RF] :GAIN [:STATe] ?
Dependencies	Preamp is not available on all hardware platforms. If the preamp is not present or is unlicensed, the

	key is not shown. The preamp is not available when the electronic/soft attenuator is enabled.
--	--

Couplings	The act of connecting the U7227A USB Preamplifier to one of the analyzer's USB ports will cause the Internal Preamp to be switched on. When this happens an informational message will be generated: "Internal Preamp turned on for optimal operation with USB Preamp." Note that if the Internal Preamp was already on, there will be no change to the setting, but if it was Off it will be switched On, to Full Range. Note that this same action occurs when the SA mode is selected while the USB Preamp is connected to one of the analyzer's USB ports, if it is the first time that the SA mode has run since powerup, or if the last time the SA mode was running the USB Preamp was NOT connected. Subsequently disconnecting the USB Preamp from USB does not change the Internal Preamp setting nor restore the previous setting.
Preset	OFF
State Saved	Saved in instrument state
Initial S/W Revision	Prior to A.02.00
Modified at S/W Revision	A.14.00

Key Path	AMPTD Y Scale, Internal Preamp
Scope	Meas Global
Remote Command	[:SENSe] : POWer [:RF] : GAIN : BAND LOW FULL [:SENSe] : POWer [:RF] : GAIN : BAND ?
Dependencies	Preamp is not available on all hardware platforms. If the preamp is not present or is unlicensed, the key is not shown. If a POW:GAIN:BAND FULL command is sent when a low band preamp is available, the preamp band parameter is to LOW instead of FULL, and an "Option not installed" message is generated.
Preset	LOW
State Saved	Saved in instrument state
Initial S/W Revision	Prior to A.02.00

Off

Turns the internal preamp off

Key Path	AMPTD Y Scale, Internal Preamp
Example	:POW:GAIN OFF
Readback	Off
Initial S/W Revision	Prior to A.02.00

Low Band

Sets the internal preamp to use only the low band.

The frequency range of the installed (optional) low-band preamp is displayed in square brackets on the Low Band key label.

Key Path	AMPTD Y Scale, Internal Preamp
Example	:POW:GAIN ON :POW:GAIN:BAND LOW
Readback	Low Band
Initial S/W Revision	Prior to A.02.00

Full Range

Sets the internal preamp to use its full range. The low band (0–3.6 GHz or 0–3GHz, depending on the model) is supplied by the low band preamp and the frequencies above low band are supplied by the high band preamp.

The frequency range of the installed (optional) preamp is displayed in square brackets on the Full Range key label. If the high band option is not installed the Full Range key does not appear.

Key Path	AMPTD Y Scale, Internal Preamp
Example	:POW:GAIN ON :POW:GAIN:BAND FULL
Readback	Full Range
Initial S/W Revision	Prior to A.02.00

Ref Position

Positions the reference level at the top, center or bottom of the Y Scale display. Changing the reference position does not change the reference level value.

Key Path	AMPTD Y Scale
Mode	All except SA and BASIC
Remote Command	:DISPlay:MONitor:VIEW[1]:WINDow[1]:TRACe:Y[:SCALe]:RPOSition TOP CENTer BOTTom :DISPlay:MONitor:VIEW[1]:WINDow[1]:TRACe:Y[:SCALe]:RPOSition?
Example	DISP:MON:VIEW:WIND:TRAC:Y:RPOS CENT DISP:MON:VIEW:WIND:TRAC:Y:RPOS?
Preset	TOP
State Saved	Saved in instrument state.
Range	Top Ctr Bot
Initial S/W Revision	Prior to A.02.00

Auto Scaling

Toggles the Auto Scaling function between On and Off.

Key Path	AMPTD Y Scale
Mode	All except SA and BASIC
Remote Command	:DISPlay:MONitor:VIEW[1]:WINDow[1]:TRACe:Y[:SCALe]:COUPle 0 1 OFF ON :DISPlay:MONitor:VIEW[1]:WINDow[1]:TRACe:Y[:SCALe]:COUPle?
Example	DISP:MON:VIEW:WIND:TRAC:Y:COUP ON DISP:MON:VIEW:WIND:TRAC:Y:COUP?
Couplings	When Auto Scaling is On, and the Restart front-panel key is pressed, this function automatically determines the scale per division and reference values based on the measurement results. When you set a value to either Scale/Div or Ref Value manually, Auto Scaling automatically changes to Off.
Preset	ON
State Saved	Saved in instrument state.
Range	On Off
Initial S/W Revision	Prior to A.02.00

Auto Couple

The Auto Couple feature provides a quick and convenient way to automatically couple multiple instrument settings. This helps ensure accurate measurements and optimum dynamic range. When the Auto Couple feature is activated, either from the front panel or remotely, all parameters of the current measurement that have an Auto/Manual mode are set to Auto mode and all measurement settings dependent on (or coupled to) the Auto/Man parameters are automatically adjusted for optimal performance.

However, the Auto Couple key actions are confined to the current measurement only. It does not affect other measurements in the mode, and it does not affect markers, marker functions, or trace or display attributes.

See "[More Information](#)" on page 1985

Key Path	Front-panel key
Remote Command	:COUPle ALL NONE
Example	:COUP ALL
Notes	:COUPle ALL puts all Auto/Man parameters in Auto mode (equivalent to pressing the Auto Couple key). :COUPLE NONE puts all Auto/Man parameters in manual mode. It decouples all the coupled instrument parameters and is not recommended for making measurements.
Initial S/W Revision	Prior to A.02.00

More Information

There are two types of functions that have Auto/Manual modes.

Auto/Man Active Function keys

An Auto/Man toggle key controls the binary state associated with an instrument parameter by toggling between Auto (where the parameter is automatically coupled to the other parameters it is dependent upon) and Man (where the parameter is controlled independent of the other parameters), as well as making the parameter the active function. The current mode is indicated on the softkey with either Auto or Man underlined as illustrated below.



Auto/Man 1-of-N keys

An Auto/Man 1-of-N key allows you to manually pick from a list of parameter values, or place the function in Auto, in which case the value is automatically selected (and indicated) as shown below. If in Auto, Auto is underlined on the calling key. If in manual operation, manual is indicated on the calling key. But the calling key does not actually toggle the function, it simply opens the menu.

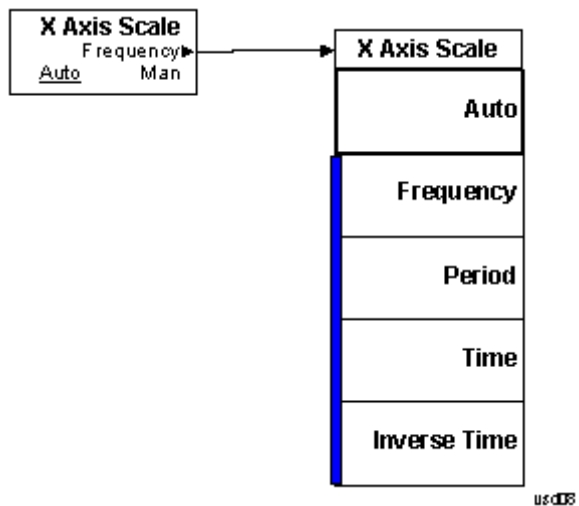

BW

Accesses a menu that enables you to specify the resolution bandwidth functions that control the bandwidth and filter selection.

Key Path	Front-panel key
Initial S/W Revision	Prior to A.02.00

Res BW

Sets the resolution bandwidth for the current measurement. If an unavailable bandwidth is entered with the numeric keypad, the closest available bandwidth is selected.

Key Path	BW
Mode	All except SA and BASIC
Remote Command	<pre>[:SENSe]:MONitor:BANDwidth[:RESolution] <freq> [:SENSe]:MONitor:BANDwidth[:RESolution]? [:SENSe]:MONitor:BANDwidth[:RESolution]:AUTO OFF ON 0 1 [:SENSe]:MONitor:BANDwidth[:RESolution]:AUTO?</pre>
Example	<pre>MON:BAND 2.4 MHz MON:BAND? MON:BAND:AUTO ON MON:BAND:AUTO?</pre>
Preset	<pre>WCDMA: Automatically calculated WIMAX OFDMA: 100kHz C2K: Automatically calculated BLUETOOTH: Automatically calculated PN: Automatically calculated GSM/EDGE: Automatically calculated TD-SCDMA: Automatically calculated 1xEVDO: 30kHz DVB-T/H: 3.9kHz DTMB (CTTB): 3.9kHz ISDB-T: 3.9kHz CMMB: 3.9kHz LTE: 100 kHz LTETDD: 100 kHz Digital Cable TV: 3.9kHz WLAN: 100 kHz MSR: Automatically calculated LTEAFDD, LTEATDD: 100kHz</pre>

	WCDMA: ON
	WIMAX: OFF
	C2K: ON
	BLUETOOTH: ON
	PN: ON
	GSM/EDGE: ON
	TD-SCDMA: ON
	1xEVDO: ON
	DVB-T/H: OFF
	DTMB (CTTB): OFF
	ISDB-T: OFF
	CMMB: OFF
	LTE:OFF
	LTETDD: OFF
	Digital Cable TV: OFF
	WLAN: OFF
	MSR: ON
	LTEAFDD, LTEATDD: OFF
State Saved	Saved in instrument state.
Min	1.0 Hz
Max	8.0 MHz
Backwards Compatibility SCPI	<code>[[:SENSe]:MONitor:BWIDth[:RESolution]</code>
Initial S/W Revision	Prior to A.02.00
Modified at S/W Revision	A.02.00
Modified at S/W Revision	A.03.00

Video BW

Changes the analyzer post-detection filter.

Key Path	BW
Mode	All except SA and BASIC
Remote Command	<code>[[:SENSe]:MONitor:BANDwidth:VIDeo <bandwidth></code> <code>[[:SENSe]:MONitor:BANDwidth:VIDeo?</code> <code>[[:SENSe]:MONitor:BANDwidth:VIDeo:AUTO ON OFF 1 0</code> <code>[[:SENSe]:MONitor:BANDwidth:VIDeo:AUTO?</code>
Example	MON:BAND:VID 10 MHz MON:BAND:VID? MON:BAND:VID:AUTO OFF

MON:BAND:VID:AUTO?	
Preset	WCDMA: Automatically calculated WIMAX OFDMA: 1 MHz C2K: Automatically calculated BLUETOOTH: Automatically calculated PN: Automatically calculated GSM/EDGE: Automatically calculated TD-SCDMA: Automatically calculated 1xEVDO: 300kHz DVB-T/H: 39kHz DTMB (CTTB): 39kHz ISDB-T: 39kHz CMMB: 39kHz LTE: 1 MHz LTETDD: 1 MHz Digital Cable TV: 39kHz WLAN: 1 MHz MSR: Automatically calculated LTEAFDD, LTEATDD: 1 MHz WCDMA: ON WIMAX: OFF C2K: ON BLUETOOTH: ON PN: ON GSM/EDGE: ON TD-SCDMA: ON 1xEVDO: ON DVB-T/H: OFF DTMB (CTTB): OFF ISDB-T: OFF CMMB: OFF LTE: OFF LTETDD: OFF Digital Cable TV: OFF WLAN: OFF MSR: ON LTEAFDD, LTEATDD: OFF
State Saved	Saved in instrument state.
Min	1 Hz
Max	50 MHz

Backwards Compatibility SCPI	<code>[:SENSe] :MONitor :BWIDth :VIDeo</code>
Initial S/W Revision	Prior to A.02.00
Modified at S/W Revision	A.02.00
Modified at S/W Revision	A.03.00

VBW:3dB RBW

Selects the ratio between the video bandwidth and the equivalent 3 dB resolution bandwidth to be used for setting the VBW when VBW is in Auto.

Key Path	BW
Mode	All except SA and BASIC
Remote Command	<code>[:SENSe] :MONitor :BANDwidth :VIDeo :RATio <real></code> <code>[:SENSe] :MONitor :BANDwidth :VIDeo :RATio?</code> <code>[:SENSe] :MONitor :BANDwidth :VIDeo :RATio :AUTO OFF ON 0 1</code> <code>[:SENSe] :MONitor :BANDwidth :VIDeo :RATio :AUTO?</code>
Example	MON:BAND:VID:RAT 2 MON:BAND:VID:RAT? MON:BAND:VID:RAT:AUTO 0 MON:BAND:VID:RAT:AUTO?
Preset	1 ON
State Saved	Saved in instrument state.
Min	0.00001
Max	3000000
Backwards Compatibility SCPI	<code>[:SENSe] :MONitor :BWIDth :VIDeo :RATio</code>
Initial S/W Revision	Prior to A.02.00

Span:3dB RBW

Selects the ratio between span and resolution bandwidth.

The default setting is Auto with a Span:3 dB RBW ratio of 106:1. You can manually change this ratio by pressing the key, entering a new value, and pressing Enter.

Key Path	BW
Mode	All except SA and BASIC
Remote Command	<code>[:SENSe] :MONitor :FREQuency :SPAN :BANDwidth [:RESolution] :RATio <integer></code>

	<code>[:SENSe] :MONitor :FREQuency :SPAN :BANDwidth [:RESolution] :RATio ?</code>
	<code>[:SENSe] :MONitor :FREQuency :SPAN :BANDwidth [:RESolution] :RATio :AUTO OFF ON 0 1</code>
	<code>[:SENSe] :MONitor :FREQuency :SPAN :BANDwidth [:RESolution] :RATio :AUTO ?</code>
Example	<code>MON:FREQ:SPAN:BAND:RAT 200</code> <code>MON:FREQ:SPAN:BAND:RAT?</code> <code>MON:FREQ:SPAN:BAND:RAT:AUTO ON</code> <code>MON:FREQ:SPAN:BAND:RAT:AUTO?</code>
Preset	106 ON
State Saved	Saved in instrument state.
Min	2
Max	10000
Backwards Compatibility SCPI	<code>[:SENSe] :MONitor :FREQuency :SPAN :BWIDth [:RESolution] :RATio</code>
Initial S/W Revision	Prior to A.02.00
Modified at S/W Revision	A.04.00

Cont (Continuous Measurement/Sweep)

Sets the analyzer for Continuous measurement operation. The single/continuous state is Meas Global so the setting will affect all measurements. If you are Paused, pressing Cont does a Resume.

Key Path	Front-panel key
Remote Command	:INITiate:CONTinuous OFF ON 0 1 :INITiate:CONTinuous?
Example	:INIT:CONT 0 puts analyzer in Single measurement operation. :INIT:CONT 1 puts analyzer in Continuous measurement operation
Preset	ON (Note that SYST:PRESet sets INIT:CONT to ON but *RST sets INIT:CONT to OFF)
State Saved	Saved in instrument state
Backwards Compatibility Notes	For Spectrum Analysis mode in ESA and PSA, there is no Cont hardkey, instead there is a Sweep Single/Cont key. In these analyzers, switching the Sweep Single/Cont key from Single to Cont restarts averages (displayed average count reset to 1), but does not restart Max Hold and Min Hold. The X-Series has Single and Cont keys in place of the SweepSingleCont key. In the X-Series, if in single measurement, the Cont key (and INIT:CONT ON) switches to continuous measurement, but never restarts a measurement and never resets a sweep.
Initial S/W Revision	Prior to A.02.00

In Swept SA Measurement (Spectrum Analysis Mode):

The analyzer takes repetitive sweeps, averages, measurements, etc., when in Continuous mode. When the average count reaches the Average/Hold Number the count stops incrementing, but the analyzer keeps sweeping. See the Trace/Detector section for the averaging formula used both before and after the Average/Hold Number is reached. The trigger condition must be met prior to each sweep. The type of trace processing for multiple sweeps, is set under the Trace/Detector key, with choices of Trace Average, Max Hold, or Min Hold.

In Other Measurements/Modes:

With Avg/Hold Num (in the Meas Setup menu) set to Off or set to On with a value of 1, a sweep is taken after the trigger condition is met; and the analyzer continues to take new sweeps after the current sweep has completed and the trigger condition is again met. However, with Avg/Hold Num set to On with a value >1, multiple sweeps (data acquisitions) are taken for the measurement. The trigger condition must be met prior to each sweep. The sweep is not stopped when the average count k equals the number N set for Avg/Hold Num is reached, but the number k stops incrementing. A measurement average usually applies to all traces, marker results, and numeric results. But sometimes it only applies to the numeric results.

If the analyzer is in Single measurement, pressing the Cont key does not change k and does not cause the sweep to be reset; the only action is to put the analyzer into Continuous measurement operation.

If it is already in continuous sweep:

the INIT:CONT 1 command has no effect

the INIT:CONT 0 command will place the analyzer in Single Sweep but will have no effect on the current sequence until $k = N$, at which point the current sequence will stop and the instrument will go to the idle state.

16 Monitor Spectrum Measurement
File

File

See "File" on page 336

FREQ Channel

Accesses a menu of keys that allow you to control the Frequency and Channel parameters of the instrument.

Some features in the Frequency menu are the same for all measurements – they do not change as you change measurements. Settings like these are called “Meas Global” and are unaffected by Meas Preset. For example, the Center Freq setting is the same for all measurements – it does not change as you change measurements.

Key Path	Front-panel key
Initial S/W Revision	Prior to A.02.00

Center Freq

Sets the frequency that corresponds to the horizontal center of the graticule (when frequency Scale Type is set to linear). While adjusting the Center Frequency the Span is held constant, which means that both Start Frequency and Stop Frequency will change.

Pressing Center Freq also sets the frequency entry mode to Center/Span. In Center/Span mode, the center frequency and span values are displayed below the graticule, and the default active function in the Frequency menu is Center Freq.

The center frequency setting is the same for all measurements within a mode, that is, it is Meas Global. Some modes are also able to share a Mode Global center frequency value. If this is the case, the Mode will have a Global Settings key in its Mode Setup menu.

The Center Freq function sets (and queries) the Center Frequency for the currently selected input. If your analyzer has multiple inputs, and you select another input, the Center Freq changes to the value for that input. SCPI commands are available to directly set the Center Freq for a specific input.

Center Freq is remembered as you go from input to input. Thus you can set a Center Freq of 10 GHz with the RF Input selected, change to BBIQ and set a Center Freq of 20 MHz, then switch to External Mixing and set a Center Freq of 60 GHz, and when you go back to the RF Input the Center Freq will go back to 10 GHz; back to BBIQ and it is 20 MHz; back to External Mixing and it is 60 GHz.

See ["RF Center Freq" on page 1998](#)

See [Ext Mix Center Freq](#)

See ["I/Q Center Freq" on page 2000](#)

See ["Center Frequency Presets" on page 1996](#)

Key Path	FREQ Channel
Scope	Meas Global
Remote Command	[:SENSe] :FREQuency:CENTer <freq> [:SENSe] :FREQuency:CENTer?

Example	FREQ:CENT 50 MHz FREQ:CENT UP changes the center frequency to 150 MHz if you use FREQ:CENT:STEP 100 MHz to set the center frequency step size to 100 MHz FREQ:CENT?
Notes	This command sets either the RF or I/Q Center Frequency depending on the selected input. For RF input it is equivalent to FREQ:RF:CENT For I/Q input it is equivalent to FREQ:IQ:CENT Preset and Max values are dependent on Hardware Options (5xx) If no terminator (e.g. MHz) is sent the terminator Hz is used. If a terminator with unit other than Frequency is used, an invalid suffix error message is generated.
Dependencies	The Center Frequency can be limited by Start or Stop Freq limits, if the Span is so large that Start or Stop reach their limit.
Couplings	When operating in "swept span", any value of the Center Frequency or Span that is within the frequency range of the analyzer is allowed when the value is being set through the front panel numeric key pad or the SCPI command. The other parameter is forced to a different value if needed, to keep the Start and the Stop Frequencies within the analyzer's frequency range
Preset	Depends on instrument maximum frequency, mode, measurement, and selected input. See "Center Frequency Presets" on page 1996 and "RF Center Freq" on page 1998 and Ext Mix Center Freq and "I/Q Center Freq" on page 2000 .
State Saved	Saved in instrument state
Min	Depends on instrument maximum frequency, mode, measurement, and selected input.. See "Center Frequency Presets" on page 1996 and "RF Center Freq" on page 1998 and "I/Q Center Freq" on page 2000 .
Max	Depends on instrument maximum frequency, mode, measurement, and selected input.. See "Center Frequency Presets" on page 1996 and "RF Center Freq" on page 1998 and "I/Q Center Freq" on page 2000 .
Default Unit	Hz
Status Bits/OPC	Non-overlapped
Dependencies	
Initial S/W Revision	Prior to A.02.00

Center Frequency Presets

The following table provides the Center Frequency Presets for the Spectrum Analyzer mode, and the Max Freq, for the various frequency options:

Freq Option	CF after Mode Preset	Stop Freq after Mode Preset	Max Freq (can't tune)

			above)
503 (all but N9000A)	1.805 GHz	3.6 GHz	3.7 GHz
503 (N9000A)	1.505 GHz	3.0 GHz	3.08 GHz
507 (all but N9000A)	3.505 GHz	7.0 GHz	7.1 GHz
507 (N9000A)	3.755 GHz	7.5 GHz	7.58 GHz
508 (all but N9038A)	1.805 GHz	3.6 GHz	8.5 GHz
508 (N9038A)	4.205 GHz	8.4 GHz	8.5 GHz
513	6.805 GHz	13.6 GHz	13.8 GHz
526 (all but N9000A and N9038A)	13.255 GHz	26.5 GHz	27.0 GHz
526 (N9000A)	13.255 GHz	26.5 GHz	26.55 GHz
526 (N9038A)	1.805 GHz	3.6 GHz	27.0 GHz
532	16.005 GHz	32.0 GHz	32.5 GHz
543	21.505 GHz	43.0 GHz	TBD
544	22.005 GHz	44.0 GHz	44.5 GHz
550	25.005 GHz	50.0 GHz	51 GHz

Input 2:

Model	CF after Mode Preset	Stop Freq after Mode Preset	Max Freq (can't tune above)
N9000A opt C75	0.7505GHz	1.5 GHz	1.58 GHz
N9038A	505 MHz	1 GHz	1.000025 GHz

Tracking Generator Frequency Limits (N9000A only):

Tracking Generator Option	Min Freq (clips to this freq when turn TG on and	If above this Freq, Stop Freq clipped to this Freq when	Max Freq (can't tune above) while TG

	can't tune below while TG on)	TG turned on	on
T03	9 kHz	3.0 GHz	3.08 GHz
T06	9 kHz	6.0 GHz	6.05 GHz

The following table shows the Center Frequency Presets for modes other than Spectrum Analyzer:

Mode	CF Preset for RF
WCDMA	1 GHz
WIMAXOFDMA,	1 GHz
BASIC	1 GHz
ADEMOD	1 GHz
VSA	1 GHz
TDSCDMA	1 GHz
PNOISE	1 GHz
LTE	1 GHz
LTETDD	1 GHz
MSR	1 GHz
GSM	935.2 MHz
NFIGURE	1.505 GHz

RF Center Freq

SCPI command for specifying the RF Center Frequency. This command will set the Center Frequency to be used when the RF input is selected, even if the RF input is not the input that is selected at the time the command is sent. Note that the Center Freq function in the Frequency menu on the front panel always applies to the currently selected input.

Scope	Meas Global
Remote Command	[:SENSe] :FREQuency:RF:CENTer <freq> [:SENSe] :FREQuency:RF:CENTer?
Example	FREQ:RF:CENT 30 MHz
Notes	This command is the same in all modes, but the parameter is Measurement Global. So the value is independent in each mode and common across all the measurements in the mode.
Dependencies	If the electronic/soft attenuator is enabled, any attempt to set Center Frequency such that the Stop Frequency would be >3.6 GHz fails and results in an advisory message. If the equivalent SCPI command is sent, this same message is generated as part of a “-221, Settings conflict” warning. If Source Mode is set to Tracking, and the Max or Min Center Freq is therefore limited by the limits of the source, a warning message is generated, “Data out of range;clipped to source max/min” if these limits are exceeded. Note that for an external source, these limits can be affected by the settings of

	Source Numerator, Source Denominator and Power Sweep.
Preset	See table above
State Saved	Saved in instrument state.
Min	-79.999995 MHz, unless Source Mode is set to Tracking, in which case it is limited by the minimum frequency of the Source
Max	See table above. Basically instrument maximum frequency - 5 Hz. Note that, if the Source Mode is set to Tracking, the effective instrument maximum frequency may be limited by the source maximum frequency. If the knob or step keys are being used, also depends on the value of the other three interdependent parameters Span, Start Frequency and Stop Frequency
Initial S/W Revision	Prior to A.02.00
Modified at S/W Revision	A.03.00

Ext Mix Center Freq

SCPI command for specifying the External Mixer Center Frequency. This command will set the Center Frequency to be used when the External Mixer is selected, even if the External Mixer input is not the input which is selected at the time the command is sent. Note that the Center Freq function in the Frequency menu on the front panel always applies to the currently selected input.

Scope	Meas Global
Remote Command	<code>[:SENSe] :FREQuency:EMIXer:CENTer <freq></code> <code>[:SENSe] :FREQuency:EMIXer:CENTer?</code>
Example	<code>:FREQ:EMIX:CENT 60 GHz</code> <code>:FREQ:EMIX:CENT?</code>
Notes	This command is the same in all modes, but the parameter is Measurement Global. So the value is independent in each mode and common across all the measurements in the mode.
Couplings	When returning to External Mixing after having been switched to one of the other inputs (e.g., RF), you will come back into the settings that you had when you left External Mixing. So you will come back to the band you were in with the Center Frequency that you had. However, Span is not an input-dependent parameter, therefore you will bring the span over from the other input. Therefore, the analyzer comes back with the span from the previous input, limited as necessary by the current mixer setup.
Preset	When a Mode Preset is performed while in External Mixing, the Start frequency of the current Mode is set to the nominal Min Freq of the lowest harmonic range in the Harmonic Table for the current mixer setup. Similarly, the Stop frequency of the current Mode is set to the nominal Max Freq of the highest harmonic range in the Harmonic Table. The Center Freq thus presets to the point arithmetically equidistant from these two frequencies. If the current measurement has a limited Span available to it, and cannot achieve the Span shown in the table ($\text{Span} = \text{Stop Freq} - \text{Start Freq}$), the analyzer uses the maximum Span the measurement allows, and still sets the Center Freq to the midpoint of the Start and Stop Freq values in the Harmonic Table.

	<p>When Restore Input/Output Defaults is performed, the mixer presets to the 11970A, whose Start and Stop frequencies are 26.5 and 40 GHz respectively. The center of these two frequencies is 33.25 GHz.</p> <p>Therefore, after a Restore Input/Output Defaults, if you go into External Mixing and do a Mode Preset while in the Spectrum Analyzer Mode, the resulting Center Freq is 33.25 GHz.</p>
State Saved	Saved in instrument state.
Min	The minimum frequency in the currently selected mixer band + 5 Hz
Max	The maximum frequency in the currently selected mixer band – 5 Hz If the knob or step keys are being used, also depends on the value of the other three interdependent parameters Span, Start Frequency and Stop Frequency
Initial S/W Revision	A.08.01

I/Q Center Freq

SCPI command for specifying the I/Q Center Frequency. This command will set the Center Frequency to be used when the I/Q input is selected, even if the I/Q input is not the input which is selected at the time the command is sent. Note that the Center Freq function in the Frequency menu on the front panel always applies to the currently selected input.

Scope	Meas Global
Remote Command	<pre>[:SENSe] :FREQuency:IQ:CENTer <freq></pre> <pre>[:SENSe] :FREQuency:IQ:CENTer?</pre>
Example	FREQ:IQ:CENT: 30 MHz
Notes	This command is the same in all modes, but the parameter is Measurement Global. So the value is independent in each mode and common across all the measurements in the mode.
Preset	0 Hz
State Saved	Saved in instrument state.
Min	-40.049995 MHz
Max	40.049995 MHz
Initial S/W Revision	Prior to A.02.00

CF Step

Changes the step size for the center frequency and start and stop frequency functions. Once a step size has been selected and the center frequency function is active, the step keys (and the UP|DOWN parameters for Center Frequency from remote commands) change the center frequency by the step-size value. The step size function is useful for finding harmonics and sidebands beyond the current frequency span of the analyzer.

Note that the start and stop frequencies also step by the CF Step value.

Key Path	FREQ Channel
Remote Command	[:SENSe]:FREQuency:CENTer:STEP[:INCRement] <freq> [:SENSe]:FREQuency:CENTer:STEP[:INCRement]? [:SENSe]:FREQuency:CENTer:STEP:AUTO OFF ON 0 1 [:SENSe]:FREQuency:CENTer:STEP:AUTO?
Example	FREQ:CENT:STEP:AUTO ON FREQ:CENT:STEP 500 MHz FREQ:CENT UP increases the current center frequency value by 500 MHz FREQ:CENT:STEP? FREQ:CENT:STEP:AUTO?
Notes	Preset and Max values are depending on Hardware Options (503, 507, 508, 513, 526)
Notes	Preset and Max values are dependent on Hardware Options (5xx)
Dependencies	Freq Offset is not available in External Mixing. In this case the Freq Offset key is grayed out and shows a value of zero. It will once again be available, and show the previously set value, when you return to the RF Input.
Dependencies	Span, RBW, Center frequency If the electronic/soft attenuator is enabled, any attempt to change the value of the center frequency >3.6 GHz by pressing the Up-arrow key, fails and results in an advisory message. If the equivalent SCPI command is sent, this same message is generated as part of a “-221, Settings conflict” warning.
Couplings	When auto-coupled in a non-zero span, the center frequency step size is set to 10% of the span. When auto-coupled in zero span, the center frequency step size is set to the equivalent -3 dB RBW value.
Preset	Auto ADEMOD: 1 MHz ON
State Saved	Saved in instrument state
Min	– (the maximum frequency of the instrument). That is, 27 GHz max freq instrument has a CF step range of +/- 27 GHz. Note that this is the maximum frequency given the current settings of the instrument, so in External Mixing, for example, it is the maximum frequency of the current mixer band.
Max	The maximum frequency of the instrument. That is, 27 GHz max freq instrument has a CF step range of +/- 27 GHz. Note that this is the maximum frequency given the current settings of the instrument, so in External Mixing, for example, it is the maximum frequency of the current mixer band.
Default Unit	Hz
Status Bits/OPC dependencies	non-overlapped
Initial S/W Revision	Prior to A.02.00
Modified at S/W Revision	A.03.00

16 Monitor Spectrum Measurement
Input/Output

Input/Output

See "[Input/Output](#)" on page 196

Marker

Accesses a menu that enables you to select, set up and control the markers for the current measurement.

For remote-only commands associated with Marker functionality, see:

- "Marker X Axis Value (Remote Command only)" on page 2006
- "Marker X Axis Position (Remote Command only)" on page 2006
- "Marker Y Axis Value (Remote Command only)" on page 2007

Key Path	Front-panel key
Initial S/W Revision	Prior to A.02.00

Select Marker

Displays 12 markers available for selection.

Key Path	Marker
Initial S/W Revision	Prior to A.02.00

Marker Type

Sets the marker control mode to Normal, Delta or Off. If the selected marker is Off, pressing Marker sets it to Normal and places a single marker at the center of the display. At the same time, Marker X Axis Value appears on the Active Function area.

Key Path	Marker
Mode	All except SA and BASIC
Remote Command	:CALCulate:MONitor:MARKer[1] 2 ... 12:MODE POSition DELTa OFF :CALCulate:MONitor:MARKer[1] 2 ... 12:MODE?
Example	CALC:MON:MARK:MODE POS CALC:MON:MARK:MODE?
Notes	If the selected marker is Off, pressing Marker sets it to Normal and places it at the center of the screen on the trace determined by the Marker Trace rules. At the same time, Marker X Axis Value appears on the Active Function area. Default Active Function: the active function for the selected marker's current control mode. If the current control mode is Off, there is no active function and the active function is turned off. Active Function Display: the marker X axis value entered in the active function area displays the marker value to its full entered precision.
Preset	OFF
State Saved	Saved in instrument state.
Range	Normal Delta Off
Initial S/W Revision	Prior to A.02.00

Properties

Accesses a menu that enables you to select the active marker, the reference marker and the trace for the current measurement.

Key Path	Marker
Initial S/W Revision	Prior to A.02.00

Select Marker

Displays 12 markers available for selection.

Key Path	Marker
Initial S/W Revision	Prior to A.02.00

Relative To

Selects the desired marker. The selected marker is relative to its reference marker.

Key Path	Marker, Properties
Mode	All except SA and BASIC
Remote Command	:CALCulate:MONitor:MARKer[1] 2 ... 12:REFerence <integer> :CALCulate:MONitor:MARKer[1] 2 ... 12:REFerence?
Example	CALC:MON:MARK2:REF 1 CALC:MON:MARK2:REF?
Notes	A marker cannot be relative to itself so that choice is grayed out, and if sent from SCPI generates error -221: "Settings conflict; marker cannot be relative to itself." When queried a single value is returned (the specified marker number's relative marker).
Preset	2 3 4 5 6 7 8 9 10 11 12 1
State Saved	Saved in instrument state.
Min	1
Max	12
Initial S/W Revision	Prior to A.02.00

Marker Trace

Assigns the specified marker to the designated trace.

Key Path	Marker, Properties
Mode	All except SA and BASIC

Remote Command	:CALCulate:MONitor:MARKer[1] 2 ... 12:TRACe <integer> :CALCulate:MONitor:MARKer[1] 2 ... 12:TRACe?
Example	CALC:MON:MARK:TRAC 1 CALC:MON:MARK:TRAC?
Preset	1
State Saved	Saved in instrument state.
Min	1
Max	3
Initial S/W Revision	Prior to A.02.00

Couple Markers

When this function is true, moving any marker causes an equal X Axis movement of every other marker that is not Off. By “equal X Axis movement” we mean that we preserve the difference between each marker’s X Axis value (in the fundamental x-axis units of the trace that marker is on) and the X Axis value of the marker being moved (in the same fundamental x-axis units).

Key Path	Marker
Mode	All except SA and BASIC
Remote Command	:CALCulate:MONitor:MARKer:COUPle[:STATe] ON OFF 1 0 :CALCulate:MONitor:MARKer:COUPle[:STATe]?
Example	CALC:MON:MARK:COUP ON CALC:MON:MARK:COUP?
Preset	OFF
State Saved	Saved in instrument state.
Range	On Off
Initial S/W Revision	Prior to A.02.00

All Markers Off

Turns off all markers on the current measurement.

Key Path	Marker
Mode	All except SA and BASIC
Remote Command	:CALCulate:MONitor:MARKer:AOFF
Example	CALC:MON:MARK:AOFF
Initial S/W Revision	Prior to A.02.00

Marker X Axis Value (Remote Command only)

Sets the marker X Axis value in the current marker X Axis Scale unit. It has no effect if the control mode is Off, but is the SCPI equivalent of entering an X value if the control mode is Normal or Delta.

Mode	All except SA and BASIC
Remote Command	:CALCulate:MONitor:MARKer[1] 2 ... 12:X <freq> :CALCulate:MONitor:MARKer[1] 2 ... 12:X?
Example	CALC:MON:MARK3:X 0 CALC:MON:MARK3:X?
Notes	If no suffix is sent, uses the fundamental units for the current marker X Axis Scale. If a suffix is sent that does not match the current marker X Axis Scale unit, an error "Invalid suffix" is generated. The query returns the marker's absolute X Axis value if the control mode is Normal, or the offset from the marker's reference marker if the control mode is Delta. The query is returned in the fundamental units for the current marker X Axis scale: Hz for Frequency and Inverse Time, seconds for Period and Time. If the marker is Off the response is not a number.
Preset	After a preset, all markers are turned OFF, so Marker X Axis Value query returns a not a number (NAN).
State Saved	No
Min	-9.9E+37
Max	9.9E+37
Initial S/W Revision	Prior to A.02.00

Marker X Axis Position (Remote Command only)

Sets the marker X position in trace points. It has no effect if the control mode is Off, but is the SCPI equivalent of entering a value if the control mode is Normal or Delta – except in trace points rather than X Axis Scale units. The entered value is immediately translated into the current X Axis Scale units for setting the value of the marker.

Mode	All except SA and BASIC
Remote Command	:CALCulate:MONitor:MARKer[1] 2 ... 12:X:POSition <real> :CALCulate:MONitor:MARKer[1] 2 ... 12:X:POSition?
Example	CALC:MON:MARK:X:POS 0 CALC:MON:MARK:X:POS?
Notes	The query returns the marker's absolute X Axis value in trace points if the control mode is Normal, or the offset from the marker's reference marker in trace points if the control mode is Delta. The value is returned as a real number, not an integer, corresponding to the translation from X Axis Scale units to trace points. If the marker is Off the response is not a number.
Preset	After a preset, all markers are turned OFF, so Marker X Axis Value query returns a not a number (NAN).
State Saved	No
Min	-9.9E+37

Max	9.9E+37
Initial S/W Revision	Prior to A.02.00

Marker Y Axis Value (Remote Command only)

Returns the marker Y Axis value in the current marker.

Mode	All except SA and BASIC
Remote Command	:CALCulate:MONitor:MARKer[1] 2 ... 12:Y?
Example	CALC:MON:MARK11:Y?
Preset	Result dependent on markers setup and signal source
Backwards Compatibility SCPI	:CALCulate:MONitor:MARKer[1] 2 ... 12:FUNCTion:RESult?
Initial S/W Revision	Prior to A.02.00

Marker Function

Accesses special marker functions such as marker noise, and power in a specified bandwidth or time interval.

Key Path	Front-panel key
Initial S/W Revision	Prior to A.02.00

Select Marker

Displays 12 markers available for selection.

Key Path	Marker
Initial S/W Revision	Prior to A.02.00

Marker Function Type

Sets the marker control function type to one of the following:

NOISe	Marker Noise
BPOWer	Band/Interval Power
BDENsity	Band Interval Density
OFF	Marker Function Off

Key Path	Marker Function
Mode	All except SA and BASIC
Remote Command	:CALCulate:MONitor:MARKer[1] 2 ... 12:FUNCTION NOISe BPOWer BDENsity OFF :CALCulate:MONitor:MARKer[1] 2 ... 12:FUNCTION?
Example	CALC:MON:MARK:FUNC NOISCALC:MON:MARK:FUNC?
Preset	OFF
State Saved	Saved in instrument state.
Range	Marker Noise Band/Interval Power Band Interval Density Marker Function Off
Initial S/W Revision	Prior to A.02.00

Band Adjust

Accesses a menu that enables you to set the frequency span width and the left and right edge, or time values, for the band or interval of the selected marker.

Key Path	Marker Function
Initial S/W Revision	Prior to A.02.00

Band/Interval Span for Frequency Domain

Sets the width of the frequency span for the selected marker.

Key Path	Marker Function
Mode	All except SA and BASIC
Remote Command	:CALCulate:MONitor:MARKer[1] 2 ... 12:FUNCtion:BAND:SPAN <freq> :CALCulate:MONitor:MARKer[1] 2 ... 12:FUNCtion:BAND:SPAN?
Example	CALC:MON:MARK12:FUNC:BAND:SPAN 20 MHz CALC:MON:MARK12:FUNC:BAND:SPAN?
Couplings	Changing the Band/Interval Span necessarily changes the Band/Interval Left and Band/Interval Right values.
Preset	Depends on X axis range of selected Trace.
State Saved	Saved in instrument state.
Min	-9.9E+37
Max	9.9E+37
Initial S/W Revision	Prior to A.02.00

Band/Interval Left for Frequency Domain

Sets the left edge frequency or time value for the band of the selected marker.

Key Path	Marker Function
Mode	All except SA and BASIC
Remote Command	:CALCulate:MONitor:MARKer[1] 2 ... 12:FUNCtion:BAND:LEFT <freq> :CALCulate:MONitor:MARKer[1] 2 ... 12:FUNCtion:BAND:LEFT?
Example	CALC:MON:MARK12:FUNC:BAND:LEFT 20 GHz CALC:MON:MARK12:FUNC:BAND:LEFT?
Couplings	Changing the Band/Interval Left necessarily changes the Band/Interval Span value.
Preset	Depends on X axis range of selected Trace.
State Saved	Saved in instrument state.
Min	-9.9E+37
Max	9.9E+37
Initial S/W Revision	Prior to A.02.00

Band/Interval Right for Frequency Domain

Sets the right edge frequency or time value for the band of the selected marker.

Key Path	Marker Function
Mode	All except SA and BASIC
Remote Command	:CALCulate:MONitor:MARKer[1] 2 ... 12:FUNCTion:BAND:RIGHT <freq> :CALCulate:MONitor:MARKer[1] 2 ... 12:FUNCTion:BAND:RIGHT?
Example	CALC:MON:MARK12:FUNC:BAND:RIGH 20 GHz CALC:MON:MARK12:FUNC:BAND:RIGH?
Couplings	Changing the Band/Interval Right necessarily changes the Band/Interval Span value.
Preset	Depends on X axis range of selected Trace.
State Saved	Saved in instrument state.
Min	-9.9E+37
Max	9.9E+37
Initial S/W Revision	Prior to A.02.00

Marker To

There is no 'Marker To' functionality supported in Monitor Spectrum. The front-panel key displays a blank menu when pressed.

Key Path	Front-panel key
Initial S/W Revision	Prior to A.02.00

Meas

The information in this section is common to all measurements. For key and remote command information for a specific measurement, refer to the section that describes the measurement of interest.

Measurements available under the Meas key are specific to the current Mode.

When viewing Help for measurements, note the following:

NOTE

Operation for some keys differs between measurements. The information displayed in Help pertains to the current measurement. To see how a key operates in a different measurement, exit Help (press the Cancel Esc key), select the measurement, then reenter Help (press the Help key) and press that key.

Key Path	Front-panel key
Initial S/W Revision	Prior to A.02.00

Remote Measurement Functions

This section contains the following topics:

["Measurement Group of Commands" on page 2206](#)

["Current Measurement Query \(Remote Command Only\)" on page 2208](#)

["Limit Test Current Results \(Remote Command Only\)" on page 2208](#)

["Data Query \(Remote Command Only\)" on page 2208](#)

["Calculate/Compress Trace Data Query \(Remote Command Only\)" on page 2209](#)

["Calculate Peaks of Trace Data \(Remote Command Only\)" on page 2214](#)

[Hardware-Accelerated Fast Power Measurement \(Remote Command Only\)](#)

["Format Data: Numeric Data \(Remote Command Only\)" on page 2215](#)

["Format Data: Byte Order \(Remote Command Only\)" on page 2216](#)

Initial S/W Revision	Prior to A.02.00
----------------------	------------------

Measurement Group of Commands

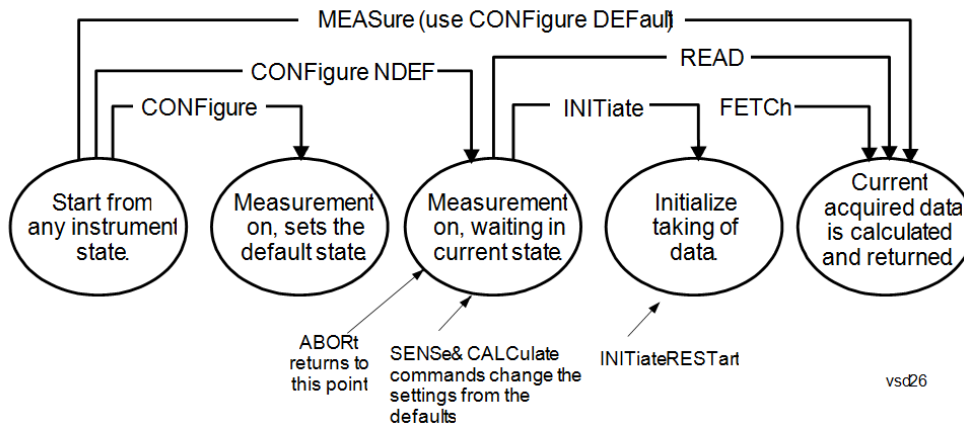

Measure Commands:

:MEASure:<measurement>[n]?

This is a fast single-command way to make a measurement using the factory default instrument settings. These are the settings and units that conform to the Mode Setup settings (e.g. radio standard) that you have currently selected.

- Stops the current measurement (if any) and sets up the instrument for the specified measurement using the factory defaults
- Initiates the data acquisition for the measurement
- Blocks other SCPI communication, waiting until the measurement is complete before returning results.
- If the function does averaging, it is turned on and the number of averages is set to 10.
- After the data is valid it returns the scalar results, or the trace data, for the specified measurement. The type of data returned may be defined by an [n] value that is sent with the command.
- The scalar measurement results will be returned if the optional [n] value is not included, or is set to 1. If the [n] value is set to a value other than 1, the selected trace data results will be returned. See each command for details of what types of scalar results or trace data results are available.
- ASCII is the default format for the data output. (Older versions of Spectrum Analysis and Phase Noise mode measurements only use ASCII.) The binary data formats should be used for handling large blocks of data since they are smaller and faster than the ASCII format. Refer to the FORMat:DATA command for more information.

If you need to change some of the measurement parameters from the factory default settings you can set up the measurement with the CONFIgure command. Use the commands in the SENSe:<measurement> and CALCulate:<measurement> subsystems to change the settings. Then you can use the READ? command to initiate the measurement and query the results.

If you need to repeatedly make a given measurement with settings other than the factory defaults, you can use the commands in the SENSe:<measurement> and CALCulate:<measurement> subsystems to set up the measurement. Then use the READ? command to initiate the measurement and query results.

Measurement settings persist if you initiate a different measurement and then return to a previous one. Use READ:<measurement>? if you want to use those persistent settings. If you want to go back to the default settings, use MEASure:<measurement>?.

Configure Commands:

:CONFIgure:<measurement>

This command stops the current measurement (if any) and sets up the instrument for the specified measurement using

the factory default instrument settings. It does not initiate the taking of measurement data unless INIT:CONTinuous is ON. If you change any measurement settings after using the CONFigure command, the READ command can be used to initiate a measurement without changing the settings back to their defaults.

In the Swept SA measurement in Spectrum Analyzer mode the CONFigure command also turns the averaging function on and sets the number of averages to 10 for all measurements.

:CONFigure: <measurement>: NDEFault stops the current measurement and changes to the specified measurement. It does not change the settings to the defaults. It does not initiate the taking of measurement data unless INIT:CONTinuous is ON.

The CONFigure? query returns the current measurement name.

The CONFigure:CATalog? query returns a quoted string of all licensed measurement names in the current mode. For example, "SAN, CHP, OBW, ACP, PST, TXP, SPUR, SEM, LIST".

Fetch Commands:

:FETCh:<measurement>[n]?

This command puts selected data from the most recent measurement into the output buffer. Use FETCh if you have already made a good measurement and you want to return several types of data (different [n] values, for example, both scalars and trace data) from a single measurement. FETCh saves you the time of re-making the measurement. You can only FETCh results from the measurement that is currently active, it will not change to a different measurement. An error message is reported if a measurement other than the current one is specified.

If you need to get new measurement data, use the READ command, which is equivalent to an INITiate followed by a FETCh.

The scalar measurement results will be returned if the optional [n] value is not included, or is set to 1. If the [n] value is set to a value other than 1, the selected trace data results will be returned. See each command for details of what types of scalar results or trace data results are available. The binary data formats should be used for handling large blocks of data since they are smaller and transfer faster than the ASCII format. (FORMat:DATA)

FETCh may be used to return results other than those specified with the original READ or MEASure command that you sent.

INITiate Commands:

:INITiate:<measurement>

This command is not available for measurements in all the instrument modes:

- Initiates a trigger cycle for the specified measurement, but does not output any data. You must then use the FETCh<meas> command to return data. If a measurement other than the current one is specified, the instrument will switch to that measurement and then initiate it.
 - For example, suppose you have previously initiated the ACP measurement, but now you are running the channel power measurement. If you send INIT:ACP? it will change from channel power to ACP and will initiate an ACP measurement.
 - Does not change any of the measurement settings. For example, if you have previously started the ACP measurement and you send INIT:ACP? it will initiate a new ACP measurement using the same instrument settings as the last time ACP was run.
 - If your selected measurement is currently active (in the idle state) it triggers the measurement, assuming the trigger conditions are met. Then it completes one trigger cycle. Depending upon the measurement and the number of averages, there may be multiple data acquisitions, with multiple trigger events, for one full trigger cycle. It also holds off additional commands on GPIB until the acquisition is complete.
-

READ Commands:

:READ:<measurement>[n]?

- Does not preset the measurement to the factory default settings. For example, if you have previously initiated the ACP
-

measurement and you send READ:ACP? it will initiate a new measurement using the same instrument settings.

- Initiates the measurement and puts valid data into the output buffer. If a measurement other than the current one is specified, the instrument will switch to that measurement before it initiates the measurement and returns results.
 - For example, suppose you have previously initiated the ACP measurement, but now you are running the channel power measurement. Then you send READ:ACP? It will change from channel power back to ACP and, using the previous ACP settings, will initiate the measurement and return results.
 - Blocks other SCPI communication, waiting until the measurement is complete before returning the results
 - If the optional [n] value is not included, or is set to 1, the scalar measurement results will be returned. If the [n] value is set to a value other than 1, the selected trace data results will be returned. See each command for details of what types of scalar results or trace data results are available. The binary data formats should be used when handling large blocks of data since they are smaller and faster than the ASCII format. (FORMat:DATA)
-

Initial S/W Revision	Prior to A.02.00
----------------------	------------------

Current Measurement Query (Remote Command Only)

This command returns the name of the measurement that is currently running.

Remote Command	:CONFigure?
-----------------------	-------------

Example	CONF?
----------------	-------

Initial S/W Revision	Prior to A.02.00
----------------------	------------------

Limit Test Current Results (Remote Command Only)

Queries the status of the current measurement limit testing. It returns a 0 if the measured results pass when compared with the current limits. It returns a 1 if the measured results fail any limit tests.

Remote Command	:CALCulate:CLIMits:FAIL?
-----------------------	--------------------------

Example	CALC:CLIM:FAIL? queries the current measurement to see if it fails the defined limits. Returns a 0 or 1: 0 it passes, 1 it fails.
----------------	--

Initial S/W Revision	Prior to A.02.00
----------------------	------------------

Data Query (Remote Command Only)

Returns the designated measurement data for the currently selected measurement and subopcode.

n = any valid subopcode for the current measurement. See the measurement command results table for your current measurement, for information about what data is returned for the subopcodes.

This command uses the data setting specified by the FORMat:BORDER and FORMat:DATA commands and can return real or ASCII data. (See the format command descriptions under Input/Output in the Analyzer Setup section.)

Remote Command	:CALCulate:DATA[n]?
Notes	The return trace depends on the measurement. In CALCulate:<meas>:DATA[n], n is any valid subopcode for the current measurement. It returns the same data as the FETCH:<measurement>? query where <measurement> is the current measurement.
Initial S/W Revision	Prior to A.02.00

Calculate/Compress Trace Data Query (Remote Command Only)

Returns compressed data for the currently selected measurement and sub-opcode [n].

n = any valid sub-opcode for that measurement. See the MEASure:<measurement>? command description of your specific measurement for information on the data that can be returned.

The data is returned in the current Y Axis Unit of the analyzer. The command is used with a sub-opcode <n> (default=1) to specify the trace. With trace queries, it is best if the analyzer is not sweeping during the query. Therefore, it is generally advisable to be in Single Sweep, or Update=Off.

This command is used to compress or decimate a long trace to extract and return only the desired data. A typical example would be to acquire N frames of GSM data and return the mean power of the first burst in each frame. The command can also be used to identify the best curve fit for the data.

Remote Command	:CALCulate:DATA<n>:COMPRESS? BLOCK CFIT MAXimum MINimum MEAN DMEan RMS RMSCubed SAMPLE SDEVIation PPHase [,<soffset> [,<length>[,<roffset>[,<rlimit>]]]]
Example	To query the mean power of a set of GSM bursts: Supply a signal that is a set of GSM bursts. Select the IQ Waveform measurement (in IQ Analyzer Mode). Set the sweep time to acquire at least one burst. Set the triggers such that acquisition happens at a known position relative to a burst. Then query the mean burst levels using, CALC:DATA2:COMP? MEAN, 24e-6, 526e-6 (These parameter values correspond to GSM signals, where 526e-6 is the length of the burst in the slot and you just want 1 burst.)
Notes	The command supports 5 parameters. Note that the last 4 (<soffset>, <length>, <roffset>, <rlimit>) are optional. But these optional parameters must be entered in the specified order. For example, if you want to specify <length>, then you must also specify <soffset>. See details below for a definition of each of these parameters. This command uses the data in the format specified by FORMat:DATA, returning either binary or ASCII data.
Initial S/W Revision	Prior to A.02.00

- BLOCK or block data - returns all the data points from the region of the trace data that you specify. For example, it could be used to return the data points of an input signal over several timeslots, excluding the portions of the trace data that you do not want. (This is x,y pairs for trace data and I,Q pairs for complex data.)

- CFIT or curve fit - applies curve fitting routines to the data. <soffset> and <length> are required to define the data that you want. <roffset> is an optional parameter for the desired order of the curve equation. The query will return the following values: the x-offset (in seconds) and the curve coefficients ((order + 1) values).

MIN, MAX, MEAN, DME, RMS, RMSC, SAMP, SDEV and PPH return one data value for each specified region (or <length>) of trace data, for as many regions as possible until you run out of trace data (using <roffset> to specify regions). Or they return the number of regions you specify (using <rlimit>) ignoring any data beyond that.

- MINimum - returns the minimum data point (y value) for the specified region(s) of trace data. For I/Q trace data, the minimum magnitude of the I/Q pairs is returned.
- MAXimum - returns the maximum data point (y value) for the specified region(s) of trace data. For I/Q trace data, the maximum magnitude of the I/Q pairs is returned.
- MEAN - returns a single value that is the arithmetic mean of the data point values (in dB/ dBm) for the specified region(s) of trace data. For I/Q trace data, the mean of the magnitudes of the I/Q pairs is returned. See the following equations.

-

NOTE

If the original trace data is in dB, this function returns the arithmetic mean of those log values, not log of the mean power which is a more useful value. The mean of the log is the better measurement technique when measuring CW signals in the presence of noise. The mean of the power, expressed in dB, is useful in power measurements such as Channel Power. To achieve the mean of the power, use the RMS option.

Equation 1

Mean Value of Data Points for Specified Region(s)

$$\text{MEAN} = \frac{1}{n} \sum_{X_i \in \text{region}(s)} X_i$$

where X_i is a data point value, and n is the number of data points in the specified region(s).

Equation 2

Mean Value of I/Q Data Pairs for Specified Region(s)

$$\text{MEAN} = \frac{1}{n} \sum_{X_i \in \text{region}(s)} |X_i|$$

where $|X_i|$ is the magnitude of an I/Q pair, and n is the number of I/Q pairs in the specified region(s).

- DMEan - returns a single value that is the mean power (in dB/ dBm) of the data point values for the specified region(s) of trace data. See the following equation:

Equation 3

DMEan Value of Data Points for Specified Region(s)

$$\text{DME} = 10 \times \log_{10} \left(\frac{1}{n} \sum_{X_i \in \text{region}(s)} 10^{\frac{X_i}{10}} \right)$$

- RMS - returns a single value that is the average power on a root-mean-squared voltage scale (arithmetic rms) of the data point values for the specified region(s) of trace data. See the following equation.

NOTE

For I/Q trace data, the rms of the magnitudes of the I/Q pairs is returned. See the following equation. This function is very useful for I/Q trace data. However, if the original trace data is in dB, this function returns the rms of the log values which is not usually needed.

Equation 4

RMS Value of Data Points for Specified Region(s)

$$\text{RMS} = \sqrt{\frac{1}{n} \sum_{X_i \in \text{region}(s)} X_i^2}$$

where X_i is a data point value, and n is the number of data points in the specified region(s).

Equation 5

RMS Value of I/Q Data Pairs for Specified Region(s)

$$\text{RMS} = \sqrt{\frac{1}{n} \sum_{X_i \in \text{region}(s)} X_i X_i^*}$$

where X_i is the complex value representation of an I/Q pair, X_i^* its conjugate complex number, and n is the number of I/Q pairs in the specified region(s).

Once you have the rms value for a region of trace data (linear or I/Q), you may want to calculate the mean power. You must convert this rms value (peak volts) to power in dBm:

$$10 \times \log[10 \times (\text{rms value})^2]$$

- SAMPLe - returns the first data value (x,y pair) for the specified region(s) of trace data. For I/Q trace data, the first I/Q pair is returned.
- SDEViation - returns a single value that is the arithmetic standard deviation for the data point values for the specified region(s) of trace data. See the following equation.
- For I/Q trace data, the standard deviation of the magnitudes of the I/Q pairs is returned. See the following equation.

Equation 6

Standard Deviation of Data Point Values for Specified Region(s)

$$\text{SDEV} = \sqrt{\frac{1}{n} \sum_{X_i \in \text{region}(s)} (X_i - \bar{X})^2}$$

where X_i is a data point value, \bar{X} is the arithmetic mean of the data point values for the specified region (s), and n is the number of data points in the specified region(s).

$$\text{SDEV} = \sqrt{\frac{1}{n} \sum_{X_i \in \text{region}(s)} (|X_i| - \bar{X})^2}$$

where $|X_i|$ is the magnitude of an I/Q pair, \bar{X} is the mean of the magnitudes for the specified region(s), and n is the number of data points in the specified region(s).

- PPHase - returns the x,y pairs of both rms power (dBm) and arithmetic mean phase (radian) for every specified region and frequency offset (Hz). The number of pairs is defined by the specified number of regions. This parameter can be used for I/Q vector ($n=0$) in Waveform (time domain) measurement and all parameters are specified by data point in PPHase.

The rms power of the specified region may be expressed as:

$$\text{Power} = 10 \times \log [10 \times (\text{RMS I/Q value})] + 10.$$

The RMS I/Q value (peak volts) is:

$$\sqrt{\frac{1}{n} \sum_{X_i \in \text{region}} X_i X_i^*}$$

where X_i is the complex value representation of an I/Q pair, X_i^* its conjugate complex number, and n is the number of I/Q pairs in the specified region.

The arithmetic mean phase of the specified region may be expressed as:

$$\frac{1}{n} \sum_{Y_i \in \text{region}} Y_i$$

where Y_i is the unwrapped phase of I/Q pair with applying frequency correction and n is the number of I/Q pairs in the specified region.

The frequency correction is made by the frequency offset calculated by the arithmetic mean of every specified region's frequency offset. Each frequency offset is calculated by the least square method against the unwrapped phase of I/Q pair.

Sample Trace Data - Constant Envelope

(See below for explanation of variables.)

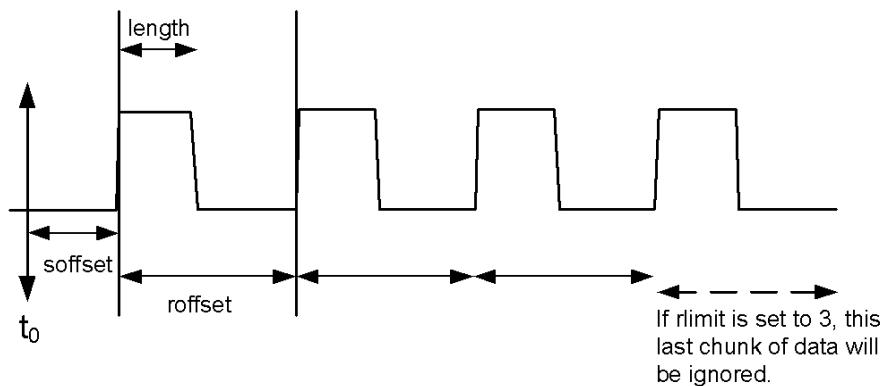

Sample Trace Data - Not Constant Envelope

(See below for explanation of variables.)

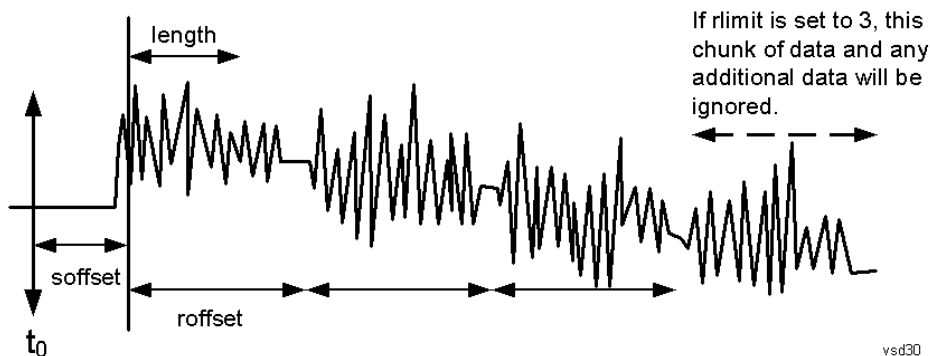

<soffset> - start offset is an optional real number. (It is in seconds for time-domain traces, and is a dimensionless index 0 to Npoints - 1, for frequency-domain traces). It specifies the amount of data at the beginning of the trace that will be ignored before the decimation process starts. It is the time or frequency change from the start of the trace to the point where you want to start using the data. The default value is zero.

<length> - is an optional real number. (It is in seconds for time-domain traces, and is a dimensionless index 0 to Npoints - 1, for frequency-domain traces). It defines how much data will be compressed into one value. This parameter has a default value equal to the current trace length.

<roffset> - repeat offset is an optional real number. (It is in seconds for time-domain traces, and is a dimensionless index 0 to Npoints - 1, for frequency-domain traces). It defines the beginning of the next field of trace elements to be compressed. This is relative to the beginning of the previous field. This parameter has a default value equal to the <length> variable. Note that this parameter is used for a completely different purpose when curve fitting (see CFIT above).

<rlimit> - repeat limit is an optional integer. It specifies the number of data items that you want returned. It will ignore any additional items beyond that number. You can use the Start offset and the Repeat limit to pick out exactly what part of the data you want to use. The default value is all the data.

Calculate Peaks of Trace Data (Remote Command Only)

Returns a list of all the peaks for the currently selected measurement and sub-opcode [n]. The peaks must meet the requirements of the peak threshold and excursion values.

n = any valid sub-opcode for the current measurement. See the MEASure:<measurement> command description of your specific measurement for information on the data that can be returned.

The command can only be used with specific sub-opcodes with measurement results that are trace data. Both real and complex traces can be searched, but complex traces are converted to magnitude in dBm. In many measurements the sub-opcode n=0, is the raw trace data which cannot be searched for peaks. And Sub-opcode n=1, is often calculated results values which also cannot be searched for peaks.

This command uses the data setting specified by the FORMat:BORDER and FORMat:DATA commands and can return real or ASCII data. If the format is set to INT,32, it returns REAL,32 data.

The command has four types of parameters:

- Threshold (in dBm)
- Excursion (in dB)
- Sorting order (amplitude, frequency, time)
- Optional in some measurements: Display line use (all, > display line, < display line)

Remote Command	<p>For Swept SA measurement:</p> <pre>:CALCulate:DATA[1] 2 ... 6:PEAKs? <threshold>,<excursion>[,AMPLitude FREQuency TIME[,ALL GTDLline LTDLine]]</pre> <p>For most other measurements:</p> <pre>:CALCulate:DATA[1] 2 ... 6:PEAKs? <threshold>,<excursion>[,AMPLitude FREQuency TIME]</pre>
-----------------------	---

Example	<p>Example for Swept SA measurement in Spectrum Analyzer Mode:</p> <p>CALC:DATA4:PEAK? -40, 10, FREQ, GTDL This will identify the peaks of trace 4 that are above -40 dBm, with excursions of at least 10 dB. The peaks are returned in order of increasing frequency, starting with the lowest frequency. Only the peaks that are above the display line are returned.</p> <p>Query Results 1:</p> <p>With FORMat:DATA REAL, 32 selected, it returns a list of floating-point numbers. The first value in the list is the number of peak points that are in the following list. A peak point consists of two values: a peak amplitude followed by its corresponding frequency (or time).</p> <p>If no peaks are found the peak list will consist of only the number of peaks, (0).</p>
----------------	---

Notes	<p><n> - is the trace that will be used</p> <p><threshold> - is the level below which trace data peaks are ignored. Note that the threshold value is required and is always used as a peak criterion. To effectively disable the threshold criterion for this command, provide a substantially low threshold value such as -200 dBm. Also note that the threshold value used in this command is independent of and has no effect on the threshold value stored under the Peak Criteria menu.</p> <p><excursion> - is the minimum amplitude variation (rise and fall) required for a signal to be identified as peak. Note that the excursion value is required and is always used as a peak criterion. To effectively disable the excursion criterion for this command, provide the minimum value of 0.0 dB. Also note that the excursion value used in this command is independent of and has no effect on the</p>
--------------	---

excursion value stored under the Peak Criteria menu.

Values must be provided for threshold and excursion. The sorting and display line parameters are optional (defaults are AMPLitude and ALL).

Note that there is always a Y-axis value for the display line, regardless of whether the display line state is on or off. It is the current Y-axis value of the display line which is used by this command to determine whether a peak should be reported

Sorting order:

AMPLitude - lists the peaks in order of descending amplitude, with the highest peak first (default if optional parameter not sent)

FREQuency - lists the peaks in order of occurrence, left to right across the x-axis.

TIME - lists the peaks in order of occurrence, left to right across the x-axis.

Peaks vs. Display Line:

ALL - lists all of the peaks found (default if optional parameter not sent).

GTDLine (greater than display line) - lists all of the peaks found above the display line.

LTDLine (less than display line) - lists all of the peaks found below the display line.

Initial S/W Revision Prior to A.02.00

Format Data: Numeric Data (Remote Command Only)

This command specifies the format of the trace data input and output. It specifies the formats used for trace data during data transfer across any remote port. It affects only the data format for setting and querying trace data for the :TRACe[:DATA], TRACe[:DATA]?, :CALCulate:DATA[n]? and FETCh:SANalyzer [n]? commands and queries.

Remote Command :FORMat [:TRACe] [:DATA] ASCii | INTeger, 32 | REAL, 32 | REAL, 64
:FORMat [:TRACe] [:DATA] ?

Notes The query response is:
ASCii: ASC,8
REAL,32: REAL,32
REAL,64: REAL,64
INTeger,32: INT,32

When the numeric data format is REAL or ASCii, data is output in the current Y Axis unit. When the data format is INTeger, data is output in units of m dBm (.001 dBm).

The INT,32 format returns binary 32-bit integer values in internal units (m dBm), in a definite length block.

Dependencies Sending a data format spec with an invalid number (for example, INT,48) generates no error. The analyzer simply uses the default (8 for ASCii, 32 for INTeger, 32 for REAL).

Sending data to the analyzer which does not conform to the current FORMat specified, results in an error. Sending ASCII data when a definite block is expected generates message -161 "Invalid Block Data" and sending a definite block when ASCII data is expected generates message -121 "Invalid Character in Number".

Preset ASCii

Backwards Compatibility Notes Note that the INT,32 format is only applicable to the command, TRACe:DATA. This preserves backwards compatibility for the Swept SA measurement. For all other commands/queries which honor FORMat:DATA, if INT,32 is sent the analyzer will behave as though it were set to REAL,32.

Initial S/W Revision Prior to A.02.00

The specs for each output type follow:

ASCIi - Amplitude values are in ASCII, in the current Y Axis Unit, one ASCII character per digit, values separated by commas, each value in the form:

SX.YYYYYEsZZ

Where:

S = sign (+ or -)

X = one digit to left of decimal point

Y = 5 digits to right of decimal point

E = E, exponent header

s = sign of exponent (+ or -)

ZZ = two digit exponent

REAL,32 - Binary 32-bit real values in the current Y Axis Unit, in a definite length block.

REAL,64 - Binary 64-bit real values in the current Y Axis Unit, in a definite length block.

Format Data: Byte Order (Remote Command Only)

This command selects the binary data byte order for data transfer and other queries. It controls whether binary data is transferred in normal or swapped mode. This command affects only the byte order for setting and querying trace data for the :TRACe[:DATA], TRACe[:DATA]? , :CALCulate:DATA[n]? and FETCh:SANalyzer[n]? commands and queries.

By definition any command that says it uses FORMat:DATA uses any format supported by FORMat:DATA.

The NORMal order is a byte sequence that begins with the most significant byte (MSB) first, and ends with the least significant byte (LSB) last in the sequence: 1|2|3|4. SWAPped order is when the byte sequence begins with the LSB first, and ends with the MSB last in the sequence: 4|3|2|1.

Remote Command	:FORMat:BORDER NORMal SWAPped :FORMat:BORDER?
Preset	NORMal
Initial S/W Revision	Prior to A.02.00

Meas Setup

Displays the setup menu for the current measurement. The measurement setup parameters include the number of measurement averages used to calculate the measurement result and the averaging mode. The setup menu also includes the option to reset the measurement settings to their factory defaults.

Key Path	Front-panel key
Initial S/W Revision	Prior to A.02.00

Avg/Hold Num

Specifies the number of measurement averages used when calculating the measurement result. The average is displayed at the end of each sweep.

After the specified number of average counts, the averaging mode (terminal control) setting determines the averaging action.

Key Path	Meas Setup
Mode	All except SA and BASIC
Remote Command	[:SENSe]:MONitor:AVERage:COUNT <integer> [:SENSe]:MONitor:AVERage:COUNT? [:SENSe]:MONitor:AVERage[:STATe] OFF ON 0 1 [:SENSe]:MONitor:AVERage[:STATe]?
Example	MON:AVER:COUN 25 MON:AVER:COUN? MON:AVER ON MON:AVER?
Preset	10 OFF
State Saved	Saved in instrument state.
Min	1
Max	1000
Initial S/W Revision	Prior to A.02.00

Avg Mode

Toggles the average mode between exponential (Exp) and Repeat.

- **Exp**– continues measurement averaging, using the specified number of averages to compute each averaged value. The average is displayed at the end of each sweep.
- **Repeat**– causes the measurement to reset the average counter each time the specified number of averages is reached.

Key Path	Meas Setup
Mode	All except SA and BASIC
Remote Command	[:SENSe] :MONitor :AVERage :TCONtrol EXPonential REPeat [:SENSe] :MONitor :AVERage :TCONtrol ?
Example	MON:AVER:TCON EXP MON:AVER:TCON?
Preset	EXPonential
State Saved	Saved in instrument state.
Range	ExpRepeat
Initial S/W Revision	Prior to A.02.00

Meas Preset

Restores all the measurement parameters to their default values.

Key Path	Meas Setup
Mode	All except SA and BASIC
Remote Command	:CONFigure:MONitor
Example	CONF:MON
Initial S/W Revision	Prior to A.02.00

16 Monitor Spectrum Measurement
Mode

Mode

See "[Mode](#)" on page 286

Mode Preset

Returns the active mode to a known state.

Mode Preset does the following for the currently active mode:

- Aborts the currently running measurement.
- Brings up the default menu for the mode, with no active function.
- Sets measurement Global settings to their preset values for the active mode only.
- Activates the default measurement.
- Brings up the default menu for the mode.
- Clears the input and output buffers.
- Sets Status Byte to 0.

Mode Preset does not:

- Cause a mode switch
- Affect mode persistent settings
- Affect system settings

See "[How-To Preset](#)" on page 2028 for more information.

Key Path	Front-panel key
Remote Command	:SYSTem:PRESet
Example	:SYST:PRES
Notes	*RST is preferred over :SYST:PRES for remote operation. *RST does a Mode Preset, as done by the :SYST:PRES command, and it sets the measurement mode to Single measurement rather than Continuous for optimal remote control throughput. Clears all pending OPC bits. The Status Byte is set to 0.
Couplings	A Mode Preset aborts the currently running measurement, activates the default measurement, and gets the mode to a consistent state with all of the default couplings set.
Backwards Compatibility Notes	In the X-Series, the legacy "Factory Preset" has been replaced with Mode Preset, which only presets the currently active mode, not the entire instrument. In the X-Series, the way to preset the entire instrument is by using System, Restore System Defaults All, which behaves essentially the same way as restore System Defaults does on ESA and PSA. There is also no "Preset Type" as there is on the PSA. There is a green Mode Preset front-panel key that does a Mode Preset and a white-with-green-letters User Preset front-panel key that does a User Preset. The old PRESet:TYPE command is ignored (without generating an error), and SYST:PRES without a parameter does a Mode Preset, which should cover most backward code compatibility issues. The settings and correction data under the Input/Output front-panel key (examples: Input Z Corr, Ext Amp Gain, etc.) are no longer part of any Mode, so they will not be preset by a Mode Preset. They are preset using Restore Input/Output Defaults, Restore System Defaults All. Note that because User Preset does a Recall State, and all of these settings are saved in State, they ARE recalled when using

	User Preset.
Initial S/W Revision	Prior to A.02.00

How-To Preset

The table below shows all possible presets, their corresponding SCPI commands and front-panel access (key paths). Instrument settings depend on the current measurement context. Some settings are local to the current measurement, some are global (common) across all the measurements in the current mode, and some are global to all the available modes. In a similar way, restoring the settings to their preset state can be done within the different contexts.

Auto Couple - is a measurement local key. It sets all Auto/Man parameter couplings in the measurement to Auto. Any Auto/Man selection that is local to other measurements in the mode will not be affected.

Meas Preset - is a measurement local key. Meas Preset resets all the variables local to the current measurement except the persistent ones.

Mode Preset - resets all the current mode's measurement local and measurement global variables except the persistent ones.

Restore Mode Defaults - resets ALL the Mode variables (and all the Meas global and Meas local variables), including the persistent ones.

Type Of Preset	SCPI Command	Front Panel Access
Auto Couple	:COUPle ALL	Auto Couple front-panel key
Meas Preset	:CONFigure:<Measurement>	Meas Setup Menu
Mode Preset	:SYSTem:PRESet	Mode Preset (green key)
Restore Mode Defaults	:INSTrument:DEFault	Mode Setup Menu
Restore All Mode Defaults	:SYSTem:DEFault MODes	System Menu; Restore System Default Menu
*RST	*RST	not possible (Mode Preset with Single)
Restore Input/Output Defaults	:SYSTem:DEFault INPUt	System Menu; Restore System Default Menu
Restore Power On Defaults	:SYSTem:DEFault PON	System Menu; Restore System Default Menu
Restore Alignment Defaults	:SYSTem:DEFault ALIGN	System Menu; Restore System Default Menu
Restore Miscellaneous Defaults	:SYSTem:DEFault MISC	System Menu; Restore System Default Menu
Restore All System Defaults	:SYSTem:DEFault [ALL] :SYSTem:PRESet:PERsistent	System Menu; Restore System Default Menu
User Preset	:SYSTem:PRESet:USER	User Preset Menu
User Preset All Modes	:SYSTem:PRESet:USER:ALL	User Preset Menu

Power On Mode Preset	:SYSTem:PON:TYPE MODE	System Menu
Power On User Preset	:SYSTem:PON:TYPE USER	System Menu
Power On Last State	:SYSTem:PON:TYPE LAST	System Menu

Preset Type (Remote Command Only)

As stated in the Backward Compatibility section, to be compatible with ESA/PSA the PRESet:TYPE command will be implemented as a no-op.

Mode	All
Remote Command	:SYSTem:PRESet:TYPE FACTory MODE USER :SYSTem:PRESet:TYPE?
Example	:SYST:PRESet:TYPE FACT
Notes	This command is supported for backward compatibility only. It is a no-op which does not change the behavior of any preset operation.
Preset	This is unaffected by Preset but is set to Mode on a “Restore System Defaults->All”
State Saved	No
Initial S/W Revision	Prior to A.02.00

Mode Setup

See "[Mode Setup](#)" on page 316

Peak Search

Places the selected marker on the trace point with the maximum y-axis value for that marker's trace. Pressing Peak Search with the selected marker off causes the selected marker to be set to Normal, then a peak search is immediately performed.

Key Path	Front-panel key
Mode	All except SA and BASIC
Remote Command	:CALCulate:MONitor:MARKer[1] 2 ... 12:MAXimum
Example	CALC:MON:MARK2:MAX
Initial S/W Revision	Prior to A.02.00

16 Monitor Spectrum Measurement
Print

Print

See ["Print" on page 341](#)

Quick Save

The Quick Save front-panel key repeats the most recent save that was performed from the Save menu, with the following exceptions:

- Register saves are not remembered as Saves for the purpose of the Quick Save function
- If the current measurement does not support the last non-register save that was performed, an informational message is generated, “File type not supported for this measurement”

Quick Save repeats the last type of qualified save (that is, a save qualified by the above criteria) in the last save directory by creating a unique filename using the Auto File Naming algorithm described below.

If Quick Save is pressed after startup and before any qualified Save has been performed, the Quick Save function performs a Screen Image save using the current settings for Screen Image saves (current theme, current directory), which then becomes the “last save” for the purpose of subsequent Quick Saves.

The Auto File Naming feature automatically generates a file name for use when saving a file. The filename consists of a prefix and suffix separated by a dot, as is standard for the Windows® file system. A default prefix exists for each of the available file types:

Type	Default Prefix	Menu
State	State_	(Save/Recall)
Trace + State	State_	(Save/Recall)
Screen	Screen_	(Save/Recall)
Amplitude Corrections	Ampcor_	(Import/Export)
Traces	Trace_	(Import/Export)
Limit Lines	LLine_	(Import/Export)
Measurement Result	MeasR_	(Import/Export)
Capture Buffer	CapBuf_	(Import/Export)

A four digit number is appended to the prefix to create a unique file name. The numbering sequence starts at 0000 within each Mode for each file type and updates incrementally to 9999, then wraps to 0000 again. It remembers where it was through a Mode Preset and when leaving and returning to the Mode. It is reset by Restore Misc Defaults and Restore System Defaults and subsequent running of the instrument application. So, for example, the first auto file name generated for State files is State_0000.state. The next is State_0001, and so forth.

One of the key features of Auto File Name is that we guarantee that the Auto File Name will never conflict with an existing file. The algorithm looks for the next available number. If it gets to 9999, then it looks for holes. If it find no holes, that is no more numbers are available, it gives an error.

For example, if when we get to State_0010.state there is already a State_0010.state file in the current directory, it advances the counter to State_0011.state to ensure that no conflict will exist (and then it verifies that State_0011.state also does not exist in the current directory and advances again if it does, and so forth).

If you enter a file name for a given file type, then the prefix becomes the filename you entered instead of the default prefix, followed by an underscore. The last four letters (the suffix) are the 4-digit number.

For example, if you save a measurement results file as “fred.csv”, then the next auto file name chosen for a measurement results save will be fred_0000.csv.

NOTE

Although 0000 is used in the example above, the number that is used is actually the current number in the Meas Results sequence, that is, the number that would have been used if you had not entered your own file name.

NOTE

If the filename you entered ends with _dddd, where d=any number, making it look just like an auto file name, then the next auto file name picks up where you left off with the suffix being dddd + 1.

Key Path	Front-panel key
Notes	No remote command for this key specifically.
Initial S/W Revision	Prior to A.02.00

Recall

The Recall menu lets you choose what you want to recall, and where you want to recall it from. Among the types of files you can recall are **States and Traces**. In addition, an Import (Data) option lets you recall a number of data types stored in CSV files (as used by Excel and other spreadsheet programs).

The default paths for Recall are data type dependent and are the same as for the Save key.

Key Path	Front-panel key
Notes	<p>No remote command for this key specifically, but the :MMEM:LOAD command is available for specific file types. An example is :MMEM:LOAD:STATE <filename>.</p> <p>If you try to recall a State file for a mode that is not licensed or not available in the instrument, an error message will occur and the state will not change.</p>
Backwards Compatibility Notes	<p>In legacy analyzers, it was possible to load a state without affecting the trace data, limit lines or correction data. Similarly (since User Preset is actually loading a state), it was possible to do a User Preset without affecting the trace data, limit lines or correction data.</p> <p>In the X-Series, “state” always includes all of this data; so whenever state is loaded, all of the traces, limit lines and corrections are affected. Although this differs from previous behavior, it is desirable behavior, and should not cause adverse issues for users.</p>
Backwards Compatibility Notes	<p>Recall for the X-Series supports backward compatibility in the sense that you can recall a state file from any X-Series model number and any version of X-Series software. This is only possible if part of the recalling process goes through a limiting step after recalling the mode settings, at least for settings that may vary with version number, model number, option and license differences. If you try to recall a state file onto an instrument with less capability than what was available on the instrument during the save, the recall will ignore the state it doesn't support and it will limit the recalled setting to what it allows.</p> <p>Example: if the saved state includes preamp ON, but the recalling instrument does not have a preamp; the preamp is limited to OFF. Conversely, if you save a state without a preamp, the preamp is OFF in the state file. When this saved file is recalled on an instrument with a licensed preamp, the preamp is changed to OFF. Another example is if the saved state has center frequency set to 20 GHz, but the instrument recalling the saved state is a different model and only supports 13.5 GHz. In this case, the center frequency is limited along with any other frequency based settings. Since the center frequency can't be preserved in this case, the recall limiting tries to at least preserve span to keep the measurement setup as intact as possible.</p> <p>It may be appropriate to issue a warning if the state is limited on the recall; warnings do not go out to SCPI so this would only affect the manual user.</p> <p>Note that there is no state file compatibility outside of the X-Series. For example, you cannot recall a state file from ESA or PSA.</p>
Initial S/W Revision	Prior to A.02.00

State

The Recall State menu lets you choose a register or file from which to recall the state.

The content of a state file includes all of the settings and data required to return the analyzer as closely as possible to the Mode it was in, with the exact settings that were in place, when the save occurred. The Mode settings in each state file include the settings that are affected by Mode Preset, as well as the

additional settings affected by Restore Mode Defaults; all of the Mode’s settings. In addition, all of the settings of the Input/Output system are included, even though they are outside of the Mode’s state, because they are needed to restore the complete setup. Persistent System settings (for example, GPIB address) are not affected by either a Mode Preset or Restore Mode Defaults, nor are they included in a saved State file.

Since each state file is only for one Mode, the settings for other Modes are unaffected when it is loaded. Recall State will cause a mode switch if the state being recalled is not from the current active mode.

After the recall completes, the message "File <filename> recalled" or “Recalled State Register <register number>” is displayed.

For rapid recalls, the State menu lists 16 registers that you can choose from to recall. Pressing a Register key initiates the recall. You can also select a file from which to recall.

The default path for all State Files is:

My Documents\<mode name>\state

where <mode name> is the parameter used to select the mode with the INST:SEL command (for example, SA for the Spectrum Analyzer).

See "[More Information](#)" on page 2037.

Key Path	Recall
Mode	All
Remote Command	:MMEMory:LOAD:STATe <filename>
Example	:MMEM:LOAD:STAT "myState.state" This recalls the file myState.state on the default path
Example	MMEM:LOAD:STAT "MyStateFile.state" This loads the state file data (on the default file directory path) into the instrument state.
Notes	<p>When you pick a file to recall, the analyzer first verifies that the file is recallable in the current instrument by checking the software version and model number of the instrument. If everything matches, a full recall proceeds by aborting the currently running measurement, clearing any pending operations, and then loading the State from the saved state file. You can open state files from any mode, so recalling a State file switches to the mode that was active when the save occurred. After switching to the mode of the saved state file, mode settings and data (if any for the mode) are loaded with values from the saved file. The saved measurement of the mode becomes the newly active measurement and the data relevant to the measurement (if there is any) is recalled.</p> <p>If there is a mismatch between file version or model number or instrument version or model number, the recall function tries to recall as much as possible and returns a warning message. It may limit settings that differ based on model number, licensing or version number.</p> <p>After recalling the state, the Recall State function does the following:</p> <ul style="list-style-type: none"> • Makes the saved measurement for the mode the active measurement. • Clears the input and output buffers. • Status Byte is set to 0. • Executes a *CLS <p>If the file specified is empty an error is generated. If the specified file does not exist, another error is generated. If there is a mismatch between the file and the proper file type, an error is generated. If</p>

	there is a mismatch between file version or model number or instrument version or model number, a warning is displayed. Then it returns to the State menu and File Open dialog goes away. After the Recall, the analyzer exits the Recall menu and returns to the previous menu.
Backwards Compatibility SCPI	:MMEMory:LOAD:STATe 1,<filename> For backwards compatibility, the above syntax is supported. The "1" is simply ignored.
Initial S/W Revision	Prior to A.02.00

More Information

In measurements that support saving Traces, for example, Swept SA, the Trace data is saved along with the State in the State file. When recalling the State, the Trace data is recalled as well. Traces are recalled exactly as they were stored, including the writing mode and update and display modes. If a Trace was updating and visible when the State was saved, it will come back updating and visible, and its data will be rewritten right away. When you use State to save and recall traces, any trace whose data must be preserved should be placed in View or Blank mode before saving.

The following table describes the Trace Save and Recall possibilities:

You want to recall state and one trace's data, leaving other traces unaffected.	Save Trace+State from 1 trace. Make sure that no other traces are updating (they should all be in View or Blank mode) when the save is performed.	On Recall, specify the trace you want to load the one trace's data into. This trace will load in View. All other traces' data will be unaffected, although their trace mode will be as it was when the state save was performed.
You want to recall all traces	Save Trace+State from ALL traces.	On Recall, all traces will come back in View (or Blank if they were in Blank or Background when saved)
You want all traces to load exactly as they were when saved.	Save State	On recall, all traces' mode and data will be exactly as they were when saved. Any traces that were updating will have their data immediately overwritten.

From File...

When you press "From File", the analyzer brings up a Windows dialog and a menu entitled "File Open." This menu allows you to navigate to the various fields in the Windows dialog without using a keyboard or mouse. The Tab and Arrow keys can also be used for dialog navigation.

16 Monitor Spectrum Measurement Recall

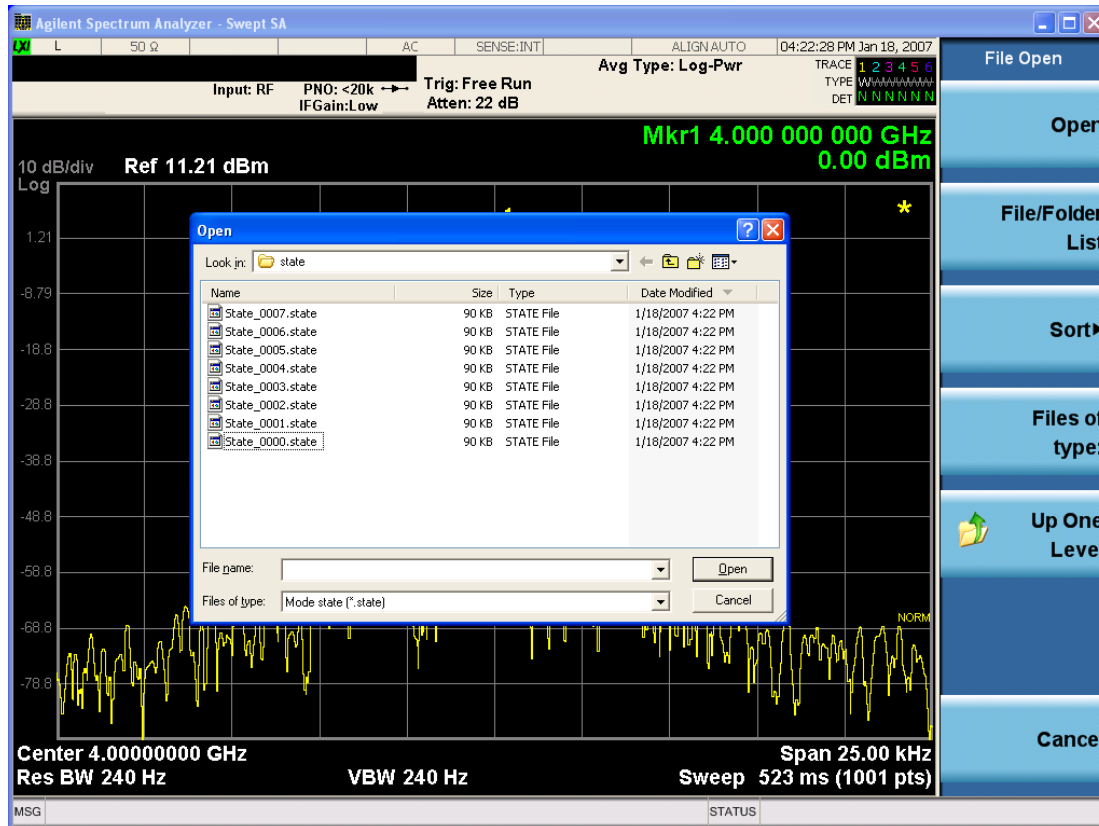

Listed below are the functions of the various fields in the dialog, and the corresponding softkeys:

Open

Performs the recall of the specified file. While the recall is being performed, the floppy icon appears briefly in the Meas bar.

File/Folder List

Enables you to navigate to the center of the dialog that contains the list of files and folders. Once here you can get information about the file and use the tab keys to navigate to the other fields in the dialog, such as Look In.

Look In

The Look In field shows the path from which the file will be recalled and allows you to change the path using the up and down arrow keys to navigate to other paths; the Enter key to open a directory; and the Backspace key to go back one directory. The **Look In field** first uses the last path from the Save As dialog **Save In:** path for that same file type. There is no softkey for directly navigating to the Look In field, but you can use the left tab to get here from the File/Folder List.

User specified paths are remembered when you leave and return to a Mode and are reset back to the default using Restore Mode Defaults.

Sort

Accesses a menu that enables you to sort the files within the File Open dialog. Only one sorting type can be selected at a time and the sorting happens immediately. The sorting types are By Date, By Name, By extension, and By Size.

Files of Type

This field shows the file suffix for the type of file you have selected to recall. For example, if you navigated here while recalling State, "Mode state (*.state)" is in the field. If you navigated here while recalling Trace, ""Mode state (*.trace)" is in the field. If you navigated here while importing a trace data file, "Trace Data (*.csv)" is in the field. For some file types, there is more than one choice in the dropdown menu, which you can select by using the up and down arrow keys and Enter.

Up One Level

This key corresponds to the icon of a folder with the up arrow that is in the tool bar of the dialog. When pressed, it causes the file and folder list to navigate up one level in the directory structure. The Backspace key does the same thing.

Cancel

This key corresponds to the Cancel selection in the dialog. It causes the current **Open** request to be cancelled. The ESC key does the same thing.

Key Path	Recall, State
Notes	Brings up the Open dialog for recalling a State Save Type
Initial S/W Revision	Prior to A.02.00

Edit Register Names

You may enter a custom name on any of the Register keys, to help you remember what you are using that state to save. To do this, press the Edit Register Names key, choose the register whose name you wish to edit, and then enter the desired label using the Alpha Editor or an external PC keyboard.

The maximum number of characters that can be added is 30. In most cases, 30 characters will fit on two lines of the key.

For more information and the SCPI command, see Edit Register Names under the Save, State function.

Key Path	Recall, State
Mode	All
Dependencies	N9060A-7FP or N9060B-2FP license required to edit the register names. When the feature is not licensed, sending the SCPI command generates an error, -221, "Settings conflict;Option not available"
Initial S/W Revision	A.11.00

Register 1 thru Register 16

Selecting any one of these register keys causes the State of the mode from the specified Register to be recalled. Each of the register keys annotates whether it is empty or at what date and time it was last

modified. In addition, you can use the Edit Register Names key under Save, State to enter custom names for each register.

Registers are shared by all modes, so recalling from any one of the registers will cause a mode switch to the mode that was active when the save to the Register occurred.

Although these 16 registers are the only registers available from the front panel, there are 128 state registers available in the instrument. Registers 17–128 are only available from the SCPI interface, using the *RCL command.

After the recall completes, the message "Register <register number> recalled" appears in the message bar. If you are in the Spectrum Analyzer Mode, and you are recalling a register that was saved in the Spectrum Analyzer Mode, then after the recall, you will still be in the Recall Register menu. If the Recall causes you to switch modes, then after the Recall, you will be in the Frequency menu.

If a requested register is empty an error is generated.

Key Path	Recall, State
Example	*RCL 1
Range	1–16 from front panel, 1–128 from SCPI
Readback	Date and time with seconds resolution are displayed on the key OR A custom name of up to 30 characters entered using the Save, State, Edit Register Names key OR “(empty)” if no prior save operation has been performed to this register.
Initial S/W Revision	Prior to A.02.00
Modified at S/W Revision	Prior to A.11.00

Register 1 thru Register 16

Selecting any one of these register keys causes the State of the mode from the specified Register to be recalled. Each of the register keys annotates whether it is empty or at what date and time it was last modified. In addition, you can use the Edit Register Names key under Save, State to enter custom names for each register.

Registers are shared by all modes, so recalling from any one of the registers will cause a mode switch to the mode that was active when the save to the Register occurred.

Although these 16 registers are the only registers available from the front panel, there are 128 state registers available in the instrument. Registers 17–128 are only available from the SCPI interface, using the *RCL command.

After the recall completes, the message "Register <register number> recalled" appears in the message bar. If you are in the Spectrum Analyzer Mode, and you are recalling a register that was saved in the Spectrum Analyzer Mode, then after the recall, you will still be in the Recall Register menu. If the Recall causes you to switch modes, then after the Recall, you will be in the Frequency menu.

If a requested register is empty an error is generated.

Key Path	Recall, State
Example	*RCL 1
Range	1–16 from front panel, 1–128 from SCPI
Readback	Date and time with seconds resolution are displayed on the key OR A custom name of up to 30 characters entered using the Save, State,Edit Register Names key OR “(empty)” if no prior save operation has been performed to this register.
Initial S/W Revision	Prior to A.02.00
Modified at S/W Revision	Prior to A.11.00

Data (Import)

Importing a data file loads data that was previously saved from the current measurement or from other measurements and/or modes that produce compatible data files. The Import Menu only contains Data Types that are supported by the current measurement.

Since the commonly exported data files are in .csv format, the data can be edited by the user prior to importing. This allows you to export a data file, manipulate the data in Excel (the most common PC Application for manipulating .csv files) and then import it.

Importing Data loads measurement data from the specified file into the specified or default destination, depending on the data type selected. Selecting an Import Data menu key will not actually cause the importing to occur, since the analyzer still needs to know from where to get the data. Pressing the Open key in this menu brings up the Open dialog and Open menu that provides you with the options from where to recall the data. Once a filename has been selected or entered in the Open menu, the recall occurs as soon as the Open button is pressed.

Key Path	Recall
Mode	All
Notes	The menu is built from whatever data types are available for the mode. Some keys will be missing completely, so the key locations in the sub-menu will vary. No SCPI command directly controls the Data Type that this key controls. The Data Type is included in the MMEM:LOAD commands.
Dependencies	If a file type is not used by a certain measurement, it is grayed out for that measurement. The key for a file type will not show at all if there are no measurements in the Mode that support it.
Preset	Is not affected by Preset or shutdown, but is reset during Restore Mode Defaults
Readback	The data type that is currently selected
Initial S/W Revision	Prior to A.02.00

Mask

Enables you to recall a preset mask file. This file type (.mask) differs from a normal “state” file because it contains the configuration for Carrier, Offset, and Limit for the specific preset profile BW. A brief description of the mask file is available in the properties view of each file. (Right-mouse-click on the file, select, "Properties" to view this information.) A detailed list of the mask parameter values is located in the .pdf file of the same name in the same directory. Blank values in the .pdf file are parameters that will not be overwritten when recalling the mask.

Key Path	Recall, Data
Mode	WIMAXOFDMA
Remote Command	:MMEMory:LOAD:MASK <string>
Example	:MMEM:LOAD:MASK "MyLimitFile.mask"
Notes	Set of parameters related to Limit, Carrier and Offset are overwritten by Preset Mask file.
Initial S/W Revision	A.02.00

This topic contains the following sections:

["File location and extension" on page 2042](#)

["Example of Preset Mask file" on page 2043](#)

File location and extension

File location: The preset mask file is located in “My Documents\WIMAXOFDMA\data\masks”.

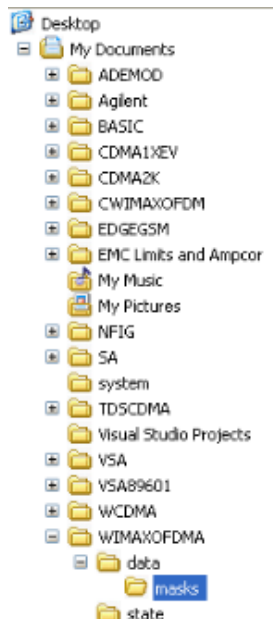

NOTE

When your X-Series analyzer starts, all mask files located in “My Documents\WIMAXOFDMA\data/masks” are overwritten, so any files you wish to save should be stored in another directory location.

File type: The file type is binary file.

File Name: The file name is decided by following naming rules. Each specific keyword is connected with underscore.

<Standard name>_<Radio device>_<Preset Profile BW>_<Measurement>.mask

<Standard name>: This term references the standard associated with each mask file.

<Radio device>: This term specifies to which radio device (BS or MS) the mask file pertains.

<Preset Profile BW>: This term specifies to which Preset Profile BW the mask file pertains.

<Measurement>: This term specifies the measurement to which the mask file is applied. Your selections are: SEM, ACP, or Mode. When selecting **Mode**, the values of some parameters in both the ACP and SEM measurement are overwritten.

File extension: The extension of preset mask file is “mask” to distinguish it from a “state” file.

When you press the open key under the Data menu, the “My Documents\WIMAXOFDMA\data\masks” folder is opened. Select one mask file.

NOTE

When you change the preset BW profile or Radio Device, all measurement parameters are reset to their original values. Thus you have to recall the appropriate preset mask file again after the change.

Example of Preset Mask file

When you import a preset mask file, it is a “Recall” function. Specific parameter values are overwritten by the contents of the preset mask file (see table below). Those values not specified by the preset mask file remain unchanged. Because the file format type is binary, you cannot view, change, or create the preset mask file. Here is an example of a preset mask file used for ACP measurements.

File Location: My Documents/WIMAXOFDMA/data/masks

File Name: ETSI-EN301-021-SysE_BS_10MHz_ACP.mask

The .pdf file that lists the parameters similarly to that shown below is named, "ETSI-EN301-021-SysE_BS_10MHz_ACP.pdf"

The set of parameters listed in the following table for the Preset Profile BW (10MHz) are imported into the ACP measurement.

Offset	Start Freq (MHz)	Stop Freq (MHz)	Sweep Time	Res BW (Hz)	Meas BW	Rel Start	Rel Stop	Fail Mask
A	5	7.14		30k	1	-8	-25	Rel
B	7.14	10.57		30k	1	-25	-27	Rel
C	10.57	20		30k	1	-27	-50	Rel
D	20	25		30k	1	-50	-50	Rel
E	25	30		30k	1	-50	-50	Rel

Zone Map

Pressing this key selects Zone Map as the data type to be imported.

The WiMAX-OFDMA application can load the Singal Studio Setup file, and the OFDMA Map file is compatible with the 89601A Mobile WiMAX omf file.

Key Path	Recall, Data
Remote Command	:MMEMory:LOAD:ZMAP <string>
Example	MMEM:LOAD:ZMAP "ZMap_0000.omf"
Notes	The SCPI parameter is a quoted string that specifies the filename. Both single and double quotes are supported for any filename parameter over SCPI.
Dependencies	You must be in the 802.16 OFDMA (WiMAX/WiBro) mode.
Status Bits/OPC dependencies	Sequential – waits for the previous measurement to complete.
Initial S/W Revision	Prior to A.02.00

Open...

When you press “Open”, the analyzer brings up a Windows dialog and a menu entitled “File Open.” This menu allows you to navigate to the various fields in the Windows dialog without using a keyboard or mouse. The Tab and Arrow keys can also be used for dialog navigation.

See "[From File...](#)" on page 2241 in Recall, State, for a full description of this dialog and menu.

Key Path	Recall, Data
Notes	The key location is mode-dependent and will vary. Brings up Open dialog for recalling a <mode specific> Save Type
Initial S/W Revision	Prior to A.02.00

Restart

The Restart function restarts the current sweep, or measurement, or set of averaged/held sweeps or measurements. If you are Paused, pressing Restart does a Resume.

The Restart function is accessed in several ways:

- Pressing the Restart key
- Sending the remote command INIT:IMMEDIATE
- Sending the remote command INIT:RESTART

See "[More Information](#)" on page 2045

Key Path	Front-panel key
Remote Command	:INITiate[:IMMEDIATE] :INITiate:RESTART
Example	:INIT:IMM :INIT:REST
Notes	:INITiate:RESTART and :INITiate:IMMEDIATE perform exactly the same function.
Couplings	Resets average/hold count k. For the first sweep overwrites all active (update=on) traces with new current data. For application modes, it resets other parameters as required by the measurement.
Status Bits/OPC dependencies	This is an Overlapped command. The STATUS:OPERation register bits 0 through 8 are cleared. The STATUS:QUESTIONable register bit 9 (INTEgrity sum) is cleared. The SWEEPING bit is set. The MEASURING bit is set.
Backwards Compatibility Notes	For Spectrum Analysis mode in ESA and PSA, the Restart hardkey and the INITiate:RESTART command restart trace averages (displayed average count reset to 1) for a trace in Clear Write, but did not restart Max Hold and Min Hold. In the X-Series, the Restart hardkey and the INITiate:RESTART command restart not only Trace Average, but MaxHold and MinHold traces as well. For wireless comms modes in ESA and PSA, the Restart hardkey and the INITiate:RESTART command restart every measurement, which includes all traces and numeric results. There is no change to this operation.
Initial S/W Revision	Prior to A.02.00

More Information

The **Restart** function first aborts the current sweep/measurement as quickly as possible. It then resets the sweep and trigger systems, sets up the measurement and initiates a new data measurement sequence with a new data acquisition (sweep) taken once the trigger condition is met.

If the analyzer is in the process of aligning when **Restart** is executed, the alignment finishes before the restart function is performed.

Even when set for Single operation, multiple sweeps may be taken when Restart is pressed (for example, when averaging/holding is on). Thus when we say that **Restart** "restarts a measurement," we may mean:

- It restarts the current sweep
- It restarts the current measurement
- It restarts the current set of sweeps if any trace is in Trace Average, Max Hold or Min Hold
- It restarts the current set of measurements if Averaging, or Max Hold, or Min Hold is on for the measurement
- depending on the current settings.

With **Average/Hold Number** (in **Meas Setup** menu) set to 1, or Averaging off, or no trace in Trace Average or Hold, a single sweep is equivalent to a single measurement. A single sweep is taken after the trigger condition is met; and the analyzer stops sweeping once that sweep has completed. However, with **Average/Hold Number** >1 and at least one trace set to **Trace Average, Max Hold, or Min Hold (SA Measurement)** or **Averaging on (most other measurements)**, multiple sweeps/data acquisitions are taken for a single measurement. The trigger condition must be met prior to each sweep. The sweep is stopped when the average count k equals the number N set for **Average/Hold Number**. A measurement average usually applies to all traces, marker results, and numeric results; but sometimes it only applies to the numeric results.

Once the full set of sweeps has been taken, the analyzer will go to idle state. To take one more sweep without resetting the average count, increment the average count by 1, by pressing the step up key while **Average/Hold Number** is the active function, or sending the remote command `CALC:AVER:TCON UP`.

Save

The Save menu lets you choose what you want to save and where you want to save it. Among the types of files you can save are **States**, **Traces**, and **Screen Images**. In addition, an Export (Data) option lets you save a number of data types as CSV files for easy import into Excel and other spreadsheet programs.

Key Path	Front-panel key
Mode	All
Notes	No remote command for this key specifically, but the :MMEM:STORe command is available for specific file types. An example is :MMEM:STOR:STATe <filename>.
Initial S/W Revision	Prior to A.02.00

State

The Save State menu lets you choose a register or file for saving the state.

The content of a state file includes all of the settings and data required to return the analyzer as closely as possible to the Mode it was in, with the exact settings which were in place, when the save occurred. The Mode settings in each state file include the settings that are affected by Mode Preset, as well as the additional settings affected by Restore Mode Defaults; all of the Mode's settings. In addition, all of the settings of the Input/Output system are included, even though they are outside of the Mode's state, because they are needed to restore the complete setup. Persistent System settings (for example, Verbose SCPI) are not affected by either Mode Preset or Restore Mode Defaults, nor are they included in a saved State file.

After the save completes, the message "File <filename> saved" or "State Register <register number> saved" is displayed.

For rapid saving, the State menu lists 16 registers to save to. Pressing a Register key initiates the save. You can also select a file to save to.

The default path for all State Files is:

My Documents\<>mode name>\state

where <mode name> is the parameter used to select the mode with the INST:SEL command (for example, SA for the Spectrum Analyzer).

Key Path	Save
Mode	All
Remote Command	:MMEMory:STORe:STATe <filename>
Example	MMEM:STOR:STATe "MyStateFile.state" This stores the current instrument state data in the file MyStateFile.state in the default directory.
Notes	Both single and double quotes are supported for any filename parameter over remote. After saving to a register, that register's menu key is updated with the date the time, unless a custom label has been entered for that key. After saving to a register, you remain in the Save State menu, so that you can see the Register key

update. After saving to a file, the analyzer automatically returns to the previous menu and any Save As dialog goes away.

Backwards Compatibility SCPI :MMEMory:STORe:STATe 1,<filename>

For backwards compatibility, the above syntax is supported. The "1" is simply ignored. The command is sequential.

Initial S/W Revision Prior to A.02.00

To File . . .

When you press “To File”, the analyzer brings up a Windows dialog and a menu entitled “Save As.” This menu allows you to navigate to the various fields in the Windows dialog without using a keyboard or mouse. The Tab and Arrow keys can also be used for dialog navigation.

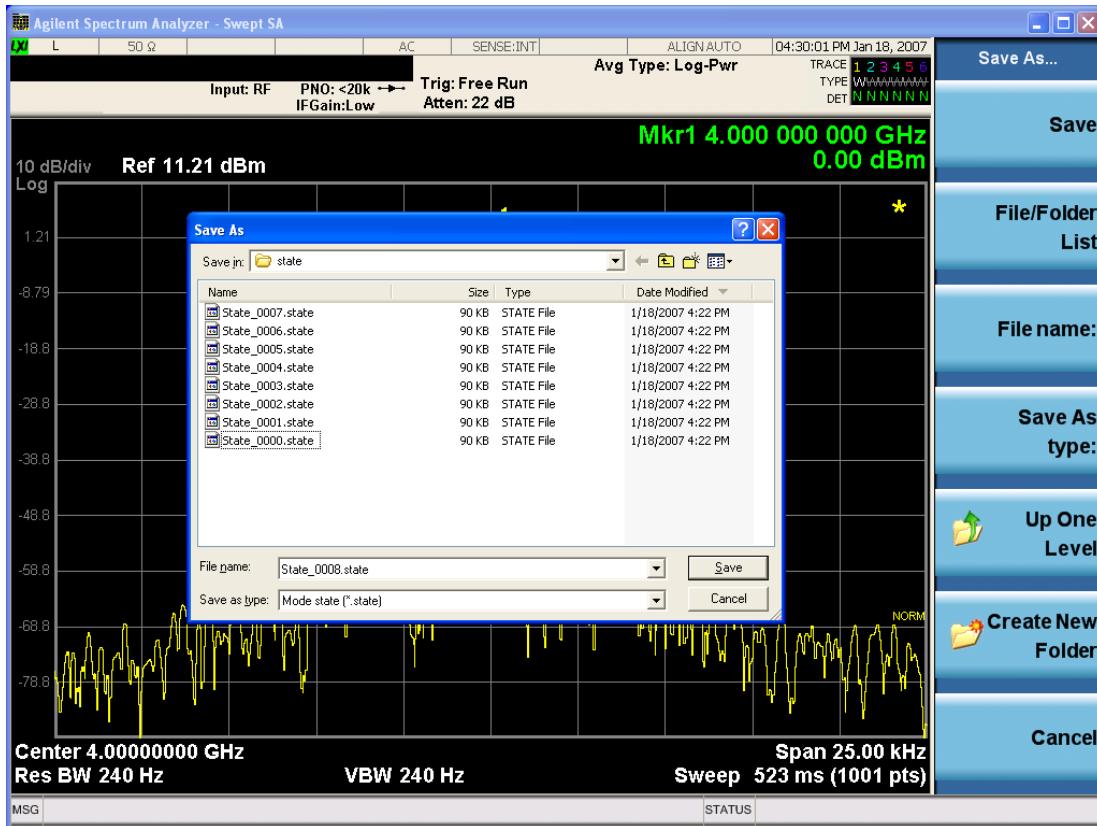

The Listed below

are the functions of the various fields in the dialog, and the corresponding softkeys:

Save

Performs the save to the specified file of the selected type. If the file already exists, a dialog will appear that allows you to replace the existing file by selecting OK, or you can Cancel the request. If you select OK, the file will be overwritten. Using the C: drive is strongly discouraged, since it runs the risk of being overwritten during an instrument software upgrade.

While the save is being performed, the floppy icon appears briefly in the Meas bar.

File/Folder List

Enables you to navigate to the center of the dialog that contains the list of files and folders. Once here you can get information about the file and use the tab keys to navigate to the other fields in the dialog, such as Save In.

Save In

The Save In field shows the path to which the file will be saved and allows you to change the path using the up and down arrow keys to navigate to other paths; the Enter key to open a directory; and the Backspace key to go back one directory. The **Save In field** defaults to the default path for this type of file and remembers the last path you used to save this type of file. There is no softkey for directly navigating to the Save In field but you can use left tab to get here from the File/Folder List.

User specified paths are remembered when you leave and return to a Mode and are reset back to the default using Restore Mode Defaults.

File Name

The File Name field is initially loaded with an automatically generated filename specific to the appropriate Save Type. The automatically generated filename is guaranteed not to conflict with any filename currently in the directory. You may replace or modify this filename using the File Name key. See the ["Quick Save " on page 2237](#) documentation for more on the automatic file naming algorithm.

When you press the File Name key the analyzer displays the Alpha Editor. Use the knob to choose the letter to add and the front-panel Enter key to add the letter to the file name. The BK character moves you back and the FW character moves you forward in the filename. The Select key on the front panel generates a space character. When you are done entering the filename press the Done softkey. This returns back to the **File Open** dialog and menu, but does not cause the save to occur.

Save As Type

This field shows the file suffix for the type of file you have selected to save. For example, if you navigated here while saving State, "Mode state (*.state)" is in the field. If you navigated here from saving Trace, ""Mode state (*.trace)" is in the field. If you navigated here while exporting a trace data file, "Trace Data (*.csv)" is in the field. For some file types, there is more than one choice in the dropdown, which you can select by using the up and down arrow keys and Enter.

Up One Level

This key corresponds to the icon of a folder with the up arrow that is in the tool bar of the dialog. When pressed, it causes the file and folder list to navigate up one level in the directory structure. The Backspace key does the same thing.

Create New Folder

This key corresponds to the icon of a folder with the "*" that is in the tool bar of the dialog. When pressed, a new folder is created in the current directory with the name **New Folder** and you can enter a new folder name using the Alpha Editor.

Cancel

This key corresponds to the Cancel selection in the dialog. It causes the current **Save As** request to be cancelled. The ESC key does the same thing.

Key Path	Save, State
Mode	All
Notes	Brings up Save As dialog for saving a State Save Type
Initial S/W Revision	Prior to A.02.00

Edit Register Names

You may enter a custom name on any of the Register keys, to help you remember what you are using that state to save. To do this, press the Edit Register Names key, choose the register whose name you wish to edit, and then enter the desired label using the Alpha Editor or an external PC keyboard.

The maximum number of characters that can be added is 30. In most cases, 30 characters will fit on two lines of the key.

See ["More Information" on page 2050](#)

Key Path	Save, State
Mode	All
Remote Command	:MMEMory:REGister:STATe:LABel <reg number>,"label" :MMEMory:REGister:STATe:LABel? <reg number>
Example	:MMEM:REG:STAT:LAB 1,"my label"
Notes	<reg number> is an integer from 1 to 16. If the SCPI specifies an invalid register number an error message is generated, -222,"Data out of range;Invalid register label number" "label" is a string from 0 to 30 characters in length. If a label exceeds 30 characters, an error message is generated, -150,"String data error;Label clipped to 30 characters" "label" of length 0 erases the custom label and restores the default (time and date) label. E.g.: :MMEM:REG:STAT:LAB 1,""
Dependencies	N9060A-7FP or N9060B-2FP license required to edit the register names. When the feature is not licensed, sending this command generates an error, -221,"Settings conflict;Option not available"
Preset	The names are unaffected by Preset or power cycle but are set to the default label (time and date) on a "Restore System Defaults->Misc"
Initial S/W Revision	A.11.00

More Information

When you edit one of the register names, the time and date field will be replaced by the custom name.

If you delete all the characters in the custom name, it restores the default (time and date).

The register names are stored within the state files, but they are not part of the instrument state; that is, once you have edited a register name, loading a new state will not change that register name. Another consequence of this is that the names will be persistent through a power cycle. Also, if a named state file is transferred to another analyzer, it will bring its custom name along with it.

If you try to edit the name of an empty register, the analyzer will first save the state to have a file to put the name in. If you load a named state file into an analyzer with older firmware it will ignore the metadata.

The *SAV and *RCL commands will not be affected by the custom register names, nor will the MMEM commands.

Register 1 thru Register 16

Selecting any one of these register menu keys causes the State of the currently active mode to be saved to the specified Register. The registers are provided for rapid saving and recalling, since you do not need to specify a filename or navigate to a file. Each of the register menu keys annotates whether it is empty or at what date and time it was last modified. In addition, you can use the Edit Register Names key to enter custom names for each register.

Although these 16 registers are the only registers available from the front panel, there are 128 state registers available in the instrument. Registers 17–128 are only available from the SCPI interface, using the *SAV command.

There is one set of 128 state registers in the instrument, not one set for each Mode. When a state is saved, the Mode it was saved from is saved with it; then when it is recalled, the instrument switches to that Mode.

After the save completes, the corresponding register menu key annotation is updated with the date and time and the message "Register <register number> saved" is displayed.

Key Path	Save, State
Mode	All
Example	*SAV 1
Range	1–16 from front panel, 1–128 from SCPI
Readback	Date and time with seconds resolution are displayed on the key OR A custom name of up to 30 characters entered using the Edit Register Names key OR “(empty)” if no prior save operation has been performed to this register.
Initial S/W Revision	Prior to A.02.00
Modified at S/W Revision	A.11.00

Register 1 thru Register 16

Selecting any one of these register menu keys causes the State of the currently active mode to be saved to the specified Register. The registers are provided for rapid saving and recalling, since you do not need to specify a filename or navigate to a file. Each of the register menu keys annotates whether it is empty or at what date and time it was last modified. In addition, you can use the Edit Register Names key to enter custom names for each register.

Although these 16 registers are the only registers available from the front panel, there are 128 state registers available in the instrument. Registers 17–128 are only available from the SCPI interface, using the *SAV command.

There is one set of 128 state registers in the instrument, not one set for each Mode. When a state is saved, the Mode it was saved from is saved with it; then when it is recalled, the instrument switches to that Mode.

After the save completes, the corresponding register menu key annotation is updated with the date and time and the message "Register <register number> saved" is displayed.

Key Path	Save, State
Mode	All
Example	*SAV 1
Range	1-16 from front panel, 1-128 from SCPI
Readback	Date and time with seconds resolution are displayed on the key OR A custom name of up to 30 characters entered using the Edit Register Names key OR “(empty)” if no prior save operation has been performed to this register.
Initial S/W Revision	Prior to A.02.00
Modified at S/W Revision	A.11.00

Data (Export)

Exporting a data file stores data from the current measurement to mass storage files. The Export Menu only contains data types that are supported by the current measurement.

Since the commonly exported data files are in .csv format, the data can be edited by you prior to importing. This allows you to export a data file, manipulate the data in Excel (the most common PC Application for manipulating .csv files) and then import it.

Selecting an Export Data menu key will not actually cause the exporting to occur, since the analyzer still needs to know where you wish to save the data. Pressing the Save As key in this menu brings up the Save As dialog and Save As menu that allows you to specify the destination file and directory. Once a filename has been selected or entered in the Open menu, the export will occur as soon as the Save key is pressed.

Key Path	Save
Mode	All
Notes	The menu is built from whatever data types are available for the mode. So the key locations in the sub menu will vary. No SCPI command directly controls the Data Type that this key controls. The Data Type is included in the MMEM:STORe commands.
Dependencies	If a file type is not used by a certain measurement, that type is grayed out for that measurement. The key for a file type will not show at all if there are no measurements in the Mode that support it.
Preset	Is not affected by a Preset or shutdown, but is reset during Restore Mode Defaults
Readback	The data type that is currently selected
Initial S/W Revision	Prior to A.02.00

Measurement Results

Pressing this key selects Meas Results as the data type to be exported. Pressing the key a second time brings up the Meas Results menu, which allows you to select which **Meas Result** to save. In the Swept SA measurement, there are three types of Measurement Results files: Peak Table, Marker Table and Spectrogram.

See "Meas Results File Contents" on page 2053.

See "Marker Table" on page 2053.

See "Peak Table" on page 2056.

See "Spectrogram" on page 2059

Remote Command	:MMEMory:STORe:RESults:MTABle PTABle SPEctrogram <filename>
Example	:MMEM:STOR:RES:MTAB "myResults.csv" Saves the results from the current marker table to the file myResults.csv in the current path. :MMEM:STOR:RES:PTAB "myResults.csv" Saves the results from the current peak table to the file myResults.csv in the current path. :MMEM:STOR:RES:SPEC "myResults.csv" Saves the results from the current Spectrogram display to the file myResults.csv in the current path. The default path is My Documents\SA\data\SAN\results
Notes	If the save is initiated via SCPI, and the file already exists, the file will be overwritten. Using the C: drive is strongly discouraged, since it runs the risk of being overwritten during an instrument software upgrade. Both single and double quotes are supported for any filename parameter over SCPI.
Dependencies	If a save of Marker Table results is requested and the Marker Table is not on, no file is saved and a message is generated If a save of Peak Table results is requested and the Peak Table is not on, no file is saved and a message is generated If a save of Spectrogram results is requested and the Spectrogram is not on, no file is saved and a message is generated. The Spectrogram choice only appears if option EDP is licensed.
Preset	Not part of Preset, but is reset to Peak Table by Restore Mode Defaults. Survives a shutdown.
Initial S/W Revision	Prior to A.02.00

Meas Results File Contents

All files are .csv files. The following section details the data in each file type.

Marker Table

This section discusses the Marker Table Meas Results file format.

Imagine that, at the point where a Marker Table Meas Result is requested, the following screen is showing:

16 Monitor Spectrum Measurement
Save

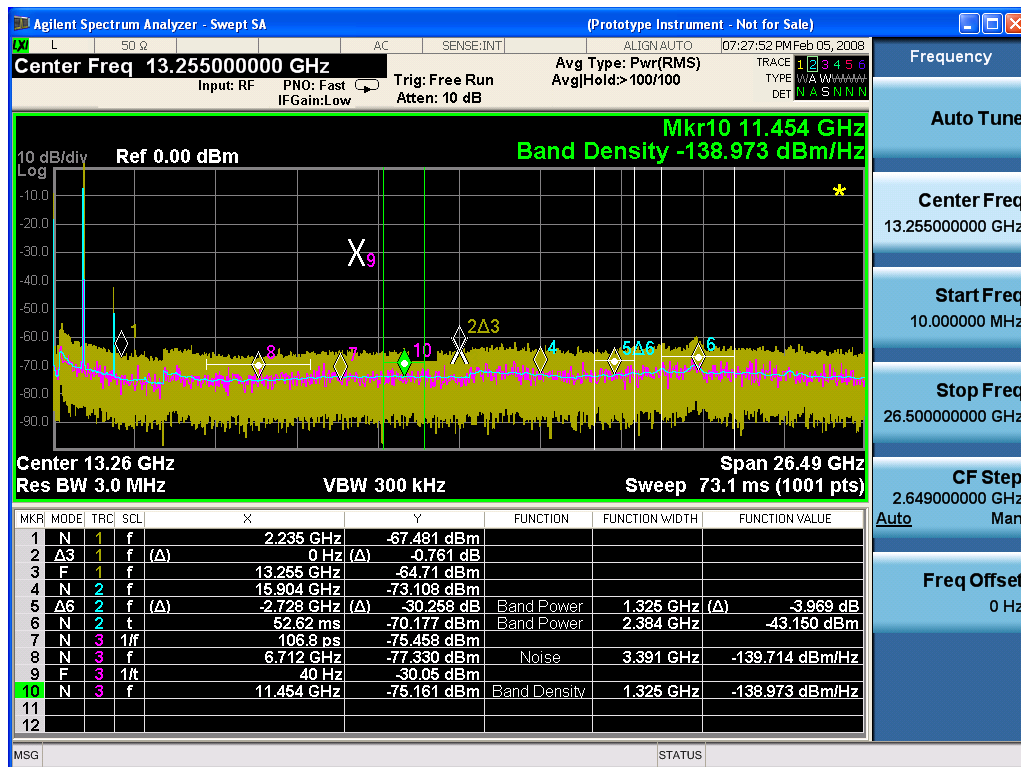

Then the Meas Results file, when opened, would show the following data:

MeasurementResult	
Swept SA	
A.01.40_R0017	N9020A
526 B25 PFR	1
P26 EA3	
Result Type	Marker Table
Ref Level	0
Number of Points	1001
Sweep Time	0.0662666 67
Start Frequency	10000000
Stop Frequency	26500000 000
Average Count	0
Average Type	LogPower (Video)
RBW	3000000

RBW Filter	Gaussian
RBW Filter BW	3dB
VBW	3000000
Sweep Type	Swept
X Axis Scale	Lin
PreAmp State	Off
PreAmp Band	Low
Trigger Source	Free
Trigger Level	1.2
Trigger Slope	Positive
Trigger Delay	1.00E-06
Phase Noise Optimization	Fast
Swept If Gain	Low
FFT If Gain	Autorange
RF Coupling	AC
FFT Width	411900
Ext Ref	10000000
Input	RF
RF Calibrator	Off
Attenuation	10
Ref Level Offset	0
External Gain	0
X Axis Units	Hz
Y Axis Units	dBm

DATA									
MKR	MODE	TR C	SCL	X	Y	FUNCTI ON	FUNCTIO N WIDTH	FUNCTI ON VALUE	FUNCTI ON UNIT
1	Normal	1	Freque ncy	2.2350E+09	- 67.481	Off	0.0000E+00	0	None
2	Delta3	1	Freque ncy	0.0000E+00	- 0.761	Off	0.0000E+00	0	None
3	Fixed	1	Freque ncy	1.3255E+10	- 64.71	Off	0.0000E+00	0	None
4	Normal	2	Freque ncy	1.5904E+10	- 73.1	Off	0.0000E+00	0	None

08									
5	Delta7	2	Frequ ncy	- 2.7280E+ 09	- 30.2 58	Band Power	1.3250E+ 06	-3.969	dB
6	Normal	2	Time	5.2620E- 02	- 70.1 77	Band Power	2.3840E+ 06	-43.15	dBm
7	Normal	3	Period	1.0680E- 10	- 75.4 58	Off	0.0000E+ 00	0	None
8	Normal	3	Frequ ncy	6.7120E+ 09	- 77.3 3	Noise	3.3910E+ 06	- 139.71 4	dBm/Hz
9	Fixed	3	Inverse Time	4.0000E+ 01	- 30.0 5	Off	0.0000E+ 00	0	None
10	Normal	3	Frequ ncy	1.1454E+ 10	- 75.1 61	Band Density	1.3250E+ 06	- 138.97 3	dBm/Hz
11	Off	1	Frequ ncy	0.0000E+ 00	0	Off	0.0000E+ 00	0	None
12	Off	1	Frequ ncy	0.0000E+ 00	0	Off	0.0000E+ 00	0	None

The numbers appear in the file exactly as they appear onscreen. If it says 11.454 GHz onscreen, then in the file it is 11.454E+09.

The metadata header is very similar to the metadata used in the trace data .csv files. See Trace File Contents. The only new information concerns the 1-of-N fields in the marker table itself.

Peak Table

This section discusses the Peak Table Meas Results file format.

Imagine that, at the point where a Marker Table Meas Result is requested, the following screen is showing:

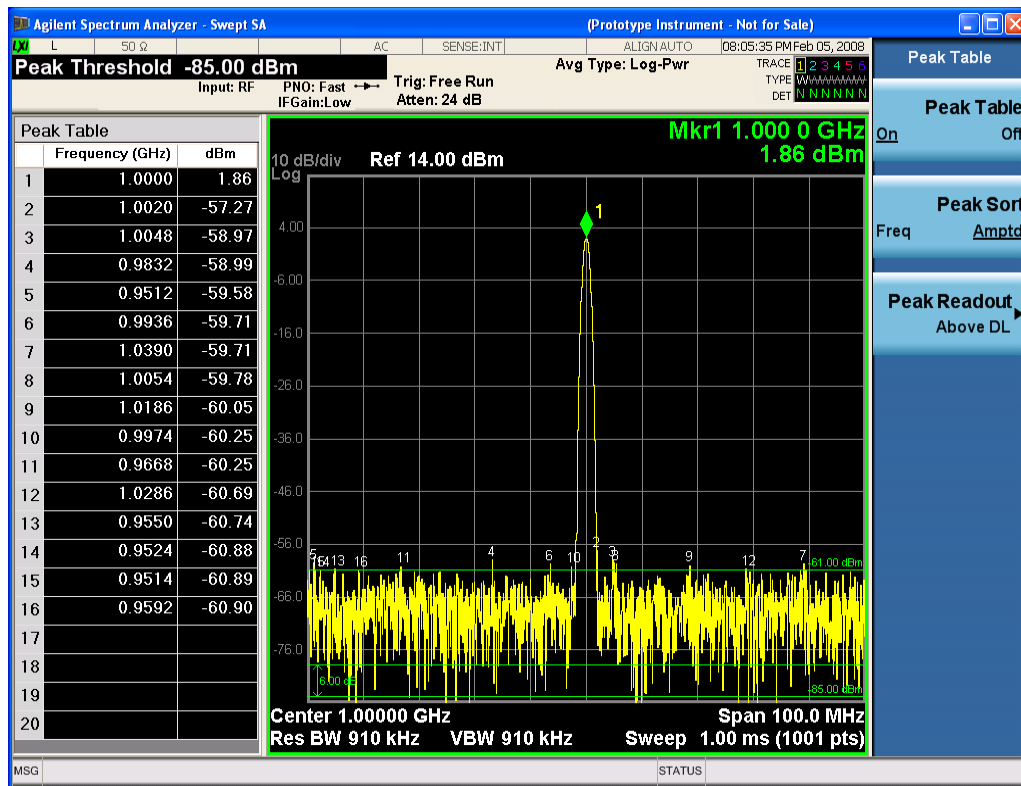

Then the Meas Results file, when opened, would show the header data (the same as for the Marker Table except that the Result Type is Peak Table) ending with a few fields of specific interest to Peak Table users:

- Peak Threshold
- Peak Threshold State (On|Off)
- Peak Excursion
- Peak Excursion State (On|Off)
- Display Line
- Peak Readout (All|AboveDL|BelowDL)
- Peak Sort (Freq|Amptd)

These fields are then followed by the data for the Peak Table itself.

Note that the label for the Frequency column changes to Time in 0 span.

Here is what the table for the above display looks like:

MeasurementResult	
Swept SA	
A.01.40_R0017	N9020A
526 B25 PFR P26 EA3	1

Result Type	Peak Table
Ref Level	0
Number of Points	1001
Sweep Time	0.066266667
Start Frequency	10000000
Stop Frequency	26500000000
Average Count	0
Average Type	LogPower(Video)
RBW	3000000
RBW Filter	Gaussian
RBW Filter BW	3dB
VBW	3000000
Sweep Type	Swept
X Axis Scale	Lin
PreAmp State	Off
PreAmp Band	Low
Trigger Source	Free
Trigger Level	1.2
Trigger Slope	Positive
Trigger Delay	1.00E-06
Phase Noise Optimization	Fast
Swept If Gain	Low
FFT If Gain	Autorange
RF Coupling	AC
FFT Width	411900
Ext Ref	10000000
Input	RF
RF Calibrator	Off
Attenuation	10
Ref Level Offset	0
External Gain	0
X Axis Units	Hz
Y Axis Units	dBm
Peak Threshold	-85
Peak Threshold State	On
Peak Excursion	6
Peak Excursion State	On

Display Line	-61	
Peak Readout	AboveDL	
Peak Sort	Amptd	
DATA		
Peak	Frequency	Amplitude
1	1.0000E+06	1.86
2	1.0020E+06	-57.27
3	1.0048E+06	-58.97
4	9.8320E+05	-58.99
5	9.5120E+05	-59.58
6	9.9360E+05	-59.71
7	1.0390E+06	-59.71
8	1.0054E+06	-59.78
9	1.1086E+06	-60.05
10	9.9740E+05	-60.25
11	9.6680E+05	-60.25
12	1.0286E+06	-60.69
13	9.5500E+05	-60.74
14	9.5240E+05	-60.88
15	9.5140E+05	-60.89
16	9.5920E+05	-60.90
17		
18		
19		
20		

Spectrogram

This section discusses the Spectrogram Results file format. The Spectrogram choice only appears if option EDP is licensed.

The Spectrogram results are the same as a Trace data export, except that instead of having just one trace's data, all 300 traces appear one after the other.

Each trace has its own data mark; the data for Spectrogram Trace 0 follows the row marked DATA, the data for Spectrogram Trace 1 follows the row marked DATA1, for Spectrogram Trace 2 follows the row marked DATA2, and so on.

Each DATA row has a timestamp in the second column (as of firmware revision A.11.01). So, for example, if Trace 0 had a relative start time of 1729.523 sec, then the first DATA row would look like this:

DATA,1729.523

And if Trace 13 had a relative start time of 100.45 sec, then the fourteenth data row would look like:

DATA13,100.453

To find the absolute time for the relative timestamps of each trace, the last row before the first DATA row gives the absolute start time of the Spectrogram, in the form YYYYMMDDHHMMSS

So, for example, if the absolute start time is 13:23:45:678 on January 30, 2012, this row would look like:

Start Time,20120130132345678

NOTE The resolution of the absolute time stored is 1 ms, which matches up with the fact that the fastest sweep time is also 1 ms. However, there is no specification for the absolute accuracy of the clock in the analyzer, nor is there any facility provided to allow the user to set this time to any particular degree of accuracy.

Traces that have not yet been filled in the Spectrogram display are empty; there is no DATA header for them. The file ends after the last non-empty trace.

Imagine that, at the point where a Spectrogram Meas Result is requested, the following screen is showing:

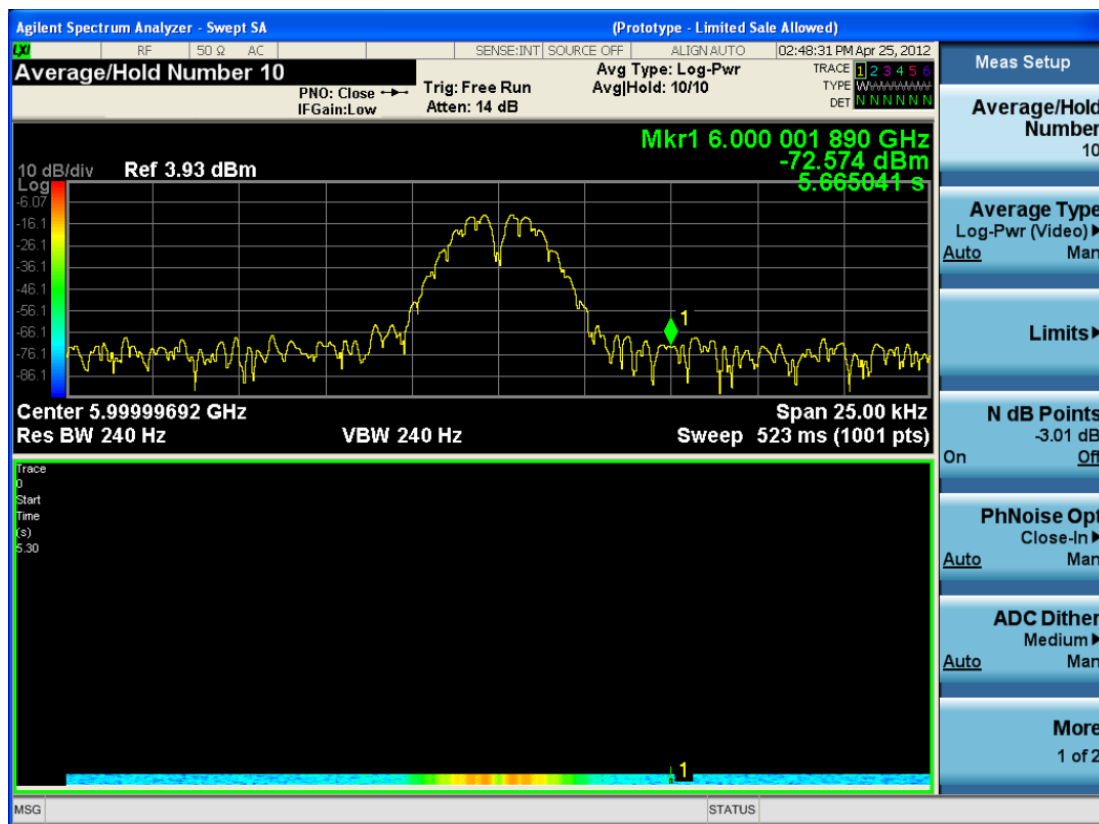

For the purpose of this example, we have set the Average/Hold Number to 10, thus we have only traces 0 thru 10. The Spectrogram was started at 02:28:08:700 pm on April 25, 2012 (that is, 700 ms after 2:28:08 pm), although the screen dump itself shows a different time, as it was taken ten minutes after the

Spectrogram data. Trace 0 is showing a start time of 5.30 seconds, meaning 5.3 seconds after the Spectrogram started (trace 10 has a start time of 0, as it was the first trace taken but has now rolled up into the tenth trace slot).

The Meas Results file, when opened, shows the header data and ten traces of trace data. Below is an extract from the result file for the above display. Note the start time of 20120425142808700 showing in the last row before the first DATA row, and the relative time of 5.299231048 showing in the first DATA row:

Result Type	Spectrogram
MeasResult	
Swept SA	
A.11.00.01	N9020A
503 508 513 526 ALL ALV B1C B1X B25 B2X B40 BAB BBA CR3 CRP DP2 DRD EA3 EDP EMC EP1 ERC ESC ESP EXM FSA HBA K03 LFE MPB P03 P08 P13 P26 PFR RTL RTS S40 SB1 SEC SM1 UK6 YAS YAV	1
Segment	0
Number of Points	1001
Sweep Time	0.523333333
Start Frequency	5999984415
Stop Frequency	6000009415
Average Count	0
Average Type	LogPower(Video)
RBW	240
RBW Filter	Gaussian
RBW Filter BW	3dB
VBW	240
Sweep Type	Swept
X Axis Scale	Lin
PreAmp State	Off
PreAmp Band	Low
Trigger Source	Free
Trigger Level	1.2
Trigger Slope	Positive
Trigger Delay	0
Phase Noise Optimization	Wide
Swept If Gain	Low
FFT If Gain	Autorange
RF Coupling	AC

Result Type	Spectrogram
FFT Width	411900
Ext Ref	10000000
Input	RF
RF Calibrator	Off
Attenuation	14
Ref Level Offset	0
External Gain	0
Trace Type	Clearwrite
Detector	Normal
Trace Math	Off
Trace Math Oper1	Trace5
Trace Math Oper2	Trace6
Trace Math Offset	0
Trace Name	Trace1
X Axis Units	Hz
Y Axis Units	dBm
Start Time	20120425142808700
DATA	5.299231048
5999984415	-76.34749519
5999984440	-77.28097006
5999984465	-75.32317869
5999984490	-73.64417681
5999984515	-72.67154604

o
o
o

6000009315	-77.94423277
6000009340	-79.51829697
6000009365	-78.46108961
6000009390	-78.46108957
6000009415	-76.59570596
DATA2	4.708697055
5999984415	-80.98197882
5999984440	-80.98197879

5999984465	-75.83142132
5999984490	-74.02712079
5999984515	-73.57213005

- o
- o
- o

6000009315	-75.9183103
6000009340	-79.53787488
6000009365	-78.82602191
6000009390	-78.82602188
6000009415	-76.37486709
DATA10	0
5999984415	-75.56751112
5999984440	-75.76485645
5999984465	-76.67718717
5999984490	-78.79238489
5999984515	-83.72680212

- o
- o
- o

6000009315	-71.3942461
6000009340	-72.28308332
6000009365	-73.92684489
6000009390	-75.45548832
6000009415	-75.17904815

Zone Map

Pressing this key selects Zone Map as the data type to be exported.

The Zone Map file contains information about current Zone Map configuration. Its format is compatible with the 89601A OFDMA map file. It is detailed in ["Zone Map File Contents" on page 2064](#) below.

Key Path	Save, Data
Remote Command	:MMEMory:STORe:ZMAP <string>
Example	MMEM:STOR:ZMAP "ZMap_0000.omf"
Notes	<p>If the save is initiated via SCPI and the file already exists, the file will be overwritten.</p> <p>The SCPI command exports Zone Map information to the file specified as the parameter in the current path. The default path is My Documents\WIMAXOFDMA\.</p> <p>Using the C: drive is strongly discouraged, since it runs the risk of being overwritten during an instrument software upgrade.</p> <p>The SCPI parameter is a quoted string that specifies the filename. Both single and double quotes are supported for any filename parameter over SCPI.</p>
Dependencies	You must be in the 802.16 OFDMA (WiMAX/WiBro) mode.
Status Bits/OPC dependencies	Sequential – waits for the previous measurement to complete.
Initial S/W Revision	Prior to A.02.00

Zone Map File Contents

A Zone Map File contains the following information of the Zone Map configuration. See ["Zone Map Data" on page 329](#) for detailed definitions.

- DemodOfdmaMap_AutoDetect
- DemodOfdmaMap_Count
- DemodOfdmaMap_F1_DL_Count
- DemodOfdmaMap_F1_DL_Z1_Active
- DemodOfdmaMap_F1_DL_Z1_AmcType
- DemodOfdmaMap_F1_DL_Z1_B1_Active
- DemodOfdmaMap_F1_DL_Z1_B1_AllocType
- DemodOfdmaMap_F1_DL_Z1_B1_Boost
- DemodOfdmaMap_F1_DL_Z1_B1_BurstType
- DemodOfdmaMap_F1_DL_Z1_B1_ColorIndex
- DemodOfdmaMap_F1_DL_Z1_B1_ModType
- DemodOfdmaMap_F1_DL_Z1_B1_Name
- DemodOfdmaMap_F1_DL_Z1_B1_SubchannelInterval
- DemodOfdmaMap_F1_DL_Z1_B1_SubchannelOffset
- DemodOfdmaMap_F1_DL_Z1_B1_SymbolInterval
- DemodOfdmaMap_F1_DL_Z1_B1_SymbolOffset

- DemodOfdmaMap_F1_DL_Z1_Count
- DemodOfdmaMap_F1_DL_Z1_DedicPilots
- DemodOfdmaMap_F1_DL_Z1_IDCell
- DemodOfdmaMap_F1_DL_Z1_IDCellCouple
- DemodOfdmaMap_F1_DL_Z1_Len
- DemodOfdmaMap_F1_DL_Z1_Locked
- DemodOfdmaMap_F1_DL_Z1_Name
- DemodOfdmaMap_F1_DL_Z1_PrbsID
- DemodOfdmaMap_F1_DL_Z1_StcMatrix
- DemodOfdmaMap_F1_DL_Z1_StcType
- DemodOfdmaMap_F1_DL_Z1_SymOffset
- DemodOfdmaMap_F1_DL_Z1_UseAllSC
- DemodOfdmaMap_F1_DL_Z1_WrapType
- DemodOfdmaMap_F1_DL_Z1_ZoneType
- DemodOfdmaMap_F1_UL_Count
- DemodOfdmaMap_F1_UL_Z1_Active
- DemodOfdmaMap_F1_UL_Z1_AmcType
- DemodOfdmaMap_F1_UL_Z1_B1_Active
- DemodOfdmaMap_F1_UL_Z1_B1_AllocType
- DemodOfdmaMap_F1_UL_Z1_B1_Boost
- DemodOfdmaMap_F1_UL_Z1_B1_BurstType
- DemodOfdmaMap_F1_UL_Z1_B1_ColorIndex
- DemodOfdmaMap_F1_UL_Z1_B1_ModType
- DemodOfdmaMap_F1_UL_Z1_B1_Name
- DemodOfdmaMap_F1_UL_Z1_B1_PilotPattern
- DemodOfdmaMap_F1_UL_Z1_B1_StcMode
- DemodOfdmaMap_F1_UL_Z1_B1_SubchannelInterval
- DemodOfdmaMap_F1_UL_Z1_B1_SubchannelOffset
- DemodOfdmaMap_F1_UL_Z1_B1_SymbolInterval
- DemodOfdmaMap_F1_UL_Z1_B1_SymbolOffset
- DemodOfdmaMap_F1_UL_Z1_Count

- DemodOfdmaMap_F1_UL_Z1_Gap
- DemodOfdmaMap_F1_UL_Z1_IDCell
- DemodOfdmaMap_F1_UL_Z1_Len
- DemodOfdmaMap_F1_UL_Z1_Locked
- DemodOfdmaMap_F1_UL_Z1_Name
- DemodOfdmaMap_F1_UL_Z1_SymOffset
- DemodOfdmaMap_F1_UL_Z1_UseSubchRotate
- DemodOfdmaMap_F1_UL_Z1_WrapType
- DemodOfdmaMap_F1_UL_Z1_ZoneType
- DemodOfdmaMap_Name
- DemodOfdmaMap_RefreshMap

Save As . . .

When you press “Save As”, the analyzer brings up a Windows dialog and a menu entitled “**Save As.**” This menu allows you to navigate to the various fields in the Windows dialog without using a keyboard or mouse. The Tab and Arrow keys can also be used for dialog navigation.

See "[To File . . .](#)" on page 2252 in Save, State for a full description of this dialog and menu.

The default path for saving files is:

For all of the Trace Data Files:

My Documents\`<mode name>`\data\traces

For all of the Limit Data Files:

My Documents\`<mode name>`\data\limits

For all of the Measurement Results Data Files:

My Documents\`<mode name>`\data\`<measurement name>`\results

For all of the Capture Buffer Data Files:

My Documents\`<mode name>`\data\captureBuffer

Key Path	Save, Data
Mode	All
Notes	The key location is mode-dependent and will vary. Brings up the Save As dialog for saving a <code><mode specific></code> Save Type. The save is performed immediately and does not wait until the measurement is complete.
Initial S/W Revision	Prior to A.02.00

Screen Image

Pressing Screen Image accesses a menu of functions that enable you to specify a format and location for the saved screen image. It brings up a menu that allows you to specify the color scheme of the Screen Image (Themes) or navigate to the Save As dialog to perform the actual save.

Screen Image files contain an exact representation of the analyzer display. They cannot be loaded back onto the analyzer, but they can be loaded into your PC for use in many popular applications.

The image to be saved is actually captured when the Save front panel key is pressed, and kept in temporary storage to be used if you ask for a Screen Image save. When the Screen Image key is pressed, a "thumbnail" of the captured image is displayed, as shown below:

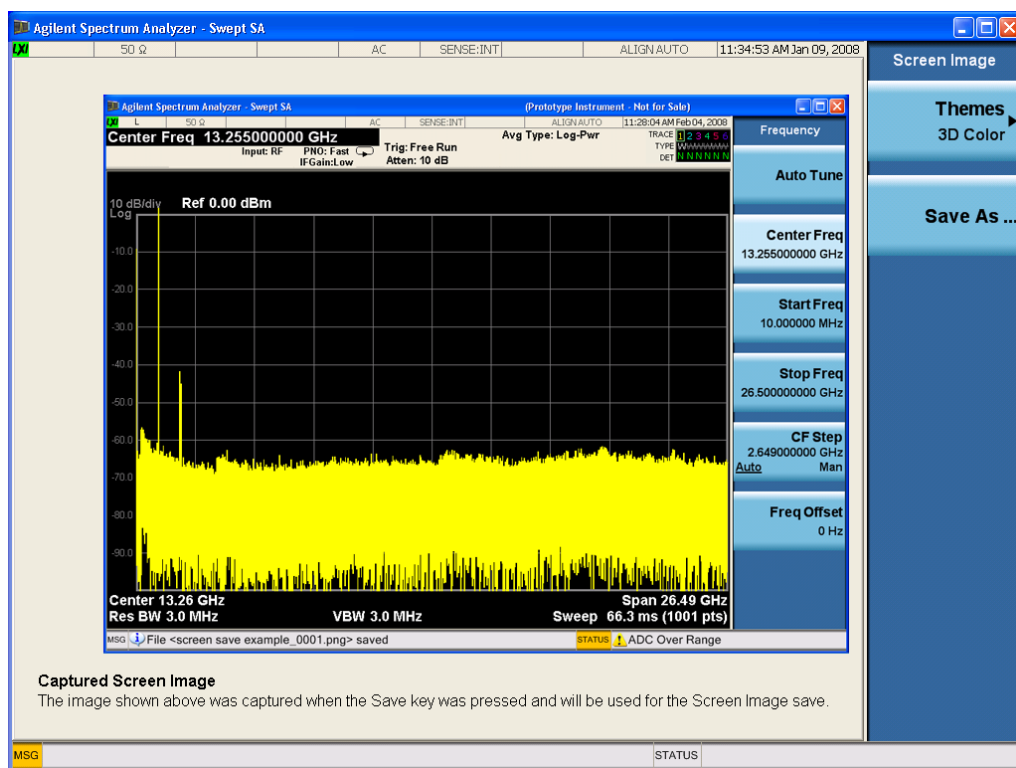

When you continue on into the Save As menu and complete the Screen Image save, the image depicted in the thumbnail is the one that gets saved, showing the menus that were on the screen before going into the Save menus. The save is performed immediately and does not wait until the measurement is complete.

After you have completed the save, the Quick Save front-panel key lets you quickly repeat the last save performed, using an auto-named file, with the current screen data.

NOTE

For versions previous to A.01.55, if you initiate a screen image save by navigating through the Save menus, the image that is saved will contain the Save menu softkeys, not the menus and the active function that were on the screen when you first pressed the Save front panel key.

Key Path	Save
Mode	All

Remote Command	:MMEMory:STORe:SCReen <filename>
Example	:MMEM:STOR:SCR "myScreen.png" This stores the current screen image in the file MyScreenFile.png in the default directory.
Initial S/W Revision	Prior to A.02.00

Themes

Accesses a menu of functions that enable you to choose the theme to be used when saving the screen image.

The **Themes** option is the same as the **Themes** option under the **Display** and **Page Setup** dialogs. It allows you to choose between themes to be used when saving the screen image.

Key Path	Save, Screen Image
Remote Command	:MMEMory:STORe:SCReen:THEMe TDColor TDMonochrome FCOLor FMONochrome :MMEMory:STORe:SCReen:THEMe?
Example	:MMEM:STOR:SCR:THEM TDM
Preset	3D Color; Is not part of Preset, but is reset by Restore Misc Defaults or Restore System Defaults All and survives subsequent running of the modes.
Readback	3D Color 3D Mono Flat Color Flat Mono
Backwards Compatibility Notes	In ESA and PSA we offer the choice of "Reverse Bitmap" or "Reverse Metafile" when saving screen images. This is much like the "Flat Color" theme available in X-Series. Also, if you selected Reverse Bitmap AND a black & white screen image, that would be much like "Flat Monochrome". In other words, each of the X-Series themes has a similar screen image type in ESA/PSA. But they are not identical.
Initial S/W Revision	Prior to A.02.00

3D Color

Selects a standard color theme with each object filled, shaded and colored as designed.

Key Path	Save, Screen Image, Themes
Example	MMEM:STOR:SCR:THEM TDC
Readback	3D Color
Initial S/W Revision	Prior to A.02.00

3D Monochrome

Selects a format that is like 3D color but shades of gray are used instead of colors.

Key Path	Save, Screen Image, Themes
Example	MMEM:STOR:SCR:THEM TDM
Readback	3D Mono
Initial S/W Revision	Prior to A.02.00

Flat Color

Selects a format that is best when the screen is to be printed on an ink printer.

Key Path	Save, Screen Image, Themes
Example	MMEM:STOR:SCR:THEM FCOL
Readback	Flat Color
Initial S/W Revision	Prior to A.02.00

Flat Monochrome

Selects a format that is like Flat Color. But only black is used (no colors, not even gray), and no fill.

Key Path	Save, Screen Image, Themes
Example	MMEM:STOR:SCR:THEM FMON
Readback	Flat Mono
Initial S/W Revision	Prior to A.02.00

Save As...

When you press "Save As", the analyzer brings up a Windows dialog and a menu entitled "**Save As.**" This menu allows you to navigate to the various fields in the Windows dialog without using a keyboard or mouse. The Tab and Arrow keys can also be used for dialog navigation.

See "[To File . . .](#)" on page 2252 in Save, State for a full description of this dialog and menu.

The default path for Screen Images is

My Documents\`<mode name>`\screen.

where `<mode name>` is the parameter used to select the mode with the INST:SEL command (for example, SA for the Spectrum Analyzer).

Key Path	Save, Screen Image
Notes	Brings up Save As dialog for saving a Screen Image Save Type
Initial S/W Revision	Prior to A.02.00

Mass Storage Catalog (Remote Command Only)

Key path	SCPI Only
Remote Command	:MMEMory:CATalog? [<directory_name>]
Notes	<p>The string must be a valid logical path.</p> <p>Queries disk usage information (drive capacity, free space available) and obtains a list of files and directories in a specified directory in the following format: <numeric_value>,<numeric_value>,{<file_entry>}</p> <p>It returns two numeric parameters and as many strings as there are files and directories. The first parameter indicates the total amount of storage currently used in bytes. The second parameter indicates the total amount of storage available, also in bytes. The <file_entry> is a string. Each <file_entry> indicates the name, type, and size of one file in the directory list: <file_name>,<file_type>,<file_size></p> <p>As the windows file system has an extension that indicates file type, <file_type> is always empty. <file_size> provides the size of the file in bytes. For directories, <file_entry> is surrounded by square brackets and both <file_type> and <file_size> are empty</p>
Initial S/W Revision	Prior to A.02.00

Mass Storage Change Directory (Remote Command Only)

Key path	SCPI Only
Remote Command	:MMEMory:CDIRectory [<directory_name>] :MMEMory:CDIRectory?
Notes	<p>The string must be a valid logical path.</p> <p>Changes the default directory for a mass memory file system. The <directory_name> parameter is a string. If no parameter is specified, the directory is set to the *RST value.</p> <p>At *RST, this value is set to the default user data storage area, that is defined as System.Environment.SpecialFolder.Personal.</p> <p>Query returns full path of the default directory.</p>
Initial S/W Revision	Prior to A.02.00

Mass Storage Copy (Remote Command Only)

Key path	SCPI Only
Remote Command	:MMEMory:COPY <string>,<string>[,<string>,<string>]
Notes	<p>The string must be a valid logical path.</p> <p>Copies an existing file to a new file or an existing directory to a new directory.</p> <p>Two forms of parameters are allowed. The first form has two parameters. In this form, the first parameter specifies the source, and the second parameter specifies the destination.</p> <p>The second form has four parameters. In this form, the first and third parameters specify the source. The second and fourth parameters specify the directories. The first pair of parameters specifies the</p>

source. The second pair specifies the destination. An error is generated if the source doesn't exist or the destination file already exists.

This command will generate an "access denied" error if the destination is a restricted folder (e.g., C:\Windows) and the current user does not have Power User or Administrator privileges.

Mass Storage Device Copy (Remote Command Only)

This command transfers data to/from a file and a peripheral device.

Key path	SCPI Only
Remote Command	:MMEMory:COpy:DEvice <source_string>,<dest_string>
Notes	<p>The strings must be a valid logical path or a valid device keyword. If the dest_string is a device keyword, the data is copied from the source file to the device. If the source_string is a device keyword, the data is copied to the source file from the device.</p> <p>Valid device keywords are:</p> <p>SNS (smart noise source)</p> <p>An error is generated if the file or device is not found.</p>

Mass Storage Delete (Remote Command Only)

Key path	SCPI Only
Remote Command	:MMEMory:DElete <file_name>[,<directory_name>]
Notes	<p>The string must be a valid logical path.</p> <p>Removes a file from the specified directory. The <file_name> parameter specifies the file name to be removed. This command will generate an "access denied" error if the file is in a restricted folder (e.g., C:\Windows) and the current user does not have Power User or Administrator privileges.</p>
Initial S/W Revision	Prior to A.02.00

Mass Storage Data (Remote Command Only)

Creates a file containing the specified data OR queries the data from an existing file.

Key path	SCPI Only
Remote Command	<p>:MMEMory:DATA <file_name>,<data></p> <p>:MMEMory:DATA? <file_name></p>
Notes	<p>The string must be a valid logical path.</p> <p>The command form is MMEMory:DATA <file_name>,<data>. It loads <data> into the file <file_name>. <data> is in 488.2 block format. <file_name> is string data.</p> <p>The query form is MMEMory:DATA? <file_name> with the response being the associated <data> in block format.</p>
Initial S/W Revision	Prior to A.02.00

Mass Storage Make Directory (Remote Command Only)

Key path	SCPI Only
Remote Command	:MMEMory:MDIRectory <directory_name>
Notes	The string must be a valid logical path. Creates a new directory. The <directory_name> parameter specifies the name to be created. This command will generate an “access denied” error if the new directory would be in a restricted folder (e.g., C:\Windows) and the current user does not have Power User or Administrator privileges.
Initial S/W Revision	Prior to A.02.00

Mass Storage Move (Remote Command Only)

Key path	SCPI Only
Remote Command	:MMEMory:MOVE <string>,<string>[,<string>,<string>]
Notes	The string must be a valid logical path. Moves an existing file to a new file or an existing directory to a new directory. Two forms of parameters are allowed. The first form has two parameters. In this form, the first parameter specifies the source, and the second parameter specifies the destination. The second form has four parameters. In this form, the first and third parameters specify the source. The second and fourth parameters specify the directories. The first pair of parameters specifies the source. The second pair specifies the destination. An error is generated if the source doesn't exist or the destination file already exists. This command will generate an “access denied” error if the destination is a restricted folder (e.g., C:\Windows) and the current user does not have Power User or Administrator privileges.
Initial S/W Revision	Prior to A.02.00

Mass Storage Remove Directory (Remote Command Only)

Key path	SCPI Only
Remote Command	:MMEMory:RDIRectory <directory_name>
Notes	The string must be a valid logical path. Removes a directory. The <directory_name> parameter specifies the directory name to be removed. All files and directories under the specified directory shall also be removed. This command will generate an “access denied” error if the folder is a restricted folder (e.g., C:\Windows) or is in a restricted folder and the current user does not have Power User or Administrator privileges.
Initial S/W Revision	Prior to A.02.00

Single (Single Measurement/Sweep)

Sets the analyzer for Single measurement operation. The single/continuous state is Meas Global, so the setting will affect all the measurements. If you are Paused, pressing Single does a Resume.

See ["More Information" on page 2073](#)

Key Path	Front-panel key
Example	:INIT:CONT OFF
Notes	See Cont key description.
Backwards Compatibility Notes	<p>For Spectrum Analysis mode in ESA and PSA, the Single hardkey and the INITiate:IMM switched from continuous measurement to single measurement and restarted sweeps and averages (displayed average count reset to 1), but did not restart Max Hold and Min Hold. In the X-Series, the Single hardkey and the INITiate:IMM command initiate a sweep/ measurement/ average sequence/hold sequence including MaxHold and MinHold.</p> <p>For Spectrum Analysis mode in ESA and PSA, the Single hardkey restarted the sweep regardless of whether or not you were in an active sweep or sweep sequence. In the X-Series, Restart does this but Single only restarts the sweep or sweep sequence if you are in the idle state.</p> <p>INIT[:IMM] in ESA & PSA Spectrum Analysis Mode does an implied ABORT. In some other PSA Modes, INIT[:IMM] is ignored if not in the idle state. . The X-Series follows the ESA/PSA SA Mode model, which may cause some Modes to have compatibility problems.</p>
Initial S/W Revision	Prior to A.02.00

More Information

See ["Restart" on page 2249](#) for details on the INIT:IMMEDIATE (Restart) function.

If you are already in single sweep, the INIT:CONT OFF command has no effect.

If you are already in Single Sweep, then pressing the Single key in the middle of a sweep does not restart the sweep or sequence. Similarly, pressing the Single key does not restart the sweep or sequence if the sweep is not in the idle state (for example, if you are taking a very slow sweep, or the analyzer is waiting for a trigger). Instead, it results in a message. "Already in Single, press Restart to initiate a new sweep or sequence". Even though pressing the Single key in the middle of a sweep does not restart the sweep, sending INIT:IMMEDIATE does reset it.

To take one more sweep without resetting the average count, increment the average count by 1, by pressing the step up key while **Average/Hold Number** is the active function, or sending the remote command CALC:AVER:TCON UP.

Source

There is no Source control functionality for this measurement. When this key is pressed, the screen either displays a blank menu, or the previously-selected menu remains unchanged.

Key Path	Front-panel key
----------	-----------------

Span X Scale

Accesses a menu of functions that enable you to set the horizontal scale parameters.

Key Path	Front-panel key
Initial S/W Revision	Prior to A.02.00

Span

Changes the frequency range symmetrically about the center frequency.

For details of WiDEN preset values, see ["IDEN Mode Span Preset for Monitor Spectrum" on page 2076](#).

Key Path	Span X Scale
Mode	All except SA, BASIC
Remote Command	[:SENSe] :MONitor:FREQuency:SPAN <freq> [:SENSe] :MONitor:FREQuency:SPAN?
Example	MON:FREQ:SPAN 1 MHz MON:FREQ:SPAN?
Couplings	Changing the span causes the resolution bandwidth to change automatically, and affects data acquisition time.
Preset	WCDMA: 10.0 MHz WIMAX OFDMA: 50.0 MHz C2K: 2.5MHz PN: 1.0 MHz GSM/EDGE: 1.0 MHz TD-SCDMA: 3.2 MHz 1xEVDO: 2.0MHz DVB-T/H: 10.0MHz DTMB (CTTB): 10.0MHz ISDB-T: 10.0MHz CMMB: 10.0MHz LTE: 50 MHz LTETDD: 50 MHz IDEN: See the table below Digital Cable TV: 10.0MHz WLAN: If Radio Std is 802.11a/b/g 802.11n(20MHz) 802.11ac(20MHz): 25 MHz If Radio Std is 802.11n(40MHz), 802.11 ac (40MHz): 50 MHz If Radio Std is 802.11ac(80MHz): 100MHz If Radio Std is 802.11ac(160MHz): 200MHz

	MSR: 20.0 MHz LTEAFDD, LTEATDD: 20.0MHz
State Saved	Saved in instrument state.
Min	10 Hz
Max	Hardware Dependent: Option 503 = 3.7 GHz Option 507 = 7.1GHz Option 508 = 8.5 GHz Option 513 = 13.8 GHz Option 526 = 27.0 GHz
Initial S/W Revision	Prior to A.02.00
Modified at S/W Revision	A.02.00
Modified at S/W Revision	A.03.00

IDEN Mode Span Preset for Monitor Spectrum

iDEN Slot Format	WiDEN Slot Format 25kHz	WiDEN Slot Format 50kHz	WiDEN Slot Format 75kHz	WiDEN Slot Format 100kHz	WiDEN Slot Format 50kHz Out
60kHz	60kHz	85kHz	110kHz	135kHz	135kHz

Full Span

Changes the Span to show the full frequency range of the analyzer.

Key Path	Span X Scale
Mode	All except SA and BASIC
Remote Command	[:SENSe] :MONitor:FREQuency:SPAN:FULL
Example	MON:FREQ:SPAN:FULL
Couplings	Sets the span to the full frequency range, and adjusts the center frequency accordingly.
Initial S/W Revision	Prior to A.02.00

Last Span

Changes the measurement span to the span setting of the previous measurement. If there is no existing previous span value, then the span remains unchanged.

Key Path	Span X Scale
----------	--------------

Mode	All except SA and BASIC
Remote Command	[:SENSe] :MONitor :FREQuency :SPAN :PREVious
Example	MON:FREQ:SPAN:PREV
Couplings	Selecting last span changes the measurement span value.
Initial S/W Revision	Prior to A.02.00

Sweep/Control

Access a menu of functions that enable you to set up and control the sweep time for the current measurement

Key Path	Front-panel key
Initial S/W Revision	Prior to A.02.00

Sweep Time

Selects the length of time in which the spectrum analyzer sweeps the displayed frequency span. Additional overhead time is required by the analyzer. It impacts the sweep rate, but is not calculated as part of the sweep time. Reducing the sweep time increases the rate of sweeps.

Key Path	Sweep/Control
Mode	All except SA and BASIC
Remote Command	[:SENSe]:MONitor:SWEep:TIME <time> [:SENSe]:MONitor:SWEep:TIME? [:SENSe]:MONitor:SWEep:TIME:AUTO OFF ON 0 1 [:SENSe]:MONitor:SWEep:TIME:AUTO?
Example	MON:SWE:TIME 100 ms MON:SWE:TIME? MON:SWE:TIME:AUTO ON MON:SWE:TIME:AUTO?
Preset	Automatically Calculated
State Saved	Saved in instrument state.
Min	1 ms
Max	4000 s
Initial S/W Revision	Prior to A.02.00
MIN/MAX/DEF Support	Yes

Pause

Pauses a measurement after the current data acquisition is complete.

When Paused, the label on the key changes to Resume. Pressing Resume continues the measurement at the point where it had been paused.

See "[Pause/Resume](#)" on page 2282 under Sweep/Control for more information.

Key Path	Sweep/Control
Initial S/W Revision	Prior to A.02.00

Gate

Accesses a menu that enables you to control the gating function. The Gate functionality is used to view signals best viewed by qualifying them with other events.

Gate setup parameters are the same for all measurements – they do not change as you change measurements. Settings like these are called “Meas Global” and are unaffected by Meas Preset.

Note that Sweep Time autocoupling rules and annotation are changed by Gate being on.

Key Path	Sweep/Control
Scope	Meas Global
Readback	The state and method of Gate, as [Off, LO] or [On, Video]. Note that for measurements that only support gated LO, the method is nonetheless read back, but always as LO.
Initial S/W Revision	Prior to A.02.00

Gate On/Off

Turns the gate function on and off.

When the Gate Function is on, the selected Gate Method is used along with the gate settings and the signal at the gate source to control the sweep and video system with the gate signal. Not all measurements allow every type of Gate Methods.

When Gate is on, the annunciation in the measurement bar reflects that it is on and what method is used, as seen in the following "Gate: LO" annunciator graphic.

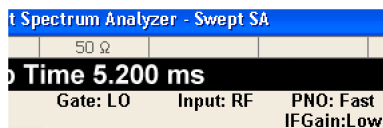

Key Path	Sweep/Control, Gate
Remote Command	[:SENSe] :SWEep:EGATe [:STATe] OFF ON 0 1 [:SENSe] :SWEep:EGATe [:STATe] ?
Example	SWE:EGAT ON SWE:EGAT?
Dependencies	The function is unavailable (grayed out) and Off when:

- Gate Method is LO or Video and FFT Sweep Type is manually selected.
- Gate Method is FFT and Swept Sweep Type is manually selected.
- Marker Count is ON.

The following are unavailable whenever Gate is on:

- FFT under Sweep Type when Method=LO or Video or Swept under Sweep Type when Method=FFT
- Marker Count

While Gate is on, the Auto Rules for Sweep Type are modified so that the choice agrees with the Gate Method: i.e., FFT for Method = FFT and Swept for Method = LO or Video.

The Gate softkey and all SCPI under the [:SENSe]:SWEep:EGATe SCPI node are grayed out when Source Mode is Tracking with an external source. This is because the Gate circuitry is used to sync the external source. If the Tracking Source is turned on, the Gate is turned off.

When in the ACP measurement:

- When Meas Method is RBW or FAST, this function is unavailable and the key is grayed out.
- Whenever Gate is on, Meas Method, RBW or FAST is unavailable and keys for those are grayed out.
- When Gate is on, Offset Res BW and Offset Video BW are ignored (if you set these values) and the measurement works as if all Offset Res BW and all Offset Video BW are coupled with the Res BW and the Video BW under the BW menu. When Gate is on, the Offset BW key in the Offset/Limit menu is grayed out.

Preset	Off LTETDD: On
State Saved	Saved in instrument state
Range	On Off
Backwards Compatibility SCPI	[:SENSe]:SWEep:TIME:GATE[:STATe] ESA compatibility
Backwards Compatibility Notes	In ESA, Trig Delay (On) and Gate (On) could not be active at the same time.. This dependency does not exist in PSA or in the X-Series.
Initial S/W Revision	Prior to A.02.00

Gate View On/Off

Turning on Gate View in the Swept SA measurement provides a single-window gate view display..

Turning on Gate View in other measurements shows the split-screen Gate View. In these measurements, when the Gate View is on, the regular view of the current measurement traces and results are reduced vertically to about 70% of the regular height. The Zero Span window, showing the positions of the Gate, is shown between the Measurement Bar and the reduced measurement window. By reducing the height of the measurement window, some of the annotation on the Data Display may not fit and is not shown.

Key Path	Sweep/Control, Gate
Remote Command	[:SENSe]:SWEep:EGATe:VIEW ON OFF 1 0 [:SENSe]:SWEep:EGATe:VIEW?

Example	SWE:EGAT:VIEW ON turns on the gate view.
Dependencies	<p>In the Swept SA measurement:</p> <p>In Gate View, the regular Sweep Time key is grayed out . When pressed, the grayed out key puts up the informational message "Use Gate View Sweep Time in the Gate menu."</p> <p>In the other measurements:</p> <p>When you turn Gate View on, the lower window takes on the current state of the instrument. Upon leaving Gate View, the instrument takes on the state of the lower window.</p> <p>When you turn Gate View on, the upper window Sweep Time is set to the gate view sweep time.</p>
Couplings	<p>These couplings apply to the Swept SA measurement:</p> <ul style="list-style-type: none"> • When Gate View is turned on, the instrument is set to Zero Span. • Gate View automatically turns off whenever a Span other than Zero is selected. • Gate View automatically turns off if you press the Last Span key while in Gate View, and the instrument returns to the Span it was in before entering Gate View (even if that is Zero Span). • When Gate View is turned on, the sweep time used is the gate view sweep time. This is set according to the rules in section "Gate View Setup" on page 2083 • When Gate View is turned off, Sweep Time is set to the normal Swept SA measurement sweep time. • If Gate View is on and Gate is off, then turning on Gate turns off Gate View.
Preset	OFF
State Saved	Saved in instrument state
Range	On Off
Initial S/W Revision	Prior to A.02.00

A sample of the Gate View screen in the Swept SA measurement is shown in the following graphic :

16 Monitor Spectrum Measurement Sweep/Control

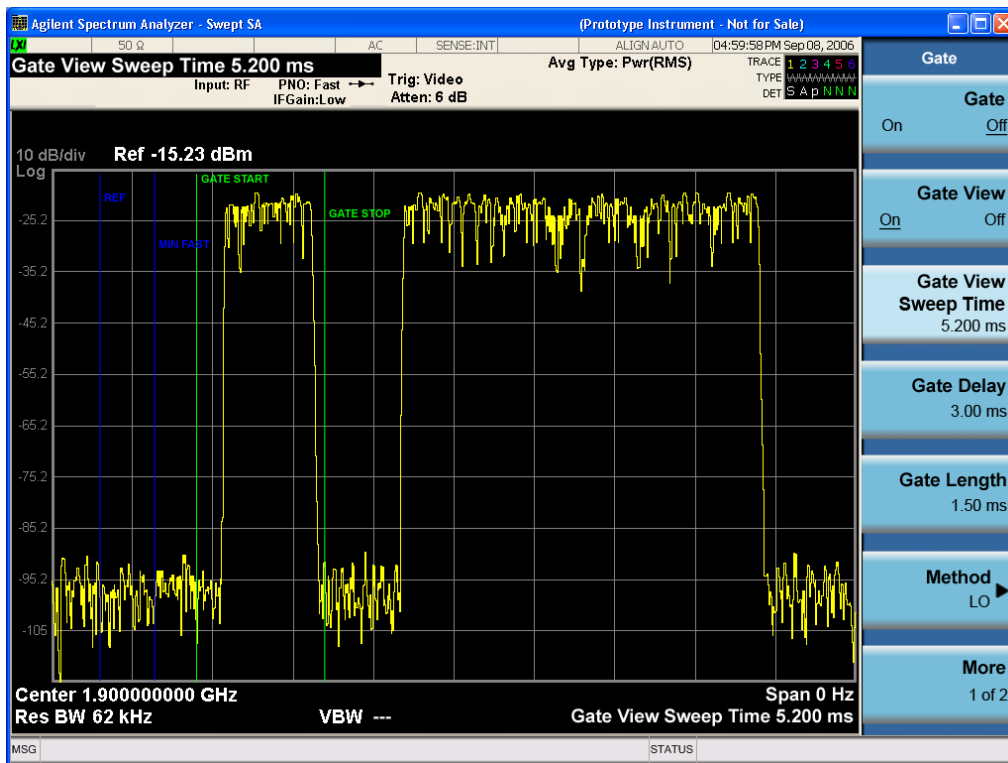

A sample of the Gate View screen in other measurements is shown in the following graphic. This example is for the ACP measurement:

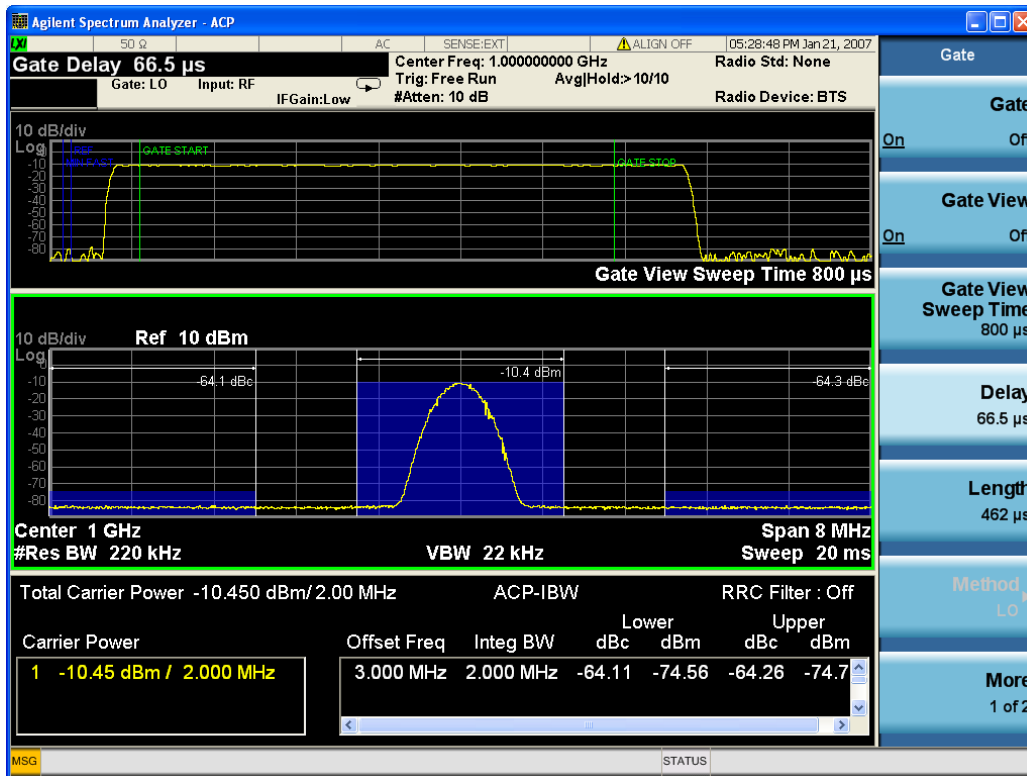

Turning Gate View off returns the analyzer to the Normal measurement view.

In the Swept SA, the normal measurement view is the single-window Swept SA view. When returning to this view, the Swept SA measurement returns to the Span it was in before entering **Gate View** (even if that is Zero Span).

The **Gate View** window is triggered from the Gate Source, with zero trigger delay. Also, when updating the **Gate View** window, the Gate itself must not operate. So it is internally shut off while the gate view window is being updated. For the Swept SA measurement, this means that the Gate is internally shut off whenever the gate view window is displayed. The measurement bar and softkeys continue to show the Trigger source for the main sweep window and give no indication that the Gate is shut off or that the Gate View window is triggered from the Gate Source.

When in **Gate View**, vertical lines are displayed in the Gate View window as follows:

- Green lines are displayed at the gate edges as follows: in Edge Gate, a line is shown for Delay and one for the end of the Gate period, defined by Length. In Level Gate a line is shown only for Delay. You can adjust the position of the green lines by adjusting the gate length and the gate delay. These lines update in the Gate View window as the active function changes, even if the window is not being updated. In Gated LO and Gated Video, these lines are positioned relative to the delay reference line (not relative to 0 time). In Gated FFT, their location is relative to the left edge of the screen.
- A blue line is displayed showing the delay reference, that is, the reference point for the Gate Delay within the Zero Span window. The blue line represents where (in time) the effective location of the gate start would be if the gate were programmed to zero delay.
-
- The second blue line is labeled "MIN FAST" as shown in the figure above because it represents the minimum Gate Delay for fast Gated LO operation. This line is only displayed in Gated LO. You cannot scroll (knob) or decrement (down key) the Gate Delay to less than that represented by the position of this line, it can only be set below this position manually, although once there it can be moved freely with the knob while below the line.
- A yellow line in the Gated Video case only, is displayed at Blength, where Blength is the display point (bucket) length for the swept trace, which is given by the sweep time for that trace divided by number of Points – 1. So it is referenced to 0 time, not to the delay reference. This line is labeled NEXT PT (it is not shown in the figure above because the figure above is for Gated LO).
- The yellow line represents the edge of a display point (bucket). Normally in Gated Video, the bucket length must be selected so that it exceeds the off time of the burst. There is another way to use the analyzer in Gated Video measurements, and that is to set the bucket width much shorter than the off time of the burst. Then use the Max Hold trace function to fill in "missing" buckets more slowly. This allows you to see some of the patterns of the Gated Video results earlier, though seeing a completely filled-in spectrum later.

Gate View Setup

Accesses a menu that enables you to setup parameters relevant to the Gate View

Key Path	Sweep/Control, Gate
Scope	Meas Global
Initial S/W Revision	A.10.00

Gate View Sweep Time

Controls the sweep time in the Gate View window. To provide an optimal view of the gate signal, the analyzer initializes Gate View Sweep Time based on the current settings of Gate Delay and Gate Length.

Key Path	Sweep/Control, Gate, Gate View Setup
Remote Command	[:SENSe] :SWEep:EGATe:TIME <time> [:SENSe] :SWEep:EGATe:TIME?
Example	SWE:EGAT:TIME 500 ms
Dependencies	Gate View Sweep Time is initialized: <ul style="list-style-type: none"> • On Preset (after initializing delay and length). • Every time the Gate Method is set/changed. <p>Additionally, in the Swept SA measurement, whenever you do a Preset, or leave Gate View, the analyzer remembers the Gate Delay and Gate Length settings. Then, when returning to Gate View, if the current Gate Delay and/or Gate Length do not match the remembered values Gate View Sweep Time is re-initialized.</p> <ol style="list-style-type: none"> 1. Compute the location of the "gate stop" line, which you know is at time $t = t_{min} + \text{GateDelay} + \text{GateLength}$.
Preset	519.3 μ s WiMAX OFDMA: 5 ms GSM/EDGE: 1 ms
State Saved	Saved in instrument state
Max	6000 s
Initial S/W Revision	Prior to A.02.00

Gate View Start Time

Controls the time at the left edge of the Gate View.

Key Path	Sweep/Control, Gate, Gate View Setup
Remote Command	[:SENSe] :SWEep:EGATe:VIEW:START <time> [:SENSe] :SWEep:EGATe:VIEW:START?
Example	SWE:EGAT:VIEW:STAR 10ms
Notes	Units of time are required or no units; otherwise an invalid suffix error message will be generated. See error -131.
Preset	0 ms
State Saved	Saved in instrument state
Min	0
Max	500 ms
Initial S/W Revision	A.10.00

Gate Delay

Controls the length of time from the time the gate condition goes True until the gate is turned on.

Key Path	Sweep/Control, Gate
Remote Command	[:SENSe] :SWEep:EGATe:DElAy <time> [:SENSe] :SWEep:EGATe:DElAy?
Example	SWE:EGAT:DElAy 500ms SWE:EGAT:DElAy?
Notes	Units of time are required or no units; otherwise an invalid suffix error message will be generated.
Preset	57.7 us WiMAX OFDMA: 71 us GSM/EDGE: 600 us WLAN: 500 us
State Saved	Saved in instrument state
Min	0.0 us
Max	100 s
Backwards Compatibility SCPI	[:SENSe] :SWEep:TIME:GATE:DElAy ESA compatibility
Initial S/W Revision	Prior to A.02.00

Gate Length

Controls the length of time that the gate is on after it opens.

Key Path	Sweep/Control, Gate
Remote Command	[:SENSe] :SWEep:EGATe:LENGth <time> [:SENSe] :SWEep:EGATe:LENGth?
Example	SWE:EGAT:LENG 1 SWE:EGAT:LENG?
Notes	Units of time are required or no units; otherwise an invalid suffix error message will be generated.
Dependencies	<p>Grayed out when Gate Method is set to FFT in which case the label changes to that shown below.</p>  <p>The key is also grayed out if Gate Control = Level.</p>
Preset	461.6 us

	WiMAX OFDMA: 50 us GSM/EDGE: 200 us WLAN: 1.54 ms
State Saved	Saved in instrument state
Min	100 ns
Max	5 s
Backwards Compatibility SCPI	[:SENSe]:SWEep:TIME:GATE:LENGth ESA compatibility
Initial S/W Revision	Prior to A.02.00

Gate Source

The menus under the Gate Source key are the same as those under the Trigger key, with the exception that neither Free Run nor Video are available as Gate Source selections. However, a different SCPI command is used to select the Gate Source (see table below) because you may independently set the Gate Source and the Trigger Source.

Any changes to the settings in the setup menus under each Gate Source selection key (for example: Trigger Level, Trigger Delay, etc.) also affect the corresponding settings under the Trigger menu keys. The SCPI commands used for these are the same for Trigger and Gate, since there is only one setting which affects both Gate and Trigger. Example: to set the Trigger Level for External 1 you use the command :TRIG:EXT1:LEV regardless of whether you are using External 1 as a Trigger Source or a Gate Source.

Key Path	Sweep/Control, Gate
Remote Command	[:SENSe]:SWEep:EGATE:SOURce EXTernal1 EXTernal2 LINE FRAME RFBurst [:SENSe]:SWEep:EGATE:SOURce?
Dependencies	In some models, there is no second External input. In these models, the External 2 key is blanked and the EXTernal2 parameter will generate a "Hardware missing; Not available for this model number" error.
Preset	EXTernal 1 GSM/EDGE, MSR: FRAME LTETDD: EXTernal 1When Direction is Downlink, FRAME when Direction is Uplink.
Backwards Compatibility Notes	In ESA, there is a single Gate input port. In PSA, the Gate Source may be taken from one of two specified input ports. In the X-Series, any Trigger Source can be a Gate Source.
Initial S/W Revision	Prior to A.02.00
Modified at S/W Revision	A.03.00, A.14.00

Line

Pressing this key, when it is not selected, selects the line signal as the trigger. A new sweep/measurement will start synchronized with the next cycle of the line voltage. Pressing this key, when it is already selected, access the line trigger setup menu.

Key Path	Trigger
Example	TRIG:SOUR LINE Swept SA measurement TRIG:<meas>:SOUR LINE Measurements other than Swept SA
Dependencies	Line trigger is not available when operating from a "dc power source", for example, when the instrument is powered from batteries.
State Saved	Saved in instrument state
Status Bits/OPC dependencies	The Status Operation Register bit 5 "Waiting for Trigger" is set at the same time as the Sweeping or Measuring bit is set. It is cleared when the trigger actually occurs (that is, after the trigger event occurs and all the applicable trigger criteria have been met). A corresponding pop-up message ("Waiting for trigger") is generated if no trigger signal appears after approximately 2 sec. This message goes away when a trigger signal appears.
Initial S/W Revision	Prior to A.02.00

Trig Slope

Controls the trigger polarity. It is set positive to trigger on a rising edge and negative to trigger on a falling edge.

Key Path	Trigger, Line
Remote Command	:TRIGger[:SEQuence]:LINE:SLOPe POSitive NEGative :TRIGger[:SEQuence]:LINE:SLOPe?
Example	TRIG:LINE:SLOP NEG
Preset	POSitive
State Saved	Saved in instrument state
Backwards Compatibility Notes	The legacy :TRIGger[:SEQuence]:SLOPe command affects the slopes for the VID, LINE, EXT1, EXT2, and RFB triggers.
Initial S/W Revision	Prior to A.02.00

External 1

Pressing this key, when it is not selected, selects an external input signal as the trigger. A new sweep/measurement will start when the external trigger condition is met using the external 1 input connector on the rear panel.

Pressing this key, when it is already selected, accesses the external 1 trigger setup menu.

Key Path	Trigger
Example	TRIG:SOUR EXT1 Swept SA measurement TRIG:<meas>:SOUR EXT1 Measurements other than Swept SA
Dependencies	Grayed out if in use by Point Trigger in the Source Setup menu. Forced to Free Run if already selected and Point Trigger is set to External 1.
State Saved	Saved in instrument state
Status Bits/OPC dependencies	The Status Operation Register bit 5 "Waiting for Trigger" is set at the same time as the Sweeping or Measuring bit is set. It is cleared when the trigger actually occurs (that is, after the trigger event occurs and all the applicable trigger criteria have been met). A corresponding pop-up message ("Waiting for trigger") is generated if no trigger signal appears after approximately 2 sec. This message goes away when a trigger signal appears.
Initial S/W Revision	Prior to A.02.00

Trigger Level

Sets the value where the external 1 trigger input will trigger a new sweep/measurement.

Key Path	Trigger, External 1
Remote Command	:TRIGger[:SEquence]:EXTernal1:LEVel <level> :TRIGger[:SEquence]:EXTernal1:LEVel?
Example	TRIG:EXT1:LEV 0.4 V
Couplings	This same level is used for the Ext1 trigger source in the Trigger menu, for the Ext1 selection in the Periodic Timer sync source (in the Trigger menu and in the Gate Source menu), and also for the Ext1 selection in the Gate Source menu.
Preset	1.2 V
State Saved	Saved in instrument state
Min	-5 V
Max	5 V
Default Unit	V
Backwards Compatibility SCPI	:TRIGger[:SEquence]:EXTernal:LEVel For backward compatibility, the parameter EXTernal is mapped to EXTernal1
Backwards Compatibility SCPI	:TRIGger[:SEquence]:FRAME:EXTernal1:LEVel
Initial S/W Revision	Prior to A.02.00

Trig Slope

Controls the trigger polarity. It is set positive to trigger on a rising edge and negative to trigger on a falling edge.

Key Path	Trigger, External 1
Remote Command	:TRIGger[:SEquence]:EXTernal1:SLOPe POSitive NEGative :TRIGger[:SEquence]:EXTernal1:SLOPe?
Example	TRIG:EXT1:SLOP NEG
Couplings	This same slope is used in the Ext1 selection for the trigger source in the Trigger menu and for the period timer sync source (in the Trigger menu and in the Gate Source menu).
Preset	POSitive
State Saved	Saved in instrument state
Backwards Compatibility SCPI	:TRIGger[:SEquence]:EXTernal:SLOPe For backward compatibility, the parameter EXTernal is mapped to EXTernal1
Backwards Compatibility SCPI	:TRIGger[:SEquence]:FRAMe:EXTernal1:SLOPe
Backwards Compatibility Notes	The legacy :TRIGger[:SEquence]:SLOPe command affects the slopes for the VID, LINE, EXT1, EXT2, and RFB triggers.
Initial S/W Revision	Prior to A.02.00

External 2

Pressing this key, when it is not selected, selects an external input signal as the trigger. A new sweep/measurement will start when the external trigger condition is met using the external 2 input connector. The external trigger 2 input connector is on the rear panel.

Pressing this key, when it is already selected, accesses the external 2 trigger setup menu.

Key Path	Trigger
Example	TRIG:SOUR EXT2 Swept SA measurement TRIG:<meas>:SOUR EXT2 Measurements other than Swept SA
Dependencies	In some models, there is no second External input. In these models, the External 2 key is blanked and the EXTernal2 parameter will generate a "Hardware missing; Not available for this model number" message. Grayed out if in use by Point Trigger in the Source Setup menu. Forced to Free Run if already selected and Point Trigger is set to External 2.
State Saved	Saved in instrument state
Status Bits/OPC dependencies	The Status Operation Register bit 5 "Waiting for Trigger" is set at the same time as the Sweeping or Measuring bit is set. It is cleared when the trigger actually occurs (that is, after the trigger event occurs and all the applicable trigger criteria have been met). A corresponding pop-up message ("Waiting for trigger") is generated if no trigger signal appears after approximately 2 sec. This message goes away when a trigger signal appears.
Initial S/W Revision	Prior to A.02.00
Modified at S/W Revision	A.03.00

Trigger Level

Sets the value where the external 2 trigger input will trigger a new sweep/measurement.

Key Path	Trigger, External 2
Remote Command	:TRIGger[:SEquence]:EXTernal2:LEVel :TRIGger[:SEquence]:EXTernal2:LEVel?
Example	TRIG:EXT2:LEV 1.1 V
Couplings	This same level is used for the Ext2 trigger source in the Trigger menu, for the Ext2 selection in the Periodic Timer sync source (in the Trigger menu and in the Gate Source menu), and also for the Ext2 selection in the Gate Source menu.
Preset	1.2 V
State Saved	Saved in instrument state
Min	-5 V
Max	5 V
Default Unit	V
Backwards Compatibility SCPI	:TRIGger[:SEquence]:FRAMe:EXTernal2:LEVel
Initial S/W Revision	Prior to A.02.00

Trig Slope

Controls the trigger polarity. It is set positive to trigger on a rising edge and negative to trigger on a falling edge.

Key Path	Trigger, External 2
Remote Command	:TRIGger[:SEquence]:EXTernal2:SLOPe POSitive NEGative :TRIGger[:SEquence]:EXTernal2:SLOPe?
Example	TRIG:EXT2:SLOP NEG
Couplings	This same slope is used in the Ext2 selection for the trigger source in the Trigger menu and for the period timer sync source (in the Trigger menu and in the Gate Source menu).
Preset	POSitive
State Saved	Saved in instrument state
Backwards Compatibility SCPI	:TRIGger[:SEquence]:FRAMe:EXTernal2:SLOPe
Backwards Compatibility Notes	The legacy :TRIGger[:SEquence]:SLOPe command affects the slopes for the VID, LINE, EXT1, EXT2, and RFB triggers.
Initial S/W Revision	Prior to A.02.00

RF Burst

Pressing this key, when it is not selected, selects the RF Burst as the trigger. A new sweep/measurement will start when an RF burst envelope signal is identified from the signal at the RF Input connector. Pressing this key, when it is already selected, accesses the RF Burst trigger setup menu.

In some models, a variety of burst trigger circuitry is available, resulting in various available burst trigger bandwidths. The analyzer automatically chooses the appropriate trigger path based on the hardware configuration and other settings of the analyzer.

Key Path	Trigger
Example	TRIG:SOUR RFB Swept SA measurement TRIG:<meas>:SOUR RFB Measurements other than Swept SA
State Saved	Saved in instrument state
Status Bits/OPC dependencies	The Status Operation Register bit 5 "Waiting for Trigger" is set at the same time as the Sweeping or Measuring bit is set. It is cleared when the trigger actually occurs (that is, after the trigger event occurs and all the applicable trigger criteria have been met). A corresponding pop-up message ("Waiting for trigger") is generated if no trigger signal appears after approximately 2 sec. This message goes away when a trigger signal appears.
Backwards Compatibility Notes	The legacy command: :TRIGger[:SEQuence]:RFBurst:FSElectivity[:STATe] OFF ON 0 1 is not supported in the X-Series, as the hardware to do Frequency Selective burst triggers does not exist in X-Series.
Initial S/W Revision	Prior to A.02.00
Modified at S/W Revision	A.04.00

Absolute Trigger Level

Sets the absolute trigger level for the RF burst envelope.

When using the External Mixing path, the Absolute Trigger Level is uncalibrated because the factory default was set to accommodate the expected IF levels for the RF path.

Key Path	Trigger, RF Burst
Scope	Meas Global
Remote Command	:TRIGger[:SEQuence]:RFBurst:LEVel:ABSolute <amp1> :TRIGger[:SEQuence]:RFBurst:LEVel:ABSolute?
Example	TRIG:RFB:LEV:ABS 10 dBm sets the trigger level of the RF burst envelope signal to the absolute level of 10 dBm
Notes	Sending this command does not switch the setting from relative to absolute; to switch it you need to send the :TRIGger[:SEQuence]:RFBurst:LEVel:TYPE command, below. Amplitude Corrections are not taken into account by the Absolute Trigger Level. For example, if you have given yourself effective gain with an amplitude correction factor, the Absolute Trigger will not fire until you have set the trigger level that far below the displayed signal level, rather than simply to

	the displayed signal level. This is only true for Amplitude Corrections, not External Gain or Ref Level Offset functions. If mode is Bluetooth, the default value is -50 dBm.
Couplings	This same level is used for the RF Burst trigger source in the Trigger menu, for the RF Burst selection in the Periodic Timer sync source (in the Trigger menu and in the Gate Source menu), and also for the RF Burst selection in the Gate Source menu
Preset	-20 dBm
State Saved	Saved in instrument state
Min	-200 dBm
Max	100 dBm
Default Unit	depends on the current selected Y-Axis unit
Backwards Compatibility SCPI	:TRIGger[:SEquence]:FRAME:RFBurst:LEVel:ABSolute
Initial S/W Revision	Prior to A.02.00
Modified at S/W Revision	A.04.00

Key Path	Trigger, RF Burst
Remote Command	:TRIGger[:SEquence]:RFBurst:LEVel:TYPE ABSolute RELative :TRIGger[:SEquence]:RFBurst:LEVel:TYPE?
Example	TRIG:RFB:LEV:TYPE REL sets the trigger level type of the RF burst trigger to Relative.
Preset	ABSolute
State Saved	Saved in instrument state
Initial S/W Revision	Prior to A.02.00
Modified at S/W Revision	A.04.00

Relative Trigger Level

Sets the relative trigger level for the RF burst envelope.

In some models, the relative burst trigger function is implemented in hardware. In other models, without the advanced triggering hardware required, the relative burst trigger function is implemented in software in some measurements, and is unavailable in other measurements.

When implemented in software, the relative RF Burst trigger function is implemented as follows:

1. The measurement starts with the absolute RF Burst trigger setting. If it cannot get a trigger with that level, auto trigger fires and the acquisition starts anyway. After the acquisition, the measurement searches for the peak in the acquired waveform and saves it.

2. Now, in the next cycle of the measurement, the measurement determines a new absolute RF Burst level based on the peak value from the first measurement and the Relative RF Burst Trigger Level (always 0 or negative dB) set by the user. The following formula is used:
 3. absolute RF Burst level = peak level of the previous acquisition + relative RF Burst level
 4. If the new absolute RF Burst level differs from the previous by more than 0.5 dB, the new level is sent to the hardware; otherwise it is not updated (to avoid slowing down the acquisition)
- Steps 2 and 3 repeat for subsequent measurements.

Key Path	Trigger, RF Burst
Scope	Meas Global
Remote Command	:TRIGger[:SEquence]:RFBurst:LEVel:RELative <rel_ampl> :TRIGger[:SEquence]:RFBurst:LEVel:RELative?
Example	TRIG:RFB:LEV:REL -10 dB sets the trigger level of the RF burst envelope signal to the relative level of -10 dB
Notes	Sending this command does not switch the setting from absolute to relative; to switch it you need to send the :TRIGger[:SEquence]:RFBurst:LEVel:TYPE command, above. The relative trigger level is not available in some measurements. In those measurements the RELative parameter, and the :TRIGger[:SEquence]:RFBurst:LEVel:TYPE command (above), will generate an error if sent.
Dependencies	This key is grayed out and Absolute Trigger Level selected if the required hardware is not present in your analyzer and the current measurement does not support Relative triggering.
Preset	-6 dB GSM: -25 dB
State Saved	Saved in instrument state
Min	-45 dB
Max	0 dB
Default Unit	dB or dBc
Backwards Compatibility SCPI	:TRIGger[:SEquence]:RFBurst:LEVel This legacy command is aliased to :TRIGger[:SEquence]:RFBurst:LEVel:RELative because the PSA had ONLY relative burst triggering
Initial S/W Revision	Prior to A.02.00
Modified at S/W Revision	A.04.00

Trigger Slope

It is set positive to trigger on a rising edge and negative to trigger on a falling edge.

Key Path	Trigger, RF Burst
Remote Command	:TRIGger[:SEquence]:RFBurst:SLOPe Positive NEGative :TRIGger[:SEquence]:RFBurst:SLOPe?

Example	TRIG:RFB:SLOP NEG
Couplings	This same slope is used in the RF Burst selection for the trigger source in the Trigger menu and for the period timer sync source (in the Trigger menu and in the Gate Source menu).
Preset	POSitive
State Saved	Saved in instrument state
Backwards Compatibility SCPI	:TRIGger[:SEquence]:FRAMe:RFBurst:SLOPe
Backwards Compatibility Notes	The legacy :TRIGger[:SEquence]:SLOPe command affects the slopes for the VID, LINE, EXT1, EXT2, and RFB triggers.
Initial S/W Revision	Prior to A.02.00

Periodic Timer (Frame Trigger)

Pressing this key, when it is not selected, selects the internal periodic timer signal as the trigger. Triggering occurrences are set by the **Period** parameter, which is modified by the **Sync Source** and **Offset**. Pressing this key, when it is already selected, accesses the periodic timer trigger setup functions.

If you do not have a sync source selected (it is Off), then the internal timer will not be synchronized with any external timing events.

Key Path	Trigger
Example	TRIG:SOUR FRAM Swept SA measurement TRIG:<meas>:SOUR FRAM Measurements other than Swept SA
State Saved	Saved in instrument state
Readback	[Sync: <value of Sync Source>], for example, [Sync: External 1]
Status Bits/OPC dependencies	The Status Operation Register bit 5 "Waiting for Trigger" is set at the same time as the Sweeping or Measuring bit is set. It is cleared when the trigger actually occurs (that is, after the trigger event occurs and all the applicable trigger criteria have been met). A corresponding pop-up message ("Waiting for trigger") is generated if no trigger signal appears after approximately 2 sec. This message goes away when a trigger signal appears.
Initial S/W Revision	Prior to A.02.00

Periodic Timer Triggering:

This feature selects the internal periodic timer signal as the trigger. Trigger occurrences are set by the **Periodic Timer** parameter, which is modified by the **Sync Source** and **Offset**.

The figure below shows the action of the periodic timer trigger. Before reviewing the figure, we'll explain some uses for the periodic trigger.

A common application is measuring periodic burst RF signals for which a trigger signal is not easily available. For example, we might be measuring a TDMA radio which bursts every 20 ms. Let's assume that the 20 ms period is very consistent. Let's also assume that we do not have an external trigger source

available that is synchronized with the period, and that the signal-to-noise ratio of the signal is not high enough to provide a clean RF burst trigger at all of the analysis frequencies. For example, we might want to measure spurious transmissions at an offset from the carrier that is larger than the bandwidth of the RF burst trigger. In this application, we can set the Periodic Timer to a 20.00 ms period and adjust the offset from that timer to position our trigger just where we want it. If we find that the 20.00 ms is not exactly right, we can adjust the period slightly to minimize the drift between the period timer and the signal to be measured.

A second way to use this feature would be to use **Sync Source** temporarily, instead of **Offset**. In this case, we might tune to the signal in a narrow span and use the RF Burst trigger to synchronize the periodic timer. Then we would turn the sync source off so that it would not miss-trigger. Miss-triggering can occur when we are tuned so far away from the RF burst trigger that it is no longer reliable.

A third example would be to synchronize to a signal that has a reference time element of much longer period than the period of interest. In some CDMA applications, it is useful to look at signals with a short periodicity, by synchronizing that periodicity to the "even-second clock" edge that happens every two seconds. Thus, we could connect the even-second clock trigger to Ext1 and use then Ext1 as the sync source for the periodic timer.

The figure below illustrates this third example. The top trace represents the even-second clock. It causes the periodic timer to synchronize with the leading edge shown. The analyzer trigger occurs at a time delayed by the accumulated offset from the period trigger event. The periodic timer continues to run, and triggers continue to occur, with a periodicity determined by the analyzer time base. The timer output (labeled "late event") will drift away from its ideal time due to imperfect matching between the time base of the signal being measured and the time base of the analyzer, and also because of imperfect setting of the period parameter. But the synchronization is restored on the next even-second clock event. ("Accumulated offset" is described in the in the **Offset** function section.)

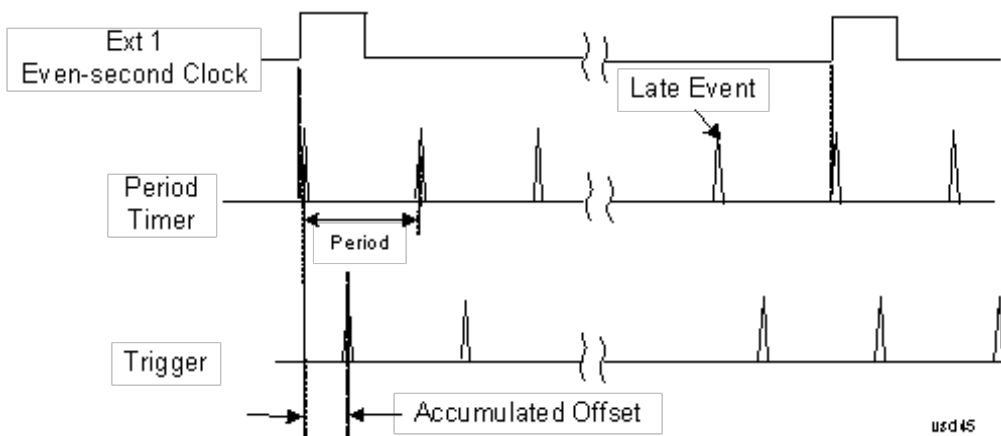

Period

Sets the period of the internal periodic timer clock. For digital communications signals, this is usually set to the frame period of your current input signal. In the case that sync source is not set to OFF, and the external sync source rate is changed for some reason, the periodic timer is synchronized at the every external synchronization pulse by resetting the internal state of the timer circuit.

Key Path	Trigger, Periodic Timer
Remote Command	:TRIGger[:SEquence]:FRAMe:PERIOD <time>

	:TRIGger[:SEquence]:FRAMe:PERiod?
Example	TRIG:FRAM:PER 100 ms
Dependencies	The invalid data indicator turns on when the period is changed, until the next sweep/measurement completes.
Couplings	The same period is used in the Gate Source selection of the period timer.
Preset	20 ms GSM: 4.615383
State Saved	Saved in instrument state
Min	100.000 ns
Max	559.0000 ms
Default Unit	S
Initial S/W Revision	Prior to A.02.00

Offset

Adjusts the accumulated offset between the periodic timer events and the trigger event. Adjusting the accumulated offset is different than setting an offset, and requires explanation.

The periodic timer is usually not synchronized with any external events, so the timing of its output events has no absolute meaning. Since the timing relative to external events (RF signals) is important, you need to be able to adjust (offset) it. However, you have no direct way to see when the periodic timer events occur. All that you can see is the trigger timing. When you want to adjust the trigger timing, you will be changing the internal offset between the periodic timer events and the trigger event. Because the absolute value of that internal offset is unknown, we will just call that the accumulated offset. Whenever the Offset parameter is changed, you are changing that accumulated offset. You can reset the displayed offset using Reset Offset Display. Changing the display does not change the value of the accumulated offset, and you can still make additional changes to accumulated offset.

To avoid ambiguity, we define that an increase in the "offset" parameter, either from the knob or the SCPI adjust command, serves to delay the timing of the trigger event.

Key Path	Trigger, Periodic Timer
Remote Command	:TRIGger[:SEquence]:FRAMe:OFFSet <time> :TRIGger[:SEquence]:FRAMe:OFFSet?
Example	TRIG:FRAM:OFFS 1.2 ms
Notes	The front panel interface (for example, the knob), and this command, adjust the accumulated offset, which is shown on the active function display. However, the actual amount sent to the hardware each time the offset is updated is the delta value, that is, the current accumulated offset value minus the previous accumulated offset value. Note that the accumulated offset value is essentially arbitrary; it represents the accumulated offset from the last time the offset was zeroed (with the Reset Offset Display key). Note that this command does not change the period of the trigger waveform. Note also that Offset is used only when the sync source is set to OFF, otherwise delay is used, see section "Trig Delay" on page 443.

	An increase in the "offset" parameter, either from the knob or the SCPI adjust command, serves to delay the timing of the trigger event.
Notes	When the SCPI command is sent the value shown on the key (and the Active Function, if this happens to be the active function) is updated with the new value. However, the actual amount sent to the hardware is the delta value, that is, the current accumulated offset value minus the previous accumulated offset value. The SCPI query simply returns the value currently showing on the key.
Dependencies	The invalid data indicator turns on when the offset is changed, until the next sweep/measurement completes.
Couplings	The same offset is used in the Gate Source selection of the period timer.
Preset	0 s
State Saved	Saved in instrument state
Min	-10.000 s
Max	10.000 s
Default Unit	S
Initial S/W Revision	Prior to A.02.00

Offset Adjust (Remote Command Only)

This remote command does not work at all like the related front panel keys. This command lets you advance the phase of the frame trigger by the amount you specify.

It does not change the period of the trigger waveform. If the command is sent multiple times, it advances the phase of the frame trigger an additional amount each time it is sent. Negative numbers are permitted.

Remote Command	:TRIGger[:SEquence]:FRAMe:ADJust <time>
Example	TRIG:FRAM:ADJ 1.2 ms
Notes	Note also that Offset is used only when the sync source is set to OFF, otherwise delay is used, see section " Trig Delay " on page 443 An increase in the "offset" parameter, either from the knob or the SCPI adjust command, serves to delay the timing of the trigger event.
Notes	The front panel interface (for example, the knob) and the :TRIG:FRAM:OFFS command adjust the accumulated offset, which is shown on the active function display. However, the actual amount sent to the hardware is the delta value, that is, the current offset value minus the previous offset value. When the SCPI command is sent the value shown on the key (and the Active Function, if this happens to be the active function) is updated by increasing it (or decreasing it if the value sent is negative) by the amount specified in the SCPI command. This is a "command only" SCPI command, with no query.
Dependencies	The invalid data indicator turns on when the offset is changed, until the next sweep/measurement completes.
Couplings	The same offset is used in the Gate Source selection of the period timer.
Preset	0 s

State Saved	Saved in instrument state
Min	-10.000 s
Max	10.000 s
Default Unit	S
Initial S/W Revision	Prior to A.02.00

Reset Offset Display

Resets the value of the periodic trigger offset display setting to 0.0 seconds. The current displayed trigger location may include an offset value defined with the Offset key. Pressing this key redefines the currently displayed trigger location as the new trigger point that is 0.0 s offset. The Offset key can then be used to add offset relative to this new timing.

Key Path	Trigger, Periodic Timer
Remote Command	:TRIGger[:SEquence]:FRAMe:OFFSet:DISPlay:RESet
Example	TRIG:FRAM:OFFS:DISP:RES
Initial S/W Revision	Prior to A.02.00

Sync Source

Selects a signal source for you to synchronize your periodic timer trigger to, otherwise you are triggering at some arbitrary location in the frame. Synchronization reduces the precision requirements on the setting of the period.

For convenience you may adjust the level and slope of the selected sync source in a conditional branch setup menu accessed from the Sync Source menu. Note that these settings match those in the **Trigger** and **Gate Source** menus; that is, each trigger source has only one value of level and slope, regardless of which menu it is accessed from.

Key Path	Trigger, Periodic Timer
Remote Command	:TRIGger[:SEquence]:FRAMe:SYNC EXTernal1 EXTernal2 RFBurst OFF :TRIGger[:SEquence]:FRAMe:SYNC?
Example	TRIG:FRAM:SYNC EXT2
Dependencies	In some models, there is no second External input. In these models, the External 2 key is blanked and the EXTernal2 parameter will generate a "Hardware missing; Not available for this model number" message.
Preset	Off GSM/EDGE, MSR,LTE,LTETDD: RFBurst
State Saved	Saved in instrument state
Readback	The current setting is read back to this key and it is also Readback to the previous Periodic Timer trigger key.

Backwards Compatibility SCPI	:TRIGger[:SEquence]:FRAMe:SYNC EXTernal
Initial S/W Revision	Prior to A.02.00
Modified at S/W Revision	A.03.00, A.14.00

Off

Turns off the sync source for your periodic trigger. With the sync source off, the timing will drift unless the signal source frequency is locked to the analyzer frequency reference.

Key Path	Trigger, Periodic Timer, Sync Source
Example	TRIG:FRAM:SYNC OFF
Readback	Off
Initial S/W Revision	Prior to A.02.00

External 1

Pressing this key, when it is not selected, selects an external input signal as the trigger. A new sweep/measurement will start when the external trigger condition is met using the external 1 input connector on the rear panel.

Pressing this key, when it is already selected, accesses the external 1 trigger setup menu.

Key Path	Trigger
Example	TRIG:SOUR EXT1 Swept SA measurement TRIG:<meas>:SOUR EXT1 Measurements other than Swept SA
Dependencies	Grayed out if in use by Point Trigger in the Source Setup menu. Forced to Free Run if already selected and Point Trigger is set to External 1.
State Saved	Saved in instrument state
Status Bits/OPC dependencies	The Status Operation Register bit 5 "Waiting for Trigger" is set at the same time as the Sweeping or Measuring bit is set. It is cleared when the trigger actually occurs (that is, after the trigger event occurs and all the applicable trigger criteria have been met). A corresponding pop-up message ("Waiting for trigger") is generated if no trigger signal appears after approximately 2 sec. This message goes away when a trigger signal appears.
Initial S/W Revision	Prior to A.02.00

Trigger Level

Sets the value where the external 1 trigger input will trigger a new sweep/measurement.

Key Path	Trigger, External 1
Remote Command	:TRIGger[:SEquence]:EXTErnal1:LEVel <level> :TRIGger[:SEquence]:EXTErnal1:LEVel?
Example	TRIG:EXT1:LEV 0.4 V
Couplings	This same level is used for the Ext1 trigger source in the Trigger menu, for the Ext1 selection in the Periodic Timer sync source (in the Trigger menu and in the Gate Source menu), and also for the Ext1 selection in the Gate Source menu.
Preset	1.2 V
State Saved	Saved in instrument state
Min	-5 V
Max	5 V
Default Unit	V
Backwards Compatibility SCPI	:TRIGger[:SEquence]:EXTErnal:LEVel For backward compatibility, the parameter EXTErnal is mapped to EXTErnal1
Backwards Compatibility SCPI	:TRIGger[:SEquence]:FRAME:EXTErnal1:LEVel
Initial S/W Revision	Prior to A.02.00

Trig Slope

Controls the trigger polarity. It is set positive to trigger on a rising edge and negative to trigger on a falling edge.

Key Path	Trigger, External 1
Remote Command	:TRIGger[:SEquence]:EXTErnal1:SLOPe POSitive NEGative :TRIGger[:SEquence]:EXTErnal1:SLOPe?
Example	TRIG:EXT1:SLOP NEG
Couplings	This same slope is used in the Ext1 selection for the trigger source in the Trigger menu and for the period timer sync source (in the Trigger menu and in the Gate Source menu).
Preset	POSitive
State Saved	Saved in instrument state
Backwards Compatibility SCPI	:TRIGger[:SEquence]:EXTErnal:SLOPe For backward compatibility, the parameter EXTErnal is mapped to EXTErnal1
Backwards Compatibility SCPI	:TRIGger[:SEquence]:FRAME:EXTErnal1:SLOPe
Backwards Compatibility Notes	The legacy :TRIGger[:SEquence]:SLOPe command affects the slopes for the VID, LINE, EXT1, EXT2, and RFB triggers.
Initial S/W Revision	Prior to A.02.00

External 2

Pressing this key, when it is not selected, selects an external input signal as the trigger. A new sweep/measurement will start when the external trigger condition is met using the external 2 input connector. The external trigger 2 input connector is on the rear panel.

Pressing this key, when it is already selected, accesses the external 2 trigger setup menu.

Key Path	Trigger
Example	TRIG:SOUR EXT2 Swept SA measurement TRIG:<meas>:SOUR EXT2 Measurements other than Swept SA
Dependencies	In some models, there is no second External input. In these models, the External 2 key is blanked and the EXTernal2 parameter will generate a "Hardware missing; Not available for this model number" message. Grayed out if in use by Point Trigger in the Source Setup menu. Forced to Free Run if already selected and Point Trigger is set to External 2.
State Saved	Saved in instrument state
Status Bits/OPC dependencies	The Status Operation Register bit 5 "Waiting for Trigger" is set at the same time as the Sweeping or Measuring bit is set. It is cleared when the trigger actually occurs (that is, after the trigger event occurs and all the applicable trigger criteria have been met). A corresponding pop-up message ("Waiting for trigger") is generated if no trigger signal appears after approximately 2 sec. This message goes away when a trigger signal appears.
Initial S/W Revision	Prior to A.02.00
Modified at S/W Revision	A.03.00

Trigger Level

Sets the value where the external 2 trigger input will trigger a new sweep/measurement.

Key Path	Trigger, External 2
Remote Command	:TRIGger[:SEquence]:EXTernal2:LEVel :TRIGger[:SEquence]:EXTernal2:LEVel?
Example	TRIG:EXT2:LEV 1.1 V
Couplings	This same level is used for the Ext2 trigger source in the Trigger menu, for the Ext2 selection in the Periodic Timer sync source (in the Trigger menu and in the Gate Source menu), and also for the Ext2 selection in the Gate Source menu.
Preset	1.2 V
State Saved	Saved in instrument state
Min	-5 V
Max	5 V
Default Unit	V
Backwards Compatibility SCPI	:TRIGger[:SEquence]:FRAMe:EXTernal2:LEVel
Initial S/W Revision	Prior to A.02.00

Trig Slope

Controls the trigger polarity. It is set positive to trigger on a rising edge and negative to trigger on a falling edge.

Key Path	Trigger, External 2
Remote Command	:TRIGger[:SEQuence]:EXTernal2:SLOPe POSitive NEGative :TRIGger[:SEQuence]:EXTernal2:SLOPe?
Example	TRIG:EXT2:SLOP NEG
Couplings	This same slope is used in the Ext2 selection for the trigger source in the Trigger menu and for the period timer sync source (in the Trigger menu and in the Gate Source menu).
Preset	POSitive
State Saved	Saved in instrument state
Backwards Compatibility SCPI	:TRIGger[:SEQuence]:FRAMe:EXTernal2:SLOPe
Backwards Compatibility Notes	The legacy :TRIGger[:SEQuence]:SLOPe command affects the slopes for the VID, LINE, EXT1, EXT2, and RFB triggers.
Initial S/W Revision	Prior to A.02.00

RF Burst

Pressing this key, when it is not selected, selects the RF Burst as the trigger. A new sweep/measurement will start when an RF burst envelope signal is identified from the signal at the RF Input connector. Pressing this key, when it is already selected, accesses the RF Burst trigger setup menu.

In some models, a variety of burst trigger circuitry is available, resulting in various available burst trigger bandwidths. The analyzer automatically chooses the appropriate trigger path based on the hardware configuration and other settings of the analyzer.

Key Path	Trigger
Example	TRIG:SOUR RFB Swept SA measurement TRIG:< meas>:SOUR RFB Measurements other than Swept SA
State Saved	Saved in instrument state
Status Bits/OPC dependencies	The Status Operation Register bit 5 "Waiting for Trigger" is set at the same time as the Sweeping or Measuring bit is set. It is cleared when the trigger actually occurs (that is, after the trigger event occurs and all the applicable trigger criteria have been met). A corresponding pop-up message ("Waiting for trigger") is generated if no trigger signal appears after approximately 2 sec. This message goes away when a trigger signal appears.
Backwards Compatibility Notes	The legacy command: :TRIGger[:SEQuence]:RFBurst:FSElectivity[:STATe] OFF ON 0 1 is not supported in the X-Series, as the hardware to do Frequency Selective burst triggers does not exist in X-Series.

Initial S/W Revision	Prior to A.02.00
Modified at S/W Revision	A.04.00

Absolute Trigger Level

Sets the absolute trigger level for the RF burst envelope.

When using the External Mixing path, the Absolute Trigger Level is uncalibrated because the factory default was set to accommodate the expected IF levels for the RF path.

Key Path	Trigger, RF Burst
Scope	Meas Global
Remote Command	:TRIGger[:SEquence]:RFBurst:LEVel:ABSolute <ampl> :TRIGger[:SEquence]:RFBurst:LEVel:ABSolute?
Example	TRIG:RFB:LEV:ABS 10 dBm sets the trigger level of the RF burst envelope signal to the absolute level of 10 dBm
Notes	Sending this command does not switch the setting from relative to absolute; to switch it you need to send the :TRIGger[:SEquence]:RFBurst:LEVel:TYPE command, below. Amplitude Corrections are not taken into account by the Absolute Trigger Level. For example, if you have given yourself effective gain with an amplitude correction factor, the Absolute Trigger will not fire until you have set the trigger level that far below the displayed signal level, rather than simply to the displayed signal level. This is only true for Amplitude Corrections, not External Gain or Ref Level Offset functions. If mode is Bluetooth, the default value is -50 dBm.
Couplings	This same level is used for the RF Burst trigger source in the Trigger menu, for the RF Burst selection in the Periodic Timer sync source (in the Trigger menu and in the Gate Source menu), and also for the RF Burst selection in the Gate Source menu
Preset	-20 dBm
State Saved	Saved in instrument state
Min	-200 dBm
Max	100 dBm
Default Unit	depends on the current selected Y-Axis unit
Backwards Compatibility SCPI	:TRIGger[:SEquence]:FRAME:RFBurst:LEVel:ABSolute
Initial S/W Revision	Prior to A.02.00
Modified at S/W Revision	A.04.00

Key Path	Trigger, RF Burst
Remote Command	:TRIGger[:SEquence]:RFBurst:LEVel:TYPE ABSolute RELative :TRIGger[:SEquence]:RFBurst:LEVel:TYPE?

Example	TRIG:RFB:LEV:TYPE REL sets the trigger level type of the RF burst trigger to Relative.
Preset	ABSolute
State Saved	Saved in instrument state
Initial S/W Revision	Prior to A.02.00
Modified at S/W Revision	A.04.00

Trigger Slope

It is set positive to trigger on a rising edge and negative to trigger on a falling edge.

Key Path	Trigger, RF Burst
Remote Command	:TRIGger[:SEquence]:RFBurst:SLOPe POSitive NEGative :TRIGger[:SEquence]:RFBurst:SLOPe?
Example	TRIG:RFB:SLOP NEG
Couplings	This same slope is used in the RF Burst selection for the trigger source in the Trigger menu and for the period timer sync source (in the Trigger menu and in the Gate Source menu).
Preset	POSitive
State Saved	Saved in instrument state
Backwards Compatibility SCPI	:TRIGger[:SEquence]:FRAME:RFBurst:SLOPe
Backwards Compatibility Notes	The legacy :TRIGger[:SEquence]:SLOPe command affects the slopes for the VID, LINE, EXT1, EXT2, and RFB triggers.
Initial S/W Revision	Prior to A.02.00

Sync Holdoff

Sync Holdoff specifies the duration that the sync source signal must be kept false before the transition to true to be recognized as the sync timing. The periodic timer phase is aligned when the sync source signal becomes true, after the Holdoff time is satisfied.

A holdoff of 2 ms will work with most WiMAX signals, but there may be cases where the burst off duration is less than 1 ms and this value will need to be changed.

Key Path	Trigger, Periodic Timer
Remote Command	:TRIGger[:SEquence]:FRAME:SYNC:HOLDoff <time> :TRIGger[:SEquence]:FRAME:SYNC:HOLDoff? :TRIGger[:SEquence]:FRAME:SYNC:HOLDoff:STATe OFF ON 0 1 :TRIGger[:SEquence]:FRAME:SYNC:HOLDoff:STATe?
Preset	On, 1.000 ms

State Saved	Saved in instrument state
Min	0 ms
Max	+500 ms
Default Unit	s
Initial S/W Revision	Prior to A.02.00

Control Edge/Level

Sets the method of controlling the gating function from the gating signal.

Edge

In Edge triggering, the gate opens (after the Delay) on the selected edge (for example, positive) of the gate signal and closes on the alternate edge (for example, negative).

Level

In Level triggering, the gate opens (after the Delay) when the gate signal has achieved a certain level and stays open as long as that level is maintained.

Key Path	Sweep/Control, Gate
Remote Command	[:SENSe] :SWEep:EGATe:CONTRol EDGE LEVel [:SENSe] :SWEep:EGATe:CONTRol?
Example	SWE:EGAT:CONT EDGE
Dependencies	If the Gate Method is FFT the Control key is grayed out and Edge is selected. If the Gate Source is TV, Frame or Line, the Control key is grayed out and Edge is selected.
Preset	EDGE
State Saved	Saved in instrument state
Backwards Compatibility SCPI	[:SENSe] :SWEep:TIME:GATE:TYPE ESA Compatibility
Initial S/W Revision	Prior to A.02.00

Gate Holdoff

Lets you increase or decrease the wait time after a gate event ends before the analyzer will respond to the next gate signal.

After any Gate event finishes, the analyzer must wait for the sweep system to settle before it can respond to another Gate signal. The analyzer calculates a "wait time," taking into account a number of factors, including RBW and Phase Noise Optimization settings. The goal is to achieve the same accuracy when gated as in ungated operation. The figure below illustrates this concept:

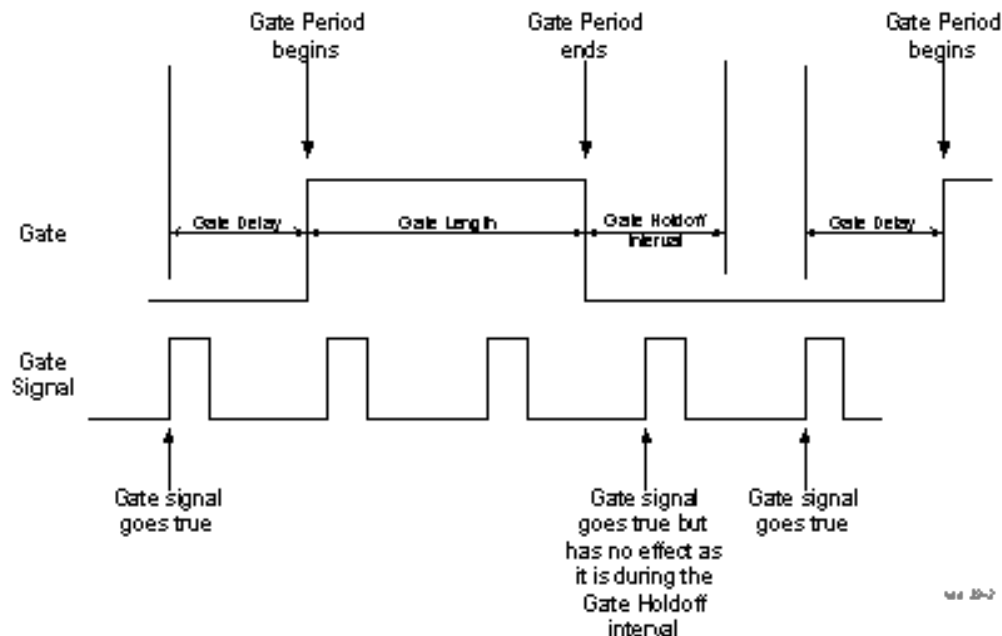

When Gate Holdoff is in Auto, the wait time calculated by the analyzer is used. When Gate Time is in Manual, the user may adjust the wait time, usually decreasing it in order to achieve greater speed, but at the risk of decreasing accuracy.

When the Method key is set to Video or FFT, the Gate Holdoff function has no effect.

In measurements that do not support Auto, the value shown when Auto is selected is “---” and the manually set holdoff is returned to a query.

Key Path	Sweep/Control, Gate
Remote Command	<pre>[:SENSe] :SWEep:EGATe:HOLDoff <time> [:SENSe] :SWEep:EGATe:HOLDoff? [:SENSe] :SWEep:EGATe:HOLDoff:AUTO OFF ON 0 1 [:SENSe] :SWEep:EGATe:HOLDoff:AUTO?</pre>
Example	<pre>SWE:EGAT:HOLD 0.0002 SWE:EGAT:HOLD? SWE:EGAT:HOLD:AUTO ON SWE:EGAT:HOLD:AUTO?</pre>
Couplings	<p>When Gate Holdoff is Auto, the Gate Holdoff key shows the value calculated by the analyzer for the wait time.</p> <p>Pressing the Gate Holdoff key while it is in Auto and not selected, causes the key to become selected and allows the user to adjust the value. If the value is adjusted, the setting changes to Man.</p> <p>Pressing the Gate Holdoff key, while it is in Auto and selected, does not change the value of Gate Holdoff, but causes the setting to change to Man. Now the user can adjust the value.</p> <p>Pressing the key while it is in Man and selected, cause the value to change back to Auto.</p> <p>Pressing the key while it is in Man and not selected, causes the key to become selected and allows the user to adjust the value.</p>

	When Method is set to Video or FFT, the Gate Holdoff function has no effect.
Preset	Auto Auto/On
State Saved	Saved in instrument state
Min	1 μ sec
Max	1 sec
Initial S/W Revision	Prior to A.02.00

Gate Delay Compensation

This function allows you to select an RBW-dependent value by which to adjust the gate delay, to compensate for changes in the delay caused by RBW effects.

You can select between uncompensated operation and two types of compensation, Delay Until RBW Settled and Compensate for RBW Group Delay.

See ["More Information" on page 2108](#)

Key Path	Sweep/Control, Gate
Scope	Meas Global
Remote Command	[:SENSe] :SWEep:EGATe:DELaY:COMPensation:TYPE OFF SETTled GDELaY [:SENSe] :SWEep:EGATe:DELaY:COMPensation:TYPE?
Example	SWE:EGAT:DEL:COMP:TYPE SETT SWE:EGAT:DEL:COMP:TYPE?
Notes	Although this function is Meas Global, there are some measurements that do not support this function. In those measurements the operation will be Uncompensated. Going into one of those measurements will not change the Meas Global selection; it will simply display the grayed-out menu key with “Uncompensated” showing as the selection. This is a non-forceful grayout, so the SCPI command is still accepted. If Gate Delay Compensation is not supported at all within a particular mode, the key is not displayed, and if the SCPI command is sent while in a measurement within that mode, an “Undefined Header” message is generated. Measurements that do not support this function include: Swept SA
Preset	TD-SCDMA mode: Compensate for RBW Group Delay All other modes: Delay Until RBW Settled
State Saved	Saved in instrument state
Range	Uncompensated Delay Until RBW Settled Compensate for RBW Group Delay
Readback text	Uncompensated Settled Group Delay
Initial S/W Revision	Prior to A.02.00
Modified at S/W Revision	A.11.0

More Information

Selecting Uncompensated means that the actual gate delay is as you sets it.

Selecting Delay Until RBW Settled causes the gate delay to be increased above the user setting by an amount equal to $3.06/\text{RBW}$. This compensated delay causes the GATE START and GATE STOP lines on the display to move by the compensation amount, and the actual hardware gate delay to be increased by the same amount. All the other gate lines (for example, MIN FAST) are unaffected. If the RBW subsequently changes, the compensation is readjusted for the new RBW. The value shown on the Gate Delay key does NOT change.

Delay Until RBW Settled allows excellent measurements of gated signals, by allowing the IF to settle following any transient that affects the burst. Excellent measurements also require that the analysis region not extend into the region affected by the falling edge of the burst. Thus, excellent measurements can only be made over a width that declines with narrowing RBWs, which is achieved by decreasing the gate length below the user setting by an amount equal to $2.53/\text{RBW}$. Therefore, for general purpose compensation, you will still want to change the gate length with changes in RBW even if the gate delay is compensated. The compensated Gate Length is limited by the analyzer so that it will never go below 10% of the value shown on the Gate Length key, as otherwise the sweep times could get very long. Anytime the Gate Length and RBW values combine in such a way that this limiting takes place, a warning is displayed. For measurements which contain multiple sweeps with different RBW like SEM and SPUR, the smallest RBW is used for this limiting.

Selecting Compensate for RBW Group Delay causes the gate delay to be increased above the user setting by an amount equal to $1.81/\text{RBW}$. This compensated delay causes the GATE START, GATE STOP lines on the display to move by the compensation amount, and the actual hardware gate delay to be increased by the same amount. All the other gate lines (for example, MIN FAST) are unaffected. If the RBW subsequently changes, the compensation is readjusted for the new RBW. The value shown on the Gate Delay key does NOT change. Compensate for RBW Group Delay also includes gate length compensation; the gate length itself is adjusted as necessary to attempt to compensate for delay effects imposed by the RBW.

Compensate for RBW Group Delay is similar to Delay Until RBW Settled, but compensates for the group delay of the RBW filter, rather than the filter settling time. As the RBW gets narrow, this can allow the settling tail of the RBW to affect the beginning part of the gated measurement, and allow the beginning of the RBW settling transient to affect the end of the gated measurement. These two effects are symmetric because the RBW response is symmetric. Because the gate length is not automatically compensated, some users might find this compensation to be more intuitive than compensation for RBW settling.

Min Fast Position Query (Remote Command Only)

This command queries the position of the MIN FAST line, relative to the delay reference (REF) line. See section ["Gate View On/Off" on page 2080](#). If this query is sent while not in gate view, the MinFast calculation is performed based on the current values of the appropriate parameters and the result is returned. Knowing this value lets you set an optimal gate delay value for the current measurement setup.

Remote Command	<code>[:SENSe] :SWEep:EGATe:MINFast?</code>
Example	<code>SWE:EGAT:MIN?</code>
Initial S/W Revision	Prior to A.02.00

Gate Preset (Remote Command Only)

Presets the time-gated spectrum analysis capability.

This command sets gate parameter values to the ESA preset values, as follows:

Gate trigger type = edge

Gate polarity = positive

Gate delay = 1 us

Gate length = 1 us

Remote Command	<code>[[:SENSe]:SWEep:TIME:GATE:PRESet</code> ESA Compatibility
Initial S/W Revision	Prior to A.02.00

Gate Level (Remote Command Only)

Sets the gate input transition point level for the external TRIGGER inputs on the front and rear panel. This is a legacy command for PSA compatibility. It is simply an alias to the equivalent trigger level command.

Remote Command	<code>[[:SENSe]:SWEep:EGATE:EXTernal[1] 2:LEVel <voltage></code> <code>[[:SENSe]:SWEep:EGATE:EXTernal[1] 2:LEVel?</code>
Notes	This command is simply an alias to <code>:TRIGger[:SEQUence]:EXTernal[1] 2:LEVel</code> For details refer
Initial S/W Revision	Prior to A.02.00

Gate Polarity (Remote Command Only)

Sets the polarity for the gate signal. This setup is now done using the gate trigger's slope setting.

When Positive (Pos) is selected, a positive-going edge (Edge) or a high voltage (Level) will satisfy the gate condition, after the delay set with the Gate Delay key. When Negative (Neg) is selected, a negative-going edge (Edge) or a low voltage (Level) will satisfy the gate condition after the delay.

Remote Command	<code>[[:SENSe]:SWEep:EGATE:POLarity</code> NEGative POSitive <code>[[:SENSe]:SWEep:EGATE:POLarity?</code>
Example	<code>SWE:EGAT:POL NEG</code> <code>SWE:EGAT:POL?</code>
Preset	POSitive
State Saved	Saved in instrument state
Backwards Compatibility SCPI	<code>[[:SENSe]:SWEep:TIME:GATE:POLarity</code> ESA compatibility
Initial S/W Revision	Prior to A.02.00

Remote Command	<code>[:SENSe] :SWEep:TIME:GATE:LEVel HIGH LOW</code> <code>[:SENSe] :SWEep:TIME:GATE:LEVel?</code> ESA compatibility
Preset	HIGH
Initial S/W Revision	Prior to A.02.00

Points

Sets the number of points per sweep. The resolution of setting the sweep time depends on the number of points selected. If Preset is selected, the number of points per sweep defaults to 1001. The current value of points is displayed parenthetically, next to the sweep time in the lower right corner of the display.

Key Path	Sweep/Control
Mode	All except SA and BASIC
Remote Command	<code>[:SENSe] :MONitor:SWEep:POINts <integer></code> <code>[:SENSe] :MONitor:SWEep:POINts?</code>
Example	<code>:MON:SWE:POIN 1000</code> <code>:MON:SWE:POIN?</code>
Couplings	Whenever the number of sweep points changes, the sweep time is re-quantized.
Preset	1001
State Saved	Saved in instrument state.
Range	1 to 20001
Min	1
Max	20001
Initial S/W Revision	Prior to A.02.00

System

See "System" on page 342

Trace/Detector

Accesses a menu that enables you to control the display, storage, detection and manipulation of trace data. Each trace is comprised of a series of data points in which X and Y axis information is stored. The analyzer updates the information for the active trace with each sweep of the current measurement.

Key Path	Front-panel key
Initial S/W Revision	Prior to A.02.00

Select Trace

Allows you to select which trace you want to use for the current measurement. You can select one of three traces. Monitor Spectrum supports 3 traces, numbered 1 through 3.

Key Path	Trace/Detector
Mode	All except SA and BASIC
Preset	Trace 1
State Saved	The number of the selected trace is saved in Instrument State
Initial S/W Revision	Prior to A.02.00

Trace Type

Allows you to select the type of trace you want to use for the current measurement. You can assign a trace type to one of the three available traces.

The first page of this menu contains a 1-of-N selection of the trace type for the selected trace:

WRITe	Clear Write
AVERAge	Average
MAXHold	Max Hold
MINHold	Min Hold

Key Path	Trace/Detector
Mode	All except SA and BASIC
Remote Command	:TRACe[1] 2 3:MONitor:TYPE WRITe AVERAge MAXHold MINHold :TRACe[1] 2 3:MONitor:TYPE?
Example	TRAC:MON:TYPE WRIT TRAC:MON:TYPE?
Preset	WRITe
State Saved	Saved in instrument state.

Range	WRITe AVERAge MAXHold MINHold for traces 1 through 3
Backwards Compatibility SCPI	:DISPlay:MONitor:VIEW:WINDow:TRACe [1] 2 3 :TYPE
Initial S/W Revision	Prior to A.02.00

Update

Toggles a trace state between Update and Off. The Off selection makes the trace inactive (or a *stored trace*). This does not affect whether the trace is visible or not. To change the trace visibility, see "[Display](#)" on page 2113.

Key Path	Trace/Detector
Mode	All except SA and BASIC
Remote Command	:TRACe [1] 2 3 :MONitor:UPDate[:STATe] ON OFF 0 1 :TRACe [1] 2 3 :MONitor:UPDate[:STATe]?
Example	TRAC3:MON:UPD OFF TRAC3:MON:UPD?
Preset	ON
State Saved	Saved in instrument state.
Range	On Off(View)
Initial S/W Revision	Prior to A.02.00

Display

Controls the visibility of a trace. When set to Blank, traces do not display nor appear on printouts but are otherwise unaffected. They may be queried and markers may be placed on them.

Key Path	Trace/Detector
Mode	All except SA and BASIC
Remote Command	:TRACe [1] 2 3 :MONitor:DISPlay[:STATe] ON OFF 0 1 :TRACe [1] 2 3 :MONitor:DISPlay[:STATe]?
Example	TRAC:MON:DISP ON TRAC:MON:DISP?
Preset	ON OFF OFF
State Saved	Saved in instrument state.
Range	Show Blank
Initial S/W Revision	Prior to A.02.00

Detector

Accesses a menu of functions that enable you to control the detectors for the current measurement. The following choices are available:

- **Auto** – the detector selected depends on marker functions, trace functions, average type, and the trace averaging function. See "[Auto](#)" on page 2115.
- **Normal** – the detector determines the peak of the CW-like signals, and it yields alternating maximums and minimums of noise-like signals. This is also referred to as Rosenfell detection.
- **Average** – the detector determines the average of the signal within the sweep points. The averaging method depends upon the Average Type selection (voltage, power or log scales).
- **Peak** – the detector determines the maximum of the signal within the sweep points.
- **Sample** – the detector indicates the instantaneous level of the signal at the center of the sweep points represented by each display point.
- **Negative Peak** – the detector determines the minimum of the signal within the sweep points.

In swept analysis, the time interval of the data collection for the display sweep points also represents a frequency interval. In FFT analysis, the sweep points represent just a frequency interval. The detector determines the relationship between the spectrum computed by the FFT and the single data point displayed for the sweep points.

Key Path	Trace/Detector
Mode	All except SA and BASIC
Remote Command	<code>[:SENSe] :MONitor :DETector :TRACe AVERAge NEGative NORMal POSitive SAMPle [:SENSe] :MONitor :DETector :TRACe?</code>
Example	MON:DET:TRAC NORM MON:DET:TRAC?
Notes	The query returns a name that corresponds to the detector type as shown below. String Returned - Definition <ul style="list-style-type: none"> • NORM - Normal • AVER - Average • POS - Peak • SAMP - Sample • NEG - Negative Peak
Couplings	When the Detector choice is Auto, the detector selected depends on average type.
Preset	NORMal
State Saved	Saved in instrument state.
Range	Normal Average(RMS) Peak Sample Negative Peak
Backwards Compatibility SCPI	<code>[:SENSe] :MONitor :DETector [:FUNction]</code>
Initial S/W Revision	Prior to A.02.00

Auto

Sets the detector for the currently selected trace to Auto. When the detector choice is Auto, the analyzer selects the detector. The selected detector depends on marker functions, trace functions, and trace averaging functions for the current measurement.

Key Path	Trace/DetectorTrace/Detector, Detector
Mode	All except SA and BASIC
Remote Command	<code>[:SENSe] :MONitor :DETECTOR :AUTO ON OFF 1 0</code> <code>[:SENSe] :MONitor :DETECTOR :AUTO ?</code>
Example	<code>MON:DET:AUTO OFF</code> <code>MON:DET:AUTO ?</code>
Couplings	When the Detector choice is Auto, the detector selected depends on average state and trace type.
Preset	ON
State Saved	Saved in instrument state.
Range	Auto Man
Initial S/W Revision	Prior to A.02.00

Clear Trace

Clears the selected trace from the display.

Key Path	Trace/Detector
Mode	All except SA and BASIC
Remote Command	<code>:TRACe :MONitor :CLEAr [TRACE1] TRACE2 TRACE3</code>
Example	<code>TRAC:MON:CLE</code>
Initial S/W Revision	Prior to A.02.00

Mode	All except SA and BASIC
Remote Command	<code>:DISPlay :MONitor :VIEW :WINDow :TRACe [1] 2 3 :CLEAr</code>
Example	<code>DISP:MON:VIEW:WIND:TRAC:CLE</code>
Initial S/W Revision	Prior to A.02.00

Clear All Traces

Clears all traces from the display.

Key Path	Trace/Detector
Mode	All except SA and BASIC

Remote Command	:TRACe:MONitor:CLEar:ALL
Example	TRAC:MON:CLE:ALL
Backwards Compatibility SCPI	:DISPlay:MONitor:VIEW:WINDow:TRACe:CLEar:ALL
Initial S/W Revision	Prior to A.02.00

Trigger

See ["Trigger" on page 412](#)

Free Run

See ["Free Run " on page 419](#)

Video

See ["Video \(IF Envelope\) " on page 420](#)

Trigger Level

See ["Trigger Level " on page 420](#)

Trig Slope

See ["Trig Slope " on page 421](#)

Trig Delay

See ["Trig Delay " on page 422](#)

Line

See ["Line " on page 2087](#)

Trig Slope

See ["Trig Slope " on page 2087](#)

Trig Delay

See ["Trig Delay " on page 424](#)

External 1

See ["External 1 " on page 2099](#)

Trigger Level

See ["Trigger Level " on page 2099](#)

Trig Slope

See ["Trig Slope " on page 2100](#)

Trig Delay

See ["Trig Delay " on page 427](#)

External 2

See ["External 2 " on page 2101](#)

Trigger Level

See ["Trigger Level "](#) on page 2101

Trig Slope

See ["Trig Slope "](#) on page 2102

Trig Delay

See ["Trig Delay "](#) on page 429

RF Burst

See ["RF Burst "](#) on page 2102

Absolute Trigger

See ["Absolute Trigger Level"](#) on page 2103

Relative Trigger

See ["Relative Trigger Level"](#) on page 2092

Trig Slope

See ["Trigger Slope "](#) on page 2104

Trig Delay

See ["Trig Delay "](#) on page 433

Periodic Timer

See ["Periodic Timer \(Frame Trigger\) "](#) on page 2094

Period

See ["Period "](#) on page 2095

Offset

See ["Offset "](#) on page 2096

Reset Offset Display

See ["Reset Offset Display "](#) on page 2098

Sync Source

See ["Sync Source "](#) on page 2098

Off

See ["Off "](#) on page 2099

External 1

See "External 1 " on page 2099

Trigger Level

See "Trigger Level " on page 2099

Trig Slope

See "Trig Slope " on page 2100

External 2

See "External 2 " on page 2101

Trigger Level

See "Trigger Level " on page 2101

Trig Slope

See "Trig Slope " on page 2102

RF Burst

See "RF Burst " on page 2102

Absolute Trigger

See "Absolute Trigger Level" on page 2103

Trig Slope

See "Trigger Slope " on page 2104

Trig Delay

See "Trig Delay" on page 443

Auto/Holdoff

See "Auto/Holdoff " on page 444

Auto Trig

See "Auto Trig " on page 444

Trig Holdoff

See "Trig Holdoff " on page 445

User Preset

Accesses a menu that gives you the following three choices:

- User Preset – recalls a state previously saved using the Save User Preset function.
- User Preset All Modes – presets all of the modes in the analyzer
- Save User Preset– saves the current state for the current mode

Key Path	Front-panel key
Backwards Compatibility Notes	<p>User Preset is actually loading a state, and in legacy analyzers, it was possible to load a state without affecting the trace data, limit lines or correction data. Similarly it was possible to do a User Preset without affecting the trace data, limit lines or correction data.</p> <p>In the X-Series, “state” always includes all of this data; so whenever state is loaded, or User Preset is executed, all of the traces, limit lines and corrections are affected. Although this differs from previous behavior, it is desirable behavior, and should not cause adverse issues for users.</p> <p>On ESA and PSA, User Preset affected the entire instrument’s state. In the X-Series, User Preset only recalls the state for the active mode. There is a User Preset file for each mode. User Preset can never cause a mode switch as it can in legacy analyzers. If you want to recall all modes to their user preset file state, you will need to do a User Preset after mode switching into each mode.</p> <p>User Preset recalls mode state which can now include data like traces; whereas on ESA and PSA, User Preset did not affect data.</p>
Initial S/W Revision	Prior to A.02.00

User Preset

User Preset sets the state of the currently active mode back to the state that was previously saved for this mode using the Save User Preset menu key or the SCPI command, SYST:PRES:USER:SAV. It not only recalls the Mode Preset settings, but it also recalls all of the mode persistent settings, and the Input/Output system setting that existed at the time Save User Preset was executed.

If a Save User Preset has not been done at any time, User Preset recalls the default user preset file for the currently active mode. The default user preset files are created if, at power-on, a mode detects there is no user preset file. There will never be a scenario when there is no user preset file to restore. For each mode, the default user preset state is the same state that would be saved if a Save User Preset is performed in each mode right after doing a Restore Mode Default and after a Restore Input/Output Defaults.

The User Preset function does the following:

- Aborts the currently running measurement.
- Sets the mode State to the values defined by Save User Preset.
- Makes the saved measurement for the currently running mode the active measurement.
- Brings up the saved menu for the power-on mode.
- Clears the input and output buffers.
- Sets the Status Byte to 0.

Key Path	User Preset
Remote Command	:SYSTem:PRESet:USER
Example	:SYST:PRES:USER:SAVE:SYST:PRES:USER
Notes	:SYST:PRES:USER:SAVE is used to save the current state as the user preset state. Clears all pending OPC bits. The Status Byte is set to 0. Pressing the User Preset front-panel key while already in the User Preset menu will cause the User Preset to get executed
Couplings	A user preset will cause the currently running measurement to be aborted and cause the saved measurement to be active. Recalling a User Preset file has the same issues that recalling a Save State file has. Some settings may need to be limited and therefore re-coupled, since the capabilities of the mode may have changes when the User Preset file was last saved.
Initial S/W Revision	Prior to A.02.00

User Preset All Modes

Recalls all of the User Preset files for each mode, switches to the power-on mode, and activates the saved measurement from the power-on mode User Preset file.

NOTE

When the instrument is secured, all of the user preset files are converted back to their default user preset files.

The User Preset function does the following:

- Aborts the currently running measurement.
- Switches the Mode to the power-on mode.
- Restores the User Preset files for each mode.
- Makes the saved measurement for the power-on mode the active measurement.
- Brings up the saved menu for the power-on mode.
- Clears the input and output buffers.
- Sets the Status Byte to 0.

Key Path	User Preset
Remote Command	:SYSTem:PRESet:USER:ALL
Example	:SYST:PRES:USER:SAVE:SYST:PRES:USER:ALL
Notes	Clears all pending OPC bits. The Status Byte is set to 0. :SYST:PRES:USER:SAVE is used to save the current state as the user preset state.
Couplings	A user preset will cause the currently running measurement to be aborted, cause a mode switch to the power-on mode, and cause the saved measurement to be active in the power-on mode. Recalling a User Preset file has the same issues that recalling a Save State file has. Some settings may need to be limited and therefore re-coupled, since the capabilities of the mode may have changes when the User Preset file was last saved.
Initial S/W Revision	Prior to A.02.00

Save User Preset

Saves the currently active mode and its State. You can recall this User Preset file by pressing the User Preset menu key or sending the SYST:PRES:USER remote command. This same state is also saved by the Save State function.

Key Path	User Preset
Remote Command	:SYSTem:PRESet:USER:SAVE
Example	:SYST:PRES:USER:SAVE
Notes	:SYST:PRES:SAVE creates the same file as if the user requested a *SAV or a MMEM:STOR:STAT, except User Preset Save does not allow the user to specify the filename or the location of the file.
Initial S/W Revision	Prior to A.02.00

View/Display

Accesses a menu of functions that enable you to control certain functions related to the display of the analyzer.

The available views and related commands depend on the currently-selected mode. This section includes the following topics:

- ["View for all modes except MSR, 1xEV-DO, LTE-Advanced FDD/TDD" on page 2123](#), LTE-Advanced FDD/TDD
- ["1xEV-DO Mode View" on page 2124](#)
- ["MSR and LTE-Advanced FDD/TDD Mode Views" on page 2124](#)
- ["View Selection by Name \(MSR and LTE-Advanced FDD/TDD mode only\)" on page 2125](#)
- ["View Selection by Number \(MSR and LTE-Advanced FDD/TDD mode only\)" on page 2125](#)

View for all modes except MSR, 1xEV-DO, LTE-Advanced FDD/TDD

When the current mode is **not** MSR, LTE-Advanced FDD/TDD or 1xEV-DO, there is a single trace view for this measurement, as shown below:

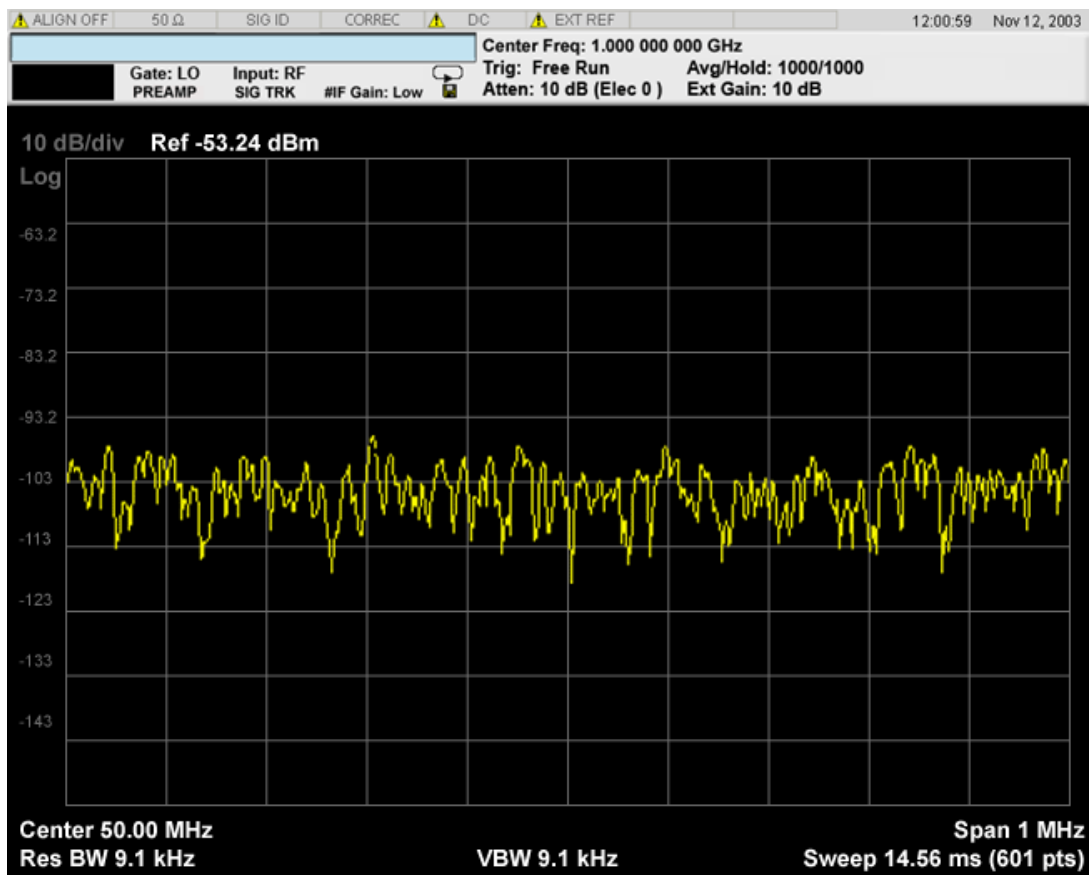

1xEV-DO Mode View

When the current mode is 1xEV-DO, a single view is available, as shown in the example below:

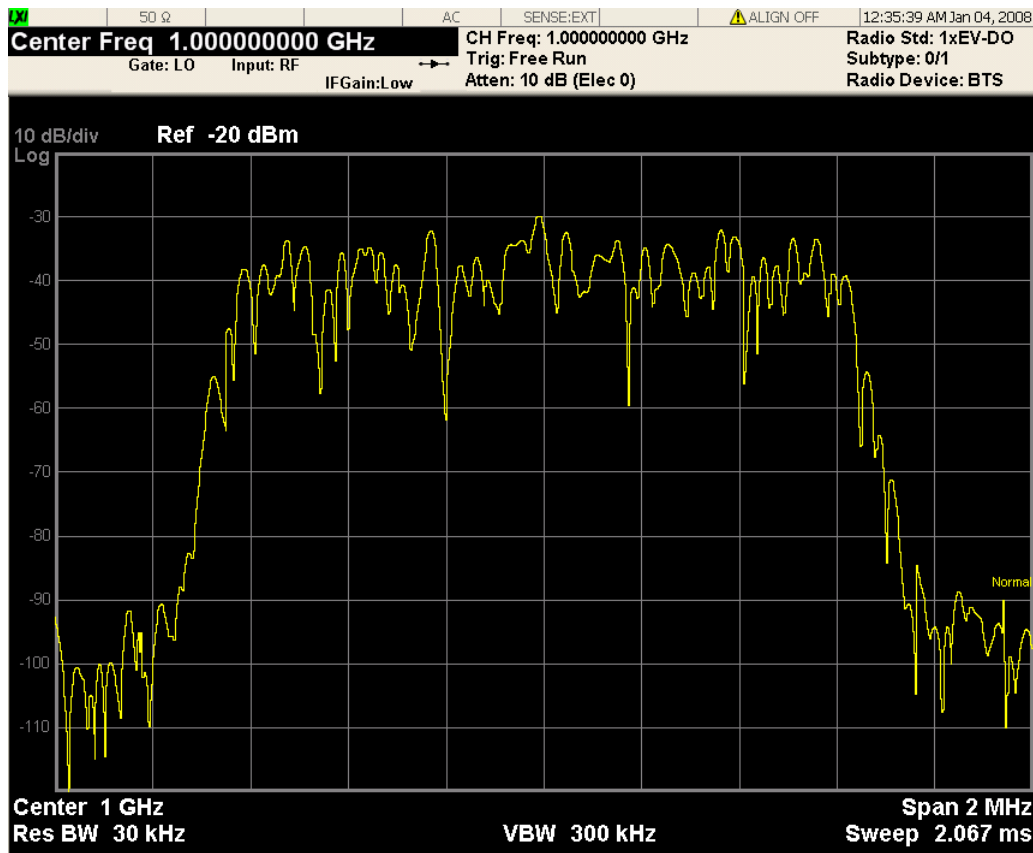

The measurement has no results, but has a number of features that make it flexible and simple to use.

MSR and LTE-Advanced FDD/TDD Mode Views

When the current mode is MSR and LTE-Advanced FDD/TDD, there are two views, Result Trace and Carrier Info, as described in the table below. The Result Trace view is the same as the common Monitor Spectrum view in other modes. Carrier Info is available on the spectrum trace.

Result Trace	<p>The spectrum trace and power bars are displayed in the upper window. Carrier and offset powers are summarized in the lower window.</p> <p>For more details, see Result Trace (MSR and LTE-Advanced FDD/TDD mode only).</p>
Carrier Info	<p>Carrier center frequency can be displayed in either offset or absolute frequency depending on Carrier Freq. The table can be scrolled by Select Carrier in the Config Carriers menu. The highlighted row changes as Select Carrier is changed. The highlighted row and Select Carrier are not coupled.</p> <p>For more details, see Carrier Info (MSR and LTE-Advanced FDD/TDD mode only).</p>

View Selection by Name (MSR and LTE-Advanced FDD/TDD mode only)

Key Path	Display
Mode	MSR, LTEAFDD, LTEATDD
Remote Command	:DISPlay:MONitor:VIEW[:SElect] RTRace CINformation :DISPlay:MONitor:VIEW[:SElect]?
Example	DISP:MON:VIEW RTR DISP:MON:VIEW?
Preset	RTRace
State Saved	Saved in instrument state
Range	Power Results Carrier Info
Initial S/W Revision	A.10.00

View Selection by Number (MSR and LTE-Advanced FDD/TDD mode only)

Key Path	DISP:MON:VIEW
Mode	MSR, LTEAFDD, LTEATDD
Remote Command	:DISPlay:MONitor:VIEW:NSElect <integer> :DISPlay:MONitor:VIEW:NSElect?
Example	DISP:MON:VIEW:NSEL 1 DISP:MON:VIEW:NSEL?
Preset	1
State Saved	Saved in instrument state
Min	1
Max	2
Initial S/W Revision	A.10.00

Key Path	Front-panel key
Initial S/W Revision	Prior to A.02.00

Display

The Display menu is common to most measurements, and is used for configuring items on the display. Some Display menu settings apply to all the measurements in a mode, and some only to the current measurement. Those under the System Display Settings key apply to all measurements in all modes.

Key Path	Display
Key Path	View/Display
Initial S/W Revision	Prior to A.02.00

Annotation

Turns on and off various parts of the display annotation. The annotation is divided up into four categories:

1. Meas Bar: This is the measurement bar at the top of the screen. It does not include the settings panel or the Active Function. Turning off the Meas Bar turns off the settings panel and the Active Function. When the Meas Bar is off, the graticule area expands to fill the area formerly occupied by the Meas Bar.
2. Screen Annotation: this is the annotation and annunciation around the graticule, including any annotation on lines (such as the display line, the threshold line, etc.) This does NOT include the marker number or the N dB result. When off, the graticule expands to fill the entire graticule area.
3. Trace annotation: these are the labels on the traces, showing their detector (or their math mode).
4. Active Function annotation: this is the active function display in the meas bar, and all of the active function values displayed on softkeys.

See the figure below. Each type of annotation can be turned on and off individually.

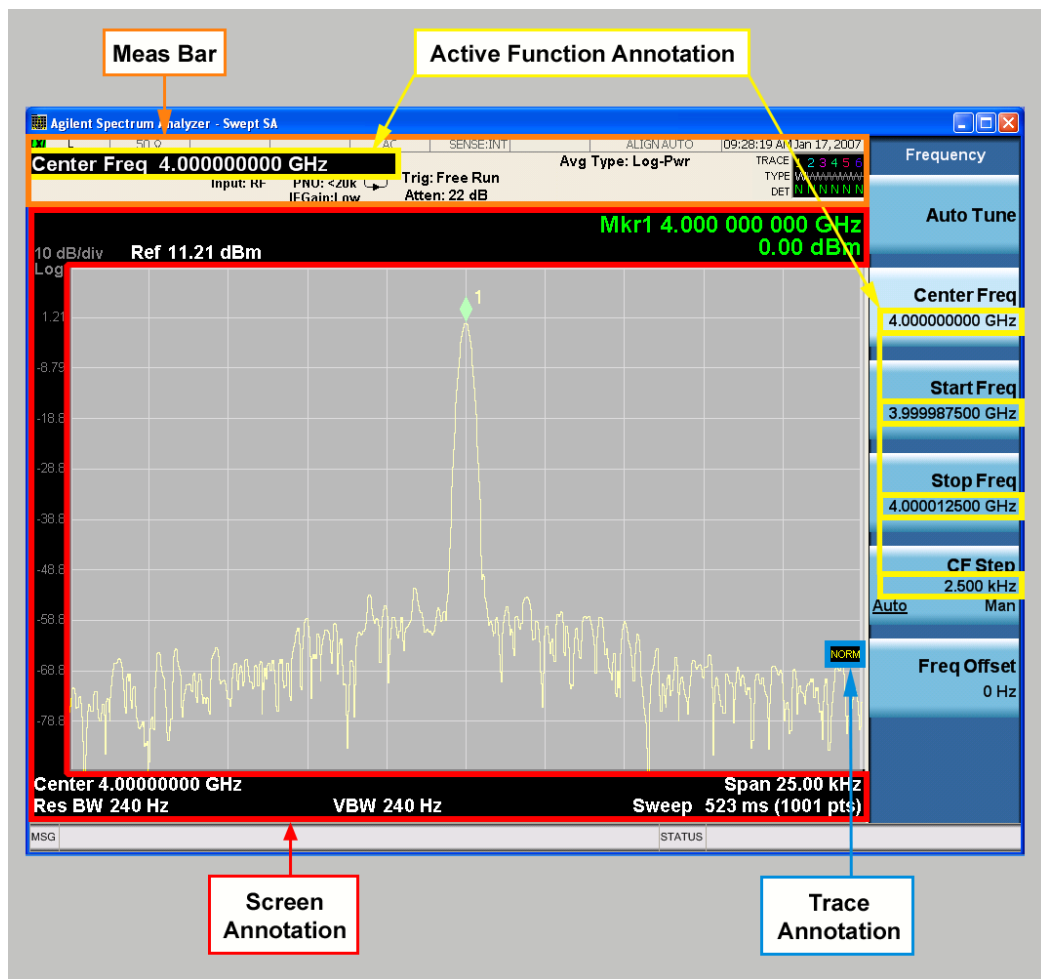

Key Path	View/Display, Display
Initial S/W Revision	Prior to A.02.00

Meas Bar On/Off

This function turns the Measurement Bar on and off, including the settings panel. When off, the graticule area expands to fill the area formerly occupied by the Measurement Bar.

Key Path	View/Display, Display, Annotation
Remote Command	:DISPlay:ANNotation:MBAR[:STATe] OFF ON 0 1 :DISPlay:ANNotation:MBAR[:STATe]?
Example	DISP:ANN:MBAR OFF
Dependencies	Grayed out and forced to OFF when System Display Settings, Annotation is set to Off.
Preset	On This should remain Off through a Preset when System DisplaySettings, Annotation is set to Off.
State Saved	Saved in instrument state.
Initial S/W Revision	Prior to A.02.00

Screen

This controls the display of the annunciation and annotation around the graticule, including any annotation on lines (such as the display line, the threshold line, etc.) and the y-axis annotation. This does NOT include marker annotation (or the N dB result). When off, the graticule expands to fill the entire graticule area, leaving only the 1.5% gap above the graticule as described in the Trace/Detector chapter.

Key Path	View/Display, Display, Annotation
Remote Command	:DISPlay:ANNotation:SCReen[:STATe] OFF ON 0 1 :DISPlay:ANNotation:SCReen[:STATe]?
Example	DISP:ANN:SCR OFF
Dependencies	Grayed-out and forced to OFF when System Display Settings, Annotation is set to Off.
Preset	On This should remain Off through a Preset when System DisplaySettings, Annotation is set to Off
State Saved	Saved in instrument state.
Initial S/W Revision	Prior to A.02.00

Active Function Values On/Off

Turns on and off the active function display in the Meas Bar, and all of the active function values displayed on the softkeys.

Note that all of the softkeys that have active functions have these numeric values blanked when this function is on. This is a security feature..

16 Monitor Spectrum Measurement
View/Display

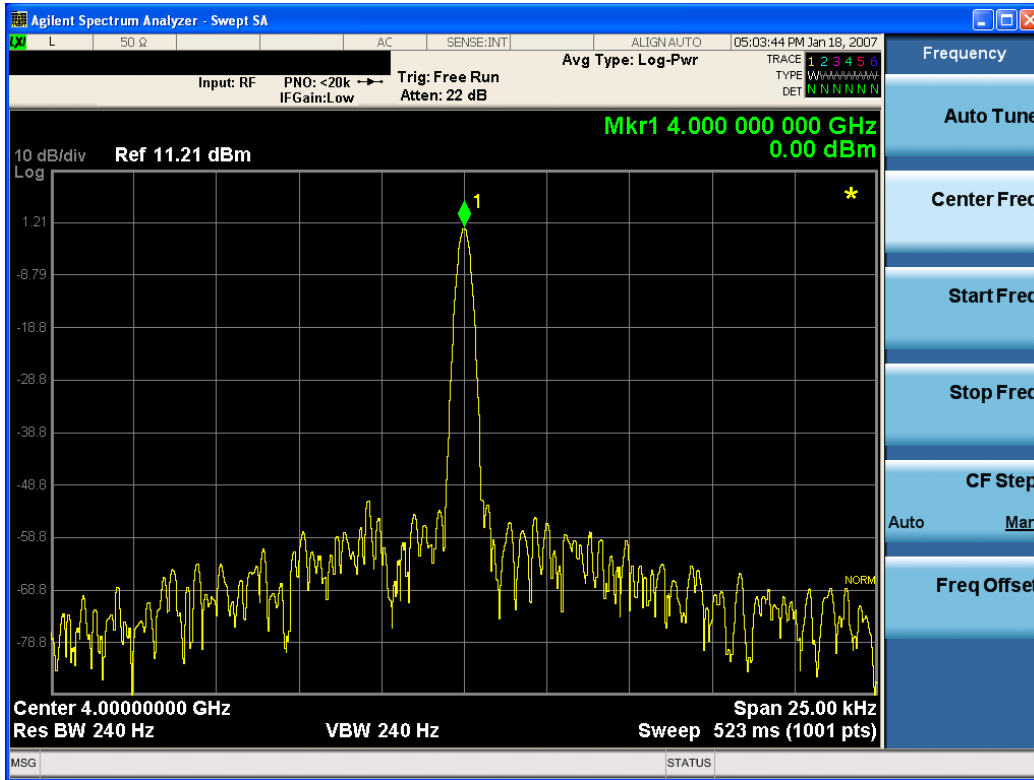

Key Path	View/Display, Display, Annotation
Remote Command	:DISPlay:ACTivefunc[:STATE] ON OFF 1 0 :DISPlay:ACTivefunc[:STATE] ?
Example	DISP:ACT OFF
Dependencies	Grayed out and forced to OFF when System Display Settings, Annotation is set to Off.
Preset	On This should remain Off through a Preset when System DisplaySettings, Annotation is set to Off
State Saved	Saved in instrument state.
Initial S/W Revision	Prior to A.02.00

Title

Displays menu keys that enable you to change or clear a title on your display.

Key Path	View/Display, Display
Initial S/W Revision	Prior to A.02.00

Change Title

Writes a title into the "measurement name" field in the banner, for example, "Swept SA".

Press Change Title to enter a new title through the alpha editor. Press Enter or Return to complete the entry. Press ESC to cancel the entry and preserve your existing title.

The display title will replace the measurement name. It remains for this measurement until you press Change Title again, or you recall a state, or a Preset is performed. A title can also be cleared by pressing Title, Clear Title.

NOTE

Notice the inclusion of the <measurement> parameter in the command below. Because each measurement remembers the Display Title, the command must be qualified with the measurement name. For the Swept SA measurement this is not the case; no <measurement> parameter is used when changing the Display Title for the Swept SA measurement.

Key Path	View/Display, Display, Title
Mode	All
Remote Command	:DISPlay:<measurement>:ANNotation:TITLe:DATA <string> :DISPlay:<measurement>:ANNotation:TITLe:DATA?
Example	DISP:ANN:TITL:DATA "This Is My Title" This example is for the Swept SA measurement in the Spectrum Analyzer mode. The SANalyzer <measurement> name is not used. DISP:ACP:ANN:TITL:DATA "This Is My Title" This example is for Measurements other than Swept SA. Both set the title to: This Is My Title
Notes	Pressing this key cancels any active function. When a title is edited the previous title remains intact (it is not cleared) and the cursor goes at the end so that characters can be added or BKSP can be used to go back over previous characters.
Preset	No title (measurement name instead)
State Saved	Saved in instrument state.
Initial S/W Revision	Prior to A.02.00

Clear Title

Clears a title from the front-panel display. Once cleared, the title cannot be retrieved. After the title is cleared, the current Measurement Name replaces it in the title bar.

Key Path	View/Display, Display, Title
Example	The following commands clear the title and restore the measurement's original title: DISP:ANN:TITL:DATA "" This example is for the Swept SA measurement in the Spectrum Analyzer mode. The SANalyzer <measurement> name is not used. DISP:ACP:ANN:TITL:DATA "" This example is for ACP; in measurements other than Swept SA the measurement name is required.
Notes	Uses the :DISPlay:<measurement>:ANNotation:TITLe:DATA <string> command with an empty string (in the Swept SA, the <measurement> is omitted).
Preset	Performed on Preset.
Initial S/W Revision	Prior to A.02.00

Graticule

Pressing Graticule turns the display graticule On or Off. It also turns the graticule y-axis annotation on and off.

Key Path	View/Display, Display
Remote Command	:DISPlay:WINDow[1]:TRACe:GRATicule:GRID[:STATe] OFF ON 0 1 :DISPlay:WINDow[1]:TRACe:GRATicule:GRID[:STATe]?
Example	DISP:WIND:TRAC:GRAT:GRID OFF
Notes	The graticule is the set of horizontal and vertical lines that make up the grid/divisions for the x-axis and y-axis.
Preset	On
State Saved	Saved in instrument state
Initial S/W Revision	Prior to A.02.00

System Display Settings

These settings are "Mode Global" – they affect all modes and measurements and are reset only by Restore Misc Defaults or Restore System Defaults under System.

Key Path	View/Display, Display
Initial S/W Revision	Prior to A.02.00

Annotation Local Settings

This is a Mode Global override of the meas local annotation settings. When it is All Off, it forces ScreenAnnotation, Meas Bar, Trace, and Active Function Values settings to be OFF for all measurements in all modes. This provides the security based "annotation off" function of previous analyzers; hence it uses the legacy SCPI command.

When it is All Off, the Screen, Meas Bar, Trace, and Active Function Values keys under the Display, Annotation menu are grayed out and forced to Off. When Local Settings is selected, you are able to set the local annotation settings on a measurement by measurement basis.

Key Path	View/Display, Display, System Display Settings
Remote Command	:DISPlay:WINDow[1]:ANNotation[:ALL] OFF ON 0 1 :DISPlay:WINDow[1]:ANNotation[:ALL]?
Example	:DISP:WIND:ANN OFF
Preset	On (Set by Restore Misc Defaults)
State Saved	Not saved in instrument state.
Backwards Compatibility Notes	The WINDow parameter and optional subopcode is included for backwards compatibility but ignored – all windows are equally affected.
Initial S/W Revision	Prior to A.02.00

Themes

Accesses a menu of functions that enable you to choose the theme to be used when saving the screen image.

The **Themes** option is the same as the **Themes** option under the **Display** and **Page Setup** dialogs. It allows you to choose between themes to be used when saving the screen image.

Key Path	Save, Screen Image
Remote Command	:MMEMory:STORe:SCReen:THEMe TDColor TDMonochrome FCOLor FMONochrome :MMEMory:STORe:SCReen:THEMe?
Example	:MMEM:STOR:SCR:THEM TDM
Preset	3D Color; Is not part of Preset, but is reset by Restore Misc Defaults or Restore System Defaults All and survives subsequent running of the modes.
Readback	3D Color 3D Mono Flat Color Flat Mono
Backwards Compatibility Notes	In ESA and PSA we offer the choice of "Reverse Bitmap" or "Reverse Metafile" when saving screen images. This is much like the "Flat Color" theme available in X-Series. Also, if you selected Reverse Bitmap AND a black & white screen image, that would be much like "Flat Monochrome". In other words, each of the X-Series themes has a similar screen image type in ESA/PSA. But they are not identical.
Initial S/W Revision	Prior to A.02.00

3D Color

Selects a standard color theme with each object filled, shaded and colored as designed.

Key Path	Save, Screen Image, Themes
Example	MMEM:STOR:SCR:THEM TDC
Readback	3D Color
Initial S/W Revision	Prior to A.02.00

3D Monochrome

Selects a format that is like 3D color but shades of gray are used instead of colors.

Key Path	Save, Screen Image, Themes
Example	MMEM:STOR:SCR:THEM TDM
Readback	3D Mono
Initial S/W Revision	Prior to A.02.00

Flat Color

Selects a format that is best when the screen is to be printed on an ink printer.

Key Path	Save, Screen Image, Themes
Example	MMEM:STOR:SCR:THEM FCOL
Readback	Flat Color
Initial S/W Revision	Prior to A.02.00

Flat Monochrome

Selects a format that is like Flat Color. But only black is used (no colors, not even gray), and no fill.

Key Path	Save, Screen Image, Themes
Example	MMEM:STOR:SCR:THEM FMON
Readback	Flat Mono
Initial S/W Revision	Prior to A.02.00

Backlight

Accesses the display backlight on/off keys. This setting may interact with settings under the Windows "Power" menu.

When the backlight is off, pressing ESC, TAB, SPACE, ENTER, UP, DOWN, LEFT, RIGHT, DEL, BKSP, CTRL, or ALT turns the backlight on without affecting the application. Pressing any other key will turn backlight on and could potentially perform the action as well.

Key Path	View/Display, Display, System Display Settings
Remote Command	:DISPlay:BACKlight ON OFF :DISPlay:BACKlight?
Preset	ON (Set by Restore Misc Defaults)
Initial S/W Revision	Prior to A.02.00

Backlight Intensity

An active function used to set the backlight intensity. It goes from 0 to 100 where 100 is full on and 0 is off. This value is independent of the values set under the Backlight on/off key.

Key Path	View/Display, Display, System Display Settings
Remote Command	:DISPlay:BACKlight:INTensity <integer> :DISPlay:BACKlight:INTensity?
Example	DISP:BACK:INT 50

Preset	100 (Set by Restore Misc Defaults)
Min	0
Max	100
Initial S/W Revision	Prior to A.02.00

17 Waveform Measurement

The waveform measurement is a generic measurement for viewing the input signal waveforms in the time domain. This measurement represents how the instrument performs the zero span functionality found in traditional spectrum analyzers. For more details, see ["Waveform Measurement Description" on page 2138](#) below.

This topic contains the following sections:

["Measurement Commands for Waveform" on page 2136](#)

["Remote Command Results for the Waveform Measurement" on page 2137](#)

Measurement Commands for Waveform

The general functionality of CONFigure, INITiate, FETCh, MEASure, and READ are described at this section.

:CONFigure:WAVeform

:CONFigure:WAVeform:NDEFault

:INITiate:WAVeform

:FETCh:WAVeform[n]?

:MEASure:WAVeform[n]?

:READ:WAVeform[n]?

For more measurement related commands, see the SENSE subsystem, and the section ["Remote Measurement Functions" on page 2205](#).

Remote Command Results for the Waveform Measurement

The following table denotes the returned results from the FETCh|MEASure|READ commands:

n	Results Returned
0	Returns unprocessed I/Q trace data, as a series of trace point values, in volts. The I values are listed first in each pair, using the 0 through even-indexed values. The Q values are the odd-indexed values.
1	<p>Returns the following scalar results:</p> <ol style="list-style-type: none"> 1. Sample Time is a floating point number representing the time between samples when using the trace queries (n=0, 2, and so forth). 2. Mean Power is the mean power (in dBm). This is the power across the entire trace. If averaging is on, the power is for the latest acquisition. 3. Mean Power Averaged is the power (in dBm) for N averages, if averaging is on. This is the power across the entire trace. If averaging is on, the power is for the latest acquisition. If averaging is off, the value of the mean power averaged is the same as the value of the mean power. 4. Number of samples is the number of data points in the captured signal. This number is useful when performing a query on the signal (i.e. when n=0, 2, etc.). 5. Peak-to-mean ratio has units of dB. This is the ratio of the maximum signal level to the mean power. Valid values are only obtained with averaging turned off. If averaging is on, the peak-to-mean ratio is calculated using the highest peak value, rather than the displayed average peak value. 6. Maximum value is the maximum of the most recently acquired data (in dBm). 7. Minimum value is the minimum of the most recently acquired data (in dBm).
2	Returns trace point values of the entire captured signal envelope trace data. These data points are floating point numbers representing the power of the signal (in dBm). There are N data points, where N is the number of samples. The period between the samples is defined by the sample time.

Waveform Measurement Description

Also available under the basic Waveform measurement is an I/Q window, which shows the I and Q signal waveforms in parameters of voltage versus time to disclose the voltages that comprise the complex modulated waveform of a digital signal.

The waveform measurement can also be used to perform general purpose power measurements to a high degree of accuracy.

Key Path	Front-panel key
Initial S/W Revision	Prior to A.02.00

AMPTD Y Scale

Accesses a menu of functions that enable you to set the vertical scale parameters.

Key Path	Front-panel key
Initial S/W Revision	Prior to A.02.00

Ref Value (RF Envelope View)

Sets the Y Scale reference value (in dBm) when the RF Envelope View is active. By default, the measurement determines the reference value with Auto Scaling. Entering a reference value manually turns Auto Scaling off.

Key Path	AMPTD Y Scale
Mode	BASIC, PNOISE, WCDMA, C2K, GSM, WIMAXOFDMA, TDSCDMA, 1XEVD0, DVB, DTMB, ISDBT, CMMB, LTE, LTETDD, DCATV, WLAN,LTEATDD, LTEAFDD
Remote Command	:DISPlay:WAVeform:VIEW[1]:WINDow[1]:TRACe:Y[:SCALE]:RLEVel <ampl> :DISPlay:WAVeform:VIEW[1]:WINDow[1]:TRACe:Y[:SCALE]:RLEVel?
Example	DISP:WAV:VIEW:WIND:TRAC:Y:RLEV -50 dBm DISP:WAV:VIEW:WIND:TRAC:Y:RLEV?
Notes	You must be in the mode that includes Waveform measurement to use this command. Use INSTRument:SElect to set the mode.
Couplings	When Auto Scaling is On, this value is automatically determined by the measurement result. When you set a value manually, Auto Scaling automatically changes to Off.
Preset	10.00 dBm
State Saved	Saved in instrument state.
Range	-250.00 dBm to 250.00 dBm
Min	-250.00 dBm
Max	250.00 dBm
Initial S/W Revision	Prior to A.02.00
Modified at S/W Revision	A.03.00

Attenuation

This menu controls the attenuator functions and interactions between the attenuation system components.

There are two attenuator configurations in the X-Series. One is a dual attenuator configuration consisting of a mechanical attenuator and an optional electronic attenuator. The other configuration uses a single attenuator with combined mechanical and electronic sections that controls all the attenuation functions. Different models in the X-Series come with different configurations.

See "[Dual Attenuator Configurations:](#)" on page 2140

See "Single Attenuator Configuration:" on page 2141

Most Attenuation settings are the same for all measurements – they do not change as you change measurements. Settings like these are called “Meas Global” and are unaffected by Meas Preset.

Key Path	AMPTD Y Scale
Scope	Meas Global
Dependencies	In measurements that support the I/Q inputs, this key is unavailable when I/Q is the selected input, and is replaced by the Range key in that case.
Readback Line	Contains a summary in [] brackets of the current total attenuation. See the descriptions of the , " (Mech) Atten " on page 2141, and " Enable Elec Atten " on page 2143 keys for more detail on the contributors to the total attenuation. Note that when "Pre-Adjust for Min Clip" is on, this value can change at the start of every measurement.
Initial S/W Revision	Prior to A.02.00
Modified at S/W Revision	A.03.00

Dual Attenuator Configurations:

Configuration 1: Mechanical attenuator + optional electronic attenuator

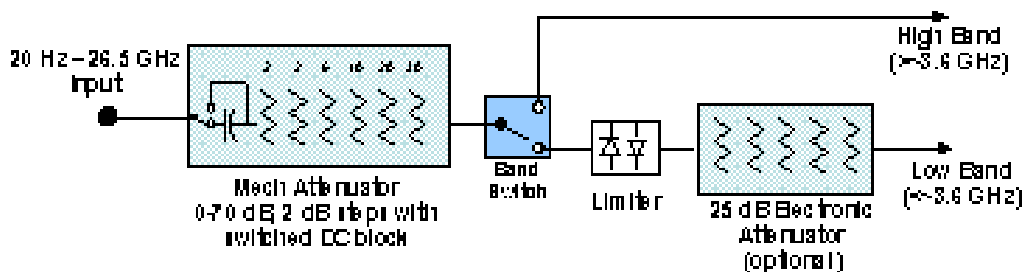

Configuration 2: Mechanical attenuator, no optional electronic attenuator

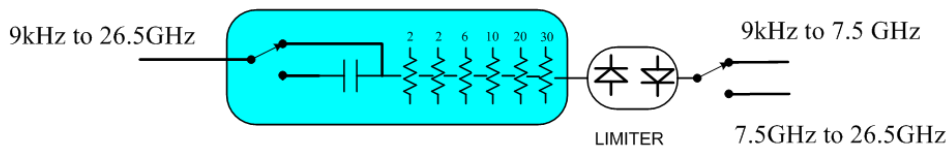

(note that Configuration 2 is not strictly speaking a dual-section attenuator, since there is no electronic section available. However, it behaves exactly like Configuration 1 without the Electronic Attenuator option EA3, therefore for the sake of this document it is grouped into the “Dual Attenuator” configuration)

Single Attenuator Configuration:

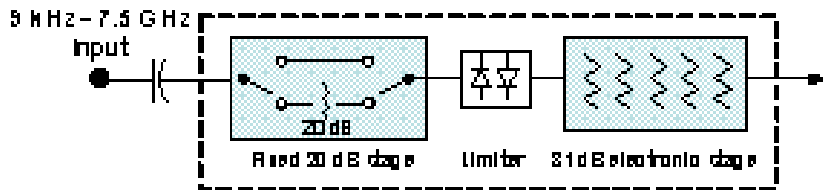

You can tell which attenuator configuration you have by pressing the Attenuation key, which (in most Modes) opens the Attenuation menu. If the first key in the Attenuation menu says Mech Atten you have the dual attenuator configuration. If the first key says Atten you have the single attenuator configuration.

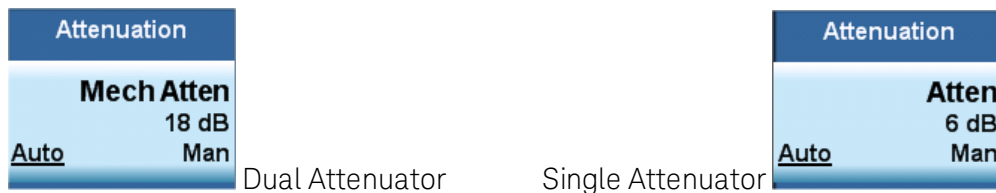

In the single attenuator configuration, you control the attenuation with a single control, as the fixed stage has only two states. In the dual attenuator configuration, both stages have significant range so you are given separate control of the mechanical and electronic attenuator stages.

When you have the dual attenuator configuration, you may still have only a single attenuator, because unless option EA3 (the Electronic Attenuator option) is available, and you purchase it, you will have only the mechanical attenuator.

(Mech) Atten

This key is labeled Mech Atten in dual attenuator models and Atten in single attenuator models. In the dual attenuator configuration, this key only affects the mechanical attenuator.

This key lets you modify the attenuation applied to the RF input signal path. This value is normally auto coupled to the Ref Level, the Internal Preamp Gain, any External Gain that is entered, and the Max Mixer Level, as described in the table below.

See "[Attenuator Configurations and Auto/Man](#)" on page 2143

Key Path	AMPTD Y Scale, Attenuation
Remote Command	<pre>[:SENSe]:POWer[:RF]:ATTenuation <rel_amp1> [:SENSe]:POWer[:RF]:ATTenuation? [:SENSe]:POWer[:RF]:ATTenuation:AUTO OFF ON 0 1 [:SENSe]:POWer[:RF]:ATTenuation:AUTO?</pre>
Example	<p>POW:ATT 20</p> <p>Dual attenuator configuration: sets the mechanical attenuator to 20 dB</p> <p>Single attenuator mode: sets the main attenuation to 20 dB (see below for definition of "main" attenuation).</p> <p>If the attenuator was in Auto, it sets it to Manual.</p>
Dependencies	Some measurements do not support the Auto setting of (Mech) Atten. In these measurements, the

Auto/Man selection is not available, and the Auto/Man line on the key disappears.

In dual attenuator configurations, when the electronic attenuator is enabled, the mechanical attenuator has no auto setting and the Auto/Man line on the key disappears. The state of Auto/Man is remembered and restored when the electronic attenuator is once again disabled. This is described in more detail in the ["Enable Elec Atten" on page 2143](#) key description.

See ["Attenuator Configurations and Auto/Man" on page 2143](#) for more information on the Auto/Man functionality of Attenuation.

Couplings

When (Mech) Atten is in Auto, it uses the following algorithm to determine a value:

If the USB Preamp is connected to USB, use 0 dB.

Otherwise, $Atten = ReferenceLevel + PreAmpGain + ExternalGain - RefLevelOffset - MaxMixerLevel + IF\ Gain$.

Limit this value to be between 6 dB and the Max value. No value below 6 dB can ever be chosen by Auto.

The resulting value is rounded up to the largest value possible given the attenuation step setting. That is, 50.01 dB would change to 60 dB (for a 10 dB attenuation step).

The "IF Gain" term in the equation above is either 0 dB or +10 dB, depending on the settings of FFT IF Gain, Swept IF Gain, max Ref Level and the Auto/Man setting of Mech Atten.

In External Mixing and BBIQ, where the Attenuator is not in the signal path, the Attenuator setting changes as described above when (Mech) Atten is in Auto, but no changes are made to the actual attenuator hardware setting until the input is changed back to the RF Input.

Preset The preset for Mech Attenuation is "Auto."
 The Auto value of attenuation is:
 CXA, EXA, MXA and PXA: 10 dB

State Saved Saved in instrument state

Min 0 dB

The attenuation set by this key cannot be decreased below 6 dB with the knob or step keys. To get to a value below 6 dB it has to be directly entered from the keypad or via SCPI. This protects from adjusting the attenuation to a dangerously small value which can put the instrument at risk of damage to input circuitry. However, if the current mechanical attenuation is below 6 dB it can be increased with the knob and step keys, but not decreased.

Max CXA N9000A-503/507: 50 dB
 CXA N9000A-513/526: 70dB
 EXA: 60 dB
 MXA and PXA: 70 dB

In the single attenuator configuration, the total of ATT and EATT cannot exceed 50 dB, so if the EATT is set to 24 dB first, the main attenuation cannot be greater than 26 dB and will be reduced accordingly; if the main attenuator is set to 40 dB first, EATT cannot be greater than 10 dB.

Initial S/W Revision Prior to A.02.00

Modified at S/W Revision A.03.00

Attenuator Configurations and Auto/Man

As described in the Attenuation key description, there are two distinct attenuator configurations available in the X-Series, the single attenuator and dual attenuator configurations. In dual attenuator configurations, we have the mechanical attenuation and the electronic attenuation, and the current total attenuation is the sum of the electronic + mechanical attenuation. In single attenuator configurations, we refer to the attenuation set using the (Mech) Atten key (or POW:ATT SCPI) as the “main” attenuation; and the attenuation that is set by the SCPI command POW:EATT as the “soft” attenuation (the POW:EATT command is honored even in the single attenuator configuration, for compatibility purposes). Then the current total attenuation is the sum of the main + soft attenuation. See the Elec Atten key description for more on “soft” attenuation.

In the dual attenuator configuration, when the electronic attenuator is enabled, there is no Auto/Man functionality for the mechanical attenuator, and the third line of the key label (the Auto/Man line) disappears:

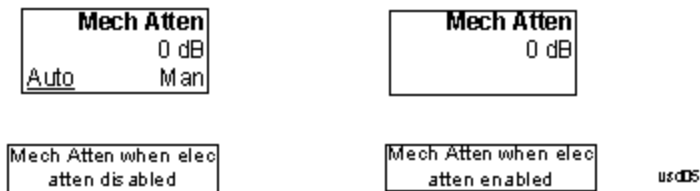

Enable Elec Atten

Enables the Electronic Attenuator.

The electronic attenuator offers finer steps than the mechanical attenuator, has no acoustical noise, is faster, and is less subject to wear. These advantages primarily aid in remote operation and are negligible for front panel use. See ["Using the Electronic Attenuator: Pros and Cons" on page 2145](#) for a detailed discussion of the pros and cons of using the electronic attenuator.

For the single attenuator configuration, for SCPI backwards compatibility, the “soft” attenuation feature replaces the dual attenuator configuration’s electronic attenuator. All the same couplings and limitations apply. See ["Attenuator Configurations and Auto/Man" on page 2143](#)

See ["More Information" on page 2144](#)

Key Path	AMPTD Y Scale, Attenuation
Remote Command	[:SENSe] :POWer [:RF] :EATTenuation :STATE OFF ON 0 1 [:SENSe] :POWer [:RF] :EATTenuation :STATE ?
Example	POW:EATT:STAT ON
Dependencies	This key only appears in Dual Attenuator models with an Electronic Attenuator installed. It does not appear in models with the Single Attenuator configuration, as in the single attenuator configuration there is no “electronic attenuator” there is only a single integrated attenuator (which has both a mechanical and electronic stage). However, in the single attenuator configuration, EATT SCPI commands are accepted for compatibility with other X-series instruments and set a “soft” attenuation as described in "Attenuator Configurations and Auto/Man" on page 2143 . The electronic attenuator (and the “soft” attenuation function provided in single attenuator configurations) is unavailable above 3.6 GHz. Therefore, if the Stop Frequency of the analyzer is > 3.6 GHz then the Enable Elec Atten key will be OFF and grayed out.

	<p>If the Internal Preamp is on, meaning it is set to Low Band or Full, the electronic attenuator (and the “soft” attenuation function provided in single attenuator configurations) is unavailable. In this case the Enable Elec Atten key will be OFF and grayed out.</p> <p>If either of the above is true, if the SCPI command is sent, an error indicating that the electronic attenuator is unavailable will be sent.</p> <p>If the electronic/soft Attenuator is enabled, then the Stop Freq of the analyzer is limited to 3.6 GHz and the Internal Preamp is unavailable.</p> <p>The SCPI-only “soft” electronic attenuation for the single-attenuator configuration is not available in all measurements; in particular, it is not available in the Swept SA measurement.</p>
Couplings	Enabling and disabling the Electronic Attenuator affects the setting of the Mechanical Attenuator (in dual attenuator configurations). This is described in more detail below this table.
Preset	OFF for Swept SA measurement; ON for all other measurements that support the electronic attenuator
State Saved	Saved in instrument state
Initial S/W Revision	Prior to A.02.00
Modified at S/W Revision	A.03.00

More Information

Mechanical Attenuator Transition Rules

When the Electronic Attenuator is enabled, the Mechanical Attenuator transitions to a state that has no Auto function. Below are the rules for transitioning the Mechanical Attenuator. NOTE that the information below ONLY applies to the dual attenuator configurations, and ONLY when the Electronic Attenuator is installed:

When the Electronic Attenuation is enabled from a disabled state:

- The Mechanical Attenuator is initialized to 10 dB (this is its optimal performance setting). You can then set it as desired with SCPI, numeric keypad, step keys, or knob, and it behaves as it normally would in manual mode
- The Auto/Man state of (Mech) Atten is saved
- The Auto/Man line on the (Mech) Atten key disappears and the auto rules are disabled
- The Electronic Attenuator is set to 10 dB less than the previous value of the Mechanical Attenuator, within the limitation that it must stay within the range of 0 to 24 dB of attenuation.

Examples in the dual attenuator configuration:

- Mech Atten at 20 dB. Elec Atten enabled, Mech Atten set to 10 dB, and Elec Atten set to 10 dB. New total attenuation equals the value before Elec Atten enabled.
- Mech Atten at 0 dB. Elec Atten enabled, Mech Atten set to 10 dB, and Elec Atten set to 0 dB. New total attenuation does not equal the value before Elec Atten enabled.
- Mech Atten at 40 dB. Elec Atten enabled, Mech Atten set to 10 dB, and Elec Atten set to 24 dB. New total attenuation does not equal the value before Elec Atten enabled.

When the Electronic Attenuation is disabled from an enabled state:

- The Elec Atten key is grayed out
- The Auto/Man state of (Mech) Atten is restored
- If now in Auto, (Mech) Atten recouples
- If now in Man, (Mech) Atten is set to the value of total attenuation that existed before the Elec Atten was disabled. The resulting value is rounded up to the smallest value possible given the (Mech) Atten Step setting - (That is, 57 dB changes to 58 dB when (Mech) Atten Step is 2 dB.)

Using the Electronic Attenuator: Pros and Cons

The electronic attenuator offers finer steps than the mechanical attenuator, has no acoustical noise, is faster, and is less subject to wear.

The “finer steps” advantage of the electronic attenuator is beneficial in optimizing the alignment of the analyzer dynamic range to the signal power in the front panel as well as remote use. Thus, you can achieve improved relative signal measurement accuracy. Compared to a mechanical attenuator with 2 dB steps, the 1 dB resolution of the electronic attenuator only gives better resolution when the odd-decibel steps are used. Those odd-decibel steps are less accurately calibrated than the even-decibel steps, so one tradeoff for this superior relative accuracy is reduced absolute amplitude accuracy.

Another disadvantage of the electronic attenuator is that the spectrum analyzer loses its “Auto” setting, making operation less convenient.

Also, the relationship between the dynamic range specifications (TOI, SHI, compression and noise) and instrument performance are less well-known with the electrical attenuator. With the mechanical attenuator, TOI, SHI and compression threshold levels increase dB-for-dB with increasing attenuation, and the noise floor does as well. With the electronic attenuator, there is an excess attenuation of about 1 to 3 dB between 0 and 3.6 GHz, making the effective TOI, SHI, and so forth, less well known. Excess attenuation is the actual attenuation relative to stated attenuation. Excess attenuation is accounted for in the analyzer calibration

Elec Atten

Controls the Electronic Attenuator in dual attenuator configurations. This key does not appear in single attenuator configurations, as the control of both the mechanical and electronic stages of the single attenuator is integrated into the single Atten key.

Key Path	AMPTD Y Scale, Attenuation
Remote Command	<code>[:SENSe]:POWer[:RF]:EATTenuation <rel_ampl></code> <code>[:SENSe]:POWer[:RF]:EATTenuation?</code>
Notes	Electronic Attenuation's specification is defined only when Mechanical Attenuation is 6 dB.
Dependencies	This key only appears in Dual Attenuator models with an Electronic Attenuator installed. It does not appear in models with the Single Attenuator configuration, as in the single attenuator configuration there is no “electronic attenuator” there is only a single integrated attenuator (which has both a mechanical and electronic stage). However, in the single attenuator configuration, EATT SCPI commands are accepted for compatibility with other X-series instruments and set a “soft” attenuation as described in "Attenuator Configurations and Auto/Man" on page 2143 . The “soft” attenuation is treated as an addition to the “main” attenuation value set by the Atten softkey or the

	POW:ATT SCPI command and affects the total attenuation displayed on the Attenuation key and the Meas Bar. When Enable Elec Atten is off or grayed out, the Elec Atten key is grayed out.
Preset	0 dB
State Saved	Saved in instrument state
Min	0 dB
Max	Dual attenuator configuration: 24 dB Single attenuator configuration: the total of ATT and EATT cannot exceed 50 dB, so if the EATT is set to 24 dB first, the main attenuation cannot be greater than 26 dB and will be reduced accordingly; if the main attenuator is set to 40 dB first, EATT cannot be greater than 10 dB
Initial S/W Revision	Prior to A.02.00
Modified at S/W Revision	A.03.00

Adjust Atten for Min Clip

Sets the combination of mechanical and electronic attenuation and gain based on the current measured signal level so that clipping will be at a minimum.

This is an "immediate action" function, that is, it executes once, when the key is pressed.

This key is grayed out in measurements that do not support this functionality. The spectrum analyzer measurement, Swept SA, does not support this functionality.

Key Path	AMPTD Y Scale, Attenuation
Remote Command	<code>[:SENSe] :POWer [:RF] :RANGe:OPTimize IMMEDIATE</code>
Initial S/W Revision	Prior to A.02.00
Modified at S/W Revision	A.03.00

Pre-Adjust for Min Clip

If this function is on, it does the adjustment described under ["Adjust Atten for Min Clip" on page 2146](#) each time a measurement restarts. Therefore, in Continuous measurement mode, it only executes before the first measurement.

In dual attenuator models, you can set Elec+Mech Atten, in which case both attenuators participate in the autoranging, or Elec Atten Only, in which case the mechanical attenuator does not participate in the autoranging. This latter case results in less wear on the mechanical attenuator and is usually faster.

This key is grayed out in measurements that do not support this functionality. The spectrum analyzer measurement, Swept SA, does not support this functionality.

Key Path	AMPTD Y Scale, Attenuation
Remote Command	<code>[:SENSe] :POWer [:RF] :RANGe:OPTimize:ATTenuation OFF ELECTRical COMBined</code>

	<code>[:SENSe] :POWer [:RF] :RANGe:OPTimize:ATTenuation?</code>
Notes	The SCPI parameter <code>ELECTrical</code> sets this function to On in single attenuator models. The SCPI parameter <code>COMBined</code> is mapped to <code>ELECTrical</code> in single attenuator models; if you send <code>COMBined</code> , it sets the function to On and returns <code>ELEC</code> to a query.
Dependencies	This key only appears in Dual Attenuator models with an Electronic Attenuator installed. In instruments with Dual Attenuator model, when Enable Elec Atten is off or grayed out, the Pre-Adjust for Min Clip key is grayed out.
Preset	OFF for Swept SA measurement; ON for all other measurements that support Pre-Adjust for Min Clip
State Saved	Saved in instrument state
Range	Dual attenuator models: Off Elec Atten Only Mech + Elec Atten Single attenuator models: Off On
Initial S/W Revision	Prior to A.02.00
Modified at S/W Revision	A.03.00

Remote Command	<code>[:SENSe] :POWer [:RF] :RANGe:AUTO ON OFF 1 0</code> <code>[:SENSe] :POWer [:RF] :RANGe:AUTO?</code>
Notes	ON aliases to "Elec Atten Only" (<code>:POW:RANG:OPT:ATT ELEC</code>) OFF aliases to "Off" (<code>:POW:RANG:OPT:ATT OFF</code>) The query <code>:POW:RANG:AUTO?</code> returns true if <code>:POW:RANG:OPT:ATT</code> is not "Off"
Initial S/W Revision	Prior to A.02.00

Off

Turns Pre-Adjust for Min Clip off. This is the default setting.

This key is grayed out in measurements that do not support this functionality. The spectrum analyzer measurement, Swept SA, does not support this functionality.

Key Path	AMPTD Y Scale, Attenuation, Pre-Adjust for Min Clip
Example	<code>:POW:RANGe:OPT:ATT OFF</code>
Initial S/W Revision	Prior to A.02.00

Elec Atten Only

Selects only the electric attenuator to participate in auto ranging. This offers less wear on the mechanical attenuator and is usually faster.

This key is grayed out in measurements that do not support this functionality. The spectrum analyzer measurement, Swept SA, does not support this functionality.

Key Path	AMPTD Y Scale, Attenuation, Pre-Adjust for Min Clip
Example	:POW:RANGe:OPT:ATT ELEC
Initial S/W Revision	Prior to A.02.00

Mech + Elec Atten

In dual attenuator models, this selects both attenuators participate in the autoranging.

This key is grayed out in measurements that do not support this functionality. The spectrum analyzer measurement, Swept SA, does not support this functionality.

Key Path	AMPTD Y Scale, Attenuation, Pre-Adjust for Min Clip
Example	:POW:RANGe:OPT:ATT COMB
Initial S/W Revision	Prior to A.02.00

(Mech) Atten Step

This controls the step size used when making adjustments to the input attenuation.

This key is labeled Mech Atten Step in dual attenuator models and Atten Step in single attenuator models. In the dual attenuator configuration, this key only affects the step size of the mechanical attenuator.

Key Path	AMPTD Y Scale, Attenuation
Remote Command	[:SENSe] : POWer [:RF] : ATTenuation : STEP [:INCRement] 10 dB 2 dB [:SENSe] : POWer [:RF] : ATTenuation : STEP [:INCRement] ?
Example	POW:ATT:STEP 2
Notes	Note this feature works like a 1-N choice from the front panel, but it takes a specific value (in dB) when used remotely. The only valid values are 2 and 10.
Dependencies	Blanked in CXA and EXA if option FSA (2 dB steps) is not present. If blanked, attempts to set it via SCPI will yield an error.
Couplings	When the attenuation step size changes, the current mechanical attenuation value is adjusted (if necessary) to be quantized to the new step size. That is, if step is set to 10 dB, mech atten is increased if necessary so it is a multiple of 10 dB
Preset	PXA and MXA: 2 dB EXA and CXA: 10 dB (2 dB with option FSA)
State Saved	Saved in instrument state
Initial S/W Revision	Prior to A.02.00
Modified at S/W Revision	A.03.00

Scale/Div (RF Envelope View)

Sets the scale per division for the RF Envelope result waveform (time domain) measurements in the graph window.

Key Path	AMPTD Y Scale
Mode	BASIC, PNOISE, WCDMA, C2K, GSM, WIMAXOFDMA, TDSCDMA, 1XEVD0, DVB, DTMB, ISDBT, CMMB, LTE, LTETDD, DCATV, WLAN, LTEATDD, LTEAFDD
Remote Command	:DISPlay:WAVeform:VIEW[1]:WINDow[1]:TRACe:Y[:SCALE]:PDIVision <rel_ ampl> :DISPlay:WAVeform:VIEW[1]:WINDow[1]:TRACe:Y[:SCALE]:PDIVision?
Example	DISP:WAV:VIEW:WIND:TRAC:Y:PDIV 5 DISP:WAV:VIEW:WIND:TRAC:Y:PDIV?
Notes	You must be in a mode that includes the Waveform measurement to use this command. Use INSTRUMENT:SElect to set the mode.
Couplings	When Auto Scaling is On, this value is automatically determined by the measurement result. When you set a value manually, Auto Scaling automatically changes to Off.
Preset	10.00 dB
State Saved	Saved in instrument state.
Range	0.10 dB to 20.00 dB
Min	0.10 dB
Max	20.00 dB
Initial S/W Revision	Prior to A.02.00
Modified at S/W Revision	A.03.00

Presel Center

When this key is pressed, the centering of the preselector filter is adjusted to optimize the amplitude accuracy at the frequency of the selected marker. If the selected marker is not on when Presel Center is pressed, the analyzer will turn on the selected marker, perform a peak search, and then perform centering on the marker's center frequency. If the selected marker is already on and between the start and stop frequencies of the analyzer, the analyzer performs the preselector calibration on that marker's frequency. If the selected marker is already on, but outside the frequency range between Start Freq and Stop Freq, the analyzer will first perform a peak search, and then perform centering on the marker's center frequency.

The value displayed on the Presel Adjust key will change to reflect the new preselector tuning (see Presel Adjust).

A number of considerations should be observed to ensure proper operation. See ["Proper Preselector Operation" on page 2150](#).

Key Path	AMPTD Y Scale
Remote Command	[:SENSe]:POWer[:RF]:PCENter

Example	POW:PCEN
Notes	Note that the rules outlined above under the key description apply for the remote command as well as the key. The result of the command is dependent on marker position, and so forth. Any message shown by the key press is also shown in response to the remote command.
Dependencies	<ul style="list-style-type: none"> • Grayed out if the microwave preselector is off.) • If the selected marker's frequency is below Band 1, advisory message 0.5001 is generated and no action is taken. • Grayed out if entirely in Band 0. • Blank in models that do not include a preselector, such as option 503. If the SCPI is sent in these instruments, it is accepted without error, and the query always returns 0. • Grayed out in the Spectrogram View.
Couplings	<p>The active marker position determines where the centering will be attempted.</p> <p>If the analyzer is in a measurement such as averaging when centering is initiated, the act of centering the preselector will restart averaging but the first average trace will not be taken until the centering is completed.</p>
Status Bits/OPC dependencies	<p>When centering the preselector, *OPC will not return true until the process is complete and a subsequent measurement has completed, nor will results be returned to a READ or MEASure command.</p> <p>The Measuring bit should remain set while this command is operating and should not go false until the subsequent sweep/measurement has completed.</p>
Initial S/W Revision	Prior to A.02.00
Modified at S/W Revision	A.03.00

Proper Preselector Operation

A number of considerations should be observed to ensure proper operation:

1. If the selected marker is off, the analyzer will turn on a marker, perform a peak search, and adjust the preselector using the selected marker's frequency. It uses the "highest peak" peak search method unqualified by threshold or excursion, so that there is no chance of a 'no peak found' error. It continues with that peak, even if it is the peak of just noise. Therefore, for this operation to work properly, there should be a signal on screen in a preselected range for the peak search to find.
2. If the selected marker is already on, the analyzer will attempt the centering at that marker's frequency. There is no preselector for signals below about 3.6 GHz, therefore if the marker is on a signal below 3.6 GHz, no centering will be attempted and an advisory message generated
3. In some models, the preselector can be bypassed. If it is bypassed, no centering will be attempted in that range and a message will be generated.

Preselector Adjust

Allows you to manually adjust the preselector filter frequency to optimize its response to the signal of interest. This function is only available when **"Presel Center"** on page 2149 is available.

For general purpose signal analysis, using Presel Center is recommended. Centering the filter minimizes the impact of long-term preselector drift. Presel Adjust can be used instead to manually optimize the preselector. One application of manual optimization would be to peak the preselector response, which both optimizes the signal-to-noise ratio and minimizes amplitude variations due to small (short-term) preselector drifting.

Key Path	AMPTD Y Scale
Scope	Meas Global
Remote Command	<code>[:SENSe] :POWer [:RF] :PADJust <freq></code> <code>[:SENSe] :POWer [:RF] :PADJust?</code>
Example	POW:PADJ 100KHz POW:PADJ?
Notes	The value on the key reads out to 0.1 MHz resolution.
Dependencies	<ul style="list-style-type: none"> • Grayed out if microwave preselector is off.) • Grayed out if entirely in Band 0. • Blank in models that do not include a preselector, such as option 503. If the SCPI is sent in these instruments, it is accepted without error, and the query always returns 0. • Grayed out in the Spectrogram View.
Preset	0 MHz
State Saved	The Presel Adjust value set by Presel Center, or by manually adjusting Presel Adjust, is not saved in instrument state, and does not survive a Preset or power cycle.
Min	-500 MHz
Max	500 MHz
Default Unit	Hz
Backwards Compatibility SCPI	<code>[:SENSe] :POWer [:RF] :MW :PADJust</code> <code>[:SENSe] :POWer [:RF] :MMW :PADJust</code> PSA had multiple preselectors, but the X-Series has only one. These commands simply alias to <code>[:SENSe] :POWer [:RF] :PADJust</code>
Initial S/W Revision	Prior to A.02.00
Modified at S/W Revision	A.03.00

Remote Command	<code>[:SENSe] :POWer [:RF] :PADJust :PRESelector MWAVE MMWave EXTERNAL</code> <code>[:SENSe] :POWer [:RF] :PADJust :PRESelector?</code>
Notes	PSA had multiple preselectors, and you could select which preselector to adjust. Since the X-Series has only one mm/uW preselector, the preselector selection softkey is no longer available. However, to provide backward compatibility, we accept the legacy remote commands. The command form has no effect, the query always returns MWAVE
Initial S/W Revision	Prior to A.02.00

μW Path Control

The μW Path Control functions include the μW Preselector Bypass (Option MPB) and Low Noise Path (Option LNP) controls in the High Band path circuits.

When the μW Preselector is bypassed, the user has better flatness, but will be subject to spurs from out of band interfering signals. When the Low Noise Path is enabled, the analyzer automatically switches around certain circuitry in the high frequency bands which can contribute to noise, when it is appropriate based on other analyzer settings.

For most applications, the preset state is Standard Path, which gives the best remote-control throughput, minimizes acoustic noise from switching and minimizes the risk of wear out in the hardware switches. For applications that utilize the wideband IF paths, the preset state is the μW Preselector Bypass path, if option MPB is present. This is because, when using a wideband IF such as the 140 MHz IF, the μW Preselector's bandwidth can be narrower than the available IF bandwidth, causing degraded amplitude flatness and phase linearity, so it is desirable to bypass the preselector in the default case.

Users may choose Low Noise Path Enable. It gives a lower noise floor, especially in the 21–26.5 GHz region, though without improving many measures of dynamic range, and without giving the best possible noise floor. The preamp, if purchased and used, gives better noise floor than does the Low Noise Path, however its compression threshold and third-order intercept are much poorer than that of the non-preamp Low Noise Path. There are some applications, typically for signals around –30 dBm, for which the third-order dynamic range of the standard path is good enough, but the noise floor is not low enough even with 0 dB input attenuation. When the third-order dynamic range of the preamp path is too little and the noise floor of the standard path is too high, the Low Noise Path can provide the best dynamic range.

Key Path	AMPTD Y Scale
Mode	SA, BASIC, PNOISE, VSA , LTE, LTETDD
Scope	Meas Global
Remote Command	[:SENSe] :POWer [:RF] :MW:PATH STD LNPath MPBypass FULL [:SENSe] :POWer [:RF] :MW:PATH?
Example	:POW:MW:PATH LNP Enables the Low Noise path
Notes	If a Presel Center is performed, the analyzer will momentarily switch to the Standard Path, regardless of the setting of μW Path Control The DC Block will always be switched in when the low noise path is switched in, to protect succeeding circuitry from DC. Note that this does not mean “when the low noise path is enabled” but when, based on the Low Noise Path rules, the path is actually switched in. This can happen when the selection is Low Noise Path Enable . In the case where the DC Block is switched in the analyzer is now AC coupled. However, if the user has selected DC coupling, the UI will still behave as though it were DC coupled, including all annunciation, warnings, status bits, and responses to SCPI queries. This is because, based on other settings, the analyzer could switch out the low noise path at any time and hence go back to being DC coupled. Alignment switching ignores the settings in this menu, and restores them when finished.
Dependencies	Unavailable in BBIQ and External Mixing
Preset	All modes other than IQ Analyzer mode and VXA: STD IQ Analyzer, VXA and WLAN mode:

	MPB option present and licensed: MPB MPB option not present and licensed: STD
State Saved	Save in instrument state
Readback	Value selected in the submenu
Initial S/W Revision	A.04.00
Modified at S/W Revision	A.10.00

Standard Path

This path gives the best remote-control throughput, minimizes acoustic noise from switching and minimizes the risk of wear in the hardware switches, particularly in remote test scenarios where both low band and high band setups will follow in rapid succession.

In this path, the bypass of the low band/high band switch and microwave preamp is never activated, which can cause some noise degradation but preserves the life of the bypass switch.

Key Path	AMPTD Y Scale, μ W Path Control
Example	:POW:MW:PATH STD
Readback Text	Standard Path
Initial S/W Revision	A.04.00

Low Noise Path Enable

You may choose Low Noise Path Enable, which gives a lower noise floor under some circumstances, particularly when operating in the 21–26.5 GHz region. With the Low Noise Path enabled, the low band/high band switch and microwave preamp are bypassed whenever all of the following are true:

- The analyzer is not in the Low Band, meaning:
- the start frequency is above 3.5 GHz and
- the stop frequency is above 3.6 GHz.
- the internal preamp is not installed or (if installed) is set to Off or Low Band

Note that this means that, when any part of a sweep is done in Low Band, the Low Noise Path is not used, whether or not the Low Noise Path Enable is selected in the user interface. Also, if the preamp is turned on, the Low Noise Path is not used, whether or not the Low Noise Path Enable is selected in the user interface. The only time the Low Noise Path is used is when Low Noise Path Enable is selected, the sweep is completely in High Band (> 3.6 GHz) and no preamp is in use.

See "[More Information](#)" on page 2154

Key Path	AMPTD Y Scale, μ W Path Control
Measurement	Swept SA

Example	:POW:MW:PATH LNP
Notes	<p>For measurements that use IQ acquisition, the low noise path is used when the Center Frequency is in High Band (> 3.6 GHz) and no preamp is in use.</p> <p>In other words, the rules above are modified to use only the center frequency to qualify which path to switch in.</p> <p>This is not the case for FFT's in the Swept SA measurement; they use the same rules as swept measurements.</p>
Dependencies	<p>Key is blanked if current mode does not support it.</p> <p>Key is grayed out if mode supports it but current measurement does not support it.</p> <p>Unless Option LNP is present and licensed, key is blank and if SCPI command sent, error -241, "Hardware missing; Option not installed" is generated.</p>
Readback Text	Low Noise Path Enable
Initial S/W Revision	A.04.00

More Information

The user should understand that the Low Noise Path, while giving improved DANL, has the disadvantage of decreased TOI performance and decreased gain compression performance relative to the standard path.

The user should also understand that the bypass switch is a mechanical switch and has finite life, so if the Low Noise Path is enabled, it is possible to cause frequent cycling of this switch by frequently changing analyzer settings such that the above conditions hold true only some of the time. A user making tests of this nature should consider opting for the Standard Path, which will never throw the bypass switch, at the expense of some degraded noise performance.

The low noise path is useful for situations where the signal level is so low that the analyzer performance is dominated by noise even with 0 dB attenuation, but still high enough that the preamp option would have excessive third-order intermodulation or compression. The preamp, if purchased and used, gives better noise floor than does the "Low Noise Path." However, its compression threshold and third-order intercept are much poorer than that of the non-preamp path. There are some applications, typically for signals around -30 dBm, for which the third-order dynamic range of the standard path is good enough, but the noise floor is not low enough even with 0 dB input attenuation. When the third-order dynamic range of the preamp path is too little and the noise floor of the standard path is too high, the Low Noise Path can provide the best dynamic range

The graph below illustrates the concept. It shows, in red, the performance of an analyzer at different attenuation settings, both with the preamp on and off, in a measurement that is affected by both analyzer noise and analyzer TOI. The green shows the best available dynamic range, offset by 0.5 dB for clarity. The blue shows how the best available dynamic range improves for moderate signal levels with the low noise path switched in. In this illustration, the preamp improves the noise floor by 15 dB while degrading the third-order intercept by 30 dB, and the low noise path reduces loss by 8 dB. The attenuator step size is 2 dB.

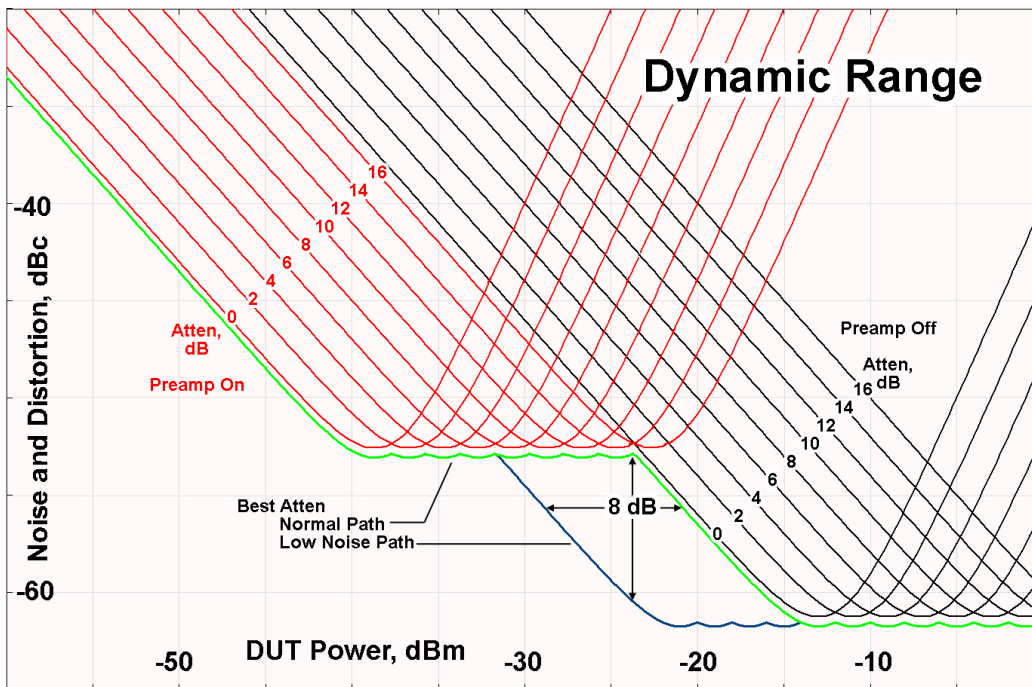

There are other times where selecting the low noise path improves performance, too. Compression-limited measurements such as finding the nulls in a pulsed-RF spectrum can profit from the low noise path in a way similar to the TOI-limited measurement illustrated. Accuracy can be improved when the low noise path allows the optimum attenuation to increase from a small amount like 0, 2 or 4 dB to a larger amount, giving better return loss at the analyzer input. Harmonic measurements, such as second and third harmonic levels, are much improved using the low noise path because of the superiority of that path for harmonic (though not intermodulation) distortion performance.

μ W Preselector Bypass

This key toggles the preselector bypass switch for band 1 and higher. When the microwave preselector is on, the signal path is preselected. When the microwave preselector is off, the signal path is not preselected. The preselected path is the normal path for the analyzer.

The preselector is a tunable bandpass filter which prevents signals away from the frequency of interest from combining in the mixer to generate in-band spurious signals (images). The consequences of using a preselector filter are its limited bandwidth, the amplitude and phase ripple in its passband, and any amplitude and phase instability due to center frequency drift.

Option MPB or pre-selector bypass provides an unpreselected input mixer path for certain X-Series signal analyzers with frequency ranges above 3.6 GHz. This signal path allows a wider bandwidth and less amplitude variability, which is an advantage when doing modulation analysis and broadband signal analysis. The disadvantage is that, without the preselector, image signals will be displayed. Another disadvantage of bypassing the preselector is increased LO emission levels at the front panel input port.

Image responses are separated from the real signal by twice the 1st IF. For IF Paths of 10 MHz and 25 MHz, the 1st IF is 322.5 MHz, so the image response and the real signal will be separated by 645 MHz. The 1st IF will be different for other IF Path settings. When viewing a real signal and its corresponding image response in internal mixing, the image response will be to the left of the real signal.

Also, the image response and the real signal typically have the same amplitude and exhibit the same shape factor.

However, if Option FS1, Fast Sweep Capability, is enabled, the image response in the Swept SA measurement will appear lower in amplitude and have a much wider shape factor compared to the real signal.

Key Path	AMPTD Y Scale, μ W Path Control
Example	:POW:MW:PATH MPB
Dependencies	Key is blanked if current mode does not support it. Key is grayed out if mode supports it but current measurement does not support it. Key is blank unless Option MPB is present and licensed. If SCPI command sent when MPB not present, error -241, "Hardware missing; Option not installed" is generated.
Readback Text	μ W Preselector Bypass
Initial S/W Revision	A.04.00

Remote Command	[:SENSe] :POWeR [:RF] :MW:PRESelector [:STATe] ON OFF 0 1 [:SENSe] :POWeR [:RF] :MW:PRESelector [:STATe] ?
Example	:POW:MW:PRES OFF Bypasses the microwave preselector
Notes	The ON parameter sets the STD path (:POW:MW:PATH STD) The OFF parameter sets path MPB (:POW:MW:PATH MPB)
Preset	ON

Internal Preamp

Accesses a menu of keys that control the internal preamps. Turning on the preamp gives a better noise figure, but a poorer TOI to noise floor dynamic range. You can optimize this setting for your particular measurement.

The instrument takes the preamp gain into account as it sweeps. If you sweep outside of the range of the preamp the instrument will also account for that. The displayed result will always reflect the correct gain.

For some measurements, when the preamp is on and any part of the displayed frequency range is below the lowest frequency for which the preamp has specifications, a warning condition message appears in the status line. For example, for a preamp with a 9 kHz lowest specified frequency: "Preamp: Accy unspec'd below 9 kHz".

Key Path	AMPTD Y Scale
Scope	Meas Global
Remote Command	[:SENSe] :POWeR [:RF] :GAIN [:STATe] OFF ON 0 1 [:SENSe] :POWeR [:RF] :GAIN [:STATe] ?
Dependencies	Preamp is not available on all hardware platforms. If the preamp is not present or is unlicensed, the

	key is not shown. The preamp is not available when the electronic/soft attenuator is enabled.
--	--

Couplings	<p>The act of connecting the U7227A USB Preamplifier to one of the analyzer's USB ports will cause the Internal Preamp to be switched on. When this happens an informational message will be generated: "Internal Preamp turned on for optimal operation with USB Preamp." Note that if the Internal Preamp was already on, there will be no change to the setting, but if it was Off it will be switched On, to Full Range.</p> <p>Note that this same action occurs when the SA mode is selected while the USB Preamp is connected to one of the analyzer's USB ports, if it is the first time that the SA mode has run since powerup, or if the last time the SA mode was running the USB Preamp was NOT connected.</p> <p>Subsequently disconnecting the USB Preamp from USB does not change the Internal Preamp setting nor restore the previous setting.</p>
Preset	OFF
State Saved	Saved in instrument state
Initial S/W Revision	Prior to A.02.00
Modified at S/W Revision	A.14.00

Key Path	AMPTD Y Scale, Internal Preamp
Scope	Meas Global
Remote Command	[:SENSe]:POWer[:RF]:GAIN:BAND LOW FULL [:SENSe]:POWer[:RF]:GAIN:BAND?
Dependencies	<p>Preamp is not available on all hardware platforms. If the preamp is not present or is unlicensed, the key is not shown.</p> <p>If a POW:GAIN:BAND FULL command is sent when a low band preamp is available, the preamp band parameter is to LOW instead of FULL, and an "Option not installed" message is generated.</p>
Preset	LOW
State Saved	Saved in instrument state
Initial S/W Revision	Prior to A.02.00

Off

Turns the internal preamp off

Key Path	AMPTD Y Scale, Internal Preamp
Example	:POW:GAIN OFF
Readback	Off
Initial S/W Revision	Prior to A.02.00

Low Band

Sets the internal preamp to use only the low band.

The frequency range of the installed (optional) low-band preamp is displayed in square brackets on the Low Band key label.

Key Path	AMPTD Y Scale, Internal Preamp
Example	:POW:GAIN ON :POW:GAIN:BAND LOW
Readback	Low Band
Initial S/W Revision	Prior to A.02.00

Full Range

Sets the internal preamp to use its full range. The low band (0–3.6 GHz or 0–3GHz, depending on the model) is supplied by the low band preamp and the frequencies above low band are supplied by the high band preamp.

The frequency range of the installed (optional) preamp is displayed in square brackets on the Full Range key label. If the high band option is not installed the Full Range key does not appear.

Key Path	AMPTD Y Scale, Internal Preamp
Example	:POW:GAIN ON :POW:GAIN:BAND FULL
Readback	Full Range
Initial S/W Revision	Prior to A.02.00

Ref Position (RF Envelope View)

Positions the reference level at the top, center or bottom of the Y Scale display. Changing the reference position does not change the reference level value.

Key Path	AMPTD Y Scale
Mode	BASIC, PNOISE, WCDMA, C2K, GSM, WIMAXOFDMA, TDSCDMA, 1XEVD0, DVB, DTMB, ISDBT, CMMB, LTE, LTETDD, DCATV, WLAN,LTEATDD, LTEAFDD
Remote Command	:DISPlay:WAVeform:VIEW[1]:WINDow[1]:TRACe:Y[:SCALE]:RPOSition TOP CENTer BOTTom :DISPlay:WAVeform:VIEW[1]:WINDow[1]:TRACe:Y[:SCALE]:RPOSition?
Example	DISP:WAV:VIEW:WIND:TRAC:Y:RPOS CENT DISP:WAV:VIEW:WIND:TRAC:Y:RPOS?
Notes	You must be in a mode that includes the Waveform measurement to use this command. Use INSTRument:SElect to set the mode.
Preset	TOP

State Saved	Saved in instrument state.
Range	Top Ctr Bot
Initial S/W Revision	Prior to A.02.00
Modified at S/W Revision	A.03.00

Auto Scaling

Toggles the Auto Scaling function between On and Off. When the Restart front-panel key is pressed, this function automatically determines the scale per division and reference values based on the measurement results.

Key Path	AMPTD Y Scale
Mode	BASIC, PNOISE, WCDMA, C2K, GSM, WIMAXOFDMA, TDSCDMA, 1XEVD0, DVB, DTMB, ISDBT, CMMB, LTE, LTETDD, DCATV, WLAN,LTEATDD, LTEAFDD
Remote Command	:DISPlay:WAVeform:VIEW[1] 2:WINDow[1]:TRACe:Y[:SCALe]:COUPle 0 1 OFF ON :DISPlay:WAVeform:VIEW[1] 2:WINDow[1]:TRACe:Y[:SCALe]:COUPle?
Example	DISP:WAV:VIEW:WIND:TRAC:Y:COUP OFF DISP:WAV:VIEW:WIND:TRAC:Y:COUP?
Notes	You must be in a mode that includes the Waveform measurement to use this command. Use INSTRument:SElect to set the mode.
Couplings	When Auto Scaling is On, upon pressing the Restart front-panel key, this function automatically switches the scale per division and reference values into the defaults. When you set a value to either Scale/Div or Ref Value manually, Auto Scaling automatically changes to Off.
Preset	OFF
State Saved	Saved in instrument state.
Range	On Off
Initial S/W Revision	Prior to A.02.00
Modified at S/W Revision	A.03.00

Range

This key is only available when I/Q is the selected input. It replaces the Attenuation key in that case.

Each input channel (I and Q) has four internal gain ranges. The maximum allowed voltage in each gain range is slightly more than the nominal value, so the break point between ranges is a couple of millivolts higher than the nominal (setting a peak voltage of 0.502 mV will still map to the 0.5 V Peak range).

Gain Setting	Volts RMS	Volts Peak	Volts Peak - Peak	dBm (50Ω)	Break Point
0 dB	0.7071	1.0	2.0	10	n/a

6 dB	0.3536	0.5	1.0	4	0.502 V Peak
12 dB	0.1768	0.25	0.5	-2	0.252 V Peak
18 dB	0.0884	0.125	0.25	-8	0.127 V Peak

Key Path	AMPTD Y Scale
Notes	Visible only when the selected input is I/Q.
State Saved	No
Readback Text	When Range is Auto, "[Auto]" When Range is Man and I & Q are the same, "[<range value>]" When Range is Man and I & Q are different: "[: <I range value> Q: <Q range value>]" See I Range and Q Range for the <range value> enumeration definition.
Initial S/W Revision	Prior to A.02.00

Range Auto/Man

The Auto setting for Range causes the range to be set based on the Y Scale settings. When Range is "Auto", the I & Q Range are set based on the top of the Y Scale when the Y scale is in dB units (for example, power), or to the max(abs(top), abs(bottom)) when the Y scale reference is not at the top of the screen.

Not all measurements support Range Auto/Man. If Auto is not supported in the current measurement, this key is grayed out and shows "Man" and MAN is returned to a SCPI query, but this does NOT change the Auto/Man setting for Range. When you go to a measurement that supports Auto, it goes back to Auto if it was previously in Auto mode.

Key Path	AMPTD Y Scale, Range
Scope	Meas Global
Remote Command	<code>[:SENSe]:VOLTage:IQ:RANGe:AUTO OFF ON 0 1</code> <code>[:SENSe]:VOLTage:IQ:RANGe:AUTO?</code>
Example	Put the I Range and Q Range in manual. <code>VOLT:IQ:RANG:AUTO OFF</code>
Dependencies	If Auto is not supported, sending the SCPI command will generate an error.
Couplings	When in Auto, both I Range and Q Range are set to the same value, computed as follows: Maximum absolute value is computed for the Y Scale. The top and bottom of the graph are computed based on Ref Value, Scale/Div, and Ref Position. Formula: $Y_{Max} = \max(\text{abs}(\text{top}), \text{abs}(\text{bottom}))$. The I Range and Q Range are then set to YMax.
Preset	ON
State Saved	Saved in instrument state
Range	Auto Man
Initial S/W Revision	Prior to A.02.00

Remote Command	<code>[:SENSe] :POWeR :IQ :RANGe :AUTO OFF ON 0 1</code> <code>[:SENSe] :POWeR :IQ :RANGe :AUTO ?</code>
Example	Put the I Range and Q Range in manual. <code>POW:IQ:RANG:AUTO OFF</code>
Notes	The <code>POW:IQ:RANG:AUTO</code> is an alternate form of the <code>VOLT:IQ:RANG:AUTO</code> command. This is to maintain consistency with I Range and Q Range, which support both the <code>POWeR</code> and <code>VOLTage</code> forms of the command.
Preset	ON
Range	Auto Man
Initial S/W Revision	Prior to A.02.00

I Range

This is the internal gain range for the I channel when Input Path is I Only or I and I/Q, and it is used for both the I and Q channels when the Input Path is I+Q. See "[I/Q Gain Ranges](#)" on page 2165.

Key Path	AMPTD Y Scale, Range
Remote Command	<code>[:SENSe] :VOLTagE :IQ [:I] :RANGe [:UPPer] <voltage></code> <code>[:SENSe] :VOLTagE :IQ [:I] :RANGe [:UPPer] ?</code>
Example	Set the I Range to 0.5 V Peak <code>VOLT:IQ:RANG 0.5 V</code>
Notes	The numeric entries are mapped to the smallest gain range whose break point is greater than or equal to the value, or 1 V Peak if the value is greater than 1 V.
Couplings	When Q Same as I is On, the I Range value will be copied to the Q Range. Changing the value will also set Range = Man.
Preset	1 V Peak
State Saved	Saved in instrument state
Range	1 V Peak 0.5 V Peak 0.25 V Peak 0.125 V Peak
Min	0.125 V
Max	1 V
Initial S/W Revision	Prior to A.02.00

Remote Command	<code>[:SENSe] :POWeR :IQ [:I] :RANGe [:UPPer] <ampl></code> <code>[:SENSe] :POWeR :IQ [:I] :RANGe [:UPPer] ?</code>
Example	Set the I Range to 0.5 V Peak when Reference Z is 50Ω, and to 1.0 V Peak when Reference Z is 75Ω. <code>POW:IQ:RANG 4 dBm</code>
Notes	The <code>POWeR</code> form of the command is provided for convenience. It maps to the same underlying gain

range parameter as the VOLTage form of the command.

The Reference Z (not the I channel Input Z) is used to convert the power to peak voltage, which is then used to set the I Range as with the VOLTage form of the command. The power values of the 4 range states (1V Peak, 0.5V Peak, 0.25V Peak, and 0.125V Peak) will vary with Reference Z. Here are some examples:

50Ω: 10, 4, -2, -8

75Ω: 8.2, 2.2, -3.8, -9.8

600Ω: -0.8, -6.8, -12.8, -18.9

Preset	10.0 dBm
Range	-20 dBm to 10 dBm
Min	-20 dBm
Max	10 dBm
Initial S/W Revision	Prior to A.02.00

1 V Peak

Set the channel gain state to 1 Volt Peak.

Key Path	AMPTD Y Scale, I Range Q Range
Initial S/W Revision	Prior to A.02.00

0.5 V Peak

Set the channel gain state to 0.5 Volt Peak.

Key Path	AMPTD Y Scale, I Range Q Range
Initial S/W Revision	Prior to A.02.00

0.25 V Peak

Set the channel gain state to 0.25 Volt Peak.

Key Path	AMPTD Y Scale, I Range Q Range
Initial S/W Revision	Prior to A.02.00

0.125 V Peak

Set the channel gain state to 0.125 Volt Peak.

Key Path	AMPTD Y Scale, I Range Q Range
Initial S/W Revision	Prior to A.02.00

Q Range Value

This is the internal gain range for the Q channel. See "[I/Q Gain Ranges](#)" on page 2165. The Q Range only applies to Input Path Q Only and Ind I/Q. For input I+jQ the I Range determines both I and Q channel range settings.

Key Path	AMPTD Y Scale, Range
Remote Command	[:SENSe] :VOLTage:IQ:Q:RANGe [:UPPer] <voltage> [:SENSe] :VOLTage:IQ:Q:RANGe [:UPPer] ?
Example	Set the Q Range to 0.5 V Peak VOLT:IQ:Q:RANG 0.5 V
Notes	The numeric entries are mapped to the smallest gain range whose break point is greater than or equal to the value, or 1 V Peak if the value is greater than 1 V. The Q Range is only used for Input Path Q Only and Ind I/Q. For input I+jQ the I Range determines both I and Q channel range settings.
Couplings	When Q Same as I is On, the I Range value will be copied to the Q Range and the range value keys are disabled. Changing the value will also set Range = Man.
Preset	1 V Peak
State Saved	Saved in instrument state
Range	1 V Peak 0.5 V Peak 0.25 V Peak 0.125 V Peak
Min	0.125 V
Max	1 V
Initial S/W Revision	Prior to A.02.00

Remote Command	[:SENSe] :POWer:IQ:Q:RANGe [:UPPer] <ampl> [:SENSe] :POWer:IQ:Q:RANGe [:UPPer] ?
Example	Will set the Q Range to 0.5 V Peak when Reference Z is 50Ω, and to 1.0 V Peak when Reference Z is 75Ω. POW:IQ:Q:RANG 4 dBm
Notes	The POWER form of the command is provided for convenience. It maps to the same underlying gain range parameter as the VOLTage form of the command. The Reference Z (not the Q channel Input Z) is used to convert the power to peak voltage, which is then used to set the Q Range as with the VOLTage form of the command. The power values of the 4 range states (1V Peak, 0.5V Peak, 0.25V Peak, and 0.125V Peak) will vary with Reference Z. Here are some examples: 50Ω: 10, 4, -2, -8 75Ω: 8.2, 2.2, -3.8, -9.8 600Ω: -0.8, -6.8, -12.8, -18.9
Preset	10.0 dBm

Range	-20 dBm to 10 dBm
Min	-20 dBm
Max	10 dBm
Initial S/W Revision	Prior to A.02.00

Q Same as I

Many, but not all, usages require the I and Q channels to have an identical setup. To simplify channel setup, the Q Same as I will cause the Q channel range to be mirrored from the I channel. That way you only need to set up one channel (the I channel). The I channel values are copied to the Q channel, so at the time Q Same as I is Off, the I and Q channel setups will be identical.

Key Path	AMPTD Y Scale, Range, Q Range
Remote Command	[:SENSe] :VOLTage POWer : IQ : MIRRored OFF ON 0 1 [:SENSe] :VOLTage POWer : IQ : MIRRored ?
Example	Turn off the mirroring of I Range to Q Range. VOLT:IQ:MIRR OFF POW:IQ:MIRR OFF
Couplings	When On, the I Range value is mirrored (copied) to the Q Range.
Preset	On
State Saved	Saved in instrument state.
Range	On Off
Readback Text	"Q Same as I" when On, otherwise none.
Initial S/W Revision	Prior to A.02.00

1 V Peak

Set the channel gain state to 1 Volt Peak.

Key Path	AMPTD Y Scale, I Range Q Range
Initial S/W Revision	Prior to A.02.00

0.5 V Peak

Set the channel gain state to 0.5 Volt Peak.

Key Path	AMPTD Y Scale, I Range Q Range
Initial S/W Revision	Prior to A.02.00

0.25 V Peak

Set the channel gain state to 0.25 Volt Peak.

Key Path	AMPTD Y Scale, I Range Q Range
Initial S/W Revision	Prior to A.02.00

0.125 V Peak

Set the channel gain state to 0.125 Volt Peak.

Key Path	AMPTD Y Scale, I Range Q Range
Initial S/W Revision	Prior to A.02.00

I/Q Gain Ranges

See the following sections:

["1 V Peak" on page 2165](#)

["0.5 V Peak" on page 2165](#)

["0.25 V Peak" on page 2165](#)

["0.125 V Peak" on page 2166](#)

1 V Peak

Set the channel gain state to 1 Volt Peak.

Key Path	AMPTD Y Scale, I Range Q Range
Initial S/W Revision	Prior to A.02.00

0.5 V Peak

Set the channel gain state to 0.5 Volt Peak.

Key Path	AMPTD Y Scale, I Range Q Range
Initial S/W Revision	Prior to A.02.00

0.25 V Peak

Set the channel gain state to 0.25 Volt Peak.

Key Path	AMPTD Y Scale, I Range Q Range
Initial S/W Revision	Prior to A.02.00

0.125 V Peak

Set the channel gain state to 0.125 Volt Peak.

Key Path	AMPTD Y Scale, I Range Q Range
Initial S/W Revision	Prior to A.02.00

Ref Value

Sets the absolute power reference value. However, since Auto Scaling is defaulted to On, this value is automatically determined by the measurement result. When you set a value manually, Auto Scaling automatically changes to Off.

This functionality depends on the selected view:

- ["Ref Value \(RF Envelope View\)" on page 2166](#)
- ["Ref Value \(I/Q Waveform View\)" on page 2167](#)

Ref Value (RF Envelope View)

Sets the Y Scale reference value (in dBm) when the RF Envelope View is active. By default, the measurement determines the reference value with Auto Scaling. Entering a reference value manually turns Auto Scaling off.

Key Path	AMPTD Y Scale
Mode	BASIC, PNOISE, WCDMA, C2K, GSM, WIMAXOFDMA, TDSCDMA, 1XEVD0, DVB, DTMB, ISDBT, CMMB, LTE, LTETDD, DCATV, WLAN, LTEATDD, LTEAFDD
Remote Command	:DISPlay:WAVeform:VIEW[1]:WINDow[1]:TRACe:Y[:SCALe]:RLEVel <ampl> :DISPlay:WAVeform:VIEW[1]:WINDow[1]:TRACe:Y[:SCALe]:RLEVel?
Example	DISP:WAV:VIEW:WIND:TRAC:Y:RLEV -50 dBm DISP:WAV:VIEW:WIND:TRAC:Y:RLEV?
Notes	You must be in the mode that includes Waveform measurement to use this command. Use INSTRument:SElect to set the mode.
Couplings	When Auto Scaling is On, this value is automatically determined by the measurement result. When you set a value manually, Auto Scaling automatically changes to Off.
Preset	10.00 dBm
State Saved	Saved in instrument state.
Range	-250.00 dBm to 250.00 dBm
Min	-250.00 dBm
Max	250.00 dBm
Initial S/W Revision	Prior to A.02.00
Modified at S/W Revision	A.03.00

Ref Value (I/Q Waveform View)

Sets the Y Scale reference value (in volts) when the I/Q Waveform View is active. By default, the measurement determines the reference value with Auto Scaling. Entering a reference value manually turns Auto Scaling off.

Key Path	AMPTD Y Scale
Mode	BASIC, PNOISE, WCDMA, C2K, GSM, WIMAXOFDMA, TDSCDMA, 1XEVD0, DVB, DTMB, ISDB-T, CMMB, LTE, LTETDD, DCATV, WLAN, LTEATDD, LTEAFDD
Remote Command	:DISPlay:WAVeform:VIEW2:WINDow[1]:TRACe:Y[:SCALE]:RLEVel <voltage> :DISPlay:WAVeform:VIEW2:WINDow[1]:TRACe:Y[:SCALE]:RLEVel?
Example	DISP:WAV:VIEW2:WIND:TRAC:Y:RLEV 25 V DISP:WAV:VIEW2:WIND:TRAC:Y:RLEV?
Notes	You must be in a mode that includes the Waveform measurement to use this command. Use INSTRument:SElect to set the mode.
Couplings	When Auto Scaling is On, this value is automatically determined by the measurement result. When you set a value manually, Auto Scaling automatically changes to Off.
Preset	0 V
State Saved	Saved in instrument state.
Min	-250 V
Max	250 V
Initial S/W Revision	Prior to A.02.00
Modified at S/W Revision	A.03.00

Scale/Div

Sets the units per division of vertical scale in the logarithmic display. However, since Auto Scaling is defaulted to On, this value is automatically determined by the measurement result. When you set a value manually, Auto Scaling automatically changes to Off.

This functionality depends on the selected view:

- ["Scale/Div \(RF Envelope View\)" on page 2167](#)
- ["Scale/Div \(I/Q Waveform View\)" on page 2168](#)

Scale/Div (RF Envelope View)

Sets the scale per division for the RF Envelope result waveform (time domain) measurements in the graph window.

Key Path	AMPTD Y Scale
Mode	BASIC, PNOISE, WCDMA, C2K, GSM, WIMAXOFDMA, TDSCDMA, 1XEVD0, DVB, DTMB, ISDBT, CMMB, LTE, LTETDD, DCATV, WLAN, LTEATDD, LTEAFDD
Remote Command	:DISPlay:WAVeform:VIEW[1]:WINDow[1]:TRACe:Y[:SCALE]:PDIVision <rel_

	<pre> ampl> :DISPlay:WAVeform:VIEW[1]:WINDow[1]:TRACe:Y[:SCALe]:PDIVision? </pre>
Example	<pre> DISP:WAV:VIEW:WIND:TRAC:Y:PDIV 5 DISP:WAV:VIEW:WIND:TRAC:Y:PDIV? </pre>
Notes	You must be in a mode that includes the Waveform measurement to use this command. Use INSTRUMENT:SELEct to set the mode.
Couplings	When Auto Scaling is On, this value is automatically determined by the measurement result. When you set a value manually, Auto Scaling automatically changes to Off.
Preset	10.00 dB
State Saved	Saved in instrument state.
Range	0.10 dB to 20.00 dB
Min	0.10 dB
Max	20.00 dB
Initial S/W Revision	Prior to A.02.00
Modified at S/W Revision	A.03.00

Scale/Div (I/Q Waveform View)

Sets the scale per division for the I/Q signal waveform graph.

Key Path	AMPTD Y Scale
Mode	BASIC, PNOISE, WCDMA, C2K, GSM, WIMAXOFDMA, TDSCDMA, 1XEVD0, DVB, DTMB, ISDBT, CMMB, LTE, LTETDD, DCATV, WLAN,LTEATDD, LTEAFDD
Remote Command	<pre> :DISPlay:WAVeform:VIEW2:WINDow[1]:TRACe:Y[:SCALe]:PDIVision <voltage> :DISPlay:WAVeform:VIEW2:WINDow[1]:TRACe:Y[:SCALe]:PDIVision? </pre>
Example	<pre> DISP:WAV:VIEW2:WIND:TRAC:Y:PDIV 25mV DISP:WAV:VIEW2:WIND:TRAC:Y:PDIV? </pre>
Notes	You must be in a mode that includes the Waveform measurement to use this command. Use INSTRUMENT:SELEct to set the mode.
Couplings	When Auto Scaling is On, this value is automatically determined by the measurement result. When you set a value manually, Auto Scaling automatically changes to Off.
Preset	100.0 mV
State Saved	Saved in instrument state.
Min	1.0 nV
Max	20 V
Initial S/W Revision	Prior to A.02.00
Modified at S/W Revision	A.03.00

Ref Position

Positions the reference level at the top, center or bottom of the Y Scale display. Changing the reference position does not change the reference level value.

This functionality depends on the selected view:

- "Ref Position (RF Envelope View)" on page 2169
- "Ref Position (I/Q Waveform View)" on page 2169

Ref Position (RF Envelope View)

Positions the reference level at the top, center or bottom of the Y Scale display. Changing the reference position does not change the reference level value.

Key Path	AMPTD Y Scale
Mode	BASIC, PNOISE, WCDMA, C2K, GSM, WIMAXOFDMA, TDSCDMA, 1XEVD0, DVB, DTMB, ISDBT, CMMB, LTE, LTETDD, DCATV, WLAN,LTEATDD, LTEAFDD
Remote Command	:DISPlay:WAVeform:VIEW[1]:WINDow[1]:TRACe:Y[:SCALE]:RPOSition TOP CENTER BOTTom :DISPlay:WAVeform:VIEW[1]:WINDow[1]:TRACe:Y[:SCALE]:RPOSition?
Example	DISP:WAV:VIEW:WIND:TRAC:Y:RPOS CENT DISP:WAV:VIEW:WIND:TRAC:Y:RPOS?
Notes	You must be in a mode that includes the Waveform measurement to use this command. Use INSTRument:SElect to set the mode.
Preset	TOP
State Saved	Saved in instrument state.
Range	Top Ctr Bot
Initial S/W Revision	Prior to A.02.00
Modified at S/W Revision	A.03.00

Ref Position (I/Q Waveform View)

Positions the reference level at the top, center or bottom of the Y Scale display. Changing the reference position does not change the reference level value.

Key Path	AMPTD Y Scale
Mode	BASIC, PNOISE, WCDMA, C2K, GSM, WIMAXOFDMA, TDSCDMA, 1XEVD0, DVB, DTMB, ISDBT, CMMB, LTE, LTETDD, DCATV, WLAN,LTEATDD, LTEAFDD
Remote Command	:DISPlay:WAVeform:VIEW2:WINDow[1]:TRACe:Y[:SCALE]:RPOSition TOP CENTER BOTTom :DISPlay:WAVeform:VIEW2:WINDow[1]:TRACe:Y[:SCALE]:RPOSition?
Example	DISP:WAV:VIEW2:WIND:TRAC:Y:RPOS CENT DISP:WAV:VIEW2:WIND:TRAC:Y:RPOS?

Notes	You must be in a mode that includes the Waveform measurement to use this command. Use INSTRument:SElect to set the mode.
Preset	CENT
State Saved	Saved in instrument state.
Range	Top Ctr Bot
Initial S/W Revision	Prior to A.02.00
Modified at S/W Revision	A.03.00

Auto Couple

The Auto Couple feature provides a quick and convenient way to automatically couple multiple instrument settings. This helps ensure accurate measurements and optimum dynamic range. When the Auto Couple feature is activated, either from the front panel or remotely, all parameters of the current measurement that have an Auto/Manual mode are set to Auto mode and all measurement settings dependent on (or coupled to) the Auto/Man parameters are automatically adjusted for optimal performance.

However, the Auto Couple key actions are confined to the current measurement only. It does not affect other measurements in the mode, and it does not affect markers, marker functions, or trace or display attributes.

See ["More Information" on page 2171](#)

Key Path	Front-panel key
Remote Command	:COUPle ALL NONE
Example	:COUP ALL
Notes	:COUPle ALL puts all Auto/Man parameters in Auto mode (equivalent to pressing the Auto Couple key). :COUPLE NONE puts all Auto/Man parameters in manual mode. It decouples all the coupled instrument parameters and is not recommended for making measurements.
Initial S/W Revision	Prior to A.02.00

More Information

There are two types of functions that have Auto/Manual modes.

Auto/Man Active Function keys

An Auto/Man toggle key controls the binary state associated with an instrument parameter by toggling between Auto (where the parameter is automatically coupled to the other parameters it is dependent upon) and Man (where the parameter is controlled independent of the other parameters), as well as making the parameter the active function. The current mode is indicated on the softkey with either Auto or Man underlined as illustrated below.



Auto/Man 1-of-N keys

An Auto/Man 1-of-N key allows you to manually pick from a list of parameter values, or place the function in Auto, in which case the value is automatically selected (and indicated) as shown below. If in Auto, Auto is underlined on the calling key. If in manual operation, manual is indicated on the calling key. But the calling key does not actually toggle the function, it simply opens the menu.

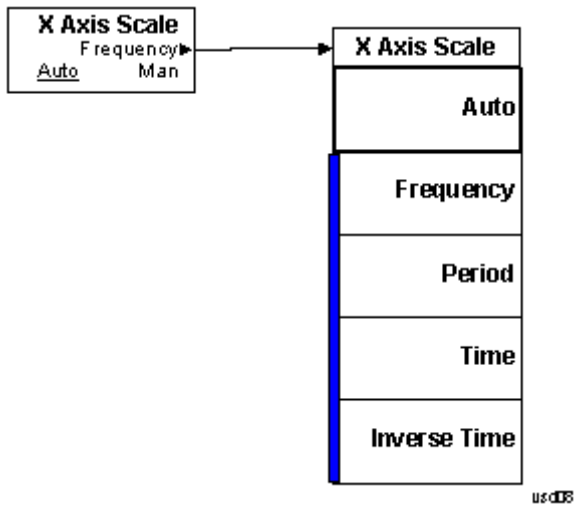

BW

Accesses a menu that enables you to control the information bandwidth functions of the instrument. You can also select the filter type for the measurement.

Key Path	Front-panel key
Initial S/W Revision	Prior to A.02.00

Digital IF BW

Enables you to set the Digital IF (formerly Info BW) bandwidth of the instrument.

Key Path	BW
Mode	BASIC, PNOISE, WCDMA, C2K, GSM, WIMAXOFDMA, TD-SCDMA, 1XEVD0, DVB, DTMB, ISDBT, CMMB, LTE, LTETDD, DCATV, WLAN, MSR,LTEATDD, LTEAFDD
Remote Command	<code>[:SENSe] :WAVeform :DIF :BANDwidth <freq></code> <code>[:SENSe] :WAVeform :DIF :BANDwidth?</code>
Example	WAV:DIF:BAND 1kHz WAV:DIF:BAND?
Notes	Max value depends on the IF Path Selection
Remote Command Notes	You must be in a mode that includes the Waveform measurements to use this command. Use INSTRument:SElect to set the mode.
Dependencies	For applications that have the IF Path Selection menu such as the BASIC mode, if IF Path Auto is OFF, the maximum value depends on which IF Path is currently selected. If 10 MHz, 25 MHz, 40 MHz, 85 MHz, 125 MHz, 140 MHz or 160 MHz paths are selected, the maximum value of this parameter will be 10, 25, 40, 85, 125, 140 or 160 MHz, respectively. If IF Path Auto is ON, the maximum value will be the maximum Digital IF BW available in the instrument regardless of the current IF Path Selection. For example, if the instrument has the options B25, B40, and B1X installed, the maximum available Digital IF BW of the instrument is 140 MHz. Thus, if IF Path Auto is ON and IF Path Selection is 25 MHz, the maximum Digital IF BW is not limited to 25 MHz but is 140 MHz.
Preset	All except the following list: 100 kHz GSM/EDGE: 510 kHz TDSCDMA: 1.3 MHz 1xEVD0: 1.3 MHz DVB-T/H: 8.0 MHz DTMB (CTTB): 8.0 MHz ISDB-T: 6.0 MHz CMMB: 8.0 MHz Digital Cable TV: 8 MHz LTEAFDD, LTEATDD: 6 MHz LTETDD: 6 MHz

	WLAN: Hardware Dependent No option = 10 MHz Option B25 = 25 MHz Option B40: if Radio Std is 802.11a/b/g/n(20MHz) = 25 MHz if Radio Std is 802.11n(40MHz) = 40 MHz if Radio Std is 802.11ac(20MHz) = 25 MHz if Radio Std is 802.11ac(40MHz) = 40 MHz Option B1X: if Radio Std is 802.11ac(80MHz) = 80 MHz Option B1Y: if Radio Std is 802.11ac(160MHz) = 160 MHz
State Saved	Saved in instrument state.
Min	10 Hz
Max	Hardware Dependent: RF Input: No Option = 10 MHz Option B25 = 25 MHz Option B40 = 40 MHz Option B85 = 85.0 MHz Option B1A = 125.0 MHz Option B1X = 140 MHz Option B1Y = 160 MHz I/Q Input: No Option = 10 MHz per channel (20 MHz for I+jQ) Option B25 = 25 MHz per channel (50 MHz for I+jQ) Option S40 = 40 MHz per channel (80 MHz for I+jQ)
Backwards Compatibility SCPI	[:SENSe]:WAVEform:BWIDth[:RESolution]
Initial S/W Revision	Prior to A.02.00
Modified at S/W Revision	A.03.00, A.13.00

Filter Type

Selects the type of bandwidth filter that is used.

Besides the Gaussian filter shape, a variety of other filter types are available with variable alpha settings for maximum control over the filter shape..

Key Path	BW
Mode	BASIC, PNOISE, WCDMA, C2K, GSM, WIMAXOFDMA, TDSCDMA, 1XEVD0, DVB, DTMB, ISDBT,

	CMMB, LTE, LTE40, DCATV, WLAN, MSR,,LTE40, LTEAFDD
Remote Command	[:SENSe]:WAVeform:DIF:FILTer:TYPE GAUSSian FLATtop [:SENSe]:WAVeform:DIF:FILTer:TYPE? (With DIF40 and/or WBDIF) [:SENSe]:WAVeform:DIF:FILTer:TYPE GAUSSian FLATtop SNYQuist RSNYquist RCOSine RRCosine [:SENSe]:WAVeform:DIF:FILTer:TYPE?
Example	WAV:DIF:FILT:TYPE GAUS WAV:DIF:FILT:TYPE?
Remote Command Notes	You must be in a mode that includes the Waveform measurements to use this command. Use INSTRument:SElect to set the mode.
Dependencies	Gaussian and Flattop are available in all DIF configurations. For the other filter types, the filters are only available when Option DP2, B40, or wider IF Bandwidth option is installed.
Preset	BASIC with DP2, B40, or wider IF Bandwidth option: FLATtop All other apps: GAUSSian
State Saved	Saved in instrument state.
Range	Gaussian FlatTop When Option DP2, B40, or wider IF Bandwidth option is installed, the range is as follows. Gaussian Flattop Short nyquist Root Short Nquist Raised Cosine Root RaisedCosine
Backwards Compatibility SCPI	[:SENSe]:WAVeform:BANDwidth:SHApe [:SENSe]:WAVeform:BWIDth:SHApe [:SENSe]:WAVeform:BANDwidth BWIDth[:RESolution]:TYPE
Initial S/W Revision	Prior to A.02.00
Modified at S/W Revision	A.03.00, A.13.00

Filter BW

This feature is only available when Option DP2, B40, or wider IF Bandwidth option is installed.

Key Path	BW
Mode	BASIC
Remote Command	[:SENSe]:WAVeform:DIF:FILTer:BANDwidth <freq> [:SENSe]:WAVeform:DIF:FILTer:BANDwidth? [:SENSe]:WAVeform:DIF:FILTer:BANDwidth:AUTO ON OFF 1 0 [:SENSe]:WAVeform:DIF:FILTer:BANDwidth:AUTO?
Example	WAV:DIF:FILT:BAND 1MHz WAV:DIF:FILT:BAND? WAV:DIF:FILT:BAND:AUTO 0

	WAV:DIF:FILT:BAND:AUTO?
Notes	You must be in the IQ Analyzer (Basic) mode to use this command. Use INSTRUMENT:SElect to set the mode.
Dependencies	This feature is only available when Option DP2, B40, or wider IF Bandwidth option is installed.
Couplings	Sets the same value as the current Digital IF BW value upon a preset or when Channel Filter Bandwidth Auto is ON.
Preset	Same value as Digital IF BW ON
State Saved	Saved in instrument state.
Min	10 Hz
Max	Clipped to the current Digital IF BW value.
Initial S/W Revision	A.04.00, A.13.00

Filter Alpha

Sets the filter alpha for the DIF filter. This feature is only available when Option DP2, B40, or wider IF Bandwidth option is installed.

Key Path	BW
Mode	BASIC
Remote Command	[:SENSE] :WAVeform:DIF:FILTer:ALPHa <real> [:SENSE] :WAVeform:DIF:FILTer:ALPHa?
Example	WAV:DIF:FILT:ALPH 0.5 WAV:DIF:FILT:ALPH?
Notes	You must be in the IQ Analyzer (Basic) mode to use this command. Use INSTRUMENT:SElect to set the mode.
Dependencies	This feature is only available when Option DP2, B40, or wider IF Bandwidth option is installed.
Preset	0.2
State Saved	Saved in instrument state.
Min	0.01
Max	1.00
Backwards Compatibility SCPI	[:SENSe] :WAVeform:WBiF:FILTer:ALPHa
Modified at S/W Revision	A.13.00

Filter Type Bwcc

This parameter is strictly for Bwcc purposes.

Remote Command	[:SENSe] :WAVeform:WBIF:FILTer[:TYPE] GAUSSian NONE NYQuist RNYQuist RCOSine RRCosine [:SENSe] :WAVeform:WBIF:FILTer[:TYPE] ?
Preset	BASIC with Option DP2, B40, or wider IF Bandwidth option: FLATtop All other apps: GAUSSian

Gaussian

When Option DP2, B40, or wider IF Bandwidth option is installed, the capability for arbitrary Digital IF bandwidths is available. However, for instruments without DP2, B40, or wider IF Bandwidth option, the selectable Gaussian filter bandwidths are predetermined as shown in the following list. There are 160 Info BWs (RBWs) arranged in a 24-per-decade sequence from 1 Hz through 3 MHz, plus the 4, 5, 6 and 8 MHz settings.

The following table list all 160 Gaussian filter types

Gaussian filters

Normal (-3 dB)	-6 dB	Noise	Impulse
1.0 Hz	1.41 Hz	1.06 Hz	1.49 Hz
1.1 Hz	1.55 Hz	1.16 Hz	1.63 Hz
1.2 Hz	1.69 Hz	1.27 Hz	1.77 Hz
1.3 Hz	1.83 Hz	1.37 Hz	1.92 Hz
1.5 Hz	2.11 Hz	1.59 Hz	2.22 Hz
1.6 Hz	2.25 Hz	1.69 Hz	2.37 Hz
1.8 Hz	2.53 Hz	1.90 Hz	2.66 Hz
2.0 Hz	2.81 Hz	2.12 Hz	2.96 Hz
2.2 Hz	3.09 Hz	2.33 Hz	3.25 Hz
2.4 Hz	3.38 Hz	2.54 Hz	3.55 Hz
2.7 Hz	3.80 Hz	2.86 Hz	3.99 Hz
3.0 Hz	4.22 Hz	3.17 Hz	4.44 Hz
3.3 Hz	4.64 Hz	3.49 Hz	4.88 Hz
3.6 Hz	5.06 Hz	3.81 Hz	5.32 Hz
3.9 Hz	5.49 Hz	4.12 Hz	5.77 Hz
4.3 Hz	6.05 Hz	4.55 Hz	6.36 Hz
4.7 Hz	6.61 Hz	4.97 Hz	6.95 Hz
5.1 Hz	7.17 Hz	5.39 Hz	7.54 Hz
5.6 Hz	7.87 Hz	5.92 Hz	8.27 Hz
6.2 Hz	8.72 Hz	6.56 Hz	9.17 Hz

6.8 Hz	9.55 Hz	7.18 Hz	10.0 Hz
7.5 Hz	10.5 Hz	7.93 Hz	11.1 Hz
8.2 Hz	11.5 Hz	8.66 Hz	12.1 Hz
9.1 Hz	12.8 Hz	9.64 Hz	13.5 Hz
10 Hz	14.0 Hz	10.6 Hz	14.8 Hz
11 Hz	15.4 Hz	11.6 Hz	16.2 Hz
12 Hz	16.9 Hz	12.7 Hz	17.7 Hz
13 Hz	18.3 Hz	13.7 Hz	19.2 Hz
15 Hz	21.1 Hz	15.9 Hz	22.2 Hz
16 Hz	22.5 Hz	16.9 Hz	23.7 Hz
18 Hz	25.3 Hz	19.1 Hz	26.6 Hz
20 Hz	28.1 Hz	21.1 Hz	29.5 Hz
22 Hz	30.9 Hz	23.2 Hz	32.5 Hz
24 Hz	33.8 Hz	25.4 Hz	35.5 Hz
27 Hz	38.0 Hz	28.6 Hz	40.0 Hz
30 Hz	42.3 Hz	31.8 Hz	44.5 Hz
33 Hz	46.3 Hz	34.8 Hz	48.7 Hz
36 Hz	50.7 Hz	38.1 Hz	53.3 Hz
39 Hz	54.9 Hz	41.3 Hz	57.7 Hz
43 Hz	60.5 Hz	45.5 Hz	63.6 Hz
47 Hz	66.1 Hz	49.7 Hz	69.5 Hz
51 Hz	71.7 Hz	53.9 Hz	75.3 Hz
56 Hz	78.9 Hz	59.3 Hz	83.0 Hz
62 Hz	87.3 Hz	65.6 Hz	91.7 Hz
68 Hz	95.5 Hz	71.8 Hz	100 Hz
75 Hz	106 Hz	79.4 Hz	111 Hz
82 Hz	115 Hz	86.8 Hz	121 Hz
91 Hz	128 Hz	96.4 Hz	135 Hz
100 Hz	141 Hz	106 Hz	148 Hz
110 Hz	154 Hz	116 Hz	162 Hz
120 Hz	169 Hz	127 Hz	178 Hz
130 Hz	183 Hz	137 Hz	192 Hz
150 Hz	211 Hz	159 Hz	222 Hz
160 Hz	225 Hz	169 Hz	237 Hz
180 Hz	253 Hz	190 Hz	266 Hz
200 Hz	281 Hz	211 Hz	295 Hz
220 Hz	309 Hz	232 Hz	325 Hz

240 Hz	337 Hz	254 Hz	355 Hz
270 Hz	380 Hz	286 Hz	400 Hz
300 Hz	422 Hz	317 Hz	444 Hz
330 Hz	463 Hz	348 Hz	487 Hz
360 Hz	507 Hz	381 Hz	533 Hz
390 Hz	550 Hz	413 Hz	578 Hz
430 Hz	605 Hz	455 Hz	636 Hz
470 Hz	662 Hz	498 Hz	696 Hz
510 Hz	718 Hz	540 Hz	755 Hz
560 Hz	789 Hz	593 Hz	829 Hz
620 Hz	872 Hz	655 Hz	916 Hz
680 Hz	958 Hz	720 Hz	1.01 kHz
750 Hz	1.06 kHz	794 Hz	1.11 kHz
820 Hz	1.15 kHz	866 Hz	1.21 kHz
910 Hz	1.28 kHz	964 Hz	1.35 kHz
1.0 kHz	1.41 kHz	1.06 kHz	1.48 kHz
1.1 kHz	1.55 kHz	1.17 kHz	1.63 kHz
1.2 kHz	1.69 kHz	1.27 kHz	1.78 kHz
1.3 kHz	1.83 kHz	1.38 kHz	1.93 kHz
1.5 kHz	2.11 kHz	1.59 kHz	2.22 kHz
1.6 kHz	2.26 kHz	1.70 kHz	2.37 kHz
1.8 kHz	2.54 kHz	1.91 kHz	2.67 kHz
2.0 kHz	2.82 kHz	2.12 kHz	2.96 kHz
2.2 kHz	3.10 kHz	2.33 kHz	3.26 kHz
2.4 kHz	3.38 kHz	2.54 kHz	3.56 kHz
2.7 kHz	3.80 kHz	2.86 kHz	4.00 kHz
3.0 kHz	4.23 kHz	3.18 kHz	4.44 kHz
3.3 kHz	4.65 kHz	3.49 kHz	4.89 kHz
3.6 kHz	5.06 kHz	3.81 kHz	5.32 kHz
3.9 kHz	5.48 kHz	4.12 kHz	5.76 kHz
4.3 kHz	6.07 kHz	4.56 kHz	6.38 kHz
4.7 kHz	6.62 kHz	4.98 kHz	6.96 kHz
5.1 kHz	7.16 kHz	5.38 kHz	7.53 kHz
5.6 kHz	7.87 kHz	5.92 kHz	8.27 kHz
6.2 kHz	8.74 kHz	6.57 kHz	9.18 kHz
6.8 kHz	9.58 kHz	7.20 kHz	10.1 kHz
7.5 kHz	10.5 kHz	7.92 kHz	11.1 kHz

8.2 kHz	11.5 kHz	8.66 kHz	12.1 kHz
9.1 kHz	12.8 kHz	9.64 kHz	13.5 kHz
10 kHz	14.1 kHz	10.6 kHz	14.8 kHz
11 kHz	15.4 kHz	11.6 kHz	16.2 kHz
12 kHz	16.9 kHz	12.7 kHz	17.8 kHz
13 kHz	18.3 kHz	13.7 kHz	19.2 kHz
15 kHz	21.2 kHz	15.9 kHz	22.3 kHz
16 kHz	22.4 kHz	16.8 kHz	23.5 kHz
18 kHz	25.2 kHz	19.0 kHz	26.5 kHz
20 kHz	28.4 kHz	21.3 kHz	29.8 kHz
22 kHz	31.2 kHz	23.4 kHz	32.8 kHz
24 kHz	33.8 kHz	25.4 kHz	35.6 kHz
27 kHz	38.1 kHz	28.7 kHz	40.1 kHz
30 kHz	42.1 kHz	31.7 kHz	44.3 kHz
33 kHz	46.8 kHz	35.2 kHz	49.2 kHz
36 kHz	50.1 kHz	37.7 kHz	52.7 kHz
39 kHz	54.8 kHz	41.2 kHz	57.6 kHz
43 kHz	61.1 kHz	46.0 kHz	64.3 kHz
47 kHz	66.2 kHz	49.8 kHz	69.6 kHz
51 kHz	72.3 kHz	54.3 kHz	76.0 kHz
56 kHz	79.5 kHz	59.8 kHz	83.6 kHz
62 kHz	86.3 kHz	64.9 kHz	90.8 kHz
68 kHz	96.5 kHz	72.6 kHz	101 kHz
75 kHz	106 kHz	79.7 kHz	111 kHz
82 kHz	114 kHz	86.0 kHz	120 kHz
91 kHz	129 kHz	97.3 kHz	136 kHz
100 kHz	140 kHz	105 kHz	147 kHz
110 kHz	154 kHz	116 kHz	162 kHz
120 kHz	169 kHz	127 kHz	178 kHz
130 kHz	182 kHz	137 kHz	192 kHz
150 kHz	210 kHz	158 kHz	221 kHz
160 kHz	223 kHz	168 kHz	235 kHz
180 kHz	253 kHz	190 kHz	266 kHz
200 kHz	280 kHz	211 kHz	295 kHz
220 kHz	308 kHz	232 kHz	324 kHz
240 kHz	336 kHz	253 kHz	353 kHz
270 kHz	380 kHz	286 kHz	400 kHz

300 kHz	420 kHz	316 kHz	441 kHz
330 kHz	467 kHz	352 kHz	491 kHz
360 kHz	506 kHz	380 kHz	532 kHz
390 kHz	550 kHz	414 kHz	578 kHz
430 kHz	599 kHz	451 kHz	629 kHz
470 kHz	660 kHz	497 kHz	693 kHz
510 kHz	715 kHz	538 kHz	750 kHz
560 kHz	786 kHz	592 kHz	826 kHz
620 kHz	867 kHz	653 kHz	912 kHz
680 kHz	952 kHz	717 kHz	1.00 MHz
750 kHz	1.05 MHz	791 kHz	1.10 MHz
820 kHz	1.14 MHz	859 kHz	1.19 MHz
910 kHz	1.27 MHz	960 kHz	1.34 MHz
1.0 MHz	1.40 MHz	1.06 MHz	1.47 MHz
1.1 MHz	1.53 MHz	1.15 MHz	1.61 MHz
1.2 MHz	1.66 MHz	1.26 MHz	1.75 MHz
1.3 MHz	1.80 MHz	1.36 MHz	1.89 MHz
1.5 MHz	2.06 MHz	1.56 MHz	2.17 MHz
1.6 MHz	2.19 MHz	1.66 MHz	2.29 MHz
1.8 MHz	2.51 MHz	1.91 MHz	2.63 MHz
2.0 MHz	2.75 MHz	2.10 MHz	2.88 MHz
2.2 MHz	3.00 MHz	2.30 MHz	3.14 MHz
2.4 MHz	3.30 MHz	2.54 MHz	3.45 MHz
2.7 MHz	3.63 MHz	2.81 MHz	3.78 MHz
3.0 MHz	4.09 MHz	3.18 MHz	4.22 MHz
4 MHz	5.30 MHz	4.23 MHz	5.30 MHz
5 MHz	5.78 MHz	4.81 MHz	5.41 MHz
6 MHz	6.31 MHz	5.50 MHz	5.82 MHz
8 MHz	8.07 MHz	7.21 MHz	6.90 MHz

Flattop

When Option DP2, B40, or wider IF Bandwidth option is installed, the capability for arbitrary Digital IF bandwidths is available. However, for instruments without Option DP2, B40 or wider IF Bandwidth option, the selectable Flattop filter bandwidths are predefined as shown in the following table. There are 134 Digital IF BWs (RBWs).

The table in the section ["Flattop Filters" on page 2182](#) lists all 134 Flattop filter types.

Flattop Filters

3.0 Hz	3.3 Hz	3.6 Hz	3.9 Hz
4.3 Hz	4.7 Hz	5.1 Hz	5.6 Hz
6.2 Hz	6.8 Hz	7.5 Hz	8.2 Hz
9.1 Hz	10 Hz	11 Hz	12 Hz
13 Hz	15 Hz	16 Hz	18 Hz
20 Hz	22 Hz	24 Hz	27 Hz
30 Hz	33 Hz	36 Hz	39 Hz
43 Hz	47 Hz	51 Hz	56 Hz
62 Hz	68 Hz	75 Hz	82 Hz
91 Hz	100 Hz	110 Hz	120 Hz
130 Hz	150 Hz	160 Hz	180 Hz
200 Hz	220 Hz	240 Hz	270 Hz
300 Hz	330 Hz	360 Hz	390 Hz
430 Hz	470 Hz	510 Hz	560 Hz
620 Hz	680 Hz	750 Hz	820 Hz
910 Hz	1.0 kHz	1.1 kHz	1.2 kHz
1.3 kHz	1.5 kHz	1.6 kHz	1.8 kHz
2.0 kHz	2.2 kHz	2.4 kHz	2.7 kHz
3.0 kHz	3.3 kHz	3.6 kHz	3.9 kHz
4.3 kHz	4.7 kHz	5.1 kHz	5.6 kHz
6.2 kHz	6.8 kHz	7.5 kHz	8.2 kHz
9.1 kHz	10 kHz	11 kHz	12 kHz
13 kHz	15 kHz	16 kHz	18 kHz
20 kHz	22 kHz	24 kHz	27 kHz
30 kHz	33 kHz	36 kHz	39 kHz
43 kHz	47 kHz	51 kHz	56 kHz
62 kHz	68 kHz	75 kHz	82 kHz
91 kHz	100 kHz	110 kHz	120 kHz
130 kHz	150 kHz	160 kHz	180 kHz
200 kHz	220 kHz	240 kHz	270 kHz
300 kHz	330 kHz	390 kHz	430 kHz
510 kHz	620 kHz	750 kHz	1.0 MHz
1.5 MHz	3.0 MHz	4 MHz	5 MHz
6 MHz	8 MHz		

Channel Filter Bandwidth Bwcc (Remote Command Only)

This is the backward compatibility command for Channel Filter Bandwidth.

Mode	BASIC
Remote Command	[:SENSe] :WAVeform:WBIF:FILTer:BA NDwidth <real> [:SENSe] :WAVeform:WBIF:FILTer:BA NDwidth?
Example	WAV:WBIF:FILT:BA ND 0.3 WAV:WBIF:FILT:BA ND?
Notes	You must be in the IQ Analyzer (Basic) mode to use this command. Use INSTRument:SElect to set the mode.
Dependencies	This feature is only available when Option DP2, B40, or wider IF Bandwidth option is installed.
Couplings	The value is determined by the following equation. $\text{ChannelFilterBwBwcc} = (\text{ChannelFilterBw} / (\text{DigitalIFBw} * \text{OverSampleRatio}))$
Preset	0.8
State Saved	Saved in instrument state.
Min	0.01
Max	1.0
Initial S/W Revision	A.04.00
Modified at S/W Revision	A.13.00

Cont (Continuous Measurement/Sweep)

Sets the analyzer for Continuous measurement operation. The single/continuous state is Meas Global so the setting will affect all measurements. If you are Paused, pressing Cont does a Resume.

Key Path	Front-panel key
Remote Command	:INITiate:CONTinuous OFF ON 0 1 :INITiate:CONTinuous?
Example	:INIT:CONT 0 puts analyzer in Single measurement operation. :INIT:CONT 1 puts analyzer in Continuous measurement operation
Preset	ON (Note that SYST:PRESet sets INIT:CONT to ON but *RST sets INIT:CONT to OFF)
State Saved	Saved in instrument state
Backwards Compatibility Notes	For Spectrum Analysis mode in ESA and PSA, there is no Cont hardkey, instead there is a Sweep Single/Cont key. In these analyzers, switching the Sweep Single/Cont key from Single to Cont restarts averages (displayed average count reset to 1), but does not restart Max Hold and Min Hold. The X-Series has Single and Cont keys in place of the SweepSingleCont key. In the X-Series, if in single measurement, the Cont key (and INIT:CONT ON) switches to continuous measurement, but never restarts a measurement and never resets a sweep.
Initial S/W Revision	Prior to A.02.00

In Swept SA Measurement (Spectrum Analysis Mode):

The analyzer takes repetitive sweeps, averages, measurements, etc., when in Continuous mode. When the average count reaches the Average/Hold Number the count stops incrementing, but the analyzer keeps sweeping. See the Trace/Detector section for the averaging formula used both before and after the Average/Hold Number is reached. The trigger condition must be met prior to each sweep. The type of trace processing for multiple sweeps, is set under the Trace/Detector key, with choices of Trace Average, Max Hold, or Min Hold.

In Other Measurements/Modes:

With Avg/Hold Num (in the Meas Setup menu) set to Off or set to On with a value of 1, a sweep is taken after the trigger condition is met; and the analyzer continues to take new sweeps after the current sweep has completed and the trigger condition is again met. However, with Avg/Hold Num set to On with a value >1, multiple sweeps (data acquisitions) are taken for the measurement. The trigger condition must be met prior to each sweep. The sweep is not stopped when the average count k equals the number N set for Avg/Hold Num is reached, but the number k stops incrementing. A measurement average usually applies to all traces, marker results, and numeric results. But sometimes it only applies to the numeric results.

If the analyzer is in Single measurement, pressing the Cont key does not change k and does not cause the sweep to be reset; the only action is to put the analyzer into Continuous measurement operation.

If it is already in continuous sweep:

the INIT:CONT 1 command has no effect

the INIT:CONT 0 command will place the analyzer in Single Sweep but will have no effect on the current sequence until $k = N$, at which point the current sequence will stop and the instrument will go to the idle state.

17 Waveform Measurement
File

File

See "File" on page 336

FREQ Channel

Accesses a menu of keys that allow you to control the Frequency and Channel parameters of the instrument.

Some features in the Frequency menu are the same for all measurements – they do not change as you change measurements. Settings like these are called “Meas Global” and are unaffected by Meas Preset. For example, the Center Freq setting is the same for all measurements – it does not change as you change measurements.

Key Path	Front-panel key
Initial S/W Revision	Prior to A.02.00

Center Freq

Sets the frequency that corresponds to the horizontal center of the graticule (when frequency Scale Type is set to linear). While adjusting the Center Frequency the Span is held constant, which means that both Start Frequency and Stop Frequency will change.

Pressing Center Freq also sets the frequency entry mode to Center/Span. In Center/Span mode, the center frequency and span values are displayed below the graticule, and the default active function in the Frequency menu is Center Freq.

The center frequency setting is the same for all measurements within a mode, that is, it is Meas Global. Some modes are also able to share a Mode Global center frequency value. If this is the case, the Mode will have a Global Settings key in its Mode Setup menu.

The Center Freq function sets (and queries) the Center Frequency for the currently selected input. If your analyzer has multiple inputs, and you select another input, the Center Freq changes to the value for that input. SCPI commands are available to directly set the Center Freq for a specific input.

Center Freq is remembered as you go from input to input. Thus you can set a Center Freq of 10 GHz with the RF Input selected, change to BBIQ and set a Center Freq of 20 MHz, then switch to External Mixing and set a Center Freq of 60 GHz, and when you go back to the RF Input the Center Freq will go back to 10 GHz; back to BBIQ and it is 20 MHz; back to External Mixing and it is 60 GHz.

See ["RF Center Freq" on page 2190](#)

See [Ext Mix Center Freq](#)

See ["I/Q Center Freq" on page 2192](#)

See ["Center Frequency Presets" on page 2188](#)

Key Path	FREQ Channel
Scope	Meas Global
Remote Command	[:SENSe] :FREQuency:CENTer <freq> [:SENSe] :FREQuency:CENTer?

Example	FREQ:CENT 50 MHz FREQ:CENT UP changes the center frequency to 150 MHz if you use FREQ:CENT:STEP 100 MHz to set the center frequency step size to 100 MHz FREQ:CENT?
Notes	This command sets either the RF or I/Q Center Frequency depending on the selected input. For RF input it is equivalent to FREQ:RF:CENT For I/Q input it is equivalent to FREQ:IQ:CENT Preset and Max values are dependent on Hardware Options (5xx) If no terminator (e.g. MHz) is sent the terminator Hz is used. If a terminator with unit other than Frequency is used, an invalid suffix error message is generated.
Dependencies	The Center Frequency can be limited by Start or Stop Freq limits, if the Span is so large that Start or Stop reach their limit.
Couplings	When operating in "swept span", any value of the Center Frequency or Span that is within the frequency range of the analyzer is allowed when the value is being set through the front panel numeric key pad or the SCPI command. The other parameter is forced to a different value if needed, to keep the Start and the Stop Frequencies within the analyzer's frequency range
Preset	Depends on instrument maximum frequency, mode, measurement, and selected input. See "Center Frequency Presets" on page 2188 and "RF Center Freq" on page 2190 and Ext Mix Center Freq and "I/Q Center Freq" on page 2192.
State Saved	Saved in instrument state
Min	Depends on instrument maximum frequency, mode, measurement, and selected input.. See "Center Frequency Presets" on page 2188 and "RF Center Freq" on page 2190 and "I/Q Center Freq" on page 2192.
Max	Depends on instrument maximum frequency, mode, measurement, and selected input.. See "Center Frequency Presets" on page 2188 and "RF Center Freq" on page 2190 and "I/Q Center Freq" on page 2192.
Default Unit	Hz
Status Bits/OPC	Non-overlapped
Dependencies	
Initial S/W Revision	Prior to A.02.00

Center Frequency Presets

The following table provides the Center Frequency Presets for the Spectrum Analyzer mode, and the Max Freq, for the various frequency options:

Freq Option	CF after Mode Preset	Stop Freq after Mode Preset	Max Freq (can't tune)

			above)
503 (all but N9000A)	1.805 GHz	3.6 GHz	3.7 GHz
503 (N9000A)	1.505 GHz	3.0 GHz	3.08 GHz
507 (all but N9000A)	3.505 GHz	7.0 GHz	7.1 GHz
507 (N9000A)	3.755 GHz	7.5 GHz	7.58 GHz
508 (all but N9038A)	1.805 GHz	3.6 GHz	8.5 GHz
508 (N9038A)	4.205 GHz	8.4 GHz	8.5 GHz
513	6.805 GHz	13.6 GHz	13.8 GHz
526 (all but N9000A and N9038A)	13.255 GHz	26.5 GHz	27.0 GHz
526 (N9000A)	13.255 GHz	26.5 GHz	26.55 GHz
526 (N9038A)	1.805 GHz	3.6 GHz	27.0 GHz
532	16.005 GHz	32.0 GHz	32.5 GHz
543	21.505 GHz	43.0 GHz	TBD
544	22.005 GHz	44.0 GHz	44.5 GHz
550	25.005 GHz	50.0 GHz	51 GHz

Input 2:

Model	CF after Mode Preset	Stop Freq after Mode Preset	Max Freq (can't tune above)
N9000A opt C75	0.7505GHz	1.5 GHz	1.58 GHz
N9038A	505 MHz	1 GHz	1.000025 GHz

Tracking Generator Frequency Limits (N9000A only):

Tracking Generator Option	Min Freq (clips to this freq when turn TG on and	If above this Freq, Stop Freq clipped to this Freq when	Max Freq (can't tune above) while TG

	can't tune below while TG on)	TG turned on	on
T03	9 kHz	3.0 GHz	3.08 GHz
T06	9 kHz	6.0 GHz	6.05 GHz

The following table shows the Center Frequency Presets for modes other than Spectrum Analyzer:

Mode	CF Preset for RF
WCDMA	1 GHz
WIMAXOFDMA,	1 GHz
BASIC	1 GHz
ADEMOD	1 GHz
VSA	1 GHz
TDSCDMA	1 GHz
PNOISE	1 GHz
LTE	1 GHz
LTETDD	1 GHz
MSR	1 GHz
GSM	935.2 MHz
NFIGURE	1.505 GHz

RF Center Freq

SCPI command for specifying the RF Center Frequency. This command will set the Center Frequency to be used when the RF input is selected, even if the RF input is not the input that is selected at the time the command is sent. Note that the Center Freq function in the Frequency menu on the front panel always applies to the currently selected input.

Scope	Meas Global
Remote Command	<code>[:SENSe] :FREQuency:RF:CENTer <freq></code> <code>[:SENSe] :FREQuency:RF:CENTer?</code>
Example	FREQ:RF:CENT 30 MHz
Notes	This command is the same in all modes, but the parameter is Measurement Global. So the value is independent in each mode and common across all the measurements in the mode.
Dependencies	If the electronic/soft attenuator is enabled, any attempt to set Center Frequency such that the Stop Frequency would be >3.6 GHz fails and results in an advisory message. If the equivalent SCPI command is sent, this same message is generated as part of a “-221, Settings conflict” warning. If Source Mode is set to Tracking, and the Max or Min Center Freq is therefore limited by the limits of the source, a warning message is generated, “Data out of range;clipped to source max/min” if these limits are exceeded. Note that for an external source, these limits can be affected by the settings of

	Source Numerator, Source Denominator and Power Sweep.
Preset	See table above
State Saved	Saved in instrument state.
Min	-79.999995 MHz, unless Source Mode is set to Tracking, in which case it is limited by the minimum frequency of the Source
Max	See table above. Basically instrument maximum frequency - 5 Hz. Note that, if the Source Mode is set to Tracking, the effective instrument maximum frequency may be limited by the source maximum frequency. If the knob or step keys are being used, also depends on the value of the other three interdependent parameters Span, Start Frequency and Stop Frequency
Initial S/W Revision	Prior to A.02.00
Modified at S/W Revision	A.03.00

Ext Mix Center Freq

SCPI command for specifying the External Mixer Center Frequency. This command will set the Center Frequency to be used when the External Mixer is selected, even if the External Mixer input is not the input which is selected at the time the command is sent. Note that the Center Freq function in the Frequency menu on the front panel always applies to the currently selected input.

Scope	Meas Global
Remote Command	<code>[:SENSe] :FREQuency:EMIXer:CENTer <freq></code> <code>[:SENSe] :FREQuency:EMIXer:CENTer?</code>
Example	<code>:FREQ:EMIX:CENT 60 GHz</code> <code>:FREQ:EMIX:CENT?</code>
Notes	This command is the same in all modes, but the parameter is Measurement Global. So the value is independent in each mode and common across all the measurements in the mode.
Couplings	When returning to External Mixing after having been switched to one of the other inputs (e.g., RF), you will come back into the settings that you had when you left External Mixing. So you will come back to the band you were in with the Center Frequency that you had. However, Span is not an input-dependent parameter, therefore you will bring the span over from the other input. Therefore, the analyzer comes back with the span from the previous input, limited as necessary by the current mixer setup.
Preset	When a Mode Preset is performed while in External Mixing, the Start frequency of the current Mode is set to the nominal Min Freq of the lowest harmonic range in the Harmonic Table for the current mixer setup. Similarly, the Stop frequency of the current Mode is set to the nominal Max Freq of the highest harmonic range in the Harmonic Table. The Center Freq thus presets to the point arithmetically equidistant from these two frequencies. If the current measurement has a limited Span available to it, and cannot achieve the Span shown in the table ($\text{Span} = \text{Stop Freq} - \text{Start Freq}$), the analyzer uses the maximum Span the measurement allows, and still sets the Center Freq to the midpoint of the Start and Stop Freq values in the Harmonic Table.

	<p>When Restore Input/Output Defaults is performed, the mixer presets to the 11970A, whose Start and Stop frequencies are 26.5 and 40 GHz respectively. The center of these two frequencies is 33.25 GHz.</p> <p>Therefore, after a Restore Input/Output Defaults, if you go into External Mixing and do a Mode Preset while in the Spectrum Analyzer Mode, the resulting Center Freq is 33.25 GHz.</p>
State Saved	Saved in instrument state.
Min	The minimum frequency in the currently selected mixer band + 5 Hz
Max	<p>The maximum frequency in the currently selected mixer band – 5 Hz</p> <p>If the knob or step keys are being used, also depends on the value of the other three interdependent parameters Span, Start Frequency and Stop Frequency</p>
Initial S/W Revision	A.08.01

I/Q Center Freq

SCPI command for specifying the I/Q Center Frequency. This command will set the Center Frequency to be used when the I/Q input is selected, even if the I/Q input is not the input which is selected at the time the command is sent. Note that the Center Freq function in the Frequency menu on the front panel always applies to the currently selected input.

Scope	Meas Global
Remote Command	<pre>[:SENSe] :FREQuency:IQ:CENTer <freq></pre> <pre>[:SENSe] :FREQuency:IQ:CENTer?</pre>
Example	FREQ:IQ:CENT: 30 MHz
Notes	This command is the same in all modes, but the parameter is Measurement Global. So the value is independent in each mode and common across all the measurements in the mode.
Preset	0 Hz
State Saved	Saved in instrument state.
Min	-40.049995 MHz
Max	40.049995 MHz
Initial S/W Revision	Prior to A.02.00

Input/Output

See ["Input/Output" on page 196](#)

Marker

Accesses a menu that enables you to select, set up and control the markers for the current measurement.

Key Path	Front-panel key
Initial S/W Revision	Prior to A.02.00

Select Marker

Displays 12 markers available for selection.

Key Path	Marker
Initial S/W Revision	Prior to A.02.00

Marker Type

Sets the marker control mode to Normal, Delta, Fixed or Off. All interactions and dependencies detailed under the key description are enforced when the remote command is sent. If the selected marker is Off, pressing Marker sets it to Normal and places it at the center of the screen on the trace determined by the Marker Trace rules. At the same time, the Marker X Axis Value appears on the Active Function area.

The default active function is the active function for the currently selected marker control mode. If the current control mode is Off, there is no active function and the active function is turned off.

Key Path	Marker
Mode	BASIC, PNOISE, WCDMA, C2K, GSM, WIMAXOFDMA, TDSCDMA, 1XEVD0, DVB, DTMB, ISDBT, CMMB, LTE, LTETDD, DCATV, WLAN,,LTEATDD, LTEAFDD
Remote Command	:CALCulate:WAVeform:MARKer[1] 2 ... 12:MODE POSition DELTa OFF :CALCulate:WAVeform:MARKer[1] 2 ... 12:MODE?
Example	CALC:WAV:MARK:MODE OFF CALC:WAV:MARK:MODE?
Notes	If the selected marker is Off, pressing Marker sets it to Normal and places it at the center of the screen on the trace determined by the Marker Trace rules. At the same time, Marker X Axis Value appears on the Active Function area. Default Active Function: the active function for the selected marker's current control mode. If the current control mode is Off, there is no active function and the active function is turned off. Active Function Display: the marker X axis value entered in the active function area displays the marker value to its full entered precision. You must be in a mode that includes the Waveform measurement to use this command. Use INSTRument:SElect to set the mode.
Preset	OFF
State Saved	Saved in instrument state.

Range	Normal Delta Off
Initial S/W Revision	Prior to A.02.00
Modified at S/W Revision	A.03.00

Properties

Accesses the marker properties menu.

Key Path	Marker
Initial S/W Revision	Prior to A.02.00

Select Marker

Displays 12 markers available for selection.

Key Path	Marker
Initial S/W Revision	Prior to A.02.00

Relative To

Selects the marker that the selected marker is relative to (*its reference marker*).

Key Path	Marker, Properties
Mode	BASIC, PNOISE, WCDMA, C2K, GSM, WIMAXOFDMA, TDSCDMA, 1XEVD0, DVB, DTMB, ISDBT, CMMB, LTE, LTETDD, DCATV, WLAN,,LTEATDD, LTEAFDD
Remote Command	:CALCulate:WAVEform:MARKer[1] 2 ... 12:REFerence <integer> :CALCulate:WAVEform:MARKer[1] 2 ... 12:REFerence?
Example	CALC:WAV:MARK:REF 8 CALC:WAV:MARK:REF?
Notes	A marker cannot be relative to itself so that choice is grayed out, and if sent from SCPI generates error -221: "Settings conflict; marker cannot be relative to itself." When queried a single value is returned (the specified marker numbers relative marker). You must be in a mode that includes the Waveform measurement to use this command. Use INSTRument:SElect to set the mode.
Preset	2 3 4 5 6 7 8 9 10 11 12 1
State Saved	Saved in instrument state.
Min	1
Max	12
Initial S/W Revision	Prior to A.02.00
Modified at S/W Revision	A.03.00

Marker Trace

Assigns the specified marker to the designated trace.

Key Path	Marker
Mode	BASIC, PNOISE, WCDMA, C2K, GSM, WIMAXOFDMA, TDSCDMA, 1XEVD0, DVB, DTMB, ISDBT, CMMB, LTE, LTETDD, DCATV, WLAN,,LTEATDD, LTEAFDD
Remote Command	:CALCulate:WAVeform:MARKer[1] 2 ... 12:TRACe RFENvelope I Q IQ :CALCulate:WAVeform:MARKer[1] 2 ... 12:TRACe?
Example	CALC:WAV:MARK:TRAC RFEN CALC:WAV:MARK:TRAC?
Notes	Assigns the specified marker to the designated trace. The IQ selection is for backward compatibility purposes. It is recommended that the users use the I and/or Q selection instead. You must be in a mode that includes the Waveform measurement to use this command. Use INSTRument:SElect to set the mode.
Preset	RFEN
State Saved	Saved in instrument state.
Range	RF Envelope I Q IQ
Initial S/W Revision	Prior to A.02.00
Modified at S/W Revision	A.03.00

Couple Markers

Toggles the state of the markers to be coupled On or Off. When this function is true (On), moving any marker causes an equal X-axis movement of every other marker which is not Off. "Equal X-axis movement" refers to the difference between each marker's X-Axis value (in the fundamental x-axis units of the trace that marker is on) and the X-Axis value of the marker being moved (in the same fundamental x-axis units) are preserved.

Key Path	Marker
Mode	BASIC, PNOISE, WCDMA, C2K, GSM, WIMAXOFDMA, TDSCDMA, 1XEVD0, DVB, DTMB, ISDBT, CMMB, LTE, LTETDD, DCATV, WLAN,,LTEATDD, LTEAFDD
Remote Command	:CALCulate:WAVeform:MARKer:COUPle[:STATe] ON OFF 1 0 :CALCulate:WAVeform:MARKer:COUPle[:STATe]?
Example	CALC:WAV:MARK:COUP ON CALC:WAV:MARK:COUP ON
Notes	You must be in a mode that includes the Waveform measurement to use this command. Use INSTRument:SElect to set the mode.
Preset	OFF

State Saved	Saved in instrument state.
Range	On Off
Initial S/W Revision	Prior to A.02.00
Modified at S/W Revision	A.03.00

All Markers Off

Turns off all markers.

Key Path	Marker
Mode	BASIC, PNOISE, WCDMA, C2K, GSM, WIMAXOFDMA, TDSCDMA, 1XEVD0, DVB, DTMB, ISDBT, CMMB, LTE, LTETDD, DCATV, WLAN,LTEATDD, LTEAFDD
Remote Command	:CALCulate:WAVeform:MARKer:AOFF
Example	CALC:WAV:MARK:AOFF
Notes	You must be in a mode that includes the Waveform measurement to use this command. Use INSTRument:SElect to set the mode.
Initial S/W Revision	Prior to A.02.00
Modified at S/W Revision	A.03.00

Marker X Axis Value (Remote Command Only)

Sets the marker X Axis value in the current marker X Axis Scale unit. It has no effect if the control mode is Off, but is the SCPI equivalent of entering an X value if the control mode is Normal or Delta.

Mode	BASIC, PNOISE, WCDMA, C2K, GSM, WIMAXOFDMA, TDSCDMA, 1XEVD0, DVB, DTMB, ISDBT, CMMB, LTE, LTETDD, DCATV, WLAN,,LTEATDD, LTEAFDD
Remote Command	:CALCulate:WAVeform:MARKer[1] 2 ... 12:X <time> :CALCulate:WAVeform:MARKer[1] 2 ... 12:X?
Example	CALC:WAV:MARK:X 50 ms CALC:WAV:MARK:X?
Notes	If no suffix is sent, uses the fundamental units for the current marker X Axis Scale. If a suffix is sent that does not match the current marker X Axis Scale unit, an error "Invalid suffix" is generated. If the specified marker is Fixed and a Marker Function is on, error -221 "Settings conflict; cannot adjust Fixed marker while Marker Function is on" is generated. The query returns the marker's absolute X Axis value if the control mode is Normal, or the offset from the marker's reference marker if the control mode is Delta. The query is returned in the fundamental units for the current marker X Axis scale: Hz for Frequency and Inverse Time, seconds for Period and Time. If the marker is Off the response is not a number. You must be in a mode that includes the Waveform measurement to use this command. Use INSTRument:SElect to set the mode.
Preset	0

Preset	After a preset, all markers are turned OFF, so Marker X Axis Value query returns a not a number (NAN).
State Saved	No
Min	(9.9E+37
Max	9.9E+37
Initial S/W Revision	Prior to A.02.00
Modified at S/W Revision	A.03.00

Marker X Axis Position (Remote Command Only)

Sets the marker X position in trace points. It has no effect if the control mode is Off, but is the SCPI equivalent of entering a value if the control mode is Normal or Delta. The entered value is immediately translated into the current X Axis Scale units for setting the value of the marker.

Mode	BASIC, PNOISE, WCDMA, C2K, GSM, WIMAXOFDMA, TDSCDMA, 1XEVD0, DVB, DTMB, ISDBT, CMMB, LTE, LTETDD, DCATV, WLAN,,LTEATDD, LTEAFDD
Remote Command	:CALCulate:WAVeform:MARKer[1] 2 ... 12:X:POSition <real> :CALCulate:WAVeform:MARKer[1] 2 ... 12:X:POSition?
Example	CALC:WAV:MARK:X:POS 500 CALC:WAV:MARK:X:POS?
Notes	The query returns the marker's absolute X Axis value in trace points if the control mode is Normal or the offset from the marker's reference marker in trace points if the control mode is Delta. The value is returned as a real number, not an integer, corresponding to the translation from X Axis Scale units to trace points. You must be in a mode that includes the Waveform measurement to use this command. Use INSTRument:SElect to set the mode.
Preset	0
Preset	After a preset, all markers are turned OFF, so Marker X Axis Value query returns a not a number (NAN).
State Saved	No
Min	(9.9E+37
Max	9.9E+37
Initial S/W Revision	Prior to A.02.00
Modified at S/W Revision	A.03.00

Marker Y Axis Value (Remote Command Only)

Queries the marker Y Axis value in the current marker Y Axis unit.

Mode	BASIC, PNOISE, WCDMA, C2K, GSM, WIMAXOFDMA, TDSCDMA, 1XEVD0, DVB, DTMB, ISDBT, CMMB, LTE, LTETDD, DCATV, WLAN,,LTEATDD, LTEAFDD
------	---

Remote Command	:CALCulate:WAVeform:MARKer[1] 2 ... 12:Y?
Example	CALC:WAV:MARK11:Y?
Notes	<p>When the marker is on, IQ waveform returns I and Q values.</p> <p>Case #1 - Trace RF, I or Q: returns a single double value.</p> <p>>:CALC:WAV:MARK1:Y? -2.402406506109E+001</p> <p>Case #2 - Trace IQ: returns a double array of two values, the first is I, and the second is Q.</p> <p>>:CALC:WAV:MARK1:Y? -3.006944493834E-003,+9.9870666467354E-004</p> <p>The IQ selection is for backward compatibility purposes. It is recommended that the users use the I and/or Q selection instead.</p> <p>You must be in a mode that includes the Waveform measurement to use this command. Use INSTRument:SElect to set the mode.</p>
Preset	Result dependent on the marker setup and signal source.
State Saved	No
Backwards Compatibility SCPI	:CALCulate:WAVeform:MARKer[1] 2 ... 12:FUNCTion:RESult?
Initial S/W Revision	Prior to A.02.00
Modified at S/W Revision	A.03.00

Backward Compatibility SCPI Commands

Sets or queries the state of a marker. Setting a marker that is OFF to state ON or 1 puts it in Normal mode and places it at the center of the screen.

Mode	BASIC, PNOISE, WCDMA, CDMA2K, EDGE GSM, WIMAX OFDMA, TDSCDMA, CDMA1XEV, DVB, DTMB, ISDBT, CMMB, LTE, LTETDD, DCATV, WLAN
Remote Command	:CALCulate:WAVeform:MARKer[1] 2 ... 12:STATe OFF ON 0 1 :CALCulate:WAVeform:MARKer[1] 2 ... 12:STATe?
Example	CALC:WAV:MARK:STAT ON CALC:WAV:MARK:STAT?
Notes	You must be in a mode that includes the Waveform measurement to use this command. Use INSTRument:SElect to set the mode.
Preset	OFF
State Saved	Saved in instrument state.
Range	On Off
Initial S/W Revision	Prior to A.02.00
Modified at S/W Revision	A.03.00

Marker ->

There is no 'Marker ->' functionality supported in Waveform measurements. The front-panel key displays a blank menu when pressed.

Key Path	Front-panel key
Initial S/W Revision	Prior to A.02.00

Marker Function

Accesses a menu of marker functions that perform post-processing operations on markers based on the measurement specifications. Marker functions are distinct from measurement functions, which automatically perform complex sequences of setup, data acquisition, and display operations in order to measure specified signal characteristics. Marker Functions are specified for each individual marker and may be turned on individually for each marker.

The Marker Function menu controls which marker functions are turned on and allows you to adjust the setup parameters for each function. These parameters include the following, but only one parameter can be assigned to a given marker:

- Marker Noise
- BandInterval Power
- Band/Interval Density
- Marker Function Off

Key Path	Front-panel key
Initial S/W Revision	Prior to A.02.00

Select Marker

Displays 12 markers available for selection.

Key Path	Marker
Initial S/W Revision	Prior to A.02.00

Marker Function Type

Sets the marker control function type to, Marker Noise, Band/Interval Power, Band Interval Density, or Marker Function Off

Key Path	Marker Function
Mode	BASIC, PNOISE, WCDMA, C2K, GSM, WIMAXOFDMA, TDSCDMA, 1XEVD0, DVB, DTMB, ISDBT, CMMB, LTE, LTETDD, DCATV, WLAN,,LTEATDD, LTEAFDD
Remote Command	:CALCulate:WAVeform:MARKer[1] 2 ... 12:FUNctIon BPOwer BDENsity OFF :CALCulate:WAVeform:MARKer[1] 2 ... 12:FUNctIon?
Example	CALC:WAV:MARK:FUNC BPOW CALC:WAV:MARK:FUNC?
Notes	You must be in a mode that includes the Waveform measurement to use this command. Use INSTRument:SElect to set the mode.
Preset	OFF

State Saved	Saved in instrument state.
Range	Band/Interval Power Band Interval Density Marker Function Off
Initial S/W Revision	Prior to A.02.00
Modified at S/W Revision	A.03.00

Band Adjust

Accesses a menu that enables you to set the frequency span width and the left and right edge, or time values, for the band or interval of the selected marker.

Key Path	Marker Function
Initial S/W Revision	Prior to A.02.00

Band/Interval Span for Time Domain

Sets the width of the frequency span for the selected marker.

Key Path	Marker Function
Mode	BASIC, PNOISE, WCDMA, C2K, GSM, WIMAXOFDMA, TDSCDMA, 1XEVD0, DVB, DTMB, ISDBT, CMMB, LTE, LTETDD, DCATV, WLAN,LTEATDD, LTEAFDD
Remote Command	:CALCulate:WAVEform:MARKer[1] 2 ... 12:FUNCtion:BAND:SPAN <time> :CALCulate:WAVEform:MARKer[1] 2 ... 12:FUNCtion:BAND:SPAN?
Example	CALC:WAV:MARK:FUNC:BAND:SPAN 20 ms CALC:WAV:MARK:FUNC:BAND:SPAN?
Notes	You must be in a mode that includes the Waveform measurement to use this command. Use INSTRument:SElect to set the mode.
Couplings	Changing the Band/Interval Span necessarily changes the Band/Interval Left and Band/Interval Right values
Preset	0
Preset	10% of Meas Time
State Saved	Saved in instrument state.
Min	0
Max	100 s
Backwards Compatibility SCPI	:CALCulate:WAVEform:MARKer[1] 2 ... 4:X:SPAN
Initial S/W Revision	Prior to A.02.00
Modified at S/W Revision	A.03.00

Band/Interval Left for Time Domain

Sets the left edge frequency or time value for the band of the selected marker.

Key Path	Marker Function
Mode	BASIC, PNOISE, WCDMA, C2K, GSM, WIMAXOFDMA, TDSCDMA, 1XEVD0, DVB, DTMB, ISDBT, CMMB, LTE, LTETDD, DCATV, WLAN,,LTEATDD, LTEAFDD
Remote Command	:CALCulate:WAVeform:MARKer[1] 2 ... 12:FUNction:BAND:LEFT <time> :CALCulate:WAVeform:MARKer[1] 2 ... 12:FUNction:BAND:LEFT?
Example	CALC:WAV:MARK12:FUNC:BAND:LEFT 1 s CALC:WAV:MARK12:FUNC:BAND:LEFT?
Notes	You must be in a mode that includes the Waveform measurement to use this command. Use INSTRument:SElect to set the mode.
Couplings	Changing the Band/Interval Left necessarily changes the Band/Interval Span and Band/Interval Right values
Preset	0
Preset	5% of Meas Time
State Saved	Saved in instrument state.
Min	0
Max	100 s
Initial S/W Revision	Prior to A.02.00
Modified at S/W Revision	A.03.00

Band/Interval Right for Time Domain

Sets the right edge frequency or time value for the band of the selected marker.

Key Path	Marker Function
Mode	BASIC, PNOISE, WCDMA, C2K, GSM, WIMAXOFDMA, TDSCDMA, 1XEVD0, DVB, DTMB, ISDBT, CMMB, LTE, LTETDD, DCATV, WLAN,,LTEATDD, LTEAFDD
Remote Command	:CALCulate:WAVeform:MARKer[1] 2 ... 12:FUNction:BAND:RIGHT <time> :CALCulate:WAVeform:MARKer[1] 2 ... 12:FUNction:BAND:RIGHT?
Example	CALC:WAV:MARK12:FUNC:BAND:RIGH 1 s CALC:WAV:MARK12:FUNC:BAND:RIGH?
Notes	You must be in a mode that includes the Waveform measurement to use this command. Use INSTRument:SElect to set the mode.
Couplings	Changing the Band/Interval Left necessarily changes the Band/Interval Span and Band/Interval Right values
Preset	0
Preset	5% of Meas Time
State Saved	Saved in instrument state.

17 Waveform Measurement
Marker Function

Min	0
Max	100 s
Initial S/W Revision	Prior to A.02.00
Modified at S/W Revision	A.03.00

Meas

The information in this section is common to all measurements. For key and remote command information for a specific measurement, refer to the section that describes the measurement of interest.

Measurements available under the Meas key are specific to the current Mode.

When viewing Help for measurements, note the following:

NOTE

Operation for some keys differs between measurements. The information displayed in Help pertains to the current measurement. To see how a key operates in a different measurement, exit Help (press the Cancel Esc key), select the measurement, then reenter Help (press the Help key) and press that key.

Key Path	Front-panel key
Initial S/W Revision	Prior to A.02.00

Remote Measurement Functions

This section contains the following topics:

"Measurement Group of Commands" on page 2206

"Current Measurement Query (Remote Command Only)" on page 2208

"Limit Test Current Results (Remote Command Only)" on page 2208

"Data Query (Remote Command Only)" on page 2208

"Calculate/Compress Trace Data Query (Remote Command Only)" on page 2209

"Calculate Peaks of Trace Data (Remote Command Only)" on page 2214

Hardware-Accelerated Fast Power Measurement (Remote Command Only)

"Format Data: Numeric Data (Remote Command Only)" on page 2215

"Format Data: Byte Order (Remote Command Only)" on page 2216

Initial S/W Revision	Prior to A.02.00
----------------------	------------------

Measurement Group of Commands

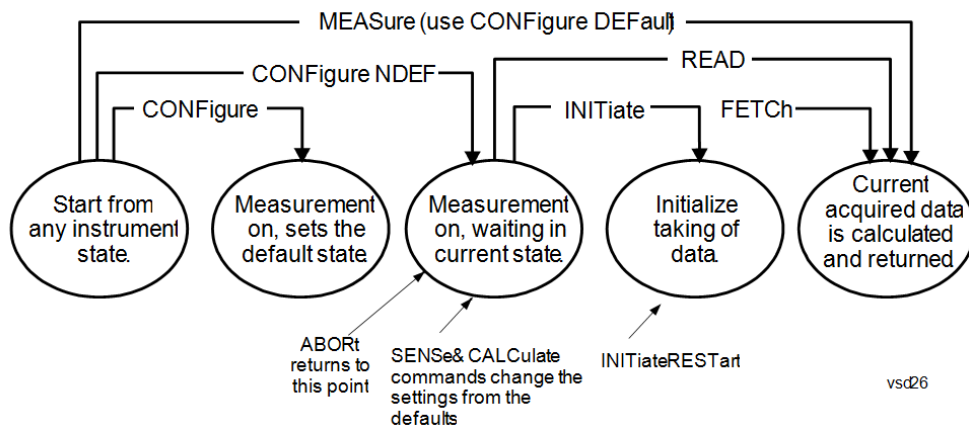

Measure Commands:

:MEASure:<measurement>[n]?

This is a fast single-command way to make a measurement using the factory default instrument settings. These are the settings and units that conform to the Mode Setup settings (e.g. radio standard) that you have currently selected.

- Stops the current measurement (if any) and sets up the instrument for the specified measurement using the factory defaults
- Initiates the data acquisition for the measurement
- Blocks other SCPI communication, waiting until the measurement is complete before returning results.
- If the function does averaging, it is turned on and the number of averages is set to 10.
- After the data is valid it returns the scalar results, or the trace data, for the specified measurement. The type of data returned may be defined by an [n] value that is sent with the command.
- The scalar measurement results will be returned if the optional [n] value is not included, or is set to 1. If the [n] value is set to a value other than 1, the selected trace data results will be returned. See each command for details of what types of scalar results or trace data results are available.
- ASCII is the default format for the data output. (Older versions of Spectrum Analysis and Phase Noise mode measurements only use ASCII.) The binary data formats should be used for handling large blocks of data since they are smaller and faster than the ASCII format. Refer to the FORMat:DATA command for more information.

If you need to change some of the measurement parameters from the factory default settings you can set up the measurement with the CONFIgure command. Use the commands in the SENSe:<measurement> and CALCulate:<measurement> subsystems to change the settings. Then you can use the READ? command to initiate the measurement and query the results.

If you need to repeatedly make a given measurement with settings other than the factory defaults, you can use the commands in the SENSe:<measurement> and CALCulate:<measurement> subsystems to set up the measurement. Then use the READ? command to initiate the measurement and query results.

Measurement settings persist if you initiate a different measurement and then return to a previous one. Use READ:<measurement>? if you want to use those persistent settings. If you want to go back to the default settings, use MEASure:<measurement>?.

Configure Commands:

:CONFIgure:<measurement>

This command stops the current measurement (if any) and sets up the instrument for the specified measurement using

the factory default instrument settings. It does not initiate the taking of measurement data unless INIT:CONTinuous is ON. If you change any measurement settings after using the CONFigure command, the READ command can be used to initiate a measurement without changing the settings back to their defaults.

In the Swept SA measurement in Spectrum Analyzer mode the CONFigure command also turns the averaging function on and sets the number of averages to 10 for all measurements.

:CONFigure: <measurement>: NDEFault stops the current measurement and changes to the specified measurement. It does not change the settings to the defaults. It does not initiate the taking of measurement data unless INIT:CONTinuous is ON.

The CONFigure? query returns the current measurement name.

The CONFigure:CATalog? query returns a quoted string of all licensed measurement names in the current mode. For example, "SAN, CHP, OBW, ACP, PST, TXP, SPUR, SEM, LIST".

Fetch Commands:

:FETCh:<measurement>[n]?

This command puts selected data from the most recent measurement into the output buffer. Use FETCh if you have already made a good measurement and you want to return several types of data (different [n] values, for example, both scalars and trace data) from a single measurement. FETCh saves you the time of re-making the measurement. You can only FETCh results from the measurement that is currently active, it will not change to a different measurement. An error message is reported if a measurement other than the current one is specified.

If you need to get new measurement data, use the READ command, which is equivalent to an INITiate followed by a FETCh.

The scalar measurement results will be returned if the optional [n] value is not included, or is set to 1. If the [n] value is set to a value other than 1, the selected trace data results will be returned. See each command for details of what types of scalar results or trace data results are available. The binary data formats should be used for handling large blocks of data since they are smaller and transfer faster than the ASCII format. (FORMat:DATA)

FETCh may be used to return results other than those specified with the original READ or MEASure command that you sent.

INITiate Commands:

:INITiate:<measurement>

This command is not available for measurements in all the instrument modes:

- Initiates a trigger cycle for the specified measurement, but does not output any data. You must then use the FETCh<meas> command to return data. If a measurement other than the current one is specified, the instrument will switch to that measurement and then initiate it.
 - For example, suppose you have previously initiated the ACP measurement, but now you are running the channel power measurement. If you send INIT:ACP? it will change from channel power to ACP and will initiate an ACP measurement.
 - Does not change any of the measurement settings. For example, if you have previously started the ACP measurement and you send INIT:ACP? it will initiate a new ACP measurement using the same instrument settings as the last time ACP was run.
 - If your selected measurement is currently active (in the idle state) it triggers the measurement, assuming the trigger conditions are met. Then it completes one trigger cycle. Depending upon the measurement and the number of averages, there may be multiple data acquisitions, with multiple trigger events, for one full trigger cycle. It also holds off additional commands on GPIB until the acquisition is complete.
-

READ Commands:

:READ:<measurement>[n]?

- Does not preset the measurement to the factory default settings. For example, if you have previously initiated the ACP
-

measurement and you send READ:ACP? it will initiate a new measurement using the same instrument settings.

- Initiates the measurement and puts valid data into the output buffer. If a measurement other than the current one is specified, the instrument will switch to that measurement before it initiates the measurement and returns results.
 - For example, suppose you have previously initiated the ACP measurement, but now you are running the channel power measurement. Then you send READ:ACP? It will change from channel power back to ACP and, using the previous ACP settings, will initiate the measurement and return results.
 - Blocks other SCPI communication, waiting until the measurement is complete before returning the results
 - If the optional [n] value is not included, or is set to 1, the scalar measurement results will be returned. If the [n] value is set to a value other than 1, the selected trace data results will be returned. See each command for details of what types of scalar results or trace data results are available. The binary data formats should be used when handling large blocks of data since they are smaller and faster than the ASCII format. (FORMat:DATA)
-

Initial S/W Revision	Prior to A.02.00
----------------------	------------------

Current Measurement Query (Remote Command Only)

This command returns the name of the measurement that is currently running.

Remote Command	:CONFigure?
-----------------------	-------------

Example	CONF?
----------------	-------

Initial S/W Revision	Prior to A.02.00
----------------------	------------------

Limit Test Current Results (Remote Command Only)

Queries the status of the current measurement limit testing. It returns a 0 if the measured results pass when compared with the current limits. It returns a 1 if the measured results fail any limit tests.

Remote Command	:CALCulate:CLIMits:FAIL?
-----------------------	--------------------------

Example	CALC:CLIM:FAIL? queries the current measurement to see if it fails the defined limits. Returns a 0 or 1: 0 it passes, 1 it fails.
----------------	--

Initial S/W Revision	Prior to A.02.00
----------------------	------------------

Data Query (Remote Command Only)

Returns the designated measurement data for the currently selected measurement and subopcode.

n = any valid subopcode for the current measurement. See the measurement command results table for your current measurement, for information about what data is returned for the subopcodes.

This command uses the data setting specified by the FORMat:BORDER and FORMat:DATA commands and can return real or ASCII data. (See the format command descriptions under Input/Output in the Analyzer Setup section.)

Remote Command	:CALCulate:DATA[n]?
Notes	The return trace depends on the measurement. In CALCulate:<meas>:DATA[n], n is any valid subopcode for the current measurement. It returns the same data as the FETCH:<measurement>? query where <measurement> is the current measurement.
Initial S/W Revision	Prior to A.02.00

Calculate/Compress Trace Data Query (Remote Command Only)

Returns compressed data for the currently selected measurement and sub-opcode [n].

n = any valid sub-opcode for that measurement. See the MEASure:<measurement>? command description of your specific measurement for information on the data that can be returned.

The data is returned in the current Y Axis Unit of the analyzer. The command is used with a sub-opcode <n> (default=1) to specify the trace. With trace queries, it is best if the analyzer is not sweeping during the query. Therefore, it is generally advisable to be in Single Sweep, or Update=Off.

This command is used to compress or decimate a long trace to extract and return only the desired data. A typical example would be to acquire N frames of GSM data and return the mean power of the first burst in each frame. The command can also be used to identify the best curve fit for the data.

Remote Command	:CALCulate:DATA<n>:COMPRESS? BLOCK CFIT MAXimum MINimum MEAN DMEan RMS RMSCubed SAMPLE SDEVIation PPHase [,<soffset> [,<length>[,<roffset>[,<rlimit>]]]]
Example	To query the mean power of a set of GSM bursts: Supply a signal that is a set of GSM bursts. Select the IQ Waveform measurement (in IQ Analyzer Mode). Set the sweep time to acquire at least one burst. Set the triggers such that acquisition happens at a known position relative to a burst. Then query the mean burst levels using, CALC:DATA2:COMP? MEAN, 24e-6, 526e-6 (These parameter values correspond to GSM signals, where 526e-6 is the length of the burst in the slot and you just want 1 burst.)
Notes	The command supports 5 parameters. Note that the last 4 (<soffset>, <length>, <roffset>, <rlimit>) are optional. But these optional parameters must be entered in the specified order. For example, if you want to specify <length>, then you must also specify <soffset>. See details below for a definition of each of these parameters. This command uses the data in the format specified by FORMat:DATA, returning either binary or ASCII data.
Initial S/W Revision	Prior to A.02.00

- BLOCK or block data - returns all the data points from the region of the trace data that you specify. For example, it could be used to return the data points of an input signal over several timeslots, excluding the portions of the trace data that you do not want. (This is x,y pairs for trace data and I,Q pairs for complex data.)

- CFIT or curve fit - applies curve fitting routines to the data. <soffset> and <length> are required to define the data that you want. <roffset> is an optional parameter for the desired order of the curve equation. The query will return the following values: the x-offset (in seconds) and the curve coefficients ((order + 1) values).

MIN, MAX, MEAN, DME, RMS, RMSC, SAMP, SDEV and PPH return one data value for each specified region (or <length>) of trace data, for as many regions as possible until you run out of trace data (using <roffset> to specify regions). Or they return the number of regions you specify (using <rlimit>) ignoring any data beyond that.

- MINimum - returns the minimum data point (y value) for the specified region(s) of trace data. For I/Q trace data, the minimum magnitude of the I/Q pairs is returned.
- MAXimum - returns the maximum data point (y value) for the specified region(s) of trace data. For I/Q trace data, the maximum magnitude of the I/Q pairs is returned.
- MEAN - returns a single value that is the arithmetic mean of the data point values (in dB/ dBm) for the specified region(s) of trace data. For I/Q trace data, the mean of the magnitudes of the I/Q pairs is returned. See the following equations.

NOTE If the original trace data is in dB, this function returns the arithmetic mean of those log values, not log of the mean power which is a more useful value. The mean of the log is the better measurement technique when measuring CW signals in the presence of noise. The mean of the power, expressed in dB, is useful in power measurements such as Channel Power. To achieve the mean of the power, use the RMS option.

Equation 1

Mean Value of Data Points for Specified Region(s)

$$MEAN = \frac{1}{n} \sum_{X_i \in \text{region}(s)} X_i$$

where X_i is a data point value, and n is the number of data points in the specified region(s).

Equation 2

Mean Value of I/Q Data Pairs for Specified Region(s)

$$MEAN = \frac{1}{n} \sum_{X_i \in \text{region}(s)} |X_i|$$

where $|X_i|$ is the magnitude of an I/Q pair, and n is the number of I/Q pairs in the specified region(s).

- DMEan - returns a single value that is the mean power (in dB/ dBm) of the data point values for the specified region(s) of trace data. See the following equation:

Equation 3

DMEan Value of Data Points for Specified Region(s)

$$\text{DME} = 10 \times \log_{10} \left(\frac{1}{n} \sum_{X_i \in \text{region}(s)} 10^{\frac{X_i}{10}} \right)$$

- RMS - returns a single value that is the average power on a root-mean-squared voltage scale (arithmetic rms) of the data point values for the specified region(s) of trace data. See the following equation.

NOTE

For I/Q trace data, the rms of the magnitudes of the I/Q pairs is returned. See the following equation. This function is very useful for I/Q trace data. However, if the original trace data is in dB, this function returns the rms of the log values which is not usually needed.

Equation 4

RMS Value of Data Points for Specified Region(s)

$$\text{RMS} = \sqrt{\frac{1}{n} \sum_{X_i \in \text{region}(s)} X_i^2}$$

where X_i is a data point value, and n is the number of data points in the specified region(s).

Equation 5

RMS Value of I/Q Data Pairs for Specified Region(s)

$$\text{RMS} = \sqrt{\frac{1}{n} \sum_{X_i \in \text{region}(s)} X_i X_i^*}$$

where X_i is the complex value representation of an I/Q pair, X_i^* its conjugate complex number, and n is the number of I/Q pairs in the specified region(s).

Once you have the rms value for a region of trace data (linear or I/Q), you may want to calculate the mean power. You must convert this rms value (peak volts) to power in dBm:

$$10 \times \log[10 \times (\text{rms value})^2]$$

- SAMPLe - returns the first data value (x,y pair) for the specified region(s) of trace data. For I/Q trace data, the first I/Q pair is returned.
- SDEViation - returns a single value that is the arithmetic standard deviation for the data point values for the specified region(s) of trace data. See the following equation.
- For I/Q trace data, the standard deviation of the magnitudes of the I/Q pairs is returned. See the following equation.

Equation 6

Standard Deviation of Data Point Values for Specified Region(s)

$$\text{SDEV} = \sqrt{\frac{1}{n} \sum_{X_i \in \text{region}(s)} (X_i - \bar{X})^2}$$

where X_i is a data point value, \bar{X} is the arithmetic mean of the data point values for the specified region (s), and n is the number of data points in the specified region(s).

$$\text{SDEV} = \sqrt{\frac{1}{n} \sum_{X_i \in \text{region}(s)} (|X_i| - \bar{X})^2}$$

where $|X_i|$ is the magnitude of an I/Q pair, \bar{X} is the mean of the magnitudes for the specified region(s), and n is the number of data points in the specified region(s).

- PPHase - returns the x,y pairs of both rms power (dBm) and arithmetic mean phase (radian) for every specified region and frequency offset (Hz). The number of pairs is defined by the specified number of regions. This parameter can be used for I/Q vector ($n=0$) in Waveform (time domain) measurement and all parameters are specified by data point in PPHase.

The rms power of the specified region may be expressed as:

$$\text{Power} = 10 \times \log [10 \times (\text{RMS I/Q value})] + 10.$$

The RMS I/Q value (peak volts) is:

$$\sqrt{\frac{1}{n} \sum_{X_i \in \text{region}} X_i X_i^*}$$

where X_i is the complex value representation of an I/Q pair, X_i^* its conjugate complex number, and n is the number of I/Q pairs in the specified region.

The arithmetic mean phase of the specified region may be expressed as:

$$\frac{1}{n} \sum_{Y_i \in \text{region}} Y_i$$

where Y_i is the unwrapped phase of I/Q pair with applying frequency correction and n is the number of I/Q pairs in the specified region.

The frequency correction is made by the frequency offset calculated by the arithmetic mean of every specified region's frequency offset. Each frequency offset is calculated by the least square method against the unwrapped phase of I/Q pair.

Sample Trace Data - Constant Envelope

(See below for explanation of variables.)

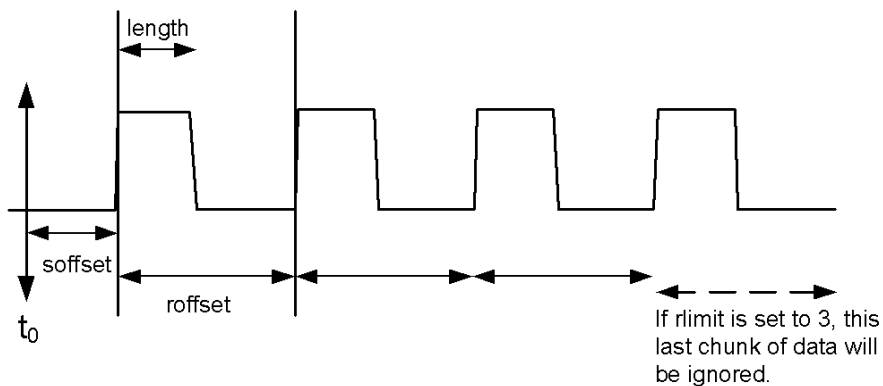

Sample Trace Data - Not Constant Envelope

(See below for explanation of variables.)



<soffset> - start offset is an optional real number. (It is in seconds for time-domain traces, and is a dimensionless index 0 to Npoints - 1, for frequency-domain traces). It specifies the amount of data at the beginning of the trace that will be ignored before the decimation process starts. It is the time or frequency change from the start of the trace to the point where you want to start using the data. The default value is zero.

<length> - is an optional real number. (It is in seconds for time-domain traces, and is a dimensionless index 0 to Npoints - 1, for frequency-domain traces). It defines how much data will be compressed into one value. This parameter has a default value equal to the current trace length.

<roffset> - repeat offset is an optional real number. (It is in seconds for time-domain traces, and is a dimensionless index 0 to Npoints - 1, for frequency-domain traces). It defines the beginning of the next field of trace elements to be compressed. This is relative to the beginning of the previous field. This parameter has a default value equal to the <length> variable. Note that this parameter is used for a completely different purpose when curve fitting (see CFIT above).

<rlimit> - repeat limit is an optional integer. It specifies the number of data items that you want returned. It will ignore any additional items beyond that number. You can use the Start offset and the Repeat limit to pick out exactly what part of the data you want to use. The default value is all the data.

Calculate Peaks of Trace Data (Remote Command Only)

Returns a list of all the peaks for the currently selected measurement and sub-opcode [n]. The peaks must meet the requirements of the peak threshold and excursion values.

n = any valid sub-opcode for the current measurement. See the MEASure:<measurement> command description of your specific measurement for information on the data that can be returned.

The command can only be used with specific sub-opcodes with measurement results that are trace data. Both real and complex traces can be searched, but complex traces are converted to magnitude in dBm. In many measurements the sub-opcode n=0, is the raw trace data which cannot be searched for peaks. And Sub-opcode n=1, is often calculated results values which also cannot be searched for peaks.

This command uses the data setting specified by the FORMat:BORDER and FORMat:DATA commands and can return real or ASCII data. If the format is set to INT,32, it returns REAL,32 data.

The command has four types of parameters:

- Threshold (in dBm)
- Excursion (in dB)
- Sorting order (amplitude, frequency, time)
- Optional in some measurements: Display line use (all, > display line, < display line)

Remote Command	<p>For Swept SA measurement:</p> <pre>:CALCulate:DATA[1] 2 ... 6:PEAKs? <threshold>,<excursion>[,AMPLitude FREQuency TIME[,ALL GTDLine LTDLine]]</pre> <p>For most other measurements:</p> <pre>:CALCulate:DATA[1] 2 ... 6:PEAKs? <threshold>,<excursion>[,AMPLitude FREQuency TIME]</pre>
-----------------------	--

Example	<p>Example for Swept SA measurement in Spectrum Analyzer Mode:</p> <p>CALC:DATA4:PEAK? -40, 10, FREQ, GTDL This will identify the peaks of trace 4 that are above -40 dBm, with excursions of at least 10 dB. The peaks are returned in order of increasing frequency, starting with the lowest frequency. Only the peaks that are above the display line are returned.</p> <p>Query Results 1:</p> <p>With FORMat:DATA REAL, 32 selected, it returns a list of floating-point numbers. The first value in the list is the number of peak points that are in the following list. A peak point consists of two values: a peak amplitude followed by its corresponding frequency (or time).</p> <p>If no peaks are found the peak list will consist of only the number of peaks, (0).</p>
----------------	---

Notes	<p><n> - is the trace that will be used</p> <p><threshold> - is the level below which trace data peaks are ignored. Note that the threshold value is required and is always used as a peak criterion. To effectively disable the threshold criterion for this command, provide a substantially low threshold value such as -200 dBm. Also note that the threshold value used in this command is independent of and has no effect on the threshold value stored under the Peak Criteria menu.</p> <p><excursion> - is the minimum amplitude variation (rise and fall) required for a signal to be identified as peak. Note that the excursion value is required and is always used as a peak criterion. To effectively disable the excursion criterion for this command, provide the minimum value of 0.0 dB. Also note that the excursion value used in this command is independent of and has no effect on the</p>
--------------	---

excursion value stored under the Peak Criteria menu.

Values must be provided for threshold and excursion. The sorting and display line parameters are optional (defaults are AMPLitude and ALL).

Note that there is always a Y-axis value for the display line, regardless of whether the display line state is on or off. It is the current Y-axis value of the display line which is used by this command to determine whether a peak should be reported. Sorting order:

AMPLitude - lists the peaks in order of descending amplitude, with the highest peak first (default if optional parameter not sent)

FREQUENCY - lists the peaks in order of occurrence, left to right across the x-axis.

TIME - lists the peaks in order of occurrence, left to right across the x-axis.

Peaks vs. Display Line:

ALL - lists all of the peaks found (default if optional parameter not sent).

GTDLine (greater than display line) - lists all of the peaks found above the display line.

LTDLine (less than display line) - lists all of the peaks found below the display line.

Initial S/W Revision Prior to A.02.00

Format Data: Numeric Data (Remote Command Only)

This command specifies the format of the trace data input and output. It specifies the formats used for trace data during data transfer across any remote port. It affects only the data format for setting and querying trace data for the :TRACe[:DATA], TRACe[:DATA]?, :CALCulate:DATA[n]? and FETCh:SANalyzer[n]? commands and queries.

Remote Command	:FORMat[:TRACe][:DATA] ASCii INTeger,32 REAL,32 REAL,64 :FORMat[:TRACe][:DATA]?
-----------------------	---

Notes	<p>The query response is:</p> <p>ASCii: ASC,8</p> <p>REAL,32: REAL,32</p> <p>REAL,64: REAL,64</p> <p>INTeger,32: INT,32</p> <p>When the numeric data format is REAL or ASCii, data is output in the current Y Axis unit. When the data format is INTeger, data is output in units of m dBm (.001 dBm).</p> <p>The INT,32 format returns binary 32-bit integer values in internal units (m dBm), in a definite length block.</p>
-------	---

Dependencies	<p>Sending a data format spec with an invalid number (for example, INT,48) generates no error. The analyzer simply uses the default (8 for ASCii, 32 for INTeger, 32 for REAL).</p> <p>Sending data to the analyzer which does not conform to the current FORMat specified, results in an error. Sending ASCII data when a definite block is expected generates message -161 "Invalid Block Data" and sending a definite block when ASCII data is expected generates message -121 "Invalid Character in Number".</p>
--------------	--

Preset	ASCii
--------	-------

Backwards Compatibility Notes	Note that the INT,32 format is only applicable to the command, TRACe:DATA. This preserves backwards compatibility for the Swept SA measurement. For all other commands/queries which honor FORMat:DATA, if INT,32 is sent the analyzer will behave as though it were set to REAL,32.
-------------------------------	--

Initial S/W Revision	Prior to A.02.00
----------------------	------------------

The specs for each output type follow:

AScii - Amplitude values are in ASCII, in the current Y Axis Unit, one ASCII character per digit, values separated by commas, each value in the form:

SX.YYYYYEsZZ

Where:

S = sign (+ or -)

X = one digit to left of decimal point

Y = 5 digits to right of decimal point

E = E, exponent header

s = sign of exponent (+ or -)

ZZ = two digit exponent

REAL,32 - Binary 32-bit real values in the current Y Axis Unit, in a definite length block.

REAL,64 - Binary 64-bit real values in the current Y Axis Unit, in a definite length block.

Format Data: Byte Order (Remote Command Only)

This command selects the binary data byte order for data transfer and other queries. It controls whether binary data is transferred in normal or swapped mode. This command affects only the byte order for setting and querying trace data for the :TRACe[:DATA], TRACe[:DATA]? , :CALCulate:DATA[n]? and FETCh:SANalyzer[n]? commands and queries.

By definition any command that says it uses FORMat:DATA uses any format supported by FORMat:DATA.

The NORMal order is a byte sequence that begins with the most significant byte (MSB) first, and ends with the least significant byte (LSB) last in the sequence: 1|2|3|4. SWAPped order is when the byte sequence begins with the LSB first, and ends with the MSB last in the sequence: 4|3|2|1.

Remote Command	:FORMat:BORDER NORMal SWAPped
-----------------------	---------------------------------

	:FORMat:BORDER?
--	-----------------

Preset	NORMal
---------------	--------

Initial S/W Revision	Prior to A.02.00
-----------------------------	------------------

Meas Setup

Displays the setup menu keys that enable you to control the parameters for the current measurement.

Key Path	Front-panel key
Initial S/W Revision	Prior to A.02.00

Average/Hold Num

Sets the number of sweeps (average counts) that are averaged. After the specified number of sweeps, the averaging mode (terminal control) setting determines the averaging action.

Key Path	Meas Setup
Mode	BASIC, PNOISE, WCDMA, C2K, GSM, WIMAXOFDMA, TDSCDMA, 1XEVD0, DVB, DTMB, ISDBT, CMMB, LTE, LTETDD, DCATV, WLAN, MSR, LTEATDD, LTEAFDD
Remote Command	[:SENSe]:WAVeform:AVERage:COUNT <integer> [:SENSe]:WAVeform:AVERage:COUNT? [:SENSe]:WAVeform:AVERage[:STATe] OFF ON 0 1 [:SENSe]:WAVeform:AVERage[:STATe]?
Example	WAV:AVER:COUN 1001 WAV:AVER:COUN? WAV:AVER ON WAV:AVER?
Notes	You must be in a mode that includes the Waveform measurement to use this command. Use INSTRument:SElect to set the mode.
Preset	10 OFF
State Saved	Saved in instrument state.
Min	1
Max	20001
Initial S/W Revision	Prior to A.02.00
Modified at S/W Revision	A.03.00

Avg Mode

Enables you to set the averaging mode.

- When set to Exponential (Exp) the measurement averaging continues using the specified number of averages to compute each averaged value. The average is displayed at the end of each sweep.
- When set to Repeat, the measurement resets the average counter each time the specified number of averages is reached.

Key Path	Meas Setup
Mode	BASIC, PNOISE, WCDMA, C2K, GSM, WIMAXOFDMA, TDSCDMA, 1XEVD0, DVB, DTMB, ISDBT, CMMB, LTE, LTETDD, DCATV, WLAN, MSR,LTEATDD, LTEAFDD
Remote Command	<code>[:SENSe] :WAVeform:AVERage:TCONtrol EXPonential REPEAT</code> <code>[:SENSe] :WAVeform:AVERage:TCONtrol?</code>
Example	WAV:AVER:TCON REP WAV:AVER:TCON?
Notes	You must be in a mode that includes the Waveform measurement to use this command. Use INSTRUMENT:SElect to set the mode.
Preset	EXPonential
State Saved	Saved in instrument state.
Range	Exp Repeat
Initial S/W Revision	Prior to A.02.00
Modified at S/W Revision	A.03.00

Avg Type

Selects the type of averaging.

Key Path	Meas Setup
Mode	BASIC, PNOISE, WCDMA, C2K, GSM, WIMAXOFDMA, TDSCDMA, 1XEVD0, DVB, DTMB, ISDBT, CMMB, LTE, LTETDD, DCATV, WLAN, MSR,LTEATDD, LTEAFDD
Remote Command	<code>[:SENSe] :WAVeform:AVERage:TYPE LOG MAXimum MINimum RMS SCALar</code> <code>[:SENSe] :WAVeform:AVERage:TYPE?</code>
Example	WAV:AVER:TYPE RMS WAV:AVER:TYPE?
Notes	The SCPI selection of MAX and MIN are kept for BWCC, but they are removed from the front panel access because they are not an Average function. You must be in a mode that includes the Waveform measurement to use this command. Use INSTRUMENT:SElect to set the mode.
Preset	RMS
State Saved	Saved in instrument state.
Range	Pwr Avg(RMS) Log-Pwr Avg(Video) Voltage Avg
Initial S/W Revision	Prior to A.02.00
Modified at S/W Revision	A.03.00

Time Avg Num

Sets the number of HW averages to be executed per each data acquisition.

Key Path	Meas Setup
Mode	BASIC
Remote Command	[:SENSe] :WAVeform:AVERage:TACount <integer> [:SENSe] :WAVeform:AVERage:TACount?
Example	WAV:AVER:TAC 10WAV:AVER:TAC?
Notes	This feature is only available when Option DP2, B40, or wider IF Bandwidth option is installed.
Preset	1
State Saved	Saved in instrument state
Min	1
Max	65535
Default Unit	Enter

Meas Time

Sets how long the measurement is performed. X Scale only changes the representation of the display.

Key Path	Meas Setup
Mode	BASIC, PNOISE, WCDMA, C2K, GSM, WIMAXOFDMA, TDSCDMA, 1XEVD0, DVB, DTMB, ISDBT, CMMB, LTE, LTEADD, DCATV, WLAN, MSR,LTEATDD, LTEAFDD
Remote Command	[:SENSe] :WAVeform:SWEep:TIME <time> [:SENSe] :WAVeform:SWEep:TIME?
Example	WAV:SWE:TIME 50 ms WAV:SWE:TIME?
Notes	Specifies and returns how long the measurement is performed. It is the time record length of the measurement waveform. The Max time may be reduced when the sample frequency is high due to the memory limitation. You must be in a mode that includes the Waveform measurement to use this command. Use INSTRument:SElect to set the mode.
Preset	All except the following list: 2.000000 ms LTEAFDD, LTEATDD: 10 ms LTETDD: 10 ms
State Saved	Saved in instrument state.
Range	1.000 (s to 100.00 s
Min	1.000 us
Max	3200 s
Initial S/W Revision	Prior to A.02.00
Modified at S/W Revision	A.03.00, A.14.00

Sample Rate

Enables you to set an arbitrary sample rate for the acquired data to be processed.

Key Path	Meas Setup
Mode	BASIC
Remote Command	[:SENSe] :WAVeform:SRATe <freq> [:SENSe] :WAVeform:SRATe?
Example	WAV:SRAT 1.3636 MHz
Notes	Command and query available when Option DP2, B40, or wider IF Bandwidth option is installed. For other configuration, only query is available.
Couplings	The coupling between Sample Rate and IF BW depends on Physics implementation.
Preset	125.0 kHz
Min	12.5 Hz
Max	<ul style="list-style-type: none"> • (For Option DP2, B40 or wider IF Bandwidth option) • Digital IF 10 MHz path: 12.5 MHz • Digital IF 25 MHz path: 31.25 MHz • Digital IF 40 MHz path: 50 MHz • Option B85 85 MHz path: 106.25 MHz • Option B1A 125 MHz path: 156.25 MHz • Option B1X 140 MHz path: 175 MHz • Option B1Y 160 MHz path: 200 MHz • (For all other configuration) • 10 MHz path: 15 MHz • Option B25 25 MHz path: 45 MHz
Modified at S/W Revision	13.00

PhNoise Opt

Selects the LO (local oscillator) phase noise behavior for various desired operating conditions.

Key Path	Meas Setup
Remote Command	[:SENSe] :WAVeform:FREQuency:SYNThesis [:STATe] 1 2 3 [:SENSe] :WAVeform:FREQuency:SYNThesis [:STATe] ?
Example	WAV:FREQ:SYNT 2 Selects optimization for best wide offset phase noise
Notes	Parameter: 1 optimizes phase noise for small frequency offsets from the carrier. 2 optimizes phase noise for wide frequency offsets from the carrier. 3 optimizes LO for tuning speed

	(In PXA, the local oscillator hardware provides for extra-low phase noise at the expense of some speed.)
Dependencies	Does not appear in all models. The key is blank in those models, but the SCPI command is accepted for compatibility (although no action is taken).
Preset	Because this function is in Auto after preset, and because Digital IF BW after preset < 150 kHz for MXA/EXA and > 400 kHz for PXA the state of this function after Preset will be 1 for MXA/EXA and 2 for PXA.
State Saved	Saved in instrument state.
Min	1
Min	1
Max	3
Initial S/W Revision	Prior to A.07.00
Modified at S/W Revision	A.07.00

Auto

Selects the LO (local oscillator) phase noise behavior to optimize dynamic range and speed for various instrument operating conditions.

The X-Series has two grades of LO; a high performance LO that gives the best phase noise performance; and a medium-performance LO that gives excellent performance.

In models with the high performance LO, Auto will choose:

	Best Close in Phase Noise	Best Wide-offset Phase Noise
Filter BW	≤ 400 kHz	> 400 kHz

In models with the medium-performance LO, Auto will choose:

	Best Close in Phase Noise	Best Wide-offset Phase Noise
Filter BW	≤ 150 kHz	>150 kHz

Note that Fast Tuning will not be selected when in Auto.

Key Path	Meas Setup, PhNoise Opt
Remote Command	<code>[:SENSe] :WAVeform:FREQuency:SYNTHeSis:AUTO[:STATe] OFF ON 0 1</code> <code>[:SENSe] :WAVeform:FREQuency:SYNTHeSis:AUTO[:STATe] ?</code>
Example	WAV:FREQ:SYNT:AUTO ON
Preset	ON
State Saved	Saved in instrument state.
Initial S/W Revision	Prior to A.07.00

Best Close-in P Noise

The LO phase noise is optimized for smaller offsets from the carrier, at the expense of phase noise farther out.

Key Path	Meas Setup, PhNoise Opt
Example	WAV:FREQ:SYNT 1
Couplings	<p>The frequency below which the phase noise is optimized is model dependent:</p> <ul style="list-style-type: none"> • CXA: n/a • EXA: [offset \leq150 kHz] • MXA: [offset \leq150 kHz] • PXA: [offset \leq400 kHz]
Readback	<p>Close-in.</p> <p>If manually selected, “Man” will be underlined. The actual frequency offset within which noise is optimized is shown with in square brackets, as this can vary depending on the hardware set in use. For example, in some analyzers this annotation appears as [offset < 150 kHz]</p>
Initial S/W Revision	Prior to A.07.00

Best Wide-offset P Noise

The LO phase noise is optimized for wider offsets from the carrier. Closer offsets are compromised and the throughput of measurements (especially remote measurements where the center frequency is changing rapidly), is reduced.

Key Path	Meas Setup, PhNoise Opt
Example	WAV:FREQ:SYNT 2
Couplings	<p>The frequency below which the phase noise is optimized is model dependent:</p> <p>CXA: n/a</p> <p>EXA: [offset >150 kHz]</p> <p>MXA: [offset >150 kHz]</p> <p>PXA: [offset >400 kHz]</p>
Readback	<p>Wide-offset.</p> <p>If manually selected, “Man” will be underlined. The actual frequency offset beyond which noise is optimized is shown with in square brackets, as this can vary depending on the hardware set in use. For example, in some analyzers this annotation appears as [offset > 150 kHz]</p>
Initial S/W Revision	Prior to A.07.00

Fast Tuning

In this mode, the LO behavior compromises phase noise at many offsets from the carrier in order to allow rapid measurement throughput when changing the center frequency. The term “fast tuning” refers to the time it takes to move the local oscillator to the start frequency and begin a capture; this setting does not impact the actual measurement time in any way.

Key Path	Meas Setup, PhNoise Opt
Example	WAV:FREQ:SYNT 3
State Saved	Saved in instrument state.
Readback	Fast Tuning. If manually selected the “Man” will be underlined.
Initial S/W Revision	Prior to A.07.00

Advanced

Accesses a menu of advanced functions that are used for specific applications. These settings should not be changed for most measurements.

Key Path	Meas Setup
Initial S/W Revision	Prior to A.02.00

ADC Dither

Accesses the ADC Dither control menu.

Key Path	Meas Setup, Advanced
Initial S/W Revision	Prior to A.02.00

ADC Dither Auto

Sets ADC dithering to automatically select whether dithering is needed.

Key Path	Meas Setup, Advanced, ADC Dither
Mode	BASIC, PNOISE, WCDMA, C2K, GSM, WIMAXOFDMA, TDSCDMA, 1XEVD0, DVB, DTMB, ISDBT, CMMB, LTE, LTETDD, DCATV, WLAN, MSR,LTEATDD, LTEAFDD
Remote Command	[:SENSe] :WAVeform:ADC:DITHer:AUTO [:STATe] OFF ON 0 1 [:SENSe] :WAVeform:ADC:DITHer:AUTO [:STATe] ?
Example	WAV:ADC:DITH:AUTO ON WAV:ADC:DITH:AUTO?
Notes	The dither function improves linearity for low level signals, at the expense of a higher noise floor. You must be in a mode that includes the Waveform measurement to use this command. Use

	INSTRument:SElect to set the mode.
Preset	OFF
State Saved	Saved in instrument state.
Range	On Off
Initial S/W Revision	Prior to A.02.00
Modified at S/W Revision	A.03.00

ADC Dither

Toggles the dither function On and Off. The dither function improves linearity for low level signals, at the expense of a higher noise floor.

The reduced clipping-to-noise ratio results in higher noise, because the clipping level of the ADC relative to the front terminals remains unchanged with the introduction of dither. The enhanced linearity is mostly improved scale fidelity.

With dither on, the third-order distortions are usually invisible for mixer levels below -35 dBm. With dither off, these distortions can be visible, with typical power levels of -110 dBm referred to the mixer. Detection nonlinearity can reach 1 dB for dither off at mixer levels around -70 dBm and lower, while the specified nonlinearity is many times smaller with dither on.

Key Path	Meas Setup, Advanced, ADC Dither
Mode	BASIC, PNOISE, WCDMA, C2K, GSM, WIMAXOFDMA, TDSCDMA, 1XEVD0, DVB, DTMB, ISDBT, CMMB, LTE, LTETDD, DCATV, WLAN, MSR,LTEATDD, LTEAFDD
Remote Command	[:SENSe] :WAVeform:ADC:DITHer [:STATe] OFF ON 0 1 [:SENSe] :WAVeform:ADC:DITHer [:STATe] ?
Example	WAV:ADC:DITH ON WAV:ADC:DITH?
Notes	The dither function improves linearity for low level signals, at the expense of a higher noise floor. . You must be in a mode that includes the Waveform measurement to use this command. Use INSTRument:SElect to set the mode.
Preset	OFF
State Saved	Saved in instrument state.
Range	Auto Man
Backwards Compatibility SCPI	[:SENSe] :WAVeform:WBIF:ADC:DITHer [:SENSe] :WAVeform:PDITHer
Initial S/W Revision	Prior to A.02.00
Modified at S/W Revision	A.03.00

IF Gain

Accesses the keys to select the IF Gain settings.

When in Autorange mode, the IF checks its range once for data acquisition, to provide the best signal to noise ratio. You can specify the range for the best speed, and optimize for noise or for large signals.

When the IF Gain is set to Autorange, the IF Gain is set to High initially for each chunk of data. The data is then acquired. If the IF overloads, then the IF Gain is set to Low and the data is re-acquired. Because of this operation, the Autorange setting uses more measurement time as the instrument checks/resets its range. You can get faster measurement speed by forcing the range to either the high or low gain setting. But you must know that your measurement conditions will not overload the IF (in the high gain range) and that your signals are well above the noise floor (for the low gain range), and that the signals are not changing.

When Digital Bus Out (under the Input/Output menu) is ON, the IF Gain State Autorange selection is not allowed. Thus, in this case, IF Gain State will be set to Low.

This only applies to the RF input. It does not apply to baseband I/Q input.

Key Path	Meas Setup, Advanced
Initial S/W Revision	Prior to A.02.00

IF Gain Auto

Activates the auto rules for IF Gain

Key Path	Meas Setup, Advanced, IF Gain
Mode	BASIC, PNOISE, WCDMA, C2K, GSM, WIMAXOFDMA, TDSCDMA, 1XEVD0, DVB, DTMB, ISDBT, CMMB, LTE, LTE-TDD, DCATV, WLAN, MSR, LTE-TDD, LTEAFDD
Remote Command	[:SENSe] :WAVeform:IF:GAIN:AUTO [:STATe] ON OFF 1 0 [:SENSe] :WAVeform:IF:GAIN:AUTO [:STATe] ?
Example	WAV:IF:GAIN:AUTO ON WAV:IF:GAIN:AUTO?
Notes	This only applies to the RF input. It does not apply to baseband I/Q input. You must be in a mode that includes the Waveform measurement to use this command. Use INSTRument:SElect to set the mode.
Preset	ON
State Saved	Saved in instrument state.
Range	On Off
Initial S/W Revision	Prior to A.02.00
Modified at S/W Revision	A.03.00

IF Gain State

Selects the range of IF gain.

Key Path	Meas Setup, Advanced, IF Gain
Mode	BASIC, PNOISE, WCDMA, C2K, GSM, WIMAXOFDMA, TDSCDMA, 1XEVD0, DVB, DTMB, ISDBT, CMMB, LTE, LTETDD, DCATV, WLAN, MSR,LTEATDD, LTEAFDD
Remote Command	[:SENSe] :WAVeform:IF:GAIN [:STATe] AUTOrange LOW HIGH [:SENSe] :WAVeform:IF:GAIN [:STATe] ?
Example	WAV:IF:GAIN HIGH WAV:IF:GAIN?
Notes	This only applies to the RF input and does not apply to baseband I/Q input. You must be in a mode that includes the Waveform measurement to use this command. Use INSTRument:SElect to set the mode. If the user tries to select Autorange while Digital Bus Out is ON, an error message -221 "Settings conflict; "IF Gain Autorange not allowed when Digital Bus Out is ON" is displayed.
Couplings	If the user tries to select Autorange via SCPI while Digital Bus Out is ON, an error message - 224, "Illegal parameter value; "IF Gain Autorange not allowed when Digital Bus Out is on" is displayed. If the user tries to select Autorange via front panel while Digital Bus Out is ON, an advisory message "IF Gain Autorange not allowed when Digital Bus Out is on" is displayed.
Preset	LOW
State Saved	Saved in instrument state.
Range	Autorange (Slower Follows Signals) Low (Best for Large Signals) High (Best Noise Level)
Readback Text	Autorange Low High
Initial S/W Revision	Prior to A.02.00
Modified at S/W Revision	A.03.00

IF Gain Offset

Sets the IF Gain offset in 2 dB step from -6 dB to +6 dB. Increasing the gain can increase the amplitude of small signals as long as you do not overdrive the hardware. Wideband gain should usually be adjusted after setting the input attenuation.

Internally, the IF Gain value will change based on the current configuration of the hardware. If you choose to offset this value, you may do so with this parameter. The value specified is not an absolute value but relative to the current internal IF Gain setting.

For example:

IF Gain Low + IF Gain Offset +4 dB = Total IF Gain of +4 dB (0 + 4 = 4)

IF Gain High + IF Gain Offset +4 dB = Total IF Gain of +14 dB (10 + 4 = 14)

IF Gain Low + IF Gain Offset -6 dB = Total IF Gain of -6 dB (0 - 6 = -6)

IF Gain High + IF Gain Offset -6 dB = Total IF Gain of +6 dB (10 - 6 = 4)

The total IF Gain range when IF Gain Offset is available is a minimum of $0 - 6 = -6$ dB and a maximum of $10 + 6 = 16$ dB. The available IF Gain depends on the IF Path and center frequency. The maximum IF Gain may not be achievable at all times depending on the configuration.

Key Path	Meas Setup, Advanced
Remote Command	<code>[:SENSe] :WAVeform:IF:GAIN:OFFSet <rel_ampl ></code> <code>[:SENSe] :WAVeform:IF:GAIN:OFFSet?</code>
Example	WAV:IF:GAIN:OFFS 2 Sets the IF Gain offset to 2
Preset	0
State Saved	Saved in instrument state.
Min	-6
Max	+6
Default Unit	dB

Meas Preset

Restores all the measurement parameters to their default values.

Key Path	Meas Setup
Mode	BASIC, PNOISE, WCDMA, C2K, GSM, WIMAXOFDMA, TDSCDMA, 1XEVD0, DVB, DTMB, ISDBT, CMMB, LTE, LTE4DD, DCATV, WLAN, MSR,LTEATDD, LTEAFDD
Remote Command	<code>:CONFigure:WAVeform</code>
Example	CONF:WAV
Notes	Restore default values of all parameters. You must be in a mode that includes the Waveform measurement to use this command. Use INSTRument:SElect to set the mode.
Initial S/W Revision	Prior to A.02.00
Modified at S/W Revision	A.03.00

HW Averaging

Changes the number of time averages is to be made using hardware. This averaging is much faster than the standard averaging done in software. The hardware averaging is done on the complex voltage time trace data before any measurement application averaging is done. Both types of averaging (HW and SW) can be done on the same measurement data.

When time averaging is being done in HW, each trace update represents N fresh data acquisitions averaged together, where N is the number of averages. You cannot access the individual time data. Note that in the spectrum measurement this averaging is done prior to the standard averaging done within the application. Thus the yellow trace in this measurement shows the result of the time averaging. Subsequent averaging is orthogonal to this hardware based time averaging and its result is seen as the blue trace in this and other applications.

So it is possible to turn off the averaging within the application but still have the HW averaging set to a certain number. In other words, turning averaging off within the measurement will not affect HW averaging. If HW averaging needs to be turned off, simply set the HW Averaging parameter to 1.

Since it is time averaging, a trigger source something other than Free Run should be used to avoid cancelling out the signal to be measured. It is most useful for a periodic signal with known periods.

Sample Period (Aperture) Setting (Remote Command Only)

Returns the time between samples (sample period or aperture).

Mode	BASIC
Remote Command	[:SENSe] :WAVeform:APERture?
Example	WAV:APER?
Notes	Query only.
Couplings	Coupled to Sample Rate by the following equation. Sample Period = 1/(Sample Rate)
Preset	1/(Sample Rate Default)
Min	1/(Max Sample Rate)
Max	1/(Min Sample Rate)

Mode

See "Mode" on page 286

Mode Preset

Returns the active mode to a known state.

Mode Preset does the following for the currently active mode:

- Aborts the currently running measurement.
- Brings up the default menu for the mode, with no active function.
- Sets measurement Global settings to their preset values for the active mode only.
- Activates the default measurement.
- Brings up the default menu for the mode.
- Clears the input and output buffers.
- Sets Status Byte to 0.

Mode Preset does not:

- Cause a mode switch
- Affect mode persistent settings
- Affect system settings

See ["How-To Preset" on page 2231](#) for more information.

Key Path	Front-panel key
Remote Command	:SYSTem:PRESet
Example	:SYST:PRES
Notes	*RST is preferred over :SYST:PRES for remote operation. *RST does a Mode Preset, as done by the :SYST:PRES command, and it sets the measurement mode to Single measurement rather than Continuous for optimal remote control throughput. Clears all pending OPC bits. The Status Byte is set to 0.
Couplings	A Mode Preset aborts the currently running measurement, activates the default measurement, and gets the mode to a consistent state with all of the default couplings set.
Backwards Compatibility Notes	In the X-Series, the legacy "Factory Preset" has been replaced with Mode Preset, which only presets the currently active mode, not the entire instrument. In the X-Series, the way to preset the entire instrument is by using System, Restore System Defaults All, which behaves essentially the same way as restore System Defaults does on ESA and PSA. There is also no "Preset Type" as there is on the PSA. There is a green Mode Preset front-panel key that does a Mode Preset and a white-with-green-letters User Preset front-panel key that does a User Preset. The old PRESet:TYPE command is ignored (without generating an error), and SYST:PRES without a parameter does a Mode Preset, which should cover most backward code compatibility issues. The settings and correction data under the Input/Output front-panel key (examples: Input Z Corr, Ext Amp Gain, etc.) are no longer part of any Mode, so they will not be preset by a Mode Preset. They are preset using Restore Input/Output Defaults, Restore System Defaults All. Note that because User Preset does a Recall State, and all of these settings are saved in State, they ARE recalled when using

	User Preset.
Initial S/W Revision	Prior to A.02.00

How-To Preset

The table below shows all possible presets, their corresponding SCPI commands and front-panel access (key paths). Instrument settings depend on the current measurement context. Some settings are local to the current measurement, some are global (common) across all the measurements in the current mode, and some are global to all the available modes. In a similar way, restoring the settings to their preset state can be done within the different contexts.

Auto Couple - is a measurement local key. It sets all Auto/Man parameter couplings in the measurement to Auto. Any Auto/Man selection that is local to other measurements in the mode will not be affected.

Meas Preset - is a measurement local key. Meas Preset resets all the variables local to the current measurement except the persistent ones.

Mode Preset - resets all the current mode's measurement local and measurement global variables except the persistent ones.

Restore Mode Defaults - resets ALL the Mode variables (and all the Meas global and Meas local variables), including the persistent ones.

Type Of Preset	SCPI Command	Front Panel Access
Auto Couple	:COUPlE ALL	Auto Couple front-panel key
Meas Preset	:CONFIgure:<Measurement>	Meas Setup Menu
Mode Preset	:SYSTem:PRESet	Mode Preset (green key)
Restore Mode Defaults	:INSTRument:DEFault	Mode Setup Menu
Restore All Mode Defaults	:SYSTem:DEFault MODEs	System Menu; Restore System Default Menu
*RST	*RST	not possible (Mode Preset with Single)
Restore Input/Output Defaults	:SYSTem:DEFault INPut	System Menu; Restore System Default Menu
Restore Power On Defaults	:SYSTem:DEFault PON	System Menu; Restore System Default Menu
Restore Alignment Defaults	:SYSTem:DEFault ALIGn	System Menu; Restore System Default Menu
Restore Miscellaneous Defaults	:SYSTem:DEFault MISC	System Menu; Restore System Default Menu
Restore All System Defaults	:SYSTem:DEFault [ALL] :SYSTem:PRESet:PERSistent	System Menu; Restore System Default Menu
User Preset	:SYSTem:PRESet:USER	User Preset Menu
User Preset All Modes	:SYSTem:PRESet:USER:ALL	User Preset Menu

Power On Mode Preset	:SYSTem:PON:TYPE MODE	System Menu
Power On User Preset	:SYSTem:PON:TYPE USER	System Menu
Power On Last State	:SYSTem:PON:TYPE LAST	System Menu

Preset Type (Remote Command Only)

As stated in the Backward Compatibility section, to be compatible with ESA/PSA the PRESet:TYPE command will be implemented as a no-op.

Mode	All
Remote Command	:SYSTem:PRESet:TYPE FACTory MODE USER :SYSTem:PRESet:TYPE?
Example	:SYST:PRESet:TYPE FACT
Notes	This command is supported for backward compatibility only. It is a no-op which does not change the behavior of any preset operation.
Preset	This is unaffected by Preset but is set to Mode on a "Restore System Defaults->All"
State Saved	No
Initial S/W Revision	Prior to A.02.00

Mode Setup

See ["Mode Setup" on page 316](#)

Peak Search

Places the selected marker on the trace point with the maximum y-axis value for that marker's trace and accesses a menu that enables you to select to do a next peak or minimum peak search.

Key Path	Front-panel key
Mode	BASIC, PNOISE, WCDMA, C2K, GSM, WIMAXOFDMA, TDSCDMA, 1XEVD0, DVB, DTMB, ISDBT, CMMB, LTE, LTETDD, DCATV, WLAN, MSR,LTEATDD, LTEAFDD
Remote Command	:CALCulate:WAVEform:MARKer[1] 2 ... 12:MAXimum
Example	CALC:WAV:MARK2:MAX
Notes	You must be in a mode that includes the Waveform measurement to use this command. Use INSTRument:SElect to set the mode.
Initial S/W Revision	Prior to A.02.00
Modified at S/W Revision	A.03.00

Next Peak

Moves the selected marker to the next highest local maximum with a value less than that of the current marker.

Key Path	Peak Search
Mode	BASIC, PNOISE, WCDMA, C2K, GSM, WIMAXOFDMA, TDSCDMA, 1XEVD0, DVB, DTMB, ISDBT, CMMB, LTE, LTETDD, DCATV, WLAN, MSR,LTEATDD, LTEAFDD
Remote Command	:CALCulate:WAVEform:MARKer[1] 2 ... 12:MAXimum:NEXT
Example	CALC:WAV:MARK:MAX:NEXT
Notes	You must be in a mode that includes the Waveform measurement to use this command. Use INSTRument:SElect to set the mode.
Initial S/W Revision	Prior to A.02.00
Modified at S/W Revision	A.03.00

Min Search

Moves the selected marker to the minimum y-axis value on the current trace.

Key Path	Peak Search
Mode	BASIC, PNOISE, WCDMA, C2K, GSM, WIMAXOFDMA, TDSCDMA, 1XEVD0, DVB, DTMB, ISDBT, CMMB, LTE, LTETDD, DCATV, WLAN, MSR,LTEATDD, LTEAFDD
Remote Command	:CALCulate:WAVEform:MARKer[1] 2 ... 12:MINimum
Example	CALC:WAV:MARK:MIN
Notes	You must be in a mode that includes the Waveform measurement to use this command. Use INSTRument:SElect to set the mode.

Initial S/W Revision	Prior to A.02.00
Modified at S/W Revision	A.03.00

17 Waveform Measurement
Print

Print

See "Print" on page 341

Quick Save

The Quick Save front-panel key repeats the most recent save that was performed from the Save menu, with the following exceptions:

- Register saves are not remembered as Saves for the purpose of the Quick Save function
- If the current measurement does not support the last non-register save that was performed, an informational message is generated, “File type not supported for this measurement”

Quick Save repeats the last type of qualified save (that is, a save qualified by the above criteria) in the last save directory by creating a unique filename using the Auto File Naming algorithm described below.

If Quick Save is pressed after startup and before any qualified Save has been performed, the Quick Save function performs a Screen Image save using the current settings for Screen Image saves (current theme, current directory), which then becomes the “last save” for the purpose of subsequent Quick Saves.

The Auto File Naming feature automatically generates a file name for use when saving a file. The filename consists of a prefix and suffix separated by a dot, as is standard for the Windows® file system. A default prefix exists for each of the available file types:

Type	Default Prefix	Menu
State	State_	(Save/Recall)
Trace + State	State_	(Save/Recall)
Screen	Screen_	(Save/Recall)
Amplitude Corrections	Ampcor_	(Import/Export)
Traces	Trace_	(Import/Export)
Limit Lines	LLine_	(Import/Export)
Measurement Result	MeasR_	(Import/Export)
Capture Buffer	CapBuf_	(Import/Export)

A four digit number is appended to the prefix to create a unique file name. The numbering sequence starts at 0000 within each Mode for each file type and updates incrementally to 9999, then wraps to 0000 again. It remembers where it was through a Mode Preset and when leaving and returning to the Mode. It is reset by Restore Misc Defaults and Restore System Defaults and subsequent running of the instrument application. So, for example, the first auto file name generated for State files is State_0000.state. The next is State_0001, and so forth.

One of the key features of Auto File Name is that we guarantee that the Auto File Name will never conflict with an existing file. The algorithm looks for the next available number. If it gets to 9999, then it looks for holes. If it find no holes, that is no more numbers are available, it gives an error.

For example, if when we get to State_0010.state there is already a State_0010.state file in the current directory, it advances the counter to State_0011.state to ensure that no conflict will exist (and then it verifies that State_0011.state also does not exist in the current directory and advances again if it does, and so forth).

If you enter a file name for a given file type, then the prefix becomes the filename you entered instead of the default prefix, followed by an underscore. The last four letters (the suffix) are the 4-digit number.

For example, if you save a measurement results file as “fred.csv”, then the next auto file name chosen for a measurement results save will be fred_0000.csv.

NOTE

Although 0000 is used in the example above, the number that is used is actually the current number in the Meas Results sequence, that is, the number that would have been used if you had not entered your own file name.

NOTE

If the filename you entered ends with _dddd, where d=any number, making it look just like an auto file name, then the next auto file name picks up where you left off with the suffix being dddd + 1.

Key Path	Front-panel key
Notes	No remote command for this key specifically.
Initial S/W Revision	Prior to A.02.00

Recall

The Recall menu lets you choose what you want to recall, and where you want to recall it from. Among the types of files you can recall are **States and Traces**. In addition, an Import (Data) option lets you recall a number of data types stored in CSV files (as used by Excel and other spreadsheet programs).

The default paths for Recall are data type dependent and are the same as for the Save key.

Key Path	Front-panel key
Notes	<p>No remote command for this key specifically, but the :MMEM:LOAD command is available for specific file types. An example is :MMEM:LOAD:STATe <filename>.</p> <p>If you try to recall a State file for a mode that is not licensed or not available in the instrument, an error message will occur and the state will not change.</p>
Backwards Compatibility Notes	<p>In legacy analyzers, it was possible to load a state without affecting the trace data, limit lines or correction data. Similarly (since User Preset is actually loading a state), it was possible to do a User Preset without affecting the trace data, limit lines or correction data.</p> <p>In the X-Series, “state” always includes all of this data; so whenever state is loaded, all of the traces, limit lines and corrections are affected. Although this differs from previous behavior, it is desirable behavior, and should not cause adverse issues for users.</p>
Backwards Compatibility Notes	<p>Recall for the X-Series supports backward compatibility in the sense that you can recall a state file from any X-Series model number and any version of X-Series software. This is only possible if part of the recalling process goes through a limiting step after recalling the mode settings, at least for settings that may vary with version number, model number, option and license differences. If you try to recall a state file onto an instrument with less capability than what was available on the instrument during the save, the recall will ignore the state it doesn't support and it will limit the recalled setting to what it allows.</p> <p>Example: if the saved state includes preamp ON, but the recalling instrument does not have a preamp; the preamp is limited to OFF. Conversely, if you save a state without a preamp, the preamp is OFF in the state file. When this saved file is recalled on an instrument with a licensed preamp, the preamp is changed to OFF. Another example is if the saved state has center frequency set to 20 GHz, but the instrument recalling the saved state is a different model and only supports 13.5 GHz. In this case, the center frequency is limited along with any other frequency based settings. Since the center frequency can't be preserved in this case, the recall limiting tries to at least preserve span to keep the measurement setup as intact as possible.</p> <p>It may be appropriate to issue a warning if the state is limited on the recall; warnings do not go out to SCPI so this would only affect the manual user.</p> <p>Note that there is no state file compatibility outside of the X-Series. For example, you cannot recall a state file from ESA or PSA.</p>
Initial S/W Revision	Prior to A.02.00

State

The Recall State menu lets you choose a register or file from which to recall the state.

The content of a state file includes all of the settings and data required to return the analyzer as closely as possible to the Mode it was in, with the exact settings that were in place, when the save occurred. The Mode settings in each state file include the settings that are affected by Mode Preset, as well as the

additional settings affected by Restore Mode Defaults; all of the Mode's settings. In addition, all of the settings of the Input/Output system are included, even though they are outside of the Mode's state, because they are needed to restore the complete setup. Persistent System settings (for example, GPIB address) are not affected by either a Mode Preset or Restore Mode Defaults, nor are they included in a saved State file.

Since each state file is only for one Mode, the settings for other Modes are unaffected when it is loaded. Recall State will cause a mode switch if the state being recalled is not from the current active mode.

After the recall completes, the message "File <filename> recalled" or "Recalled State Register <register number>" is displayed.

For rapid recalls, the State menu lists 16 registers that you can choose from to recall. Pressing a Register key initiates the recall. You can also select a file from which to recall.

The default path for all State Files is:

My Documents\<mode name>\state

where <mode name> is the parameter used to select the mode with the INST:SEL command (for example, SA for the Spectrum Analyzer).

See ["More Information" on page 2241](#).

Key Path	Recall
Mode	All
Remote Command	:MMEMory:LOAD:STATe <filename>
Example	:MMEM:LOAD:STAT "myState.state" This recalls the file myState.state on the default path
Example	MMEM:LOAD:STAT "MyStateFile.state" This loads the state file data (on the default file directory path) into the instrument state.
Notes	<p>When you pick a file to recall, the analyzer first verifies that the file is recallable in the current instrument by checking the software version and model number of the instrument. If everything matches, a full recall proceeds by aborting the currently running measurement, clearing any pending operations, and then loading the State from the saved state file. You can open state files from any mode, so recalling a State file switches to the mode that was active when the save occurred. After switching to the mode of the saved state file, mode settings and data (if any for the mode) are loaded with values from the saved file. The saved measurement of the mode becomes the newly active measurement and the data relevant to the measurement (if there is any) is recalled.</p> <p>If there is a mismatch between file version or model number or instrument version or model number, the recall function tries to recall as much as possible and returns a warning message. It may limit settings that differ based on model number, licensing or version number.</p> <p>After recalling the state, the Recall State function does the following:</p> <ul style="list-style-type: none"> • Makes the saved measurement for the mode the active measurement. • Clears the input and output buffers. • Status Byte is set to 0. • Executes a *CLS <p>If the file specified is empty an error is generated. If the specified file does not exist, another error is generated. If there is a mismatch between the file and the proper file type, an error is generated. If</p>

	there is a mismatch between file version or model number or instrument version or model number, a warning is displayed. Then it returns to the State menu and File Open dialog goes away. After the Recall, the analyzer exits the Recall menu and returns to the previous menu.
Backwards Compatibility SCPI	:MMEMory:LOAD:STATe 1,<filename> For backwards compatibility, the above syntax is supported. The "1" is simply ignored.
Initial S/W Revision	Prior to A.02.00

More Information

In measurements that support saving Traces, for example, Swept SA, the Trace data is saved along with the State in the State file. When recalling the State, the Trace data is recalled as well. Traces are recalled exactly as they were stored, including the writing mode and update and display modes. If a Trace was updating and visible when the State was saved, it will come back updating and visible, and its data will be rewritten right away. When you use State to save and recall traces, any trace whose data must be preserved should be placed in View or Blank mode before saving.

The following table describes the Trace Save and Recall possibilities:

You want to recall state and one trace's data, leaving other traces unaffected.	Save Trace+State from 1 trace. Make sure that no other traces are updating (they should all be in View or Blank mode) when the save is performed.	On Recall, specify the trace you want to load the one trace's data into. This trace will load in View. All other traces' data will be unaffected, although their trace mode will be as it was when the state save was performed.
You want to recall all traces	Save Trace+State from ALL traces.	On Recall, all traces will come back in View (or Blank if they were in Blank or Background when saved)
You want all traces to load exactly as they were when saved.	Save State	On recall, all traces' mode and data will be exactly as they were when saved. Any traces that were updating will have their data immediately overwritten.

From File...

When you press "From File", the analyzer brings up a Windows dialog and a menu entitled "File Open." This menu allows you to navigate to the various fields in the Windows dialog without using a keyboard or mouse. The Tab and Arrow keys can also be used for dialog navigation.

17 Waveform Measurement Recall

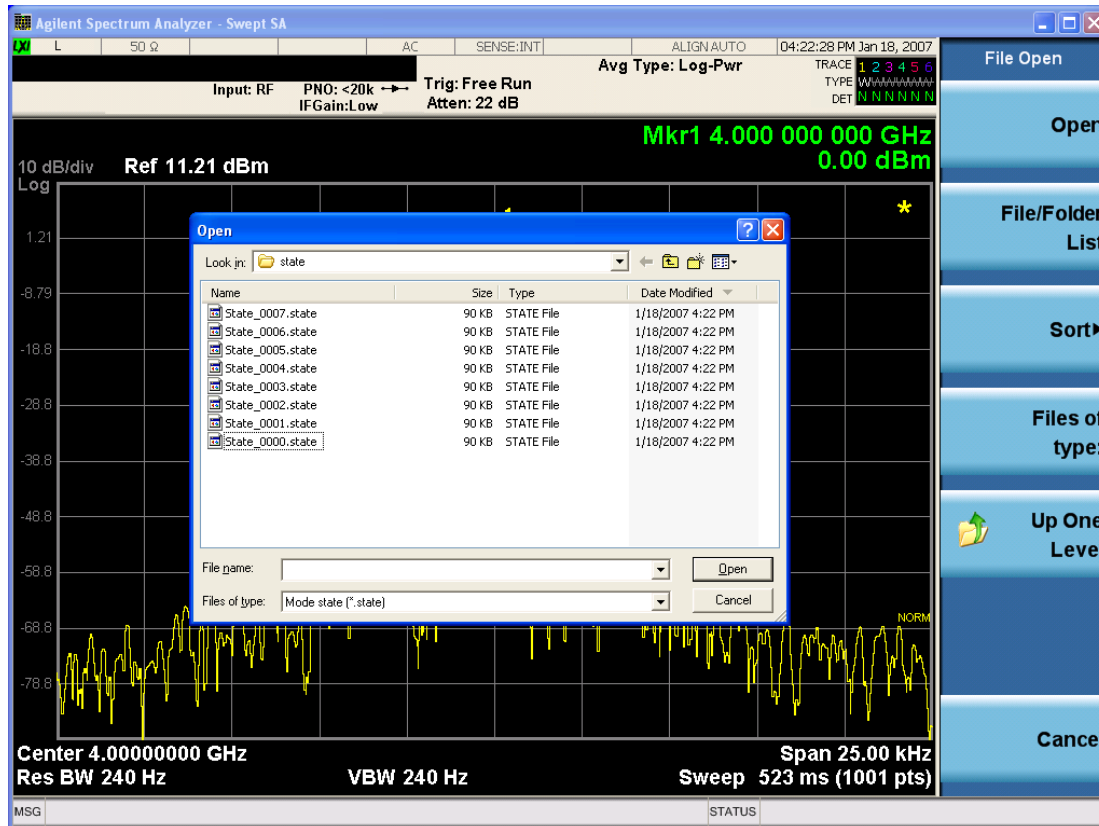

Listed below are the functions of the various fields in the dialog, and the corresponding softkeys:

Open

Performs the recall of the specified file. While the recall is being performed, the floppy icon appears briefly in the Meas bar.

File/Folder List

Enables you to navigate to the center of the dialog that contains the list of files and folders. Once here you can get information about the file and use the tab keys to navigate to the other fields in the dialog, such as Look In.

Look In

The Look In field shows the path from which the file will be recalled and allows you to change the path using the up and down arrow keys to navigate to other paths; the Enter key to open a directory; and the Backspace key to go back one directory. The **Look In field** first uses the last path from the Save As dialog **Save In:** path for that same file type. There is no softkey for directly navigating to the Look In field, but you can use the left tab to get here from the File/Folder List.

User specified paths are remembered when you leave and return to a Mode and are reset back to the default using Restore Mode Defaults.

Sort

Accesses a menu that enables you to sort the files within the File Open dialog. Only one sorting type can be selected at a time and the sorting happens immediately. The sorting types are By Date, By Name, By extension, and By Size.

Files of Type

This field shows the file suffix for the type of file you have selected to recall. For example, if you navigated here while recalling State, "Mode state (*.state)" is in the field. If you navigated here while recalling Trace, ""Mode state (*.trace)" is in the field. If you navigated here while importing a trace data file, "Trace Data (*.csv)" is in the field. For some file types, there is more than one choice in the dropdown menu, which you can select by using the up and down arrow keys and Enter.

Up One Level

This key corresponds to the icon of a folder with the up arrow that is in the tool bar of the dialog. When pressed, it causes the file and folder list to navigate up one level in the directory structure. The Backspace key does the same thing.

Cancel

This key corresponds to the Cancel selection in the dialog. It causes the current **Open** request to be cancelled. The ESC key does the same thing.

Key Path	Recall, State
Notes	Brings up the Open dialog for recalling a State Save Type
Initial S/W Revision	Prior to A.02.00

Edit Register Names

You may enter a custom name on any of the Register keys, to help you remember what you are using that state to save. To do this, press the Edit Register Names key, choose the register whose name you wish to edit, and then enter the desired label using the Alpha Editor or an external PC keyboard.

The maximum number of characters that can be added is 30. In most cases, 30 characters will fit on two lines of the key.

For more information and the SCPI command, see Edit Register Names under the Save, State function.

Key Path	Recall, State
Mode	All
Dependencies	N9060A-7FP or N9060B-2FP license required to edit the register names. When the feature is not licensed, sending the SCPI command generates an error, -221, "Settings conflict;Option not available"
Initial S/W Revision	A.11.00

Register 1 thru Register 16

Selecting any one of these register keys causes the State of the mode from the specified Register to be recalled. Each of the register keys annotates whether it is empty or at what date and time it was last

modified. In addition, you can use the Edit Register Names key under Save, State to enter custom names for each register.

Registers are shared by all modes, so recalling from any one of the registers will cause a mode switch to the mode that was active when the save to the Register occurred.

Although these 16 registers are the only registers available from the front panel, there are 128 state registers available in the instrument. Registers 17–128 are only available from the SCPI interface, using the *RCL command.

After the recall completes, the message "Register <register number> recalled" appears in the message bar. If you are in the Spectrum Analyzer Mode, and you are recalling a register that was saved in the Spectrum Analyzer Mode, then after the recall, you will still be in the Recall Register menu. If the Recall causes you to switch modes, then after the Recall, you will be in the Frequency menu.

If a requested register is empty an error is generated.

Key Path	Recall, State
Example	*RCL 1
Range	1–16 from front panel, 1–128 from SCPI
Readback	Date and time with seconds resolution are displayed on the key OR A custom name of up to 30 characters entered using the Save, State, Edit Register Names key OR “(empty)” if no prior save operation has been performed to this register.
Initial S/W Revision	Prior to A.02.00
Modified at S/W Revision	Prior to A.11.00

Register 1 thru Register 16

Selecting any one of these register keys causes the State of the mode from the specified Register to be recalled. Each of the register keys annotates whether it is empty or at what date and time it was last modified. In addition, you can use the Edit Register Names key under Save, State to enter custom names for each register.

Registers are shared by all modes, so recalling from any one of the registers will cause a mode switch to the mode that was active when the save to the Register occurred.

Although these 16 registers are the only registers available from the front panel, there are 128 state registers available in the instrument. Registers 17–128 are only available from the SCPI interface, using the *RCL command.

After the recall completes, the message "Register <register number> recalled" appears in the message bar. If you are in the Spectrum Analyzer Mode, and you are recalling a register that was saved in the Spectrum Analyzer Mode, then after the recall, you will still be in the Recall Register menu. If the Recall causes you to switch modes, then after the Recall, you will be in the Frequency menu.

If a requested register is empty an error is generated.

Key Path	Recall, State
Example	*RCL 1
Range	1–16 from front panel, 1–128 from SCPI
Readback	Date and time with seconds resolution are displayed on the key OR A custom name of up to 30 characters entered using the Save, State,Edit Register Names key OR “(empty)” if no prior save operation has been performed to this register.
Initial S/W Revision	Prior to A.02.00
Modified at S/W Revision	Prior to A.11.00

Data (Import)

Importing a data file loads data that was previously saved from the current measurement or from other measurements and/or modes that produce compatible data files. The Import Menu only contains Data Types that are supported by the current measurement.

Since the commonly exported data files are in .csv format, the data can be edited by the user prior to importing. This allows you to export a data file, manipulate the data in Excel (the most common PC Application for manipulating .csv files) and then import it.

Importing Data loads measurement data from the specified file into the specified or default destination, depending on the data type selected. Selecting an Import Data menu key will not actually cause the importing to occur, since the analyzer still needs to know from where to get the data. Pressing the Open key in this menu brings up the Open dialog and Open menu that provides you with the options from where to recall the data. Once a filename has been selected or entered in the Open menu, the recall occurs as soon as the Open button is pressed.

Key Path	Recall
Mode	All
Notes	The menu is built from whatever data types are available for the mode. Some keys will be missing completely, so the key locations in the sub-menu will vary. No SCPI command directly controls the Data Type that this key controls. The Data Type is included in the MMEM:LOAD commands.
Dependencies	If a file type is not used by a certain measurement, it is grayed out for that measurement. The key for a file type will not show at all if there are no measurements in the Mode that support it.
Preset	Is not affected by Preset or shutdown, but is reset during Restore Mode Defaults
Readback	The data type that is currently selected
Initial S/W Revision	Prior to A.02.00

Mask

Enables you to recall a preset mask file. This file type (.mask) differs from a normal “state” file because it contains the configuration for Carrier, Offset, and Limit for the specific preset profile BW. A brief description of the mask file is available in the properties view of each file. (Right-mouse-click on the file, select, "Properties" to view this information.) A detailed list of the mask parameter values is located in the .pdf file of the same name in the same directory. Blank values in the .pdf file are parameters that will not be overwritten when recalling the mask.

Key Path	Recall, Data
Mode	WIMAXOFDMA
Remote Command	:MMEMory:LOAD:MASK <string>
Example	:MMEM:LOAD:MASK "MyLimitFile.mask"
Notes	Set of parameters related to Limit, Carrier and Offset are overwritten by Preset Mask file.
Initial S/W Revision	A.02.00

This topic contains the following sections:

["File location and extension" on page 2246](#)

["Example of Preset Mask file" on page 2247](#)

File location and extension

File location: The preset mask file is located in “My Documents\WIMAXOFDMA\data\masks”.

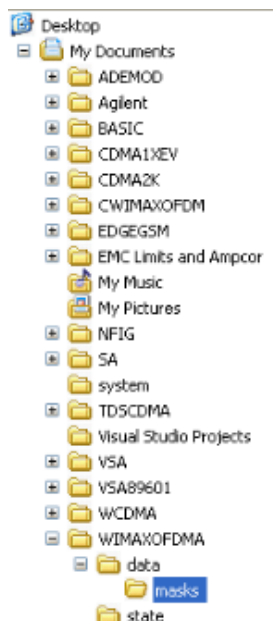

NOTE

When your X-Series analyzer starts, all mask files located in “My Documents\WIMAXOFDMA\data/masks” are overwritten, so any files you wish to save should be stored in another directory location.

File type: The file type is binary file.

File Name: The file name is decided by following naming rules. Each specific keyword is connected with underscore.

<Standard name>_<Radio device>_<Preset Profile BW>_<Measurement>.mask

<Standard name>: This term references the standard associated with each mask file.

<Radio device>: This term specifies to which radio device (BS or MS) the mask file pertains.

<Preset Profile BW>: This term specifies to which Preset Profile BW the mask file pertains.

<Measurement>: This term specifies the measurement to which the mask file is applied. Your selections are: SEM, ACP, or Mode. When selecting **Mode**, the values of some parameters in both the ACP and SEM measurement are overwritten.

File extension: The extension of preset mask file is “mask” to distinguish it from a “state” file.

When you press the open key under the Data menu, the “My Documents\WIMAXOFDMA\data\masks” folder is opened. Select one mask file.

NOTE

When you change the preset BW profile or Radio Device, all measurement parameters are reset to their original values. Thus you have to recall the appropriate preset mask file again after the change.

Example of Preset Mask file

When you import a preset mask file, it is a “Recall” function. Specific parameter values are overwritten by the contents of the preset mask file (see table below). Those values not specified by the preset mask file remain unchanged. Because the file format type is binary, you cannot view, change, or create the preset mask file. Here is an example of a preset mask file used for ACP measurements.

File Location: My Documents/WIMAXOFDMA/data/masks

File Name: ETSI-EN301-021-SysE_BS_10MHz_ACP.mask

The .pdf file that lists the parameters similarly to that shown below is named, "ETSI-EN301-021-SysE_BS_10MHz_ACP.pdf"

The set of parameters listed in the following table for the Preset Profile BW (10MHz) are imported into the ACP measurement.

Offset	Start Freq (MHz)	Stop Freq (MHz)	Sweep Time	Res BW (Hz)	Meas BW	Rel Start	Rel Stop	Fail Mask
A	5	7.14		30k	1	-8	-25	Rel
B	7.14	10.57		30k	1	-25	-27	Rel
C	10.57	20		30k	1	-27	-50	Rel
D	20	25		30k	1	-50	-50	Rel
E	25	30		30k	1	-50	-50	Rel

Zone Map

Pressing this key selects Zone Map as the data type to be imported.

The WiMAX-OFDMA application can load the Singal Studio Setup file, and the OFDMA Map file is compatible with the 89601A Mobile WiMAX omf file.

Key Path	Recall, Data
Remote Command	:MMEMory:LOAD:ZMAP <string>
Example	MMEM:LOAD:ZMAP "ZMap_0000.omf"
Notes	The SCPI parameter is a quoted string that specifies the filename. Both single and double quotes are supported for any filename parameter over SCPI.
Dependencies	You must be in the 802.16 OFDMA (WiMAX/WiBro) mode.
Status Bits/OPC dependencies	Sequential – waits for the previous measurement to complete.
Initial S/W Revision	Prior to A.02.00

Open...

When you press “Open”, the analyzer brings up a Windows dialog and a menu entitled “File Open.” This menu allows you to navigate to the various fields in the Windows dialog without using a keyboard or mouse. The Tab and Arrow keys can also be used for dialog navigation.

See "[From File...](#)" on page 2241 in Recall, State, for a full description of this dialog and menu.

Key Path	Recall, Data
Notes	The key location is mode-dependent and will vary. Brings up Open dialog for recalling a <mode specific> Save Type
Initial S/W Revision	Prior to A.02.00

Restart

The Restart function restarts the current sweep, or measurement, or set of averaged/held sweeps or measurements. If you are Paused, pressing Restart does a Resume.

The Restart function is accessed in several ways:

- Pressing the Restart key
- Sending the remote command INIT:IMMEDIATE
- Sending the remote command INIT:RESTART

See "[More Information](#)" on page 2249

Key Path	Front-panel key
Remote Command	:INITiate[:IMMEDIATE] :INITiate:RESTART
Example	:INIT:IMM :INIT:REST
Notes	:INITiate:RESTART and :INITiate:IMMEDIATE perform exactly the same function.
Couplings	Resets average/hold count k. For the first sweep overwrites all active (update=on) traces with new current data. For application modes, it resets other parameters as required by the measurement.
Status Bits/OPC dependencies	This is an Overlapped command. The STATUS:OPERation register bits 0 through 8 are cleared. The STATUS:QUESTIONable register bit 9 (INTEgrity sum) is cleared. The SWEEPING bit is set. The MEASURING bit is set.
Backwards Compatibility Notes	For Spectrum Analysis mode in ESA and PSA, the Restart hardkey and the INITiate:RESTART command restart trace averages (displayed average count reset to 1) for a trace in Clear Write, but did not restart Max Hold and Min Hold. In the X-Series, the Restart hardkey and the INITiate:RESTART command restart not only Trace Average, but MaxHold and MinHold traces as well. For wireless comms modes in ESA and PSA, the Restart hardkey and the INITiate:RESTART command restart every measurement, which includes all traces and numeric results. There is no change to this operation.
Initial S/W Revision	Prior to A.02.00

More Information

The **Restart** function first aborts the current sweep/measurement as quickly as possible. It then resets the sweep and trigger systems, sets up the measurement and initiates a new data measurement sequence with a new data acquisition (sweep) taken once the trigger condition is met.

If the analyzer is in the process of aligning when **Restart** is executed, the alignment finishes before the restart function is performed.

Even when set for Single operation, multiple sweeps may be taken when Restart is pressed (for example, when averaging/holding is on). Thus when we say that **Restart** "restarts a measurement," we may mean:

- It restarts the current sweep
- It restarts the current measurement
- It restarts the current set of sweeps if any trace is in Trace Average, Max Hold or Min Hold
- It restarts the current set of measurements if Averaging, or Max Hold, or Min Hold is on for the measurement
- depending on the current settings.

With **Average/Hold Number** (in **Meas Setup** menu) set to 1, or Averaging off, or no trace in Trace Average or Hold, a single sweep is equivalent to a single measurement. A single sweep is taken after the trigger condition is met; and the analyzer stops sweeping once that sweep has completed. However, with **Average/Hold Number** >1 and at least one trace set to **Trace Average, Max Hold, or Min Hold (SA Measurement)** or **Averaging on (most other measurements)**, multiple sweeps/data acquisitions are taken for a single measurement. The trigger condition must be met prior to each sweep. The sweep is stopped when the average count k equals the number N set for **Average/Hold Number**. A measurement average usually applies to all traces, marker results, and numeric results; but sometimes it only applies to the numeric results.

Once the full set of sweeps has been taken, the analyzer will go to idle state. To take one more sweep without resetting the average count, increment the average count by 1, by pressing the step up key while **Average/Hold Number** is the active function, or sending the remote command CALC:AVER:TCON UP.

Save

The Save menu lets you choose what you want to save and where you want to save it. Among the types of files you can save are **States**, **Traces**, and **Screen Images**. In addition, an Export (Data) option lets you save a number of data types as CSV files for easy import into Excel and other spreadsheet programs.

Key Path	Front-panel key
Mode	All
Notes	No remote command for this key specifically, but the :MMEM:STORe command is available for specific file types. An example is :MMEM:STOR:STATe <filename>.
Initial S/W Revision	Prior to A.02.00

State

The Save State menu lets you choose a register or file for saving the state.

The content of a state file includes all of the settings and data required to return the analyzer as closely as possible to the Mode it was in, with the exact settings which were in place, when the save occurred. The Mode settings in each state file include the settings that are affected by Mode Preset, as well as the additional settings affected by Restore Mode Defaults; all of the Mode's settings. In addition, all of the settings of the Input/Output system are included, even though they are outside of the Mode's state, because they are needed to restore the complete setup. Persistent System settings (for example, Verbose SCPI) are not affected by either Mode Preset or Restore Mode Defaults, nor are they included in a saved State file.

After the save completes, the message "File <filename> saved" or "State Register <register number> saved" is displayed.

For rapid saving, the State menu lists 16 registers to save to. Pressing a Register key initiates the save. You can also select a file to save to.

The default path for all State Files is:

My Documents\<<mode name>\state

where <mode name> is the parameter used to select the mode with the INST:SEL command (for example, SA for the Spectrum Analyzer).

Key Path	Save
Mode	All
Remote Command	:MMEMory:STORe:STATe <filename>
Example	MMEM:STOR:STATe "MyStateFile.state" This stores the current instrument state data in the file MyStateFile.state in the default directory.
Notes	Both single and double quotes are supported for any filename parameter over remote. After saving to a register, that register's menu key is updated with the date the time, unless a custom label has been entered for that key. After saving to a register, you remain in the Save State menu, so that you can see the Register key

update. After saving to a file, the analyzer automatically returns to the previous menu and any Save As dialog goes away.

Backwards Compatibility SCPI :MMEMory:STORe:STATe 1,<filename>

For backwards compatibility, the above syntax is supported. The "1" is simply ignored. The command is sequential.

Initial S/W Revision Prior to A.02.00

To File . . .

When you press “To File”, the analyzer brings up a Windows dialog and a menu entitled “Save As.” This menu allows you to navigate to the various fields in the Windows dialog without using a keyboard or mouse. The Tab and Arrow keys can also be used for dialog navigation.

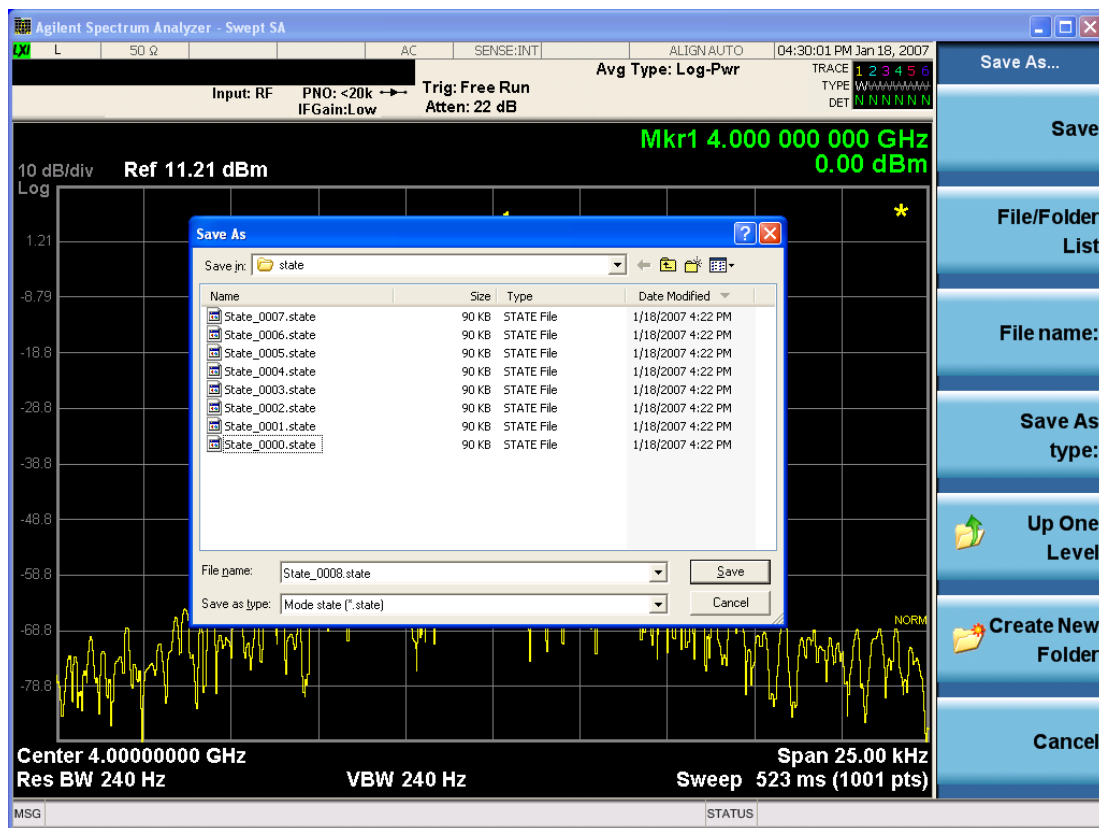

The Listed below

are the functions of the various fields in the dialog, and the corresponding softkeys:

Save

Performs the save to the specified file of the selected type. If the file already exists, a dialog will appear that allows you to replace the existing file by selecting OK, or you can Cancel the request. If you select OK, the file will be overwritten. Using the C: drive is strongly discouraged, since it runs the risk of being overwritten during an instrument software upgrade.

While the save is being performed, the floppy icon appears briefly in the Meas bar.

File/Folder List

Enables you to navigate to the center of the dialog that contains the list of files and folders. Once here you can get information about the file and use the tab keys to navigate to the other fields in the dialog, such as Save In.

Save In

The Save In field shows the path to which the file will be saved and allows you to change the path using the up and down arrow keys to navigate to other paths; the Enter key to open a directory; and the Backspace key to go back one directory. The **Save In field** defaults to the default path for this type of file and remembers the last path you used to save this type of file. There is no softkey for directly navigating to the Save In field but you can use left tab to get here from the File/Folder List.

User specified paths are remembered when you leave and return to a Mode and are reset back to the default using Restore Mode Defaults.

File Name

The File Name field is initially loaded with an automatically generated filename specific to the appropriate Save Type. The automatically generated filename is guaranteed not to conflict with any filename currently in the directory. You may replace or modify this filename using the File Name key. See the ["Quick Save " on page 2237](#) documentation for more on the automatic file naming algorithm.

When you press the File Name key the analyzer displays the Alpha Editor. Use the knob to choose the letter to add and the front-panel Enter key to add the letter to the file name. The BK character moves you back and the FW character moves you forward in the filename. The Select key on the front panel generates a space character. When you are done entering the filename press the Done softkey. This returns back to the **File Open** dialog and menu, but does not cause the save to occur.

Save As Type

This field shows the file suffix for the type of file you have selected to save. For example, if you navigated here while saving State, "Mode state (*.state)" is in the field. If you navigated here from saving Trace, ""Mode state (*.trace)" is in the field. If you navigated here while exporting a trace data file, "Trace Data (*.csv)" is in the field. For some file types, there is more than one choice in the dropdown, which you can select by using the up and down arrow keys and Enter.

Up One Level

This key corresponds to the icon of a folder with the up arrow that is in the tool bar of the dialog. When pressed, it causes the file and folder list to navigate up one level in the directory structure. The Backspace key does the same thing.

Create New Folder

This key corresponds to the icon of a folder with the "*" that is in the tool bar of the dialog. When pressed, a new folder is created in the current directory with the name **New Folder** and you can enter a new folder name using the Alpha Editor.

Cancel

This key corresponds to the Cancel selection in the dialog. It causes the current **Save As** request to be cancelled. The ESC key does the same thing.

Key Path	Save, State
Mode	All
Notes	Brings up Save As dialog for saving a State Save Type
Initial S/W Revision	Prior to A.02.00

Edit Register Names

You may enter a custom name on any of the Register keys, to help you remember what you are using that state to save. To do this, press the Edit Register Names key, choose the register whose name you wish to edit, and then enter the desired label using the Alpha Editor or an external PC keyboard.

The maximum number of characters that can be added is 30. In most cases, 30 characters will fit on two lines of the key.

See ["More Information" on page 2254](#)

Key Path	Save, State
Mode	All
Remote Command	:MMEMory:REGister:STATe:LABel <reg number>,"label" :MMEMory:REGister:STATe:LABel? <reg number>
Example	:MMEM:REG:STAT:LAB 1,"my label"
Notes	<reg number> is an integer from 1 to 16. If the SCPI specifies an invalid register number an error message is generated, -222,"Data out of range;Invalid register label number" "label" is a string from 0 to 30 characters in length. If a label exceeds 30 characters, an error message is generated, -150,"String data error;Label clipped to 30 characters" "label" of length 0 erases the custom label and restores the default (time and date) label. E.g.: :MMEM:REG:STAT:LAB 1,""
Dependencies	N9060A-7FP or N9060B-2FP license required to edit the register names. When the feature is not licensed, sending this command generates an error, -221,"Settings conflict;Option not available"
Preset	The names are unaffected by Preset or power cycle but are set to the default label (time and date) on a "Restore System Defaults->Misc"
Initial S/W Revision	A.11.00

More Information

When you edit one of the register names, the time and date field will be replaced by the custom name.

If you delete all the characters in the custom name, it restores the default (time and date).

The register names are stored within the state files, but they are not part of the instrument state; that is, once you have edited a register name, loading a new state will not change that register name. Another consequence of this is that the names will be persistent through a power cycle. Also, if a named state file is transferred to another analyzer, it will bring its custom name along with it.

If you try to edit the name of an empty register, the analyzer will first save the state to have a file to put the name in. If you load a named state file into an analyzer with older firmware it will ignore the metadata.

The *SAV and *RCL commands will not be affected by the custom register names, nor will the MMEM commands.

Register 1 thru Register 16

Selecting any one of these register menu keys causes the State of the currently active mode to be saved to the specified Register. The registers are provided for rapid saving and recalling, since you do not need to specify a filename or navigate to a file. Each of the register menu keys annotates whether it is empty or at what date and time it was last modified. In addition, you can use the Edit Register Names key to enter custom names for each register.

Although these 16 registers are the only registers available from the front panel, there are 128 state registers available in the instrument. Registers 17–128 are only available from the SCPI interface, using the *SAV command.

There is one set of 128 state registers in the instrument, not one set for each Mode. When a state is saved, the Mode it was saved from is saved with it; then when it is recalled, the instrument switches to that Mode.

After the save completes, the corresponding register menu key annotation is updated with the date and time and the message "Register <register number> saved" is displayed.

Key Path	Save, State
Mode	All
Example	*SAV 1
Range	1–16 from front panel, 1–128 from SCPI
Readback	Date and time with seconds resolution are displayed on the key OR A custom name of up to 30 characters entered using the Edit Register Names key OR “(empty)” if no prior save operation has been performed to this register.
Initial S/W Revision	Prior to A.02.00
Modified at S/W Revision	A.11.00

Register 1 thru Register 16

Selecting any one of these register menu keys causes the State of the currently active mode to be saved to the specified Register. The registers are provided for rapid saving and recalling, since you do not need to specify a filename or navigate to a file. Each of the register menu keys annotates whether it is empty or at what date and time it was last modified. In addition, you can use the Edit Register Names key to enter custom names for each register.

Although these 16 registers are the only registers available from the front panel, there are 128 state registers available in the instrument. Registers 17–128 are only available from the SCPI interface, using the *SAV command.

There is one set of 128 state registers in the instrument, not one set for each Mode. When a state is saved, the Mode it was saved from is saved with it; then when it is recalled, the instrument switches to that Mode.

After the save completes, the corresponding register menu key annotation is updated with the date and time and the message "Register <register number> saved" is displayed.

Key Path	Save, State
Mode	All
Example	*SAV 1
Range	1-16 from front panel, 1-128 from SCPI
Readback	Date and time with seconds resolution are displayed on the key OR A custom name of up to 30 characters entered using the Edit Register Names key OR “(empty)” if no prior save operation has been performed to this register.
Initial S/W Revision	Prior to A.02.00
Modified at S/W Revision	A.11.00

Data (Export)

Exporting a data file stores data from the current measurement to mass storage files. The Export Menu only contains data types that are supported by the current measurement.

Since the commonly exported data files are in .csv format, the data can be edited by you prior to importing. This allows you to export a data file, manipulate the data in Excel (the most common PC Application for manipulating .csv files) and then import it.

Selecting an Export Data menu key will not actually cause the exporting to occur, since the analyzer still needs to know where you wish to save the data. Pressing the Save As key in this menu brings up the Save As dialog and Save As menu that allows you to specify the destination file and directory. Once a filename has been selected or entered in the Open menu, the export will occur as soon as the Save key is pressed.

Key Path	Save
Mode	All
Notes	The menu is built from whatever data types are available for the mode. So the key locations in the sub menu will vary. No SCPI command directly controls the Data Type that this key controls. The Data Type is included in the MMEM:STORe commands.
Dependencies	If a file type is not used by a certain measurement, that type is grayed out for that measurement. The key for a file type will not show at all if there are no measurements in the Mode that support it.
Preset	Is not affected by a Preset or shutdown, but is reset during Restore Mode Defaults
Readback	The data type that is currently selected
Initial S/W Revision	Prior to A.02.00

Measurement Results

Pressing this key selects Meas Results as the data type to be exported. Pressing the key a second time brings up the Meas Results menu, which allows you to select which **Meas Result** to save. In the Swept SA measurement, there are three types of Measurement Results files: Peak Table, Marker Table and Spectrogram.

See "Meas Results File Contents" on page 2257.

See "Marker Table" on page 2257.

See "Peak Table" on page 2260.

See "Spectrogram" on page 2263

Remote Command	:MMEMory:STORe:RESults:MTABle PTABle SPEctrogram <filename>
Example	:MMEM:STOR:RES:MTAB "myResults.csv" Saves the results from the current marker table to the file myResults.csv in the current path. :MMEM:STOR:RES:PTAB "myResults.csv" Saves the results from the current peak table to the file myResults.csv in the current path. :MMEM:STOR:RES:SPEC "myResults.csv" Saves the results from the current Spectrogram display to the file myResults.csv in the current path. The default path is My Documents\SA\data\SAN\results
Notes	If the save is initiated via SCPI, and the file already exists, the file will be overwritten. Using the C: drive is strongly discouraged, since it runs the risk of being overwritten during an instrument software upgrade. Both single and double quotes are supported for any filename parameter over SCPI.
Dependencies	If a save of Marker Table results is requested and the Marker Table is not on, no file is saved and a message is generated If a save of Peak Table results is requested and the Peak Table is not on, no file is saved and a message is generated If a save of Spectrogram results is requested and the Spectrogram is not on, no file is saved and a message is generated. The Spectrogram choice only appears if option EDP is licensed.
Preset	Not part of Preset, but is reset to Peak Table by Restore Mode Defaults. Survives a shutdown.
Initial S/W Revision	Prior to A.02.00

Meas Results File Contents

All files are .csv files. The following section details the data in each file type.

Marker Table

This section discusses the Marker Table Meas Results file format.

Imagine that, at the point where a Marker Table Meas Result is requested, the following screen is showing:

17 Waveform Measurement
Save

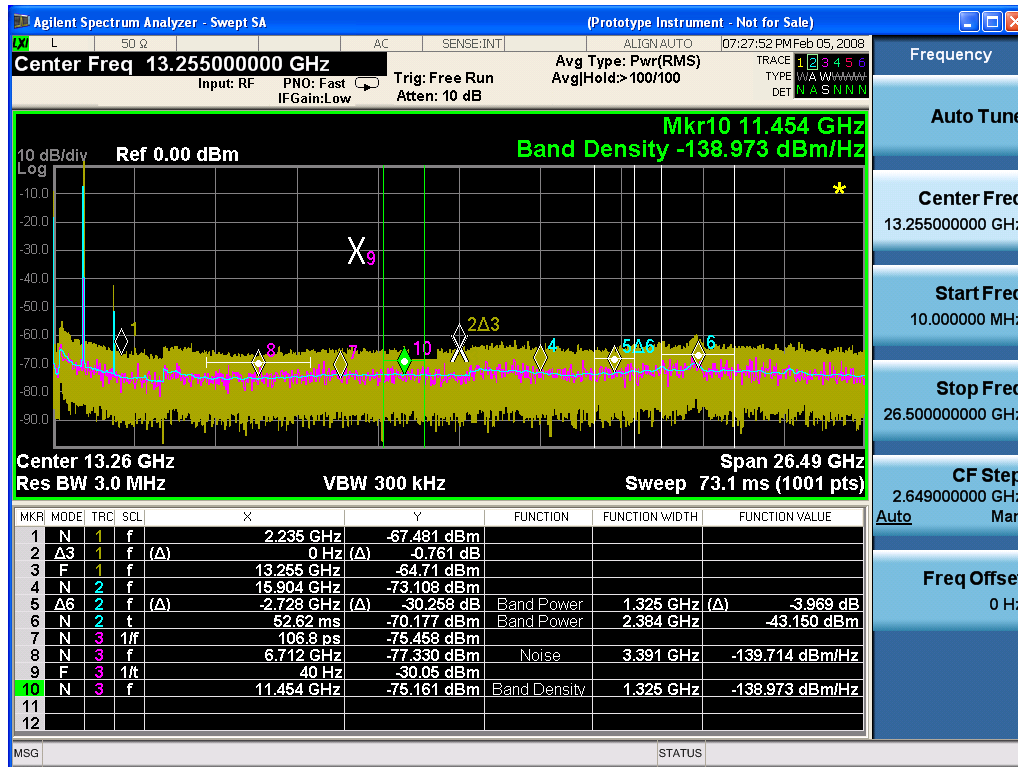

Then the Meas Results file, when opened, would show the following data:

MeasurementResult	
Swept SA	
A.01.40_R0017	N9020A
526 B25 PFR	1
P26 EA3	
Result Type	Marker Table
Ref Level	0
Number of Points	1001
Sweep Time	0.0662666 67
Start Frequency	10000000
Stop Frequency	26500000 000
Average Count	0
Average Type	LogPower (Video)
RBW	3000000

RBW Filter	Gaussian
RBW Filter BW	3dB
VBW	3000000
Sweep Type	Swept
X Axis Scale	Lin
PreAmp State	Off
PreAmp Band	Low
Trigger Source	Free
Trigger Level	1.2
Trigger Slope	Positive
Trigger Delay	1.00E-06
Phase Noise Optimization	Fast
Swept If Gain	Low
FFT If Gain	Autorange
RF Coupling	AC
FFT Width	411900
Ext Ref	10000000
Input	RF
RF Calibrator	Off
Attenuation	10
Ref Level Offset	0
External Gain	0
X Axis Units	Hz
Y Axis Units	dBm

DATA									
MKR	MODE	TR C	SCL	X	Y	FUNCTI ON	FUNCTIO N WIDTH	FUNCTI ON VALUE	FUNCTI ON UNIT
1	Normal	1	Freque ncy	2.2350E+09	- 67.481	Off	0.0000E+00	0	None
2	Delta3	1	Freque ncy	0.0000E+00	- 0.761	Off	0.0000E+00	0	None
3	Fixed	1	Freque ncy	1.3255E+10	- 64.71	Off	0.0000E+00	0	None
4	Normal	2	Freque ncy	1.5904E+10	- 73.1	Off	0.0000E+00	0	None

08									
5	Delta7	2	Frequency	-2.7280E+09	-30.258	Band Power	1.3250E+06	-3.969	dB
6	Normal	2	Time	5.2620E-02	-70.177	Band Power	2.3840E+06	-43.15	dBm
7	Normal	3	Period	1.0680E-10	-75.458	Off	0.0000E+00	0	None
8	Normal	3	Frequency	6.7120E+09	-77.33	Noise	3.3910E+06	-139.714	dBm/Hz
9	Fixed	3	Inverse Time	4.0000E+01	-30.05	Off	0.0000E+00	0	None
10	Normal	3	Frequency	1.1454E+10	-75.161	Band Density	1.3250E+06	-138.973	dBm/Hz
11	Off	1	Frequency	0.0000E+00	0	Off	0.0000E+00	0	None
12	Off	1	Frequency	0.0000E+00	0	Off	0.0000E+00	0	None

The numbers appear in the file exactly as they appear onscreen. If it says 11.454 GHz onscreen, then in the file it is 11.454E+09.

The metadata header is very similar to the metadata used in the trace data .csv files. See Trace File Contents. The only new information concerns the 1-of-N fields in the marker table itself.

Peak Table

This section discusses the Peak Table Meas Results file format.

Imagine that, at the point where a Marker Table Meas Result is requested, the following screen is showing:

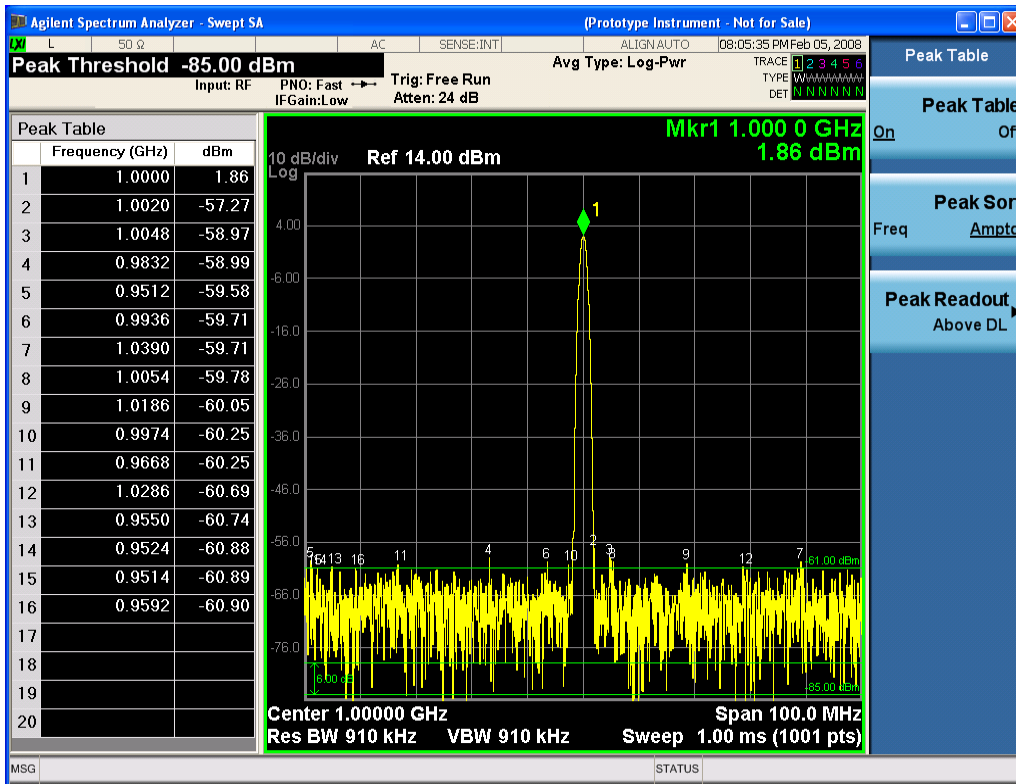

Then the Meas Results file, when opened, would show the header data (the same as for the Marker Table except that the Result Type is Peak Table) ending with a few fields of specific interest to Peak Table users:

- Peak Threshold
- Peak Threshold State (On|Off)
- Peak Excursion
- Peak Excursion State (On|Off)
- Display Line
- Peak Readout (All|AboveDL|BelowDL)
- Peak Sort (Freq|Amptd)

These fields are then followed by the data for the Peak Table itself.

Note that the label for the Frequency column changes to Time in 0 span.

Here is what the table for the above display looks like:

MeasurementResult	
Swept SA	
A.01.40_R0017	N9020A
526 B25 PFR P26 EA3	1

Result Type	Peak Table
Ref Level	0
Number of Points	1001
Sweep Time	0.066266667
Start Frequency	10000000
Stop Frequency	26500000000
Average Count	0
Average Type	LogPower(Video)
RBW	3000000
RBW Filter	Gaussian
RBW Filter BW	3dB
VBW	3000000
Sweep Type	Swept
X Axis Scale	Lin
PreAmp State	Off
PreAmp Band	Low
Trigger Source	Free
Trigger Level	1.2
Trigger Slope	Positive
Trigger Delay	1.00E-06
Phase Noise Optimization	Fast
Swept If Gain	Low
FFT If Gain	Autorange
RF Coupling	AC
FFT Width	411900
Ext Ref	10000000
Input	RF
RF Calibrator	Off
Attenuation	10
Ref Level Offset	0
External Gain	0
X Axis Units	Hz
Y Axis Units	dBm
Peak Threshold	-85
Peak Threshold State	On
Peak Excursion	6
Peak Excursion State	On

Display Line	-61	
Peak Readout	AboveDL	
Peak Sort	Amptd	
DATA		
Peak	Frequency	Amplitude
1	1.0000E+06	1.86
2	1.0020E+06	-57.27
3	1.0048E+06	-58.97
4	9.8320E+05	-58.99
5	9.5120E+05	-59.58
6	9.9360E+05	-59.71
7	1.0390E+06	-59.71
8	1.0054E+06	-59.78
9	1.1086E+06	-60.05
10	9.9740E+05	-60.25
11	9.6680E+05	-60.25
12	1.0286E+06	-60.69
13	9.5500E+05	-60.74
14	9.5240E+05	-60.88
15	9.5140E+05	-60.89
16	9.5920E+05	-60.90
17		
18		
19		
20		

Spectrogram

This section discusses the Spectrogram Results file format. The Spectrogram choice only appears if option EDP is licensed.

The Spectrogram results are the same as a Trace data export, except that instead of having just one trace's data, all 300 traces appear one after the other.

Each trace has its own data mark; the data for Spectrogram Trace 0 follows the row marked DATA, the data for Spectrogram Trace 1 follows the row marked DATA1, for Spectrogram Trace 2 follows the row marked DATA2, and so on.

Each DATA row has a timestamp in the second column (as of firmware revision A.11.01). So, for example, if Trace 0 had a relative start time of 1729.523 sec, then the first DATA row would look like this:

DATA,1729.523

And if Trace 13 had a relative start time of 100.45 sec, then the fourteenth data row would look like:

DATA13,100.453

To find the absolute time for the relative timestamps of each trace, the last row before the first DATA row gives the absolute start time of the Spectrogram, in the form YYYYMMDDHHMMSS

So, for example, if the absolute start time is 13:23:45:678 on January 30, 2012, this row would look like:

Start Time,20120130132345678

NOTE The resolution of the absolute time stored is 1 ms, which matches up with the fact that the fastest sweep time is also 1 ms. However, there is no specification for the absolute accuracy of the clock in the analyzer, nor is there any facility provided to allow the user to set this time to any particular degree of accuracy.

Traces that have not yet been filled in the Spectrogram display are empty; there is no DATA header for them. The file ends after the last non-empty trace.

Imagine that, at the point where a Spectrogram Meas Result is requested, the following screen is showing:



For the purpose of this example, we have set the Average/Hold Number to 10, thus we have only traces 0 thru 10. The Spectrogram was started at 02:28:08:700 pm on April 25, 2012 (that is, 700 ms after 2:28:08 pm), although the screen dump itself shows a different time, as it was taken ten minutes after the

Spectrogram data. Trace 0 is showing a start time of 5.30 seconds, meaning 5.3 seconds after the Spectrogram started (trace 10 has a start time of 0, as it was the first trace taken but has now rolled up into the tenth trace slot).

The Meas Results file, when opened, shows the header data and ten traces of trace data. Below is an extract from the result file for the above display. Note the start time of 20120425142808700 showing in the last row before the first DATA row, and the relative time of 5.299231048 showing in the first DATA row:

Result Type	Spectrogram
MeasResult	
Swept SA	
A.11.00.01	N9020A
503 508 513 526 ALL ALV B1C B1X B25 B2X B40 BAB BBA CR3 CRP DP2 DRD EA3 EDP EMC EP1 ERC ESC ESP EXM FSA HBA K03 LFE MPB P03 P08 P13 P26 PFR RTL RTS S40 SB1 SEC SM1 UK6 YAS YAV	1
Segment	0
Number of Points	1001
Sweep Time	0.523333333
Start Frequency	5999984415
Stop Frequency	6000009415
Average Count	0
Average Type	LogPower(Video)
RBW	240
RBW Filter	Gaussian
RBW Filter BW	3dB
VBW	240
Sweep Type	Swept
X Axis Scale	Lin
PreAmp State	Off
PreAmp Band	Low
Trigger Source	Free
Trigger Level	1.2
Trigger Slope	Positive
Trigger Delay	0
Phase Noise Optimization	Wide
Swept If Gain	Low
FFT If Gain	Autorange
RF Coupling	AC

Result Type	Spectrogram
FFT Width	411900
Ext Ref	10000000
Input	RF
RF Calibrator	Off
Attenuation	14
Ref Level Offset	0
External Gain	0
Trace Type	Clearwrite
Detector	Normal
Trace Math	Off
Trace Math Oper1	Trace5
Trace Math Oper2	Trace6
Trace Math Offset	0
Trace Name	Trace1
X Axis Units	Hz
Y Axis Units	dBm
Start Time	20120425142808700
DATA	5.299231048
5999984415	-76.34749519
5999984440	-77.28097006
5999984465	-75.32317869
5999984490	-73.64417681
5999984515	-72.67154604

o
o
o

6000009315	-77.94423277
6000009340	-79.51829697
6000009365	-78.46108961
6000009390	-78.46108957
6000009415	-76.59570596
DATA2	4.708697055
5999984415	-80.98197882
5999984440	-80.98197879

5999984465	-75.83142132
5999984490	-74.02712079
5999984515	-73.57213005

○
○
○

6000009315	-75.9183103
6000009340	-79.53787488
6000009365	-78.82602191
6000009390	-78.82602188
6000009415	-76.37486709
DATA10	0
5999984415	-75.56751112
5999984440	-75.76485645
5999984465	-76.67718717
5999984490	-78.79238489
5999984515	-83.72680212

○
○
○

6000009315	-71.3942461
6000009340	-72.28308332
6000009365	-73.92684489
6000009390	-75.45548832
6000009415	-75.17904815

Zone Map

Pressing this key selects Zone Map as the data type to be exported.

The Zone Map file contains information about current Zone Map configuration. Its format is compatible with the 89601A OFDMA map file. It is detailed in ["Zone Map File Contents" on page 2268](#) below.

Key Path	Save, Data
Remote Command	:MMEMory:STORe:ZMAP <string>
Example	MMEM:STOR:ZMAP "ZMap_0000.omf"
Notes	<p>If the save is initiated via SCPI and the file already exists, the file will be overwritten.</p> <p>The SCPI command exports Zone Map information to the file specified as the parameter in the current path. The default path is My Documents\WIMAXOFDMA\.</p> <p>Using the C: drive is strongly discouraged, since it runs the risk of being overwritten during an instrument software upgrade.</p> <p>The SCPI parameter is a quoted string that specifies the filename. Both single and double quotes are supported for any filename parameter over SCPI.</p>
Dependencies	You must be in the 802.16 OFDMA (WiMAX/WiBro) mode.
Status Bits/OPC dependencies	Sequential – waits for the previous measurement to complete.
Initial S/W Revision	Prior to A.02.00

Zone Map File Contents

A Zone Map File contains the following information of the Zone Map configuration. See ["Zone Map Data" on page 329](#) for detailed definitions.

- DemodOfdmaMap_AutoDetect
- DemodOfdmaMap_Count
- DemodOfdmaMap_F1_DL_Count
- DemodOfdmaMap_F1_DL_Z1_Active
- DemodOfdmaMap_F1_DL_Z1_AmcType
- DemodOfdmaMap_F1_DL_Z1_B1_Active
- DemodOfdmaMap_F1_DL_Z1_B1_AllocType
- DemodOfdmaMap_F1_DL_Z1_B1_Boost
- DemodOfdmaMap_F1_DL_Z1_B1_BurstType
- DemodOfdmaMap_F1_DL_Z1_B1_ColorIndex
- DemodOfdmaMap_F1_DL_Z1_B1_ModType
- DemodOfdmaMap_F1_DL_Z1_B1_Name
- DemodOfdmaMap_F1_DL_Z1_B1_SubchannelInterval
- DemodOfdmaMap_F1_DL_Z1_B1_SubchannelOffset
- DemodOfdmaMap_F1_DL_Z1_B1_SymbolInterval
- DemodOfdmaMap_F1_DL_Z1_B1_SymbolOffset

- DemodOfdmaMap_F1_DL_Z1_Count
- DemodOfdmaMap_F1_DL_Z1_DedicPilots
- DemodOfdmaMap_F1_DL_Z1_IDCell
- DemodOfdmaMap_F1_DL_Z1_IDCellCouple
- DemodOfdmaMap_F1_DL_Z1_Len
- DemodOfdmaMap_F1_DL_Z1_Locked
- DemodOfdmaMap_F1_DL_Z1_Name
- DemodOfdmaMap_F1_DL_Z1_PrbsID
- DemodOfdmaMap_F1_DL_Z1_StcMatrix
- DemodOfdmaMap_F1_DL_Z1_StcType
- DemodOfdmaMap_F1_DL_Z1_SymOffset
- DemodOfdmaMap_F1_DL_Z1_UseAllSC
- DemodOfdmaMap_F1_DL_Z1_WrapType
- DemodOfdmaMap_F1_DL_Z1_ZoneType
- DemodOfdmaMap_F1_UL_Count
- DemodOfdmaMap_F1_UL_Z1_Active
- DemodOfdmaMap_F1_UL_Z1_AmcType
- DemodOfdmaMap_F1_UL_Z1_B1_Active
- DemodOfdmaMap_F1_UL_Z1_B1_AllocType
- DemodOfdmaMap_F1_UL_Z1_B1_Boost
- DemodOfdmaMap_F1_UL_Z1_B1_BurstType
- DemodOfdmaMap_F1_UL_Z1_B1_ColorIndex
- DemodOfdmaMap_F1_UL_Z1_B1_ModType
- DemodOfdmaMap_F1_UL_Z1_B1_Name
- DemodOfdmaMap_F1_UL_Z1_B1_PilotPattern
- DemodOfdmaMap_F1_UL_Z1_B1_StcMode
- DemodOfdmaMap_F1_UL_Z1_B1_SubchannelInterval
- DemodOfdmaMap_F1_UL_Z1_B1_SubchannelOffset
- DemodOfdmaMap_F1_UL_Z1_B1_SymbolInterval
- DemodOfdmaMap_F1_UL_Z1_B1_SymbolOffset
- DemodOfdmaMap_F1_UL_Z1_Count

- DemodOfdmaMap_F1_UL_Z1_Gap
- DemodOfdmaMap_F1_UL_Z1_IDCell
- DemodOfdmaMap_F1_UL_Z1_Len
- DemodOfdmaMap_F1_UL_Z1_Locked
- DemodOfdmaMap_F1_UL_Z1_Name
- DemodOfdmaMap_F1_UL_Z1_SymOffset
- DemodOfdmaMap_F1_UL_Z1_UseSubchRotate
- DemodOfdmaMap_F1_UL_Z1_WrapType
- DemodOfdmaMap_F1_UL_Z1_ZoneType
- DemodOfdmaMap_Name
- DemodOfdmaMap_RefreshMap

Save As . . .

When you press “Save As”, the analyzer brings up a Windows dialog and a menu entitled “**Save As.**” This menu allows you to navigate to the various fields in the Windows dialog without using a keyboard or mouse. The Tab and Arrow keys can also be used for dialog navigation.

See "[To File . . .](#)" on page 2252 in Save, State for a full description of this dialog and menu.

The default path for saving files is:

For all of the Trace Data Files:

My Documents\`<mode name>`\data\traces

For all of the Limit Data Files:

My Documents\`<mode name>`\data\limits

For all of the Measurement Results Data Files:

My Documents\`<mode name>`\data\`<measurement name>`\results

For all of the Capture Buffer Data Files:

My Documents\`<mode name>`\data\captureBuffer

Key Path	Save, Data
Mode	All
Notes	The key location is mode-dependent and will vary. Brings up the Save As dialog for saving a <code><mode specific></code> Save Type. The save is performed immediately and does not wait until the measurement is complete.
Initial S/W Revision	Prior to A.02.00

Screen Image

Pressing Screen Image accesses a menu of functions that enable you to specify a format and location for the saved screen image. It brings up a menu that allows you to specify the color scheme of the Screen Image (Themes) or navigate to the Save As dialog to perform the actual save.

Screen Image files contain an exact representation of the analyzer display. They cannot be loaded back onto the analyzer, but they can be loaded into your PC for use in many popular applications.

The image to be saved is actually captured when the Save front panel key is pressed, and kept in temporary storage to be used if you ask for a Screen Image save. When the Screen Image key is pressed, a "thumbnail" of the captured image is displayed, as shown below:

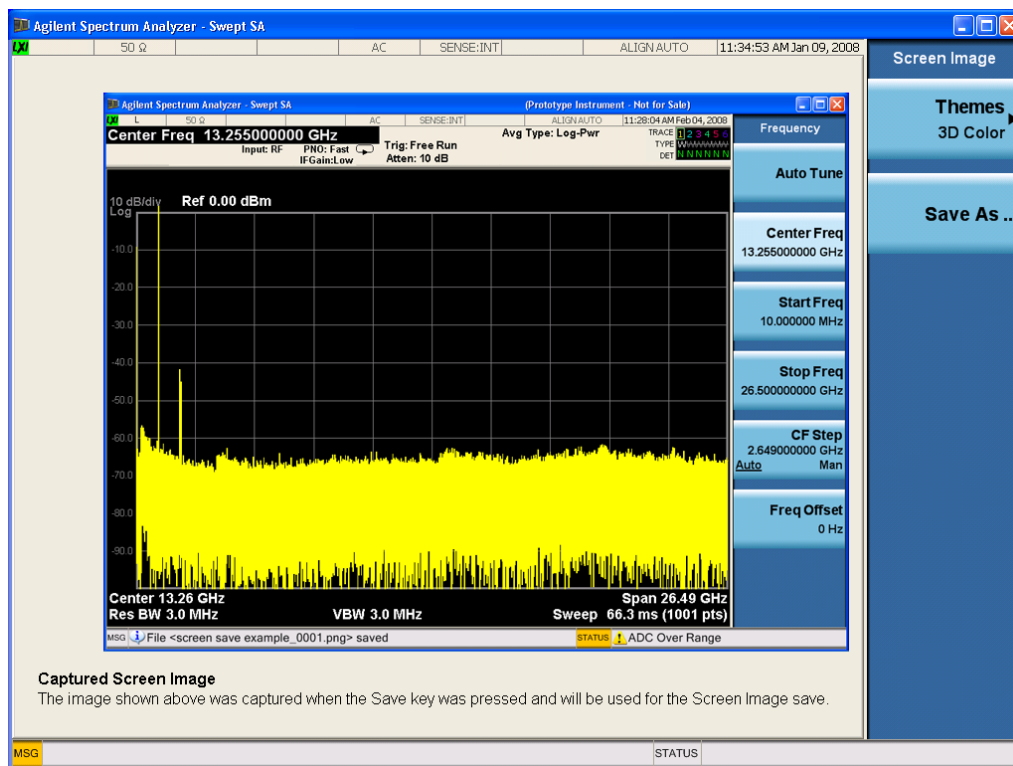

When you continue on into the Save As menu and complete the Screen Image save, the image depicted in the thumbnail is the one that gets saved, showing the menus that were on the screen before going into the Save menus. The save is performed immediately and does not wait until the measurement is complete.

After you have completed the save, the Quick Save front-panel key lets you quickly repeat the last save performed, using an auto-named file, with the current screen data.

NOTE

For versions previous to A.01.55, if you initiate a screen image save by navigating through the Save menus, the image that is saved will contain the Save menu softkeys, not the menus and the active function that were on the screen when you first pressed the Save front panel key.

Key Path	Save
Mode	All

Remote Command	:MMEMory:STORe:SCReen <filename>
Example	:MMEM:STOR:SCR "myScreen.png" This stores the current screen image in the file MyScreenFile.png in the default directory.
Initial S/W Revision	Prior to A.02.00

Themes

Accesses a menu of functions that enable you to choose the theme to be used when saving the screen image.

The **Themes** option is the same as the **Themes** option under the **Display** and **Page Setup** dialogs. It allows you to choose between themes to be used when saving the screen image.

Key Path	Save, Screen Image
Remote Command	:MMEMory:STORe:SCReen:THEMe TDColor TDMonochrome FCOLor FMONochrome :MMEMory:STORe:SCReen:THEMe?
Example	:MMEM:STOR:SCR:THEM TDM
Preset	3D Color; Is not part of Preset, but is reset by Restore Misc Defaults or Restore System Defaults All and survives subsequent running of the modes.
Readback	3D Color 3D Mono Flat Color Flat Mono
Backwards Compatibility Notes	In ESA and PSA we offer the choice of "Reverse Bitmap" or "Reverse Metafile" when saving screen images. This is much like the "Flat Color" theme available in X-Series. Also, if you selected Reverse Bitmap AND a black & white screen image, that would be much like "Flat Monochrome". In other words, each of the X-Series themes has a similar screen image type in ESA/PSA. But they are not identical.
Initial S/W Revision	Prior to A.02.00

3D Color

Selects a standard color theme with each object filled, shaded and colored as designed.

Key Path	Save, Screen Image, Themes
Example	MMEM:STOR:SCR:THEM TDC
Readback	3D Color
Initial S/W Revision	Prior to A.02.00

3D Monochrome

Selects a format that is like 3D color but shades of gray are used instead of colors.

Key Path	Save, Screen Image, Themes
Example	MMEM:STOR:SCR:THEM TDM
Readback	3D Mono
Initial S/W Revision	Prior to A.02.00

Flat Color

Selects a format that is best when the screen is to be printed on an ink printer.

Key Path	Save, Screen Image, Themes
Example	MMEM:STOR:SCR:THEM FCOL
Readback	Flat Color
Initial S/W Revision	Prior to A.02.00

Flat Monochrome

Selects a format that is like Flat Color. But only black is used (no colors, not even gray), and no fill.

Key Path	Save, Screen Image, Themes
Example	MMEM:STOR:SCR:THEM FMON
Readback	Flat Mono
Initial S/W Revision	Prior to A.02.00

Save As...

When you press "Save As", the analyzer brings up a Windows dialog and a menu entitled "**Save As.**" This menu allows you to navigate to the various fields in the Windows dialog without using a keyboard or mouse. The Tab and Arrow keys can also be used for dialog navigation.

See "[To File . . .](#)" on page 2252 in Save, State for a full description of this dialog and menu.

The default path for Screen Images is

My Documents\`<mode name>`\screen.

where `<mode name>` is the parameter used to select the mode with the INST:SEL command (for example, SA for the Spectrum Analyzer).

Key Path	Save, Screen Image
Notes	Brings up Save As dialog for saving a Screen Image Save Type
Initial S/W Revision	Prior to A.02.00

Mass Storage Catalog (Remote Command Only)

Key path	SCPI Only
Remote Command	:MMEMory:CATalog? [<directory_name>]
Notes	<p>The string must be a valid logical path.</p> <p>Queries disk usage information (drive capacity, free space available) and obtains a list of files and directories in a specified directory in the following format: <numeric_value>,<numeric_value>,{<file_entry>}</p> <p>It returns two numeric parameters and as many strings as there are files and directories. The first parameter indicates the total amount of storage currently used in bytes. The second parameter indicates the total amount of storage available, also in bytes. The <file_entry> is a string. Each <file_entry> indicates the name, type, and size of one file in the directory list: <file_name>,<file_type>,<file_size></p> <p>As the windows file system has an extension that indicates file type, <file_type> is always empty. <file_size> provides the size of the file in bytes. For directories, <file_entry> is surrounded by square brackets and both <file_type> and <file_size> are empty</p>
Initial S/W Revision	Prior to A.02.00

Mass Storage Change Directory (Remote Command Only)

Key path	SCPI Only
Remote Command	:MMEMory:CDIRectory [<directory_name>] :MMEMory:CDIRectory?
Notes	<p>The string must be a valid logical path.</p> <p>Changes the default directory for a mass memory file system. The <directory_name> parameter is a string. If no parameter is specified, the directory is set to the *RST value.</p> <p>At *RST, this value is set to the default user data storage area, that is defined as System.Environment.SpecialFolder.Personal.</p> <p>Query returns full path of the default directory.</p>
Initial S/W Revision	Prior to A.02.00

Mass Storage Copy (Remote Command Only)

Key path	SCPI Only
Remote Command	:MMEMory:COPY <string>,<string>[,<string>,<string>]
Notes	<p>The string must be a valid logical path.</p> <p>Copies an existing file to a new file or an existing directory to a new directory.</p> <p>Two forms of parameters are allowed. The first form has two parameters. In this form, the first parameter specifies the source, and the second parameter specifies the destination.</p> <p>The second form has four parameters. In this form, the first and third parameters specify the source. The second and fourth parameters specify the directories. The first pair of parameters specifies the</p>

source. The second pair specifies the destination. An error is generated if the source doesn't exist or the destination file already exists.

This command will generate an "access denied" error if the destination is a restricted folder (e.g., C:\Windows) and the current user does not have Power User or Administrator privileges.

Mass Storage Device Copy (Remote Command Only)

This command transfers data to/from a file and a peripheral device.

Key path	SCPI Only
Remote Command	:MMEMory:COpy:DEvice <source_string>,<dest_string>
Notes	<p>The strings must be a valid logical path or a valid device keyword. If the dest_string is a device keyword, the data is copied from the source file to the device. If the source_string is a device keyword, the data is copied to the source file from the device.</p> <p>Valid device keywords are:</p> <p>SNS (smart noise source)</p> <p>An error is generated if the file or device is not found.</p>

Mass Storage Delete (Remote Command Only)

Key path	SCPI Only
Remote Command	:MMEMory:DElete <file_name>[,<directory_name>]
Notes	<p>The string must be a valid logical path.</p> <p>Removes a file from the specified directory. The <file_name> parameter specifies the file name to be removed. This command will generate an "access denied" error if the file is in a restricted folder (e.g., C:\Windows) and the current user does not have Power User or Administrator privileges.</p>
Initial S/W Revision	Prior to A.02.00

Mass Storage Data (Remote Command Only)

Creates a file containing the specified data OR queries the data from an existing file.

Key path	SCPI Only
Remote Command	<p>:MMEMory:DATA <file_name>,<data></p> <p>:MMEMory:DATA? <file_name></p>
Notes	<p>The string must be a valid logical path.</p> <p>The command form is MMEMory:DATA <file_name>,<data>. It loads <data> into the file <file_name>. <data> is in 488.2 block format. <file_name> is string data.</p> <p>The query form is MMEMory:DATA? <file_name> with the response being the associated <data> in block format.</p>
Initial S/W Revision	Prior to A.02.00

Mass Storage Make Directory (Remote Command Only)

Key path	SCPI Only
Remote Command	:MMEMory:MDIRectory <directory_name>
Notes	<p>The string must be a valid logical path.</p> <p>Creates a new directory. The <directory_name> parameter specifies the name to be created.</p> <p>This command will generate an “access denied” error if the new directory would be in a restricted folder (e.g., C:\Windows) and the current user does not have Power User or Administrator privileges.</p>
Initial S/W Revision	Prior to A.02.00

Mass Storage Move (Remote Command Only)

Key path	SCPI Only
Remote Command	:MMEMory:MOVE <string>,<string>[,<string>,<string>]
Notes	<p>The string must be a valid logical path.</p> <p>Moves an existing file to a new file or an existing directory to a new directory.</p> <p>Two forms of parameters are allowed. The first form has two parameters. In this form, the first parameter specifies the source, and the second parameter specifies the destination.</p> <p>The second form has four parameters. In this form, the first and third parameters specify the source. The second and fourth parameters specify the directories. The first pair of parameters specifies the source. The second pair specifies the destination. An error is generated if the source doesn't exist or the destination file already exists.</p> <p>This command will generate an “access denied” error if the destination is a restricted folder (e.g., C:\Windows) and the current user does not have Power User or Administrator privileges.</p>
Initial S/W Revision	Prior to A.02.00

Mass Storage Remove Directory (Remote Command Only)

Key path	SCPI Only
Remote Command	:MMEMory:RDIRectory <directory_name>
Notes	<p>The string must be a valid logical path.</p> <p>Removes a directory. The <directory_name> parameter specifies the directory name to be removed. All files and directories under the specified directory shall also be removed.</p> <p>This command will generate an “access denied” error if the folder is a restricted folder (e.g., C:\Windows) or is in a restricted folder and the current user does not have Power User or Administrator privileges.</p>
Initial S/W Revision	Prior to A.02.00

Single (Single Measurement/Sweep)

Sets the analyzer for Single measurement operation. The single/continuous state is Meas Global, so the setting will affect all the measurements. If you are Paused, pressing Single does a Resume.

See "[More Information](#)" on page 2277

Key Path	Front-panel key
Example	:INIT:CONT OFF
Notes	See Cont key description.
Backwards Compatibility Notes	<p>For Spectrum Analysis mode in ESA and PSA, the Single hardkey and the INITiate:IMM switched from continuous measurement to single measurement and restarted sweeps and averages (displayed average count reset to 1), but did not restart Max Hold and Min Hold. In the X-Series, the Single hardkey and the INITiate:IMM command initiate a sweep/ measurement/ average sequence/hold sequence including MaxHold and MinHold.</p> <p>For Spectrum Analysis mode in ESA and PSA, the Single hardkey restarted the sweep regardless of whether or not you were in an active sweep or sweep sequence. In the X-Series, Restart does this but Single only restarts the sweep or sweep sequence if you are in the idle state.</p> <p>INIT[:IMM] in ESA & PSA Spectrum Analysis Mode does an implied ABORT. In some other PSA Modes, INIT[:IMM] is ignored if not in the idle state. . The X-Series follows the ESA/PSA SA Mode model, which may cause some Modes to have compatibility problems.</p>
Initial S/W Revision	Prior to A.02.00

More Information

See "[Restart](#)" on page 2249 for details on the INIT:IMMEDIATE (Restart) function.

If you are already in single sweep, the INIT:CONT OFF command has no effect.

If you are already in Single Sweep, then pressing the Single key in the middle of a sweep does not restart the sweep or sequence. Similarly, pressing the Single key does not restart the sweep or sequence if the sweep is not in the idle state (for example, if you are taking a very slow sweep, or the analyzer is waiting for a trigger). Instead, it results in a message. "Already in Single, press Restart to initiate a new sweep or sequence". Even though pressing the Single key in the middle of a sweep does not restart the sweep, sending INIT:IMMEDIATE does reset it.

To take one more sweep without resetting the average count, increment the average count by 1, by pressing the step up key while **Average/Hold Number** is the active function, or sending the remote command CALC:AVER:TCON UP.

Source

There is no Source control functionality for this measurement. When this key is pressed, the screen either displays a blank menu, or the previously-selected menu remains unchanged.

Key Path	Front-panel key
----------	-----------------

Span X Scale

Accesses a menu of functions that enable you to set the horizontal scale parameters.

Key Path	Front-panel key
Initial S/W Revision	Prior to A.02.00

Ref Value

Sets the reference value for time on the horizontal axis. When Auto Scaling is set to On, the displayed plots use a Scale/Div value determined by the analyzer, based on the measurement result.

Key Path	SPAN X Scale
Mode	BASIC, PNOISE, WCDMA, C2K, GSM, WIMAXOFDMA, TDSCDMA, 1XEVD0, DVB, DTMB, ISDBT, CMMB, LTE, LTETDD, DCATV, WLAN, MSR,LTEATDD, LTEAFDD
Remote Command	:DISPlay:WAVeform:VIEW[1] 2:WINDow[1]:TRACe:X[:SCALe]:RLEVel <time> :DISPlay:WAVeform:VIEW[1] 2:WINDow[1]:TRACe:X[:SCALe]:RLEVel?
Example	DISP:WAV:VIEW:WIND:TRAC:X:RLEV 10 ms DISP:WAV:VIEW:WIND:TRAC:X:RLEV?
Notes	You must be in a mode that includes the Waveform measurement to use this command. Use INSTRument:SElect to set the mode.
Couplings	If Auto Scaling is set to On, this value is automatically determined by the measurement result. When you set this value manually, Auto Scaling automatically changes to Off.
Preset	0.00 s
State Saved	Saved in instrument state.
Min	-1.000 s
Max	10.00 s
Initial S/W Revision	Prior to A.02.00
Modified at S/W Revision	A.03.00

Scale/Div

Sets the horizontal scale by changing a time value per division.

Key Path	SPAN X Scale
Mode	BASIC, PNOISE, WCDMA, C2K, GSM, WIMAXOFDMA, TDSCDMA, 1XEVD0, DVB, DTMB, ISDBT, CMMB, LTE, LTETDD, DCATV, WLAN, MSR,LTEATDD, LTEAFDD
Remote Command	:DISPlay:WAVeform:VIEW[1] 2:WINDow[1]:TRACe:X[:SCALe]:PDIVision <time> :DISPlay:WAVeform:VIEW[1] 2:WINDow[1]:TRACe:X[:SCALe]:PDIVision?
Example	DISP:WAV:VIEW:WIND:TRAC:X:PDIV 500 us DISP:WAV:VIEW:WIND:TRAC:X:PDIV?

Notes	You must be in a mode that includes the Waveform measurement to use this command. Use INSTRument:SElect to set the mode.
Couplings	If Auto Scaling is set to On, this value is automatically determined by the measurement result. When you set this value manually, Auto Scaling automatically changes to Off.
Preset	All except the following list: 200.0 us LTEAFDD, LTEATDD: 1.000 ms LTETDD: 1.000 ms
State Saved	Saved in instrument state.
Min	1.000 ns
Max	320 s
Initial S/W Revision	Prior to A.02.00
Modified at S/W Revision	A.03.00, A.14.00

Ref Position

Sets the reference position for the X axis to Left, Center or Right.

Key Path	SPAN X Scale
Mode	BASIC, PNOISE, WCDMA, C2K, GSM, WIMAXOFDMA, TDSCDMA, 1XEVD0, DVB, DTMB, ISDBT, CMMB, LTE, LTETDD, DCATV, WLAN, MSR,LTEATDD, LTEAFDD
Remote Command	:DISPlay:WAVeform:VIEW[1] 2:WINDow[1]:TRACe:X[:SCALE]:RPOSition LEFT CENTER RIGHT :DISPlay:WAVeform:VIEW[1] 2:WINDow[1]:TRACe:X[:SCALE]:RPOSition?
Example	DISP:WAV:VIEW:WIND:TRAC:X:RPOS LEFT DISP:WAV:VIEW:WIND:TRAC:X:RPOS?
Notes	Allows you to set the reference position to Left, Ctr (center) or Right. You must be in a mode that includes the Waveform measurement to use this command. Use INSTRument:SElect to set the mode.
Preset	LEFT
State Saved	Saved in instrument state.
Range	Left Ctr Right
Initial S/W Revision	Prior to A.02.00
Modified at S/W Revision	A.03.00

Auto Scaling

Toggles the scale coupling function between On and Off.

Key Path	SPAN X Scale
Mode	BASIC, PNOISE, WCDMA, C2K, GSM, WIMAXOFDMA, TDSCDMA, 1XEVD0, DVB, DTMB, ISDBT, CMMB, LTE, LTE_TDD, DCATV, WLAN, MSR, LTE_TDD, LTEAFDD
Remote Command	:DISPlay:WAVeform:VIEW[1] 2:WINDow[1]:TRACe:X[:SCALe]:COUPle 0 1 OFF ON :DISPlay:WAVeform:VIEW[1] 2:WINDow[1]:TRACe:X[:SCALe]:COUPle?
Example	DISP:WAV:VIEW:WIND:TRAC:X:COUP ON DISP:WAV:VIEW:WIND:TRAC:X:COUP?
Notes	You must be in a mode that includes the Waveform measurement to use this command. Use INSTRument:SElect to set the mode.
Couplings	When Auto Scaling is On and the Restart front-panel key is pressed, this function automatically determines the scale per division and reference values based on the measurement results. When you set a value to either Scale/Div or Ref Value manually, Auto Scaling automatically changes to Off.
Preset	1
State Saved	Saved in instrument state.
Range	On Off
Initial S/W Revision	Prior to A.02.00
Modified at S/W Revision	A.03.00

Sweep/Control

Accesses a menu that enables you to configure the Sweep and Control functions of the analyzer, such as Sweep Time and Gating.

Key Path	Front-panel key
Initial S/W Revision	Prior to A.02.00

Pause/Resume

Pauses a measurement after the current data acquisition is complete.

When Paused, the label on the key changes to Resume. Pressing Resume un-pauses the measurement. When you are Paused, pressing Restart, Single or Cont does a Resume.

Key Path	Sweep/Control
Remote Command	:INITiate:PAUSE
Dependencies	Grayed out in Measurements that do not support Pausing. Blanked in Modes that do not support Pausing.
Initial S/W Revision	Prior to A.02.00

Key Path	Sweep/Control
Remote Command	:INITiate:RESume
Dependencies	Grayed out in Measurements that do not support Pausing. Blanked in Modes that do not support Pausing.
Initial S/W Revision	Prior to A.02.00

Abort (Remote Command Only)

This command is used to stop the current measurement. It aborts the current measurement as quickly as possible, resets the sweep and trigger systems, and puts the measurement into an "idle" state. If the analyzer is in the process of aligning when ABORT is sent, the alignment finishes before the abort function is performed. So ABORT does not abort an alignment.

If the analyzer is set for Continuous measurement, it sets up the measurement and initiates a new data measurement sequence with a new data acquisition (sweep) taken once the trigger condition is met.

If the analyzer is set for Single measurement, it remains in the "idle" state until an :INIT:IMM command is received.

Remote Command	:ABORT
Example	:ABOR

Notes	<p>If :INITiate:CONTinuous is ON, then a new continuous measurement will start immediately; with sweep (data acquisition) occurring once the trigger condition has been met.</p> <p>If :INITiate:CONTinuous is OFF, then :INITiate:IMMediate is used to start a single measurement; with sweep (data acquisition) occurring once the trigger condition has been met.</p>
Dependencies	<p>For continuous measurement, ABORt is equivalent to the Restart key.</p> <p>Not all measurements support the abort command.</p>
Status Bits/OPC dependencies	<p>The STATus:OPERation register bits 0 through 8 are cleared.</p> <p>The STATus:QUEStionable register bit 9 (INTEgrity sum) is cleared.</p> <p>Since all the bits that feed into OPC are cleared by the ABORt, the ABORt will cause the *OPC query to return true.</p>
Initial S/W Revision	<p>Prior to A.02.00</p>

System

See ["System" on page 342](#)

Trace/Detector

There is no Trace/Detector functionality supported in the Waveform measurement. The front-panel key displays a blank menu when pressed.

Key Path	Front-panel key
Initial S/W Revision	Prior to A.02.00

Trigger

See ["Trigger" on page 412](#)

Free Run

See ["Free Run " on page 419](#)

Video

See ["Video \(IF Envelope\) " on page 420](#)

Trigger Level

See ["Trigger Level " on page 420](#)

Trig Slope

See ["Trig Slope " on page 421](#)

Trig Delay

See ["Trig Delay " on page 422](#)

Line

See ["Line " on page 2087](#)

Trig Slope

See ["Trig Slope " on page 2087](#)

Trig Delay

See ["Trig Delay " on page 424](#)

External 1

See ["External 1 " on page 2099](#)

Trigger Level

See ["Trigger Level " on page 2099](#)

Trig Slope

See ["Trig Slope " on page 2100](#)

Trig Delay

See ["Trig Delay " on page 427](#)

External 2

See ["External 2 " on page 2101](#)

Trigger Level

See ["Trigger Level "](#) on page 2101

Trig Slope

See ["Trig Slope "](#) on page 2102

Trig Delay

See ["Trig Delay "](#) on page 429

RF Burst

See ["RF Burst "](#) on page 2102

Absolute Trigger

See ["Absolute Trigger Level"](#) on page 2103

Relative Trigger

See ["Relative Trigger Level"](#) on page 2092

Trig Slope

See ["Trigger Slope "](#) on page 2104

Trig Delay

See ["Trig Delay "](#) on page 433

Periodic Timer

See ["Periodic Timer \(Frame Trigger\) "](#) on page 2094

Period

See ["Period "](#) on page 2095

Offset

See ["Offset "](#) on page 2096

Offset Adjust (Remote Command Only)

See ["Offset Adjust \(Remote Command Only\)"](#) on page 2097

Reset Offset Display

See ["Reset Offset Display "](#) on page 2098

Sync Source

See ["Sync Source "](#) on page 2098

Off

See ["Off "](#) on page 2099

External 1

See ["External 1 "](#) on page 2099

Trigger Level

See ["Trigger Level "](#) on page 2099

Trig Slope

See ["Trig Slope "](#) on page 2100

External 2

See ["External 2 "](#) on page 2101

Trigger Level

See ["Trigger Level "](#) on page 2101

Trig Slope

See ["Trig Slope "](#) on page 2102

RF Burst

See ["RF Burst "](#) on page 2102

Absolute Trigger

See ["Absolute Trigger Level"](#) on page 2103

Trig Slope

See ["Trigger Slope "](#) on page 2104

Trig Delay

See ["Trig Delay"](#) on page 443

Auto/Holdoff

See ["Auto/Holdoff "](#) on page 444

Auto Trig

See ["Auto Trig "](#) on page 444

Trig Holdoff

See ["Trig Holdoff "](#) on page 445

Baseband I/Q

See [__](#) on page X

I/Q Mag

See ___ on page X

Trigger Level

See ___ on page X

Trig Slope

See ___ on page X

Trig Delay

See ___ on page X

I

See ___ on page X

Trigger Level

See ___ on page X

Trig Slope

See ___ on page X

Trig Delay

See ___ on page X

Q

See ___ on page X

Trigger Level

See ___ on page X

Trig Slope

See ___ on page X

Trig Delay

See ___ on page X

Input I

See ___ on page X

Trigger Level

See ___ on page X

Trig Slope

See ___ on page X

Trig Delay

See ___ on page X

Input Q

See ___ on page X

Trigger Level

See ___ on page X

Trig Slope

See ___ on page X

Trig Delay

See ___ on page X

Aux Channel Center Freq

See ___ on page X

Trigger Level

See ___ on page X

Trig Slope

See ___ on page X

Trig Delay

See ___ on page X

Trigger Center Freq

See ___ on page X

Trigger BW

See ___ on page X

User Preset

Accesses a menu that gives you the following three choices:

- User Preset – recalls a state previously saved using the Save User Preset function.
- User Preset All Modes – presets all of the modes in the analyzer
- Save User Preset– saves the current state for the current mode

Key Path	Front-panel key
Backwards Compatibility Notes	<p>User Preset is actually loading a state, and in legacy analyzers, it was possible to load a state without affecting the trace data, limit lines or correction data. Similarly it was possible to do a User Preset without affecting the trace data, limit lines or correction data.</p> <p>In the X-Series, “state” always includes all of this data; so whenever state is loaded, or User Preset is executed, all of the traces, limit lines and corrections are affected. Although this differs from previous behavior, it is desirable behavior, and should not cause adverse issues for users.</p> <p>On ESA and PSA, User Preset affected the entire instrument’s state. In the X-Series, User Preset only recalls the state for the active mode. There is a User Preset file for each mode. User Preset can never cause a mode switch as it can in legacy analyzers. If you want to recall all modes to their user preset file state, you will need to do a User Preset after mode switching into each mode.</p> <p>User Preset recalls mode state which can now include data like traces; whereas on ESA and PSA, User Preset did not affect data.</p>
Initial S/W Revision	Prior to A.02.00

User Preset

User Preset sets the state of the currently active mode back to the state that was previously saved for this mode using the Save User Preset menu key or the SCPI command, SYST:PRES:USER:SAV. It not only recalls the Mode Preset settings, but it also recalls all of the mode persistent settings, and the Input/Output system setting that existed at the time Save User Preset was executed.

If a Save User Preset has not been done at any time, User Preset recalls the default user preset file for the currently active mode. The default user preset files are created if, at power-on, a mode detects there is no user preset file. There will never be a scenario when there is no user preset file to restore. For each mode, the default user preset state is the same state that would be saved if a Save User Preset is performed in each mode right after doing a Restore Mode Default and after a Restore Input/Output Defaults.

The User Preset function does the following:

- Aborts the currently running measurement.
- Sets the mode State to the values defined by Save User Preset.
- Makes the saved measurement for the currently running mode the active measurement.
- Brings up the saved menu for the power-on mode.
- Clears the input and output buffers.
- Sets the Status Byte to 0.

Key Path	User Preset
Remote Command	:SYSTem:PRESet:USER
Example	:SYST:PRES:USER:SAVE:SYST:PRES:USER
Notes	:SYST:PRES:USER:SAVE is used to save the current state as the user preset state. Clears all pending OPC bits. The Status Byte is set to 0. Pressing the User Preset front-panel key while already in the User Preset menu will cause the User Preset to get executed
Couplings	A user preset will cause the currently running measurement to be aborted and cause the saved measurement to be active. Recalling a User Preset file has the same issues that recalling a Save State file has. Some settings may need to be limited and therefore re-coupled, since the capabilities of the mode may have changes when the User Preset file was last saved.
Initial S/W Revision	Prior to A.02.00

User Preset All Modes

Recalls all of the User Preset files for each mode, switches to the power-on mode, and activates the saved measurement from the power-on mode User Preset file.

NOTE

When the instrument is secured, all of the user preset files are converted back to their default user preset files.

The User Preset function does the following:

- Aborts the currently running measurement.
- Switches the Mode to the power-on mode.
- Restores the User Preset files for each mode.
- Makes the saved measurement for the power-on mode the active measurement.
- Brings up the saved menu for the power-on mode.
- Clears the input and output buffers.
- Sets the Status Byte to 0.

Key Path	User Preset
Remote Command	:SYSTem:PRESet:USER:ALL
Example	:SYST:PRES:USER:SAVE:SYST:PRES:USER:ALL
Notes	Clears all pending OPC bits. The Status Byte is set to 0. :SYST:PRES:USER:SAVE is used to save the current state as the user preset state.
Couplings	A user preset will cause the currently running measurement to be aborted, cause a mode switch to the power-on mode, and cause the saved measurement to be active in the power-on mode. Recalling a User Preset file has the same issues that recalling a Save State file has. Some settings may need to be limited and therefore re-coupled, since the capabilities of the mode may have changes when the User Preset file was last saved.
Initial S/W Revision	Prior to A.02.00

Save User Preset

Saves the currently active mode and its State. You can recall this User Preset file by pressing the User Preset menu key or sending the SYST:PRES:USER remote command. This same state is also saved by the Save State function.

Key Path	User Preset
Remote Command	:SYSTem:PRESet:USER:SAVE
Example	:SYST:PRES:USER:SAVE
Notes	:SYST:PRES:SAVE creates the same file as if the user requested a *SAV or a MMEM:STOR:STAT, except User Preset Save does not allow the user to specify the filename or the location of the file.
Initial S/W Revision	Prior to A.02.00

View/Display

Accesses a menu of functions that enable you to set up and control the display parameters for the current measurement.

This topic contains the following sections:

["View Selection by name \(Remote Command Only\)" on page 2294](#)

["View Selection by number \(Remote Command Only\)" on page 2294](#)

View Selection by name (Remote Command Only)

Selects the results view.

Key Path	View/Display
Mode	BASIC, PNOISE, WCDMA, C2K, GSM, WIMAXOFDMA, TDSCDMA, 1XEVD0, DVB, DTMB, ISDBT, CMMB, LTE, LTETDD, DCATV, WLAN, MSR,LTEATDD, LTEAFDD
Remote Command	:DISPlay:WAVeform:VIEW[:SElect] RFENvelope IQ :DISPlay:WAVeform:VIEW[:SElect]?
Example	DISP:WAV:VIEW RFEN DISP:WAV:VIEW?
Notes	You must be in a mode that includes the Waveform measurement to use this command. Use INSTRument:SElect to set the mode.
Preset	RFENvelope
State Saved	Saved in instrument state.
Range	RF Envelope Q Waveform
Initial S/W Revision	Prior to A.02.00
Modified at S/W Revision	A.03.00

View Selection by number (Remote Command Only)

Displays the numeric values of the measurement results.

Mode	BASIC, PNOISE, WCDMA, C2K, GSM, WIMAXOFDMA, TDSCDMA, 1XEVD0, DVB, DTMB, ISDBT, CMMB, LTE, LTETDD, DCATV, WLAN, MSR,LTEATDD, LTEAFDD
Remote Command	:DISPlay:WAVeform:VIEW:NSElect <integer> :DISPlay:WAVeform:VIEW:NSElect?
Example	DISP:WAV:VIEW:NSEL 1 DISP:WAV:VIEW:NSEL?
Notes	You must be in a mode that includes the Waveform measurement to use this command. Use INSTRument:SElect to set the mode.
Preset	1
State Saved	Saved in instrument state.

Min	1
Max	2
Initial S/W Revision	Prior to A.02.00
Modified at S/W Revision	A.03.00

Key Path	Front-panel key
Initial S/W Revision	Prior to A.02.00

Display

The Display menu is common to most measurements, and is used for configuring items on the display. Some Display menu settings apply to all the measurements in a mode, and some only to the current measurement. Those under the System Display Settings key apply to all measurements in all modes.

Key Path	Display
Key Path	View/Display
Initial S/W Revision	Prior to A.02.00

Annotation

Turns on and off various parts of the display annotation. The annotation is divided up into four categories:

1. Meas Bar: This is the measurement bar at the top of the screen. It does not include the settings panel or the Active Function. Turning off the Meas Bar turns off the settings panel and the Active Function. When the Meas Bar is off, the graticule area expands to fill the area formerly occupied by the Meas Bar.
2. Screen Annotation: this is the annotation and annunciation around the graticule, including any annotation on lines (such as the display line, the threshold line, etc.) This does NOT include the marker number or the N dB result. When off, the graticule expands to fill the entire graticule area.
3. Trace annotation: these are the labels on the traces, showing their detector (or their math mode).
4. Active Function annotation: this is the active function display in the meas bar, and all of the active function values displayed on softkeys.

See the figure below. Each type of annotation can be turned on and off individually.

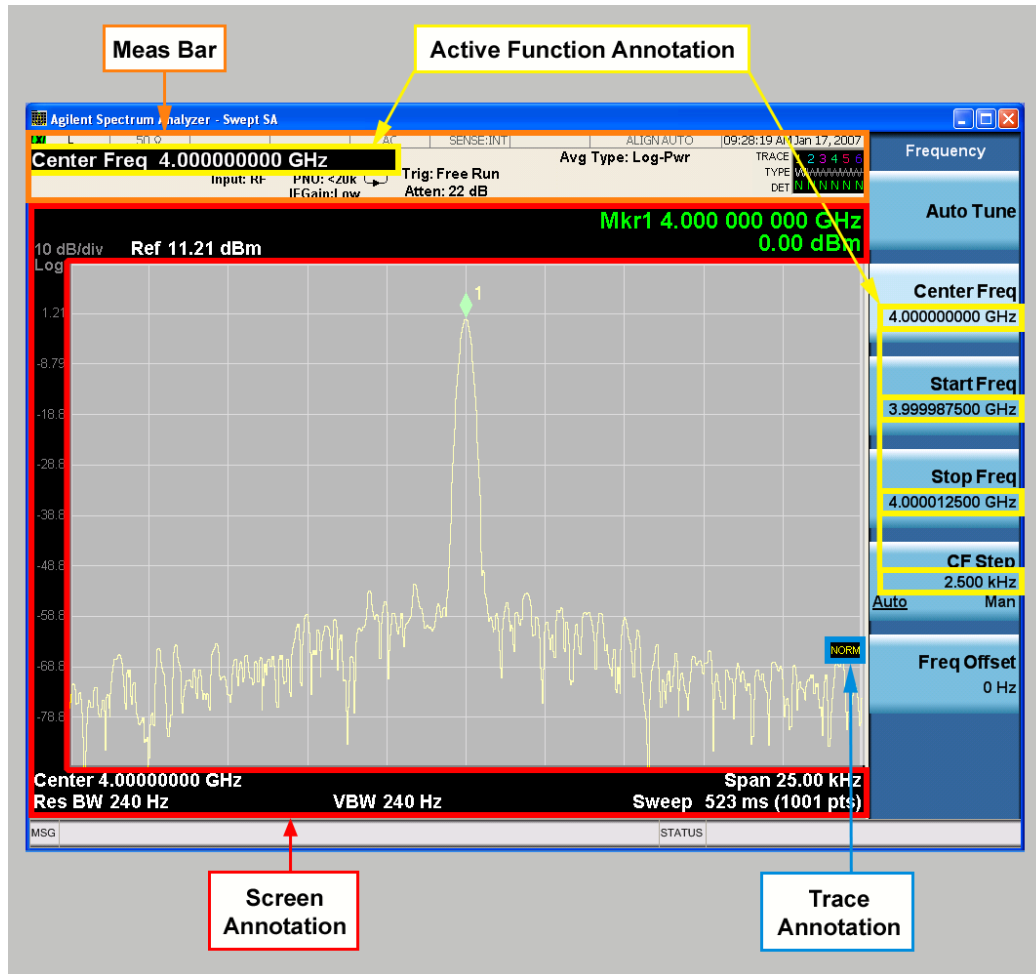

Key Path	View/Display, Display
Initial S/W Revision	Prior to A.02.00

Meas Bar On/Off

This function turns the Measurement Bar on and off, including the settings panel. When off, the graticule area expands to fill the area formerly occupied by the Measurement Bar.

Key Path	View/Display, Display, Annotation
Remote Command	:DISPlay:ANNOtation:MBAR[:STATe] OFF ON 0 1 :DISPlay:ANNOtation:MBAR[:STATe]?
Example	DISP:ANN:MBAR OFF
Dependencies	Grayed out and forced to OFF when System Display Settings, Annotation is set to Off.
Preset	On This should remain Off through a Preset when System DisplaySettings, Annotation is set to Off.
State Saved	Saved in instrument state.
Initial S/W Revision	Prior to A.02.00

Screen

This controls the display of the annunciation and annotation around the graticule, including any annotation on lines (such as the display line, the threshold line, etc.) and the y-axis annotation. This does NOT include marker annotation (or the N dB result). When off, the graticule expands to fill the entire graticule area, leaving only the 1.5% gap above the graticule as described in the Trace/Detector chapter.

Key Path	View/Display, Display, Annotation
Remote Command	:DISPlay:ANNotation:SCReen[:STATe] OFF ON 0 1 :DISPlay:ANNotation:SCReen[:STATe]?
Example	DISP:ANN:SCR OFF
Dependencies	Grayed-out and forced to OFF when System Display Settings, Annotation is set to Off.
Preset	On This should remain Off through a Preset when System DisplaySettings, Annotation is set to Off
State Saved	Saved in instrument state.
Initial S/W Revision	Prior to A.02.00

Active Function Values On/Off

Turns on and off the active function display in the Meas Bar, and all of the active function values displayed on the softkeys.

Note that all of the softkeys that have active functions have these numeric values blanked when this function is on. This is a security feature..

17 Waveform Measurement
View/Display

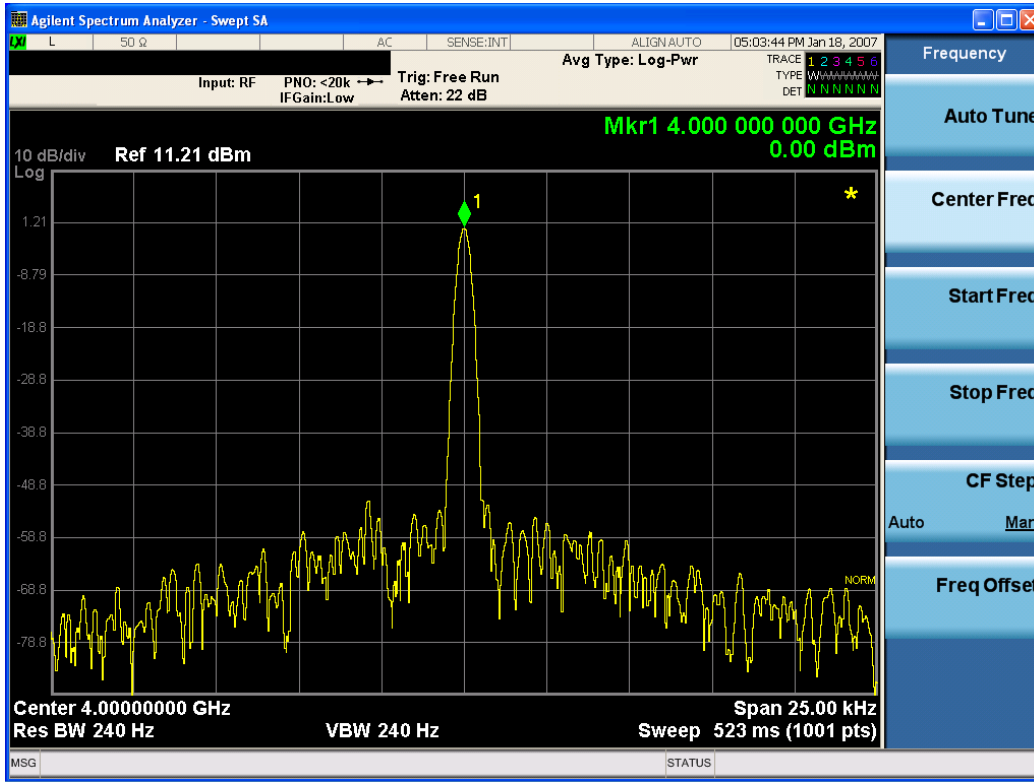

Key Path	View/Display, Display, Annotation
Remote Command	:DISPlay:ACTivefunc[:STATE] ON OFF 1 0 :DISPlay:ACTivefunc[:STATE] ?
Example	DISP:ACT OFF
Dependencies	Grayed out and forced to OFF when System Display Settings, Annotation is set to Off.
Preset	On This should remain Off through a Preset when System DisplaySettings, Annotation is set to Off
State Saved	Saved in instrument state.
Initial S/W Revision	Prior to A.02.00

Title

Displays menu keys that enable you to change or clear a title on your display.

Key Path	View/Display, Display
Initial S/W Revision	Prior to A.02.00

Change Title

Writes a title into the "measurement name" field in the banner, for example, "Swept SA".

Press Change Title to enter a new title through the alpha editor. Press Enter or Return to complete the entry. Press ESC to cancel the entry and preserve your existing title.

The display title will replace the measurement name. It remains for this measurement until you press Change Title again, or you recall a state, or a Preset is performed. A title can also be cleared by pressing Title, Clear Title.

NOTE

Notice the inclusion of the <measurement> parameter in the command below. Because each measurement remembers the Display Title, the command must be qualified with the measurement name. For the Swept SA measurement this is not the case; no <measurement> parameter is used when changing the Display Title for the Swept SA measurement.

Key Path	View/Display, Display, Title
Mode	All
Remote Command	:DISPlay:<measurement>:ANNotation:TITLe:DATA <string> :DISPlay:<measurement>:ANNotation:TITLe:DATA?
Example	DISP:ANN:TITL:DATA "This Is My Title" This example is for the Swept SA measurement in the Spectrum Analyzer mode. The SANalyzer <measurement> name is not used. DISP:ACP:ANN:TITL:DATA "This Is My Title" This example is for Measurements other than Swept SA. Both set the title to: This Is My Title
Notes	Pressing this key cancels any active function. When a title is edited the previous title remains intact (it is not cleared) and the cursor goes at the end so that characters can be added or BKSP can be used to go back over previous characters.
Preset	No title (measurement name instead)
State Saved	Saved in instrument state.
Initial S/W Revision	Prior to A.02.00

Clear Title

Clears a title from the front-panel display. Once cleared, the title cannot be retrieved. After the title is cleared, the current Measurement Name replaces it in the title bar.

Key Path	View/Display, Display, Title
Example	The following commands clear the title and restore the measurement's original title: DISP:ANN:TITL:DATA "" This example is for the Swept SA measurement in the Spectrum Analyzer mode. The SANalyzer <measurement> name is not used. DISP:ACP:ANN:TITL:DATA "" This example is for ACP; in measurements other than Swept SA the measurement name is required.
Notes	Uses the :DISPlay:<measurement>:ANNotation:TITLe:DATA <string> command with an empty string (in the Swept SA, the <measurement> is omitted).
Preset	Performed on Preset.
Initial S/W Revision	Prior to A.02.00

Graticule

Pressing Graticule turns the display graticule On or Off. It also turns the graticule y-axis annotation on and off.

Key Path	View/Display, Display
Remote Command	:DISPlay:WINDow[1]:TRACe:GRATicule:GRID[:STATe] OFF ON 0 1 :DISPlay:WINDow[1]:TRACe:GRATicule:GRID[:STATe]?
Example	DISP:WIND:TRAC:GRAT:GRID OFF
Notes	The graticule is the set of horizontal and vertical lines that make up the grid/divisions for the x-axis and y-axis.
Preset	On
State Saved	Saved in instrument state
Initial S/W Revision	Prior to A.02.00

System Display Settings

These settings are "Mode Global" – they affect all modes and measurements and are reset only by Restore Misc Defaults or Restore System Defaults under System.

Key Path	View/Display, Display
Initial S/W Revision	Prior to A.02.00

Annotation Local Settings

This is a Mode Global override of the meas local annotation settings. When it is All Off, it forces ScreenAnnotation, Meas Bar, Trace, and Active Function Values settings to be OFF for all measurements in all modes. This provides the security based "annotation off" function of previous analyzers; hence it uses the legacy SCPI command.

When it is All Off, the Screen, Meas Bar, Trace, and Active Function Values keys under the Display, Annotation menu are grayed out and forced to Off. When Local Settings is selected, you are able to set the local annotation settings on a measurement by measurement basis.

Key Path	View/Display, Display, System Display Settings
Remote Command	:DISPlay:WINDow[1]:ANNOtation[:ALL] OFF ON 0 1 :DISPlay:WINDow[1]:ANNOtation[:ALL]?
Example	:DISP:WIND:ANN OFF
Preset	On (Set by Restore Misc Defaults)
State Saved	Not saved in instrument state.
Backwards Compatibility Notes	The WINDow parameter and optional subopcode is included for backwards compatibility but ignored – all windows are equally affected.
Initial S/W Revision	Prior to A.02.00

Themes

Accesses a menu of functions that enable you to choose the theme to be used when saving the screen image.

The **Themes** option is the same as the **Themes** option under the **Display** and **Page Setup** dialogs. It allows you to choose between themes to be used when saving the screen image.

Key Path	Save, Screen Image
Remote Command	:MMEMory:STORe:SCReen:THEMe TDColor TDMonochrome FCOLOR FMONochrome :MMEMory:STORe:SCReen:THEMe?
Example	:MMEM:STOR:SCR:THEM TDM
Preset	3D Color; Is not part of Preset, but is reset by Restore Misc Defaults or Restore System Defaults All and survives subsequent running of the modes.
Readback	3D Color 3D Mono Flat Color Flat Mono
Backwards Compatibility Notes	In ESA and PSA we offer the choice of "Reverse Bitmap" or "Reverse Metafile" when saving screen images. This is much like the "Flat Color" theme available in X-Series. Also, if you selected Reverse Bitmap AND a black & white screen image, that would be much like "Flat Monochrome". In other words, each of the X-Series themes has a similar screen image type in ESA/PSA. But they are not identical.
Initial S/W Revision	Prior to A.02.00

3D Color

Selects a standard color theme with each object filled, shaded and colored as designed.

Key Path	Save, Screen Image, Themes
Example	MMEM:STOR:SCR:THEM TDC
Readback	3D Color
Initial S/W Revision	Prior to A.02.00

3D Monochrome

Selects a format that is like 3D color but shades of gray are used instead of colors.

Key Path	Save, Screen Image, Themes
Example	MMEM:STOR:SCR:THEM TDM
Readback	3D Mono
Initial S/W Revision	Prior to A.02.00

Flat Color

Selects a format that is best when the screen is to be printed on an ink printer.

Key Path	Save, Screen Image, Themes
Example	MMEM:STOR:SCR:THEM FCOL
Readback	Flat Color
Initial S/W Revision	Prior to A.02.00

Flat Monochrome

Selects a format that is like Flat Color. But only black is used (no colors, not even gray), and no fill.

Key Path	Save, Screen Image, Themes
Example	MMEM:STOR:SCR:THEM FMON
Readback	Flat Mono
Initial S/W Revision	Prior to A.02.00

Backlight

Accesses the display backlight on/off keys. This setting may interact with settings under the Windows "Power" menu.

When the backlight is off, pressing ESC, TAB, SPACE, ENTER, UP, DOWN, LEFT, RIGHT, DEL, BKSP, CTRL, or ALT turns the backlight on without affecting the application. Pressing any other key will turn backlight on and could potentially perform the action as well.

Key Path	View/Display, Display, System Display Settings
Remote Command	:DISPlay:BACKlight ON OFF :DISPlay:BACKlight?
Preset	ON (Set by Restore Misc Defaults)
Initial S/W Revision	Prior to A.02.00

Backlight Intensity

An active function used to set the backlight intensity. It goes from 0 to 100 where 100 is full on and 0 is off. This value is independent of the values set under the Backlight on/off key.

Key Path	View/Display, Display, System Display Settings
Remote Command	:DISPlay:BACKlight:INTensity <integer> :DISPlay:BACKlight:INTensity?
Example	DISP:BACK:INT 50

Preset	100 (Set by Restore Misc Defaults)
Min	0
Max	100
Initial S/W Revision	Prior to A.02.00

RF Envelope

This view shows an example of the RF Envelope result for the waveform (time domain) measurements in the graph window. The measured values for the mean power and peak-to-mean power are shown in the text window.

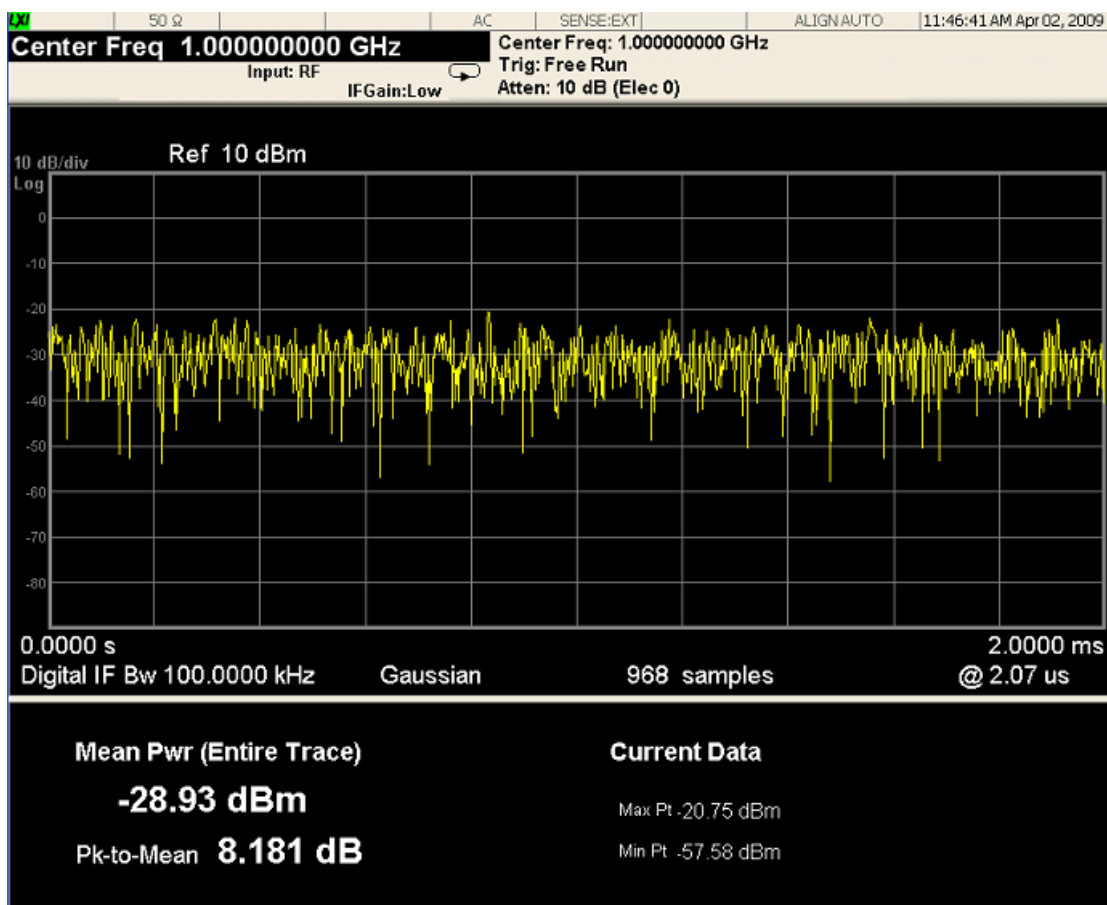

Numeric Results

Name	Type	Description	Unit	Format
Mean Pwr	Float64	The mean power (dBm). This is either the power across the entire trace, or the power between markers if the markers are enabled.	dBm	XX.XX dBm

Name	Type	Description	Unit	Format
Pk-to-Mean	Float64	This is the ratio of the maximum signal level to the mean power.	dB	XX.XX dB
Max Pt	Float64	The maximum of the most recently acquired data.	dBm	XX.XX dBm
Min Pt	Float64	The minimum of the most recently acquired data.	dBm	XX.XX dBm

Key Path	View/Display
Initial S/W Revision	Prior to A.02.00

I/Q Waveform

This view shows the I and Q signal waveforms in parameters of voltage versus time.

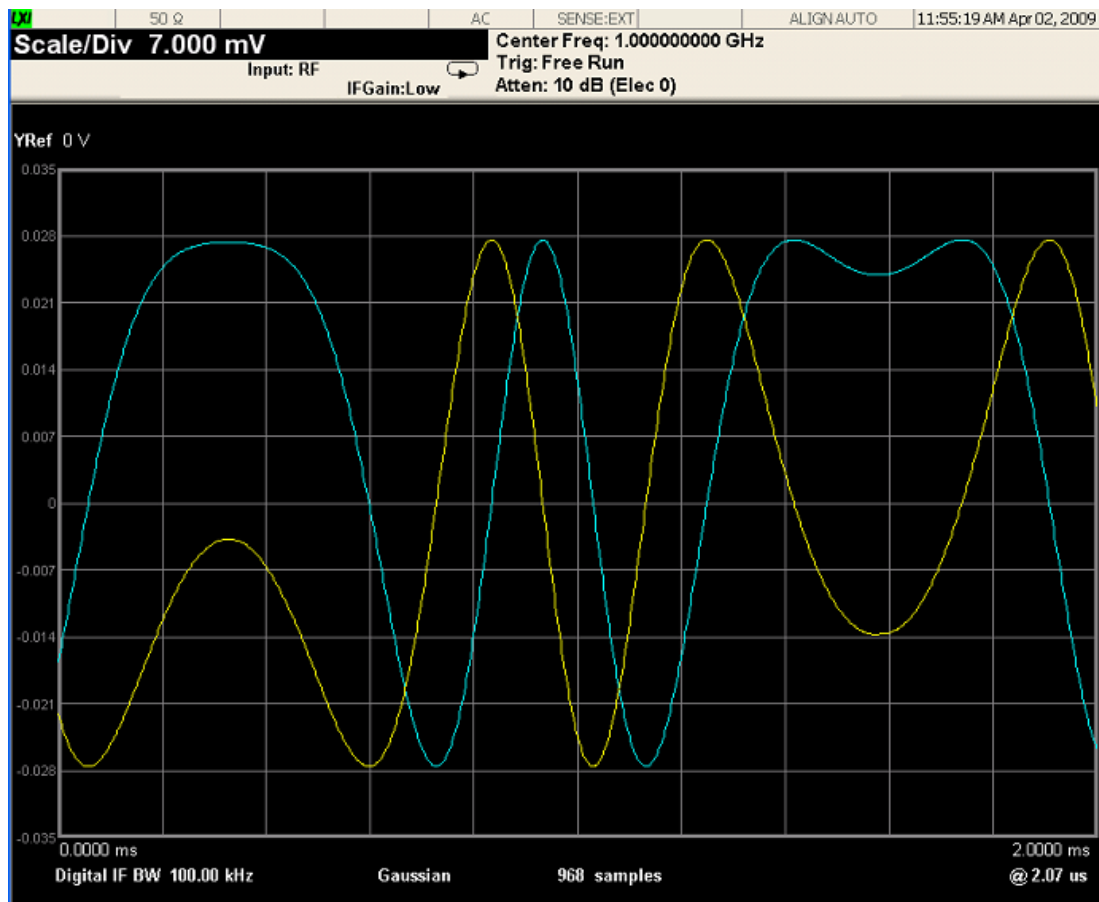

Key Path	View/Display
Initial S/W Revision	Prior to A.02.00

