



Agilent U1452A, U1452AT, and U1451A Insulation Tester

User's Guide



Agilent Technologies

Notices

© Agilent Technologies, Inc. 2014

No part of this manual may be reproduced in any form or by any means (including electronic storage and retrieval or translation into a foreign language) without prior agreement and written consent from Agilent Technologies, Inc. as governed by United States and international copyright laws.

Manual Part Number

U1451-90003

Edition

First Edition, January 13, 2014

Agilent Technologies, Inc.
5301 Stevens Creek Blvd.
Santa Clara, CA 95051 USA

Warranty

The material contained in this document is provided “as is,” and is subject to being changed, without notice, in future editions. Further, to the maximum extent permitted by applicable law, Agilent disclaims all warranties, either express or implied, with regard to this manual and any information contained herein, including but not limited to the implied warranties of merchantability and fitness for a particular purpose. Agilent shall not be liable for errors or for incidental or consequential damages in connection with the furnishing, use, or performance of this document or of any information contained herein. Should Agilent and the user have a separate written agreement with warranty terms covering the material in this document that conflict with these terms, the warranty terms in the separate agreement shall control.

Technology Licenses

The hardware and or software described in this document are furnished under a license and may be used or copied only in accordance with the terms of such license.

Restricted Rights Legend

U.S. Government Restricted Rights. Software and technical data rights granted to the federal government include only those rights customarily provided to end user customers. Agilent provides this customary commercial license in Software and technical data pursuant to FAR 12.211 (Technical Data) and 12.212 (Computer Software) and, for the Department of Defense, DFARS 252.227-7015 (Technical Data - Commercial Items) and DFARS 227.7202-3 (Rights in Commercial Computer Software or Computer Software Documentation).

Safety Notices

CAUTION









A **CAUTION** notice denotes a hazard. It calls attention to an operating procedure, practice, or the like that, if not correctly performed or adhered to, could result in damage to the product or loss of important data. Do not proceed beyond a **CAUTION** notice until the indicated conditions are fully understood and met.

WARNING

A **WARNING** notice denotes a hazard. It calls attention to an operating procedure, practice, or the like that, if not correctly performed or adhered to, could result in personal injury or death. Do not proceed beyond a **WARNING** notice until the indicated conditions are fully understood and met.

Safety Symbols

The following symbols on the instrument and in the documentation indicate precautions which must be taken to maintain safe operation of the instrument.

	Direct current (DC)		Caution, risk of electric shock
	Alternating current (AC)		Caution, risk of danger (refer to this manual for specific Warning or Caution information)
	Both direct and alternating current	CAT III 1000 V	Category III 1000 V overvoltage protection
	Earth (ground) terminal	CAT IV 600 V	Category IV 600 V overvoltage protection
	Equipment protected throughout by double insulation or reinforced insulation		Do not use in distribution systems with voltages higher than 600 V

Safety Considerations

Read the information below before using this tester. Model U1452A appears in all illustrations.

WARNING

- **Do not use the tester if it is damaged. Before you use the tester, inspect the case. Look for cracks or missing plastic. Pay particular attention to the insulation surrounding the connectors.**
 - **Inspect the test leads for damaged insulation or exposed metal. Check the test leads for continuity. Replace damaged test leads before you use the tester.**
 - **Do not operate the tester around explosive gas, vapor, or wet environments.**
 - **Do not apply more than the rated voltage (as marked on the tester) between terminals, or between terminal and earth ground.**
 - **Before use, verify the tester's operation by measuring a known voltage.**
 - **When servicing the tester, use only the specified replacement parts.**
 - **Use caution when working above 60 VDC, 30 VAC RMS, or 42.4 V peak. Such voltages pose a shock hazard.**
 - **When using the probes, keep your fingers behind the finger guards on the probes.**
 - **Connect the common test lead before you connect the live test lead. When you disconnect the leads, disconnect the live test lead first.**
 - **Remove the test leads from the tester before you open the battery cover.**
 - **Do not operate the tester with the battery cover or portions of the cover removed or loosened.**
 - **To avoid false readings, which may lead to possible electric shock or personal injury, replace the battery as soon as the low battery indicator appears and flashes.**
 - **Ensure that you do not perform insulation resistance tests in distribution systems with voltages higher than 600 V.**
 - **For insulation resistance tests, ensure that you select a suitable test voltage for the equipment to be tested.**
-

CAUTION

- Disconnect circuit power and discharge all high-voltage capacitors before testing resistance, continuity, or capacitance.
 - Use the proper terminals, function, and range for your measurements.
 - This device is for use at altitudes of up to 2,000 m.
 - Always use the specified battery type. The power for the tester is supplied with four 1.5 V AA batteries. Observe the correct polarity markings before you insert the batteries to ensure proper insertion of the batteries in the tester.
-

Environmental Conditions

This instrument is designed for indoor use and in an area with low condensation. The table below shows the general environmental requirements for this instrument.





Environmental condition	Requirement
Temperature	<ul style="list-style-type: none">• Operating condition<ul style="list-style-type: none">• –20 °C to 55 °C, 0% to 80% RH (using Alkaline batteries), 20 minutes operating time• Storage condition<ul style="list-style-type: none">• –40 °C to 70 °C, 0% to 80% RH (without batteries)
Humidity	Full accuracy up to 80% RH for temperatures up to 30 °C, decreasing linearly to 50% RH at 55 °C
Altitude	Up to 2,000 meters
Pollution degree	Pollution degree II

NOTE

The U1452A/U1452AT/U1451A Insulation Tester complies with the following safety and EMC requirements:

- **Safety compliance**
 - Designed in compliance to IEC/EN 61010-1:2010 for Category III 1000 V and Category IV 600 V
 - Designed in compliance to IEC/EN 61557-1, IEC/EN 61557-2, and IEC/EN 61557-4
- **EMC compliance**
 - Commercial limits compliance with IEC 61326-1:2005/EN 61326-1:2006

Regulatory Markings

	<p>The CE mark is a registered trademark of the European Community. This CE mark shows that the product complies with all the relevant European Legal Directives.</p>		<p>The C-tick mark is a registered trademark of the Spectrum Management Agency of Australia. This signifies compliance with the Australia EMC Framework regulations under the terms of the Radio Communication Act of 1992.</p>
<p>ICES/NMB-001</p>	<p>ICES/NMB-001 indicates that this ISM device complies with the Canadian ICES-001. Cet appareil ISM est conforme a la norme NMB-001 du Canada.</p>		<p>This instrument complies with the WEEE Directive (2002/96/EC) marking requirement. This affixed product label indicates that you must not discard this electrical or electronic product in domestic household waste.</p>
	<p>The CSA mark is a registered trademark of the Canadian Standards Association.</p>		<p>This symbol indicates the time period during which no hazardous or toxic substance elements are expected to leak or deteriorate during normal use. Forty years is the expected useful life of the product.</p>

Waste Electrical and Electronic Equipment (WEEE) Directive 2002/96/EC

This instrument complies with the WEEE Directive (2002/96/EC) marking requirement. This affixed product label indicates that you must not discard this electrical or electronic product in domestic household waste.

Product Category:

With reference to the equipment types in the WEEE directive Annex 1, this instrument is classified as a “Monitoring and Control Instrument” product.

The affixed product label is as shown below.



Do not dispose in domestic household waste.

To return this unwanted instrument, contact your nearest Agilent Service Center, or visit

www.agilent.com/environment/product

for more information.

Declaration of Conformity (DoC)

The Declaration of Conformity (DoC) for this instrument is available on the Agilent website. You can search the DoC by its product model or description at:

<http://regulations.corporate.agilent.com/DoC/search.htm>

NOTE

If you are unable to search for the respective DoC, please contact your local Agilent representative.

THIS PAGE HAS BEEN INTENTIONALLY LEFT BLANK.

Table of Contents

1 Introduction

About This Manual	2
Documentation map	2
Safety notes	2
Preparing Your Tester	3
Check the shipment	3
Install or change the batteries	3
Turn on your tester	6
Select the range	6
Adjust the tilt stand	7
Connect to the Handheld Meter Logger Software	8
Connect the Bluetooth adapter	9
Your Tester in Brief	10
Dimensions	10
Overview	12
Rotary switch	14
Keypad	16
Display screen	20
Input terminals	24
Cleaning Your Tester	25
Additional Features	26
Automatic power-off	26
Hazardous voltage indication	26
Power-on options	26

2 Making Measurements

Insulation Resistance Test	30
Using the Remote Switch Probe	32

Locking the test	33
Timed insulation resistance/earth-bond resistance test	34
Measuring the Dielectric Absorption Ratio (DAR)	35
Measuring the Polarization Index (PI)	36
Viewing the leakage current	37
Earth-Bond Resistance Test	38
Measuring AC or DC Voltage	41
Auto AC or DC signal identification	43
Measuring Frequency	44
Measuring Resistance	46
Continuity Test	48
Measuring Capacitance	50
3 Tester Features	
Making Relative Measurements (Null)	54
Freezing the Display (TrigHold and AutoHold)	55
Performing Limit Comparisons (Limit)	57
Recording Measurement Data (Log)	59
Performing manual logs (HAND)	60
Performing interval logs (AUTO)	60
Performing event logs (TRIG)	61
Reviewing Previously Recorded Data (View)	63
4 Setup Options	
Using the Setup Menu	66
Editing numerical values	67
Setup Menu Summary	68
Setup Menu Items	71

Changing the variation count	71
Enabling smooth mode	71
Changing the beep frequency	72
Changing the auto power-off (APO) timer	73
Changing the LCD backlight timeout	73
Changing the continuity alert	74
Disabling the power-on melody	75
Changing the battery type	75
Resetting the tester's Setup options	76
Changing the display count	76
Changing the cable length unit	77
Changing the cable length scale	78
Changing the alert indicators	78
Changing the sample interval duration	79
Changing the recording option	80
Changing the IR and EBR test period	80
Changing the maximum inhibit voltage for IR tests	81
Disabling the lock once feature	82
Changing the button operation on the remote switch probe	82
Changing the Dielectric Absorption Ratio (DAR) for IR tests	83

5 Characteristics and Specifications

Product Characteristics	86
Specification Considerations	88
Measurement Category	88
Electrical Specifications	89
DC specifications	89
AC specifications	91
Capacitance specifications	92
Frequency specifications	93
Sensitivity for voltage measurements	94

Insulation resistance specifications	95
Earth-bond resistance specifications	97
EN61557 specifications	97
Display update rate (approximate)	99

List of Figures

Figure 1-1	Agilent Handheld Meter Logger Software	8
Figure 1-2	Bluetooth adapter connection	9
Figure 1-3	Width dimension	10
Figure 1-4	Height and depth dimensions	11
Figure 1-5	Display screen allocation example	20
Figure 1-6	Connecting the remote switch probe	24
Figure 2-1	Insulation resistance test example	31
Figure 2-2	T/Time operation	34
Figure 2-3	DAR operation	35
Figure 2-4	PI operation	36
Figure 2-5	Earth-bond resistance test example	39
Figure 2-6	AC or DC voltage measurement example	42
Figure 2-7	Definition of frequency	45
Figure 2-8	Resistance measurement example	47
Figure 2-9	Continuity test example	49
Figure 2-10	Capacitance measurement example	51

THIS PAGE HAS BEEN INTENTIONALLY LEFT BLANK.

List of Tables

Table 1-1	Front panel part descriptions	12
Table 1-2	Rear panel parts	13
Table 1-3	U1452A/U1452AT/U1451A rotary switch functions	14
Table 1-4	U1452A/U1452AT/U1451A keypad functions	16
Table 1-5	General annunciators	20
Table 1-6	Measurement units display	22
Table 1-7	Analog bar graph display	23
Table 1-8	Terminal connections for different measuring functions	24
Table 1-9	Power-on options	26
Table 2-1	Rotary switch position for insulation resistance tests	30
Table 2-2	Earth-bond resistance test position	38
Table 2-3	AC and DC voltage measurement positions	41
Table 2-4	Resistance measurement position	46
Table 2-5	Continuity test position	48
Table 2-6	Capacitance measurement position	50
Table 3-1	Limit settling default values	57
Table 3-2	Log maximum capacity	59
Table 3-3	Event log trigger conditions	61
Table 4-1	Setup menu key functions	66
Table 4-2	Setup menu item descriptions	68
Table 5-1	DC voltage specifications with accuracy of \pm (% of reading + no. of least significant digit)	89
Table 5-2	Resistance specifications with accuracy of \pm (% of reading + no. of least significant digit)	90
Table 5-3	AC voltage specifications with accuracy of \pm (% of reading + no. of least significant digit)	91
Table 5-4	Capacitance specifications with accuracy of \pm (% of reading + no. of least significant digit) ^{[1][2][3]}	92
Table 5-5	Frequency specifications with accuracy of \pm (% of reading + no. of least significant digit) ^{[1][2]}	93
Table 5-6	Sensitivity for voltage measurements	94
Table 5-7	Insulation resistance specifications with accuracy of \pm (% of reading + no. of least significant digit)	95

- Table 5-8** Earth-bond resistance specifications with accuracy of \pm (% of reading + no. of least significant digit)^{[1][2]} 97
- Table 5-9** Display update rate (approximate) 99



1 Introduction

About This Manual	2
Documentation map	2
Safety notes	2
Preparing Your Tester	3
Check the shipment	3
Install or change the batteries	3
Turn on your tester	6
Select the range	6
Adjust the tilt stand	7
Connect to the Handheld Meter Logger Software	8
Connect the Bluetooth adapter	9
Your Tester in Brief	10
Dimensions	10
Overview	12
Rotary switch	14
Keypad	16
Display screen	20
Input terminals	24
Cleaning Your Tester	25
Additional Features	26
Automatic power-off	26
Hazardous voltage indication	26
Power-on options	26

This chapter teaches you how to set up your tester for the first time. An introduction to all the features of the tester is also given.



About This Manual

Documentation map

The following manuals and software related to the *U1452A/U1452AT/U1451A Insulation Tester* are available for download. Please visit our website at <http://www.agilent.com/find/hhTechLib> for the latest version.

Check the manual edition on the first page of each manual.

User's Guide. This manual.

Quick Start Guide. Printed copy for outdoor use, included with shipment.

Service Guide. Downloadable from <http://www.agilent.com/find/hhTechLib>

Agilent Handheld Meter Logger Software, Help, and Quick Start Guide. Downloadable from <http://www.agilent.com/hhmeterlogger>

Safety notes

The following safety notes are used throughout this manual. More pertinent safety notes for using this product are located under the “[Safety Symbols](#)” section.

CAUTION

Caution denotes a hazard. It calls attention to a procedure that, if not correctly performed or adhered to, could result in damage to or destruction of the product. Do not proceed beyond a caution notice until the indicated conditions are fully understood and met.

WARNING

Warning denotes a hazard. It calls attention to a procedure which, if not correctly performed or adhered to, could result in injury or loss of life. Do not proceed beyond a warning note until the indicated conditions are fully understood and met.

Preparing Your Tester

Check the shipment

When you receive your tester, check the shipment according to the following procedure.

- 1 Inspect the shipping container for damage. Signs of damage may include a dented or torn shipping container or cushioning material that indicates signs of unusual stress or compacting. Save the packaging material in case the tester needs to be returned.
- 2 Carefully remove the contents from the shipping container, and verify that the standard accessories and your ordered options are included in the shipment according to the standard shipped items list found in the printed copy of the *U1452A/U1452AT/U1451A Quick Start Guide*.
- 3 For any question or problems, refer to the Agilent contact numbers on the back of this manual.

Install or change the batteries

Your tester is powered by four 1.5 V AA alkaline batteries (included in the shipment). When you receive your tester, the batteries are not installed.

Use the following procedure to install or change the batteries.

CAUTION

Before you proceed with the batteries installation, remove all cable connections to the terminals and ensure that the rotary switch is at the **OFF** position. Use only the battery type specified in the “[Product Characteristics](#)” on page 86.

1 Introduction

Preparing Your Tester

- 1 Remove the orange rubber holster. Pull from a top corner and stretch the orange rubber holster off the tester.
- 2 Loosen and remove the two screws with a suitable Phillips screwdriver as shown on the right.

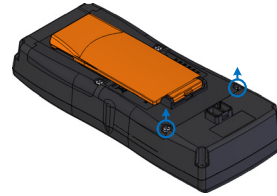

- 3 Lift up and remove the battery cover as shown on the left.

- 4 Lift the inner rubber cover to access the battery compartment.
- 5 Observe the proper batteries polarity. The terminal ends of each battery are indicated inside the battery compartment. Insert four 1.5 V AA batteries.

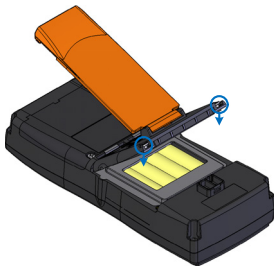
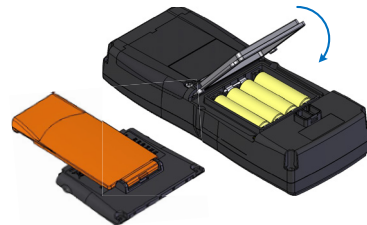

- 6 Ensure that the inner rubber cover is positioned properly.
- 7 Replace the battery cover back in its original position and tighten the screws.
- 8 Finally fit the orange rubber holster back on the tester.

The battery level indicator in the upper left-hand corner of the display indicates the relative condition of the batteries.

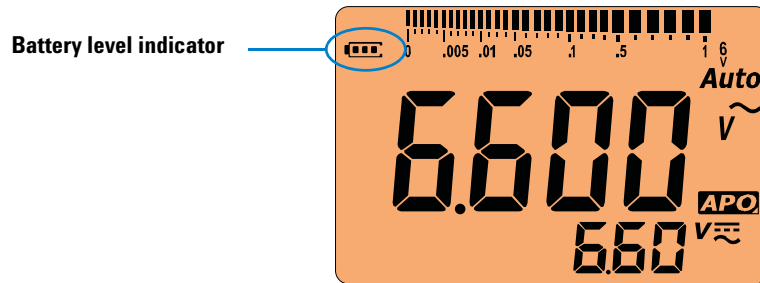

Replace the batteries as soon as possible when the low battery indicator (☐) is shown.

WARNING

To avoid false readings, which could lead to possible electric shock or personal injury, replace the battery as soon as the low battery indicator appears. Do not discharge the battery by shorting the battery or reverse the battery polarity in any of the subjects.

CAUTION

To avoid instruments being damage from battery leakage:

- Always remove dead batteries immediately.
- Always remove the batteries and store them separately if the tester is not going to be used for a long period.

Turn on your tester

To power ON your tester, turn the rotary switch from the **OFF** position to any other position.

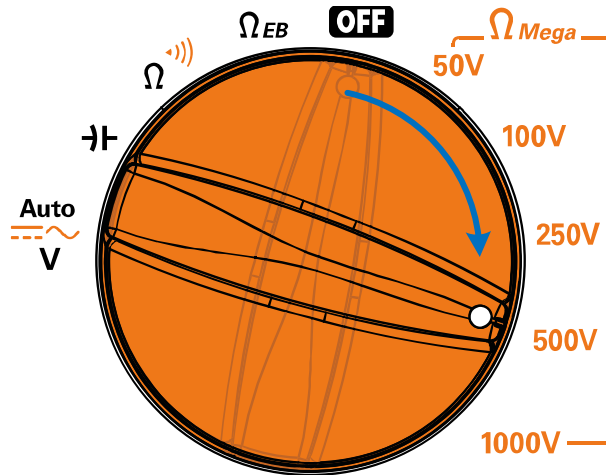

Select the range

The tester's selected range is always displayed on the right-hand end of the bar graph.

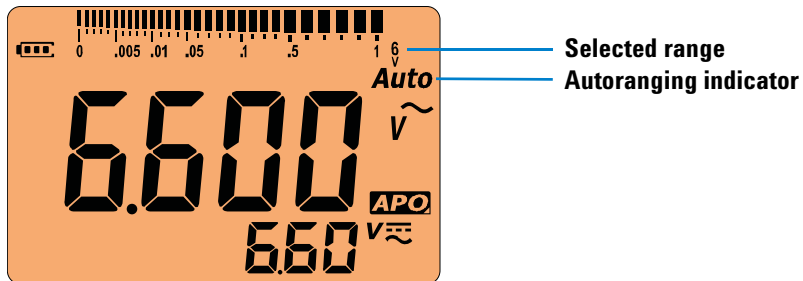

Pressing **Range** changes the tester range (and disables auto-ranging). Each additional press of **Range** (in manual ranging) sets the tester to the next higher range, unless it is already in the highest range, at which point the range switches to the lowest range.

Press and hold **Range** to switch the tester to **auto-ranging**. Auto-ranging is convenient because the tester automatically selects an appropriate range for sensing and displaying each measurement.

NOTE

- Changing the tester range (and disabling auto-ranging) is not allowed for earth-bond resistance tests and insulation resistance tests.
- In auto-range, the tester selects the lowest range to display the highest available precision (resolution) for the input signal.
- If a reading is greater than maximum available range, **OL** (overload) is shown on the display — except for earth-bond resistance tests and insulation resistance tests where to indicate maximum reading, **>** is shown on the display instead.

Adjust the tilt stand

To adjust the tester to a 60° standing position, pull the tilt-stand outward to its maximum reach.

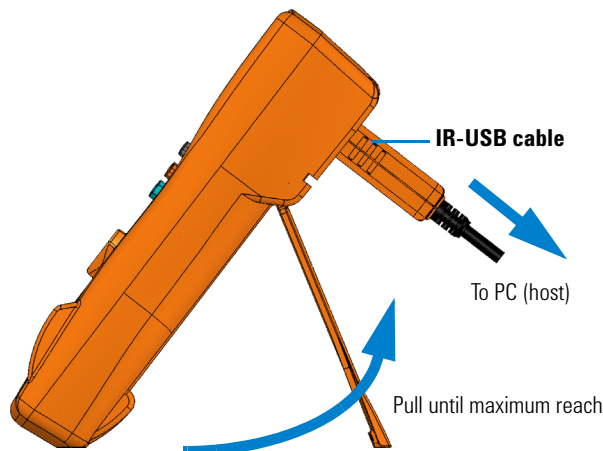

Connect to the Handheld Meter Logger Software

You can use the IR communication link (IR communication port, located at the rear panel) and the Agilent Handheld Meter Logger Software to control your tester remotely, perform data logging operations, and transfer the contents of your tester's memory to a PC.

Ensure that the Agilent logo on the U1173A IR-USB cable connected to the tester is facing up. Firmly push the IR head into the tester's IR communication port until it snaps into place.

Refer to the *Agilent Handheld Meter Logger Software Help* and *Quick Start Guide* for more information on the IR communication link and the Agilent Handheld Meter Logger Software.

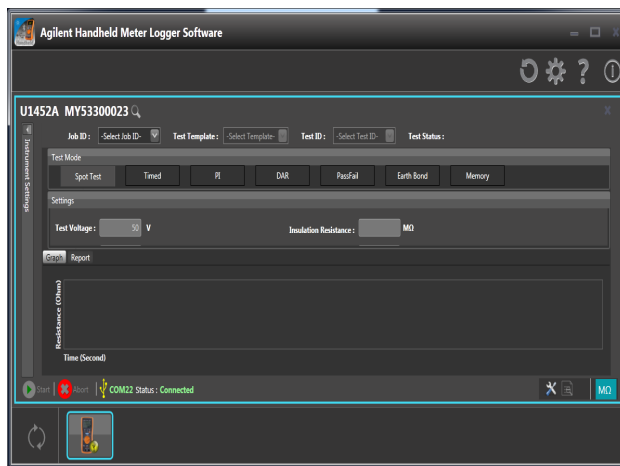

Figure 1-1 Agilent Handheld Meter Logger Software

The Agilent Handheld Meter Logger Software and its supporting documents (Quick Start Guide and Help) are available for download from <http://www.agilent.com/hhmeterlogger>.

Connect the Bluetooth adapter

The U1117A Infrared (IR)-to-**Bluetooth**® adapter allows you to connect the tester wirelessly to any Windows PC, Android device, or iOS device.

The U1117A is compatible with the following application or software:

- Agilent Handheld Meter Logger (for Windows PC)
- Agilent Mobile Meter (for Android or iOS devices)
- Agilent Mobile Logger (for Android or iOS devices)

Snap the optic side of the U1117A to the tester's IR communication port (see [Figure 1-2](#)).

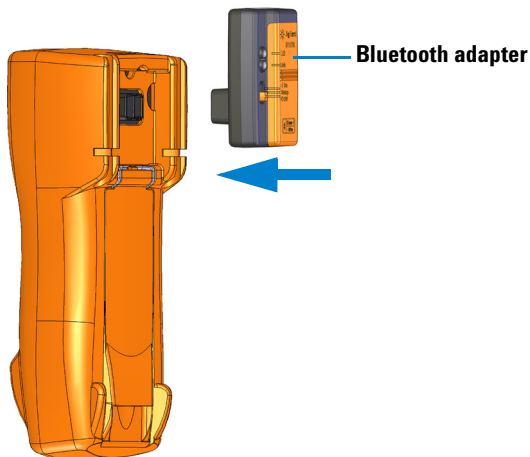

Figure 1-2 Bluetooth adapter connection

Refer to the *Agilent U1117A IR- to- Bluetooth Adapter Operating Instructions* (download from <http://www.agilent.com/find/U1117A>) for more information on how to set up the U1117A to a Windows PC, Android device, or iOS device.

Your Tester in Brief

Dimensions

Front view



Figure 1-3 Width dimension

Rear and side view

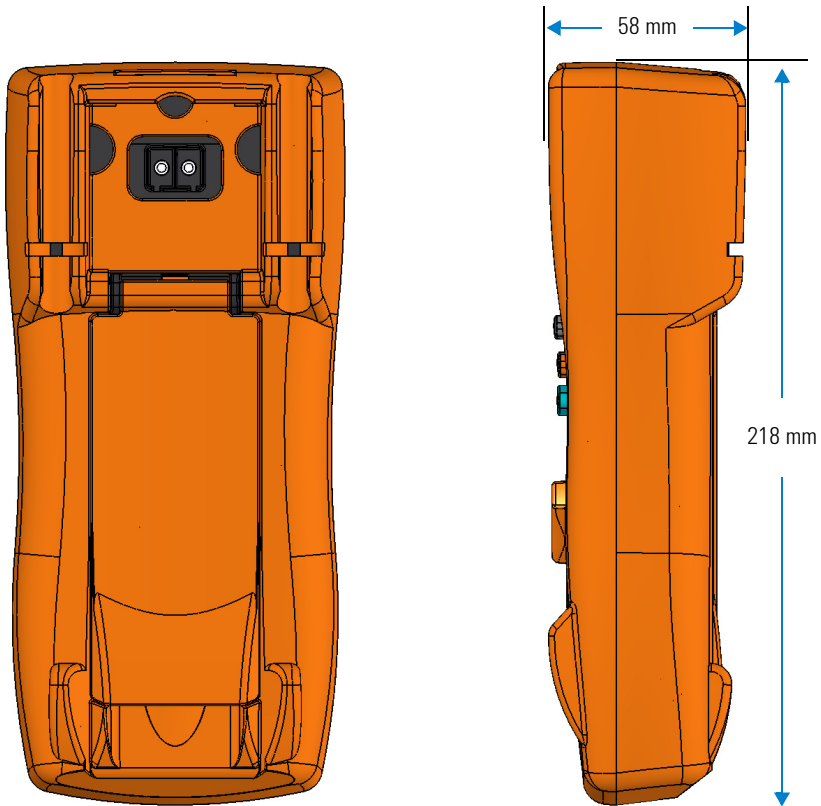

Figure 1-4 Height and depth dimensions

Overview

Front panel

The front panel parts of your tester are described in this section.

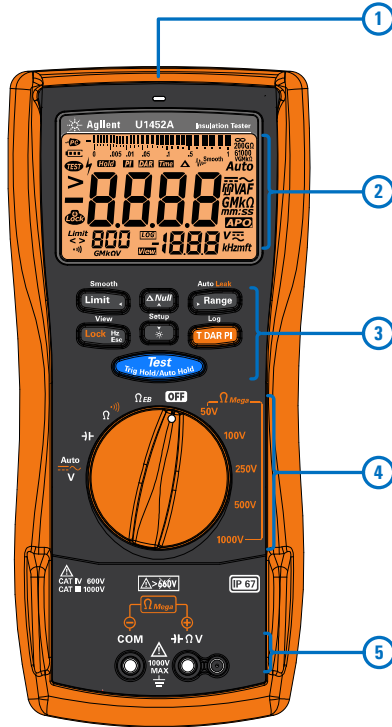

Table 1-1 Front panel part descriptions

Legend	Description	Learn more on:
1	Red LED indicator	page 54
2	Display screen	page 20
3	Keypad	page 16
4	Rotary switch	page 14
5	Input terminals	page 24

Rear panel

The rear panel parts of your tester are described in this section.

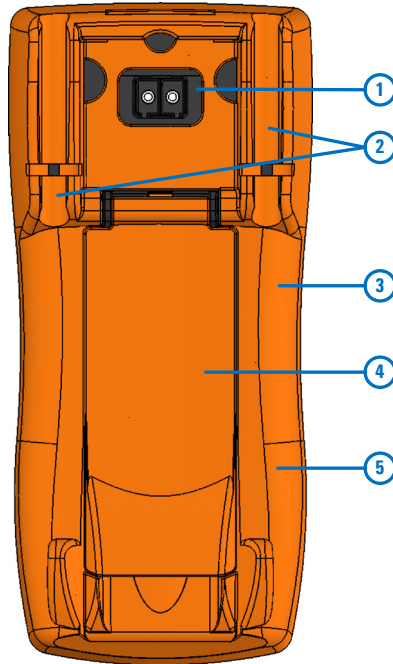

Table 1-2 Rear panel parts

Legend	Description	Learn more on:
1	IR communication port	page 8
2	Test lead/probe holders	-
3	Battery access (under the orange rubber holster)	page 3
4	Tilt stand	page 7
5	Fuse access (under the orange rubber holster)	-

Rotary switch

The measurement functions for each rotary switch position are described in [Table 1-3](#). Turning the rotary switch changes the measurement function and resets all other measurement options.

WARNING

Remove the test leads from the measuring source or target before changing the rotary switch position.

NOTE

Press **T DAR PI** to select the alternate measurement function(s) or test methods for insulation resistance tests. See [page 16](#) for more information on the **T DAR PI** key.

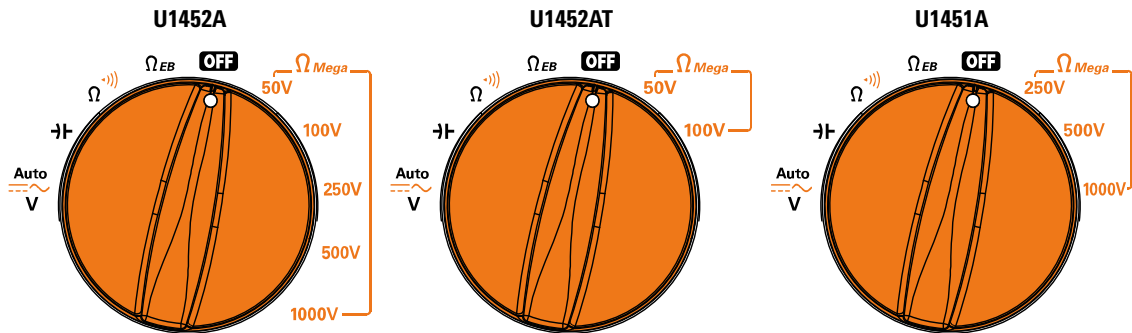

Table 1-3 U1452A/U1452AT/U1451A rotary switch functions

Legend	Measurement function	U1452A	U1452AT	U1451A	Learn more on:
	50 V Insulation resistance test	✓	✓	-	page 38
Ω Mega 50V	T - Timed test	✓	✓	-	
	DAR - Dielectric Absorption Ratio test	✓	✓	-	
	PI - Polarization Index Test	✓	✓	-	

Table 1-3 U1452A/U1452AT/U1451A rotary switch functions (continued)

Legend	Measurement function	U1452A	U1452AT	U1451A	Learn more on:
	100 V Insulation resistance test	✓	✓	-	page 38
	T - Timed test	✓	✓	-	
	DAR - Dielectric Absorption Ratio test	✓	✓	-	
	PI - Polarization Index Test	✓	✓	-	
	250 V Insulation resistance test	✓	-	✓	page 38
	T - Timed test	✓	-	✓	
	DAR - Dielectric Absorption Ratio test	✓	-	-	
	PI - Polarization Index Test	✓	-	-	
	500 V Insulation resistance test	✓	-	✓	page 38
	T - Timed test	✓	-	✓	
	DAR - Dielectric Absorption Ratio test	✓	-	-	
	PI - Polarization Index Test	✓	-	-	
	1000 V Insulation resistance test	✓	-	✓	page 38
	T - Timed test	✓	-	✓	
	DAR - Dielectric Absorption Ratio test	✓	-	-	
	PI - Polarization Index Test	✓	-	-	
	Earth-bond resistance test	✓	✓	✓	page 38
	T - Timed test	✓	✓	✓	
	Resistance measurement	✓	✓	✓	page 46
	Continuity test	✓	✓	✓	page 48
	Capacitance measurement	✓	✓	✓	page 50
	Auto voltage measurement	✓	✓	✓	page 30
	DC voltage measurement	✓	✓	✓	
	AC voltage measurement	✓	✓	✓	

Keypad

The operation of each key is explained in Table 1-4 below. Pressing a key enables a function, displays a related symbol, and emits a beep. Turning the rotary switch to another position resets the current operation of the key.

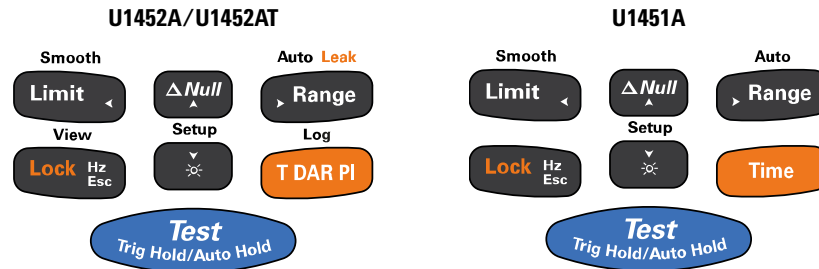

Table 1-4 U1452A/U1452AT/U1451A keypad functions









Legend	Function when pressed for:	
	Less than 1 second	More than 1 second
	<p>Insulation Resistance (IR) Test: Initiates an IR test (when the rotary switch is in one of the Ω_{Mega} positions) as long as  is held — the tester sources (outputs) a high voltage and measures insulation resistance and  is shown on the display.</p>	
	<p>Earth-Bond Resistance (EBR) Test: Initiates an EBR test (when the rotary switch is in the Ω_{EB} position) as long as  is held — the tester measures earth-bond resistance and  is shown on the display.</p>	
	<p>Trig Hold: Freezes the present reading in the display (except when the rotary switch is in one of the Ω_{Mega} positions or in the Ω_{EB} position).</p> <ul style="list-style-type: none"> In TrigHold mode, press  to manually trigger the holding of the next measured value. Press and hold  again to exit this mode. 	<p>Auto Hold: Automatically freezes the present reading once the reading is stable (except when the rotary switch is in one of the Ω_{Mega} positions or in the Ω_{EB} position).</p> <ul style="list-style-type: none"> In AutoHold mode, the reading is updated automatically once the reading is stable and the count setting is exceeded. Press and hold  again to exit this mode.

Table 1-4 U1452A/U1452AT/U1451A keypad functions (continued)































Legend	Function when pressed for:	
	Less than 1 second	More than 1 second
<p>U1451A</p> 	<p>Lock: Press  to lock the insulation test or earth-bond resistance test (when the rotary switch is in the appropriate position).</p> <p>Press  >  to initiate an IR or EBR test. The test will remain active until you press  or  again to release the lock.</p>	<p>View: Press and hold  to enter the Log Review menu.</p> <ul style="list-style-type: none"> Press  to cycle through the previously recorded manual (VIEW H), interval (VIEW A), or event (VIEW E) logging data. Press  or  to view first or last logged data respectively. Press  or  to scroll through the logged data. Press  to delete the last logged data. Press and hold  to clear all the logged data for the selected logging mode. Press and hold  again to exit this mode.
<p>U1452A/U1452AT</p> 	<p>Hz: Press  to display the frequency for voltage or current measurements.</p> <p>Press  again to disable the frequency display.</p> <p>Esc: Press  in the Setup menu to discard your changes.</p>	
<p>U1451A</p> 	<p>Press  to switch or cycle between the default and alternate measurement function(s).</p> <p>T: Configures the tester for a timed test (when the rotary switch is in one of the Ω Mega positions or the Ω EB position). The test will start when you press .</p>	<p>Log: The recording option (HAND, AUTO, or TRIG) must first be selected in the Setup menu (see page 80).</p> <ul style="list-style-type: none"> HAND (manual data logging) — Press and hold  to log the present reading into the memory. The display will return to normal after a short while (\approx 1 second). To manually log another reading, press and hold  again. AUTO (automatic data logging) — Press and hold  to enable the automatic data logging mode, where data is logged at the interval defined in the Setup menu (see page 79). Press and hold  again to exit this mode. TRIG (event data logging) — Press and hold  to enable the event data logging mode, where data is logged each time a triggering condition is satisfied (see page 62). Press and hold  again to exit this mode.
<p>U1452A/U1452AT</p> 	<p>DAR: Configures the tester for a dielectric absorption ratio test (when the rotary switch is in one of the Ω Mega positions). The test will start when you press .</p> <p>PI: Configures the tester for a polarization index test (when the rotary switch is in one of the Ω Mega positions). The test will start when you press .</p>	

Table 1-4 U1452A/U1452AT/U1451A keypad functions (continued)











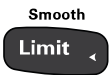

















Legend	Function when pressed for:	
	Less than 1 second	More than 1 second
	<p>Limit: Press  to enable the comparison for limit mode.</p> <ul style="list-style-type: none"> Press  again to set the comparison value. Use the arrow keys to change the value shown and press  to save your changes. Press and hold  to exit this mode. 	<p>Smooth: Press and hold  to smoothen the refresh rate of the readings. Press and hold  again to exit this mode.</p>
	<p>Range: Press  to set a manual range and disable auto-ranging. Press  again to cycle through each available measurement range.</p>	<p>Auto: Press and hold  to enable auto-ranging.</p>
<p>U1452A/U1452AT</p> 	<p>Leak: Press  to display the leakage current.</p>	
	<p>Null: Press  to enable the relative function.</p> <ul style="list-style-type: none"> The displayed value is saved as a reference to be subtracted from subsequent measurements. Press  again to view the stored reference value that has been saved. The display will return to normal after a brief period of time (approx. 3 seconds). Pressing  while the stored reference value is being displayed will cancel the relative function. 	

Table 1-4 U1452A/U1452AT/U1451A keypad functions (continued)

Legend	Function when pressed for:	
	Less than 1 second	More than 1 second
	<p>☀: Press  to enable or disable the LCD backlight.</p>	<p>Setup: Press and hold  to enter the Setup menu.</p> <ul style="list-style-type: none"> In the Setup menu, press  or  to navigate through the menu pages. Press  or  at each menu page to move the cursor to a specific menu item. Press  to change the value of the selected menu item. Use the arrow keys to change the value shown. Press  again to save your changes, or press  to discard your changes. Press and hold  again to exit the Setup menu.

Display screen

The display annunciators of your tester are described in this section. See also “[Measurement units](#)” on page 22 for a list of available measurement signs and notations and “[Analog bar graph](#)” on page 23 for a tutorial on the analog bar graph located at the bottom of your display screen.

Display annunciators

The display annunciators of your tester are described in the [Table 1-5](#).

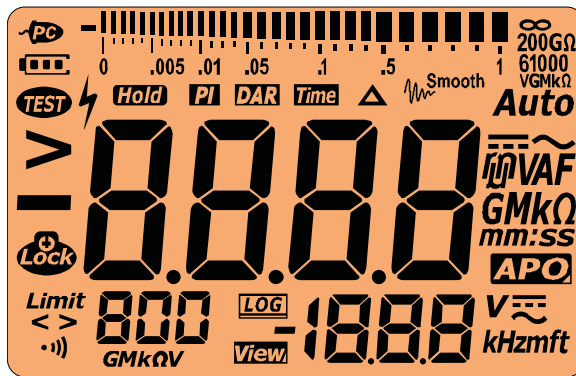

Figure 1-5 Display screen allocation example

Table 1-5 General annunciators





Legend	Description
	Remote control enabled
	Battery capacity indication
	Analog bar graph
	Test indication for insulation resistance and earth-bond resistance tests
	Hazardous voltage sign for measuring voltage ≥ 30 V or OL (overload)

Table 1-5 General annunciators (continued)









Legend	Description
Hold	Auto hold/Trigger hold enabled
PI	Polarization Index test enabled
DAR	Dielectric Absorption Ratio test enabled
Time	Timed test enabled
△	Relative (Null) enabled
 Smooth	Smooth mode enabled
Auto	Auto-ranging enabled or Auto signal indicator enabled
>	Greater than range (for insulation resistance and earth-bond resistance tests)
 Lock	Test and Test Lock indication for insulation resistance and earth-bond resistance tests
-8888	Primary display
	AC or DC indication
VAF GMkΩ	Measuring units for primary display
mm:ss	Test time indication for earth-bond resistance and insulation resistance tests
APO	APO (Auto Power-Off) enabled
Limit <>	Limit comparison enabled
LOG	Data logging in progress

Table 1-5 General annunciators (continued)

Legend	Description
	View mode for reviewing previously logged data
	Audible continuity test selected
	Secondary display
	Measuring units and AC+DC indication for secondary display
	Tertiary display
	Measuring units for tertiary display

Measurement units

The available signs and notations for each measurement function in your tester are described in [Table 1-6](#). The units listed below are applicable to the primary display and secondary display measurements of your tester.

Table 1-6 Measurement units display

Sign/Notation	Description
G	Giga 1E+09 (1000000000)
M	Mega 1E+06 (1000000)
k	kilo 1E+03 (1000)
n	nano 1E-09 (0.000000001)
μ	micro 1E-06 (0.000001)
m	milli 1E-03 (0.001)
mV, V	Voltage, units for voltage measurement
nF, μF, mF	Farad, units for capacitance measurement

Table 1-6 Measurement units display (continued)

Sign/Notation	Description
Ω , k Ω , M Ω , G Ω	Ohm, units for resistance measurement
kHz, Hz	Hertz, units for frequency measurement
m	Meter, unit for length
ft	Feet, unit for length

Analog bar graph



The analog bar emulates the needle on an analog tester, without displaying the overshoot.

NOTE

For frequency measurements, the bar graph does not represent the primary display value. For example, when frequency is displayed on the primary display during voltage measurement, the bar graph represents the voltage value (not the frequency value).

The “-” sign indicates that the measured or calculated value is negative. Each segment is presented as a ratio to the range value indicated on the peak bar-graph. The unit and range will be indicated according to various measurements (see [Table 1-7](#)).

Table 1-7 Analog bar graph display

Function	Bar graph
V	
Ω , Ω_{EB} , Ω_{Mega}	
\pm	









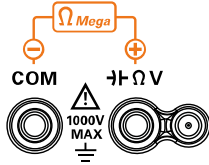

Input terminals

WARNING

To avoid damaging this device, do not exceed the input limit.

The terminal connections for the different measurement functions of your tester are described in the table below.

Table 1-8 Terminal connections for different measuring functions

Rotary switch position	Input terminals	Overload protection
		1000 Vrms
		1000 Vrms for short circuit <0.3 A
     		440 mA/1000 V, 30 kA fast-acting fuse

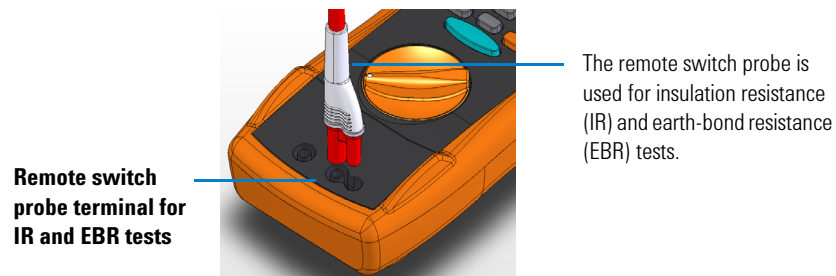

Figure 1-6 Connecting the remote switch probe

Cleaning Your Tester

WARNING

To avoid electrical shock or damage to the tester, ensure that the insides of the casing stay dry at all times.

Dirt or moisture in the terminals can distort readings. Follow the steps below to clean your tester.

- 1 Turn the tester off, and remove the test leads.
- 2 Turn the tester over, and shake out any dirt that may have accumulated in the terminals.

Wipe the case with a damp cloth and mild detergent – do not use abrasives or solvents. Wipe the contacts in each terminal with a clean swab dipped in alcohol.

Additional Features

Automatic power-off

Your tester automatically turns off if the rotary switch is not moved or a key is not pressed for 10 minutes (default). Pressing any key will turn the tester back on after it is powered off automatically.

To change the timer period or completely disable the automatic power-off, refer to “[Changing the auto power-off \(APO\) timer](#)” on page 73.

Hazardous voltage indication

The tester will display the hazardous voltage (⚡) symbol as an early precaution when the measured voltage is equal to or greater than \pm DC 30 V or AC 30 V, or when the measured voltage is over the measurement range, **OL** (overload).

Power-on options

Some options can be selected only while you turn the tester on. These power-on options are listed in the table below. To select a power-on option, press and hold the specified key while turning the rotary switch from the **OFF** position to any other position. Power-on options remain selected until the tester is turned off.

Table 1-9 Power-on options







Key	Description
	Simulates the Auto Power-Off (APO) mode. Press any key to turn the tester back on and resume normal operation.
	Checks firmware version. The tester’s firmware version will be shown on the primary display. Press any key to exit this mode.

Table 1-9 Power-on options (continued)

Key	Description
	<p>Toggles the red LED indicator alert for insulation resistance tests. If enabled, the red LED indicator will blink every two seconds during an insulation resistance test.</p> <p>The red LED indicator alert is disabled when the Limit feature (see page 57) is enabled.</p>
<p>U1451A</p> 	<p>Change the resolution count to high. To permanently enable change the resolution count. See “Changing the display count” on page 76.</p>
<p>U1452A/U1452AT</p> <p>Log</p> 	<p>Tests the LCD. All LCD annunciators are lighted. Press any key to exit this mode.</p>
	<p>Tests the LCD. All LCD annunciators are lighted. Press any key to exit this mode.</p>

THIS PAGE HAS BEEN INTENTIONALLY LEFT BLANK.

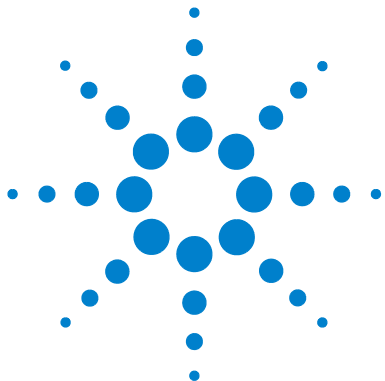

2 Making Measurements

Insulation Resistance Test	30
Using the Remote Switch Probe	32
Locking the test	33
Timed insulation resistance/earth-bond resistance test	34
Measuring the Dielectric Absorption Ratio (DAR)	35
Measuring the Polarization Index (PI)	36
Viewing the leakage current	37
Earth-Bond Resistance Test	38
Measuring AC or DC Voltage	41
Auto AC or DC signal identification	43
Measuring Frequency	44
Measuring Resistance	46
Continuity Test	48
Measuring Capacitance	50







The following sections describe how to take measurements with your tester.



Insulation Resistance Test

Set up your tester as shown in [Figure 2-1](#). Set the rotary switch to a test voltage value that does not exceed the maximum voltage limitation of the circuit under test. Ensure that the device-under-test (DUT) is de-energized before performing any resistance measurement.

Table 2-1 Rotary switch position for insulation resistance tests

Legend	Default function		Function when  is pressed	
Rotary switch position	Primary display	Secondary display	Primary display	Secondary display
	50 V insulation resistance test			
	100 V insulation resistance test			
	250 V insulation resistance test		AC+DC V or DC V (during test)	AC+DC V or DC V (during test)
	500 V insulation resistance test			
	1000 V insulation resistance test			

CAUTION

- **DO NOT** perform insulation resistance test in distribution systems with voltages higher than 600 V.
- The tester automatically detects if the circuit is energized. If the external voltage is detected to be greater than 30 V (or 50 V or 75 V; depending on selected option in Setup), the test is inhibited. The symbol ⚡ is shown on the display when either the external voltage or the test voltage is greater than 30 V. Disconnect the tester and remove the power of the circuit before proceeding.

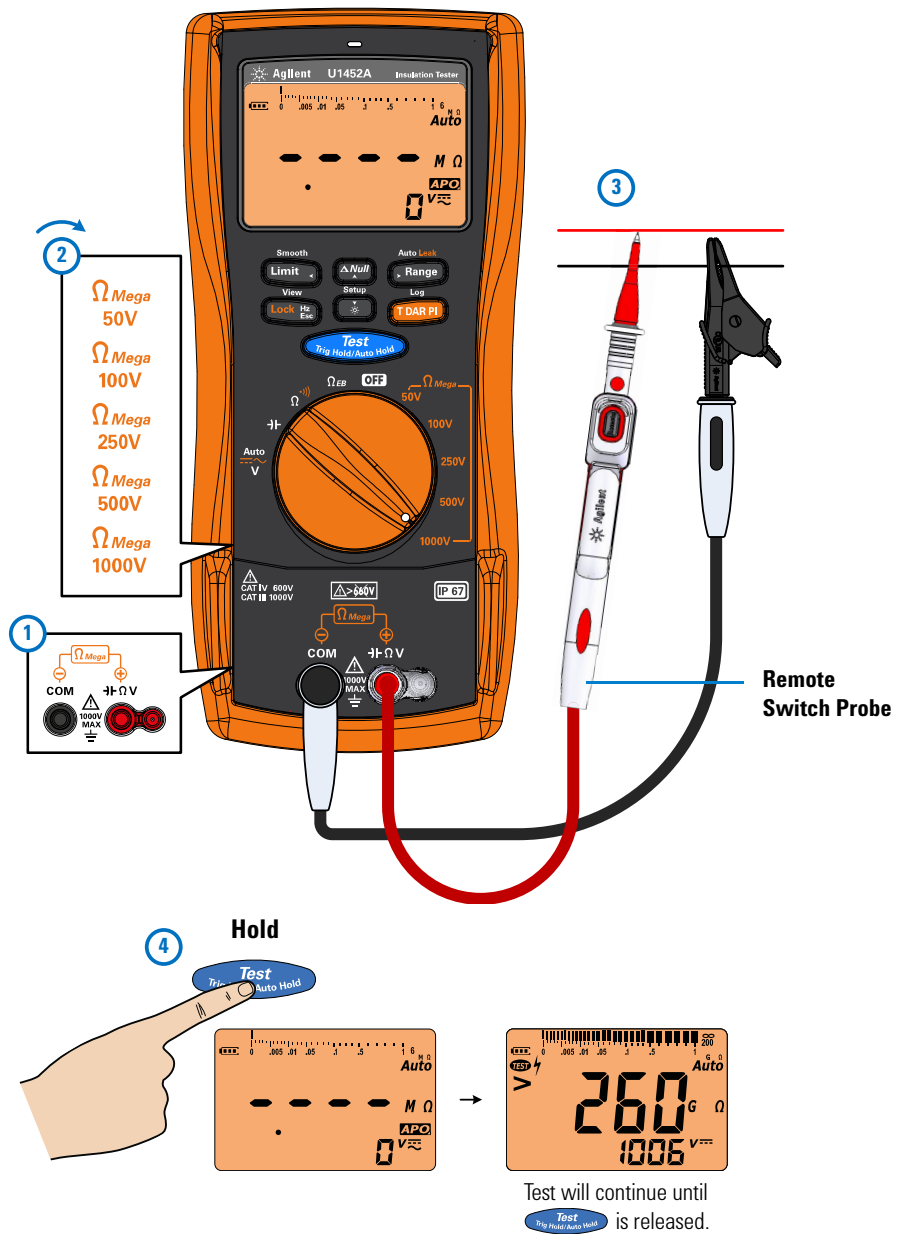

Figure 2-1 Insulation resistance test example

2 Making Measurements

Insulation Resistance Test

CAUTION

The insulation meter will auto-discharge the DUT when the test complete. However, the DUT will not be auto-discharged when you disconnect the probe before the test is complete. Avoid touching the DUT when the DUT is not fully discharged as it may lead to possible electric shock.

NOTE

When an insulation test is in progress, the red LED indicator at the top of the tester will blink every 2 seconds (if the Limit function is not enabled). To disable this feature see “Power-on options” on page 26.

Using the Remote Switch Probe

The Remote Switch Probe (included in shipment) is used with insulation resistance tests and earth-bond resistance tests, enabling the tester to be controlled remotely from the button on the Remote Switch Probe.

By default the button on the Remote Switch Probe emulates the

Test
Trig Hold/Auto Hold

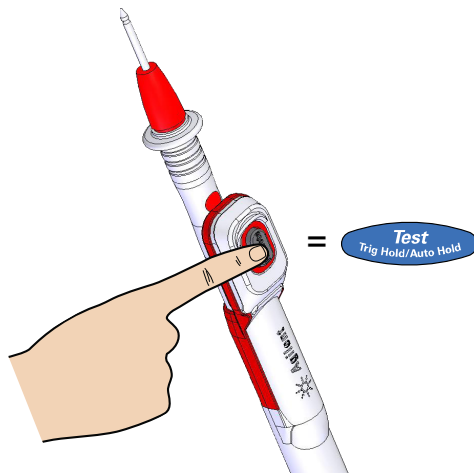

To change the default button operation, see “Changing the button operation on the remote switch probe” on page 82

Locking the test

You can lock the insulation resistance tests or earth-bond resistance tests temporarily.

Press **Lock Hz Esc** to enable the *lock once* feature. The **Lock** symbol will be shown on the display. The test will start when you press **Test Trg Hold/Auto Hold**, and it remain active until **Test Trg Hold/Auto Hold** or **Lock Hz Esc** is pressed again.

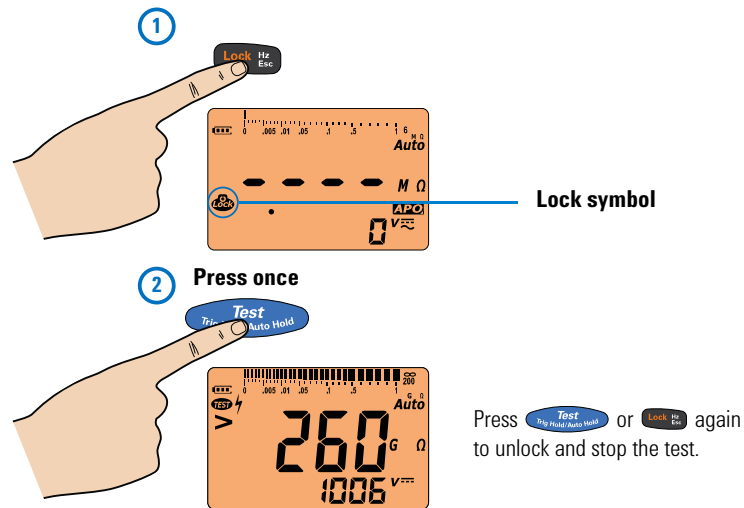

By default, the tester will reset the locked status when the test is stopped by pressing **Test Trg Hold/Auto Hold** or **Lock Hz Esc**. See “[Changing the Dielectric Absorption Ratio \(DAR\) for IR tests](#)” on page 83 to disable this feature.

If you disable this feature, you will need to press **Lock Hz Esc** to unlock the tester, even if the test has already stopped.

Timed insulation resistance/earth-bond resistance test

Use the timed test to obtain measurement results with consistent test times – for later comparisons. Set up your tester as shown in Figure 2-1, and follow the steps shown below.

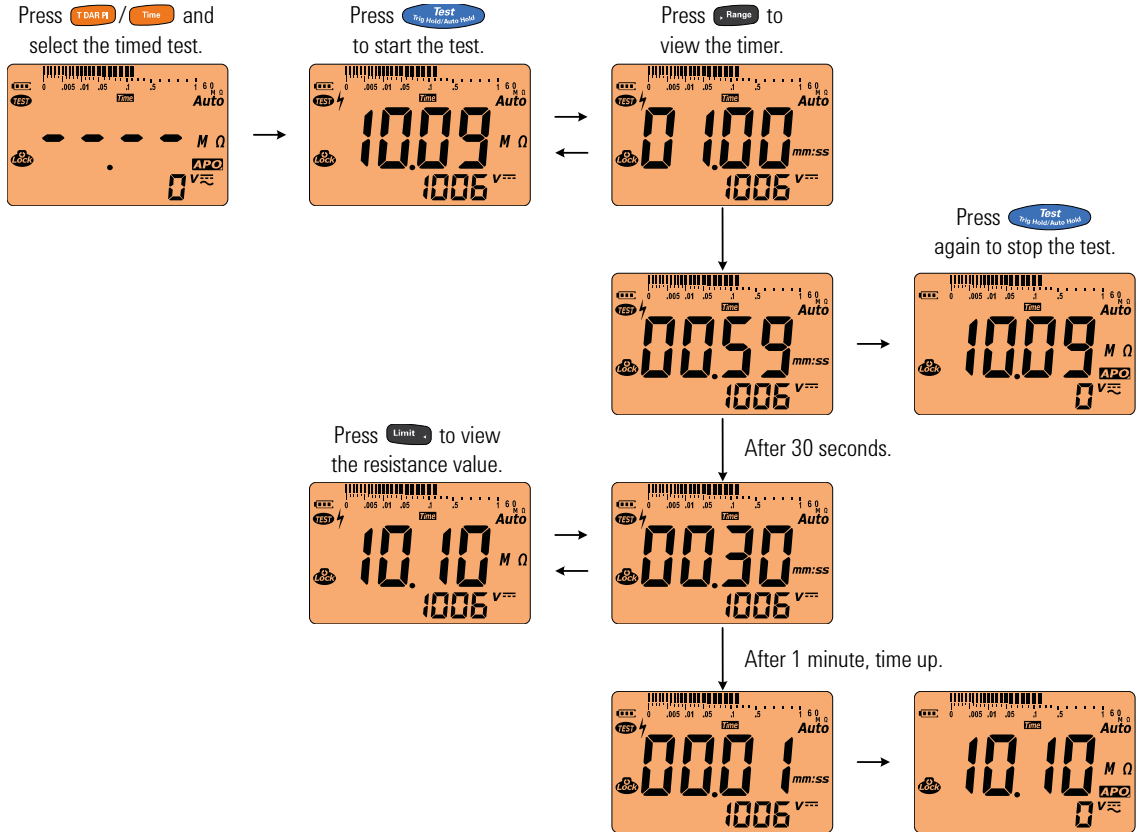

Figure 2-2 T/Time operation

Measuring the Dielectric Absorption Ratio (DAR)

Dielectric Absorption Ratio (DAR) is the ratio of the insulation resistance tested at 60 seconds to the insulation resistance tested at 30 seconds. Set up your tester as shown in **Figure 2-1**, and follow the steps shown below.

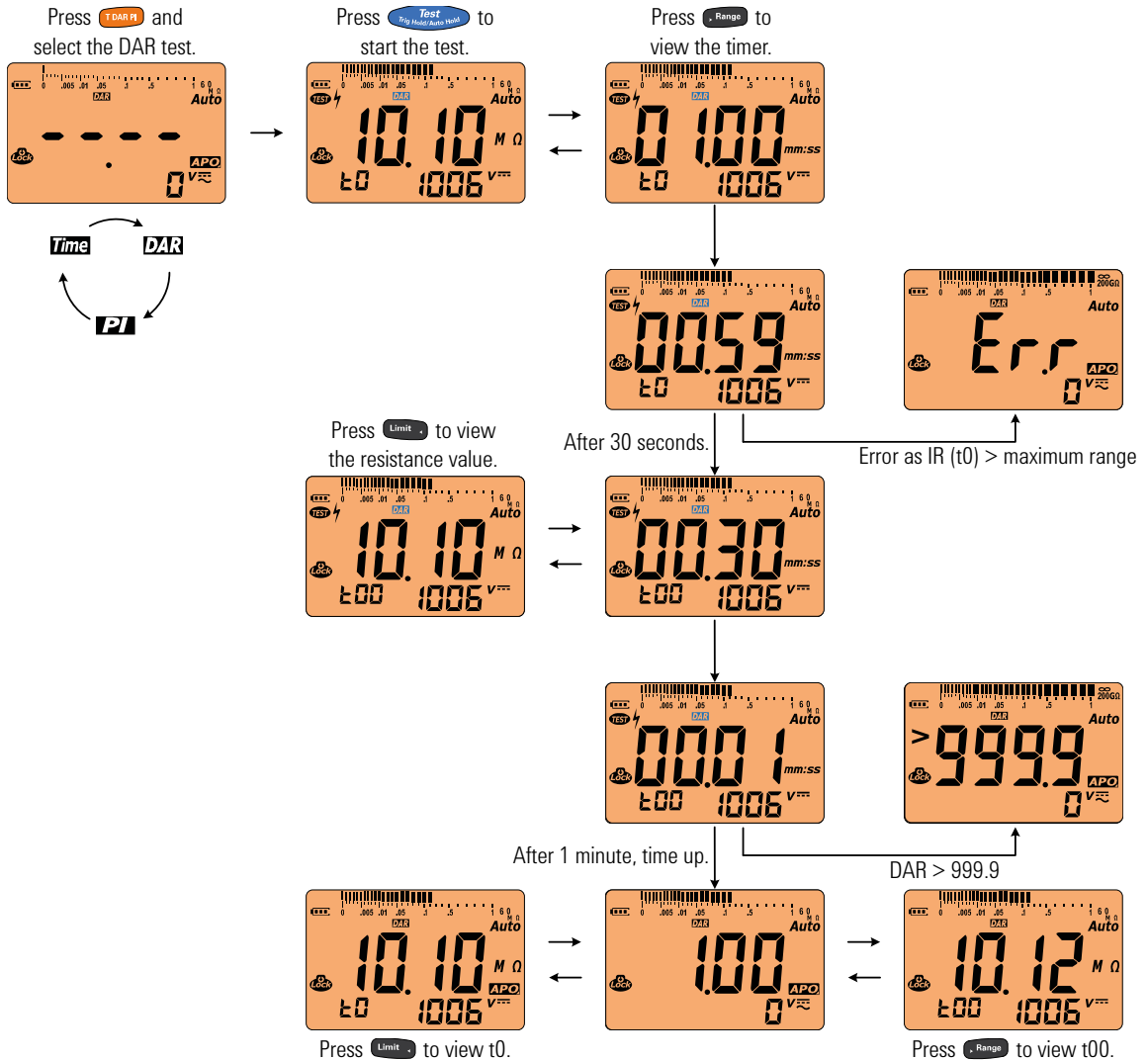

Figure 2-3 DAR operation

Measuring the Polarization Index (PI)

Polarization Index (PI) is the ratio of the insulation resistance tested at 10 minutes to the insulation resistance tested at 1 minute. Set up your tester as shown in **Figure 2-1**, and follow the steps shown below.

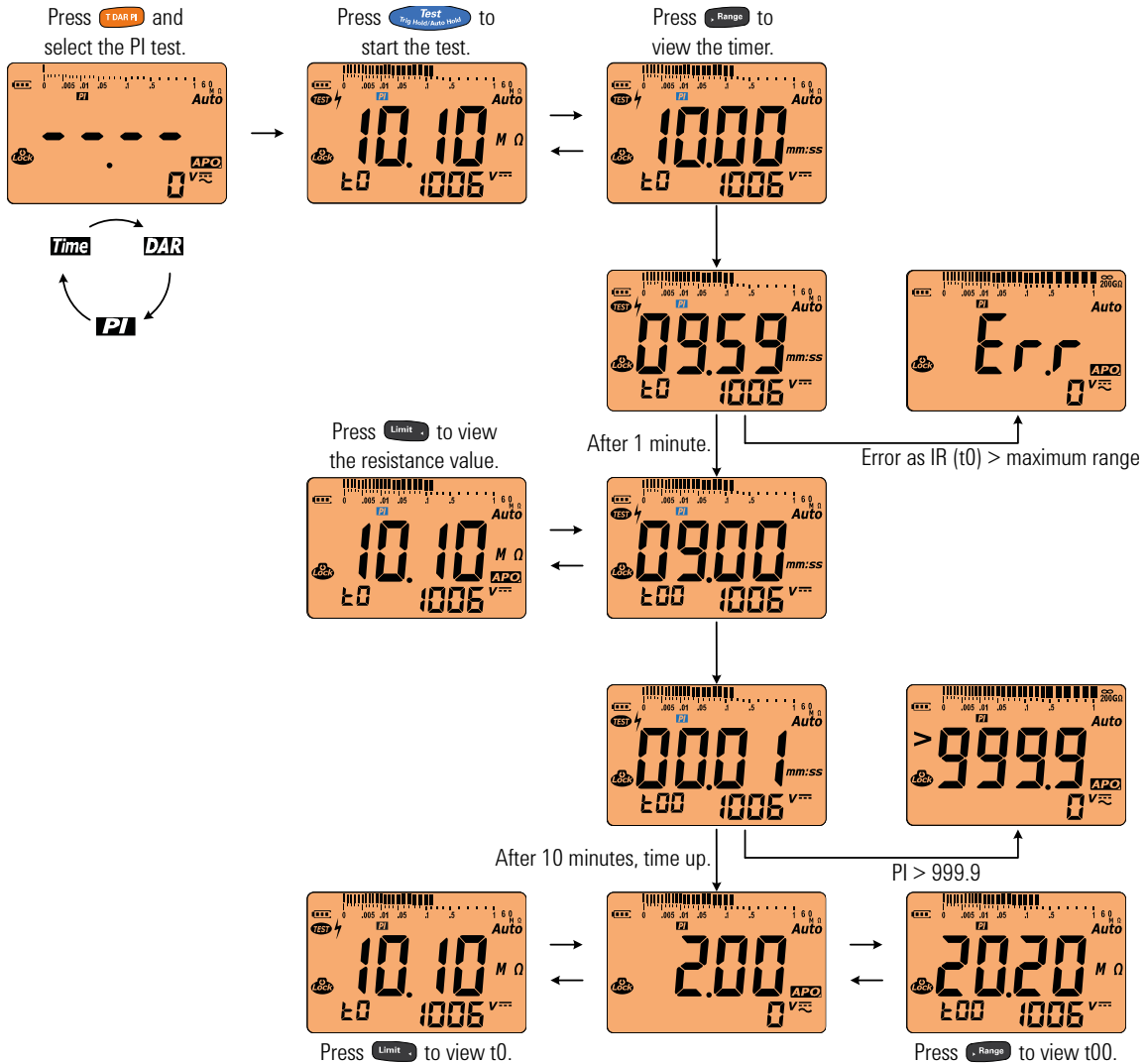

Figure 2-4 PI operation

NOTE

- Because of the time required to perform the T, PI, and DAR tests, the use of alligator test clips is recommended.
- For timed (page 34) tests, The length of the timer is 1 minute by default. To change this value, see “Changing the IR and EBR test period” on page 80 for more information.
- For DAR (page 35) tests, you can change the DAR from 60:30 to 60:15 in the Setup. See “Changing the Dielectric Absorption Ratio (DAR) for IR tests” on page 83 for more information.
- For DAR (page 35) and PI (page 36) tests, **Err** is shown on the display if the IR is greater than the maximum range or less than 0.001 MΩ; if the test is interrupted by the user; or if the tester’s battery is low.

Viewing the leakage current

Press **Range** to view the leakage current display. The leakage current display is related to the insulation resistance. The higher the resistance tested, the lower the current is to be measured.

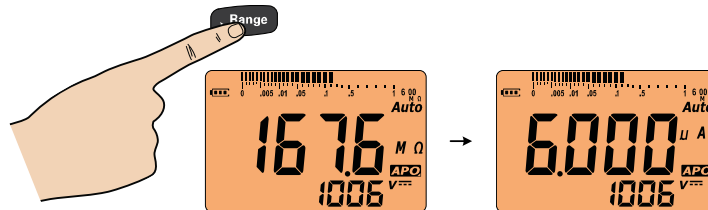

Earth-Bond Resistance Test

Set up your tester to perform earth-bond resistance tests as shown in [Figure 2-5](#).

Table 2-2 Earth-bond resistance test position

Legend	Default function		Function when  is pressed	
Rotary switch position	Primary display	Secondary display	Primary display	Secondary display
Ω_{EB}	Earth-bond resistance test	AC+DC V or DC V (during test)	Timed (T) test	AC+DC V or DC V (during test)

CAUTION

- To avoid possible damage to your tester or to the equipment under test, disconnect the circuit power and discharge all high-voltage capacitors before measuring resistance.
- The tester automatically detects if the circuit is energized. If the external voltage is detected to be greater than 2 V, the test will not start. Disconnect the tester and remove power before proceeding.

NOTE

- The earth-bond resistance function is used to measure the resistance between earth conductors, protective earth conductors, and conductors for equipotential bonding; including their connections and terminals; with an indication of the measured value or indication of limits.
- The voltage source is <6.8 V, and the current is >200 mA when the resistance of $\leq 2 \Omega$ is to be measured. When the source voltage is <4.7 V, the tester will inhibit the test automatically. The secondary display indicates the voltage (with auto-ranging enabled).
- The APO (auto power-off) function is disabled during the test.
- See also “[Timed insulation resistance/earth-bond resistance test](#)” on page 34.

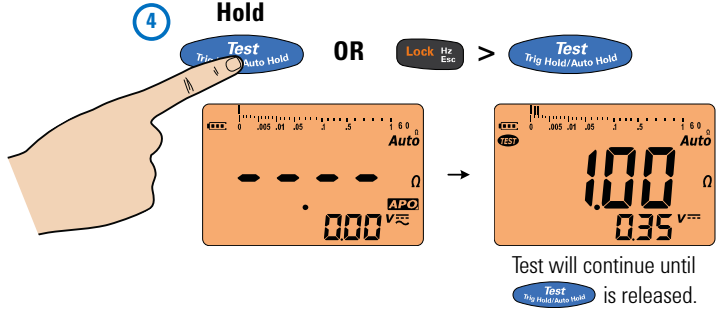
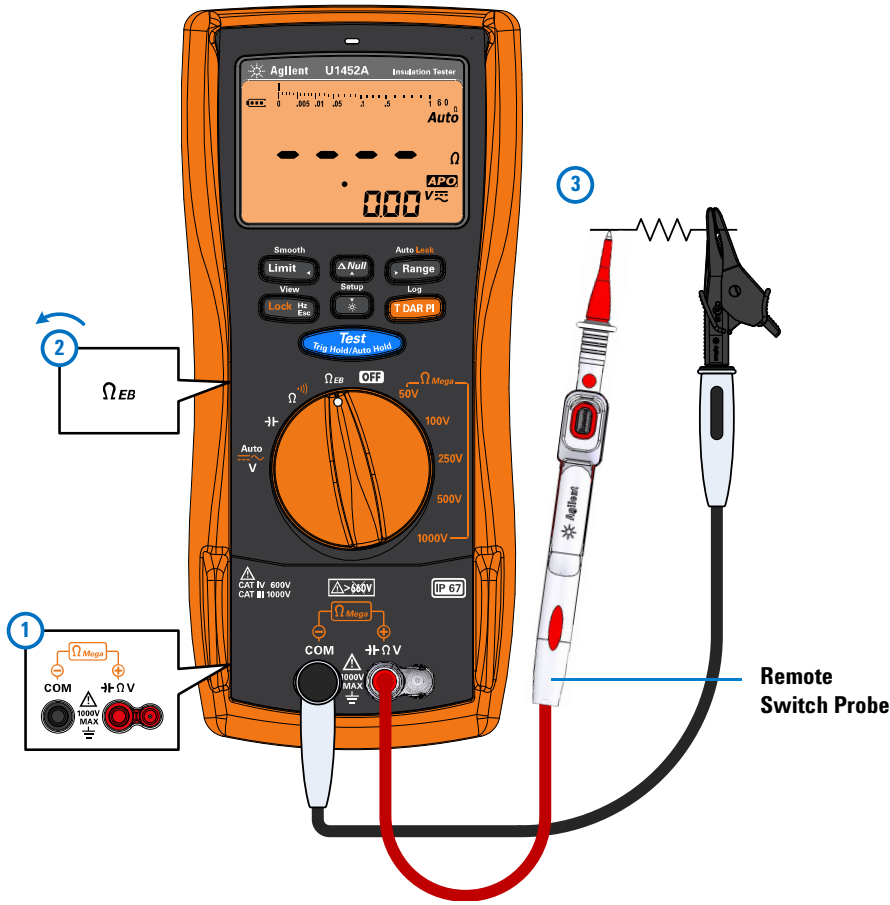



Figure 2-5 Earth-bond resistance test example

2 Making Measurements

Earth-Bond Resistance Test

Using the earth-bond resistance test to verify the fuse condition

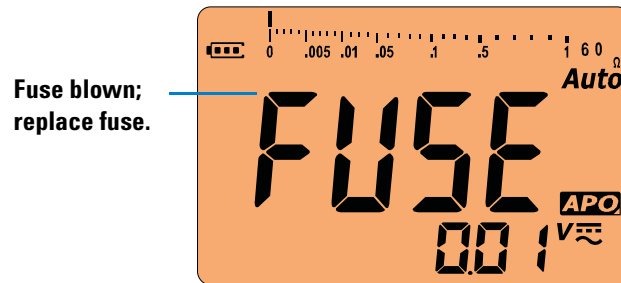

- 1 Keep the test leads open, and ensure that no voltage is applied to the terminals.
- 2 Press and hold  to verify the fuse condition.
- 3 If the fuse has been blown, **FUSE** will be shown on the display. Follow the instructions in the *U1452A/U1452AT/U1451A Service Guide* to replace the fuse.



Measuring AC or DC Voltage

Set up your tester to measure AC or DC voltage as shown in [Figure 2-6](#).

Table 2-3 AC and DC voltage measurement positions

Legend	Default function		Function when  is pressed	
Rotary switch position	Primary display	Secondary display	Primary display	Secondary display
	Auto (V)	AC+DC V	<i>Cycles between</i>	
			1 DC V	1 AC+DC V
			2 AC V	2 AC+DC V
			3 Auto (V)	3 AC+DC V

NOTE

- This tester displays DC voltage values as well as their polarity. Negative DC voltages will return a negative sign on the left of the display.
- Press  to measure the frequency of the voltage source. See [“Measuring Frequency”](#) on page 44 to learn more.

2 Making Measurements

Measuring AC or DC Voltage

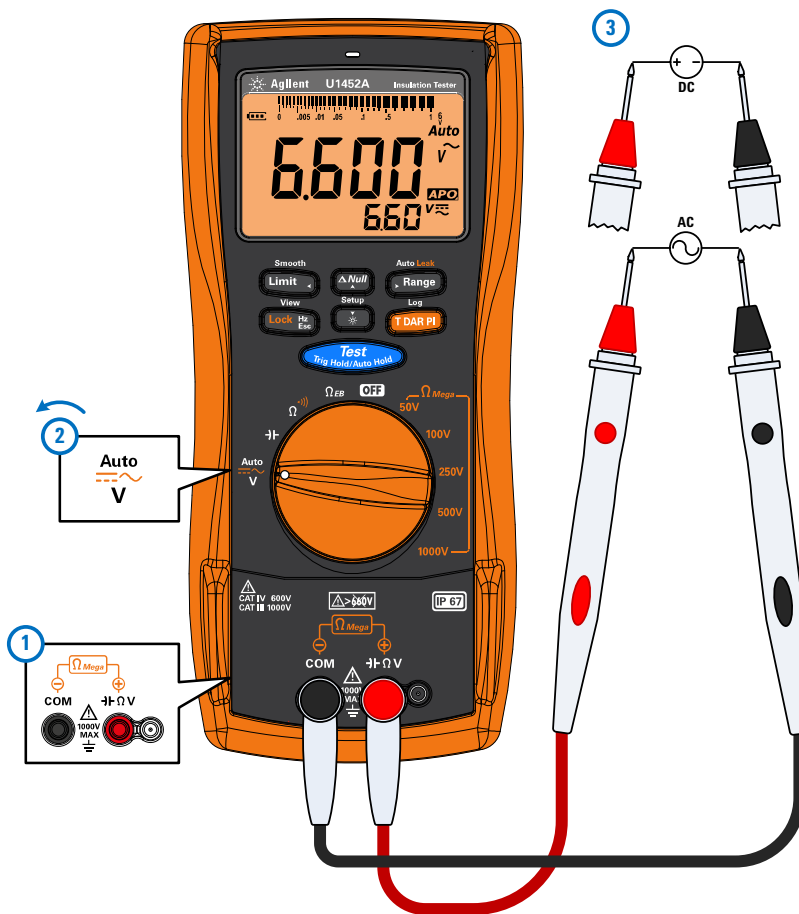
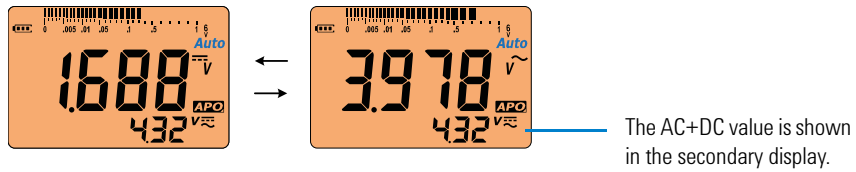

Figure 2-6 AC or DC voltage measurement example

Auto AC or DC signal identification

The **Auto** function is able to automatically identify the signal component (AC or DC) of an electrical source and select a suitable measurement range according to the AC+DC reading.

The symbol **Auto** blinks during the identification.



The **Auto** function identifies the signal component using the following rules:

- It will consider which component value is greater between the AC or DC.
- The AC value should be greater than a minimum value of 50 counts (based on 6000 counts) of range to prevent residual value due to range changing.
- The frequency measured is greater than 10 Hz for the AC mode.

While the signal is being identified, you can press **T/DAR/PI** to lock the (AC or DC) signal on the primary display.

At any time, you can press **Range** to stop the **Auto** function and lock the identified signal component (AC or DC).

Measuring Frequency

Your tester allows simultaneous monitoring of real-time voltage with frequency measurements. To measure frequency, rotate the switch to measure voltage (see [Figure 2-6](#)) and set up the tester accordingly.

Press . Probe the test points, and read the display.

WARNING

Never measure the frequency where the voltage level exceeds the specified range. Manually set the voltage range if you want to measure frequencies below 20 Hz.

NOTE

- Pressing  controls the input range of the voltage function and not the frequency range.
- To obtain the best measuring results for frequency measurements, please use the AC measuring path.

Frequency measurement techniques

- Measuring the frequency of a signal helps detect the presence of harmonic currents in neutral conductors and determines whether these neutral currents are the result of unbalanced phases or non-linear loads.
- Frequency is the number of cycles a signal completes each second. Frequency is defined as $1/\text{Period}$. Period is defined as the time between the middle threshold crossings of two consecutive, like-polarity edges, as shown in [Figure 2-7](#).
- The tester measures the frequency of a voltage signal by counting the number of times the signal crosses a threshold level within a specified period of time.
- If a reading shows as 0 Hz or is unstable, the input signal may be below or near the trigger level. You can usually correct these problems by manually selecting a lower input range, which increases the sensitivity of the tester.

- If a reading seems to be a multiple of what you expect, the input signal may be distorted. Distortion can cause multiple triggerings of the frequency counter. Selecting a higher voltage range might solve this problem by decreasing the sensitivity of the tester. In general, the lowest frequency displayed is the correct one.
- The frequency of the input signal is shown in the primary display. The voltage value of the signal is shown in the secondary display. The bar graph does not indicate frequency but indicates the voltage value of the input signal.

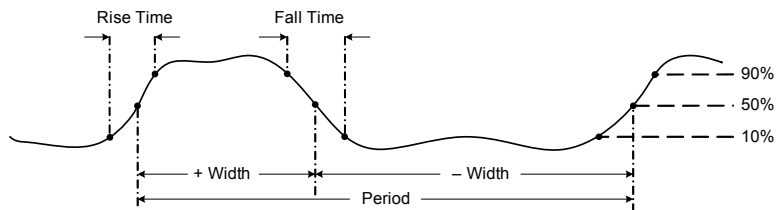



Figure 2-7 Definition of frequency

Measuring Resistance

Set up your tester to measure resistance as shown in Figure 2-8.

Table 2-4 Resistance measurement position

Legend	Default function		Function when  is pressed	
	Primary display	Secondary display	Primary display	Secondary display
	Resistance	-	Continuity	-

CAUTION

To avoid possible damage to your tester or to the equipment under test, disconnect the circuit power and discharge all high-voltage capacitors before measuring resistance.

NOTE

Resistance (opposition to the current flow) is measured by sending a small current out through the test leads to the circuit under test. Because this current flows through all possible paths between the leads, the resistance reading represents the total resistance of all paths between the leads. Resistance is measured in ohms (Ω).

Keep the following in mind when measuring resistance.

- The test leads can add 0.1 Ω to 0.2 Ω of error to resistance measurements. To test the leads, touch the probe tips together and read the resistance of the leads. To remove lead resistance from the measurement, hold the test lead tips together and press . Now the resistance at the probe tips will be subtracted from all future display readings.
- Because the tester's test current flows through all possible paths between the probe tips, the measured value of a resistor in a circuit is often different from the resistor's rated value.

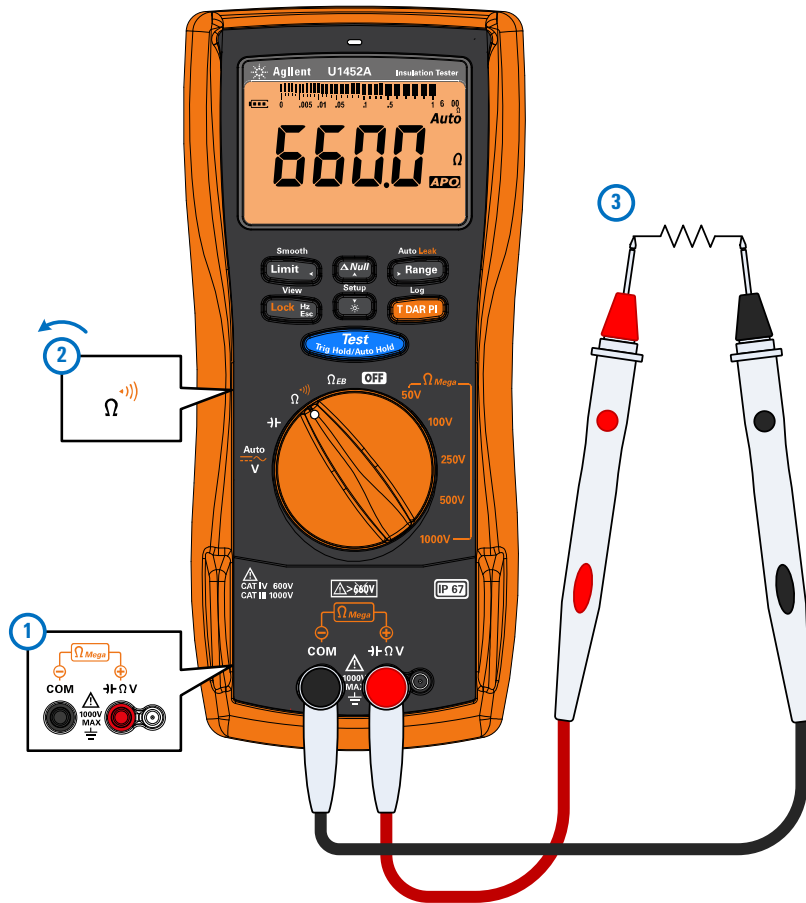



Figure 2-8 Resistance measurement example

Continuity Test

Set up your tester to perform continuity tests as shown in [Figure 2-9](#). The beeper will sound and the red will light LED up as a continuity indication.

Table 2-5 Continuity test position

Legend	Default function		Function when  is pressed	
	Primary display	Secondary display	Primary display	Secondary display
	Resistance	-	Continuity	-

CAUTION

To avoid possible damage to your tester or to the equipment under test, disconnect the circuit power and discharge all high-voltage capacitors before testing for continuity.

NOTE

- Continuity is the presence of circuit continuities. The beeper sounds as the resistance falls down to the threshold, and the red LED indicator will be lit (if enabled in the Setup). The audible and visual alert allows you to perform quick continuity tests without having to watch the display.
- The continuity function detects intermittent shorts and opens. A brief short causes the tester to emit a short beep.
- You can enable or disable the audible alert via the Setup. See [“Changing the continuity alert”](#) on page 74 for more information on the audible alert option.

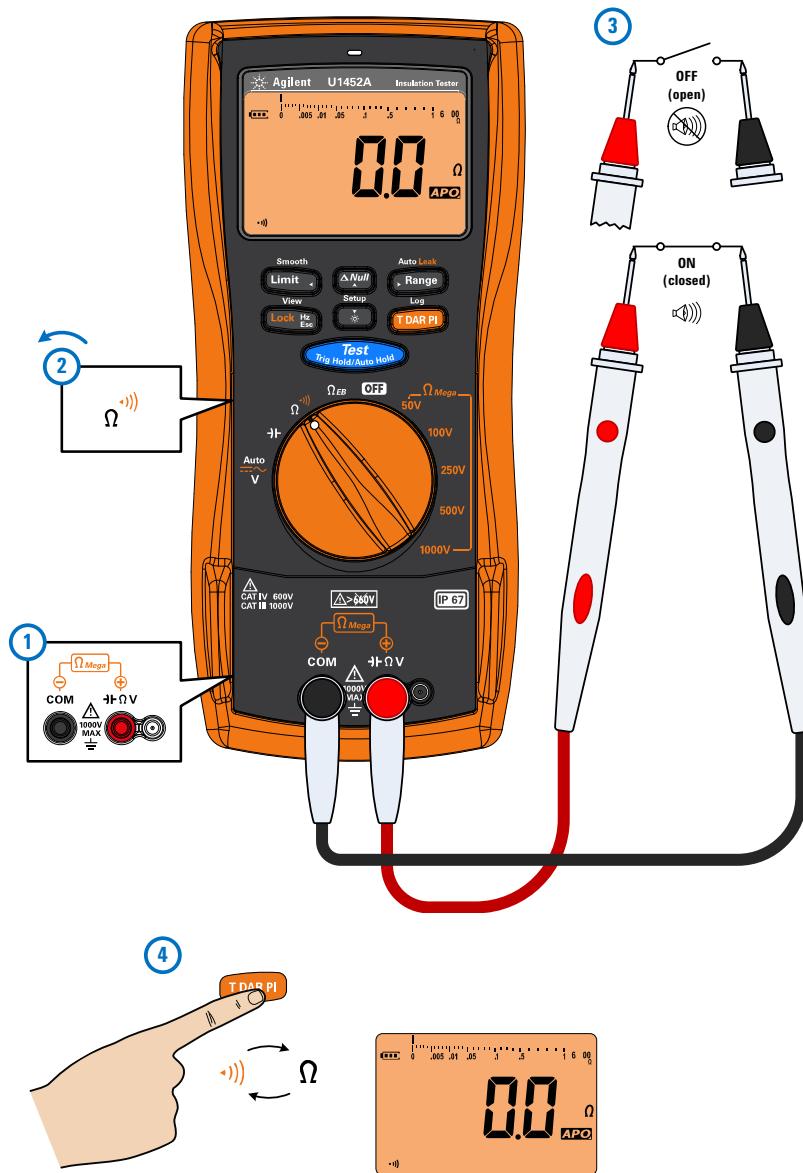



Figure 2-9 Continuity test example

Measuring Capacitance

Set up your tester to measure capacitance as shown in [Figure 2-10](#). The cable length of the circuit under test is shown in the secondary display.

- The default cable length scale is 1 km per 40 nF (km/C). To change this value, see [“Changing the cable length scale”](#) on page 78.
- You can also change the cable length unit (Meter or Feet). To change this value, see [“Changing the cable length unit”](#) on page 77.

Table 2-6 Capacitance measurement position

Legend	Default function		Function when  is pressed	
	Primary display	Secondary display	Primary display	Secondary display
	Capacitance	Cable length	-	-

CAUTION

To avoid possible damage to the tester or to the equipment under test, disconnect circuit power and discharge all high-voltage capacitors before measuring capacitance. Use the DC voltage function to confirm that the capacitor is fully discharged.

NOTE

- The tester measures capacitance by using an AC sine wave.
- The resistance of the test leads will impact the accuracy of the measurement. It is recommended to use short leads to measure capacitance.
- The test frequency is 54.5 Hz.

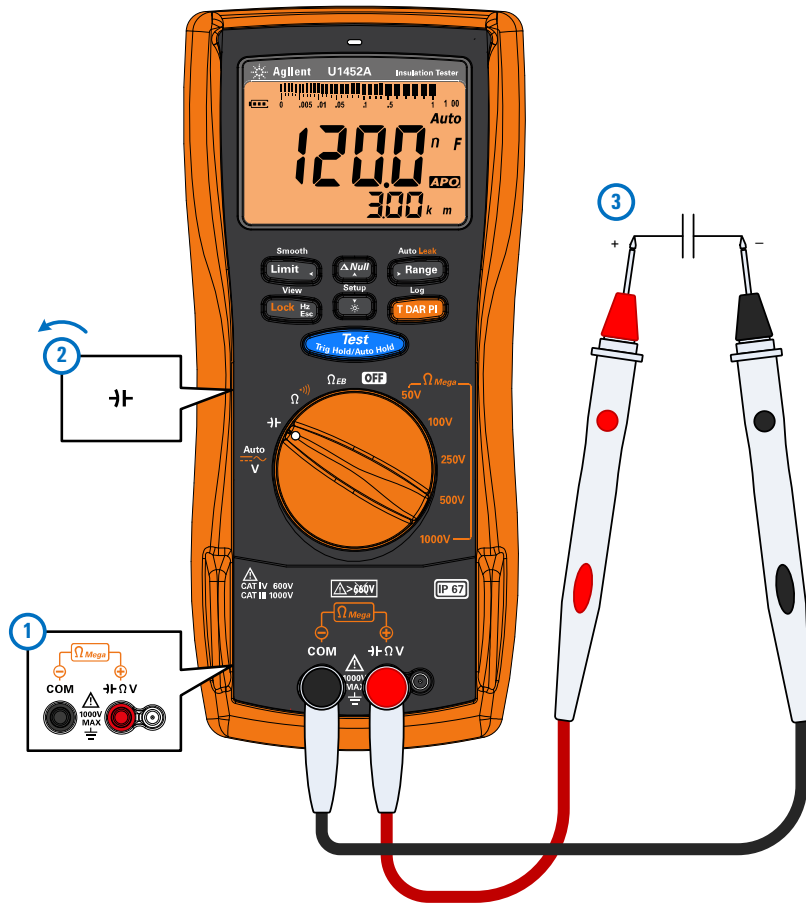

Figure 2-10 Capacitance measurement example

2 Making Measurements

Measuring Capacitance

THIS PAGE HAS BEEN INTENTIONALLY LEFT BLANK.



3 Tester Features

Making Relative Measurements (Null)	54
Freezing the Display (TrigHold and AutoHold)	55
Performing Limit Comparisons (Limit)	57
Recording Measurement Data (Log)	59
Performing manual logs (HAND)	60
Performing interval logs (AUTO)	60
Performing event logs (TRIG)	61
Reviewing Previously Recorded Data (View)	63

The following sections describe the additional features available in your tester.



3 Tester Features

Making Relative Measurements (Null)

Making Relative Measurements (Null)

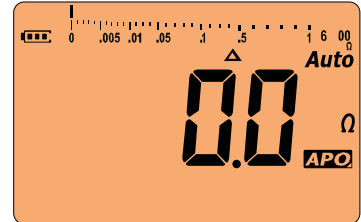

When making null measurements, also called relative, each reading is the difference between a stored (selected or measured) null value and the input signal.

One possible application is to increase the accuracy of a resistance measurement by nulling the test lead resistance.





NOTE

Null can be set for both auto and manual range settings, but not in the case of an overload.

- 1 To activate Null, press . The measurement value at the time that when Null (Δ) is enabled, is stored as the reference value.
- 2 Press  again to view the stored reference value (the Δ annunciator blinks). The display will return to normal after 3 seconds.
- 3 To disable Null, press  while the stored reference value is shown (step 2).

For any measurement function, you can directly measure and store the null value by pressing  with the test leads open (nulls the test lead capacitance), shorted (nulls the test lead resistance), or across a desired null value circuit.

NOTE

- In resistance measurement, the tester will read a non-zero value even when the two test leads are in direct contact, because of the resistance of these leads. Press  to zero-adjust the display.
- For DC voltage measurements, the thermal effect will influence the accuracy of the measurements. Short the test leads and press  when the displayed value is stable to zero-adjust the display.

Freezing the Display (TrigHold and AutoHold)

TrigHold operation

Press  to freeze the display for any function, except for the Ω Mega or the Ω EB function.

Press  again to trigger a new reading. The **Hold** annunciator blinks while waiting for the reading to be stable.

Press and hold  to exit this mode.

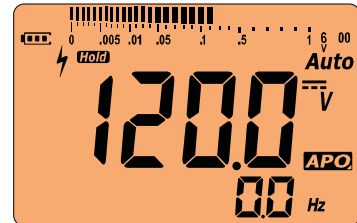

NOTE

Pressing  when the rotary switch is in one of the Ω Mega or the Ω EB position will result in a test being performed instead.

AutoHold operation

Press and hold  to activate AutoHold for any function, except for the Ω Mega or the Ω EB function.

AutoHold monitors the input signal and updates the display and, if enabled, emits a beep, whenever a new stable measurement is detected. The **Hold** annunciator blinks while waiting for the reading to be stable.

Press and hold  to exit this mode.

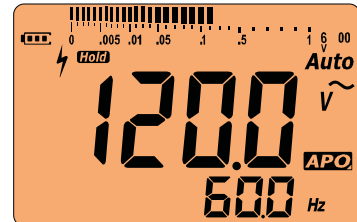

NOTE

Pressing and holding  when the rotary switch is in one of the Ω Mega or the Ω EB position will result in a test being performed instead.

3 Tester Features

Freezing the Display (TrigHold and AutoHold)

A trigger point is one that varies more than a selected adjustable (AutoHold threshold) variation count (default 500 counts). The following conditions are not included in the update.

Function	None updated counts
Voltage	50
Resistance	OL or Open
Capacitance	50

To change the default AutoHold threshold count see [“Changing the variation count”](#) on page 71 for more information.

NOTE

If the reading value is unable to reach a stable state, the reading value will not be updated.

Performing Limit Comparisons (Limit)

Limit is used to compare the test result with the chosen settling value. The default settling values are shown in the table below.

You can set pass condition to be > or < the value measured.

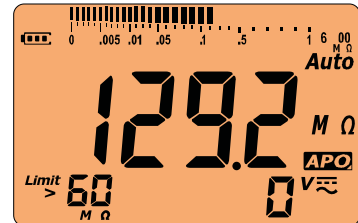

Table 3-1 Limit settling default values

Function	Default value	Range	Limit settling range
Voltage measurement ^[1]	>30 V	Auto or Manual	1 V < LS < 900 V
Resistance measurement	<10 Ω	Auto or Manual	1 Ω < LS < 90 MΩ
Capacitance measurement ^[2]	>10	Range locked	10 < LS < 900
Earth-bond resistance test	<10 Ω	Auto	1 Ω < LS < 90 kΩ
Insulation resistance test	>10 MΩ	Auto	1 kΩ < LS < 90 GΩ

[1] Absolute value comparison, regardless of polarity.

[2] Limit for capacitance is represented without a unit.

- 1 Press **Limit** to activate Limit.
- 2 Press **Limit** again to set the comparison value. Use the arrow keys to position the cursor and to change the value shown.

The most significant digit can be set to a value from 1 to 9. The remaining two digits can be set to 0, 00, or left blank along with any unit combination (see [Table 3-1](#)).

- 3 Position the cursor on the > annunciator to change the Limit pass condition (< or >).
- 4 Press **T DAR Pt** to save your changes (or press **Lock Hr Esc** to discard your changes).

3 Tester Features

Performing Limit Comparisons (Limit)

- 5 If the new value is passed:
 - *PAS* is shown
 - A short beep tone is heard
 - The red LED blinks once
- 6 If the new value is failed:
 - *FR* is shown
 - Three short beep tones are heard
 - The red LED blinks thrice

NOTE

When the Limit feature is enabled for insulation resistance tests, the red LED indicator lights up accordingly to the changes in the limit values instead of blinking every 2 seconds.

Recording Measurement Data (Log)

Log provides you with the convenience of recording test data for future review or analysis. Since data is stored in the nonvolatile memory, the data remains saved even when the tester is turned OFF or if the battery is replaced.

Log collects measurement information over a user-specified duration. There are three Log options that can be used to capture measurement data: manual (**HAND**), interval (**AUTO**), or event (**TRIG**).

- A manual log stores an instance of the measured signal each time you press and hold  (see [page 60](#)).
- An interval log stores a record of the measured signal at a user-specified interval (see [page 60](#)).
- An event log stores a record of the measured signal each time a trigger condition is satisfied (see [page 61](#)).

Table 3-2 Log maximum capacity

Log option	Maximum capacity for saving
Manual (HAND)	H00 to H99 (100 entries)
Interval (AUTO)	A00 to A99 (100 entries)
Event (TRIG)	E00 to E99 (100 entries)

NOTE

Each recorded index includes two parameters: the primary display and the secondary display. Examples include IR-V or V-Hz.

Before starting a recording session, set up the tester for the measurements to be recorded.

To change the Log option see “[Changing the recording option](#)” on page 80 for more information.

See “[Reviewing Previously Recorded Data \(View\)](#)” on page 63 to review or erase the recorded entries.

3 Tester Features

Recording Measurement Data (Log)

Performing manual logs (HAND)

Ensure that *Hand* is selected as the Log option in the Setup.

- 1 Press and hold  to store the present input signal value.

LOG and the log entry number are displayed. The display will return to normal after a short while (around 1 second).

- 2 Repeat [step 1](#) again to save the next input signal value.

The maximum number of readings that can be stored for the manual log is 100 entries. When all entries are occupied, *HFL* will be shown when you press and hold .

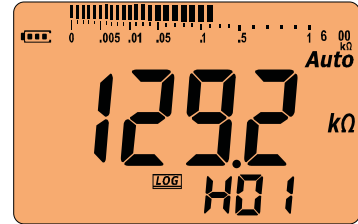

Performing interval logs (AUTO)

Ensure that *Auto* is selected as the Log option in the Setup.

The default recording interval duration is 1 second. To change the recording interval duration, see [“Changing the sample interval duration”](#) on page 79 for more information.

The duration set in the Setup will determine how long each recording interval takes. The input signal value at the end of each interval will be recorded and saved into the tester’s memory.

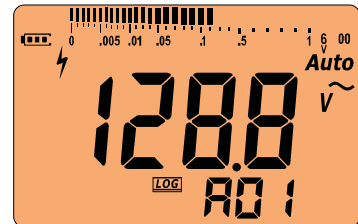

Start the interval log mode

- 1 Press and hold  to start interval log mode.

LOG and the log entry number are displayed. Subsequent readings are automatically recorded into the tester’s memory at the interval specified in the Setup.

- 2 Press and hold  again to exit the interval log mode.

The maximum number of readings that can be stored for the interval log is 100 entries. When all entries are occupied, *AFU* will be shown when you press and hold .

NOTE

When the interval log recording session is running, all other keypad operations are disabled; the exception is , which, when pressed for more than 1 second, will stop and exit the recording session. Furthermore, APO (auto power-off) is disabled during the recording session.

Performing event logs (TRIG)

Ensure that *TRIG* is selected as the Log option in the Setup.

Event logs are used only with the following modes:

- TrigHold and AutoHold (page 55)
- Earth-bond resistance tests (page 38)
- Insulation resistance tests (page 38)
- T/DAR/PI tests (page 30)

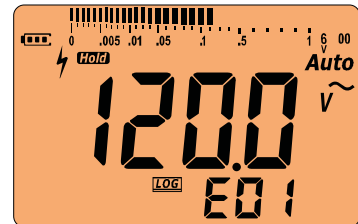

Event records are triggered by the measured signal satisfying a trigger condition set by the measurement function used in the following modes:

Table 3-3 Event log trigger conditions

Modes	Trigger condition	Primary display recorded	Secondary display recorded
	<i>The input signal value is recorded:</i>		
TrigHold	Each time you press  and the reading update is stable.	Voltage, resistance, or capacitance	Voltage, frequency, capacitance cable length, or output source voltage
AutoHold	When the input signal varies more than the variation count and the reading update is stable.	Voltage, resistance, or capacitance	Voltage, frequency, capacitance cable length, or output source voltage

3 Tester Features

Recording Measurement Data (Log)

Table 3-3 Event log trigger conditions (continued)

Modes	Trigger condition	Primary display recorded	Secondary display recorded
Earth-bond resistance test	Each time you press  to stop the test output source.	Resistance or leak current value	Test output source voltage
Insulation resistance test			
T/Time	When the time is up (Timer = 00:00), the final value is recorded before the test output source is stopped.	Resistance or leak current value	Test output source voltage

NOTE

The values of DAR t30 (or DAR t15), DAR t60, PI t1, and PI t10 will be recorded in every IR rotary switch location. For more information on DAR and PI tests, see [page 35](#) and [page 36](#) respectively.

Start the event log mode

- 1 Select one of the modes listed in [Table 3-3](#).
- 2 Press and hold  to start event log mode.

LOG and the log entry number are displayed. The primary display and secondary display readings will be recorded into the memory. Subsequent readings are automatically recorded into the tester's memory every time the trigger condition specified in [Table 3-3](#) is satisfied.

- 3 Press and hold  again to exit the event log mode.



The maximum number of readings that can be stored for the event log is 100 entries. When all entries are occupied, *EFU* will be shown when you press and hold .

NOTE

APO (auto power-off) is disabled during the recording session.







Reviewing Previously Recorded Data (View)

Viewing data stored in the tester's memory is performed through the  key.

- 1 Press and hold  to View the previously recorded data. Press  again to cycle through the manual (H), interval (I), or event (E) records.

If nothing has been recorded, H--, I--, or E-- will be displayed instead.

- 2 Select the desired recording category to view its entries.

- i Press  to jump to the first stored entry. Press  to jump to the last stored entry.
- ii Press  to view the next stored entry. The index number increases by one. Press  to view the previous stored entry. The index number decreases by one.
- iii Press  to clear the last stored entry for the selected log type. Press and hold  to clear all entries for the selected log type.

- 3 Press and hold  again to exit the View mode.

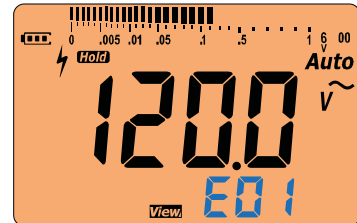

Sanitizing the Log Memories

You have the option to sanitize the log memories of your tester. This operation erases the log memories of your tester thoroughly. The data stored in the tester's memory will not be able to be reconstructed in any way after the data sanitization operation.



Prior to sanitizing the log memories, ensure that all manual (H), interval (I), or event (E) records have been cleared (see [step iii](#)). When all entries are cleared (H--, I--, and E--), press and hold  to sanitize the log memories.

CAUTION

The data sanitization operation may take up to 30 seconds to complete. Do not press any keys or turn the rotary switch until the data sanitization operation is completed.

3 **Tester Features**

Reviewing Previously Recorded Data (View)

THIS PAGE HAS BEEN INTENTIONALLY LEFT BLANK.

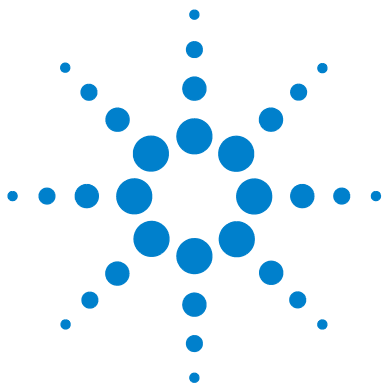

4 Setup Options

Using the Setup Menu	66
Editing numerical values	67
Setup Menu Summary	68
Setup Menu Items	71
Editing numerical values	67
Changing the variation count	71
Enabling smooth mode	71
Changing the beep frequency	72
Changing the auto power-off (APO) timer	73
Changing the LCD backlight timeout	73
Changing the continuity alert	74
Disabling the power-on melody	75
Changing the battery type	75
Resetting the tester's Setup options	76
Changing the display count	76
Changing the cable length unit	77
Changing the cable length scale	78
Changing the alert indicators	78
Changing the sample interval duration	79
Changing the recording option	80
Changing the IR and EBR test period	80
Changing the maximum inhibit voltage for IR tests	81
Disabling the lock once feature	82
Changing the button operation on the remote switch probe	82
Changing the Dielectric Absorption Ratio (DAR) for IR tests	83

The following sections describe how to change the preset features of your tester.





















Using the Setup Menu

The Setup menu allows you to change a number of nonvolatile preset features. Modifying these settings affects the general operation of your tester across several functions. Select a setting to edit in order to perform one of the following actions:

- Switch between two values, such as on or off.
- Cycle through multiple values from a predefined list.
- Decrease or increase a numerical value within a fixed range.

The contents of the Setup menu are summarized in [Table 4-2](#) on page 68.

Table 4-1 Setup menu key functions

Legend	Description
	<ul style="list-style-type: none"> • Press  for more than 1 second to access the Setup menu. • Press and hold  until the tester restarts to exit the Setup menu.
 	<ul style="list-style-type: none"> • Press  or  to browse each menu page.
 	<ul style="list-style-type: none"> • Press  or  at each menu page to move the cursor to a specific menu item.
<p>U1451A</p> 	<ul style="list-style-type: none"> • Press  to edit the selected menu item. The menu item's value will flash to indicate that you can now change the value shown.
<p>U1452A/U1452AT</p> <p>Log</p> 	<ul style="list-style-type: none"> • Press  again to switch between two values, to cycle through multiple values from a list, or to decrease or increase a numerical value. • Press  to save your changes.
	<ul style="list-style-type: none"> • While the menu item's value is flashing, press  to discard your changes.

NOTE

The tester will automatically exit the Setup menu after 30 seconds of inactivity.

Editing numerical values

When editing numerical values, use the **Limit** and **Range** to position the cursor on a numerical digit.

- Press **Limit** to move the cursor to the left, and
- Press **Range** to move the cursor to the right.

When the cursor is positioned over a digit, use the **ΔNull** and **▽** keys to change the numerical digit.

- Press **ΔNull** to increment the digit, and
- Press **▽** to decrement the digit.

When you have completed your changes, save the new numerical value by pressing **T D A R M**. (Or alternatively, if you wish to discard the changes you made, press **Lock Hz Esc**.)

Press and hold **▽** for more than 1 second to enter the Setup menu.

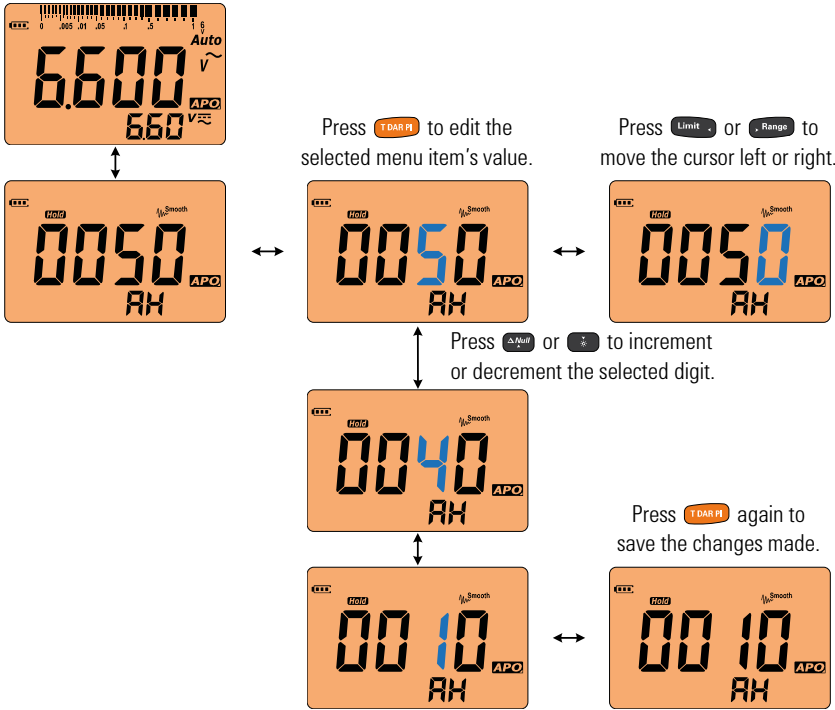

Setup Menu Summary

The Setup menu items are summarized in the table below. Click the respective “Learn more” pages for more information on each menu item.

Table 4-2 Setup menu item descriptions



Legend	Available settings	Description	Learn more on:
 Hold RH	0001 to 9999 counts	Set the AutoHold and Smooth threshold count from 1 to 9999 counts. Default is 0050 counts.	page 71
 SIO	0001 to 9999 (d or E)	Set the settling value from 0001 to 9999. You can also disable this feature (d). Default is disabled (0009 _d).	page 71
bEE	3200 Hz to 4267 Hz, or OFF	Set the beep frequency from 3200 Hz to 4267 Hz. You can also disable this feature (OFF). Default is 3840 Hz.	page 72
APo	01 to 99 minutes (d or E)	Set the auto power-off timer period from 1 to 99 minutes (1 hour, 39 minutes). You can also disable this feature (d). Default is 15 minutes (15 _E).	page 73
bLE	01 to 99 seconds (d or E)	Set the backlight timer period from 1 to 99 seconds (1 minute, 39 seconds). You can also disable this feature (d). Default is 15 seconds (15 _E).	page 73
 tYP	SHor or tonE	Set the tester to sound a single beep (SHor) or a tone (tonE) during continuity alerts for short circuits. Default is a single beep for short circuits (SHor).	page 74
Snd	TELo, USEr, bEEE, or OFF	Set the power-on melody to the factory default (TELo), a beep (bEEE), or disable this feature (OFF). Default is a beep (bEEE).	page 75
bRE	Pr1 or SEC	Change the battery selection from primary (Pr1) to secondary (SEC). Default is primary (Pr1).	page 75
rSE	YES or no	Reset the tester to its factory default settings.	page 76

Table 4-2 Setup menu item descriptions (continued)

Legend	Available settings	Description	Learn more on:
	Hi or Lo	Set the display count to High (Hi) or Low (Lo). Default is Low (Lo).	page 76
	MEtE (m) or Foot (Foot)	Set the cable length unit to Meter (MEtE) or Foot (Foot) for capacitance measurements. Default is MEtE (m).	page 77
	01 to 99 nF/km	Set the capacitance measurement versus cable length scale from 1 to 99 nF/km. Default is 40 nF/km.	page 78
Limit (bELL)	bELL, --rL, bE.--, or --.--	Set the tester to beep momentarily and light up the red LED indicator for limit and continuity alerts. You can also disable either or both alerts (off). Default is to beep momentarily and light up the red LED indicator (bELL).	page 78
LOG t ii	0001 to 9999 seconds	Set the logging duration for interval logs from 1 to 9999 seconds (2 hours, 46 minutes, 39 seconds). Default is 1 second.	page 79
LOG tYP	HRnd, AUtO, or t r iS	Set the data logging option (HRnd: manual log, AUtO: interval log, or t r iS: event log). Default is manual log (HRnd).	page 80
t ii	00.05 to 59.59 mm:ss	Set the insulation resistance or earth-bond resistance test period. Default is 10 seconds (00.10 mm:ss)	page 80
inH	30 V, 50 V, or 75 V	Set the maximum inhibit voltage for insulation resistance test. Default is 30 V.	page 81
onE	YES or no	Enable or disable the lock once feature. Default is enabled (YES).	page 82

4 Setup Options

Setup Menu Summary

Table 4-2 Setup menu item descriptions (continued)

Legend	Available settings	Description	Learn more on:
$rE\bar{1}$	$bE-1$ to $bE-7$ (d or E)	Change or disable the button operation on the remote probe. Default is  ($bE-7E$).	page 82
DAR $E\bar{1}$	60:30 or 60:15 seconds	Set the Dielectric Absorption Ratio in seconds (60:30 or 60:15). Default is 60:30 (seconds).	page 83





Setup Menu Items

Changing the variation count

This setting is used with the AutoHold feature (see [page 55](#)). When the variation of the measured value exceeds the value of the variation count, the AutoHold feature will be ready to trigger.

Legend	Range	Default setting
AH	(0001 to 9999) counts	0050

To change the variation count:

- 1 Press  for more than 1 second to enter the Setup menu.
- 2 Browse to AH (M_{Smooth} and **Hold** are shown on the display), and press  to edit the value.
- 3 Use the arrow keys to change the variation count.
- 4 Press  to save your changes (or press  to discard your changes).
- 5 Press and hold  until the tester restarts to return to normal operation.

Enabling smooth mode

Smooth is used to smoothen the refresh rate of the readings in order to reduce the impact of unexpected noise and to help you achieve a stable reading.





The smooth refresh rate can be set from 0001 to 9999. The smooth time is defined as the set value +1. Smooth will be restarted when the variation count is exceeded, when the range is changed, or after a tester function or feature is enabled. The variation count is set to the value used for the AutoHold feature (see “[Changing the variation count](#)” on page 71).

4 Setup Options

Setup Menu Items

Legend	Range	Default setting
$S_{\bar{r}0}$	<ul style="list-style-type: none"> • 0001 to 9999 • d(isabled) or E(nabled) 	0009 _d

To change the smooth refresh rate:





- 1 Press  for more than 1 second to enter the Setup menu.
- 2 Browse to $S_{\bar{r}0}$ ($M_{\bar{r}}^{Smooth}$ is shown on the display), and press  to edit the value.
- 3 Use the arrow keys to change the smooth refresh rate. Select E to enable the Smooth feature.
- 4 Press  to save your changes (or press  to discard your changes).
- 5 Press and hold  until the tester restarts to return to normal operation.

Changing the beep frequency

The beeper alerts users to the presence of circuit continuities and newly sensed values for Max Min recordings.

Legend	Range	Default setting
bEE	(4267, 4151, 4042, 3938, 3840, 3746, 3675, 3572, 3491, 3413, 3339, 3268, 3200) Hz, or OFF	3840

To change the beep frequency:

- 1 Press  for more than 1 second to enter the Setup menu.
- 2 Browse to bEE, and press  to edit the value.
- 3 Use the arrow keys to change the beep frequency. Select OFF to disable the beeper.
- 4 Press  to save your changes (or press  to discard your changes).





- 5 Press and hold  until the tester restarts to return to normal operation.

Changing the auto power-off (APO) timer

The APO (see [page 6](#)) feature uses a timer to determine when to automatically turn the tester off.

Legend	Range	Default setting
AP_{\square}	<ul style="list-style-type: none"> • (01 to 99) minutes • E(nabled) or d(isabled) 	15E

To change the APO timer period:





- 1 Press  for more than 1 second to enter the Setup menu.
- 2 Browse to AP_{\square} , and press  to edit the value.
- 3 Use the arrow keys to change the APO timer period. Select d to disable the APO feature.
- 4 Press  to save your changes (or press  to discard your changes).
- 5 Press and hold  until the tester restarts to return to normal operation.

Changing the LCD backlight timeout

The tester's LCD backlight uses a timer to determine when to turn off the LCD backlight.

Legend	Range	Default setting
bL_{\square}	<ul style="list-style-type: none"> • (01 to 99) seconds • E(nabled) or d(isabled) 	15E

To change the LCD backlight timer period:







- 1 Press  for more than 1 second to enter the Setup menu.
- 2 Browse to *bLt*, and press  to edit the value.
- 3 Use the arrow keys to change the backlight timer period. Select *d* to disable the backlight timer.
- 4 Press  to save your changes (or press  to discard your changes).
- 5 Press and hold  until the tester restarts to return to normal operation.

Changing the continuity alert

This setting is used with continuity tests (see [page 48](#)). The tester will beep to alert users to the presence of circuit continuities for short circuits. If tone is selected, the tester will sound different tones according to the bar graph display.

Legend	Range	Default setting
<i>tYP</i>	<i>SHor</i> (t) or <i>tOnE</i>	<i>SHor</i>

To change the continuity alert:



- 1 Press  for more than 1 second to enter the Setup menu.
- 2 Browse to *tYP* ( is shown on the display), and press  to edit the value.
- 3 Use the arrow keys to change the continuity alert.
- 4 Press  to save your changes (or press  to discard your changes).
- 5 Press and hold  until the tester restarts to return to normal operation.

Disabling the power-on melody

The tester plays a melody or a beep when it is powered on.



Legend	Range	Default setting
<i>5nd</i>	<i>iiELo(dy), USEr, bEEE, or oFF</i>	<i>bEEE</i>

To disable the power-on melody:

- 1 Press  for more than 1 second to enter the Setup menu.
- 2 Browse to *5nd*, and press  to edit the value.
- 3 Use the arrow keys to change the power-on melody. Select *oFF* to disable the power-on melody.

NOTE

The *USEr* option is for Agilent internal use.

- 4 Press  to save your changes (or press  to discard your changes).
- 5 Press and hold  until the tester restarts to return to normal operation.

Changing the battery type





If you are using rechargeable batteries to power your tester, change the battery type from *Pr i* to *SEC* for the tester to accurately reflect the battery capacity indication.

Legend	Range	Default setting
<i>bAt</i>	<i>Pr i (mary) or SEC (ondary)</i>	<i>Pr i</i>

4 Setup Options

Setup Menu Items





To change the battery type:

- 1 Press  for more than 1 second to enter the Setup menu.
- 2 Browse to *bAt*, and press  to edit the value.
- 3 Use the arrow keys to change the battery type.
- 4 Press  to save your changes (or press  to discard your changes).
- 5 Press and hold  until the tester restarts to return to normal operation.

Resetting the tester's Setup options

The tester's Setup options can be reset to its default values through the Setup menu.

Legend	Range	Default setting
<i>r5t</i>	<i>4E5</i> or <i>n0</i>	<i>n0</i>

- 1 Press  for more than 1 second to enter the Setup menu.
- 2 Browse to *r5t*, and press  to edit the value.
- 3 Use the arrow keys to select *4E5*.
- 4 Press and hold  for more than 1 second to perform the reset. The tester will beep once and return to the first Setup menu page. Or, alternatively press  to discard your changes.

Changing the display count





Use these settings to change the display count for the following measurements/tests. The low resolution count is a tenth of the original display count. As an example, if the original display count is 6000 counts, then the low resolution display count is 600 counts.

Legend	Range	Default setting
Cnt	High(gh) or Low(w)	Lo

NOTE

- Voltage and capacitance measurements are fixed at 6000 counts.
- DAR and PI tests are fixed at 9999 counts.

To change the display count:



- 1 Press  for more than 1 second to enter the Setup menu.
- 2 Browse to Cnt , and press  to edit the value.
- 3 Use the arrow keys to change the display count.
- 4 Press  to save your changes (or press  to discard your changes).
- 5 Press and hold  until the tester restarts to return to normal operation.

Changing the cable length unit

This setting is used with capacitance measurements (see [page 50](#)). Change the unit (Meter or Feet) of the cable length display.



Legend	Range	Default setting
CAB_{UNIT}	EEEE(r) or Foot	EEEE

To change the cable length unit:

- 1 Press  for more than 1 second to enter the Setup menu.
- 2 Browse to CAB_{UNIT} , and press  to edit the value.
- 3 Use the arrow keys to change the cable length unit.

4 Setup Options

Setup Menu Items





- 4 Press  to save your changes (or press  to discard your changes).
- 5 Press and hold  until the tester restarts to return to normal operation.

Changing the cable length scale

This setting is used with capacitance measurements (see [page 50](#)). Change the scale from 1 nF to 99 nF per kilometer for capacitance transfers to cable length.

Legend	Range	Default setting
ζRb	(01 to 99) nF	40

To change the cable length scale:





- 1 Press  for more than 1 second to enter the Setup menu.
- 2 Browse to ζRb , and press  to edit the value.
- 3 Use the arrow keys to change the cable length scale.
- 4 Press  to save your changes (or press  to discard your changes).
- 5 Press and hold  until the tester restarts to return to normal operation.

Changing the alert indicators

The tester's audible and visual alerts users to the presence of circuit continuities (see [page 48](#)) and values exceeding the Limit values set (see [page 48](#)).

Legend	Range	Default setting
RLE	$bE.rL, --.rL, bE.--, or --.--$	$bE.rL$

To change the alert indicators:





- 1 Press  for more than 1 second to enter the Setup menu.
- 2 Browse to *AL*E (*Limit* and *••*) is shown on the display), and press  to edit the value.
- 3 Use the arrow keys to change the alert indicators. Select -- to disable either the beeper, the red LED, or both the alert indicators.
- 4 Press  to save your changes (or press  to discard your changes).
- 5 Press and hold  until the tester restarts to return to normal operation.

Changing the sample interval duration

This setting is used with the Interval Data Logging feature (see [page 60](#)). The tester will record a measurement value at the beginning of every sample interval.

Legend	Range	Default setting
ε <i>••</i>	(0001 to 9999) seconds	0001

To change the sample interval duration:

- 1 Press  for more than 1 second to enter the Setup menu.
- 2 Browse to ε *••* (*LOG* is shown on the display), and press  to edit the value.
- 3 Use the arrow keys to change the sample interval duration.
- 4 Press  to save your changes (or press  to discard your changes).
- 5 Press and hold  until the tester restarts to return to normal operation.





Changing the recording option

This setting is used with the Data Logging feature (see [page 59](#)). There are three available recording options for the Data Logging feature.

- *HRnd*: Manual log
- *RUt0*: Interval log
- *Er i9*: Event log

Legend	Range	Default setting
<i>LYP</i>	<i>HRnd, RUt0, or Er i9</i>	<i>HRnd</i>

To change the recording option:





- 1 Press  for more than 1 second to enter the Setup menu.
- 2 Browse to *LYP* (**LOG** is shown on the display), and press  to edit the value.
- 3 Use the arrow keys to change the recording option.
- 4 Press  to save your changes (or press  to discard your changes).
- 5 Press and hold  until the tester restarts to return to normal operation.

Changing the IR and EBR test period

This setting is used with insulation resistance tests (see [page 38](#)) or earth-bond resistance measurements (see [page 38](#)). The tester performs the test over the timed period defined in this setting.

Legend	Range	Default setting
<i>t m</i>	(00.05 to 59.59) mm:ss	00.10

To change the insulation resistance and earth-bond resistance test period:





- 1 Press  for more than 1 second to enter the Setup menu.
- 2 Browse to t_{IR} , and press  to edit the value.
- 3 Use the arrow keys to change the test period.
- 4 Press  to save your changes (or press  to discard your changes).
- 5 Press and hold  until the tester restarts to return to normal operation.

Changing the maximum inhibit voltage for IR tests

This setting is used with insulation resistance tests (see [page 38](#)). The tester will not perform the insulation resistance test if it detects that the external voltage exceeds the inhibit voltage value set here.

Legend	Range	Default setting
i_{RH}	(30, 50, or 75) V	30

To change the maximum inhibit voltage:

- 1 Press  for more than 1 second to enter the Setup menu.
- 2 Browse to i_{RH} , and press  to edit the value.
- 3 Use the arrow keys to change the value of the inhibit voltage.
- 4 Press  to save your changes (or press  to discard your changes).
- 5 Press and hold  until the tester restarts to return to normal operation.





Disabling the lock once feature

This setting is used with insulation resistance tests (see [page 38](#)) and earth-bond resistance measurements (see [page 38](#)). By default, the tester will reset the locked status when the test is stopped by pressing .

If you disable this feature, you will need to press  to unlock the tester, even if the test has already stopped.







Legend	Range	Default setting
<i>onE</i>	YES or nO	YES

To disable the lock once feature:





- 1 Press  for more than 1 second to enter the Setup menu.
- 2 Browse to *onE*, and press  to edit the value.
- 3 Use the arrow keys to select YES.
- 4 Press  to save your changes (or press  to discard your changes).
- 5 Press and hold  until the tester restarts to return to normal operation.

Changing the button operation on the remote switch probe

This setting is used with the remote switch probe. The button operation on the remote switch probe will emulate the function selected in this setting.

Legend	Range	Default setting
$rE\bar{i}$	<ul style="list-style-type: none"> • $bE-1$ -  • $bE-2$ -  • $bE-3$ -  • $bE-4$ -  • $bE-5$ -  • $bE-6$ -  • $bE-7$ -  	$bE-7E$
	• d (isable) or E (nable)	

To change the button operation on the remote switch probe:



- 1 Press  for more than 1 second to enter the Setup menu.
- 2 Browse to $rE\bar{i}$, and press  to edit the value.
- 3 Use the arrow keys to change the function of the remote switch probe button. Select d to disable the remote switch probe button.
- 4 Press  to save your changes (or press  to discard your changes).
- 5 Press and hold  until the tester restarts to return to normal operation.

Changing the Dielectric Absorption Ratio (DAR) for IR tests

This setting is used with insulation resistance tests (see [page 38](#)). The tester perform the DAR test using the ratio set here.



Legend	Range	Default setting
$E\bar{i}$	(60.30 or 60.15) seconds	60.30

To change the DAR ratio:

- 1 Press  for more than 1 second to enter the Setup menu.
- 2 Browse to $E\bar{i}$ (**DAR** is shown on the display), and press  to edit the value.

4 Setup Options

Setup Menu Items

- 3 Use the arrow keys to change the value of the DAR ratio.
- 4 Press  to save your changes (or press  to discard your changes).
- 5 Press and hold  until the tester restarts to return to normal operation.

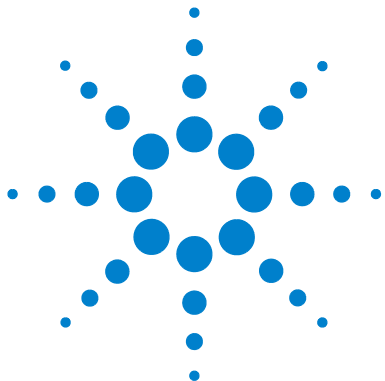

5 Characteristics and Specifications

Product Characteristics	86
Specification Considerations	88
Measurement Category	88
Electrical Specifications	89
DC specifications	89
AC specifications	91
Capacitance specifications	92
Frequency specifications	93
Sensitivity for voltage measurements	94
Insulation resistance specifications	95
Earth-bond resistance specifications	97
EN61557 specifications	97
Display update rate (approximate)	99

This chapter lists the characteristics, considerations, and specifications of the U1452A/U1452AT/U1451A tester.



Product Characteristics

POWER SUPPLY

Battery type:

- 4 × 1.5 V AA Alkaline batteries (ANSI/NEDA 15A or IEC LR6)
- 4 × 1.5 V AA Zinc Chloride batteries (ANSI/NEDA 15D or IEC R6)

Battery life:

- 270 hours typical, based on new alkaline batteries for DC voltage measurement at room temperature.
- Insulation Resistance (IR) test: 1000 times of standard test with new alkaline batteries at room temperature. The standard test is 1000 V into 1 MΩ with a cycling of 5 seconds ON and 25 or 55 seconds OFF without backlight.
- Earth-Bond Resistance (EBR) test: 2800 or 2500 times of standard test with new alkaline batteries at room temperature. The standard test is 1 Ω with a cycling of 5 seconds ON and 25 or 55 seconds OFF without backlight.
- Low battery indicator will flash when the battery voltage drops below
 - For normal operation: 3.4 V (approximately)
 - For IR and EBR operation: 4.7 V (approximately)

POWER CONSUMPTION

2.7 VA maximum (with backlight)

FUSE

10 × 35 mm 30 kA fast-acting fuse

DISPLAY

Liquid Crystal Display (LCD), 4 digits with maximum reading of 6600 counts

OPERATING ENVIRONMENT

Refer to “[Environmental Conditions](#)” on page VI

STORAGE COMPLIANCE

Refer to “[Environmental Conditions](#)” on page VI

SAFETY AND EMC COMPLIANCE

Refer to “[Environmental Conditions](#)” on page VI

SURGE PROTECTION

8 kV peak per IEC1010.1-92 (IEC1010-1)

MEASUREMENT CATEGORY

CAT III 1000 V/CAT IV 600 V

IP RATING

IP-67, protected against dust and the effect of immersion between 15 cm and 1 m

DROP TEST

1 meter per EN/IEC 61010-1:2001 and 3 meters, 6 sides drop to oak floor and tester with holster.

TEMPERATURE COEFFICIENT

$0.05 \times (\text{specified accuracy}) / ^\circ\text{C}$ (from -20°C to 18°C , or 28°C to 55°C)

COMMON MODE REJECTION RATIO (CMRR)

>120 dB at DC, 50/60 Hz $\pm 0.1\%$ (1 k Ω unbalanced)

NORMAL MODE REJECTION RATIO (NMRR)

>60 dB at 50/60 Hz $\pm 0.1\%$

DIMENSIONS (W \times H \times D)

100 \times 218 \times 58 mm

WEIGHT

728 grams (with alkaline batteries and orange rubber holster)

WARRANTY

Please refer to http://www.agilent.com/go/warranty_terms

- Three years for the product
 - Three months for the product's standard accessories, unless otherwise specified
 - Please take note that for the product, the warranty does not cover:
 - Damage from contamination
 - Normal wear and tear of mechanical components
 - Manuals, fuses, and standard disposable batteries
-

CALIBRATION CYCLE

One year

Specification Considerations

- Accuracy is given as \pm (% of reading + counts of least significant digit) at $23\text{ }^{\circ}\text{C} \pm 5\text{ }^{\circ}\text{C}$, with relative humidity less than 80% RH.
- The AC measurement is calibrated for sine waves only.

Measurement Category

The Agilent U1452A/U1452AT/U1451A tester has a safety rating of CAT III, 1000 V and CAT IV, 600 V.

Measurement CAT I are for measurements performed on circuits not directly connected to the AC mains. Examples are measurements on circuits not derived from the AC mains and specially protected (internal) mains-derived circuits.

Measurement CAT II are measurements performed on circuits directly connected to a low-voltage installation. Examples are measurements on household appliances, portable tools, and similar equipment.

Measurement CAT III are measurements performed in the building installation. Examples are measurements on distribution boards, circuit-breakers, wiring, including cables, bus-bars, junction boxes, switches, socket outlets in the fixed installation, and equipment for industrial use, and some other equipment including stationary motors with permanent connection to the fixed installation.

Measurement CAT IV are measurements performed at the source of the low-voltage installation. Examples are electricity meters and measurements on primary over current protection devices and ripple control units.

Electrical Specifications

NOTE

Specification considerations are given on [page 88](#).

DC specifications

Table 5-1 DC voltage specifications with accuracy of \pm (% of reading + no. of least significant digit)

Function	Range	Resolution	Accuracy		Input impedance
			U1451A	U1452A/U1452AT	
Voltage ^[1]	6 V	0.001 V	0.5% + 2	0.2% + 2	10 M Ω (nominal)
	60 V	0.01 V	0.5% + 2	0.2% + 2	10 M Ω (nominal)
	600 V	0.1 V	0.5% + 2	0.2% + 2	10 M Ω (nominal)
	1000 V	1 V	0.5% + 2	0.2% + 2	10 M Ω (nominal)

Notes:

1 DC V overload protection: 1000 V_{RMS}.

5 Characteristics and Specifications

Electrical Specifications

Table 5-2 Resistance specifications with accuracy of \pm (% of reading + no. of least significant digit)

Function	Range	Resolution	Accuracy	
			U1451A	U1452A/U1452AT
Resistance ^[1]	600 Ω	0.1 Ω	1.5% + 3	1.0% + 3
	6 k Ω	0.001 k Ω	1.5% + 3	1.0% + 3
	60 k Ω	0.01 k Ω	1.5% + 3	1.0% + 3
	600 k Ω	0.1 k Ω	1.5% + 3	1.0% + 3
	6 M Ω	0.001 M Ω	2.0% + 3	1.2% + 3
	60 M Ω	0.01 M Ω	2.5% + 3	2.0% + 3

Notes:

- 1** The following statements are true for resistance measurements:
- Overload protection: 1000 VRMS for short circuits with <0.3 A current.
 - Maximum open voltage is <+2.8 V.
 - The built-in buzzer beeps when the resistance measured is less than 30 $\Omega \pm 15 \Omega$.
 - The accuracy is specified after the Null function is used to subtract the test lead resistance and thermal effect (by shorting the test leads).

AC specifications

Table 5-3 AC voltage specifications with accuracy of \pm (% of reading + no. of least significant digit)

Function	Range	Resolution	Accuracy
			45 Hz to 400 Hz
Voltage ^[1]	6 V	0.001 V	2.0% + 3
	60 V	0.01 V	2.0% + 3
	600 V	0.1 V	2.0% + 3
	1000 V	1 V	2.0% + 3

Notes:

- 1** The following statements are true for resistance measurements:
- AC V overload protection: 1000 VRMS.
 - AC V input impedance: 10 M Ω in parallel with <100 pF (nominal).
 - The input signal is lower than the product of 1,000,000 V \times Hz.

5 Characteristics and Specifications

Electrical Specifications

Capacitance specifications

Table 5-4 Capacitance specifications with accuracy of \pm (% of reading + no. of least significant digit)^{[1][2][3]}

Range	Resolution	Accuracy	Signal
100 nF	0.1 nF	3% + 2	Sine wave: 54.5 Hz, <2 V
1 μ F	0.001 μ F	3% + 2	
10 μ F	0.01 μ F	3% + 2	
100 μ F	0.1 μ F	5% + 2 ^[4] @ <50 μ F	

Notes:

- 1 Overload protection: 1000 VRMS for short circuits with <0.3 A current
- 2 The accuracy of for all ranges is specified based on a film capacitor or better, and after the Null function is used to subtract the residual values (by opening the test leads).
- 3 The maximum display is 1200 counts.
- 4 Add additional accuracy of 0.1% per μ F for values greater than 50 μ F — for example 100 μ F, additional accuracy of 5% is to be added.

Frequency specifications

Table 5-5 Frequency specifications with accuracy of \pm (% of reading + no. of least significant digit)^{[1][2]}

Range	Resolution	Accuracy	Minimum input frequency
19.99 Hz	0.01 Hz	0.2% + 1	
199.9 Hz	0.1 Hz	0.2% + 1	2 Hz
<400 Hz	1 Hz	0.2% + 1 @ ≤ 400 Hz	

Notes:

- 1** Overload protection: 1000 V; input signal is $<1,000,000 \text{ V} \times \text{Hz}$ (product of voltage and frequency).
- 2** The frequency measurement is susceptible to error when measuring low-voltage and low-frequency signals. Shielding inputs from external noise pickup is critical for minimizing measurement errors.

5 Characteristics and Specifications

Electrical Specifications

Sensitivity for voltage measurements

Table 5-6 Sensitivity for voltage measurements

Input range ^[1]	Minimum sensitivity (RMS sine wave)
	2 Hz to 400 Hz
6 V	0.5 V
60 V	5 V
600 V	65 V
1000 V	65 V

Notes:

1 Maximum input for specified accuracy, refer to “AC specifications” on page 91.

Insulation resistance specifications

Table 5-7 Insulation resistance specifications with accuracy of \pm (% of reading + no. of least significant digit)

Test voltage	Range	Resolution	Accuracy	Test current
50 V	6 M Ω	0.001 M Ω	2% + 5	1 mA @ 50 k Ω
	<50 M Ω	0.01 M Ω	2% + 5	
	~60 G Ω	~0.01 G Ω	2% + 5 ^[7]	
100 V	6 M Ω	0.001 M Ω	2% + 5	1 mA @ 100 k Ω
	60 M Ω	0.01 M Ω	2% + 5	
	<100 M Ω	0.1 M Ω	2% + 5	
	~60 G Ω	~0.01 G Ω	2% + 5 ^[7]	
250 V	6 M Ω	0.001 M Ω	1.5% + 5	1 mA @ 250 k Ω
	60 M Ω	0.01 M Ω	1.5% + 5	
	<250 M Ω	0.1 M Ω	1.5% + 5	
	~200 G Ω	~0.1 G Ω	1.5% + 5 ^[7]	
500 V	6 M Ω	0.001 M Ω	1.5% + 5	1 mA @ 500 k Ω
	60 M Ω	0.01 M Ω	1.5% + 5	
	<500 M Ω	0.1 M Ω	1.5% + 5	
	~200 G Ω	~0.1 G Ω	1.5% + 5 ^[7]	
1000 V	6 M Ω	0.001 M Ω	1.5% + 5	1 mA @ 1 M Ω
	60 M Ω	0.01 M Ω	1.5% + 5	
	600 M Ω	0.1 M Ω	1.5% + 5	
	<1 G Ω	0.001 G Ω	1.5% + 5	
	~200 G Ω	~0.1 G Ω	1.5% + 5 ^[7]	

5 Characteristics and Specifications

Electrical Specifications

Notes:

- 1 The voltage indication on the display refers to the voltage at the DUT (device under test), and the accuracy is according to the DC voltage measurement. The default test voltage is shown in the table below.

Ω Mega position (Mark)	1000 V	500 V	250 V	100 V	50 V
Test voltage	1000 V	500 V	250 V	100 V	50 V
Test accuracy	0% to +20%	0% to +20%	0% to +20%	0% to +20%	0% to +20%

The test voltage across a resistor of a value of $U_N \times (1000 \Omega/V)$ shall not differ by more than 10% relative to no load (open) voltage, as a result of possibly present AC voltage components in the output voltage, when a capacitor of $1 \mu F$ is connected in parallel with the insulation resistance to be measured. U_N represents the nominal output test voltage.

- 2 Live circuit detection: The test will be inhibited if the terminal voltage $>30 V/50 V/75 V$ (AC/DC) prior to initialization of the test.
- 3 Short-circuit test current: 1.0 mA nominal.
- 4 Auto discharge time: <0.5 seconds for capacitors less or equal to $1 \mu F$.
- 5 Maximum capacitive load: Operable with up to $1 \mu F$ load.
- 6 The accuracy of the leakage current may be referred to as the DC current measurement.
- 7 Additional accuracy is to be added to the basic accuracy as shown in the table below.

Voltage	1000 V	500 V	250 V	100 V	50 V
Above	1 G Ω	500 M Ω	250 M Ω	100 M Ω	50 M Ω
Basic accuracy	1.5% + 5	1.5% + 5	1.5% + 5	2.0% + 5	2.0% + 5
Additional accuracy	0.1%/G Ω	0.2%/G Ω	0.4%/G Ω	1.0%/G Ω	2.0%/G Ω

Earth-bond resistance specifications

Table 5-8 Earth-bond resistance specifications with accuracy of \pm (% of reading + no. of least significant digit)^{[1][2]}

Range	Resolution	Accuracy		Open circuit voltage
		U1451A	U1452A/U1452AT	
60 Ω	0.01 Ω	1.5% + 3	1.0% + 3	>4 V and <7 V
600 Ω	0.1 Ω	1.5% + 3	1.0% + 3	
6 k Ω	0.001 k Ω	1.5% + 3	1.0% + 3	
60 k Ω	0.01 k Ω	1.5% + 3	1.0% + 3	

Notes:

- The following statements are true for earth-bond resistance tests:
 - Overload protection: <2 V and 0.44 A/1000 V; 10 × 35 mm 30 kA fast-acting fuse
 - Short circuit current: >200.0 mA as resistance < or = 2 Ω
- The accuracy is specified after the Null function is used to subtract the test lead resistance and thermal effect (by shorting the test leads).

EN61557 specifications

The following specifications are a requirement for European labeling.

Measurement	Intrinsic uncertainty		Operating uncertainty ^[1]
	U1451A	U1452A/U1452AT	
Voltage	\pm (0.5% + 2)	\pm (0.2% + 2)	30%

Notes:

- The maximum resistance to meet the standard of EN61557-1, 5.2.4, which indicates the maximum amount allowed as less than 30%.

5 Characteristics and Specifications

Electrical Specifications

Measurement	Intrinsic uncertainty		Operating uncertainty ^[1]
	U1451A	U1452A/U1452AT	
Earth-bond resistance	$\pm (1.5\% + 3)$	$\pm (1.0\% + 3)$	30%
Insulation resistance	Based on the test voltage and range. See " Insulation resistance specifications " on page 95.		30%

Notes:

- 1 The maximum resistance to meet the standard of EN61557-1, 5.2.4, which indicates the maximum amount allowed as less than 30%.

Test voltage ^{[1][2][3]}	IR <	Intrinsic uncertainty (A)	Temperature (E3)	Operating Uncertainty
50 V	12.85 G Ω	27.6%	2%	27.6% + 1.15 \times E3
100 V	25.7 G Ω	27.6%	2%	27.6% + 1.15 \times E3
250 V	65.5 G Ω	27.6%	2%	27.6% + 1.15 \times E3
500 V	131 G Ω	27.6%	2%	27.6% + 1.15 \times E3
1000 V	260 G Ω	27.4%	2%	27.4% + 1.15 \times E3

Notes:

- 1 Specification confidence level to 99.73% as coverage factor up to 3.
- 2 Temperature range is from 0 °C to 35 °C.
- 3 Test voltage/maximum range for different models:

Test voltage	U1451A	U1452A	U1452AT
50 V	-	60 G Ω	60 G Ω
100 V	-	60 G Ω	60 G Ω
250 V	60 G Ω	200 G Ω	-
500 V	60 G Ω	200 G Ω	-
1000 V	60 G Ω	200 G Ω	-

Display update rate (approximate)

Table 5-9 Display update rate (approximate)

Function	Times/Second
AC V	5
DC V	5
Ω	5
Capacitance	5
EBR	5
IR	5
Frequency	1 (>10 Hz)

5 Characteristics and Specifications

Electrical Specifications

THIS PAGE HAS BEEN INTENTIONALLY LEFT BLANK.

www.agilent.com

Contact us

To obtain service, warranty, or technical assistance, contact us at the following phone or fax numbers:

United States:

(tel) 800 829 4444 (fax) 800 829 4433

Canada:

(tel) 877 894 4414 (fax) 800 746 4866

China:

(tel) 800 810 0189 (fax) 800 820 2816

Europe:

(tel) 31 20 547 2111

Japan:

(tel) (81) 426 56 7832 (fax) (81) 426 56 7840

Korea:

(tel) (080) 769 0800 (fax) (080) 769 0900

Latin America:

(tel) (305) 269 7500

Taiwan:

(tel) 0800 047 866 (fax) 0800 286 331

Other Asia Pacific Countries:

(tel) (65) 6375 8100 (fax) (65) 6755 0042

Or visit Agilent World Wide Web at:

www.agilent.com/find/assist

Product specifications and descriptions in this document are subject to change without notice. Always refer to Agilent website for the latest revision.

© Agilent Technologies, Inc. 2014

First Edition, January 13, 2014
U1451-90003



Agilent Technologies