



Agilent U1602B and U1604B Handheld Digital Oscilloscopes

User's and Service Guide



Agilent Technologies

Notices

© Agilent Technologies, Inc. 2006–2014

No part of this manual may be reproduced in any form or by any means (including electronic storage and retrieval or translation into a foreign language) without prior agreement and written consent from Agilent Technologies, Inc. as governed by United States and international copyright laws.

Manual Part Number

U1602-90023

Edition

Eleventh Edition, March 14, 2014

Printed in Malaysia

Agilent Technologies, Inc.
3501 Stevens Creek Blvd.
Santa Clara, CA 95052 USA

Warranty

The material contained in this document is provided “as is,” and is subject to being changed, without notice, in future editions. Further, to the maximum extent permitted by applicable law, Agilent disclaims all warranties, either express or implied, with regard to this manual and any information contained herein, including but not limited to the implied warranties of merchantability and fitness for a particular purpose. Agilent shall not be liable for errors or for incidental or consequential damages in connection with the furnishing, use, or performance of this document or of any information contained herein. Should Agilent and the user have a separate written agreement with warranty terms covering the material in this document that conflict with these terms, the warranty terms in the separate agreement shall control.

Technology Licenses

The hardware and/or software described in this document are furnished under a license and may be used or copied only in accordance with the terms of such license.

Restricted Rights Legend

U.S. Government Restricted Rights. Software and technical data rights granted to the federal government include only those rights customarily provided to end user customers. Agilent provides this customary commercial license in Software and technical data pursuant to FAR 12.211 (Technical Data) and 12.212 (Computer Software) and, for the Department of Defense, DFARS 252.227-7015 (Technical Data - Commercial Items) and DFARS 227.7202-3 (Rights in Commercial Computer Software or Computer Software Documentation).

Safety Notices

CAUTION

A **CAUTION** notice denotes a hazard. It calls attention to an operating procedure, practice, or the like that, if not correctly performed or adhered to, could result in damage to the product or loss of important data. Do not proceed beyond a **CAUTION** notice until the indicated conditions are fully understood and met.

WARNING

A **WARNING** notice denotes a hazard. It calls attention to an operating procedure, practice, or the like that, if not correctly performed or adhered to, could result in personal injury or death. Do not proceed beyond a **WARNING** notice until the indicated conditions are fully understood and met.

Notices

No part of this manual may be reproduced in any form or by any means (including electronic storage and retrieval or translation into a foreign language) without prior agreement and written consent from Agilent Technologies, Inc. as governed by United States and international copyright laws.

The information contained in this document is subject to change without notice.

To the extent allowed by local law, Agilent makes no warranty of any kind with regard to this material, including, but not limited to, the implied warranties of merchantability and fitness for a particular purpose.

To the extent allowed by local law, Agilent shall not be liable for errors contained herein or for incidental or consequential damages in connection with the furnishing, performance, or use of this material.

Certification

Agilent Technologies certifies that this product met its published specifications at the time of shipment. Agilent further certifies that its calibration measurements are traceable to the United States National Institute of Standard and Technology (formerly National Bureau of Standards), to the extent allowed by that organization's calibration facility, and to the calibration facilities of other International Standards Organization members.

General Warranty

The material contained in this document is provided “as is,” and is subject to being changed, without notice, in future editions. Further, to the maximum extent permitted by applicable law, Agilent disclaims all warranties, either express or implied with regard to this manual and any information contained herein, including but not limited to the implied warranties of merchantability and fitness for a particular purpose. Agilent shall not be liable for errors or for incidental or consequential damages in connection with the furnishing, use, or performance of this document or any information contained herein. Should Agilent and the user have a separate written agreement with warranty terms covering the material in this document that conflict with these terms, the warranty terms in the separate agreement will control. Duration and conditions of warranty for this product may be superseded when the product is integrated into (becomes a part of) other Agilent products. During the warranty period, Agilent will, at its option, either repair or replace products which prove to be defective. The warranty period begins on the date of delivery or on the date of installation if installed by Agilent.

Warranty Service

For warranty service or repair, this product must be returned to a service facility designated by Agilent. For products returned to Agilent for warranty service, the Buyer shall prepay shipping charges to Agilent and Agilent shall pay shipping charges to return the product to the Buyer. However, the Buyer shall pay all shipping charges, duties, and taxes for products returned to Agilent from another country.

Limitation of Warranty

The foregoing warranty shall not apply to defects resulting from improper or inadequate maintenance by the Buyer, Buyer-supplied products or interfacing, unauthorized modification or misuse, operation outside of the environmental specifications for the product, or improper site preparation or maintenance.

The design and implementation of any circuit on this product is the sole responsibility of the Buyer. Agilent does not warrant the Buyer's circuitry or malfunctions of Agilent products that result from the Buyer's circuitry. In addition, Agilent does not warrant any damage that occurs as a result of the Buyer's circuit or any defects that result from Buyer-supplied products.

To the extent allowed by local law, Agilent makes no other warranty, expressed or implied, whether written or oral with respect to this product and specifically disclaims any implied warranty or condition of merchantability, fitness for a particular purpose or satisfactory quality.

Exclusive Remedies

To the extent allowed by local law, the remedies provided herein are the Buyer's sole and exclusive remedies. Agilent shall not be liable for any direct, indirect, special, incidental, or consequential damages (including lost profit or data), whether based on warranty, contract, tort, or any other legal theory.

Safety Summary

The following general safety precautions must be observed during all phases of operation of this instrument. Failure to comply with these precautions or with specific warnings elsewhere in this manual violates safety standards of design, manufacture, and intended use of the instrument. Agilent Technologies, Inc. assumes no liability for the customer's failure to comply with these requirements.

Safety Notices

WARNING









A **WARNING** calls attention to a procedure, practice or the like, which, if not correctly performed or adhered to, could result in injury or loss of life. Do not proceed beyond a **WARNING** until the indicated conditions are fully understood and met.

CAUTION

A **CAUTION** notice denotes a hazard. It calls attention to an operating procedure, practice, or the like that, if not correctly performed or adhered to, could result in damage to the product or loss of important data. Do not proceed beyond a **CAUTION** notice until the indicated conditions are fully understood and met.

Safety Symbols

The following symbols on the instrument and in the documentation indicate precautions which must be taken to maintain safe operation of the instrument.

	Earth ground terminal
	Equipotentiality
	Caution, risk of electric shock
	The Instruction Documentation Symbol. The product is marked with this symbol when it is necessary for the user to refer to the instructions in the supplied documentation.
	Direct and alternating current
	Direct current
	Equipment protected throughout by DOUBLE INSULATION or REINFORCED INSULATION
	Caution, hot surface
CAT III	Measurement category III are measurements performed in the building installation

Regulatory Markings



The CE mark is a registered trademark of the European Community. This CE mark shows that the product complies with all the relevant European Legal Directives. If it was accompanied by a year, it indicates the year the design was approved. This ISM device complies with Canadian ICES-001.



The CSA mark is a registered trademark of the Canadian Standards Association.



The C-tick mark is a registered trademark of the Spectrum Management Agency of Australia. This signifies compliance with the Australia EMC Framework regulations under the terms of the Radio Communication Act of 1992.

General Safety Information

The following general safety precautions must be observed during all phases of operation, service and repair of this instrument. Failure to comply with these precautions or with specific warnings elsewhere in this manual violates safety standards of design, manufacture and intended use of the instrument. Agilent Technologies assumes no liability for the customer's failure to comply with these requirements.

WARNING

- **All DMM/Scope COM are internally connected. Only connect DMM/Scope COM to same potential.**
 - **Remove all unused scope probes and test leads.**
-

WARNING

- **Do not connect DMM test leads and scope probes at the same time.**
 - **Disconnect scope probe from instrument before using DMM functions.**
 - **Disconnect DMM test leads from instrument before using scope functions.**
-

WARNING

To avoid electrical shock or fire during battery replacement:

- **Disconnect test leads, probes and power supply before opening case or battery door.**
 - **Do not operate the instrument with battery cover open.**
 - **Use only specified insulated probes and leads.**
 - **Use only U1571A, 7.2 V Ni-MH battery pack supplied by manufacturer.**
-

WARNING

Prevention of fire or injury:

- Use only the designated AC adapter and test leads supplied with the instrument.
- Observe all ratings and markings on the instrument before connecting to the instrument.
- When performing measurement, ensure that the right safety and performance ratings of instrument and accessories are used.



Maximum Input Voltages

- Input CH1 and CH2 direct (1:1 Probe) — 300 V CAT III
- Input CH1 and CH2 via 1:10 Probe — 600 V CAT III
- Input CH1 and CH2 via 1:100 Probe — 600 V CAT III
- Meter Input — 300 V CAT III, 600 V CAT II
- Scope Input — 300 V CAT III
- Voltage ratings are V_{rms} (50 /60 Hz) for AC sine wave and VDC for DC applications.



Maximum Floating Voltage

- From any terminal to ground — 300 V_{rms} CAT III (up to 400 Hz)
-

WARNING

- **Plug the probe or test leads to instrument before connecting to any active circuit for testing. Before disconnecting from instrument, remove scope probe or test leads from active circuit.**
 - **Do not connect the ground wire to voltages higher than 42 V_{peak} (30 V_{rms}) from earth ground if either the DMM COM or the OSC COM is connected to the DUT or is being accessed by the user.**
 - **Do not expose the circuit or operate the instrument without its cover or while power is being supplied.**
 - **Do not use exposed metal BNC or banana plug connectors. Use only the insulated voltage probes, test leads and adapters that come with the instrument.**
 - **Do not supply any voltage when measuring resistance or capacitance in multimeter mode.**
 - **Do not operate the instrument if it does not operate properly. Have the instrument inspected by qualified service personnel.**
 - **Do not operate the instrument in wet or damp environments.**
 - **Do not operate the instrument in any environment at risk of explosion. Do not operate the product in the presence of flammable gases or flames.**
 - **Keep the instrument's surface clean and dry.**
-

CAUTION

Prevention of electro-static discharge

Electro-static discharge (ESD) can result in damage to the components in the instrument and accessories.

- Select a static-free work location when installing and removing sensitive equipment.
 - Handle sensitive components to the minimum extent possible. Do not allow contacts between components and exposed connector pins.
 - Transport and store in ESD preventive bag or container that protects sensitive components from static electricity.
 - The battery (optional) must be properly recycled or disposed.
-

Waste Electrical and Electronic Equipment (WEEE) Directive 2002/96/EC

This instrument complies with the WEEE Directive (2002/96/EC) marking requirement. This affixed product label indicates that you must not discard this electrical/electronic product in domestic household waste.

Product Category:

With reference to the equipment types in the WEEE directive Annex 1, this instrument is classified as a “Monitoring and Control Instrument” product.

The affixed product label is shown as below:

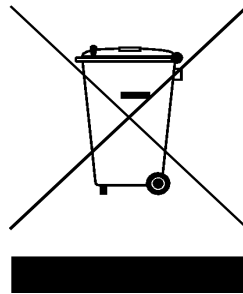

Do not dispose in domestic household waste

To return this unwanted instrument, contact your nearest Agilent office, or visit:

<http://www.agilent.com/environment/product>

for more information.

Agilent Technologies, through Rechargeable Battery Recycling Corporation (RBRC), offers free and convenient battery recycling options in the U.S. and Canada. Contact RBRC at 877-2-RECYCLE (877.273.2925) or online at: <http://www.call2recycle.org/> for the nearest recycling location.

Environment Conditions

This instrument is designed for indoor use and in area with low condensation. Table 1 shows general environment requirements.

Table 1 Environment Requirements

Environment Conditions	Requirements
Maximum Altitude	2000 m
Temperature	0 to 50 °C (Operating) –20 °C to 70°C (Non-operating)
Humidity	80 %RH at 40 °C (Operating at full accuracy)

CAUTION

This instrument is designed to be used for measurement in Measurement Category III, 300V for scope measurement, Measurement Category III, 300 V and Category II, 600 V for multimeter measurement, and operate in environment Pollution Degree 2 with the following safety compliance:

- IEC 61010-1:2001 / EN61010-1:2001
- Canada: CSA C22.2 No. 61010-1:2004
- USA: UL 61010-1:2004

In This Guide...

- 1 Getting Started** Chapter 1 guides you to set up and get started with the handheld digital oscilloscope. This chapter also guides you through the basics of the handheld scope's front panel features.
- 2 Front Panel and Displays Overview** Chapter 2 describes the overview of the front panel and display of the instrument, providing you a brief picture of the general features and functions provided by this instrument.
- 3 Using the Scope Functions** Chapter 3 describes in detail on signal channel coupling, waveform measuring and waveform display control. This chapter also provides step-by-step instructions for you to get familiar with each scope function.
- 4 Using the Digital Multimeter Functions** Chapter 4 contains reference information to help you select and utilize multimeter functions. This chapter also guides you on how to configure connections to perform the meter measurements.
- 5 Using the Data Logger Functions** Chapter 5 describes the usage of the data logging for multimeter measurement functions.
- 6 Service and Maintenance** Chapter 6 provides you with warranty services, maintenance procedures and troubleshooting hints to solve general problems that you may encounter with the instrument.
- 7 Performance Tests** Chapter 7 explains on how to verify the operation and performance of the handheld scope to meet the performance specifications.
- 8 General Disassemble** Chapter 8 contains procedures for removing assembled parts from the handheld scope and the replaceable parts list.
- 9 Characteristics and Specifications** Chapter 9 lists specifications and characteristics of the U1602B and U1604B handheld digital oscilloscopes.

Declaration of Conformity (DoC)

The Declaration of Conformity (DoC) for this instrument is available on the Web site. You can search for the DoC by its product model or description.

<http://regulations.corporate.agilent.com/DoC/search.htm>

NOTE

If you are unable to search for the respective DoC, please contact your local Agilent representative.

THIS PAGE HAS BEEN INTENTIONALLY LEFT BLANK.

Contents

1	Getting Started	1
	To Inspect Package Contents	2
	To Charge a Battery	5
	To Power On Instrument	7
	To Reset to Default Factory Settings	7
	To Perform Self-Calibration	9
	To Set Date and Time	10
	To Set Auto-Power Off	12
	To Select Quick Help Language	13
	To Adjust Contrast of Display	14
	To Compensate Scope Probe	15
2	Front Panel and Displays Overview	19
	Front Panel Overview	20
	Oscilloscope Display Overview	25
	Multimeter Display Overview	27
3	Using the Scope Functions	29
	Vertical Controls	30
	Channel Selection for Waveform Display	30
	Vertical System Setup	32
	To Change Vertical Reference Ground Position	32
	To Center the Waveform on the Display	33
	To Change Vertical Sensitivity	34
	Channel Coupling Control	35
	AC Channel Coupling	35
	DC Channel Coupling	36
	Ground channel coupling	36

Probe Attenuation Control	37
Invert Control	38
Horizontal Controls	40
Vertical System Setup	40
To Change Horizontal Scale Factor	40
To Set Delay of the Waveforms	41
To Change Trigger Point Indicator	42
Horizontal Mode Functions	43
Time Base mode	43
Main/Zoom Mode	44
Roll Mode	46
Trigger Controls	47
Trigger Modes	47
Auto Trigger Mode	48
Normal Trigger Mode	48
Single Trigger Mode	48
Trigger Types	49
Edge Trigger	49
Pattern Trigger	52
Video Trigger	55
Waveform Controls	56
Normal Acquisition Mode	57
Average Acquisition Mode	57
Peak Detection Mode	58
Display Controls	59
Display Types	59
Display Contrast	60
Graticule	61
Persistence	61
Automatic Measurement	62
To Perform Automatic Measurements	63
Time Automatic Measurements	64
+ Duty	64

-Duty	64
+Width	65
Frequency	65
Rise Time	65
Fall Time	66
Period	66
Voltage Automatic Measurements	66
Mean	66
Mean Cycle	66
Amplitude	66
Top	67
Base	67
Maximum	67
Minimum	67
Peak-to-peak	67
Phase and Delay	68
Phase	68
Delay	69
Preshoot and Overshoot	69
Preshoot	69
+Overshoot	70
-Overshoot	70
Cursor Measurement Controls	71
X-Cursor Measurement	72
Y-Cursor Measurement	75
Math Functions Control	78
Dual Waveform Math — Add, Subtract	78
Add (CH1 + CH2)	79
Subtraction (CH1 – CH2, CH2 – CH1)	80
FFT (Fast Fourier Transform)	81
Source	81
V Axis	81
Window	82
Save and Recall Controls	83

Save and Recall Controls without USB Flash Memory Device	84
To Save and Recall Waveform	86
To Erase Setup	88
To Erase Waveform	89
To Restore Factory Setup	90
Save and Recall Controls with USB Flash Memory Device	92
To Save Waveform	93
To Load Waveform	93
To Erase Waveform	94
To Clear Waveform	95
Autoscale and Run/Stop Controls	96
Autoscale	96
Run/Stop Controls	97
Utility Controls	98
Auto-Power Off Control	98
Language Selection	99
USB Flash Memory On/Off	99
Date and Time Setting	99
Self-Calibration	99
Probe Calibration	100
Low Battery Mode	100
Mute Function	101

4 Using the Digital Multimeter Functions 103

Voltmeter	104
Ohmmeter	106
Resistance Measurement	106
Continuity Test	108
Diode Test	109
Capacitance Measurement	111
Auxiliary Meter	112

Temperature Meter	112
Ampere Meter	114
Humidity Meter	115
Pressure Meter	116
Relative Function	118
Automatic Measurement in Multimeter Mode	120
Restart Test	121
Auto-range Mode	121
5 Using the Data Logger Functions	123
Data Logger Function	124
Automatic Measurement in Data Logger Mode	127
CSV Saving Function and Interval Setting	127
Restart Test	128
6 Service and Maintenance	129
Warranty Services	130
Standard Warranty (Worldwide)	130
Accessories Warranty	131
Standard Calibration Service (optional)	131
Returning instrument to Agilent Technologies for service	132
Cleaning	133
Basic Troubleshooting Hints	133
7 Performance Tests	137
Performance Test Interval	138
Performance Test Record	138
Warming Up Before Testing	138
List of Test Equipment	139

Oscilloscope Performance Verification Tests	141
Voltage Measurement Accuracy Verification Test	141
Bandwidth Verification Test	144
Horizontal Dt and 1/Dt Accuracy Verification Test	146
Trigger Sensitivity Verification Test	147
Multimeter Performance Verification Tests	149
DC Voltage Verification Test	149
AC Voltage Verification Test	151
Resistance Verification Test	152
Capacitance Verification Test	153
Diode Verification Test	154
Continuity Verification Test	155
Self-Calibration	156
Self-Calibration Error Code	157

8 General Disassemble 163

Mechanical Disassemble	164
To remove stand	165
To remove battery pack	166
To replace battery pack	167
To remove handler	170
To remove front and rear casing	171
To remove keypad	173
To dismantle system boards	174
To remove LCD display	175
Replacement Parts	176

9 Characteristics and Specifications 177

Specifications	178
Characteristics	181
General Characteristics	187

Environmental Conditions	189
Pollution Degree	189
Pollution Degree Definitions	189
Measurement Category	190
Measurement Category Definitions	190

THIS PAGE HAS BEEN INTENTIONALLY LEFT BLANK.

Figures

- Figure 1-1. Standard shipped components 3
- Figure 1-2. Optional accessories 4
- Figure 1-3. Battery charging 6
- Figure 1-4. Factory setup 8
- Figure 1-5. Self-calibration dialog box 10
- Figure 1-6. Select the date format 11
- Figure 1-7. Date and time setting 11
- Figure 1-8. Auto-power off function 12
- Figure 1-9. Adjust display contrast 14
- Figure 1-10. Connection for scope probe compensation 15
- Figure 1-11. A 10X scope probe with over compensation, adjust the trimmer capacitor to obtain the flattest pulse possible as shown in Figure 1-13. 16
- Figure 1-12. Trimmer capacitor for probe compensation 16
- Figure 1-13. Pulse shape reference for scope probe compensation 17
- Figure 2-1. U1600B series handheld digital oscilloscope front and side view 21
- Figure 2-2. Interpreting Scope Display 25
- Figure 2-3. Interpreting meter display 27
- Figure 3-1. Scope menu display with displayed of both channels display. 30
- Figure 3-2. Select On or Off to enable or disable the waveform display 31
- Figure 3-3. Adjust vertical position for the waveform displayed. 32
- Figure 3-4. Reset vertical ground reference symbol to zero volt. 33
- Figure 3-5. Vertical sensitivity display 34
- Figure 3-6. AC channel coupling 35
- Figure 3-7. DC channel coupling 36
- Figure 3-8. Gnd channel coupling 36
- Figure 3-9. Probe attenuation scale setting 37

Figure 3-10. The waveform before inversion.	38
Figure 3-11. The waveform after inversion	39
Figure 3-12. Time/div display in status line	40
Figure 3-13. Changing time base of a waveform	41
Figure 3-14. Select time reference	43
Figure 3-15. XY format display	44
Figure 3-16. When Window function is turned on, a zoom area selection bar appears at the center of the display. Adjust rotary switch clockwise to expand the zoom area.	45
Figure 3-17. Press F1 to enable zooming function	46
Figure 3-18. Normal trigger mode	47
Figure 3-19. Normal acquisition mode	57
Figure 3-20. Average acquisition mode	58
Figure 3-21. Peak Detection Mode	58
Figure 3-22. Dots display type	59
Figure 3-23. Vectors display type	60
Figure 3-24. Select automatic measurement for the Measure 1 file.	64
Figure 3-25. +Width and –Width measurements	65
Figure 3-26. Period measurement	66
Figure 3-27. Voltage measurement	68
Figure 3-28. Phase measurement	69
Figure 3-29. Delay measurement	69
Figure 3-30. Cursor measurement menu	71
Figure 3-31. X-cursor measurement for channel 1 signal with X1 and X2 cursor lines	73
Figure 3-32. X-cursor measurement for channel 2 signal with X1 and X2 cursor lines	74
Figure 3-33. Math functions for X-cursor measurement	74
Figure 3-34. Y-cursor measurement for channel 1 signal with Y1 and Y2 cursor lines	76
Figure 3-35. Y-cursor measurement for channel 2 signal with X1 and X2 cursor lines	77
Figure 3-36. Math function for Y-cursor measurement	77

- Figure 3-37. Addition of channel 1 and channel 2 function 79
- Figure 3-38. Subtraction signal at channel 2 from channel 1 80
- Figure 3-39. Save/Recall menu 84
- Figure 3-40. The <Save> display indicates no setup file is being saved. You can press F1 to save the setup into Setup 1. 85
- Figure 3-41. The <Load> display indicates that a configuration setup file has been saved into Setup 1 and you can press F1 to retrieve the setup from internal memory. 86
- Figure 3-42. The <Save> display indicates no waveform is being saved, you can press F1 to save the waveform into Waveform 1. 87
- Figure 3-43. The <Load> display indicates the a waveform file is saved into Waveform 1 and you can press F1 to retrieve the waveform from internal memory. This function is useful for waveform comparison. 87
- Figure 3-44. The <None> display indicates that no setup file is saved. The <Erase> in Setup 1 shows that you can erase the setup file from the internal memory. 88
- Figure 3-45. The <None> display indicates that no waveform is being saved. The <Erase> in Waveform 1 shows that you can erase the waveform from the internal memory. 89
- Figure 3-46. Restore factory setup in Save/Load Setup menu. 91
- Figure 3-47. The instrument requests confirmation to restore factory default setting. 91
- Figure 3-48. Connect a USB flash memory to save or download waveforms to/from the external memory device. 92
- Figure 3-49. Load a waveform from a USB flash memory device 94
- Figure 3-50. Run and Stop modes 97
- Figure 3-51. Auto-power off control 98
- Figure 3-52. Message display during low battery condition 100
- Figure 4-1. Multimeter display 104
- Figure 4-2. DC measurement display 105
- Figure 4-3. Resistance measurement 107

- Figure 4-4. Continuity test shorted with audible beeper sound. 108
- Figure 4-5. Diode in forward bias condition 110
- Figure 4-6. Diode in open condition 110
- Figure 4-7. Capacitance measurement 111
- Figure 4-8. Temperature measurement in degrees Celsius (°C) together with degree Fahrenheit (°F) display. 113
- Figure 4-9. Current measurement 115
- Figure 4-10. Humidity measurement 116
- Figure 4-11. Pressure measurement 117
- Figure 4-12. Set the reading as reference value 118
- Figure 4-13. Set the reading as measured value 119
- Figure 4-14. Relative value obtained from the delta of the measured and reference value. 119
- Figure 4-15. Automatic measurement in resistance measurement mode 120
- Figure 4-16. Auto-range mode 122
- Figure 4-17. Manual range mode 122
- Figure 5-1. Maximum measurement is selected for DC voltage data recording. The initial time base is 15 seconds — 150 seconds. 126
- Figure 5-2. After exceeding 150 seconds, the graph automatically compresses to half screen and the time base changes to 30 seconds — 300 seconds. 126
- Figure 5-3. Enabling the CSV saving function 127
- Figure 5-4. Setting the interval 128
- Figure 7-1. Test connection from calibrator to instrument and digital multimeter 143
- Figure 7-2. Test connections from calibrator to instrument 150
- Figure 7-3. Self-calibration dialog box 157
- Figure 8-1. Push towards the arrow direction to remove the stand 165
- Figure 8-2. Disassemble the stand from the instrument 165
- Figure 8-3. Remove battery cover screw 166

- Figure 8-4. Unplug 3-wire connector from PCBA board using tweezers 167
- Figure 8-5. Remove battery pack cover without removing stand 168
- Figure 8-6. Unplug 2-wire connector with a tweezers. 168
- Figure 8-7. Remove screw from the rear cover 170
- Figure 8-8. Remove handler from the instrument 170
- Figure 8-9. Remove and keep the above wear-and-tear parts for re-assemble process 171
- Figure 8-10. Remove front casing (right) and rear casing (left) from PCBA of the instrument 172
- Figure 8-11. Remove the ten screws from the front cover 173
- Figure 8-12. Remove keypad from the front cover 173
- Figure 8-13. Remove the six screws and pull the ribbon cable from the PCBA board 174
- Figure 8-14. Remove four screw to dismantle the LCD display unit 175

THIS PAGE HAS BEEN INTENTIONALLY LEFT BLANK.

Tables

Table 1-1. Power cord types	4
Table 3-1. Autoscale conditions	96
Table 7-1. List of test equipments for scope performance test	139
Table 7-2. List of test equipment for multimeter performance test	140
Table 7-3. Settings used to verify voltage measurement accuracy	142
Table 7-4. Signal generator frequency setting	145
Table 7-5. DC Volts Verification Test	150
Table 7-6. AC Volts Verification Test	151
Table 7-7. Resistance Verification Test	152
Table 7-8. Capacitance Verification Test	153
Table 7-9. Diode Verification Test	154
Table 7-10. Self-calibration error code	158
Table 8-1. Replacement part list	176
Table 9-1. Warranted specifications	178
Table 9-2. Characteristics	181
Table 9-3. Sampling Rate	186
Table 9-4. General characteristics	187

THIS PAGE HAS BEEN INTENTIONALLY LEFT BLANK.



1 Getting Started

To Inspect Package Contents	2
To Charge a Battery	5
To Power On Instrument	7
To Reset to Default Factory Settings	7
To Perform Self-Calibration	9
To Set Date and Time	10
To Set Auto-Power Off	12
To Select Quick Help Language	13
To Adjust Contrast of Display	14
To Compensate Scope Probe	15

The U1600B Series handheld digital oscilloscopes are high performance troubleshooting tools in multi-industrial automation, process control, facility maintenance and automotive-service industries. The U1600B Series comprises two models: U1602B and U1604B, with 20 MHz and 40 MHz bandwidths, respectively. With its 4.5-inch LCD color display, it is capable of clearly distinguishing waveforms from two channels. Both models are dual-channel scopes with real-time sampling rate of up to 200 MSa/s. The U1600B Series can also function as a digital multimeter (DMM) and data logger. Users can use the Dual Waveform Math (DWM) and Fast Fourier Transform (FFT) functions (in U1604B) to perform a quick waveform analysis in both time and frequency domain. The U1600B Series with built-in 6000-count resolution and true RMS comes with an auto range function that allows users to perform quick and accurate DMM measurements. Additionally, with data logger function, users can perform automatic data logging for all DMM measurements.



To Inspect Package Contents

- ✓ Unpack and inspect the shipping container for damage.

If your shipping container appears to be damaged, keep the shipping container or cushioning material until you have inspected the contents of the shipment for completeness and checked the handheld digital scope mechanically and electrically.

Verify that you have received the following items for the standard shipped components or optional accessories you may have ordered:

- U1602B or U1604B handheld digital oscilloscope
- Power cord
- AC adapter
- Oscilloscope probes
 - Two 10:1 10 M Ω passive probes
- Two DMM test leads
- Three medium jaw alligator clips
- Two oscilloscope hook clips
- Two oscilloscope ground alligator clips
- Quick Start Guide
- Certificate of Calibration (CoC)

Optional accessories:

- 100:1 10 M Ω passive probe and a ground alligator clip
- Soft casing

- ✓ Inspect the oscilloscope
 - If there is any mechanical damage or defect, or if the instrument does not operate properly or does not pass performance tests, notify your Agilent Technologies Sales Office.
 - If the shipping container is damaged, or the cushioning material shows signs of stress, notify the carrier and the Agilent Technologies Sales Office. Keep the shipping material for the carrier's inspection. The Agilent Technologies Sales Office would arrange for repair or replacement at Agilent's discretion without waiting for claim settlement.

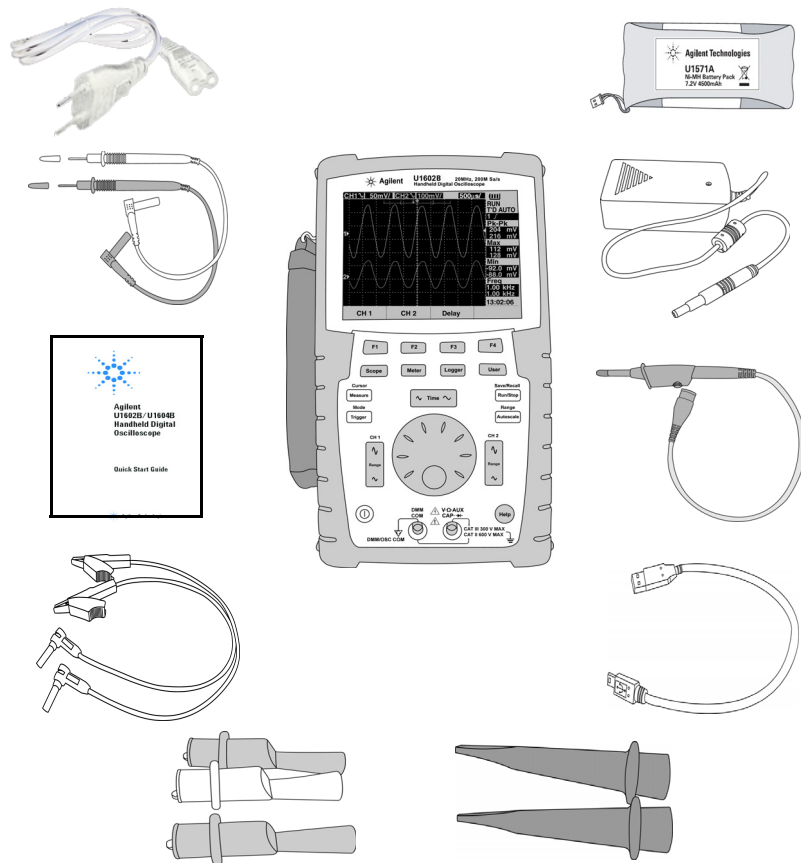

Figure 1-1 Standard shipped components

1 Getting Started

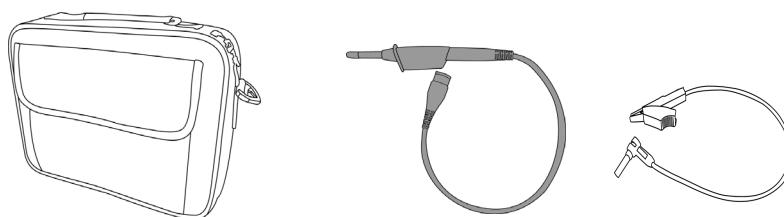

Figure 1-2 Optional accessories

Table 1-1 Power cord types

Plug Type	Part No.	Plug Type	Part No.
United Kingdom	8120-6315	South Africa and India	8121-0702
Australia, New Zealand	8120-6312	Japan	8120-6316
Europe	8120-6314	Brazil, Thailand, Philippines	8121-0664
United State, Canada (120V)	8120-6313	Argentina	8120-6316
China	8120-8373	Chile	8120-8452
Korea	8120-8441		

NOTE

The power cord type shown in [Figure 1-1](#) is for illustration purposes only. The power cord type you receive as part of the standard shipping components varies with your region as stated in [Table 1-1](#).

To Charge a Battery

- ✓ Before using the instrument for the first time, fully charge the battery for approximately 25 hours with the unit turned on by using the designated Agilent AC adapter. Ensure that you have the correct line power cord (refer to Table 1-1). The AC adapter automatically converts input line voltage ranges from 100 VAC – 240 VAC, 50/60 Hz to output voltage 12 VDC, 2 A.

A new rechargeable battery comes in a discharged condition and must be charged before use. Upon initial use (or after a prolonged storage period) the rechargeable battery may require three to four charge/discharge cycles before achieving maximum capacity. To discharge, simply run the oscilloscope under the rechargeable battery's power until it shuts down or until you get a low battery warning.

CAUTION

To avoid instruments being damage from battery leakage, always remove dead batteries immediately.

NOTE

For quick charging mode with instrument turned off, the charging time is approximately 4.5 hours.

1 Getting Started

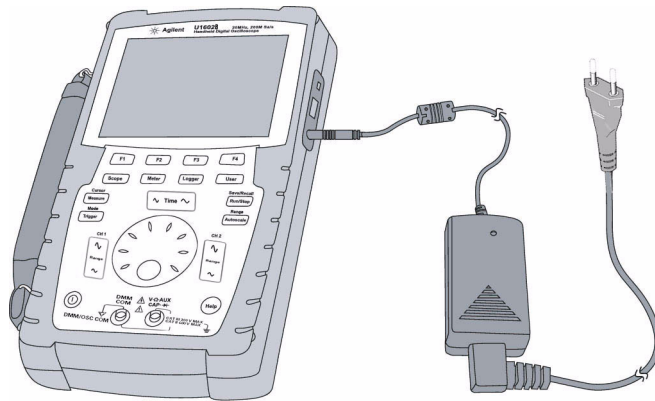



Figure 1-3 Battery charging

To Power On Instrument

- ✓ To turn the instrument on or off, press and hold the  button for three seconds. The power switch button is located at the lower left corner of the front panel. The instrument loads the last configuration setup from its non-volatile memory of the instrument.

To Reset to Default Factory Settings

- ✓ The default factory setting returns the instrument to its known operating condition. Pressing the F1 Factory Setup softkey removes all previous user-defined configuration settings of the instrument. Once deleted, these user-defined settings cannot be recovered.

- 1 Press and hold  button to enter Save/Recall menu.
- 2 Select F1 softkey to enter Save/Recall Setup mode.
- 3 On page 1/4 of Save/Recall mode, press F1 to restore factory setup.

The major default settings are:

Horizontal Main mode, 100 μ s/div scale, 0 s delay, center time reference, window off

Vertical Vertical channel 1 on, 5 V/div scale, DC coupling, 0 V position, probe factor to 1X

Trigger Edge trigger, Auto sweep mode, 0 V level, channel 1 source, DC coupling, rising edge slope

Display Vector on, 50% contrast, graticule grid, persistence off

Acquire Normal mode, Run/Stop to Run, cursors and measurement off

DMM Voltmeter set to DC, relative off, auto-measurement

Ohmmeter set to Resistance, relative off, auto-measurement

1 Getting Started

Temperature meter set to °C, relative off

Ampere meter set to DC, relative off

Humidity meter set to %RH, relative off

Pressure meter set to psi, relative off.

Logger Logger Volt, DC input, Maximum logging

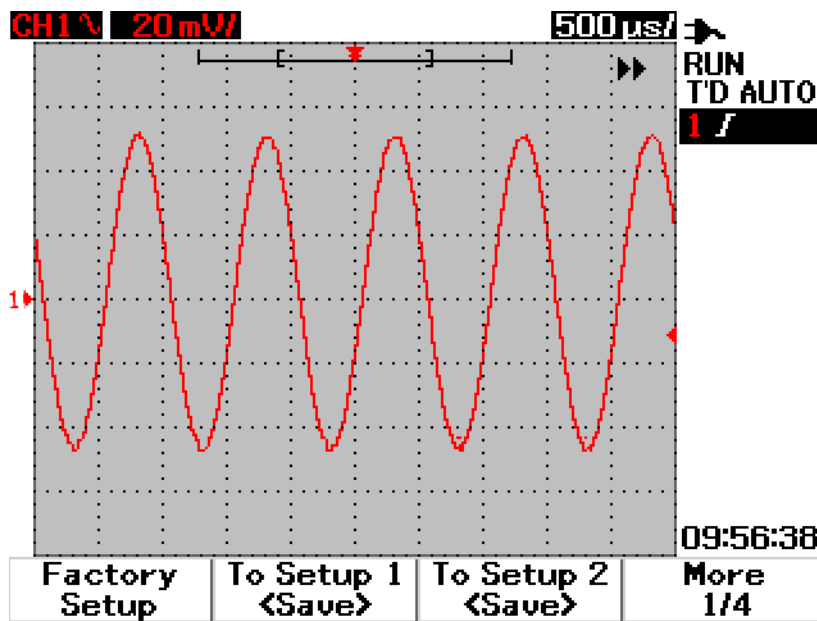



Figure 1-4 Factory setup

To Perform Self-Calibration

- ✓ Perform self-calibration to verify that your instrument is operating properly. Self-calibration performs an internal self-alignment routine to optimize the signal path in the oscilloscope. The routine uses internally generated signals to optimize circuits that affect channel sensitivity, offset and trigger parameters.

Let the instrument to warm up for at least 30 minutes before performing self-calibration. You should perform self-calibration according to the following recommendations:

- Every 12 months or after 2000 hours of operation
- If the ambient temperature is > 10 °C from the calibration temperature
- If you want to maximize the measurement accuracy
- after experiencing abnormal operation.
- to verify proper operation after repairing.

- 1 Press  button to access Utility mode at F4 softkey.
- 2 On page 3/4 of Utility mode, press F1 to start self-calibration.
- 3 A self-calibration dialog box appears to alert user to remove all input connections to the instrument before pressing F1 to start self-calibration.

WARNING

Disconnect all probe and meter connections to the input terminal of the instrument. Allow the instrument to warm up at least 30 minutes before performing self-calibration. Refer to ““Self-Calibration” on page 156” for more information.

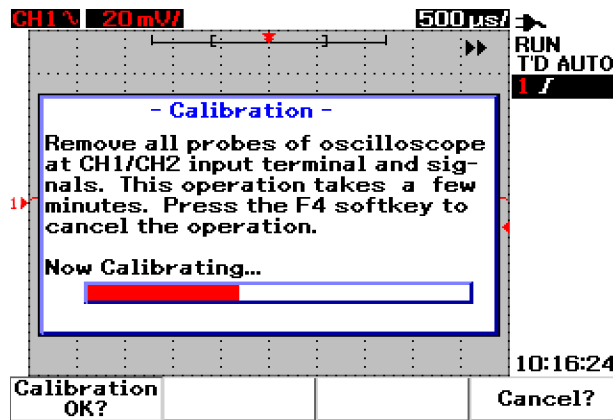

Figure 1-5 Self-calibration dialog box

To Set Date and Time

- ✓ You can set the current date and time on the instrument. The current time and date will appear at the right bottom corner of the display. To set the date and time, do the following:

- 1 Press button and F4 softkey to enter Utility mode.
- 2 On page 2/4 of Utility mode, press F1 to select time format in MM/DD/YY or YY/MM/DD.
 - MM – month
 - DD – day
 - YY – year

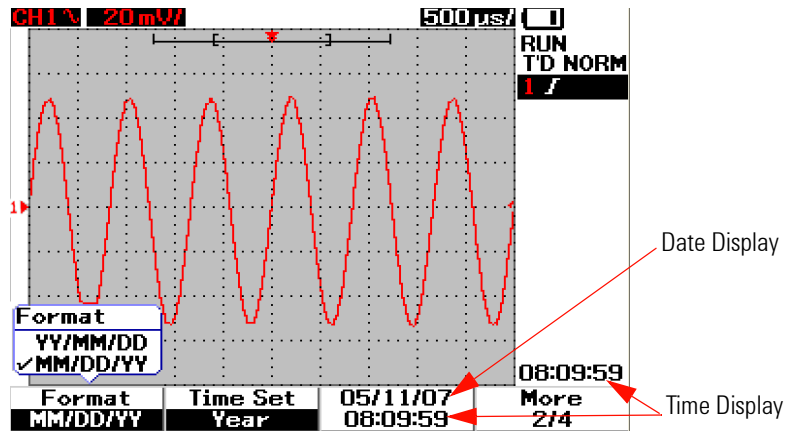

Figure 1-6 Select the date format

- 3 Press F2 to select Year, Month, Day, Hour, Minute or Second and turn the rotary switch to select the desired value.
- 4 Press the rotary switch to store the preferences.

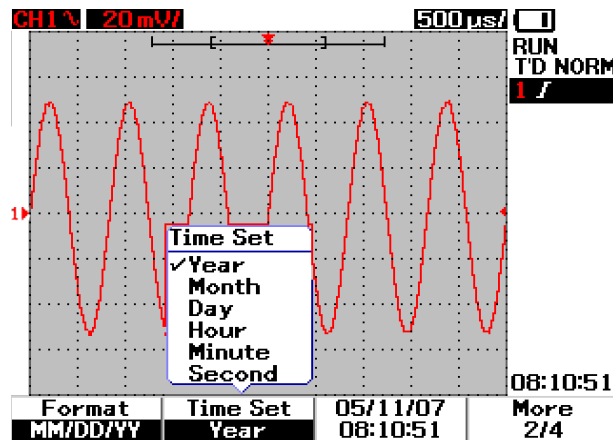

Figure 1-7 Date and time setting

To Set Auto-Power Off

- ✓ This instrument consists of auto power off function. This function aims to save battery life when none of the front panel keys are active during the set timer period. After the set timing, the instrument saves the last configuration settings and turns off automatically.

To set auto power off, do the following:

- 1 Press User button and F4 softkey to enter Utility mode.
- 2 On 1/4 page of Utility mode, press F1 to select your preferred timing: 5 min/10 min/30 min/1 hour/2 hours/4 hours.

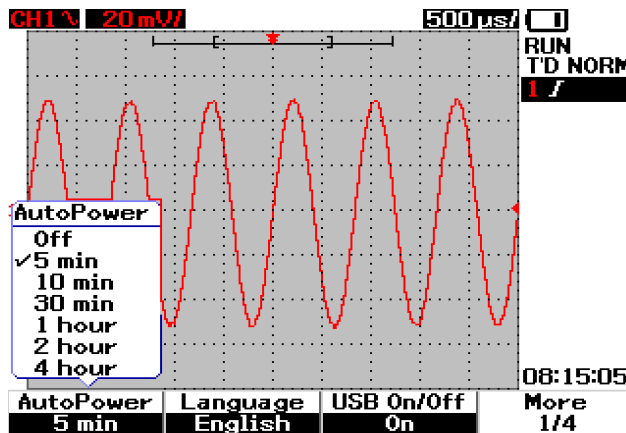



Figure 1-8 Auto-power off function

To Select Quick Help Language

- ✓ You can access Quick Help in different languages. At the time of publication, Quick Help is available in English, German, French, Italian, Portuguese, Spanish and Korean. The instrument provides Quick Help in English, optionally you can download your preference language from the product webpage: www.agilent.com/find/handheldscope

To select a Quick Help language in the oscilloscope, do the following:

- 1 Press  button and F4 softkey to enter Utility mode.
- 2 On 1/4 page of the Utility mode, press F2 to display a pull up menu with a list of languages for selection.
- 3 Press the rotary switch to store the language of your preference.

See the following steps for upgrading your instrument's firmware or downloading the Quick Help in different languages:

- 1 Select and save the firmware (binary file) to any directory on your hard disk.
- 2 Ensure that the instrument is disconnected from your PC.
- 3 Double-click and launch the firmware loader.
- 4 Click **Open BIN** to browse the saved firmware binary file.
- 5 Power on the instrument if the instrument has not been powered up. To turn on the USB connection of the instrument, press User > Utility (F4 softkey) > USB On/Off (page 1 of 4) > On (F3 softkey) on the instrument front panel.
- 6 Connect the instrument to your PC via the USB cable. The PC will automatically detect the instrument.
- 7 Power off the instrument, and power on again for the firmware upgrading to take effect. Once power on, upgrading will automatically execute to replace the old firmware with the new firmware.

CAUTION

Do not remove the USB connection between the instrument and PC during the firmware downloading process. If this is violated, the instrument will hang and may not be able to power off. When this incident occurred, disconnect the battery and repeat step 1 to 10.

- 8 After firmware upgrade completion, the instrument will automatically power off.
- 9 Click **Exit** to close the firmware loader.
- 10 Power on the instrument, press User > Utility (F4 softkey) > Languages (F2 softkey) on the front panel to select the English or installed language. The Quick Help menu will be displayed in the selected language.

To Adjust Contrast of Display

- ✓ The instrument allows you to adjust the LCD brightness with the following steps:
 - 1 Press **User** button and F1 softkey to enter Display mode.
 - 2 On 1/2 page of Display mode, press F2 once to release the figure lock.
 - 3 To increase the contrast of the display, turn the rotary switch clockwise. To decrease the contrast, turn the rotary switch counter-clockwise.
 - 4 Press F2 again to lock the contrast setting.

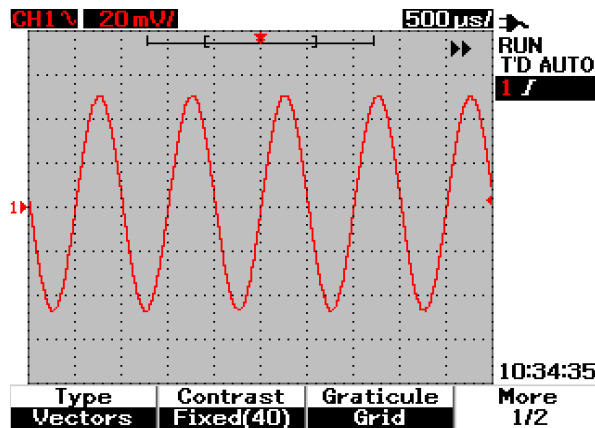

Figure 1-9 Adjust display contrast

To Compensate Scope Probe

- ✓ Perform scope probe compensation whenever you attach a passive scope probe to any input channel for the first time. This is important to match the probe characteristic to the instrument. Without a properly compensated probe, the accuracy of your measurement is not guaranteed.

To adjust the scope probe compensation, perform the following steps:

- 1 Press **User** button and F4 softkey to enter Utility mode.
- 2 On page 3/4 of Utility mode, press F2 to start probe calibration.
- 3 Select probe attenuation at F1 (10X or 100X) before connecting the probe to the instrument.
- 4 Connect the passive probe to channel 2 and probe contact to channel 1. The input signal is 3 Vp-p with 1 kHz from channel 1.

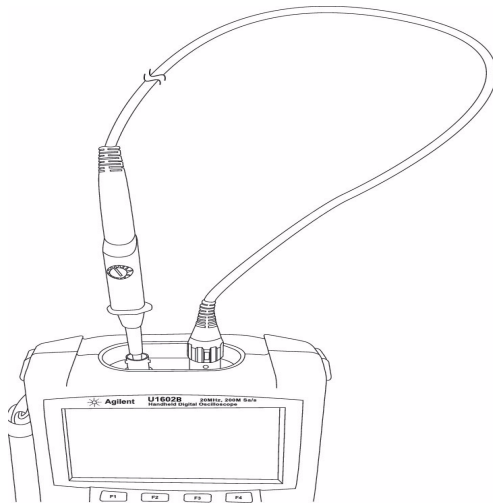

Figure 1-10 Connection for scope probe compensation

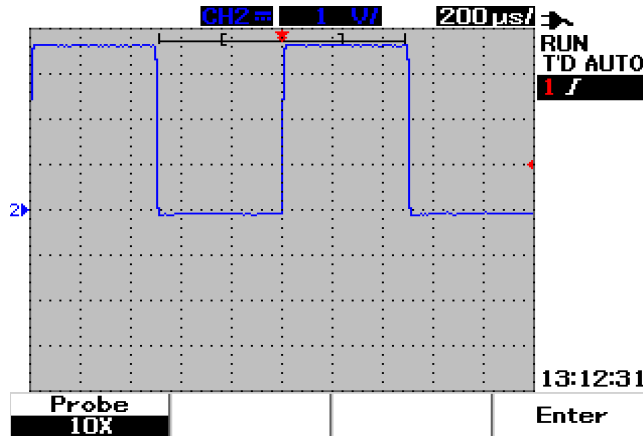

Figure 1-11 A 10X scope probe with over compensation, adjust the trimmer capacitor to obtain the flattest pulse possible as shown in Figure 1-13.

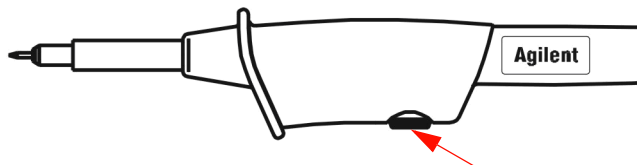

Figure 1-12 Trimmer capacitor for probe compensation

Use a nonmetallic tool to adjust the trimmer capacitor on the probe for the flattest pulse possible, refer to Figure 1-13. The trimmer capacitor is located as shown in Figure 1-12.

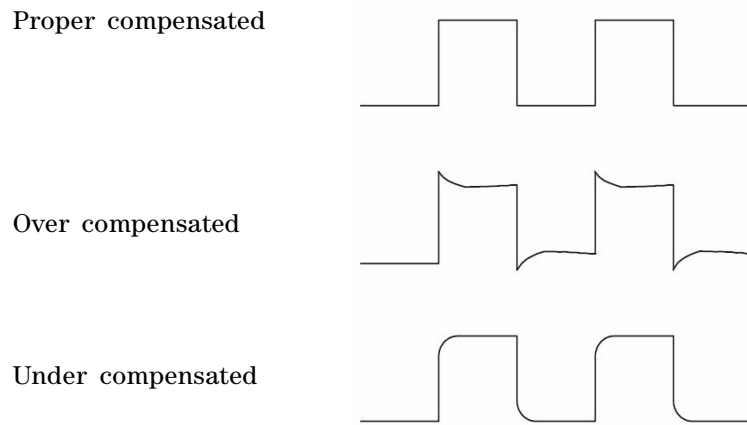

Figure 1-13 Pulse shape reference for scope probe compensation

THIS PAGE HAS BEEN INTENTIONALLY LEFT BLANK.



2 Front Panel and Displays Overview

Front Panel Overview [20](#)

Oscilloscope Display Overview [25](#)

Multimeter Display Overview [27](#)



Front Panel Overview

This chapter describes the front panel controls of the Agilent U1600B series handheld digital oscilloscope series. The front panel keys are used for setting up and making scope and meter measurements. They provide access to the softkey menus for respective function and value setting selected by turning the rotary switch. These front panel keys lead you to the first layer of the function's menu, where four softkeys located below the display are used to select the sub-menu of the function. With these four softkeys, you can access and alter the settings of the individual function.

The rotary switch acts as an enter button to set as a selector to reposition a channel waveform. To adjust the value setting, turn rotary switch clockwise to increase or counter clockwise to decrease the value, and press the rotary switch to fix the value.

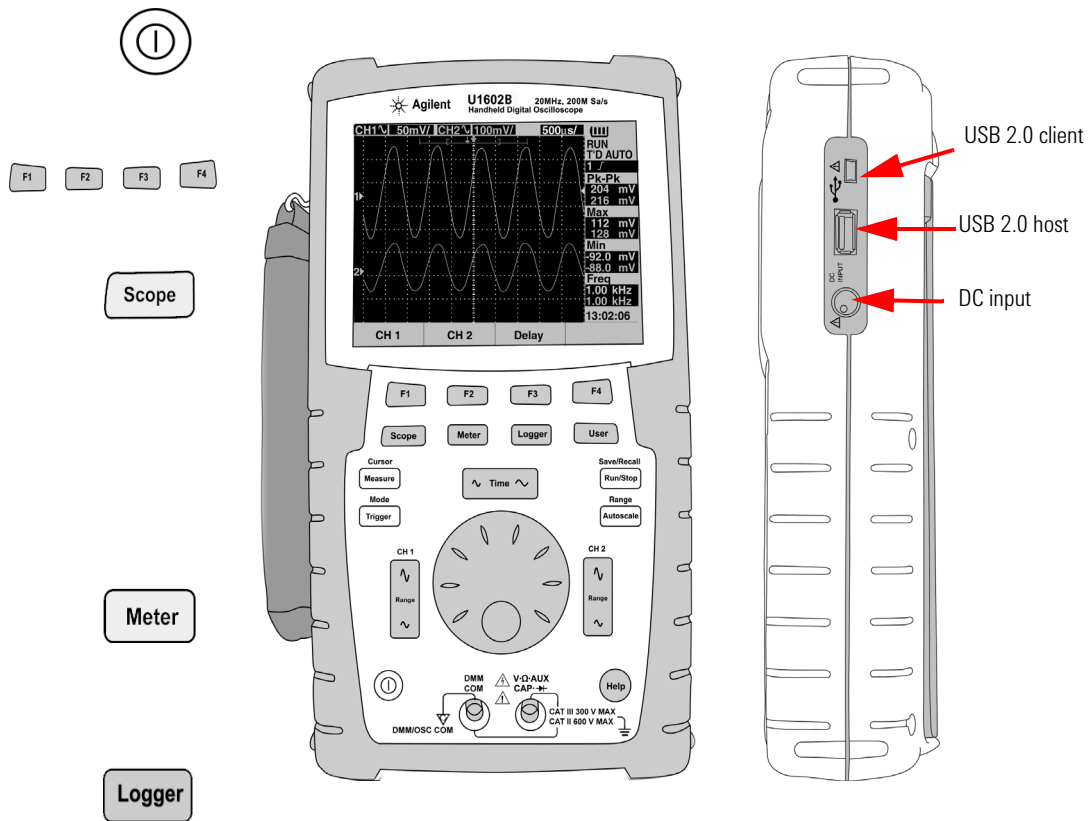



Figure 2-1 U1600B series handheld digital oscilloscope front and side view

User

To EXIT the sub-menu of the main function, press any of the main function keys.

2 Front Panel and Displays Overview

- 1 **Power Switch** Press and hold power switch  button to power the instrument ON or OFF.

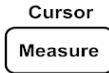

- 2 **Softkeys** The function of each key varies with the menus shown on the display. The four softkeys are located below the LCD display.

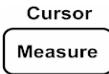

- 3 **Scope** Main function key to access channel 1 and channel 2 waveform settings. Under Scope mode, you can set the waveform display to delayed section, whereby you can select XY and YT time base. By turning the rotary switch, you can change the waveform's vertical position on the display. You can also set the acquisition window relative to the trigger point and trigger time reference point on this menu. In addition to this, you can pan and zoom into the virtual waveform by turning the zoom window horizontally.

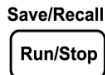
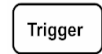

- 4 **Meter** Main function key to switch to multimeter mode. This meter mode provides access to Voltmeter, Ohmmeter and Auxiliary meter sub-menu. Use the softkey to select and access the various multimeter functions that work in auto-range mode.

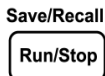

- 5 **Logger** Main function key to consolidate data point for data logging purposes. This data logging function is available for all multimeter functions.

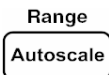

- 6 **User** Main function key to access Display, Acquire, Math and Utility menus.

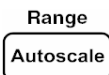

- **Display** mode allows you to set the type, contrast and graticule setting for the display background. You can persist the captured waveform without erasing the previous waveform acquisitions.
- **Acquire** mode lets you set the signal acquisition to Normal, Average or Peak modes.
- **Math** mode provides the Dual Waveform Math functions to multiply and subtract waveforms. FFT (Fast Fourier Transform) function is available for U1604B.

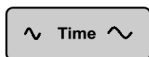

- **Utility** mode allows you to configure the instrument's real time display, auto power off, language selection for Quick Help, USB connectivity, self-calibration and self-test operation.



- 7 Measure** Main function key to select a list of predefined auto-measurement to be displayed on the screen.

- 8 Cursor** Main function key to perform waveform measurement using X or Y cursor functions. To access this function, press and hold the  button.

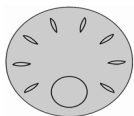

- 9 Trigger** Main function key to determine the type of trigger control to capture different types of waveform signals.

- 10 Run/Stop** Main function key to force instrument to start scanning for trigger. If the trigger mode is set to Normal, the display will not update until a trigger is found. If the trigger mode is set to Auto, the instrument looks for a trigger. If no trigger is found, it will automatically trigger and display the signals immediately.

- 11 Save/Recall** Main function key that allows you to save, recall and erase the previously stored configuration setup and waveform. Connect a USB flash memory to store or recall instrument's configuration setup files and waveforms. Simply unplug the USB flash memory without any precaution before removing it.



- 12 Autoscale** By pressing the Autoscale key, both the channels will be activated and the input signal is scaled to the best display.

- 13 Range** By pressing the Autoscale key in any auto-range meter mode, the instrument allows you to select the range of your preference.

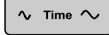
14 Horizontal Scale Use this  button to change the time per horizontal division (time/div) on the display. Pressing the right of the button (ns) zooms down the time/div and pressing the left of the button (ns) zooms up the time/div.



15 Vertical Scale Use this  button to scale up or down the vertical sensitivity (gain) in voltage per vertical division (volt/div) of the channel. Pressing the upper button (mV) will scale down the sensitivity and pressing the lower button (V) will scale up the vertical sensitivity. There are two buttons for each channel's adjustment.

16 Rotary Switch This rotary switch is activated only in oscilloscope mode for adjustment of the following functions:

- Channel's reference ground position
- Delay trigger time reference
- Edge trigger level
- Pulse trigger level and condition
- Pattern trigger level and condition
- Video trigger line
- Auto measurement parameter selection
- Zoom window
- Cursor move
- LCD display contrast
- Average number selection in Acquisition mode
- Date and time setting

17 The Quick Help is a built-in function in the instrument. It provides help for each front panel and softkey. To view the quick help for each function, press  button. Turn the rotary switch clockwise to go to the next page.

Oscilloscope Display Overview

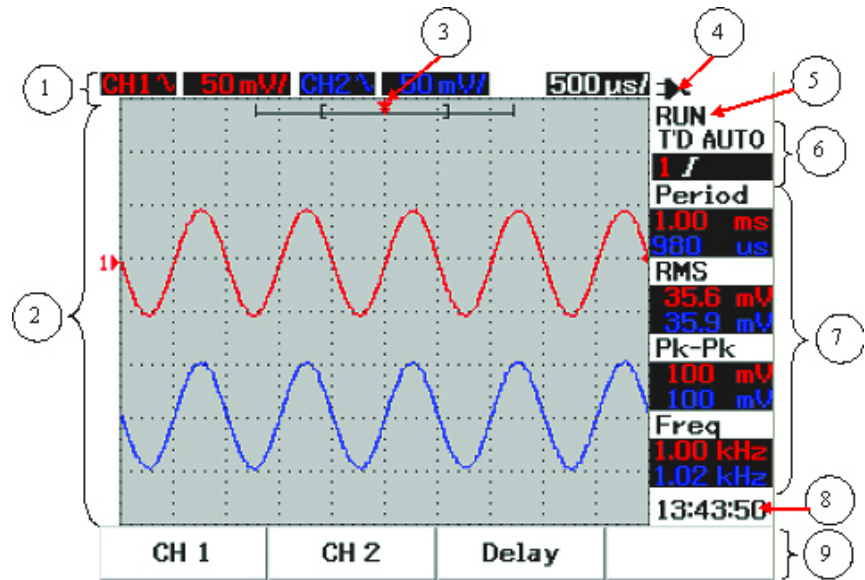



Figure 2-2 Interpreting Scope Display

- 1 Status line** The top line of the display shows the setup information of channel 1 and channel 2 in vertical sensitivity (volt/div) and sweep speed (time/div).
- 2 Waveform display area** The display area contains the waveform acquisition, channel identifiers in two different colors, trigger level and ground reference indicator.
- 3 Time reference and trigger point** This position point is used as an indicator as well as a trigger point for time reference in waveform window.
- 4 Power source indicator** This indicator will shows the status of the battery from full to empty  and indicate the AC connectivity for battery charging.

2 Front Panel and Displays Overview

- 5 Acquisition status** This Run/Stop mode shows the waveform acquisition status in running frozen condition.
- 6 Trigger status** These two rows display the trigger status, type and mode. The trigger status (T'D) blinks when no signal is detected.
- 7 Measurement line** This column displays the results of the selected automatic measurements.
- 8 Real-time display** You can set the date and time in the User -> Utility mode.
- 9 Menu display area** The softkey below the LCD display allows you to select and set up parameters for the respective mode and menu.

Multimeter Display Overview

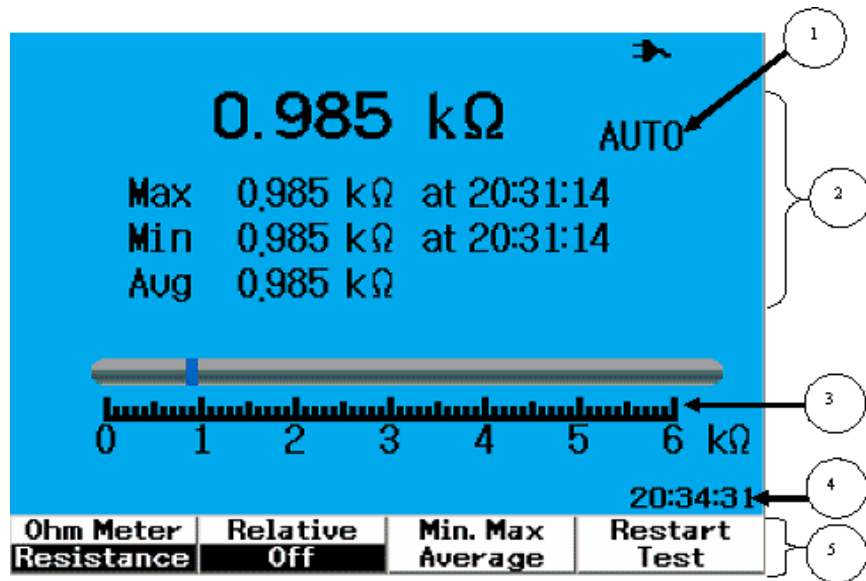

Figure 2-3 Interpreting meter display

- 1 Auto-Range** This true RMS auto-range is applicable to all multimeter functions of this instrument. It automatically selects the appropriate range based on the measured value. This function can be turned off for user to select the range of preference. Manual range option is available only for Voltmeter and Ohmmeter mode.
- 2 Meter display area** The display area contains results of real-time maximum, minimum and average measurement values with the corresponding time indication.
- 3 Analogue bar graph** This bar graph displays precise real-time measurement value in the selected range.
- 4 Real-time display** You can set the date and time in the User -> Utility mode.
- 5 Menu display area** The softkey below the LCD display allows you to select and set up parameters for the respective mode and menu.

THIS PAGE HAS BEEN INTENTIONALLY LEFT BLANK.



3 Using the Scope Functions

Vertical Controls	30
Horizontal Controls	40
Trigger Controls	47
Waveform Controls	57
Display Controls	60
Automatic Measurement	63
Cursor Measurement Controls	72
Math Functions Control	79
Save and Recall Controls	84
Autoscale and Run/Stop Controls	97
Utility Controls	99
Low Battery Mode	101
Mute Function	102

This section guides you through the operation steps in setting up the vertical system control of the instrument. It is highly recommended that you read through this chapter to get familiar with the basic operation setup before performing measurements with the instrument.

NOTE

- For option selections in all function menus, press the respective softkey to select and set the option with a tick (✓) is shown.
- For any adjustment using rotary switch, the menu displays  to indicate the rotary switch is required for the adjustment.



Vertical Controls

Each channel consists of vertical control setting in the scope menu of each respective channel. This section describes the vertical channel controls for each channel.

Channel Selection for Waveform Display

The default configuration setting of the instrument enables the waveform display for vertical channel 1. You can enable either one channel or both channels simultaneously. The following steps show how to enable the waveform or disable it from the display.

- 1 Press button on front panel to access Scope menu. You will see the following scope menu display in Figure 3-1, which shows both channels disabled.

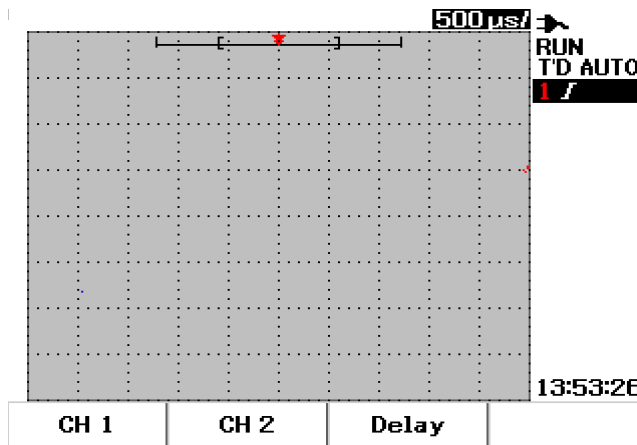

Figure 3-1 Scope menu display with displayed of both channels display.

- 2 Press F1 softkey to access channel 1 (CH 1) submenu or F2 to access channel 2 (CH 2) submenu.
- 3 The submenu for both channels are similar. Figure 3-2 shows the generic submenu for channel 1. To enable waveform display for channel 1, press F1 to display the pull-up menu.

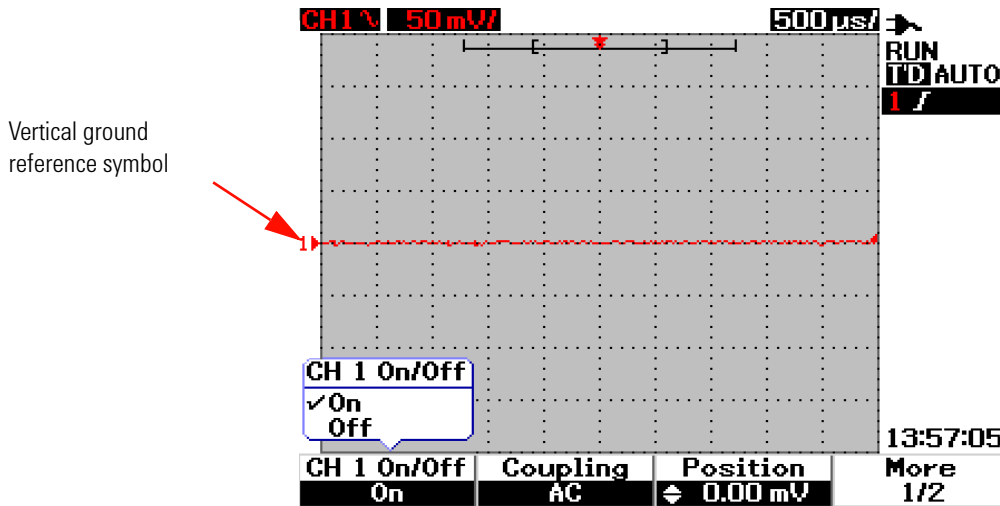

Figure 3-2 Select On or Off to enable or disable the waveform display

- 4 Select “On” in the pull-up menu by pressing F1 to display waveform input.
- 5 In the “On” state, the vertical sensitivity in Volt/div (displayed in V/) and indication of the vertical ground reference position will be displayed according to the position setting of the channel (refer to the next section for detailed explanation).
- 6 You can perform the same procedure for channel 2 or for both channels.

Vertical System Setup

To Change Vertical Reference Ground Position

You can adjust the waveform vertically by pressing the F3 softkey. The following Figure 3-3 displays the vertical position adjustment setting.

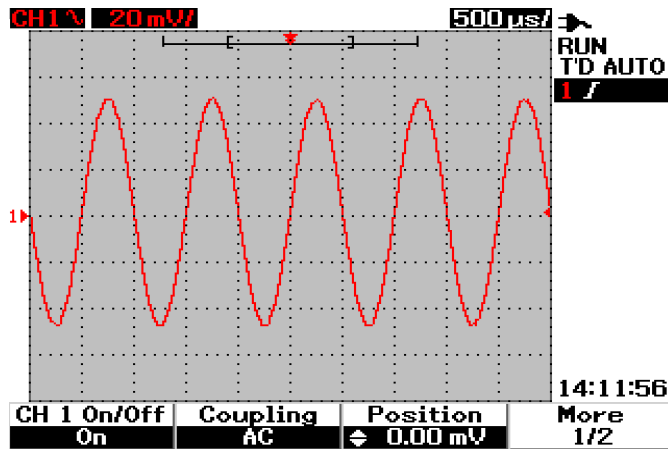



Figure 3-3 Adjust vertical position for the waveform displayed.

- 1 Press the F3 softkey to enable the setting of the waveform position. Turn rotary switch clockwise to move the waveform up and vice-versa to move the waveform down.
- 2 As you turn the rotary switch , the corresponding voltage value is displayed under the Position header shown in Figure 3-3. This voltage value indicates how far the ground reference is from the center of the screen.
- 3 Notice that the waveform and the ground reference symbol moves vertically with respect to the rotary switch position.

NOTE

The maximum positive reference offset is 250 mV and the minimum negative reference offset is -250 mV.

To Center the Waveform on the Display

You can quickly reset the waveform to the center of the screen. To navigate to the next page of the submenu, press the F4 softkey. In the page 2/2 of the channel submenu, press F3 to reset the vertical ground reference position to the center of the screen.

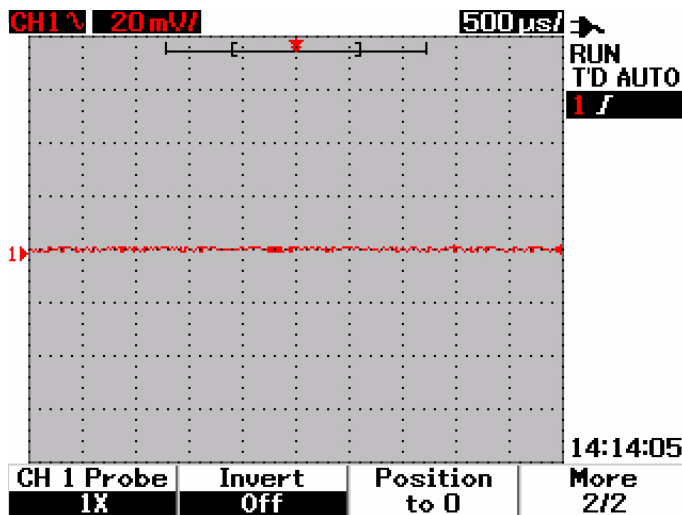



Figure 3-4 Reset vertical ground reference symbol to zero volt.

NOTE

Position to 0 is a convenient function to return the waveform offset to the original state after changing ground offset via rotary switch.

To Change Vertical Sensitivity



By pressing the  button, you can change the vertical sensitivity (Volts/div) of a waveform. The vertical scale factor changes the Volts/div scale in a 1-2-5 step sequence depending on the probe attenuation.

- 5 mV/div to 100 V/div for 1:1 scope probe
- 50 mV/div to 1 kV/div for 10:1 scope probe
- 500 mV/div to 10 kV/div for 100:1 scope probe



To change vertical sensitivity for each channel, use the  vertical scale factor button for sensitivity increment and reduction. Press the upper button (with mV indicator) to increase vertical sensitivity or press the bottom button (with V indicator) to reduce it. The channel Volts/div value is displayed in the status line (refer to “[Oscilloscope Display Overview](#)” on page 25) as shown in Figure 3-5.

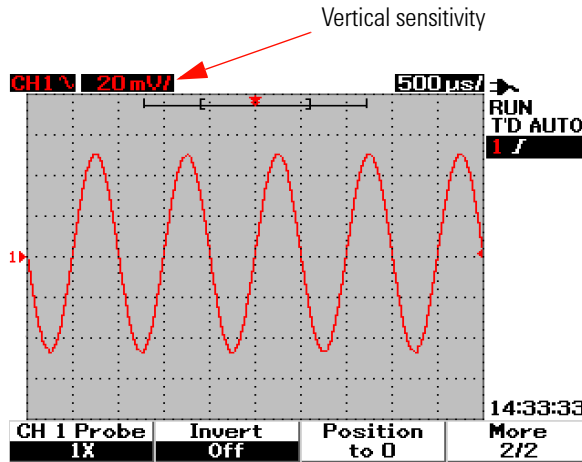



Figure 3-5 Vertical sensitivity display



NOTE

By pressing the  button for channel 1 or channel 2, the respective channel’s setting menu will appear.

Channel Coupling Control

The channel coupling control can be used to remove any DC offset voltage on a waveform. You can select the input channel coupling to either AC (alternating current), DC (direct current) or Gnd (Ground).

To select the input channel coupling, follow the procedures below:

- 1 Go to individual channel 1 and channel 2 menu by pressing the  button.
- 2 On page 1/2 of each respective channel's submenu, you can view and set the channel coupling by pressing the F2 softkey. A pull-up menu is displayed with the selections of AC, DC and GND.

AC Channel Coupling

AC coupling is useful for viewing waveforms with large DC offsets. You can select AC coupling to block any DC component from being passed through the instrument. In this case, only AC component of the input signal can be viewed. The  symbol is shown at the top left of the status line. See [Figure 3-6](#) for AC channel coupling.

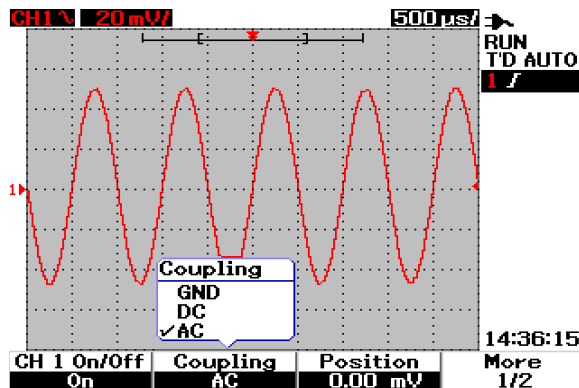



Figure 3-6 AC channel coupling

DC Channel Coupling

In DC coupling mode, both AC and DC components exist in the input waveform to the instrument. DC coupling is useful for viewing waveforms as low as 0 Hz that do not have large DC offsets. The  symbol is shown at the top left of the status line. See Figure 3-7 for DC channel coupling.

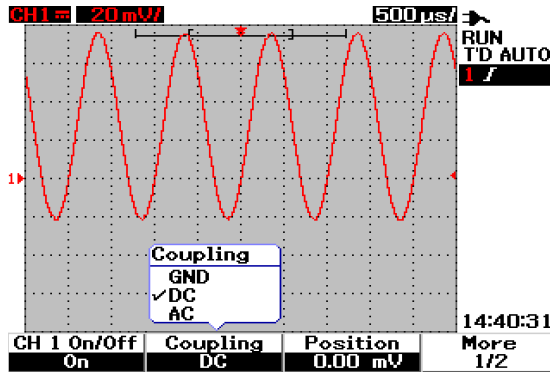



Figure 3-7 DC channel coupling

Ground channel coupling

In GND coupling mode, the waveform is disconnected from the oscilloscope input. The  symbol is shown at the top left of the status line. See Figure 3-8 for Gnd channel coupling.

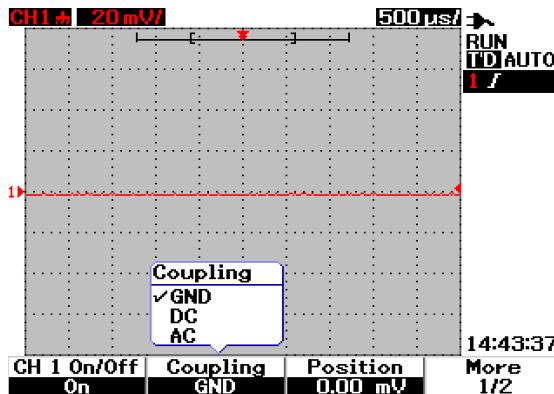

Figure 3-8 Gnd channel coupling

Probe Attenuation Control

Probe attenuation control is dependent on the capability of the probe attenuation attached to the instrument. The probe attenuation changes the attenuation factor for the probe. The probe attenuation factor must be set according to the probe being used to ensure the measurement results reflect the actual voltage level.

Three scale types of probe attenuation are available:

- 1X : Select when using 1:1 probe or when directly sourcing the signal to the input terminal.
- 10X : Select when using a 10:1 probe.
- 100X: Select when using a 100:1 probe

You can set the probe attenuation factor as follow:

- 1 Go to individual channel 1 and channel 2 menu by pressing the Scope button.
- 2 On page 2/2 of each respective channel's submenu, you can view and set the channel probe attenuation by pressing F1 softkey. A pull-up menu is displayed with the selection of 1X, 10X and 100X.
- 3 Set probe attenuation scale in accordance with the probe you use.

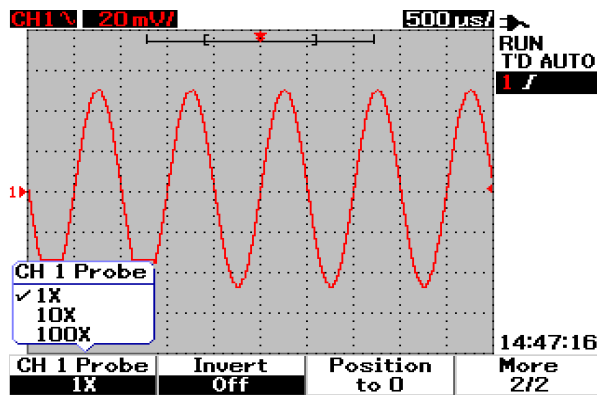



Figure 3-9 Probe attenuation scale setting

Invert Control

The invert control inverts the displayed waveform with respect to the ground level. The waveform voltage level is inverted as shown in Figure 3-10. The vertical trigger position remain unchanged after the inversion, a reposition of the trigger is required in order to view the triggered inverted signal.

To invert the waveform on channel 1, do the following:

- 1 Go to individual channel 1 and channel 2 menu by pressing the  button.
- 2 On page 2/2 of each respective channel's submenu, you can turn the Invert control on or off by pressing F2 softkey. See the subsequent three figures for detailed explanation.

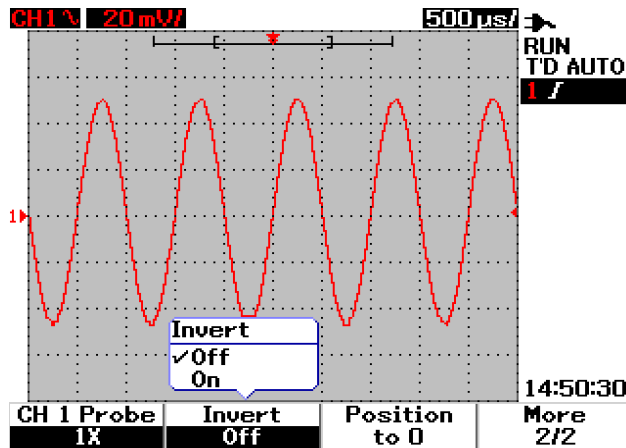

Figure 3-10 The waveform before inversion.

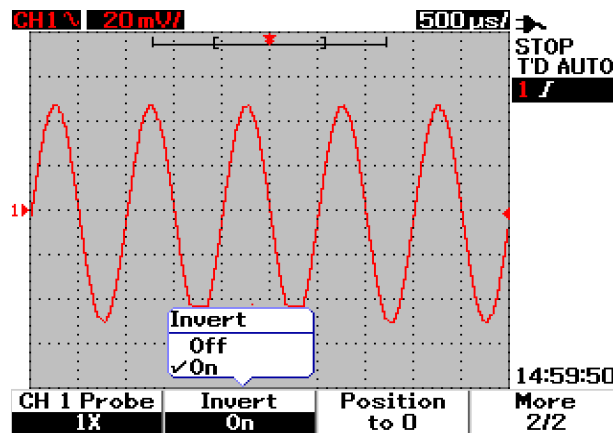

Figure 3-11 The waveform after inversion

NOTE

The Invert function does not affect triggering. If the instrument is set to trigger on a rising edge, it remains set to trigger on the same edge and at the same point on the waveform after the channel is inverted.

Horizontal Controls

All waveforms share the same time base, the instrument displays only one time/div value for both the channels at the top right of the status line. The horizontal controls can change the horizontal scale and position of the waveforms. The horizontal center of the screen is the time reference for waveforms. Changing the horizontal scale causes expansion or contraction of the waveform about the time reference point. The horizontal control changes the position of the trigger point relative to the center of the screen.

Vertical System Setup

To Change Horizontal Scale Factor

Horizontal scale is applied to both channels including math waveform.

To change horizontal scale factor, you can use the  button to scale up or down the time base setting. Press the left side of the button (with s indicator) to scale up the time scale factor and press the right side of the button (with ns indicator) to scale down the time scale factor. The time/div is displayed in status line (refer to [“Oscilloscope Display Overview”](#) on page 25) as shown in Figure 3-12.

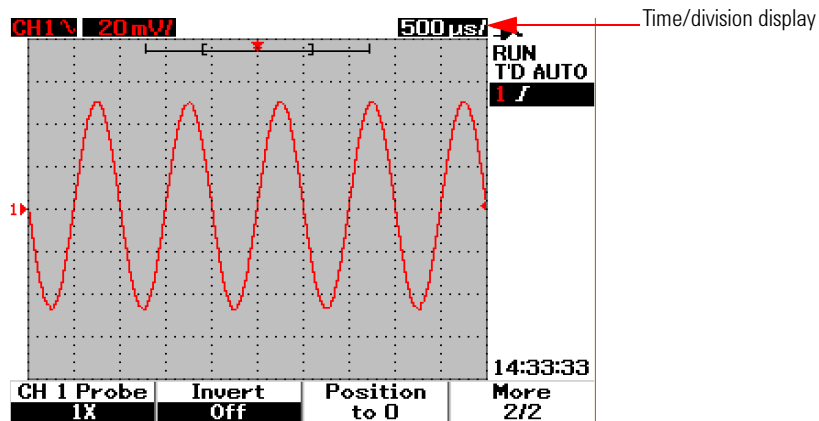

Figure 3-12 Time/div display in status line

NOTE

The horizontal scale factor changes the sweep speed in a 1-2-5 step sequence.

To Set Delay of the Waveforms

The time reference position sets the initial position of the trigger event within acquisition memory with delay set to 0. The delay setting sets the specific location of the trigger event with respect to the time reference position. Turning the rotary switch to move the trigger point indicator ↓ to the left or right from the time reference indicator ▼. When delay time is set to zero, the delay time indicator overlaps the time reference indicator.

To set delay for a waveform, follow instructions below:

- 1 Enter the Scope menu by pressing the Scope button.
- 2 In Scope menu, press F3 to access Delay submenu.
- 3 On page 1/2, press F1 softkey to enable the time base adjustment to the waveform. Turn the rotary switch clockwise to move the waveform to positive (right side of the trigger point) direction and anti-clockwise to move the waveform to the negative (left side of the trigger point) direction.
- 4 While turning the rotary switch, you will notice the corresponding time value is displayed under the Time header column.

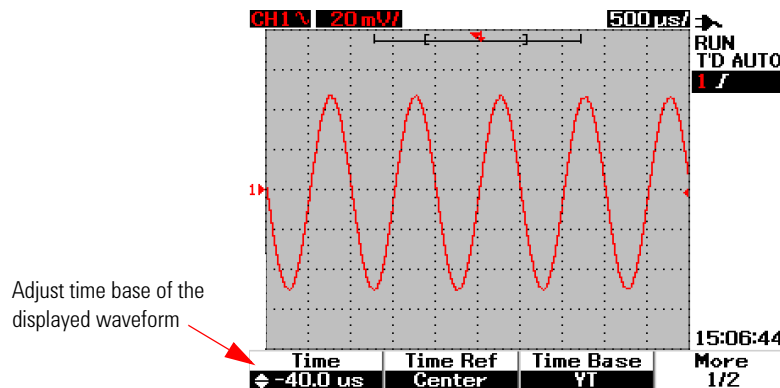





Figure 3-13 Changing time base of a waveform

NOTE

Notice that the sweep speed is set to 1 division step sequence with  indicator at the right corner in the waveform display area (refer to “Oscilloscope Display Overview” on page 25).

Turn the vernier scale on by pressing the rotary switch once. You will notice the  indicator is disappeared and now you can move the sweep speed in smaller increments.

To Change Trigger Point Indicator

Time reference  is the reference point on the display for delay time. To move the trigger point indicator from the time reference, do the following:

- 1 Enter the Scope menu by pressing the  button.
- 2 In Scope menu, press F3 to access Delay submenu.
- 3 On page 1/2, press F2 softkey to display a pull-up menu for the following selections:
 - Left (10% of the horizontal full scale)
 - Center (50% of the horizontal full scale)
 - Right (90% of the horizontal full scale)

All events displayed at the left of the trigger point are called pre-trigger information because they happen before the triggering. All events at the right of the trigger point, measuring after the trigger point, are called post-trigger information. The amount of delay range (pre-trigger and post-trigger information) is available depending on the sweep speed selected and memory depth.

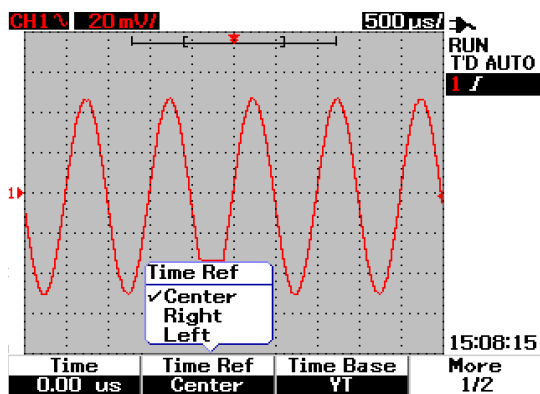

Figure 3-14 Select time reference

Horizontal Mode Functions

Time Base mode

This instrument provides two types of time base format:

- YT
- XY

The YT format refers to ordinary volts-versus-time display, that is the default for this instrument. In this format, amplitude is plotted on vertical Y-axis and time is plotted on horizontal Y-axis.

XY format changes the display from volts-versus-time to a volts-versus-volts display. Channel 1 amplitude is plotted on the horizontal X-axis and channel 2 amplitude is plotted on the vertical Y-axis. The time base is turned off. Use the cursors to make measurements on XY mode waveforms.

3 Using the Scope Functions

This XY mode is useful in comparing the voltage levels of two waveforms point by point and study the frequency and phase relationships between the two waveforms. To enable the XY mode, follow the instructions below:

- 1 Enter the Scope menu by pressing the  button.
- 2 In Scope menu, press F3 to access Delay submenu.
- 3 On page 1/2, press F3 softkey to display a pull-up menu for the YT and XY time base selections.
- 4 Select YT format for volts-versus-time display or XY format for volts-versus-volts display.

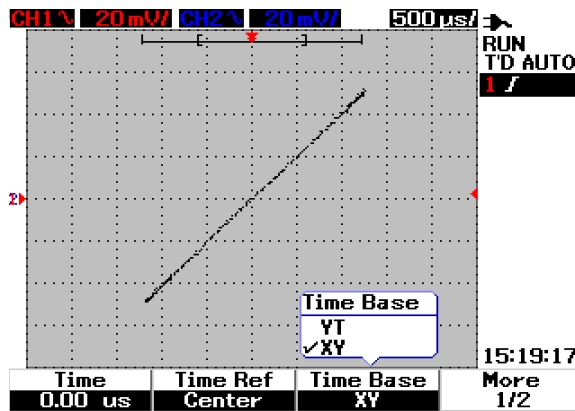

Figure 3-15 XY format display

Main/Zoom Mode

The Main mode is the normal viewing mode for the instrument. You can use the Main function to return to the view before magnification, where the horizontal scale factor would then return to its original level.

The Zoom function expands the view of the main waveform window to allow user a more comprehensive analysis on the waveform. To enable this zooming function, a zoom window needs to be set prior to magnification of the targeted waveform area. See the instructions below:

- 1 Enter the Scope menu by pressing the Scope button.
- 2 In Scope menu, press F3 to access Delay submenu.
- 3 On page 2/2, press F2 softkey to turn on the Window. This Window is used to select a zoom window on a waveform. Turning off the Window function removes the zoom area selection bar from the display.
- 4 Turn the rotary switch clockwise to expand the zoom area from the center of the window. Press F1 to magnify the waveform in the targeted zoom area. See the following figures for the waveform zooming function.

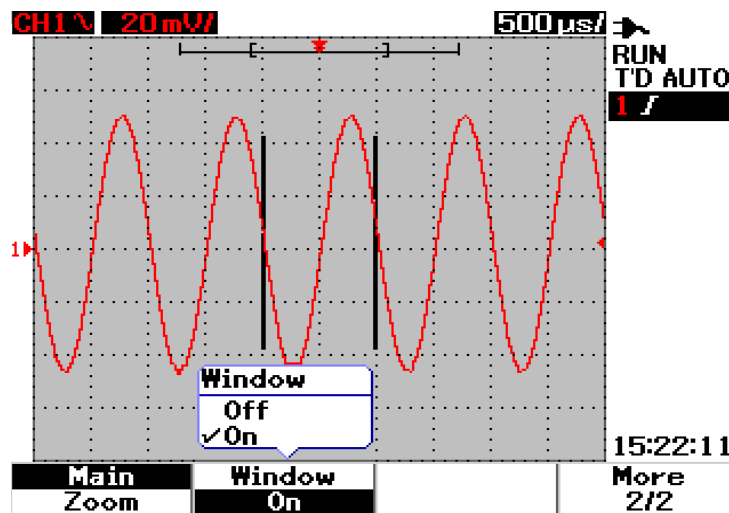

Figure 3-16 When Window function is turned on, a zoom area selection bar appears at the center of the display. Adjust rotary switch clockwise to expand the zoom area.

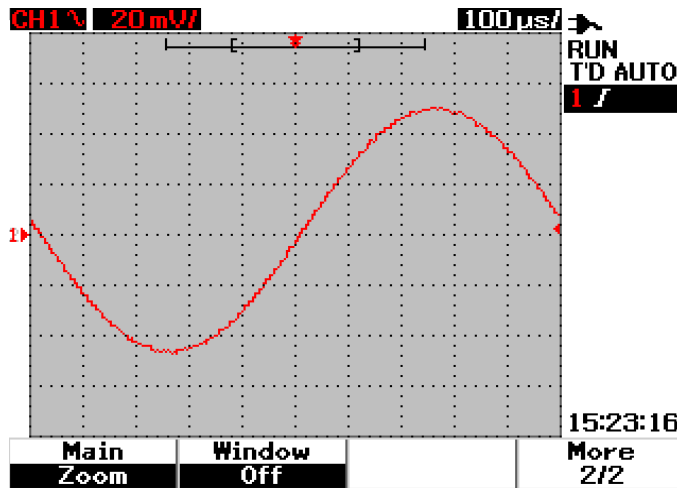

Figure 3-17 Press F1 to enable zooming function

NOTE

- The Zoom function is only applicable in Run Mode and NOT in Stop Mode.
- If Main function is selected during Zoom mode, the display will return to its previous view before magnification.

Roll Mode

The option for Roll mode operates on time base setting of 50 ms/div or slower. This roll mode causes the waveform to move slowly across the screen from right to left. If Roll mode is selected, there is no triggering capability and the scope is acquiring data continuously in auto trigger mode. The Roll mode is useful in low frequency waveform to yield a display in much like a strip chart recorder that allows the waveform to roll across the display.

To enable trigger mode at 50 ms/div or slower time bases, go to User > Acquire > Roll,Trig and select Trigger option to opt for triggering mode instead of Roll mode. This enables triggering at these slower time bases.

NOTE

The spanning functions are not available for time base setting of 50 ms/div or slower and 125 ns/div or faster.



Trigger Controls

Trigger function is applicable only for Scope measurement functions. The trigger determines when the oscilloscope starts to acquire data and display a waveform. Trigger control lets you synchronize the display to the activity of the circuit under test by defining a trigger condition. This signal triggering function obtains a stable and representable signal display from an unstable signal.

Trigger Modes

The trigger mode affects the way the instrument searches for the trigger. The trigger event divides the acquisition memory into a pre-trigger and a post-trigger buffer. The position of the trigger event in acquisition memory is defined by the time reference point and the delay setting.

To select triggering mode, do the following:

- 1 The default trigger mode is Auto trigger. Press and hold the  button at the front panel to select the Normal trigger mode.
- 2 To select Single trigger mode, press and hold the  button again.
- 3 Press and hold the  button to return to Auto trigger mode.

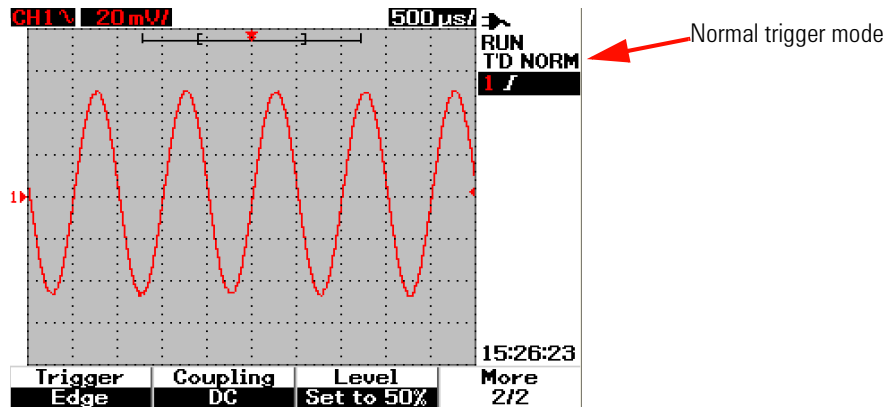

Figure 3-18 Normal trigger mode

Auto Trigger Mode

The Auto trigger mode displays a waveform when the trigger conditions are met. If the trigger conditions are not met, it forces the instrument to trigger.

In Auto trigger mode, the instrument operates by first filling the pre-trigger buffer. It continues to flow data through this buffer while searching for a trigger and updates the pre-trigger buffer. After a trigger is found, the pre-trigger buffer will contain the events that occur just before the trigger. If no trigger is found, the instrument generates a trigger and displays the data as though a trigger had occurred. The indicator of the trigger mode and status are shown at the trigger status line at the right column of the display (refer to [“Oscilloscope Display Overview”](#) on page 25).

Normal Trigger Mode

The normal mode displays a waveform when the trigger conditions are met, otherwise the instrument does not trigger and the display is not updated. If you press RUN when the instrument is in Normal trigger mode, a trigger must be detected before an acquisition can complete.

In Normal trigger mode, the instrument must fill the pre-trigger buffer with data before it starts to search for a trigger event. While searching for the trigger, the instrument updates the pre-trigger buffer. After a trigger is found, the oscilloscope will fill the post-trigger buffer and display the acquisition memory.

In many cases, a triggered display is not needed to check for signal levels or activity. For these applications, use Auto Trigger mode (default setting). Use Normal trigger mode only if you want to acquire specific events as specified by the trigger settings.

Single Trigger Mode

When you select the Single trigger mode, the instrument will fill the pre-trigger buffer memory. It continues to flow data through the pre-trigger buffer until the auto trigger overrides the searching and forces a trigger. At the end of the trace, the instrument will stop and display the results.

Trigger Types

You can use any input channel as the source for all the triggering type. This instrument provides four trigger types: edge, pulse, pattern and video. To enable trigger control, do the following:

- 1 Press  button at the front panel to access the Trigger type menu.
- 2 You can choose the trigger types by pressing F1 (Trigger) softkey until you see a pull-up menu with the following trigger type selections:
 - Edge Trigger
 - Pulse Trigger
 - Pattern Trigger
 - Video Trigger

Edge Trigger

The Edge trigger type identifies a trigger by looking for a specific edge (slope) and voltage level on a waveform. Edge trigger can be used for analog and digital circuits. You can define the trigger source, coupling, level and slope in this menu. The slope controls the signal to be triggered at the rising or falling edge of a waveform. The level control determines the voltage point on the waveform where trigger occurs and can be set to rising or falling edge. The trigger type, source and level are displayed in the soft key menu on the display.



To set the edge trigger, do the following:

- 1 Press  button at the front panel to access the Trigger type menu.
- 2 Press F1 to select the edge trigger type from the pull-up list.
- 3 The submenu of edge trigger is displayed concurrently after this selection.
- 4 The submenu of edge trigger includes:

- **Source**

Press F2 on page 1/2 to select channel source for the trigger. The channel you select is shown in the trigger status line at the right of the display.

- **Slope**

Press F3 on page 1/2 to select rising edge  or falling edge . The selected slope is displayed at the trigger status line at the right of the display.

- **Coupling**

Press F2 on page 2/2 to select trigger coupling:

- **DC** coupling allows DC and AC signals to pass through the trigger path.
- **AC** coupling allows AC signals to pass through the trigger path and filter DC offset voltage from the trigger waveform. The coupling cutoff frequency is less than 1 Hz. The AC coupling is useful to get a stable edge trigger when the waveform has a large DC offset.
- **HF Rejection** coupling places a 50 kHz low-pass filter in the trigger path to remove high frequency components from the trigger waveform. The HF-Rej is useful to observe low frequency signals while getting rid of high frequency noise from trigger path.
- **LF Rejection** coupling places a 30 kHz high-pass filter in series with the trigger waveform to remove any unwanted low frequency components from the trigger waveform. This LF-Rej is useful to obtain a stable edge trigger when your waveform contains low frequency noise.

- **Noise Rejection** coupling is three times the DC coupled limits. The Noise-Rej provides additional hysteresis to the trigger circuitry.
- **Level**
Press F3 on page 2/2 to select the types of trigger level adjustment.
 - **Manual** trigger level allows you to change the trigger level by turning the rotary switch. The value of the trigger level is displayed under the Level column.
 - **TTL** trigger level sets the trigger level to recognize the High/Low condition in a TTL signal automatically.
 - **ECL** trigger level sets the trigger level to recognize the High/Low condition in an ETL signal automatically.
 - **Set to 50%** trigger level sets the trigger level to the center of the High/Low value of the waveform currently displayed. This setting is useful when the trigger level is beyond the display.

Pulse Trigger

Pulse trigger sets the instrument to trigger on a positive or negative pulse of a specified width. A pulse trigger occurs when a pulse is found in a waveform that matches the pulse definition. You can set the pulse width using the Condition function in the submenu.

/

To set the pulse trigger, do the following:



- 1 Press  button at the front panel to access the Trigger type menu.
- 2 Press F1 to select the pulse trigger type from the pull-up list.
- 3 The submenu of pulse trigger is displayed concurrently after this selection.
- 4 The submenu of pulse trigger includes:
 - **Source**
Press F2 on page 1/2 to select channel source for the trigger. The channel you select is shown in the trigger status line at the right of the display.

- **Level**

Press F3 on page 1/2 to select the types of trigger level adjustment.

- **Manual** trigger level allows you to change the trigger level by turning the rotary switch. The value of the trigger level is displayed under the Level column.
- **TTL** trigger level sets the trigger level to recognize the High/Low condition in a TTL signal automatically.
- **ECL** trigger level sets the trigger level to recognize the High/Low condition in an ETL signal automatically.
- **Set to 50%** trigger level sets the trigger level to the center of the High/Low value of the waveform currently displayed. This setting is useful when the trigger level is beyond the display.

- **Polarity**

Press F2 on page 2/2 to select positive  and negative  polarity for the pulse width you want to capture. The selected pulse polarity is displayed in the trigger status line.

The positive pulse will trigger on the high to low transition of the pulse if the qualifying condition is true. The negative pulse will trigger on the low to high transition of the pulse if the qualifying condition is true.

- **Condition**

Press F3 on page 2/2 to set the pulse width and qualifying condition. You can set the pulse width by turning the rotary switch. There are 4 conditions for your selection:

- The “less than” (<) qualifier sets the instrument to trigger on a pulse width less than the time value.
- The “greater than” (>) qualifier sets the instrument to trigger on a pulse width greater than the time value.
- The “equal” (=) sets the instrument to trigger with equivalent to the time value.
- The “not equal” (≠) sets the instrument to trigger with not equivalent to time value.

Pattern Trigger

The Pattern trigger identifies a trigger condition by looking for a specific pattern. This pattern is a logical gate combination of the channels. Each channel can have a value of high (H) and low (L).

To set the pulse trigger, do the following:

- 1 Press  button at the front panel to access the Trigger type menu.
- 2 Press F1 to select the pattern trigger type from the pull-up list.
- 3 The submenu of pattern trigger is displayed concurrently after this selection.

The submenu of pattern trigger includes:

- **Input 1**

Press F2 in page 1/3 to select Input 1 condition High or Low for channel 1 and channel 2.

- **Level**

Press F3 in page 1/3 to select the types of trigger level adjustment for Input 1.

- **Manual** trigger level allows you to change the trigger level by turning the rotary switch. The value of the trigger level is displayed under the Level column.
- **TTL** trigger level sets the trigger level to recognize the High/Low condition in a TTL signal automatically.
- **ECL** trigger level sets the trigger level to recognize the High/Low condition in an ETL signal automatically.
- **Set to 50%** trigger level sets the trigger level to the center of the High/Low value of the waveform currently displayed. This setting is useful when the trigger level is beyond the display.

- **Input 2**

Press F2 on page 2/3 to select Input 2 condition High or Low for channel 1 and channel 2.

- **Level**

Press F3 on page 2/3 to select the types of trigger level adjustment for Input 2.

- **Manual** trigger level allows you to change the trigger level by turning the rotary switch. The value of the trigger level is displayed under the Level column.
- **TTL** trigger level sets the trigger level to recognize the High/Low condition in a TTL signal automatically.
- **ECL** trigger level sets the trigger level to recognize the High/Low condition in an ETL signal automatically.
- **Set to 50%** trigger level sets the trigger level to the center of the High/Low value of the waveform currently displayed. This setting is useful when the trigger level is beyond the display.

NOTE

The High condition sets the voltage level to greater than the channel's trigger level.

The Low condition sets the voltage level to less than the channel's trigger level.

- **Gate**

Press F2 on page 3/3 to set the logical gate combination of the channel.

- **Condition**

Press F3 on page 3/3 to set the pulse width and qualifying condition. You can set the pulse width by turning the rotary switch. There are 4 conditions for your selection:

- The “less than” (<) qualifier sets the instrument to trigger on a pulse width less than the time value.
- The “greater than” (>) qualifier sets the instrument to trigger on a pulse width greater than the time value.
- The “equal” (=) sets the instrument to trigger with equivalent to the time value.

- The “not equal” (\neq) sets the instrument to trigger with not equivalent to time value.

Video Trigger

The Video trigger is used to trigger on fields or lines of NTSC, PAL or SECAM standard video waveforms. You can either set the instrument to trigger on an odd or even field.

To set the video trigger, do the following:

- 1 Press  button at the front panel to access the Trigger type menu.
- 2 Press F1 to select the video trigger type from the pull-up list.
- 3 The submenu of video trigger display concurrently after the selection.

The submenu of video trigger includes:

- **Standard**

Press F2 on page 1/2 to select the standard video waveform: 625/PAL, SECAM or 525/NTSC.

- **Source**

Press F3 on page 1/2 to select normal or invert waveform condition of channel 1 and channel 2.

- **Even/Odd**

Press F2 on page 2/2 to select the video signal line to be triggered at odd or even field.

- **Line**

Press F3 on page 2/2 to change the line number in the selected field. Turn the rotary switch to select the desired count number from 5 to 263.

Waveform Controls

The U1600B series handheld oscilloscope offers real time sampling rate of up to 200 MSa/s for one channel or 100 MSa/s for two channels operating simultaneously. The equivalent sampling rate is up to 2.5 GSa/s for repetitive signal.

The real time sampling can be used with either repetitive signals or single-shot signals. This means the waveform display is produced from samples collected during one trigger event and all samples from previous trigger events are erased.

The equivalent sampling is an acquisition technique used only with repetitive signals. With this technique, samples from previous trigger events are maintained. This means multiple trigger events actually build the waveform.

This instrument provides the following acquisition mode:

- Normal Acquisition Mode
- Average Acquisition Mode
- Peak Detect Acquisition Mode

To select acquisition mode, follow the instructions below:

- 1 Press  button at the front panel to access the User menu.
- 2 Press F2 to access the Acquire submenu.
- 3 Press F1 to prompt a pull-up menu for the three acquisition modes selection.

Normal Acquisition Mode

The Normal acquisition mode is used for most waveforms with normal decimating and no averaging. This mode provides the best display for most waveforms.

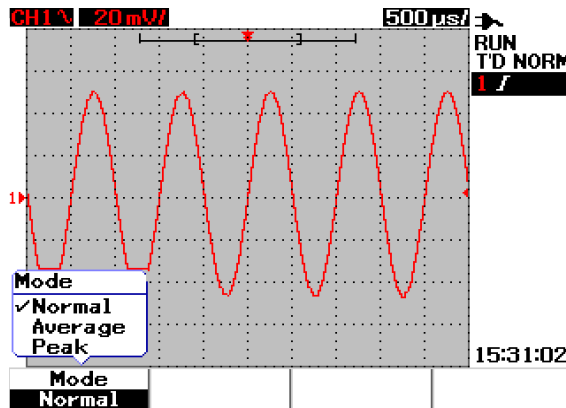

Figure 3-19 Normal acquisition mode

Average Acquisition Mode

The Average acquisition mode is used to reduce random noise and increase vertical resolution by averaging multiple acquisitions. By changing the average number from 2 to 256 in power-of-2 increments, you can improve the measurement accuracy. A higher number of averages produces a clearer waveform and decreases the sensitivity of signal changes. To change the average number, turn the rotary switch to select the average number for waveform acquisition.

NOTE

The higher the number of averages, the slower the response is to change in the waveform display.

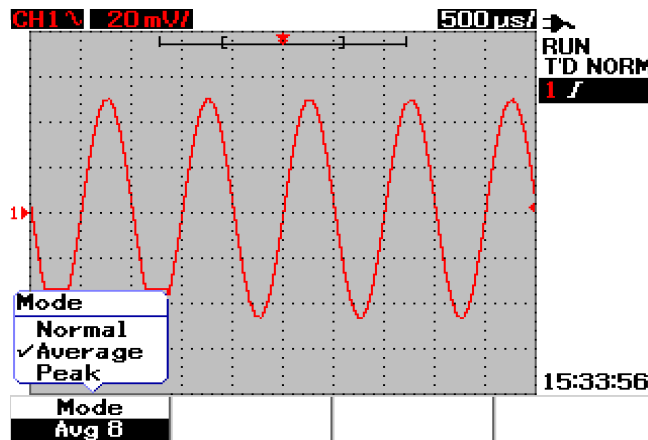

Figure 3-20 Average acquisition mode

Peak Detection Mode

The Peak Detection mode captures the maximum and minimum values of the sampling signal over multiple acquisition. This is useful to verify aliasing of the displayed waveform.

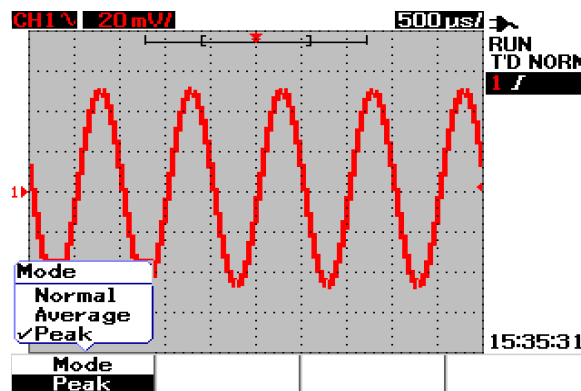

Figure 3-21 Peak Detection Mode

Display Controls

Display Types

This instrument provides alternative selections display types vectors and dots. The vectors display type is a connection of dots and gives more realistic waveforms compared to the dots display type. It allows the view of steep edges on a waveform, especially square waves. The vector display type is set as the default display type and subtle detail of complex waveforms.

To select display types, follow the instruction below:

- 1 Press button at the front panel to access the User menu.
- 2 Press F1 to access the Display submenu.
- 3 Press F1 on page 1/2 of the Display submenu to select the display type from a pull-up menu.

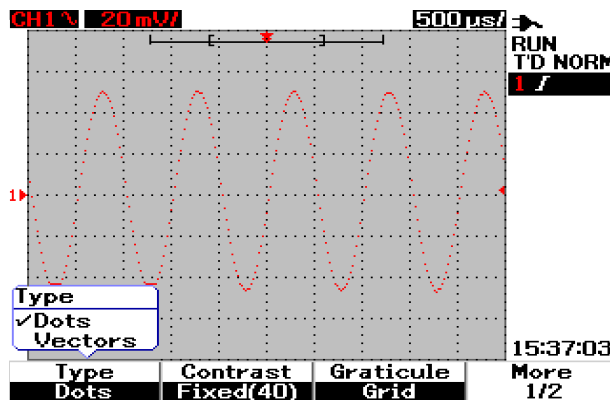

Figure 3-22 Dots display type

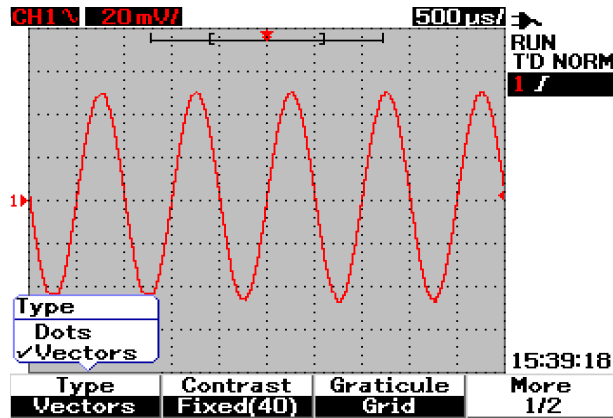

Figure 3-23 Vectors display type

Display Contrast

You are allowed to tweak the display contrast to obtain a better view of the display. To adjust the display contrast, do the following:

- 1 Press button at the front panel to access the User menu.
- 2 Press F1 to access the Display submenu.
- 3 Press F2 on page 1/2 of Display submenu to enable the display contrast setting.
- 4 Turn rotary switch clockwise to reduce brightness of the display and vice-versa.
- 5 Press F2 again to fix the contrast value.

Graticule

This instrument provides four selections types of graticule display. You can select different grid shapes for the waveform display section. To select graticule of the display, follow the instructions below:

- 1 Press  button at the front panel to access the User menu.
- 2 Press F1 to access the Display submenu.
- 3 Press F3 on page 1/2 of the Display submenu to select any of the following graticule:
 - Full: 10 × 8 lines including grid
 - Cross Hair: cross + sharp lines
 - Grid: 10 × 8 lines
 - Frames: Outer frame lines

Persistence

Infinite persistence updates the display with new acquisitions, but does not erase the results of previous acquisitions. New acquisitions are shown in the respective channel's signal line color while all previous acquisitions are displayed in a dimmer color. You can use this infinite persistence function for the following purposes:

- measure noise and jitter
- observe the worst case of a varying waveform
- look for timing violations
- capture events that occur irregularly

To set infinite persistence, follow the instructions below:

- 1 Press  button at the front panel to access the User menu.
- 2 Press F1 to access the Display submenu.
- 3 Press F1 on page 2/2 to enable the infinite persistence function. Turn off the persistence by pressing F1 again.
- 4 Press F2 (Clear Display) on page 2/2 to clear and erase previous acquisitions and restart the accumulation of acquisitions.

NOTE

The Clear Display function is used to erase the previous acquisitions with the Persistence “Infinite” mode turned on under the RUN mode.

Automatic Measurement

The U1600B series handheld digital oscilloscope offers up to 22 automatic measurements in four measurement displays at the measurement line (refer to “[Oscilloscope Display Overview](#)” on page 25) at the right of the display. You can display any four different automatic measurement types simultaneously. The 22 automatic measurement types include:

Time Measurements

- +Duty
- -Duty
- Frequency
- Period
- Rise Time
- Fall Time
- +Width
- -Width

Voltage Measurements

- Mean
- Cycle mean
- Amplitude
- Base
- Maximum
- Minimum
- Peak-to-peak

- RMS
- Top

Phase and Delay

- Phase
- Delay

Preshoot and Overshoot

- Preshoot
- +Overshoot
- -Overshoot

To Perform Automatic Measurements

You can use automatic measurements for both channels. Up to four measurement results can be displayed simultaneously at the dedicated measurement line. To turn on the automatic measurement, follow the instructions below:

- 1 Press  to access Measure menu.
- 2 Notice there are four measurement files to be selected among the 22 automatic measurement types. Press the respective softkey to activate the corresponding measurement file.
- 3 Turn the rotary switch to select the automatic measurement type.
- 4 Press the rotary switch to set the selected automatic measurement type. Measurement results for both channels are displayed at the measurement line concurrently.
- 5 Repeat the same steps to select measurements for the other three measurement files.

- 6 To turn off the measurement file, turn the rotary switch for the respective file until you see “Off” in the list. Press the rotary switch to set the off condition.

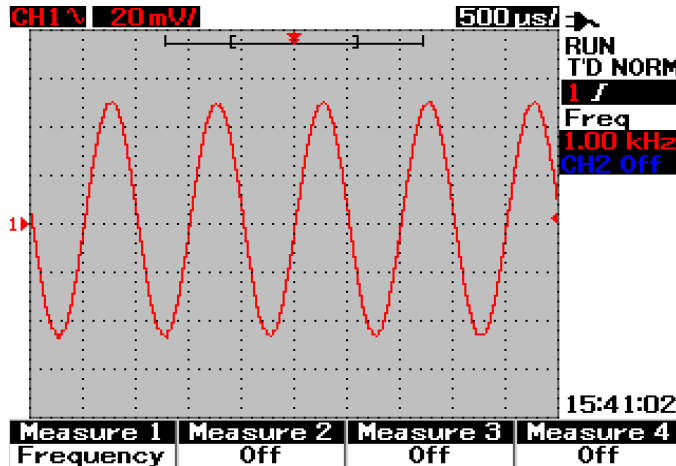

Figure 3-24 Select automatic measurement for the Measure 1 file.

Time Automatic Measurements

+ Duty

The positive duty cycle of a repetitive pulse train is the ratio of the positive pulse width to the period, expressed in percentage.

$$+Duty\ cycle = \frac{+Width \times 100}{Period}$$

–Duty

The negative duty cycle of a repetitive pulse train is the ratio of the negative pulse width to the period, expressed in percentage.

3 Using the Scope Functions

$$\text{Duty cycle} = \frac{\text{Width} \times 100}{\text{Period}}$$

+Width

+Width is the time from the middle threshold of the rising edge to the middle threshold of the next falling edge.

-Width

-Width is the time from the middle threshold of the falling edge to the middle threshold of the next rising edge.

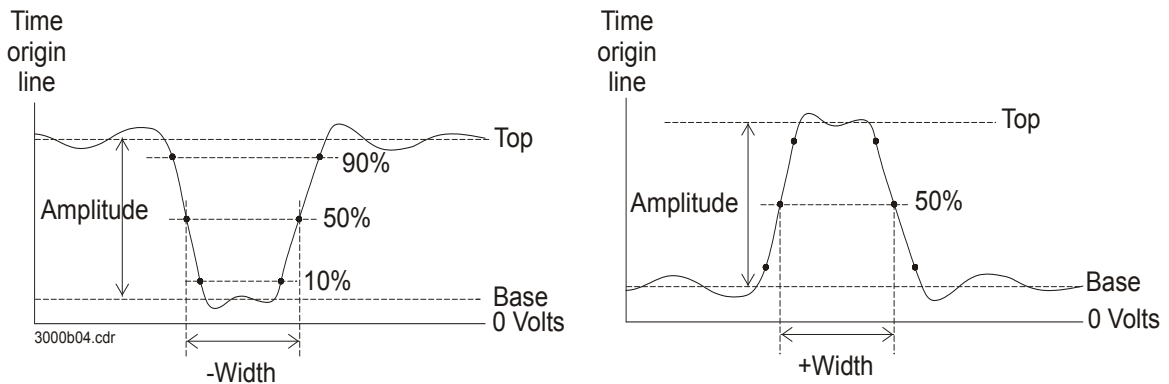

Figure 3-25 +Width and -Width measurements

Frequency

Frequency is defined as 1/period and it used to measure the frequency of a waveform.

Rise Time

The rise time of a signal is the time difference between the crossing of the lower threshold and the crossing of the upper threshold for a positive-going edge.

Fall Time

The fall time of a signal is the time difference between the crossing of the upper threshold and the crossing of the lower threshold for a negative-going edge.

Period

Period is the time period of the complete waveform cycle and it used to measure the period of a waveform.

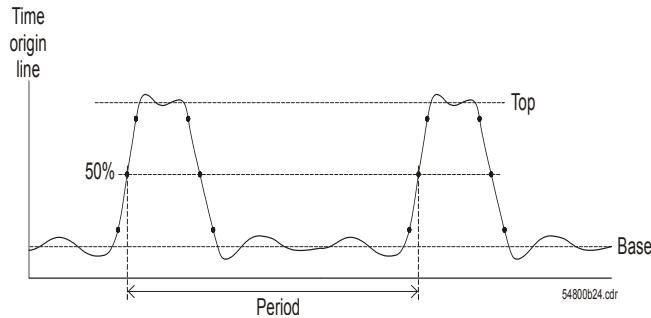

Figure 3-26 Period measurement

Voltage Automatic Measurements

Mean

The mean value of a measurement is the statistical average of the measurement.

Mean Cycle

The mean cycle value of a measurement is the statistical average of the measurement within a cycle period.

Amplitude

Amplitude is defined as the difference between the measurement's Top and Base values.

Top

The Top of a waveform is the mode (most common value) of the upper part of the waveform. If the mode is not well-defined, the Top is the same as Maximum.

Base

The Base of a waveform is the mode (most common value) of the lower part of the waveform. If the mode is not well-defined, the Base is the same as Minimum.

Maximum

Maximum is the highest value in the waveform display.

Minimum

Minimum is the lowest value in the waveform display.

Peak-to-peak

Peak-to-peak is defined as the difference between maximum and minimum values.

RMS

RMS (DC) is the root-mean-square value of the waveform over one or more full periods. If less than one period is displayed, RMS (DC) average is calculated over the full width of the display.

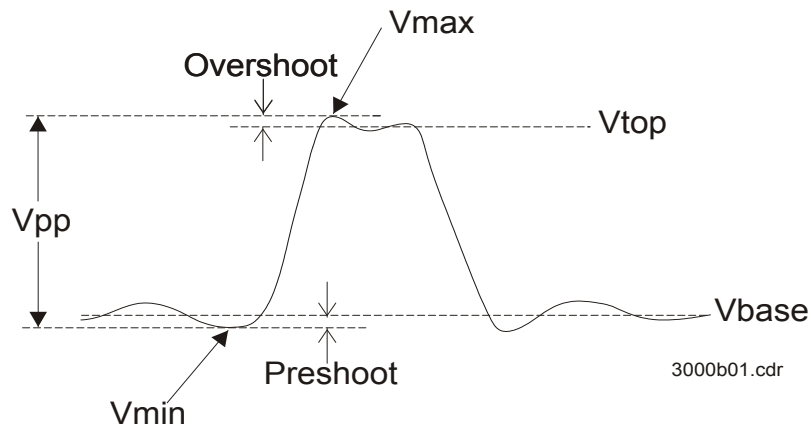

Figure 3-27 Voltage measurement

Phase and Delay

Phase

Phase is the calculated phase shift from input source 1 to input source 2, expressed in degrees. Negative phase shift values indicate that the rising edge of source 1 occur after the rising edge of source 2.

$$\text{Phase} = \frac{\text{Delay}}{\text{Source 1 period}} \times 360$$

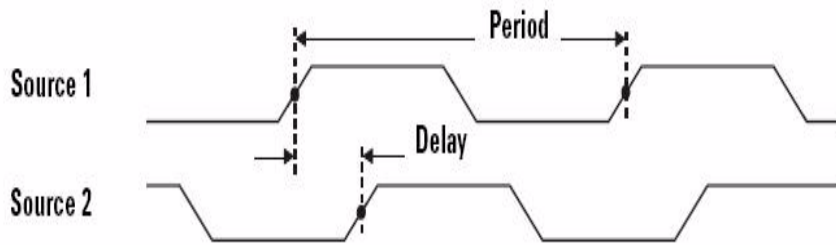

Figure 3-28 Phase measurement

Delay

Delay is defined as the difference between the selected edge on source 1 and the selected edge on source 2, closest trigger reference point being the middle threshold points on the waveforms. Negative delay indicates that the selected edge of source 1 occur after the selected edge of source 2.

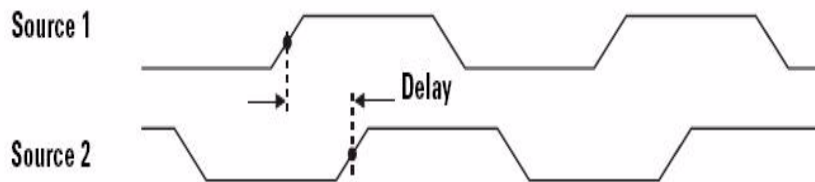

Figure 3-29 Delay measurement

Preshoot and Overshoot

Preshoot

Preshoot is the distortion that precedes a major edge transition expressed as a percentage of amplitude (refer to Figure 3-26).

$$\text{Rising edge preshoot} = \frac{V_{\text{base}} - V_{\text{min}} \times 100}{\text{Amplitude}}$$

$$\text{Falling edge preshoot} = \frac{V_{\text{max}} - V_{\text{top}} \times 100}{\text{Amplitude}}$$

+Overshoot

Overshoot is the distortion that follows a major edge transition expressed as a percentage of amplitude (refer to Figure 3-26).

$$\text{Rising edge overshoot} = \frac{V_{\text{max}} - V_{\text{top}} \times 100}{\text{Amplitude}}$$

-Overshoot

Overshoot is the distortion that follows a major edge transition expressed as a percentage of amplitude (refer to Figure 3-26).

$$\text{Falling edge overshoot} = \frac{V_{\text{Base}} - V_{\text{min}} \times 100}{\text{Amplitude}}$$

Cursor Measurement Controls

The U1600B series is equipped with the cursor measurement function that allows you to obtain a precise and accurate measurement in voltage and time base at any desired point of a waveform. The horizontal cursor marker indicates the X-axis value for time base measurement, and the vertical cursor marker indicates the Y-axis value for voltage measurement.

To make cursor measurement, follow the steps below:

- 1 Press and hold Measure button to access cursor measurement function.
- 2 Press F1 to enable and select cursor measurement type for X or Y cursor.
- 3 To turn off this function, press F1.

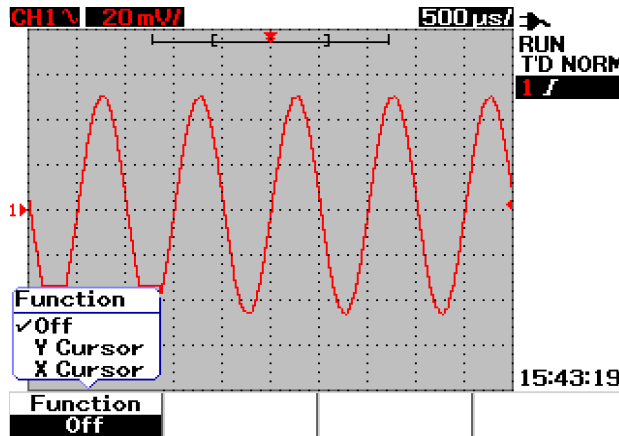

Figure 3-30 Cursor measurement menu

X-Cursor Measurement

The X-cursor measurement places two vertical lines across the displayed waveform to measure values (in volts or amperes) and time relative to the trigger point. You can select cursor's mode to be in either single cursor line X1 or X2, or combination of X1 and X2 cursor lines. The selected cursor line is displayed as a long-dashed vertical line while the non-selected cursor line is displayed as a short-dashed vertical line.

The delta of the X1 and X2 (Δ) are displayed at the top right of the waveform display area. The instructions below will guide you through the steps of setting up the X-cursor measurement:

- 1 On the X-cursor menu page, press F2 to select cursor mode to be either single X1 or X2 cursor line, or the combination of X1 and X2 cursor lines from a pull-up menu.
- 2 Turn the rotary switch to adjust the X1 and X2 cursor lines. If both cursor lines are selected, both lines move in parallel with the same delta X-cursor value.
- 3 Press F3 to display the pull-up menu to select the channel source to be measured.
- 4 In Figure 3-30, two cursor lines – X1 and X2 mode – are selected, where measurement is made for the signal at channel 1.

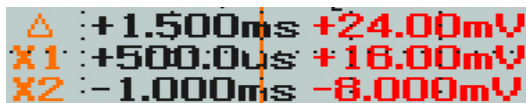

Δ	: +1.500ms	+24.00mV
X1	: +500.0 μ s	+16.00mV
X2	: -1.000ms	-8.000mV

The X1 measurement is +16.00 mV at +500.0 μ s.

The X2 measurement is -8.000 mV at -1.000 ms.

The delta of X1 and X2 voltage measurement is +24.00 mV with time relative difference of +1.500 ms.

3 Using the Scope Functions

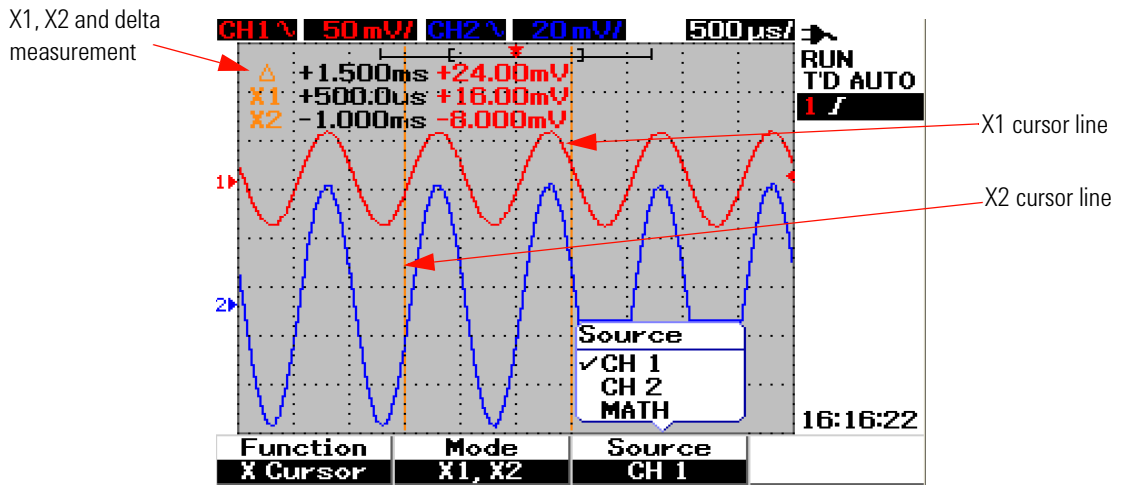

Figure 3-31 X-cursor measurement for channel 1 signal with X1 and X2 cursor lines

5 In Figure 3-31, measurement is made for the signal at channel 2.

```

Δ : +1.500ms +22.40mV
X1 : +500.0us +11.20mV
X2 : -1.000ms -11.20mV
  
```

The X1 measurement is +11.20 mV at +500.0 μs.

The X2 measurement is -11.20 mV at -1.000 ms.

The delta of X1 and X2 voltage measurement is +22.40 mV with time relative difference of +1.500 ms.

X1, X2 and delta measurement

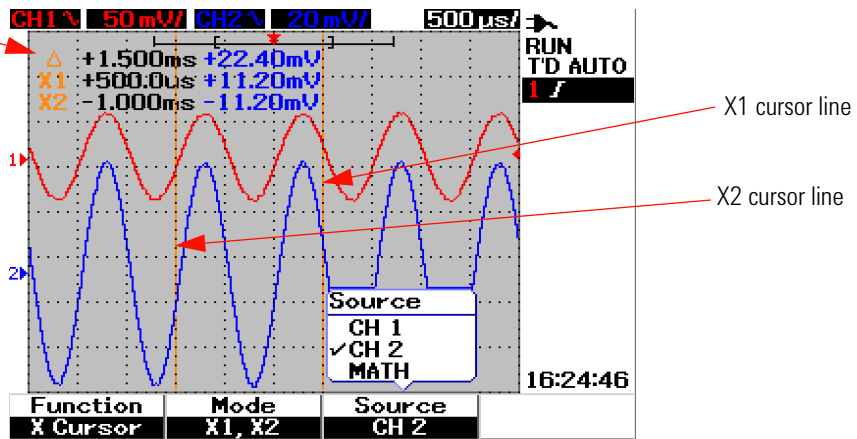

Figure 3-32 X-cursor measurement for channel 2 signal with X1 and X2 cursor lines

6 In Figure 3-32, math function is selected.

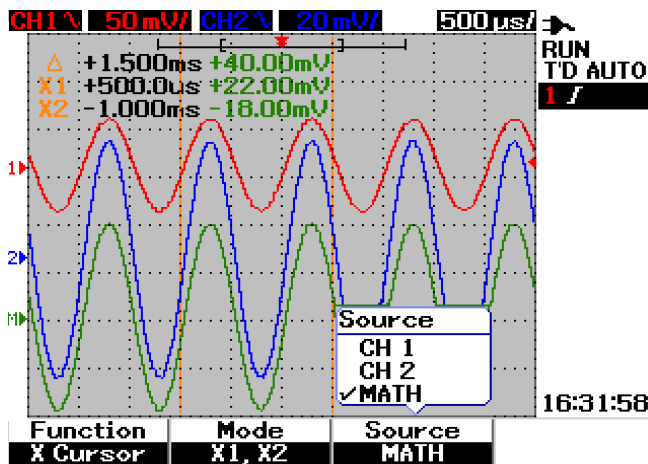

Figure 3-33 Math functions for X-cursor measurement

Y-Cursor Measurement

The Y-cursor measurement are two horizontal lines that can be adjusted vertically to measure volts or amperes. Like the X-cursor, you can select the cursor's mode to be either in single cursor line Y1 or Y2, or the combination of Y1 and Y2 cursor lines. The selected cursor line is displayed as a long-dashed vertical line while the non-selected cursor line is shown as a short-dashed vertical line.

The Y1, Y2 and delta of Y1 and Y2 (Δ) are displayed at the top right of the waveform display area.

- 1 On the Y-cursor menu page, press F2 to select cursor mode to be in either single Y1 or Y2 cursor line, or the combination of Y1 and Y2 cursor line from a pull-up menu.
- 2 Turn the rotary switch to adjust the Y1 and Y2 cursor line. If both cursor lines are selected, both lines move in parallel with the same delta Y value.
- 3 Press F3 to display the pull-up menu to select the channel source to be measured.
- 4 In Figure 3-33, two cursor lines – Y1 and Y2 mode – are selected, the measurement is made for the signal at channel 1.

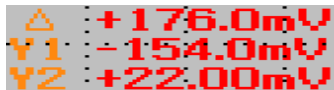

```
Δ : +176.0mV
Y1 : -154.0mV
Y2 : +22.00mV
```

The Y1 measurement is -154.00 mV.

The Y2 measurement is +22.00 mV.

The delta of Y1 and Y2 voltage measurement is +176.00 mV.

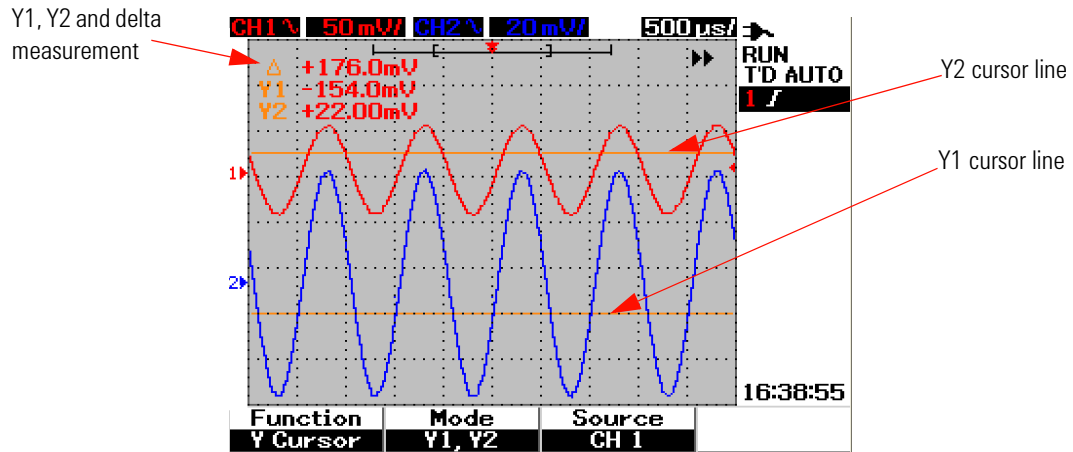

Figure 3-34 Y-cursor measurement for channel 1 signal with Y1 and Y2 cursor lines

5 In Figure 3-34, the measurement is made for the signal at channel 2.



The Y1 measurement is -13.60 mV.

The Y2 measurement is $+56.80$ mV.

The delta of Y1 and Y2 voltage measurement is $+70.40$ mV.

3 Using the Scope Functions

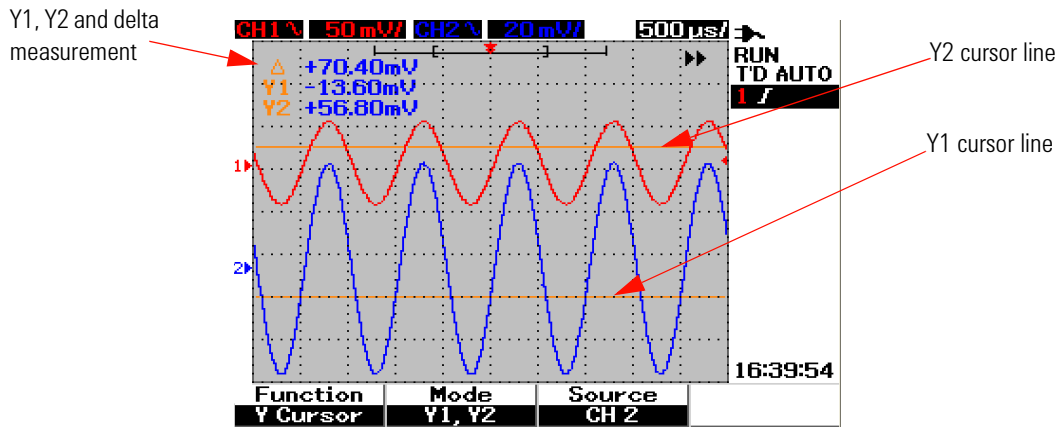

Figure 3-35 Y-cursor measurement for channel 2 signal with X1 and X2 cursor lines

- 6 In Figure 3-35, math function is selected and the result is displayed in red at the top right of the waveform display area.

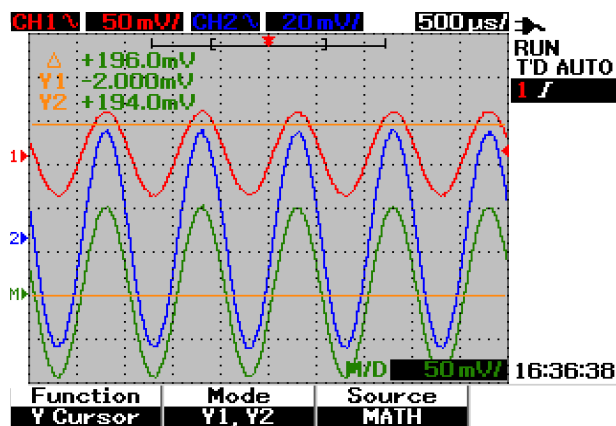



Figure 3-36 Math function for Y-cursor measurement

Math Functions Control

The math functions control allows you to perform math functions add, subtract and FFT (Fast Fourier Transform) for channel 1 and channel 2. A new redundant mathematical waveform is produced and displayed on the screen in real time. You can turn the rotary switch to offset the vertical position of the math waveform in math menu mode for your ease of observation.

Dual Waveform Math — Add, Subtract

To select math functions, follow the instructions below:

- 1 Press  button to access User menu.
- 2 Press F3 to access Math function menu.
- 3 In the Math submenu, press F1 to select the dual waveform math (DWM) from a pull-up menu.
- 4 To turn off the math function, select “off” with F1 to erase all math data.
- 5 After selecting the DWM, the submenu of the DWM function prompts the selection of addition and subtraction functions in F2.
 - CH1 + CH2
 - CH1 – CH2
 - CH2 – CH1

3 Using the Scope Functions

Add (CH1 + CH2)

You can perform addition of channel 1 and channel 2 waveforms by pressing F2 for function selection. There is a possibility of the math waveform overlapping both the channel waveforms, turn the rotary switch to adjust the vertical position of the math waveform for ease of viewing and measurement consideration.

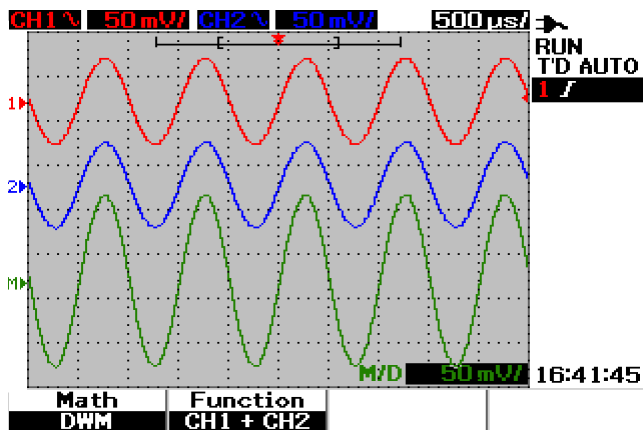

Figure 3-37 Addition of channel 1 and channel 2 function

Subtraction (CH1 – CH2, CH2 – CH1)

When you select CH1 – CH2, the channel 2 voltage values are subtracted from channel 1 voltage values, point by point. Conversely, if the CH2 – CH1 is selected, the channel 1 voltage values are subtracted from channel 2 voltage values and the result is displayed in math waveform. This function is useful for comparison of the two waveforms and to make a differential measurement. For adjusting the math vertical position, turn the rotary switch to offset the position.

NOTE

If the waveforms from channel 1 and channel 2 have different vertical scale factor, the math waveform vertical scale is automatically set to the higher sensitivity of the vertical scale factor.

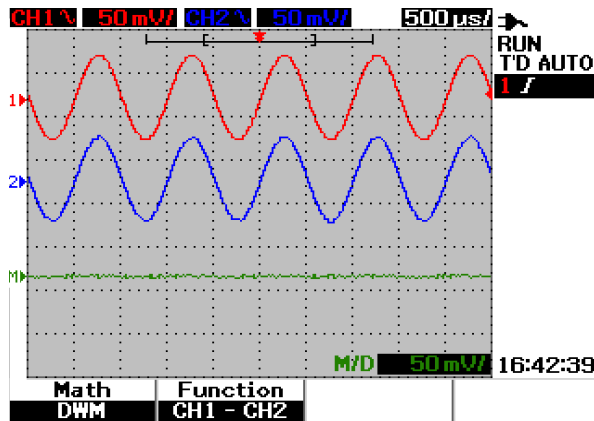

Figure 3-38 Subtraction signal at channel 2 from channel 1

FFT (Fast Fourier Transform)

The FFT math function converts a time-domain waveform into frequency-domain waveform and the magnitude of the FFT spectrum is displayed in dBV. In other words, the readout for the horizontal axis changes from time to frequency (Hertz) and the vertical axis changes from volts to decibels (dB).

FFT waveforms are useful to determine the harmonic contents and distortion in analog waveforms caused by amplifier non-linearity, for characterizing noise in DC power supplies or to adjust analog filters.

NOTE

The FFT function is only available for model U1604B.

To perform FFT measurement, follow the instructions below:

- 1 Press  button to access User menu.
- 2 Press F3 to access Math function menu.
- 3 In the Math submenu, press F1 to select the FFT function.
- 4 After selecting FFT, the submenu of the FFT function is displayed concurrently for function properties setting.

Source

Press F2 to select the source (channel 1 or channel 2) for the FFT.

V Axis

Press F3 to select vertical scale factor expressed in dB/div. There are four scale factors for your selection:

- 1 dB
- 2 dB

- 5 dB
- 10 dB
- 20 dB

Window

Press F4 to select any of the four FFT windows with respective trade-off between frequency resolution and amplitude accuracy. Refer to the following guidelines to select the best window based on your source waveform characteristics and your measurement priorities.

- **Rectangle**

This window provides good frequency resolution and amplitude accuracy. This window is best for measuring pseudo-random noise, impulses, sine bursts and decaying sinusoids.

- **Hamming**

This window provides better frequency resolution but less amplitude accuracy compare to Rectangle. The Hamming window has a slightly better frequency resolution than Hanning, and is suitable for measuring sine, periodic and asymmetric transients or bursts.

- **Hanning**

This window is similar to the Hamming window, used for making accurate frequency measurement or resolving two frequencies that are close together and performs similar applications to the Hamming.

- **Blackman-Harris**

This window provides the best amplitude resolution, but less frequency resolution compared to the other three windows. This window is normally used for measuring single frequency waveforms to obtain higher order harmonics.

NOTE

To reduce the DC component that potentially affects the FFT waveform magnitude values, choose AC coupling on the source waveform.

Save and Recall Controls

This instrument allows you to save and recall up to ten configuration setups and waveforms. You can either store or recall waveforms to/from the instrument's internal memory or a USB flash memory device.

The configuration setup includes the horizontal and vertical measurements, cursors, math functions and trigger settings that are saved in a setup file. Saving a waveform lets you store the visible acquisition waveform for later recall and comparison.

NOTE

- A waveform saved in the internal memory cannot be transferred to a PC.
 - A waveform saved in a USB flash memory device can be transferred to a PC in either the .bmp or .swf file format. You can convert the waveform from the .swf format to the .csv format using the U1602B/U1604B PC Link application which can be obtained from <http://www.agilent.com>.
-

Save and Recall Controls without USB Flash Memory Device

The instrument allows you to save and recall the setups and waveforms to/from internal memory. The Save/Recall menu consists of four different submenus as described in the following sections.

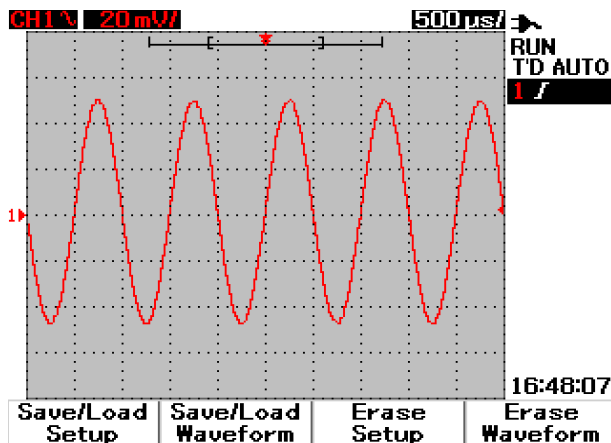

Figure 3-39 Save/Recall menu

To Save and Recall Setup

To save or recall configuration setups to/from internal memory, follow the instructions below:

- 1 Press and hold Save/Recall
Run/Stop to access Save/Recall menu.
- 2 Press F1 to access Save/Load Setup menu.
- 3 Up to 10 setups can be stored over four pages of menu. Press the respective softkey to save or load setups to/from internal memory.
- 4 In Figure 3-39, press F1 to save the configuration setup into Setup 1.
- 5 Press the F1 again to load the Setup 1 from the internal memory, refer to Figure 3-40.
- 6 Go through the same save and recall setup steps for saving and recalling the subsequent setups.

3 Using the Scope Functions

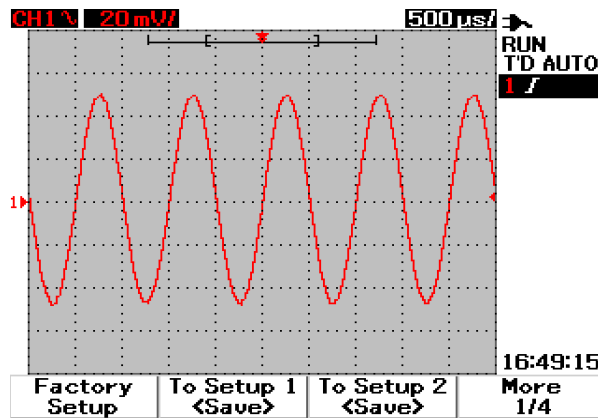

Figure 3-40 The <Save> display indicates no setup file is being saved. You can press F1 to save the setup into Setup 1.

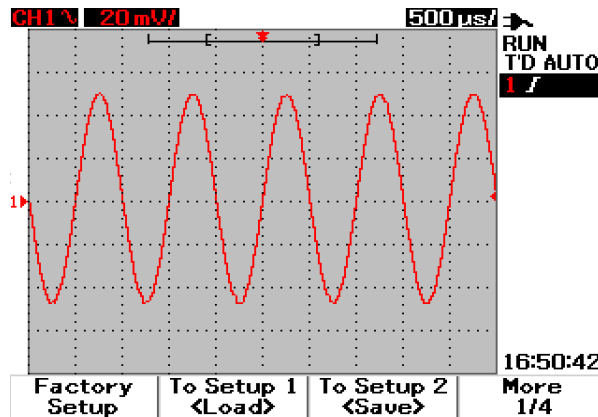

Figure 3-41 The <Load> display indicates that a configuration setup file has been saved into Setup 1 and you can press F1 to retrieve the setup from internal memory.

To Save and Recall Waveform

To save or recall waveforms from internal memory, follow the instructions below:

- 1 Press and hold Save/Recall
Run/Stop to access Save/Recall menu.
- 2 Press F2 to access Save/Load Waveform menu.
- 3 Up to 10 waveforms can be stored over four pages of menu. Press the respective softkey to save or load waveform to/from internal memory.
- 4 In Figure 3-41, press F1 to save the configuration setup into Setup 1.
- 5 Press F1 again to load the Waveform 1 from the internal memory. Refer to Figure 3-42.
- 6 Go through the same save and recall waveform steps for saving and recalling the subsequent waveforms.

3 Using the Scope Functions

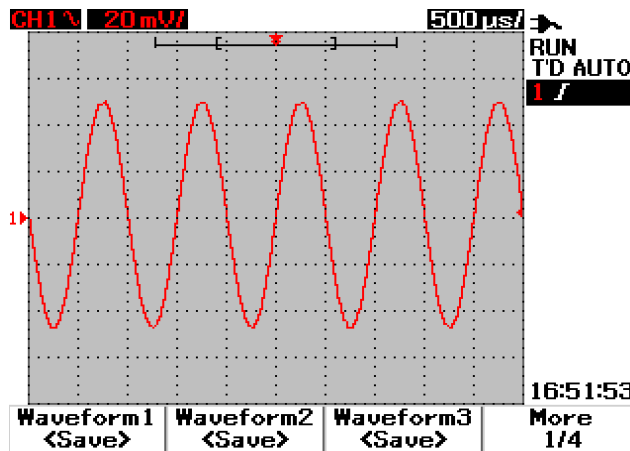

Figure 3-42 The <Save> display indicates no waveform is being saved, you can press F1 to save the waveform into Waveform 1.

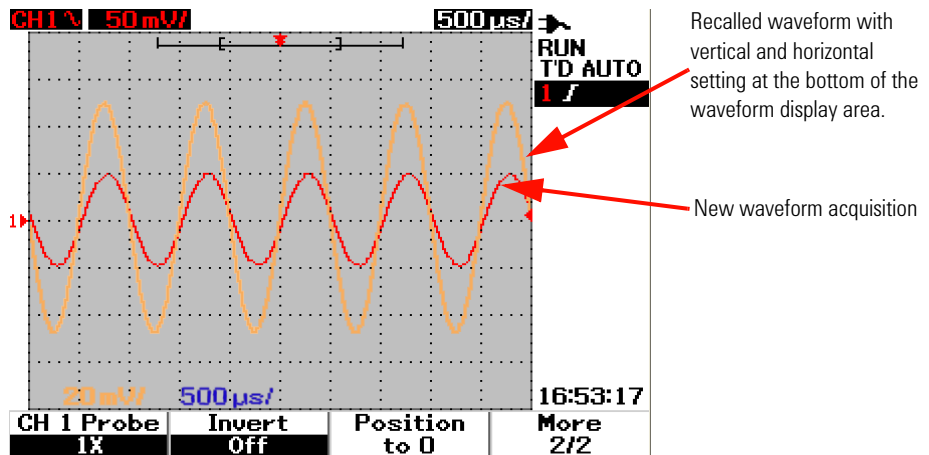

Figure 3-43 The <Load> display indicates the a waveform file is saved into Waveform 1 and you can press F1 to retrieve the waveform from internal memory. This function is useful for waveform comparison.

To Erase Setup

To erase configuration setups from internal memory, follow the instructions below:

- 1 Press and hold Save/Recall
Run/Stop to access the Save/Recall menu.
- 2 Press F3 to access the Erase Setup menu.
- 3 Press the respective softkey to erase the stored setup from internal memory.
- 4 In Figure 3-44, press F1 to erase the configuration setup from Setup 1.

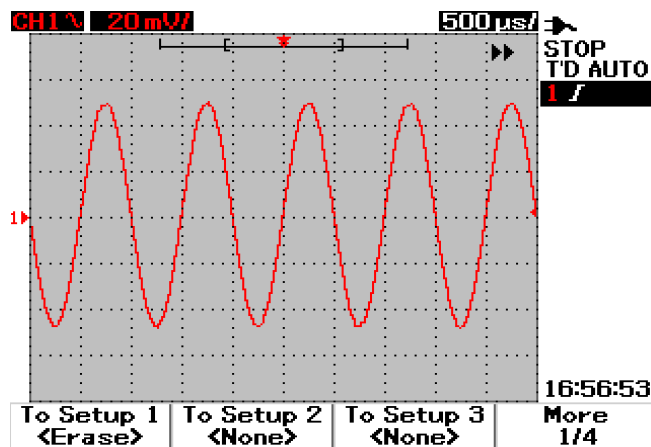



Figure 3-44 The <None> display indicates that no setup file is saved. The <Erase> in Setup 1 shows that you can erase the setup file from the internal memory.

To Erase Waveform

To erase the previous saved waveform from internal memory, follow the instructions below:

- 1 Press and hold  to access the Save/Recall menu.
- 2 Press F4 (Erase Waveform) to access the Erase Waveform menu.
- 3 On page 4/4, press F3 (Erase Waveform) to clear and erase the recalled waveform.
- 4 In [Table 3-45](#), press F1 to erase the waveform from Waveform 1.

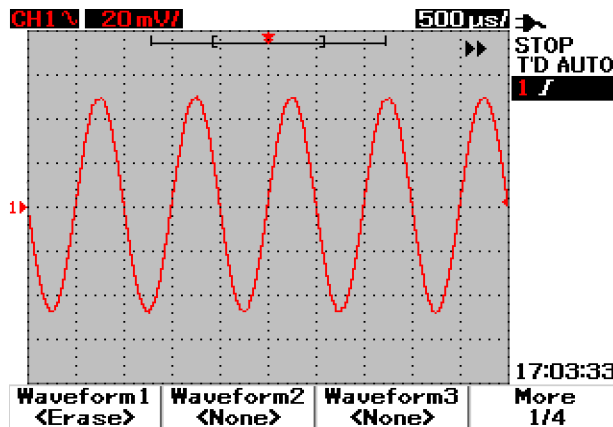

Figure 3-45 The <None> display indicates that no waveform is being saved. The <Erase> in Waveform 1 shows that you can erase the waveform from the internal memory.

To Restore Factory Setup

The default configuration settings return the oscilloscope to its default settings and place the oscilloscope in a known operating condition. The major default settings are:

Horizontal Main mode, 100 $\mu\text{s}/\text{div}$ scale, 0 s delay, center time reference, window off

Vertical Vertical channel 1 on, 5 V/div scale, DC coupling, 0 V position, probe factor 1 \times

Trigger Edge trigger, Auto sweep mode, 0 V level, Channel 1 source, DC coupling, rising edge slope

Display Vectors on, 50% contrast, Grid graticule, persistence off

Acquire Normal mode, Run/Stop to Run

Others cursor measurement off, auto-measurement off, auto-power off, English language

DMM Voltmeter set as DC, relative off, auto-measurement off

Ohmmeter set as Resistance, relative off, auto-measurement off

Temperature meter set as $^{\circ}\text{C}$, relative off, auto-measurement off

Ampere meter set as DC, relative off, auto-measurement off

Humidity meter set as %RH, relative off, auto-measurement off

Pressure meter set as psi, relative off, auto-measurement off

Logger Logger Volt, input DC, maximum logging

To restore default settings of the instrument, do the following:

- 1 Press and hold  to access Save/Recall menu.
- 2 Press F1 to access Save/Load Setup menu.
- 3 On page 1/4 of Save/Load submenu, press F1 to restore the factory default setup.
- 4 The instrument prompts a “Recall OK?” message to request confirmation on restoring the factory setup. Press F1 to confirm.

3 Using the Scope Functions

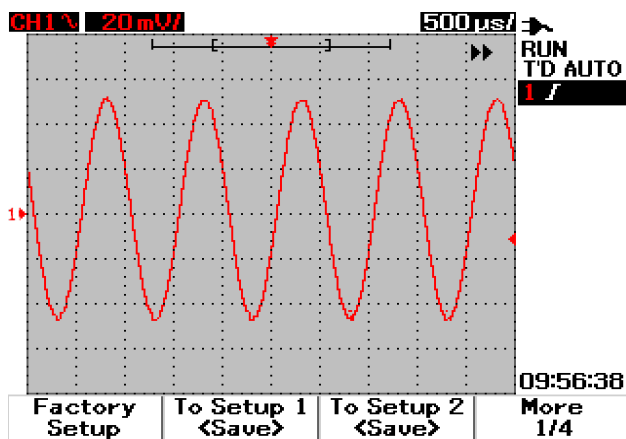

Figure 3-46 Restore factory setup in Save/Load Setup menu.

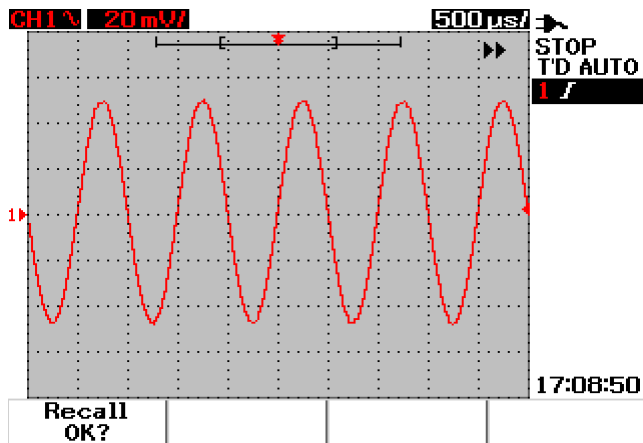



Figure 3-47 The instrument requests confirmation to restore factory default setting.

Save and Recall Controls with USB Flash Memory Device

As an option, you can save or download waveforms to/from an external USB flash memory device. When using the USB flash memory, waveform and configuration settings are saved simultaneously. The size of the saved file is approximately 1 kilobyte.

You are required to enable the USB flash connectivity prior to utilizing the save and recall functions via USB connectivity. When the USB flash memory is connected, a message to of detecting the USB flash memory appears and alert users not to remove the USB flash memory. To enable the USB connectivity function, follow the instructions below:

- 1 Press  button to access User menu.
- 2 Press F4 to access Utility menu.
- 3 On page 1/4 of Utility submenu, press F3 to turn on the USB function.
- 4 Plug in USB flash memory, press and hold the  button to enter Save/Recall menu.

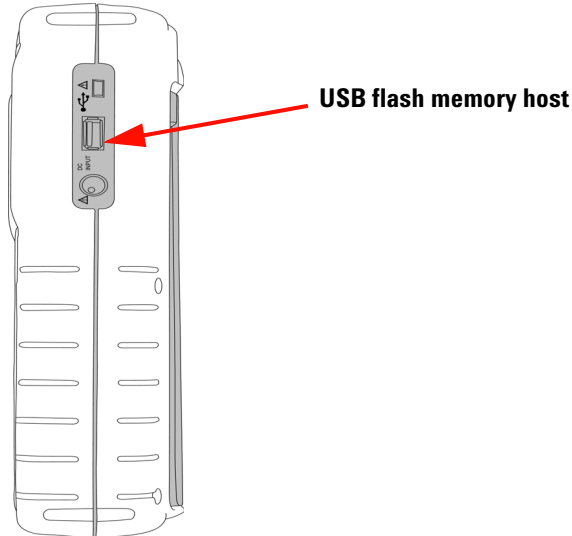



Figure 3-48 Connect a USB flash memory to save or download waveforms to/from the external memory device.

To Save Waveform

The instrument allows you to save a waveform in *.bmp image format or *.svw file format. The instrument saves the configuration settings and waveform simultaneously in *.svw file format. To save waveforms to a USB flash memory device, follow the instructions below:

- 1 Connect a USB flash memory device, press and hold  to access Save/Recall menu.
- 2 The display will list the flash memory's contents. A message box with option to save waveform in BMP or SVW format will appear. Turn the rotary switch to select the format.
- 3 Press F1 to save the waveform. You will be prompted to input filename for the waveform.
- 4 Turn the rotary switch to move the cursor to the desired character from the list of characters located at the bottom of the screen.
- 5 After completion of entering the filename, press F1 to save the waveform into USB flash memory device. The filename with *.svw or *.bmp extension will appear in the file list.

NOTE

The filename can be configured for English capital letters and numeric numbers. The backspace is used to delete the previous character when entering the filename. Clear is used to clear all entered characters when entering the filename.

To Load Waveform

When downloading a waveform from USB flash memory, you are prompted to select the file to download from the list of USB flash memory contents. Do the following to load a waveform from the external memory device:

- 1 Connect a USB flash memory device. Press and hold  to access Save/Recall menu.
- 2 The display lists the flash memory's contents. Turn the rotary switch to move the cursor to select the file.

- Press F2 to load the waveform. The horizontal and vertical scale factors will appear at the bottom of the waveform display area.

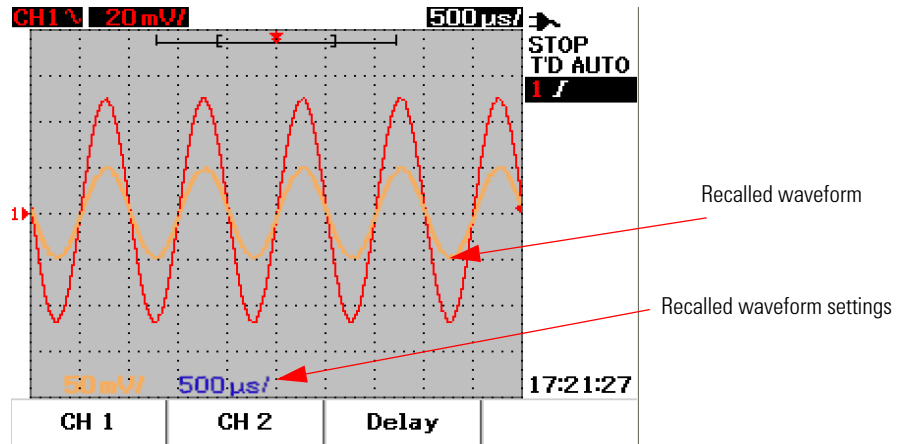

Figure 3-49 Load a waveform from a USB flash memory device

To Erase Waveform

To erase saved waveforms from the USB flash memory drive, follow the instructions below:

- Press and hold to access Save/Recall menu.
- The display lists the flash memory's contents. Turn the rotary switch to move the cursor to select the file.
- Press F3 to erase the file from the list. This step removes the waveform permanently.

3 Using the Scope Functions

To Clear Waveform

To clear the current displayed waveform from the screen, follow the instructions below:

- 1 Press and hold  to access Save/Recall menu.
- 2 Press F4 to clear the waveform from the display.

Autoscale and Run/Stop Controls

Autoscale

Autoscale automatically configures the oscilloscope to the best display of input signals for both channels. Autoscale analyzes and adjusts the vertical sensitivity, horizontal sensitivity and trigger configurations at the best condition. The instrument sets the time/div by counting the trigger pulse and selects the most appropriate time/div for both the input signals.



Both channels are turned on and will be examined for signal activities concurrently. By pressing the  button at the front panel, the instrument sets the following default values to the autoscale mode:

Table 3-1 Autoscale conditions

Functions	Autoscale conditions
CH 1 Coupling	AC
CH1 Invert	Off
CH 1 Position	0 div
CH 2 Coupling	AC
CH 2 Invert	Off
CH 2 Position	0 div
Time Position	Center
Trigger Type	Edge
Trigger Edge	CH 1
Trigger Edge Coupling	DC
Trigger Edge Slope	Rising

Run/Stop Controls

The Run/Stop  button at the front panel allows users to begin or stop signal acquisition. In **Run** mode, if the trigger is set to **Normal** mode, the display will not update until a trigger is found. If the trigger mode is set to Auto mode, the instrument looks for a trigger. If no trigger is found, it will set the trigger automatically and display the input signals immediately.

The Auto and Normal trigger indicator is shown in the trigger line located at the right of the display. If no trigger is found, the **T'D** (Trigger Detected) indicator will flash, indicating that the instrument is forcing triggers.

In **Stop** mode, the instrument is forced to stop acquiring signal. The acquisition status is displayed at the right of the display indicating if the instrument is in run or stop mode.

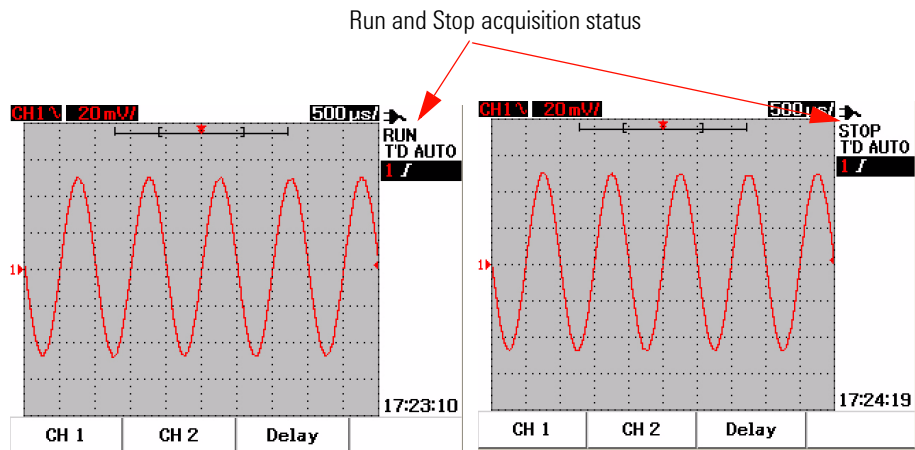

Figure 3-50 Run and Stop modes

Utility Controls

The Utility menu allows you to set the user interface of the instrument. Under this Utility menu, you can control the following settings:

- Auto power off control
- Language Setting
- USB flash memory on/off
- Date Setting
- Time Setting
- Self-calibration
- Probe-calibration

Auto-Power Off Control

You can save power consumption with this auto power off function. The instrument will automatically turn off based on the previously set auto power off time setting. Refer to “[To Set Auto-Power Off](#)” on page 12 for the steps to select auto-power off setting.

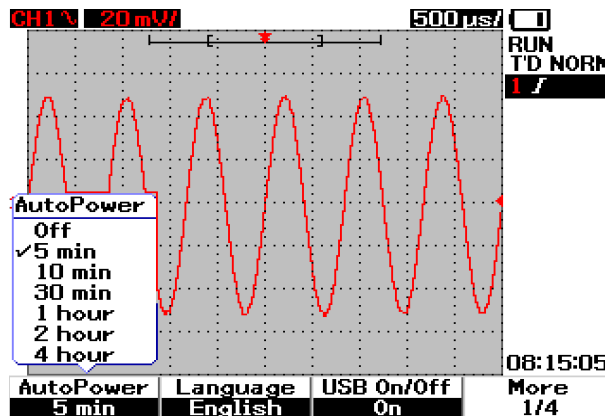

Figure 3-51 Auto-power off control

Language Selection

Language selection is available for the Quick Help function of this instrument. At time of publication, Quick Help is available in English, German, French, Italian, Portuguese, Spanish and Korean. Refer to [“To Select Quick Help Language”](#) on page 13 for the steps of language selection.

USB Flash Memory On/Off

The USB flash memory is an optional feature to facilitate you in saving and loading configuration setups and waveforms via a USB flash memory device. Before connecting a USB flash memory device to the instrument, you need to enable the utility of the USB flash memory drive. Refer to [“Save and Recall Controls with USB Flash Memory Device”](#) on page 93 on detailed instructions of setting this feature.

Date and Time Setting

You are allowed to set the date and time display for the instrument. The time setting is displayed in 24-hour format with minute and second fields. Refer to [“To Set Date and Time”](#) on page 10 on more detailed information.

Self-Calibration

To perform verification or performance optimization to the instrument, you can run self-calibration on your instrument. This self-calibration performs an internal self-alignment routine to optimize the signal path that affects channel sensitivity, offset and trigger parameters.

Refer to [“Self-Calibration”](#) on page 156 on more detailed information of self-calibration.

WARNING

Disconnect all probe connections to the input terminal of the instrument. Allow the instrument to warm up at least 30 minutes before performing self-calibration.

Probe Calibration

When connecting a passive probe to the instrument for the first time, scope probe compensation must be performed to guarantee the accuracy of your measurement. Refer to [“To Compensate Scope Probe”](#) on page 15 for the step-by-step instructions for scope probe compensation.

Low Battery Mode

When the instrument is under low battery condition, the following warning message appears on the display screen and audible beeper sounds. After the display of the warning message, the instrument can be used for approximately 15 minutes before the instrument automatically turn off. If the instrument is under low battery mode in power off condition, when users turn the instrument on, it automatically shuts off after one minute to protect the internal circuit.

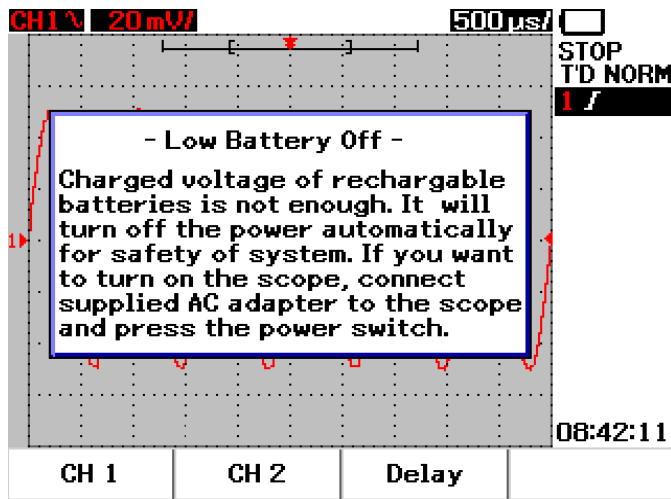
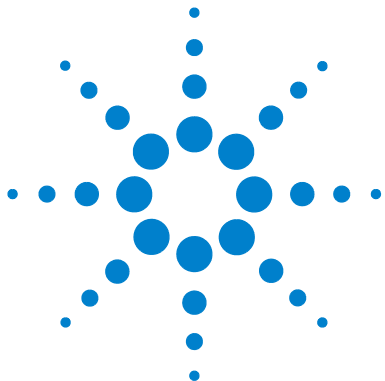

Figure 3-52 Message display during low battery condition

Mute Function

This Mute function allows you to turn on and off the key sound and low battery alarm alert. To access this function, follow the steps below:

- 1 Press **User**, then **F4** softkey to access **Utility** mode.
- 2 On page 4/4 of the Utility menu, press **F1** to display the mute on/off menu.
- 3 Select **Mute On** to turn off the key sound and low battery alarm alert and vice-versa.





4k Using the Digital Multimeter Functions

Voltmeter	104
Ohmmeter	106
Auxiliary Meter	112
Relative Function	118
Automatic Measurement in Multimeter Mode	120
Restart Test	121
Auto-range Mode	121

The U1600B series handheld digital oscilloscope is equipped with multimeter functions. The built-in 6000 count resolution true RMS digital multimeter comes with auto-range function that provides flexibility in performing quick and accurate meter measurement. Multimeter functions include voltage, resistance and auxiliary measurements. In addition to this, the U1600B series also come with data logging function that allows users to consolidate a sequence of data points for data recording.

NOTE

- All multimeter measurements operates in auto-range mode. To enable manual range, press  button to manually select your preferred range for multimeter measurement.
- Users can hold the measurement reading by pressing  button.

NOTE

For best measurement accuracy in the digital multimeter functions, the instrument has to be battery-powered only.



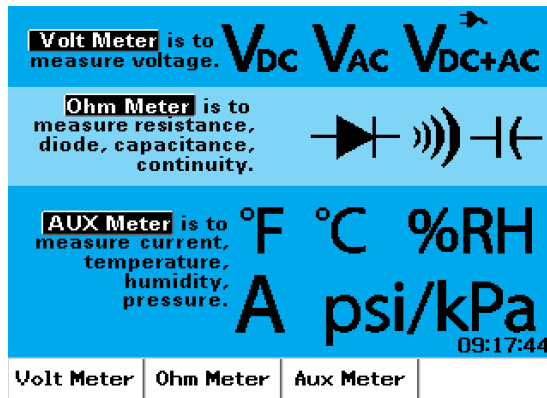

Figure 4-1 Multimeter display

Voltmeter

The voltmeter functions include AC, DC and AC+DC measurement. This instrument offers true RMS AC voltage measurement that provides accurate measurement for any input signal. For input signal AC with DC offset, you are recommended to use AC+DC measurement.

To perform voltage measurement, see the following instructions:

- 1 Press Meter button to access meter menu.
- 2 Press F1 to access voltmeter submenu.
- 3 In the voltmeter submenu, press F1 to select DC, AC or AC+DC measurement function.
- 4 Connect the red test lead to the **V·Ω·AUX** **CAP·→** input terminal and the black test lead to the **COM** terminal.
- 5 Probe the test point of the circuit under test.
- 6 Read the voltage reading from the display. The display indicates the proper decimal point, value and symbols.
- 7 To perform relative function, refer to “Relative Function 118” section in this chapter.

- 8 Press F3 to perform automatic measurement for minimum, maximum and average readings.
- 9 Press F4 to refresh and recollect measurement reading.

WARNING

Ensure the probe tips are in contact with the metal contacts inside the outlet. Improper contact may lead to inaccurate voltage measurement. This poses to cause risk of electrocution if the device under test is powered, but this however fails to be detected by the instrument due to poor contact.

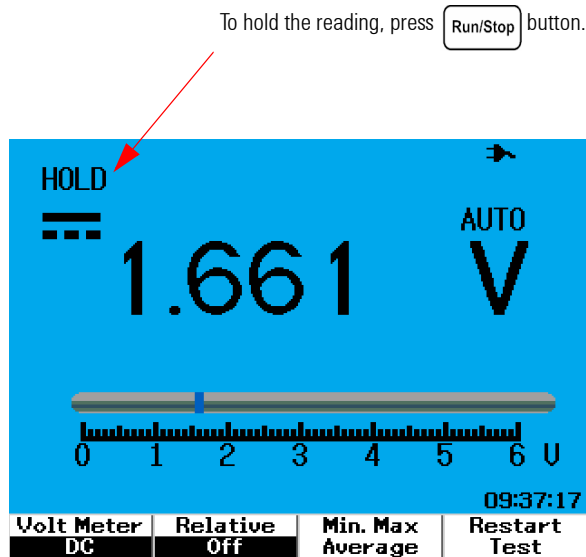

Figure 4-2 DC measurement display

CAUTION

Do not switch on or off a motor under test when measuring AC or DC voltage. This is to avoid the instrument from being damaged due to large voltage surge during the on and off operation.

Ohmmeter



The ohmmeter provides measurements for resistance, continuity test, capacitance and diode test. The instrument automatically select the range using auto-range. However, you can manually adjust the range of the measurement, giving faster performance. Refer to “Auto-range Mode” in this section for more detailed information.

Resistance Measurement

WARNING

Disconnect power to the device or circuit under test and discharge all high voltage capacitors to avoid electric shock and prevent possible damage to the instrument or device under test while taking resistance measurement.

To perform resistance measurement, do the following instructions:

- 1 Press  button to access meter menu.
- 2 Press F2 to access ohmmeter submenu.
- 3 In the ohmmeter submenu, press F1 to select the resistance measurement from the pull-up menu.
- 4 Connect the red test lead to the **V·Ω·AUX** input terminal and the black test lead to the **COM** terminal. 
- 5 Probe the test point of the circuit or device under test.
- 6 Read the resistance reading from the display. The display indicates the proper decimal point, value and symbols.
- 7 To perform relative function, please refer to the “Relative Function” section in this chapter.

- 8 Press F3 to perform automatic measurement for minimum, maximum and average readings/
- 9 Press F4 to refresh and recollect measurement reading.

NOTE

If the device under test is an assembled part of a circuit, it is highly recommended that you disconnect one site of the device to reduce interference to the resistance reading.

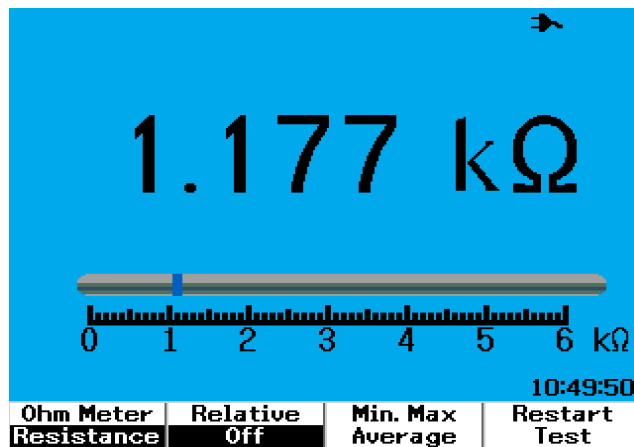

Figure 4-3 Resistance measurement

Continuity Test

WARNING

Disconnect circuit power and discharge all high-voltage capacitors before measuring continuity on circuits or wires to avoid electric shock and damage to the instrument.

To perform the continuity test, do the following instructions:

- 1 Press Meter button to access meter menu.
- 2 Press F2 to access ohmmeter submenu.
- 3 In the ohmmeter submenu, press F1 to select the continuity measurement from the pull-up menu.
- 4 Connect the red test lead to the **V·Ω·AUX** input terminal and the black test lead to the **COM** terminal. **CAP·→**
- 5 Probe the test point of the circuit or device under test.
- 6 Read the resistance reading from the display. The display indicates the proper decimal point, value and symbols.
- 7 If the resistance is less than 60 Ω, the audible beeper will sound.
- 8 Press F3 to perform automatic measurement for minimum, maximum and average readings.
- 9 Press F4 to refresh and recollect measurement reading.

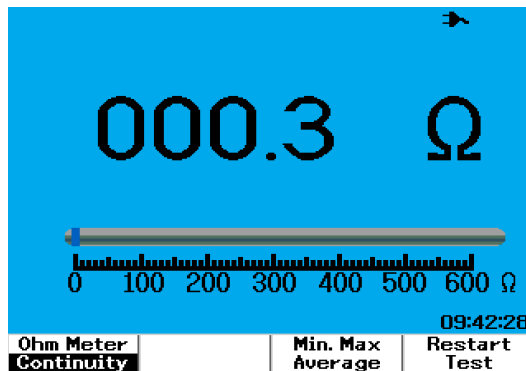



Figure 4-4 Continuity test shorted with audible beeper sound.

Diode Test

WARNING

Disconnect circuit power and discharge all high-voltage capacitors before performing diode test to avoid electric shock and damage to the instrument.

To perform the diode test, do the following instructions:

- 1 Press  button to access meter menu.
- 2 Press F2 to access ohmmeter submenu.
- 3 In the ohmmeter submenu, press F1 to select the diode test from the pull-up menu.
- 4 Connect the red test lead to the **V·Ω·AUX** input terminal and the black test lead to the **COM** terminal. 
- 5 Probe the red test point to the positive terminal (anode) of the diode and the black test lead on the negative terminal (cathode).
- 6 Read the voltage reading from the display.
- 7 Reverse the polarity of the probes and measure the voltage across the diode again. Read the voltage reading from the display.
- 8 Diode test result can be described as the following:
 - Diode is considered good if the instrument displays a voltage value (approximately 0.25 V for germanium and 0.7 V for silicon) in forward bias mode and displays “OL” in reverse bias mode.
 - Diode is considered shorted if the instrument displays approximately 0 V in both forward and reverse bias modes.
 - Diode is considered open if the instrument displays “OL” in both forward and reverse bias modes.

NOTE

The typical diode forward bias is in the range of 0.3 V to 1.00 V.

4 Using the Digital Multimeter Functions

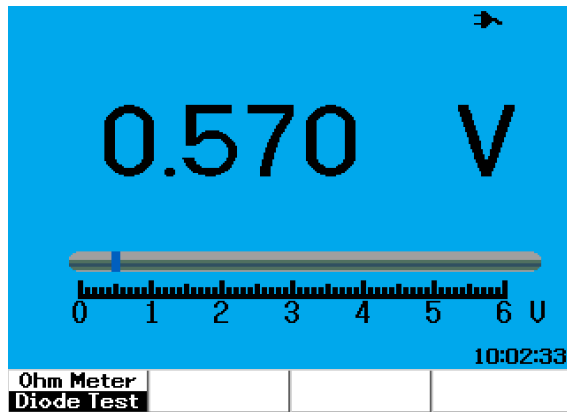
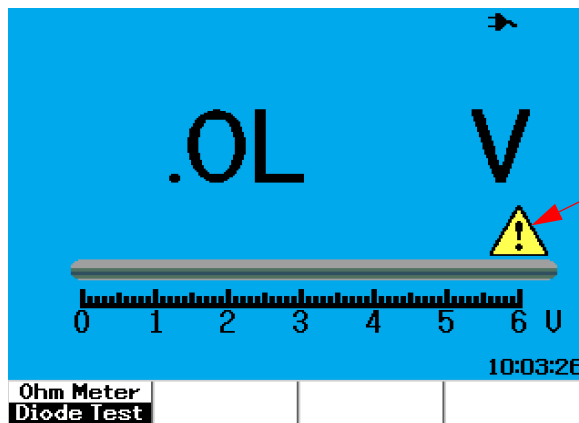

Figure 4-5 Diode in forward bias condition



A caution symbol appears in open loop condition

Figure 4-6 Diode in open condition

Capacitance Measurement

WARNING

Disconnect circuit power and discharge all high-voltage capacitors before performing capacitance measurement to avoid electric shock and damage to the instrument.

The capacitance measurement is available only for auto-range mode. To perform the capacitance measurement, do the following instructions:

- 1 Press Meter button to access meter menu.
- 2 Press F2 to access ohmmeter submenu.
- 3 In the ohmmeter submenu, press F1 to select the capacitance measurement (displayed as “Cap”) from the pull-up menu.
- 4 Connect the red test lead to the **V·Ω·AUX** input terminal and the black test lead to the **COM** terminal. **CAP·→**
- 5 Probe the red test point to the positive terminal (anode) of the capacitor and the black test lead on the negative terminal (cathode).
- 6 Read the capacitance reading from the display.
- 7 To perform relative function, please refer to the “Relative Function” section in this chapter.

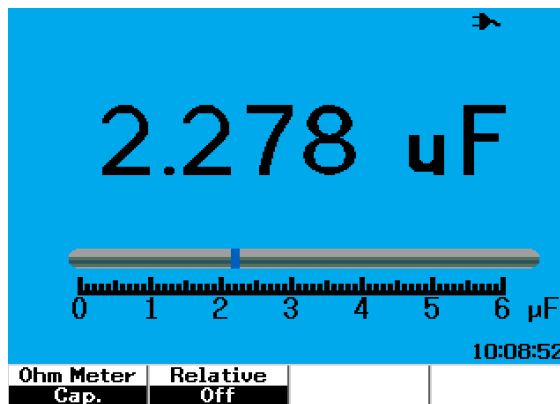

Figure 4-7 Capacitance measurement



Auxiliary Meter

The U1600B series handheld digital oscilloscope expands its capability with auxiliary meter functions, that includes temperature, ampere, pressure and humidity meter measurement. The designated external adapters are needed to perform the auxiliary measurements.

Temperature Meter

The temperature measurement works in auto-range mode with a external temperature adapter. Users can select measurement unit as either degree Celsius (°C) or degree Fahrenheit (°F).

To perform temperature measurement, follow the instructions below:

- 1 Press  button to access meter menu.
- 2 Press F3 to access auxiliary submenu.
- 3 In the auxiliary submenu, press F1 to select the temperature meter (displayed as “**Temp Meter**”).
- 4 In the temperature meter submenu, press F1 to select measurement unit as either degree Celsius (°C) or degree Fahrenheit (°F).
- 5 Ensure the temperature adapter positive terminal (+) is connected to instrument input terminal  and negative terminal (-) to **COM** input jacks of the instrument.
- 6 Touch the material under test with the temperature probe tip.
- 7 Note the temperature reading from instrument. A negative sign (-) at the prefix of the reading indicates the temperature is below zero °C or °F respectively.
- 8 To perform relative function, refer to the “[Relative Function](#)” section in this chapter.
- 9 Press F3 to perform automatic measurement for minimum, maximum and average readings.

10 Press F4 to refresh and recollect measurement reading.

CAUTION

- Avoid severe excessive bending and kinking of the temperature probe leads, as prolonged bending condition may break leads.
- Do not dip the temperature probe tip into acidic liquids.
- Do not apply voltage to any part of the temperature probe tip.

NOTE

To obtain accurate measurement, ensure good contact between probe tip and object. Ensure the probe tip surface is dry and clean for good temperature transfer from object to probe tip.

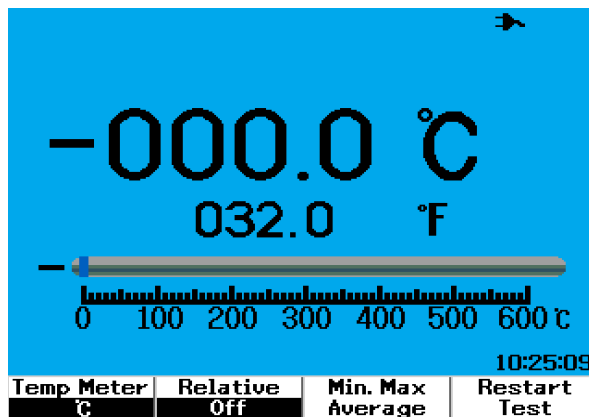



Figure 4-8 Temperature measurement in degrees Celsius (°C) together with degree Fahrenheit (°F) display.

Ampere Meter

The current or ampere measurement requires a current adapter to work with the instrument. The current range is auto-selected by the instrument and displayed in proper decimal point, value and symbols.

To perform current measurement, follow the instructions below:

- 1 Press  button to access meter menu.
- 2 Press F3 to access auxiliary submenu.
- 3 In the auxiliary submenu, press F2 to select the ampere meter.
- 4 In the ampere meter submenu, press F1 to select AC current or DC current measurement (refer to Figure 4-9).
- 5 Adjust the scale setting of your current adapter (1 mV/A or 10 mV/A).
- 6 Press F4 to proceed to page 2/2 of the ampere meter submenu.
- 7 Press F1 in page 2/2 to select the measurement range (refer to Figure 4-9). The measurement range is selected based on the setting on the current adapter (1 mV/A or 10 mV/A).
- 8 Ensure the current adapter positive terminal (+) is connected to instrument input terminal  and negative terminal (-) to **COM** input jacks of the instrument.
- 9 Probe the test point of the device under test.
- 10 Read the current reading from the display. The display indicates the proper decimal point, value and symbols.
- 11 To perform relative function, please refer to the “[Relative Function](#)” section in this chapter.
- 12 Press F3 to perform automatic measurement for minimum, maximum and average readings.
- 13 Press F2 in page 2/2 of the ampere meter submenu to refresh and recollect measurement reading.

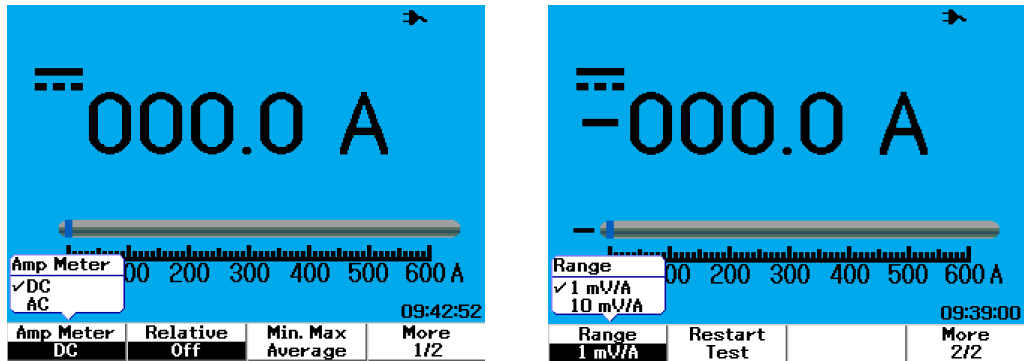

Figure 4-9 Current measurement

Humidity Meter

To perform humidity measurement, a humidity adapter is required. The humidity range is auto-selected by the instrument and displayed in proper decimal point, value and symbols.

To perform humidity measurement, follow the instructions below:

- 1 Press Meter button to access meter menu.
- 2 Press F3 to access auxiliary submenu.
- 3 In the auxiliary submenu, press F3 to select the humidity meter.
- 4 Ensure the humidity adapter positive terminal (+) is connected to instrument input terminal $V\cdot\Omega\cdot AUX$ and negative terminal (-) to **COM** input jacks of the instrument.
- 5 Touch the material under test with the probe tip.
- 6 Read the humidity reading in %RH from the display. The display indicates the proper decimal point, value and symbols.
- 7 To perform relative function, please refer to the “Relative Function” section in this chapter.

- 8 Press F3 to perform automatic measurement for minimum, maximum and average readings.
- 9 Press F4 to refresh and recollect measurement reading.

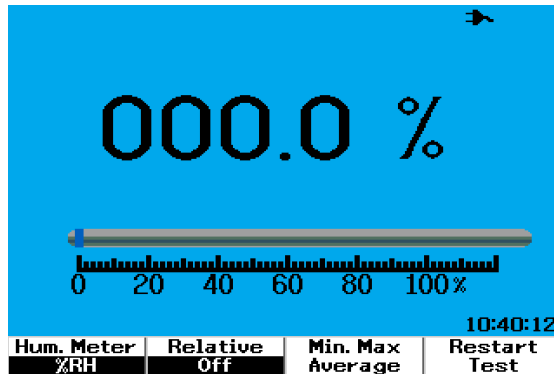

Figure 4-10 Humidity measurement

Pressure Meter

A pressure adapter is required to perform the pressure measurement. The instrument auto-selects the most proper measurement range and displays in proper decimal point, value and symbols.

To perform pressure measurement, follow the instructions below:

- 1 Press button to access meter menu.
- 2 Press F3 to access auxiliary submenu.
- 3 In the auxiliary submenu, press F4 to select the pressure meter.
- 4 In the pressure meter submenu, press F1 to select measurement unit to either psi or kPa.
- 5 Ensure the pressure adapter positive terminal (+) is connected to instrument input terminal $V\cdot\Omega\cdot AUX$ CAP $\rightarrow +$ and negative terminal (-) to COM input jacks of the instrument.
- 6 Touch the material under test with the probe tip.
- 7 Read the pressure reading from the display. The display indicates the proper decimal point, value and symbols.

- 8 To perform relative function, please refer to “Relative Function 118” section in this chapter.
- 9 Press F3 to perform automatic measurement for minimum, maximum and average readings.
- 10 Press F4 to refresh and recollect measurement reading.

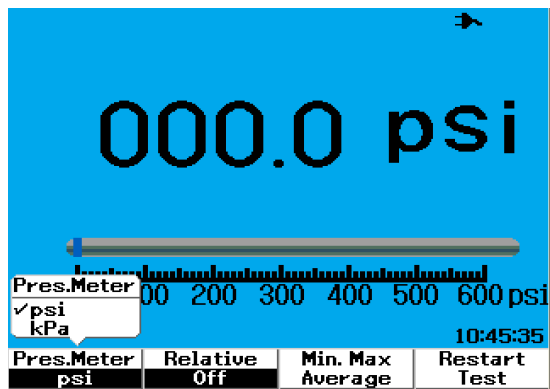

Figure 4-11 Pressure measurement

NOTE

1 kPa = 6.89476 psi

Relative Function

The relative function is also called Null measurement, which is the difference between a stored null value or a reference value and the measured value. This relative function is applicable for all multimeter measurement except the diode test and continuity test. To turn on or off the relative function, press F2 in each respective multimeter function submenu.

Example:

Obtain a 1.177 k Ω from a resistance measurement and set the reading as a reference value by turning on the Relative function. The reading will be displayed as 0 Ω . Perform the second resistance measurement, if the reading obtained is 1.766 k Ω (measured value), the delta of approximately 0.586 k Ω (relative value) will be displayed. Formula is shown as below:

Relative value = Measured value - Reference value

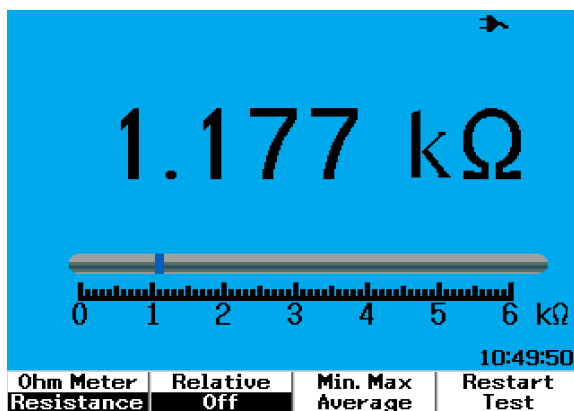

Figure 4-12 Set the reading as reference value

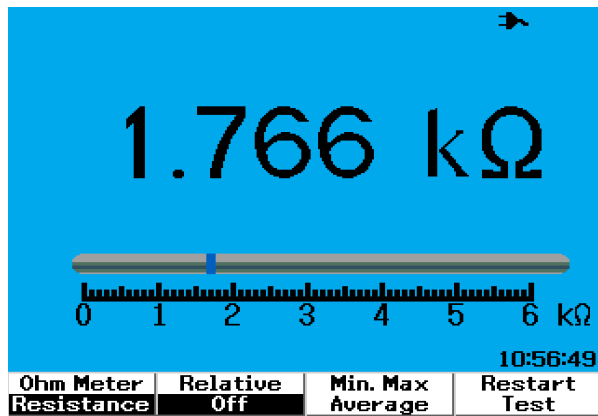

Figure 4-13 Set the reading as measured value

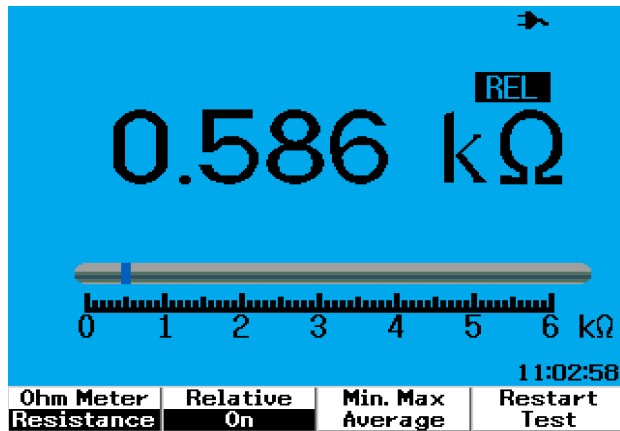

Figure 4-14 Relative value obtained from the delta of the measured and reference value.

Automatic Measurement in Multimeter Mode

The automatic measurement minimum, maximum and average are also available for all multimeter measurements except diode test and capacitance measurement.

The real-time minimum and maximum measurement are displayed along with the recorded time. The average value is the arithmetic average value of the last 8 readings.

To enable the function, press F3 in each respective multimeter function submenu. Refer to Figure 4-15.

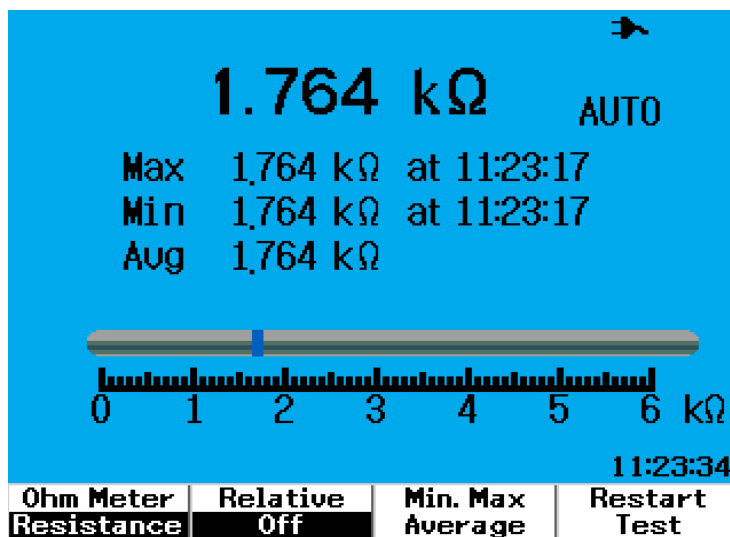

Figure 4-15 Automatic measurement in resistance measurement mode



Restart Test

Users are able to clear the prior captured readings and refresh the minimum, maximum and average values. By enabling this function, the instrument will restart and retest multimeter measurements.

To enable the restart test function, press F4 in each of the respective multimeter submenu. This feature is not available for diode test and capacitance measurement.

Auto-range Mode

All multimeter measurement is set to Auto-range mode as default. To enable or disable manual range mode, do the following:

- 1 Press  button to enable manual range mode. The “AUTO” sign displayed at the right corner will disappear.
- 2 Notice the range shown below the bar graph changes with every press of the  button.
- 3 Select your preferred range and perform your measurement.
- 4 To disable the manual range mode, press and hold  until the beeper sounds.

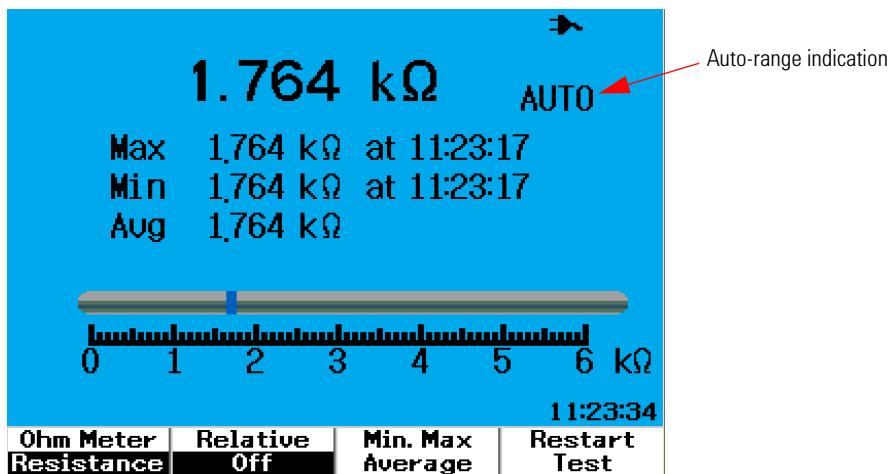

Figure 4-16 Auto-range mode



Figure 4-17 Manual range mode



5 Using the Data Logger Functions

Data Logger Function [124](#)

Automatic Measurement in Data Logger Mode [127](#)

CSV Saving Function and Interval Setting [127](#)

Restart Test [128](#)

The U1600B series handheld digital oscilloscope is equipped with data logging function for multimeter measurements. The data logger plots the measurement values versus time base in graph display. The instrument allows you to record up to 20 days of data with compressed and resizing to be displayed on a full screen.



Data Logger Function

The data logger plots the graph from left to right until the screen reaches the right edge of the screen. The data logging function automatically compresses the screen to half with the time base changes as follows:

- 150 seconds
- 300 seconds
- 10 minutes
- 20 minutes
- 50 minutes
- 100 minutes
- 200 minutes
- 10 hours
- 20 hours
- 30 hours
- 60 hours
- 120 hours
- 10 days
- 20 days

The time base increments changes by every 10 divisions from a minimum of 15 s/div (150 seconds) to maximum of 2 days/div for data logging. To utilize this function, do the following:

- 1 Press  button to access data logger mode.
- 2 Press F1 to select the following multimeter functions for data logging:
 - Voltmeter (displayed as “Volt”)
 - Ohmmeter (displayed as “Ohm”)
 - Auxiliary meter (displayed as “Aux”)
- 3 After selecting the multimeter function, press F2 to select the sub-function of each multimeter function, listed as below:

- Voltmeter
 - DC
 - AC
 - AC+DC
- Ohmmeter
 - Resistance
 - Diode test
 - Continuity
 - Capacitance (displayed as “Cap”)
- Auxiliary meter
 - DC current
 - AC current
 - Temperature °C (displayed as “°C Temp”)
 - Temperature °F (displayed as “°F Temp”)
 - Relative Humidity (displayed as “%RH”)
 - Pressure (displayed as “psi”)

NOTE

All multimeter measurements for data logger operates in auto-range mode.

5 Using the Data Logger Functions

Refer to the following two examples for resistance and DC voltage data logger.

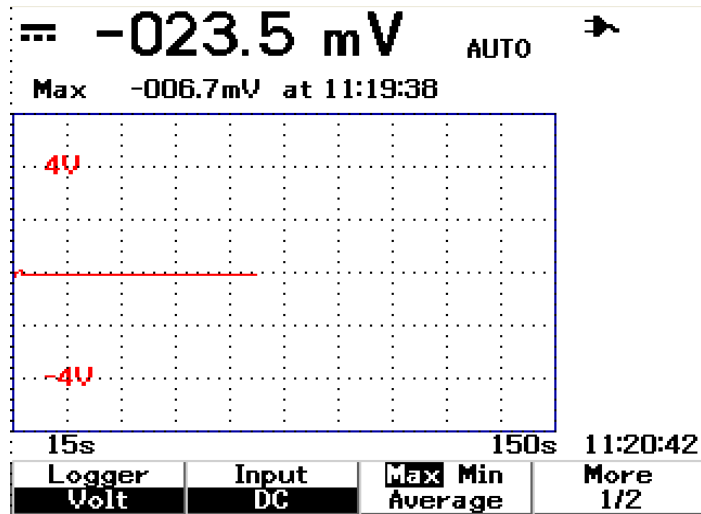

Figure 5-1 Maximum measurement is selected for DC voltage data recording. The initial time base is 15 seconds — 150 seconds.

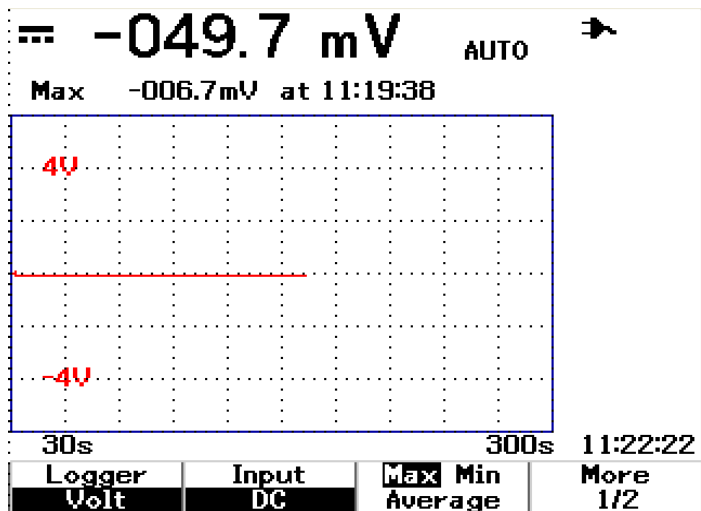

Figure 5-2 After exceeding 150 seconds, the graph automatically compresses to half screen and the time base changes to 30 seconds — 300 seconds.

Automatic Measurement in Data Logger Mode

The automatic measurement for minimum, maximum and average values are available for data logging function. You can select any of these measurements for data recording purposes.

The real-time minimum and maximum measurements are displayed along with the recorded time. The average value is the arithmetic average value of the last 8 readings.

To enable the function, press F3 in the respective multimeter function submenu.

CSV Saving Function and Interval Setting

This function allows the users to directly save their data into the USB flash drive. To enable the function, do the following:

- 1 Press **Logger** to access the data logger mode.
- 2 Press F4 to proceed to page 2/2 of the data logger mode.
- 3 To enable the CSV saving function, press F2 to toggle between start and stop options (refer to Figure 5-3 below). You can save up to 500 kilobytes of data.
- 4 To change the interval settings, press F3 repetitively to scroll down the list and make the selection (refer to Figure 5-4 below).

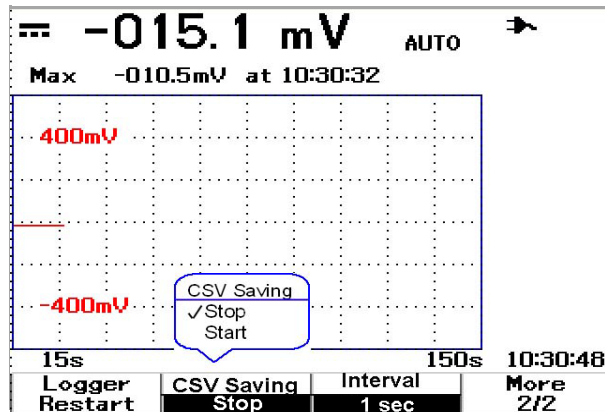

Figure 5-3 Enabling the CSV saving function

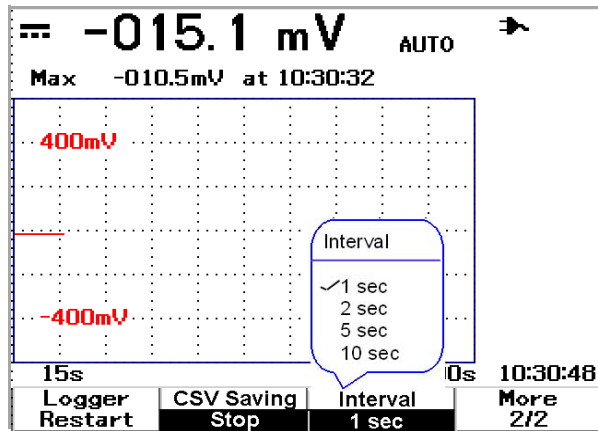

Figure 5-4 Setting the interval

Restart Test

Users are able to clear the previously captured readings and refresh the minimum, maximum and average values. To enable this function, press F4 to proceed to page 2/2 of the data logger mode. Then press F1 in page 2/2 to activate the function.



6 Service and Maintenance

Warranty Services 130

Cleaning 133

Basic Troubleshooting Hints 133



Warranty Services

Standard Warranty (Worldwide)

If your instrument fails during the three years warranty period, Agilent Technologies will repair or replace the unit under the terms of your warranty. After the expiration of the warranty, Agilent will offer repair services at a very competitive price.

This warranty does not cover defects resulting from improper or inadequate maintenance by the Buyer. Buyer-supplied products or interfacing, unauthorized modification or misuse, operation outside of the environmental specifications for the product, or improper site preparation or maintenance.

If your product is defective, contact the nearest Agilent Technologies Service Center to obtain service for your instrument. They will arrange to have your unit repaired or replaced.

To obtain warranty, service or technical support assistance, you can contact Agilent Technologies at the following telephone numbers:

United States:

(tel) 800 829 4444

(fax) 800 829 4433

Canada:

(tel) 877 894 4414

(fax) 800 746 4866

China:

(tel) 800 810 0189

(fax) 800 820 2816

Europe:

(tel) 31 20 547 2111

Japan:

(tel) (81) 426 56 7832

(fax) (81) 426 56 7840

Korea:

(tel) (080) 769 0800

(fax) (080) 769 0900

Latin America:

(tel) (305) 269 7500

Taiwan:

(tel) 0800 047 866

(fax) 0800 286 331

Other Asia Pacific Countries:

(tel) (65) 6375 8100

(fax) (65) 6755 0042

Or contact Agilent worldwide through the following Web link:

www.agilent.com/find/contactus

Accessories Warranty

Agilent offers warranty for product's accessories for up to 3 months from the end-user acceptance date.

Standard Calibration Service (optional)

Agilent offers an optional calibration service contract for a period of 3 years from end-user acceptance date.

Returning instrument to Agilent Technologies for service

Before shipping your instrument for repair or replacement, Agilent recommends that you acquire the shipping instructions from the Agilent Technologies Service Center. A clear understanding of the shipping instructions is necessary to secure your product for shipment.

- 1 Write the following information on a tag and if attach to the instrument.
 - Name and address of owner
 - Instrument model number
 - Instrument serial number
 - Description of the service required or failure indications

- 2 Remove all accessories from the instrument

Do not include accessories unless they are associated with the failure symptoms.

- 3 Protect the instrument by wrapping it in plastic or heavy paper.

- 4 Pack the instrument in foam or other shock absorbing material and place it in a strong shipping container.

You are recommended to use the original shipping material or order materials from an Agilent Technologies Sales Office. If both options are not available, place 8 to 10 cm (3 to 4 inches) of shock-absorbing and static-free packaging material around the instrument to avoid movement during shipping.

- 5 Seal the shipping container securely.
- 6 Mark the shipping container as FRAGILE.

In the ensuing correspondence, refer to the instrument by its model number and full serial number.

Agilent suggests that you always insure your shipments.

Cleaning

If the instrument requires cleaning, ensure you follow the instructions below:

- Remove power from the instrument
- Clean the external surfaces of the instrument with a soft, lint-free and slightly dampened cloth.
- Make sure that the instrument is completely dry before reconnecting it to a power source.

Disassemble is not required or recommended for cleaning.

Basic Troubleshooting Hints

This section provides hints and suggestions for solving general problems that you may encounter with the instrument. It guides you on what to check in the following situations:

- **If there is no display**
 - ✓ Check the power switch at the front panel is on.
 - ✓ Check the battery condition. Charge the battery if the battery is exhausted.
 - ✓ Contact Agilent Technologies Service Center to obtain technical assistance, if necessary.

- **If there is no trace display**

- ✓ Recall factory default setting by pressing  button on the front panel. Press F1 to enter Save/Load Setup menu, in the page 1/4, then press F1 to restore factory default setting.
- ✓ Check that the scope probe lead wires are securely inserted into the connector assembly and that the probe clips are making good contact with the probe lead wires.
- ✓ Check that the circuit under test is powered on, probe clips are securely connected to test points on the circuit under test, and ground is connected.
- ✓ Press Autoscale button to allow the instrument to automatically trigger the signal to the best display.
- ✓ Contact Agilent Technologies Service Center to obtain technical assistance, if necessary.

- **If the trace display is unusual or unexpected**

- ✓ Check that the horizontal time/division is correctly set for the expected frequency range of the input signals.
- ✓ Check that all scope probes are connected to the correct signals on the circuit under test, and ground lead is securely connected to ground of the circuit under test.
- ✓ The trigger setup is the most important factor in capturing the signal you desire. Check that the trigger setup is correct.
- ✓ Check that infinite persistence in the Display menu is turned off. Press Clear Display to remove the display.
- ✓ Press the Autoscale button to allow the instrument to automatically trigger the signal to the best display.
- ✓ Contact the Agilent Technologies Service Center to obtain technical assistance, if necessary.

- **If you cannot see a channel**

- ✓ Recall factory default setting by pressing  button on front panel. Press F1 to enter Save/Load Setup menu. On page 1/4, press F1 to restore the factory default setting.
- ✓ Check that the scope probe cable is securely connected to the input connector.
- ✓ Check that the scope probe lead wires are securely inserted into the connector assembly and that the probe clips are making good contact with the probe lead wires.
- ✓ Check that the circuit under test is powered on, probe clips are securely connected to test points in the circuit under test, and ground is connected.
- ✓ Check that the correspond scope channel is being turned on.
- ✓ Press Autoscale button to allow the instrument to automatically set up all channels.
- ✓ Contact Agilent Technologies Service Center to obtain technical assistance, if necessary.

NOTE

If you cannot get any response from the instrument, contact the nearest Agilent Technologies Service Center to obtain further assistance.

THIS PAGE HAS BEEN INTENTIONALLY LEFT BLANK.



7 Performance Tests

List of Test Equipment	139
Oscilloscope Performance Verification Tests	141
Multimeter Performance Verification Tests	149
Self-Calibration	156
Self-Calibration Error Code	157

This section documents procedures of performance testing. You will be guided on how to verify instrument operations and perform tests to ensure that the instrument meets the performance specifications. This section is divided into two sections — one for scope test performance while the other is for multimeter test performance.



Performance Test Interval

The performance testing described in this section may be performed for incoming inspection and should be performed periodically to verify that the oscilloscope is operating within specification. The recommended test interval is once per year. Performance should also be tested after repairs or major upgrades.

Performance Test Record

A test record form is provided in “[Agilent U1602B/U1604B Handheld Digital Oscilloscope Test Record](#)”. This record lists performance tests, test limits and columns to record test results.

Warming Up Before Testing

For accurate test results, let the instrument and test equipment warm up for 30 minutes, and perform Self-Calibration before testing. Refer to “[Self-Calibration](#)” for more information on Self-Calibration.

NOTE

If performance test fails after the Self-Cal, send the instrument to your nearest Agilent Technologies Service Center for servicing.

List of Test Equipment

For scope performance verification, the recommended test equipments are listed as below.

Table 7-1 List of test equipments for scope performance test

Application	Equipment	Critical Specifications	Recommended Equipment
Voltage measurement accuracy	Calibrator / Power supply	5 mV to 35 VDC, 0.1 mV resolution	FLUKE 5520A
	Digital multimeter	Better than 0.01% accuracy	Agilent 34401A
	Cable	BNC, quantity of 2	Agilent 10503A
	Shorting capacitor	BNC	Agilent 1250-0774
	Adapter	BNC (f) to banana (m)	Agilent 1251-2277
	Adapter	BNC tee (m) (f) (f)	Agilent 1250-0781
Bandwidth	Calibrator	NA	FLUKE 5520A
	Feedthrough	50Ω, BNC connector (m) and (f)	Agilent 11048C
	Cable	Type N (m), 24 inches	Agilent 11500B
Horizontal time base accuracy	Calibrator	5 ppm after 1/2 an hour	FLUKE 5520A
	Feedthrough	50Ω, BNC connector (m) and (f)	Agilent 10503A
	Cable	BNC, 3 feet length	Agilent 11048C
Trigger sensitivity	Calibrator	25 MHz, 60 MHz and 100 MHz sine waves.	FLUKE 5520A
	Power splitter	Outputs differ < 0.15 dB	Agilent 11667B
	Cable	BNC, quantity of 3	Agilent 10503A
	Adapter	N (m) to BNC (f), quantity of 3	Agilent 1250-0780
	Feedthrough	50Ω, BNC connector (m) and (f), quantity of 2	Agilent 11048C

7 Performance Tests

For multimeter performance verification, the recommended test equipments are listed as below.

Table 7-2 List of test equipment for multimeter performance test

Application	Recommended Equipment
DC Voltage	FLUKE 5520A
AC Voltage	FLUKE 5520A
Resistance	FLUKE 5520A
Capacitance	FLUKE 5520A
Diode Test	FLUKE 5520A
Continuity	FLUKE 5520A

Oscilloscope Performance Verification Tests

The performance tests verify the channel's measurement accuracy and acquisition system to provide confidence in functionality and accuracy of the instrument. The performance verification tests are based on the instrument's specification as listed in "Chapter 9 Specification and Characteristic".

Voltage Measurement Accuracy Verification Test

This test verifies the voltage measurement accuracy. In this test, you will measure the output of a power supply using dual cursors* of the instrument and compare the results with reading from the multimeter.

Test limits: 50 mV/div to 100 V/div $\pm 3\%$ of full scale[†]

5 mV/div to 20 mV/div $\pm 5\%$ of full scale[†]

Refer to Table 7-1 for the equipment required for this voltage measurement accuracy verification test. Perform the following procedures for channel 1, then repeat the same procedure for channel 2.

- 1 Set up the instrument.
 - Set the Volts/div to the value stated in the first line in Table 7-3.

* Dual Y-Cursor Measurement instructions can be found on [page 76](#).

† Full scale on all ranges is defined as 8 divisions multiplied by the V/div setting.

Table 7-3 Settings used to verify voltage measurement accuracy

Volts/div	Power Supply Setting	Min Test Limit	Max Test Limit
100 V/div	250 V	226 V	274 V
50 V/div	250 V	238 V	262 V
20 V/div	140 V	135.2 V	144.8 V
10 V/div	70 V	67.6 V	72.4 V
5 V/div	35 V	33.8 V	36.2 V
2 V/div	14 V	13.52 V	14.48 V
1 V/div	7 V	6.76 V	7.24 V
0.5 V/div	3.5 V	3.38 V	3.62 V
0.2 V/div	1.4 V	1.352 V	1.448 V
100 mV/div	700 mV	676 mV	724 mV
50 mV/div	350 mV	338 mV	362 mV
20 mV/div	140 mV	132 mV	148 mV
10 mV/div	70 mV	66 mV	74 mV
5 mV/div	35 mV	33 mV	37 mV

- Select User mode of the instrument, then press F2 softkey to select Acquire mode. Press F1 to select Average acquisition mode. Turn the rotary switch to select averaging number of 8 (Avg 8). Press the rotary switch to set the setting.
 - Select Scope mode of the instrument, then press F3 to access Delay menu. On page 1/2 of Delay menu, set time base YT by pressing F3.
 - Press  and set the time to 200 μ s.
 - Move the position of the channel offset to -3 div. (*This is to allow the complete input signal to display at full range.*)
- 2 Place the calibrator in Standby (STBY) mode.
 - 3 Use the BNC tee and cables to connect the calibrator/power supply to the instrument and multimeter as shown in Figure 7-1.

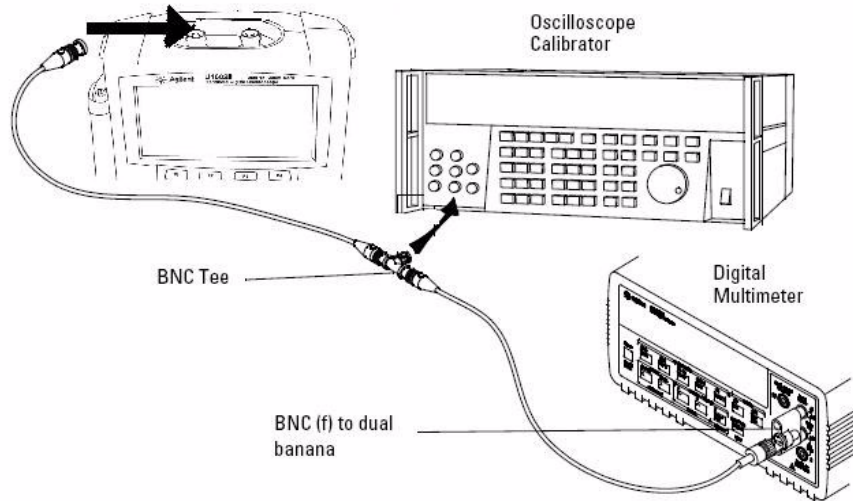

Figure 7-1 Test connection from calibrator to instrument and digital multimeter

- 4 Enable the Y-Cursor and align the Y1 cursor with the signal trace.
- 5 Adjust the output of the calibrator and observe the reading display on the multimeter.
- 6 Wait a few seconds for the measurement to settle. Align the Y2 cursor with the updated signal trace.
- 7 Compare the measurement results (Delta) displayed on the instrument and multimeter to the corresponding test limits shown in Table 7-3.
- 8 Continue to check voltage measurement accuracy with the remaining Volts/div setting values in Table 7-3.
- 9 When you have finished checking all of the power supply setting values, disconnect the power supply from the oscilloscope.
- 10 Repeat the same verification procedures for channel 2.

Bandwidth Verification Test

This test verifies bandwidth of the instrument. In this test, you will use an oscilloscope calibrator to output a sine wave signal at 1 MHz and bandwidth frequency (20 MHz and 40 MHz). You will use the peak-to-peak voltage to verify the bandwidth response of the instrument.

U1602B

Test limits ≥ -3 dB at 20 MHz (for all channels)

U1604B

Test limits ≥ -3 dB at 40 MHz (for all channels)

Refer to Table 7-1 for the equipment required for this bandwidth verification test.

NOTE

The oscilloscope calibrator is supplied with 2 or more coaxial cables N (m), BNC (m), 1 meter long and Fluke P/N 686318.

- 1 Connect the calibrator output through a 50 Ω feedthrough termination to input channel 1 of the instrument.
- 2 Set up the instrument.
 - Set the time base to 500 ns/div.
 - Set the Volts/Div for channel 1 to 200 mV/div.
 - Select User mode of the instrument, then press F2 softkey for Acquire mode.
 - Press F1 to select Average acquisition mode. Turn the rotary switch to select averaging number of 8 (Avg 8). Press the rotary switch to set the setting.
- 3 Set the calibrator to "Level Sine" and OPR/STBY to "OPR". Set the calibrator to 1 MHz and six divisions of amplitude.

- 4 Press Autoscale on the instrument.
- 5 Select Measure mode, then press F1 to enable the auto measurement selection for Measure 1. Turn rotary switch to select peak-to-peak voltage (Pk-Pk) measurement from the list of auto measurement.
Wait for a few seconds for the measurement to settle.
- 6 View the Pk-Pk reading at the measurement line display. Record the reading: $V_{p-p} = \text{_____ V}$. (refer to “[Agilent U1602B/U1604B Handheld Digital Oscilloscope Test Record](#)”)
- 7 Change the frequency of the signal generator to the value shown below for your instrument.

Table 7-4 Signal generator frequency setting

Selected Channel	U1602B	U1604B
Channel 1	20 MHz	40 MHz
Channel 2	20 MHz	40 MHz

- 8 Change the time base to 50 ns/div.
- 9 Wait for a few seconds for the measurement to settle.
- 10 View the Pk-Pk reading at the measurement line display.
- 11 Record the reading: $V_{p-p} = \text{_____ mV}$.
- 12 Calculate the bandwidth response (dB) using the following formula:

$$20\log_{10} [\text{Reading from step \#11} / \text{Reading from step \#6}]$$
- 13 The result from step 12 should be greater than or equal to -3.0 dB.
- 14 Move cable from channel 1 to channel 2 input and repeat the same verification procedures for channel 2.

Horizontal Δt and $1/\Delta t$ Accuracy Verification Test

This test verifies the horizontal Δt and $1/\Delta t$ accuracy. In this test, you will use the oscilloscope to measure the output of a time mark generator.

Test limits: $\pm 3\%$ reading $\pm 0.4\%$ screen

Refer to Table 7-1 for the equipment required for this horizontal Δt and $1/\Delta t$ accuracy verification test.

- 1 Connect the calibrator to the instrument's channel 1 using a 50 Ω feedthrough termination.
- 2 Set up the signal source.
 - Select Marker on the calibrator
 - Set the calibrator for 100 μs markers.
 - Set the spike shape on the calibrator.
- 3 Set up the oscilloscope.
 - Press the Autoscale key.
 - Set the time base to 20 $\mu s/div$.
 - Select Scope mode and press F3 to access Delay menu.
 - Set the Time Reference to Left at F2.
 - Adjust the trigger level to obtain a stable display.
- 4 Select Measure mode, then press F1 to enable auto measurement selection for Measure 1. Turn rotary switch to select Frequency measurement from the list of auto measurements. Set Measure 2 for Period measurement. Measure the following:
 - Frequency of 10 kHz – Test limits are 9.63 kHz to 10.40 kHz.
 - Period of 100 μs – Test limits are 96.20 μs to 103.8 μs .
- 5 Change the calibrator to 1 μs markers and time base to 250 ns/div. Adjust the trigger level to obtain a stable display.
- 6 Measure the following:
 - Frequency of 1 MHz – Test limits are 962 kHz to 1.04 MHz.
 - Period of 1 μs – Test limits are 0.96 μs to 1.04 μs .

U1602B

- 1 Change the calibrator to 50 ns markers and time base to 50 ns/div. Adjust the trigger level to obtain a stable display.
- 2 Measure the following:
 - Frequency of 20 MHz – Test limits are 18.69 MHz to 21.51 MHz.
 - Period of 50 ns – Test limits are 46.5 ns to 53.5 ns.

U1604B

- 1 Change the calibrator to 25 ns markers and time base to 10ns/div. Adjust the trigger level to obtain a stable display.
- 2 Measure the following:
 - Frequency of 40 MHz – Test limits are 38.24 MHz to 41.93 MHz.
 - Period of 25 ns – Test limits are 23.85 ns to 26.15 ns.

Trigger Sensitivity Verification Test

This test verifies the trigger sensitivity. In this test, you supply a sine wave to the instrument and decrease the amplitude of the signal to the specified levels. Check to see if the oscilloscope is still triggered. You will then repeat the same procedures for the upper bandwidth limit of each model.

Test limits for the trigger:

- 5 MHz at 0.8 div
- 20 MHz and 40 MHz at 1 div

Refer to Table 7-1 for the equipment required for this trigger sensitivity verification test.

7 Performance Tests

- 1 Connect the calibrator to channel 1 using a 50 Ω feedthrough at the oscilloscope input.
- 2 Verify the trigger sensitivity at 5 MHz, 0.8 division.
 - Set the calibrator to “level sine” and OPR/STBY to “OPR” mode.
 - Set output of the calibrator to 5 MHz and the amplitude to 100 mVp-p.
 - Press the Autoscale key.
 - Set the time base to 50 ns/div.
 - Set channel 1 to 100 mV/div.
 - Decrease the output signal of the calibrator until 0.8 vertical division of the signal is displayed.
 - The trigger is stable when the displayed waveform is stable. If the trigger is not stable, try to adjust the trigger level. If adjustment is able to stabilize the waveform, the test result is still considered a pass.
- 3 Verify the trigger sensitivity at maximum bandwidth at 1 division.
 - Change the output signal of the calibrator to 40 MHz for the U1604B or 20 MHz for the U1602B, and set the amplitude to 100 mVp-p.
 - Press the autoscale key.
 - Set the time base to 10 ns/div.
 - Decrease the output of the calibrator until 1 vertical division of the signal is displayed.
 - The trigger is stable when the displayed waveform is stable. If the trigger is not stable, try to adjust the trigger level. If the adjustment is able to stabilize the waveform, the test count is still considered a pass.
- 4 Repeat the same verification procedures for channels 2.

Multimeter Performance Verification Tests

Use the Performance Verification Test to verify multimeter measurement performance of the instrument. The performance verification tests are based on the instrument's specification as listed in the "Chapter 8 Specification and Characteristic".

WARNING

Some of the verification tests involve high voltages, hence only qualified personnel is recommended to perform the tests.

To avoid electrical shock or personal injury, always place the calibrator in Standby (STBY) mode before starting verification test.

DC Voltage Verification Test

- 1 Put the calibrator in Standby (STBY) mode.
- 2 Select Meter mode of the instrument, then press F1 softkey for Volt Meter.
- 3 Press F1 to select DC Voltage measurement.
- 4 Connect the calibrator to instrument's input and ground terminal as shown in Figure 7-2 using a banana plug.
- 5 Select each function and range in the order shown in Table 7-5 and apply the values from the calibrator shown in Table 7-5 below.
- 6 Compare measurement results to the corresponding test limits shown in Table 7-5.

7 Performance Tests

Table 7-5 DC Volts Verification Test

Calibrator Voltage	Function	Range	Min Limit	Max Limit
600 mV	DC Volts	600 mV	597.7 mV	602.3 mV
6 V		6 V	5.977 V	6.023 V
30 V		60 V	29.86 V	30.14 V
60 V		60 V	59.77 V	60.23 V
600 V		600 V	597.7 V	602.3 V

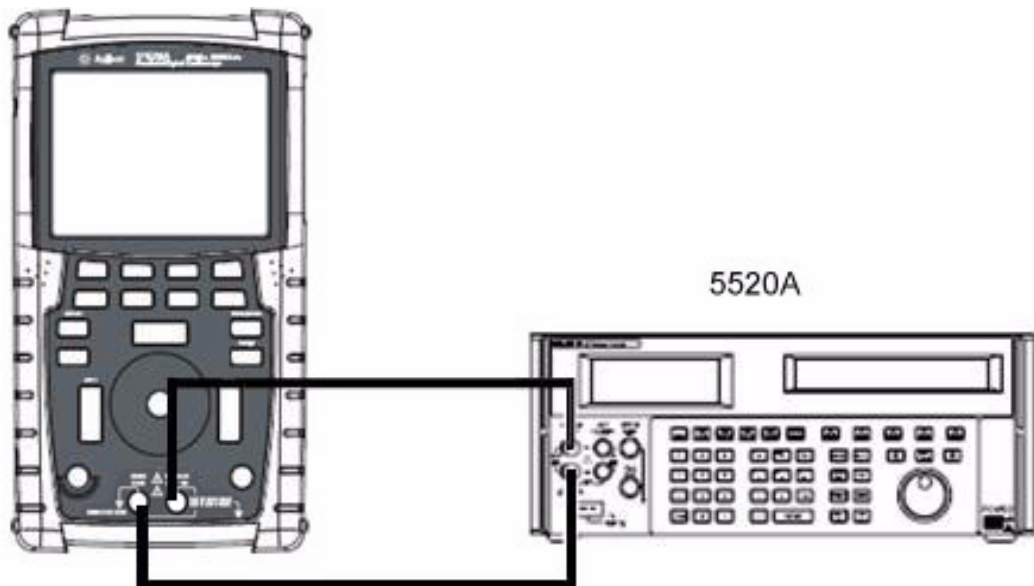

Figure 7-2 Test connections from calibrator to instrument

AC Voltage Verification Test

- 1 Put the calibrator in Standby (STBY) mode.
- 2 Select Meter mode of the instrument, press F1 softkey for Voltmeter.
- 3 Press F1 to select AC voltage measurement.
- 4 Connect the calibrator to the instrument's input and ground terminal as shown in Figure 7-2 using a banana plug.
- 5 Select each function and range in the order shown in Table 7-6. Apply the values from the calibrator shown in Table 7-6 below.
- 6 Compare the measurement results to the corresponding test limits shown in the Table 7-6.

Table 7-6 AC Volts Verification Test

Calibrator Voltage	Calibrator Frequency	Range	Min Limit	Max Limit
6 V	1kHz	6 V	5.928 V	6.072 V
6 V	30 kHz	6 V	5.808V	6.192 V
60 V	1 kHz	60 V	59.28 V	60.72 V
60 V	30 kHz	60 V	58.08 V	61.92 V
300 V	50 Hz	600 V	295.80 V	304.2 V
540 V	1 kHz	600 V	533.40 V	546.60 V
590 V	10 kHz	600 V	571.1 V	608.9 V

Resistance Verification Test

- 1 Put the calibrator in Standby (STBY) mode.
- 2 Select Meter mode of the instrument, then press F2 softkey for Ohmmeter.
- 3 Press F1 to select resistance measurement.
- 4 Connect the calibrator to the instrument's input and ground terminal as shown in Figure 7-2 using a banana plug.
- 5 Select each function and range in the order shown in Table 7-7. Apply the values from the calibrator shown in Table 7-7 below.
- 6 Compare the measurement results to the corresponding test limits shown in Table 7-7.

Table 7-7 Resistance Verification Test

Calibrator Settings	Function	Range	Min Limit	Max Limit
600 Ω	2-Wire Ohms	600 Ω	595.8 Ω	604.2 Ω
6 k Ω		6 k Ω	5.958 k Ω	6.042 k Ω
60 k Ω		60 k Ω	59.58 k Ω	60.42 k Ω
600 k Ω		600 k Ω	595.8 k Ω	604.2 k Ω
3 M Ω		6 M Ω	2.973 M Ω	3.027 M Ω
6 M Ω		6 M Ω	5.958 M Ω	6.042 M Ω
60 M Ω		60 M Ω	59.28 M Ω	60.72 M Ω

Capacitance Verification Test

- 1 Put the calibrator in Standby (STBY) mode.
- 2 Select Meter mode of the instrument, press F2 softkey for Ohmmeter.
- 3 Press F1 to select capacitance measurement.
- 4 Connect the calibrator to the instrument's input and ground terminal as shown in Figure 7-2 using a banana plug.
- 5 Select each function and range in the order shown in Table 7-8. Apply the values from the calibrator shown in table 7-8 below.
- 6 Compare the measurement results to the corresponding test limits shown in table 7-8.

Table 7-8 Capacitance Verification Test

Calibrator Settings	Function	Range	Min Limit	Max Limit
60 nF	Capacitance	60 nF	58.68 nF	61.32 nF
600 nF		600 nF	586.8 nF	613.2 nF
6 μ F		6 μ F	5.868 μ F	6.132 μ F
36 μ F		60 μ F	35.16 μ F	36.84 μ F
60 μ F		60 μ F	58.68 μ F	61.32 μ F
300 μ F		300 μ F	293.4 μ F	306.6 μ F

Diode Verification Test

- 1 Put the calibrator in Standby (STBY) mode.
- 2 Select Meter mode of the instrument, then press F2 softkey for Ohmmeter.
- 3 Press F1 to select diode test.
- 4 Connect the calibrator to the instrument's input and ground terminal as shown in Figure 7-2 using a banana plug.
- 5 Select each function and range in the order shown in Table 7-9. Apply the values from the calibrator shown in Table 7-9 below.
- 6 Compare the measurement results to the corresponding test limits shown in table 7-9.

Table 7-9 Diode Verification Test

Calibrator Voltage	Function	Min Limit	Max Limit
0.9 V	Diode	0.8812 V	0.9188 V

Continuity Verification Test

- 1 Put the calibrator in Standby (STBY) mode.
- 2 Select Meter mode of the instrument, then press F2 softkey for Ohmmeter.
- 3 Press F1 to select continuity test.
- 4 Connect the calibrator to the instrument's input and ground terminal as shown in Figure 7-2 using banana plug.
- 5 Apply a resistance output of 30 Ω from the calibrator, buzzer should sound.
- 6 Apply a resistance output of 75 Ω from the calibrator, buzzer should not sound.

Self-Calibration

The self-calibration performs an internal self-alignment routine to optimize the signal path that affects channel sensitivity, offset and trigger parameters. It is recommended that you run self-calibration in the following situations:

- Every 12 months or after 2000 hours of operation
- If the ambient temperature is $> 10^{\circ}\text{C}$ from the calibration temperature
- If you want to maximize the measurement accuracy
- after experiencing abnormal operation.
- to verify proper operation after repairing.

WARNING

Disconnect all probe and meter connections to the input terminal of the instrument. Allow the instrument to warm up at least 30 minutes before performing self-calibration.

To start self-calibration, do the following:

- 1 Press  button to access Utility mode at F4 softkey.
- 2 On page 3/4 of Utility mode, press F1 to start self-calibration.

A self-calibration dialog box appears to alert user to remove all input connections to the instrument before pressing F1 to start self-calibration.

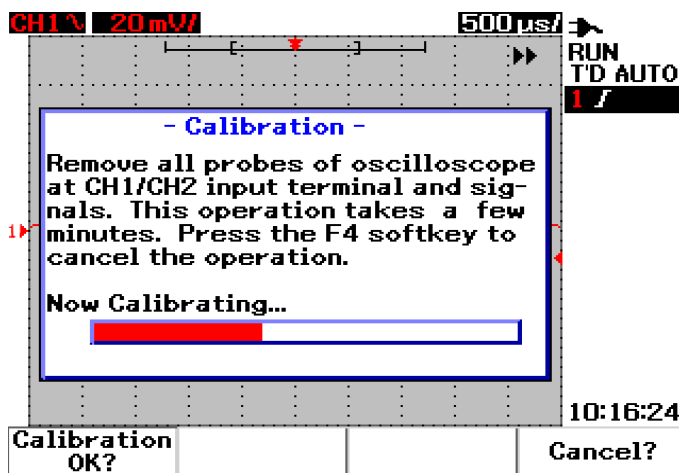

Figure 7-3 Self-calibration dialog box

Self-Calibration Error Code

The following error codes indicate failures that may occur during the instrument's self-calibration.

Table 7-10 Self-calibration error code

Offset Error	Bit number	Description
TE4	[14]	Trigger level calibration error at the second input source for channel 2 in pattern trigger.
TE3	[13]	Trigger level calibration error at the second input source for channel 1 in pattern trigger.
TE2	[12]	Trigger level calibration error for trigger source at channel 2 in DC trigger coupling.
TE1	[11]	Trigger level calibration error for AC trigger coupling for both channels.
TE0	[10]	Trigger level calibration error for trigger source at channel 1 in DC trigger coupling.
OE9	[9]	Offset gain calibration error for channel 2
OE8	[8]	Offset gain calibration error for channel 1
OE7	[7]	Second zero offset calibration error for channel 2 at the range of 5 mV/div to 20 mV/div.
OE6	[6]	Second zero offset calibration error for channel 1 at the range of 5 mV/div to 20 mV/div.
OE5	[5]	Second zero offset calibration error for channel 2 at the range of 50 mV to 100 V/div.
OE4	[4]	Second zero offset calibration error for channel 1 at the range 50 mV to 100 V/div.
OE3	[3]	First zero offset calibration error for channel 2 at 125 ns/div
OE2	[2]	First zero offset calibration error for channel 1 at 125 ns/div
OE1	[1]	First zero offset calibration error for channel 2 at the following conditions: <ul style="list-style-type: none"> • all time base divisions except 125 ns/div • when using both channels at 125 ns/div
OE0	[0]	First zero offset calibration error for channel 1 at the following conditions: <ul style="list-style-type: none"> • all time base divisions except 125 ns/div • when using both channels at 125 ns/div

NOTE

- OE — Zero offset calibration error
- TE — Trigger level calibration error

The self-calibration error code carry 15 bits (0 to 14 as stated in the bit number in Table 6-1). The bit number is expressed in hexadecimal with pass as “0” and fail as “1”. See below for examples:

- 1 In all pass status, the instrument displays “OK” instead of hexadecimal code (0x0000)
- 2 In all fail status, the instrument displays 0x7fff.

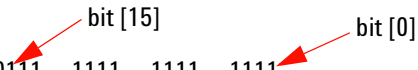

0000 0111 1111 1111 1111

0x 7 f f f (Hexadecimal code)

- 3 If multi-error occurred in TE3, TE4, OE2 and OE3, the hexadecimal code “0x600C” will be displayed as self-calibration result.

0000 0110 0000 0000 1100

0x 6 0 0 C (Hexadecimal code)

7 Performance Tests

Agilent U1602B/U1604B Handheld Digital Oscilloscope Test Record

Serial No. _____
 Test Interval _____
 Recommended Next Testing _____

Test by _____
 Work Order No. _____
 Temperature _____

Oscilloscope Performance Verification Tests

Voltage Measurement Accuracy

<u>Volt/div</u>	<u>Power Supply Setting</u>	<u>Test Limits</u>	<u>Channel 1</u>	<u>Channel 2</u>
100 V/div	250 V	226 V to 274 V	_____	_____
50 V/div	250 V	238 V to 262 V	_____	_____
20 V/div	140 V	135.2 V to 144.8 V	_____	_____
10 V/div	70 V	67.6 V to 72.4 V	_____	_____
5 V/div	35 V	33.8 V to 36.2 V	_____	_____
2 V/div	14 V	13.52 V to 14.48 V	_____	_____
1 V/div	7 V	6.76 V to 7.24 V	_____	_____
0.5 V/div	3.5 V	3.38 V to 3.62 V	_____	_____
0.2 V/div	1.4 V	1.352 V to 1.448 V	_____	_____
0.1 V/div	700 mV	676 mV to 724 mV	_____	_____
50 mV/div	350 mV	338 mV to 362 mV	_____	_____
20 mV/div	140 mV	132 mV to 148 mV	_____	_____
10 mV/div	70 mV	66 mV to 74 mV	_____	_____
5 mV/div	35 mV	33 mV to 37 mV	_____	_____

Bandwidth

<u>Model</u>	<u>Test Limits</u>	<u>Channel 1</u>	<u>Channel 2</u>
U1602B	±3 dB at 20 MHz	_____	_____
U1604B	±3 dB at 40 MHz	_____	_____

Horizontal Time Base Accuracy

<u>Model</u>	<u>Calibrator Setting</u>	<u>Test Limits</u>	<u>Results</u>
U1602B	Frequency: 10 kHz	9.63 kHz to 10.40 kHz	_____
	Period: 100 μ s	96.20 μ s to 103.8 μ s	_____
	Frequency: 1 MHz	962 kHz to 1.04 MHz	_____
	Period: 1 μ s	0.96 μ s to 1.04 μ s	_____
	Frequency: 20 MHz	18.69 MHz to 21.51 MHz	_____
	Period: 50 ns	46.5 ns to 53.5 ns	_____

U1604B	Frequency: 10 kHz	9.63 kHz to 10.4 kHz	_____
	Period: 100 μ s	96.20 μ s to 103.8 μ s	_____
	Frequency: 1 MHz	962 kHz to 1.04 MHz	_____
	Period: 1 μ s	0.96 μ s to 1.04 μ s	_____
	Frequency: 40 MHz	38.24 MHz to 41.93 MHz	_____
	Period: 25 ns	23.85 ns to 26.15 ns	_____

Trigger Sensitivity**Calibrator Setting**

100 mVp-p at 5 MHz
 100 mVp-p at 20 MHz
 100 mVp-p at 40 MHz

Test Limits

0.8 division at 5 MHz
 1 division at 20 MHz (U1602B)
 1 division at 40 MHz (U1604B)

Channel 1

[PASS/FAIL]
 [PASS/FAIL]
 [PASS/FAIL]

Channel 2

[PASS/FAIL]
 [PASS/FAIL]
 [PASS/FAIL]

Multimeter Performance Verification Tests**DC Voltage Verification Test****Calibrator Voltage**

<u>Calibrator Voltage</u>	<u>Range</u>	<u>Test Limit</u>	<u>Results</u>
600 mV	600 mV	597.7 mV to 602.3 mV	_____
6 V	6 V	5.977 V to 6.023 V	_____
30 V	60 V	29.86 V to 30.14 V	_____
60 V	60 V	59.77 V to 60.23 V	_____
600 V	600 V	597.7 V to 602.3 V	_____

AC Voltage Verification Test**Calibrator Voltage**

<u>Calibrator Voltage</u>	<u>Range</u>	<u>Test Limit</u>	<u>Results</u>
6 V at 1 kHz	6 V	5.928 V to 6.072 V	_____
6 V at 30 kHz	6 V	5.808 V to 6.192 V	_____
60 V at 1 kHz	60 V	59.28 V to 60.72 V	_____
60 V at 30 kHz	60 V	58.08 V to 61.92 V	_____
300 V at 50 Hz	600 V	295.80 V to 304.20 V	_____
540 V at 1 kHz	600 V	533.40 V to 546.60 V	_____
590 V at 10 kHz	600 V	571.1 V to 608.9 V	_____

7 Performance Tests

Resistance Verification Test (2-Wire Ohms)

<u>Calibrator Settings</u>	<u>Range</u>	<u>Test Limit</u>	<u>Results</u>
600 Ω	600 Ω	595.8 Ω to 604.2 Ω	_____
6 k Ω	6 k Ω	5.958 k Ω to 6.042 k Ω	_____
60 k Ω	60 k Ω	59.58 k Ω to 60.42 k Ω	_____
600 k Ω	600 k Ω	595.8 k Ω to 604.2 k Ω	_____
3 M Ω	6 M Ω	2.973 M Ω to 3.027 M Ω	_____
6 M Ω	6 M Ω	5.958 M Ω to 6.042 M Ω	_____
60 M Ω	60 M Ω	59.28 M Ω to 60.72 M Ω	_____

Capacitance Verification Test

<u>Calibrator Settings</u>	<u>Range</u>	<u>Test Limit</u>	<u>Results</u>
60 nF	60 nF	58.68 nF to 61.32 nF	_____
600 nF	600 nF	586.8 nF to 613.2 nF	_____
6 μ F	6 μ F	5.868 μ F to 6.132 μ F	_____
36 μ F	60 μ F	35.16 μ F to 36.84 μ F	_____
60 μ F	60 μ F	58.68 μ F to 61.32 μ F	_____
300 μ F	300 μ F	293.4 μ F to 306.6 μ F	_____

Diode Verification Test

<u>Calibrator Voltage</u>	<u>Test Limit</u>	<u>Results</u>
0.9 V	0.8812 V to 0.9188 V	_____

Continuity Verification Test

<u>Calibrator Settings</u>	<u>Condition</u>	<u>Results</u>
30 Ω	Buzzer sounds on	[PASS/FAIL]
75 Ω	Buzzer sounds off	[PASS/FAIL]



8 General Disassemble

Mechanical Disassemble 164

Replacement Parts 176

This chapter guides you step-by-step on how to dismantle the instrument and install the replacement assembly. To assemble back the instrument, follow the instructions in reverse order.

The parts shown in the following figures are representative and may look different than what you have in your instrument.

The removable assemblies include:

- Stand
- Battery
- Handler
- Front casing and rear casing
- Keypad
- System board
- LCD display unit



WARNING

SHOCK HAZARD. Only service-trained personnel who are aware of the hazards involved should remove the instrument covers. To avoid electrical shock and personal injury, make sure to disconnect the power cord from the instrument before removing the covers. Some circuits are active and have power applied even when the power switch is turned off. Wait at least three minutes for the capacitors in the instrument to discharge before you begin disassemble.

CAUTION

AVOID DAMAGE TO ELECTRONIC COMPONENTS

ELECTROSTATIC DISCHARGE (ESD) can damage electronic components. When doing any of the procedures in this chapter, use proper ESD precautions. As a minimum, you should place the instrument on a properly grounded ESD mat and wear a properly grounded ESD strap.

Mechanical Disassemble

Follow the instructions in this section for instrument's disassemble process.

WARNING

After disassemble the instrument, calibration adjustment must be performed to insure the accuracy of the meter and scope measurement. Only service-trained personnel is authorized to perform calibration adjustment to the instrument. Send the instrument to the nearest Agilent Technologies service center for calibration adjustment.

To remove stand

- 1 Remove power cord and all connections from the instrument.
- 2 Push and lift up gently at either side of the stand as pointed in Figure 8-1.



Figure 8-1 Push towards the arrow direction to remove the stand

- 3 Remove the stand from the rear panel of the instrument.



Figure 8-2 Disassemble the stand from the instrument

To remove battery pack

WARNING

To avoid electric shock, ensure you disconnect all input and power cord to the instrument. Do not operate the instrument until the battery covers are covered securely.

There are two alternative ways to remove battery pack from the instrument:

- without stand installed
- with stand installed (for battery replacement purpose)

To remove battery pack without stand installed, perform the instructions below and followed by the battery removing procedures:

- [To remove stand](#)

1 Remove two screw as pointed in Figure 8-3.



Figure 8-3 Remove battery cover screw

- 2 Open up the battery cover and unplug the 3-wire connector from PCBA board using a tweezer.

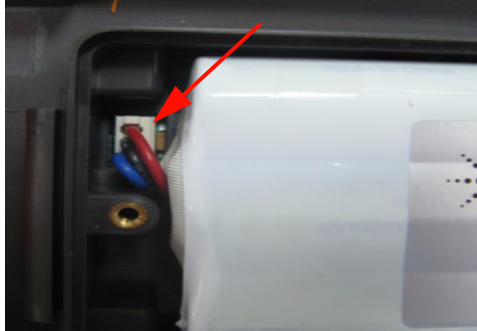

Figure 8-4 Unplug 3-wire connector from PCBA board using tweezer

To replace battery pack

WARNING

To avoid electrical shock or fire during battery replacement:

- Disconnect test leads, probes and power supply before opening case or battery door.
- Do not operate with battery cover open.
- Use only insulated probes and leads specified.
- Only replace batteries with 7.2 V Ni-MH custom pack

For battery replacement purpose, you can remove battery pack without removing stand, follow the steps below:

8 General Disassemble

- 1 Remove two screws at the location shown in Figure 8-3 and open up the battery cover.



Figure 8-5 Remove battery pack cover without removing stand

- 2 Use tweezers to unplug the battery pin connector gently through the stand hole as shown in Figure 8-6.



Figure 8-6 Unplug 2-wire connector with a tweezers.

- 3 Install a new battery pack and proceed to reassemble the battery pack in reverse instructions.

WARNING

Do not use non-rechargeable batteries (alkaline, carbon-zinc, etc.) with AC power adapter connected.

NOTE

For battery replacement, ensure the new battery pack are located in the correct polarity in the battery compartment and proper contacts between the 3-wire connection to the PCBA board. Assemble the battery pack into the instrument by following the reverse disassemble process.

To remove handler

- 1 Perform the following procedures:
 - To remove stand
 - To remove battery pack
- 2 To remove the front and rear cover, unscrew all the pointed locations as shown in Figure 8-7 from the plastic cover.



Figure 8-7 Remove screw from the rear cover

- 3 Gently push up the front panel and remove the handler hook from hook clamp.

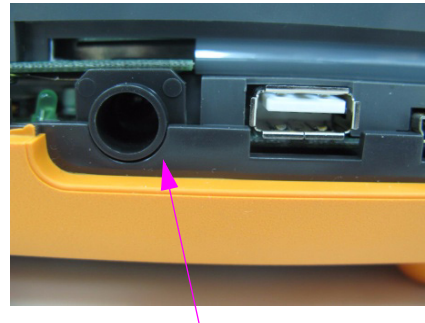
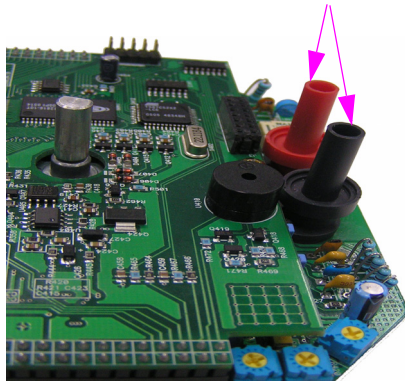

Figure 8-8 Remove handler from the instrument

To remove front and rear casing

- 1 Perform the following procedures:
 - To remove stand
 - To remove battery pack
 - To remove handler
- 2 After performing the above two procedures, gently dismantle the front and rear casing from the instrument.
- 3 Remove the terminal connector and washer from the multimeter input terminal. Remove the AC power connector from the instrument and keep safe for the instrument re-assembly.

Multimeter input terminal connector



AC Power Connector

Figure 8-9 Remove and keep the above wear-and-tear parts for re-assembly process



Figure 8-10 Remove front casing (right) and rear casing (left) from PCBA of the instrument

To remove keypad

- 1 Perform the following procedures:
 - To remove stand
 - To remove battery pack
 - To remove handler
 - To remove front and rear casing
- 2 Loosen the screws as pointed in Figure 8-11 below to remove the keypad interface board.

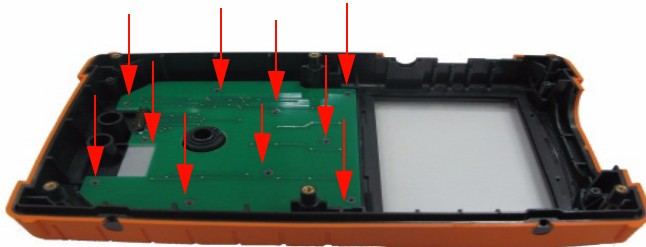

Figure 8-11 Remove the ten screws from the front cover

- 3 Disengage the keypad interface board and pull the rubber keypad from the front cover.

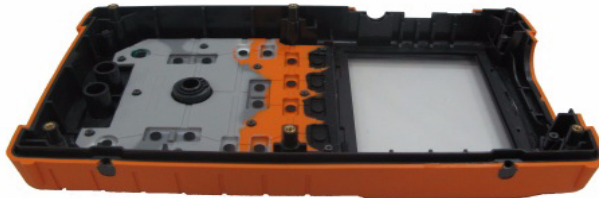

Figure 8-12 Remove keypad from the front cover

To dismantle system boards

- 1 Perform the following procedures:
 - To remove stand
 - To remove battery pack
 - To remove handler
 - To remove front and rear casing
- 2 The front view of the PCBA board is shown in Figure 8-10. Turn over the PCB assembly board with the LCD display facing downward and remove the screw at the location as pointed in Figure 8-13.

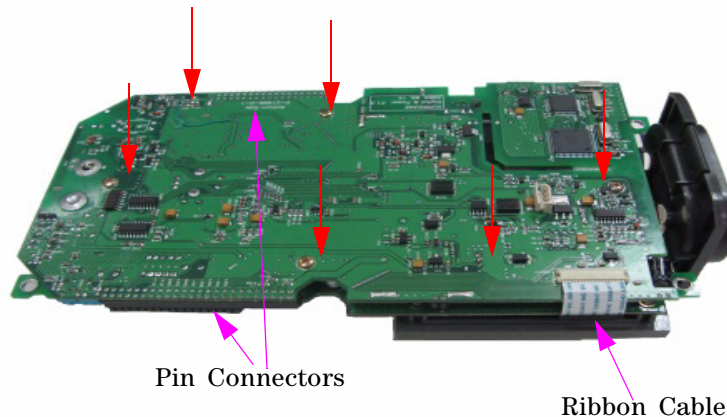

Figure 8-13 Remove the six screws and pull the ribbon cable from the PCBA board

- 3 Gently disconnect the ribbon cable of the LCD display from the PCBA board.
- 4 Unplug the pin connectors at both side of the PCBA board as pointed in Figure 8-13.
- 5 Gently segregate both the PCBA boards from each other.
 - The first PCBA board with LCD display unit attached is the multimeter measurement board.
 - The second PCBA board is the scope measurement board.

To remove LCD display

- 1 Perform the following procedures:
 - To remove stand
 - To remove battery pack
 - To remove handler
 - To remove front and rear casing
 - To dismantle system boards
- 2 Unscrew the four screw as located in the Figure 8-14.

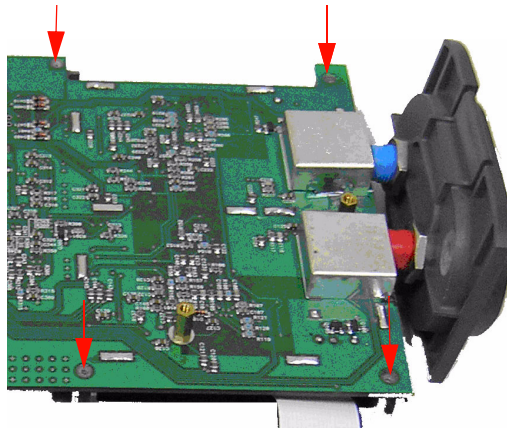

Figure 8-14 Remove four screw to dismantle the LCD display unit

NOTE

To re-assemble the instrument, follow the reverse instructions of this chapter.

Replacement Parts

This section provide information for ordering replacement parts of this instrument. The replacement parts list in Table 8-1 include a brief description of each part with the respective reference part numbers.

You can order replacement parts from Agilent using the part number as listed in Table 8-1. To order replacement parts from Agilent, do the following:

- 1 Contact your nearest Agilent Sales Office or Service Center.
- 2 Identify the parts with the Agilent part number as shown in the replacement part list.
- 3 Provide the instrument model number and serial number.

Table 8-1 Replacement part list

Part number	Description
U1602-38300	Keypad
U1602-46403	Battery cover
U1602-44702	Stand
U1602-30004	Strap handle

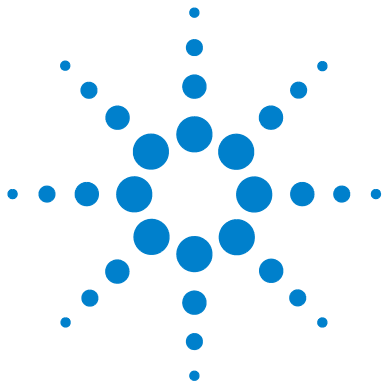

9 Characteristics and Specifications

Specifications	178
Characteristics	181
General Characteristics	187
Environmental Conditions	189
Pollution Degree	189
Measurement Category	190
Measurement Category Definitions	190

This chapter lists specifications, characteristics, environmental conditions, and measurement category for Agilent U1602B and U1604B oscilloscope.



Specifications

All specification are warranted. Specifications are valid after a 30-minute warm-up period and within ± 10 °C from firmware calibration temperature.

Table 9-1 Warranted specifications

SCOPE SPECIFICATIONS	
Vertical System: Scope Channels	
Bandwidth (–3 dB)	U1602B: DC to 20 MHz
	U1604B: DC to 40 MHz
DC vertical gain accuracy	5 mV/div to 20 mV/div: $\pm 5\%$ full scale
	50 mV/div to 100 V/div: $\pm 3\%$ full scale
Scope Channel Triggering	
Trigger sensitivity	DC to 5 MHz: 0.8 divisions
	U1602B: 5 MHz to 20 MHz — 1 division
	U1604B: 5 MHz to 40 MHz — 1 division

DIGITAL MULTIMETER SPECIFICATIONS^[1] ± (% of reading + % of range)

Function	Range	Frequency, Test Current or Burden Voltage	1 year Tcal ± 5 °C
DC Voltage	600.0 mV		0.3 + 0.08
	6.000 V		0.3 + 0.08
	60.00 V		0.3 + 0.08
	600.0 V		0.3 + 0.08
AC Voltage	600.0 mV – 600.0 V	50 Hz – 1 kHz	1.0 + 0.2
		1 kHz – 30 kHz	3.0 + 0.2
AC+DC Voltage	6.0000 V – 600.0 V	50 Hz – 1 kHz	1.0 + 0.2
		1 kHz – 30 kHz	3.0 + 0.2
Resistance	600.0 Ω		0.5 + 0.2
	6.000 kΩ		0.5 + 0.2
	60.00 kΩ		0.5 + 0.2
	600.0 kΩ		0.5 + 0.2
	6.000 MΩ		0.5 + 0.2
	60.00 MΩ		1.0 + 0.2
Capacitance	60.00 nF		2.0 + 0.2
	600.0 nF		2.0 + 0.2
	6000 nF		2.0 + 0.2
	60.00 μF		2.0 + 0.2
	300.0 μF		2.0 + 0.2
Diode	1.000 V	0.5 mA	2.0 + 0.08

[1] For temperature between 0 °C to 18 °C and 28 °C to 50 °C, add 0.1% of reading + 0.02% of range for every degree Celsius.

9 Characteristics and Specifications

AUXILIARY METER SPECIFICATIONS \pm (% of reading + % of range)

Function	Range	Frequency	1 year Tcal \pm 5 °C
Temperature, °C	600.0 °C		0.3 + 0.08
	6000 °C		0.3 + 0.08
Temperature, °F	600.0 °F		0.3 + 0.08
	6000 °F		0.3 + 0.08
AC Current	60.00 A	50 Hz – 1 kHz	1.0 + 0.2
	600.0 A	50 Hz – 1 kHz	1.0 + 0.2
DC Current	60.00 A		1.0 + 0.08
	600.0 A		1.0 + 0.08
Humidity	100.00 %		1.0 + 0.08
Pressure, PSI	600.0 psi		1.0 + 0.08

Characteristics

All characteristics are typical performance values and are not warranted. Characteristics are valid after a 30-minute warm-up period and within ± 10 °C from firmware calibration temperature.

Table 9-2 Characteristics

SCOPE CHARACTERISTICS

Description	Sampling rate	Time base	Remarks
Maximum sample rate	100 MSa/s each channel	50 s/div to 250 ns/div	Maximum sampling rates are shown here. Sampling rate will vary according to time base selected. Refer to Table 9-3 .
	200 MSa/s single channel and interleaved	125 ns/div	200 MS/s only available at 125 ns/div timebase.
Equivalent sample rate	2.5 GSa/s	125 ns/div to 10 ns/div	Functions only for U1604B.
Maximum Recording length	125,000 points viewable on screen with zoom function. Number of points displayed will vary according to time base selected.		

Vertical System: Scope Channels

Analog channels	Channel 1 and Channel 2 simultaneous acquisition
Bandwidth (–3 dB)	U1602B: DC to 20 MHz
	U1604B: DC to 40 MHz
AC coupled	< 10 Hz without probe
	< 1 Hz with 10 M Ω 10:1 passive probe
Rise time	U1602B: < 17.5 ns
	U1604B: < 8.8 ns
Single shot bandwidth	U1602B: 20 MHz
	U1604B: 40 MHz

9 Characteristics and Specifications

Vertical sensitivity	5 mV/div to 100 V/div (1:1 passive probe) 50 mV/div to 1 kV/div (10:1 passive probe) 500mV/div to 10 kV/div (100:1 passive probe)
Maximum input	CAT III 300 Vrms (up to 400 Hz) from terminal to ground
Offset/Dynamic range	± 5 div
Input impedance	1 MΩ < 20 pF
Coupling	AC, DC, GND
Probes	U1560-60001 1:1 passive probe U1561-60001 10:1 passive probe U1562-60001 100:1 passive probe
Probe attenuation factors	1x, 10x, 100x
Probe compensation output	3 Vp-p, ~ 1 kHz
Maximum probe input	1x CAT III 300 VAC 10x, 100x CAT III 600 VAC
Noise peak-to-peak	3% of full scale or 5 mV, whichever is greater
DC vertical offset accuracy	±0.1 div ±2 mV ±0.5% offset value
Single cursor accuracy	4% full scale
Dual cursor accuracy	4% full scale
Horizontal System	
Range	U1602B: 50 ns to 50 s/div U1604B: 10 ns to 50 s/div
Resolution	U1602B: 2 ns U1604B: 400 ps
Reference position	Left, center, right
Delay range (pre-trigger)	15 divisions
Delay range (post-trigger)	1000 divisions
Analog Δt accuracy	± 3% reading ± 0.4% screen
Modes	Main, XY, Roll
RMS Jitter	5% of horizontal scale or 5 ns whichever is higher

Trigger System

Source	Channel 1 and Channel 2
Modes	Auto, normal, single
Selections	Edge, pulse width, pattern, video
Edge	Trigger on a rising or falling edge of any source.
Pattern	Trigger at the beginning of a pattern of high, low levels and rising or falling edge established across any of the channels with conditions of AND, OR, NOR and NAND between the channels.
Pulse width	200 ns to 10 s. Trigger when a positive or negative pulse width of any source larger than, less than, equal to or not equal to duration.
Video	Video trigger sensitivity: 0.7 division trigger level. Available to both Channel 1 and Channel 2. Analog progressive and interlaced video standards including NTSC, PAL and SECAM. Positive or negative sync pulse polarity. Modes — all fields, even fields, odd fields or line 5 – 263 within a field.
Range	± 4 divisions from center screen
Level accuracy	± 0.5 divisions
Trigger sensitivity	DC to 5 MHz: 0.8 divisions U1602B: 5 MHz to 20 MHz — 1 division U1604B: 5 MHz to 40 MHz — 1 division
Coupling	DC, AC (< 1 Hz), HF reject (> 50 kHz), LF reject (<30 kHz), Noise reject

Measurement System

Autoscale	Finds and displays all active scope channels, sets edge trigger mode on highest numbered channel, sets vertical sensitivity on scope channel. Requires voltage > 20 mVp-p, 0.5% duty cycle and frequency > 100 Hz.
Automatic measurement	Measurements continuously updated.
Voltage	Peak-to-peak, maximum, minimum, amplitude, top, base, +overshoot, –overshoot, preshoot, RMS, mean and one cycle mean.

9 Characteristics and Specifications

Time	Frequency, period, +width, –width and +duty cycle and –duty cycle on any channel. Rise time, fall time, delay and phase shift.
Cursors	Manually place readout of horizontal (X, ΔX) and vertical (Y, ΔY).
Waveform math	CH1 + CH2, CH1 – CH2, CH2 – CH1

FFT^[1]

Window	Rectangular, Hamming, Hanning, Blackman-Harris.
Amplitude Display	Selectable in amplitude display of 1 dB, 2 dB, 5 dB, 10 dB, 20 dB

Display System

Display	4.5-inch diagonal color CSTN LCD
Resolution	320 x 240 pixels
Control	Contrast control, infinite persistence on/off
Build-in help system	Functional help displayed by pressing help button
Real time clock	Time and date (user adjustable)

Storage

Save/Recall (non-volatile)	Up to 10 setups and traces
----------------------------	----------------------------

[1] FFT function is only available for U1604B model.

DIGITAL MULTIMETER CHARACTERISTICS

DMM Measurement

Full scale reading	6000 count
DC voltage, True RMS AC Voltage	Maximum input voltage, 600 Vrms CAT II, 300 Vrms CAT III DC coupled input coupling Input resistance, 10 M Ω
Continuity	Beeper < 60 Ω in 600 Ω range

Data Logger

Source	Digital multimeter measurements
Range	10 divisions
Record size	250 points
Time span	Auto range 150 seconds to 20 days
Time reference	Time from start
Record method	Selectable minimum, maximum and average

Table 9-3 Sampling Rate

Time/div	Sample Rate (displayed)	Time/div	Sample Rate (displayed)
10 ns	2.5 GS/s	1 ms	25 kSa/s
25 ns	1.25 GS/s	2 ms	12.5 kSa/s
50 ns	500 MS/s	5 ms	5 kSa/s
125 ns	200 MS/s	10 ms	2.5 kSa/s
250 ns	100 MSa/s	20 ms	1.25 kSa/s
500 ns	50 MSa/s	50 ms	500 Sa/s
1 us	25 MSa/s	100 ms	250 Sa/s
2 us	12.5 MSa/s	200 ms	125 Sa/s
5 us	5 MSa/s	500 ms	50 Sa/s
10 us	2.5 MSa/s	1 s	25 Sa/s
20 us	1.25 MSa/s	2 s	12.5 Sa/s
50 us	500 kSa/s	5 s	5 Sa/s
100 us	250 kSa/s	10 s	2.5 Sa/s
200 us	125 kSa/s	20 s	1.25 Sa/s
500 us	50 kSa/s	50 s	0.5 Sa/s

General Characteristics

Table 9-4 General characteristics

Power Adapter	Line voltage range 50/60 Hz, 100 – 240 VAC Output voltage 12 VDC
Battery	U1571A Ni-MH rechargeable battery pack 7.2 V Operating time: 4 hours Charging time (instrument in “off” condition): Approximately 4.5 hours Charging time (instrument in “on” condition): Approximately 25 hours Allow ambient temperature during charging: 10 °C to 40 °C
Dimension (HxWxD)	24.1 cm height x 13.8 cm width x 6.6 cm depth
Weight	1.5 kg
I/O	USB 2.0 Full Speed client (standard) and USB 2.0 Full Speed host (optional). Firmware upgrade through USB.
Warranty	Please refer to http://www.agilent.com/go/warranty_terms <ul style="list-style-type: none"> • Three years for the product • Three months for the product's standard accessories, unless otherwise specified <p>Please take note that for the product, the warranty does not cover:</p> <ul style="list-style-type: none"> • Damage from contamination • Normal wear and tear of mechanical components • Manuals
Operating Environment	
Temperature	Operating full accuracy: 0 °C to 50 °C Non-operating: –20 °C to 70 °C
Humidity	Operating full accuracy to 80% RH at 40 °C
Altitude	Operating: Up to 2000 m Non-operating: 15000 m (50000 ft)
Shock and Vibration	Tested to IEC/EN 60068-2

9 Characteristics and Specifications

ESD tolerance	± 4 kV
Safety Compliance	IEC 61010-1:2001 / EN61010-1:2001 Canada: CSA C22.2 No. 61010-1:2004 USA: UL 61010-1:2004 Pollution degree 2 This instrument is rated for indoor use only.

Environmental Conditions

Pollution Degree

The product may be operated in environments of Pollution Degree 2.

Pollution Degree Definitions

Pollution Degree 1: No pollution or only dry, non-conductive pollution occurs. The pollution has no influence. Example is a clean room or climate controlled office environment.

Pollution Degree 2: Normally only dry non-conductive pollution occurs. Occasionally a temporary conductivity caused by condensation may occur. Example is general indoor environment.

Pollution Degree 3: Conductive pollution occurs, or dry, non-conductive pollution occurs which becomes conductive due to condensation which is expected. Example is sheltered outdoor environment.

Measurement Category

The U1602B and U1604B oscilloscope is intended to be used for measurement in Measurement Category III, 300 V for scope measurement and Measurement Category III, 300 V and Category II, 600 V for multimeter measurement.

Measurement Category Definitions

Measurement CAT I is for measurements performed on circuits not directly connected to MAINS. Examples are measurements on circuits not derived from MAINS, and specially protected (internal) mains-derived circuits.

Measurement CAT II are measurements performed on circuits directly connected to the low voltage installation. Examples are measurements on household appliances, portable tools and similar equipment.

Measurement CAT III are measurements performed in the building installation. Examples are measurements on distribution boards, circuit-breakers, wiring, including cables, bus-bars, junction boxes, switches, socket-outlets in the fixed installation, and equipment for industrial use and some other equipment including stationary motors with permanent connection to the fixed installation.

Measurement CAT IV are measurements performed at the source of the low-voltage installation. Examples are electricity meters and measurements on primary over current protection devices and ripple control units.

WARNING

When performing measurement, ensure that the right safety and performance ratings of instrument and accessories are used.

Maximum input voltage

- Input CH1 and CH2 direct (1:1 Probe) — 300 V CAT III
 - Input CH1 and CH2 via 1:10 Probe — 600 V CAT III
 - Input CH1 and CH2 via 1:100 Probe — 600 V CAT III
 - Meter Input — 300 V CAT III, 600 V CAT II
 - Scope Input — 300 V CAT III
 - Voltage ratings are V_{rms} (50/60 Hz) for AC sine wave and VDC for DC applications.
-

WARNING**Maximum floating voltage**

- From any terminal to ground — 300 V_{rms} CAT III (up to 400 Hz)
-

THIS PAGE HAS BEEN INTENTIONALLY LEFT BLANK.

Index

A

AC 35
 AC Voltage Verification Test 151
 Accessories Warranty 131
 acquisition status 26
 alligator clips 2
 ampere 114
 Amplitude 62
 Analogue bar graph 27
 Attenuation 37
 Auto 27
 Auto Trigger 48
 Automatic Measurement 62
 Auto-Power Off 12
 Auto-range 121
 Autoscale 23, 96
 auxiliary 112
 Average acquisition 57

B

bandwidth 144
 Base 62
 Battery 100
 battery pack 166
 Blackman 82

C

cables
 power 4
 capacitance 111
 Capacitance Verification Test 153
 Channel Selection 30
 characteristics 181
 cleaning 133
 Compensate 15
 continuity 108
 Continuity Verification Test 155
 Contrast 14

contrast 60
 Cross hair 61
 current 114
 Cursor 23
 Cursor Measurement 71
 Cycle mean 62

D

data logger 124
 Date 10
 DC Channel Coupling 36
 DC Voltage Verification Test 149
 Default factory settings 7
 Delay 41, 63
 disassemble 164
 diode 109
 Diode Verification Test 154
 Display 25
 dots display 59

E

Edge Trigger 49
 Environment 189
 erase 88
 Error Code 157

F

Fall time 62
 Frames 61
 Frequency 62
 Front panel 20

G

General Characteristics 187
 Getting Started 1
 graticule 61
 Grid 61

H

Hamming 82
 handler 170
 Hanning 82
 hook clips 2
 Horizontal Scale 24
 humidity 115

I

input 5
 Interval 138
 Invert Control 38

K

keypad 173

L

LCD display 175
 Logger 22

M

Main 44
 Maximum 62
 Mean 62
 Measure 23
 Measurement line 26
 Meter 22
 Minimum 62
 multimeter 103

N

Normal acquisition mode 57
 Normal Trigger 48

O

ohmmeter 106

Optional 2
 Optional accessories 2
 options
 power cable 4

P

Package 2
 Package Contents 2
 Pattern Trigger 52
 Peak 62
 peak detection 58
 performance test 141
 Period 62
 persistence 61
 Phase 63
 plugs
 power 4
 post 42
 Power 4
 power cables 4
 Power cord 4
 power switch 22
 pre 42
 Preshoot 63
 pressure 116
 Probe Calibration 100
 Product reference 2
 Pulse Trigger 51

Q

Quick Help 13
 Quick Start Guide 2

R

Range 23
 Real 26
 rear 171
 recall 86
 Rectangle 82
 relative 118

replacement parts 176
 resistance 106
 Resistance Verification Test 152
 restart test 121
 Restore Factory Setup 90
 Rise time 62
 RMS 63
 Roll Mode 46
 Rotary Switch 24
 Run 23

S

Save 23
 save 83
 Scope 22
 Self-Calibration 9
 shipping 2, 132
 Single Trigger 48
 Softkeys 22
 specification 178
 stand 165
 Standard Warranty 130
 Status line 25
 system boards 174

T

temperature 112
 test equipments 139
 Test Record 138
 Time 10
 Top 63
 Trigger 23
 Trigger Modes 47
 Trigger point 42
 Trigger status 26
 Troubleshooting 133

U

USB flash memory 92
 User 22

Utility 23

V

verification test 141
 Vertical Controls 30
 vertical reference 32
 Vertical sensitivity 34
 vertical sensitivity 31
 Video Trigger 55
 voltmeter 104

W

Warming 138
 Waveform display 25

X

X-Cursor 72
 XY 43

Y

YT 43

Contact us

To obtain service, warranty or technical support assistance, contact us at the following phone numbers:

United States:

(tel) 800 829 4444 (fax) 800 829 4433

Canada:

(tel) 877 894 4414 (fax) 800 746 4866

China:

(tel) 800 810 0189 (fax) 800 820 2816

Europe:

(tel) 31 20 547 2111

Japan:

(tel) (81) 426 56 7832 (fax) (81) 426 56 7840

Korea:

(tel) (080) 769 0800 (fax) (080) 769 0900

Latin America:

(tel) (305) 269 7500

Taiwan:

(tel) 0800 047 866 (fax) 0800 286 331

Other Asia Pacific Countries:

(tel) (65) 6375 8100 (fax) (65) 6755 0042

Or visit the Agilent World Wide Web at:

www.agilent.com/find/assist

Product specifications and descriptions in this document are subject to change without notice. Always refer to the English version on the Agilent Web site for the latest revision.

© Agilent Technologies, Inc. 2006–2014

Printed in Malaysia
Eleventh Edition, March 14, 2014



U1602-90023



Agilent Technologies