

Keysight Technologies U3020AD01

User's and Service Guide

Notice: This document contains references to Agilent. Please note that Agilent's Test and Measurement business has become Keysight Technologies. For more information, go to www.keysight.com.

Notices

© Keysight Technologies, Inc.
2011-2014

No part of this manual may be reproduced in any form or by any means (including electronic storage and retrieval or translation into a foreign language) without prior agreement and written consent from Keysight Technologies, Inc. as governed by United States and international copyright laws.

Manual Part Number

U3020-90004

Print Date

October 2014

Supersede August 2012

Published in USA

Keysight Technologies Inc.
1400 Fountaingrove Parkway
Santa Rosa, CA 95403

Where to Find the Latest Information

Documentation is updated periodically. For the latest information about these products, including instrument software upgrades, application information, and product information, browse to the following URL, search for the name of your product:

<http://www.keysight.com/find>

Technology Licenses

The hardware and/or software described in this document are furnished under a license and may be used or copied only in accordance with the terms of such license.

Restricted Rights Legend

If software is for use in the performance of a U.S. Government prime contract or subcontract, Software is delivered and licensed as "Commercial computer software" as defined in DFAR 252.227-7014 (June 1995), or as a "commercial item" as defined in FAR 2.101(a) or as "Restricted computer software" as defined in FAR 52.227-19 (June 1987) or any equivalent agency regulation or contract clause. Use, duplication or disclosure of Software is subject to Keysight Technologies' standard commercial license terms, and non-DOD Departments and Agencies of the U.S. Government will receive no greater than Restricted Rights as defined in FAR 52.227-19(c)(1-2) (June 1987). U.S. Government users will receive no greater than Limited Rights as defined in FAR 52.227-14 (June 1987) or DFAR 252.227-7015 (b)(2) (November 1995), as applicable in any technical data.

Warranty

THE MATERIAL CONTAINED IN THIS DOCUMENT IS PROVIDED "AS IS," AND IS SUBJECT TO BEING CHANGED, WITHOUT NOTICE, IN FUTURE EDITIONS. FURTHER, TO THE MAXIMUM EXTENT PERMITTED BY APPLICABLE LAW, KEYSIGHT DISCLAIMS ALL WARRANTIES, EITHER EXPRESS OR IMPLIED WITH REGARD TO THIS MANUAL AND ANY INFORMATION CONTAINED HEREIN, INCLUDING BUT NOT LIMITED TO THE IMPLIED WARRANTIES OF MERCHANTABILITY AND FITNESS FOR A PARTICULAR PURPOSE. KEYSIGHT SHALL NOT BE LIABLE FOR ERRORS OR FOR INCIDENTAL OR CONSEQUENTIAL DAMAGES IN CONNECTION WITH THE FURNISHING, USE, OR PERFORMANCE OF THIS DOCUMENT OR ANY INFORMATION CONTAINED HEREIN. SHOULD KEYSIGHT AND THE USER HAVE A SEPARATE WRITTEN AGREEMENT WITH WARRANTY TERMS COVERING THE MATERIAL IN THIS DOCUMENT THAT CONFLICT WITH THESE TERMS, THE WARRANTY TERMS IN THE SEPARATE AGREEMENT WILL CONTROL.

Safety Notices

CAUTION

A **CAUTION** notice denotes a hazard. It calls attention to an operating procedure, practice, or the like that, if not correctly performed or adhered to, could result in damage to the product or loss of important data. Do not proceed beyond a **CAUTION** notice until the indicated conditions are fully understood and met.

WARNING

A **WARNING** notice denotes a hazard. It calls attention to an operating procedure, practice, or the like that, if not correctly performed or adhered to, could result in personal injury or death. Do not proceed beyond a **WARNING** notice until the indicated conditions are fully understood and met.

Table of Contents

U3020AD01

Introduction	2
Description	3
Verifying the Shipment	3
Network Analyzer Requirements	3
General Performance	4
Power Requirements	4
Environmental Requirements	5
Environmental Tests	5
Equipment Heating and Cooling	5
Required Conditions for Accuracy Enhanced Measurement	5
Dimensions and Space Requirements	5
Maximum Power Levels and Performance Characteristics	6
Front and Rear Panel Features	7
System Setup	10
Adding Instruments to the Interface	10
Configuring the LAN Interface	10
Locating the Instrument	11
Configuring the GPIB Interface	12
Adding Instruments to the GPIB Configuration	12
Changing the GPIB Address	12
Controlling the Test Set and Making Measurements	13
Making Measurements and Functional Tests	21
Functional Tests	21
Equipment Required	21
Transmission	23
Service Information	25
Troubleshooting	25
Troubleshooting the Power Supply	25
Troubleshooting the Controller Board	25
Replaceable Parts	27
Electrostatic Discharge Protection	28
Safety and Information	29
Introduction	29
Safety Earth Ground	29
Declaration of Conformity	29
Statement of Compliance	29
Before Applying Power	30
Connector Care and Cleaning Precautions	31
Regulatory Information	32
Instrument Markings	32
Battery Collection	33
Electrical Safety Compliance	33
EMI and EMC Compliance	33
Keysight Support, Services, and Assistance	34
Service and Support Options	34
Contacting Keysight	34
Shipping Your Product to Keysight for Service or Repair	34

Table of Contents

U3020AD01

Introduction

This document describes how to use the Keysight U3020AD01 Dynamic Accuracy Test Set with a Keysight N5247A PNA-X Network Analyzer.

Figure 1 N5247A with the U3020AD01

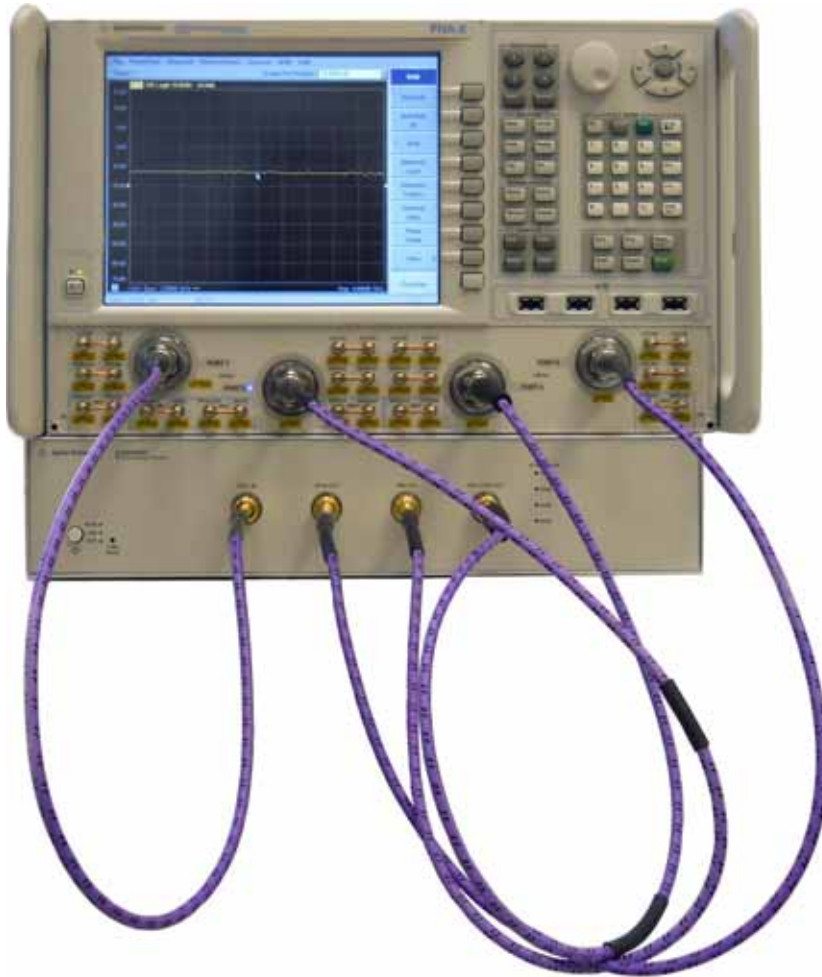

Description

The Keysight U3020AD01 Dynamic Accuracy Test Set is designed for use with the PNA-X Network Analyzers and based on the L4490A RF Switch Platform.

The U3020AD01 is used to characterize the PNA-X power linearity (dynamic accuracy) designed for maximum measurement accuracy over a 110 dB dynamic range. The signal is controlled via internal attenuators.

The U3020AD01 can only be controlled using an external GPIB controller or LAN.

When using Keysight IO Libraries "Connection Expert Utility," the interface identifies the Test Set as "U3020A" without D01. D01 will be listed on the rear panel serial tag.

Verifying the Shipment

To verify the contents shipped with your product, refer to the "Box Content List" included with the shipment.

Inspect the shipping container. If the container or packing material is damaged, it should be kept until the contents of the shipment have been checked mechanically and electrically. If there is physical damage refer to "[Contacting Keysight](#)" on page 34. Keep the damaged shipping materials (if any) for inspection by the carrier and an Keysight Technologies representative.

Network Analyzer Requirements

- The N5247A PNA-X Network Analyzer (10 MHz to 67 GHz)

More PNA-X information is available on the following websites:

- Documentation - <http://www.keysight.com/find/pna>
- Network Analyzer Firmware - <http://na.support.keysight.com/pna/firmware>

General Performance

The Test Set is used to characterize the power linearity of the PNA-X. Actual performance of the system is based on the your PNA-X and options that are used with the Test Set. It is not specified as an overall system performance. A functional certificate is supplied for the U3020AD01.

There are no internal adjustment in the U3020AD01, therefore an annual calibration is not required.

CAUTION This product has an autoranging line voltage input. Be sure the supply voltage is within the specified range.

Power Requirements

Verify that the required ac power is available at all necessary locations before installing the Test Set to the PNA-X.

- 100-240 V (50/60 Hz)
- The instruments can operate with mains supply voltage fluctuations up to $\pm 10\%$ of the nominal voltage.
- Air conditioning equipment (or other motor-operated equipment) should not be placed on the same ac line that powers the Test Set.
- **Table 1** contains the maximum wattage for the Test Set. This table can be use to determine the electrical and cooling requirements.

Table 1 Power Requirements

Instrument	Maximum Wattage
U3020AD01	50

Environmental Requirements

Refer to the PNA-X standard documentation for environmental requirements.

Environmental Tests

The U3020AD01 complies with all applicable safety and regulatory requirements for the intended location of use.

- Operating Environment (Indoor Use)
- Operating Ambient: Temperature 0 to 40 °C
- Operating Altitude: 0 to 2000 meters (~ 6,562 feet)
- The instrument can safely operate in a relative humidity of 80% for temperatures to 31 degrees C, decreasing linearly to 50% relative humidity at 40 degrees C.

Equipment Heating and Cooling

If necessary, install air conditioning and heating to maintain the ambient temperature within the appropriate range. Air conditioning capacity must be consistent with the rating listed in the PNA standard documentation.

Required Conditions for Accuracy Enhanced Measurement

Accuracy-enhanced (error-corrected) measurements require the ambient temperature of the PNA-X and Test Set to be maintained within ± 1 °C of the ambient temperature at calibration.

Dimensions and Space Requirements

Standard installation of the U3020AD01 and PNA includes configuration and installation on a customer provided lab bench or table top of adequate size and strength.

Table 2 System Dimensions

Item	Weight
Required Bench Top Dimension:	
Clearance above the bench	8.9 cm (3.5 in)
Width	42.5 cm (16.73 in)
Depth	58 cm (22.83 in)
Weight	9 kg (19.84 lb)

Maximum Power Levels and Performance Characteristics

Table 3 Power Levels

RF Input/Output Power Damage Levels:	
SRC 1 IN	+30 dBm
SRC 2 IN	+30 dBm
SRC 2 CPLD OUT	+30 dBm
RCVR OUT	+30 dBm

NOTE Refer to your PNA-X standard documentation specifications to determine the maximum input power levels for the PNA-X access and test ports, or to optimize the power levels in the receivers.

NOTE Damage and maximum levels are not necessarily the optimum level.

Table 4 Performance Characteristics

Parameter	Typical
Operating Frequency	1 GHz to 4 GHz
Isolation: (1.8 GHz to 2.2 GHz)	
RCVR OUT to SRC 1 IN RCVR OUT to SRC 2 IN	< -45 dB
SRC 1 IN to SRC 2 IN	< -70 dB
RCVR OUT to CPLD OUT	< -80 dB
Transmission:	
CPLD OUT to SRC 2 IN (1 GHz to 4 GHz)	-14 dB < trans < -18 dB
SRC 2 IN to RCVR OUT (1.8 GHz to 2.2 GHz) (3.5 GHz to 4 GHz)	-3 dB < trans < -9 dB < -38 dB
SRC 1 IN to RCVR OUT (1.8 GHz to 2.2 GHz) (3.5 GHz to 4 GHz)	-3 dB < trans < -9 dB < -34 dB
Match: (all ports)	
1.8 GHz to 2.2 GHz	< -12 dB

Front and Rear Panel Features

CAUTION Refer to the standard instrument documentation for damage limits to the ports. Verify that your test setup will not cause those limits to be exceeded.

Figure 2 Front Panel

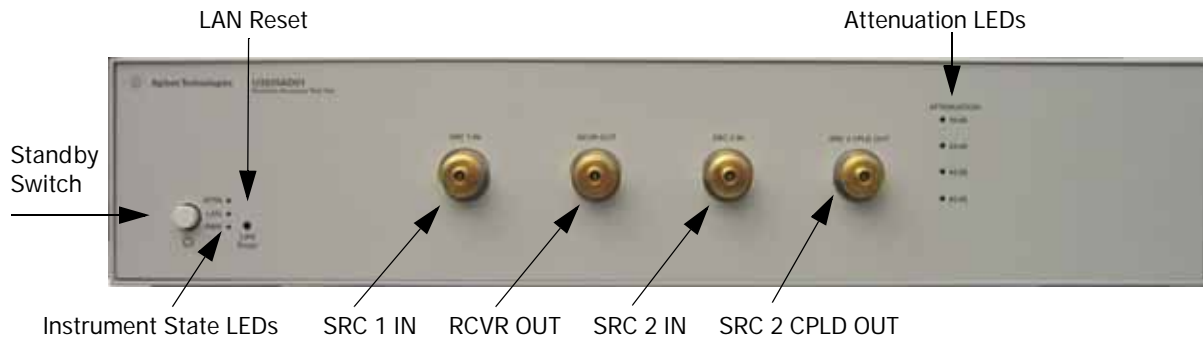

Standby Switch

Note that this switch is Standby only, not a line switch. The main power cord can be used as the system disconnecting device. It disconnects the mains circuits from the mains supply.

LAN Reset

The LAN reset button restores the instrument's default LAN configuration.

Attenuation LEDs

The LED's indicate the attenuation state of the programmable step attenuator.

RF Input/Output

- SRC 1 IN (Source 1 Input)
- RCVR OUT (Receiver Out)
- SRC 2 IN (Source 2 Input)
- SRC 2 CPLD OUT (Coupler Out)

Instrument State LEDs

When the power is applied to the U3020AD01, the instrument enters its power-on sequence which requires several seconds to complete. The LEDs provide information on the state of the instrument during power-on and during upgrades of the instrument firmware. [Table 5](#) identifies the instrument states based on the color and functioning of the LEDs.

Table 5 LED Definitions and Instrument States

LED	Color	Instrument State
ATTN LAN PWR	Off Green Green	Instrument in "ready" state LAN connection established - instrument has an IP address Firmware download complete
ATTN LAN PWR	flashing flashing Green	Power-on/boot-up. ATTN and LAN will flash red and then green during the power-on self-test.
ATTN LAN PWR	Off Red Green	No LAN connection due to: - disconnected LAN cable - failure to acquire and IP address - waiting for DHCP-assigned address
ATTN LAN PWR	Green (flashing) Green Green	Instrument Busy State - firmware download (LAN LED red if download over GPIB) - lengthy instrument operation in progress
ATTN LAN PWR	Red (flashing) Green Green	Instrument programming error or self-test error. Error queue is read using SYSTem:ERRor?
ATTN LAN PWR	Off Green (flashing) Green	Instrument identification. Activated from instrument Web interface: ON: <u>Turn on Front Panel Interface Indicator</u> OFF: <u>Turn off Front Panel Interface Indicator</u>

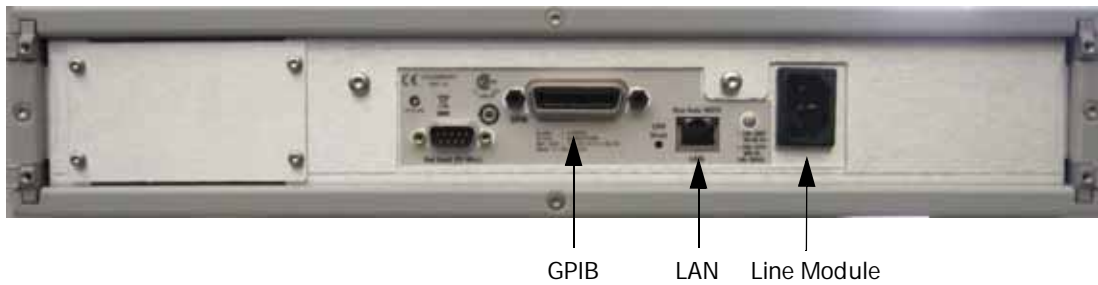
Figure 3 Rear Panel

GPIB Connector

This connector allows the Test Set to be connected directly to a controller.

LAN

The instrument is controlled over Local Area Network (LAN).

Line Module

The line module contains the power cord receptacle. The line fuse, as well as a spare, reside within the line module.

Install the instrument so that the detachable power cord is readily identifiable and is easily reached by the operator. The detachable power cord is the instrument disconnecting device. It disconnects the mains circuits from the mains supply before other parts of the instrument. The front panel switch is only a standby switch and is not a LINE switch. Alternatively, an externally installed switch or circuit breaker (which is readily identifiable and is easily reached by the operator) may be used as a disconnecting device.

CAUTION Always use the three-prong ac power cord supplied with this product. Failure to ensure adequate grounding by not using this cord may cause damage to the product.

Power Cords

A line power cord is supplied in one of several configurations, depending on the destination of the original shipment. Keysight can supply additional certified power cords to meet region electrical supply and receptacle configurations. Please contact Keysight at: www.keysight.com for assistance in power cord selection.

WARNING This is a Safety Class I Product (provided with a protective earthing ground incorporated in the power cord). The mains plug shall be only be inserted in a socket outlet provided with a protective earth contact. Any interruption of the protective conductor inside or outside of the product is likely to make the product dangerous. Intentional interruption is prohibited.

System Setup

Adding Instruments to the Interface

This section contains information to configure the U3020A LAN and GPIB interfaces using Keysight IO Libraries "Connection Expert Utility."

Configuring the LAN Interface

1. Connect the Test Set to the PC.
2. Turn On the Test Set.
3. Select IO Control icon > Keysight Connection Expert from the application window.

Figure 4 Keysight Connection Expert

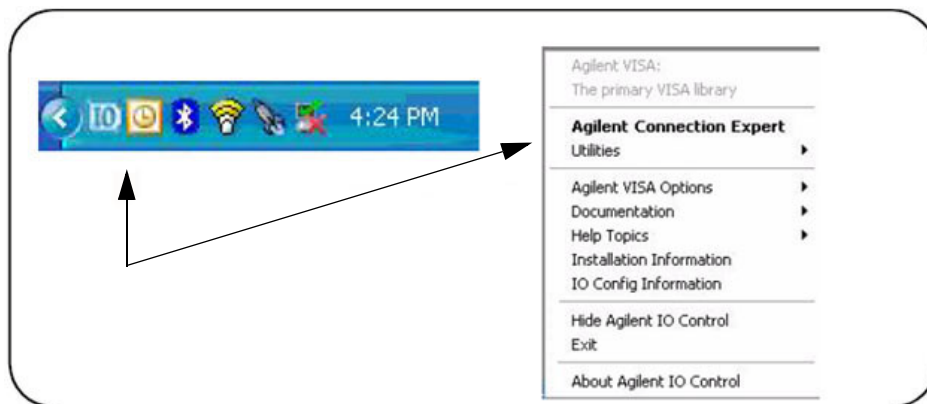

Locating the Instrument

Keysight Connection Expert opens with a “Welcome Screen,” and a window similar to that shown in [Figure 4](#). The available computer interfaces are configured during installation of the Keysight IO Libraries and are displayed in the left column (Explorer Pane). The properties of the configured interface are displayed in the right column (Properties Pane).

Figure 5 Explorer and Properties Pane

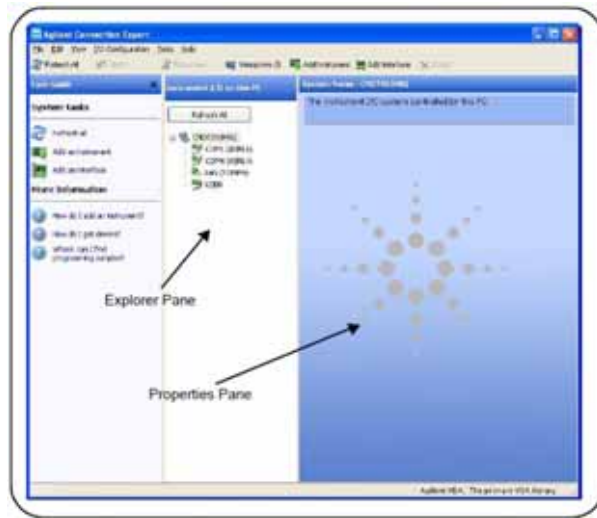

1. Click **Add Instrument** on the tool bar to search the network for instruments.
2. Select **Add LAN Instrument on LAN (TCPIP0) > OK**. Keysight Connection Expert performs an automatic find of all instruments on the same subnet as the computer.
3. Select the desired instruments from the list and click **OK**. Communication paths to the instruments are verified and the instruments are added to the configured interface.

Figure 6 Adding Instruments

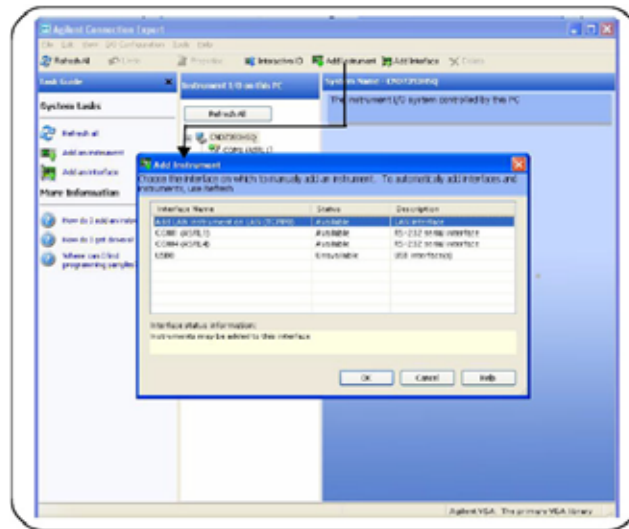

Configuring the GPIB Interface

Programming access to the Test Set is also available through the instrument's GPIB interface. The GPIB connector is located on the rear panel of the instrument.

1. Select the **Keysight Control** icon > **Keysight Connection Expert**. If a GPIB card is installed in your computer, the GPIB interface was configured during installation of the IO libraries and is displayed in the Explorer Pane of the "Welcome" Screen.

Figure 7 Keysight Connection Expert



Adding Instruments to the GPIB Configuration

1. Select **Add Instrument** on the tool bar.
2. Select **GPIB Interface** > **OK**.
3. Select **U3020A's Address** in the GPIB address drop-down list >**OK**.
(Factory set address = 9)

Changing the GPIB Address

The U3020A GPIB address can only be changed programmatically. The GPIB address command is:

```
SYSTEM:COMMunicate:GPIB:ADDRESS <address>
```

When the address is changed, the new GPIB address is *not* updated in the Keysight Connection Expert if the instrument was previously configured.

1. From the Keysight Connection Expert application window, highlight the instrument that's address was changed and click **Change Properties** in the Configurable Properties application window, change the address to the new address setting and select **OK**.

Controlling the Test Set and Making Measurements

Keysight U3020A is a “slave” instruments. A controller must be used to control the Test Set. There are two methods that can be used to control the Test Set.

- Using LAN connection
- Using GPIB connection

Once the connection between the Controller and the Test Set has been established (LAN or GPIB), the Test Set can be controlled using SCPI commands.

Reset Command

This command resets the instrument.

Syntax

*RST

Remote Interface Configuration

LAN Configuration Commands

Description

This command assigns a static Internet Protocol (IP) address for the U3020A. Contact your network administrator for the valid IP address to use for your instrument.

NOTE If you change the IP address, you must cycle power on the U3020A to activate the new address.

Syntax

SYSTem:COMMunicate:LAN:IPADdress <address>

SYSTem:COMMunicate:LAN:IPADdress?

You can also queries the U3020A for the IP address it was assigned to.

Example

The following command sets the IP address:

SYST:COMM:IPAD 169.254.149.35

The following query returns the IP address currently being used by the instrument (quotes are also returned).

SYST:COMM:LAN:IPAD?

Typical Response: "169.254.149.35"

Description

This command disable or enable the use of Auto-IP standard to automatically assign an IP address to the U3020A when on a network that does not have DHCP servers.

Syntax

```
SYSTem:COMMunicate:LAN:AUTOip {OFF|0|ON|1}
```

```
SYSTem:COMMunicate:LAN:AUTOip?
```

Example

The following command disable the Auto-IP:

```
SYST:COMM:LAN:AUTOIP OFF
```

The following query returns the current Auto-IP setting:

```
SYST:COMM:LAN:AUTOIP?
```

Typical Response: 0

Description

This command disables or enables the use of the Dynamic Host Configuration Protocol (DHCP).

Syntax

```
SYSTem:COMMunicate:LAN:DHCP {OFF|0|ON|1}
```

```
SYSTem:COMMunicate:LAN:DHCP?
```

When DHCP is enable (factory setting), the instrument will try to obtain an IP address from the DHCP server. If a DHCP server is found, it will assign a Dynamic IP address, Subnet Mask, and Default Gateway to the instrument.

When the DHCP is disable or unavailable, the instrument will use the Static IP address, Subnet Mask, and Default Gateway during power-on.

NOTE If you change the DHCP setting, you must cycle power on the U3020A to activate the new setting.

Example

The following command disables DHCP:

```
SYST:COMM:LAN:DHCP OFF
```

The following query returns the current DHCP setting:

```
SYST:COMM:LAN:DHCP?
```

Typical Response: 0

Description

This command assigns the IP address of the Domain Name System (DNS) server. Contact your network administrator to determine if DNS is being used and for the correct address.

Syntax

```
SYSTem:COMMunicate:LAN:DNS <address>
```

```
SYSTem:COMMunicate:LAN:DNS?
```

NOTE If you change the DNS address, you must cycle power on the U3020A to activate the new address.

Example

The following command sets the DNS address:

```
SYST:COMM:LAN:DNS 198.105.232.4
```

The following query returns the DNS address currently being used by the instrument (the quotes are also returned).

```
SYST:COMM:LAN:DNS?
```

Typical Response: "198.105.232.4"

Description

This command assigns a Domain Name to the U3020A. The Domain Name is translated into an IP address.

Syntax

```
SYSTem:COMMunicate:LAN:DOMain "<name>"
```

```
SYSTem:COMMunicate:LAN:DOMain?
```

NOTE If you change the Domain Name, you must cycle power on the U3020A to activate the new address.

Example

The following command defines the Domain Name:

```
SYST:COMM:LAN:DOM www.keysight.com
```

The following query returns the Domain Name currently being used by the instrument:

```
SYST:COMM:LAN:DOM?
```

Typical response: www.keysight.com

Description

This command assigns a Default Gateway for the U3020A. The specified IP Address sets the Default Gateway which allows the instrument to communicate with systems that are not on the local subnet. Thus, this is the Default Gateway where packets are sent which are destined for a device not on the local subnet, as determined by the Subnet Mask setting. Contact your network administrator to determine if a gateway is being used and for the correct address.

Syntax

```
SYSTEM:COMMunicate:LAN:GATEway <address>
```

```
SYSTEM:COMMunicate:LAN:GATEway?
```

Example

The following command sets the Default Gateway address:

```
SYST:COMM:LAN:GATEWAY 255.255.20.11
```

The following query returns the Default Gateway address currently being used by the instrument (the quotes are also returned).

```
SYST:COMM:LAN:GATEWAY?
```

Typical Response: "255.255.20.11"

Description

This command assigns a Host Name to the U3020A. The Host Name is the host portion of the domain name, which is translated into an IP address.

Syntax

```
SYSTEM:COMMunicate:LAN:HOSTname "<name>"
```

```
SYSTEM:COMMunicate:LAN:HOSTname?
```

NOTE If you change the Domain Name, you must cycle power on the U3020A to activate the new address.

Example

The following command defines a Host Name:

```
SYST:COMM:LAN:HOST "LAB1-U3020A"
```

The following query returns the Host Name currently being used by the instrument (the quotes are also returned):

```
SYST:COMM:LAN:HOST?
```

Typical Response: "LAB1-U3020A"

GPIB Configuration Commands

Description

This command assigns a GPIB address to the U3020A.

Syntax

```
SYSTem:COMMunicate:GPIB:ADDRess <address>
```

```
SYSTem:COMMunicate:GPIB:ADDRess?
```

NOTE If you change the GPIB address, you must cycle power on the U3020A to activate the new address.

Example

The following command sets the GPIB address to 10:

```
SYST:COMM:GPIB:ADDR 10
```

The following query returns the current GPIB address:

```
SYST:COMM:GPIB:ADDR?
```

Typical Response: 10

NOTE For a complete list of SCPI commands, refer to the Keysight L449xA RF Switch Platform User's Guide (L4490-90001)

Controlling Test Set Attenuator Settings

Description

This command executes the specified factory defined sequence from the non-volatile memory. If the specified sequence name not currently stored in the memory, due to corrupted program or accidentally deleted, an error will be generated.

Syntax

ROUTE:SEQ:TRIGger <command>

Parameters

Refer to [Table 6](#) for commands use to control the Test Set's programmable attenuator.

Table 6 Programmable Attenuator Commands

Commands	Description	Explanatory Remarks
ATT1_00	Attenuator setting = 0 dB	LED on the front panel will indicate current attenuator setting.
ATT1_10	Attenuator setting = 10 dB	
ATT1_20	Attenuator setting = 20 dB	
ATT1_30	Attenuator setting = 30 dB	
ATT1_40	Attenuator setting = 40 dB	
ATT1_50	Attenuator setting = 50 dB	
ATT1_60	Attenuator setting = 60 dB	
ATT1_70	Attenuator setting = 70 dB	
ATT1_80	Attenuator setting = 80 dB	
ATT1_90	Attenuator setting = 90 dB	
ATT1_100	Attenuator setting = 100 dB	
ATT1_110	Attenuator setting = 110 dB	
ATT1_CARD1	10 dB Attenuator Bank On	
ATT1_CARD2	20 dB Attenuator Bank On	
ATT1_CARD3	40 dB Attenuator 1st Bank On	
ATT1_CARD4	40 dB Attenuator 2nd Bank On	
LED_ALL	All LEDs On	
LED_OFF	All LEDs Off	

Example

The following executed a sequence name "ATT1_00" which set the programmable step attenuator to 0 dB.

```
ROUT:SEQ:TRIG ATT1_00
```

Theory of Operation

This section provides a general description of the U3020A Dynamic Accuracy Test Set. This is followed by a more detailed operating theory. The operation of each group is described briefly to the assembly level only. Detailed component level circuit theory is not provided.

Dynamic Accuracy Test Set System Operation

Figure 8 illustrates the components and interconnects of the Dynamic Accuracy Test Set.

The main function of this Test Set is to measure receiver's relative power linearity of the network analyzer. The Test Set consists of four main components: a controller module, a 39495EXT module, distribution board for programmable step attenuator, and a front panel LED indicator.

Figure 8 Block Diagram for Dynamic Accuracy Test Set

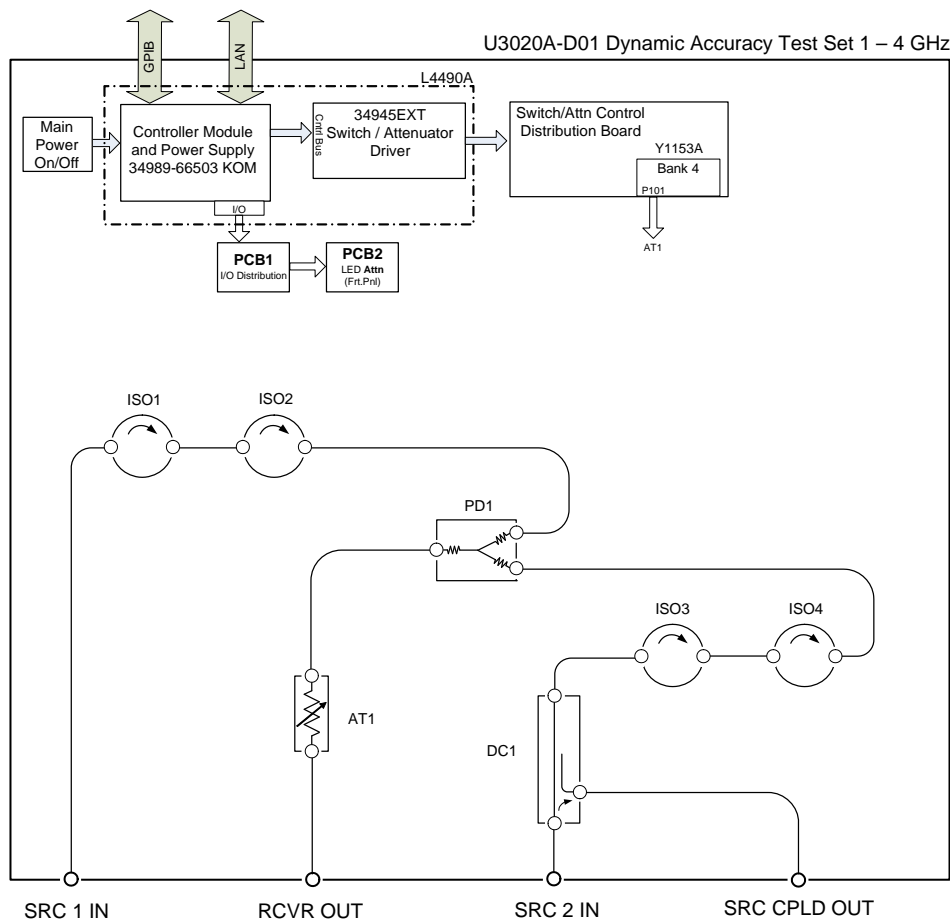

Controller Module

Inside the controller module there are two main components, the AC-DC power supply and controller board. The AC-DC power supply is a 12V/65W power supply that is converted to various voltages by means of DC-DC converter inside the module. It provides regulated voltages to all assemblies in the Test Set as well as following voltages to drive programmable step attenuator in the Test Set. The internal DC voltage has the following specification:

- +24V/0.6A
- +12V/3A fuse
- +5V/1A

The controller board is the “brain” of the Test Set, it handles all the communication between the Controller and the Test Set via LAN or GPIB connectivity. Refer to [“Controlling the Test Set and Making Measurements” on page 13.](#)

39495EXT Module

This module drives the programmable step attenuators. The attenuators are connected to the Test Set through the distribution board (Y1153A), which is installed on the 34945EXT module.

The 34945EXT is divided into four banks, organized by channel number. Any distribution board may be installed in any bank, and multiple distribution boards of the same type may be installed on the same 34495EXT module.

Distribution Board

The distribution board provides an interface between the 34945EXT module and the programmable step attenuator. Depending on the model number and attenuator, a suitable distribution board will be use.

LED Indicator Board

This board provides an LED indication of the attenuator setting in the Test Set. The LED indicator board is driven by the digital IO of the Test Set.

Making Measurements and Functional Tests

Functional Tests

Functional testing consists of measuring transmission insertion loss, return loss, and isolation between all ports. For the most accurate measurements, the use of an Keysight PNA Network Analyzer is recommended and its use is assumed in these notes. Familiarity with RF/microwave measurements is also assumed. The use of adapters may be required and their effects should be accounted within the measurements.

NOTE [Table 8 on page 27](#) may be duplicated to record the results of the functional tests.

Equipment Required

- Keysight PNA-X Network Analyzer (or equivalent)
- Test Port Extension Cables and Adapters
- 85032B Calibration Kit (50 W, Type-N or equivalent)

There are no adjustments required for the Keysight U3020AD01 Test Set.

The U3020AD01 Test Set is designed to be placed near the network analyzer on a bench top and connected as shown in [Figure 1 on page 2](#).

The instrument should be placed so that the detachable power cord is readily identifiable and is easily reached by the operator. The detachable power cord is the instrument disconnecting device. It disconnects the mains circuits from the mains supply before other parts of the instrument. The front panel switch is only a standby switch and is not a LINE switch.

Alternatively, an externally installed switch or circuit breaker (which is readily identifiable and is easily reached by the operator) may be used as a disconnecting device.

1. Connect a GPIB cable from the controller to the rear panel of the network analyzer. Refer to [Figure 3 on page 9](#).
2. After the proper front and rear panel connections have been made, turn on the Test Set using the front panel switch.

NOTE For accurate repeatable measurements, be sure to let the Test Set warm up for at least two hours. For the most stable and accurate measurements, leave the Test Set turned on at all times. Do not touch the power sensor for at least 30 minutes before making measurements.

Set up the network analyzer as follows:
Refer to the standard PNA documentation for adapter removal.

1. Select [Center Frequency] > [2.5 GHz].
2. Select [Frequency Span] > [3 GHz].

Perform a full 4-Port adapter removal calibration at the four test ports of the network analyzer. (Use a Type-N female-to-female adaptor for the transmission calibration).

Figure 9 Connecting the Test Set to the Network Analyzer

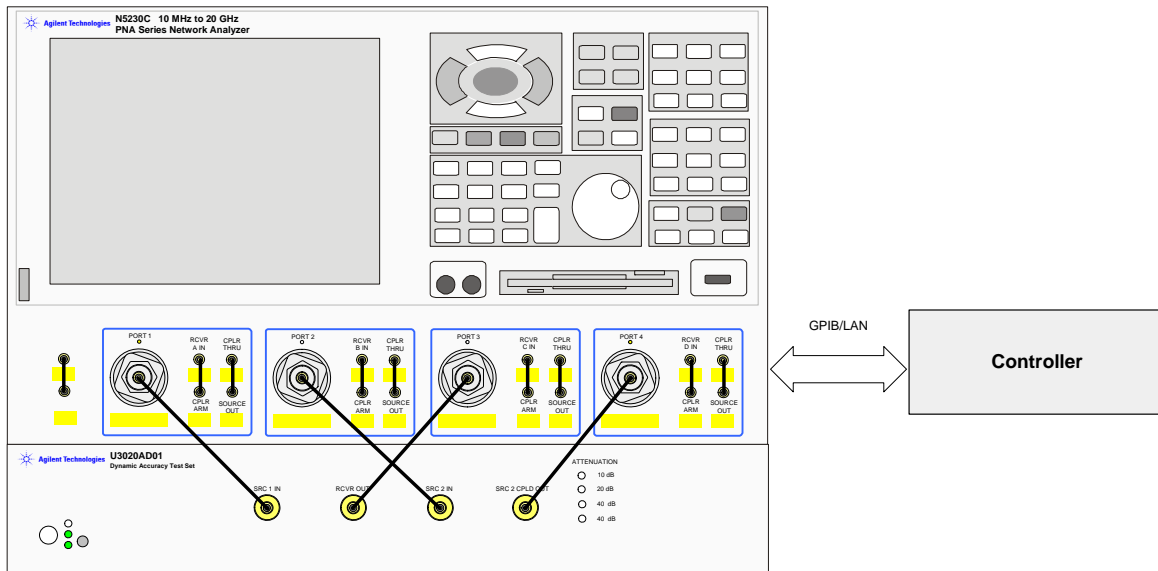

NOTE In this example we are using a 4-Port PNA-L. A 2-Port PNA can also be used.

Transmission

1. Connect the cable attached to PORT 1 of the network analyzer to "SRC 1 IN" of the Test Set.
2. Connect the cable from PORT 2 of the network analyzer to "SRC 2 IN" of the Test Set.
3. Connect the cable from PORT 3 of the network analyzer to the "RCVR OUT" of the Test Set.
4. Connect the cable from PORT 4 of the network analyzer to "SRC 2 CPLD OUT" of the Test Set.
5. Set up the Test Set with the attenuators at 0 dB. Execute the following command over GPIB:
ROUT:SEQ:TRIG ATT1_00
For complete information on controlling the Test Set, refer to ["Controlling the Test Set and Making Measurements" on page 13](#).
6. Set up the network analyzer to measure S31.
7. Measure the amplitude at 2 GHz and record the value in [Table 7 on page 24](#).
8. Measure the amplitude at 3.5 GHz and record the value.
9. Step through all of the attenuator CARDS (att1_card1, card2, card3, and card4), using the commands listed in [Table 6 on page 18](#). Verify that all of the attenuator cards are functioning correctly. ROUT:SEQ:TRIG att1_cardX <command>
10. Repeat [step 6](#) through [step 9](#) measuring S32 (SRC 2 to RCVR OUT).
11. Verify the isolation and match for all ports.

Table 7 Test Record

Parameter	Nominal	Measured Results
Operating Frequency	1 GHz to 4 GHz	
Isolation: (1.8 GHz to 2.2 GHz)		
RCVR OUT to SRC 1 IN RCVR OUT to SRC 2 IN	< -45 dB	
SRC 1 IN to SRC 2 IN	< -70 dB	
RCVR OUT to CPLD OUT	< -80 dB	
Transmission:	Nominal	
CPLD OUT to SRC 2 IN (1 GHz to 4 GHz)	-14 dB < trans < -18 dB	
SRC 2 IN to RCVR OUT (1.8 GHz to 2.2 GHz) (3.5 GHz to 4 GHz)	-3 dB < trans < -9 dB < -38 dB	_____ _____
SRC 1 IN to RCVR OUT (1.8 GHz to 2.2 GHz) (3.5 GHz to 4 GHz)	-3 dB < trans < -9 dB < -34 dB	_____ _____
Match: (all ports)¹	Typical	
1.8 GHz to 2.2 GHz	< -14 dB	

1. Port match may be effected by the test port cable. The Test Set and RF cable are included in your shipment.

Service Information

There are many other repair and calibration options available from the Keysight Technologies support organization. The options cover a range of service agreements with varying response times. Contact Keysight for additional information on available service agreements for this product.

WARNING These servicing instructions are for use by qualified personnel only. To avoid electrical shock, do not perform any servicing unless you are qualified to do so.

Troubleshooting

This section contains information for troubleshooting the Test Set to the assembly level only. By following these procedures, you may determine if the power supply, front panel, or main switch board needs replacing. Refer to [Figure 8, "Block Diagram for Dynamic Accuracy Test Set,"](#) as an aid in troubleshooting.

NOTE Refer to the L449xA Service manual for lower level component replacement.

NOTE If you need to disassemble the instrument, be sure to work at an antistatic workstation and use a grounded wrist strap to prevent damage from electrostatic discharge (ESD).

Troubleshooting the Power Supply

Turn the instrument on. Verify the condition of the LED on the front panel:

1. Check the cable and connections between the main board and front panel board.
2. If the cable and connections are working and the LED is still off, there is still a possibility that the power supply is not supplying the necessary +24 V, +12 V, and +5 V to the main board.

Disconnect the dc power cable from the power supply to the main switch board and measure the voltages. They should be +24 V, +12 V, and +5 V. If not, replace the power supply.

Troubleshooting the Controller Board

Turn the instrument power on and verify the following:

1. Check the LED display for the model/option and revision information; if there is no backlite or horizontal/vertical lines are missing, verify that the power supply is working properly, if so replace the LED display.
2. If there is no information or the information is scrambled, replace the controller board.
3. Verify the switching paths by issuing commands to switch each of the paths. Ensure that the LED indicates the appropriate path.

Figure 10 U3020AD01 (top view)

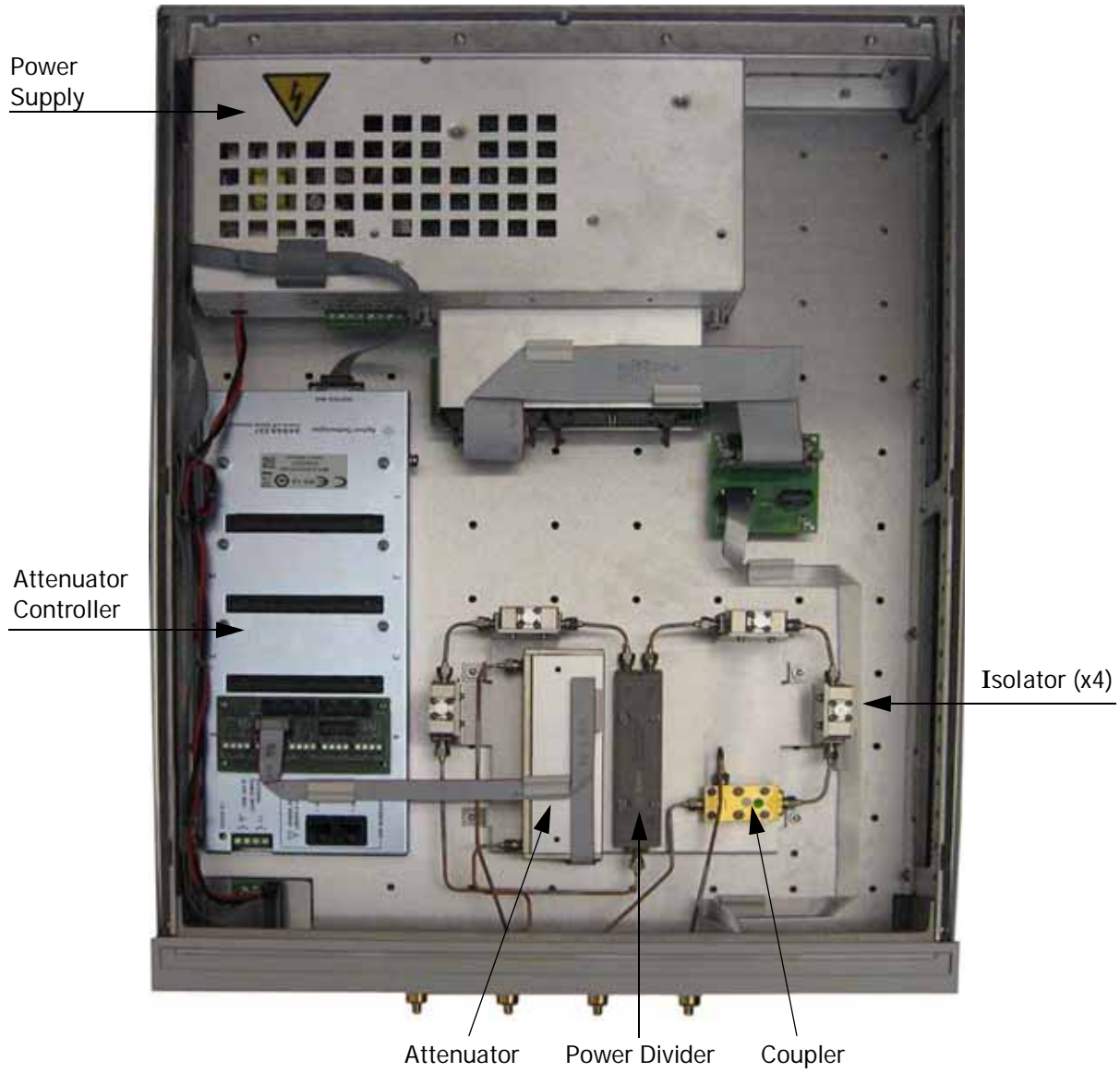

Power Supply

Attenuator Controller

Attenuator

Power Divider

Coupler

Isolator (x4)

Replaceable Parts

Special options are built to order, long lead times may be encountered when ordering replacement parts.

Table 8 **Replaceable Parts**

Replacement Part	Part Number	Qty
Power divider, 1 to 26.5 GHz	0955-1421	1
Microwave Coax Isolator (SMA f - f)	0955-2284	4
RF Connector (SMA male, straight 50 Ohm)	1810-0118	1
Attenuator	33322-60010	1
Bulkhead Connector, 3.5 mm	5062-6618	4
Coupler	5087-7729	1
Cable, RF 50 Ohm (3.5MM-3.5MM), 24" long	8121-2111	4
2U RF Switch Platform with Integrated Switch Driver, includes 64 Switch Drive lines with Option 004	L4490A-CFG002	1
Extender Driver for 34945A, 1 required for each 64 coils with standard option	34945EXT-CFG001	1
PCA, Front Panel	34989-66502	1
Assembly, controller Box for L4490A and L4491A	L4490-60001	1
LED Board	N5261-63005	1
Distribution Card	Y1153-66501	1
Attenuator LED Interface Board	U3020-63114	1

NOTE Before replacing an assembly or board, inspect the assembly for obvious, easily repaired defects such as bent pins on ICs or cold solder joints.

Electrostatic Discharge Protection

Electrostatic discharge (ESD) can damage or destroy electronic components. The instrument is shipped in materials that prevent damage from static, and should only be removed from the packaging in an anti-static area ensuring that the correct anti-static precautions are taken.

Two types of ESD protection are listed below. Purchase acceptable ESD accessories from your local supplier.

- Conductive table-mat and wrist-strap combination
- Conductive floor-mat and heel-strap combination

Both types, when used together, provide a significant level of ESD protection. To ensure user safety, static-safe accessories must provide at least 1 Meg ohm of isolation from ground.

Safety and Information

Introduction

Review this product and related documentation to familiarize yourself with safety markings and instructions before you operate the instrument.

This product has been designed and tested in accordance with accepted industry standards, and has been supplied in a safe condition. The documentation contains information and warnings that must be followed by the user to ensure safe operation and to maintain the product in a safe condition.

Safety Earth Ground

WARNING This is a Safety Class I Product (provided with a protective earthing ground incorporated in the power cord). The mains plug shall only be inserted in a socket outlet provided with a protective earth contact. Any interruption of the protective conductor inside or outside of the product is likely to make the product dangerous. Intentional interruption is prohibited.

CAUTION Always use the three prong AC power cord supplied with this product. Failure to ensure adequate earth grounding by not using this cord may cause product damage and the risk of electrical shock.

Declaration of Conformity

A copy of the Declaration of Conformity is available upon request, or a copy is available on the Keysight Technologies web site at <http://regulations.corporate.keysight.com/DoC/search.htm>

Statement of Compliance

This product has been designed and tested in accordance with accepted industry standards, and has been supplied in a safe condition. The documentation contains information and warnings that must be followed by the user to ensure safe operation and to maintain the product in a safe condition.

Before Applying Power

Verify that the premises electrical supply is within the range of the instrument. The instrument has an autoranging power supply.

WARNING If this product is not used as specified, the protection provided by the equipment could be impaired. This product must be used in a normal condition (in which all means for protection are intact) only.

CAUTION The Mains wiring and connectors shall be compatible with the connector used in the premise electrical system. Failure, to ensure adequate earth grounding by not using the correct components may cause product damage, and serious injury.

CAUTION Always use the three prong AC power cord supplied with this product. Failure to ensure adequate earth grounding by not using this cord may cause product damage and the risk of electrical shock.

CAUTION This product is designed for use in Installation Category II and Pollution Degree.

CAUTION Before switching on this instrument, make sure the supply voltage is in the specified range.

CAUTION Verify that the premise electrical voltage supply is within the range specified on the instrument.

CAUTION Ventilation Requirements: When installing the instrument in a cabinet, the convection into and out of the instrument must not be restricted. The ambient temperature (outside the cabinet) must be less than the maximum operating temperature of the instrument by 4 °C for every 100 watts dissipated in the cabinet. If the total power dissipated in the cabinet is greater than 800 watts, forced convection must be used.

WARNING	Danger of explosion if battery is incorrectly replaced. Replace only with the same or equivalent type recommended. Discard used batteries according to manufacturer's instructions.
----------------	---

WARNING	For continued protection against fire hazard replace line fuse only with same type and rating. The use of other fuses or material is prohibited.
----------------	--

WARNING	These servicing instructions are for use by qualified personnel only. To avoid electrical shock, do not perform any servicing unless you are qualified to do so.
----------------	--

WARNING	The opening of covers or removal of parts is likely to expose the user to dangerous voltages. Disconnect the instrument from all voltage sources before opening.
----------------	--

WARNING	No operator serviceable parts inside. Refer servicing to qualified personnel. To prevent electrical shock, do not remove covers.
----------------	--

WARNING	The detachable power cord is the instrument disconnecting device. It disconnects the mains circuits from the mains supply before other parts of the instrument. The front panel switch is only a standby switch and is not a LINE switch (disconnecting device).
----------------	--

Connector Care and Cleaning Precautions

Remove the power cord to the instrument. To clean the connectors use alcohol in a well ventilated area. Allow all residual alcohol moisture to evaporate, and fumes to dissipate prior to energizing the instrument.

WARNING	To prevent electrical shock, disconnect the Keysight U3020AD01 from mains electrical supply before cleaning. Use a dry cloth or one slightly dampened with water to clean the external case parts. Do not attempt to clean internally.
----------------	---

WARNING	If flammable cleaning materials are used, the material shall not be stored, or left open in the area of the equipment. Adequate ventilation shall be assured to prevent the combustion of fumes, or vapors.
----------------	---

Regulatory Information

This section contains information that is required by various government regulatory agencies.

Instrument Markings



The instruction documentation symbol. The product is marked with this symbol when it is necessary for the user to refer to the instructions in the documentation.



The AC symbol indicates the required nature of the line module input power.



This symbol indicates separate collection for electrical and electronic equipment, mandated under EU law as of August 13, 2005. All electric and electronic equipment are required to be separated from normal waste for disposal (Reference WEEE Directive, 2002/96/EC).



This symbol indicates that the power line switch is ON.



This symbol indicates that the power line switch is in the STANDBY position.



This symbol indicates that the power line switch is in the OFF position.



This symbol is used to identify a terminal which is internally connected to the product frame or chassis.



The CE mark is a registered trademark of the European Community. (If accompanied by a year, it is when the design was proven.)



The CSA mark is a registered trademark of the CSA International.



This mark designates the product is an Industrial Scientific and Medical Group 1 Class A product (reference CISPR 11, Clause 5)



This is a marking to indicate product compliance with the Canadian Interference-Causing Equipment Standard (ICES-001).



Direct Current.



The instrument has been designed to meet the requirements of IP 2 0 for egress and operational environment.



The RCM mark is a registered trademark of the Australian Communications and Media Authority



Indicates the time period during which no hazardous or toxic substance elements are expected to leak or deteriorate during normal use. Forty years is the expected useful life of the product.



This symbol on all primary and secondary packaging indicates compliance to China standard GB 18455-2001.



South Korean Certification (KC) mark; includes the marking's identifier code which follows the format: MSIP-REM-YYY-ZZZZZZZZZZZZZZ.

Battery Collection

Do not throw batteries away but collect as small chemical waste, or in accordance with your country's requirements. You may return the battery to Keysight Technologies for disposal. Refer to ["Contacting Keysight" on page 34](#) for assistance.

Electrical Safety Compliance

SAFETY

Complies with European Low Voltage Directive 2014/35/EU

- IEC/EN 61010-1:2010, 3rd Edition
- Canada: CSA C22.2 No. 61010-1-12
- USA: UL std no. 61010-1, 3rd Edition
- Acoustic statement (European Machinery Directive 2022/42/EC, 1.7.4.2U)
 Accoustical noise emission
 LpA<70 dB
 Operator position
 Normal operation mode
 Per ISO 7779

EMI and EMC Compliance

EMC

Complies with European EMC Directive 2014/30/EU

- IIEC 61326-1:2012/EN 61326-1:2013
- CISPR Pub 11 Group 1, class A
- AS/NZS CISPR 11:2011
- ICES/NMB-001
 This ISM device complies with Canadian ICES-001.
 Cet appareil ISM est conforme a la norme NMB du Canada.
- South Korean Class A EMC declaration: This equipment is Class A suitable for professional use and is for use in electromagnetic environments outside of the home.

A () (A)
 , 가 .

Keysight Support, Services, and Assistance

Service and Support Options

There are many other repair and calibration options available from the Keysight Technologies support organization. These options cover a range of service agreements with varying response times. Contact Keysight for additional information on available service agreements for this product.

Contacting Keysight

Assistance with test and measurement needs, and information on finding a local Keysight office are available on the Internet at:

<http://www.keysight.com/find/assist>

You can also purchase accessories or documentation items on the Internet at:

<http://www.keysight.com/find>

If you do not have access to the Internet, contact your field engineer.

NOTE In any correspondence or telephone conversation, refer to the Keysight product by its model number and full serial number. With this information, the Keysight representative can determine the warranty status of your unit.

Shipping Your Product to Keysight for Service or Repair

IMPORTANT Keysight Technologies reserves the right to reformat or replace the internal hard disk drive in your analyzer as part of its repair. This will erase all user information stored on the hard disk. It is imperative, therefore, that you make a backup copy of your critical test data located on the analyzer's hard disk before shipping it to Keysight for repair.

If you wish to send your instrument to Keysight Technologies for service or repair:

- Include a complete description of the service requested or of the failure and a description of any failed test and any error message.
- Remove and retain the front handles and all rack mount hardware. The analyzer should be sent to Keysight in the same configuration as it was originally shipped.
- Remove and retain the front handles and all rack mount hardware. The analyzer should be sent to Keysight in the same configuration as it was originally shipped.
- Contact Keysight for instructions on where to ship your analyzer.