

Keysight U1401B Handheld Multi-Function Calibrator/Meter



User's and
Service Guide

NOTICE: This document contains references to Agilent Technologies. Agilent's former Test and Measurement business has become Keysight Technologies. For more information, go to www.keysight.com.



Notices

© Keysight Technologies 2009 – 2014

No part of this manual may be reproduced in any form or by any means (including electronic storage and retrieval or translation into a foreign language) without prior agreement and written consent from Keysight Technologies as governed by United States and international copyright laws.

Manual Part Number

U1401-90055

Edition

Edition 12, November 21, 2014

Printed in Malaysia

Keysight Technologies
1400 Fountaingrove Parkway
Santa Rosa, CA 95403 USA

Warranty

The material contained in this document is provided “as is,” and is subject to being changed, without notice, in future editions. Further, to the maximum extent permitted by applicable law, Keysight disclaims all warranties, either express or implied, with regard to this manual and any information contained herein, including but not limited to the implied warranties of merchantability and fitness for a particular purpose. Keysight shall not be liable for errors or for incidental or consequential damages in connection with the furnishing, use, or performance of this document or of any information contained herein. Should Keysight and the user have a separate written agreement with warranty terms covering the material in this document that conflict with these terms, the warranty terms in the separate agreement shall control.

Technology Licenses

The hardware and/or software described in this document are furnished under a license and may be used or copied only in accordance with the terms of such license.

Restricted Rights Legend

U.S. Government Restricted Rights. Software and technical data rights granted to the federal government include only those rights customarily provided to end user customers. Keysight provides this customary commercial license in Software and technical data pursuant to FAR 12.211 (Technical Data) and 12.212 (Computer Software) and, for the Department of Defense, DFARS 252.227-7015 (Technical Data - Commercial Items) and DFARS 227.7202-3 (Rights in Commercial Computer Software or Computer Software Documentation).

Safety Notices

CAUTION

















A **CAUTION** notice denotes a hazard. It calls attention to an operating procedure, practice, or the like that, if not correctly performed or adhered to, could result in damage to the product or loss of important data. Do not proceed beyond a **CAUTION** notice until the indicated conditions are fully understood and met.

WARNING

A **WARNING** notice denotes a hazard. It calls attention to an operating procedure, practice, or the like that, if not correctly performed or adhered to, could result in personal injury or death. Do not proceed beyond a **WARNING** notice until the indicated conditions are fully understood and met.

Safety Symbols

The following symbols on the instrument and in the documentation indicate precautions which must be taken to maintain safe operation of the instrument.

	Direct current (DC)		Off (supply)
	Alternating current (AC)		On (supply)
	Both direct and alternating current		Caution, risk of electric shock
	Three-phase alternating current		Caution, risk of danger (refer to this manual for specific Warning or Caution information)
	Earth (ground) terminal		Caution, hot surface
	Protective conductor terminal		Out position of a bistable push control
	Frame or chassis terminal		In position of a bistable push control
	Equipotentiality	CAT II 150 V	Category II 150 V overvoltage protection
	Equipment protected throughout by double insulation or reinforced insulation		

General Safety Information

The following general safety precautions must be observed during all phases of operation, service, and repair of this instrument. Failure to comply with these precautions or with specific warnings elsewhere in this manual violates safety standards of design, manufacture, and intended use of the instrument. Keysight Technologies assumes no liability for the customer's failure to comply with these requirements.

WARNING

- Do not exceed any of the measurement limits defined in the specifications to avoid instrument damage and the risk of electric shock.
 - When working above DC 60 V, AC 30 Vrms or AC 42.4 Vpeak, exercise caution – these ranges pose a shock hazard.
 - Do not measure more than the rated voltage (as marked on the instrument) between terminals, or between terminal and earth ground.
 - Double-check the instrument operation by measuring a known voltage.
 - This instrument is designed for measurement under CAT II 150 V. Avoid measuring power mains with voltage exceeding 150 V.
 - For current measurement, turn off circuit power before connecting the instrument to the circuit. Always place the instrument in series with the circuit.
 - When connecting probes, always connect the common test probe first. When disconnecting probes, always disconnect the live test probe first.
 - Detach test probes from the instrument before you open the battery cover.
 - Do not use the instrument with the battery cover or part of the cover removed or loose.
 - Recharge or replace the battery as soon as the low battery indicator  flashes on screen. This is to avoid false readings, which may lead to possible electric shock or personal injury.
 - Do not use the instrument if it is damaged. Before you use the instrument, inspect the casing. Look for cracks or missing plastic. Do not operate the instrument around explosive gas, vapor, or dust.
 - Inspect the test probes for damaged insulation or exposed metal, and check for continuity. Do not use the test probe if it is damaged.
 - Do not use any other AC charger adapter apart from the one certified by Keysight with this product.
 - Do not use repaired fuses or short-circuited fuse-holders. For continued protection against fire, replace the line fuses only with fuses of the same voltage and current rating and recommended type.
-

WARNING

- **Do not service or perform adjustments alone. Under certain condition, hazardous voltages may exist, even with the equipment switched off. To avoid dangerous electric shock, service personnel must not attempt internal service or adjustment unless another person, capable of rendering resuscitation or first aid, is present.**
 - **Do not substitute parts or modify equipment to avoid the danger of introducing additional hazards. Return the product to the nearest Keysight Technologies Sales and Service Office for service and repair to ensure the safety features are maintained.**
 - **Do not operate damaged equipment as the safety protection features built into this product may have been impaired, either through physical damage, excessive moisture, or any other reason. Remove power and do not use the product until safe operation can be verified by service-trained personnel. If necessary, return the product to the nearest Keysight Technologies Sales and Service Office for service and repair to ensure the safety features are maintained.**
-

CAUTION

- Turn off circuit power and discharge all high-voltage capacitors in the circuit before you perform resistance and capacitance measurements or continuity and diode tests.
 - Use the correct terminals, function, and range for your measurements.
 - Do not measure voltage when current measurement is selected.
 - Use only the recommended rechargeable battery. Ensure proper insertion of battery in the instrument, and follow the correct polarity.
 - Disconnect test leads from all the terminals during battery charging.
-

Environmental Conditions

This instrument is designed for indoor use and in areas with low condensation. The table below shows the general environmental requirements for this instrument.

Environmental conditions	Requirements
Operating temperature	Full accuracy from 0 °C to 40 °C
Operating humidity	Full accuracy up to 80% R.H. (relative humidity) for temperature up to 31 °C, decreasing linearly to 50% R.H. at 40 °C
Storage temperature	–20 °C to 60 °C (with battery removed)
Storage humidity	5% to 80% R.H. non-condensing
Altitude	Up to 2000 m
Pollution degree	Pollution Degree 2

CAUTION







The Handheld Multi-Function Calibrator/Meter complies with the following safety and EMC requirements.

- IEC 61010-1:2001/EN61010-1:2001 (2nd Edition)
- Canada: CAN/CSA-C22.2 No. 61010-1-04
- USA: ANSI/UL 61010-1:2004
- IEC61326-2-1:2005/EN61326-2-1:2006
- Canada: ICES/NMB-001:2004
- Australia/New Zealand: AS/NZS CISPR11:2004

CAUTION

Degradation of some product specifications can occur in the presence of ambient electromagnetic (EM) fields and noise that are coupled to the power line or I/O cables of the instrument. The instrument will self-recover and operate to all specifications when the source of ambient EM field and noise are removed or when the instrument is protected from the ambient EM field or when the instrument cabling is shielded from the ambient EM noise.

Regulatory Markings

	<p>The CE mark is a registered trademark of the European Community. This CE mark shows that the product complies with all the relevant European Legal Directives.</p>		<p>The C-tick mark is a registered trademark of the Spectrum Management Agency of Australia. This signifies compliance with the Australia EMC Framework regulations under the terms of the Radio Communication Act of 1992.</p>
<p>ICES/NMB-001</p>	<p>ICES/NMB-001 indicates that this ISM device complies with the Canadian ICES-001. Cet appareil ISM est conforme a la norme NMB-001 du Canada.</p>		<p>This instrument complies with the WEEE Directive (2002/96/EC) marking requirement. This affixed product label indicates that you must not discard this electrical or electronic product in domestic household waste.</p>
	<p>The CSA mark is a registered trademark of the Canadian Standards Association.</p>		

Waste Electrical and Electronic Equipment (WEEE) Directive 2002/96/EC

This instrument complies with the WEEE Directive (2002/96/EC) marking requirement. This affixed product label indicates that you must not discard this electrical or electronic product in domestic household waste.

Product Category:

With reference to the equipment types in the WEEE directive Annex 1, this instrument is classified as a "Monitoring and Control Instrument" product.

The affixed product label is as shown below.



Do not dispose in domestic household waste

To return this unwanted instrument, contact your nearest Keysight Technologies, or visit:

www.keysight.com/environment/product

for more information.

Keysight Technologies, through Rechargeable Battery Recycling Corporation (RBRC), offers free and convenient battery recycling options in the U.S. and Canada. Contact RBRC at 877-2-RECYCLE (877.273.2925) or online at: <http://www.call2recycle.org/> for the nearest recycling location.

In This Guide...

1 Getting Started

This chapter contains a brief description of the U1401B Handheld Multi-Function Calibrator/Meter front panel, rotary switch, keypad, display, terminals, and rear panel.

2 Calibrator Output Operations

This chapters contains detailed information on how to generate signals using the U1401B.

3 Making Measurements

This chapter contains the detailed information on how measurements are taken using the U1401B.

4 Changing the Default Settings

This chapter describes how to change the default settings of the U1401B.

5 Application Examples

This chapter describes some application examples for the U1401B.

6 Maintenance

This chapter will help you troubleshoot the U1401B for faults.

7 Performance Tests and Calibration

This chapter contains the performance test procedures and adjustment procedures to help you ensure that the U1401B is operating within its published specifications.

8 Specifications

This chapter details the specifications of the U1401B.

Declaration of Conformity (DoC)

The Declaration of Conformity (DoC) for this instrument is available on the Web site. You can search the DoC by its product model or description.

<http://www.keysight.com/go/conformity>

NOTE

If you are unable to search for the respective DoC, please contact your local Keysight representative.

Contents

1 Getting Started

Introducing the U1401B Handheld Multi-Function
Calibrator/Meter 2

Standard Purchase Items 3

List of Accessories 4

Product Overview 5

Slide switch 5

The front panel at a glance 7

The rotary switch at a glance 8

The keypad at a glance 9

The display at a glance 13

The terminals at a glance 17

The rear panel at a glance 19

Display selection with the Hz key 20

Display selection with the DUAL key 22

Remote Communication 23

2 Calibrator Output Operations

Enabling and Disabling the Output 28

Constant Voltage Operation 29

Constant Current Operation 30

Memory Generation 31

Autoscan output 31

Autoramp output 36

Square Wave Output 41

3 Making Measurements

Measuring Voltage 46

Contents

Measuring DC voltage	46
Measuring AC voltage	48
Measuring Current	49
DC mA measurement	49
Percentage scale of DC mA measurement	50
Measuring Temperature	51
Measuring Resistance and Testing Continuity	54
Alerts and Warning During Measurement	56
Overload alert for voltage measurement	56
Math Operations	57
Dynamic recording	57
Relative (zero)	60
Triggering Operations	61
Data hold (manual trigger)	61
Refresh hold (auto trigger)	62
1 ms peak hold	63
4 Changing the Default Settings	
Entering the Setup Mode	66
Available Setting Options	68
Setting the data hold/refresh hold mode	69
Setting the temperature unit	71
Setting the beeper frequency	73
Setting the minimum measurable frequency	74
Setting the percentage scale readout	75
Setting the print mode	76
Setting the echo mode	77
Setting the data bit	78
Setting the parity check	79
Setting the baud rate	80

Setting the display backlight timer 81

Setting the power saving mode 82

5 Application Examples

Source Mode for mA Output 86

Simulation Mode for mA Output 88

 Simulating a 2-wire transmitter on a current loop 90

Measuring a Pressure Transducer 92

Zener Diode Test 94

Diode Test 96

Bipolar Junction Transistor (BJT) Test 98

 Determining transistor h_{fe} 102

Junction Field-Effect Transistor (JFET) Switch Test 104

Operational Amplifier Verification 108

 Current-to-voltage converter 108

 Voltage-to-current converter 110

 Integrator: square wave to triangle wave conversion 111

2-Wire Transmitter Verification 113

Frequency Transmitter Verification 115

6 Maintenance

Maintenance 118

 General maintenance 118

 Battery replacement 119

 Recharging the batteries 121

 Fuse replacement 122

 Troubleshooting 124

7 Performance Tests and Calibration

Calibration Overview 128

Contents

Closed-case electronic calibration	129
Keysight Technologies' calibration services	129
Calibration interval	129
Other recommendations for calibration	130
Environmental conditions	130
Warm up	130
Recommended Test Equipment	131
Performance Verification Tests	132
Self-verification	132
Input performance verification	133
Output performance verification	137
Adjustment Considerations	138
Adjustment Procedures	139
Input calibration	139
Output calibration	144
8 Specifications	
General Specifications	148
Measurement Category	150
Measurement category definitions	150
Input Specifications	151
DC specifications	151
AC specifications	152
AC+DC specifications	153
Temperature specifications	154
Frequency specifications	155
1 ms peak hold specifications	157
Resistance specifications	157
Diode check and audible continuity specifications	158
Output Specifications	159

Constant voltage and constant current outputs	159
Square wave output	160

Contents

THIS PAGE HAS BEEN INTENTIONALLY LEFT BLANK.

Tables

Table 1-1. List of accessories	4
Table 1-2. Slide switch functions	5
Table 1-3. Rotary switch positions and their corresponding functions	8
Table 1-4. Keypad functions	10
Table 1-5. Instructions involving shifted functions	12
Table 1-6. Description of display annunciators	14
Table 1-7. Description of terminals	17
Table 1-8. Overload protection for the input terminals	18
Table 1-9. Measurement functions and corresponding display selection with the Hz key	20
Table 1-10. Measurement functions and corresponding display selection with the DUAL key	22
Table 2-1. Default settings for the autoscan output	33
Table 2-2. Default settings for the autoramp output	37
Table 2-3. Available frequencies	41
Table 3-1. Measurement ranges for audible continuity	54
Table 4-1. Setup options and default settings	68
Table 5-1. Typical pressure range and maximum output voltages of millivolt output pressure transducers	92
Table 5-2. Base terminal according to probe test	99
Table 5-3. Polarity and terminals if Pin 3 is the base	99
Table 5-4. Polarities and terminals if Pin 2 is the base	100
Table 5-5. Polarities and terminals if Pin 1 is the base	100
Table 5-6. Polarity and terminals if Pin 2 is the base	101
Table 5-7. Gate terminal according to probe test	105
Table 6-1. Fuse specifications	123
Table 6-2. Troubleshooting	125
Table 6-3. Replacement parts list	126
Table 7-1. Recommended test equipment	131
Table 7-2. Functions that can be self-verified	132

Tables

Table 7-3. Input performance verification tests	133
Table 7-4. Output performance verification tests	137
Table 7-5. Calibration tests	140
Table 7-6. Output voltage calibration steps	145
Table 7-7. Output current calibration steps	146
Table 8-1. DC mV/voltage specifications	151
Table 8-2. DC current specifications	152
Table 8-3. AC mV/voltage specifications	152
Table 8-4. AC current specifications	153
Table 8-5. AC+DC mV/voltage specifications	153
Table 8-6. AC+DC current specifications	154
Table 8-7. Temperature specifications	154
Table 8-8. Frequency specifications	155
Table 8-9. Frequency sensitivity and trigger level specifications for voltage measurement	155
Table 8-10. Duty cycle specifications	156
Table 8-11. Pulse width specifications	156
Table 8-12. Frequency sensitivity specifications for current measurement	156
Table 8-13. Peak hold specifications	157
Table 8-14. Resistance specifications	157
Table 8-15. Diode check specifications	158
Table 8-16. Constant voltage (CV) output specifications	159
Table 8-17. Constant current (CC) output specifications	159
Table 8-18. Square wave output specifications	160

Figures

Figure 1-1. The slide switch	5
Figure 1-2. The front panel	7
Figure 1-3. The rotary switch	8
Figure 1-4. Keypad functions	9
Figure 1-5. Keypad shifted functions	10
Figure 1-6. Full display	13
Figure 1-7. Terminals	17
Figure 1-8. The rear panel	19
Figure 1-9. IR-USB cable	24
Figure 1-10. IR-USB cable connection	25
Figure 1-11. IR-USB cable	25
Figure 2-1. Selecting autoscan output mode	34
Figure 2-2. Example of a typical autoscan output	34
Figure 2-3. Defining the autoscan output	36
Figure 2-4. Selecting autoramp output mode	38
Figure 2-5. Ramp output	38
Figure 2-6. Defining the autoramp output	40
Figure 2-7. Parameter selection for square wave output	43
Figure 3-1. DC voltage measurement	47
Figure 3-2. AC voltage measurement	48
Figure 3-3. DC current (mA) measurement	49
Figure 3-4. Surface temperature measurement	53
Figure 3-5. Resistance measurement	55
Figure 3-6. Enabling and disabling the continuity test	55
Figure 3-7. Dynamic recording mode	59
Figure 3-8. Relative (zero) mode	60
Figure 3-9. Data hold mode	61
Figure 3-10. 1 ms peak hold mode	64
Figure 4-1. Entering the setup mode	66
Figure 4-2. Setting the data hold or refresh hold mode	70
Figure 4-3. Setting the temperature unit	72

Figures

- Figure 4-4. Setting the beeper frequency 73
- Figure 4-5. Setting the minimum frequency 74
- Figure 4-6. Setting the percentage scale readout 75
- Figure 4-7. Setting the print mode for remote control 76
- Figure 4-8. Setting the echo mode for remote control 77
- Figure 4-9. Setting the data bit for remote control 78
- Figure 4-10. Setting the parity check for remote control 79
- Figure 4-11. Setting the baud rate for remote control 80
- Figure 4-12. Setting the display backlight timer 81
- Figure 4-13. Setting the auto power-off mode 83
- Figure 5-1. Testing a 4 mA to 20 mA current loop with the source mode 87
- Figure 5-2. mA output simulation 89
- Figure 5-3. Use the yellow test lead to perform the 2-wire transmitter simulation 91
- Figure 5-4. Pressure transducer measurement 93
- Figure 5-5. Zener diode test 95
- Figure 5-6. Diode test 97
- Figure 5-7. TO-92 Transistor 98
- Figure 5-8. TO-3 Transistor 101
- Figure 5-9. Determining transistor h_{fe} 103
- Figure 5-10. TO-92 JFET 104
- Figure 5-11. N- Channel JFET 106
- Figure 5-12. P- Channel JFET 107
- Figure 5-13. Current-to-voltage converter 109
- Figure 5-14. Voltage-to-current converter 111
- Figure 5-15. Square wave to triangular wave conversion 112
- Figure 5-16. Verifying a two-wire transmitter 114
- Figure 5-17. Verifying a frequency transmitter 116
- Figure 6-1. Battery replacement 120
- Figure 6-2. Recharging the batteries 122
- Figure 6-3. Fuse replacement 124

**U1401B Handheld Multi-Function Calibrator/Meter
User's and Service Guide**

1 Getting Started

Introducing the U1401B Handheld Multi-Function Calibrator/Meter	2
Standard Purchase Items	3
List of Accessories	4
Product Overview	5
Slide switch	5
The front panel at a glance	7
The rotary switch at a glance	8
The keypad at a glance	9
The display at a glance	13
The terminals at a glance	17
The rear panel at a glance	19
Display selection with the Hz key	20
Display selection with the DUAL key	22
Remote Communication	23

This chapter contains a brief description of the U1401A Handheld Multi-Function Calibrator/Meter front panel, rotary switch, keypad, display, terminals, and rear panel.

Introducing the U1401B Handheld Multi-Function Calibrator/Meter

The key features of the U1401B are:

- Simultaneous signal generation and measurement.
- DC, AC, and AC+DC voltage and current measurements.
- DC voltage, DC current, and square wave outputs.
- Intelligent output and standby control.
- Rechargeable Ni-MH battery with built-in charging capability.
- Smart charger design without battery removal.
- Bright Electroluminescence (EL) backlight with 5-digit LCD display.
- Percentage scale readout for 4-20 mA or 0-20 mA measurement.
- Load driving capability up to 1200 Ω for 20 mA simulation with yellow test lead.
- Adjustable steps and time interval for Autoscan.
- Adjustable resolutions and start for linear Ramp output.
- 1 ms peak hold to catch inrush voltage and current easily.
- Temperature measurement with selectable 0 °C compensation.
- Frequency, duty cycle, and pulse width measurements.
- Dynamic recording for minimum, maximum and average readings.
- Data hold with manual or autotrigger and relative mode.
- Diode and audible continuity tests.
- Bidirectional optic computer interface with SCPI commands.
- Resistance measurement up to 50 M Ω .
- Safe, precise and fast closed case calibration.
- 50,000 count precision true-rms digital meter, designed to meet IEC 61010-1 CAT II 150V standard.

Standard Purchase Items

Verify that you have received the following items with your U1401B Handheld Multi-Function Calibrator/Meter:

- Protective holster
- Rechargeable battery pack (1.2 V NiMH AA × 8)
- Power cord and AC power adapter
- Silicone test leads
- 19 mm probes
- Alligator clips
- Yellow test lead for mA simulation
- Certificate of calibration
- Printed Quick Start Guide

If anything is missing, contact your nearest Keysight Technologies Sales and Service Office.

List of Accessories

Table 1-1 List of accessories

Type	Keysight part number	Description
Standard		Protective holster
		Rechargeable battery pack (1.2V NiMH AA x 8)
		AC Power Adapter for Handheld Multi-Function Calibrator/Meter
		Power cord (according to country)
		Silicone test leads
		19 mm probes
		Alligator clips
		Yellow test lead for mA simulation
		Certificate of calibration
		Printed Quick Start Guide: one English + one local language
Optional	U1186A	K-type thermocouple input adapter and probe bundle
	U1184A	K-type thermocouple input adapter
	U1181A	K-type immersion probe
	U1182A	Industrial surface probe
	U1183A	Air probe
	U1160A	Standard test lead kit
	U1161A	Extended test lead kit
	U1162A	Alligator clips
	U1168A	Standard test lead set with 4 mm test probes
	U1169A	Standard test leads with 4 mm probe tip
	U5481A	IR-to-USB cable
	U5491A	Soft carrying case for handheld and accessories

Product Overview

Slide switch

The slide switch has the following positions:

- **Charge:** Select this position to charge the batteries. Use the AC adapter provided to charge this instrument.
- **M:** Select this position to enable only the measurement functions.
- **M/S:** Select this position to enable both the measurement and source functions.

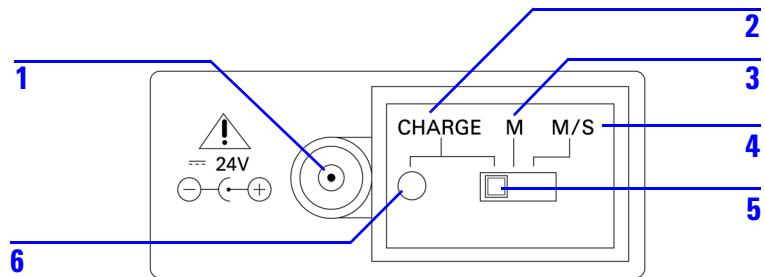

Figure 1-1 The slide switch

Table 1-2 Slide switch functions

No.	Description	Function
1	External AC adapter jack	Allows an external AC adapter to be connected to provide power or charge the batteries.
2	CHARGE	Charges the batteries with an external AC adapter.
3	M	Enables only the measurement functions.
4	M/S	Enables both measurement and source functions.

1 Getting Started

Table 1-2 Slide switch functions (continued)

No.	Description	Function
5	Slide Switch	—
6	Charging indication	Indicates the charging process. GREEN: Fully charged YELLOW: Charging

The front panel at a glance

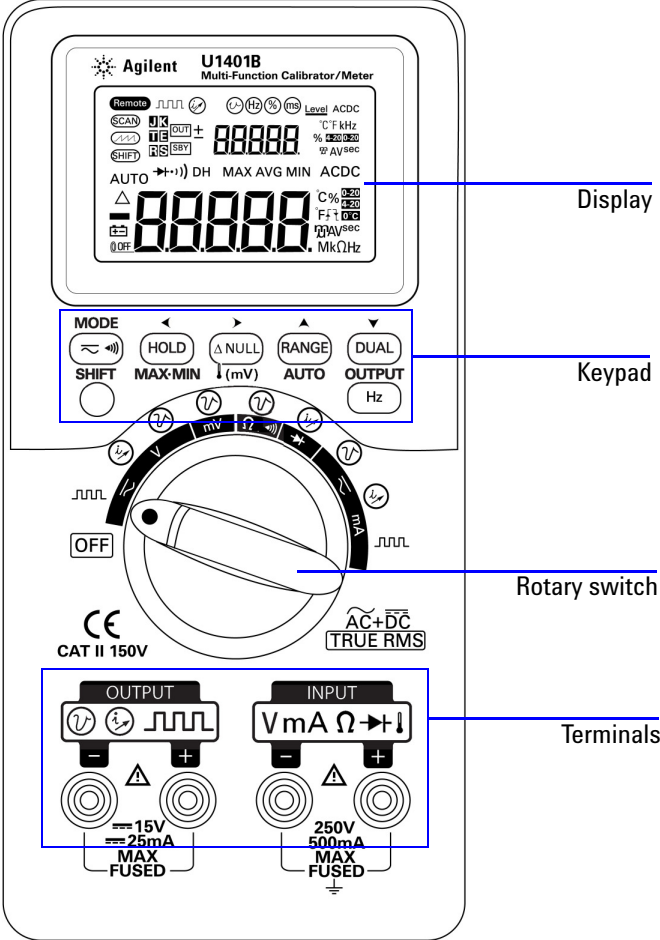

Figure 1-2 The front panel

The rotary switch at a glance

Before powering on the U1401A, set the slide switch to **M** or **M/S** position. To switch on the U1401A, turn the rotary switch to the desired function. The input and output functions are selected together. The outer circle indicates the *output (source)* function while the inner circle indicates the *input (meter)* function.

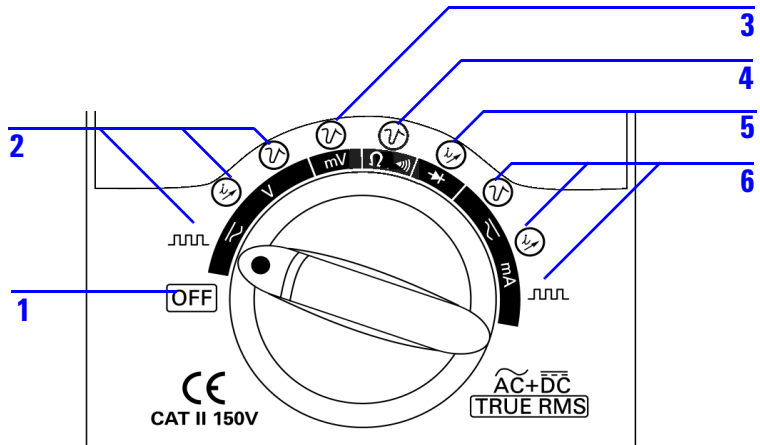

Figure 1-3 The rotary switch

Table 1-3 Rotary switch positions and their corresponding functions

No.	Description/Function	
	Input (white)	Output (orange)
1	OFF	—
2	DC, AC, or AC+DC voltage measurements	<ul style="list-style-type: none"> • Square wave output • Constant current: ± 25 mA • Constant voltage: ± 1.5 V, ± 15 V
3	DC, AC, or AC+DC mV measurements or temperature measurement	Constant voltage: ± 1.5 V, ± 15 V
4	Resistance measurement and continuity test	Constant voltage: ± 1.5 V, ± 15 V

Table 1-3 Rotary switch positions and their corresponding functions

No.	Description/Function	
	Input (white)	Output (orange)
5	Diode and continuity tests	Constant current: ± 25 mA
6	DC, AC, or AC+DC mA measurements: 50 mA or 500 mA	<ul style="list-style-type: none"> • Constant voltage: ± 1.5 V, ± 15 V • Constant current: ± 25 mA • Square wave output

The keypad at a glance

The operation of each key is shown below. A related annunciator appears on the display and the instrument beeps when a key is pressed. Turning the rotary switch to another position resets the present operation of the key.

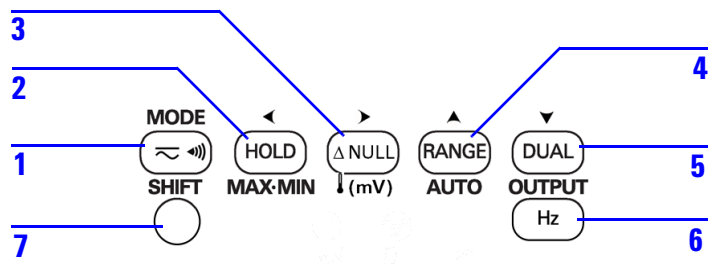
**Figure 1-4** Keypad functions

1 Getting Started

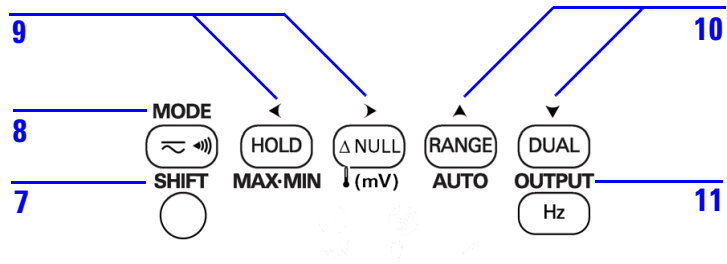

Figure 1-5 Keypad shifted functions

Table 1-4 Keypad functions

No.	Key	Function when pressed for less than one second	Function when pressed for more than one second
1		Selects DC, AC, or AC+DC	Toggles between peak hold ON or OFF for V and mA measurement
2	HOLD	If the data hold mode is enabled: Freezes the present measured value. Press again to trigger the next measured value.	Exits data hold mode ^[1]
		If the refresh hold mode is enabled: Enters or exits the refresh hold mode	—
	MAX MIN ^[2]	Cycles through MAX, MIN, AVG, and present (MAX AVG MIN) readings in dynamic recording mode	Enters or exits the dynamic recording mode ^[1]
3	Δ NULL	Saves the displayed value as a reference to be subtracted from subsequent measurements	Toggles between mV and temperature tests
4	RANGE	Changes measurement range	Sets to autorange
5	DUAL	Cycles through different combinations of primary and secondary displays	—
6	Hz	Selects frequency (Hz), duty cycle (%), or pulse width (ms) on the primary display	Exits selection

Table 1-4 Keypad functions (continued)

No.	Key	Function when pressed for less than one second	Function when pressed for more than one second
7	SHIFT	Enables and disables the shifted functions of the other keys	Toggles backlight ON/OFF
8 ^[3]	MODE	Selects output modes for constant voltage/constant current, autoscan and autoramp. Selects frequency (Hz), duty cycle (%), pulse width (ms), and level adjustments for square wave output.	Enters the adjustment mode (for autoscan and autoramp outputs).
9 ^[3]	◀ ▶	Selects a digit or the polarity to be adjusted. The selected digit/polarity will be flashing on the secondary display.	—
10 ^[3]	▲ ▼	Adjusts a digit or the polarity. Press to adjust the selected digit or toggle the output polarity.	—
11 ^[3]	OUTPUT	Toggles the output state on and off. OUT indicates that the signal is being generated and SBY indicates that the output has been disabled.	—

[1] When the HOLD key is pressed for more than one second, its function depends on the present state of the instrument. If the instrument is presently in the data hold mode, pressing this key for more than one second will exit the data hold mode; if the instrument is not in the data hold mode, pressing this key for more than one second will enter or exit the dynamic recording mode.

[2] Only applicable when the instrument is in the dynamic recording mode.











[3] Shifted functions.

Shifted functions

Every key (except the **SHIFT** key itself) has a shifted function. To access these shifted functions, you must first press **SHIFT**. After pressing **SHIFT**, the shifted functions will remain enabled (the LCD display will indicate **SHIFT**) until the **SHIFT** key is pressed again.

Throughout this manual, instructions that involve shifted functions will be given without explicit mention of the **SHIFT** key. Refer to **Table 1-5 on page 12** for a list of such instructions and what you will need to do.

Table 1-5 Instructions involving shifted functions

Instruction	Required actions
Press MODE	Press SHIFT ^[1] , then press  .
Press 	Press SHIFT ^[1] , then press  .
Press 	Press SHIFT ^[1] , then press  .
Press 	Press SHIFT ^[1] , then press  .
Press 	Press SHIFT ^[1] , then press  .
Press OUTPUT	Press SHIFT ^[1] , then press  .

^[1] If the shifted functions are not already enabled.

The display at a glance

To view the full display (with all segments illuminated), press (HOLD) while turning the rotary switch from OFF to any non-OFF position. After you are done viewing the full display, press any key to resume the normal function, depending on the rotary switch position.

The instrument will then enter power save mode if the auto power-off (@OFF) feature is enabled. To wake the instrument up, perform the following steps:

- 1 Turn the rotary switch (knob) to the OFF position;
- 2 Then turn the rotary switch to any position other than square wave output and press any key.

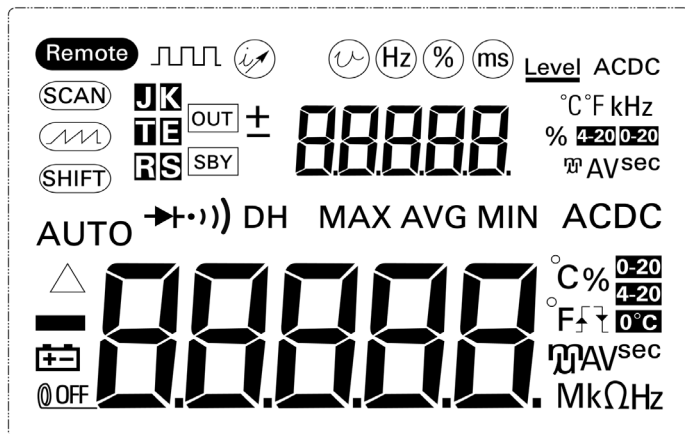

Figure 1-6 Full display

1 Getting Started

Table 1-6 Description of display annunciators











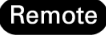















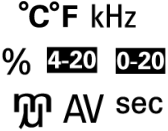
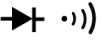

LCD display annunciator	Description
	Remote control
	Scan output
	Ramp output
	Shifted functions enabled
AUTO	Autorange
	Relative mode
	Low battery indication
	Auto power-off enabled
	Square wave output
	Frequency (Hz), duty cycle (%), pulse width (ms), and level for square wave output
	Constant current output
	Constant voltage output

Table 1-6 Description of display annunciators (continued)

LCD display annunciator	Description
	Thermocouple type for temperature test. The U1401B supports K-type thermocouple only.
	 Output enabled and  output disabled
	Secondary display for output and input
	Output or input units for secondary display
	Diode or audible continuity
	Audible continuity for resistance
DH	Trigger (manual) hold
MAXAVGMIN	Dynamic recording mode: Present value on primary display
MAX	Dynamic recording mode: Maximum value on primary display
AVG	Dynamic recording mode: Average value on primary display
MIN	Dynamic recording mode: Minimum value on primary display
ACDC	Alternating/direct current
	Primary display for input

1 Getting Started

Table 1-6 Description of display annunciators (continued)

LCD display annunciator	Description
°C % °F μV sec MΩ Hz	Input units for primary display
 	Square wave output. Positive  or negative  trigger slope
	Positive slope for pulse width (ms) and duty cycle (%) measurement
	Negative slope for pulse width (ms) and duty cycle (%) measurement
 	Percentage scale for 0 to 20 mA and 4 to 20 mA current measurement
	Without ambient temperature compensation

The terminals at a glance

WARNING

To avoid damaging this instrument, do not exceed the rated input limit.

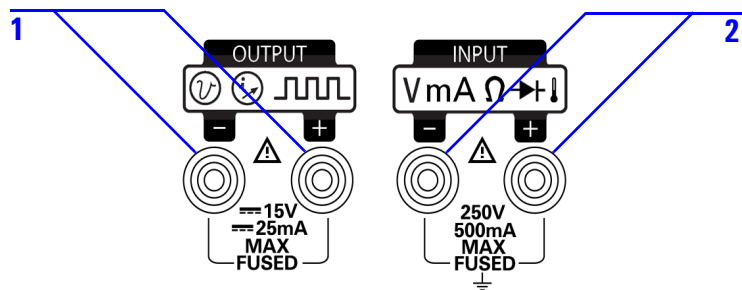

Figure 1-7 Terminals

Table 1-7 Description of terminals

No.	Description	Function
1	OUTPUT (Orange)	For constant voltage, constant current, and square wave output functions
2	INPUT (Grey-white)	For voltage, current, and resistance measurements, and diode and audible continuity tests

This instrument has four terminals. The two terminals for input functions are protected against overloads for the limits specified in [Table 1-8](#). The other two terminals are for output functions, with DC 30 V overload protection.

1 Getting Started

Table 1-8 Overload protection for the input terminals

Rotary switch position	Input terminal	Overload protection
AC/DC voltage range: 5 V to 250 V	+ and –	250 Vrms
AC/DC voltage range: 50 mV to 500 mV		
Ohm (Ω)		
Diode (\cdot))		
Temperature		
AC/DC current range: 50 mA to 500 mA		250 V/ 630 mA, fast-acting fuse

The rear panel at a glance

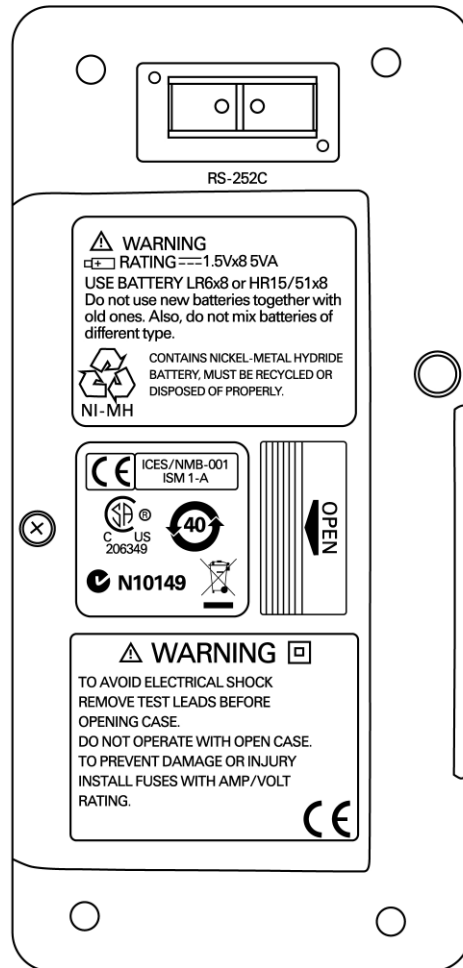

Figure 1-8 The rear panel

Display selection with the Hz key

The frequency measurement function is able to detect the presence of harmonic currents in neutral conductors and determines, whether these neutral currents are the result of unbalanced phases or non-linear loads. Press **Hz** to enter the frequency measurement mode for current or voltage measurements. The voltage or current values will be displayed on the secondary display and the frequency values on the primary display. Press this key again to step through frequency (Hz), duty cycle (%), or pulse width (ms). This allows simultaneous monitoring of real-time voltage or current with frequency, duty cycle, or pulse width.

After you press and hold **Hz** for more than one second, the primary display will revert to voltage or current measurement values.

Table 1-9 Measurement functions and corresponding display selection with the Hz key

Measurement function	Primary display	Secondary display
AC voltage	Frequency (Hz)	AC voltage
	Duty cycle (%)	
	Pulse width (ms)	
DC voltage	Frequency (Hz)	DC voltage
	Duty cycle (%)	
	Pulse width (ms)	
AC+DC voltage	Frequency (Hz)	AC+DC voltage
	Duty cycle (%)	
	Pulse width (ms)	
AC current	Frequency (Hz)	AC current
	Duty cycle (%)	
	Pulse width (ms)	

Table 1-9 Measurement functions and corresponding display selection with the Hz key (continued)

Measurement function	Primary display	Secondary display
DC current	Frequency (Hz)	DC current
	Duty cycle (%)	
	Pulse width (ms)	
AC+DC current	Frequency (Hz)	AC+DC current
	Duty cycle (%)	
	Pulse width (ms)	
Current in percentage scale (0 mA to 20 mA or 4 mA to 20 mA)	Frequency (Hz)	Current in percentage scale (0 mA to 20 mA or 4 mA to 20 mA)
	Duty cycle (%)	
	Pulse width (ms)	

Display selection with the DUAL key

Press **DUAL** to enable the dual display function, in which two separate parameters of the measured signal is displayed simultaneously on the primary and secondary displays. The dual display function is not available in dynamic recording or trigger mode. Refer to **Table 1-10**.

Table 1-10 Measurement functions and corresponding display selection with the DUAL key

Measurement function	Primary display	Secondary display
AC voltage	AC voltage	Hz (AC coupling)
DC voltage	DC voltage	Hz (DC coupling)
AC+DC voltage	AC+DC voltage	Hz (AC coupling)
DC current	DC current	Hz (DC coupling)
AC current	AC current	Hz (AC coupling)
AC+DC current	AC+DC current	Hz (AC coupling)
Current in percentage scale (0 mA to 20 mA or 4 mA to 20 mA)	Current in percentage scale (0 mA to 20 mA or 4 mA to 20 mA)	Hz (DC coupling)
Temperature	Celsius (°C)	Fahrenheit (°F)
	Fahrenheit (°F)	Celsius (°C)

Remote Communication

The U1401B has a bidirectional (full duplex) communication capability that makes it very easy to transfer data from the instrument to a PC.

The required accessory for this feature is an optional IR-USB cable, to be used with an application software that is downloadable from the Keysight Web site.

To communicate with the personal computer through remote communication:

- 1 Set up the communication parameters of the instrument and the personal computer you are using. The default values for baud rate, parity, data bits, and stop bit for the instrument are 9600, n, 8, and 1 respectively.
- 2 Make sure that the USB driver and the Keysight data logger software has been installed on your computer.

NOTE

You will need to download the Keysight data logger software from Keysight's website in order to use this feature. Please go to: <http://www.keysight.com/find/hhTechLib> to download the software.

- 3 Attach the optic side of the cable to the communication port on the instrument. Make sure that the text side is facing upwards. See [Figure 1-10 on page 25](#).
- 4 Plug the other end of the USB cable terminal into the USB port of your personal computer.
- 5 Use the data transfer software to retrieve the data that you need.
- 6 Press the flaps to remove the cable from the communication port of the instrument. See [Figure 1-11 on page 25](#).
- 7 It is not recommended to remove the connector cover of the IR-USB cable. But sometime, while pressing the flap to unplug the cable, the connector cover may come off accidentally as shown in [Figure 1-11 on page 25](#). To

1 Getting Started

reattach the cover, simply slip the cover over the connector. Make sure that the text on the cover is on the same side as the text on the top case of the connector. You will hear a click when the cover snaps properly into its place.



Figure 1-9 IR-USB cable

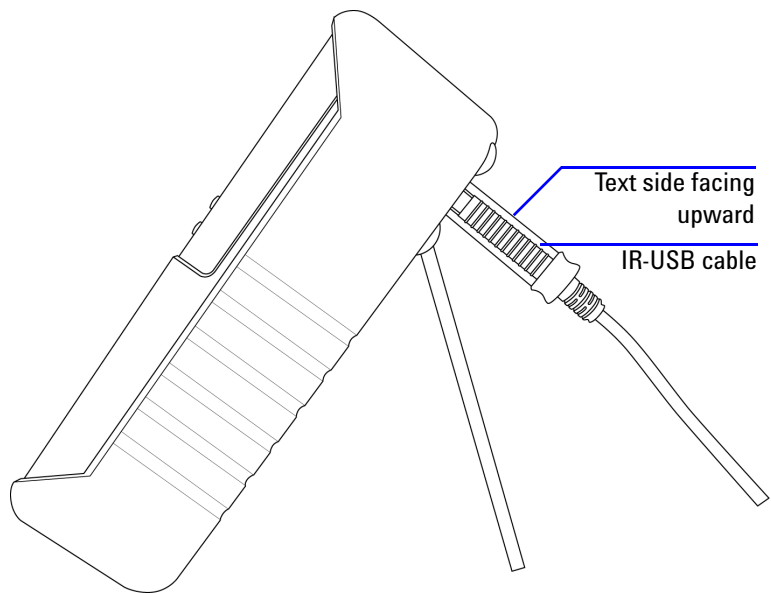

Figure 1-10 IR-USB cable connection

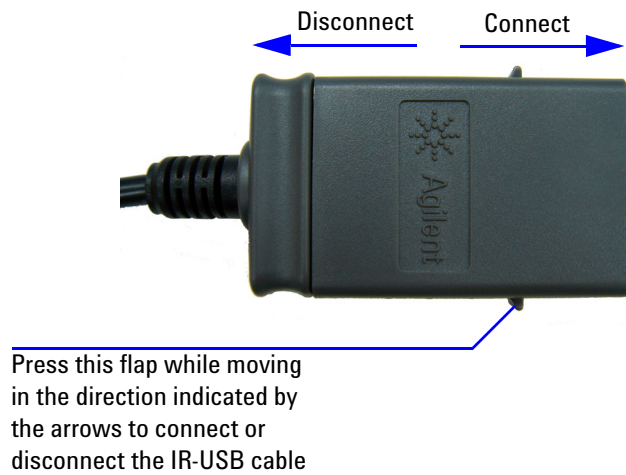

Figure 1-11 IR-USB cable

THIS PAGE HAS BEEN INTENTIONALLY LEFT BLANK.

2 Calibrator Output Operations

Enabling and Disabling the Output	28
Constant Voltage Operation	29
Constant Current Operation	30
Memory Generation	31
Autoscan output	31
Autoramp output	36
Square Wave Output	41

This chapters contains detailed information on how to generate signals using the U1401B.

Enabling and Disabling the Output

The U1401B can generate and measure signals simultaneously. Pressing the OUTPUT key disables the U1401B output by placing it in the standby mode. Pressing this key again toggles the output on.

When the output is in the standby mode, the **OUT** annunciator disappears and the **SBY** annunciator is displayed instead. This means the calibrator has stopped generating its output.













The standby mode will also be activated automatically if:

- you accidentally feed an external signal into the output terminals while the output function is enabled.
- the noise from an external power system or output terminals causes an error signal to the output. For example, when ESD is performed with a voltage of 8000 V, this instrument will go into standby mode.
- an overload condition has been detected when generating constant voltage or square wave outputs.
- the weak or low battery condition occurs. This ensures output quality and serves as another alert to let the user know that the energy level of the batteries is low.
- you put the slide switch into the **M** (input only) position (you should do this to conserve battery power if you do not intend to use any of the output functions).

Constant Voltage Operation

The U1401B can generate a constant voltage output in two different ranges, namely ± 1.5 V and ± 15 V.











To select the constant voltage output function:

- 1 Turn the rotary switch to any one of the  (constant voltage output) positions.
- 2 Press **SHIFT** to access the shifted operations of the keypad. The  annunciator will appear on the display.
- 3 Press **MODE** to cycle through ± 1.5 V, ± 15 V,  ± 1.5 V,  ± 15 V,  ± 1.5 V, and  ± 15 V output modes. Select either ± 1.5 V or ± 15 V for constant output (or steady output, as opposed to *autoscan* or *autoramp* outputs, which will be discussed under “**Memory Generation**” on page 31), depending on the voltage range you require.
 - Unlike the autoscan and autoramp modes, there is no special annunciator on the display to indicate constant voltage (CV) operation.
- 4 With the instrument in standby mode (you should see the  annunciator on the display; if not, press **OUTPUT**), you can adjust the amplitude of the output by pressing  and  to select the digit to be adjusted, and then pressing  and  to adjust the value of the selected digit.
- 5 Press **OUTPUT** to start the source output. The  annunciator will appear on the display.

Constant Current Operation

The U1401B can generate a constant current output in the range of ± 25 mA.

To select the constant voltage output function:











- 1 Turn the rotary switch to any one of the  (constant current output) positions.
- 2 Press **SHIFT** to access the shifted operations of the keypad. The  annunciator will appear on the display.
- 3 Press **MODE** to cycle through ± 25 mA,  ± 25 mA, and  ± 25 mA output modes. Select the ± 25 mA output mode for constant output (or steady output, as opposed to *autoscan* or *autoramp* outputs, which will be discussed under “Memory Generation” on page 31).
 - Unlike the autoscan and autoramp modes, there is no special annunciator on the display to indicate constant current (CC) operation.
- 4 With the instrument in standby mode (you should see the  annunciator on the display; if not, press **OUTPUT**), you can adjust the amplitude of the output by pressing  and  to select the digit to be adjusted, and then pressing  and  to adjust the value of the selected digit.
- 5 Press **OUTPUT** to start the source output. The  annunciator will appear on the display.

Memory Generation

For constant voltage and current outputs, the U1401B offers two additional useful functions. One is an *autoscan* output that is able to generate up to 16 different steps of constant voltage or current each with its own user-defined amplitude and time interval. The other one is an *autoramp* output with user-defined dual slopes and number of steps for linear simulation.

Autoscan output

To set the *autoscan* output:

- 1 Turn the rotary switch to any one of the  (constant current output) or  (constant voltage output) positions.
- 2 Press **SHIFT** to access the shifted operations of the keypad. The  annunciator will appear on the display.
- 3 Follow one of the instructions below:
 - For voltage output, press **MODE** to cycle through ± 1.5 V, ± 15 V,  ± 1.5 V,  ± 15 V,  ± 1.5 V, and  ± 15 V output modes. Select one of the two  output modes, depending on the voltage range you require.
 - For current output, press **MODE** to cycle through ± 25 mA,  ± 25 mA, and  ± 25 mA output modes. Select the  output mode.

- 4 After selecting the required **SCAN** function, press **◀** or **▶** to select one of three modes: Continuous, Cycle, or Step. The secondary display will indicate **Cont**, **CyCLE**, or **StEP** respectively (Figure 2-1 on page 34).
- **Continuous mode (Cont):** This mode will output a signal according to the amplitudes and time intervals defined in the memory, starting from step 1 until the step where the time interval is “00” second, then it will start again from step 1. For instance, according to the default settings (Table 2-1 on page 33), the output signal will follow step 1 through step 11, and then return to step 1 because the time interval of step 12 is “00” second.
 - **Cycle mode (CyCLE):** This is similar to the Continuous mode, but it steps the output through only one cycle. The output will vary according to the amplitudes and time intervals defined in the memory, starting from step 1 until the step where the time interval is “00” second. The output level will then be maintained at the amplitude of the last step before the zero-interval step. For instance, according to the default settings, the output signal will follow step 1 through step 11, and then remain at step 11.
 - **Step mode (StEP):** This is a step-by-step output mode. You can manually select which step of the user-defined signals you want to output. After selecting this mode, press **▲** or **▼** to select which step to output. The output amplitude will be maintained until you select another step as the output.
- 5 Press **OUTPUT** to start the source output. The **OUT** annunciator will appear on the display.

Continuous and Cycle outputs always start from step 1. If the time interval of step 1 is “00” second, the output level will be set to the amplitude of step 1 and the output status will be set to **SBY**. If you stop the signal output in the continuous or cycle mode, the next output step will start from step 1.

Table 2-1 Default settings for the autoscan output

Mode	SCAN ±1.5000 V		SCAN ±15.000 V		SCAN ±25.000 mA	
	Amplitude	Time interval	Amplitude	Time interval	Amplitude	Time interval
1	+1.5000 V	02 sec	+15.000 V	02 sec	+00.000 mA	02 sec
2	+1.2000 V	02 sec	+12.000 V	02 sec	+04.000 mA	02 sec
3	+0.9000 V	02 sec	+09.000 V	02 sec	+08.000 mA	02 sec
4	+0.6000 V	02 sec	+06.000 V	02 sec	+12.000 mA	02 sec
5	+0.3000 V	02 sec	+03.000 V	02 sec	+16.000 mA	02 sec
6	+0.0000 V	02 sec	+00.000 V	02 sec	+20.000 mA	02 sec
7	-0.3000 V	02 sec	-03.000 V	02 sec	+16.000 mA	02 sec
8	-0.6000 V	02 sec	-06.000 V	02 sec	+12.000 mA	02 sec
9	-0.9000 V	02 sec	-09.000 V	02 sec	+08.000 mA	02 sec
10	-1.2000 V	02 sec	-12.000 V	02 sec	+04.000 mA	02 sec
11	-1.5000 V	02 sec	-15.000 V	02 sec	+00.000 mA	02 sec
12	+0.0000 V	00 sec	+00.000 V	00 sec	+04.000 mA	00 sec
13	+0.0000 V	00 sec	+00.000 V	00 sec	+08.000 mA	00 sec
14	+0.0000 V	00 sec	+00.000 V	00 sec	+12.000 mA	00 sec
15	-1.5000 V	00 sec	-15.000 V	00 sec	+16.000 mA	00 sec
16	+0.0000 V	00 sec	+00.000 V	00 sec	+20.000 mA	00 sec

2 Calibrator Output Operations

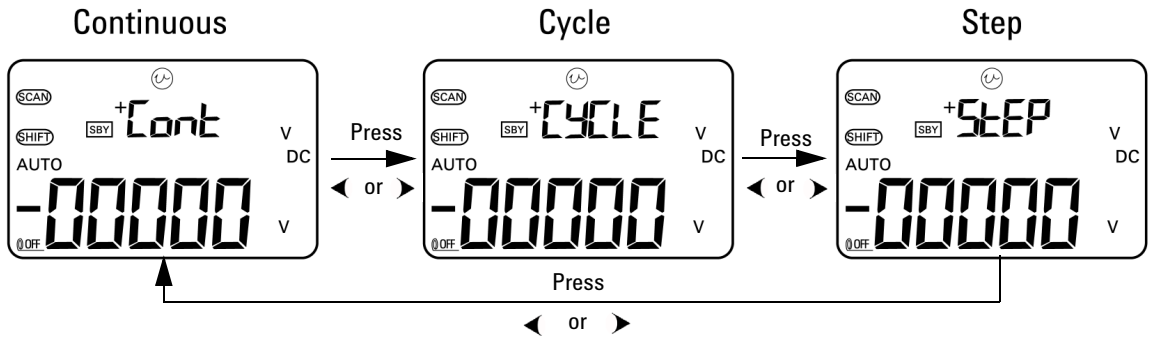

Figure 2-1 Selecting autoscan output mode

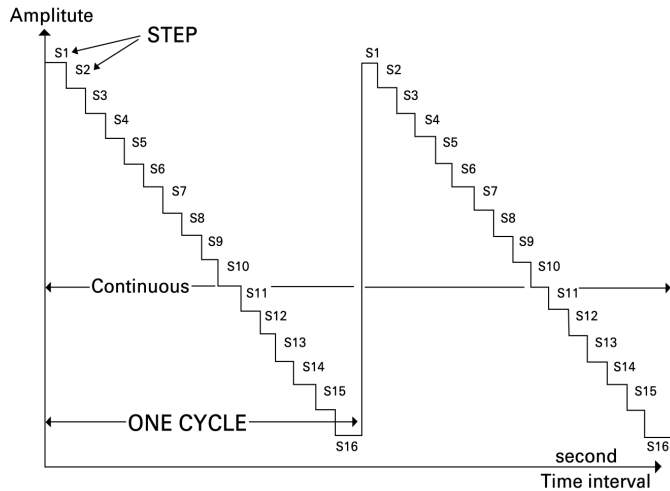

Figure 2-2 Example of a typical autoscan output

Defining the autoscan parameters in the memory

Press and hold **MODE** for more than one second to enter the autoscan adjustment mode. A total of 16 steps with individually definable time interval and amplitude are available.

When the instrument is in the autoscan adjustment mode, the secondary display shows the amplitude. The first two digits of the primary display are used to indicate which step is being adjusted. The last two digits of the primary display are used to indicate time interval.

- 1 Press **MODE** to cycle through step, time interval, and amplitude adjustments. The digit to be adjusted will flash on the display.
 - For amplitude adjustment, press ◀ and ▶ to select the digit to be adjusted, and then press ▲ and ▼ to adjust the value of the selected digit. The amplitude can be set to any value within the selected output range (± 1.5 V or ± 15 V for constant voltage output, ± 25 mA for constant current output).
 - For time interval adjustment, press ◀ and ▶ to select the digit to be adjusted, and then press ▲ and ▼ to adjust the value of the selected digit. The time interval can be set within the range of 0 to 99 seconds.
 - Press ▶ for more than one second to directly reset the time interval and amplitude of the present step to zero.

2 Press **OUTPUT** to save the settings.

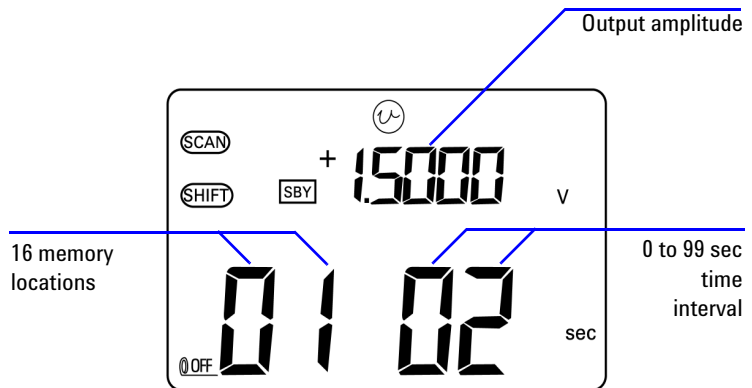

Figure 2-3 Defining the autoscan output

Autoramp output

To set the *autoramp* output:



















- 1 Turn the rotary switch to any one of the  or  positions.
- 2 Press **SHIFT** to access the shifted operations of the keypad. The  annunciator will appear on the display.
- 3 Follow one of the instructions below:
 - For voltage output, press **MODE** to cycle through ± 1.5 V, ± 15 V,  ± 1.5 V,  ± 15 V,  ± 1.5 V, and  ± 15 V output modes. Select either of the two  (*autoramp*) output modes, depending on the voltage range you require.
 - For current output, press **MODE** to cycle through ± 25 mA,  ± 25 mA, and  ± 25 mA output modes. Select the  output mode.

Table 2-2 Default settings for the autoramp output

Mode	 ±1.5000 V		 ±15.000 V		 ±25.000 mA	
Position	Amplitude	Resolution	Amplitude	Resolution	Amplitude	Resolution
Start	-1.5000 V	015 steps	-15.000 V	015 steps	-25.000 mA	025 steps
End	+1.5000 V	015 steps	+15.000 V	015 steps	+25.000 mA	025 steps

- 4 After selecting the required  function, press ◀ or ▶ to select one of two modes: Continuous or Cycle. The secondary display will indicate **Cont** or **CyCLE**, respectively (Figure 2-4 on page 38).
 - **Continuous mode (Cont):** In this mode, the ramp signal is repeated continuously. The signal will be generated according to the amplitudes and number of steps defined in the memory, with each step taking approximately 0.33 seconds. For instance, according to the default settings (Table 2-2), the step size of the positive slope is (end amplitude – start amplitude)/number of steps. Therefore, the step size is $(1.5\text{ V} - (-1.5\text{ V}))/15\text{ steps} = 0.2\text{ V}$ for  ±1.5000 V. The step size of the negative slope is (start amplitude – end amplitude)/number of steps. Therefore, the step size is $(-1.5\text{ V} - 1.5\text{ V})/15\text{ steps} = -0.2\text{ V}$ for  ±1.5000 V.
 - **Cycle mode (CyCLE):** In this mode, only one cycle of the ramp signal is generated. The signal will be generated according to the amplitudes and number of steps defined in the memory, with each step taking approximately 0.33 seconds, and then the output amplitude will be maintained at the final value of the ramp signal.
- 5 Press **OUTPUT** to start the source output. The  annunciator will appear on the display.

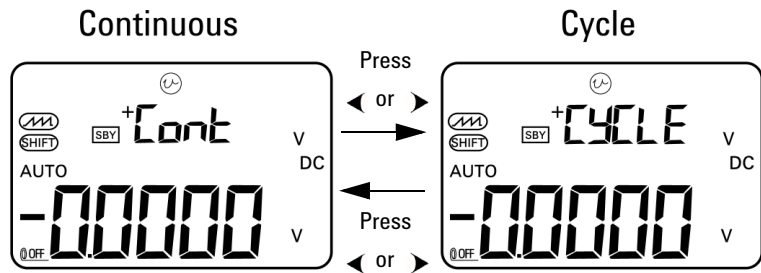

Figure 2-4 Selecting autoramp output mode

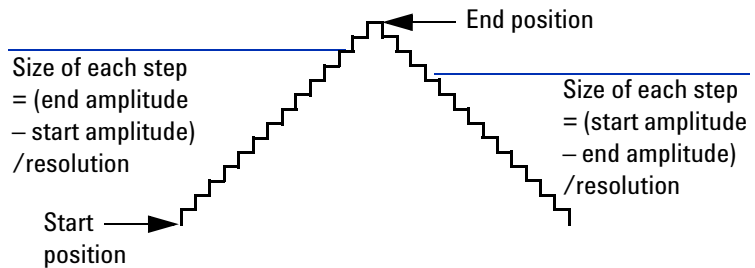

Figure 2-5 Ramp output

Defining the autoramp parameters in the memory

Press and hold **MODE** for more than one second to enter the autoramp adjustment mode. The ramp function is a dual slope output. You may adjust the number of steps between the start and end positions or the end and start positions, and the amplitudes of the start and end positions.

When the U1401B is in the autoramp adjustment mode, the secondary display shows the amplitude of the start or end position. The first digit on the left of the primary display is

used to indicate the start or end position. The last three digits of the primary display are used to indicate the number of steps (the number of steps from start to end).

- 1 Press **MODE** to cycle through position (start or end), number of steps, and amplitude adjustment. The digit to be adjusted will flash on the display.
 - For adjusting the amplitude, to adjust the value of the selected digit. The amplitude can be set to any value within the selected output range (± 1.5 V or ± 15 V for constant voltage output, ± 25 mA for constant current output).
 - For adjusting the number of steps, press ◀ and ▶ to select the digit to be adjusted, then press ▲ and ▼ to adjust the value of the selected digit. The number of steps can be set within the range of 0 to 999 steps.
 - Press ▶ for more than one second to directly reset the time interval and amplitude of the present step to zero.
- 2 Press **OUTPUT** to save the settings.

2 Calibrator Output Operations

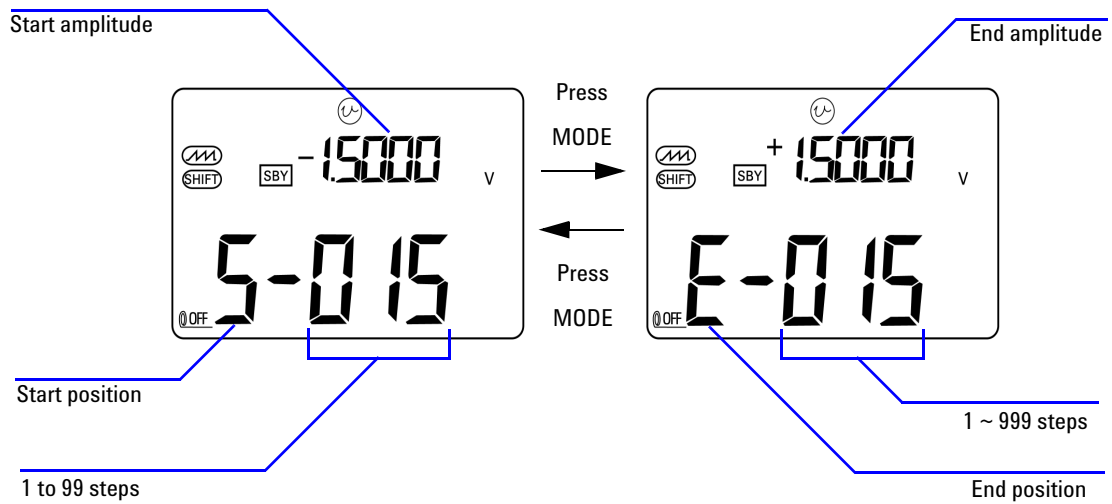

Figure 2-6 Defining the autoramp output

Square Wave Output

The square wave output can be used to generate a PWM (pulse width modulation) output or provide a synchronous clock source (baud rate generator). You can also use it to check and calibrate flow-meter displays, counters, tachometers, oscilloscopes, frequency converters, frequency transmitters, and other frequency input devices.

The frequency, amplitude, duty cycle, and pulse width of the square wave output are all adjustable.

To select the square wave output function:

- 1 Turn the rotary switch to the  position.
- 2 Press **SHIFT** to access the shifted operations of the keypad. The **SHIFT** annunciator will appear on the display.
 - The default settings for the parameters are 150 Hz (frequency), 50.00% (duty cycle), 3.3333 ms (pulse width), and +5 V (amplitude). See [Figure 2-7](#).
- 3 Press **OUTPUT** to output the square wave signal.

Table 2-3 Available frequencies

Frequency (Hz)
0.5, 1, 2, 5, 10, 15, 20, 25, 30, 40, 50, 60, 75, 80, 100, 120, 150, 200, 240, 300, 400, 480, 600, 800, 1200, 1600, 2400, 4800

There are 28 frequencies to choose from (See [Table 2-3](#)). To change the frequency:

- 1 Press **SHIFT** to access the shifted operations of the keypad. The **SHIFT** annunciator will appear on the display.
- 2 Press **MODE** to select frequency adjustment. The **Hz** annunciator will appear on the display.
- 3 Select the frequency by pressing **▲** or **▼**.
- 4 Press **OUTPUT** to output the signal.

2 Calibrator Output Operations

The duty cycle can be stepped through 256 equal steps, with each step equivalent to 0.390625%, and you can set its value from 1 to 255 steps (0.390625% to 99.609375%). However, the display can only indicate this to the nearest 0.01%.

To adjust the duty cycle:

- 1 Press **MODE** to select duty cycle adjustment. The $\text{\textcircled{\%}}$ annunciator will appear on the display.
- 2 Press \blacktriangle or \blacktriangledown to adjust the duty cycle.

The pulse width can be stepped through 256 equal steps, with each step being equal to $1/(256 \times \text{frequency})$. You can set its value from 1 to 255 steps.

To adjust the pulse width:

- 1 Press **MODE** to select pulse width adjustment. The $\text{\textcircled{ms}}$ annunciator will appear on the display.
- 2 Press \blacktriangle or \blacktriangledown to adjust the pulse width.

The amplitude can be set as +5 V, ± 5 V, +12 V, or ± 12 V.

To adjust the amplitude:

- 1 Press **MODE** to select amplitude adjustment. The **Level** annunciator will appear on the display.
- 2 Press \blacktriangle or \blacktriangledown to select the amplitude.

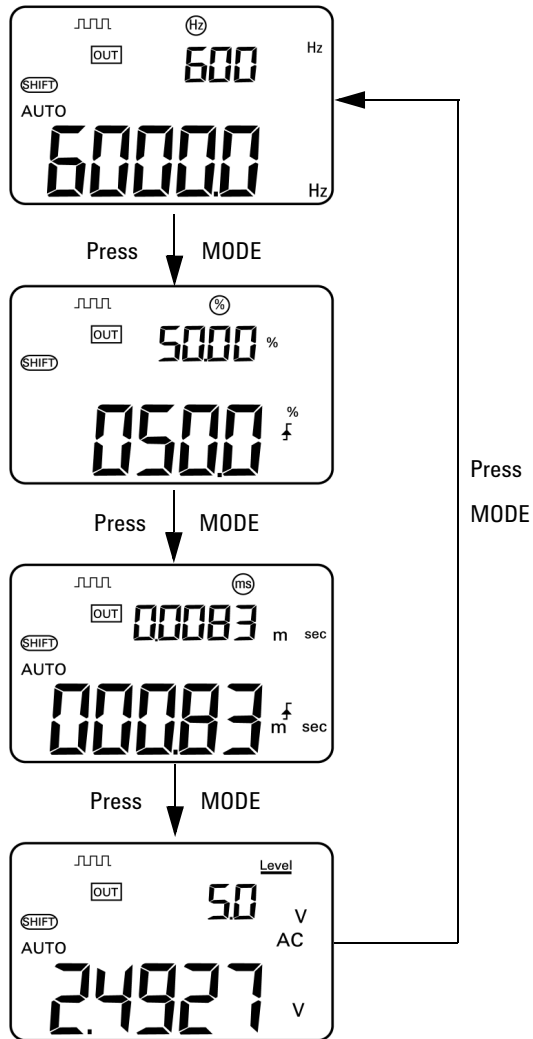

Figure 2-7 Parameter selection for square wave output

2 Calibrator Output Operations

THIS PAGE HAS BEEN INTENTIONALLY LEFT BLANK.

3 Making Measurements

Measuring Voltage	46
Measuring DC voltage	46
Measuring AC voltage	48
Measuring Current	49
DC mA measurement	49
Percentage scale of DC mA measurement	50
Measuring Temperature	51
Measuring Resistance and Testing Continuity	54
Alerts and Warning During Measurement	56
Overload alert for voltage measurement	56
Math Operations	57
Dynamic recording	57
Relative (zero)	60
Triggering Operations	61
Data hold (manual trigger)	61
Refresh hold (auto trigger)	62
1 ms peak hold	63

This chapter contains the detailed information on how measurements are taken using the U1401A.

Measuring Voltage

The U1401B performs true-rms AC measurements that are accurate for square waves without any DC offset.

WARNING

Make sure that the terminal connections are correct for a particular measurement before making the measurement. To avoid damaging the U1401A, do not exceed the rated input limit.

Measuring DC voltage

- 1 Turn the rotary switch to $\sim V$.
- 2 Press $\left(\sim \text{V}\right)$ to select DC voltage measurement.
- 3 Connect the red and black test leads to the positive and negative input terminals respectively (Figure 3-1 on page 47).
- 4 Probe the test points and read the display.

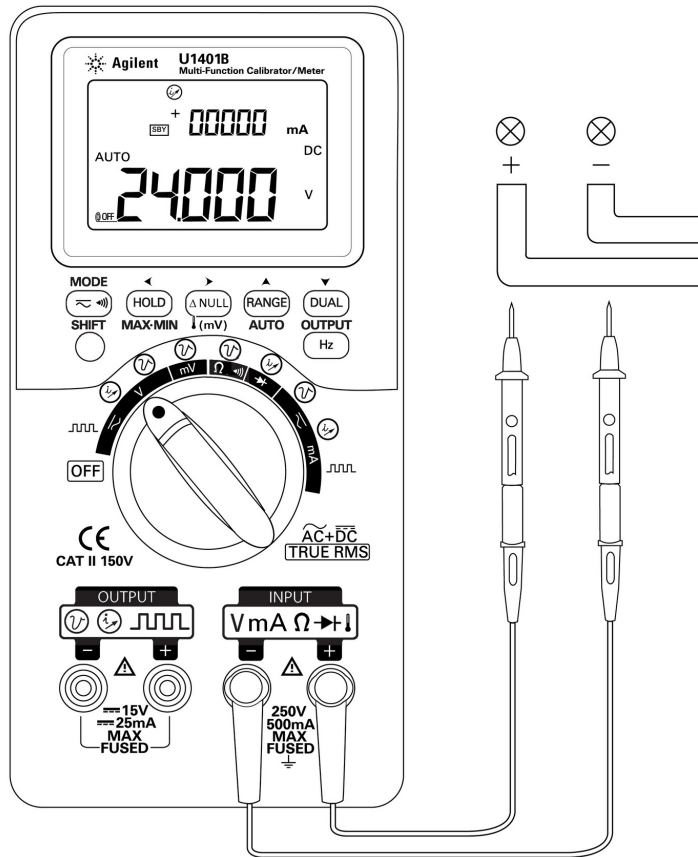

Figure 3-1 DC voltage measurement

Measuring AC voltage

- 1 Turn the rotary switch to $\sim V$.
- 2 Press $\left(\sim \right)$ to select AC voltage measurement.
- 3 Connect the red and black test leads to the positive and negative input terminals respectively (Figure 3-2).
- 4 Probe the test points and read the display.

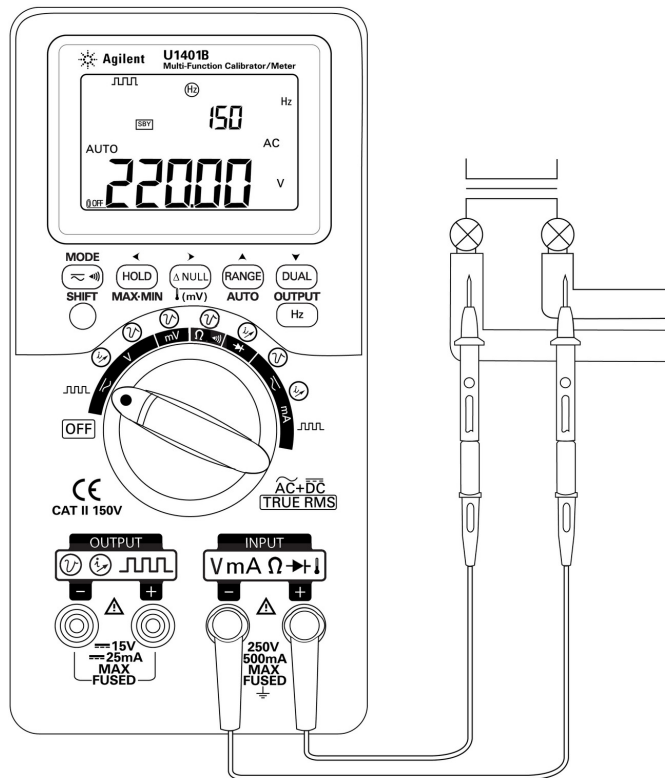

Figure 3-2 AC voltage measurement

Measuring Current

DC mA measurement

- 1 Turn the rotary switch to \sim mA .
- 2 Press $\left(\leftarrow \rightarrow\right)$ to select DC current measurement.
- 3 Connect the red and black test leads to the positive and negative input terminals respectively.
- 4 Probe the test points in series with the circuit and read the display (see [Figure 3-3](#)).

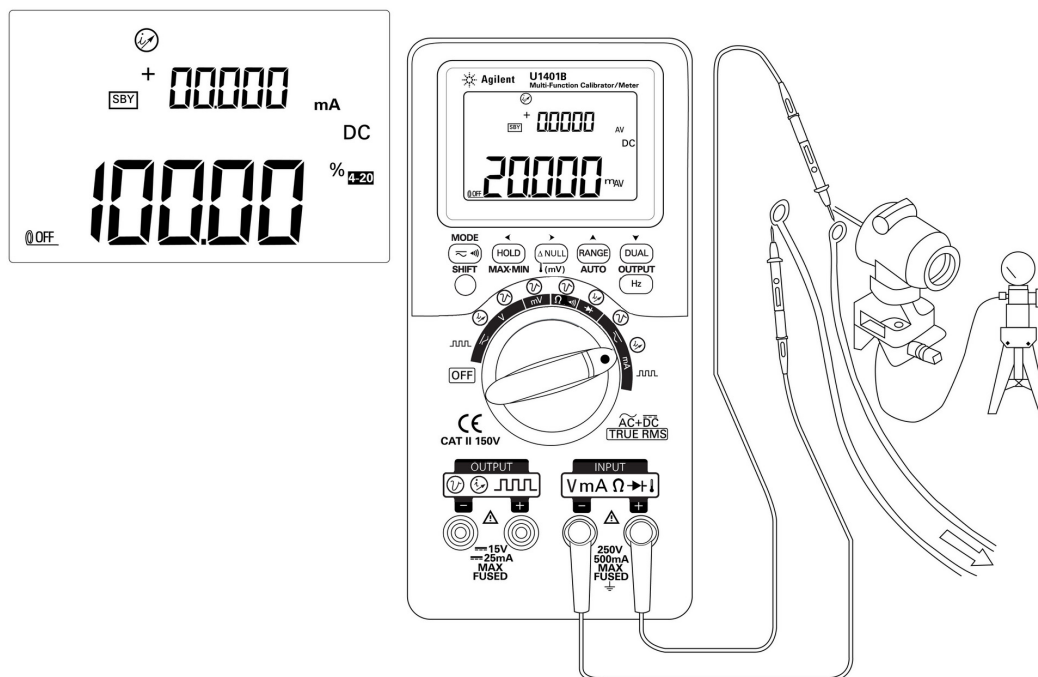

Figure 3-3 DC current (mA) measurement

Percentage scale of DC mA measurement

The percentage scale for 4 mA to 20 mA or 0 mA to 20 mA is calculated based on the measured DC mA value.

- 1 Select the required range (4 mA to 20 mA or 0 mA to 20 mA) in the Setup mode (refer to [Chapter 4, “Setting the percentage scale readout”](#)).
- 2 Turn the rotary switch to $\overline{\sim}$ mA .
- 3 Press $\overline{(\sim \text{m})}$ to select percentage scale display for DC mA measurement.
- 4 Connect the red and black test leads to the positive and negative input terminals respectively.
- 5 Probe the test points in series with the circuit and read the display. The inset display in [Figure 3-3](#) shows the percentage scale reading representing 20 mA in the range of 4 mA to 20 mA.

Measuring Temperature

CAUTION

Do not bend the thermocouple leads at sharp angles. Repeated bending over a period of time may break the leads.

The bead type thermocouple probe is suitable for measuring temperature from $-40\text{ }^{\circ}\text{C}$ to $204\text{ }^{\circ}\text{C}$ in PTFE compatible environments. Above this temperature range, probes may emit toxic gas. Do not immerse the thermocouple probe in any liquid. For best results, use a thermocouple probe designed for each specific application – an immersion probe for liquid or gel, and an air probe for air measurements. Observe the following measurement techniques:

- Clean the surface to be measured and make sure that the probe is securely touching the surface. Remember to disable the applied power.
- When measuring above the ambient temperature, move the thermocouple along the surface until you get the highest temperature reading.
- When measuring below the ambient temperature, move the thermocouple along the surface until you get the lowest temperature reading.
- Always set the slide switch to the **M** position (meter operation only). Place the instrument in the operating environment for at least one hour as the instrument is using a non-compensation transfer adapter with miniature thermal probe. If you are using the type of thermocouple probe where the thermal wires penetrate into the banana or lantern terminals, you only need to place the instrument in the operating environment for at least 15 minutes.
- For quick measurements, use the $0\text{ }^{\circ}\text{C}$ compensation to observe the temperature variation of the thermocouple sensor. The $0\text{ }^{\circ}\text{C}$ compensation makes it possible for you to measure the relative temperature immediately.

3 Making Measurements

To measure temperature, follow these steps:

- 1 Set the slide switch to the **M** position to disable the output.
- 2 Turn the rotary switch to the \sim mV position.
- 3 Press and hold Δ NULL for more than 1 second to select temperature measurement.
- 4 Plug the thermocouple adapter (with the thermocouple probe connected to it) into the positive and negative input terminals (**Figure 3-4 on page 53**).
- 5 Touch the surface to be measured with the thermocouple probe.
- 6 Read the display.

If you are working in a constantly varying environment, where the ambient temperature is not constant, follow these steps:

- 1 Press $\left(\overline{\sim}\right)$ to select 0 °C compensation. This allows a quick measurement of the relative temperature.
- 2 Avoid contact between the thermocouple probe and the surface to be measured.
- 3 After a constant reading is obtained, press Δ NULL to set the reading as the relative reference temperature.
- 4 Touch the surface to be measured with the thermocouple probe.
- 5 Read the display for the relative temperature.

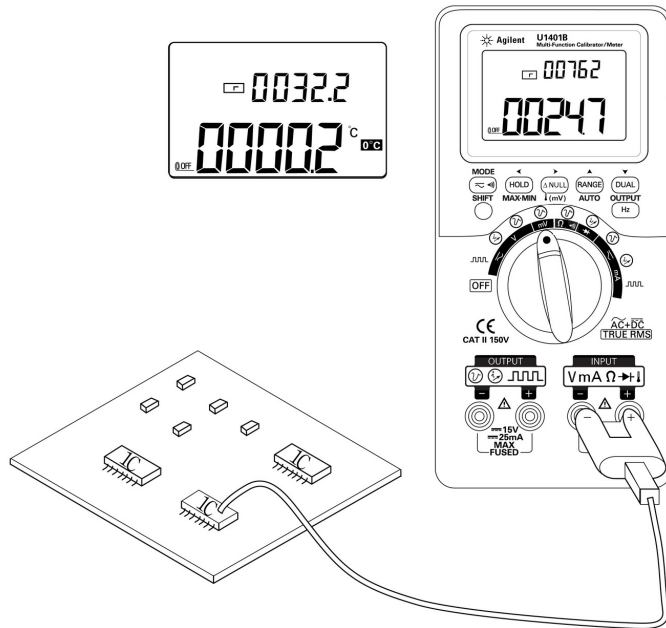



Figure 3-4 Surface temperature measurement

Measuring Resistance and Testing Continuity

CAUTION

Disconnect circuit power and discharge all high-voltage capacitors before measuring resistance to prevent possible damage to the instrument or the device under test.

To measure resistance, follow these steps:

- 1 Turn the rotary switch to the Ω  position.
- 2 Connect the red and black test leads to the positive and negative input terminals respectively.
- 3 Probe the resistor (or shunt) leads and read the display.

To perform continuity test, press  to toggle the audible continuity function ON or OFF.

For the 500 Ω range, the instrument will beep if the resistance value falls below 10 Ω . For other ranges, the instrument will beep if the resistance falls below the typical values indicated in the table below.

Table 3-1 Measurement ranges for audible continuity

Measurement range	Resistance threshold
500.00 Ω	10 Ω
5.0000 k Ω	100 Ω
50.000 k Ω	1 k Ω
500.00 k Ω	10 k Ω
5.0000 M Ω	100 k Ω
50.000 M Ω	1 M Ω

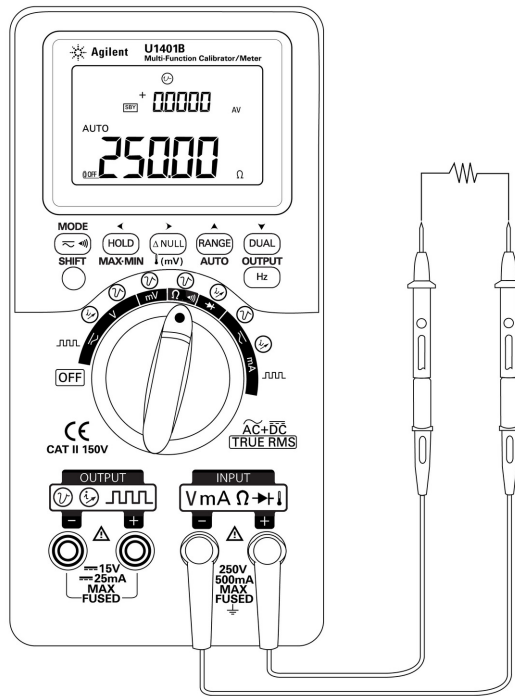

Figure 3-5 Resistance measurement

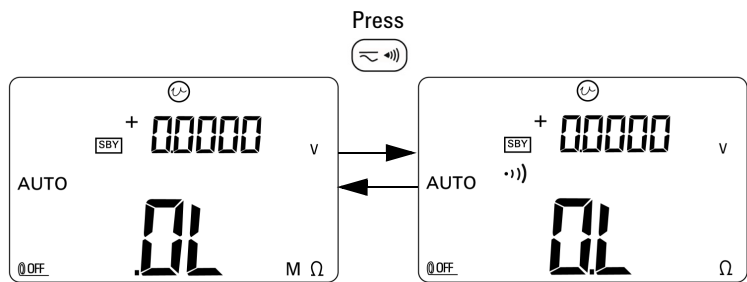

Figure 3-6 Enabling and disabling the continuity test

Alerts and Warning During Measurement

Overload alert for voltage measurement

WARNING

For your own safety, please do not ignore the overload alert. When the instrument gives you an overload alert, immediately remove the test leads from the source being measured.

This instrument provides an overload alert for voltage measurement in both auto and manual range modes. The instrument starts to beep periodically once the measured voltage exceeds 251 V. Immediately remove the test leads from the source being measured.

Math Operations

Dynamic recording

The dynamic recording mode can be used to detect intermittent turn-on or turn-off voltage or current surges, and to verify measurement performance without your supervision. While the readings are being recorded, you may perform other tasks.

The average reading is useful for smoothing out unstable inputs, estimating the percentage of time a circuit is operated, and verifying circuit performance.

The operating procedure is described below:

- 1** Press **MAX • MIN** for more than 1 second to enter the dynamic recording mode. The instrument is now in continuous mode (non-data hold mode), and the instrument will display the **MAX AVG MIN** annunciator and the present (instantaneous) reading.
 - The instrument will constantly calculate and update the average measured value in the memory.
 - Whenever a new maximum or minimum value is recorded, the instrument will beep once.
- 2** Press **MAX • MIN** to cycle through the maximum, minimum, average and present readings. The **MAX**, **MIN**, **AVG**, or **MAX AVG MIN** annunciator will appear to indicate which value is being displayed. See [Figure 3-7 on page 59](#).
 - While you are viewing the recorded maximum, minimum, or average readings, the instrument will continue to measure or calculate and update these values.
- 3** Press **MAX • MIN** for more than 1 second to exit the dynamic recording mode.

3 Making Measurements

NOTE

- If an overload condition occurs, the averaging function will stop. The recorded average value becomes **OL** (overload).
 - In dynamic recording, the auto power off feature will be disabled. This is indicated by the absence of the **⓪OFF** annunciator on the display.
 - When performing dynamic recording in autorange, the maximum, minimum, and average readings may be recorded in different ranges.
 - The recording interval in manual range is approximately 0.067 seconds.
 - The average value is the true average of all measured values taken since the recording mode was activated.
-

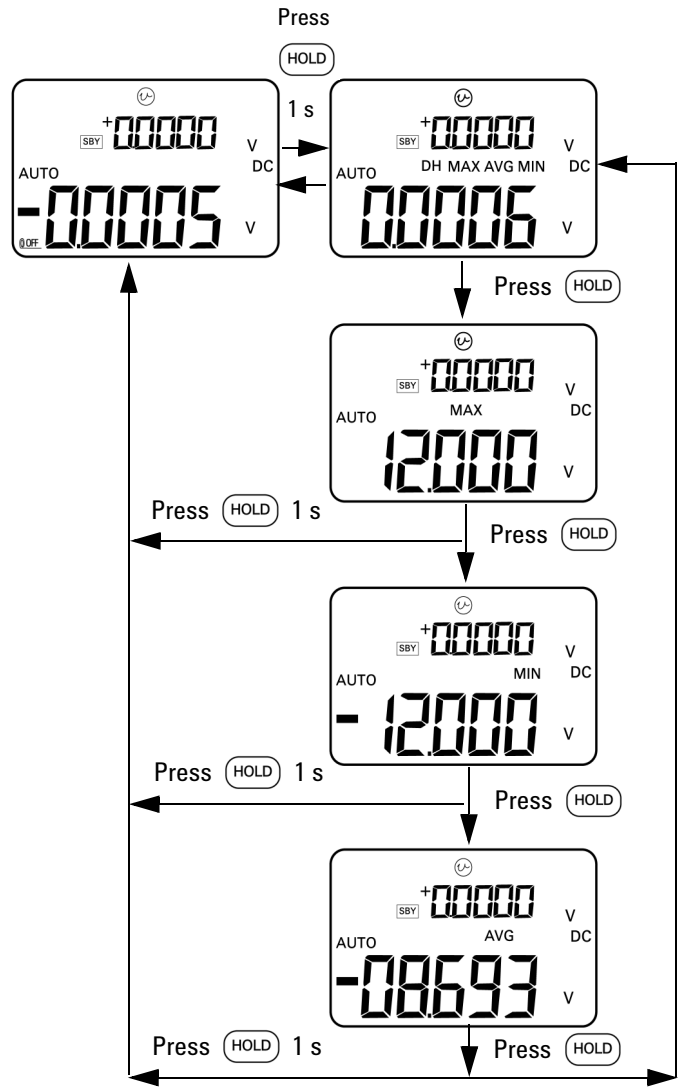

Figure 3-7 Dynamic recording mode

Relative (zero)

The relative function subtracts a stored value from the present measured value and displays the difference.

- 1 Press Δ NULL to store the currently displayed reading as the reference value to be subtracted from subsequent measurements. The Δ annunciator will be displayed.
- 2 The relative mode can be activated in both auto and manual ranges, but it cannot be set if the present reading is overload (OL).
- 3 Press Δ NULL to exit the relative mode.

There are two possible applications:

- For a resistance measurement, the display will read a non-zero value even when no measurement is being taken, due to the resistance of the test leads. You can use the relative function to zero-adjust the reading.
- For a DC voltage measurement, the thermal effect will influence the accuracy. Use the relative function to offset the thermal effect. Short the test leads and press Δ NULL when the displayed value has settled down to a stable state.

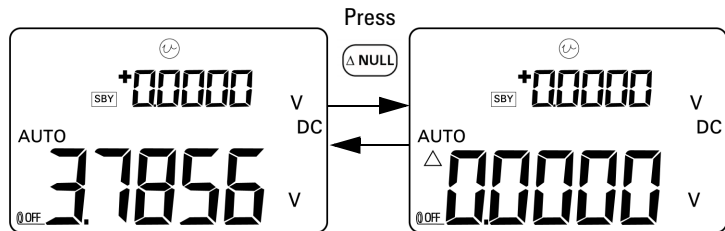

Figure 3-8 Relative (zero) mode

Triggering Operations

Data hold (manual trigger)

The data hold mode allows you to hold the displayed value.

- 1 Press **HOLD** to freeze the currently displayed value and enter the manual trigger mode. The **DH** annunciator will appear on the display.
- 2 Press the key again to trigger another new measured value and update the display. The **DH** annunciator will flash momentarily before the new update.
- 3 Press **HOLD** for more than one second to exit this mode.

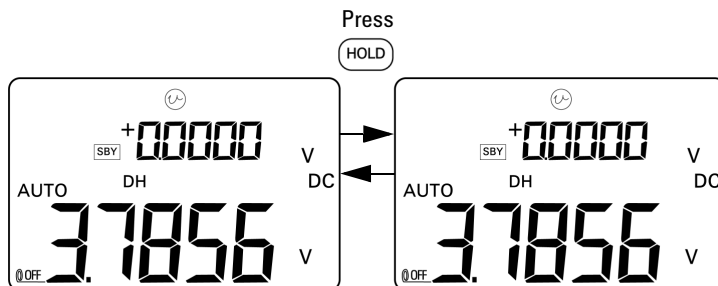

Figure 3-9 Data hold mode

Refresh hold (auto trigger)

The refresh hold mode freezes the displayed value until the reading variation exceeds the specified number of counts.

This function will autotrigger and update the held value with a new measured value. When a new value is updated, the instrument will beep once as a notification. The keypad operation is similar to the operation of data hold mode.

- 1 Make sure the refresh hold mode is enabled in the setup mode.
- 2 Press **HOLD** to enter the refresh hold mode.
 - The present value will be held and the **DH** annunciator will appear on the display.
 - It will be ready to hold the new measured value once the variation of the instantaneous reading exceeds the preset variation count (defined in setup mode); while it waits for a stable new reading, the **DH** annunciator will flash.
 - The **DH** annunciator will stop flashing once a stable new reading is available, and then the new value will be updated to the display. The instrument will beep once as a notification.
- 3 Press **HOLD** to exit this mode.





For voltage and current measurements, the held value will not be updated if the variation of the reading is below 500 counts. For resistance and diode measurements, the held value will not be updated if the reading is **OL** or open. For all measurements, the held value will not be updated if the reading cannot reach a stable state.

1 ms peak hold

This function allows the measurement of peak voltage for analysis of components such as power distribution transformers and power factor correction capacitors. The peak voltage obtained can be used to determine the crest factor.

Crest factor = Peak value/True-rms value

To measure the half-cycle peak voltage:

- 1 Press  for more than one second to toggle 1 ms peak hold mode on or off.
- 2 Press  to show the peak+ or peak- value after activating the peak mode. The **DH MAX** annunciator indicates the peak+ value while the **DH MIN** annunciator indicates the peak- value. See [Figure 3-10 on page 64](#).
- 3 If the reading is **OL**, press  to change the measurement range and restart the peak value measurement.
- 4 While the peak hold mode is on, you can press  at any time to restart the peak value measurement.

3 Making Measurements

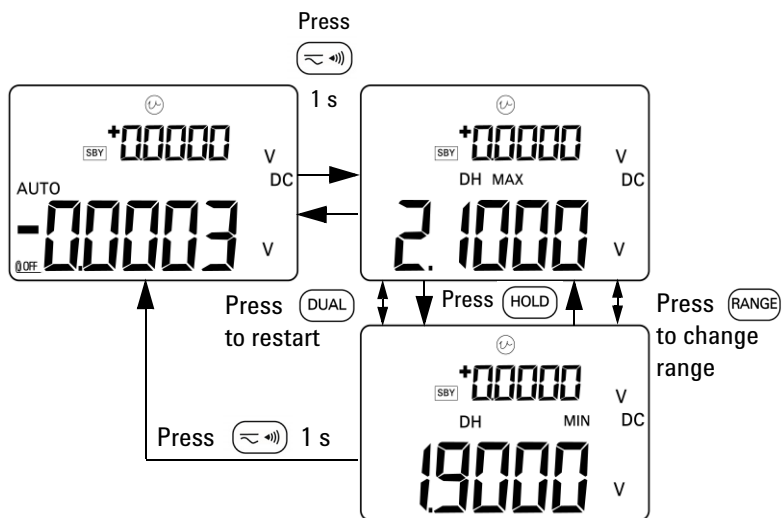

Figure 3-10 1 ms peak hold mode

4 Changing the Default Settings

Entering the Setup Mode	66
Available Setting Options	68
Setting the data hold/refresh hold mode	69
Setting the temperature unit	71
Setting the beeper frequency	73
Setting the minimum measurable frequency	74
Setting the percentage scale readout	75
Setting the print mode	76
Setting the echo mode	77
Setting the data bit	78
Setting the parity check	79
Setting the baud rate	80
Setting the display backlight timer	81
Setting the power saving mode	82

This chapter describes how to change the default settings of the U1401B.

Entering the Setup Mode

To enter the setup mode, perform the following steps:

- 1 Turn the instrument off.
- 2 From the OFF position, turn the rotary switch to any non-OFF position while pressing and holding .

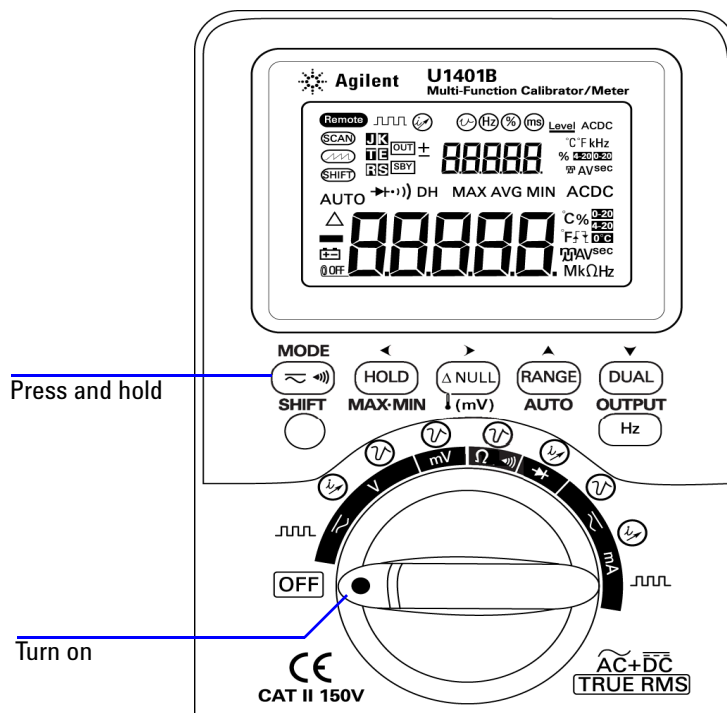



Figure 4-1 Entering the setup mode

- 3 To configure a menu item in the setup mode, perform the following steps:
 - i Press ◀ or ▶ to scroll through the available menu items.
 - ii Press ▲ or ▼ to change or select the setting. See [Table 4-1 on page 68](#) for details on the available options.
 - iii Press  to save the changes. These parameters will remain in the non-volatile memory.
- 4 Press **SHIFT** for more than one second to exit the setup mode.

Available Setting Options

Table 4-1 Setup options and default settings

Menu item		Available setting options		Default factory setting
Display	Description	Display	Description	
rhoLd	Data Hold/ Refresh Hold	OFF	Enables data hold (manual trigger)	OFF
		100–1000	Sets the variation count for refresh hold (auto trigger)	
tEMP	Temperature ^[1]	<ul style="list-style-type: none"> • d-C • d-CF • d-F • d-FC 	Selects the temperature unit Four combinations can be selected: <ul style="list-style-type: none"> • °C only • °C/ °F • °F only • °F/ °C 	d-C
bEEP	Beep	4800 Hz, 2400 Hz, 1200 Hz, 600 Hz	Sets the beeper frequency	4800 Hz
		OFF	Disables the beeper	
FrEq	Minimum frequency measurement	0.5 Hz, 1 Hz, 2 Hz	Sets the minimum frequency that can be measured	0.5 Hz
PECnt	Percentage scale	4–20mA 0–20mA	Selects which percent scale readout is used	4-20 mA
Print	Print	On or OFF	ON: Enables automatic and continuous transmission of data to PC	OFF
Echo	Echo	On or OFF	ON: Enables the return of characters to PC in remote communication	OFF
dAtAAb	Data bit	8bit or 7bit (Stop bit is always 1bit)	Sets the data bit length for remote communication with a PC (remote control)	8bit

Table 4-1 Setup options and default settings (continued)

Menu item		Available setting options		Default factory setting
Display	Description	Display	Description	
PArY	Parity	En, odd, or nonE	Sets even, odd, or no parity check for remote communication with a PC (remote control)	nonE
bAud	Baud rate	2400 Hz, 4800 Hz, 9600 Hz, 19200 Hz	Sets baud rate for remote communication with a PC (remote control)	9600 Hz
bLit	Display backlight timer	1 to 99 s	Sets the timer for automatically turning off the LCD display backlight	30 sec
		OFF	Disables the LCD display backlight from automatically turning off	
AoFF	Auto power off	1 to 99 min	Sets the timer for auto power off	15 min
		OFF	Disables auto power off	

[1] The temperature menu item will only be visible and selectable if the shifted mode is on. Press **SHIFT** for more than one second to enable the temperature options.

Setting the data hold/refresh hold mode

- To enable the data hold mode (manual trigger), set this parameter as “OFF”.
- To enable the refresh hold mode (automatic trigger), set the variation count within the range of 100 to 1000. Once the variation of the measured value exceeds this preset variation count, the refresh hold mode will be ready to trigger and update a new value.

4 Changing the Default Settings

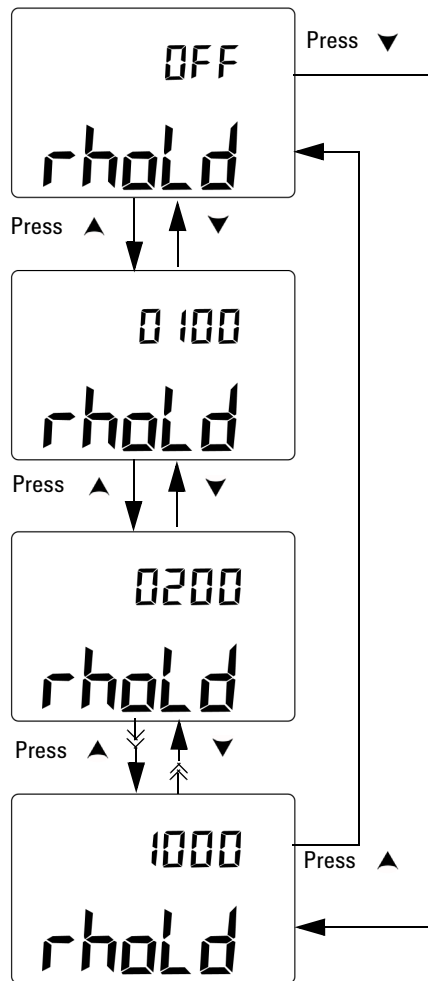

Figure 4-2 Setting the data hold or refresh hold mode

Setting the temperature unit

Four combinations of temperature unit display are available:

- Celsius only (°C on the primary display)
- Celsius (°C) on the primary display and Fahrenheit (°F) on the secondary display (for dual display setting).
- Fahrenheit only (°F on the primary display)
- Fahrenheit (°F) on the primary display and Celsius (°C) on the secondary display (for dual display setting).

4 Changing the Default Settings

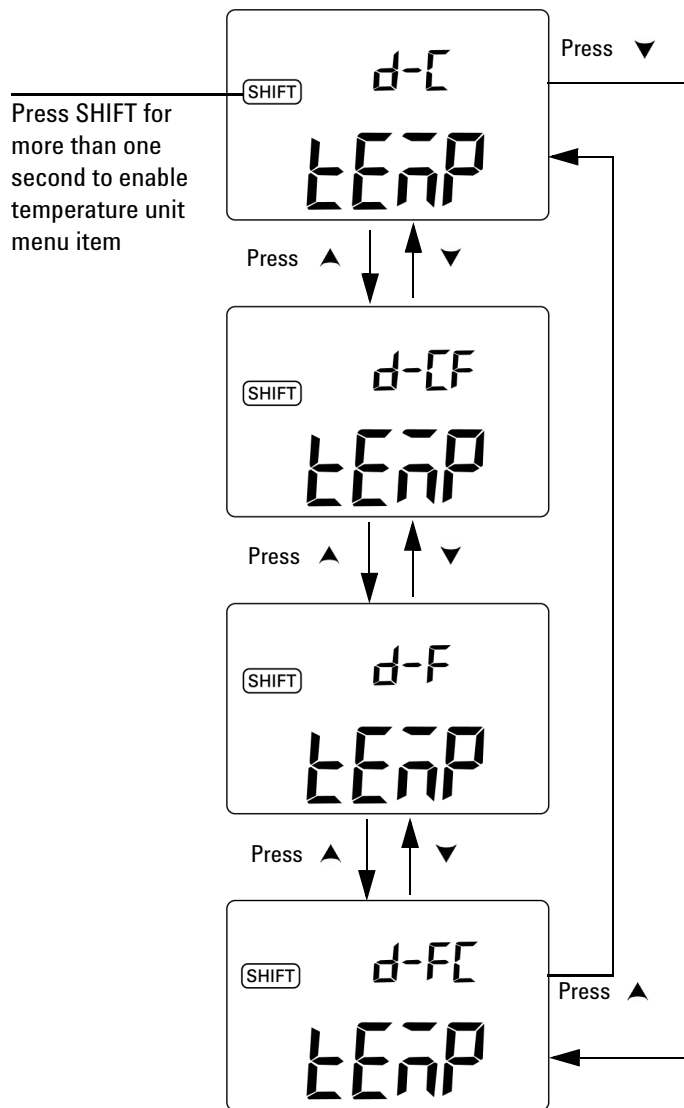

Figure 4-3 Setting the temperature unit

Setting the beeper frequency

The beeper frequency can be set to 4800 Hz, 2400 Hz, 1200 Hz, or 600 Hz. "OFF" means the beeper is disabled.

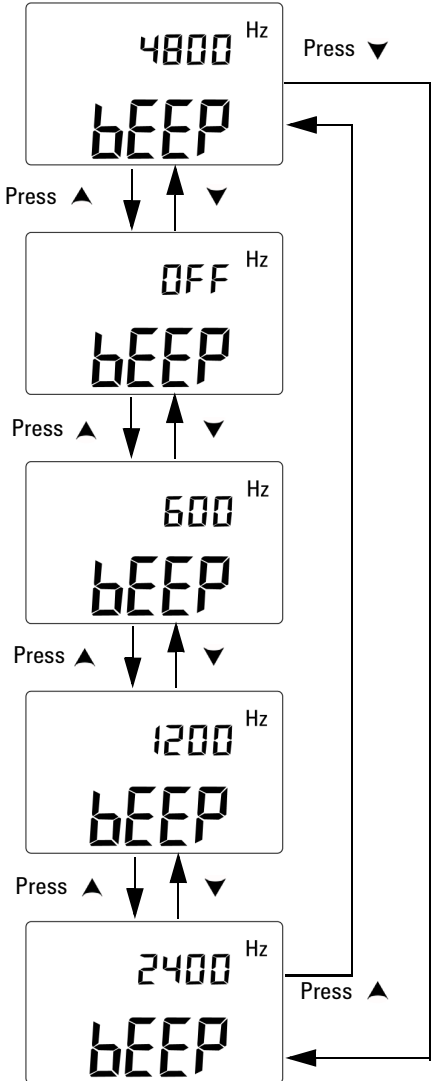

Figure 4-4 Setting the beeper frequency

Setting the minimum measurable frequency

This setting will influence the measurement rates for frequency, duty cycle, and pulse width. The typical measurement rate as defined in the general specifications is based on a minimum frequency of 1 Hz.

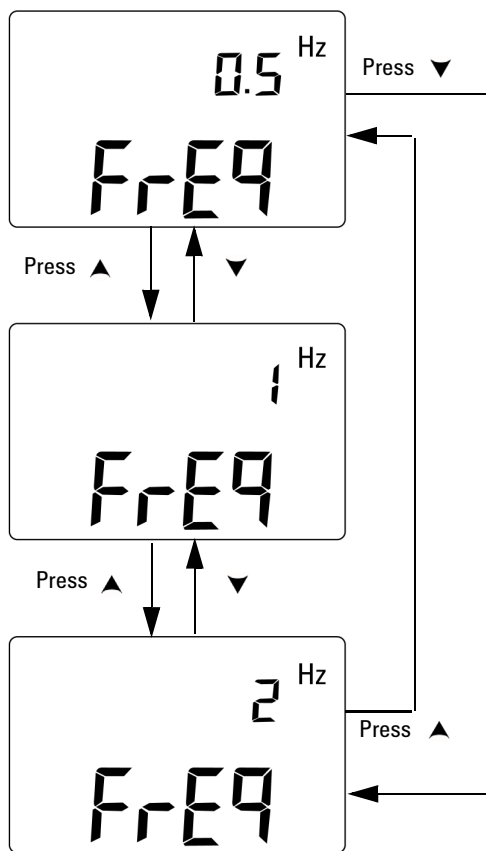

Figure 4-5 Setting the minimum frequency

Setting the percentage scale readout

This function converts the DC current measurement display to a percentage scale readout from 0% to 100% based on a range of 4 mA to 20 mA or 0 mA to 20 mA. For example, a 25% readout represents DC 8 mA for the 4 mA to 20 mA range, or DC 5 mA for the 0 mA to 20 mA range.

You may choose between the two available ranges.

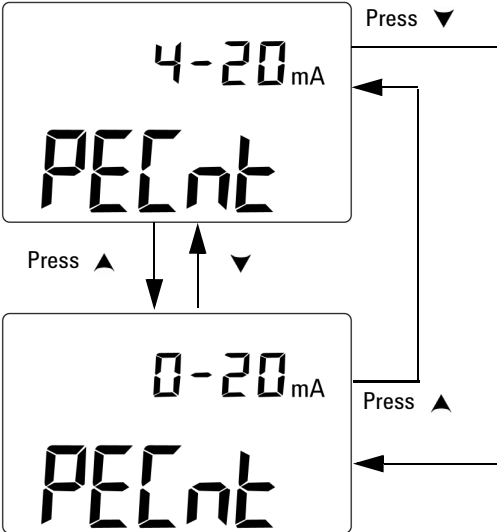

Figure 4-6 Setting the percentage scale readout

Setting the print mode

Setting this feature *on* enables the printing of measured data to a PC (connected to the instrument for remote communication) when a measurement cycle is completed.

In this mode, the instrument automatically and continuously sends the latest data to the host, but does not accept any commands from the host. The **Remote** annunciator flashes during the Print operation.

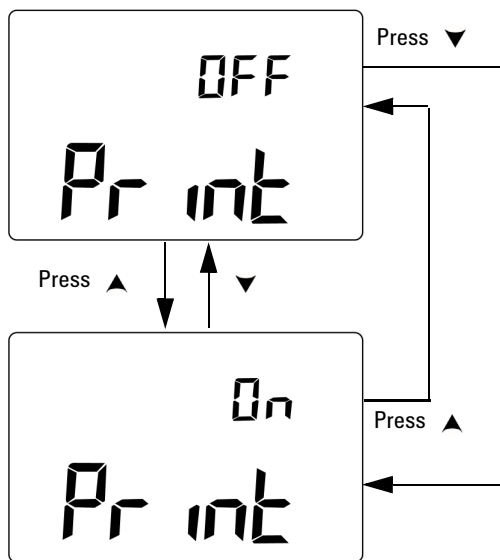

Figure 4-7 Setting the print mode for remote control

Setting the echo mode

Setting this feature *on* enables the return of characters to a PC in remote communication, which is useful when developing PC programs with SCPI commands.

NOTE

- This mode is for internal use by Keysight Technologies only.
- During normal operation, it is recommended that you disable this function.

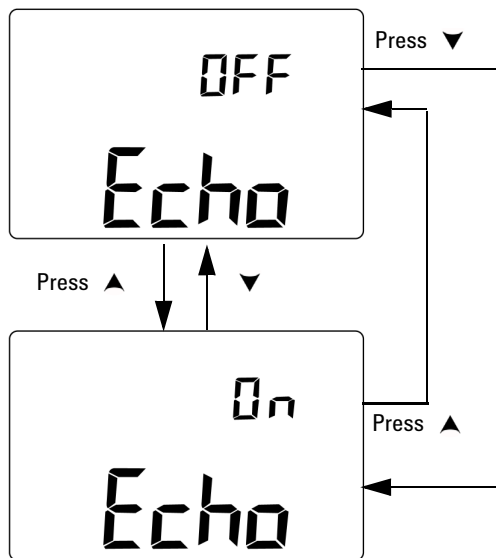

Figure 4-8 Setting the echo mode for remote control

Setting the data bit

The number of data bits (data width) for remote communication with a PC can be set to either 8 bits or 7 bits. There is only one stop bit, which cannot be changed.

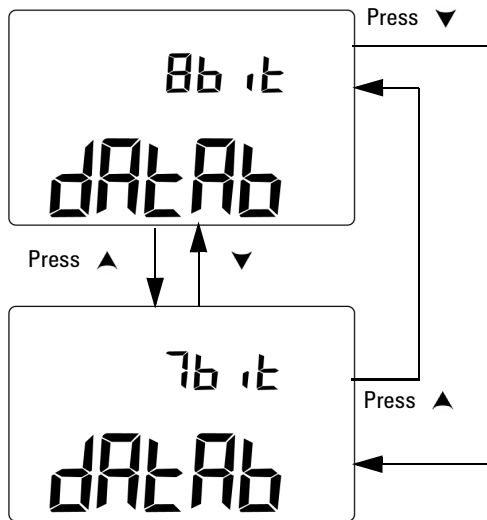

Figure 4-9 Setting the data bit for remote control

Setting the parity check

The parity check for remote communication with a PC can be set to either none, even, or odd.

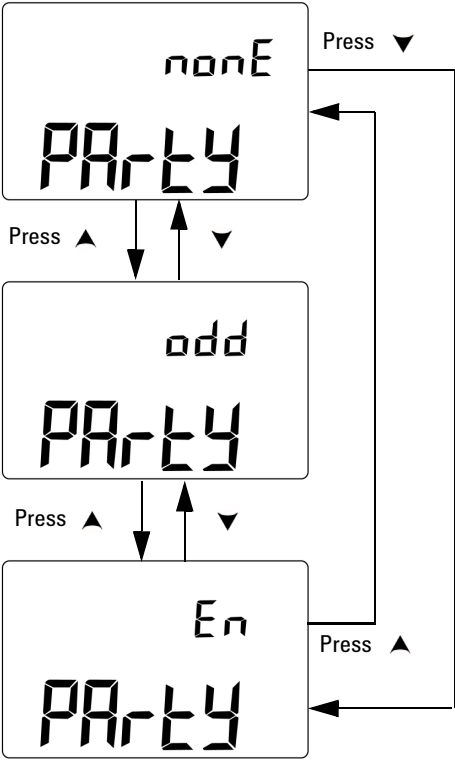

Figure 4-10 Setting the parity check for remote control

Setting the baud rate

The baud rate used in the remote communication with a PC can be set as 2400 Hz, 4800 Hz, 9600 Hz, or 19200 Hz.

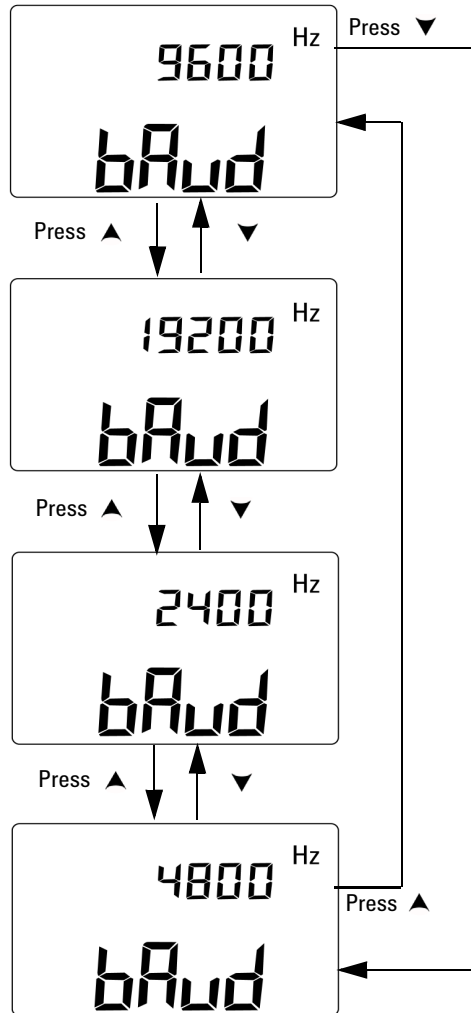

Figure 4-11 Setting the baud rate for remote control

Setting the display backlight timer

The display backlight timer can be set from 1 to 99 seconds. The backlight turns off automatically after the set period. "OFF" means the backlight will not turn off automatically.

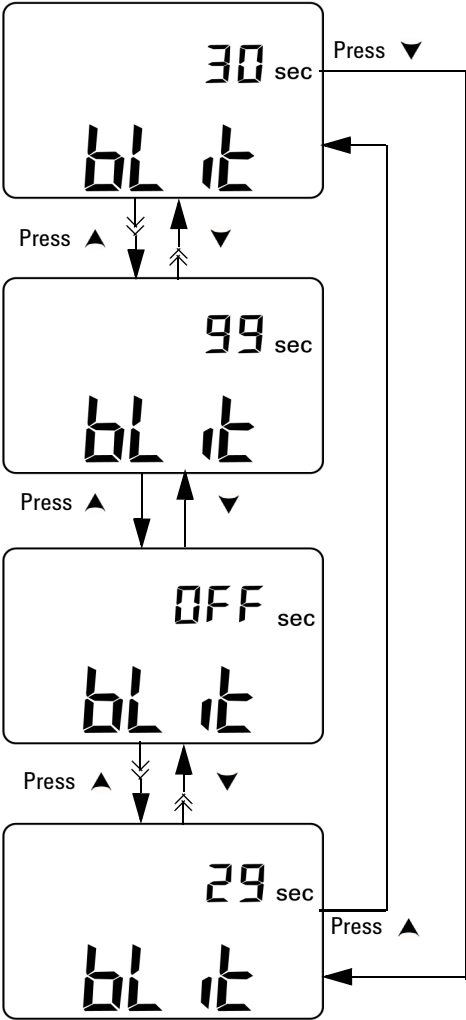

Figure 4-12 Setting the display backlight timer

Setting the power saving mode

To enable auto power-off, set this timer to any value from 1 to 99 minutes.

This feature is incorporated for power saving. The instrument will automatically turn off after the specified period of time, if none of the following happens within that period:

- A key on the keypad is pressed
- A measurement function is changed
- The dynamic recording mode is activated
- The 1 ms peak hold mode is activated
- The auto power-off feature has been disabled in the setup mode
- The output has been enabled (the **OUT** annunciator is displayed)

To reactivate the instrument after auto power-off, turn the rotary switch to the OFF position and then turn it on again.

If the instrument is to be used for a long period of time, you may want to disable the auto power-off feature. When the auto power-off feature is disabled, the **OFF** annunciator will not be shown on the display. The instrument will remain on until you manually turn the rotary switch to the OFF position, or until the batteries run flat.

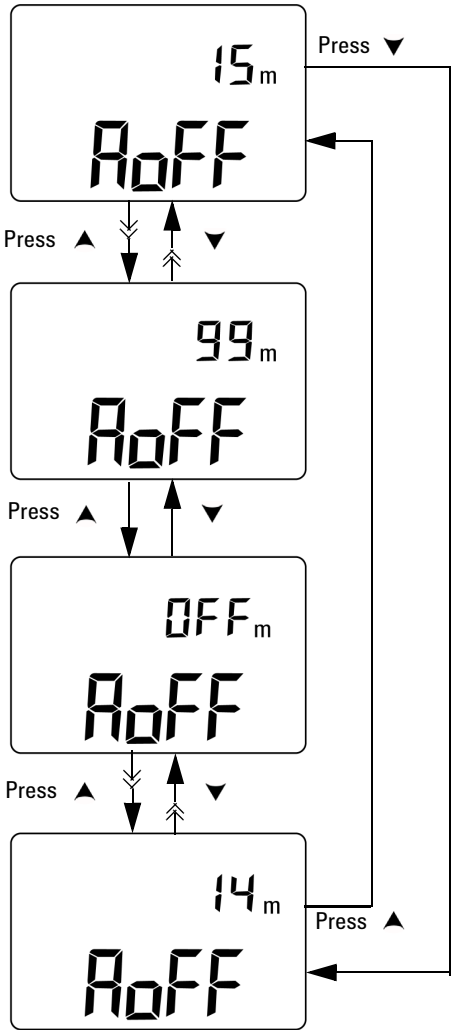

Figure 4-13 Setting the auto power-off mode

4 Changing the Default Settings

THIS PAGE HAS BEEN INTENTIONALLY LEFT BLANK.

5 Application Examples

Source Mode for mA Output	86
Simulation Mode for mA Output	88
Simulating a 2-wire transmitter on a current loop	90
Measuring a Pressure Transducer	92
Zener Diode Test	94
Diode Test	96
Bipolar Junction Transistor (BJT) Test	98
Determining transistor h_{fe}	102
Junction Field-Effect Transistor (JFET) Switch Test	104
Operational Amplifier Verification	108
Current-to-voltage converter	108
Voltage-to-current converter	110
Integrator: square wave to triangle wave conversion	111
2-Wire Transmitter Verification	113
Frequency Transmitter Verification	115

This chapter describes some application examples for the U1401B.

Source Mode for mA Output

This instrument provides steady, stepped, and ramped current output for testing 0 mA to 20 mA and 4 mA to 20 mA current loops.

The source mode can be used to supply current to a passive circuit such as a current loop without loop supply.

- 1 Turn the rotary switch to the \sim mA /  position.
- 2 Plug the red and black banana plugs of the alligator leads into the positive (+) and negative (-) output terminals respectively.
- 3 Connect the red and black alligator clips to the current loop. Make sure that the polarity is correct.
- 4 Press **SHIFT** to access the shifted operations of the keypad. The **SHIFT** annunciator will appear on the display.
- 5 Set the output level at +08.000 mA to get a 25% scale readout for 4 mA to 20 mA.
- 6 Press **OUTPUT** to start the source output. The **OUT** annunciator will appear on the display.

You can use autoscan to test the loop with varying levels of current output. Refer to [Chapter 2, “Autoscan output,” on page 31](#) for more information on the memory default values.

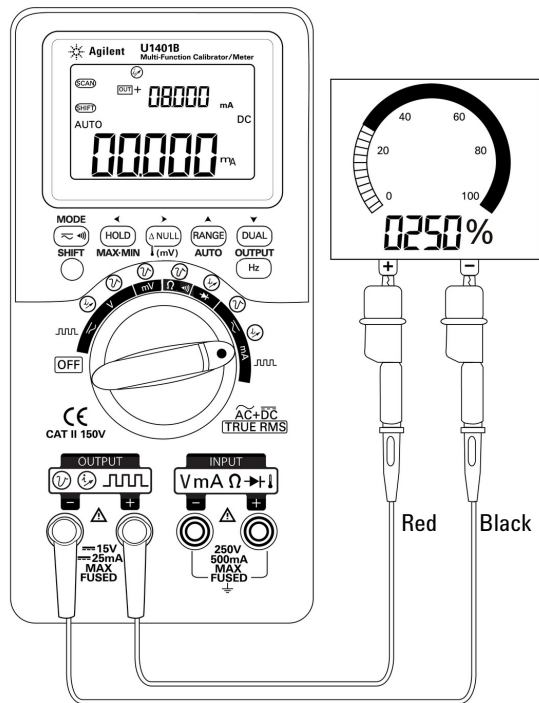

Figure 5-1 Testing a 4 mA to 20 mA current loop with the source mode



Simulation Mode for mA Output

CAUTION

Always use the supplied special yellow test lead to perform mA simulation.

Disconnect the test lead from the current loop before turning the rotary switch to change function or to power-off this instrument. Failure to do so will result in a current of at least 16 mA in the 250 Ω load connected loop.

In simulation mode, the instrument simulates a current loop transmitter. Use this simulation mode when an external DC 24 V or 12 V supply is in series with the current loop being tested. Always use the special yellow test lead. Follow the procedure below when performing mA output simulation.

- 1 Turn the rotary switch to any one of the \sim mA /  or \sim V /  positions.
- 2 Connect the special yellow test lead between the positive output terminal of the instrument and the positive terminal of the measurement device on the current loop. Refer to [Figure 5-2 on page 89](#).
- 3 Connect the black alligator lead between the **COM** terminal of the loop source and the negative terminal of the measurement device on the current loop.
- 4 Connect the red alligator lead between the negative output terminal of the instrument and the positive terminal of the current loop source. Make sure the polarity is correct.
- 5 Set the current level of the calibrator between 0 mA and 20 mA. Do not set a negative current output value.
- 6 Press **OUTPUT** to output the test current.

This connection can be used for any loop voltage from 12 V to 30 V.

CAUTION

Do not apply an external voltage exceeding 30 V across the output terminals of the instrument.

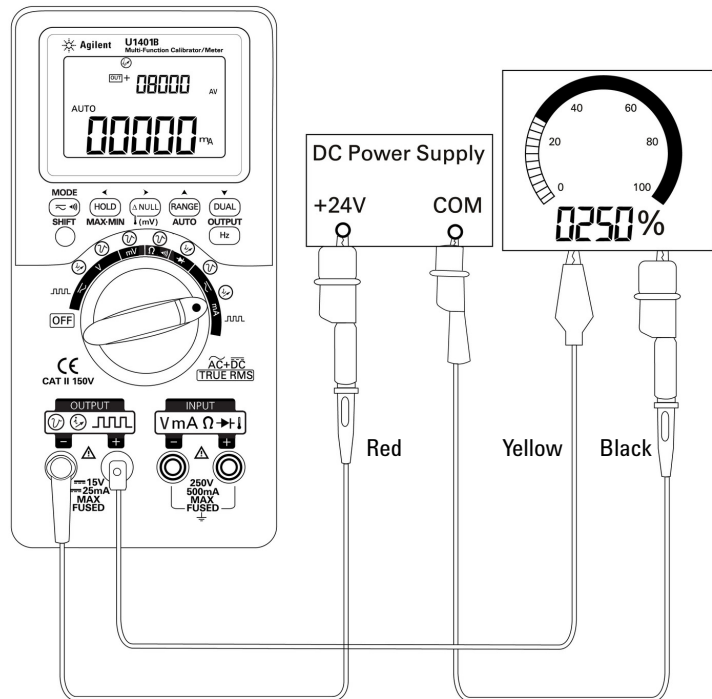



Figure 5-2 mA output simulation

Simulating a 2-wire transmitter on a current loop

The special yellow test lead supplied with the U1401B can also be used for simulating a 2-wire transmitter. This lead is used in place of the red lead (which is used in most other applications). It protects the instrument from high loop voltages, and it also has the advantage of using the same two output terminals for all applications.

- 1 Turn the rotary switch to any one of the \sim mA /  or \sim V /  positions.
- 2 Connect the special yellow test lead between the positive output terminal of the instrument and the input terminal of the measurement device on the current loop. Refer to [Figure 5-3 on page 91](#).
- 3 Connect the black alligator lead between the negative output terminal of the instrument and the current loop excitation source. Make sure the polarity is correct.
- 4 Set the current level between 0 mA and 20 mA. Do not set a negative current output value.
- 5 Press **OUTPUT** to output the test current.

This connection can be used for any loop voltage from 12 V to 30 V.

CAUTION

Do not apply an external voltage exceeding 30 V across the output terminals of the instrument.

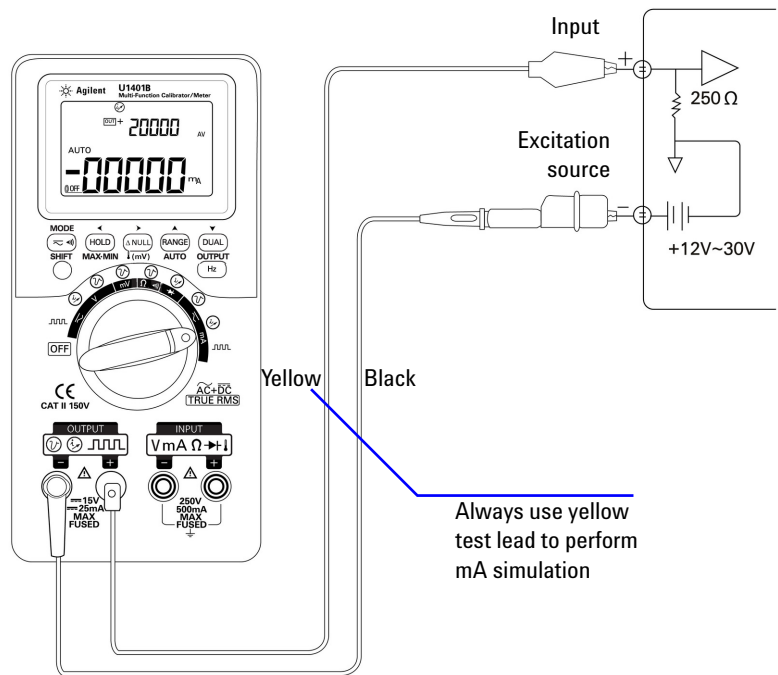

Figure 5-3 Use the yellow test lead to perform the 2-wire transmitter simulation

Measuring a Pressure Transducer

To measure a pressure transducer, follow these steps:

- 1 Turn the rotary switch to \sim mV.
- 2 Connect the red and black probe leads to the positive and negative input terminals respectively.
- 3 Probe the test points (Figure 5-4 on page 93) and read the display.

Table 5-1 Typical pressure range and maximum output voltages of millivolt output pressure transducers

Pressure range	Maximum output voltage
0 PSIG to 5 PSIG	50 mV
0 PSIG to 15 PSIG	100 mV
0 PSIG to 30 PSIG	80 mV
0 PSIG to 60 PSIG	60 mV
0 PSIG to 100 PSIG	100 mV
0 PSIG to 150 PSIG	60 mV

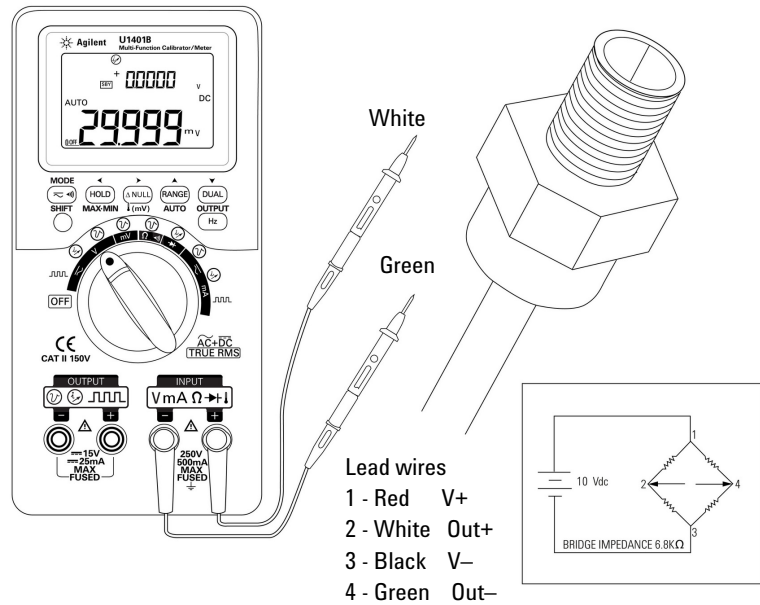



Figure 5-4 Pressure transducer measurement

Zener Diode Test

CAUTION

To avoid damaging the instrument, disconnect the circuit power and discharge all high-voltage capacitors before testing the diodes.

To perform zener diode test:

- 1 Turn the rotary switch to the \overline{V} /  position.
- 2 Connect the red alligator lead between the positive output terminal and the positive (anode) side of the zener diode. See [Figure 5-5 on page 95](#).
- 3 Connect the black alligator lead between the negative output terminal and the negative (cathode) side of the zener diode.
- 4 Connect the red and black probe leads to the input terminals.
- 5 Output a constant current of +1 mA, then measure the forward voltage of the zener diode.
- 6 Output a constant current of -1 mA, then measure the breakdown voltage of the zener diode.

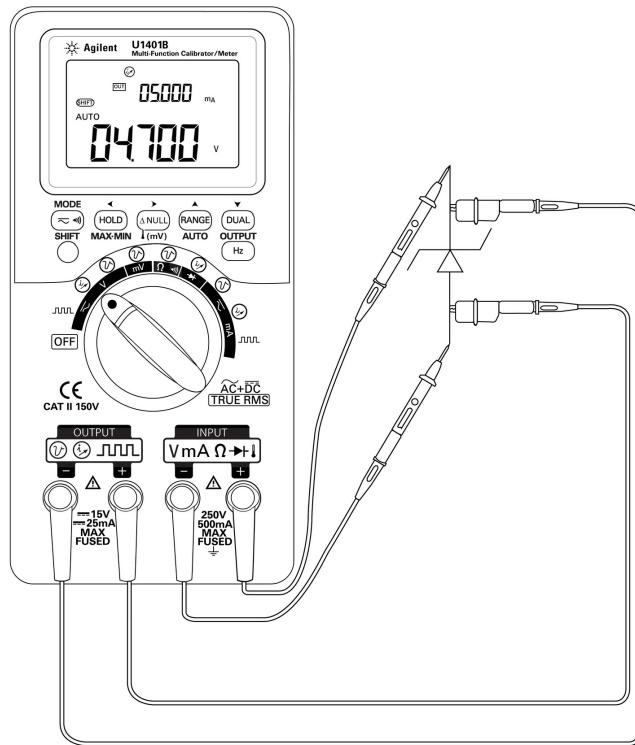



Figure 5-5 Zener diode test

Diode Test

A good diode allows current to flow in one direction only.

To test a diode, turn the circuit power off, remove the diode from the circuit, and proceed as follows:

- 1 Turn the rotary switch to the  /  position.
- 2 Connect the red and black probe leads to the positive and negative input terminals respectively.
- 3 Probe the positive (anode) side of the diode with the red lead, and the negative (cathode) side with the black lead.

NOTE

The cathode of a diode is the side indicated with band(s).

- 4 Reverse the probe leads and measure the voltage across the diode again.
- 5 If the diode is:
 - Good: In step 3, a forward voltage drop typically from 0.3 V to 0.8 V is indicated (the instrument can display diode voltage drops up to approximately 2.1 V) accompanied by a beep. In step 4, **OL** is indicated.
 - Shorted: A voltage drop of nearly 0 V is indicated in both directions, and the instrument will beep continuously.
 - Open: **OL** is indicated in both directions.

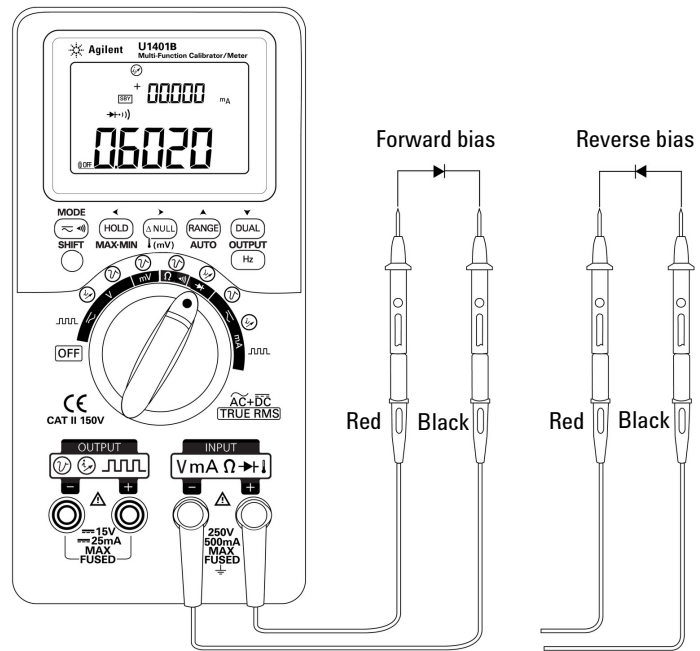

Figure 5-6 Diode test

Bipolar Junction Transistor (BJT) Test

A BJT typically has three terminals, namely emitter (E), base (B), and collector (C). There are two types of BJT depending on polarity: PNP type and NPN type. It is recommended that you obtain the specific data sheet from the manufacturers. You can also use the U1401B to identify the polarity and terminals of a BJT by following the procedure below:

- 1 Turn the rotary switch to the \rightarrow position.
- 2 Connect the red and black test leads to the positive and negative input terminals respectively. The positive terminal will provide a positive test voltage.
- 3 In this example, we will use a BJT with TO-92 package as shown in [Figure 5-7](#).

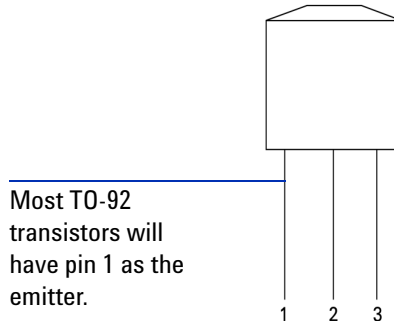

Figure 5-7 TO-92 Transistor

- 4 Probe pin 1 with the red test lead, and pin 2 with the black test lead. If the measured value is **OL**, reverse the probes. If the measured value is still **OL**, you can assume that these two pins are the emitter and collector terminals. The remaining pin 3 is the base terminal. Always find out first which pin is the Base terminal. Refer to [Table 5-2](#).

Table 5-2 Base terminal according to probe test

Pin	Probe		Base
	Red/Black	Black/Red	
1-2	OL	OL	3
1-3	OL	OL	2
2-3	OL	OL	1

- 5 Probe the base terminal with the red test lead, and the other two pins (in turn) with the black test lead. Record the readings.
- 6 Repeat **step 5**, but reverse the red and black test leads. Record the readings.
- 7 The polarities (NPN or PNP) and terminals can be identified by referring to **Table 5-3**, **Table 5-4** and **Table 5-5**. V_{be} is always greater than V_{bc} . Most TO-92 transistors will have pin 1 as the emitter. It is recommended that you check and verify with the specific data sheet from the manufacturer.

Table 5-3 Polarity and terminals if Pin 3 is the base

Test leads	Pins		Terminals ($V_{be} > V_{bc}$)	Type
	3-1	3-2		
Red/Black	0.6749 V	0.6723 V	ECB	NPN
	0.6723 V	0.6749 V	CEB	NPN
Black/Red	0.6749 V	0.6723 V	ECB	PNP
	0.6723 V	0.6749 V	CEB	PNP

5 Application Examples

Table 5-4 Polarities and terminals if Pin 2 is the base

Test leads	Pins		Terminals ($V_{be} > V_{bc}$)	Type
	2-1	2-3		
Red/Black	0.6749 V	0.6723 V	EBC	NPN
	0.6723 V	0.6749 V	CBE	NPN
Black/Red	0.6749 V	0.6723 V	EBC	PNP
	0.6723 V	0.6749 V	CBE	PNP

Table 5-5 Polarities and terminals if Pin 1 is the base

Test leads	Pins		Terminals ($V_{be} > V_{bc}$)	Type
	1-2	1-3		
Red/Black	0.6749 V	0.6723 V	BEC	NPN
	0.6723 V	0.6749 V	BCE	NPN
Black/Red	0.6749 V	0.6723 V	BEC	PNP
	0.6723 V	0.6749 V	BCE	PNP

Another common type of transistor is the TO-3 package as shown in [Figure 5-8 on page 101](#).

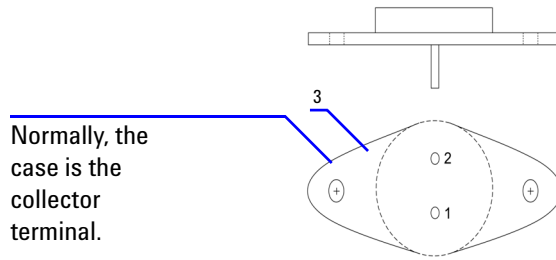

Figure 5-8 TO-3 Transistor

A silicon NPN high power transistor (2N3055) is used as an example to demonstrate how the polarity and terminals are identified.

According to the previous procedure, pin 2 is the base.

Table 5-6 Polarity and terminals if Pin 2 is the base

Test leads	Pins		Terminals ($V_{be} > V_{bc}$)	Type
	2-1	2-3		
Red/Black	0.5702 V	0.5663 V	EBC	NPN

Determining transistor h_{fe}

NOTE

If you wish to obtain the correct results, please adjust the values of V_{DD} and I_B according to the conditions specified by the transistor manufacturer.

For NPN-type BJT

- 1 Turn the rotary switch to the $\sim \text{mA}$ /  position.
- 2 Connect the base to the positive output terminal.
- 3 Connect the emitter to the negative output terminal and the negative terminal of a DC power supply (which supplies the required V_{DD}).
- 4 Connect the collector to the negative input terminal.
- 5 Connect the positive terminal of the DC power supply to the positive input terminal through a resistor.
- 6 Output a constant current of +1.000 mA (this is I_B).
- 7 Read the measured current value (this is I_C).

For PNP-type BJT

- 1 Turn the rotary switch to the $\sim \text{mA}$ /  position.
- 2 Connect the base to the positive output terminal.
- 3 Connect the collector to the negative output terminal and the positive terminal of a DC power supply (which supplies the required V_{DD}).
- 4 Connect the emitter to the negative input terminal.
- 5 Connect the negative terminal of the DC power supply to the positive input terminal through a resistor.
- 6 Output a constant current of -0.500 mA (this is I_B).
- 7 Read the measured current value (this is I_C).

The transistor h_{fe} is calculated as the ratio of I_C over I_B .

$$h_{fe} = I_C / I_B = 152$$

I_B = Current source

$$h_{fe} = I_C / I_B = 300$$

I_C = Meter reading

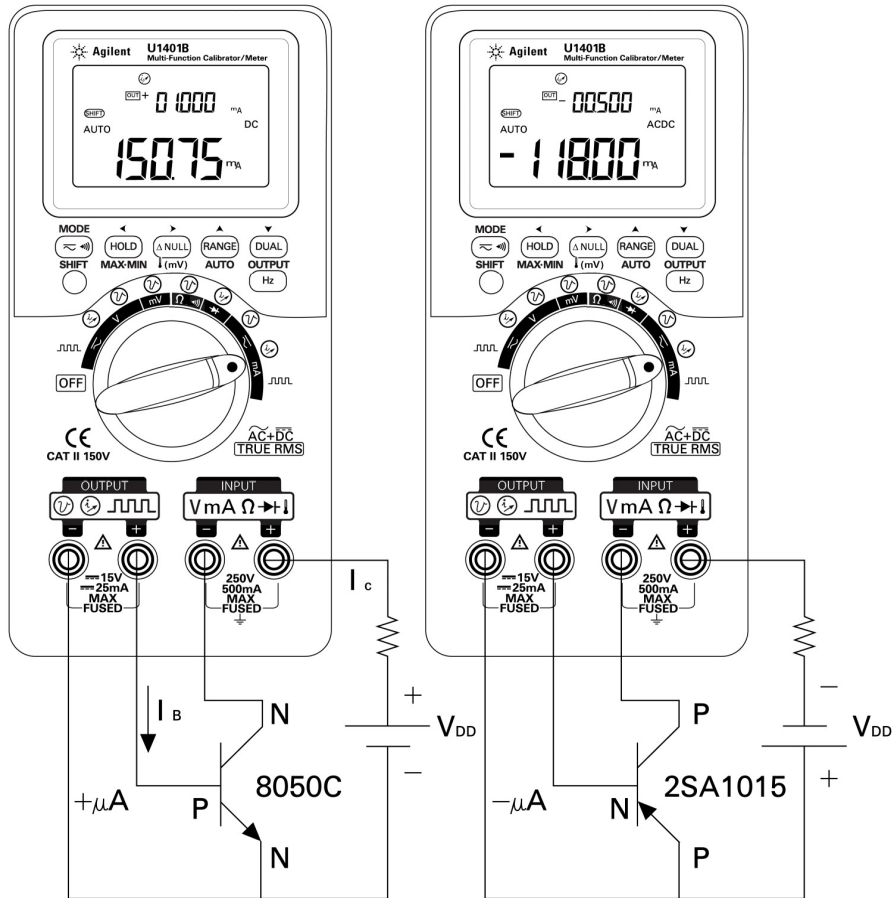

Figure 5-9 Determining transistor h_{fe}

Junction Field-Effect Transistor (JFET) Switch Test

A JFET typically has three terminals, namely drain (D), gate (G), and source (S). There are two types of JFET depending on the channel type: p-channel and n-channel. It is recommended that you obtain the specific data sheet from the manufacturers. You can also use the U1401B to identify a JFET by following the procedure below:

- 1 Turn the rotary switch to the Ω \blacktriangleright) position.
- 2 Connect the red and black test leads to the positive and negative input terminals respectively. The positive terminal will provide a positive test voltage.
- 3 In this example, we will use a JFET with TO-92 package as shown in [Figure 5-10](#).

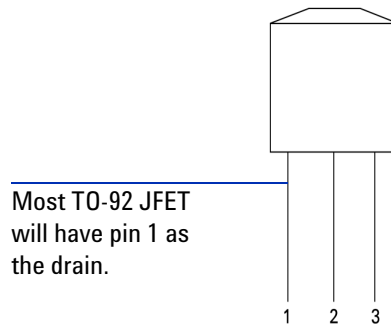

Figure 5-10 TO-92 JFET

- 4 Probe pin 1 with the red test lead, and pin 2 with the black test lead. Then reverse the test leads and obtain the reading. If both readings are $<1 \text{ k}\Omega$, you can assume that these pins are the drain and source terminals. The remaining pin 3 is the gate terminal. Always find out first which pin is the gate terminal. Refer to [Table 5-7 on page 105](#).

Table 5-7 Gate terminal according to probe test

Pins	Test leads		Gate
	Red/Black	Black/Red	
1-2	<1 k Ω	<1 k Ω	3
1-3	<1 k Ω	<1 k Ω	2
2-3	<1 k Ω	<1 k Ω	1

You can identify the channel type of a JFET by measuring its drain-source resistance (R_{DS}) when it is biased with a constant voltage source. Usually, both channel types will switch on under a gate-source voltage (V_{GS}) of 0 V.

- 5** Connect the red input probe lead to the drain.
- 6** Connect the black input probe lead to the source.
- 7** Connect the red output alligator lead to the gate terminal through a 100 k Ω resistor, and connect the black output alligator lead to the black input probe lead.

If R_{DS} increases when V_{GS} is a negative value, then it is an n-channel JFET. On the other hand, if R_{DS} increases when V_{GS} is a positive value, then it is a p-channel JFET.

The cutoff voltage of an n-channel JFET

To determine the cutoff voltage of an n-channel JFET:

- 1 Connect the red input probe lead to the drain.
- 2 Connect the black input probe lead to the source.
- 3 Connect the red output alligator lead to the gate terminal through a 100 k Ω resistor, and connect the black output alligator lead to the black input probe lead.
- 4 Gradually decrease the voltage output from +00.000 V to -15.000 V. The R_{DS} value will increase correspondingly (Figure 5-11 on page 106).
- 5 Observe at what point the resistance reading becomes **OL**; the voltage bias level at that point would be the cutoff voltage for the n-channel JFET.

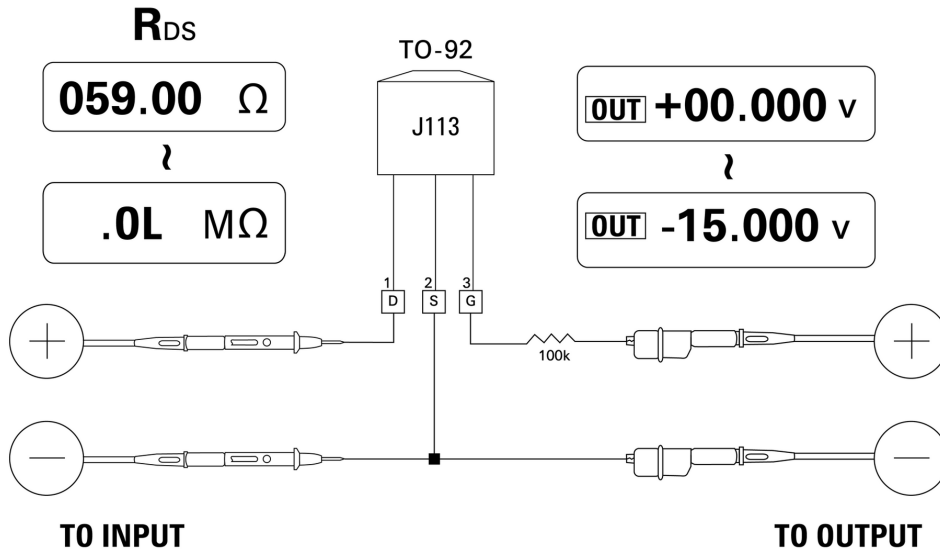

Figure 5-11 N- Channel JFET

The cutoff voltage of a p-channel JFET

To determine the cutoff voltage of a p-channel JFET:

- 1 Connect the red input probe lead to the drain.
- 2 Connect the black input probe lead to the source.
- 3 Connect the red output alligator lead to the gate terminal through a 100 k Ω resistor, and connect the black output alligator lead to the black input probe lead.
- 4 Gradually decrease the voltage output from +00.000 V to +15.000 V. The R_{DS} value will increase correspondingly (Figure 5-12 on page 107).
- 5 Observe at what point the resistance reading becomes **OL**; the voltage bias level at that point would be the cutoff voltage for the p-channel JFET.

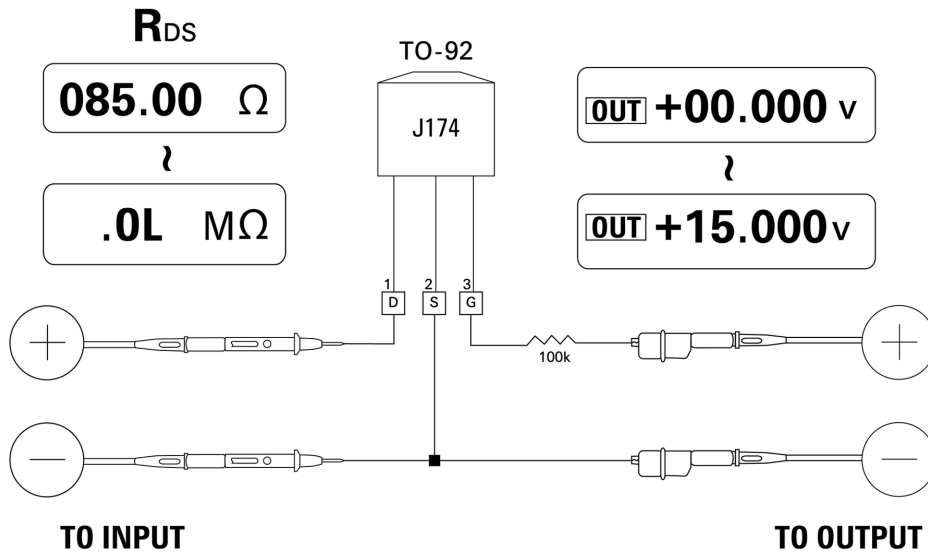

Figure 5-12 P- Channel JFET

Operational Amplifier Verification

The ideal amplifier is assumed to have the following characteristics:

- Infinite gain
- Infinite input impedance
- Infinite bandwidth (a bandwidth extending from zero to infinity)
- Zero output impedance
- Zero voltage and current offset

There are two basic ways of applying feedback to a differential operational amplifier. One is by configuring the operational amplifier as an inverting current-to-voltage converter, and the other by configuring the operational amplifier as a non-inverting voltage-to-current converter.

Current-to-voltage converter

An ideal operational amplifier can act as a current-to-voltage converter. In [Figure 5-13](#), the ideal operational amplifier maintains its inverting input terminal at earth potential and forces any input current to flow through the feedback resistor. Thus $I_{in} = I_f$ and $V_o = -I_f \times R_f$. Notice that the circuit provides the basis for an ideal current measurement; it introduces zero voltage drop into the measurement circuit and the effective input impedance of the circuit as measured directly at the inverting input terminal is zero.

- 1 Turn the rotary switch to the $\sim V$ /  position.
- 2 Manually select the DC 50 V range for the voltage measurement.
- 3 Connect the red and black probe leads to the positive and negative input terminals respectively.

- 4 Connect the red and black alligator leads to the positive and negative output terminals respectively.
- 5 Connect the operational amplifier as shown in **Figure 5-13**.
- 6 Use a DC power supply with +15 V and -15 V outputs to power the operational amplifier.
- 7 Feed a constant current of +00.000 mA into the operational amplifier and measure the offset voltage, V_o .
- 8 Gradually increase the U1401B output current from +00.000 mA to +12.000 mA while monitoring the output voltage of the operational amplifier. The V_o value will increase correspondingly from around 00.000 V to around -12.000 V. The actual V_o is influenced by the tolerance of the feedback resistor and the offset of the operational amplifier.

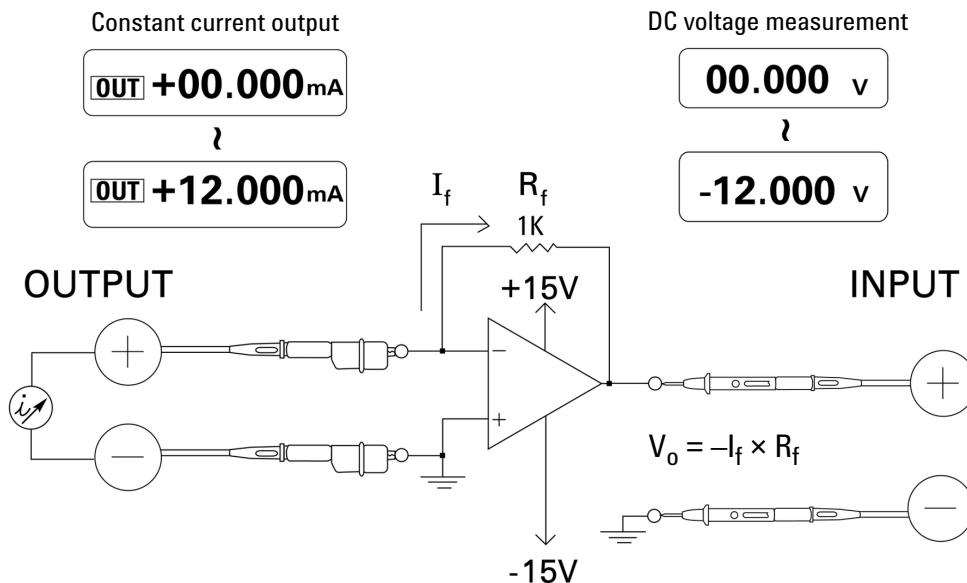

Figure 5-13 Current-to-voltage converter

Voltage-to-current converter

In maintaining its differential input voltage at zero, the operational amplifier shown in [Figure 5-14](#) forces a current $I = V_{in}/R1$ to flow through the R2 load in the feedback path. This current is independent of the load.

- 1 Turn the rotary switch to the $\sim V / \text{Ⓢ}$ position.
- 2 Manually select the DC 50 V range for the voltage measurement.
- 3 Connect the red and black probe leads to the positive and negative input terminals respectively.
- 4 Connect the red and black alligator leads to the positive and negative output terminals respectively.
- 5 Connect the operational amplifier as shown in [Figure 5-14](#).
- 6 Use a DC power supply with +15 V and -15 V outputs to power the operational amplifier.
- 7 Gradually increase the U1401B output voltage from +00.000 mV to +06.000 V while measuring the output voltage of the operational amplifier. You will find the output voltage increasing correspondingly from around +00.000 V to around +12.000 V. You can then verify the characteristic of the voltage-to-current converter by performing the necessary calculations.
- 8 As an alternative, you can set the rotary switch to the $\sim mA / \text{Ⓢ}$ position and connect the input probe leads in place of the meter **A** as shown in [Figure 5-14](#). You will find that the measured current is proportional to the voltage input into the operational amplifier.

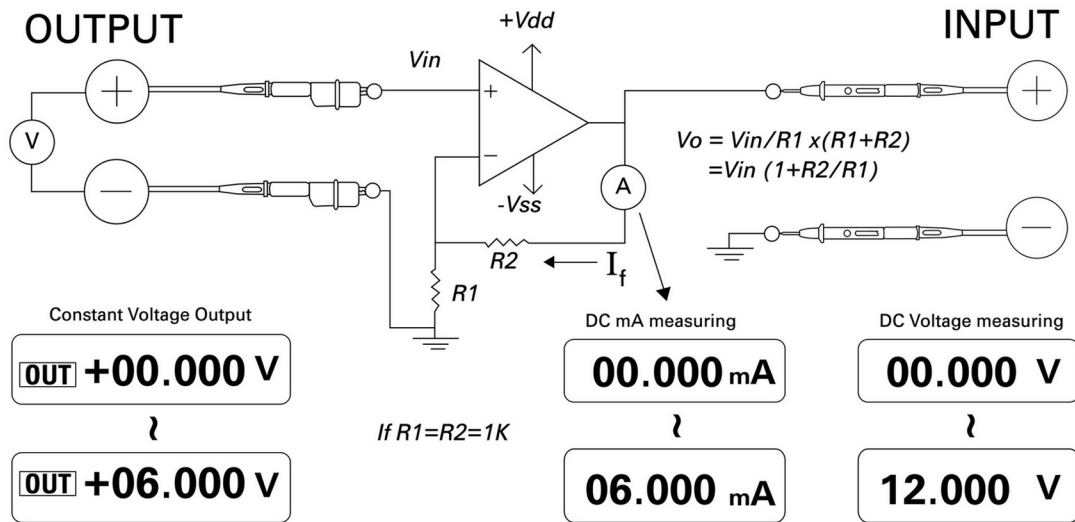

Figure 5-14 Voltage-to-current converter

Integrator: square wave to triangle wave conversion

The integrating circuit in [Figure 5-15 on page 112](#) produces an output voltage that is proportional to the integral of the input voltage.

One of the many uses of this integrator is to convert a square wave into a triangle wave.

- 1 Turn the rotary switch to the $\approx V / \square$ position.
- 2 Connect the red and black alligator leads to the positive and negative output terminals respectively.
- 3 Connect the operational amplifier as shown in [Figure 5-15 on page 112](#).

5 Application Examples

- 4 Use a DC power supply with +15 V and -15 V outputs to power the operational amplifier.
- 5 Use an oscilloscope to monitor the output waveform.
- 6 Set the square wave duty cycle to 50.00% and its amplitude to 5 V.
- 7 Output the square wave.
- 8 Select a different frequency and vary the duty cycle to further understand the characteristics of the integrator.

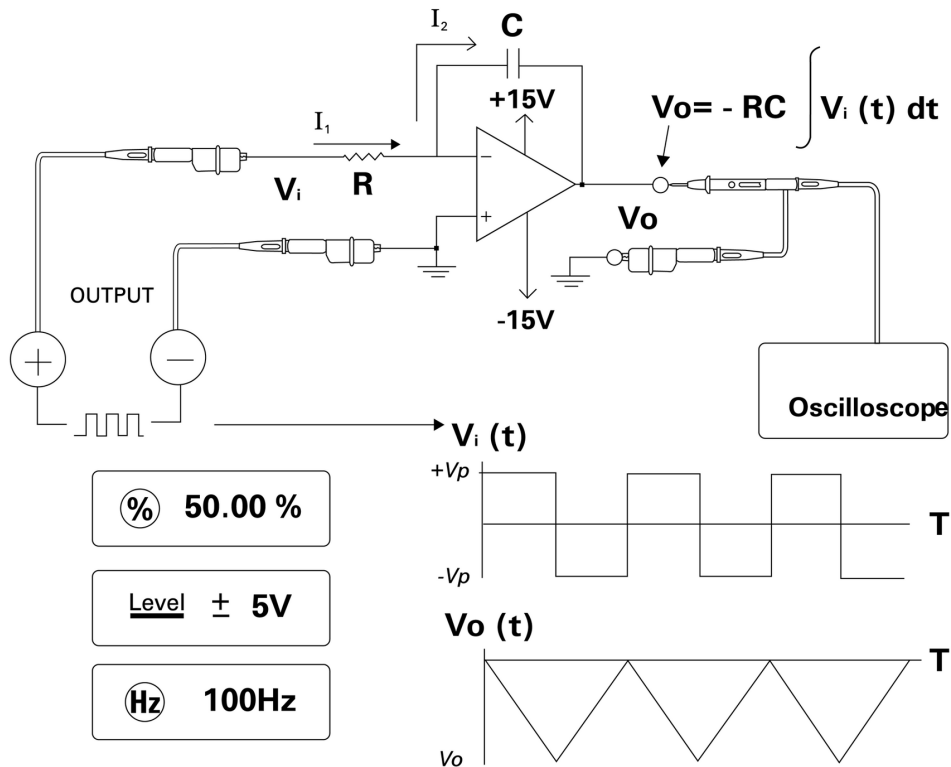

Figure 5-15 Square wave to triangular wave conversion

2-Wire Transmitter Verification

You can use the following method to verify the operation of a 2-wire transmitter. The method takes advantage of the ability of this instrument to simultaneously source voltage and measure current.

- 1 Turn the rotary switch to $\overline{\sim}$ mA / Ⓢ position.
- 2 Connect the red alligator lead between the positive output terminal of the instrument and the positive output terminal of the two-wire transmitter. Refer to [Figure 5-16 on page 114](#).
- 3 Connect a shorting plug between the negative output terminal and negative input terminal of the instrument.
- 4 Connect the black alligator lead between the positive input terminal of the instrument and the negative output terminal of the two-wire transmitter.
- 5 The supply can be set to any voltage up to +15 V.
- 6 Press **OUTPUT** to output the excitation voltage.
- 7 The instrument display will indicate a transmitter output current if an input signal is present.

5 Application Examples

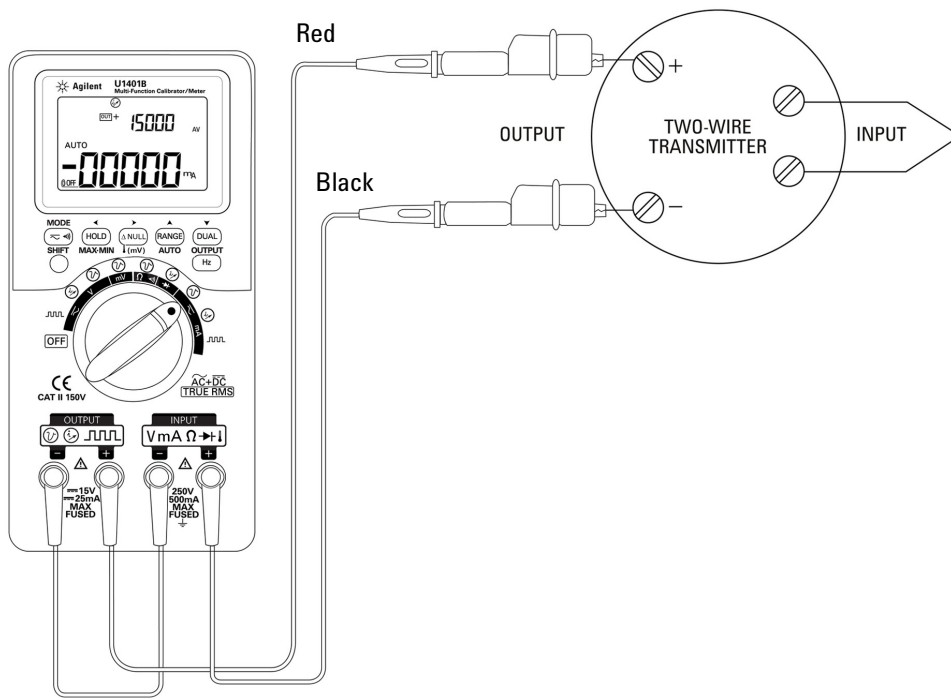



Figure 5-16 Verifying a two-wire transmitter

Frequency Transmitter Verification

For some frequency transmitters, you can use the square wave output as a source simulator and measure the current from the transmitter output.

- 1 Turn the rotary switch to the \sim mA /  position.
- 2 Press **MODE** to cycle through duty cycle, pulse width, output level, and frequency adjustments.
- 3 Set the output frequency to 150 Hz and duty cycle to 50%.
- 4 Connect the probe leads between the input terminals of the U1401B and the output terminals of the transducer.
- 5 Connect the alligator leads between the output terminals of the U1401B and the input terminals of the transducer. Make sure the polarity is correct.
- 6 Press **OUTPUT** to output the signal.
- 7 Read the display. Check the measured current to determine whether the frequency is consistent with the transducer specifications.
- 8 Change the square wave frequency and monitor the measured current on the display.

5 Application Examples

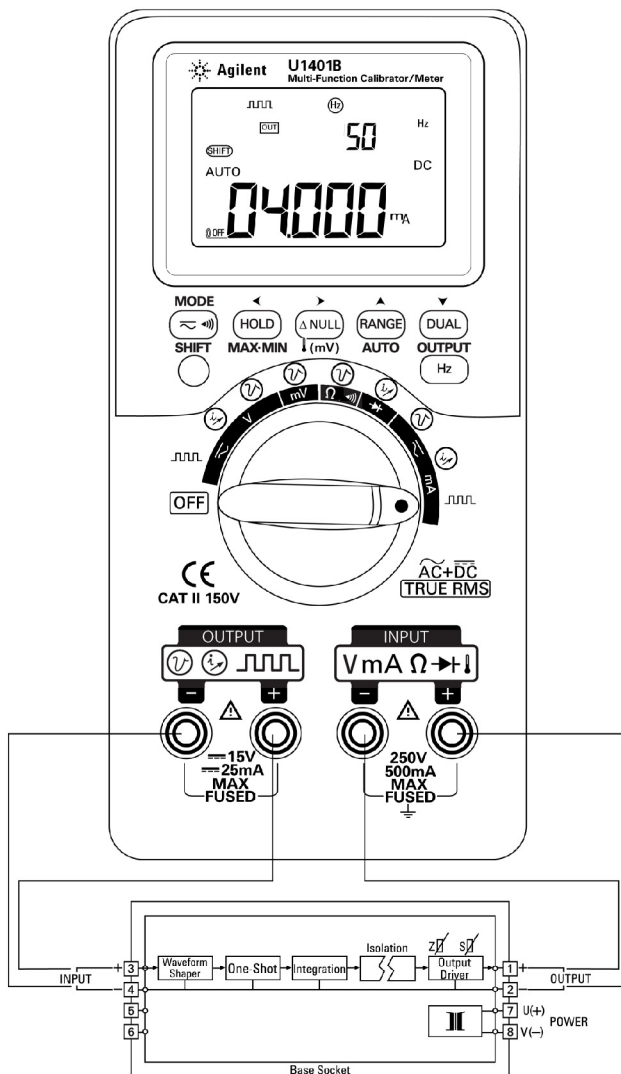

Figure 5-17 Verifying a frequency transmitter

6 Maintenance

Maintenance	118
General maintenance	118
Battery replacement	119
Recharging the batteries	121
Fuse replacement	122
Troubleshooting	124
Replacement parts	126

This chapter will help you troubleshoot the U1401B for faults.

Maintenance

CAUTION

Repairs or services which are not covered in this manual should only be performed by qualified personnel.

General maintenance

WARNING

Make sure that the terminal connections are correct for a particular measurement before making any measurement. To avoid damaging the instrument, do not exceed the rated input limit.

Besides the hazards mentioned above, dirt or moisture in the terminals can also distort the readings. The cleaning procedure is outlined below:

WARNING

To avoid electrical shock or damage to the instrument, prevent water from getting inside the case.

- 1 Turn the instrument off and remove the test leads.
- 2 Turn the instrument over and shake out any dirt that may have accumulated in the terminals.
- 3 Wipe the case with a damp cloth and mild detergent – do not use abrasives or solvents containing benzene, benzene, toluene, xylene, acetone or similar chemicals. Also, do not spray cleaner liquid directly onto the instrument, because it may seep into the case and cause damage. Wipe the contacts in each terminal with a clean swab moistened in alcohol.
- 4 Make sure the instrument has dried completely before using it.

Battery replacement

WARNING

The batteries contain nickel-metal hydride and must be recycled or disposed off properly.

Remove all test leads and external adapter before opening the case.

CAUTION

To avoid instruments being damage from battery leakage, always remove dead batteries immediately.

The instrument is powered by four sets of rechargeable batteries. To ensure that the instrument performs within its specifications, it is recommended that you replace the batteries immediately when the low battery annunciator starts flashing. Below are the procedures for battery replacement:

- 1 Loosen the screw of the battery cover on the rear panel.
- 2 Slide the cover to the left, pull it up, and remove it. See [Figure 6-1](#).
- 3 It is recommended that you replace all the batteries.
- 4 To close the battery cover, reverse the procedures above.

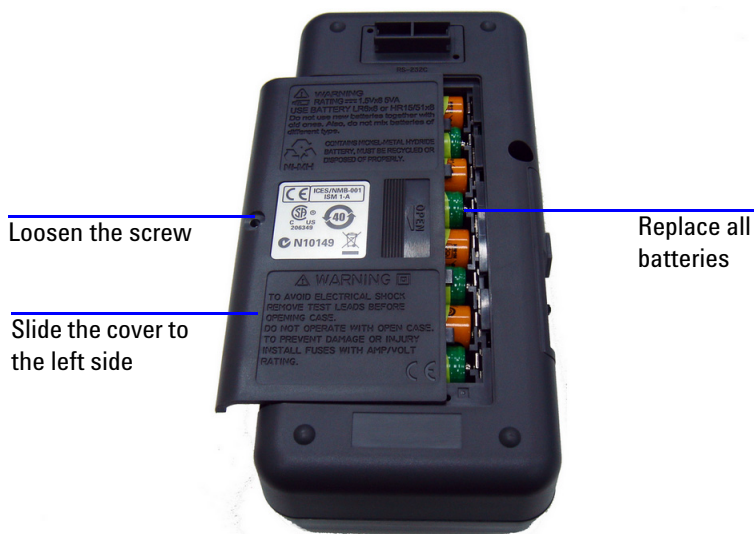

Figure 6-1 Battery replacement

Recharging the batteries

WARNING

Do not discharge a battery by shorting it or subjecting it to reverse polarity. Do not mix different types of battery. Make sure a battery is rechargeable before charging it.

NOTE

- A new rechargeable battery comes in a discharged condition and must be charged before use. Upon initial use (or after a prolonged storage period), the rechargeable battery may require three to four charge/discharge cycles before achieving maximum capacity. To discharge, simply run the instrument using the rechargeable battery's power until it shuts down or until the low battery warning appears.
 - In some instances, the instrument may indicate that the charging is complete after ten minutes or so when charging a new rechargeable battery. This is a normal phenomenon with rechargeable batteries. Remove the rechargeable battery from the device, reinsert it, and repeat the charging procedure.
-

This instrument is powered by four sets of rechargeable batteries. Charge the batteries immediately when the low battery annunciator starts flashing. It is strongly recommended that you use only the specified type of 24 V AC adapter to charge these rechargeable batteries. Do not turn the rotary switch while the instrument is being recharged because a DC 24 V supply is applied to the charging terminal.

Follow the procedures below to recharge the batteries:

- 1 Power down the instrument and disconnect all the test leads from the terminals.
- 2 Plug the AC adapter into the jack on the side panel.
- 3 Set the slide switch at the **CHARGE** position.
- 4 The red light indicates that the batteries are being recharged.
- 5 When the batteries have been fully recharged, the green light turns on. Remove the AC adapter and set the slide switch at the **M** or **M/S** position.

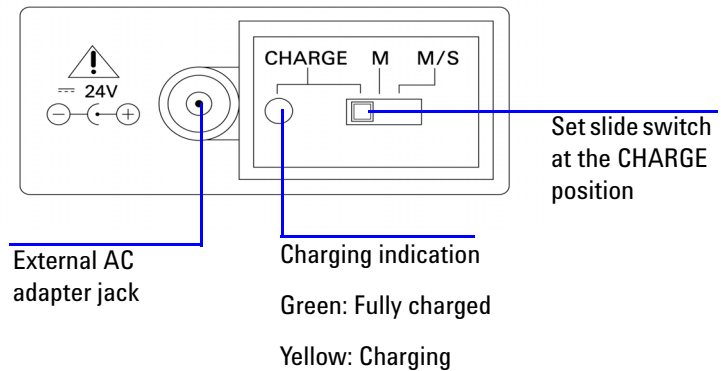

Figure 6-2 Recharging the batteries

Fuse replacement

NOTE

This manual provides only the fuse replacement procedures, but not the fuse replacement markings.

Replace any blown fuse in the instrument according to the following procedures:

- 1 Power down the instrument and disconnect all the test leads. Make sure that the charging adapter is also removed.
- 2 Remove the battery cover and the batteries.
- 3 Loosen the three screws found on the bottom of the case and remove the bottom cover.
- 4 Take out the circuit board as shown in [Figure 6-3](#).
- 5 Gently remove the defective fuse by prying one end of the fuse loose and sliding it out of the fuse bracket.
- 6 Replace it with a new fuse of the same size and rating. Make sure the new fuse is centered in the fuse holder.

- 7 Throughout the fuse replacement procedures, make sure that the knob of the rotary switch on the top case and the rotary switch itself on the circuit board remain at the OFF position.
- 8 After replacing the fuse, re-fasten the circuit board and the bottom cover.
- 9 Refer to [Table 6-1](#) for the part number, rating, and size of the fuses.

Table 6-1 Fuse specifications

Fuse	Keysight part number	Rating	Size	Type
1	2110-1464	630 mA/ 250 V	5 mm x 20 mm	Fast-blow ceramic-type
2	2110-1463	63 mA/ 250 V	5 mm x 20 mm	Slow-blow UL/VDE

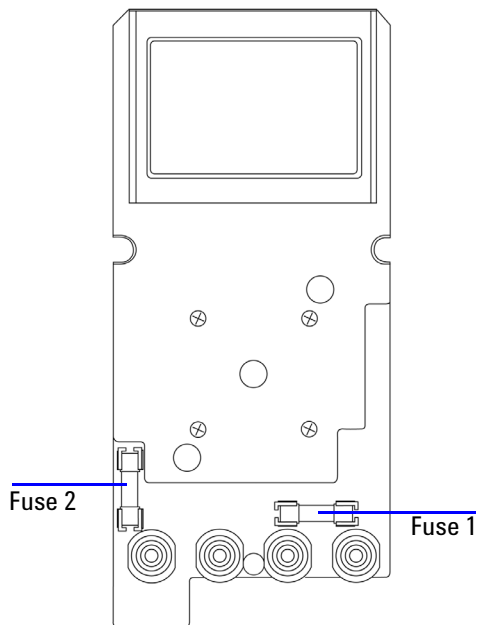

Figure 6-3 Fuse replacement

Troubleshooting

WARNING

To avoid electrical shock, do not perform any servicing unless you are qualified to do so.

If the instrument fails to operate, check the batteries and test leads. Replace them if necessary. After that, if the instrument still does not function, check to ensure that you have followed the operating procedures given in this instruction manual, before considering servicing the instrument.

When servicing the instrument, use only the specified replacement parts.

Table 6-2 will assist you in identifying some of the basic problems.

Table 6-2 Troubleshooting

Malfunction	Identification of the problem
No LCD display after switching ON	<ul style="list-style-type: none"> • Check the position of the slide switch. Set it to the M or M/S position • Check the batteries. Recharge or replace the batteries if necessary
No beeper tone	Check the setup mode to see if the beeper has been disabled ("OFF"). Select the desired driving frequency
Failed to measure current	Check fuse 1
No output signal when: <ul style="list-style-type: none"> • the OUT annunciator is displayed. • the OUTPUT key is pressed and the OUT annunciator only appeared for a short while before being replaced by the SBY annunciator. 	<ul style="list-style-type: none"> • The batteries are low • Check the position of the slide switch. Set it to the M/S position • Check the external load to see whether the rated limit is exceeded. • Check whether the loop has a 24 V power. If yes, use the special yellow test lead for mA simulation (see Chapter 5, "Simulation Mode for mA Output") • Check fuse 2
No charging indication	<ul style="list-style-type: none"> • Set the slide switch to the CHARGE position • Check the external adapter to see whether the output is 24 VDC and whether it is properly plugged in to the charging terminal • Check the line power voltage (100 VAC to 250 VAC 47 Hz/63 Hz) and the power cord
Remote control failure	<ul style="list-style-type: none"> • Make sure that the optical side of cable is connected to the instrument and the text side of the connector cover should be facing up • Check the baud rate, parity, data bit, and stop bit (default settings: 9600, n, 8, 1) • Install the driver for IR-USB on your PC

Replacement parts

This section contains information for ordering replacement parts for the U1401B. **Table 6-3** includes a brief description of each replacement part with its corresponding part number.

NOTE

You may find the latest U1401B parts list in the Keysight Test and Measurement Parts Catalog (<http://www.keysight.com/find/parts>)

To order replacement parts

NOTE

Not all parts listed are available as field-replaceable parts.

To order replacement parts from Keysight:

- 1 Contact your nearest Keysight Sales Office or Service Center.
- 2 Identify the parts by their corresponding Keysight part numbers shown in the replacement parts list.
- 3 Provide the instrument model number and serial number.

Table 6-3 Replacement parts list

Part number	Description
U1401-46400	Battery cover (without screw)
U1401-60027	Battery assembly (rechargeable) 1.2 V NiMH 1300 mAh No.3
0515-5254	Battery cover screw tapping button-HD Phillips M3 x 0.5 8 mm
0950-5480	Power supply AC-DC switching 60 W 1-output (AC charger adapter)
2110-1463	Fuse 63 mA 250 V time-delay 20 x 5.2 x 5.2 mm
2110-1464	Fuse 0.63 A 250 V no time-delay 20 x 5.2 x 5.25 mm
U1401-38300	Bumper
U1401-44700	Stand

7

Performance Tests and Calibration

Calibration Overview	128
Closed-case electronic calibration	129
Keysight Technologies' calibration services	129
Calibration interval	129
Other recommendations for calibration	130
Environmental conditions	130
Warm up	130
Recommended Test Equipment	131
Performance Verification Tests	132
Self-verification	132
Input performance verification	133
Output performance verification	137
Adjustment Considerations	138
Adjustment Procedures	139
Input calibration	139
Output calibration	144

This chapter contains the performance test procedures and adjustment procedures.

Calibration Overview

CAUTION

This instrument should only be calibrated by qualified personnel with the appropriate equipment. For detailed information about the calibration procedures, please contact your nearest Keysight Technologies representative or authorized distributor.

This manual contains procedures for verifying the instrument performance, as well as procedures for making adjustments where necessary.

The performance test procedure verifies that the Handheld Multi-Function Calibrator/Meter is operating within its published specifications. The adjustment procedure ensures that the multimeter remains within its specifications until the next calibration.

Closed-case electronic calibration

This instrument features closed-case electronic calibration. In other words, no internal electro-mechanical adjustment is required. This instrument calculates correction factors based on the input reference signals you feed into it during the calibration process. The new correction factors are stored in non-volatile EEPROM memory until the next calibration (adjustment) is performed. The contents of the non-volatile EEPROM memory will not change even when the power is switched off.

Keysight Technologies' calibration services

When your instrument is due for calibration, contact your local Keysight Service Center to inquire about recalibration services.

Calibration interval

A one-year calibration interval is adequate for most applications. Accuracy specifications are warranted only if calibration is performed at regular intervals. Accuracy specifications are not warranted beyond the one-year calibration interval. Keysight does not recommend extending calibration intervals beyond 2 years for any application.

Other recommendations for calibration

Specifications are only guaranteed within the specified period from the last calibration. Keysight recommends that readjustment should be performed during the calibration process for best performance. This will ensure that the Handheld Multi-Function Calibrator/Meter remains within its specifications. This calibration criterion provides the best long-term stability.

During performance verification tests, only the performance data is collected; these tests do not guarantee that the instrument will remain within the specified limits. The tests are only for identifying the functions which need adjustment.

Environmental conditions

Calibration or verification tests should be performed under laboratory conditions where the ambient temperature or relative humidity can be controlled.

Warm up

Allow at least 20 minutes for the instrument to warm-up before performing calibration. After being exposed or stored in a high humidity (condensing) environment, a relatively longer recovery period is required.

Recommended Test Equipment

The test equipment recommended for the performance verification and adjustment procedures are listed below. If the exact instrument is not available, substitute with another calibration standard of equivalent accuracy.

Table 7-1 Recommended test equipment

Application	Recommended equipment	Recommended accuracy requirements
DC Voltage	Fluke 5520A	<1/5 instrument 1 year spec
DC Current	Fluke 5520A	<1/5 instrument 1 year spec
Resistance	Fluke 5520A	<1/5 instrument 1 year spec
AC Voltage	Fluke 5520A	<1/5 instrument 1 year spec
AC Current	Fluke 5520A	<1/5 instrument 1 year spec
Frequency	Keysight 33250A	<1/5 instrument 1 year spec
Temperature	Fluke 5520A	<1/5 instrument 1 year spec
Duty Cycle	Fluke 5520A	<1/5 instrument 1 year spec
Diode	Fluke 5520A	<1/5 instrument 1 year spec

Performance Verification Tests

Self-verification

To perform a self-verification on the output voltage level of the instrument:

- 1 Turn the rotary switch to the $\sim V$ / Ⓢ position.
- 2 Short the input test leads for voltage measurement, then press Ⓢ NULL momentarily to zero the residual of thermal effect until the measurement value is stable.
- 3 Connect the positive ends of input and output together.
- 4 Connect the negative ends of input and output together.
- 5 Set output value to +4.5000 V.
- 6 Observe the measurement value in the primary display.

Refer to [Table 7-2](#) for functions that can be self-verified.

Table 7-2 Functions that can be self-verified



Rotary switch position	Output value	Measuring value (input)
$\sim V$ / Ⓢ	+4.5000 V	DC 4.5000 V
$\sim mA$ / Ⓢ	+25.0000 mA	DC 25.0000 mA
$\sim V$ / Ⓢ	100 Hz	100.00 Hz
	0.39~99.60%	0.3~99.6%
	±5 V	AC 4.9586 V
	±12 V	AC 11.959 V

[Table 7-2](#) is for reference only. Refer to [Chapter 8](#), “Specifications,” on [page 147](#) for the detailed specifications.

Input performance verification

To verify the input functions of the Handheld Multi-Function Calibrator/Meter, perform the verification tests listed in [Table 7-3](#). Refer to [Table 7-1 on page 131](#) for the recommended test equipment for verifying each function.

Table 7-3 Input performance verification tests

Step	Test Function	Connection to 5520A	Range	5520A output	Error from nominal 1 year
1	Turn the rotary switch to mV . Press  to select DC.	Connect the Normal Hi-Low output terminals of the calibrator to the U1401B input terminals.	50 mV	0.05 V	$\pm 75 \mu\text{V}$
				-0.05 V	$\pm 75 \mu\text{V}$
			500 mV	0.5 V	$\pm 0.2 \text{ mV}$
				-0.5 V	$\pm 0.2 \text{ mV}$
	5 V		5 V	$\pm 2 \text{ mV}$	
			-5 V	$\pm 2 \text{ mV}$	
	50 V		50 V	$\pm 20 \text{ mV}$	
			-50 V	$\pm 20 \text{ mV}$	
	250 V		250 V	$\pm 0.125 \text{ V}$	
			-250 V	$\pm 0.125 \text{ V}$	
2	Turn the rotary switch to V . Press  to select DC.	Connect the Normal Hi-Low output terminals of the calibrator to the U1401B input terminals.	50 mV	50 mVrms @ 45 Hz	$\pm 0.39 \text{ mVrms}$
				50 mVrms @ 5 kHz	$\pm 0.39 \text{ mVrms}$
				50 mVrms @ 20 kHz	$\pm 0.79 \text{ mVrms}$

7 Performance Tests and Calibration

Table 7-3 Input performance verification tests (continued)















Step	Test Function	Connection to 5520A	Range	5520A output	Error from nominal 1 year
2 (cont)	Turn the rotary switch to  V. Press  to select AC.	Connect the Normal Hi-Low output terminals of the calibrator to the U1401B input terminals.	500 mV	500 mVrms @ 45 Hz	±3.7 mVrms
				500 mVrms @ 5 kHz	±3.7 mVrms
				500 mVrms @ 20 kHz	±7.7 mVrms
			5 V	5 Vrms @ 45 Hz	±37 mVrms
				5 Vrms @ 5 kHz	±37 mVrms
				5 Vrms @ 20 kHz	±77 mVrms
			50 V	50 Vrms @ 45 Hz	±0.37 Vrms
				50 Vrms @ 5 kHz	±0.37 Vrms
				50 Vrms @ 20 kHz	±0.77 Vrms
			250 V	250 Vrms @ 45 Hz	±1.95 Vrms
				250 Vrms @ 5 kHz	±1.95 Vrms
				250 Vrms @ 20 kHz	±3.95 Vrms

Table 7-3 Input performance verification tests (continued)

Step	Test Function	Connection to 5520A	Range	5520A output	Error from nominal 1 year
3	Turn the rotary switch to  V. Press  to select frequency.	Connect the Normal Hi-Low output terminals of the calibrator to the U1401B input terminals.	100 Hz	10 Hz @ 16 mV	±5 mHz
			100 kHz	20 kHz @ 16mV	±7 Hz
			200 kHz	200 kHz @ 24 mV	±30 kHz
4	Turn the rotary switch to  V. Press  to select duty cycle.	Connect the Normal Hi-Low output terminals of the calibrator to the U1401B input terminals.	0.1% to 99%	50% @ 50 Hz @ 5 Vac	0.3%
				50% @ 800 Hz @ 5 Vac	0.3%
5	Turn the rotary switch to  ).	Connect the Normal Hi-Low output terminals and the AUX Hi-Low output terminals of the calibrator (with a two-cable stacked configuration) to the U1401B input terminals.	500 Ω	500 Ω	±0.83 Ω
			5 kΩ	5 kΩ	±8 Ω
			50 kΩ	50 kΩ	±80 Ω
			500 kΩ	500 kΩ	±800 Ω
			5 MΩ	5 MΩ	±8 kΩ
			50 MΩ	50 MΩ	±508 kΩ
6	Turn the rotary switch to  mA. Press  to select DC.	Connect the AUX Hi-Low output terminals of the calibrator to the U1401B input terminals.	0.05 A	0.045 A	±18.5 μA
			0.5 A	0.45 A	±0.185 mA
7	Turn the rotary switch to  mA. Press  to select AC.	Connect the AUX Hi-Low output terminals of the calibrator to the U1401B input terminals.	0.05 A	0.005 A @ 1 kHz	±50 μA
				0.045 A @ 1 kHz	±0.29 mA
			0.5 A	0.05 A @ 50 Hz	±0.5 mA
				0.45 A @ 60 Hz	±2.9 mA

7 Performance Tests and Calibration



Table 7-3 Input performance verification tests (continued)

Step	Test Function	Connection to 5520A	Range	5520A output	Error from nominal 1 year
8	Turn the rotary switch to  .	Connect a diode to the U1401B input terminals in forward bias position.	2 V	1.9 V	±1.45 mV
9	Turn the rotary switch to mV . Press and hold  for more than 1 second.	Connect K-type thermocouple to the U1401B input terminals.	-40 °C to 1372 °C	0 °C	±3 °C
			-40 °F to 2502 °F	32 °F	±6.096 °F

Output performance verification

To verify the output functions of the Handheld Multi-Function Calibrator/Meter, perform the verification tests listed in [Table 7-4](#). Refer to [Table 7-1 on page 131](#) for the recommended test equipment for verifying each function.

Table 7-4 Output performance verification tests

Step	Function	Recommended test equipment and connection	Range or parameter	U1401B output	Nominal error within 1 year
1	Turn the rotary switch to any one of the  positions.	Connect the U1401B output terminals to the 34405A Multimeter.	±1.5000 V	-1.5 V	±0.75 mV
				0 V	±0.3 mV
				+1.5 V	±0.75 mV
			±15.000 V	-15 V	±7.5 mV
				0 V	±3 mV
				+15 V	±7.5 mV
2	Turn the rotary switch to any one of the  positions.	Connect the U1401B output terminals to the 34405A Multimeter.	±25.000 mA	-25 mA	±12.5 µA
				+25 mA	±12.5 µA
3	Turn the rotary switch to any one of the  positions.	Connect the U1401B output terminals to the 53131A Universal Counter.	Frequency (10 kHz)	4.8 kHz	±0.25 Hz
			Frequency (1 kHz)	600 Hz	±0.04 Hz
			Duty cycle (0.39% to 99.60%)	5 V, 25% @150 Hz	±0.203%
				5 V, 75%@ 150 Hz	±0.208%

Adjustment Considerations

To adjust (calibrate) the instrument, you will need a set of test input cables and connectors for receiving the reference signals. You will also need a shorting plug.

Adjustments for each function should be performed with the following considerations (where applicable):





- Allow the instrument to warm up and stabilize for five minutes before performing the adjustments.
- Make sure that the batteries will not run low during the adjustments. Replace or recharge the batteries before making adjustments to avoid false reading.
- Consider the thermal effects as you connect the test leads between the calibrator and this instrument. It is recommended that you wait for one minute after connecting the test leads before you begin the calibration.
- During ambient temperature adjustment, ensure that the instrument has been turned on for at least one hour with a K-type thermocouple connected between the instrument and the calibration source.

CAUTION

Do not turn off the instrument during calibration. This may delete the calibration memory for the present function.

Adjustment Procedures

Input calibration

- 1 Set the slide switch to the **M/S** position.
- 2 Allow the instrument to warm up for 20 minutes before performing calibration.
- 3 To enter the calibration mode, press  and  for more than one second. The primary display will indicate **CHEEP**.
- 4 Press  to enter the input calibration mode.
- 5 Turn the rotary switch to the “**Test Function**” position as shown in the adjustment table.
- 6 The primary display will show the corresponding reference value of the Cal item.
- 7 Configure each Cal item.
- 8 Use the ▲ or ▼ arrow keys to select the Cal range.
- 9 Apply the input signal shown in the Input column of the table.
- 10 The secondary display will now show the value of the input voltage that is needed; press the HOLD button to switch between the Offset and Gain values.
- 11 Press  to complete the calibration tests.
- 12 Repeat steps 5 through 10 for each adjustment point.

7 Performance Tests and Calibration

Table 7-5 Calibration tests





Step	Test function	Cal range		Input	U1401B
a.	Turn the rotary switch to mV . Press  to select DC.	50 mV	Short	Dual banana plug with copper wire shorted between 2 terminals	Short
			45 mV	45 mV	45.000 mV
		500 mV	Short	Dual banana plug with copper wire shorted between 2 terminals	Short
			450 mV	450 mV	450.00 mV
	Turn the rotary switch to V . Press  to select DC.	5 V	Short	Dual banana plug with copper wire shorted between 2 terminals	Short
			4.5 V	4.5 V	4.5000 V
		50 V	Short	Dual banana plug with copper wire shorted between 2 terminals	Short
			45 V	45 V	45.000 V
		500 V	Short	Dual banana plug with copper wire shorted between 2 terminals	Short
			450 V	450 V	450.00 V
		1000 V	Short	Dual banana plug with copper wire shorted between 2 terminals	Short
			900 V	900 V	900.0 V

Table 7-5 Calibration tests





Step	Test function	Cal range		Input	U1401B
b.	Turn the rotary switch to mV . Press  to select AC.	50 mV @ 1 kHz	5 mV	5 mV	5.000 mV
			45 mV	45 mV	45.000 mV
		500 mV @ 1 kHz	50 mV	50 mV	50.00 mV
			450 mV	450 mV	450.00 mV
	Turn the rotary switch to  V . Press  to select AC.	5 V @ 1 kHz	0.5 V	0.5 V	0.5000 V
			4.5 V	4.5 V	4.5000 V
		50 V @ 1 kHz	5 V	5 V	5.000 V
			45 V	45 V	45.000 V
		500 V @ 1 kHz	25 V	25 V	25.00 V
			250 V	250 V	250.00 V
		750 V @ 1 kHz	75 V	75 V	75.0 V
			750 V	750 V	750.0 V

7 Performance Tests and Calibration



Table 7-5 Calibration tests

Step	Test function	Cal range		Input	U1401B		
c.	Turn the rotary switch to $\Omega \leftarrow \right\rangle$.	500 Ω	Short	Dual banana plug with copper wire shorted between 2 terminals	Short		
			450 Ω	450 Ω	450.00 Ω		
		5 k Ω	Short	Dual banana plug with copper wire shorted between 2 terminals	Short		
			4.5 k Ω	4.5 k Ω	4.5000 k Ω		
		50 k Ω	Short	Dual banana plug with copper wire shorted between 2 terminals	Short		
			45 k Ω	45 k Ω	45.000 k Ω		
		500 k Ω	Short	Dual banana plug with copper wire shorted between 2 terminals	Short		
			450 k Ω	450 k Ω	450.00 k Ω		
		5 M Ω	Short	Dual banana plug with copper wire shorted between 2 terminals	Short		
			4.5 M Ω	4.5 M Ω	4.5000 M Ω		
				50 M Ω	Short	Dual banana plug with copper wire shorted between 2 terminals	Short
					30 M Ω	30 M Ω	30.000 M Ω
					15 M Ω	15 M Ω	15.000 M Ω



Table 7-5 Calibration tests

Step	Test function	Cal range		Input	U1401B
d.	Turn the rotary switch to  .	Diode	Short	Dual banana plug with copper wire shorted between 2 terminals	Short
			1.9 V	1.9 V	1.9000 V
e.	Turn the rotary switch to  mA position. Press  to select DC.	50 mA		5 mA	5.000 mA
				45 mA	45.000 mA
		500 mA		50 mA	50.00 mA
				450 mA	450.00 mA
f.	Turn the rotary switch to the  mA position. Press  to select AC.	50 mA @ 1 kHz		5 mA	5.000 mA
				45 mA	45.000 mA
		500 mA @ 1 kHz		50 mA	50.00 mA
				450 mA	450.00 mA

Temperature calibration

- 1 In calibration mode, turn the rotary switch to the mV position.
- 2 Press  for more than one second to enter temperature calibration.
- 3 Plug a K-type thermocouple into the input terminal. Feed in the reference input signal that represents 0 °C and wait for 10 minutes.
- 4 Press  to finish the temperature calibration.

Output calibration

- 1 Set the slide switch to the **M/S** position.
- 2 Allow the instrument to warm up for 10 minutes before performing calibration.
- 3 To enter the calibration mode, press  and  for more than one second. The primary display will indicate “CHEEP”.
- 4 Press  to enter the input calibration mode.
- 5 Turn the rotary switch to any one of the “Current Input/Voltage Output” positions, and press **SHIFT** for more than one second to enter the output calibration mode.

CAL-0 & CAL-1



In the output calibration mode, the primary and secondary display will show “CAL-0” and “-rdy-” respectively.

Connect the output terminals to a multimeter (refer to [Table 7-1 on page 131](#) for the recommended test equipment).

- **CAL-0:**

- 1 Press **OUTPUT**. The primary and secondary displays show “CAL-0” and “00000” respectively.
- 2 Wait until the instrument reading becomes stable, then record the value.

- **CAL-1:**

- 1 Press **MODE**. The primary and secondary displays show “CAL-1” and “-rdy-” respectively.
- 2 Press **OUTPUT**. The primary and secondary displays show “CAL-1” and “00000” respectively.
- 3 Press  or  to adjust the output voltage until the reading on the meter is the same as the **CAL-0** value recorded above.
- 4 Press **MODE** to finish the **CAL-0** and **CAL-1** calibration.

After finishing the **CAL-0** and **CAL-1** calibration procedures, the instrument will automatically enter the 1.5 V output calibration mode.

Output voltage calibration

Follow the steps below to perform calibration for the output voltage ranges and values listed in **Table 7-6**:

- 1 As you enter each calibration step, the primary and secondary displays show the *output voltage value* and “- rdy-” respectively.
- 2 Press **OUTPUT**. The primary and secondary displays show the *output voltage value* and “00000” respectively, which means the present output level is as shown on the primary display.
- 3 Press **▲** or **▼** to adjust the output voltage until the multimeter reading is the same as the value shown on the primary display.
- 4 Press **MODE** to enter the next calibration step.

Table 7-6 Output voltage calibration steps

Voltage range	Calibration step	Output voltage value
1.5 V	1	+0.0000 V
	2	+1.1000 V
	3	-1.1000 V
15 V	4	+00.000 V
	5	+11.000 V
	6	-11.000 V

At the end of the last calibration step, the primary display will show “PASS” after the **MODE** button is pressed.

Output current calibration

- 1 Without exiting the calibration mode, turn the rotary switch to any one of the “Current Input/Voltage Output” positions.
- 2 Connect the output terminals to a recommended multimeter (refer to **Table 7-1 on page 131** for the recommended test equipment).

Follow the steps below to perform calibration for the output voltage ranges and values listed in **Table 7-7**:

- 1 As you enter each calibration step, the primary and secondary displays show the *output current value* and “-rdy-” respectively.
- 2 Press **OUTPUT**. The primary and secondary displays show the *output current value* and “00000” respectively, which means the present output level is as shown on the primary display.
- 3 Press **▲** or **▼** to adjust the output current until the multimeter reading is the same as the value shown on the primary display.
- 4 Press **MODE** to enter the next calibration step.

Table 7-7 Output current calibration steps

Current range	Calibration step	Output current value
25 mA	1	+00.000 mA
	2	+11.000 mA
	3	-11.000 mA

At the end of the last calibration step, the primary display will show “PASS” after the **MODE** button is pressed.

8 Specifications

General Specifications	148
Measurement Category	150
Measurement category definitions	150
Input Specifications	151
DC specifications	151
AC specifications	152
AC+DC specifications	153
Temperature specifications	154
Frequency specifications	155
1 ms peak hold specifications	157
Resistance specifications	157
Diode check and audible continuity specifications	158
Output Specifications	159
Constant voltage and constant current outputs	159
Square wave output	160

This chapter details the specifications of the Handheld Multi-Function Calibrator/Meter.

General Specifications

Display

- Both primary and secondary displays are 5-digit liquid crystal display (LCD) with a maximum reading of 51,000 counts and automatic polarity indication.

Power Consumption

- Charging battery: 9.3 VA typical
- DC constant current at 25 mA, maximum load: 5.5 VA typical (on 24 V DC adapter) or 2.4 VA typical (on 9.6 V batteries)
- Meter only: 1.8 VA typical (on 24 V DC adapter) or 0.6 VA typical (on 9.6 V batteries)

Power Supply

- Rechargeable batteries — 1.2 V × 8 pieces (Ni-MH), no cadmium, lead or mercury.
- External switching adapter, AC 100 V to 240V, 50/60 Hz input and DC 24 V/2.5 A output.

Operating Environment

- Full accuracy at 0 °C to 40 °C (32 °F to 104 °F)
- Full accuracy up to 80% Relative Humidity (RH) for temperature up to 31 °C, decreasing linearly to 50% RH at 40 °C

Storage Compliance

- -20 °C to 60 °C (-4 °F to 140 °F) with batteries removed.

Safety Compliance

- IEC 61010-1:2001/EN61010-1:2001 (2nd Edition)
- Canada: CAN/CSA-C22.2 No. 61010-1-04
- USA: ANSI/UL 61010-1:2004

Measurement Category

- CAT-II 150V, Pollution Degree 2 Environment.

EMC Compliance

- IEC61326-2-1:2005/EN61326-2-1:2006
- Canada: ICES/NMB-001:2004
- Australia/New Zealand: AS/NZS CISPR11:2004

Measurement

- 3 times per second (AC+DC: 1 time per second)
- 1 time per second for frequency or duty cycle measurement. (>1 Hz)
- 0.25 to 1 time per second for Pulse Width measurements. (>1 Hz)

Common Mode Rejection Ratio (CMRR)

- > 90 dB at DC, 50/60 Hz ± 0.1% (1 kΩ unbalanced)

Normal Mode Rejection Ratio (NMRR)

- > 60 dB at DC, 50/60 Hz ± 0.1%

Temperature Coefficient

- Input: 0.15 * (specified accuracy)/ °C (from 0 °C to 18 °C or 28 °C to 40 °C)
 - Output: ± (50ppm output + 0.5dgt)/ °C
-

Dimensions

- H = 192 mm
- W = 90 mm
- D = 54 mm

Weight

- 0.98 kg with holster and batteries

Battery Life

- Approximately 20 hours for meter functions only, four hours for meter/source. (Assuming fully charged Ni-MH 1300 mA batteries are used.)
- Low battery indicator () appears when the series battery voltage drops below 9V (approximate).

Charging Time

- Approximately three hours, in an environment of 10 °C to 30 °C. (If the battery has been fully discharged, a prolonged charging time is required to bring the battery back to full capacity.)

Warranty

- Please refer to http://www.keysight.com/go/warranty_terms
 - Three years for the product
 - Three months for the standard accessories unless, otherwise specified
 - Please note that for the product, the warranty does not cover:
 - Damage from contamination
 - Normal wear and tear of mechanical components
 - Manuals, fuses, and standard disposable batteries
-

Measurement Category

The U1401B is intended to be used for measurement under Measurement Category II, 150 V for altitude up to 2000 m.

Measurement category definitions

Measurement CAT I	Measurements performed on circuits that are not directly connected to MAINS. For example, measurements on circuits that are not derived from MAINS, and specifically protected (internal) mains-derived circuits.
Measurement CAT II	Measurements performed on circuits that are directly connected to the low voltage installation. For example, measurements on household appliances, portable tools, and similar equipment.
Measurement CAT III	Measurements performed in fixed building installation. For example, measurements on distribution boards, circuit breakers, wiring (including cables), bus bars, junction boxes, switches, socket outlets in fixed installation, equipment for industrial use, and stationary motors with permanent connections to fixed installation.
Measurement CAT IV	Measurements performed at the source of the low voltage installation. For example, electricity meters, measurements on primary overcurrent protection devices, and ripple control units.

Input Specifications

The accuracy is given as \pm (% of reading + counts of least significant digit) at $23\text{ }^{\circ}\text{C} \pm 5\text{ }^{\circ}\text{C}$, with relative humidity less than 80% R.H., and warmed up for at least five minutes. Without warming up, an additional five counts of LSD will have to be added to the accuracy.

DC specifications

Table 8-1 DC mV/voltage specifications

Function	Range	Resolution	Accuracy	Overload protection
DC mV/voltage ^[1]	50 mV	1 μV	0.05% + 50 ^[2]	250 Vrms
	500 mV	10 μV	0.03% + 5	
	5 V	0.1 mV		
	50 V	1 mV		
	250 V	10 mV		

^[1] Input impedance: 10 M Ω (nominal) for the range of 5 V and above, and 1 G Ω (nominal) for the 50/500 mV range.

^[2] The accuracy could be improved to 0.05% + 5. Always use the relative function to offset the thermal effect (short the test leads) before measuring the signal.

8 Specifications

Table 8-2 DC current specifications

Function	Range	Resolution	Accuracy	Burden voltage/shunt	Overload protection
DC current	50 mA ^[1]	1 μ A	0.03% + 5	0.06 V (1 Ω)	250 V, 630 mA
	500 mA ^[1]	10 μ A		0.6 V (1 Ω)	Quick acting fuse

^[1] Always use the relative function to offset the thermal effect before measuring the signal. If this function is not used, the accuracy will be 0.03% + 25. The thermal effect could be present in the following conditions:

- Constant current, constant voltage, or square wave output.
- Wrong operation — where the resistance, diode, or mV measurement function is used to measure high voltage signals exceeding 250 V.
- After battery charging has completed.
- After measuring a current greater than 50 mA.

AC specifications

WARNING

Exceeding the crest factor limit may result in an incorrect or a lower reading. Do not exceed the crest factor limit to avoid instrument damage and the risk of electric shock.

Table 8-3 AC mV/voltage specifications

Function	Range	Resolution	Accuracy		Overload protection
			45 Hz to 5 kHz	5 kHz to 20 kHz	
AC mV/voltage ^[1] (True-rms: From 5% to 100% of range)	50 mV	1 μ V	0.7% + 40	1.5% + 40	250 Vrms
	500 mV	10 μ V	0.7% + 20	1.5% + 20	
	5 V	0.1 mV			
	50 V	1 mV			
	250 V	10 mV			

^[1] Input impedance: 1.1 M Ω in parallel with <100 pF (nominal) for the range of 5 V and above, and 1 G Ω (nominal) for the 50/500 mV range. Crest factor: \leq 3.

Table 8-4 AC current specifications

Function	Range	Resolution	Accuracy 45 Hz to 5 kHz	Burden voltage/shunt	Overload protection
AC current ^[1] (True-rms: From 5% to 100% of range)	50 mA	1 μ A	0.6% + 20	0.06 V (1 Ω)	250 V, 630 mA Quick acting fuse
	500 mA	10 μ A		0.6 V (1 Ω)	

^[1] Crest factor: ≤ 3

AC+DC specifications

Table 8-5 AC+DC mV/voltage specifications

Function	Range	Resolution	Accuracy		Overload protection
			45 Hz to 5 kHz	5 kHz to 20 kHz	
AC+DC mV/ voltage ^[1] (True-rms: From 5% to 100% of range)	50 mV	1 μ V	0.8% + 70	1.6% + 70	250 Vrms
	500 mV	10 μ V	0.8% + 25	1.6% + 25	
	5 V	0.1 mV			
	50 V	1 mV			
	250 V	10 mV			

^[1] Input impedance: 1.1 M Ω in parallel with <100 pF (nominal) for the range of 5 V and above, and 1 G Ω (nominal) for the 50/500 mV range. Crest factor: ≤ 3

8 Specifications

Table 8-6 AC+DC current specifications

Function	Range	Resolution	Accuracy 45 Hz to 5 kHz	Burden voltage/shunt	Overload protection
AC+DC current ^[1] (True-rms: From 5% to 100% of range)	50 mA	1 μ A	0.7% + 25	0.06 V (1 Ω)	250 V, 630 mA
	500 mA	10 μ A		0.6 V (1 Ω)	Quick acting fuse

^[1] Crest factor: ≤ 3

Temperature specifications

Table 8-7 Temperature specifications

Function	Thermocouple type	Range	Resolution	Accuracy	Overload protection
Temperature ^[1]	K	-40 °C to 1372 °C	0.1 °C	0.3% + 3 °C	250 Vrms
		-40 °F to 2502 °F	0.1 °F	0.3% + 6 °F	

^[1] The accuracy is defined for meter operation only and excludes the tolerance of thermocouple probe. The instrument should be placed in the operating area for at least one hour with the slide switch set at the **M** position for meter operation only.

Frequency specifications

Table 8-8 Frequency specifications

Range	Resolution	Accuracy	Minimum input frequency	Overload protection
100 Hz	0.001 Hz	0.02% + 3	1 Hz	250 Vrms
1 kHz	0.01 Hz			
10 kHz	0.1 Hz			
100 kHz	1 Hz			
200 kHz	10 Hz			

Frequency sensitivity and trigger level for voltage measurement

For the maximum input voltage-frequency product (V-Hz) and input impedance, refer to AC voltage measurement.

Table 8-9 Frequency sensitivity and trigger level specifications for voltage measurement

Input range (Maximum input for specified accuracy = 10 × range or 250 V)	Minimum sensitivity (rms sine wave)		Trigger level for DC coupling	
	1 Hz to 100 kHz	>100 kHz	<20 kHz	20 kHz to 200 kHz
50 mV	15 mV	25 mV	20 mV	30 mV
500 mV	35 mV	50 mV	60 mV	80 mV
5 V	0.3 V	0.5 V	0.6 V	0.8 V
50 V	3 V	5 V	6 V	8 V
250 V	30 V	—	60 V	—

Duty cycle ^[1]

Table 8-10 Duty cycle specifications

Mode	Range	Accuracy at full scale
DC coupling	0.1% to 99.9%	0.3% per kHz + 0.3%
AC coupling	5% to 95%	

Pulse width ^[1, 2]

Table 8-11 Pulse width specifications

Range	Accuracy at full scale
0.01 ms to 1999.9 ms	0.2% + 3

[1] The accuracy for duty cycle and pulse width is based on a 5 V square wave input to the DC 5 V range.

[2] Pulse width must be greater than 10 μ s and its range and resolution are determined by the frequency of the signal. Refer to [Table 8-8](#) for details.

Frequency sensitivity for current measurement

For maximum input, refer to AC voltage measurement.

Table 8-12 Frequency sensitivity specifications for current measurement

Input range	Minimum sensitivity (rms sine wave) 30 Hz to 20 kHz
50 mA	2.5 mA
500 mA	25 mA

1 ms peak hold specifications

Table 8-13 Peak hold specifications

Signal width	Accuracy for DC mV/voltage/current
Single event >1 ms	2% + 400 for all ranges

Resistance specifications

The following resistance specifications are valid if the maximum open voltage is less than +4.8 V. For continuity test, the instrument will beep when the resistance is less than 10.00 Ω .

Table 8-14 Resistance specifications

Range	Resolution	Accuracy	Minimum input current	Overload protection
500 Ω ^[1]	0.01 Ω	0.15% + 8	0.45 mA	250 V rms
5 k Ω ^[1]	0.1 Ω	0.15% + 5	0.45 mA	
50 k Ω	1 Ω		45 μ A	
500 k Ω	10 Ω		4.5 μ A	
5 M Ω	0.1 k Ω		450 nA	
50 M Ω ^[2]	1 k Ω	1% + 8	45 nA	

^[1] The accuracy of 500 Ω and 5 k Ω is specified after applying the relative function, which is used to offset the test lead resistance and the thermal effect.

^[2] For the 50 M Ω range, the R.H. is specified for <60%.

Diode check and audible continuity specifications

The overload protection is 250 Vrms and the instrument will beep when the reading is below 50 mV (approximate).

Table 8-15 Diode check specifications

Range	Resolution	Accuracy	Test current	Open voltage
Diode	0.1 mV	0.05% + 5	Approximately 0.45 mA	< +4.8 VDC

Output Specifications

Accuracy is given as \pm (% of output + counts of least significant digit) at $23\text{ }^{\circ}\text{C} \pm 5\text{ }^{\circ}\text{C}$, with relative humidity less than 80% R.H., and warmed up for at least five minutes.

Constant voltage and constant current outputs

Table 8-16 Constant voltage (CV) output specifications

Function	Range	Resolution	Accuracy	Maximum output current ^[2]
Constant voltage (CV) ^[1]	$\pm 1.500\text{ V}$	0.1 mV	0.03% + 3	25 mA or below
	$\pm 15.000\text{ V}$	1 mV		

^[1] The maximum input voltage protection is 30 VDC.

^[2] Loading coefficient: 0.012 mV/mA for 1.5 V output.

Table 8-17 Constant current (CC) output specifications

Function	Range	Resolution	Accuracy	Maximum output voltage ^[2]
Constant current (CC) ^[1]	$\pm 25.000\text{ mA}$	1 μA	0.03% + 5	12 V or below ^[3]

^[1] The maximum input voltage protection is 30 VDC.

^[2] Loading coefficient: 1 $\mu\text{A}/\text{V}$, the minimum output voltage is based on 20 mA into a 600 Ω load.

^[3] If the current loop has a 24 V power, a minimum output voltage of 24 V is achievable with a 20 mA current in a 1200 Ω load. This is only applicable for the simulation mode for mA output, refer to ["Simulation Mode for mA Output"](#) on page 88 for more information.

Square wave output

The maximum input voltage protection is 30 VDC.

Table 8-18 Square wave output specifications

Output	Range	Resolution	Accuracy
Frequency (Hz)	0.5, 1, 2, 5, 10, 15, 20, 25, 30, 40, 50, 60, 75, 80, 100, 120, 150, 200, 240, 300, 400, 480, 600, 800, 1200, 1600, 2400, 4800	0.01	0.005% + 1
Duty Cycle (%) ^[1]	0.39% to 99.60%	0.390625%	0.01% + 0.2% ^[2]
Pulse Width (ms) ^[1]	1 / Frequency	Range/256	0.01% + 0.3 ms
Amplitude (V)	5 V, 12 V	0.1 V	2% + 0.2 V
	±5 V, ±12 V		2% + 0.4 V

^[1] The positive or negative pulse width must be greater than 50 μ s for adjusting the duty cycle or pulse width under different frequency. Else, the accuracy and range will be different from the definition.

^[2] For signal frequencies greater than 1 kHz, an addition of 0.1% per kHz is added to the accuracy.

www.keysight.com

Contact us

To obtain service, warranty or technical assistance, contact us at the following phone or fax numbers:

United States:

(tel) 800 829 4444 (fax) 800 829 4433

Canada:

(tel) 877 894 4414 (fax) 800 746 4866

China:

(tel) 800 810 0189 (fax) 800 820 2816

Europe:

(tel) 31 20 547 2111

Japan:

(tel) (81) 426 56 7832 (fax) (81) 426 56 7840

Korea:

(tel) (080) 769 0800 (fax) (080) 769 0900

Latin America:

(tel) (305) 269 7500

Taiwan:

(tel) 0800 047 866 (fax) 0800 286 331

Other Asia Pacific Countries:

(tel) (65) 6375 8100 (fax) (65) 6755 0042

Or visit the Keysight World Wide Web at:

www.keysight.com/find/assist

Product specifications and descriptions in this document are subject to change without notice. Always refer to the English version on the Keysight Web site for the latest revision.

This information is subject to change without notice.

© Keysight Technologies 2009 – 2014

Edition 12, November 21, 2014



U1401-90055
www.keysight.com